

# THE INFANTRY RIFLE COMPANY

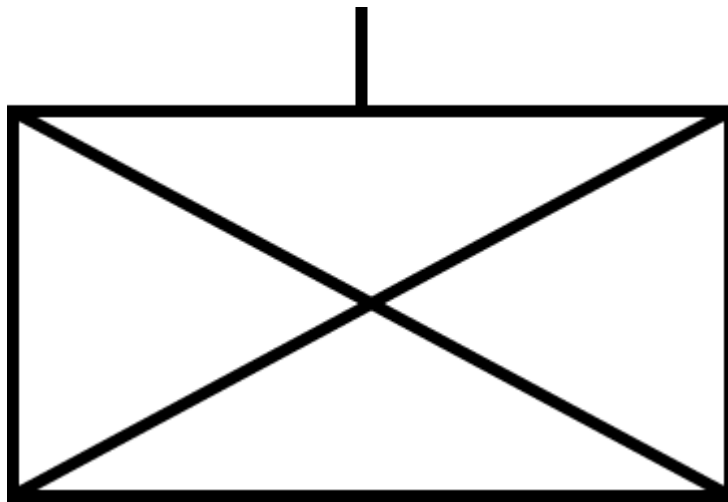

**CHANGE 1**

**HEADQUARTERS  
DEPARTMENT OF THE ARMY  
Washington, DC, 31 October 2000**

## **The Infantry Rifle Company**

1. Change FM 7-10, dated 14 December 1990, as follows:

**REMOVE OLD PAGES**

**None**

**INSERT NEW PAGES**

**L-1 through L-54**

2. A star (\*) marks new or changed material.
3. File this transmittal sheet in front of the publication.

DISTRIBUTION RESTRICTION—Approved for public release; distribution is unlimited.

By Order of the Secretary of the Army:

**ERIC K. SHINSEKI**  
*General, United States Army*  
*Chief of Staff*

Official:



Handwritten signature of Joel B. Hudson in cursive script.

**JOEL B. HUDSON**  
*Administrative Assistant to the  
Secretary of the Army*  
0028602

## US NATIONAL POLICY ON ANTIPERSONNEL LAND MINES

On 16 May 96, The President of the United States announced a national policy that eliminates or restricts the use of antipersonnel land mines, beginning with those that do not self-destruct but eventually including all types. This policy is in effect now. It applies to all Infantry units either engaged in, or training for, operations worldwide.

Current US policy allows the use of non-self-destructing antipersonnel land mines only along internationally recognized national borders or in established demilitarized zones, specifically for the defense of Korea. Such mines must be within an area having a clearly marked perimeter. They must be monitored by military personnel and protected by adequate means to ensure the exclusion of civilians.

US national policy also forbids US forces from using standard or improvised explosive devices as booby traps.

Except for units in Korea or units going there for a designated exercise, this policy specifically forbids all training on or actual employment of inert M14 and M16 antipersonnel land mines either at the unit's home station or at a Combat Training Center except in the context of countermine or de-mining training. No training with live M14 mines is authorized, and training with live M16 mines is authorized only for soldiers actually on Korean soil.

This policy does not affect the standard use of antivehicular mines. It does not affect training and use of the M18 Claymore mine in the command detonated mode.

For the immediate future, units may still use self-destructing antipersonnel mines, such as the ADAM, when authorized by the appropriate commander. Under proper command authority, units may still emplace mixed minefields containing self-destructing antipersonnel land mines used to protect antivehicular land mines, for example, MOPMS or Volcano.

Users of this manual should consider all references to antipersonnel mines and the employment of minefields in the light of the national policy limiting the use of non-self-destructing antipersonnel land mines.

Readers should not construe any uses of the terms mines, antipersonnel obstacle, protective minefield, or minefield contained in this manual to mean an obstacle that contains non-self-destructing antipersonnel land mines, or booby traps.

# THE INFANTRY RIFLE COMPANY

## CONTENTS

|   |  | Page |
|---|--|------|
| Preface.....                              |  | vii  |
| <b>CHAPTER 1. INTRODUCTION</b>            |  |      |
| Section                                   | I. Preparation for War .....                                   | 1-1  |
|   | 1-1. The Soldier.....  | 1-1  |
|   | 1-2. The Leader .....  | 1-1  |
|   | 1-3. The Unit .....  | 1-2  |
|   | 1-4. The Training Program.....                                 | 1-2  |
| Section                                   | II. AirLand Battle .....                                       | 1-2  |
|   | 1-5. Combat Power.....   | 1-2  |
|   | 1-6. Tenets of AirLand Battle .....                            | 1-4  |
|   | 1-7. AirLand Battle Imperatives.....                           | 1-5  |
| Section                                   | III. Battlefield Operating Systems .....                       | 1-6  |
|   | 1-8. Intelligence System.....                                  | 1-6  |
|   | 1-9. Maneuver System.....                                      | 1-6  |
|   | 1-10. Fire Support System.....                                 | 1-7  |
|   | 1-11. Mobility, Countermobility, and Survivability System..... | 1-7  |
|   | 1-12. Air Defense System .....                                 | 1-7  |
|   | 1-13. Combat Service Support System .....                      | 1-7  |
|   | 1-14. Command and Control System .....                         | 1-8  |
| Section                                   | IV. Organization.....  | 1-8  |
|   | 1-15. Mission.....   | 1-8  |
|   | 1-16. Employment Considerations.....                           | 1-8  |
|   | 1-17. Company Organizations.....                               | 1-9  |
| <br><b>CHAPTER 2. COMMAND AND CONTROL</b> |  |      |
| Section                                   | I. Command and Control System .....                            | 2-3  |
|   | 2-1. Definitions.....  | 2-3  |
|   | 2-2. Commander's Leadership .....                              | 2-4  |
|   | 2-3. Mission-Oriented Command and Control.....                 | 2-4  |

DISTRIBUTION RESTRICTION—Approved for public release; distribution is unlimited.

\*This publication supersedes FM 7-10 (HTF), 8 January 1982; and FM 7-71, 28 August 1987.



|         |  | <b>Page</b> |
|---------|--|-------------|
|         | 2-4. Commander's Intent.....                           | 2-5         |
|         | 2-5. Mission Orders.....                               | 2-6         |
|         | 2-6. Duties and Responsibilities of Key Personnel..... | 2-6         |
|         | 2-7. Succession of Command.....                        | 2-9         |
|         | 2-8. Orders Group.....                                 | 2-9         |
|         | 2-9. Company Command Post.....                         | 2-9         |
| Section | II. Command and Control Process.....                   | 2-10        |
|         | 2-10. Troop-Leading Procedures.....                    | 2-10        |
|         | 2-11. Communications.....                              | 2-14        |
|         | 2-12. Electronic Counter-Countermeasures.....          | 2-18        |
| Section | III. The Estimate of the Situation.....                | 2-19        |
|         | 2-13. Conduct a Detailed Mission Analysis.....         | 2-19        |
|         | 2-14. Analyze the Situation.....                       | 2-21        |
|         | 2-15. Analyze the Terrain.....                         | 2-22        |
|         | 2-16. Analyze the Enemy.....                           | 2-25        |
|         | 2-17. Analyze Troops Available.....                    | 2-28        |
|         | 2-18. Analyze the Time.....                            | 2-28        |
|         | 2-19. Develop Courses of Action.....                   | 2-28        |
|         | 2-20. Analyze the Courses of Action.....               | 2-32        |
|         | 2-21. Compare the Courses of Action.....               | 2-35        |
|         | 2-22. Make a Decision.....                             | 2-37        |
|         | 2-23. Complete the Tentative Plan.....                 | 2-38        |
| Section | IV. Continuous Operations.....                         | 2-40        |
|         | 2-24. Sustained Operations.....                        | 2-40        |
|         | 2-25. Degradation of Combat Capability.....            | 2-40        |
|         | 2-26. Techniques to Sustain Operations.....            | 2-40        |
|         | 2-27. Unit Sleep Plan.....                             | 2-41        |

**CHAPTER 3. MOVEMENT**

|  |      |
|--|------|
| 3-1. Fundamentals.....                         | 3-1  |
| 3-2. Locations of Key Leaders and Weapons..... | 3-2  |
| 3-3. Movement Formations.....                  | 3-3  |
| 3-4. Movement Techniques.....                  | 3-11 |
| 3-5. Control Techniques.....                   | 3-15 |
| 3-6. Security During Movement.....             | 3-15 |
| 3-7. Movement as Part of a Battalion.....      | 3-17 |

**CHAPTER 4. OFFENSIVE OPERATIONS**

|         |   |     |
|---------|---|-----|
| Section | I. Offensive Fundamentals.....                    | 4-4 |
|         | 4-1. Purpose.....                                 | 4-4 |
|         | 4-2. Characteristics of Offensive Operations..... | 4-4 |
|         | 4-3. Phases of Offensive Operations.....          | 4-5 |
|         | 4-4. Offensive Framework.....                     | 4-5 |
|         | 4-5. Forms of Maneuver.....                       | 4-8 |

|  |   | <b>Page</b> |
|--|---|-------------|
| Section                                    | II. Infiltration .....                      | 4-14        |
|  | 4-6. Fundamentals .....                     | 4-14        |
|  | 4-7. Considerations.....                    | 4-15        |
| Section                                    | III. Movement to Contact.....               | 4-18        |
|  | 4-8. Fundamentals .....                     | 4-18        |
|  | 4-9. Considerations.....                    | 4-18        |
|  | 4-10. The Search-and-Attack Technique ..... | 4-19        |
|  | 4-11. The Approach-March Technique .....    | 4-25        |
| Section                                    | IV. Attacks .....                           | 4-30        |
|  | 4-12. Types.....                            | 4-30        |
|  | 4-13. Offensive Concept Development.....    | 4-30        |
|  | 4-14. Actions on the Objective.....         | 4-33        |
|  | 4-15. Reorganization .....                  | 4-34        |
|  | 4-16. Consolidation .....                   | 4-34        |
|  | 4-17. Fire Support .....                    | 4-35        |
| Section                                    | V. Attack Techniques .....                  | 4-37        |
|  | 4-18. Assault of a Strongpoint.....         | 4-37        |
|  | 4-19. Attack During Limited Visibility..... | 4-44        |
|  | 4-20. Deception Operations.....             | 4-54        |
|  | 4-21. Security Operations.....              | 4-54        |
|  | 4-22. Rifle Company as the Reserve .....    | 4-55        |
| <br><b>CHAPTER 5. DEFENSIVE OPERATIONS</b> |   |             |
| Section                                    | I. Defensive Fundamentals.....              | 5-3         |
|  | 5-1. Purpose.....                           | 5-3         |
|  | 5-2. Characteristics of the Defense .....   | 5-3         |
|  | 5-3. Defensive Framework.....               | 5-4         |
| Section                                    | II. Plans and Preparations .....            | 5-6         |
|  | 5-4. Defensive Concept Development .....    | 5-6         |
|  | 5-5. Sectors and Battle Positions.....      | 5-8         |
|  | 5-6. Company Fire Plan .....                | 5-12        |
|  | 5-7. Security Requirements .....            | 5-16        |
|  | 5-8. Employment of the Reserve.....         | 5-18        |
|  | 5-9. Logistics Considerations.....          | 5-21        |
|  | 5-10. Command Post Location.....            | 5-22        |
| Section                                    | III. Conduct of Operations .....            | 5-23        |
|  | 5-11. Reconnaissance.....                   | 5-23        |
|  | 5-12. Occupation of the Defense.....        | 5-23        |
|  | 5-13. Priority of Work.....                 | 5-24        |
|  | 5-14. Time Management .....                 | 5-26        |
|  | 5-15. Daylight Scenario.....                | 5-27        |
|  | 5-16. Defensive Battle.....                 | 5-27        |
|  | 5-17. Counterattack .....                   | 5-28        |
|  | 5-18. Reorganization .....                  | 5-29        |

|   | <b>Page</b> |
|---|-------------|
| Section IV. Defensive Techniques.....     | 5-30        |
| 5-19. Nonlinear Defense .....             | 5-30        |
| 5-20. Defense in Sector .....             | 5-32        |
| 5-21. Defense from Battle Positions ..... | 5-34        |
| 5-22. Defense on a Reverse Slope.....     | 5-37        |
| 5-23. Perimeter Defense.....              | 5-40        |
| 5-24. Linear Defense.....                 | 5-45        |
| 5-25. Defense of a Strongpoint .....      | 5-47        |

**CHAPTER 6. OTHER TACTICAL OPERATIONS**

|  |      |
|--|------|
| Section I. Passage of Lines.....         | 6-1  |
| 6-1. Purpose.....                        | 6-1  |
| 6-2. General Considerations .....        | 6-1  |
| 6-3. Specific Considerations .....       | 6-1  |
| 6-4. Conduct of the Forward Passage..... | 6-3  |
| 6-5. Conduct of a Rearward Passage.....  | 6-4  |
| Section II. Relief in Place.....         | 6-5  |
| 6-6. Purpose.....                        | 6-5  |
| 6-7. Planning Considerations .....       | 6-5  |
| 6-8. Conduct of the Relief.....          | 6-9  |
| Section III. Retrograde Operations ..... | 6-10 |
| 6-9. Delays .....                        | 6-11 |
| 6-10. Withdrawals .....                  | 6-14 |
| 6-11. Retirements .....                  | 6-18 |
| Section IV. Linkups .....                | 6-18 |
| 6-12. Planning .....                     | 6-18 |
| 6-13. Conduct of the Linkup .....        | 6-19 |
| Section V. Water Crossing .....          | 6-20 |
| 6-14. With Opposition.....               | 6-20 |
| 6-15. Without Opposition.....            | 6-21 |
| Section VI. Patrolling.....              | 6-21 |
| 6-16. Involvement .....                  | 6-21 |
| 6-17. Organization.....                  | 6-22 |
| 6-18. Raid.....                          | 6-26 |
| 6-19. Ambush.....                        | 6-30 |
| 6-20. Patrol Base .....                  | 6-35 |
| Section VII. Stay-Behind Operations..... | 6-35 |
| 6-21. Purpose.....                       | 6-35 |
| 6-22. Types.....                         | 6-36 |
| 6-23. Planning .....                     | 6-36 |
| 6-24. Breakout from Encirclement.....    | 6-37 |

**CHAPTER 7. COMBAT SUPPORT**

|                                  |     |
|----------------------------------|-----|
| Section I. Relationships.....    | 7-1 |
| 7-1. Command Relationships ..... | 7-1 |
| 7-2. Support Relationships ..... | 7-1 |

|   |   | <b>Page</b> |
|---|---|-------------|
| Section   | II. Nonorganic Assets .....                                   | 7-2         |
|   | 7-3. Battalion .....  | 7-2         |
|   | 7-4. Supporting Units .....                                   | 7-3         |
| Section   | III. Fire Support Planning .....                              | 7-9         |
|   | 7-5. Maneuver Commander's Intent .....                        | 7-9         |
|   | 7-6. Planning Process .....                                   | 7-9         |
|   | 7-7. Targets .....  | 7-11        |
|   | 7-8. Final Protective Fires .....                             | 7-12        |
|   | 7-9. Special Munitions .....                                  | 7-13        |
|   | 7-10. Forward Observer's Positions .....                      | 7-13        |
|   | 7-11. Rehearsal and Execution .....                           | 7-14        |
|   | 7-12. Communications .....                                    | 7-14        |
|   | 7-13. Indirect Fires in Close Support .....                   | 7-15        |
|   | 7-14. Tactical Air Support .....                              | 7-15        |
| <br><b>CHAPTER 8. COMBAT SERVICE SUPPORT</b>                              |   |             |
| Section   | I. Fundamentals .....   | 8-2         |
|   | 8-1. AirLand Battle Imperatives .....                         | 8-2         |
|   | 8-2. Battalion Support .....                                  | 8-2         |
|   | 8-3. Responsibilities and Organization .....                  | 8-3         |
| Section   | II. Resupply Operations .....                                 | 8-4         |
|   | 8-4. Requirements .....                                       | 8-4         |
|   | 8-5. Distribution of Supplies from Battalion to Company ..... | 8-6         |
|   | 8-6. Company Resupply Techniques .....                        | 8-6         |
|   | 8-7. Considerations .....                                     | 8-7         |
|   | 8-8. Transportation .....                                     | 8-8         |
|   | 8-9. Maintenance .....  | 8-8         |
| Section   | III. Soldier's Load .....                                     | 8-10        |
|   | 8-10. Load Planning .....                                     | 8-10        |
|   | 8-11. Load Calculation .....                                  | 8-12        |
|   | 8-12. Load Management Techniques .....                        | 8-12        |
| Section   | IV. Personnel Service Support .....                           | 8-15        |
|   | 8-13. Personnel Services .....                                | 8-15        |
|   | 8-14. Replacement Operations .....                            | 8-17        |
| Section   | V. Medical Support .....                                      | 8-18        |
|   | 8-15. Preventive Medicine .....                               | 8-18        |
|   | 8-16. Treatment .....   | 8-18        |
|   | 8-17. Evacuation of Casualties .....                          | 8-18        |
| <br>APPENDIX A. Low Intensity Conflict .....                              |   |             |
| APPENDIX A.   |   | A-1         |
| APPENDIX B. Light/Heavy Operations .....                                  |   |             |
| APPENDIX B.   |   | B-1         |
| APPENDIX C. Obstacles .....   |   |             |
| APPENDIX C.   |   | C-1         |
| APPENDIX D. Helicopter Support .....                                      |   |             |
| APPENDIX D.   |   | D-1         |
| APPENDIX E. Company Mortars .....   |   |             |
| APPENDIX E.   |   | E-1         |
| APPENDIX F. Nuclear, Biological, or Chemical Environment Operations ..... |   |             |
| APPENDIX F.   |   | F-1         |
| APPENDIX G. Orders Formats and Supplements .....                          |   |             |
| APPENDIX G.   |   | G-1         |

|   | <b>Page</b>  |
|---|--------------|
| APPENDIX H. Road Marches and Assembly Areas ..... | H-1          |
| APPENDIX I. Demolition Guard .....                | I-1          |
| APPENDIX J. Employment of Antiarmor Weapons ..... | J-1          |
| APPENDIX K. Directed-Energy Weapons .....         | K-1          |
| Glossary .....                                    | Glossary-1   |
| References .....                                  | References-1 |
| Index .....                                       | Index-1      |

"Look at your mission, see what you have to do it with, and then work out the most sensible (which may frequently be the most unusual and most audacious) way of doing it—and let fly. Use your brain, your imagination, your initiative."

**GENERAL HAMILTON H. HOWZE**

## **PREFACE**

This manual provides doctrine, tactics, techniques, and procedures on how all infantry rifle companies fight. Infantry rifle companies include light infantry companies, air assault, airborne, ranger, and H-series infantry (Reserve Component). This manual is aligned with the Army's AirLand Battle doctrine and is not intended to be a stand-alone publication. An understanding of FM 7-8 and FM 7-20 is essential. Also, the references section provides publications that users of this manual must be familiar with.

The primary audiences for this manual are the rifle company commander; his executive officer, first sergeant, and platoon leaders; instructors in TRADOC schools; and writers of infantry training literature. The secondary audiences include other infantry company commanders (HHC and antiarmor), infantry battalion staff officers, service schools, and ROTC and military academy instructors.

Tough, realistic training is inherently dangerous; therefore, commanders and leaders must instill an awareness of individual and unit safety and always consider the welfare of their soldiers. All soldiers must be alert to potential risks and safety violations. The specifics of how to train the company are explained in ARTEP 7-10 MTP, requiring users to understand the TTP discussed in this manual.

This manual does not present the tactical solution to all tactical situations. Infantry leaders are expected to use the doctrine, tactics, techniques, and procedures discussed in this manual as part of a detailed estimate of the situation. They can then develop an effective plan to accomplish the assigned mission.

This publication implements the following international agreement:

**STANAG 2017/QSTAG 508  
(Edition 3)**

**Orders to the Demolition Guard,  
Commander and Demolition Firing  
Party Commander**

The proponent of this publication is US Army Infantry School. Send comments and recommendations on DA form 2028 (Recommended Changes to Publications and Blank Forms) directly to Commandant, US Army Infantry School, ATTN: ATSH-ATD, Fort Benning, Georgia 31905-5410.

Unless this publication states otherwise, masculine nouns and pronouns do not refer exclusively to men.

## CHAPTER 1 INTRODUCTION

*In operations in which light forces predominate, airborne, air assault, or other light infantry lead the combined arms attack, and all other arms support the infantry.*

FM 100-5, May 1986

*The infantry company is organized to fight anywhere in the world and win. The basic fighting doctrine for the US Army is called AirLand Battle. AirLand Battle at the company level equates to maneuver warfare. This requires bold, aggressive leaders who are willing to accept known risks in pursuit of mission accomplishment. Infantry leaders on the modern battlefield must be capable of using their initiative and making rapid decisions to take advantage of unexpected opportunities. Infantry companies must be aggressive, physically fit, disciplined, and well-trained organizations. The inherent strategic mobility of infantry units dictates a need to be prepared for rapid deployment into combat. The potential locations and possible enemy threats that an infantry company may face require infantry companies to maintain a high state of readiness.*

### **Section I. PREPARATION FOR WAR**

The infantry rifle company is organized and equipped to close with the enemy to kill him, destroy his equipment, and shatter his will to resist. This close personal fight requires combat-ready units composed of skilled soldiers and resourceful leaders. These units are the result of a tough, thorough, and demanding training program conducted by leaders who understand the effective employment of infantry forces.

#### **1-1. THE SOLDIER**

Our infantrymen must be proficient in marksmanship, close combat, and fieldcraft. They should be proficient with other weapons in the unit as well as their own. They should also be familiar with foreign-made weapons they are apt to meet in battle. In the close fight, our infantrymen must be skilled in the employment of all weapons (rifles, bayonets, LAWs/AT4s, grenades, mines, and even their bare hands). They must be totally confident in their ability to fight with these weapons. These infantrymen must be highly skilled in land navigation, camouflage, and tracking and stalking techniques. Each soldier must be capable of moving undetected in close proximity to enemy soldiers for reconnaissance, for infiltration, and for achieving surprise in all operations. Our infantrymen must have the skill and the will—not to just participate in the close fight, but to dominate it.

#### **1-2. THE LEADER**

Our infantry leaders must be the most capable soldiers in the unit. Their leadership will determine the unit's success or failure in battle. They must be tactically and technically proficient. They must be proficient at land navigation and have a thorough appreciation for terrain. For a foot soldier, the terrain is both protector and ally. When properly

exploited it will increase the combat potential of the unit and support the achievement of surprise. The infantry leader must be a resourceful, tenacious, and decisive warrior. The leaders in the rifle company are the combined arms integrators that are closest to the fight; they must be highly skilled in the employment of all the weapons and assets in the combined arms team. The infantry leader must be innovative and flexible in the employment of his unit. He must have the mental agility to quickly grasp the situation and the initiative to take independent action based on the situation and the commander's intent. Above all else, he must possess the leadership skills and attributes essential to his unit's survival and success in close combat.

### **1-3. THE UNIT**

The strength of our infantry units comes from the skill, courage, and discipline of the individual soldiers. The individual capabilities of these men are enhanced by the teamwork and cohesion in the squads and platoons. This cohesion is essential to the survival and success of our infantry units in close combat. It provides the infantryman's will and determination to persevere, to accept the hardships, and to refuse to accept defeat. In the close fight when the decision hangs in the balance, these are the factors that will decide the victor. It is at the squad- and platoon-level that cohesion and teamwork provide the greatest benefits to the combat effectiveness of the unit. This horizontal bonding within squads is crucial, but there must also be a vertical bonding within the infantry force. Vertical bonding occurs when the soldiers have complete trust and confidence in their leaders. Leaders earn their soldiers trust and confidence by sharing the hardships and by displaying the leadership attributes described in FM 22-100. Leaders must have the same confidence in their soldiers.

### **1-4. THE TRAINING PROGRAM**

The unit training program must instill these individual and collective attributes. This training must focus on developing tough combat-ready units. It must consist of difficult, challenging training events that prepare the soldiers, leaders, and units for the close fight. It must be conducted IAW SOPs, FM 25-100, and ARTEP 7-10-MTP. It should emphasize physical fitness and marksmanship skills. The soldiers must be challenged to achieve expert proficiency in all of the combat critical skills. Night training, especially night live-fire exercises, should be routine. The environment of the close fight should be simulated whenever possible. Training events that require subordinate leaders to use their initiative and take independent action are essential to prepare for the decentralized operations that the unit normally conducts. The training must be harsh, realistic, physically demanding, and mentally stressful to prepare the soldiers for combat. This will also develop cohesive, tenacious squads and platoons that will overcome all obstacles to ensure the safety of their unit and the accomplishment of the mission. This training program must continue even after the unit begins conducting combat operations. To maintain the combat effectiveness of the unit, the skills, teamwork, and cohesion must be sustained as replacements arrive in the unit.



---

## Section II. AIRLAND BATTLE

The company commander must understand the concepts and fundamentals of AirLand Battle to effectively lead his company in battle. First and foremost among these is the concept of combat power.

### 1-5. COMBAT POWER

AirLand Battle doctrine defines combat power as the ability of a unit to fight. To fight outnumbered and win, AirLand Battle requires commanders to rapidly concentrate their combat power at decisive points on the battlefield. A commander must understand—

- How to apply the combat potential of his unit.
- How to generate maximum combat power.
- How the enemy will attempt to degrade his unit's combat power.
- How the terrain and other environmental factors affect the combat potential of his unit and the enemy.
- How to sustain the combat power of his unit.

Combat potential is the ability of a unit to fight before enemy contact. Combat power is the actual amount of combat potential that is brought to bear on the enemy. Both are dynamic concepts; they are constantly changing based on the situation. They are also affected by enemy actions to degrade the unit's ability to generate combat power. Commanders must seek conditions where their relative mobility, firepower, and protection exceeds those of the enemy. For example, the infantry company fights in restrictive terrain where the enemy is reduced to foot movement or, they fight in close with the enemy to limit his ability to employ his heavier weapons effectively. A primary means of gaining protection for dismounted infantry is conducting operations at night. Combat power is not determined just by the number of weapons or systems that a unit has; the unit's ability to fight is determined by maneuver, firepower, protection, and leadership. It is measured by the effect on the enemy force resulting from these four factors during combat. Superior combat power is generated through a commander's skillful combination of these factors.

a. **Maneuver.** Maneuver is defined as movement, supported by fires, to a position of advantage from which to destroy or threaten destruction of the enemy. An infantry rifle company is designed to move by foot. The company uses stealth, camouflage, and dispersion to close with the enemy. It uses the terrain and all available fires (organic and supporting) to support its movement. These fires may not always be needed, but the company always plans them. Maneuver is the primary means of gaining or retaining the initiative. It may also preserve the company's freedom of action and reduce the unit's vulnerability to enemy fires. Infantry companies take advantage of their ability to move across difficult terrain in any weather to surprise the enemy. Infantry commanders understand their mobility capabilities and avoid fighting heavy forces on terrain that allows the heavy force a distinct mobility advantage. The commander's concept orients on reaching the decisive point using the indirect approach. This requires avoiding the enemy's strength, moving through gaps or weaknesses or around his flanks, and striking him at critical locations to rapidly destroy his will and ability to fight. The CO must also have a thorough understanding of time-space relationships and the impact that their soldiers' loads have on mobility, and plan accordingly.

b. **Firepower.** Infantry rifle companies, properly employed, have significant organic firepower. They also have supporting fires (direct and indirect) available. The elements of maneuver and firepower are complementary. Maneuver allows weapon systems to reach a position of advantage where their fires will be most effective. It is the effect of our fires on the enemy that matters. A few weapons firing accurately from a location that surprises and shocks the enemy has a greater effect than many weapons with a large volume of less accurate fire. Firepower supports maneuver by suppressing the enemy's weapon systems. Infantry companies destroy enemy forces and their will to fight with accurate fires directed at critical targets. Leaders must understand the techniques of controlling and integrating all available fires. They must understand the capabilities of their weapons and supporting weapons. They must be experts at positioning and employing these systems.

c. **Protection.** Protection is the conservation of the fighting potential of the force. It includes all actions that degrade the enemy's ability to maneuver against or place fires on the friendly unit. These include security measures and the use of limited visibility, cover and concealment, air defense, camouflage, and dispersion. Protection also includes maintaining the soldiers' health and morale. Maneuver provides protection for the company by preventing the enemy from fixing the unit and concentrating firepower against it. Firepower can also provide protection, such as suppressive fires during an assault. Infantry companies gain protection by avoiding detection during movement and digging fighting positions when stationary.

d. **Leadership.** This is the most essential element of combat power. The commander and subordinate leaders in the company determine how to employ their units. The combat power generated by their units is dependent upon the concepts and plans they develop. Leaders in an infantry company are expected to lead by personal example and to provide direction for their soldiers. They must be at the point of decision to maintain control, understand the situation, and issue orders if required. They must be capable of motivating their men to accomplish dangerous tasks under difficult circumstances. They must be proficient soldiers themselves, able to act decisively and confidently under any conditions.

## **1-6. TENETS OF AIRLAND BATTLE**

The tenets of AirLand Battle are the essential principles for success in battle. They apply at company level and in every operation.

a. **Initiative.** Initiative means setting or changing the terms of battle by action. Infantry companies maintain their freedom of action while attempting to limit the enemy's freedom of action. Commanders preserve the initiative by preventing the enemy from reducing their unit's freedom of action. When the enemy force has the initiative, the company commander must reduce this advantage by protecting his company and forcing the enemy to react to his actions. This requires an offensive spirit in all operations. Decentralized operations, in which the squads and platoons aggressively fight through enemy resistance with the immediately available resources, support the seizure/maintenance of the initiative. On an individual basis, initiative requires the willingness and ability of subordinates to act independently within the framework of their commanders' concept. This willingness is generated from an environment of mutual trust and confidence between commanders and their soldiers. To provide his soldiers the ability to use their initiative, the leader must ensure his men understand the intent of the

commanders two echelons above their level. The commanders do this by using mission-type orders and clear and concise directions, and by ensuring that each of their subordinates understands the concept and how he fits within it.

b. **Agility.** For an infantry unit to seize or retain the initiative, it must be capable of acting/reacting faster than the enemy it is fighting. This begins with the agility of the commander, which includes his ability to rapidly analyze a tactical situation. He determines the most effective use of all available resources to accomplish the mission. This requires the mental agility to rapidly think through many possible COAs and the likely enemy reactions to them, and to determine the most effective and least costly COA. The company must also be an agile unit capable of rapidly executing assigned missions. This often depends on the unit's SOPs, which reduce the need for long detailed orders and allow subordinates to accomplish routine, recurring tasks without instructions.

c. **Depth.** Depth is the extension of operations in time, space, and resources. Planning operations in depth results in maintaining the momentum in an attack and flexibility in the defense. Commanders seek to fight the enemy throughout the depth of his formations by properly positioning his forces or by skillfully maneuvering his unit. This allows the unit to seek out and concentrate against enemy weaknesses. By swiftly concentrating against first one then another enemy weakness, a skilled commander can begin to seize the initiative on a local level. This success may then allow commanders at a higher echelon to exploit this opportunity. Fighting in depth also requires a commander to anticipate likely events or requirements and plan for them.

d. **Synchronization.** Synchronization is the arrangement of battlefield activities in time, space, and purpose to produce maximum combat power at the decisive point. A commander synchronizes his subordinates' actions on the battlefield by assigning clear missions, by having them understand the timings required in the operation, and by focusing all actions toward achieving overwhelming combat power at a decisive point. Synchronization begins in the mind of the commander as he conducts his estimate. The CO concentrates on the synchronization of his company's fires and movement. He also ensures that his concept maintains the synchronization required by his battalion commander's concept. Issuing mission orders, identifying the main effort, and assigning each platoon clear task(s) and purpose(s), are the best means of maintaining synchronization in a fast paced, fluid environment. These tools allow subordinate leaders to focus on the critical actions of the main effort at the decisive point. Synchronization is also achieved through a detailed time schedule and control measures; however, this synchronization is more likely to be disrupted by enemy actions and changes in the situation.

## 1-7. AIRLAND BATTLE IMPERATIVES

AirLand Battle doctrine is based upon the Principles of War found in Appendix A of FM 100-5. Leaders at every level should know and understand these principles. They have proven sound over the 60 years that they have been a part of our doctrine. The AirLand Battle imperatives were derived from the principles of war. These imperatives prescribe key operating requirements and provide more specific guidance than the principles of war. The 10 imperatives apply in all operations.

a. **Ensure Unity of Effort.** Leaders in the rifle company provide purpose, direction, and motivation to their soldiers. The company's mission and how he supports it must be

clearly understood by every soldier in the unit. Plans are kept simple, and control measures are easy to understand, apply, and communicate. Each subordinate's concept or plan fits within the next higher leader's plan. A main effort is always clearly designated. All actions throughout the unit must ensure the success of the main effort.

b. **Anticipate Events on the Battlefield.** To maintain or gain the initiative, a rifle company commander must anticipate the enemy's action. Failure to do so results in the commander reacting to the enemy's actions throughout the fight. The ability to effectively anticipate enemy actions depends on the commander's knowledge of the enemy's doctrine, tactics, and weapons, and the commander's experience gained from fighting that enemy.

c. **Concentrate Combat Power Against Enemy Weaknesses.** The rifle company commander must have enough knowledge of the enemy to determine his vulnerabilities and weaknesses. The concentration of fires/effective maneuver can also create enemy weaknesses. Once weaknesses are identified or created, the rifle company commander must have a plan to quickly exploit them. At company level, enemy weaknesses may be of short duration and easily corrected by the enemy commander.

d. **Designate, Sustain, and Shift the Main Effort.** The subordinate unit with the most important task in the commander's concept is designated the main effort for the company. The commander concentrates all of his resources to ensure the quick success of this unit. During the fight, the actions of the main effort provide focus, orientation, and synchronization to all other subordinate units. If the main effort does not succeed or a more lucrative enemy weakness develops, the commander must quickly shift the orientation of the main effort or shift the main effort to another subordinate unit.

e. **Press the Fight.** The commander's plan should be aggressive and offensively oriented. Once the fight begins, the rifle company commander must be persistent in the pursuit of accomplishing his mission. When the enemy is off balance, the company must maintain or increase the pressure to prevent the enemy from recovering. The commander is in a position to personally lead and motivate his men in the decisive action. A well-trained, physically tough rifle company led by capable leaders can increase the tempo when the fight hangs in the balance.

f. **Move Fast, Strike Hard, and Finish Rapidly.** Infantry companies must be capable of fast, dispersed movements followed by a rapid concentration of combat power at a decisive location. The violent attack on the enemy should be directed at enemy weaknesses and from an unexpected direction. Once completed, the unit disperses again to avoid the enemy's counterattack.

g. **Use Terrain, Weather, Deception, and OPSEC.** Terrain and weather significantly impact on a rifle company's operations. The commander should be expert at land navigation. He must understand the potential of the terrain to support maneuver, provide protection, and support the employment of all organic weapon systems. The commander who uses the terrain and weather better than his enemy gains a combat multiplier. The commander's personal reconnaissance helps him understand the effects the environment can have on both forces. Deception operations are planned above company level, but the rifle company commander often uses simple deception tasks or actions to confuse or mislead the enemy. Operations security is continuous for an infantry rifle company. The commander denies the enemy useful information on his unit.

h. **Conserve Strength for Decisive Action.** The company commander protects his unit's combat potential. He ensures that in each fight he brings the maximum combat power to bear on the enemy. He identifies risks and reduces them without unnecessarily taking resources away from his main effort. He reduces his soldiers' loads and ensures his company is organized and trained to conduct continuous operations.

i. **Combine Arms and Sister Services to Complement and Reinforce.** A rifle company commander must be a proficient combined arms' warrior. He is the combined arms integrator who is closest to the fight. Therefore, he must be expert in employing not only his organic assets but also the resources and weapons that may support a rifle company. These may include TOWs, tanks, field artillery, engineers, and ADA systems. At times, he may also control attack helicopters and close air support.

j. **Understand the Effects of Battle on Soldiers, Units, and Leaders.** The infantry company commander must ensure that his unit is trained to withstand the rigors of the modern battlefield. He should know his men before entering the fight. Once in battle, he monitors the condition of his men and sustains the unit's effectiveness. Well-trained, physically fit soldiers in cohesive units retain the qualities of tenacity and aggressiveness.

### **Section III. BATTLEFIELD OPERATING SYSTEMS**

The seven battlefield operating systems allow the commander to analyze the various functions of his unit in battle. His plan integrates each of these systems to effectively accomplish his mission.

#### **1-8. INTELLIGENCE SYSTEM**

The rifle company commander depends on intelligence from higher headquarters to conduct operations. However, the company commander can collect critical information required to complete his plan. This requires an aggressive, continuous reconnaissance effort conducted by small units moving undetected close to enemy forces. His company also assists in the battalion's intelligence collection effort. He does this by assigning his platoons specific reconnaissance or security tasks. Organic equipment, such as PEWS and NVDs, enhance the companies ability to collect information on the enemy. Additional assets, such as the battalion's scout platoon or GSRs, may support the company.

#### **1-9. MANEUVER SYSTEM**

The primary maneuver asset of a rifle company commander is the rifle platoon. The three organic platoons provide him the ability to maneuver independently. The maneuver or positioning of these units allows him to bring firepower to bear on the enemy. The commander must know the capabilities of his platoons; he also maneuvers the antiarmor and mortar sections to bring the effects of their fires on the enemy. The commander must develop an appreciation for the movement rates of his subordinate units across all types of terrain. At times, the rifle company will receive additional maneuver assets such as tanks or other infantry platoons. The direct-fire capabilities of these maneuver assets are considered part of the maneuver system.

**1-10. FIRE SUPPORT SYSTEM**

The primary fire support system for the rifle company is the 60-mm mortar section or the 81-mm mortar platoon. These assets provide the commander an organic, indirect-fire support resource immediately responsive to the company's request for fires. The commander must know the capabilities and limitations of these assets and integrate their fires in every operation. Normally, the company will also have field artillery support available. The company has a FIST habitually attached to his company. The company FSO, in charge of the FIST, assists the commander with the indirect-fire support planning and execution. The FOs with each platoon also plan and coordinate fire support, locate targets, and request and adjust fires to support the platoon leader's concept.

**1-11. MOBILITY, COUNTERMOBILITY, AND SURVIVABILITY SYSTEM**

Even without augmentation, the infantry company has significant engineering capabilities. Digging fighting positions, constructing obstacles, preparing minefields, and breaching or reducing enemy obstacles are all unit measures the rifle company may be responsible for. At times, the infantry company is supported by engineer units and equipment. Although the commander may rely on the engineer leaders recommendations, he must understand the capabilities of the engineer units and equipment. He prioritizes the work and ensures the engineering effort supports the friendly schemes of maneuver and fire plans. Survivability includes those activities and procedures that protect the company from the effects of NBC weapons.

**1-12. AIR DEFENSE SYSTEM**

The rifle company commander's primary means of air defense are passive measures that prevent the enemy from detecting and engaging his company. Moving during limited visibility and using all available cover and concealment and effective camouflage are the primary passive measures infantry companies employ. The company can also defend itself from air attack using organic direct-fire systems. The company must be well trained in the techniques for employing small-arms fire against enemy aircraft. The soldiers must also know under what conditions they have the freedom to engage enemy aircraft. The company may have ADA systems (Stingers and Vulcans) in support. The commander must ensure these systems are fully integrated into his plan.

**1-13. COMBAT SERVICE SUPPORT SYSTEM**

Infantry rifle companies have an austere supporting CSS structure—some organizations are more austere than others. The sustainment of his company in combat is one of the greatest challenges facing every rifle company commander. He must be innovative in his techniques of resupply and casualty treatment and evacuation. The company executive officer, first sergeant, and supply sergeant are key players in the company's CSS system. The maintenance program within the company must be effective and continuous, and must have leader involvement at every echelon. (A detailed discussion of CSS for the infantry company is found in Chapter 8).

## 1-14. COMMAND AND CONTROL SYSTEM

The command and control system consists of the activities and procedures employed by the commander to plan, direct, coordinate, and control the company. It includes the personnel and equipment that assist the commander with command and control. The commander employs his unit in accordance with guidance and orders received from battalion. He delegates authority to his subordinates and clearly assigns their responsibilities. The company XO is the 2IC and is employed in that role to assist the company commander. The company commander does not restrict his subordinates freedom of action with unnecessary control measures. He uses mission-type orders and trains his subordinates to operate within the framework of his concept. He clearly states his intent so every member of his unit can effectively use their initiative. A commander must be proficient at analyzing a situation to develop a plan that has the greatest chance of accomplishing his mission with the least cost in lives and equipment.

## Section IV. ORGANIZATION

The infantry rifle company organization varies, depending on the parent battalion. Airborne and air assault companies differ only slightly from the light infantry company. The ranger and H-series infantry companies are different from each of the others. Despite the differences in organization, the mission and employment considerations for each are nearly the same. The tactics for fighting each of these companies are also essentially the same.

## 1-15. MISSION

The mission of the infantry rifle company is to close with the enemy by means of fire and maneuver to destroy or capture him, or to repel his assault by fire, close combat, and counterattack.

## 1-16. EMPLOYMENT CONSIDERATIONS

The fundamental considerations for employing infantry companies result from the organization, equipment, and capabilities of these units. Other capabilities result from a unit's training program, leadership, morale, personnel strengths, and many other factors. These other capabilities constantly change, depending on the current status and situation. The infantry leader must be aware of them and plan accordingly. The capabilities and special considerations for all infantry companies are as follows:

### a. Capabilities.

(1) Conduct offensive and defensive operations in all types of environments, primarily at night. Specific tasks include the following:

- Seize, secure, occupy, and retain terrain.
- Destroy, neutralize, suppress, interdict, disrupt, block, canalize, and fix enemy forces.
- Breach enemy obstacles.
- Feint and demonstrate to deceive the enemy.
- Screen and guard friendly units.
- Reconnoiter, deny, bypass, clear, contain, and isolate. (These tasks may be oriented on both terrain and enemy.)

(2) Conduct small-unit operations.

- (3) Participate in air assault operations.
- (4) Participate in airborne operations (airborne and ranger companies).
- (5) Operate in conjunction with heavy or special operating forces.
- (6) Participate in amphibious operations.

**b. Special Considerations.**

- (1) Austere CS and CSS assets.
- (2) Limited vehicle mobility.
- (3) Vulnerable to enemy armor, artillery, and air assets.
- (4) Vulnerable to enemy NBC attacks and limited decontamination capability.

**1-17. COMPANY ORGANIZATIONS**

A rifle company can be part of a light infantry, air assault, airborne, ranger, or infantry battalion. Each rifle company is organized differently, but all are similar in size, number of platoons, and capabilities.

a. A light infantry rifle company consists of a headquarters section, three rifle platoons, a 60-mm mortar section, and an antiarmor section (Figure 1-1).

b. An airborne rifle company consists of a headquarters section, three rifle platoons, and a 60-mm mortar section (Figure 1-2).

c. An air assault rifle company consists of a headquarters section, three rifle platoons, and a weapons platoon (Figure 1-3).

d. A ranger company consists of a headquarters section, three rifle platoons, and a weapons platoon, which consists of a 60-mm mortar section and an antiarmor section (Figure 1-4).

e. An infantry rifle company consists of a headquarters section, three rifle platoons, and an 81-mm mortar platoon (Figure 1-5).

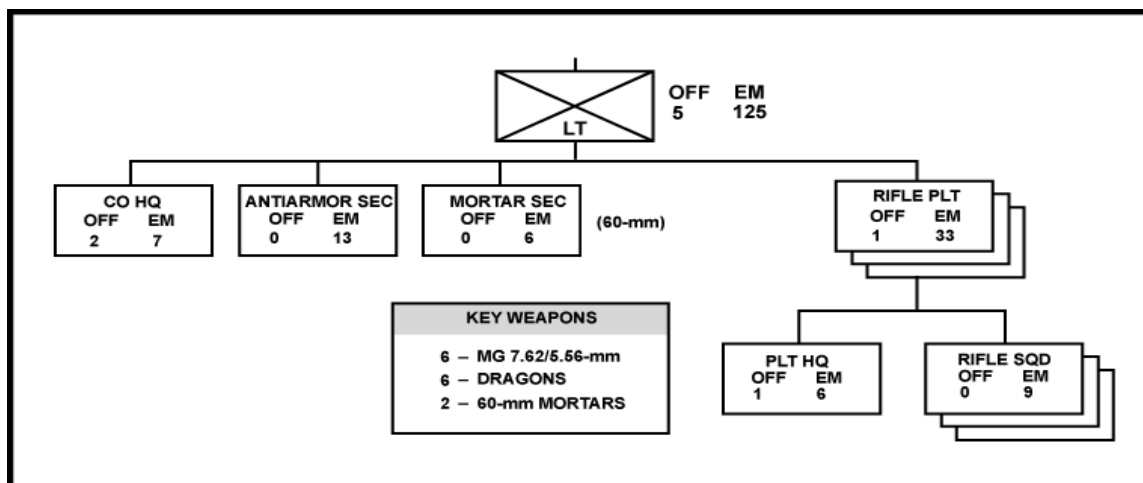

**Figure 1-1. Light infantry rifle company.**



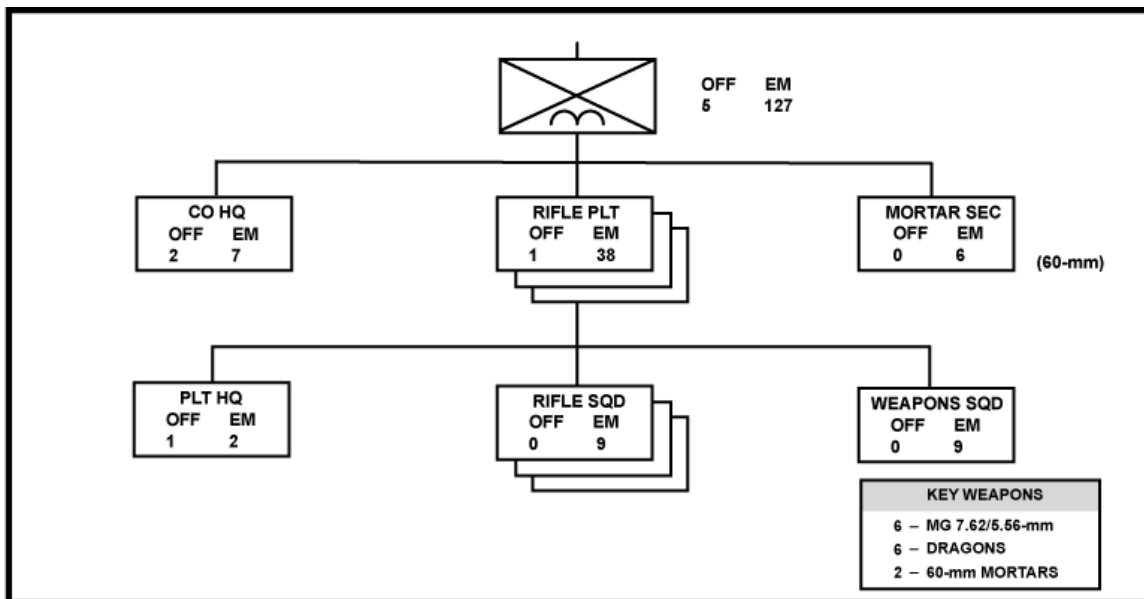

Figure 1-2. Airborne rifle company.

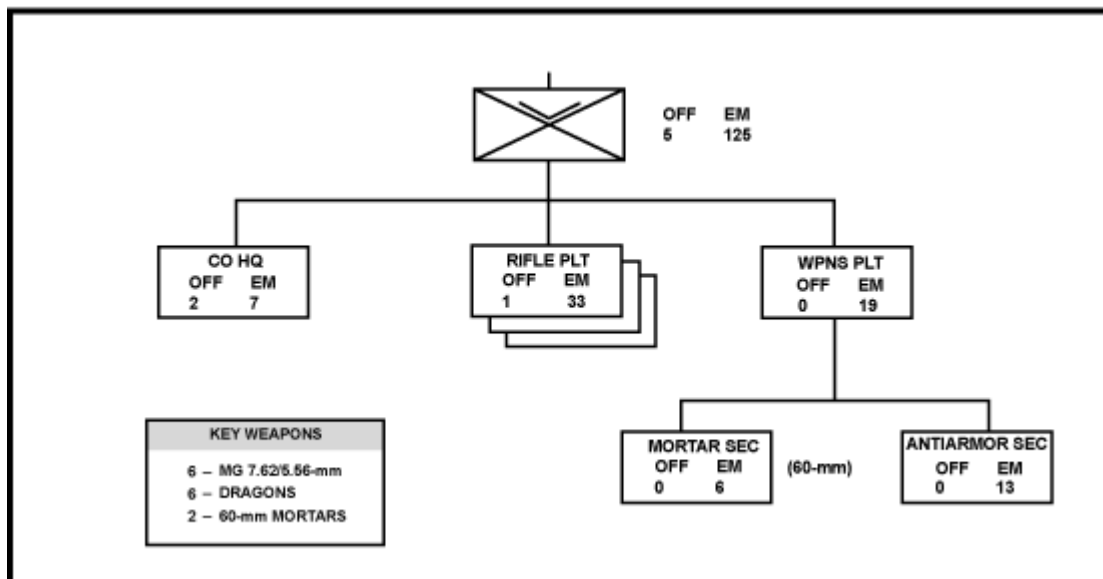

Figure 1-3. Air assault rifle company.

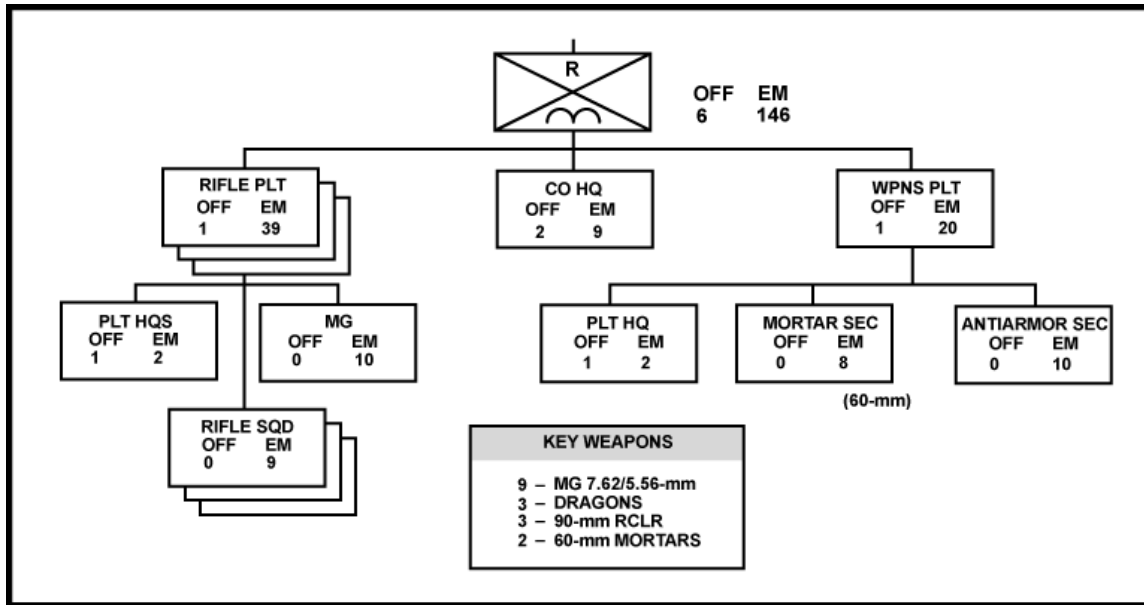

Figure 1-4. Ranger company.

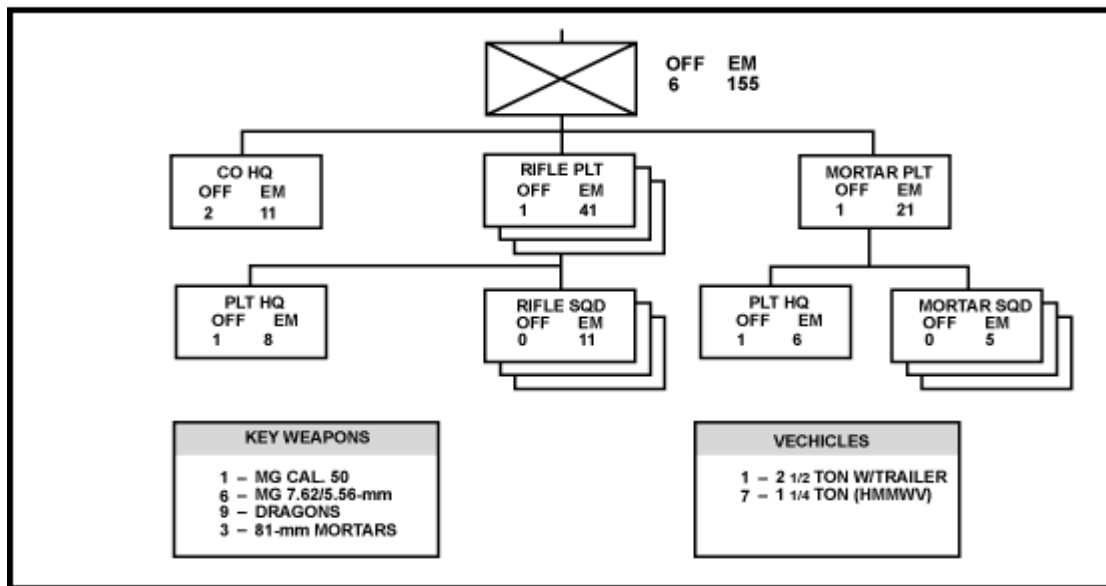

Figure 1-5. Infantry rifle company.

## CHAPTER 2

# COMMAND AND CONTROL

*The more fluid the battlefield, the more important and difficult it will be to identify decisive points and to focus combat power there.... Communications will be interrupted by enemy action at critical times.... Subordinate leaders will be expected to act on their own initiative within the framework of the commander's intent.*

FM 100-5, 1986

*Command and control is the process of directing, coordinating, and controlling the unit to accomplish the mission. The purpose of command and control is to implement the commander's will in pursuit of the unit's objective. Command and control is both a system and a process. At company level, the system consists of the personnel, equipment, procedures, and concepts that carry out the C2 process. The essential component for both the process and the system is leadership. Effective mission-oriented C2 is critical to success in battle. A detailed discussion of the key concepts and principles for M-OC2 is in Section I. The following historical vignette clearly depicts the critical importance of many of these fundamentals.*

During operation "Just Cause" in Panama in December 1989, Company A, 4th Battalion, 17th Infantry was assigned the mission of seizing the PDF barracks at Fort Espinar to prevent the PDF infantry company from deploying into their combat positions. The objective consisted of two multistory concrete buildings. These buildings were surrounded by a chain link fence built on top of a 2-foot high brick wall. Approximately 95 PDF soldiers armed with small arms, machine guns, and RPG-18 antitank rocket launchers actually occupied the buildings, although the company commander had been told to expect from 150 to 160 enemy.

The commander's concept was to isolate and suppress the objective with a support element consisting of one rifle platoon, a smaller fire support position consisting of an M60 machine gun team secured by three riflemen, and a third position occupied by the company's antitank section and a towed Vulcan 20-mm ADA gun. The three separate support positions were necessary in order to obtain the right firing angles against the objective's two main buildings, and to isolate the objective area.

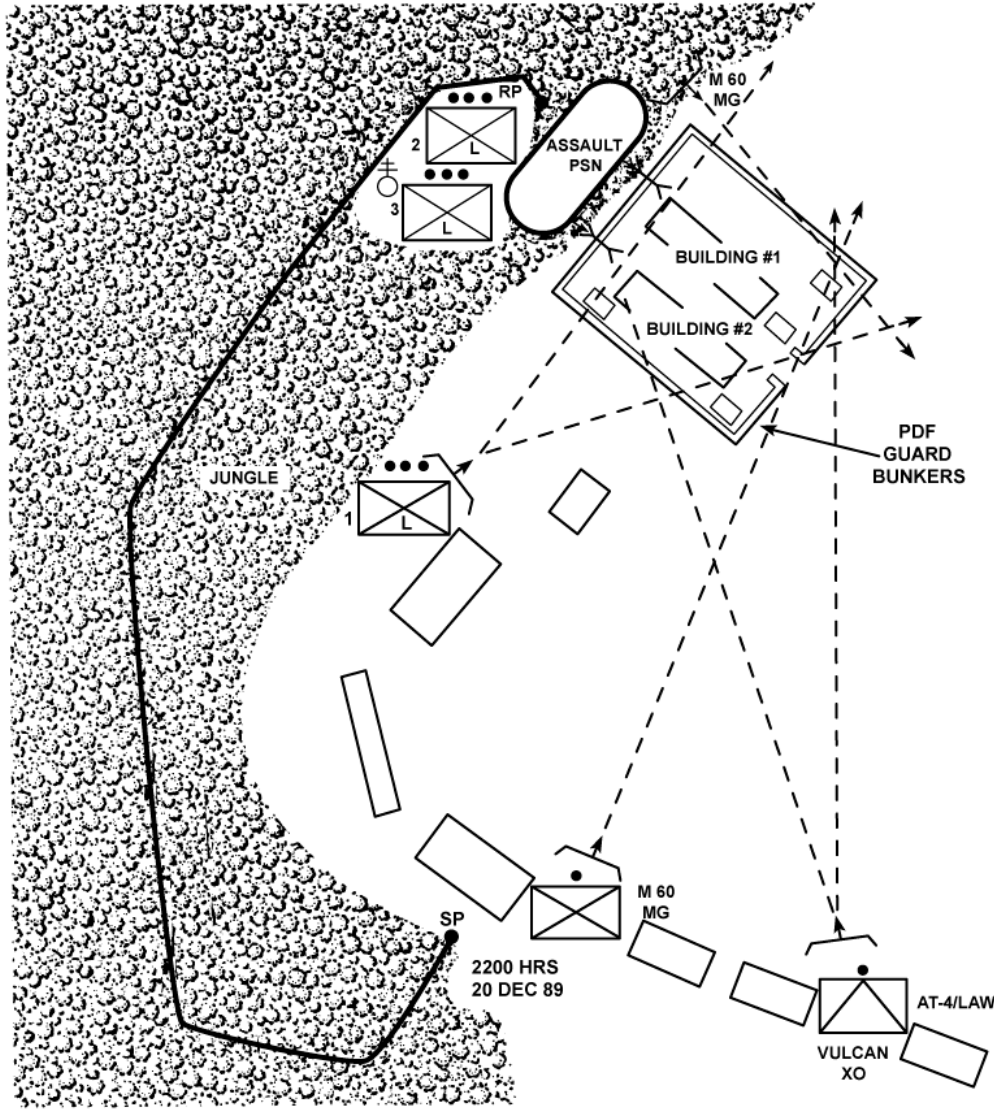

**Diagram of the objective area.**

The company XO was designated the support element leader while the CO went with the assault element (company main effort). The support element's mission was to suppress the enemy within the barracks complex to allow the breach element to breach the obstacle. The commander's intent (the purpose) for this element was to support the breach element's successful breach of the fence. The support element was also tasked to isolate the objective area and provide suppressive fires to allow the assault element to clear the objective. The XO's instructions were to initiate fires against the PDF barracks at H-hour minus two minutes. (Radio listening silence had been imposed.) He was to fire for two and one-half minutes and then cease fire while a recorded surrender request was broadcast. The breach element needed this suppressive fire to support its move from the assault position up to the designated breach positions and to prepare their demolitions.

The element of surprise was lost about 26 minutes before H-hour when shooting started at Coco Solo, about two miles away. About 10 minutes later, firing started at

another building on Fort Espinar as a platoon from an adjacent battalion was moving into its position.

The XO was under pressure from soldiers in the fire support element to initiate their fire early since the PDF were obviously alerted. He resisted this pressure and repeatedly cautioned the soldiers around him to hold their fire. At the exact preplanned time, he initiated the support element's fires.

The XO understood that the battalion commander's intent for the company (the purpose) was to prevent the deployment of the PDF company into their combat positions. Since he could observe the gate, he could initiate fires if the PDF began to deploy. He also knew that his purpose (his commander's intent) of the fire was not to inflict the maximum casualties on the PDF, it was to cover the movement of the breach element as it moved forward to prepare the bangalore in the enemy's obstacles. If he had initiated fire early, he would not have helped the breach/assault element still moving in the jungle. As it was, his timing was perfect. The assault element had just reached the edge of the jungle when the XO opened fire. They were able to move undetected up the steep slope to the compound under excellent suppressive fires.

As a result of the XO's proper decision, the mission was accomplished with near perfection. The company captured 84 enemy soldiers and killed several. Company A suffered no casualties and was ready to continue combat operations immediately following this action.

The actions of Company A provide an excellent example of many of the key fundamentals of mission-oriented command and control. The utility of the commander's intent is clearly evident as is the need to understand the intent of both higher commanders (two levels up). By clearly stating the assigned missions (task and purpose) for their subordinates in his concept, each commander ensured his subordinates were able to effectively use their initiative during the conduct of decentralized operations. In addition, the identification of the main effort provided the focus for all other subordinates to base their actions on. Because these commander's used effective mission orders, they were able to depend on their subordinates to make the proper decision allowing the commander of Company A to command well forward and locate himself at the decisive point with his main effort.

## **Section I. COMMAND AND CONTROL SYSTEM**

The company's command and control system must be reliable, responsive, and durable. It must withstand crises, even the loss of the commander, and still continue to function. Although it is the most complex system in the company, the result must be clear, concise instructions that focus the entire unit toward the company's objective. This section describes the structure and key concepts of the command and control system.

### **2-1. DEFINITIONS**

Success in battle will require a combination of command and control. The proper mix of command and control is determined by the situation, but commanders must emphasize command and reduce control measures that restrict their subordinate's freedom of action.

a. **Command.** Command is the process that instills the commander's will among his subordinates. It provides focus and direction to the company. The commander's leadership is an integral part of command.

b. **Control.** Control, as the counterpart of command, follows up a decision and minimizes deviation from the commander's concept. Control provides supervision to the operation while synchronizing all systems and activities.

c. **Synchronization.** Commanders must avoid depending on close control of their units to achieve synchronization. This slows execution and limits their subordinates' initiative. Synchronization is maintained during execution by the proper decision of subordinates. A clear understanding of the commander's intent and a simple effective concept are the keys to maintaining synchronization.

## 2-2. COMMANDER'S LEADERSHIP

Leadership is the critical element of both combat power and the command and control system. Through leadership the commander causes his unit to complete demanding tasks in difficult situations. Commanders must understand the military leadership philosophy in FM 22-100. In addition, the following factors are key to the company commander's ability to lead his company on the AirLand battlefield.

a. **Will.** Often the victor in battle is the unit that refuses to lose. Competent leaders and tough, realistic training are the keys to developing this determination. The CO must develop a "will to win" in his soldiers and his company.

b. **Trust.** The CO must earn the trust of his men. They must have confidence in his abilities. He must also trust his soldiers and develop a command climate that allows subordinates to make decisions.

c. **Delegation.** After ensuring his subordinates are well trained, the CO must delegate the proper authority and freedoms to his men. The CO focuses his time and energy on what is critical and delegates the remainder to his subordinates.

d. **Discipline.** The CO instills discipline in his soldiers. Discipline ensures proper standards are maintained in the absence of leader supervision. The decentralized operations, which the company routinely conducts, require self-discipline of every soldier in the company.

## 2-3. MISSION-ORIENTED COMMAND AND CONTROL

Mission-oriented command and control is the Army's doctrinal approach to C2 on the AirLand battlefield. It is a method of directing military operations that encourages and expects subordinates to take action consistent with the intent and concept of higher headquarters. The following principles provide the fundamentals for M-OC2.

a. **Expect Uncertainty.** The commander must understand the environment of combat; the battle will be dynamic and nonlinear. Communications will be degraded, and the chaos of battle will often prevent the commander from knowing what is happening beyond his own senses. The situation during planning will always change before execution.

b. **Reduce Leader Intervention.** Plan and direct operations to require the absolute minimum intervention during execution. When soldiers expect the commander to make the decision or initiate the action, they are reluctant to take action. When precise control is required for synchronization, such as an on-order task, the commander should also provide the subordinate the criteria for making the decision. Leaders must realize that some loss of precision is better than inactivity.

c. **Increase Subordinate Planning Time.** The CO ensures the effective use of all available planning time. Although the majority of the planning takes place at company level, the squads and platoons require extra time to conduct their rehearsals and inspections. SOPs and warning orders are key tools for using time well.

d. **Give Subordinates Maximum Freedom of Action.** Given the expected battlefield conditions, leaders at every level avoid unnecessary limits on their soldiers' freedom of action. The leader at the point of decision must have the knowledge, the training, and the freedom to make the correct decision that supports the commander's intent.

e. **Command/Lead Well Forward.** The commander locates where he can best fight his company. This is determined by a number of factors. His leadership is most effective face-to-face when he can see the situation and his soldiers can see him. Since he can not be everywhere, the CO focuses on the decisive action that will accomplish his mission. He normally locates with his main effort (the subordinate unit assigned the decisive action) to provide his leadership and to be in a position to shift or retask the main effort.

#### 2-4. COMMANDER'S INTENT

Knowing the commander's intent enables subordinates to use their initiative during the execution of an operation. Clear and concise terms are used to state the intent to ensure understanding throughout the force. It must be clearly understood by all means of communication; written, face-to-face, or spoken via radio or land line. The relationship between the battalion commander's intent for the company, the company's role in his concept, the designation of the main effort, and the development of the CO's concept and assignment of his subordinate's intent is the focus of mission orders.

a. **Intent.** Intent is defined as the result the commander expects the unit to accomplish in a specific operation. At the lowest tactical levels (company and below), intent is normally the purpose from the mission statement. As such, it is assigned by the battalion commander when he determined the company's mission statement. This mission statement consists of the mission essential task to be accomplished and the purpose (result) it achieves.

b. **Commander's Concept.** When the battalion commander develops his concept, he determines the mission for the company. He first determines the purpose the company must achieve and then assigns the task(s) he feels will achieve that purpose. During the fight, if the assigned task will not achieve the purpose, the CO is expected to retask the company to achieve it. Soldiers should make every effort to inform their commander of their actions, but they must not wait for an order to act. Another example of how the assigned purpose/intent guides actions could be: During execution, the CO sees the opportunity to achieve his assigned purpose faster or less costly by acting now. When making this decision, he must consider what his company's role is within his commander's concept. He must make every effort to operate within the framework of the battalion commander's concept because it provides the synchronization and concentration of combat power for the operation. If he determines that his actions will not jeopardize the unit or the mission, then in the absence of communications he must act.

c. **Concept Development.** To accomplish the assigned mission, the CO assigns missions to his platoons and sections. Just as the battalion commander assigned company missions and designate d his main effort, the CO does the same for the company. He also

ensures that his concept fits within the battalion commander's concept. This results in a unity of effort but supports decentralized execution. At each level, the commander is given his mission by his superior, develops a concept to accomplish the mission, organizes his unit to fight the concept, and assigns each subordinate his responsibilities. The vehicle for providing this information is the OPORD.

d. **Main Effort.** The platoon with the most important task in the CO's concept is designated the main effort. This unit is the focus; all other units support the quick success of the main effort. Success by the main effort should result in the accomplishment of the commander's mission. When considering independent action, each leader makes his decision based on his relationship to the main effort. The linkage between supporting and main efforts must be maintained except in extraordinary cases, such as when a leader of a supporting effort sees the chance to accomplish the purpose of the main effort. This leader asks the question, "What would my commander do if he knew what I know?" Since the proper response would be to shift the main effort to this leader's unit, he should immediately retask himself and accomplish the purpose that was assigned to the main effort. If the original main effort leader was informed or became aware of this development, he should determine how to best support the new main effort, retask himself, issue a FRAGO to his soldiers, and join the fight.

## **2-5. MISSION ORDERS**

AirLand Battle doctrine requires the use of mission-type orders. Mission orders focus on what tasks must be accomplished without specifying how they will be done. Whenever possible, they are oral orders issued face-to-face on the ground where the fight will take place. Mission orders require well-trained subordinates who understand their commanders' intent and concepts (two levels higher).

a. Mission orders address only the required information. Avoid unnecessary detail and redundancy; do not restate doctrine or SOPs. Develop unit SOPs that reduce the length of orders; use clear and concise terms and graphics. FM 101-5-1 is the doctrinal source for terms and graphics, every leader in the unit must understand these.

b. The commander determines exactly what he wants his platoons to accomplish and clearly communicates these requirements to them. If one of his leaders has not earned his trust or has not displayed the tactical competence to operate with a mission order, then the order must be tailored, based on the training, experience, and capability of the leader receiving the order.

(1) This may include nothing more than providing additional instructions, establishing more restrictive control measures, or directing a specific use for one of his organic assets, such as positioning one of the grenadiers to block enemy movement up a ravine to prevent the enemy from flanking the platoon's battle position.

(2) Or in an unusual situation, the CO may detail exactly how the platoon leader will employ his entire platoon, clearly state the limits for using his initiative, and collocate himself or the XO with this platoon. This should be only a short-term solution; leaders must be trained to meet their responsibilities.



## 2-6. DUTIES AND RESPONSIBILITIES OF KEY PERSONNEL

The company must accomplish many different tactical, administrative, and logistical tasks. To accomplish these, the duties and responsibilities of key personnel must be defined, coordinated, and understood.

### a. Company Commander.

(1) The commander is responsible for everything the company does or fails to do. This includes the tactical employment, training, administration, personnel management, and sustainment of his company. He must know the capabilities of his men and supporting weapons and how to tactically employ them. He must also know the capabilities of the enemy.

(2) The CO exercises command through his subordinate leaders.

(3) The CO employs his company to support the accomplishment of the battalion and brigade missions. He requests additional support from battalion when required.

### b. Executive Officer.

(1) The XO is second in command. His primary role is to help the commander fight the company. He ensures the tactical reports from the platoons are forwarded to the battalion tactical operations center. The XO may locate where he can maintain communications with the company commander and the battalion TOC. He may require additional soldiers to provide security and provide a CONOPS capability (see Section IV). The XO assumes command of the company as required.

(2) Before the battle, the XO (with the 1SG) plans and supervises the company CSS. They make sure precombat inspections are complete. He plans and coordinates logistical support with agencies outside the company while the 1SG does the same internally. He prepares or assists in the preparation of paragraph 4 of the OPORD. He may also assist the CO in planning the mission.

(3) The XO coordinates with higher, adjacent, and supporting units. He may aid in control of a phase of the battle, such as passage of lines, bridging a gap, breaching an obstacle, or assumption of control of a platoon attached on the move.

(4) The XO may be assigned tactical missions, such as the following:

(a) Landing zone/pickup zone control officer. This may include straggler control or casualty evacuations and resupply operations as well as air/ground liaison.

(b) Quartering party/detachment OIC. The XO may be the OIC of an element consisting of representatives of various company elements. Their purpose is to precede the company and reconnoiter, secure, and mark an assembly area or battle position. Or they remain behind the company to move or secure excess equipment and personnel while the company moves to a new location or conducts combat operations.

(c) Element leader. The XO may be assigned a mission and a task-organized element with which to accomplish it. He may, for instance, control all the company machine guns, the 60-mm mortars, and one rifle platoon as the support element leader in a company raid or attack. Common missions of this nature include—

- Lead the reserve.
- Lead the DLIC during a withdrawal.
- Control attachments to the company.

### c. First Sergeant.

(1) He is the senior NCO and normally the most experienced soldier in the company. He is the commander's primary tactical advisor and expert on individual and NCO skills.

He assists the commander in planning, coordinating, and supervising all activities that support the unit mission. He operates where the commander directs or where his duties require him.

(2) His specific duties include the following:

(a) Execute and supervise routine operations. This includes enforcing the tactical SOP; planning and coordinating training; coordinating and reporting personnel and administrative actions; and supervising supply, maintenance, communications, field hygiene, and medical evacuation operations.

(b) Supervise, inspect, or observe matters designated by the commander. (For example—observe and report on a portion of the company's sector or zone, inspect the mortar section, or inspect all range cards.)

(c) Assist and coordinate with the XO. Be prepared to assume his duties.

(d) Lead task-organized elements or subunits on designated missions.

**d. Fire Support Officer.**

(1) The FSO helps plan, coordinate, and execute the company's fire support. During planning, he develops a fire support plan based on the CO's concept and guidance. He coordinates the fire support plan with the battalion FSO.

(2) During the planning, the FSO also—

- Advises the CO of the capabilities and current status of all available fire support assets.
- Assists the CO in developing the OPORD to ensure full integration of fires into the commander's concept.
- Designates targets and fire control measures and determines method of engagement and responsibility for firing the targets.
- Determines the specific tasks and instructions required to conduct and control the fire plan.
- Briefs the fire support plan as part of the company OPORD and coordinates with platoon FOs to ensure they understand their responsibilities.
- Integrates platoon targets into the company target overlay and target worksheet. Passes these products to the battalion FSE.

(3) During the battle, the FSO normally locates with the CO. This allows greater flexibility in conducting or adjusting the fire support plan. At times, the FSO may locate away from the CO to more effectively control supporting fires. The FSO informs the CO of key information received on his radio net.

(4) The FSO must understand infantry tactics. This not only provides better fires integration, but if the CO becomes a casualty, the FSO may need to assume control of the operation until the XO is able to.

(5) The FSO may coordinate CAS or NGF, or employ and control the company mortar section.

(6) The FSO ensures the indirect fire plan is part of each company rehearsal.

**e. Communications Sergeant.**

(1) He supervises operation, maintenance, and installation of organic wire and FM communications. This includes sending and receiving routine traffic and making required communication checks.

(2) He supervises the company CP to include relaying information, monitoring the tactical situation, establishing the CP security plan and radio watch schedule, and informing the commander and subordinate units of significant events.

(3) He performs limited troubleshooting of organic communication equipment and provides the link between the company and the battalion for maintenance of communications equipment.

(4) He is responsible for supervising all aspects of COMSEC equipment, to include requesting, receipting, training, maintaining, securing, and employing this equipment and materials.

(5) He advises the CO in planning and employing the communication systems. Based on the CO's guidance, he prepares or assists in preparation of paragraph 5 of the OPORD.

**f. Radiotelephone Operators.**

(1) The RATELO is responsible for operating and performing maintenance on his assigned radio to include preparation for special operations (waterborne, cold weather, airborne, or air assault).

(2) He encodes and decodes messages and makes field expedient antennas.

(3) The RATELO must understand the company mission. In the event the commander becomes a casualty, the RATELO may be the only man on the radio for a time. At these times, he may request and adjust artillery, and request medical evacuation or resupply.

(4) The RATELOs may assist in the preparation of the OPORD by copying the overlays and building sand tables.

**g. Supply Sergeant.**

(1) The supply sergeant requests, receives, issues, stores, maintains, and turns in supplies and equipment for the company. He coordinates requirements with the 1SG and the battalion S4.

(2) When positioned in the battalion field trains, the supply sergeant is supervised by the HHC commander or the support platoon leader. He uses the battalion administrative/logistical radio network to communicate with the company.

(3) He may also control the vehicle and driver when one is provided to the company.

(4) He monitors the tactical situation and anticipates logistical requirements. Chapter 8 has a more detailed discussion of the CSS requirements.

**h. NBC Noncommissioned Officer.**

(1) He assists and advises the company commander in planning NBC operations. He conducts and supervises the NBC training within the company (NBC decontamination and equipment maintenance and operation).

(2) He operates forward with the company CP and assists the communications sergeant with CP operations and security.

(3) His specific duties include the following:

- Provide the commander with unit operational exposure guidance.
- Process and disseminate information on enemy and friendly NBC attacks.
- Monitor and supervise decontamination operations.
- Make recommendations to commander on decon and smoke support.
- Requisition NBC specific items of equipment and supply.

**i. Armorer.**

(1) He performs organizational maintenance on the company's small arms. He evacuates weapons to the DS maintenance unit. Normally, he assists the supply sergeant in the BSA.

(2) He may operate forward with the company CP to support continuous CP operations.

j. **Antiarmor Section Leader.**

(1) He is responsible for employing the antiarmor section.

(2) He must be prepared to execute the following tasks with his section.

(a) Provide antiarmor support to the company during defensive and offensive operations, to include assisting the CO in planning the section's employment, reconnoitering tentative firing positions, and controlling antiarmor fires.

(b) Plan and lead reconnaissance, security, and combat patrol operations.

k. **Mortar Section Leader/Platoon Leader.**

(1) He is responsible for employing the mortar section.

(2) He ensures effective mortar support for the company. He also assists the CO in planning the employment of the mortar section, coordinates with the company FSO/FIST, and controls the section during tactical operations.

## 2-7. SUCCESSION OF COMMAND

The chain of command provides for the succession of command should leaders become casualties. The normal succession of command in the rifle company is commander, XO, platoon leaders by seniority, other combat arms officers, 1SG, and NCOs by seniority.

a. To reestablish the chain of command, the new commander establishes communications with the battalion and all elements of the company. He informs them of the situation, receives status reports from the company and any new orders from battalion, and continues operations. He issues FRAGOs as required.

b. The company tactical SOP should cover reestablishment of the chain of command. The allocation of radios and radio nets, and the location at which command is reestablished should be planned for during both static and mobile situations.

## 2-8. ORDERS GROUP

A standardized orders group assists the rapid planning and dissemination of orders. It also ensures all key personnel attend the OPORD. The orders group normally includes the XO, 1SG, commo chief, NBC NCO, company FSO, platoon leaders, antiarmor section leader, mortar section leader, and leaders of supporting units. The warning order includes when and where the orders group should assemble.

a. Based on guidance from the commander, members of the orders group prepare portions of the OPORD and briefing aids (sand tables, sketches, overlays, matrixes, and so forth). These activities are supervised by the XO or 1SG, freeing the commander to perform other duties (reconnaissance, a detailed estimate, rest, and so forth).

b. The unit tactical SOP should address the composition and duties of the orders group. For example, the 1SG can prepare paragraph 4 and the communications sergeant can prepare paragraph 5b.

## 2-9. COMPANY COMMAND POST

The company CP does not have a set organization. It consists of the CO and other personnel and equipment required to support the C2 process for a specific mission. It locates where the CO determines it can best support his C2 process. Its purpose is to provide communications with higher, lower, adjacent, and supporting units; to assist the CO in planning, coordinating, and issuing the company OPORDs; and to support continuous operations by the company. Often the CP must also provide its own security.

a. Normally, the CP consists of the CO and his RATELOs, the FIST HQs, the communications sergeant, and the NBC NCO. The XO, 1SG, armorer, reserve element leader, and the leaders of attached or supporting units may also locate with the CP.

b. When positioning the CP, the CO considers his communication requirements, the security needs for the CP, and above all, the location where he can best fight his company from.

(1) In static positions (assembly areas, battle positions, and so forth), a stationary CP location may be designated by the CO. This allows wire communications to be established with battalion and the units of the company, field expedient antennas to be set up, and fighting positions to be dug. It also provides a designated spot to which messengers can report. The CP should be off natural lines of drift and key terrain features. It must be well camouflaged from ground and air observation. Local security is provided, either by its relation to the rifle platoons, by collocating with the company reserve element, or by its own personnel. When the CO leaves the CP, the XO or the 1SG normally assume control.

(2) When moving, the CO designates where the CP will move (Chapter 3). At times, he may locate away from the CP. For example, to control the company's movement better, he may move with the lead platoon; or in the attack, he may locate with the main effort. In these situations, he may designate a part of the CP (his RATELOs or the FSO) to move with him.

c. The CP personnel also assist the commander by preparing parts of the company OPORD. They also—

- Provide recommendations or input during the planning.
- Receive and send required reports and SITREPS.
- Lay land lines to subordinate units.

d. The CP must be capable of conducting continuous operations. Section IV of this chapter provides additional guidance for conducting sustained and continuous operations. Because of the impact that stress and fatigue will have on the C2 process, commanders should consider the following:

- Organize and man the CP to allow continuous operations.
- Cross train personnel.
- Discuss critical decisions with the XO or 1SG.
- Set up a CP sleep plan and ensure compliance of it.
- Ensure key decision makers get sleep (do not wait until fatigue requires this—do it from the start).

## Section II. COMMAND AND CONTROL PROCESS

The leader uses the command and control process to figure out what is going on, decide what to do about it, tell soldiers what to do, then keep track of how well his soldiers are doing. The troop-leading procedures are the leader's tools to guide the command and control process. These procedures provide a common framework for all echelons of command to apply the C2 process. Two other tools that are part of the C2 process are the estimate of the situation and METT-T analysis. The relationship of these three tools is depicted in Figure 2-1.

### 2-10. TROOP-LEADING PROCEDURES

The troop-leading procedures are the dynamic process by which a commander receives a mission, plans it, and executes it. It should be an instinctive and familiar way of thinking for a company commander. The sequence of the individual TLPs is not rigid. It is modified to meet the mission, situation, and available time. Some steps are done concurrently while others may go on continuously throughout the operation. The TLPs are time savers; as such, the leader conducts them in the order that most effectively uses the available time.

a. **Receive the Mission.** A mission may be received in the form of either a written or oral warning order, operation order, or fragmentary order. At times, a leader may deduce a change in mission, based on a change in the situation. When the battalion OPORD is issued, the company commander should have his company FSO with him.

(1) Once an upcoming mission is identified, actions to begin preparing the unit are conducted. The CO conducts an initial METT-T analysis to determine the requirements for his warning order.

(2) With the information available, the commander sets his time schedule by identifying the actions that must be done (time-critical tasks) to prepare his unit for the operation. These preparatory actions are identified by a preliminary consideration of the information on the mission, enemy, terrain, and own troops. An initial reconnaissance (may be a map reconnaissance) is conducted to allow the leader to more fully understand the time requirements for the mission. He then develops his time schedule by starting at "mission time" and working backward to the time it is now (reverse planning). The mission time is normally the most critical time in the operation.

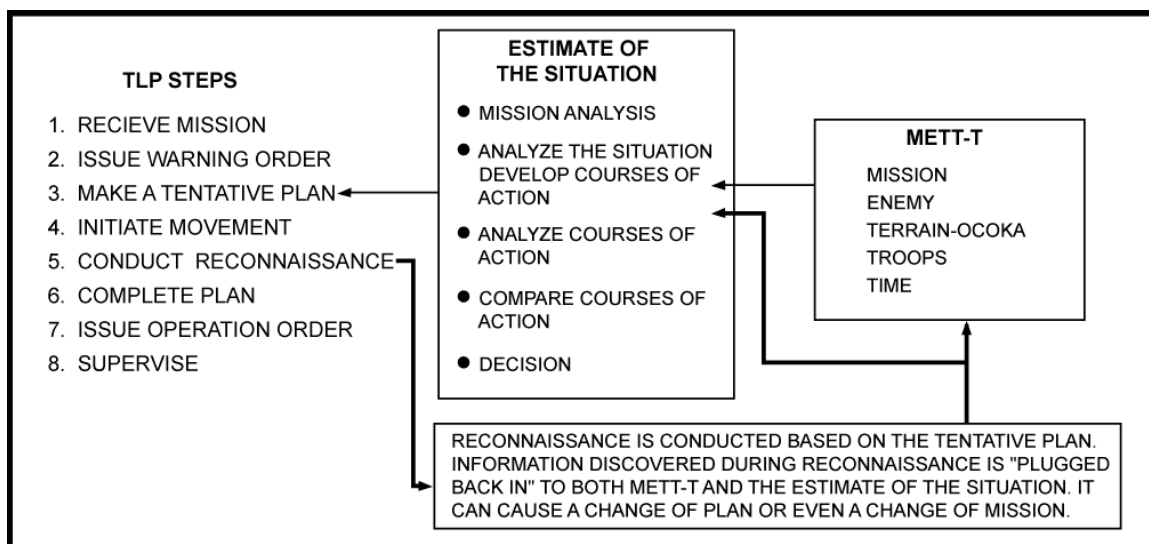

**Figure 2-1. Tools of the tactician relationship.**

(3) The commander must ensure that all subordinate echelons have sufficient time for their own planning needs. A general rule of thumb for leaders at all levels is to use no more than one-third of the available time for planning and issuance of the OPORD. This will leave the rest of the available time for subordinate leaders to use for their planning and preparation. This is a tentative time schedule, which may require adjustment as the TLP process continues.

- 0600, execute mission.
- 0530, finalize/adjust the plan, based on the leader's reconnaissance.
- 0400, establish ORP; begin leader's reconnaissance.
- 0200, begin movement.
- 2100, conduct platoon inspections.
- 1900, hold rehearsals.
- 1800, eat meals (tray packs).
- 1745, hold briefbacks (SLs to PL).
- 1630, issue platoon OPORD.
- 1500, hold briefbacks (PLs to CO).
- 1330, issue company OPORD.
- 1045, conduct reconnaissance.
- 1030, update company warning order, if required.
- 1000, receive battalion OPORD.
- 0900, receive battalion warning order; issue company warning order.

b. **Issue a Warning Order.** Do not wait for more information. Issue the best warning order possible with the information at hand and update it as needed with additional warning orders. The warning order lets units prepare for combat as soon as possible after being alerted of an upcoming mission. This normally involves a number of standard actions that should be addressed by SOP. The warning order should address those items not covered in the SOP that must be done to prepare for the mission. The specific contents for each warning order will vary, based upon the unique tactical situation. (Appendix G provides an example warning order.)

c. **Make a Tentative Plan.** Tentative plans are the basis for the OPORD. The leader uses the commander's estimate of the situation to analyze METT–T information, develop and analyze a COA, compare courses of action, and make a decision that produces a tentative plan. (See Section III for details on the estimate of the situation.)

d. **Initiate Movement.** This can be done by having a subordinate leader move the unit to an assembly area or attack position. The instructions for this move can be given in the warning order. The CO ensures that security is provided and fires are integrated for all company movements.

e. **Conduct Reconnaissance.** Reconnaissance is a continuous process during the TLP. The tentative plan should include an R&S plan. Plan and conduct reconnaissance to confirm or adjust the tentative plan. A thorough tentative plan helps the reconnaissance because specific R&S guidance can be given to subordinates. In every tactical operation the CO requires additional information, and at the same time, he must deny the enemy information about his company. These requirements provide the focus for the company R&S plan.

(1) *Prepare the plan.* The CO determines—

- What are his information requirements?
- What are his security requirements? (The higher headquarters may also assign R&S responsibilities to the company.)
- What are the priorities for these requirements?
- What assets are available to meet these requirements? (The CO may request support from higher, adjacent, and supporting units.)
- How much time is available to collect the information or establish security?
- What is most critical (and thus the focus) for his personal reconnaissance?
- To whom will he assign tasks to meet the R&S needs?

(2) *Issue the plan.* The CO provides additional instructions to supplement the assigned tasks to his subordinates. The amount of detail depends on the specific situation. A leader's reconnaissance that has several subordinate units involved requires more specific instructions. These may include the following:

- A specific tasking for selected soldiers from subordinate units, such as the 1st Platoon's RATELO.
- A specific time schedule for the reconnaissance (report, inspection, departure, and return times).
- Specified routes and formations.
- Special equipment required.
- Likely contingency plans.
- Fire support coordination.
- Withdrawal plan from the reconnaissance site.
- Link up with the company.

(3) *Select the technique.* The leader's reconnaissance is crucial to every operation. An effective leader reconnaissance provides the required information without being detected by the enemy. The risk of detection and the effect that this loss of surprise will have on the mission must be weighed against the benefit of collecting the information. Generally, the closer the reconnaissance element is to the objective, the greater the risk of detection. The two primary techniques for conducting the leader's reconnaissance are:



(a) Long-range observation/surveillance. Reconnaissance personnel generally stay beyond small-arms range from the objective. This will usually be outside the enemy's security positions also. Tentative OP sites are selected from a map reconnaissance and confirmed after the unit has occupied the ORP. This technique is generally more effective during daylight hours. When possible, OPs should provide 360-degree coverage and may require repositioning at night.

(b) Short-range observation/surveillance. This technique generally requires the reconnaissance personnel to move inside the enemy's security positions and small-arms fire range. It depends on stealth and effective use of available cover and concealment. Limited visibility may support this technique. OPs are also designated for short-range observation.

(4) *Conduct the reconnaissance.* The leader's reconnaissance should be conducted as any reconnaissance patrol; only essential personnel should take part. The smaller this element is, the less likely the enemy will detect them. This should include a leader from each of the key elements. Additional tasks during the reconnaissance may include:

- Testing communications if authorized.
- Making final coordination on precise timings, signals, weapons/personnel locations, and sub-unit responsibilities.
- Establishing security/surveillance on the objective area.

f. **Complete the Plan.** The CO must be prepared to adjust his tentative plan based on the results of the reconnaissance. He may have to change COAs if the situation is not what he expected. In this case, one of the previously analyzed and discarded COAs may be adjusted to quickly finalize his new plan. Coordination continues with all supporting agencies, higher headquarters, and adjacent units. This, along with his recon, gives the leader the information he needs to expand the tentative plan into a five-paragraph OPOD. (See OPOD format, Appendix G.)

g. **Issue the Order.** Preferably issue the order while viewing the avenues of approach/objective area. Make maximum use of visual aids (sketches and terrain models) to enhance the presentation of the order. When the CO issues the tentative plan before the leader's reconnaissance, he issues a FRAGO to finalize the plan prior to execution (see Appendix G).

h. **Supervise.** The best plan may fail if it is not managed right. Briefbacks, rehearsals, inspections, and continuous coordination of plans must be used to supervise and refine troop-leading procedures. Briefbacks and rehearsals are not the same; briefbacks focus on the planning process, and rehearsals focus on execution.

(1) *Inspect.* During pre-combat inspections, check—

- Weapons and ammunition.
- Uniforms and equipment.
- Mission-essential equipment.
- Soldiers' knowledge and understanding of the mission and their specific responsibilities.
- Communications.
- Rations and water.
- Camouflage.

(2) *Rehearse.* Rehearsals are always conducted. They are essential to ensure complete coordination and subordinate understanding. The warning order should provide

subordinate leaders sufficient detail for them to schedule and conduct rehearsals of drills/SOPs before receiving the company OPORD. Rehearsals conducted after the OPORD can then focus on mission specific tasks. Rehearsals are conducted as any other training exercise except the training area should be as much like the objective area as possible, including the same light and weather conditions. Mock-ups of the objective should be used for these practices. Rehearsals include holding soldier and leader briefbacks of individual tasks and using sand tables or sketches to talk through the execution of the plan. These are followed by walk-through exercises and then full-speed, blank-fire or live-fire rehearsals. The CO should establish the priority for rehearsals based on the available time. The priority of rehearsals, as COA development, flows from the decisive point of the operation. For example, actions on the objective, battle drills for maneuver, actions on enemy contact, special teams, movement techniques, and others as required. Security must be maintained during the rehearsal.

(3) *Briefback*. Subordinates should briefback the commander right after the OPORD to ensure they understand their instructions. Briefbacks of the subordinates' plans should also be conducted. These briefbacks may be given collectively at a meeting of the orders group. Such a technique allows exchange of information, coordination among units, and rapid distribution of changes to the initial plan.

(4) *Coordinate*. The commander visits his subordinates and adjacent units to discuss their plans. The CO ensures that all necessary preparations are being made. These may include coordination of fire support and engineer activities, maintenance, resupply, movement, and other required actions.

(a) Any departures from the plan, both before and during the operation, are coordinated with the battalion commander and staff.

(b) During execution, the CO issues FRAGOs to modify or refine the operation as the situation develops. He personally supervises and or leads the critical actions.

## 2-11. COMMUNICATIONS

The CO communicates to control his platoons and weapons, to gather and pass information, and to call for fires. He ensures required communications are available and functioning.

a. The CO analyzes each situation to determine the effect that the terrain, weather, and enemy may have on his ability to communicate. He reduces these effects by proper positioning of units, establishing visual signals for critical events, requesting a relay site be established by the battalion, and other similar measures. The best way to limit these effects is to reduce the need for communication throughout the operation by developing a simple plan, which requires the least amount of command intervention during the execution.

b. Several means of communications should be planned so the company does not depend on only one. Considerations in selecting means of communications are:

- How long does it take to install?
- How long does it take to send a message?
- How vulnerable is it to enemy action?
- How critical is it to communicate? On which net? At what time?
- How reliable is it?
- What does it cost in resources?

---

c. There are several means available to the CO. He should use each of them, as appropriate, to complement each other. They are radio, wire, visual signals, sound, and messenger.

(1) *Radio*. This is probably the most common means of communications. Radios are well suited for use when the company is on the move or in an attack. Different units often have different types of radios, but the basic company command net remains about the same (Figure 2-2). The CO normally has two radios—one for the battalion command net and the other for the company command net. He may operate from his vehicle (if assigned), which is equipped with two vehicular-mounted radios. He normally has a speech security device for secure communications on the battalion command net. The XO and platoon leaders have a radio for communications with the CO. Although most infantry companies have a radio available for the XO (three in the company headquarters), the lack of a RATELO and the limitations of the radio often limit the ability of the XO to maintain communications with higher and adjacent units. When planning radio communication, the CO considers several factors.

(a) Constant radio contact is not essential for all operations. Often, due to the terrain, radio limitations, and type of operation, radio contact will be lost. At other times, signal security will require radio listening silence be imposed. The CO must determine when and where communication will be critical during the operation and then ensure the required units can communicate.

(b) He must think through the movement of the company to ensure that he knows when the terrain may disrupt radio communications. The key lies in maintaining line-of-sight within the planning ranges of his radios. These ranges can be extended two to three times through the use of field expedient antennas (FM 24-18). When required, the CO may establish or request battalion to set up a relay site.

(c) He must ensure that all leaders know what to do in the event radio communications are lost. Redundant communications are provided through the company fire support net, if it is needed. This should be done only as a last resort.

(d) Many infantry companies have the capability to operate a secure company net. This decision should be based on the enemy threat and balanced against the soldier's load and the possible loss or capture of this equipment.

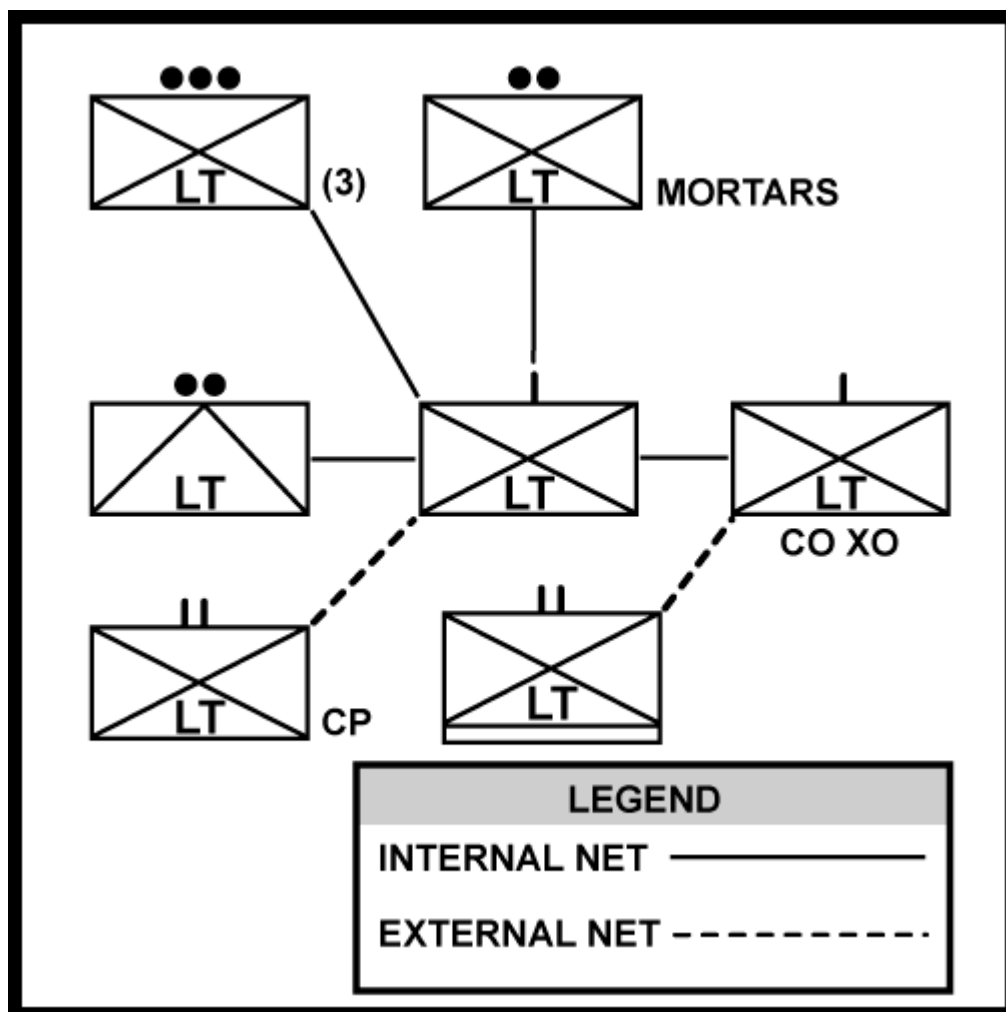

Figure 2-2. Company command net.

(2) *Wire.* Wire is more secure than radio. Wire usually provides better communications because it is less subject to interference from weather, terrain, and man-made obstacles. It is not subject to enemy electronic warfare actions, such as jamming and direction finding. It is, however, subject to breakage by direct and indirect fire and ground traffic.

(a) Although wire is more secure, it can be tapped, so transmissions must be kept secure. The time needed to install it depends on the terrain, the weather, the length of the lines, and the way they are laid. As wire can be easily broken by weapons fire, it should be buried when possible. In areas heavily traveled by vehicles, wire that cannot be buried should be put overhead. Wire lines must be checked frequently and repaired as required.

(b) The decision to use wire depends on the company's mission, amount of wire and time available, and the company's capability to install and maintain it. Most infantry companies have limited amounts of wire. Only the H-series infantry has adequate wire, equipment, and personnel to routinely use wire as the primary means of communication. The CO must prioritize the communication needs and use the available wire where required.

(c) As with the company's radio net, different types of rifle companies have different types of wire equipment. However, the company wire net normally includes the same leaders as does the company command radio net (Figure 2-3).

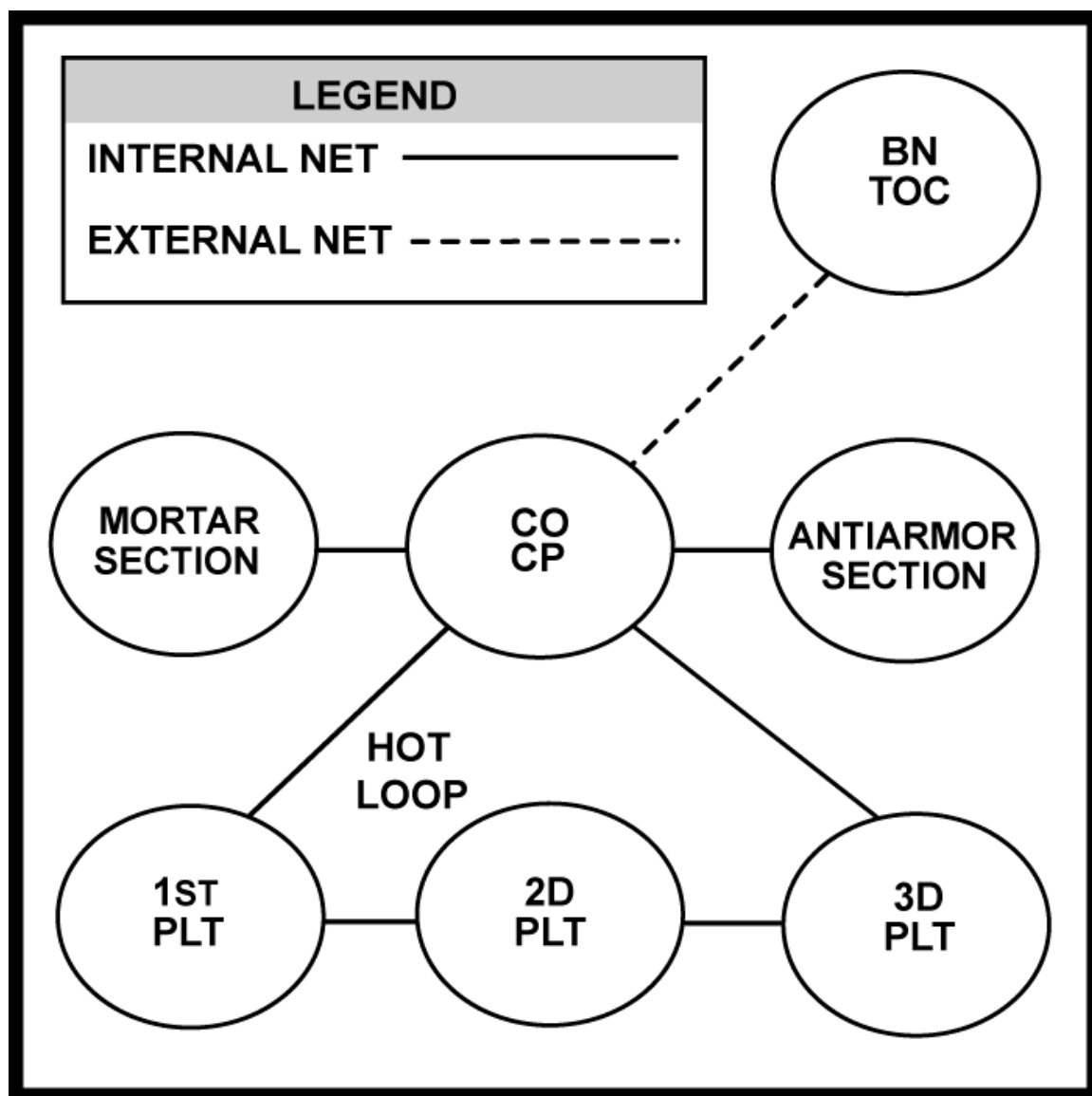

**Figure 2-3. Company wire system.**

(3) *Visual signals.* The company commander may use visual signals to send prearranged messages quickly and to identify friendly units. They include arm-and-hand signals, flags, panels, lights, weapon fires (both direct and indirect) and pyrotechnics. He may use visual signals to identify friendly positions for aircraft. Visual signals, however, may be seen by the enemy or be misunderstood by friendly units.

(a) Pyrotechnics are available in several types and colors. They include smoke grenades, smoke streamers, star clusters, star parachutes, and a variety of artillery and mortar rounds. The commander uses pyrotechnics for signals, friendly unit identification, fire control, target marking, and ground-to-air communications. Pyrotechnic signals may

be prescribed by the SOI, SOP, or the OPORD. Their advantage is the speed with which information can be transmitted.

(b) Combinations of colors fired at the same time or in a series increase the chance of error, as it is easy to miss part of a series.

(c) Visual signals may be seen by the enemy as well as by friendly units. The enemy may even imitate friendly signals. Therefore, visual signals should not be trusted fully unless the signaler can be identified.

(4) *Sound*. The company commander may use whistles, sirens, gongs, shots, and explosive devices for sound communications. These can attract attention, transmit prearranged messages, and spread alarms. Sound signals are usually good for short distances only. Their range and reliability may be further reduced by battle noise. Sound signals must be simple to avoid misunderstandings. Meanings for sound signals should be stated in the unit SOP and SOI.

(5) *Messenger*. Aside from personal contact, messengers are the most secure and reliable communications means. Messengers should always be available at the company CP. They are ideal for transmitting lengthy written messages. Their speed depends on their mode of travel, the tactical situation, and terrain. They are vulnerable, however, to enemy action in forward areas, and they lack sender-to-receiver contact. Hard copy messages are preferred over oral messages. If oral messages are sent, have the messenger repeat the message to ensure he understood. At times, the platoons may be tasked to provide a messenger to the company CP.

## 2-12. ELECTRONIC COUNTER-COUNTERMEASURES

The ECCM are those things the company does to defeat enemy electronic warfare efforts. Although the company is not usually the focus of intercept, jamming, or direction finding systems, proper COMSEC procedures are required by all radio operators. At company level, ECCM consists mainly of proper communications security and antijamming techniques. Although the SINCGARS radios have built-in ECCM features, units still use proper COMSEC procedures.

a. **Communications Security**. The use of COMSEC delays or stops the enemy from gaining information from radio transmissions. It includes the following:

- Authenticating.
- Using only approved codes.
- Changing frequencies and call signs, when specified.
- Designating periods for radio listening silence.
- Restricting the use of radios.
- Using the lowest transmitting power possible.
- Enforcing net discipline and proper radiotelephone procedure.
- Using only authorized call signs and prowords.
- Limiting transmissions to official traffic.
- Keeping transmissions short.
- Selecting radio sites with hills or other obstructions between them and the enemy.
- Using directional antennas when possible.

b. **Antijamming Procedure**. Radio operators should use the following antijamming procedures to defeat enemy jamming efforts.

(1) *Recognition*. The first thing an operator must do when his radio receives interference is to find the cause. He should not immediately assume jamming. Some jamming is similar to other types of radio interference. To help identify the problem, the operator should remove the antenna. If the interference decreases with the antenna removed, then its cause is external and may be jamming. If the interference does not decrease, the problem is in the radio.

(2) *Continued Operation*. An operator must continue normal radio operation once jamming has been identified so that the enemy will not know that his jamming is working. The rule is: During jamming, continue operating unless ordered by the net control station to shut down or to change frequencies. An operator being jammed should never mention over unsecured radio that he is being jammed. If the company cannot continue to operate on the jammed net and also continue the mission, they should switch to the antijamming frequency and continue the mission.

c. **Reporting**. Report all jamming using the meaconing, intrusion, jamming, and interference report. The MIJI report should be sent by another secure means of communications; for example, wire or messenger. A MIJI report format is usually found in the SOI or unit TACSOP and contains the following:

- Date and time of jamming.
- Frequencies jammed.
- Type and strength of jamming signal.
- Designation of the unit making the report.

### **Section III. THE ESTIMATE OF THE SITUATION**

The estimate of the situation is the Army's decision-making process. It helps the leader determine his mission, understand his situation, and select the best course of action to accomplish his assigned responsibilities. Leaders use the estimate for EVERY tactical decision. Their experience, ability, and the time available will determine the amount of detailed analysis in each estimate. The estimate is a continuous process; the CO constantly receives information about the situation. Whenever he receives the information (during planning, en route to the objective, or just before the assault begins), he must decide if this information affects his mission. If it does, then he decides how to adjust his plan to meet this new situation. It is only through the estimate process, however hasty, that the leader can make the proper decision. The estimate has five steps.

Step 1: Conduct a detailed mission analysis.

Step 2: Analyze the situation and develop courses of action.

Step 3: Analyze courses of action (wargame).

Step 4: Compare courses of action.

Step 5: Make a decision.

#### **2-13. CONDUCT A DETAILED MISSION ANALYSIS**

Leaders conduct a detailed mission analysis whenever they receive instructions to begin a new operation. These instructions may be received as warning orders, OPORDs, or FRAGOs. The leader may also deduce a change to his mission based on a change in the situation. In any case, the CO conducts the mission analysis to determine the following:

- Commander's concept and intent (battalion and brigade).
- All tasks his unit must accomplish.

- All limitations on his unit's freedom of action.
- His unit's restated mission statement.

a. **The Higher Commanders' Concept and Intent.** The company commander must know what both his battalion and brigade commanders want accomplished as the result of the operation. He must also understand his role and responsibilities within their concepts. This information is found in the battalion OPORD in paragraph 1b for the brigade and in paragraph 2 and 3 for the battalion.

b. **The Unit's Tasks.** The CO determines all the tasks that his unit must accomplish; they may be found throughout the order. Tasks that are clearly stated in the order, during the oral OPORD, or on the operation overlay are called specified tasks. Examples of specified tasks are:

- Retain hill 545 to prevent envelopment of B Co.
- Provide one squad to the 81-mm platoon to carry ammo.
- Establish an OP vic GL124325 NLT 301500 NOV 89.

(1) In addition to these specified tasks, other requirements may become apparent as the OPORD is analyzed. These are called implied tasks; they are not routine or SOP-type requirements. Nor are they requirements inherent to other assigned tasks or to military operations. Routine or SOP tasks depend on the specific unit, but generally the following type tasks would be considered routine:

- Provide security during movement.
- Conduct resupply operations.
- Coordinate with adjacent units.

(2) If the company was assigned a mission to seize an enemy position for some purpose, some examples of inherent tasks might be as follows:

- Task-organize the unit to accomplish the mission.
- Conduct reconnaissance to locate enemy weak points.
- Isolate the area at the point of attack.

(3) In some cases or for some units, tasks that should be routine, inherent, or SOP may not be. In this case, the CO (understanding the training and limitations of his unit) would identify that task as an implied task. It is not important to classify the tasks. What is important is to identify all the requirements (tasks) that the unit must complete to accomplish its mission. Once the CO identifies these tasks, he then ensures that his plan includes all of them.

c. **The Unit's Limitations.** The CO next determines all control measures or instructions in the OPORD that restrict his freedom of action; these are called limitations. In every operation, there are some limitations on the company. The operations overlay has graphic control measures that restrict the unit's freedom to maneuver. The coordinating instructions often include limitations. Throughout the order, there may be specific times that the unit must meet. The following are some examples of common limitations:

- Cross the LD at 100030 OCT 94.
- MOPP4 in effect.
- ADA weapon status, tight; warning status, yellow .

At times, it may be confusing whether something is a task or a limitation. The first example given above is both a specified task (cross the LD) and a limitation (at exactly



---

0030 hours on 10 OCT). What is important is that the information is included in the CO's concept, and that all subordinates understand and comply with it.

d. **Mission-Essential Task(s).** After reviewing all the above factors, the CO identifies his mission-essential task(s). Failure to accomplish a mission-essential task results in the company's failure to accomplish its primary purpose for that operation. In a well-written OPORD, the CO will find his mission-essential task in the maneuver paragraph.

e. **The Restated Mission Statement.** If the mission analysis began as the result of receiving a battalion OPORD, the mission statement should have been clearly stated in the battalion concept of the operation, (paragraph 3a). The mission essential tasks and purposes for each of the companies should be stated in the battalion scheme of maneuver.

(1) If the mission analysis began as the result of a short FRAGO or a significant change to the situation, the company's mission may not be clearly stated. In this case, the commander must determine his mission essential task. He does this by reviewing the battalion commander's concept and determining what his companies role is for the decisive action. What must his unit achieve to support the battalion's mission accomplishment? The relationship of his unit to the battalion's main effort may also clarify his mission essential task. If his company is the main effort, there should be a direct relationship between his purpose and the battalion's purpose. If the CO reviews each of his assigned tasks by this process, it should be clear which task is essential to the success of the battalion commander's concept.

(2) Time is continuously analyzed during the operation. Once the CO has conducted his mission analysis, he has a better understanding of the time requirements for his unit. If a time schedule was issued prior to conducting the detailed mission analysis, it may need to be updated now.

(3) The restated mission statement becomes the focus for the remainder of the estimate process. This is a clear, concise statement of the essential task(s) to be accomplished by the company and the purpose to be achieved. The mission statement will normally state WHO (the company), WHAT (the task), WHEN (the critical time), WHERE (usually a grid coordinate), and WHY (the purpose the company must achieve). It also becomes paragraph 2 of the company OPORD. The other specified and implied tasks and limitations are included in the plan where required. Some examples of restated missions follow:

- (WHO)"A Company attacks (WHEN) 090500Z Dec 92 (WHAT) to seize HILL 482 (WHERE) vicinity NB 457271 (OBJ BLUE) (WHY) to enable the battalion's main effort to destroy enemy command bunker and reserve platoon."
- (WHO)"C Company defends (WHEN) NLT 281530Z Oct 97 (WHAT) to destroy enemy forces (WHERE) from AB163456 to AB163486 to AB123456 to AB123486 to (WHY) prevent enemy forces from enveloping 1-66 Infantry (L) from the south."

**2-14. ANALYZE THE SITUATION**

With the restated mission statement from Step 1 to provide focus, the CO continues the estimate process. Step 2 involves analyzing the situation, using the remaining factors of METT-T (enemy, terrain, troops and time). The IPB integrates the enemy doctrine with the terrain and weather to evaluate enemy capabilities, vulnerabilities, and possible COAs. FM 7-20 discusses the IPB process in detail.

a. Once the CO has a full appreciation for the situation, he then develops several COAs that will accomplish his mission. Throughout this section, the analysis process is presented in a very deliberate, step-by-step manner. In reality, it is a very dynamic process. For example, this section describes the terrain analysis coming before the enemy analysis. In a tactical situation, the commander will normally have a great deal of knowledge about the enemy. In effect, this allows a more rapid estimate and decision. What must be avoided is jumping to a hasty conclusion/decision without first doing an honest analysis of the situation. Step 2 is normally the most time consuming step of the estimate.

b. During the analysis, the CO determines facts about the situation. He also determines questions for which he has no facts. He then tries to answer these questions through additional analysis or reconnaissance. When these questions impact on his ability to develop valid courses of action, he must plan from assumptions.

(1) Assumptions are used in the absence of facts. They are based on the facts that he has developed, his knowledge of the enemy's doctrine, and also his experience from fighting this enemy. An example of a valid assumption might be: The enemy has prepared antipersonnel minefields on the dismounted avenues of approach into his position. Possible minefield locations can then be deduced based on the enemy's doctrine and the CO's knowledge of his tactics. During this analysis, assumptions are treated as facts to allow the CO to deduce the impact they may have on his unit. The CO reduces the number of assumptions by conducting reconnaissance to gather the required facts.

(2) The CO also analyzes the facts to determine how they impact on his mission, on his unit, and on the enemy. For example: The CO's terrain analysis identifies a creek that is an obstacle to mounted movement. The CO analyzes this fact to deduce the impact it may have on the operation. If he is defending, he must determine how the creek will affect the enemy's movement. It may only be an obstacle to wheeled vehicles and not to tracked ones. Are there choke points along the obstacle which would allow him to concentrate combat power against the enemy? How will the obstacle affect friendly units? Is vehicle resupply and casualty evacuation possible forward of the creek or will he have to use soldiers to move supplies and casualties? How can this obstacle assist in the accomplishment of his mission? The quality of these deductions will determine the effectiveness of the courses of action developed later in Step 2. Figure 2-4 shows this analysis process for Step 2.

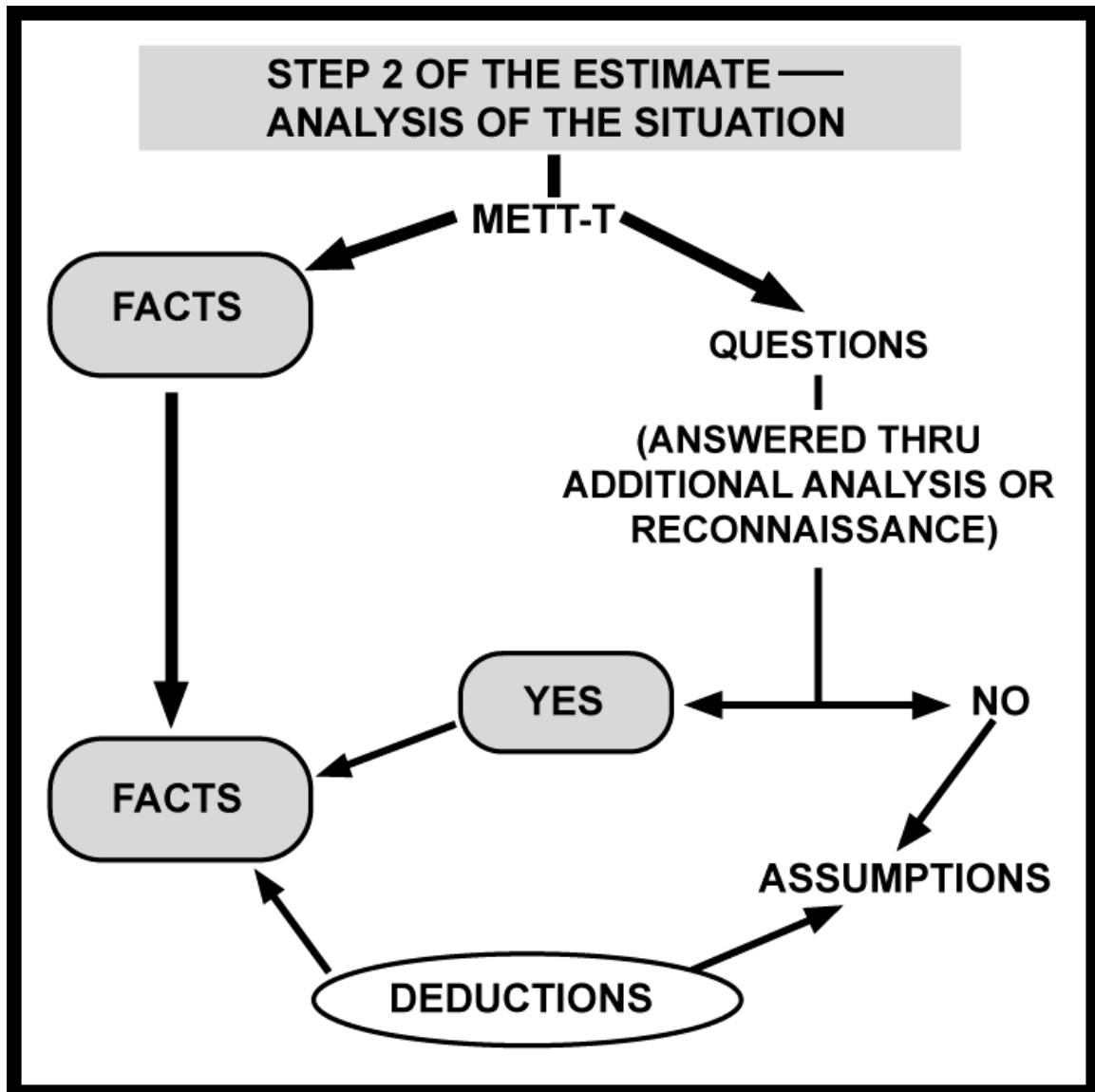

**Figure 2-4. Analysis process.**

(3) Throughout Step 2, the CO identifies potentially decisive points where he can generate superior combat power in relation to the enemy. These points may result from his terrain analysis (locations on the ground which provide an advantage or put the enemy at a disadvantage), from the enemy analysis (an identified enemy weakness that can be exploited), or possibly from the time analysis (a time when the combat potential of the enemy force is degraded). Ideally, a decisive point will be identified where an enemy weakness is positioned at a time and a location that allows the company to generate overwhelming combat power. These points are potentially decisive because the effects of the company's combat potential, when applied there, should lead to accomplishing the mission.

**2-15. ANALYZE THE TERRAIN**

The factors of METT-T guide the leader through the estimate process. Although the first factor is mission analysis, the next factor analyzed should be the terrain, not the enemy. By understanding the terrain prior to the enemy analysis, the leader will have a better appreciation for the enemy's capabilities and limitations.

a. The leader considers the terrain from both his view-point and from the enemy's. The battalion assigns the company its area of operations. If there is terrain or enemy units outside the assigned AO that could impact on the mission, the leader must be concerned with them. This terrain, including the area of operations, is called the area of interest. The leader conducts a detailed terrain analysis of this area.

b. The mnemonic OCOKA provides the significant military aspects of the terrain. These will assist the leader with his terrain analysis. In order, analyze obstacles, avenues of approach, key terrain, observation and fields of fires, and cover and concealment. Because of the effect that the weather has on the terrain, it is analyzed at the same time.

(1) *Obstacles*. Identify the existing and reinforcing obstacles and hindering terrain that will affect mobility. All terrain is evaluated and coded as either NO-GO, SLOW-GO, or GO. When time permits, a combined obstacle overlay is developed to graphically depict the mobility capability of the terrain. Figure 2-5 shows an example of a combined obstacle overlay.

- NO-GO terrain is impractical for the type of force being considered to move through it. NO-GO terrain does not always mean that units cannot pass through that terrain, but only that the speed of movement will be substantially reduced unless considerable effort is expended to enhance mobility. (Example: nonfordable stream and slopes of greater than 45 degrees for mounted movement.) With mounted forces, this would mean substantial engineer support.
- SLOW-GO terrain hinders ground movement to a lesser degree than NO-GO terrain. Little effort is needed to enhance mobility. (Example: sparsely vegetated forests and fordable streams.)
- GO terrain is fairly open terrain that presents no problem to ground movement.

(a) Offensive considerations:

- How is the enemy using these obstacles?
- How will these obstacles affect my movement?
- Where are the weapons/units that are covering these obstacles?
- How can the company avoid these obstacles?

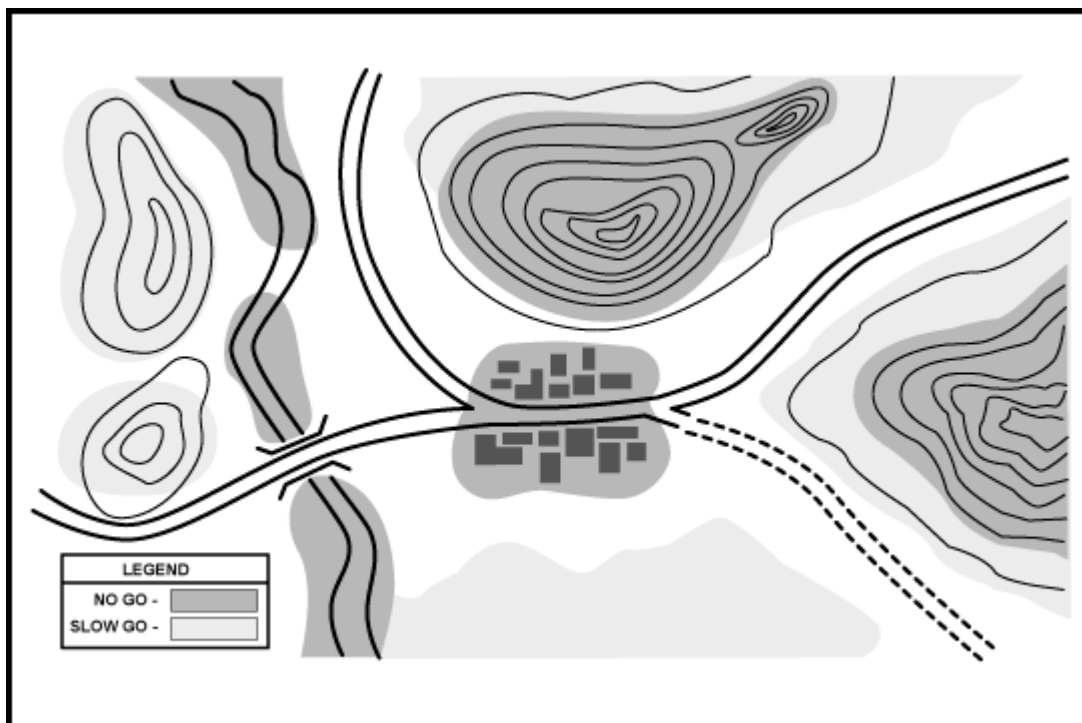

**Figure 2-5. Combined obstacle overlay.**

(b) Defensive considerations:

- How will the existing obstacles affect the enemy?
- How do the existing obstacles support my mission?

(2) *Avenues of approach.* Avenues of approach are developed next and identified one level down. These are areas through which a unit can maneuver. Normally, they are thought of in terms of mounted movement, but they can be applied to dismounted movement as well. Both mounted and dismounted avenues of approach must be identified. When selecting them, the commander uses tactical judgment with respect to the type unit to be used. They traverse GO terrain, bypass NO-GO terrain, and occasionally pass through or over SLOW-GO terrain. They are considered for both the enemy and friendly units. As such, a doctrinal width guideline for a platoon is 250 meters, a company is 500 meters, and a battalion is 1,500 meters. Aerial and subterranean avenues must also be considered.

(a) Offensive considerations:

- How can these avenues support my movement?
- What are the advantages/disadvantages of each? (Consider enemy, speed, cover, and concealment.)
- What are the likely enemy counterattack routes?

(b) Defensive considerations:

- How can the enemy use these approaches?
- Which avenue is most dangerous? Least? (Prioritize each approach.)
- Which avenues would support a counterattack?

(3) *Key terrain.* Key terrain is any location or area that the seizure, retention, or control of affords a marked advantage to either combatant. Using the map and

information already gathered, look for key terrain that dominates avenues of approach or the objective area. Next, look for decisive terrain that if held or controlled will have an extraordinary impact on the mission. The retention or seizure of decisive terrain is necessary for accomplishment of the mission. During the war-game process, other terrain may be identified as potentially key or decisive, based on likely changes in the situation. By this analysis, the commander should get a good feel for potential positions for friendly and enemy units and weapon systems. These locations are important during the development of COAs.

(a) Offensive considerations:

- Is the enemy controlling the key terrain? How?
- How does this terrain affect my mission?
- How can I gain control of this terrain?

(b) Defensive considerations:

- What advantage do I gain by controlling the key terrain?
- How can the enemy gain control of this terrain?

(4) *Observation and fields of fire.* Determine locations that provide the best observation and fields of fire along the approaches, near the objective, or on key terrain. Determine the potential of friendly or enemy forces to overwatch or support (with direct fire) the movement of their forces, and to observe movement along the avenue of approach and place fire on it from various positions on the terrain. The analysis of fields of fire is mainly concerned with the ability to cover the terrain with direct fire. Positions with good observation for the FIST personnel are also identified. Look at the capability of direct fire weapons from likely or known positions. Reconnaissance from the enemy's viewpoint is most effective when conducting a defensive analysis. Determine where fires may be concentrated.

(a) Offensive considerations:

- What are the fields of fires and observation for enemy weapons on or near the objective? En route?
- Is there any dead space around the objective? On the approaches into it?
- What are the fields of fires and observation from likely support positions?
- Where can the enemy concentrate fires? Where is he less able to concentrate his fires?

(b) Defensive considerations:

- What locations provide good fires and observation on the enemy approaches?
- How obvious are these positions to the enemy?
- Determine possible locations for the key weapons (M60 MGs, Dragons, mortars).

(5) *Cover and concealment.* The analysis of cover and concealment is often inseparable from the fields of fires and observation. Weapon positions must have both to be effective and to be survivable. Infantry units are capable of improving poor cover and concealment by digging in and camouflaging their positions. When moving, the terrain is used to provide cover and concealment.

(a) Offensive considerations:

- Determine the routes with good cover and concealment.
- Identify areas along the approaches to the objective with poor cover and concealment.

- Consider the use of smoke missions/limited visibility to provide concealment.
- (b) Defensive considerations:
- Focus on the locations with good fields of fires.
  - Think about how the enemy can use the available cover and concealment.
- c. Weather factors are considered at the same time as terrain. Primary emphasis is on temperature/humidity, precipitation, wind, cloud cover and visibility. Light data is considered as part of cloud cover and visibility. The commander focuses on how the weather affects the terrain, equipment, and soldiers of both forces.
- (1) *Terrain*. The terrain is most affected by rain, snow, or freezing temperatures. GO terrain may become NO-GO terrain after a heavy rain because it will no longer support vehicle movement. Freezing this same terrain may revert it to GO terrain if it will now support vehicles. The frozen ground may prevent digging fighting positions.
- (2) *Equipment*. The temperature and humidity can change the amount of maintenance required to keep equipment operating. Batteries may not last as long. The soldiers' clothing and boots wear out faster under some conditions.
- (a) *Vehicles*. Aviation assets are grounded by a number of weather conditions. Vehicles freeze to the ground or fail to start in extreme cold. Hot and dusty conditions increase the maintenance needs.
- (b) *Weapons*. The operation and maintenance of weapons are affected by extreme temperatures. Even if the weapon is not affected, the capability to acquire targets may be severely degraded. High winds affect the accuracy of all projectiles particularly indirect fires.
- (3) *Soldiers*. The spirit and morale of the soldiers are affected by the conditions they fight in. In winter zones, more energy and resources may be spent on just surviving the elements than fighting the enemy. Nonbattle casualties may outnumber the battle casualties.

## 2-16. ANALYZE THE ENEMY

Often, a major portion of the enemy analysis has already been completed for the company commander by the brigade and battalion S2s, who had access to much more information. The important enemy information is provided to the company commander in paragraph 1a of the OPORD. The CO must accept this information as accurate because it is what the battalion commander based his concept on. If a company commander developed his concept based on a different enemy COA, he could disrupt the entire battalion plan. Therefore the company commander begins his enemy analysis from the information provided by battalion. However, it is important to realize that the battalion S2's analysis did not focus on the enemy expected in the company's sector or the company's portion of the objective. He was looking at the situation from a broader perspective and with different concerns. It is the company commander's responsibility to refine this information to develop the detailed understanding required to complete his concept. The focus of this analysis is to locate the enemy's strengths (to avoid them) and his weaknesses (to exploit them). The end result of the enemy analysis should be a detailed statement of the enemy's most probable COA. At this point, the commander analyzes the enemy's composition, disposition, recent activities, reinforcement capabilities, possible courses of action, and weaknesses.

a. **Composition.** This is an analysis of the forces and weapons that the enemy can bring to bear. Determine their strength, what weapons systems they have available, and what additional weapons and units are supporting him. The CO must know the enemy's weapons as well as his own. It is this detailed knowledge of the specific characteristics for each weapon that allows the leader to pinpoint the enemy's weaknesses.

b. **Disposition.** The enemy's disposition is how he is arrayed on the terrain, such as in defensive positions, in an assembly area, or moving in march formation. Use enemy doctrinal templates to develop situational templates. Consider how long the enemy has to prepare his defense or attack. When analyzing the situational templates, search for his weak points, which may be exploited to destroy him or to control the decisive ground. Consider where he is accepting risk and where the terrain limits his ability to defend, attack, or gain mutual support. Finally, determine what his intentions are.

c. **Recent Activities.** Identify recent and significant enemy activities that may indicate future intentions. These activities may point out a weakness that the company can exploit. They may also provide a better understanding of what the enemy is likely to do in reaction to the company. This will result in a more effective war-game process.

d. **Reinforcement Capabilities.** Determine positions for reserves and estimated time to counterattack or reinforce. Although the enemy analysis must focus on the enemy force on the company's objective or expected in the company's sector, the CO should consider all enemy forces in his area of interest. To fully understand his enemy force, the CO must understand how the enemy he is fighting fits into the larger enemy force.

e. **Possible Courses of Actions.** Determine the enemy's possible COAs. Analyzing these COAs may ensure that the friendly unit is not surprised during execution. Determine the enemy's most likely COA; use the other possible COAs to develop contingency plans or security taskings. Develop a narrative description and sketch of the enemy COA from start to finish. Examples of enemy COAs follow.

(1) "The enemy will continue to defend with one platoon in a deliberate defense vicinity of HILL 482 oriented to the north and west. Two squads and two MGs are oriented north overlooking a mounted avenue of approach. One squad and one MG is oriented west against a dismounted approach. The platoon CP is on the topographical crest of Hill 482. There are between 20 and 30 personnel in this position. A minefield is located NW of the position at the bottom of the hill. A suspected minefield is west of the position. The confirmed OP is rotated every 8 hours. Security patrols (5 to 7 men) operate north and west of the position at random intervals. An OP is positioned vicinity of HILL 524. Suspected OP locations are at the trail intersection NW of the platoon and on the trail SW of the platoon. We can expect the enemy platoon to retain its position to prevent its parent company from being enveloped from the NW. If forced to withdraw, he will most likely move to the SE where there are supporting fires from the parent company. This company could reinforce the platoon position with up to 20 men in 20 minutes. Figure 2-6 is a situational template of this enemy position.

(2) "The enemy will attack NLT 120800 Dec 87 to seize the high ground vicinity HILL 464 with two MRC (+) conducting the main attack in prebattle formation along avenue of approach C, and one MRC (+) in the second echelon. The CRP and FSE will arrive first and attempt to locate gaps in our defenses. At PL YANKEE, the MRB main body will assume attack formation with tanks leading and will attempt to seize their objective mounted. Specific objectives for the lead MRCs will most likely be the



intersection at GL123456 and HILL 464. Artillery concentrations will be fired on Hill 464 as he crosses PL YANKEE. Smoke will be used to screen his left flank. Although he has the capability to employ chemical weapons, this is not likely. After seizing these objectives, the enemy will continue the attack to seize objectives along the battalion rear boundary. I expect BTR and BMP recon vehicles in our sector within the next 24 hours."

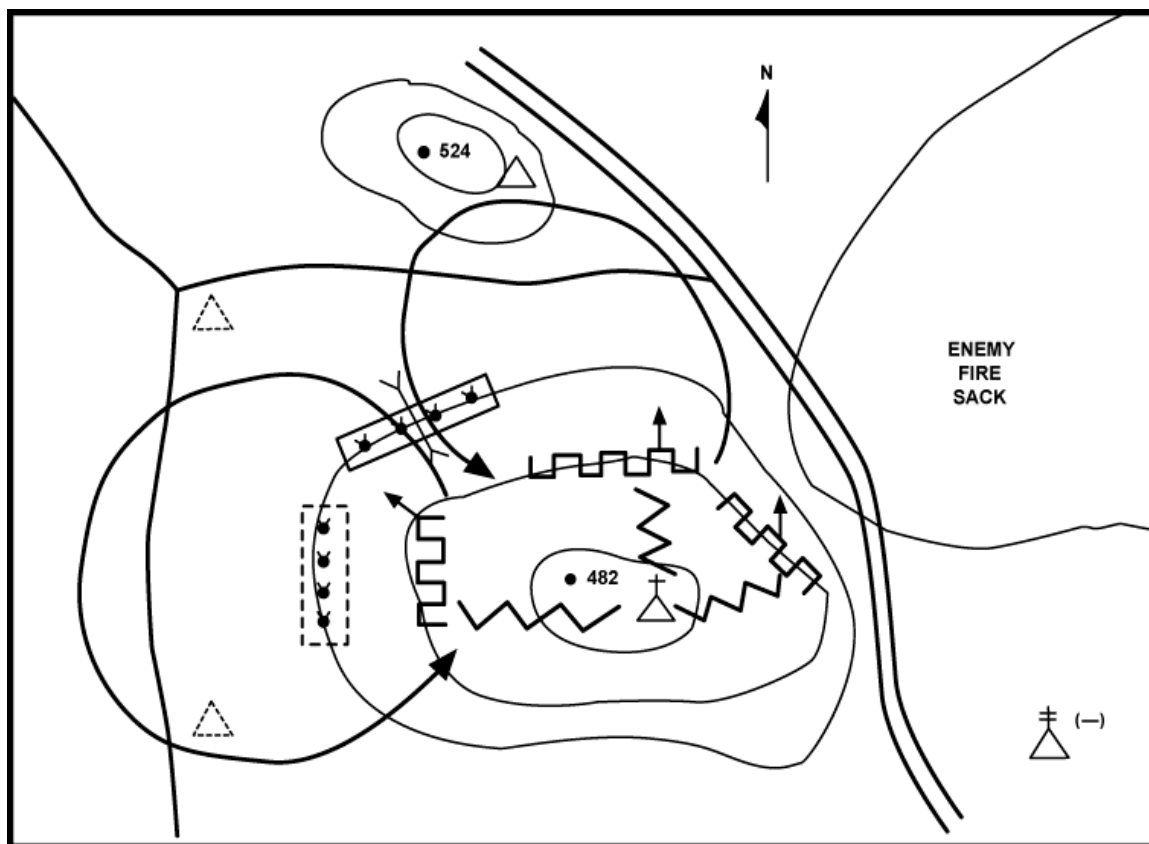

**Figure 2-6. Enemy situational template.**

**NOTE:** In addition to a narrative COA statement for the enemy, the commander develops a situational template of how he expects the enemy COA to look. For example, in the offense, a company commander develops a situational template that depicts enemy squads and their fighting positions, individual vehicles, AT weapons, and crew-served weapons. In the defense, the attacking enemy should be templated down to platoon level. His R&S activities, artillery targets, C2 assets, and obstacles should be templated. Also consider how he may employ smoke, chemical agents, CAS, and deception to support his operation.

f. **Weaknesses.** Identify the enemy weaknesses. Others may result from the war-game process. Determine how to exploit these weaknesses.

**2-17. ANALYZE TROOPS AVAILABLE**

The CO analyzes his troops available to ensure he knows the current status of his company. He also considers the friendly situation to determine how adjacent and supporting units may affect his mission. The purpose of this step is to identify all available resources and to identify any new limitations resulting from recent fighting. The CO considers his current location, disposition, supply status, and personnel strength. He is particularly concerned with losses to key leaders and weapons, ammunition status, and the morale of his men. The CO considers his current task organization and if any changes are planned. He considers the capability of any attached or supporting units and determines the impact of the company's priority in the battalion's fire priorities. Other considerations include:

- The location of the battalion trains and aid station.
- The locations for the battalion main CP and command group.

**2-18. ANALYZE THE TIME**

The commander continuously updates his initial estimate of time and the time schedule. He considers the times specified in the battalion order and any other key times that may have resulted from his analysis of the situation. The deductions made here will assist in synchronizing subordinate units. The CO evaluates time and space considerations (the consideration for how specific units will move in a given situation, the time required, the formations used, and so forth) throughout the estimate.

**2-19. DEVELOP COURSES OF ACTION**

A course of action is a possible plan that accomplishes the company's mission. It is as detailed as necessary to clearly describe how the unit will accomplish the mission and to allow effective war-gaming later in Step 3 of the estimate. It is generally a scheme of maneuver supported by a COA sketch. It describes the employment of the rifle platoons, the antiarmor and mortar sections, and possibly other significant resources, such as attached units, weapons, or engineer support.

a. Normally two or three courses of action are developed; however, the amount of planning time may limit the CO to only one. In this case the XO may assist by also developing a COA and wargaming the two with the CO. Each COA must be:

- Feasible—It accomplishes the mission and supports the commander's concept.
- Reasonable—The company remains an effective force after completing the mission.
- Distinguishable—It is not just a minor variation of another COA.

b. During the analysis of the situation, the commander integrates the facts, makes deductions, and analyzes further. Before developing the COAs, he determines the most critical facts and deductions for this mission. These provide greater focus to the COA development process. Examples of these might be:

- Potential decisive points determined from the integration of the terrain and enemy analysis.
- Limited planning time requiring an immediate decision and quick execution.
- A critical ammunition shortage for the machine guns.
- An identified mistake in positioning of enemy weapons, resulting in a major weakness in his defense.

- A complete lack of information on the enemy force.
- c. These critical factors, the restated mission statement and the other facts and deductions provide the focus for developing the COAs. Each COA should be developed starting at a potential decisive point. If one has not already been identified, consider the focus of the company's mission statement. If it focuses on—
- Gaining or retaining ground, then determine what terrain is most important. If key or decisive terrain has been identified, the decisive point is probably on this ground.
  - Enemy destruction, then determine what the enemy's weakness is. This may result from his organization, his doctrine, or his disposition on the ground. There may be a critical unit, weapon, or asset that is of great importance to the enemy. Its destruction will have a decisive effect on the enemy's ability to generate combat power. A deception task may cause the enemy to react in a way that exposes a weakness. If an obvious weakness is not identified, locate his strengths and plan to avoid these while making an enemy weakness through maneuver or the effect of the company's fires.
  - Security of a friendly force, then determine the most vulnerable part of the friendly force. Consider how the enemy may attack that unit. Look for the terrain that will provide an advantage to the enemy. Consider the approaches he will use to get to this terrain. From this analysis, the CO should be able to identify the area of greatest risk and a potential decisive point.
- d. Once the CO has identified his potential decisive point(s), he develops his COAs using the following process.
- (1) Determine decisive points and times to focus combat power.
  - (2) Determine the results that must be achieved at the decisive points to accomplish the mission.
  - (3) Determine the purposes to be achieved by the main and supporting efforts. (The supporting purposes must be clearly linked to the main effort's assigned purpose).
  - (4) Determine the essential tasks for subordinate units (main and supporting efforts) that achieve these purposes.
  - (5) Task—organize squads to accomplish each mission that has been determined. (The loss of cohesion when moving a squad to another platoon is critical. Normally, platoons do not cross—attach squads.)
  - (6) Assign C2 headquarters. (The platoon headquarters, section leaders, XO, 1SG, and other company leaders are used as required.)
  - (7) Complete a generic task organization by assigning all organic or attached units.
  - (8) Establish control measures that clarify and support the accomplishment of the platoon's assigned mission. (This may also include critical timings for key events.)
  - (9) Prepare a COA statement and sketch.
  - (10) Repeat this process for additional courses of action. (Other COAs may begin with a different potential decisive point, or they may concentrate combat power at the same one using different tasks, purposes, positions, and so forth.)
- e. Consider the following while developing courses of action.
- (1) Where can risk be taken to enable weighting the main effort? What is the likelihood of this action being overwhelmingly decisive?

(2) What assets are needed for immediate subordinates to achieve their specific tasks and purposes? Ensure the main effort is resourced first. If insufficient resources remain to ensure the supporting efforts' missions are attainable, change the tasks or modify the purpose. Do not take resources from the main effort to reduce risk in less important areas.

(3) Ensure mutual support is achieved. This may be done by the physical positioning of units and weapons in relation to each other, or it may be achieved by the clear linkage of purposes in subordinate's mission statements. Often, during decentralized operations, mutual support between the main and supporting efforts is solely dependent on a clear linkage of purposes in the unit's missions.

(4) What freedom of action do subordinates have? Use control measures (axis, DOA, assault positions, objectives, BPs, sectors, engagement areas...) to synchronize subordinate actions without stifling initiative.

f. The essential part of the COA, dealing with the actions at the decisive point (normally on the objective), has been completed. There may be additional details required to allow a thorough war game of each COA from start to finish. These may include:

- Movement prior to the maneuver at the decisive point or following the decisive action.
- Positioning other assets, such as the CP, mortars, or the company trains, and assigning them missions.
- Establishing additional fire control measures or signals.
- Significant soldiers' load decisions such as leaving the rucksacks, Dragons, or company mortars behind for an attack.

If these details are not needed to clarify the COA or to allow a complete war-game process, they should not be included at this time because they will complicate the war-game process.

g. A sketch of the COA will enhance clarity. The sketch should graphically capture the maneuver aspects of the COA. Proper graphic control measures (see FM 101-5-1) should be used, but additional graphics may also be used to clarify the COA. When using this sketch as a concept sketch (as part of an OPORD), these nonstandard graphics must be explained in a legend. The following scenarios and Figures 2-7 and 2-8 show examples of an offensive and a defensive COA statement and sketch. For additional information on concept sketch development, see Appendix G.

(1) *Offensive course of action.*

- COMPANY MISSION STATEMENT: A Co/2-66 IN(L) attacks at 190600 OCT 89, to seize high ground vicinity NB 459270 (OBJ DOG) to prevent the enemy from disrupting 3-66 IN's (BDE Main Effort) attack.
- COA STATEMENT: The company crosses the LD at 0600 along direction of attack Blue and occupies the ORP. After the leader's reconnaissance, one platoon (2 infantry squads, 2 Dragons, and the 60-mm mortars) occupy a support position vicinity hill 455 to suppress enemy positions to support the company's seizure of OBJ DOG. The antiarmor section (4 Dragons) follows the supporting PLT to checkpoint 1, then it establishes ambush positions vicinity road junction at NB459260 to isolate OBJ DOG. The remaining two platoons (3 squads each) occupy the assault position. The lead platoon seizes the western enemy squad position (OBJ TOOL) to allow the trail platoon to pass through and seize the decisive terrain. The trail platoon (company main

effort) remains in the assault position. On-order, it moves through the lead platoon, seizes the high ground vicinity NB459270 (OBJ BOX) to disrupt the enemy's command and control and to dominate the remaining squad positions. Then it destroys any enemy remaining in these positions to the south and east to prevent the enemy from disrupting 3-66 IN's attack. The 1SG with one infantry squad will follow and support the main effort by resupplying ammunition and evacuating casualties.

(2) *Defensive course of action.*

- MISSION STATEMENT: C Co/2-67 IN(L) is prepared NLT 281700 AUG 93 to destroy enemy forces from GL375651 to GL389650 to GL394660 to GL 373665 to prevent the envelopment of A Co (BN Main Effort).
- COA STATEMENT: The company defends with two PLTs forward in sector and 1 PLT in a depth BP. The PLT ( 2 squads) forward in the north destroys enemy forces to prevent enemy bypass of the main effort PLT. The PLT (3 squads, 2 Dragons) in sector to the south destroys enemy forces to prevent an organized company attack against the Co main effort. The main effort PLT (3 squads, 2 TOWs) retains Hill 657 (vic. GL 378659) to prevent the envelopment of Co A (BN Main Effort) from the south. The antiarmor section (1 squad, 4 Dragons) establishes ambush positions at the road junction (vic GL 377653) to destroy enemy vehicles to prevent a concentration of combat power against the main effort PLT. The Co mortars locate vic GL 377664. The antiarmor section initiates fires when the enemy combat reconnaissance patrol reaches the intersection.

## 2-20. ANALYZE THE COURSES OF ACTION

Step 3 of the estimate is the analysis of courses of action. This analysis is conducted by war-gaming the friendly courses of action against the enemy's most probable courses of action. This step of the estimate ensures the COA is viable and that the CO understands how the fight will take place. It clearly shows where the company is taking risks, when/where decisions may be required, and also the advantages and disadvantages of each course of action. Do not begin to compare the friendly COAs at this point in the estimate process. The comparison occurs during Step 4.

a. **Techniques.** Basic techniques for conducting the war game include the box, the belt, and the avenue of approach methods.

(1) *The box.* This method is used to focus the war-game process on a specific area of the battlefield. This may be the objective area, an engagement area, or some other critical area where the decisive action will take place. The leader uses the same action-reaction-counteraction method already discussed, but he limits himself to the actions within the box. The size of the box is determined by the situation, but it should include the units and actions that impact on the decisive action. When time is limited, this technique ensures that the war-game process considers the decisive action, but the disadvantage is that other critical actions/events may not be considered.

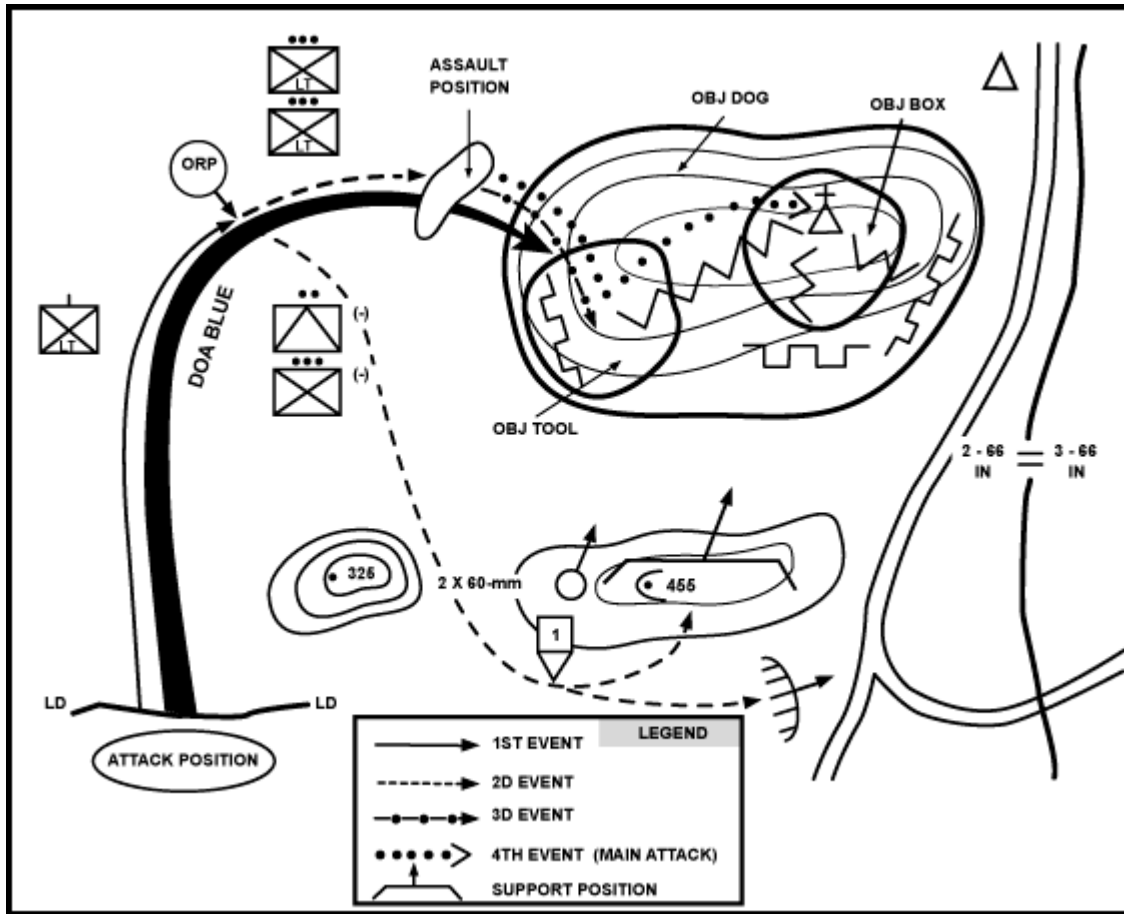

Figure 2-7. Offensive COA sketch.

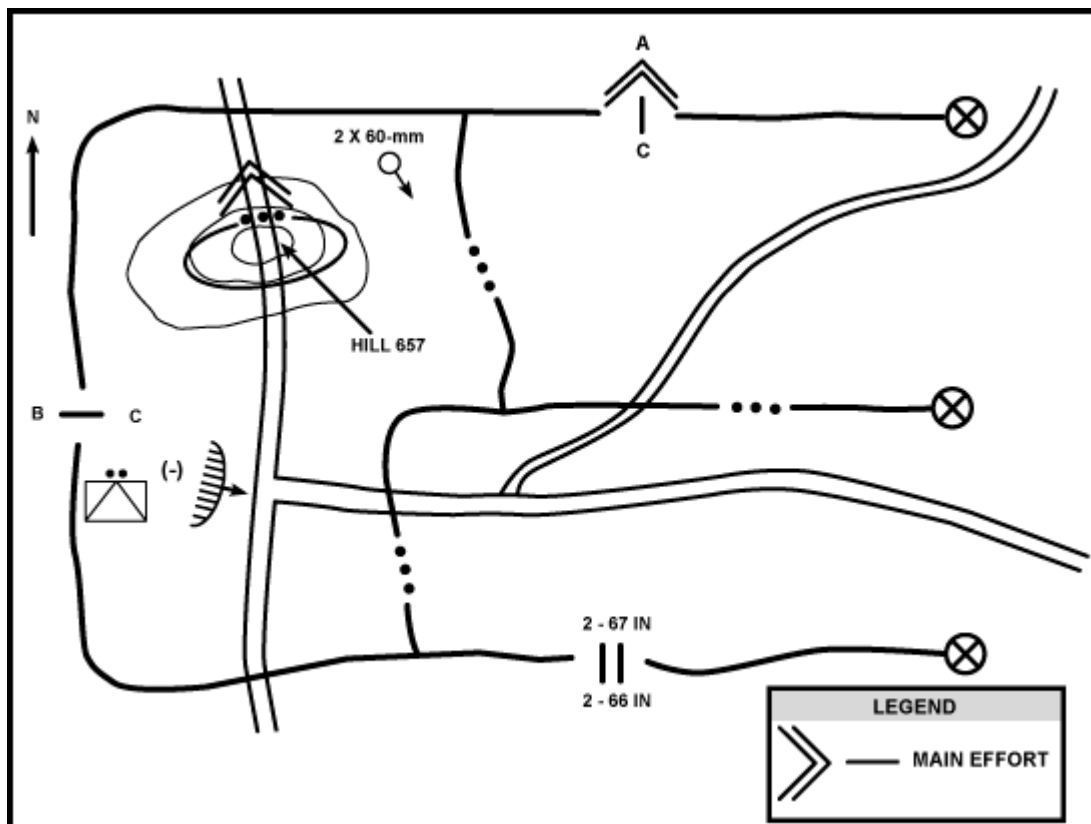

Figure 2-8. Defensive COA sketch.

(2) *The belt*. The leader using the belt technique, divides the COA into sections in depth and then war-games each of these belts in sequence. The offensive COA war-game example used the belt technique initially. The COA was divided into the following phases:

- Movement from the AA into the ATTACK POSITION.
- Movement from the LD to the ORP.
- Actions in the ORP.
- Deployment prior to the assault.
- The assault.
- Consolidation.

Each of these phases was war-gamed in sequence. In the example, once the war game reached the assault phase, the box technique was used to war-game the decisive action in detail. This technique may also be used to war-game a defensive COA.

(3) *The avenue of approach*. It is most often used to war-game a defensive COA when there are several avenues of approach that must be considered. The leader war-games the selected COA against the enemy's most probable COA by focusing the process on one avenue of approach at a time.

b. **War Game**. To war-game the friendly COAs against the enemy most probable COA, the CO mentally fights the battle as he expects it to occur. He divides the COAs into a series of actions or events, analyzes each to determine the likely result or reaction, and then considers the likely counteraction. This process of action, reaction, and

counteraction continues until the mission is accomplished or the COA fails. An example for war-gaming an offensive and defensive course of action is provided.

(1) *Offensive COA war game*. This is a war game of the COA presented in paragraph 2-19g(1).

(a) First action: The company moves from the AA into the attack position.

- Enemy reaction: None. Risk of detection is slight.

(b) Second action: The company crosses the LD and moves along DOA BLUE.

- Enemy reaction: Moderate risk of detection at danger area (HWY 27). If detected, the enemy may engage with indirect fires.
- Friendly counteraction: Suppress known enemy position (vic Hill 325) and suspected enemy position (vic NB423243). Break contact and continue movement on DOA BLUE to the ORP.

(c) Third action: Occupy the ORP.

- Enemy reaction: None.

(d) Fourth action: Conduct leader's reconnaissance.

- Enemy reaction: If detected, the enemy will increase the security on his perimeter and possibly increase his patrolling.
- Friendly counteraction: Options include complete the reconnaissance, immediately initiate the artillery preparation and execute the tentative plan, or move to the alternate ORP and issue a FRAGO.

(e) Fifth action: Support and security elements move into position. The company(-) occupies the assault position.

- Enemy reaction: If he detects the company, his options include engaging with direct and indirect fires, repositioning soldiers or vehicles within his perimeter, or withdrawing to an alternate position.
- Friendly counteraction: Initiate the assault once the support element is in position.

(f) Sixth action: Support element initiates fires; the lead platoon breaches the wire.

- Enemy reaction: Returns direct fire on the support element. Requests indirect fires (TOT- 2 minutes if we are on his planned targets, 5-7 minutes if we have avoided them.) Once detected, the breach site will be the enemy leader's main concern. The two positions with good observation will place effective small-arms fire on the breaching element. The enemy will attempt to reposition the eastern squad to the trench vicinity of the breach site.
- Friendly counteraction: The support element repositions as necessary to prevent enemy movement toward the breach site. The close-in support element (with the breaching platoon) suppresses the two enemy positions in vicinity of the breach. The lead PLT seizes a foothold and begins clearing the trench towards the enemy CP. If the breach is unsuccessful due to reinforcement by the enemy eastern squad, the breaching platoon will maintain pressure here while the trail platoon moves to the alternate breach site (vicinity of the enemy's vacated eastern squad position), to conduct a breach and clear toward the enemy CP. On-order, the lead platoon will disengage and follow through the alternate breach site.

(g) Seventh action: The lead PLT seizes its objective and begins to pass through the trail PLT (main effort).



- Enemy reaction: Options include repositioning soldiers, committing his reserve, withdrawing from this position, or counterattacking with another unit.
- Friendly counteraction: Continue the attack. Once the lead platoon has seized its objective, any enemy repositioning will have little effect. If the enemy has a reserve, it should be too small to have much effect. If he attempts to withdraw, the support element (with the FSO) will destroy him. A counterattack is unlikely and would be engaged by the isolation forces, providing at least 15 minutes early warning.

(h) Eighth action: Main effort platoon seizes the dominant terrain and destroys the enemy CP. Both platoons clear their objectives.

- Enemy reaction: Withdraw or wait for outside assistance. His remaining positions are dominated by the high ground (OBJ BOX) seized by the main effort.
- Friendly counteraction: None.

(2) *Defensive course of action war game.* This is a war game for the COA presented in paragraph 2-19g(2).

(a) First action: Enemy divisional or regimental reconnaissance assets arrive in the company sector.

- Friendly reaction: Security forces engage with direct and indirect fires.
- Enemy counteraction: If the reconnaissance unit was destroyed, the enemy may send other assets to replace them. If not destroyed, they will withdraw and attempt to bypass.

(b) Second action: Enemy CRP enters the company sector.

- Friendly reaction: Forward platoons report situation. Confirm enemy most probable COA. Antiarmor section prepares to initiate ambush at intersection.
- Enemy counteraction: None unless the CRP detects the forward platoons or prior reconnaissance has located the company's positions. If so, the enemy will use indirect fires while the CRP determines the company's dispositions.

(c) Third action: The antiarmor section initiates ambush on the CRP. Forward platoons engage enemy in sectors with direct and indirect fires.

- Enemy reaction: CRP seeks cover and reports. Lead companies deploy, return fire, and attempt to fight through forward platoons. Indirect fires called on any friendly concentrations located.
- Friendly counteraction: Avoid decisive engagements. Maintain dispersed formations.

(d) Fourth action: Main effort platoon engages enemy south of hill 657. Priority of fires shift to the main effort.

- Enemy reaction: He attempts to concentrate against the main effort by fixing with direct and indirect fires. Then he conducts a flank attack with dismounted infantry and repositions indirect assets (AGS 17s and BN mortars) to support this attack.
- Friendly counteraction: Forward platoons engage following forces to disrupt the attack against the main effort. Destroy/disrupt C2 and CS assets as they move into sector. Request CAS on enemy concentrating south of hill 657. (Preplanned CAS mission.)

(e) Fifth action: Enemy assault against the main effort platoon. The enemy second echelon battalion may begin moving through forward platoon sectors.

- Friendly reaction: Depends on the combat potential the enemy has positioned to support the assault. Possibly issue a FRAGO to the antiarmor section and the platoon(-) in the northern sector to reorient against the enemy attacking the main effort. Arrival of a second echelon battalion indicates the enemy main attack is in our sector. This is a change to the enemy most probable COA requiring a FRAGO by battalion.

(f) Sixth action: The main effort successfully retains hill 657.

- Enemy reaction: Remnants of the attacking unit occupy defensive positions vicinity hill 657 to reorganize and prepare to assault again or support another unit's assault. If the lead battalion is unsuccessful, it is unlikely that the second echelon battalion will be committed in this sector.
- Friendly counteraction: Issue a FRAGO to focus all available combat power to destroy this enemy force before he can reorganize.

OR

Action: The main effort is unsuccessful in retaining hill 657.

- Enemy reaction: If the enemy attack is successful, he will reorganize and continue the attack. Depending on his losses, he may pass through another company at this time.
- Friendly counteraction: The main effort platoon withdraws to a rally point in the restricted terrain, reorganizes, and interdicts enemy moving north. Forward platoons continue to destroy enemy in sector. The company reports the situation to battalion and continues to operate to disrupt enemy forces moving through sector.

(g) Seventh action: Exploit success of the main effort. (Even if the main effort did not retain hill 657, the enemy combat potential is degraded and his momentum disrupted.) Concentrate combat power against enemy weaknesses exposed throughout the company sector, such as isolated enemy positions, C2, and CS assets.

- Enemy reaction: He will attempt to reorganize to continue the attack.
- Friendly counteraction: Maintain pressure on the enemy throughout the depth of his unit. Use artillery, mortars, and CAS against his strengths.

c. **Information Learned.** Upon completing the war game of each COA, the leader should know its advantages and disadvantages. He also has identified any critical events that will determine the success or failure of each COA. These factors are used during Step 4 to compare the COAs. In addition, the commander now has a much greater appreciation for the conduct of this mission. The CO will use this information later as he expands the selected COA into the tentative plan for his company.

## 2-21. COMPARE THE COURSES OF ACTION

At Step 4 in the estimate process, the CO compares the COAs and selects the one that is most likely to accomplish the assigned mission. The CO considers the advantages and disadvantages for each COA. He also considers how the critical events impact on each COA. Then he selects significant factors based on this mission; the COAs are then compared using these factors. The CO may also compare the COAs using only the

advantages and disadvantages for each COA. This method is more subjective than using the significant factors that are common to all COAs.

a. **Advantages and Disadvantages.** These are the specific strengths and weaknesses that were noted during the war-game process. They may pertain to the mission, the terrain, the enemy, or any other aspect of the operation. They may apply to just one COA or to all of them.

(1) *Examples of advantages include:*

- Uses the most covered and concealed routes.
- Allows extra time for the leader's reconnaissance.
- Supports the reduction of the soldier's loads.
- Provides an excellent chance of surprise.
- Limits the risk on the secondary approach.

(2) *Examples of disadvantages include:*

- High risk of detection by the enemy's OP.
- Mortar ammunition requirements increase the soldier's loads.
- Time constraint requires daylight movement.
- Does not attack the enemy's weakest point.

b. **Critical Events.** In every operation, there are certain events or activities that will have a major impact on the success of the mission. These may have been identified during the mission analysis, the analysis of the situation, or the war-game process. Normally at company level, these critical events will apply to each COA. The significant factors for the comparison will often result from these critical events. Examples of possible critical events include:

- A forward passage of lines.
- Crossing a major stream en route to the objective.
- Breaching the protective obstacles.
- Gaining a foothold on the objective.
- Evacuating the casualties.
- Defeating the enemy's reconnaissance.
- Controlling the unit's fires into an engagement area.

c. **Significant Factors.** These are common factors that provide the focus for comparing each COA. They are selected for each tactical mission based on mission accomplishment. These factors are significant because they impact directly on the success of the mission. A long list reduces the importance of the most significant factors; therefore, the CO should limit the number of factors to a manageable number. Normally three to seven factors will provide a good comparison. There are two basic types of significant factors, mission-specific and general.

(1) *Mission-specific factors.* These are generated from the requirements for a specific mission. They are often determined by the critical events identified during the war-game process. They may also result from the advantages and disadvantages for each COA. Examples include:

- Casualty evacuation.
- Soldier's load.
- Effectiveness in accomplishing the mission.
- Time usage.

(2) *General factors.* These are for the employment of infantry in all operations. They include the Principles of War, the imperatives of AirLand Battle, the risk involved, the characteristics of the offense or defense, and other such doctrinal guidelines. Although these apply in every tactical operation, certain ones are more important to the mission at hand. The CO determines which these are and then lists them as significant factors for this mission. Examples include:

- Security.
- Simplicity.
- Surprise.
- Exploitation of enemy weaknesses.
- Risk.
- Disruption of the enemy attack.
- Concentration at the decisive point.
- Use of limited visibility.
- Employment of key weapons.

d. **Decision Matrix.** Once the CO has selected the significant factors, he must decide which COA supports each factor the best. The CO compares the COAs using each factor and then makes his decision.

(1) A more detailed technique involves a simple COA decision matrix. This may be required when there are too many factors for the CO to compare. It is important that the CO uses significant factors from his estimate of the situation to develop the matrix. Mission specific factors are used as much as possible. Figure 2-9 provides an example of a COA decision matrix.

(2) There are several ways to use this matrix. The simplest way is to give a + to the COA which best supports each factor. All other COAs would receive a -. Another way is to rank order each COA for each factor. The best COA for each factor receives a 1, next best a 2, and the COA that supports the factor the least would receive a 3. The COA with the lowest sum supports the significant factors best.

## 2-22. MAKE A DECISION

Step 5 of the estimate process involves making the decision. The CO selects the COA that he believes has the best chance of accomplishing the mission. The results of the comparison in Step 4 assist him in making this decision, but they do not make it for him. The CO may not select the COA that the decision matrix indicates is the best. There may be factors that were not included in the matrix but now have a significant impact on the mission. For example: As he analyzed the troops available in Step 2 and selected his significant factors during Step 4, he was unaware of the current status of his company's physical condition. Upon learning of the extent of his company's fatigue, the CO may decide this is the most significant factor to consider in making this decision. Even if the decision had already been made and orders issued before this new information was determined, the CO should immediately update his estimate and decide what impact this may have on his mission. It is this continuous estimate process that allows the CO to make rapid decisions during the fight.

| COAs<br>FACTORS                          | COA#1 | COA#2 | COA#3 |
|--|-------|-------|-------|
| SURPRISE                                 |       | ●     |       |
| FLEXIBILITY                              | ●     |       |       |
| SPEED                                    |       |       | ●     |
| COMBAT POWER<br>AT THE<br>DECISIVE POINT |       | ●     |       |
| USE OF KEY<br>TERRAIN                    | ●     |       |       |
| SOLDIER'S<br>LOAD                        |       | ●     |       |
| TOTAL                                    | 2     | 3     | 1     |

Figure 2-9. Course of action decision matrix.

### 2-23. COMPLETE THE TENTATIVE PLAN

The focus of this process is to generate overwhelming combat power at the decisive point. To do this, the CO positions his units and weapons, assigns them tasks and purposes, allocates resources, designates control measures, and synchronizes activities. He refers back to the deductions from his estimate to complete his plan. To complete the tentative plan, the CO begins with the COA selected at Step 5 of the estimate. He expands this COA into a complete five-paragraph OPORD. The OPORD format is a guide for deciding what information is required to complete the plan.

a. **Task Organization.** The generic task organization from the COA is the basis for this; some changes may have resulted from the war-game process. The CO refers to the task organization in the battalion order and ensures all assets under his control are included in his plan. The CO takes the generic task organization from the COA and develops a specific task organization that assigns squads and weapons to each of his platoons. An example of a company task organization follows:

1st PLT(-)  
1&2 Tms/AA SEC

2d PLT

3d PLT

AA SEC(-)

Co Control  
60-mm SEC  
1/1st PLT

b. **Enemy Situation.** The enemy situation in the BN OPORD (paragraph 1a) is the basis for this, but the CO refined this to provide the detail required by his subordinates. The CO considers the results of his enemy analysis to determine the information he includes in his paragraph 1a. This may include the enemy's composition, disposition, strength, recent activities, and capabilities. He also includes the enemy's most probable COA, which was used in the war-game process. A sketch or enemy overlay should be included.

c. **Friendly Situation.** This information is found in paragraphs 1b, 2, and 3 in the BN OPORD. The BN mission and concept are stated in paragraphs 2 and 3a respectively. The units adjacent to the company (left, right, front, and rear) are found on the operations overlay. Their mission statements are found in both paragraph 1b (adjacent BNs) and 3a (adjacent Cos). Units supporting the company will be found in the battalion task organization and in paragraphs 1b (external to the BN) and paragraph 3 (BN assets).

d. **Mission Statement.** The company mission statement was determined at Step 1 of the estimate. It is normally clearly stated in paragraph 3 of the BN OPORD.

e. **Concept of the Operation.** This paragraph describes how the CO intends to accomplish his mission. At company level, a maneuver and fires subparagraph will always be included. When needed to clarify the concept or to ensure synchronization, additional subparagraphs, such as engineering, EW, intelligence, and counterair operations may be included. The operations overlay/concept sketch is referenced here.

(1) *Maneuver.* The maneuver paragraph should be focused on the decisive action. It may, however, describe the maneuver throughout the operation. At company level, a maneuver paragraph that assigns the missions to each platoon/section and identifies the main effort normally requires no additional clarification. When additional information is required to clarify the concept, the CO may insert this information in the concept of the operation paragraph. Information such as movement formations and techniques, or the order of movement, should only be included if it clarifies the concept. Normally, the coordinating instructions paragraph is the appropriate location for this type of information.

(2) *Fires.* This paragraph describes how the CO intends for the fires to support his maneuver. The company FSO may prepare this paragraph based on the CO's guidance. This paragraph normally states the purpose to be achieved by the fires, the priority of fires for the company, and the allocation of any priority targets. A target list or overlay may be referenced here. Specific taskings for the company mortars should only be stated here if they clarify the concept of the operation.

(3) *Engineering.* Often, especially in defensive operations, this paragraph is required to clarify the CO's concept for preparing obstacles, mines and fortifications. When the company is supported by engineer equipment or units, the CO would state his guidance for employing these assets here. He may do this by stating the priority of effort

(survivability, countermobility, and mobility) and the priority of support for his subordinates (3d PLT, 1st PLT, AA section, 2d PLT, mortar section, and the CP).

f. **Tasks to Maneuver Units.** This paragraph lists the tasks/limitations for each of the platoons and sections. Each of these subordinate units will have a separate paragraph. The information included here comes from two sources—the tasks and limitations identified during the mission analysis and from the war game process.

(1) The tasks from the mission analysis may require only one subordinate unit to complete them. In this case, the CO decides which unit should do this task and assigns it. Examples of these tasks are listed.

- Provide one squad to carry ammunition for the battalion mortar platoon.
- Establish an OP at NB233876 NLT 231000.

Others may require two or more subordinate units or even the entire company to comply with them. In this case, the CO would list these tasks or limitations in the coordinating instructions.

(2) Most of these requirements result from the war game of the COA. They include—

- How to synchronize the operation.
- How to secure the company throughout the operation.
- How to concentrate the combat potential at decisive points.
- How to manage the soldier's load.
- How to degrade the enemy's combat potential.

To accomplish each of these requirements, the CO assigns specific taskings to each of his units. He also assigns specific limitations to certain subordinates. These may be listed here or noted on the company operations overlay/concept sketch.

g. **Tasks to Combat Support Units.** The 60-mm LWCM section and other CS units (engineers, ADA, and so forth) are addressed here.

h. **Coordinating Instructions.** These are requirements that apply to two or more subordinate units. These also may have been assigned by battalion or required based on the COA developed by the company CO. If they do not apply to all the subordinate units, then clearly state those units that must comply. Examples might be:

- MOPP4 in effect at 160730 MAR 94.
- The company time schedule.
- 2d and 3d PLT will each carry 30 mortar rounds.
- The consolidation plan.
- The BN rehearsal is at 211500 DEC 91.

i. **Service Support.** This paragraph provides the critical logistical information required to sustain the company during the operation. Most of this information is extracted from the battalion OPORD. There are also certain requirements generated from the company commander's concept. These may include:

- The location for the company trains.
- The casualty evacuation plan.
- Instructions for caching rucksacks, supplies, or other equipment.
- The resupply plan.

j. **Command and Signal.** This paragraph states where the C2 facilities and key personnel will be located during the operation. It includes the following information from the BN OPORD that subordinates require.

- (1) Locations for the BN main CP and the command group.
- (2) Critical communication requirements, such as radio listening silence in effect forward of the LD.
- (3) Signals for specific events or actions. The company concept will have similar requirements for the company commander to include. These may include:
  - The locations for the CO or CP, and the XO.
  - Adjustments to the unit SOP, such as a change to the succession of command or the standard PZ markings.
  - Emergency/visual signals for critical actions.
  - Signal information.

**NOTE:** The tentative plan should stand alone and have essential information so that it can be issued and executed if time does not permit physical reconnaissance to verify.

#### **Section IV. CONTINUOUS OPERATIONS**

Continuous operations are combat operations that continue around the clock at a high pace, requiring soldiers to fight without letup for extended periods. Opportunities for sleep are scattered throughout the day and night. (See FM 22-9.) Sustained operations are operations conducted 24 hours a day with little or no opportunity for sleep.

##### **2-24. SUSTAINED OPERATIONS**

Sustained operations are when the same soldiers or small units engage in combat operations with no opportunity for the unit to stand down and little time for soldiers to sleep. Infantry units must routinely plan to conduct sustained operations.

##### **2-25. DEGRADATION OF COMBAT CAPABILITY**

As sustained operations continue, all soldiers begin to show effects of general fatigue and lack of sleep. Unless counteracted, unit performance of combat tasks decline. Recent studies indicate performance is degraded by 25 percent for each 24-hour period without sleep. After 96 hours, performance can be expected to be near zero. Determination to endure must be supplemented by countering the adverse effects to slow the rate of decline. It becomes more difficult to perform assigned tasks to the required standard. Leaders need to recognize signs of serious sleep deprivation in their subordinates.

- a. Studies show that the performance in all duty positions does not degrade the same. Performance in a duty position where there is a heavy load of mental tasks (determining, calculating, thinking, decision-making) degrades faster than the performance in a position whose tasks are mainly physical (firing, running, lifting, digging).



b. In addition to the degradation caused by fear, fatigue, and loss of sleep, there is a significant loss of effectiveness caused by operation in MOPP4. When units are using full NBC protective equipment, judgment is degraded, communications are less effective, and information flow between units is reduced.

## 2-26. TECHNIQUES TO SUSTAIN OPERATIONS

To maintain effectiveness, adverse conditions of sustained operations must be overcome. The following are methods the commander can use to reduce degradation, develop the required abilities in soldiers, and prepare his unit to fight sustained operations.

a. **Build Individual Soldier Resources.** Preventive measures are often more effective for keeping groups healthy and active. They include improving or maintaining good physical condition, balanced nutrition, and immunizations.

b. **Provide Good Leadership.** Leadership is the keystone for sustained unit performance.

c. **Set High Standards.** Achieving success during sustained operations demands the highest standards of military professionalism.

d. **Develop Individual Confidence.** It is easier for units to withstand the adverse conditions of sustained operations if they maintain an optimistic, confident outlook. Confidence is the strongest bulwark against stress and performance degradation.

e. **Establish Reliable Communication Channels.** In combat, knowledge of the situation and the status of both enemy and friendly units sustains soldiers.

f. **Cross-train.** This helps ensure that someone is always available to perform a critical task or to help perform it. Criticality of tasks should determine the priority for cross-training.

g. **Develop Coping Skills.** Coping with stress is an important combat skill in sustained operations. (See FM 26-2.) Severe problems may develop after several days if leaders and soldiers do not sleep at least 4 hours every 24 hours. Ideally, the 4 hours should be continuous.

h. **Develop Good Physical Fitness.** Being physically fit strengthens the ability to recover from exhaustion.

i. **Build Stamina.** Fit soldiers withstand the stresses of sustained operations better.

j. **Foster a Spirit and Attitude of Winning.** In sustained operations, a genuine and single-minded dedication often gives the extra strength needed to win.

k. **Foster Cohesion, Esprit, Morale, and Commitment.** Cohesion holds units together; esprit keeps them dedicated to the mission. Unit cohesion and esprit are key sources of strength for enduring the stresses of sustained operations.

l. **Guarantee and Encourage the Free Exercise of Soldier's Faith.** Regardless of their religious background, most soldiers are reassured and calmed if the commander encourages and assists the battalion chaplain in his visits to the unit.

## **2-27. UNIT SLEEP PLAN**

The commander must ensure his unit can conduct both sustained and continuous operations. The only way a unit can conduct CONOPs is that all soldiers and leaders get enough rest.

a. The CO must devise and enforce a work–rest–sleep plan for the company. It must include provisions for leaders as well as soldiers to sleep. Priority for sleep should go to those whose judgment and decision-making are critical to mission accomplishment.

b. The plan should allow soldiers at least 4 to 5 hours of sleep each 24 hours; this will sustain performance for several days. Six to 8 hours of sleep can sustain performance indefinitely.

## CHAPTER 3 MOVEMENT

*Movement should be as rapid as the terrain, the mobility of the force, and the enemy situation, will permit.*

FM 100-5, 1986

*One of the strengths of the infantry rifle company, is its ability to move across almost any terrain in any weather conditions. When the rifle company is able to move undetected, it gains an advantage over the enemy force. If detected during movement, the enemy may be able to apply substantial combat power against the company. The ability to gain and or maintain the initiative often depends on undetected movement by the unit. The rifle company depends heavily upon the terrain for protection from the enemy's fires. The CO also protects his company during movement, by ensuring the company is using proper movement formations and techniques, and by applying the movement fundamentals discussed in this chapter.*

### 3-1. FUNDAMENTALS

The CO's estimate of the situation assists him in deciding how to most effectively move his unit. There is no set method for this. The following fundamentals provide guidance for planning effective company movements.

a. **Do Not Confuse Movement With Maneuver.** Maneuver is defined as movement supported by fire to gain a position of advantage over the enemy. At company level, there is considerable overlap between the two. When planning company movements, the CO must ensure the unit is moving in a way that supports a rapid transition to maneuver. Once contact with the enemy is made, squads and platoons receiving effective fire execute the appropriate battle drills, and leaders begin to maneuver their units.

b. **Conduct Reconnaissance.** Reconnaissance should be conducted by all echelons. The enemy situation and the available planning time may limit the unit's reconnaissance, but leaders at every level must aggressively seek information about the terrain and enemy. One effective technique is to send a reconnaissance element forward of the lead platoon. Even if this unit is only 15 minutes ahead of the company, it can still provide valuable information/reaction time for the company.

c. **Effectively Use the Terrain and Weather.** The company should move on covered and concealed routes. Moving during limited visibility provides more concealment, and the enemy may be less alert during these periods. Plan to avoid known danger areas.

d. **Move As Squads and Platoons.** The advantages to moving the company by squads and platoons include:

- Faster movement.
- Better security. A small unit is less likely to be detected because it requires less cover and concealment.

- More dispersion. The dispersion gained by moving the company by squads makes it much more difficult for the enemy to concentrate his fires against the company, especially indirect fires, CAS, and chemical agents. Subordinate units also gain room to maneuver.
- Better OPSEC. It is much more difficult for the enemy to determine what the friendly force is doing if all he has are isolated squad-sized spot reports.

Although the advantages normally outweigh the disadvantages, when planning decentralized movements, the CO should also consider the following:

- Numerous linkups are required to regroup the company.
- In the event of enemy contact, massing combat power to support a hasty attack or disengagement may take longer.
- There may be some squads without radio communications. This problem can be reduced by planning for contingencies and by using all available resources.

e. **Maintain Security During the Movement.** A primary responsibility of the CO is to protect his unit at all times. This is critical during movement because the company is extremely vulnerable to enemy fires. In addition to the fundamentals listed earlier, the CO provides security for the company by applying the following:

- Use the proper movement formation and technique.
- Move as fast as the situation will allow. This may degrade the enemy's ability to detect the unit and the effectiveness of his fires once detected.
- Ensure that subordinate units correctly position security elements to the flanks, front, and rear at a distance that prevents enemy direct fire on the main body. (Normally, the company formation and movement technique provides greater security to the front, it is the flanks and rear that must be secured by these security elements. The company SOP should state who is responsible for providing these security elements.)
- Enforce noise and light discipline.
- Ensure all personnel camouflage themselves and their equipment.

f. **Make Contact With the Smallest Element Possible.** By making contact with a small element, the CO maintains the ability to maneuver with the majority of his combat potential. The soldiers who first receive enemy fires are most likely to become casualties. They also are more likely to be suppressed and fixed by the enemy.

### 3-2. LOCATIONS OF KEY LEADERS AND WEAPONS

The locations for key leaders and weapons depend on the situation, the movement formation and technique, and the organization of the rifle company. This paragraph provides guidance for the CO in deciding where these assets should locate.

a. **The Company Commander.** The CO locates where he can see and control the company. Normally, he positions the CP at his location, but at times he may move separate from the CP. He may take just his company net RATELO and travel with one of his platoons. This allows him to move with a platoon without disrupting their formation. Generally, the CO (with the CP) operates just behind the lead platoon.

b. **The Company Command Post.** The CP consists of the CO, his RATELOs, the FIST HQ, the communications and NBC sergeants, and possibly other personnel and attachments (XO, ISG, or a security element). The company CP is located where it can best support the CO and maintain communications. To maintain communications, the CP

may need to locate away from the CO. In this case, the XO would control the CP (or part of it) and maintain communications with higher or adjacent units while the CO locates where he can best control the company. Although the CP can move independently, it is normally located in the company formation where it is secured by the other platoons and sections.

c. **The Company Fire Support Officer.** The company FSO normally moves with the CO. At times, he may locate elsewhere to control indirect fires or relay calls for fire from the platoon FOs.

d. **The Company Mortars.** The company mortars are located in the formation where they can provide responsive fires in the event of enemy contact. They should be positioned where they gain security from the other units in the company. They normally are not positioned last in the company formation, because they have limited capability to provide security and their soldier's load often makes them the slowest element in the company. Also, when last in movement, their ammunition, carried by the other soldiers in the company, is not readily available. The mortar squads may be attached to platoons. This would allow two platoons the ability to provide indirect fires (of reduced effects) when in overwatch without having to shift the mortar section each time.

e. **The Antiarmor Section.** This section may move as a unit or attach its teams to the platoons. Moving as a section allows the CO to more quickly mass his antiarmor fires. Attaching teams to the platoons provides some antiarmor and thermal capability throughout the company. This also allows alternating overwatch platoons without having to shift the antiarmor section from platoon to platoon.

f. **Other Attachments.** The locations of other attachments will depend on the situation. CS assets, such as engineers or Stinger teams, are positioned where they can best support the company. For example, the engineers may follow the lead platoon where they would be more responsive, and the Stinger team positioned where the terrain best supports engaging enemy aircraft.

g. **Wheeled Vehicles.** Wheeled vehicle attachments, such as TOWs, the mortar platoon, ambulances, or resupply vehicles, present certain problems to the rifle company commander. The terrain that the infantry company normally moves along will not support wheeled vehicles. It may be possible for the company to secure the roads or trails these vehicles will move on by moving through and securing more restrictive terrain on the flanks.

### 3-3. MOVEMENT FORMATIONS

The company uses six basic movement formations; the column, the line, the vee, the wedge, the file, and the echelon, right or left. These formations describe the locations of the company's platoons and sections in relation to each other. They are guides on how to form the company for movement. Each formation aids control, security, and firepower to varying degrees. The best formation to use depends on the—

- Mission.
- Enemy situation.
- Terrain.
- Weather and visibility conditions (ability to control).
- Speed of movement desired.
- Degree of flexibility desired.

a. When moving cross-country, the distance between soldiers and between platoons varies according to the terrain and the situation. Soldiers should constantly observe their sectors for likely enemy positions, and look for cover that can be reached quickly in case of enemy contact.

b. The commander may specify the platoon formations to be used within the company formation. If he does not, each platoon leader selects his platoon's formation. For example, the lead platoon leader may select a formation that permits good observation and massing of fire to the front (vee formation). The second platoon leader may select a formation that permits fast movement to overwatch positions and good flank security (wedge formation). (Squad and platoon movement formations and techniques are discussed in FM 7-8.)

c. When moving in a formation, the company normally guides on the base platoon to ease control. This should be the lead platoon. In the line or the vee formation, the CO must specify which is the base platoon. The other platoons key their speed and direction on the base platoon. This permits quick changes and lets the commander control the movement of the entire company by controlling just the base platoon. The commander normally locates himself within the formation where he can best see and direct the movement of the base platoon. Terrain features may be designated, using the control measures discussed in paragraph 3-5, for the base platoon to guide on.

d. One technique used to alert units for possible movement or for units to report their readiness to move is an alert status. With this technique, a system of four readiness conditions is used to reflect the amount of time a unit will have before it is required to move.

- REDCON 1: Be prepared to move immediately.
- REDCON 2: Be prepared to move in 15 minutes.
- REDCON 3: Be prepared to move in 1 hour.
- REDCON 4: Be prepared to move in 2 hours.

Using this technique, a CO can quickly and concisely alert a unit for movement or report its readiness to move.

e. The following is a discussion of the infantry company movement formations. (See Figure 3-1 for a legend of symbols for company personnel and elements.)

(1) *Column*. This movement formation allows the company to make contact with one platoon and maneuver with the two trail platoons. It is a flexible formation, allowing easy transition to other formations. It provides good all-round security and allows fast movement. It provides good dispersion and aids maneuver and control, especially during limited visibility. The company can deliver a limited volume of fire to the front and to the rear, but a high volume to the flanks. Figure 3-2 depicts one version of a company column; it shows the lead platoon in vee formation, the middle platoon in a wedge formation, and the last platoon in column.

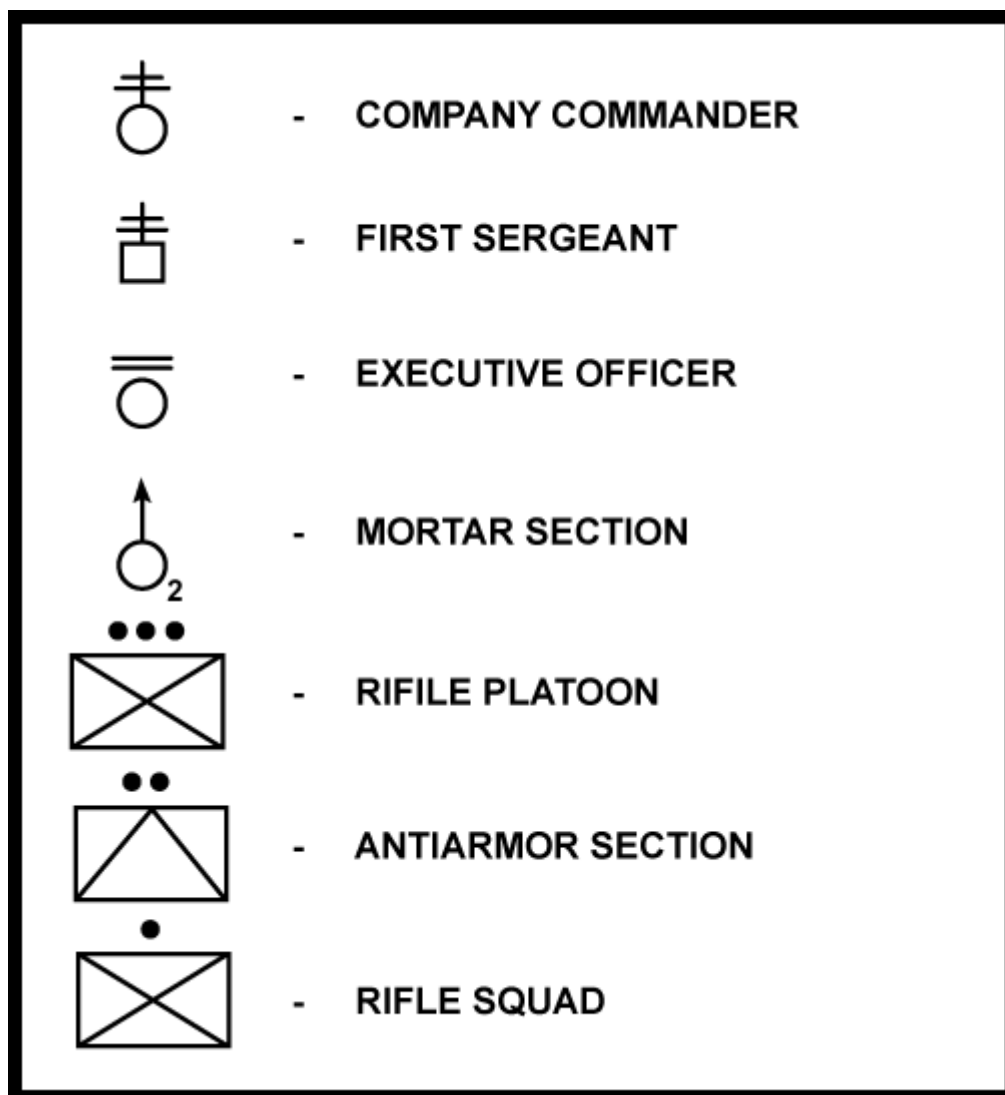

**Figure 3-1. Legend of symbols.**

(2) *Company line.* This formation puts three platoons forward along the same direction of movement and provides for the delivery of maximum fire to the front, but less to the flanks. It is the most difficult formation to control. The company commander should designate a base platoon (normally the center platoon) for the other platoons to guide on. Flank and rear security is generally poor but is improved when the flank platoons use echelon formations. Figure 3-3 depicts one example of a company line; it shows the left platoon in echelon left, the center platoon in line, and the right platoon in echelon right.

(3) *Company wedge.* This formation has two platoons in the rear that can overwatch or trail the lead platoon. It provides for immediate fire to the front or the flanks. The commander can make contact with a small element and still maneuver one or two platoons. If the company is hit from the flank, one platoon is free to maneuver. This formation is hard to control, but it allows faster movement than the company vee formation. Figure 3-4 depicts one example of the company wedge; it shows the lead platoon in wedge, the left platoon in column, and the right platoon in echelon right.

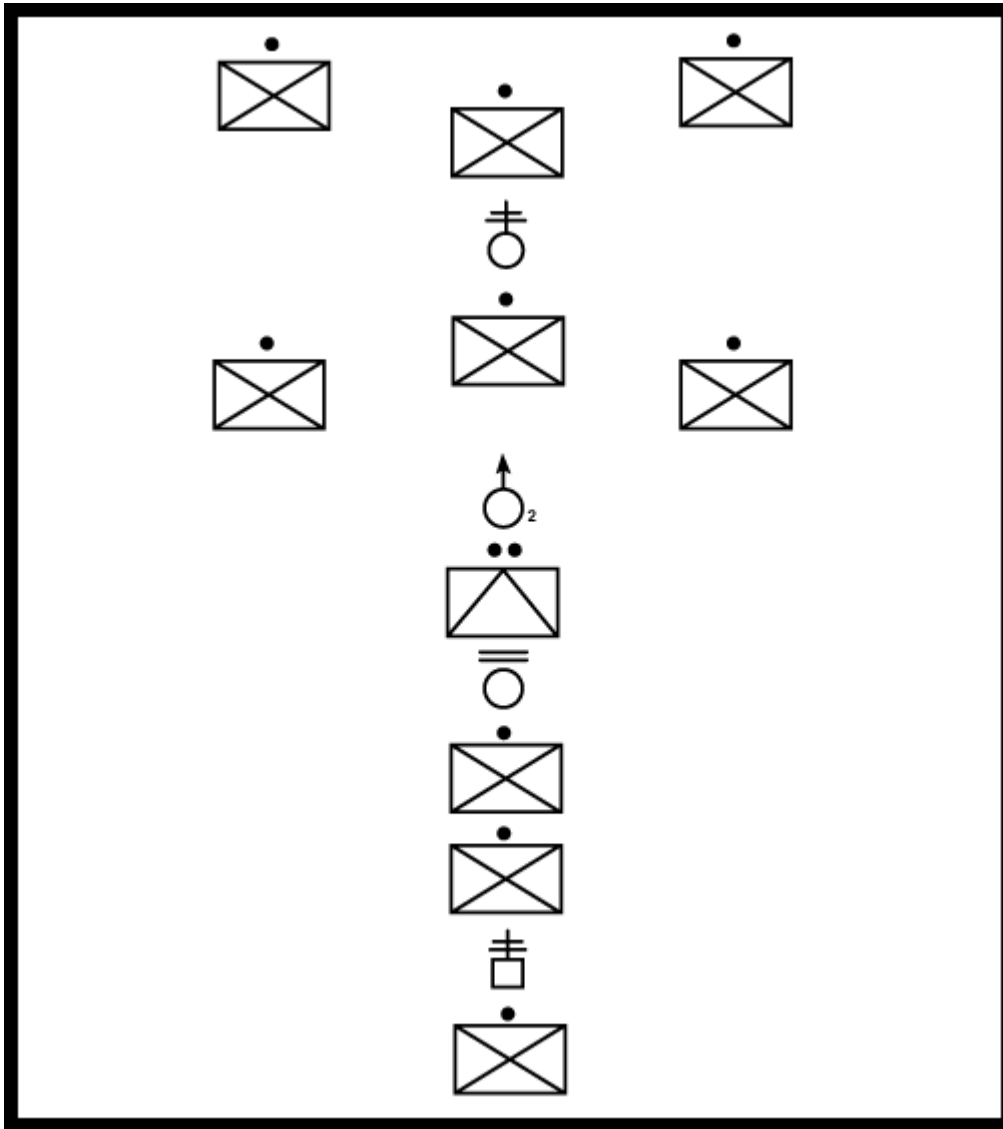
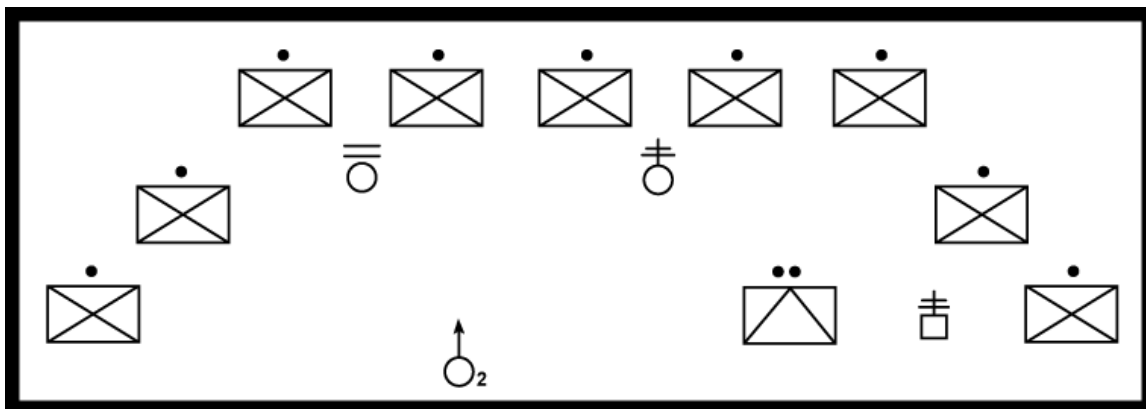
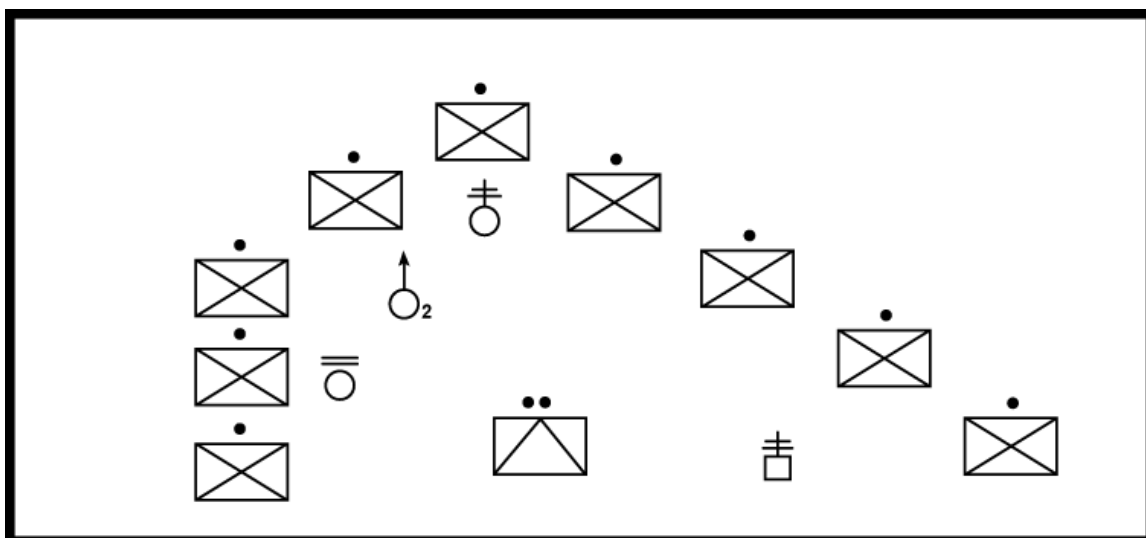

Figure 3-2. Company column.



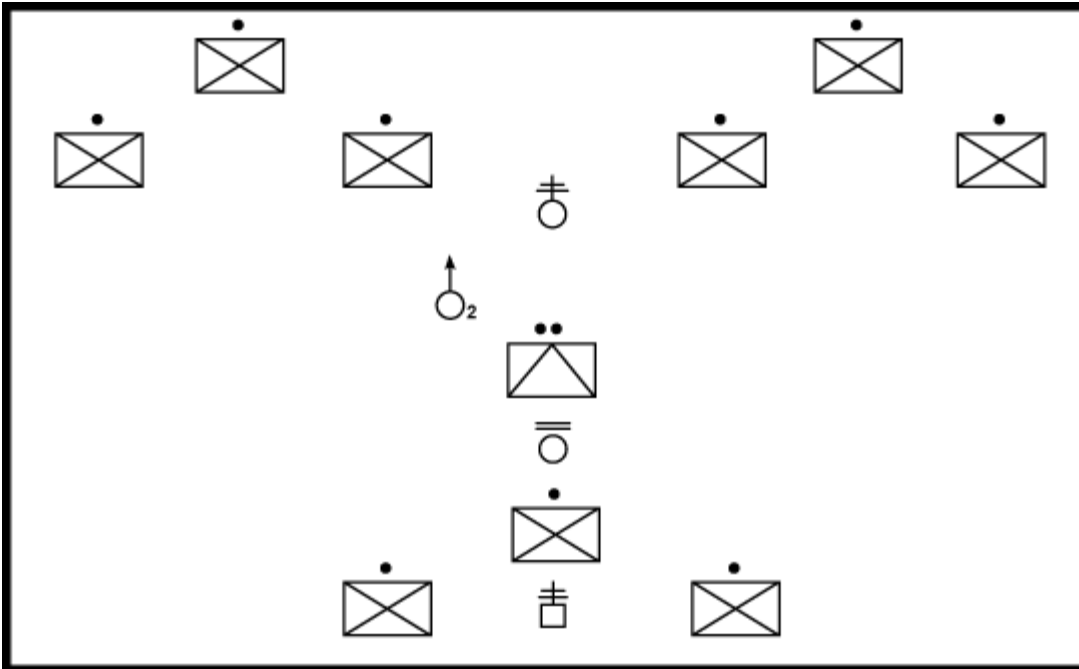

**Figure 3-3. Company line.**



**Figure 3-4. Company wedge.**

(4) *Company vee*. This formation has two platoons forward to provide immediate fire on contact or to flank the enemy. It also has one platoon in the rear, which can either overwatch or trail the others. If the company is hit from either flank, two platoons can provide fire and one is free to maneuver. This formation is hard to control and slows movement. The commander designates one of the forward platoons as the base platoon. Figure 3-5 depicts one example of a company vee; it shows all platoons in wedge.



**Figure 3-5. Company vee.**

(5) *Company file.* This formation is formed by arranging platoon and section files behind the lead element. This is the easiest formation to control. It allows rapid movement in close/restricted terrain or limited visibility and enhances control and concealment. It is also the least secure formation and the hardest from which to maneuver. Figure 3-6 depicts one example of a company file; it shows all units in file.

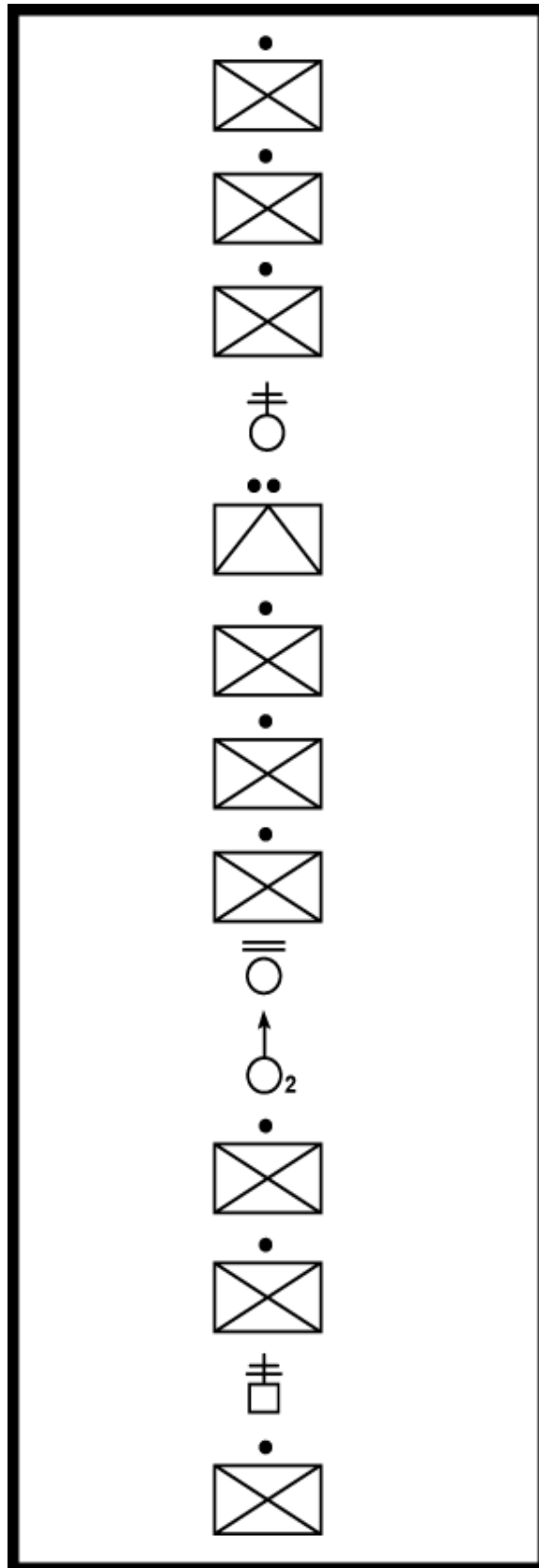

Figure 3-6. Company file.

(a) The commander locates well forward with the lead platoon headquarters or right behind the lead security element. This increases the commander's control by being in position to make critical decisions. The CP can be placed farther back (behind the lead platoon) to avoid interfering with the lead platoon's movement and to aid communications with other elements.

(b) The XO or 1SG is placed last, or nearly last, in the company file to provide leadership and to prevent breaks in contact within the file.

(c) The company file is vulnerable to breaks in contact and should only be used when necessary and for short periods of time. A company of 120 men will stretch out over 600 meters in a company file with a pass time of more than 20 minutes.

(6) *Echelon right or left.* This formation is used if the situation is vague and enemy contact to the front or on one of the flanks is likely. Normally, an obstacle or another friendly unit exists on the flank of the company opposite the echeloned flank. This prevents enemy contact on that side. This formation provides a good volume of fire and protection to the echeloned flank, but less to the opposite flank. Figure 3-7 depicts one example of the echelon right formation; it shows the lead platoon in echelon left, the middle platoon in wedge, and the last platoon in column.

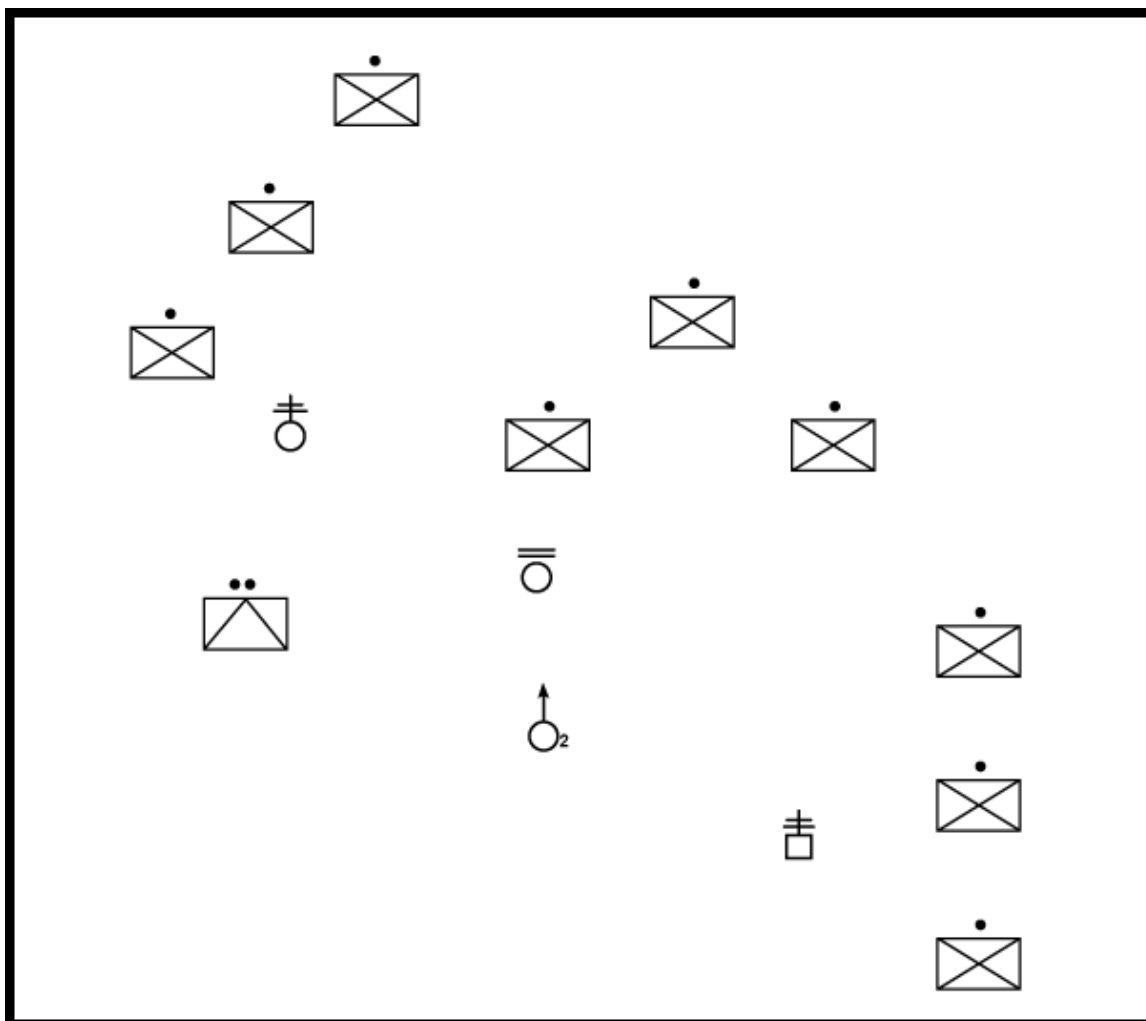

**Figure 3-7. Echelon right.**

(7) *Formation selection.* The CO selects the formation that provides the proper control, security, and speed. Table 3-1 provides a comparison of the six movement formations.

| FORMATION      | SECURITY                            | FIRES                               | CONTROL  | SPEED                |
|----------------|-------------------------------------|-------------------------------------|--|----------------------|
| <b>COLUMN</b>  | GOOD DISPERSION                     | GOOD TO FRONT & REAR                | EASY TO CONTROL  | FAST                 |
|                | GOOD 360° SECURITY                  | EXCELLENT TO THE FLANKS             | FLEXIBLE FORMATION                                     |                      |
| <b>LINE</b>    | EXCELLENT TO THE FRONT              | EXCELLENT TO THE FRONT              | DIFFICULT TO CONTROL                                   | SLOW                 |
|                | POOR TO THE FLANK & REAR            | POOR TO THE FLANK & REAR            | INFLEXIBLE FORMATION                                   |                      |
| <b>WEDGE</b>   | GOOD 360° SECURITY                  | GOOD TO THE FRONT & FLANKS          | LESS DIFFICULT THAN THE LINE<br><br>FLEXIBLE FORMATION | FASTER THAN THE LINE |
| <b>VEE</b>     | BETTER TO THE FRONT                 | VERY GOOD TO THE FRONT              | VERY DIFFICULT   | SLOW                 |
| <b>FILE</b>    | LEAST SECURE                        | POOR                                | EASY TO CONTROL  | FAST                 |
|                | EFFECTIVE USE OF CONCEALMENT        |                                     |  |                      |
| <b>ECHELON</b> | GOOD TO THE ECHELONED FLANK & FRONT | GOOD TO THE ECHELONED FLANK & FRONT | DIFFICULT  | SLOW                 |

**Table 3-1. Formation comparison chart.**

### 3-4. MOVEMENT TECHNIQUES

There are three techniques for moving when not in contact. The commander decides which one to use based on the likelihood of enemy contact, the need for speed, and the terrain and visibility. Movement techniques are not fixed formations. The distances between the soldiers and the units vary based on the mission, enemy, terrain, visibility, and any other factor that affects control. The three movement techniques are traveling, traveling overwatch, and bounding overwatch.

a. **Traveling.** This technique is used when speed is important and enemy contact is not likely (Figure 3-8). The company moves in a company column with 20 to 50 meters between platoons. The distance depends on the visibility afforded by terrain, weather, and light. All six company formations are effective when using the traveling technique.

(1) The commander usually follows the base platoon to ease navigation and control. This lets him see the route and direct the base platoon.

(2) All platoons use traveling. Adequate distance is kept between squads and between soldiers to maintain dispersion in case of enemy contact.

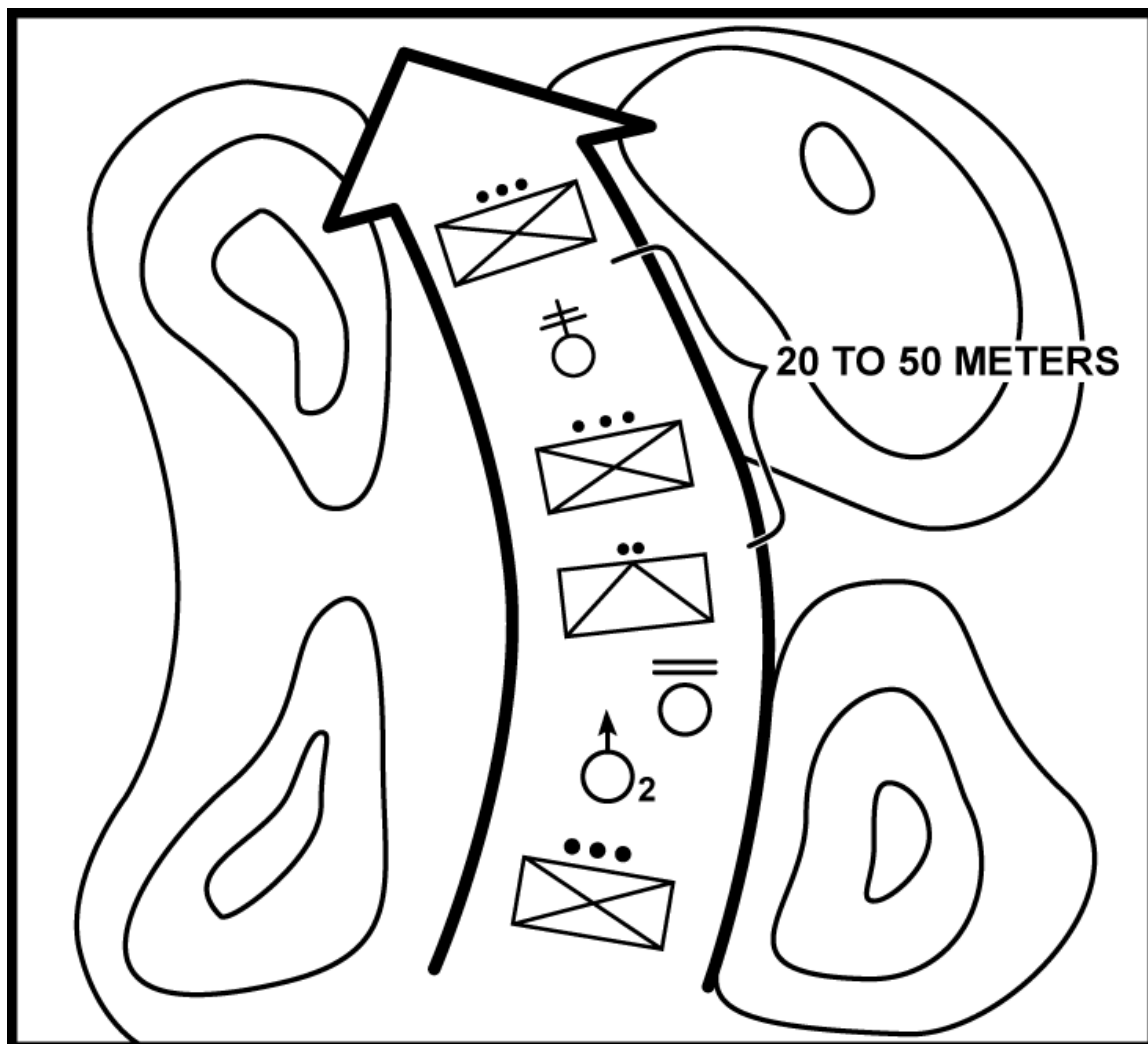

**Figure 3-8. Traveling.**

b. **Traveling Overwatch.** This technique is used when enemy contact is possible, but speed is important (Figure 3-9). The column and wedge are effective formations when using this technique of movement.

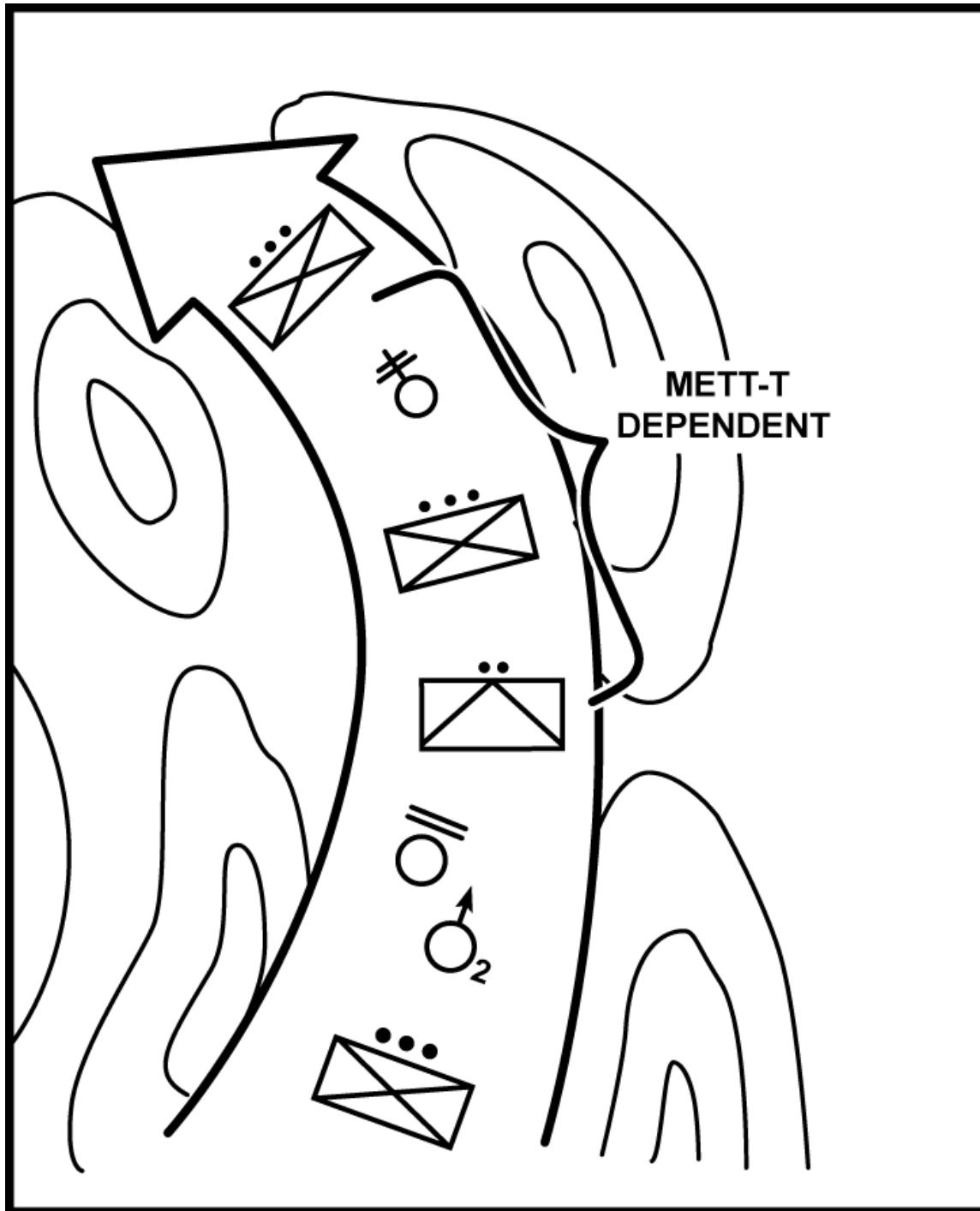

**Figure 3-9. Traveling Overwatch.**

(1) The distance between the lead platoon and the trailing platoon is not fixed. The trailing platoons stay far enough behind the lead platoon to avoid fire directed at the lead platoon, but close enough so they can provide fire support or maneuver when the lead platoon makes contact.



(2) The lead platoon normally uses traveling overwatch while the other platoons use traveling and key their movement on the trail squad of the platoon they follow. However, the company commander may have the lead platoon use bounding overwatch.

c. **Bounding Overwatch.** This technique is used when enemy contact is expected (Figure 3-10). It is the most secure, but the slowest movement technique. Part of the company—the overwatch element—occupies a covered and concealed position with good observation and fields of fire. Another part of the company—the bounding element—moves forward covered by the overwatch element. All movement is keyed to the next position from which the next bounding element will be overwatched. The bounding element never moves beyond the range where it can be supported by the weapons in the overwatch element. When using the alternate method, the roles of bounding and overwatching are changed after each bound. When using the successive method, the same platoon conducts each bound after the overwatch platoon moves forward to the next overwatch position.

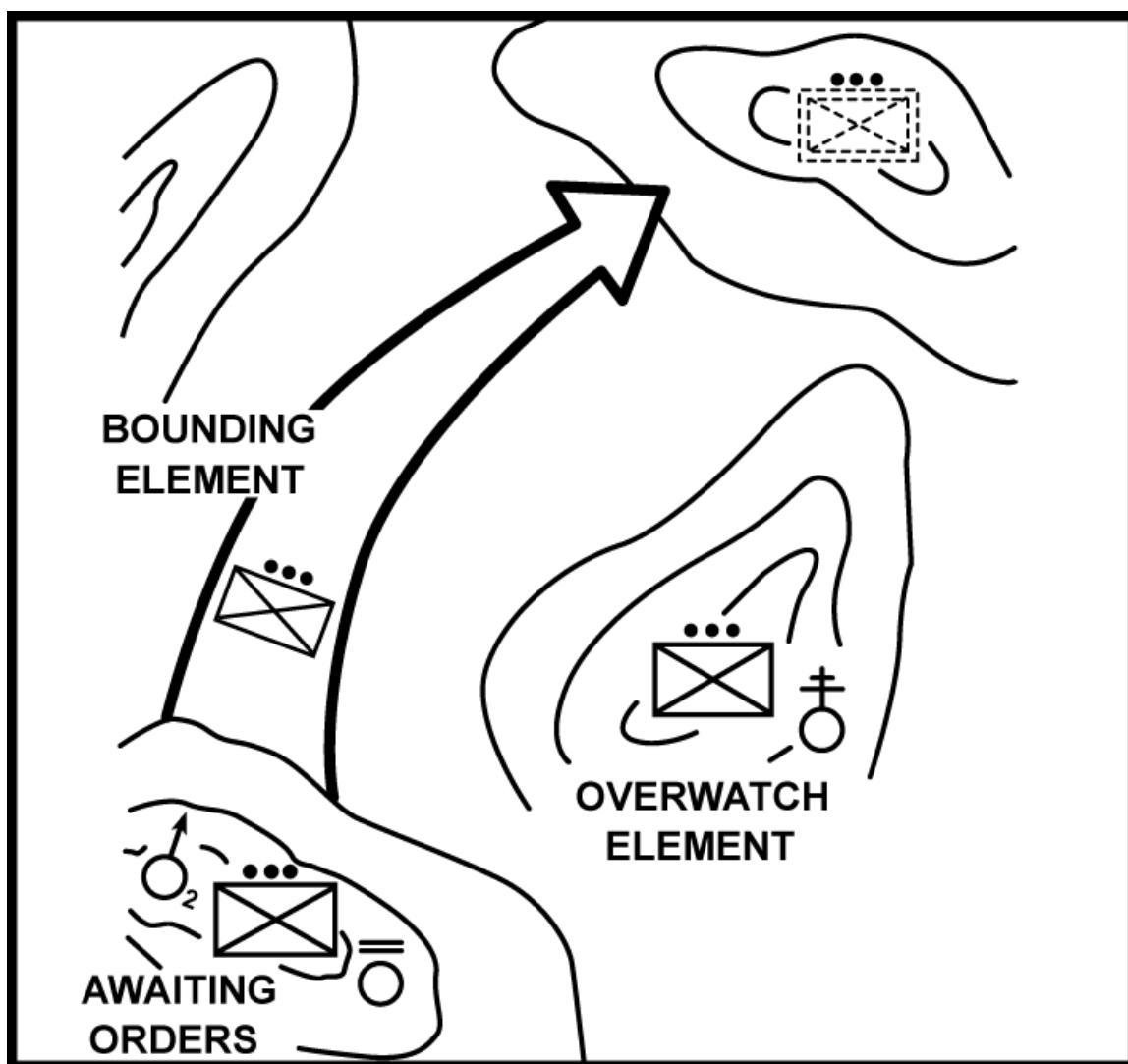

Figure 3-10. Bounding overwatch.

(1) The bounding element, normally a platoon, moves on a covered and concealed route to a position designated by the company commander. It uses either traveling overwatch or bounding overwatch. If the commander can see the entire route of the bounding platoon, he may specify which platoon movement technique to use. If the commander does not select the technique, the platoon leader does. When the platoon reaches its new position, it deploys to overwatch the movement of the rest of the company. Once in position, it remains there while another platoon bounds ahead to the next forward position (alternate method). When deciding where to bound, the commander looks for a position that has cover, concealment, and good observation and fields of fire.

(2) The overwatch element is usually one platoon and the 60-mm mortar section positioned to support the bounding element if it makes contact. Any remaining platoons remain ready and await orders to maneuver or support the bounding element by fire. The company commander normally stays with the overwatch element. The company may alternate platoons as the overwatch and bounding element or reposition the same overwatch element before each bound.

(3) Before a bound, the commander tells the platoon leaders--

- The position of the overwatch element.
- The location of the next overwatch position.
- The route of the bounding element.
- The actions on contact.
- The planned sequence of action.
- How the next order will be given.

### 3-5. CONTROL TECHNIQUES

Using the proper formation and movement technique assists the CO's control of the company. Additional control measures are often required. The following techniques may help in controlling company movements.

a. **Graphics.** Normally, the battalion assigns graphic control measures to integrate the company's movement into the battalion's movement or scheme of maneuver. The CO may need to establish other control measures to control his units. The CO ensures that each graphic control measure can be easily located on the terrain. These may include boundaries, routes, checkpoints, release points, and TRPs on likely enemy positions, to control direct fires.

b. **Reconnaissance.** Prior reconnaissance will aid control during movement. It will provide the CO a better idea of where movement is more difficult and where graphic control measures are needed. It should be conducted by all leaders.

c. **Guides.** Guides who have already seen the terrain are the best way to provide control. When it is not possible to have guides for the entire movement, have them reconnoiter the difficult areas and guide the company through them.

d. **Navigational Aids.** Every leader should use his compass and a pace man for all moves. Select routes that allow leaders to use prominent terrain to stay oriented.

e. **Limited Visibility Movements.** The control measures already listed are the best way to provide control for moving during limited visibility. However, the following measures will provide extra control during these periods.

(1) *Use night vision devices.* Every soldier does not have to use NVDs to move effectively. If the soldiers providing front, flank, and rear security use them, the entire

unit can move faster. These soldiers should be rotated to maintain effectiveness. Key leaders throughout the formation should also use them. If not being used, all NVDs should be accessible for use in the event of contact.

(2) *Reduce the interval between soldiers and units.* Closing up the formation allows the use of arm-and-hand signals and reduces the chance of breaks in contact. However, leaders should try to maintain the most dispersion possible at all times. Well-trained units should be able to operate at night as they do during the day.

(3) *Use other measures.* These include using luminous tape on the back of the helmets, slowing the speed of movement, using land line for either communications or to guide units, and moving leaders closer to the front.

### **3-6. SECURITY DURING MOVEMENT**

During movement, each platoon is responsible for a sector, depending on its position in the formation. Also, each fire team and squad within the platoons is given a sector, so the company has all-round security (Figure 3-11).

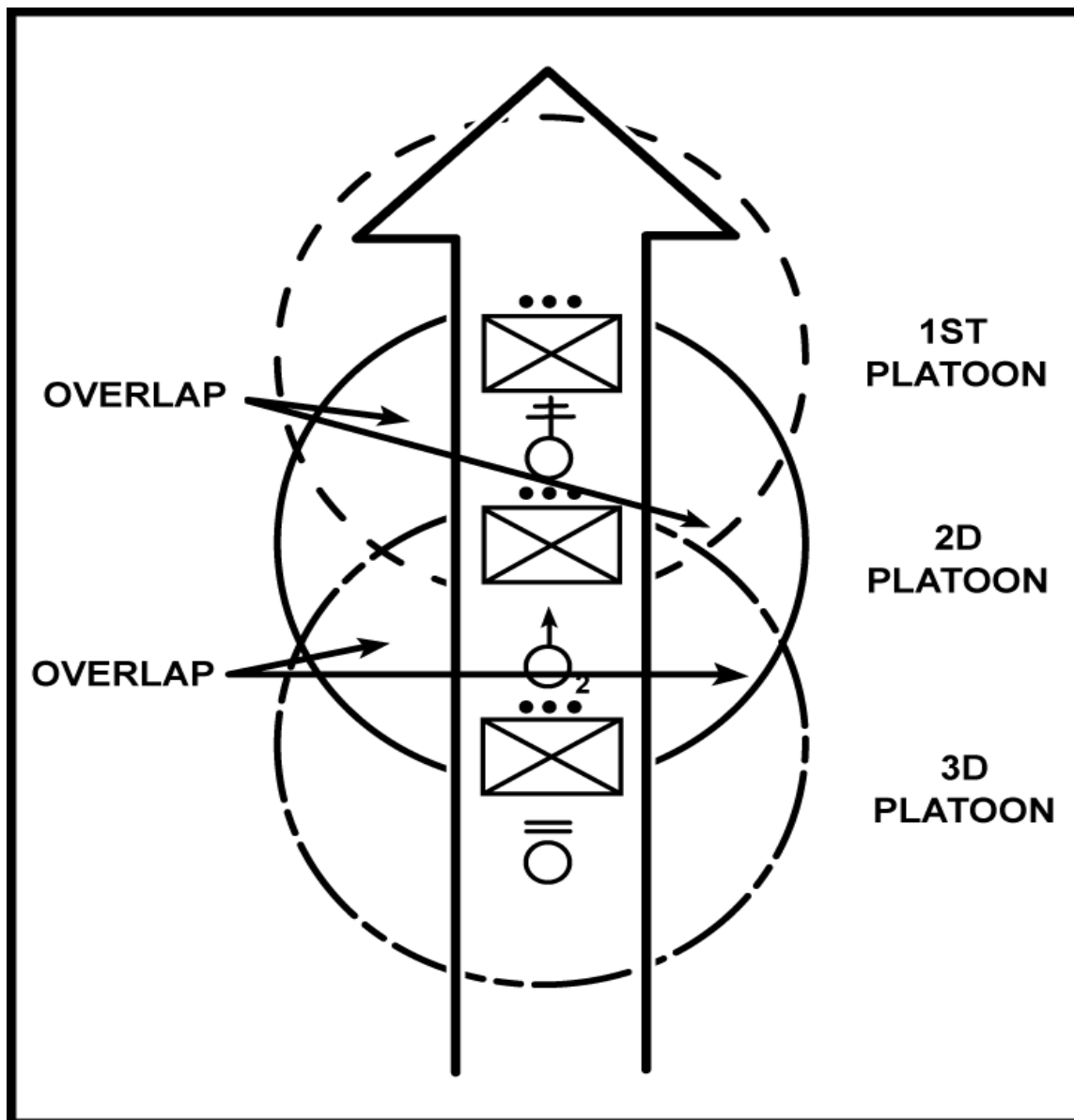

**Figure 3-11. All-round security.**

a. During short halts, soldiers spread out and assume prone positions behind cover. They watch the same sectors that were assigned while moving. Leaders set up OPs, machine guns, and antiarmor weapons on likely enemy approaches into the position. Soldiers remain alert and speak (quietly) only when necessary. They keep movement to a minimum. Soldiers with night vision devices scan areas where the enemy may be concealed during limited visibility.

b. During long halts, the company sets up a perimeter defense (Chapter 5). The commander chooses the most defensible terrain (with good cover and concealment). The company SOP should address the actions required during long halts.

c. For additional security, small ambush teams may be concealed and remain in position after a short halt. Ideally, these teams should be provided by the platoon in the center of the company formation. These teams remain in position to ambush any enemy

following the company. The linkup of these teams must be coordinated and understood by all.

d. Before occupying a static position (ORP, patrol base, or AA), the CO should ensure that the enemy is unaware of his location. In addition to using the ambush teams, the CO may also conceal security teams in or near the tentative static position as the company passes by. The company continues movement, preferably until darkness, and then circles back to link up with the security teams, who have reconnoitered the position, and guide the company in.

### **3-7. MOVEMENT AS PART OF A BATTALION**

The company often moves as part of the battalion. The battalion commander assigns the company a position within the battalion formation. The company commander uses the movement technique and movement formation that best suits the likelihood of enemy contact and the unit mission. Regardless of the company's position within the battalion formation, it must be ready to make contact or to support the other companies by fire alone or by maneuver. (See FM 7-20.)

## CHAPTER 4

# OFFENSIVE OPERATIONS

*The attack must be violent and rapid to shock the enemy and to prevent his recovery until the defense has been destroyed. The attacker must minimize his exposure to enemy fires by using maneuver and counterfire, avoiding obstacles, maintaining security, ensuring command and control, and remaining organized for the fight on the objective.*

FM 100-5, 1986

*The infantry rifle company normally conducts offensive operations as part of a larger force. Offensive actions allow the CO to choose the time and place to engage in battle and to exploit the strengths of his company in the most effective manner. This requires the company to seize/retain the initiative. In the attack, the company maneuvers along lines of least resistance using the terrain for cover and concealment. This indirect approach affords the best chance to achieve surprise on the enemy force. Infiltration by small units through the enemy main defenses allows the infantry company to concentrate combat power against enemy weak points. Once the position of advantage is achieved, the infantry company conducts a rapid and violent assault, normally under the cover of darkness, to accomplish its mission. An excellent example of an infantry company attack occurred in the Philippines during World War II.*

In January 1945, as the Sixth Army was advancing across the island of Luzon, the 6th Ranger Battalion was tasked to conduct a raid behind enemy lines to liberate more than 500 allied POWs from a camp near the town of Pangatian. The battalion commander, realizing that a smaller force had the best chance of achieving surprise, decided to use only a reinforced rifle company to conduct this raid. He selected C company and one platoon from F company. The total strength of the force was 128 personnel, but they would receive additional support from several local guerrilla units.

The initial focus was on gathering the intelligence that was critical to the success of this mission. Aerial and ground reconnaissance provided this information, and the camp was placed under surveillance days before the raid. The first phase of the operation was a 14-mile infiltration through enemy forces to a town 5 miles north of the camp. This was successfully completed the night of 28 January, and the company linked up with the guerrillas that had the camp under surveillance.

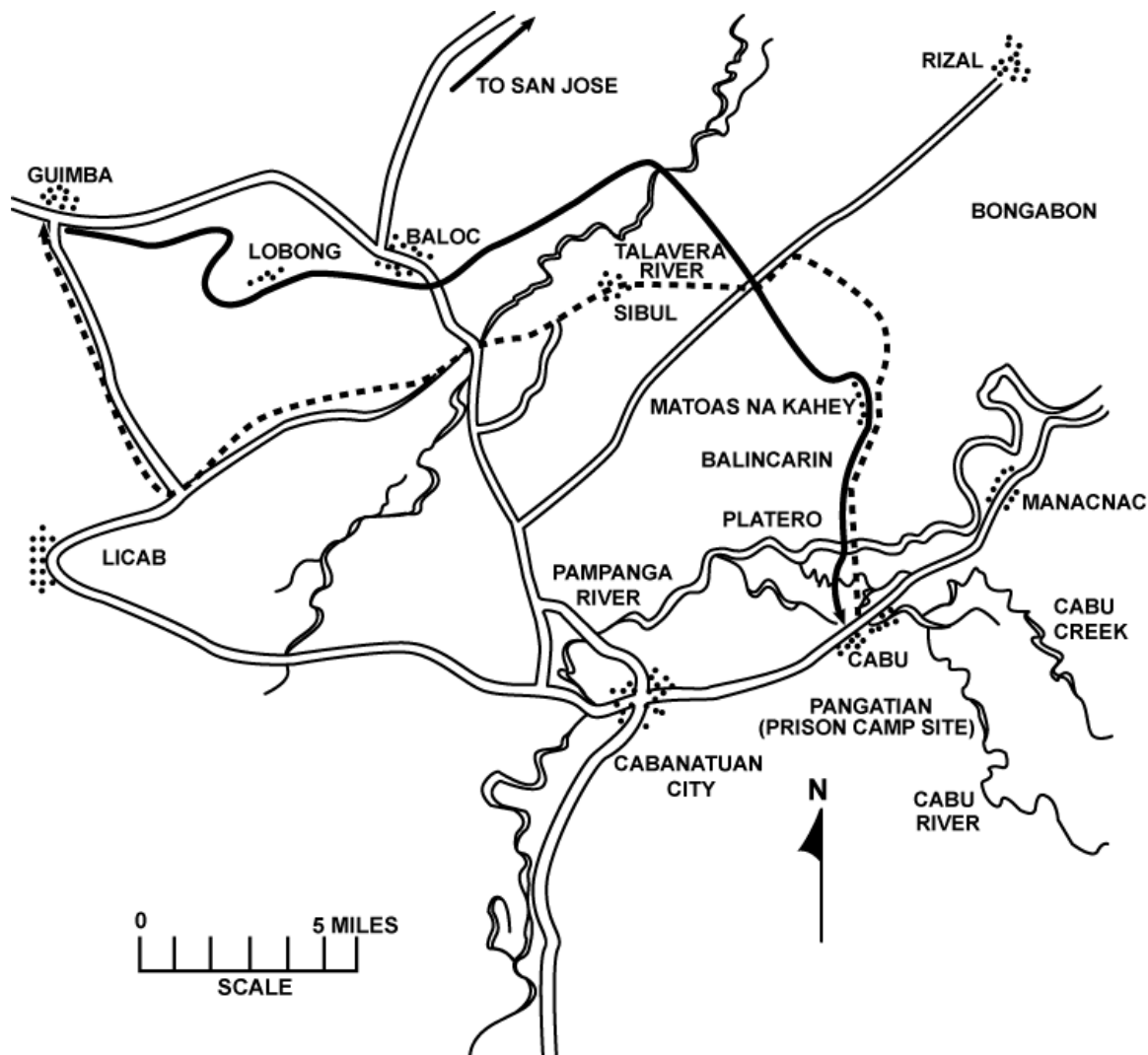

**Infiltration/exfiltration routes.**

These guerrillas stated there was heavy movement of enemy soldiers and tanks all around the camp due to the enemy's continued withdrawal from the Sixth Army. The decision was made to postpone the raid for 24 hours to conduct detailed reconnaissance of the objective area. This resulted in the location of an enemy division near Cabanatuan City and also 200-300 soldiers bivouacked on Cabu Creek just east of the camp. This was in addition to the 250 enemy soldiers who were known to be inside the camp. With this information, the plan was completed.

The plan was to initiate the raid at dusk on 30 January. The objective would be isolated by roadblocks on the main highway to prevent reinforcements from the east or west. A support element would destroy the enemy guard towers and pill boxes while the assault force penetrated through the main gate to neutralize all the enemy within the camp and to bring out the POWs. More than 50 handcarts were provided by local civilians to evacuate the POWs that were unable to walk.

At 1945 hours, all the units were in position and the assault was initiated by the support element engaging the guard positions. The assault force stormed the camp and within 12 minutes the camp was secured and the evacuation of the POWs begun. The

enemy east of the camp had reacted almost immediately and a fierce fight was taking place at the roadblock on the Cabu Creek, but the enemy was unable to get through this position. By 2015 hours, all the POWs were out of the camp and moving in a long convoy towards the north. There were two Rangers killed in the action at the camp, and only one POW had died (of an apparent heart attack).

The evacuation convoy moved as rapidly as possible towards friendly lines. By 1100 hours on 31 January, they had successfully exfiltrated 19 miles back to the forward elements of Sixth Army. Five hundred and twelve allied POWs were liberated as a result of this operation and more than 400 enemy killed. Friendly losses were 2 KIA, 2 WIA, and 27 guerrillas listed as dead or missing.

This attack was successful because the CO effectively applied the fundamentals for an attack. The infantry rifle company CO must also apply these fundamentals today. The audacity and aggressiveness displayed by F Company, 6th Ranger Battalion must also be present in our attacks today. The success of this attack began with the detailed preparations. Using the night and an indirect approach to get to the decisive point are essential to the success of today's infantry units as well. The violent concentration of combat power initiated with surprise and delivered with speed resulted in the rapid seizure of the camp. A simple concept that is clearly understood by all, based on the results of an effective reconnaissance, and executed with speed and violence are still the keys to winning the close fight.

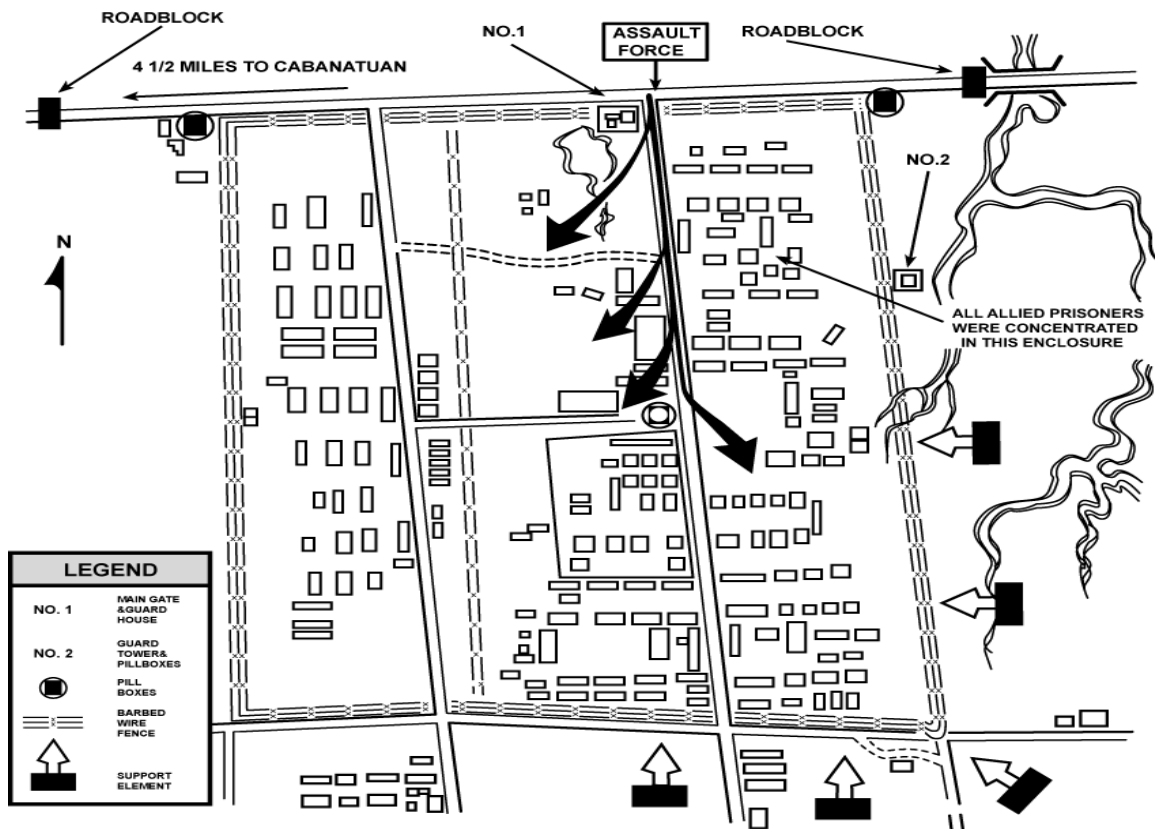

**Actions on the objective.**



## Section I. OFFENSIVE FUNDAMENTALS

The infantry rifle company is best suited for night offensive operations. It is most effective attacking at night to destroy enemy C2, CS, and CSS assets. When required to fight the enemy's combat forces, the rifle company must achieve surprise and use the indirect approach to get to the decisive point. For sustained operations or when required to fight an enemy with a significant firepower/mobility advantage, the infantry company generally requires augmentation with CS and CSS assets.

### 4-1. PURPOSE

Offensive operations are conducted for varied purposes. Some of these are—

- To destroy enemy personnel, equipment, and resources.
- To seize or secure key or decisive terrain.
- To gain information.
- To deceive and divert the enemy.
- To hold the enemy in position.
- To disrupt an enemy attack.

a. The attacker must have superior combat power at the decisive point to overcome the enemy defense. Economy of force must be used at other locations to achieve concentration of combat power at the decisive point. Once the attack is successful, the enemy must be pressed relentlessly to keep him off balance.

b. Attacks should avoid the enemy's strengths. The goal of the commander should be to strike the enemy with an overwhelming concentration of combat power from an unexpected direction when he least expects it.

### 4-2. CHARACTERISTICS OF OFFENSIVE OPERATIONS

All successful offensive operations use surprise, concentration, speed, flexibility, and audacity. The CO decides how they are applied for each mission.

a. **Surprise.** Units achieve surprise by striking the enemy at a time, at a place, or in a manner for which he is unprepared. Total surprise is rarely essential, simply delaying or disrupting the enemy's reaction is usually effective.

(1) Surprise delays his reactions, stresses his command and control, and induces psychological shock in soldiers and leaders. This may allow an attacker to succeed with fewer forces than he might otherwise require.

(2) The rifle company's ability to attack during limited visibility, to operate in small units, and to infiltrate, are often key to achieving surprise. The company must exploit the effect of surprise on the enemy before he can recover.

b. **Speed.** Speed promotes surprise, keeps the enemy off balance, contributes to the security of the attacking force, and prevents the defender from taking effective countermeasures.

(1) Properly exploited, speed confuses and immobilizes the defender until the attack becomes unstoppable. It is built into operations through careful planning.

(2) The rifle company increases its speed in the attack by using simple plans, decentralized control, and mission orders. Speed of movement depends on reconnaissance, reducing the soldiers' loads, using proper movement formations and techniques, and selecting good routes. Speed in planning results from effective SOPs, capable leaders, and the proper use of time.

c. **Concentration.** The attacker concentrates combat power at decisive points and times to achieve decisive results. Leaders strive to concentrate the effects of their combat power while maintaining their dispersion in small units.

(1) Because the attacker is often moving across terrain the enemy has prepared, he may be exposing himself to the enemy's fires. By concentrating overwhelming combat power, he can reduce both the effectiveness of the enemy fires and the amount of time he is exposed to these fires.

(2) The challenge for the CO is to concentrate combat power while reducing the enemy's ability to do the same against his unit. Actions that cause the enemy to shift combat potential away from the decisive point result in a greater advantage in combat power there.

d. **Flexibility.** At some point in most attacks, the original plan must be adjusted to meet the changes in the situation. Mission orders and competent subordinate leaders with initiative will ensure the proper adjustments are made.

(1) The commander must expect uncertainties and be ready to exploit opportunities. The flexibility required often depends on the amount of reliable intelligence on the enemy.

(2) The CO builds flexibility into his plan during his estimate. By conducting a thorough war-game process, he develops a full appreciation for possible enemy actions. A reserve increases the CO's flexibility.

e. **Audacity.** Audacity is the willingness to risk bold action to achieve positive results. The audacious commander develops confidence by conducting a thorough estimate. His actions, although quick and decisive, are based on a reasoned approach to the tactical situation and on his knowledge of his soldiers, the enemy, and the terrain. He is daring and original—he is not rash!

(1) Audacious commanders throughout history have used the "indirect approach". They maneuver to maintain a position of advantage over the enemy, seek to attack the enemy on the flank or rear, and exploit success at once, even if this briefly exposes flanks.

(2) Boldness and calculated risk have always been the keystones of successful offensive operations. They must, however, be consistent with the higher commander's mission and intent.

#### 4-3. PHASES OF OFFENSIVE OPERATIONS

All offensive operations tend to occur in phases, although the length and nature of each phase varies. The general phases of offensive operations are preparation, attack, exploitation, and pursuit.

a. **Preparation.** Companies prepare for the offense by using troop-leading procedures. These include planning and issuing orders, preparing personnel and equipment, conducting reconnaissance, and rehearsing.

b. **Attack.** Companies normally attack as part of a larger force. The attack phase may include either a hasty or a deliberate attack. Most attacks by the company consist of an approach to the objective, the assault or actions on the objective, and the reorganization/consolidation.

c. **Exploitation.** A company normally takes part in exploitations as part of a larger force; however, the company should exploit tactical success at the local level within the higher commanders' concept of the operation.

d. **Pursuit.** The objective of the pursuit phase of an operation is the total destruction of the enemy force. The company may take part in a pursuit as part of a larger force.

#### 4-4. OFFENSIVE FRAMEWORK

A simple, complete concept of operation is the basis of all tactical offensive operations. All company offensive operations consist of R&S activities, a main attack with supporting attacks, and sometimes, reserve operations. Companies may conduct any of these operations as part of the battalion mission.

a. **Reconnaissance and Security.** Before an attack can begin, the enemy must be found. This includes locating flanks, gaps, weaknesses, and obstacles in his position or formation. At the same time, friendly forces must be protected from surprise and yet still be able to rapidly deploy when contact is made with the enemy.

(1) Reconnaissance is done to obtain information about the enemy or the terrain. The company's reconnaissance is focused on collecting information that is critical to the attack. These requirements may be directed by the battalion or the CO.

(2) Security is the use of protective measures to prevent enemy observation or fires on the company. All platoons/sections are responsible for their own local security. They may also be given specific security tasks as part of the company R&S plan.

(3) Companies, platoons, and squads conduct patrols, establish OPs, and move using appropriate movement formations and techniques to accomplish both reconnaissance and security tasks. Commanders and subordinates must clearly understand what they are to accomplish. In some cases, they will only observe and report; while in others, they will also be required to fight.

b. **Attacks.** Closing with the enemy by maneuver to destroy or capture him is an attack. This is the primary task of the infantry in warfare. The company may be designated the main or supporting attack within a battalion. It also designates its own main and supporting attacks.

(1) The main attack accomplishes the mission. A platoon is the main attack for a company if the platoon's attack will accomplish the company mission.

(2) A platoon supporting attack helps the main attack succeed. Supporting attacks are used to suppress, deceive, fix, or isolate enemy units; to seize terrain that is key to the company's mission; or to protect the main attack from enemy counterattacks. A follow and support force is also a supporting attack. It is a committed force, not a reserve, that is assigned specific missions in support of the main attack. These may include: destroy by-passed units/positions; reduce obstacles; secure lines of communications; secure key areas/facilities; provide EPW search teams, demolition teams, first-aid and litter teams, and ammunition resupply.

(3) The main effort is the focus of combat power at any given time during the attack. Both the main attack and main effort are mechanisms for concentrating and coordinating combat power, but they are not synonymous. For example, the company concept for seizing an enemy strongpoint has 1st Platoon supporting by fire (a supporting attack), 2d Platoon conducting a breach and seizing a foothold (a supporting attack), and 3d Platoon seizing the decisive point on the strongpoint (the enemy CP). The 3d Platoon has the

decisive action that accomplishes the company's mission. They are the main attack throughout the operation; however, 3d Platoon's success depends on 2d Platoon's success. When 2d Platoon is conducting the breach, this is the most critical action; they should be designated the initial main effort (Figure 4-1). 1st Platoon initially supports 2d Platoon's breach, but upon commitment of 3d Platoon, they support the main attack.

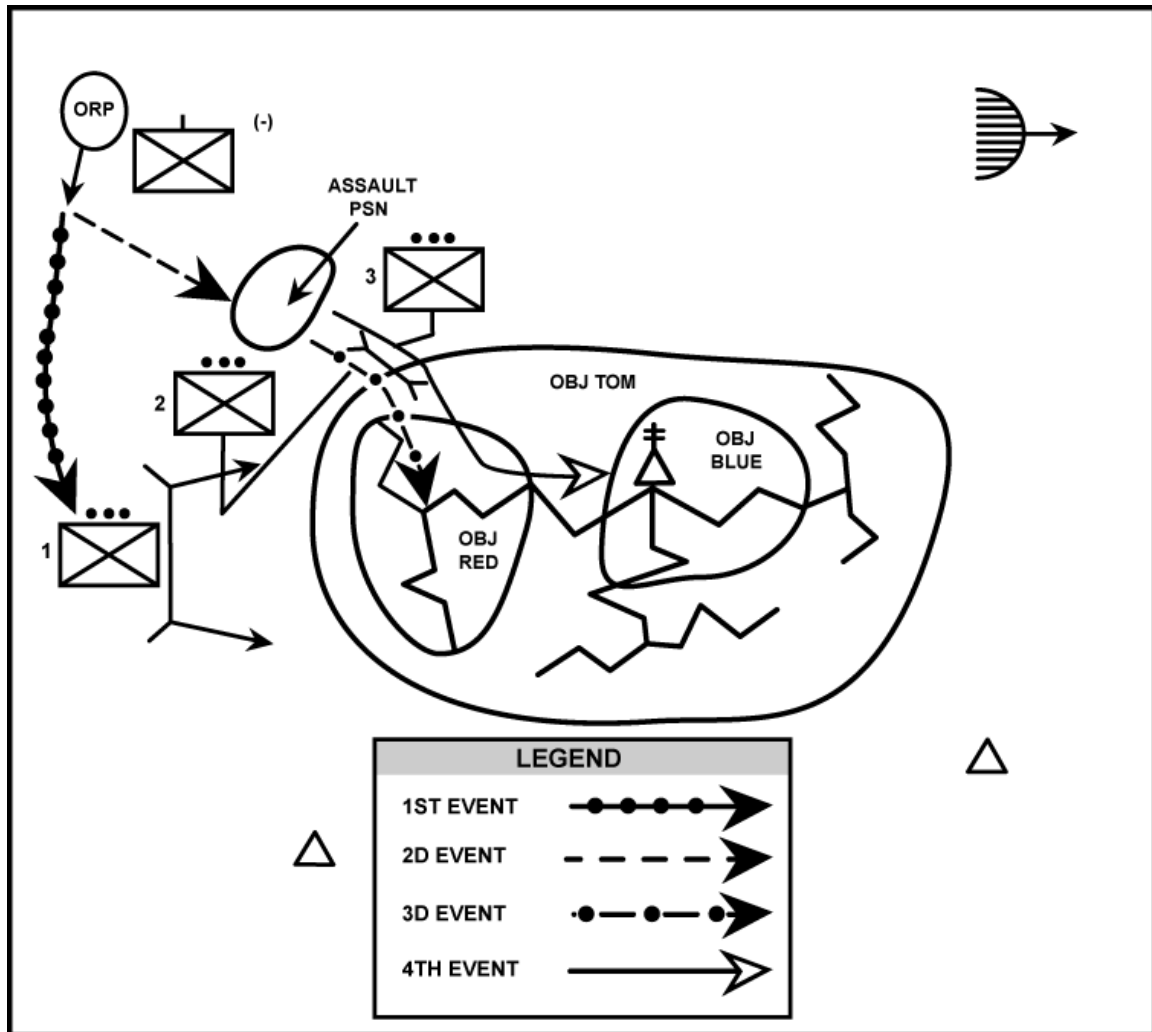

Figure 4-1. Main attack concept sketch.

c. **Reserves.** In the offense, they are positioned to weight the main effort. They exploit success, reinforce or maintain momentum, deal with enemy counterattacks, or provide security.

(1) The reserve is committed at a decisive point in the battle to ensure success of the mission or to capitalize on opportunities generated by the successful attack. Reserves must be readily available; they provide flexibility to the plan. When a designated reserve is not possible, the CO provides flexibility by other means such as be-prepared missions or additional security/reconnaissance tasks for committed platoons. Control measures that support rapid issuance of FRAGOs also provide flexibility to the plan.

(2) A unit held in reserve is not committed to a specific mission. The reserve leader is given planning guidance. For example: "In priority, be prepared to continue the main attack; be prepared to begin a movement to contact immediately after the main attack succeeds to maintain contact with the enemy; be prepared to block a counterattack along avenue of approach 2, coming from the west to prevent disruption of the main attack." The leader prepares for each mission in this order. These be-prepared missions may not be required to accomplish the company's mission. The reserve leader should also be given the criteria the CO will use to initiate each be-prepared mission.

(3) The size of the reserve and the headquarters that controls it depends upon the commander's estimate of the situation. Usually, the more vague the enemy situation, the larger the reserve. If a company is the main attack and the battalion has a reserve, then a small reserve or none at all may be designated. However, if the company is a supporting attack, a large reserve may be needed. When the reserve does not include a platoon headquarters, the XO or 1SG may be the reserve leader. The leaders of the reserve must understand their be-prepared missions; they must keep up with the current situation; and they must keep their unit ready for action on short notice.

#### **4-5. FORMS OF MANEUVER**

The positional relationships of opposing forces to one another are described as forms of maneuver. The five forms of maneuver are penetration, envelopment, turning movement, frontal attack, and infiltration. These are discussed in greater detail in FM 7-20. In every attack, the CO must determine how to maneuver his unit to get overwhelming combat power at the decisive point. He applies these basic forms of maneuver, individually or in combination, to do this. Reconnaissance is the key to selecting the proper form of maneuver. Once the maneuver is initiated, surprise, speed, and stealth are crucial to the unit's security and to prevent the enemy from effectively countering.

##### **a. Penetration.**

(1) Penetration is used when enemy flanks are not assailable and when time does not permit some other form of maneuver. Its purpose is to rupture enemy defenses on a narrow front and thereby create both assailable flanks and access to the enemy's rear (Figure 4-2).

(2) The rifle company normally conducts a penetration as part of a larger force. Penetration may be tried at one or several points, depending on the forces available. However, a company will usually focus combat power at one breach point.

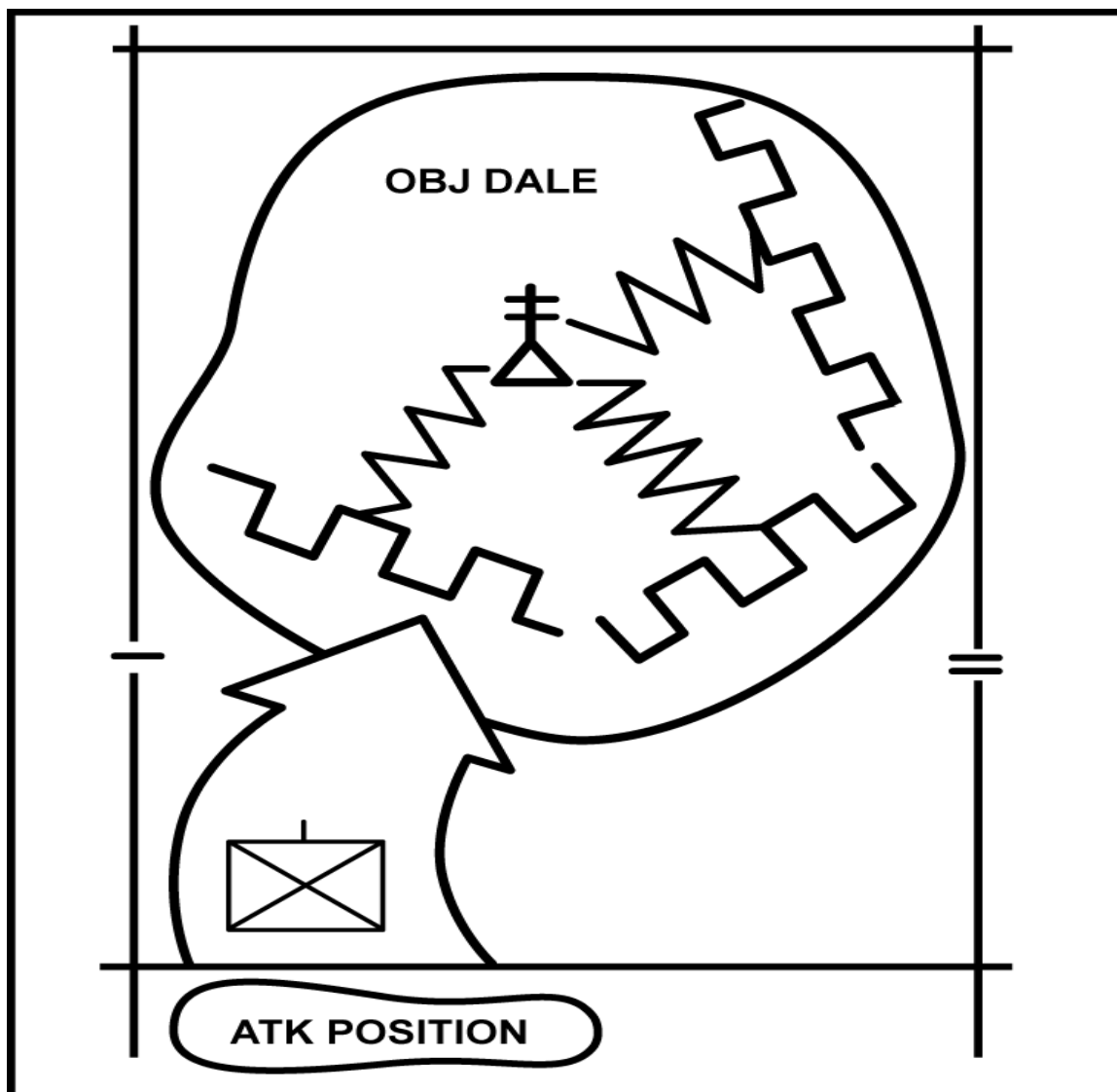

Figure 4-2. Penetration.

**b. Envelopment.**

(1) Envelopment avoids the enemy's front where his forces are more protected and his fires more easily concentrated. Instead, while fixing the defender's attention forward by supporting attacks, the attacker maneuvers his main effort to strike at his flanks and rear. Flank attacks are a variant of the envelopment in which access to the enemy's flank and rear results from the enemy's movement (Figure 4-3).

(2) Successful envelopment requires discovery or creation of an assailable flank. In meeting engagements and counterattacks, this may actually be the flank of the enemy force. In less fluid conditions, it may be a gap or weak point in the enemy's defense.

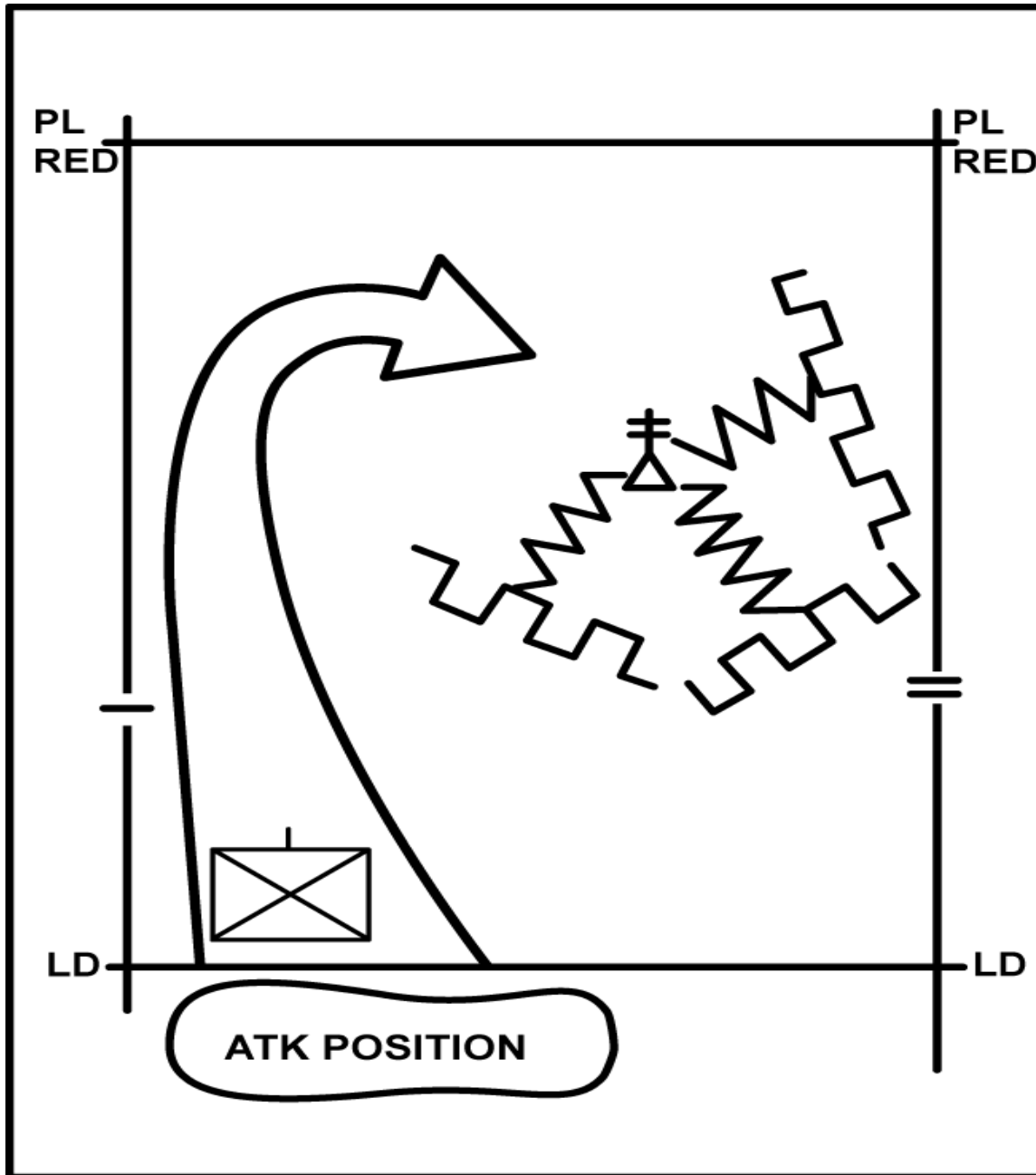
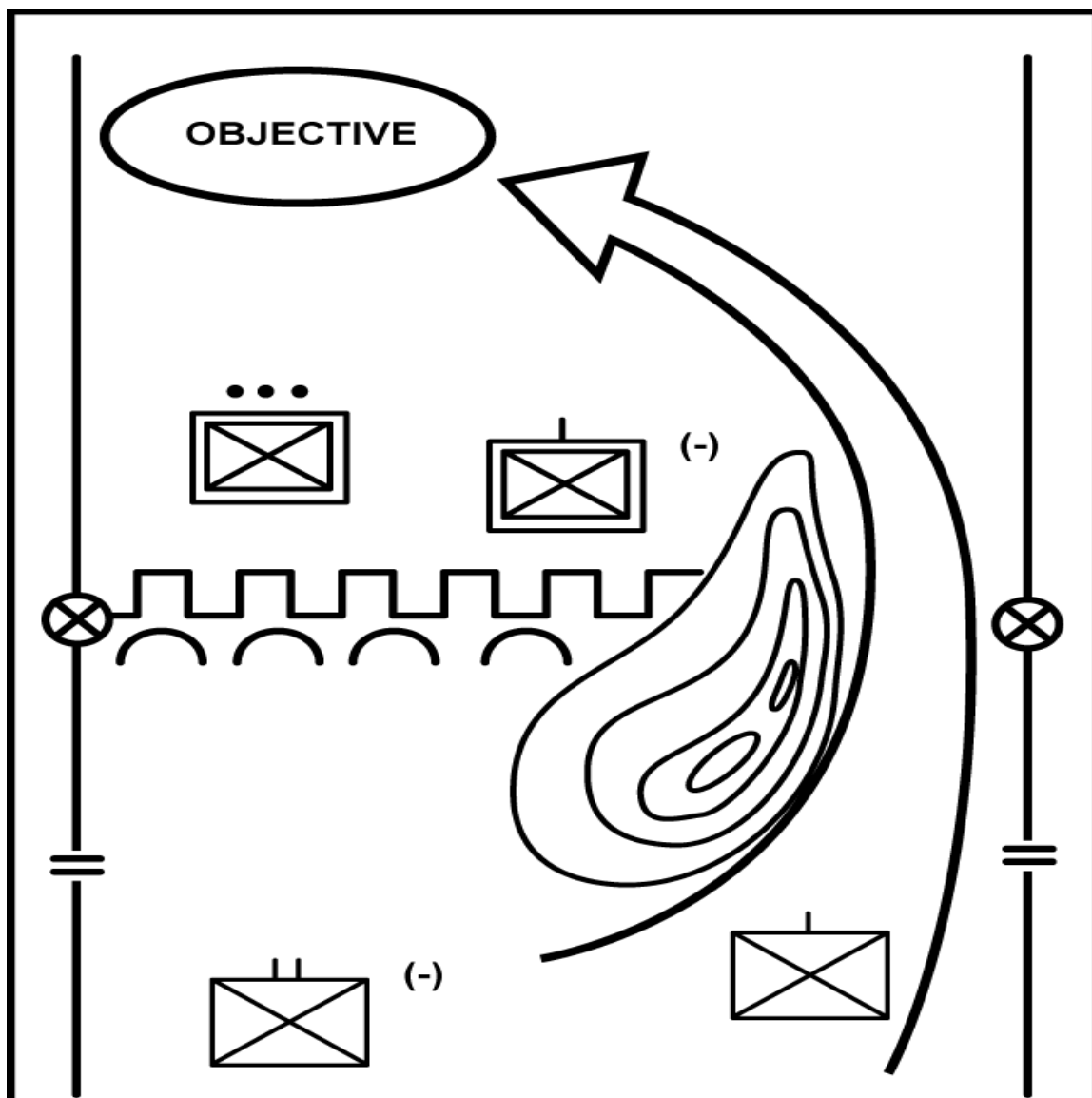

Figure 4-3. Envelopment.

**c. Turning Movement.**

(1) The turning movement is a type of envelopment in which the attacker attempts to avoid the defense entirely. Instead, he seeks to secure key terrain deep in the enemy rear and along his lines of communication. Faced with a major threat to his rear, the enemy is thus "turned" out of his defensive positions and forced to attack rearward.

(2) For a turning movement to be successful, the unit trying to turn the enemy must attack something that the enemy will fight to save. For some, it is their supply routes; for others, it may be artillery emplacements or a headquarters. In addition to attacking a decisive target, the turning unit must be strong enough to pose a real threat to the enemy (Figure 4-4). A company will never be able to turn a corps, but it may turn a battalion.



**Figure 4-4. Turning movement.**



#### d. Frontal Attack.

(1) A frontal attack strikes the enemy across a wide front and over the most direct approaches. For deliberate attacks, it is the least desirable form of maneuver since it exposes the attacker to the concentrated fire of the defender while at the same time limiting the effectiveness of the attacker's own fires.

(2) As the simplest form of maneuver, however, the frontal attack is useful for overwhelming weak defenses, security outposts, or disorganized enemy forces. It is often the best form of maneuver for an attack or meeting engagement in which speed and simplicity are key.

#### e. Infiltration.

(1) Infiltration is a means of reaching the enemy's rear without fighting through prepared defenses (Figure 4-5). It is the covert movement of all or part of the attacking force through enemy lines to a favorable position in their rear. The infiltrating unit avoids detection and engagement.

(2) Infantry companies are well suited for infiltrations. Their lack of protection and small signature when moving also make infiltrations an effective form of maneuver.

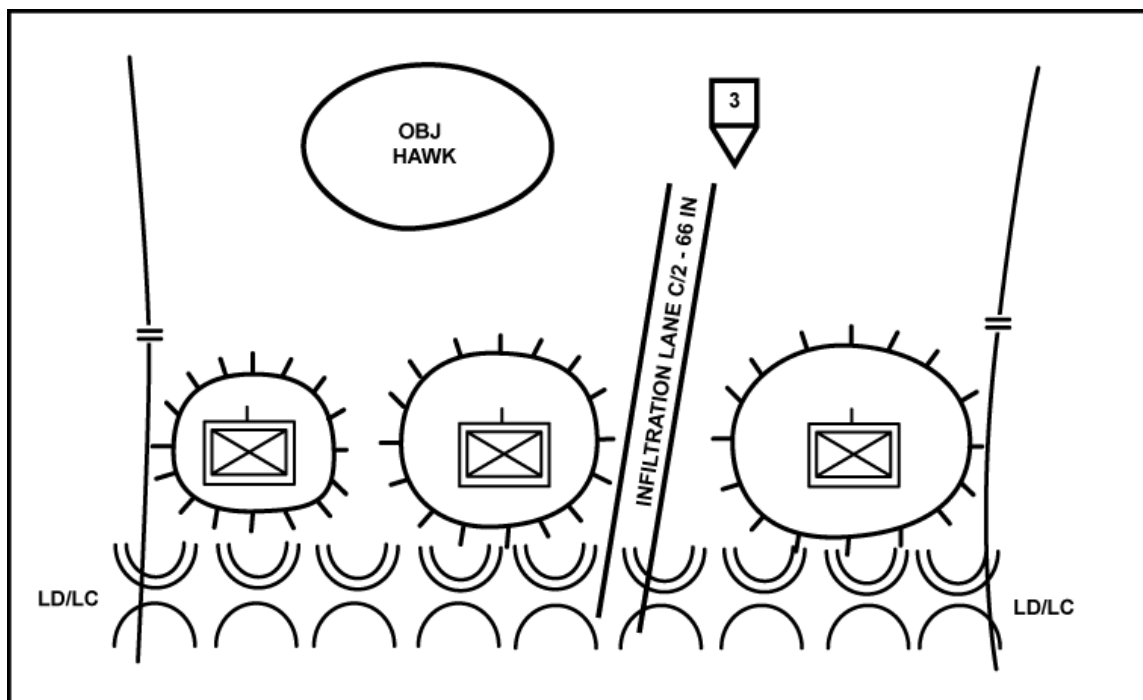

Figure 4-5. Infiltration.

### Section II. INFILTRATION

Infiltration is a form of maneuver used by infantry units in many situations. During an attack, strong enemy defensive positions may be encountered. To avoid the enemy's strength, the commander may move units by stealth through gaps or around the enemy positions to conduct operations in the enemy's rear area. The company may infiltrate to conduct raids, ambushes, or other attacks. Infiltrations may also be used for many other types of operations, such as stay-behind and reconnaissance.

#### 4-6. FUNDAMENTALS

Infiltration allows the infantry to exploit its capabilities. By infiltrating, the company can maneuver undetected by squad/platoons to critical targets, can achieve surprise, and can avoid the effects of enemy fires. Limited visibility, bad weather, and restrictive terrain reduce the chances of detection during an infiltration.

- a. A unit may infiltrate—
  - To gather information.
  - To attack the enemy at a weak point.
  - To seize key terrain or destroy vital installations behind enemy positions.
  - To harass and disrupt the enemy with ambushes in his rear area; or to attack enemy reserves, fire support units, and command posts.
- b. The phases of an infiltration are as follows:
  - (1) *Patrol*. Find gaps/weak areas in the enemy defense and locate enemy positions.
  - (2) *Prepare*. Conduct troop-leading procedures.
  - (3) *Infiltrate*. Avoid enemy contact; move by smallest units possible.
  - (4) *Consolidate*. Link up and prepare for actions at the objective.
  - (5) *Execute*. Complete the mission.

c. Infiltrations do not always require that all units move through the enemy's positions without detection/fighting. Depending on the mission, the company can still complete the mission even though some of the squads made contact en route to the linkup point. Although the enemy may have some idea of what is taking place, it will be very difficult to estimate exactly what these small contacts mean. OPSEC may require that only key leaders have the entire plan during the infiltration phase to prevent disclosure due to casualties or friendly prisoners.

#### 4-7. CONSIDERATIONS

An infiltration plan must be prepared. Units must be given enough time for preparation and movement. The company may infiltrate by itself or as part of the battalion. In either case, movement techniques and formations are based on the likelihood of enemy contact, the terrain, the visibility, and the need for speed and control.

a. **Size.** The size of the infiltrating unit depends on the amount of time available, the amount of cover and concealment, and the enemy. Other considerations may include the need to communicate, the difficulty of navigation, and the number of infiltration routes. Generally, smaller units can move quicker and make better use of available concealment. This may increase the number of linkups, requiring more time. Infiltrating by company or platoons ensures control and provides more combat power in the event of contact.

b. **Infiltration Lane.** The company may be assigned an infiltration lane or a zone. The CO must decide whether to move the entire company together through the company's lane or to assign each platoon a separate infiltration lane within the company lane. He also has the option to stagger the start time for each platoon on the one company lane. The infiltration lane should be wide enough to allow the infiltrating units to change their planned routes to avoid enemy contact.

(1) If the company uses a single company lane, the CO picks a route through it and an ORP (Figure 4-6). If multiple lanes are used, the CO assigns each platoon a lane and a start time, picks linkup points for the platoons, and picks a company ORP. The platoon leaders pick the routes through their lanes.

(2) In making his decision whether to use single or multiple lanes, the CO considers several things. Moving as a company on a single lane—

- May get the company to the ORP faster.
- Makes control easier.
- Makes navigation easier.
- Increases the chance of the entire company being detected.
- Provides greater combat potential if detected.

(3) Moving on multiple lanes (Figure 4-7) or by platoons on one lane—

- Requires linkups.
- Makes control harder.
- May make navigation more difficult.
- Decreases the chance of the entire company being detected. However, if detected there is less combat potential available.

c. **Routes.** The routes selected must—

- Avoid enemy positions.
- Have cover and concealment.
- Ease control and navigation.
- Avoid obstacles and danger areas.

(1) Routes should be reconnoitered without alerting the enemy. This may be possible by map reconnaissance only; however, consider using guides or marking the routes.

(2) Rally points may be selected based on a map reconnaissance; others are selected as the company moves along the route. If the infiltrating company is dispersed by enemy action, it rallies at the last rally point passed that is not within enemy small-arms range or impact area. The assembled unit then waits until a set number of units (soldiers) arrive at the rally point, or for a specified time, before continuing the mission. The senior man at the rally point should, in the absence of the CO, take charge and decide how to best continue the mission.

(3) Locate the ORP as close to the objective as possible without being detected or losing security. It should be large enough so that the company can deploy in it. It should be secured before it is occupied.

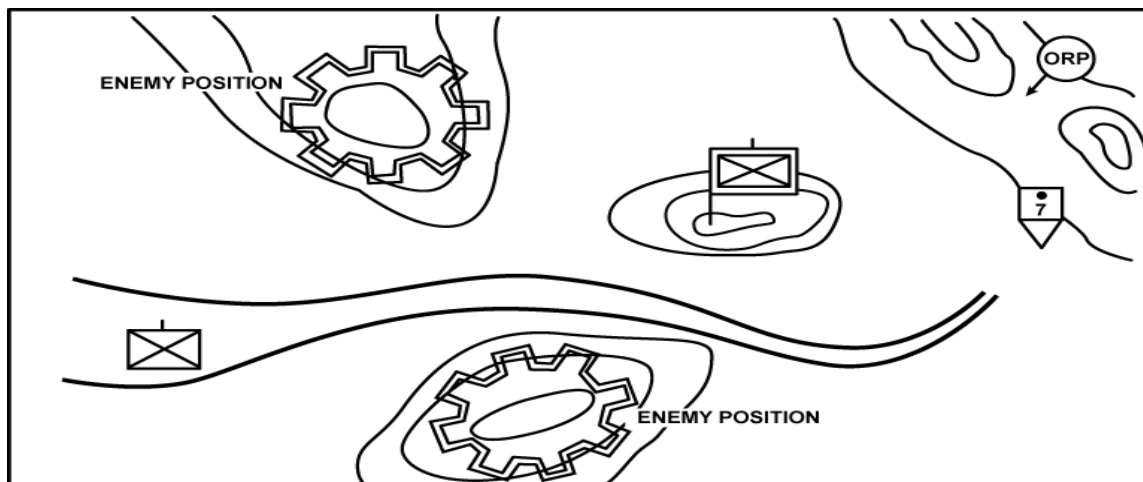
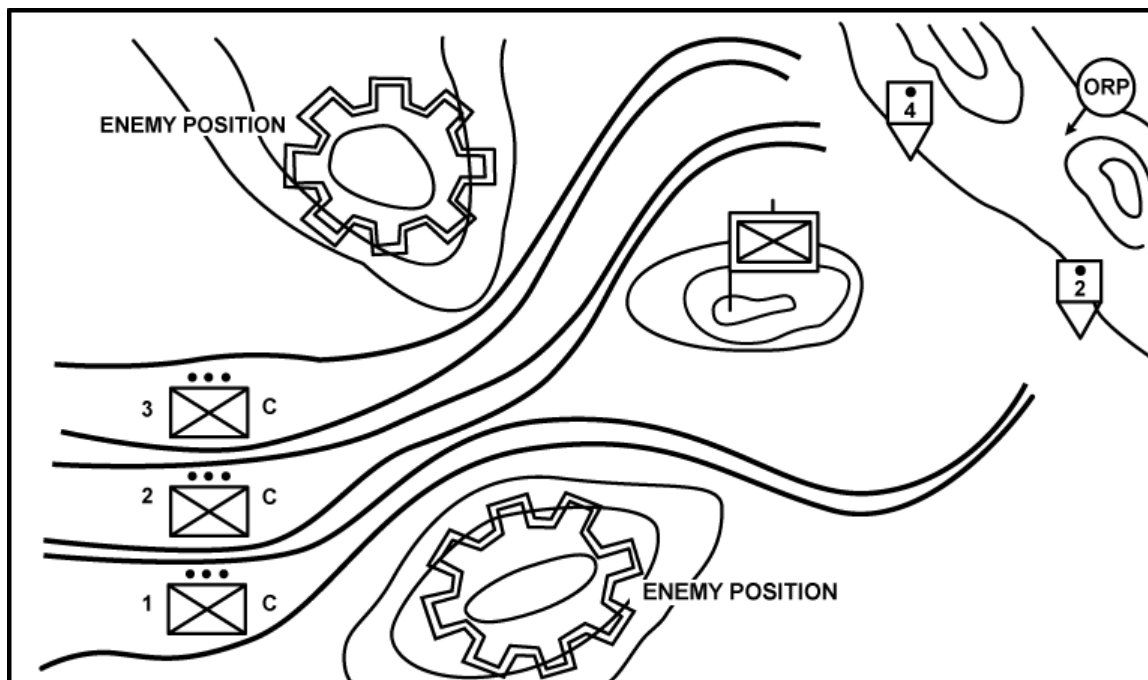

Figure 4-6. Company moving on a single infiltration lane.



**Figure 4-7. Company moving on multiple infiltration lanes.**

d. **Linkup Point.** When multiple lanes are used, the platoons meet at a linkup point and then move as a company to the ORP. Do not plan linkups at the ORP. If a unit misses its linkup, it moves to a contingency linkup point located away from the ORP and links up with a small element from the ORP. Chapter 6, Section IV discusses linkups.

e. **Signals.** Visual signals, such as arm-and-hand signals, infrared devices, and flashlights with colored lenses, reduce the chance of detection. Avoid sound signals and flares. Recognition signals are critical for actions at a linkup point or a rally point.

(1) Radio listening silence should be enforced, except when it is necessary to report the progress of the unit or when a unit detected by the enemy needs supporting fire.

(2) Radio messages to report crossing of phase lines or checkpoints (if required) should be brief—one code word. They may be transmitted without using call signs to identify units, providing each unit has separate code words.

(3) When required, units operating out of radio contact (because of terrain or distances) can be required to monitor or send codes only at a certain time. At these times, they move to terrain or set up expedient antennas so they can communicate.

f. **Fire Support.** Indirect fires are always planned but only used when contact is made or when needed to support the mission. If contact is made with an enemy element, the infiltrating unit should use indirect fire to divert the enemy's attention, suppress enemy positions, and screen friendly movement to help them disengage. Indirect fires may also be used to assist in navigation and to cause the enemy soldiers on security to seek cover.

g. **Actions on Contact.** When infiltrating on multiple lanes, detection of one infiltrating unit may alert the enemy and compromise the other infiltrating units. The OPORD must state whether to continue the mission or return to friendly lines if detected by the enemy. Units following on the same lane should switch to an alternate lane. If a soldier in the unit speaks the enemy's language, he should be positioned at or near the

front of the column in case the unit is challenged by an enemy OP or patrol. The order must also specify what to do in the event of casualties.

h. **Methods of Handling Casualties and Prisoners.** During the infiltration, it may be hard to evacuate casualties without jeopardizing security. Casualties can be carried to the ORP or linkup point and evacuated when the operation has ended or concealed and left to be picked up later. Moving the wounded, dead, or prisoners to the ORP is dangerous when trying to avoid detection. If casualties are left, soldiers with medical supplies are left with them. The KIA can be concealed and recovered later. Leave prisoners under guard at a rally point and evacuate them when the operation is over.

i. **Rehearsals.** Every soldier must know the plan and his role in it. Units should rehearse their formations and movement techniques and their actions—

- On enemy contact.
- At rally points.
- At the linkup point.
- At the ORP.
- At danger areas.
- At the objective.

### **SECTION III. MOVEMENT TO CONTACT**

Movement to contact is an offensive operation used to gain and maintain contact with the enemy. It is normally used when the enemy situation is vague and there is not time to reconnoiter extensively to locate the enemy. The fundamentals and techniques discussed here also apply to the approach phase of a hasty or deliberate attack; the main difference is the amount of enemy intelligence. Because the enemy situation is not clear, the company moves in a way that provides security and supports a rapid buildup of combat power against enemy units once they are identified. In the approach phase of an attack, the enemy situation is more clear. Therefore, the company moves toward the objective in a way that avoids enemy detection and supports its deployment in the assault. Two methods for conducting a movement to contact are the search-and-attack technique and the approach-march technique.

#### **4-8. FUNDAMENTALS**

The application of the following fundamentals is determined by the CO as he analyzes the situation and selects the proper tactics to conduct the mission. The CO retains freedom of maneuver by moving the company in a manner that—

- Makes enemy contact with the smallest element possible.(Ideally an R&S element.)
- Rapidly develops combat power upon enemy contact.
- Provides all-round security for the unit.
- Supports the battalion concept.

He reports all information rapidly and accurately, and strives to gain and maintain contact with the enemy.

#### 4-9. CONSIDERATIONS

The battalion may direct the company's technique. If not, the CO considers his mission and the battalion concept as he conducts his estimate to select the best technique. Normally, when operating as part of a battalion movement to contact, the company will employ the same technique as the battalion. The following considerations may also assist the commander in developing his concept.

a. **Time Available.** The time available for planning, coordinating, and rehearsing may impact on the decision. The approach-march technique generally requires much less time for preparation. The company may require only a brief FRAGO assigning the movement formation/technique and some simple graphic control measures to begin movement. The search-and-attack technique may require more preparation time because the platoons and squads have more planning responsibilities, such as patrol base, linkups, and casualty evacuations.

b. **Speed of Movement.** The speed that the company is required to move is a major factor. With either technique, the faster the company moves, the less effective its R&S efforts will be. It becomes more likely that the enemy will initiate fires at the time and place he selects. The approach-march technique is normally more effective in quickly reacting to enemy contacts.

c. **Enemy.** The CO considers the clarity of the enemy situation. Although the enemy situation is vague in every movement to contact, the CO should have some information. The possible enemy locations and probable strength are key. The CO considers these locations to plan the company's movement and their probable strength to determine his security needs and to analyze the risks for each technique. The expected enemy action upon contact is also considered. If the CO expects him to fight, then the approach march may be the more effective technique. If the enemy is attempting to avoid detection or quickly disengage, the search-and-attack technique may be the better method.

d. **Security.** The amount of preparation time, the required movement speed, and the enemy situation all have a direct impact on the company's security requirements. The CO also considers the terrain, the adjacent units, the available combat support, and the present status of his unit to determine how to provide security for his company. Successful movements to contact depend on locating the enemy without being detected. This provides the CO the initiative to develop the situation by fully coordinating and supporting the attack with all available resources.

e. **Combined Technique.** An effective option may be to combine the techniques and have the lead platoon use the search-and-attack technique and the rest of the unit use the approach-march technique. The lead platoon is assigned reconnaissance missions to find the enemy (Figure 4-8). In this example, the CO assigned route reconnaissance tasks to 2d Platoon. Checkpoints and NAIs are assigned to focus the subordinate on specific locations. The phase lines can also be used to control the lead platoon by directing that they be crossed on order. The company main body follows the reconnaissance at a distance that allows it to rapidly maneuver based on the reports from the lead platoon. The formation and movement technique for the main body will vary but generally applies the fundamentals for the approach-march technique (paragraph 4-11).

**4-10. THE SEARCH-AND-ATTACK TECHNIQUE**

This decentralized technique uses multiple, coordinated, small-unit (team/squad/platoon) actions to find the enemy. If the company makes contact without being detected by the enemy, the CO then has the initiative. The CO now has the option to destroy the enemy with the immediately available combat potential, to maneuver the remainder of the company to destroy the enemy, or to follow the enemy force back to its base camp and destroy him there. During his planning, the CO decides how to find the enemy, how to fix or follow him, and then how to finish him.

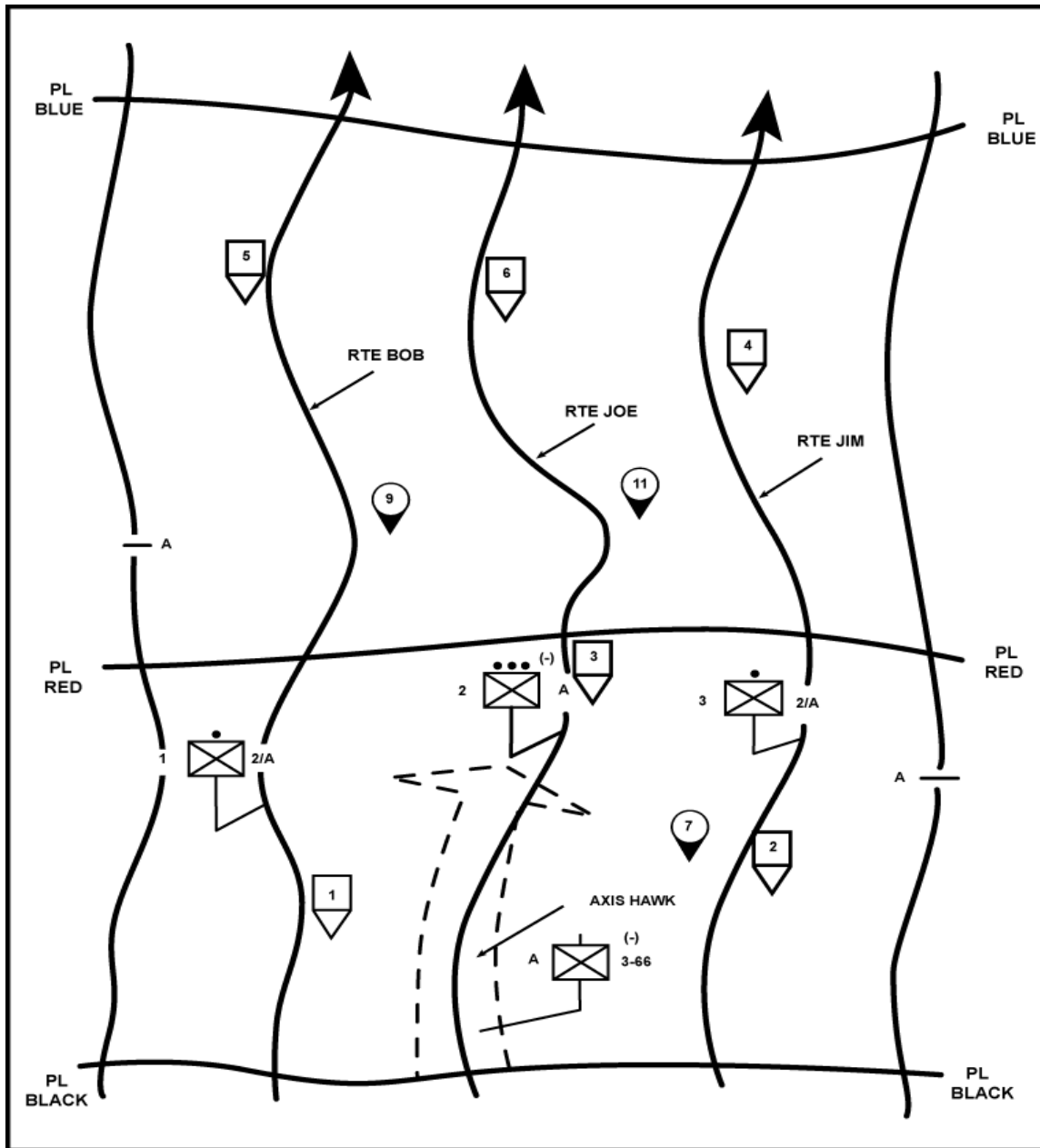

Figure 4-8. Combined techniques.

a. **Concept Development.** The concept development process in paragraph 4-13 also applies for a search and attack. Initially, the decisive points are identified as the most likely enemy locations. Once the enemy has been located, the specific decisive point must be determined as in any attack and a concept developed for generating overwhelming combat power there. The initial concept must include the actions to finish the enemy force once they are located. At times, this part of the plan may be very general or consist only of control measures and be-prepared missions to provide flexibility and support the rapid issuance of FRAGOs.

(1) The CO must understand the battalion commander's concept and what freedom of action the company has to engage the enemy. At times, the company must engage and destroy all enemy within their capabilities. In other cases, the company is expected to locate, follow, and report small, enemy units to allow the battalion to concentrate and destroy these forces.

(2) The CO must focus the platoons/squads on the likely enemy locations. He assigns missions IAW the battalion commander's concept. Possible tasks include a zone or area reconnaissance, an ambush, or a surveillance. The small-unit leaders must know what actions to take when they locate the enemy without being detected or if detected. The platoon that is most likely to make contact is normally designated the main effort.

b. **Considerations.** The CO determines the number and size of the units that will conduct reconnaissance and or combat actions against the enemy. The size of the area, the duration of the mission, the soldier's load, and the probable size of the enemy force are key to this decision.

(1) The size of the area of operations is considered in relation to how much time is available to search the area. When allocating terrain, the CO must consider how the platoons will conduct the reconnaissance, how to provide security, and how to provide control.

(a) One technique is to assign small AOs that keep the platoons more concentrated and help maintain control. The platoons are directed to move into the next AO on order.

(b) Another technique is to divide the company area into zones. The CO concentrates most of the company in one zone and uses small team/squad patrols to reconnoiter the next zone or the rest of the area. Once the company(-) has completed the reconnaissance in the initial zone, it moves into the area that has been reconnoitered by the small units. This technique is effective when a detailed reconnaissance is required but also supports the seizure of the initiative through speed, stealth, and surprise. The small, dispersed units have a better chance of locating the enemy undetected. They also provide initial reconnaissance information for the CO to focus the remainder of the company's reconnaissance efforts on.

(2) The CO must consider how the duration of the mission effects the company's ability to conduct CONOPS. If the mission will continue for days or longer, the CO must develop a concept that allows his subordinates to maintain combat effectiveness. The concept must address the use of patrol bases and limited visibility operations. The CO must ensure that the concept provides sufficient rest to maintain his soldiers' stealth, alertness, and security. The duration of the mission will also effect the soldier's load. The longer the mission is expected to last, the heavier the soldiers' loads may get to reduce the need for resupply.



(3) The soldier's load has a tremendous impact on a search-and-attack mission. The ability to move with stealth and security while close to the enemy is hindered by heavy loads. But, resupply operations may also hinder the company's operation and allow the enemy to locate the unit by following or observing the resupply vehicles.

(a) The CO must determine what the essential requirements are for the soldiers' loads. If this results in excessive loads, he plans for resupply operations that avoid enemy detection and maintain the security of the company.

(b) The CO may combine techniques to reduce the risk of moving with these heavy loads. He identifies ORPs or company patrol bases throughout the AO, and the company moves between these ORPs using the approach–march technique to provide greater control and security. After securing and occupying the ORP, the platoons leave their rucksacks and move out to conduct decentralized search-and-attack operations. A security force secures the ORP until the unit's return to get their rucksacks and move to the next ORP. Platoons can use this same technique when the risk is acceptable.

(4) The size of the enemy units that the company is likely to make contact with will assist the CO in determining the risk to the company. The CO must also consider the enemy's capabilities and likely COA. The specific enemy weapons capabilities are key to understanding the threat. The CO must consider these as he develops his concept to ensure the security of his company even when conducting decentralized operations. The CO may direct specific force protection restraints such as no patrols smaller than a squad, or platoons must be able to consolidate within 20 minutes, or platoons will depart their patrol bases NLT 60 minutes prior to BMNT.

c. **Find the Enemy.** During this phase of the operation, the focus is on reconnaissance to locate the enemy. Generally, small units able to move quickly and with stealth are more likely to locate the enemy without detection. The CO's concept may restrict the platoon's authority to destroy the enemy once located. It may be more important to locate and follow enemy units to identify their base camps. When not restricted, the unit making contact takes immediate action to destroy the enemy. If it is not within this unit's capabilities, the platoon conducts linkups to mass sufficient combat potential and to coordinate the attack.

(1) Normally, platoons will not receive a mission with the vague requirement to search and attack. The CO must be more specific in stating his concept. His concept must also address the likely actions to destroy the enemy once they are located. Specific taskings may include route, area, and zone reconnaissance or surveillance tasks. Platoons may also be tasked to conduct ambushes or to be prepared to conduct an attack to destroy enemy forces; to provide security for another force, such as the CP or the mortar section; or to act as the company reserve.

(2) During limited visibility, reconnaissance is more difficult and potentially more dangerous. If a unit makes contact with the enemy in the dark, a hasty attack is very risky. Reconnaissance is also less effective in the dark because the unit covers less area and is unable to detect many signs of enemy activity. Although observation is reduced during limited visibility, the unit may be more likely to detect the enemy by sight or smell. Route and small-area reconnaissance tasks are more effective for limited visibility.

(3) Ambushes are also very effective tasks during limited visibility. The enemy may avoid daylight movements if aware of the company's presence in the AO. Ambushes should be set up on the enemy's likely routes or near their water and or food sources.

Patrol bases should integrate ambushes and OPs (with thermal sights, NVDs, and PEWS) into their security plans. These tasks support the seizure and maintenance of the initiative.

d. **Fix and Finish the Enemy.** These phases of a search and attack are closely related. An initial attempt to finish the enemy by the platoon in contact may quickly become the fixing effort for the company's attack if the enemy was too strong for the platoon or the platoon was unable to achieve surprise. When the authority to conduct offensive actions to destroy the enemy has been decentralized to the lowest level, the fundamentals of an attack apply at every echelon.

(1) *Achieve surprise.* Locate the enemy without being detected. This allows more time to plan and coordinate the attack. Once detected, speed and violence in the assault may also achieve surprise, but this will rarely be true against a prepared enemy defense.

(2) *Limit the enemy's freedom of action.* Fix the enemy in position. Block his routes of escape with indirect fires and or maneuver forces. Suppress his weapons systems, obscure his vision, and disrupt his command and control. Reconnaissance is continuous; leaders at every echelon are seeking out the enemy's dispositions, strengths, and weaknesses. Initially, these actions are directed toward supporting an attack by the lowest echelon. At some point, the leader of this unit must determine if he is able to achieve fire superiority and also conduct the assault. If it is determined that the unit in contact has insufficient combat power to complete the destruction of the enemy, the leader focuses on fixing the enemy and reconnoitering to support the attack by the next higher echelon.

(3) *Maintain security.* While attempting to take these actions against the enemy—the enemy is attempting to do the same. Do not assume the enemy that has been identified is alone; there may be mutually supporting positions or units. The planned envelopment or flank attack of one enemy position may be moving through the kill zone of another unit. Or this maneuver may expose the flank of the assault force to fires from undetected positions.

(4) *Concentrate combat power.* Once contact is made, the plan must support the rapid concentration of combat power to fix and or destroy the enemy. Leaders at each echelon plan to destroy the enemy within their capabilities. The combat potential of small units may be increased by ensuring each has the ability to request fire support.

(a) The CO may retain a portion of the company in reserve to react quickly to enemy contact by one of the small units. However, when the company is operating in a more dispersed manner, this company reserve may not be responsive enough. It may be more effective for each platoon to retain its own reserve.

(b) If the unit or platoon cannot finish the enemy, the CO determines how to fix or contain the enemy while concentrating his dispersed combat potential. He then develops an attack plan to destroy the enemy force. He may use the fixing force to support by fire, and assault with another platoon(s); or he may use artillery and CAS to destroy him in position.

(c) Each leader must report the results of their reconnaissance to support the CO's planning. They should recommend effective support positions, good assault positions or directions of attack, and likely enemy weak points. The leader of the unit in contact should also identify good linkup points if the preplanned points are not effective. In most cases, this leader should coordinate face to face with the CO or the leader of the assault element before initiating the assault.

e. **Follow the Enemy.** When the purpose of the operation is to locate the enemy's base camps or other fixed sites, the company concept must avoid the non-decisive fights between small units. When small enemy units are located, the units report and attempt to follow or track these units back to their base camps. Well-trained trackers familiar with the area may be able to identify and follow enemy tracks that are hours or even days old (FM 7-8). The CO must ensure that his concept does not risk the security of his force in the attempt to make undetected contact and track enemy units. Units tracking the enemy must be ready to react to enemy contact and avoid likely ambush situations. It may also be possible to track the enemy's movement through the AO by using stationary OPs as trail watchers to report enemy activity.

f. **Enter the Area of Operations.** The CO also decides how the company will enter its zone or area of operations, how to move once in the area, where to locate certain units or facilities, and what the requirements for contingency plans are. This includes establishing the proper graphic control measures to control the movement of the units, to provide for linkups between units, and to support the rapid concentration of the company's combat power. It also includes synchronizing the actions of the company and providing specific tasks or restraints to ensure subordinates understand what actions should be taken once contact with the enemy is made.

(1) The company may enter the area or zone by moving as a company (Figure 4-9) and then splitting up, by air assault, or by infiltrating squads and platoons (Figure 4-10).

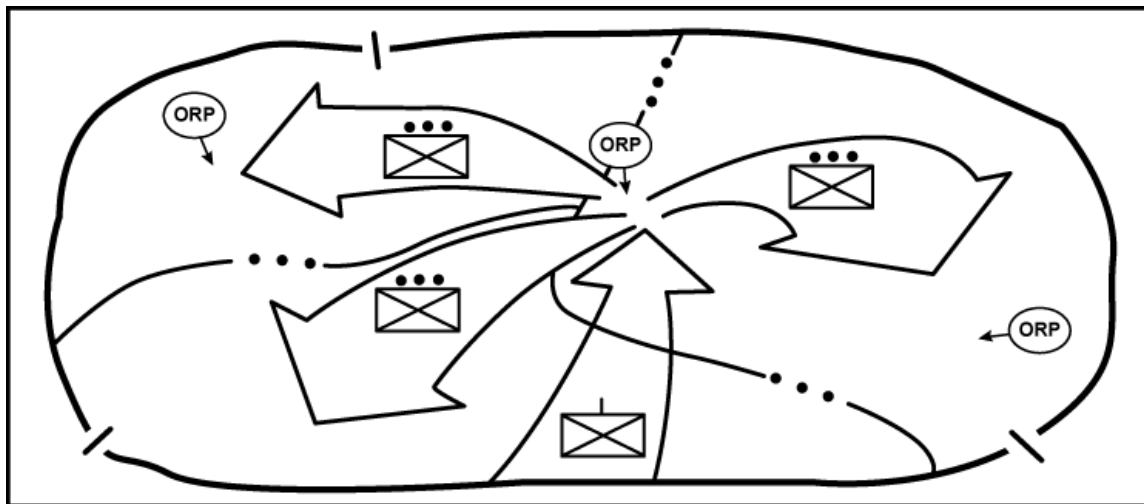
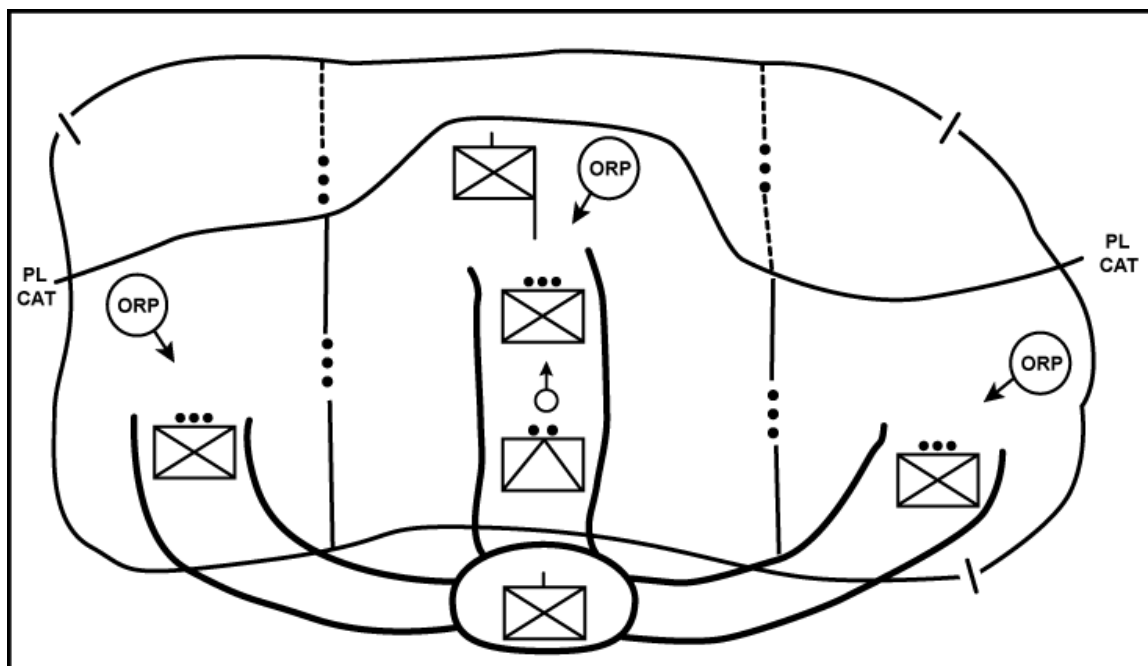

Figure 4-9. Entry by company.



**Figure 4-10. Infiltration by squad/platoon.**

(2) Movement within the area or through the zone of attack may be conducted by the entire company or by individual platoons. Figure 4-11 shows a concept sketch for a search and attack conducted without a company linkup.

(3) The CO must decide where the company CP will be. It may collocate with the main effort platoon, or it may position itself in a central location where it can communicate with and move quickly to each platoon's location. A technique to support CONOPS is to rotate a reserve platoon each day to provide security for the CP and the company mortars. Each platoon spends only 48 hours actively searching for the enemy and then rotates into the reserve role. This should prevent a serious degradation in effectiveness due to sleep loss.

(4) Company mortars must be located where they have security and can support the platoons. The CO may collocate them with the company CP. The movement of their ammunition is the most difficult challenge. The CO may direct the reserve platoon to carry the ammunition to the next firing position. Another option is to establish company ORPs or patrol bases and place the mortars at these locations. The mortar ammunition can then be carried by the entire company; the soldiers drop off the rounds before moving out to the platoon areas. However, the entire company must return to this location before continuing the operation through the zone.

(5) The threat of enemy armor and the soldier's load are two primary considerations for employing the antiarmor assets. If there is an armored threat, then the CO must decide where to position the Dragons. If the platoons are likely to encounter enemy armor, they need to have the Dragon and or 90-mm recoilless rifles with them. In very close terrain, the AT4/LAW may be more effective than the Dragon. The company antiarmor assets normally will be attached to the platoons. If the threat does not require antiarmor weapons, the CO may still use some thermal sights for observation, and the personnel can

augment the company mortar section/platoon. The resupply of batteries and cooling bottles must be considered.

(6) Contingency plans may include actions in case one platoon becomes decisively engaged or in case the company receives a new mission. All units should routinely report possible LZ/PZ locations, mortar firing positions, any sign of recent enemy activity, and any sightings of civilians in the area.

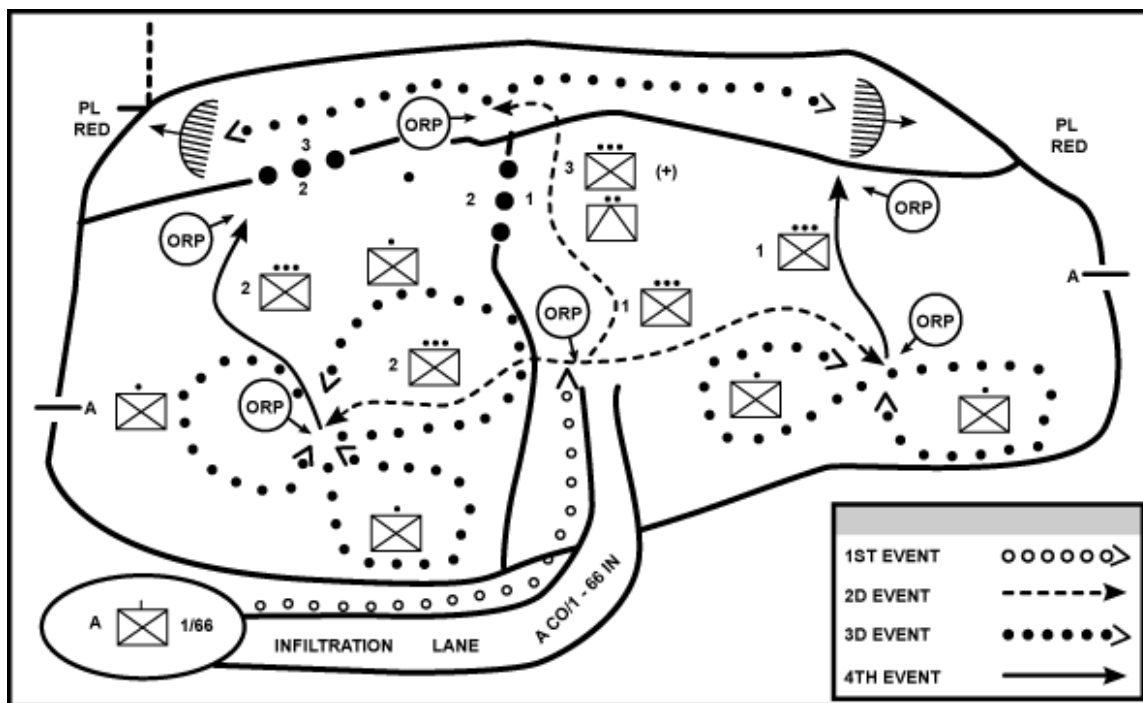

**Figure 4-11. Company search-and-attack concept sketch.**

#### 4-11. THE APPROACH-MARCH TECHNIQUE

The company normally uses this technique when it is conducting a movement to contact as part of the battalion. The rifle company can be tasked to act as the advanced guard, to move as part of the battalion main body, or to provide flank or rear guards for the battalion, depending on its location in the formation and its assigned mission.

a. When planning for an approach-march movement to contact, the CO needs certain information from the battalion commander. As a minimum, he needs to know—

- The company's mission.
- The friendly and enemy situations.
- The route (axis of advance) and the desired rate of movement.
- The control measures to be used.
- The attachments (TOWs, engineers, and air defense weapons).
- The company's actions on contact.
- The fire support plan.
- The company's actions upon reaching the march objective, if one is used.

With this information, the CO develops his scheme of maneuver and fire support plan. He provides this same information to the platoon leaders.

b. The battalion may conduct a movement to contact on a single axis or on multiple axes. The lead company (advance guard) on an axis is responsible—

(1) To protect the battalion from a surprise attack by providing early warning of enemy positions and obstacles.

(2) To assist the forward movement of the battalion by removing obstacles or finding routes around them.

(3) To destroy enemy forces (within its capability).

(4) To rapidly develop the situation once contact is made.

c. The lead company or advanced guard on an axis moves using traveling overwatch or bounding overwatch, depending on the situation. It is normally assigned an axis of advance or a zone of action and a march objective on which to orient its movement. Phase lines and checkpoints may also be used to help control movement.

(1) The CO selects the movement technique and formation based on the likelihood of enemy contact and the speed of movement desired by the battalion commander. Bounding overwatch provides the best security; but, traveling overwatch is faster. If traveling overwatch is used by the company, the lead platoon may use bounding overwatch for added security.

(2) The CO must retain the freedom to maneuver his platoons and weapons. He analyzes the terrain, anticipates where he might make contact, and plans fires on those locations. He should avoid terrain, such as draws, ravines, narrow trails, and steep slopes, that will restrict maneuver.

d. When not the lead company, the company uses traveling or traveling overwatch. It must be ready to fire or maneuver in support of the lead company, or to assume the lead company's mission.

e. Once contact is made with the enemy, the CO maintains that contact until ordered to do otherwise by the battalion commander. The following actions must take place at once:

(1) Return fire, deploy, and report. When contact is made, the platoon in contact returns fire at once and takes cover. If the enemy is unaware, the platoon making contact reports and deploys to prevent detection. The maneuver to a position of advantage by this platoon (or other units) should maintain the element of surprise until preparation for the hasty attack is completed. If detected, or once the decision is made to initiate the hasty attack, the platoon leader attempts to fight through, destroying the enemy with the resources that are immediately available. His FO should begin calling for fire. He then reports to the CO and develops the situation. The overwatch element immediately fires at the enemy position. Trail platoons that are not able to fire take cover and wait for orders.

(2) The squad/platoon that initially received direct fire immediately executes the attack drill (FM 7-8). The intent is to rapidly seize the initiative at the lowest echelon possible with aggressive small-unit actions. This unit attempts to achieve fire superiority to fix or suppress the enemy with the resources that are immediately available. This unit then executes a flank attack directed against an identified enemy weakness. If this is not possible, the unit in contact develops the situation to identify the enemy's flanks, any covered and concealed routes around the enemy position, possible supporting positions (both friendly and enemy), and any protective obstacles that the enemy has constructed. This information is quickly reported to the CO.

(3) Upon receipt of this information, the CO determines the proper action to be taken. He (or the XO) also reports the situation to battalion. The CO may conduct or direct his units to conduct additional reconnaissance. The company FSO should be requesting/coordinating indirect fires to support the company's maneuver.

(a) Conduct a hasty attack. If the CO feels he can defeat the enemy force and an attack supports the battalion commander's concept, he quickly conducts a hasty attack before the enemy can react. (See Section IV.)

(b) Bypass the enemy. The CO, with battalion permission, may bypass an enemy force. He may bypass the enemy with one platoon at a time or with the entire company at once (Figure 4-12). Or, he may be directed to fix/suppress the enemy while the battalion bypasses. Indirect fires are also used to suppress the enemy. When the company has suppressed the enemy, the battalion commander may order the company to disengage and rejoin the battalion, or hand off the enemy to a following unit.

(c) Fix and suppress the enemy. When the enemy cannot be bypassed and a hasty attack by the company would be too costly, battalion will normally have the company fix and suppress the enemy (Figure 4-13). This ensures that he does not have the freedom to fire or maneuver against the main body of the battalion while it moves to attack the enemy. The CO supports the battalion commander's planning by reconnoitering to identify the enemy's disposition, strengths, and weaknesses. Covered and concealed routes, good support positions, and enemy obstacles are also identified and reported to battalion.

(d) Establish a hasty defense. Although this action tends to give the initiative to the enemy force, it might provide a needed advantage. This might be required in a meeting engagement with a superior force. The company may establish a hasty defense to protect itself while the remainder of the battalion is maneuvering against the enemy.

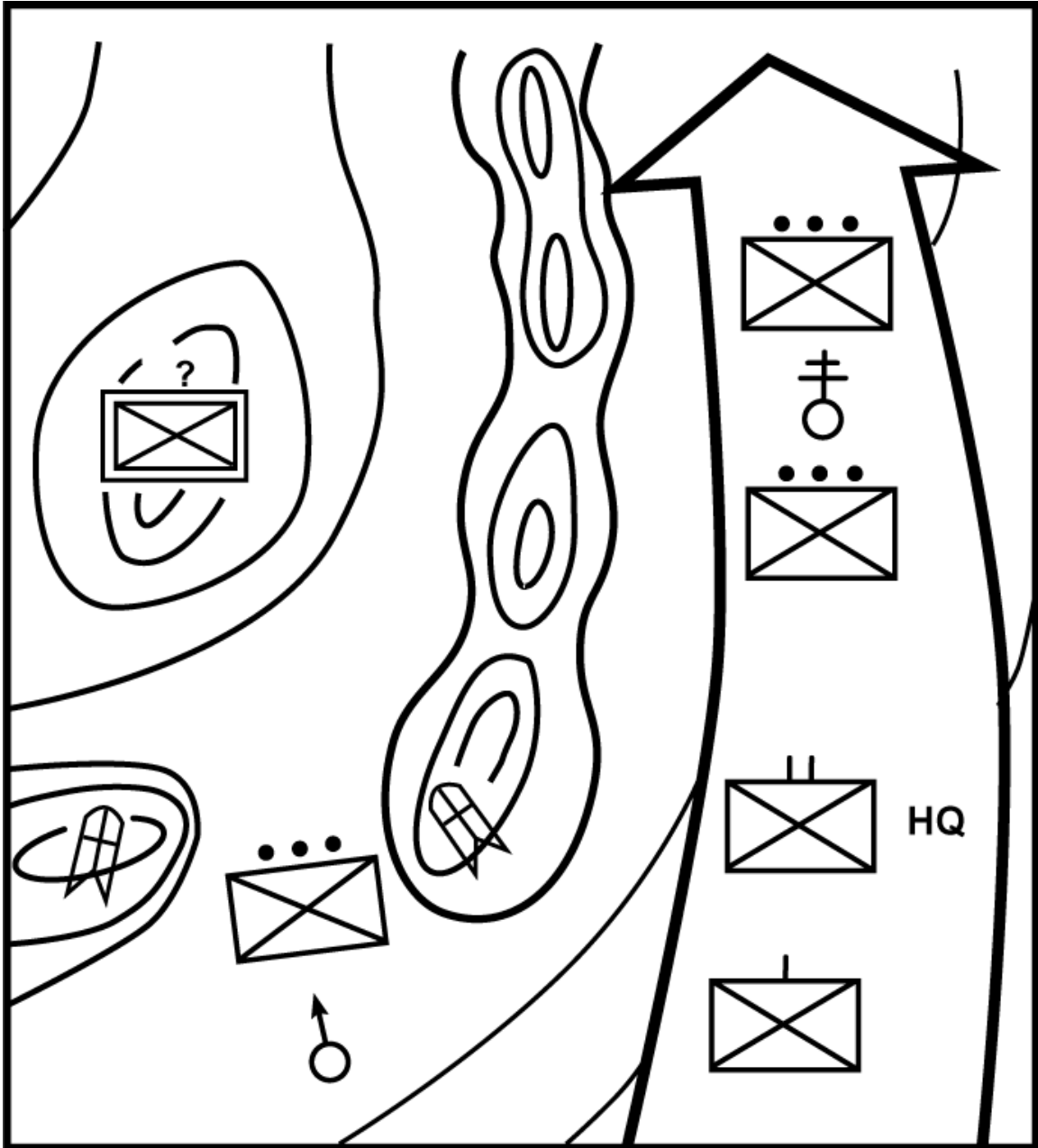
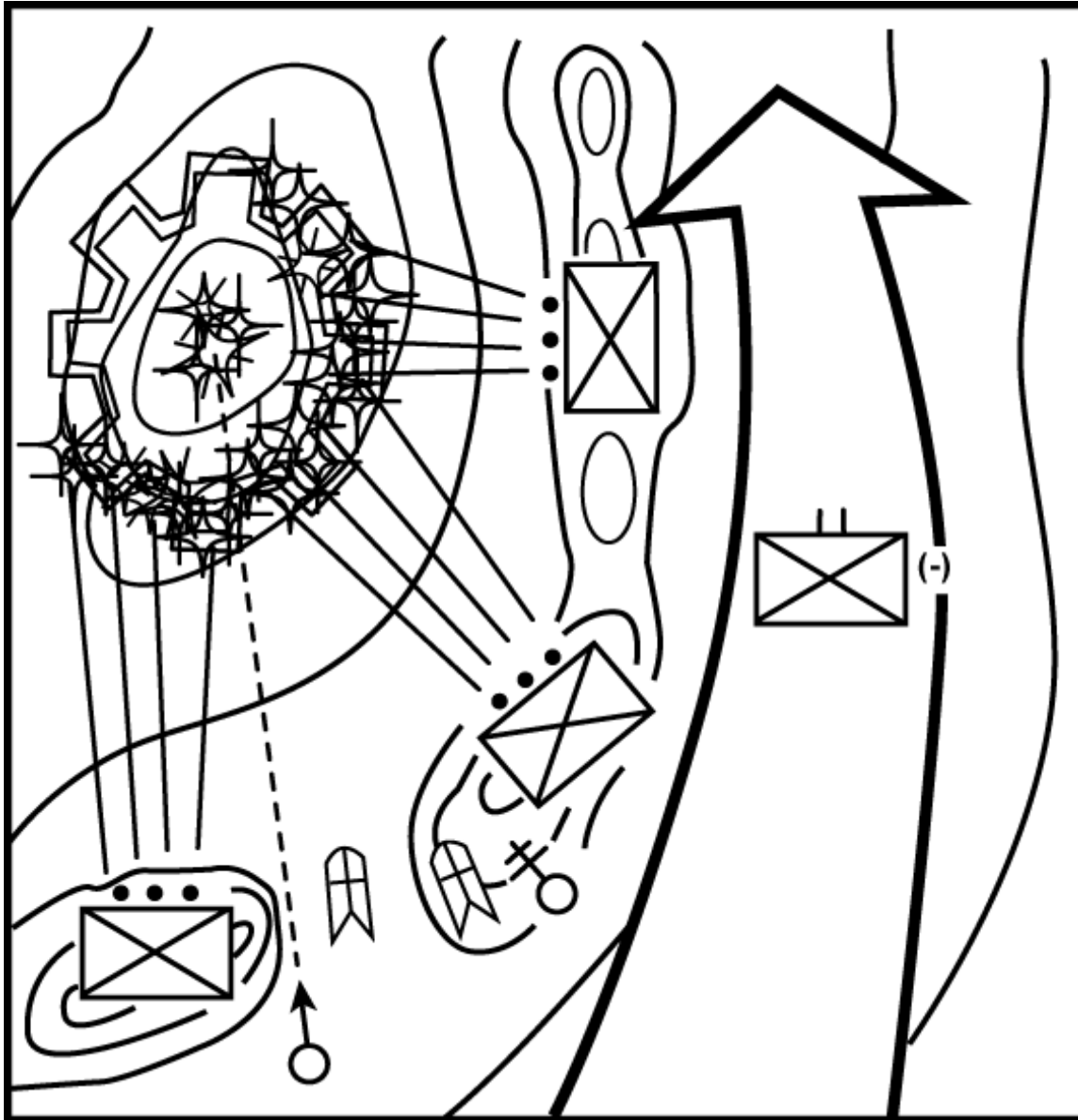

Figure 4-12. Bypass.





**Figure 4-13. Fix and suppress.**

(e) Disengage. This action is not a preferred option unless disengaging is the only way to ensure preservation of the force. Use of indirect fires and bounding/overwatch elements are essential in disengaging from a superior force. The company may disengage while another unit maintains contact. Or the company may disengage by moving back through the battalion to draw the enemy into an ambush.

## Section IV. ATTACKS

The company may conduct attacks independently or as part of the battalion. An attack may be either hasty or deliberate. Because of the difficulties with fire control, navigation, and identification of friendly and enemy soldiers, limited visibility attacks are normally deliberate attacks requiring detailed reconnaissance and planning. On receipt of the battalion warning order, the CO starts his troop-leading procedure and begins his planning.

### 4-12. TYPES

The infantry rifle company attacks as part of any operation. Counterattacks and spoiling attacks are discussed in Chapter 5. Raids and ambushes are discussed in Chapter 6. This section discusses the hasty attack and the deliberate attack.

a. **Hasty Attack.** When the company makes contact with an enemy force, the CO may conduct a hasty attack. On contact, the unit must react immediately: deploy; suppress the enemy; attack through a gap, flank, or weak point; and report to the commander. The preparation for a hasty attack is similar to that of a deliberate attack, but time and resources are limited to what is readily available. Squad and platoon attack drills and company SOPs support rapid preparation and execution of hasty attacks. The company may conduct hasty attacks as a result of a movement to contact, a meeting engagement, or a chance contact during movement; after a successful defense or as part of a defensive operation; and in any other situation when the company has the opportunity to seize the initiative and take offensive action against vulnerable enemy forces.

b. **Deliberate Attack.** A company deliberate attack is normally coordinated as part of a battalion attack. The same principles apply to hasty and deliberate attacks. The effect sought is the same; the difference lies in the amount of planning, reconnoitering, coordinating, and preparing prior to execution. Deliberate attacks are characterized by precise planning based on detailed information, thorough reconnaissance, preparation, and rehearsals. They are conducted when the enemy is in well-prepared defensive positions or when a hasty attack is not possible. The leader has more time to coordinate fire support, analyze the situation, and synchronize activities.

c. **Raids.** A raid is a surprise attack that includes a planned withdrawal from the objective.

d. **Ambushes.** These are surprise attacks against moving or temporarily halted enemy units. Infantry companies may conduct ambushes as part of offensive and defensive operations.

e. **Spoiling Attack.** This is a limited-objective attack made to delay, disrupt, or destroy the enemy's capability to attack.

f. **Counterattack.** This is an attack by defensive forces to regain the initiative or to deny the enemy success with his attack.

### 4-13. OFFENSIVE CONCEPT DEVELOPMENT

As discussed in Chapter 2, the restated mission statement and the other critical facts and deductions provide the focus for developing the offensive concept.

a. Begin developing the concept at the decisive point on the objective and work backward to the LD. First consider the decisive action on the objective. Then consider (as

required) the conduct of the breach; the positioning of the support, assault, and security elements; the leader's reconnaissance; the occupation of the ORP; and the maneuver from the company's current location to the assault position. Once the CO has identified his potentially decisive point(s), he develops his concept.

b. Determine decisive points and times to focus combat power.

(1) The battalion commander's concept and taskings for the company may focus the company on a very specific decisive point and time. This is most likely when the company is the battalion main effort.

(2) For example, the company may be tasked to conduct the main attack for the battalion's attack. In this case, the company decisive point will be somewhere in the vicinity of the objective (key terrain, a critical enemy position, or the enemy CP), and the CO's concept will seek to generate maximum combat power here to accomplish his mission.

(3) Often, particularly in the offense, there are a series of critical actions that must be accomplished for the company to complete its mission. For instance, the reconnaissance must locate the enemy's position and identify his defensive scheme to identify possible weak points at which to conduct the breach. Then the breach element must successfully breach the enemy's obstacles to allow the assault element to maneuver onto the objective. And finally, the assault element must achieve success at the decisive point.

(4) In developing the concept, the CO identifies these critical actions and the potentially decisive locations and times when they must be accomplished. The subordinate unit tasked to accomplish these actions is designated the main effort and supported by the remainder of the company. The subordinate unit that is assigned the final critical action, the decisive action that accomplishes the company's mission, is designated the main attack.

(5) The CO must identify these critical actions and decide when to shift the main effort. His concept must support the quick success of each. Proper planning and execution results in a synchronized operation that rapidly concentrates combat power at a series of potentially decisive points. The cumulative effect on the enemy is a rapid loss of combat potential and the inability to react to the main attack at the decisive point.

c. Determine the results that must be achieved at these decisive point(s) to accomplish the mission. Normally, the purpose from the company mission statement clearly states the desired results for the main attack. At times, particularly during decentralized operations, the CO must analyze the situation more closely to determine the desired results.

d. Determine the purposes to be achieved by the main and supporting efforts throughout the operation. (The supporting purposes must be clearly linked to the main effort's assigned purpose). The CO must avoid employing his main attack in support of an earlier main effort because of the risk of not having sufficient combat potential available in the main attack at the decisive time and point.

(1) The main attack's purpose is often the purpose from the company's mission statement. At times, the company's purpose must be modified slightly to be appropriate for the main attack platoon. When modified, it must be clear that success by the main attack results in success for the company.

(2) The supporting effort's purposes are selected by determining what must be achieved to support the success of the main effort. Examples of supporting effort

purposes include; to allow the main effort to maneuver on the objective, to allow the breach element to breach obstacles, to prevent surprise on the main body, or to prevent the enemy from reacting to the assault.

(3) The CO uses the offensive framework to assist him in developing his concept. Although the focus is on the decisive action by the main attack in the objective area; supporting attacks, reconnaissance and security requirements, and the need for a reserve must also be addressed.

e. Determine the essential tasks for each subordinate unit (main and supporting efforts) that achieves the selected purposes (paragraph d).

(1) When linked with the purpose, a clearly defined, attainable, and decisive mission statement is assigned. The mission should clearly focus the subordinate unit on the terrain, the enemy, or a friendly unit.

(2) Position the main and supporting attacks to concentrate combat power at the decisive point. Identify reconnaissance and security requirements. Consider the need for a reserve or other means to provide flexibility.

f. Task-organize units (platoons and sections) to accomplish the identified missions.

(1) The CO allocates resources to the main effort first and then to the supporting efforts. Normally, the CO will not task-organize below squad level or specific weapons or equipment. At times, particularly when understrength, the CO may have to task-organize below squad level.

(2) The size of these organizations may range from a squad to a reinforced platoon. If there are insufficient resources to ensure each of the supporting effort missions is attainable, the task may be modified. For example, the original mission may have been to guard the flank of the main effort to prevent his envelopment; it may now be changed to a screen task. If required the purpose may also be changed. In this case, it might be changed to provide early warning and prevent surprise of the main effort. Or if the original task was to block, a delay task may be attainable and still achieve the desired results.

g. Assign command and control headquarters for each of the task organized units.

(1) All platoon/section leaders should be used fully. If additional leaders are required, the XO, 1SG, company FSO, and other company leaders are used.

(2) When no senior leader is available, the senior squad leader may be the unit leader. Or if the company has a one squad reserve, it may be led by its assigned squad leader.

h. Complete a task organization by assigning all organic or attached units. Of particular concern may be the FOs, medics, and other attachments. They should be attached to the unit where their unique capabilities are most effectively employed or possibly where they provide the most flexibility.

i. Establish control measures that clarify and support the accomplishment of the assigned mission.

(1) Time events and use control measures (axis, boundaries, DOA, assault positions, support positions, objectives . . .) to synchronize subordinate actions without stifling initiative.

(2) Certain control measures may be required to provide additional safety for the unit. These may include fire control measures, procedures, or special signals or markings to ensure understanding.

j. The essential part of the concept, dealing with the actions at the decisive point, has been completed. The focus of this next phase in the concept development is to ensure the main effort is weighted. The CO can weight the main effort in many different ways. Some examples include:

- Attaching additional squads/weapons.
- Assigning priority of fires or allocating a priority target.
- Assigning priority of any support (CS/CSS), such as 1st in priority for engineer support.
- Limiting the main effort's area of responsibility to allow this unit to focus on the critical action. For example, tasking supporting efforts to provide security for the main effort.
- Locating other resources in the vicinity of the main effort that support the main effort's focus on the decisive action.
- Providing additional time to prepare, rehearse, or conduct reconnaissance.

k. The following actions complete the offensive concept development.

(1) *Completing the movement plan.* This should address the movement of the entire unit from its present location(s) through its eventual consolidation. Likely COAs for exploitation should also be considered. Routes, order of movement, timings, and the requirements for security and control must also be considered and addressed as appropriate.

(2) *Completing the reconnaissance and security plan.* The R&S requirements at the objective may be complete, but the CO must consider these requirements throughout the mission. What are the security requirements during movement, in the ORP, during consolidation? The company's reconnaissance effort must be focused on the decisive action, but it may also include reconnaissance of all routes, danger areas, key terrain, or other locations that may be critical to the mission. The CO then prioritizes these requirements and tasks units to accomplish them.

(3) *Completing the fire plan.* The CO plans both direct and indirect fires in the detail required by the situation. The fire planning must address all phases of the attack to include the approach into the objective area, the actions on the objective, any contingency missions, and the consolidation plan. At times, the situation may require less planning at company level and more at the platoon level. Platoon leaders routinely coordinate their fire plans.

(4) *Developing the CSS plan.* The CO must plan for casualty evacuation, resupply, and movement of rucksacks/other equipment. The CO also plans for the supplies and equipment needed to support the attack and subsequent operations. He always considers the impact of soldier's load on the mission and normally provides additional instructions to ensure the soldiers carry only what is required. He may also plan for transportation of the items normally maintained in the battalion trains so he can maintain the momentum of the attack or prepare a defense against an enemy counterattack.

(5) *Planning likely contingencies.* The CO must plan ahead for any possibilities, such as his actions in the event of detection during an infiltration or in the event of an increased threat of chemical attack by the enemy.

#### 4-14. ACTIONS ON THE OBJECTIVE

The objective for the company may vary from the kill zone of a company ambush to a complex enemy strongpoint in an urban environment. In every case, the company's actions on the objective are critical and thus the focus of the commander's concept. The concept was developed starting with the decisive point on the objective. The missions for all the subordinate units are focused on the main attack's action at the decisive point. The commander's estimate will determine what other considerations must be included for the actions on the objective.

a. The actions of the company on the objective are conducted by teams, squads, and platoons. These actions may include breaching enemy obstacles, destroying bunkers, clearing trenchlines, searching EPWs, treating/evacuating casualties, providing supporting fires, and many other tasks. These tasks are discussed in detail in FM 7-8.

b. To complete his concept, the commander must ensure that he understands what must occur on the objective for the company to accomplish its mission. He then assigns tasks and allocates resources to complete these. He must determine how much detail is required to control and synchronize the actions of his subordinates; these measures should be kept as simple as possible.

(1) The amount of control required will vary based on the situation. As in any operation, the minimum essential control measures should be used. Control is provided by the units' relationship to the main attack. This method of control has the best chance of being effective once the fight begins.

(a) Effective reconnaissance also provides control by ensuring leaders understand the situation and the terrain's effect on their unit during execution.

(b) Rehearsals are an excellent means of ensuring control during execution. Full-scale rehearsals are essential to successful, deliberate attacks. They also support synchronization.

(2) Synchronization is also provided through the relationships to the main attack. If the support element clearly understands the commander's intent for their fires, they are more likely to provide effective support than if the CO attempts to establish a detailed time schedule. They can move, initiate fire, or lift or shift fires based on the actions of the main effort. In a similar manner, the reserve can move and or reposition based upon the actions of the main effort.

c. Paragraph 4-18 discusses the company's actions on the objective for an assault against an enemy strongpoint. The fundamentals and considerations for this complex objective also apply for most other company objectives.

#### 4-15. REORGANIZATION.

This is the reorganizing of platoons, sections, and squads in order to continue operations. It is a continuous process and should be part of the company SOP. During reorganization, each platoon leader reports his platoon's situation, location, casualties, and ammunition status to the CO. The CO reports the same to the battalion. Ammunition is redistributed and units are resupplied. Casualties are treated and evacuated. Key positions are filled (weapons/leaders). Prisoners are processed and sent to collecting points, and enemy information and material are collected and reported. The company will always reorganize after an attack, but it may not always consolidate.

#### 4-16. CONSOLIDATION

This is the organizing and positioning of platoons and weapons on a newly seized objective to defend against a counterattack. The CO should always plan to consolidate after an attack. The company may not consolidate if it has not achieved the assigned purpose or if the company has the opportunity and the combat potential to exploit the successful attack, within the framework of the battalion concept.

a. The CO also decides if the mission or situation requires the company to consolidate on the objective. If not, the CO may direct the company to consolidate on adjacent terrain or to withdraw to the ORP. Disadvantages to consolidating on the objective include the enemy's knowledge of this terrain and that counterattack or indirect fires may already have been planned on it.

b. The planning considerations for consolidation are similar to a perimeter defense (see Chapter 5). The CO assigns a sector of the company objective to each platoon to consolidate. He assigns missions and locations to each subordinate. He identifies a main effort and a reserve. He ensures that all units know their responsibilities and their locations. He integrates supporting assets into the defense. When time is limited, the CO can use either the clock method or the terrain feature method for consolidation.

(1) In the clock method, the CO divides the objective into hour segments like a clock (Figure 4-14). Twelve o'clock is either a compass heading or the direction of the enemy. He then assigns each platoon a sector by hour segments.

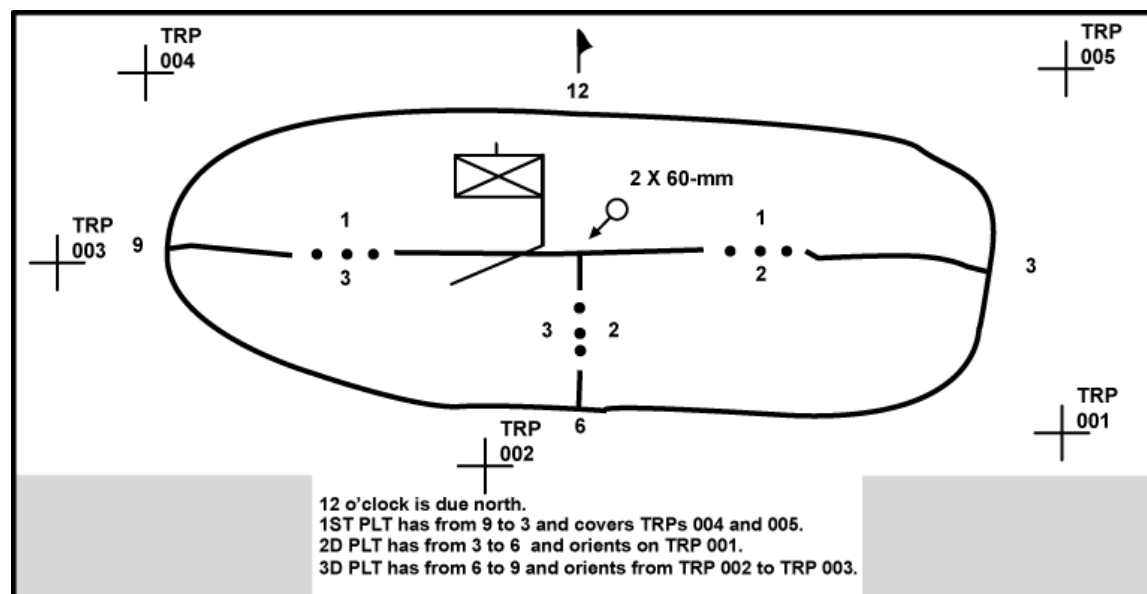

**Figure 4-14. Clock method.**

(2) In the terrain feature method, the CO gives each platoon two easily identifiable terrain features as the right and left limits of its sector/BP (Figure 4-15).

c. During consolidation, security is established (OPs and security patrols). Platoons and weapons crews are positioned to cover the most likely avenues of approach. Fields of fire are cleared, and fighting positions are prepared. Combat service support elements are moved forward, and casualties and EPWs are evacuated (see Chapter 8). Other reorganization actions also occur. Indirect fires are coordinated and FPFs are adjusted.

#### 4-17. FIRE SUPPORT

This plan is developed at the same time as the scheme of maneuver. The FSO integrates the indirect fires, based on the CO's guidance, to support the company's maneuver throughout the operation. The desired outcome is to ensure that all available indirect fires are synchronized to have the greatest effect on the enemy. This requires that the preplanned targets are correctly positioned, that the best weapon engages each target using the proper shell/fuse combination, and that the responsibility for firing the target is assigned to the observer who is in the right location and understands how this target is synchronized to support the maneuver.

a. The fire planning normally begins at levels above the company. When the company FSO begins his planning, he normally has the battalion's target list, the battalion's priority of fires and allocation of priority targets, and the commanders' guidance for employing the indirect fire assets.

b. The company fire planning is a continuation of the process begun at battalion. The company FSO/CO designates additional targets, establishes a company priority of fires, and either directs priority targets or allocates this resource to the platoons.

c. Fires are planned to support all phases of the attack. The approach; the deployment into the assault, support, and security positions; the isolation of the entire objective and the breach site; the assault; and the consolidation/exploitation. These targets are planned on all known or suspected enemy locations. They may also be planned on likely avenues of approach or on prominent terrain features to provide flexibility.

d. Indirect fire is planned to suppress, obscure, neutralize, destroy, deceive, or disrupt enemy forces. Smoke or WP is used to screen the company when moving across danger areas or when breaching obstacles. And it can be used to isolate the objective by disrupting reinforcing or counterattacking forces.

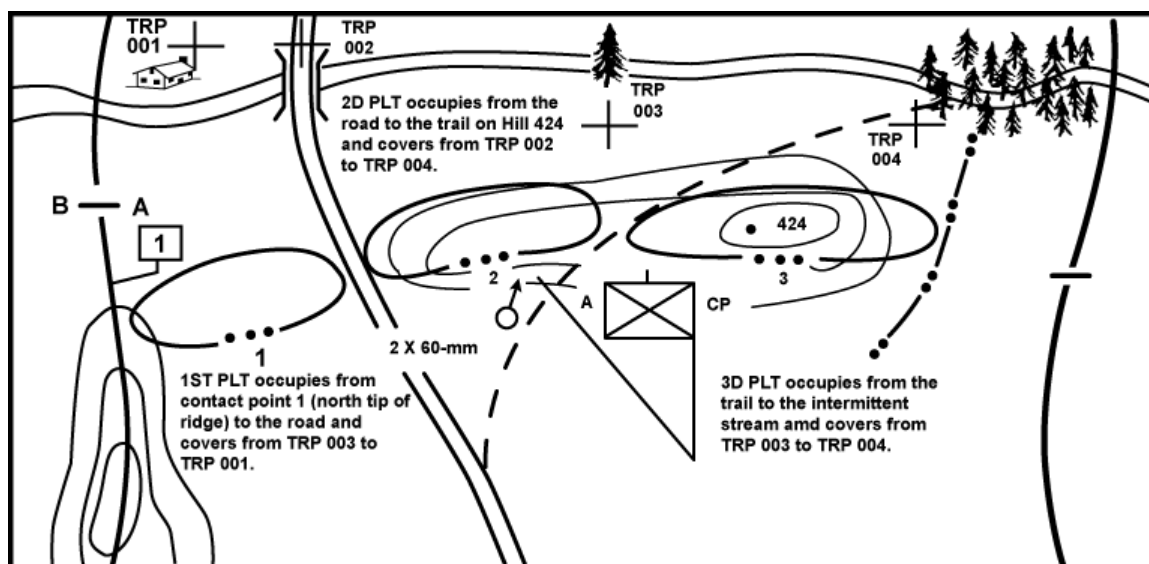

**Figure 4-15. Terrain feature method.**

e. A priority of fires is set for the company to resolve conflicts in the event two units call for fire at the same time. A different priority may be set for each supporting indirect



system. For example, priority for artillery fires is: 1st PLT, 2d PLT, 3d PLT; priority for mortar fires is 2d PLT, 1st PLT, 3d PLT.

f. Priority targets ensure that critical targets are the first priority for engagement. When allocated a priority target from battalion, the CO may either decide which target(s) will be designated priority targets or he allocates this resource to one of his platoons for planning. Normally in the offense, the CO designates priority targets. They are shifted during the conduct of the operation to provide responsive fires on the critical targets for each phase of the attack. He also assigns responsibility for observing and calling for each priority target. The firing unit should know when priority targets will shift so that by monitoring the command net, they can shift to the next priority target when required.

g. The suppression of the enemy weapon systems on the objective during the assault is normally the most critical aspect of the company fire planning. The CO must decide (if not directed by battalion) when (or if) to initiate the indirect fires on the objective. If the company is detected, these fires may have to begin earlier than planned. He must also decide when to shift the indirect fires to prevent friendly casualties. This will depend on the gun-target line, the accuracy of the firing system, the bursting radius of the round, and the ability of the direct-fire weapons to suppress the enemy. Generally, CAS or artillery will have to be shifted earlier than 81-mm or 60-mm mortars. See Chapter 7 for a more detailed discussion for employing indirect fire near friendly forces.

h. The firing locations for the company mortars are selected during the fire planning. Considerations include their maximum effective range, the desired gun-target line, the plan to move the mortar ammunition, and the control and security requirements.

(1) If the mortars can support the attack from their present location or from a position near the LD, this would reduce the ammunition transportation problem. Or they may be able to support from the ORP. Advantages from this location are that although the ammunition had to be carried forward, it did not require extra movement to get it to the firing position, and the personnel securing the ORP would also provide security for the mortars. Disadvantages include, the ORP location may be compromised due to the mortar firing, and the mortars will probably have to fire by using an FDC instead of in the direct lay or direct alignment mode.

(2) Another option is to collocate the mortars with the support element. This requires extra movement of the ammunition, but the control and security of the mortars is better from this location. It is also more likely that they can employ direct lay since the support position has line of sight to the objective.

i. The CO ensures that the fire plan for the company is supported with the proper control measures. Responsibilities must be clearly understood. Visual signals should be established to communicate critical actions, such as to initiate, cease, or shift indirect fires.

j. CAS, attack helicopters, and air defense weapons may provide additional fire support. This support is normally planned and controlled by the battalion, but the CO may request it.

## Section V. ATTACK TECHNIQUES

The assault on an enemy strongpoint and a limited visibility attack are the two most demanding attacks a rifle company will conduct. The fundamentals and techniques discussed in this section will assist the CO in planning, preparing, and conducting all attacks.

### 4-18. ASSAULT OF A STRONGPOINT

The most difficult objective for a dismounted force is to seize/clear an enemy strongpoint complete with obstacles and fortifications. The CO employs techniques that avoid attacking the enemy's main strength; instead he tries to identify and attack a weakness in the defense. The CO deceives the enemy as to the point of the main attack; he uses surprise to take advantage of his initiative in determining the time and place for the attack. He attempts to use the indirect approach to strike the enemy on exposed flanks or the rear. The concept development process discussed in paragraph 4-13 provides the specific sub-unit missions and details for planning this attack. A deliberate attack of a strongpoint is usually conducted in the following phases:

- Reconnoiter the objective and develop the concept.
- Move to the objective.
- Isolate the objective and the selected breach site.
- Attack to secure a foothold.
- Exploit the penetration and clear the objective.

a. **Reconnoiter and Develop the Concept.** The CO either recons the objective himself or has someone else do it. The recon should identify the positions on the objective (crew-served weapons, C2 locations, vehicles), the level of preparation, the gaps in the defense, and other potential weaknesses. The recon should be followed by keeping eyes on the objective to ensure the CO is informed of any change in the enemy situation.

(1) The reconnaissance may be done many different ways. An effective technique is to task-organize a reconnaissance patrol with leaders from the assault, support, and breach elements. There should be sufficient personnel to establish surveillance on the objective and to secure the ORP. The reconnaissance patrol either returns to the company's location or meets the company at a designated linkup point and guides them into the ORP. At times, the scout platoon or other battalion assets may be tasked to conduct reconnaissance in support of the company's mission.

(2) After the CO develops his concept, he often task-organizes his unit into a breach element, a support element, an assault element, and possibly a reserve. The reserve is normally under his control and is positioned where it can best exploit the success of the attack or can increase combat power as necessary. The reserve should not be so close that it loses flexibility during the assault. The reserve leader must know where he will locate throughout the attack.

(3) The breach force is usually formed around an infantry unit. Engineers, if available, are part of the breaching element. Any mechanical or explosive breaching assets are also attached to this element. The breach force makes the initial breach and passes the assault element through. It may have to organize its own assault element (to secure the breach), support element (to provide close-in suppression), and breach element (to actually breach the obstacles).

(4) The support element is organized to provide supporting (indirect/direct) fires to the breach element initially, then to the assault element. The support element may consist of infantry squads, the 60-mm mortar section, antiarmor section, machine gun teams, and M203 gunners. Their primary responsibility is to suppress the enemy that can engage the breach element, and to isolate the breach site from enemy reinforcement.

(5) The assault element is usually one or two infantry platoons, depending on the enemy situation (number of personnel, level of preparation and complexity of fortifications), and the size and composition of the breach and the support elements. Often, a small assault element supported by a large volume of accurate suppressive fires is effective in clearing the objective. The assault element may also be required to breach enemy obstacles on the objective.

(6) The CO determines the best task organization for the entire mission. It should be simple and maintain unit integrity whenever possible. At times, the company will move to the ORP task—organized as usual (no cross attachments); change task organization in the ORP for the conduct of the assault, and then modify this task organization to consolidate in defensive positions on the objective.

b. **Move to the Objective.** The company approaches the objective in a manner which supports its deployment prior to the assault. This may be a movement intended to avoid detection that allows the company to occupy the ORP and conduct the leader's reconnaissance of the objective. Or the company may cross the LD under the cover of heavy suppressive direct and indirect fires. These fires would continue until the company reaches its assault position or FCL, and then shift to allow the assault on the objective. In either case, the following fundamentals should be part of this phase of the attack (Figure 4-16).

(1) The movement from the assembly area to the LD is timed so the movement to and across the LD is continuous. The lead element of the company starts crossing the LD at the attack time specified in the battalion OPORD. Before the company's movement, a patrol may be sent to reconnoiter and mark the route and check the time it takes to move to the LD.

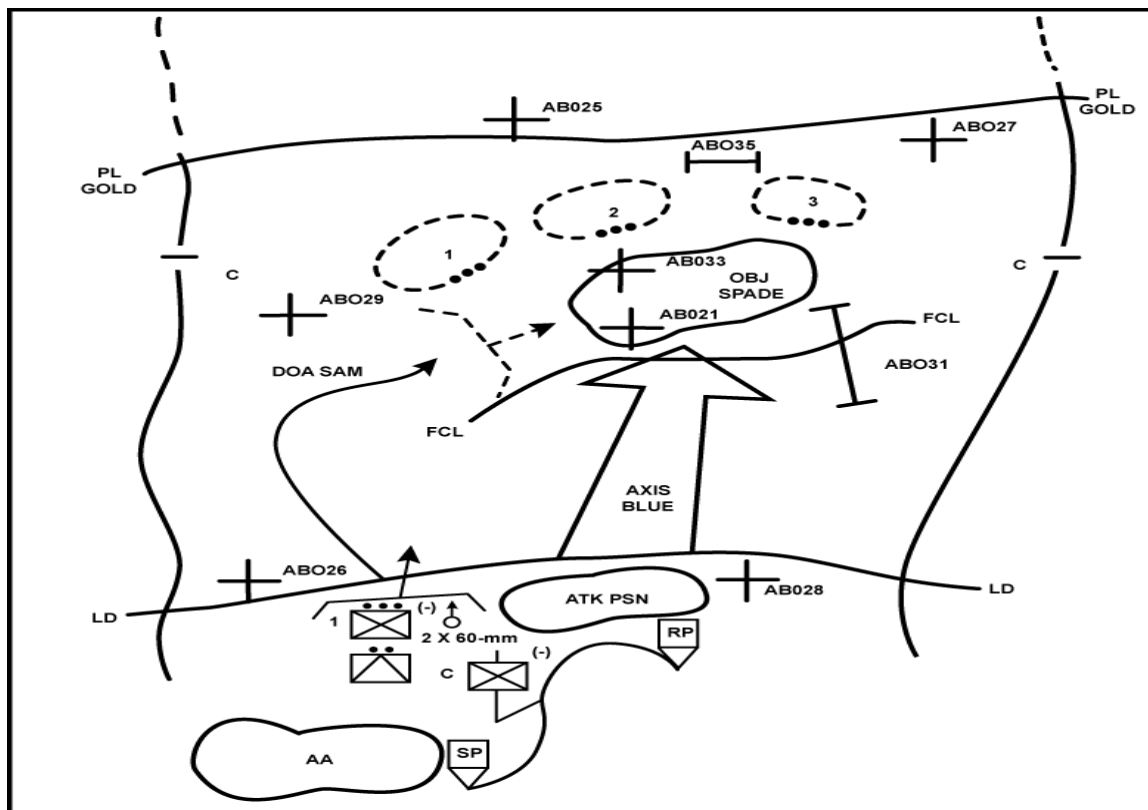

**Figure 4-16. Movement to the objective.**

(2) The support element may precede the assault and the breach elements to the LD in order to be in an overwatch position ready to fire when they cross the LD. Mortars are moved forward to a firing position near the LD to allow maximum coverage of the objective area.

(3) The CO avoids stopping in the attack position, but if they are ahead of schedule or told to hold in the attack position, they occupy the attack position, post security, and wait until it is time to move or until told to move.

(4) During movement from the LD to the assault position, the company makes the best use of cover, concealment, smoke, and supporting fire. The antiarmor section can overwatch from positions that best support the advance of the company. As the company advances, the antiarmor section leader displaces to ensure continuous support.

(5) If the company is hit by indirect fire en route, it moves quickly out of the impact area. If it meets enemy resistance short of the objective, it returns fire at once. The leader of the platoon in contact has his FO call for and adjust indirect fire on the enemy. Depending on the place and type of resistance and the company plan, the platoon may be ordered to bypass an enemy position that cannot affect the mission. The locations of all bypassed enemy are reported to the CO who, in turn, reports them to the battalion.

(6) If an enemy position cannot be bypassed, the leader of the platoon in contact and the CO must take prompt and aggressive action. The platoon leader attempts to conduct the platoon attack drill and destroy the enemy position. The CO quickly conducts an estimate of the situation and issues FRAGOs as needed to carry out his plan. He should not commit platoons piecemeal. He coordinates actions and fires so the company will attack the enemy with its full combat power. The CO should maneuver to assault the

flank or rear of the enemy position. When the enemy is destroyed/suppressed, the company continues toward its objective.

(7) Obstacles along the route are either bypassed or breached. The CO must decide the best way to overcome the obstacle without losing momentum. The battalion commander is told of obstacles that may affect units following the company. Engineers are positioned forward to provide a rapid assessment of the obstacle.

(8) If a support element (from the company) is to be used, it should be positioned before the company's assault element reaches the assault position. The support element initiates its fire on the objective on order or at a specified time. Supporting indirect fires are synchronized to impact at the same time.

c. **Isolate the Objective and the Selected Breach Site.** Normally, the battalion isolates the objective area to allow the company(s) to concentrate its combat potential on the enemy strongpoint (Figure 4-17).

(1) The company may begin the isolation during the leader's reconnaissance by positioning security elements to prevent enemy movement into or out of the objective area. The CO must ensure that these units understand what actions to take. They may initially just observe and report until the company is deployed for the assault. At a designated time or signal, they begin active measures to isolate the objective.

(2) Once the isolation of the objective area is complete, the CO focuses on isolation at the breach point or point of attack. This isolation is to prevent enemy reinforcement at the breach site and also to suppress enemy weapons and positions that have observation of the breach site. The support element is assigned the main responsibility for this isolation.

(3) The CO masses all available combat power at the initial penetration or breach point. He uses indirect fires to suppress/obscure adjacent enemy positions and isolate them from the breach site.

d. **Attack to Secure a Foothold.** The breach of the enemy position is normally the company's initial main effort. The breach element penetrates or bypasses the enemy's protective obstacles, gains a foothold in the trench line, and creates a gap large enough for the assault element to pass through (Figure 4-18).

(1) *Preparations.* Whenever a unit is conducting a breach, it must be prepared to execute the following steps:

(a) Suppress the enemy covering the obstacle/breach site.

(b) Obscure the enemy's observation of the breach element with smoke.

(c) Secure the far side of the breach by seizing the terrain or destroying the enemy that can engage the breach site.

(d) Reduce the obstacle and or widen and mark the lane, and assist passage of the assault elements.

(2) *Planning.* In planning the breach operation, the following should be considered:

(a) The breach element moves forward by covered and concealed routes. If possible, the breach should be covert to reduce the time the breach and assault elements are exposed to enemy fire. If this is not possible or if the breaching attempt is compromised, the breach element moves under the suppressive fires of the support element.

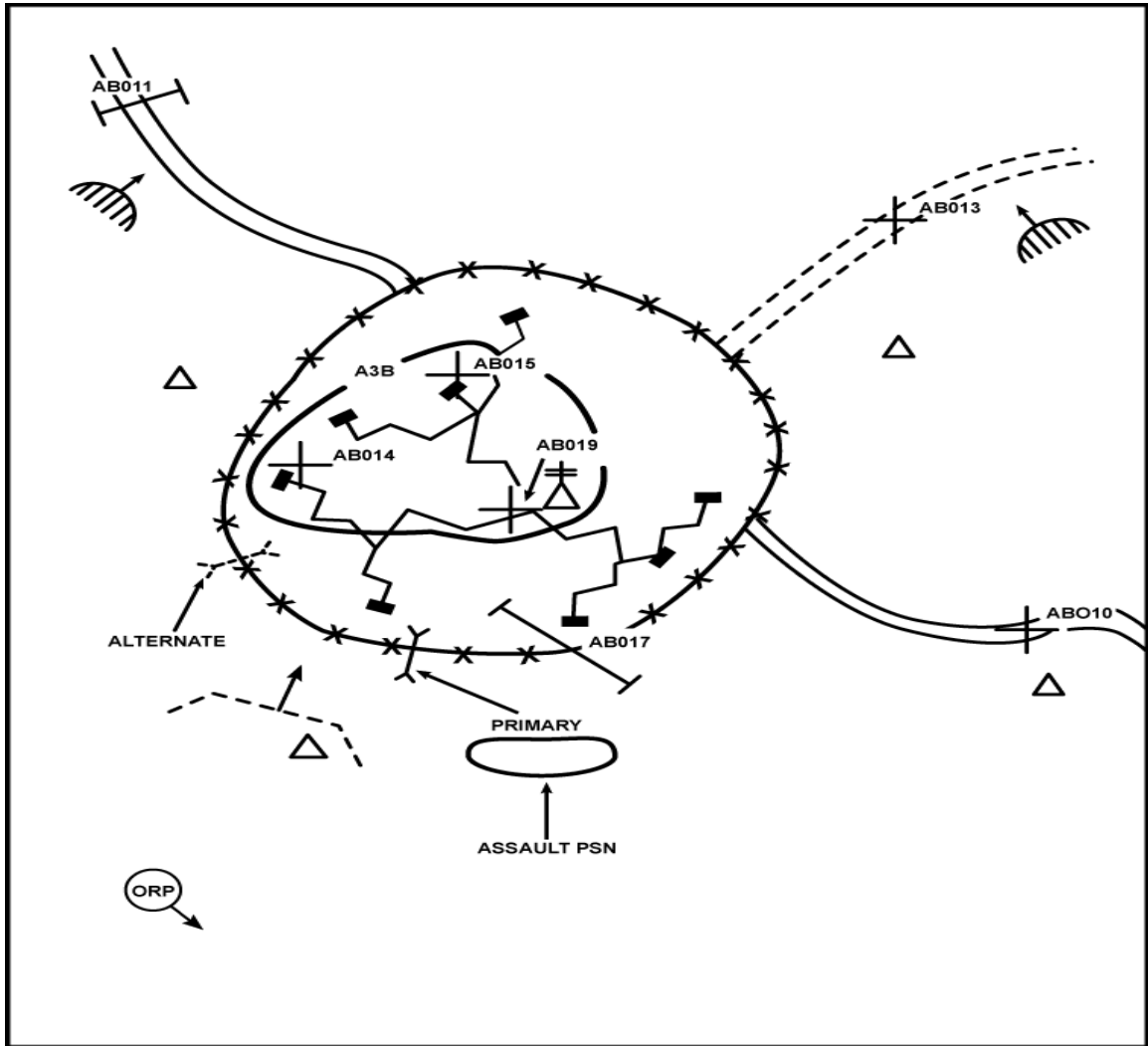
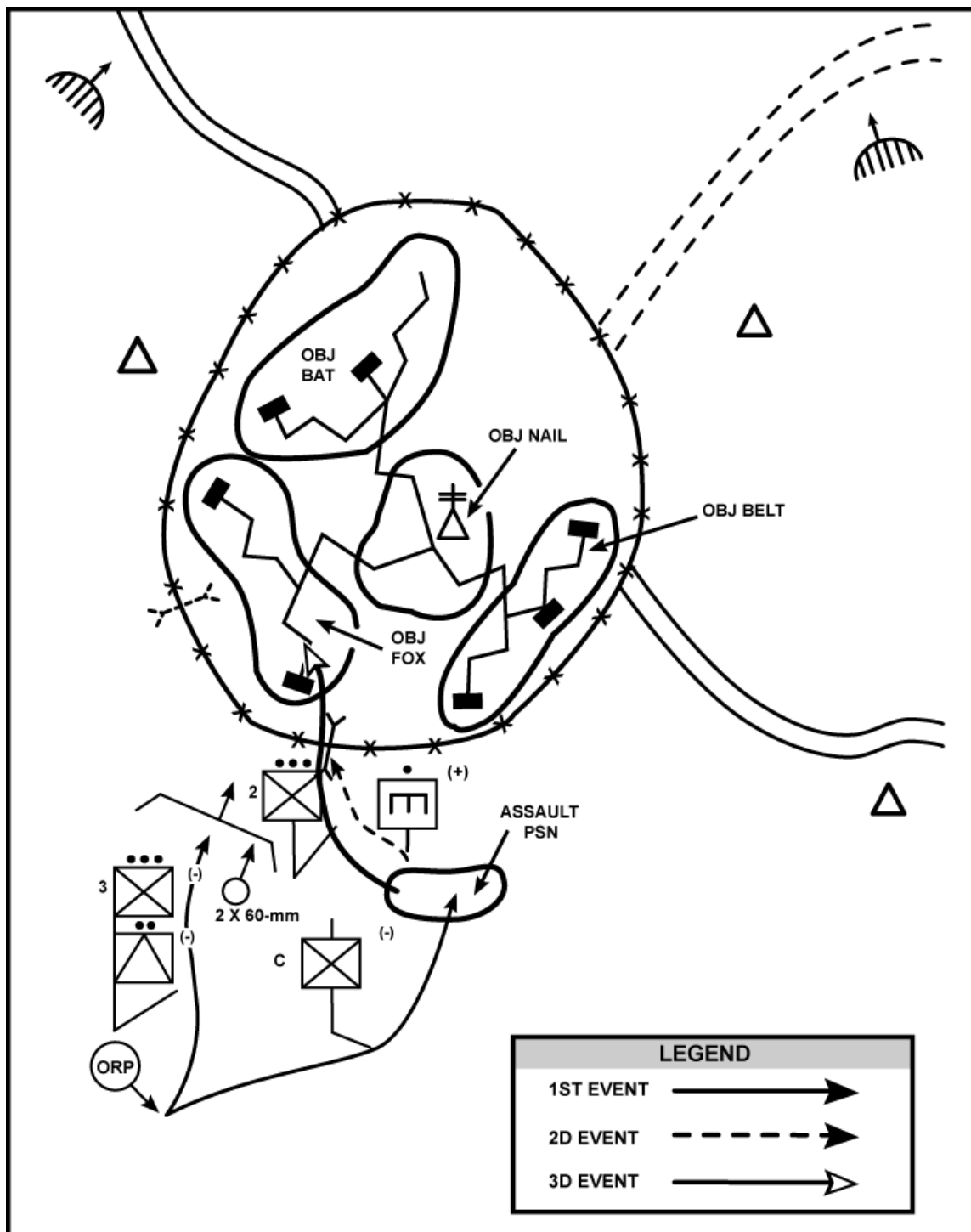

Figure 4-17. Isolation activities.



**Figure 4-18. Breach and secure a foothold.**

(b) The penetration of the enemy position is made on a narrow front. The concept is to make a narrow penetration into the enemy defenses and then expand it enough to allow rapid passage of the assault element. Normally, the company concentrates all combat power at one breach point. Two breach sites may be used if they are mutually supporting and do not result in a lack of concentration or a piece-meal assault. When only using one

breach site, an alternate site should be planned as a contingency if the primary breach is unsuccessful.

(c) The support element provides effective suppression for the breach and assault element to cross the enemy's killing ground. Each weapon in the support element should be assigned a specific enemy position or sector of responsibility. Initially, the support element establishes fire superiority with a maximum volume of fire. Once established, fire superiority is maintained throughout the attack. When indirect fires are shifted, the support element increases the rate of direct fire to maintain the suppression.

(d) The support element normally occupies one position to simplify control. At times, the support element must occupy several positions to provide effective suppression of the enemy. This may be required to prevent the masking of fires by the breach/assault element or because of the characteristics of the supporting weapons (that is, 60-mm mortar versus LAW). Also, the support element often must reposition once the assault element begins clearing the objective. They may follow the assault element through the breach or reposition outside the enemy position.

e. **Exploit the Penetration and Seize the Decisive Point.** After the successful breach, the assault element conducts the main attack. The assault element passes rapidly through the breach, supported by the fires of the support element and the breach element. In planning the assault, consider the following points:

(1) The assault element must reduce the enemy position as quickly as possible. If the assault element can capture or destroy the enemy command and control facilities or other key positions/weapons, the enemy may surrender or abandon the position. If there is key terrain, this may be the decisive point for the assault element. Normally the assault element moves within the enemy's trenches to avoid exposure to enemy fire (Figure 4-19).

(a) The assault element must also organize into support, assault, and breach elements. As subsequent positions or bunkers are encountered, the breaching operations may have to be repeated. As in the initial breach, a support by fire position is established as the same sequence of breaching and assaulting is conducted to reduce the position.

(b) The designation of a reserve allows the CO to retain flexibility during the attack. The CO should be prepared to commit his reserve to exploit success and to continue the attack. The reserve may also be used to repulse counterattacks during consolidation and reorganization.

(2) Once an assault starts, the company maneuvers aggressively to allow the enemy less time to react. The CO monitors the situation. He adjusts the plan to exploit a weakness found during the attack. If a situation develops that is beyond the capability of his company, he notifies the battalion commander. He may have to hold his position until other companies can maneuver to support him.

(3) In moving from their assault positions, platoons advance in the formation most suitable to the terrain and situation. When the assault element must move through a narrow lane in the obstacles, they maintain dispersion and assault through the lane by fire teams; signals should be coordinated to support this. The CO moves where he can best control his platoons and supporting fire. Indirect fire and the direct fires of the support element are shifted or lifted when they endanger the advancing soldiers.

(4) The assaulting soldiers clear enemy positions, secure and search prisoners, and move quickly across the objective. When they reach the far side, they take up hasty



fighting positions and continue to fire at the withdrawing enemy. When the objective is secured, the fire element, mortars, TOWs, and trains are called forward.

Once the objective is seized, the company reorganizes and consolidates if required. The CO decides if he can exploit his success IAW his commander's concept to support the main effort.

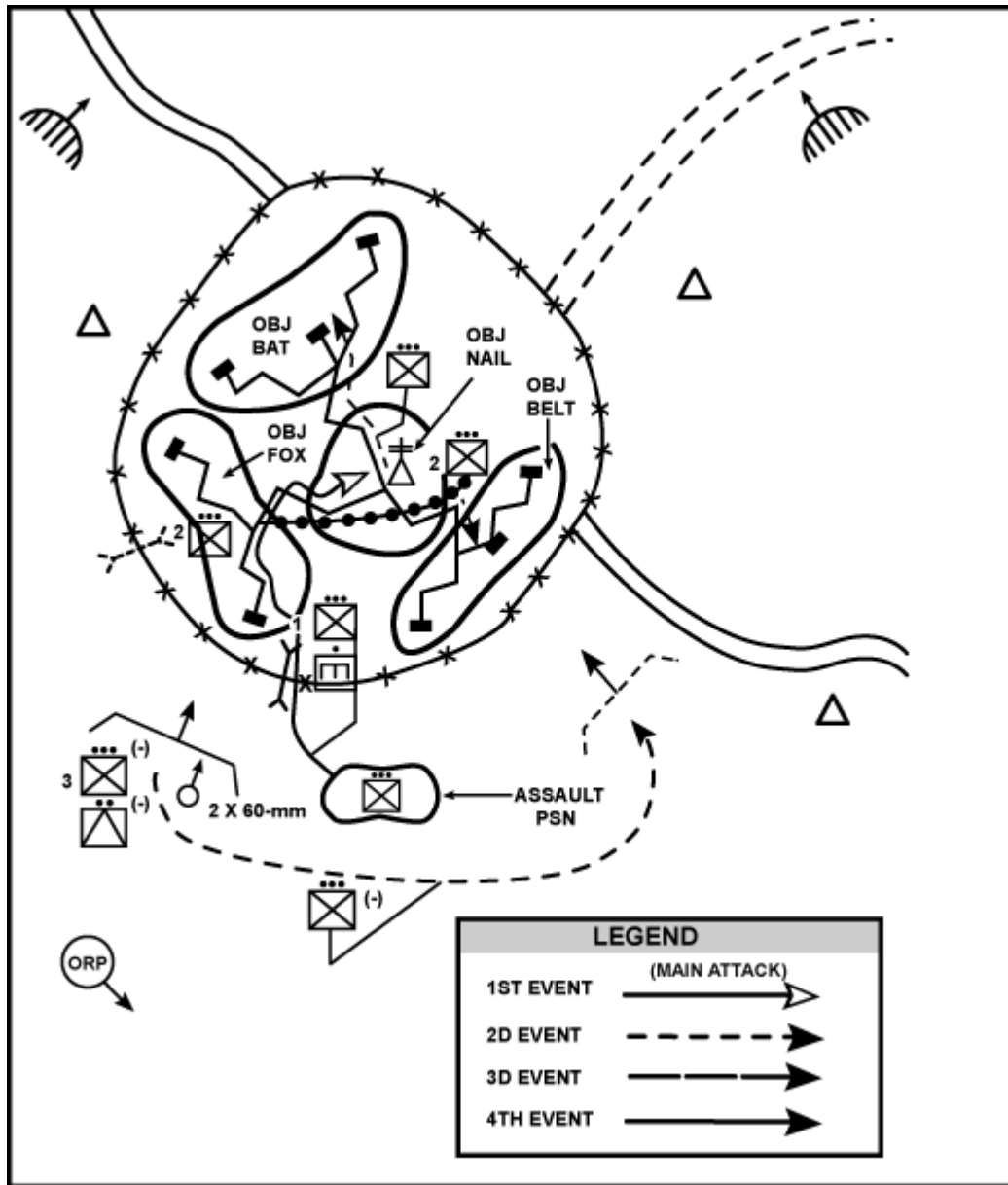

Figure 4-19. Exploit the penetration.

#### 4-19. ATTACK DURING LIMITED VISIBILITY

Successful attacks during limited visibility depend on leadership, reconnaissance, training, planning, and surprise. Although these fundamentals are also key to daylight attacks, attacks during limited visibility require certain considerations and the proper application of the techniques discussed in this chapter to ensure control in the attack. Darkness, fog, heavy rain, and falling snow limit visibility. Smoke and dust from HE fires do too, but their effects are more temporary. Infantry companies attack during limited visibility—

- To achieve surprise.
- To avoid heavy losses.
- To cause panic in a weak/disorganized enemy.
- To exploit success and maintain momentum.
- To keep pressure on the enemy.

a. The rifle company, when equipped with NVDs, conducts limited visibility attacks very much like daylight attacks (Figure 4-20). The fundamentals for a daylight attack, discussed earlier in this chapter, still apply for night attacks. To conduct attacks in this manner requires—

- A company that is well trained in limited visibility attacks.
- Enough natural light to employ the unit's NVDs.
- A simple, effective concept that takes advantage of the enemy's surprise and confusion.
- A successful reconnaissance of the objective area.
- Additional control measures/techniques, as needed.

b. When planning attacks at night, the CO must consider the increased difficulty with—

- Controlling units, soldiers, and fires.
- Identifying and engaging targets.
- Navigating and moving.
- Identifying friendly from enemy soldiers.
- Locating, treating, and evacuating casualties.
- Locating and by-passing or breaching enemy obstacles.

c. In planning limited visibility attacks, the CO should also consider the following:

(1) Feints and other deceptions may be more effective. (This is true for the enemy also. False positions/other deceptive measures may be more effective.)

(2) If a small element can infiltrate the enemy position, it can be extremely effective in supporting the main attack. Or it may covertly breach obstacles or neutralize key positions/weapons to allow the main attack to quickly seize a foothold.

(3) It may be possible to actually infiltrate the main attack inside the enemy's positions and then fight from the inside to the outside. In this case, the unit inside the position may be able to occupy defensive positions and force the enemy to attack him.

d. There are two basic decisions to be made for conducting limited visibility attacks—whether to illuminate the objective, and whether to use indirect fires to support the attack.

(1) The infantry company normally conducts nonilluminated attacks to exploit its technological and training advantage. However, illumination is normally planned for every attack at night so that it is readily available if the enemy detects the attack and uses

illumination, or if he possesses NVDs. Illumination may also be effective after the objective is secure to support the reorganization and consolidation, particularly the casualty evacuation.

(2) The infantry company conducts illuminated night attacks like a daylight attack. Illumination is available from artillery, mortars, M203s, and hand-fired and aircraft flares. Permission to fire illumination is often retained by battalion because the light may affect adjacent unit operations also. The illumination rounds may be fired to impact on the ground, providing both light and markings on the objective to orient on. They may also be placed behind the objective and in the air causing the enemy to be silhouetted. Once illumination is begun, it should be continued until the objective is secured. Sufficient ammunition must be available.

(3) Nonilluminated, nonsupported attacks offer the best chance of gaining surprise. There are several techniques for conducting these types of attacks. For highly trained units possessing modern NVDs, they are conducted like daylight attacks. For infantry units that do not have NVDs, a linear assault is one technique (Paragraph 4-19k). Another option is to infiltrate close to the enemy and then assault under illumination.

(4) Illuminated, supported attacks are almost like daylight attacks. These may be most effective when speed is essential, when there is limited time for reconnaissance, or when the enemy is weak/disorganized. When conducting these types of attacks, the attacking unit still attempts to use stealth and the concealment of limited visibility to gain surprise. Then they initiate illumination/fires to support the assault. For the H-series units, this may be the preferred option.

e. Reconnaissance is critical in every attack, but especially for attacks at night. It should be conducted during daylight down to the lowest level possible. Each unit should reconnoiter the routes that they will move on, the positions that they will occupy, and the objective that they are assigned. The need for detailed information about the enemy must be balanced against the risk of being detected and the loss of surprise.

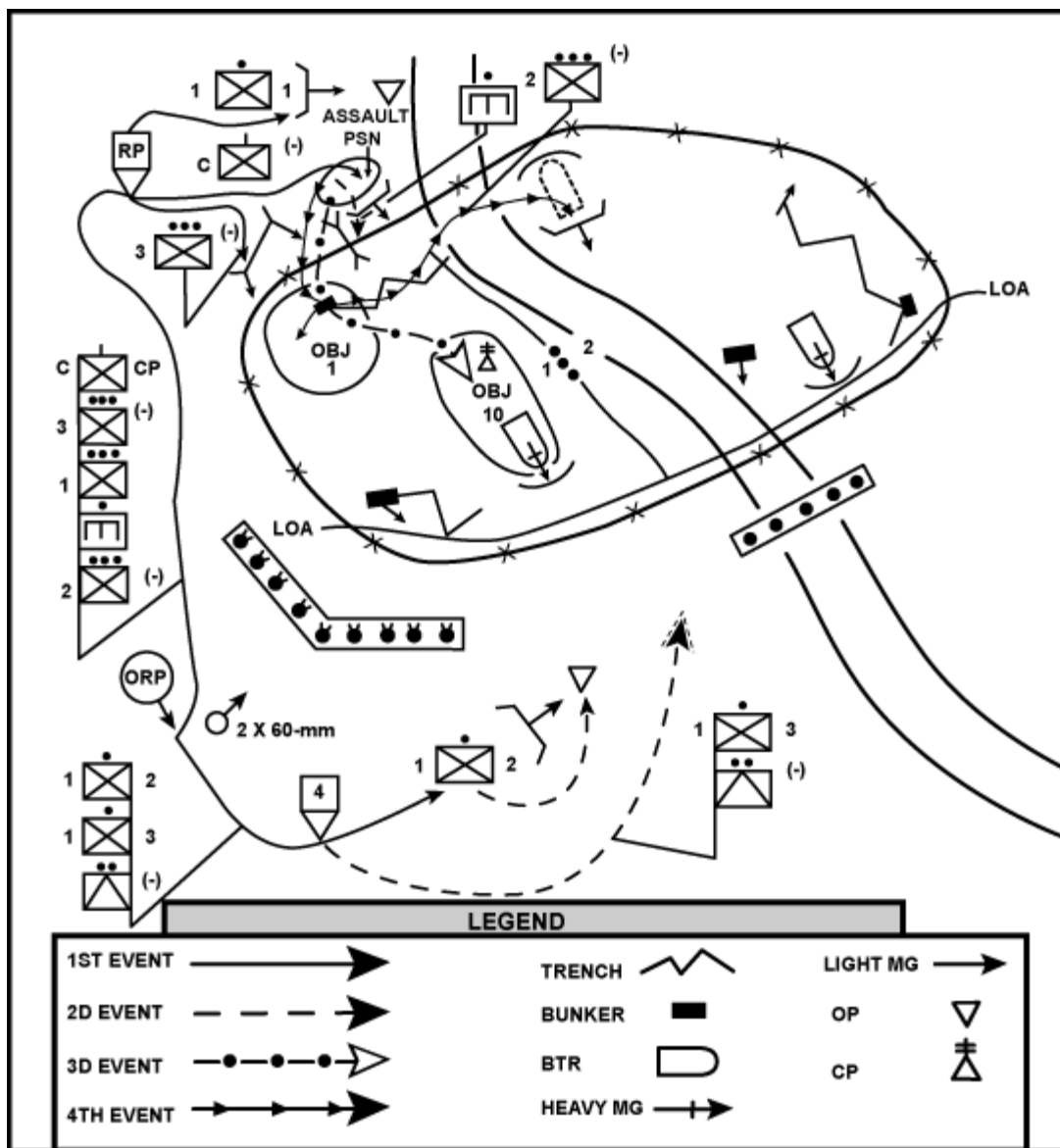

Figure 4-20. Limited visibility attack with NVDs.

(1) The reconnaissance plan should also establish surveillance on the objective in case the enemy repositions units/weapons or prepares additional obstacles. Surveillance/security elements should also secure critical locations such as assault and support positions, the LD/PLD, and key routes and RPs to protect the company from enemy ambushes/spoiling attacks. These security forces may become part of the isolation element during the attack.

(2) When reconnaissance is not successful due to lack of time, failure to identify critical aspects of the enemy's position, detection by the enemy, or any other reason, the commander should request a delay in the attack time to allow for further reconnaissance. If this is not possible, an illuminated/supported attack should be considered. A night attack with marginal information of the enemy's defense is very risky and difficult to conduct successfully.

f. A simple concept, particularly for the actions on the objective, also supports control during the assault. Platoon/squad objectives should be smaller and easily identified if possible.

(1) Avoid developing a concept that requires the company to fight for each enemy fighting position. Just as in a daylight attack, a decisive point must be identified and combat power focused at this location. Once the decisive action is accomplished, the plan must also address any remaining enemy. If required by the higher commander's concept or for an effective consolidation, all enemy may have to be cleared from the objective area.

(2) A smaller assault element maneuvering on the objective is also easier to control and less likely to suffer casualties from either friendly or enemy fires. The assault element must have clear signals to ensure control of all supporting fires, both direct and indirect.

(3) If a nonilluminated attack was planned but illumination is fired during execution due to detection by the enemy or the use of illumination by an adjacent unit, the concept should be flexible to allow adjustments to a daylight attack. This is a major problem for a unit that planned to conduct a modified linear assault attack and is forced to conduct an illuminated attack. A contingency plan that reorients this attack similar to a daylight attack should be prepared and issued. Every soldier should know under what conditions this plan is executed. In some cases (when already deployed through the PLD and advancing on the enemy for example), the company may have no choice but to continue the attack as planned or attempt to disengage.

g. Fire control techniques for limited visibility include—

(1) Using tracer fire.

(a) Leaders in the assault element fire all tracers; their men fire where the leader's tracers impact.

(b) The support element positions an automatic weapon on a tripod on the flank nearest the assault element. This weapon fires a burst of tracers every 15 seconds to indicate the near limit of the supporting fires. All other weapons in the support element keep their fires on the side of this trace away from the assault element. The assault element signals to shift fires to the next position or to a set distance. If required, these rounds can be adjusted well over the head of the assault element to preclude casualties.

(2) Marking with luminous tape or chemical lights.

(a) Mark the assault personnel to prevent fratricide. Do this in a way that avoids enemy detection, such as tape on the back of the helmet or small infrared chemical lights (if the enemy has no NVDs).

(b) The support element should know where the lead assault element is. If the individual soldier markings do not suffice, use a large chemical light (IR or visible). Place these on the ground or throw them in front of the assault element. When clearing a trench line, put the lights on a stick and move them with the lead element.

(3) Assigning weapon control restrictions to reduce the risk to the assault element. These may include:

- The platoon on the right in the assault might be given weapons free to the right flank, because there are no friendly soldiers there, but weapons tight or hold on the left because another friendly unit is located there.
- Only shotguns and pistols will be used by the assault element.

- No automatic weapons fire by the assault element on the objective. This ensures that all automatic weapons are enemy.
- (4) Using the following other techniques to increase control during the assault:
- Not allowing flares, grenades, or smoke on the objective.
  - Only allowing certain personnel with NVDs to engage targets on the objective.
  - A magnetic azimuth for maintaining direction.
  - Mortar or artillery rounds to orient attacking units.
  - The use of guides.
  - Reduced intervals between soldiers and units.

h. Mortar, artillery, and antiarmor fires are planned as in a daylight attack. They do not fire, however, unless the company is detected or until the company is ready to assault. Some weapons may fire before the attack and maintain a pattern to deceive the enemy or to help cover noise made by the company's movement. This will not be done if it discloses the attack.

(1) Indirect fire is hard to adjust when visibility is poor. If doubt exists as to the exact friendly locations, indirect fire is directed first at enemy positions beyond the objective, and then walked onto the objective. Illuminating rounds, fired to burn on the ground, can be used to mark objectives. This helps the company orient on the objective but also may adversely affect NVDs.

(2) Smoke is planned to further reduce the enemy's visibility, particularly if he has night vision devices. The smoke is laid close to or on enemy positions so as not to restrict friendly movement or hinder the breaching of obstacles. Employing smoke on the objective during the assault may make it hard for assaulting soldiers to find enemy fighting positions. If sufficient thermal sights are available, using smoke on the objective may provide a decisive advantage for a well-trained unit.

(3) Illumination is always planned for attacks to be conducted in limited visibility. That gives the commander the option of calling for it. The battalion commander normally controls illumination, but may authorize the CO to call for it, when needed. If the commander decides to use illumination, it should not be called for until the assault is initiated or the attack is detected. It should be placed on several locations over a wide area to confuse the enemy as to the exact place of the attack. It should also be placed beyond the objective to help assaulting soldiers see and fire at withdrawing or counterattacking enemy soldiers.

(4) Illumination may also be required if the enemy uses illumination to disrupt the effectiveness of the company's NVDs. Once used, illumination must be continuous because attacking soldiers will have temporarily lost their normal night vision. Any break in illumination may also reduce the effectiveness of suppressive fire when the attackers need it most. Care must be taken to ensure that the squad and platoon leaders do not use hand flares before the commander has decided to illuminate the objective.

(5) Thermal sights (TOW/Dragon) may be employed strictly for observation if there are no targets for these weapons to engage. Positioned outside the objective area, these sights can provide critical current information. These sights may also be used to assist the support element in controlling their fires or to provide the assault element reports of enemy movements on the objective.

(6) When limited NVDs are available, they must be prioritized and employed at the most critical locations. These may be with the key soldiers in the breach element, key leaders in the assault element, other members of the assault element, and key leaders/weapons in the support element.

i. When the objective has been seized, the company consolidates and reorganizes. Consolidation and reorganization are the same as for a daylight attack with the following exceptions:

(1) Guides are used to lead trains and support elements forward to their positions.

(2) The consolidation plan should be as simple as possible. Avoid changes in task organization.

(3) Locating and evacuating casualties and EPWs takes longer. They may have to be moved to the rear of the objective and kept there until visibility improves.

(4) Platoon positions are closer together to ease control and improve mutual support. Position distances are adjusted as visibility improves.

j. The modified linear assault is a technique for conducting a nonilluminated attack without NVDs to seize an occupied objective. This technique is effective in controlling the fires of the assault element by maintaining a linear formation. Each soldier assaults using individual movement techniques, while remaining generally "on line" with the soldier on his right and left. Each soldier is able to engage/suppress targets to his front with fewer restrictions because there is less chance of fratricide.

(1) In the true linear assault, the company would deploy through their respective squad release points and the entire company conducts a linear assault across the objective (Figure 4-21). This technique is normally modified to reduce the vulnerability of the assault element. This technique may be modified in a number of ways depending on the situation.

(a) The most effective modification is to establish part of the company in a support by fire position. The remainder of the company deploys at the PLD and conducts the assault (Figure 4-22). The machine guns, mortars, and Dragons are normally most effective employed in this role. M203s may also be effective if sufficient visibility exists for their employment. It is essential that the flank of the assault element nearest the support element be visible to the support element. The fire team on this flank may mark themselves with chemical lights or glint tape to ensure they are visible.

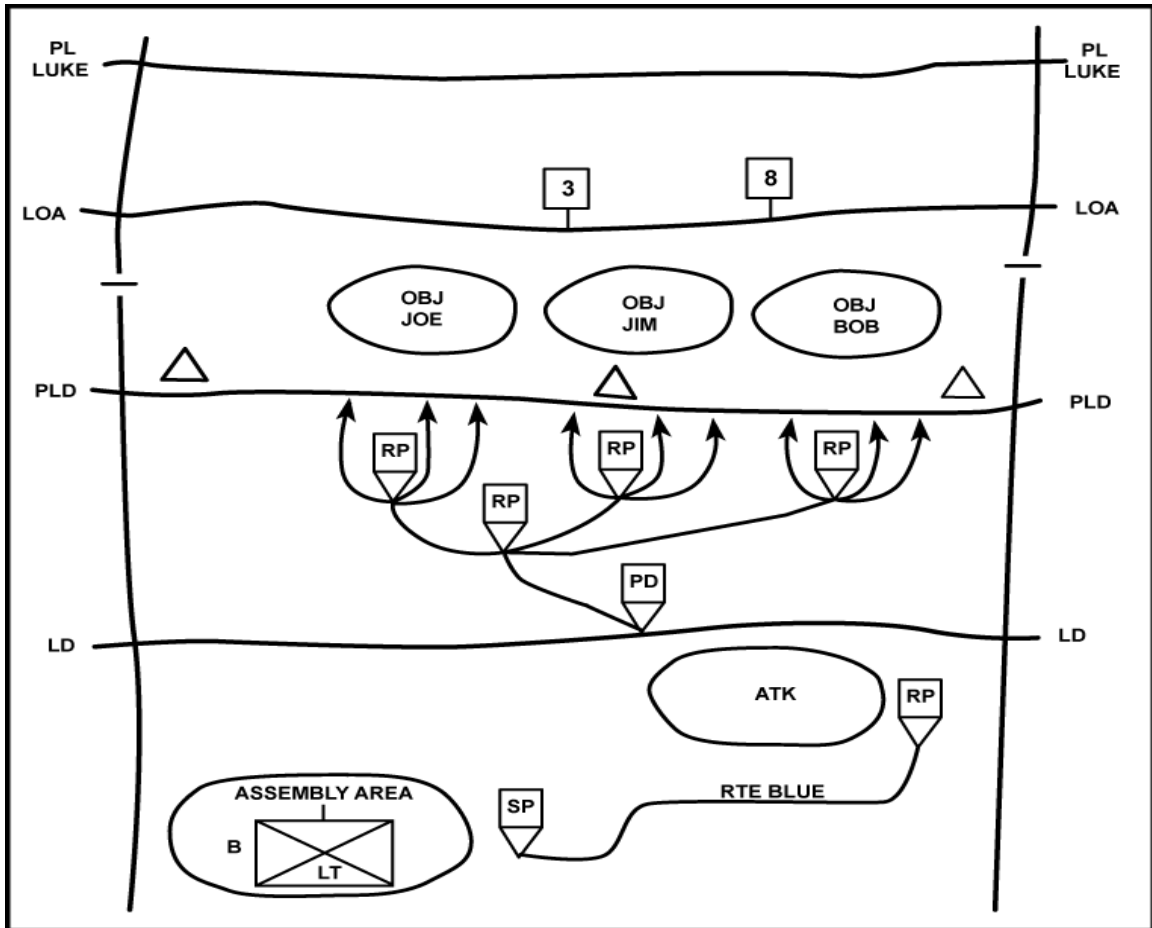
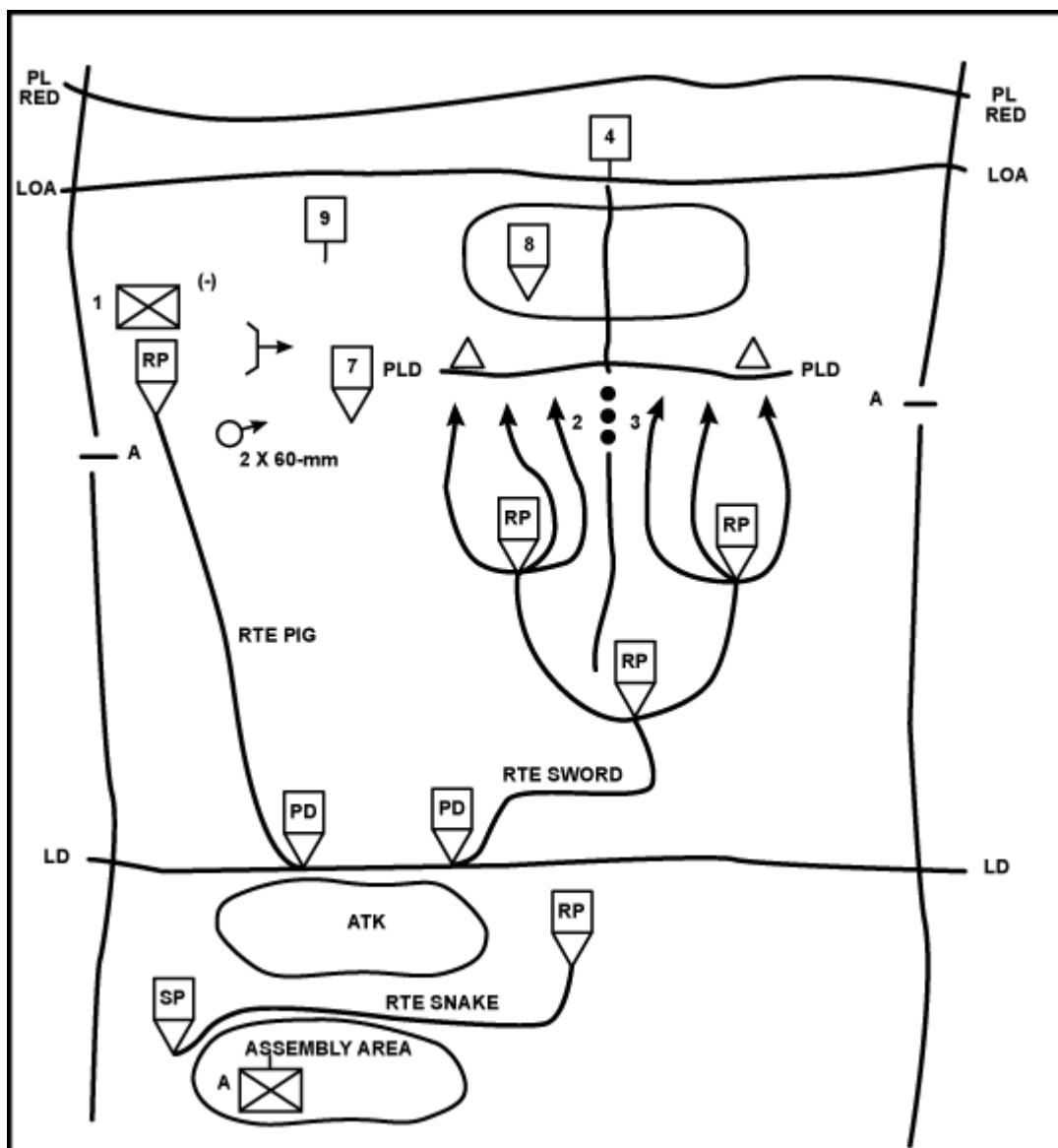

Figure 4-21. Linear assault.





**Figure 4-22. Linear assault with support element.**

(b) Other variations of this technique may include attacking on a much narrower front with a smaller assault element and having a large follow-and-support element. For example, instead of two platoons deploying at the PLD, a platoon (-) could deploy against an identified enemy weakpoint (Figure 4-23). They could be tasked to bypass enemy positions to quickly seize or destroy a critical location/facility and the follow-and-support force reduces bypassed positions. Or, the assault element may be assigned a shallow objective to support the forward passage of the trailing unit. Another option is to deploy through the platoon release points and then to attack in squad files. This technique is most effective when the situation will support an infiltration through the enemy defenses to seize decisive terrain or positions to the rear.

(2) The modified linear assault also simplifies the control of supporting fires from outside the objective. By establishing support positions perpendicular to the direction of

assault, the supporting fires can be employed next to the assault element and then shifted in front of them as they advance.

(3) The linear formation during the assault is also the biggest weakness with this technique. If the enemy is in well-prepared defensive positions, the linear formation ensures at least part of the assault element attacks through the enemy's kill zones. Also, assaulting using this technique makes it very difficult for the leader to concentrate combat power against an identified enemy weakness. Finally, if the enemy has NVDs or the assault element runs into unidentified obstacles after deploying at the PLD, fire superiority may not be achieved and the assault will rapidly come to a halt. This may result in the majority of the company being decisively engaged in the enemy killing ground.

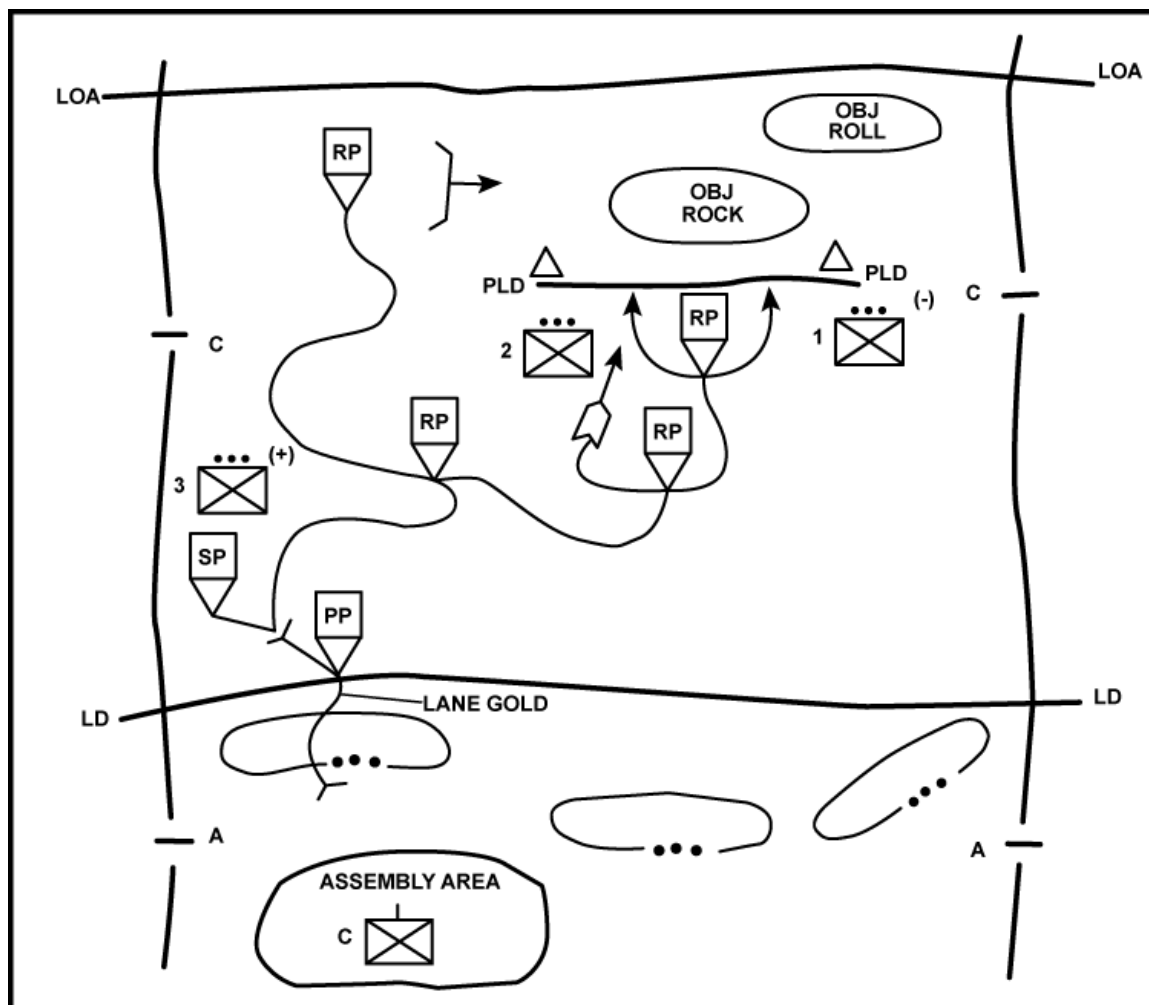

**Figure 4-23. Linear assault with follow and support.**

(4) Although there are significant difficulties with this technique, it remains a viable technique for the units without NVDs to attack during limited visibility. It is most effective against a weak or disorganized enemy. If the enemy has NVDs or a well-prepared defense with protective obstacles, this technique should not be used. An

illuminated, supported attack conducted as a daylight attack may be the most effective option in this situation.

(5) Before attacking in this manner, the company should secure the PLD and provide guides for the company from the LD to the PLD. Each platoon provides personnel to secure their portion of the PLD and to guide the platoon from the platoon RP.

(6) These soldiers are briefed on the routes from the LD to the platoon RP, actions on enemy contact, time of departure, and other information needed by the patrol units to conduct their mission.

(7) This element moves forward to the platoon RP. They then move forward to reconnoiter and or mark the platoon routes, secure their respective parts of the PLD, and observe the objective. The platoon guides come back to the platoon RP to guide their platoons to the squad RP and to the PLD.

(8) Once the company crosses the LD, movement to the PLD is continuous. They move slowly to maintain stealth. Platoons are released at the platoon RP so they can deploy before reaching the PLD. Once their units are deployed, the platoon leaders and the support element leader notify the CO. When the company is fully deployed, the CO informs the battalion commander. On the battalion commander's order, the company moves silently forward from the PLD. The platoons guide on the base platoon.

(9) Wire is a means of maintaining communications during the attack for those units with the equipment and wire available (H-series units). The wire net should link the squad leaders, platoon leaders, and the company commander. If possible, a security patrol should lay the wire before the attack. If not, the wire can be laid as the company moves. This allows the company to use wire communications throughout the movement. The laying of wire before an attack could cause the attack to be discovered by the enemy if the wire is not properly hidden, or if it is laid too far in advance.

(a) Company net. Wire is laid from the company's AA or the company RP designated by battalion to the platoon RP, and from there to the squad RPs.

(b) Platoon net. Wire is laid from the squad RP to each squad leader's position on the PLD.

(c) Assault wire. Assault wire can be used as a guide from the company RP to the squad and platoon RPs.

(d) Radios. Squad radios can be used for backup communications.

(10) When the attack is discovered, or on the CO's order, the support element opens fire. On order or when discovered, the platoons assault. Scattered enemy fire must not be taken as a loss of surprise, and it should not be cause to start the assault. Leaders must recognize that this technique for conducting a limited visibility attack results in a linear assault. To be successful, the assault must achieve surprise and rapidly overwhelm the defender. If the initial assault fails, it will be difficult to regain control.

(11) Soldiers assault aggressively using individual movement techniques to maneuver. The support element must quickly gain fire superiority with a heavy volume of fire. Tracers are used to improve accuracy, to control fires, and to allow the assault element to see where its supporting fires are impacting. The FOs call for indirect fire around and beyond the objective to disrupt enemy reinforcement. As the assault closes on the objective, fires are shifted beyond the limit of advance or lifted entirely. Soldiers must not go beyond the limit of advance.

(12) If the enemy discovers the attack before the company reaches the PLD, the CO may—

- Call for planned, supporting fire to suppress the enemy.
- Call for illumination (if authorized by the battalion commander) to ease control and movement.
- Continue as if it were a daylight attack by modifying the attack plan to a daylight attack.

**NOTE:** A linear assault, even a modified variation, is generally a very risky assault technique when conducted under illumination.

#### **4-20. DECEPTION OPERATIONS**

The company may be tasked to conduct a feint or a demonstration as part of a battalion attack. The CO uses the same planning process and troop-leading procedures as he would for any attack.

a. A feint is a limited objective supporting attack that requires the company to make contact with the enemy. Normally this will be direct-fire contact. As in any attack, the purpose that the battalion commander wants to achieve is the CO's primary concern in planning the feint. This purpose is normally stated in terms of some activity by the enemy, such as to cause the enemy—

- To reposition or commit his reserve.
- To shift his supporting fires away from the main attack.
- To reveal his defensive positions.

(1) The CO must make sure he understands the timing of the feint in relation to the main attack. He also considers what he must do if his feint achieves more success than expected. This may result from an unexpected enemy weakness or because the enemy commander fails to react to this attack. In either case, the battalion commander may decide to shift his main effort to support this unexpected success.

(2) The CO also must make sure that this attack is conducted aggressively. This will help achieve the desired reaction by the enemy and also reduce friendly casualties. If the company loses its momentum while under effective fire by the enemy force, the company must either establish a hasty defense or disengage. Either of these actions may result in needless casualties.

b. A demonstration is similar to a feint, but no contact is required with the enemy force. Battalion will normally provide specific actions required as part of the demonstration. For example, the company could be directed to provide a smoke screen using smoke pots, and to simulate preparations for an attack in this area.

#### **4-21. SECURITY OPERATIONS**

The battalion may assign the company a security mission, such as to screen or guard another friendly unit or asset. This may be part of the battalion counterreconnaissance mission (FM 7-20). The CO may also assign one of these tasks to his platoons as part of his scheme of maneuver. These tasks require the unit to orient on the friendly force to prevent enemy forces from detecting, observing, and engaging. The CO analyzes the situation and develops his plan as in any tactical situation (Chapter 2). Special considerations include:

a. **Mission.** The task, as defined in FM 101-5-1, determines the specific requirements that the unit must accomplish. A screen task (provide early warning and destroy enemy reconnaissance) is generally easier than to conduct a guard task (same as a screen plus prevent enemy ground observation and direct fire on the friendly force) in the same situation. The unit or asset being protected also significantly affects the plan. For example, if the company is tasked to guard the left flank of the battalion during movement, the CO's concept must consider how to maintain this security while the battalion is moving and dispersed in length.

b. **Terrain.** The terrain analysis will indicate likely enemy approaches, good observation points, and places where risk may be accepted.

c. **Enemy.** The enemy analysis integrated with the terrain analysis should indicate the areas that would provide enemy observation/direct fire on the friendly unit. These likely enemy locations should become the focus of the CO's concept. The expected size and strength of the enemy units will assist the commander in determining his need to be able to concentrate forces, and the size and location of a reserve/reaction force. The effective range of the enemy's direct-fire weapon systems may also assist the commander in determining how far from the friendly force to establish his screen line (if not directed by battalion).

d. **Troops.** The available friendly troops, particularly any attached vehicles or surveillance assets, will obviously affect the CO's planning. If vehicles are available, they may provide improved mobility to the reserve/reaction force. If TOWs or GSRs are attached, they will increase the company's surveillance capability.

e. **Time.** A key concern for the CO is how long the security must be maintained. For an extended period of time, the plan must allow for a part of the force to be conducting sustainment activities such as sleep, resupply, and maintenance. The plan must also address the required adjustments during limited visibility. During daylight, a screen line consisting of OPs supported by platoon reaction forces may be sufficient. During limited visibility, additional OPs would be established and gaps between the OPs would need to be covered by squad-sized patrols.

#### **4-22. RIFLE COMPANY AS THE RESERVE**

The company may be held as the battalion reserve during an attack. The battalion commander commits the reserve to decisively influence the action and to maintain the momentum of the attack. To exploit the success of the other attacking companies and to achieve surprise, the reserve should attack the enemy from a new direction. Because of the various missions that the reserve may be assigned, its commander must keep abreast of the tactical situation, know the missions and the tactical plans of the other companies, and be familiar with the terrain and the enemy situation in the objective area. The reserve must act quickly and effectively when committed.

a. The battalion commander may have the reserve company commander with him more during the fight to keep the CO abreast of the situation. This also makes it easier when the battalion commander needs to pass detailed instructions to him.

b. The reserve may be assigned one or more of the following tasks as part of its be-prepared missions.

- Protect the flanks or the rear of the battalion.
- Assume the mission of another company.

- Support by fire.
- Clear a position that has been overrun or bypassed.
- Attack from a new direction.
- Assist during the consolidation on an objective.
- Guard and evacuate prisoners.

## CHAPTER 5

# DEFENSIVE OPERATIONS

*Periods in which the defender can develop superior combat power will be brief, so concentration will have to be rapid and violent. Commanders will have to accept risks in some areas to concentrate for decisive action elsewhere.*

FM 100-5, 1986

*This chapter describes the planning, preparation, and execution of defensive operations. Defensive operations are temporary measures conducted to identify or create enemy weaknesses that allow the opportunity to go on the offense. Properly conducted, defensive operations can defeat numerically superior forces. Infantry forces in the defense must use the terrain to support their maneuver and to achieve surprise. They maintain an offensive focus and seek to avoid static defenses that surrender the initiative to the enemy. An excellent example of this type of defense occurred in North Africa during World War II.*

In March of 1943, Company K, 3rd Battalion, 18th Infantry was defending in the hills to the east of El Guettar. Company K was the right flank company for the battalion and was controlling the main road through this sector. Company K had its 1st platoon forward in the center and 2d and 3d platoons to the left and right rear respectively. 1st platoon was in a reverse slope defense on a ridgeline running down towards the road. The 2d and 3d platoons were located on the counterslope to the rear. There was a wadi or ditch on the reverse slope about 15 meters below and parallel to the crest.

The platoon prepared positions in this wadi with light machine guns and grenadiers on each flank and the squad BARs covering the entire crest. A two-man LP was established 500 meters forward of the company. Once it got dark, the 1st platoon moved forward to the exposed forward slope and prepared fighting positions there. By midnight, the company defensive position was prepared. At 0600 hours, an enemy tank column was heard approaching the company position. The CO passed the word to hold their fires. The tanks, without supporting infantry, were allowed to pass down the road and to the rear.

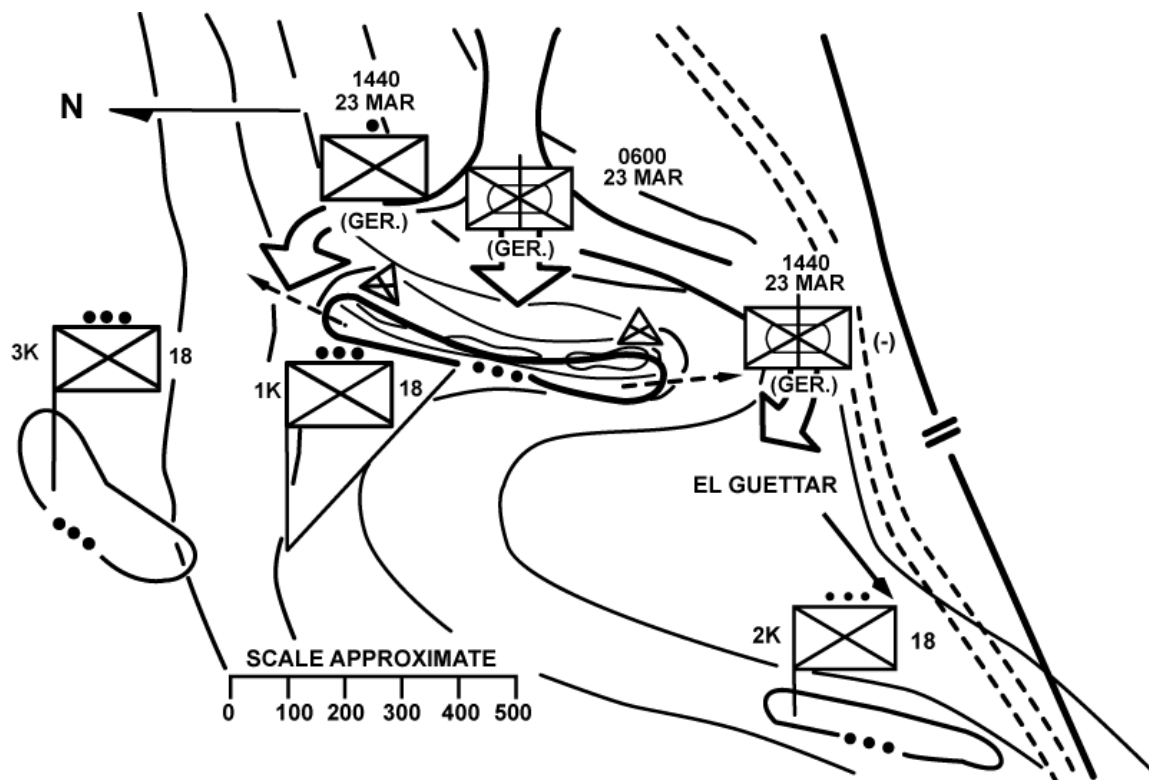

**Company K's reverse slope defense.**

At 0630, the LP reported a line of half-tracks 700 meters to the front. As they advanced, artillery began to fall on the 1st platoon's forward slope positions. The platoon immediately withdrew to its reverse slope position. They could hear the half-tracks attempting to climb the forward slope and then there was silence. A few minutes later an enemy officer and his runner peered over the crest; as he waved his men forward, the platoon opened fire. Their fire was so effective that no enemy soldiers were able to advance the 15 meters to the wadi. Three more assaults were attempted over the crest in the next hour, each was unsuccessful.

At 1440 hours, the enemy attempted a double envelopment with a dismounted attack around the left flank and a mounted attack around the right flank. But the machine guns and grenadiers on each flank had excellent fields of fire and stopped both attacks. By 1700 the enemy was forced to withdraw leaving behind 500 dead/wounded and five destroyed half-tracks. The friendly casualties totaled 1 dead and 7 wounded.

The CO of Company K understood the importance of using the terrain to protect an infantry force. When infantry must retain ground and fight from static positions, the preparation of the position is critical. The positioning and employment of the key weapons is also critical to success in the defense. The defense must be organized to defeat the enemy's most likely COA and also have the flexibility to adjust to likely contingencies. Finally, the success of every defense normally requires a violent concentration of fires. As in this vignette, these fires are most effective when delivered with surprise from undetected, well-prepared positions.



## Section I. DEFENSIVE FUNDAMENTALS

Defensive techniques are integrated into almost all operations, and they are used to accomplish a variety of tasks, such as resupply during offensive operations. In addition to the primary purpose of defeating the enemy's attack, patrol bases and assembly areas are temporary defensive positions used to provide security even during offensive operations.

### 5-1. PURPOSE

The purpose of defense operations is to cause the enemy attack to fail and to create conditions favorable to assuming the offensive. The commander's concept for the defense determines which control measures and techniques are used.

a. Conducting the defense does not simply entail killing enemy soldiers and destroying equipment faster than the enemy can replace them. The enemy's plan, the cohesion and synchronization of his forces, his morale, and his ability to see the battlefield must be destroyed. Companies conduct defensive operations—

- To defeat an enemy attack.
- To gain time to prepare for other operations.
- To allow a higher commander to concentrate forces elsewhere.
- To control key enemy forces as a prelude to offensive operations.
- To retain key or decisive terrain.

b. The infantry rifle company is organized, equipped, and supported to conduct dynamic, nonlinear defensive operations. (This varies depending on the type of division; but, it is generally true for all infantry companies.) When required to conduct a more static, linear style defense, the CO must limit the vulnerability of his force.

(1) The lethality of the modern battlefield is such that any unit located can be quickly destroyed. This threat is reduced by the proper preparation of survivability positions, but this requires a great deal of time and resources.

(2) Anytime the commander's concept requires the infantry company, or part of it, to fight from static positions, he must consider two things—How likely is it for the enemy to locate these positions and if located, what is the enemy's capability to apply combat power against my positions?

### 5-2. CHARACTERISTICS OF THE DEFENSE

The characteristics of the defense should be considered when planning or conducting company defensive operations. They are discussed in detail in FM 100-5. The considerations as they apply to the infantry company are:

a. **Preparation.** The defender arrives in the battle area before the attacker. He must take advantage of this by making the most thorough preparations for combat that time allows. By analyzing the factors of METT-T, the CO gains an understanding of the tactical situation and identifies potential friendly and enemy weaknesses. He then war-games friendly and enemy options and synchronizes his concept of the operation with all available combat multipliers. Since the enemy decides the time and place of the attack, all-round security is posted to provide early warning. The company's reconnaissance and security operations must begin immediately upon transitioning to the defense and continue throughout the operation.

b. **Disruption.** Defensive plans vary with the circumstances, but all defensive concepts of operation aim at disrupting the attacker's synchronization. Counterattacks,

indirect fires, obstacles, and retention of key or decisive terrain prevents the enemy from concentrating his strength against portions of the defense. Destroying enemy command and control vehicles disrupts enemy synchronization and flexibility. Deception measures further disrupt the enemy's attack.

c. **Concentration.** The defender must concentrate combat power at the decisive time and place if he is to succeed. He must obtain a local advantage at points of decision. Offensive action and the use of surprise and deception are often the means of gaining this advantage. The defender must remember that this concentration refers to combat power—not just soldiers. Combat power focuses on effects—not just numbers of soldiers/weapon systems. To do so, the defender normally must economize in some areas, retain a reserve, and maneuver to gain local superiority. Local counterattacks may be needed to maintain the integrity of the defense. Indirect fire can be shifted to critical points to rapidly concentrate destructive effects.

d. **Flexibility.** Flexibility is derived from sound preparation and effective C2. The defender must be agile enough to counter or avoid the attacker's blow and then strike back effectively. Flexibility results from a detailed estimate, an understanding of the unit's purpose, aggressive R&S, and, when applicable, organization in depth and retention or reconstitution of a reserve. Flexibility requires that the commander "see the battlefield"—both physically and through timely and accurate reports. Supplementary positions on secondary avenues of approach provide more flexibility to the commander. After a good analysis of the terrain and enemy, reserves can be positioned to allow the commander to react to unexpected events.

### **5-3. DEFENSIVE FRAMEWORK**

Divisions and larger units have two broad patterns of defense: mobile and area. A mobile defense is mainly oriented on enemy destruction; an area defense is oriented on retaining terrain (FM 7-20). Both types have static and maneuver elements, and both follow the defensive framework. Figure 5-1 shows the five complementary elements of the framework: deep, reconnaissance and security, defensive, rear, and reserve operations.

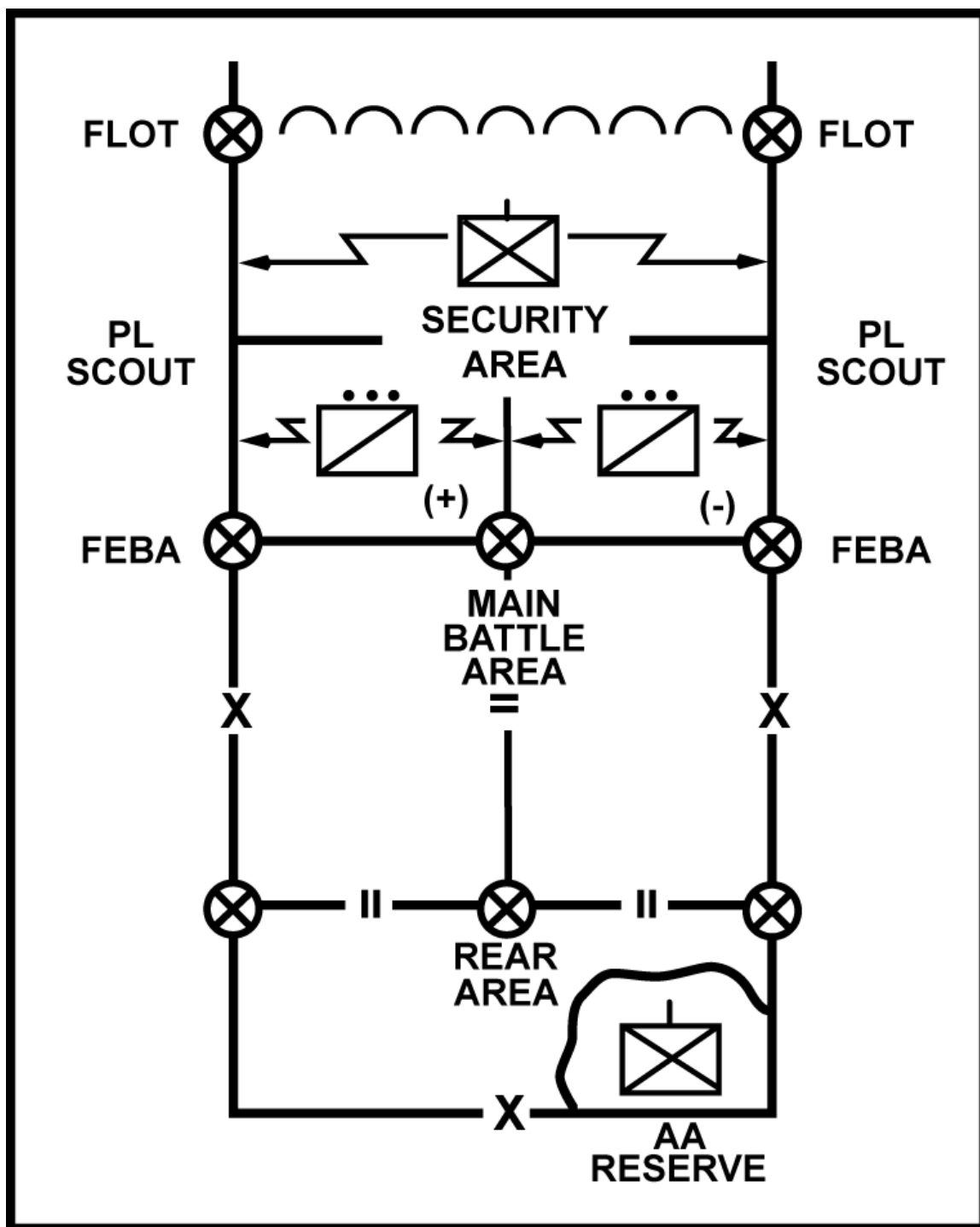

Figure 5-1. Defensive framework at brigade level.

a. Infantry companies normally conduct defensive operations as part of a larger element. The company may operate in the security area, main battle area, or the rear area, depending on the assigned missions. The company may take part in deep and rear operations as part of a larger force. At company level, the company's defensive framework normally focuses on reconnaissance and security actions, defensive operations, and actions by the reserve. At times, the company may fight a more

decentralized defense that requires them to provide forces for each of the elements of the framework.

(1) The rifle company normally defends as part of a battalion to disrupt or destroy the enemy, to protect a friendly force, or to control terrain. The orientation of the company defense is determined from the mission analysis. Normally, the company's purpose in the mission statement will clearly focus the company towards the enemy, the terrain, or a friendly force.

(2) A simple, complete concept of the operation is the basis of all defenses. The rifle company routinely uses attacks, raids, ambushes, and other offensive techniques in the conduct of defensive operations. At brigade level and below, defenses normally consist of three complementary elements:

(a) Security operations forward of and to the flanks of the MBA. These operations consist of security, reconnaissance, and counterreconnaissance tasks. Depending on the specific missions assigned, the company may simply observe and report, engage with indirect fires, and or engage with direct-fire weapons. Security operations are crucial throughout the defense—initially, to support the preparation of the defense; early in the fight, to disrupt the enemy attack and or to identify his main effort; and in the main battle area, to support the commander's decision-making process.

(b) Defensive operations conducted in the MBA oriented on enemy destruction, terrain retention, or force protection. Normally, the decisive fight occurs in the main battle area; therefore, the main effort is located there. Units tasked with security missions or reserve missions must support the main effort in the commander's concept for conducting the defense.

(c) Reserves that allow the commander to seize and maintain the initiative and preserve his flexibility. Although the reserve does not have an assigned mission that directly supports the main effort, the CO attempts to employ the reserve at the decisive time and place to ensure the success of the defense.

b. A company may perform all of these operations at the same time in its own sector; or, it may be tasked to do one or more of them for a larger unit. An example of the former is a company assigned its own defensive sector during low-intensity combat. For security, the CO may have a combination of OPs and R&S patrols. Within his MBA, the CO may consider larger ambushes and more positional defenses. For a reserve, he may position a force at a location that allows the most flexibility. As a portion of a larger force, the company may be tasked to serve as the brigade reserve.

## **Section II. PLANS AND PREPARATIONS**

Upon receipt of a battalion defense warning order, the CO starts his troop-leading procedures (Chapter 2) and makes an estimate of the situation. The result of this estimate is a concept that includes control measures, the fire plan, an R&S plan, a logistics plan, and a plan for the employment of a reserve (if required).

### **5-4. DEFENSIVE CONCEPT DEVELOPMENT**

As discussed in Chapter 2, the restated mission statement and the other critical facts and deductions provide the focus for developing the defensive concept. Each COA should be developed starting at a potential decisive point. Once the CO has identified his potential decisive point(s), he develops his concept using the following process.

a. Determine decisive points and times to focus combat power.

(1) The battalion commander's concept and taskings for the company may focus the company on a very specific decisive point and time. This is most likely when the company is the battalion main effort. For example, the company may be tasked to conduct the central ambush as part of the battalion area ambush. In this case, the company decisive point will be somewhere in the assigned kill zone, and the CO's concept will seek to generate maximum combat power there to accomplish his mission.

(2) In another situation, the decisive point may be less obvious and the techniques for generating combat power much more difficult than arraying units and weapons around a kill zone or engagement area. This may be the case when the company is a supporting effort for the battalion or when the battalion concept is much more decentralized. For example, the company may be defending in sector with a mission to guard the right flank of the battalion main effort to prevent the enemy from enveloping the main effort.

b. Determine the results that must be achieved at the decisive point to accomplish the mission. Normally, the purpose from the company mission statement clearly states the desired results. At times, particularly during decentralized operations, the CO must analyze the situation more closely to determine the desired results.

c. Determine the purposes to be achieved by the main and supporting efforts. (The supporting purposes must be clearly linked to the main effort's assigned purpose).

(1) The main effort's purpose is often the purpose from the company's mission statement. At times the company purpose must be modified slightly to be appropriate for the main effort platoon. When modified, it must be clear that by achieving the main effort's purpose the company will achieve its purpose.

(2) The supporting purposes are selected by determining what must be achieved to support the success of the main effort. Examples of supporting effort purposes include; to prevent the envelopment of the main effort, to force the enemy into an engagement area, to prevent enemy reconnaissance and identify the enemy's main attack, to deceive the enemy of the main defense locations, or to allow the main effort to maneuver against the enemy.

(3) The CO uses the framework of the defense to assist him in developing his concept. Although the focus is on the decisive fight in the main battle area, security requirements and the need for a reserve must also be addressed.

d. Determine the essential tasks for subordinate units (main and supporting efforts) that achieve these purposes.

(1) The task should clearly focus the subordinate unit on the terrain, the enemy, or a friendly unit. When linked with the purpose, a clearly defined, attainable, and decisive mission statement is assigned.

(2) The CO also considers how to achieve mutual support. It is achieved by designating a main effort and by assigning supporting effort missions that support this unit. It is increased by positioning units where they can provide security and or the ability to fire/maneuver in support of each other.

(3) Often, during decentralized defensive operations, mutual support between platoons/sections depends solely on the leaders' understanding of the CO's concept and their relationship to the main effort. The success of the defense may be determined by the initiative and aggressiveness of the supporting platoon's leadership.

e. Task—organize units (platoons and sections) to accomplish the identified missions.

(1) The CO allocates resources to the main effort first and then to the supporting efforts. Normally, the CO will not task—organize below squad level or specific weapons or equipment. At times, particularly when under strength, the CO may have to.

(2) The size of these organizations may range from a squad(-) to a platoon(+). If there are insufficient resources to ensure each of the supporting effort missions is attainable, the task may be modified. For example, the original mission may have been to guard the flank of the main effort to prevent his envelopment; it may now be changed to a screen task. If required, the purpose may also be changed. In this case it might be changed to provide early warning and prevent surprise of the main effort. Or if the original task was to block, a delay task (block enemy movement south of PL Red for two hours) may be attainable and still achieve the desired results.

f. Assign command and control headquarters for each of the task organized units.

(1) All platoon/section headquarters should be fully used. If additional leaders are required, use the XO, 1SG, company FSO, and other company leaders.

(2) In some cases, when no senior leader is available, the senior squad leader may be the unit leader. Or if the company has a one-squad reserve, it is probably led by its assigned squad leader.

g. Complete a generic task organization by assigning all organic or attached units. Of particular concern may be the FOs, medics, and other attachments. They should be attached to the unit that can best employ them or possibly where they provide the most flexibility.

h. Establish control measures that clarify and support the accomplishment of the assigned mission.

(1) Time events and use control measures (axis, sectors, BPs, engagement areas, DOA, assault positions, objectives. . .) to synchronize subordinate actions without stifling initiative.

(2) Certain control measures may be required to provide additional safety for the unit. These may include fire control measures, procedures, or special signals or markings to ensure understanding.

(3) At times, both a sector and a battle position may be an effective control measure to support the mission and to allocate terrain. Paragraph 5-5 discusses battle positions and sectors in detail.

i. The essential part of the concept, dealing with the actions at the decisive point, has been completed. The focus of this phase in the concept development is to ensure the main effort is weighted. The CO can weight the main effort in many different ways. Some examples include:

- Attaching additional squads/weapons.
- Assigning priority of fires or allocating an FPF or priority target.
- Assigning priority of any CS/CSS support.
- Limiting the main effort's area of responsibility to allow the unit to focus on the critical action. For example, assigning a smaller sector.
- By locating other resources in the vicinity of the main effort that support the main effort's focus on the decisive action.
- By providing additional time to prepare, rehearse, or conduct reconnaissance.

The plan is now completed by—

- Including the occupation plan for the defense.

- Completing the fires planning (both direct and indirect).
- Positioning other assets (such as the CP, mortars, or the company trains) and assigning them missions.
- Developing the CSS plan for resupply, casualty evacuation, and movement of rucksacks/other equipment.
- Planning for likely contingencies (such as a be-prepared mission for one unit to become the company reserve if the initial reserve is committed).

**5-5. SECTORS AND BATTLE POSITIONS**

The CO's estimate will determine the most effective control measures for every operation. There is no set criteria for selecting the control measures, but Figure 5-2 provides some basic considerations.

a. A sector is the control measure that provides the most freedom of action to a platoon. It provides flexibility to allow the platoon to operate in a decentralized manner while still ensuring sufficient control exists to prevent confusion and to synchronize the company's operation. In the close terrain that the infantry prefers to operate in, it is often difficult to achieve mutual support between platoon battle positions. It is also very difficult for the CO to see and control the fight throughout the company sector. For these reasons the infantry routinely operates in sectors.

| BATTLE POSITION                             |  | SECTOR                              |
|---|--|-------------------------------------|
| WELL-DEFENDED;<br>ENEMY CAN BE<br>CANALIZED | ← AVENUES OF APPROACH →                  | NOT EASILY DEFINED                  |
| DOMINATES<br>AVENUES OF<br>APPROACH         | ← TERRAIN →                              | DOMINATING TERRAIN<br>NOT AVAILABLE |
| NARROW/ SMALL                               | ← UNIT AREA OF<br>OPERATIONS →           | WIDE/ LARGE                         |
| ACHIEVABLE                                  | ← MUTUAL SUPPORT →                       | CANNOT EASILY BE<br>ACHIEVED        |
| GOOD  | ← COMMANDERS ABILITY<br>TO SEE/CONTROL → | DEGRADED                            |
| RETAIN<br>BLOCK                             | ← ASSIGNED TASK →                        | DISRUPT<br>CONTAIN                  |

**Figure 5-2. Selecting control measures.**

b. A battle position is a general location and orientation of forces on the ground from which units defend. The platoon is located within the general area of the BP. Security elements may be located forward and to the flanks of the BP. Platoons defending a BP may not be tied in with adjacent units; in which case, the requirement for all-round security is increased. The use of on-order BPs with the tasks of "prepare" or "recon" provides flexibility and depth to the defensive plan.

(1) If assigning BPs, the CO assigns the platoon a primary position to defend and a sector of fire. Each position must contribute to the company's accomplishment of the assigned task and purpose within the battalion commander's concept of the operation.

(2) A CO can also assign alternate/supplementary positions to platoons, depending on the situation. An alternate position is a position to the front, flank, or slightly to the rear of the primary position (Figure 5-3). It must let the platoon cover the same sector of fire as the primary position. If it is to be occupied during limited visibility, it may be forward of the primary position. The alternate position may be occupied if the platoon is driven out of the primary position by enemy fire or by assault. Or, it may be occupied to begin the fight to deceive the enemy of the platoon's primary position.

(3) A supplementary position is to the flank or the rear of the primary position. It allows the platoon to defend against an attack on an avenue of approach not covered by the primary position (Figure 5-4). It can be assigned when the platoon must cover more than one avenue of approach. A platoon moves from its primary, alternate, or supplementary position only with the CO's approval, or when a condition exists that he has prescribed as a reason to move.

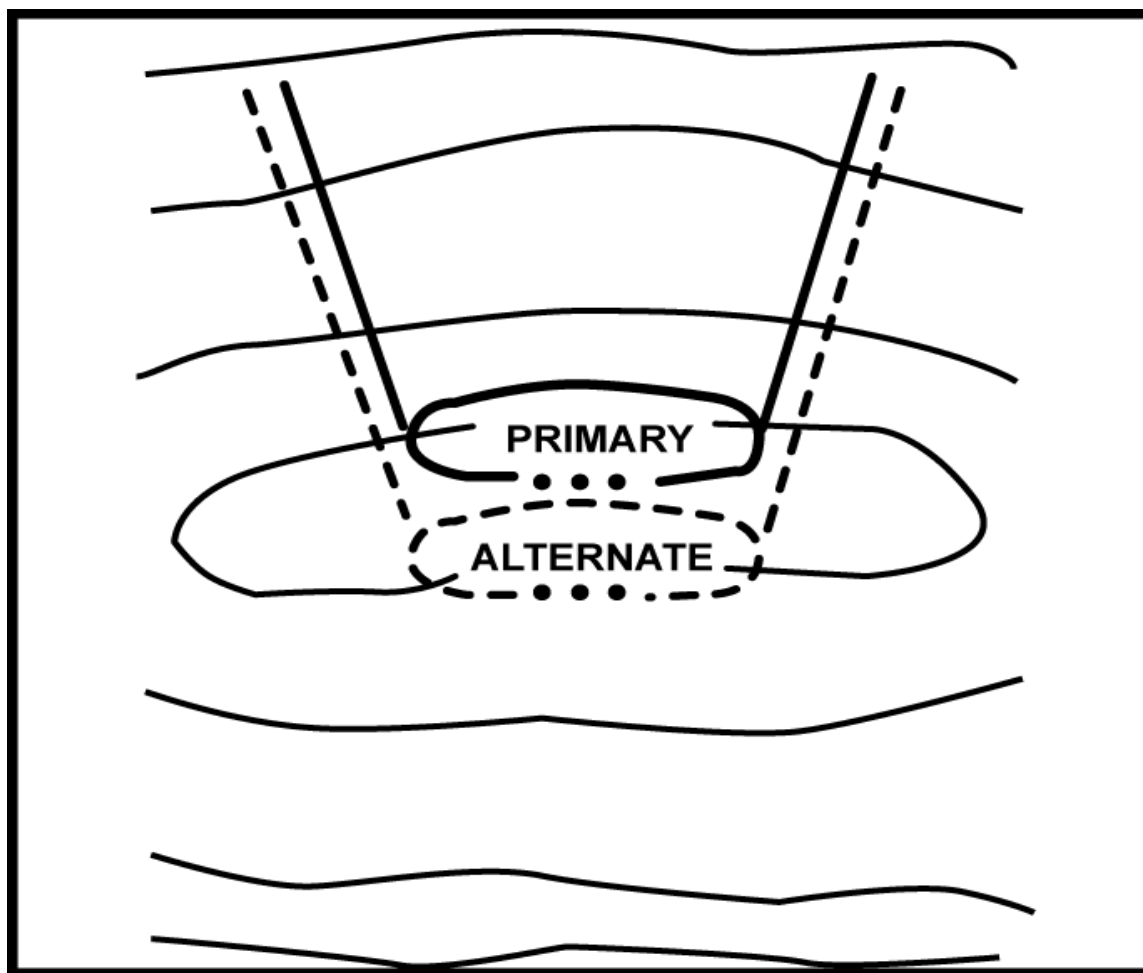
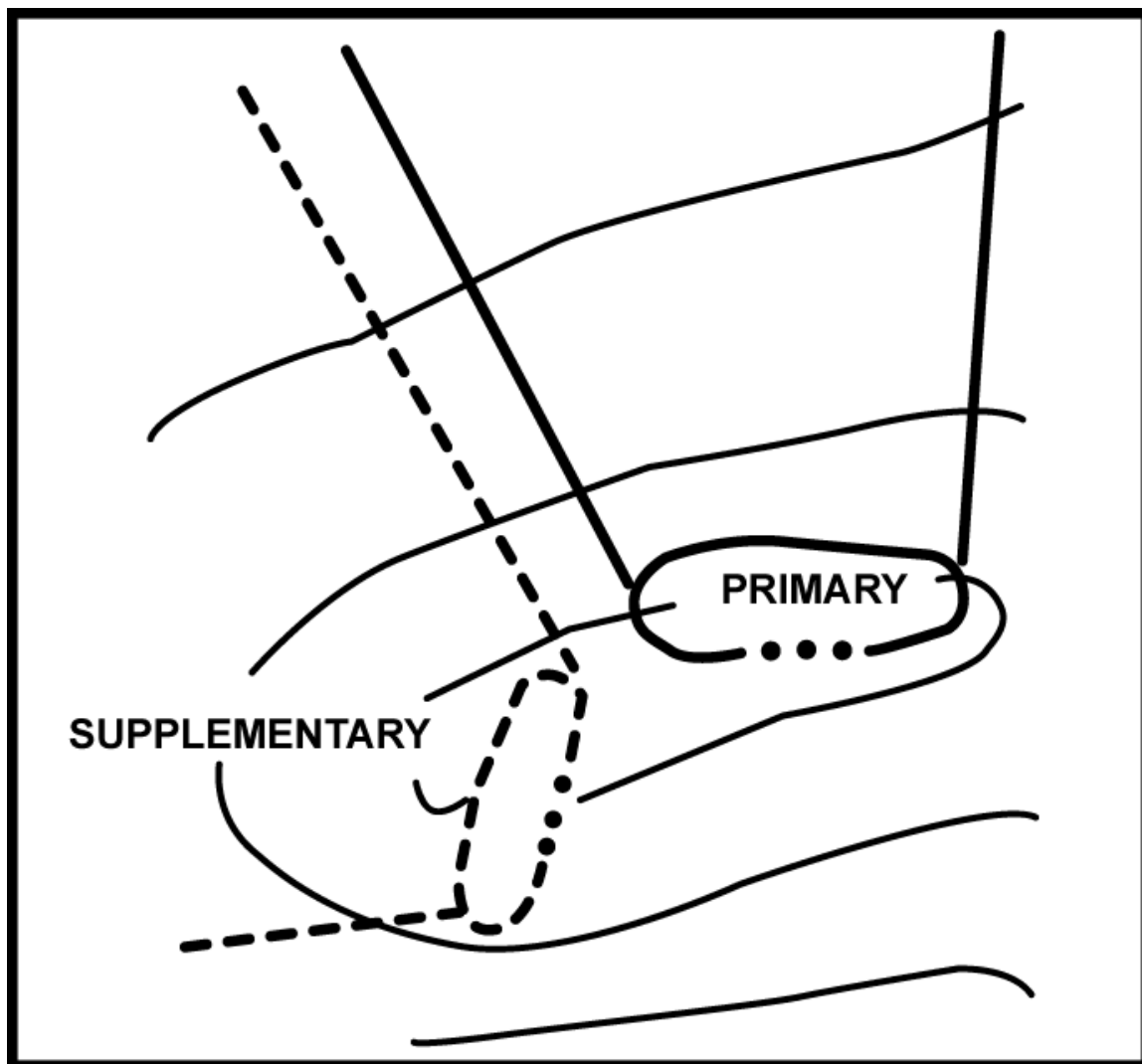

Figure 5-3. Alternate position.





**Figure 5-4. Supplementary position.**

c. Based on his estimate and the factors stated in Figure 5-2, the CO can decide to assign platoon sectors. A defensive sector is an area designated by boundaries that define where a unit operates and the terrain for which it is responsible. Sectors are normally deeper than they are wide to allow the platoon to fight the battle in depth.

d. In some situations, a platoon may receive both a battle position and a sector to provide the proper control based on the commander's concept. An example is when a platoon is initially tasked to delay or interdict enemy forces moving through an area to disrupt their attack. A sector may be the most effective control measure to allow decentralized operations and increase the subordinate's freedom of action. If this same platoon has a subsequent mission to block enemy movement through a choke point to allow the remainder of the company to counterattack critical parts of the enemy's flanks, a BP may now be the proper control measure. A BP orients this platoon on the choke point and would allow indirect fires to be employed with fewer restrictions.

(1) In this example, only one control measure would be in effect for the platoon at a time. This is depicted graphically by using a dashed line for the battle position graphic. In

a different situation, the commander's concept may require both control measures to be in effect at the same time.

(2) The use of multiple control measures (Figure 5-5) is not routine. The CO must ensure that he is not overtasking the platoon. He must also ensure that his concept and the purpose for each control measure are clear to all of his subordinates. There is a significant risk of confusion unless the concept is effective and articulated well during the OPORD. A briefback is essential.

e. Regardless of the control measure assigned by the CO, each platoon leader prepares and provides the CO with a platoon sector sketch. (See FM 7-8.) These sketches help the CO determine whether or not the company AO is well covered. From the platoon sector sketches, the CO develops his company sector sketch. These sketches do not, however, reduce the need for him to physically inspect his company's defense.

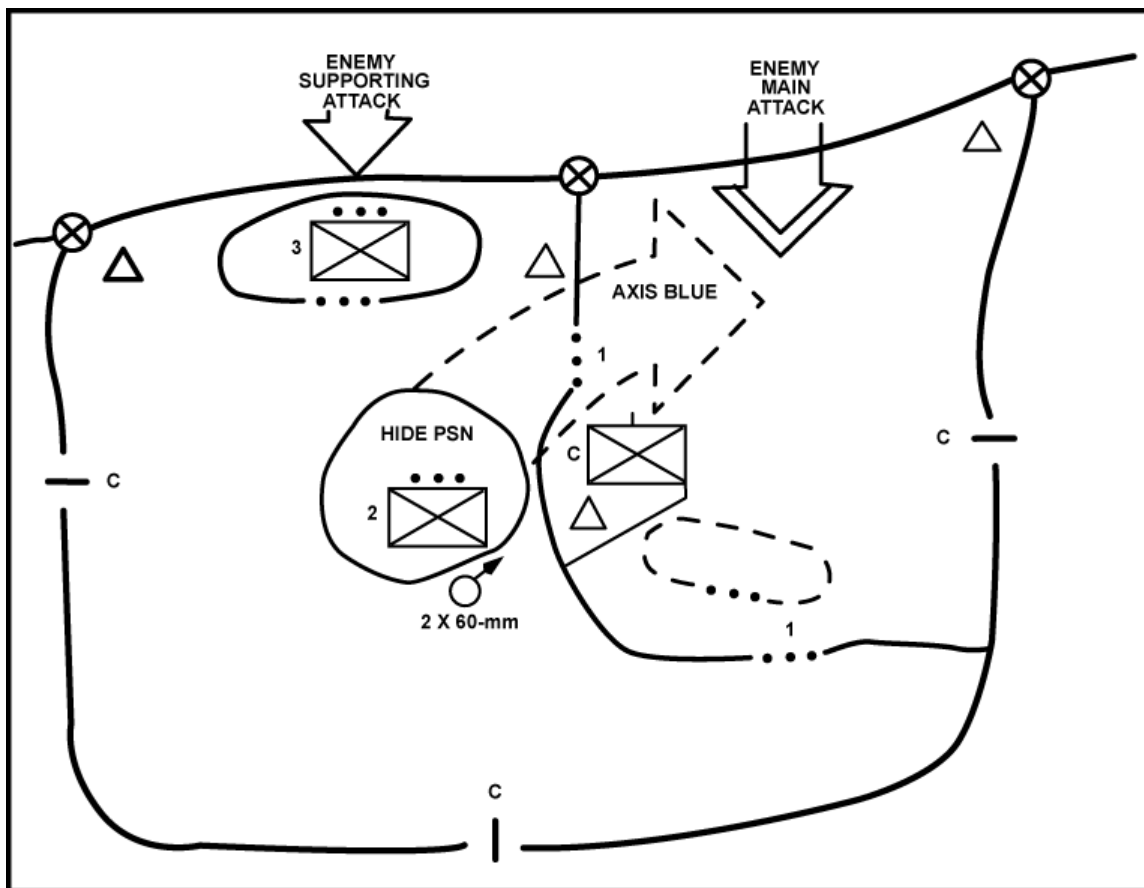

Figure 5-5. Use of multiple control measures.

## 5-6. COMPANY FIRE PLAN

The company fire plan has two parts—direct and indirect. It must fully integrate the effects of all weapon systems, the company obstacle plan, and the company scheme of maneuver to achieve the greatest effect on the enemy force. The amount of company fire planning will vary depending upon the situation and the CO's concept. When the company concept is more centralized, such as when arrayed around a large engagement area, the company fire plan may be very detailed. When fighting a more decentralized defense, such as a company area ambush with platoons in dispersed sectors, the company fire plan may only address minimal information. A detailed example for developing a company fire plan is in Appendix J. Although this example is focused on employing antiarmor weapons, the process is essentially the same for the company's small arms.

a. **Direct Fires.** The CO begins his direct-fire planning by ensuring that he understands and complies with the battalion fire plan. The extent of his planning depends on how much time is available and what fire planning/control measures are required—

- To synchronize the company battle.
- To maximize the effect of the weapons on the enemy.
- To achieve mutual support.
- To provide coverage of assigned areas of responsibility.
- To ensure the soldiers' safety from friendly fires.

(1) *Control measures.* The CO uses control measures to support the company fire plan. The definitions and graphics for these control measures are found in FM 101-5-1 and Appendix J of this manual.

(a) Sectors of fire. These may be assigned to a unit or to a specific weapon system. A primary and a secondary sector of fire may be assigned to provide flexibility or as part of a contingency mission.

(b) Engagement areas. EAs or kill zones are normally located along an avenue of approach and are used to mass fires of one or more units to destroy the enemy within these areas.

**NOTE:** Engagement areas and sectors of fire are not intended to restrict fires or cause operations to become static or fixed; they are used only as tools to concentrate fires and to optimize their effects.

(c) Target reference points. TRPs are versatile fire control measures. They can be used to identify the limits of a sector of fire and they can also be used to concentrate fires into a very precise area. When properly planned and marked, they can be used to rapidly shift fires during the battle.

(d) Trigger lines/points. These are used to synchronize the fires of the company and to prevent engaging enemy beyond the maximum range of the weapon.

(e) Engagement priorities. These are assigned to specific units/weapons to provide guidance on what targets to engage when multiple targets are available.

(f) Other control measures. At times, particularly in LIC or MOUT operations, specific weapons may have certain restrictions on their use. These may include limits on area coverage weapons when the chance of civilian casualties is too high or limits on the use of machine guns and grenades when clearing framed buildings.

(2) *Small arms.* Small arms include all the rifles, machine guns, and pistols organic to an infantry company. The company fire plan normally assigns control measures to the units and allows the unit leaders to control the fires of individual weapons.

(3) *Special weapons/munitions.* The company fire plan may also address special weapons such as LAWs, AT4s, sniper rifles, M202 (Flash), Claymores, hand grenades, demolitions, or other special purpose weapons/munitions. Snipers will normally remain under company control and receive their detailed fire control measures from the CO. The other special weapons/munitions are normally employed by the soldiers in the squads and platoons and are controlled by their leaders.

(4) *Antiarmor weapons.* An engagement priority may be assigned to each weapon or type of weapon. For example, Dragons will engage BMPs, C2 vehicles, and ADA vehicles. TOWs will engage tanks, BMPs, and engineer breaching vehicles. For a detailed discussion of antiarmor fundamentals and employment considerations, see Appendix J and FM 7-91.

(a) Dragons or 90-mm recoilless rifles. The CO normally assigns positions and sectors of fire or EAs to Dragons and 90-mm recoilless rifles. However, he may direct the general position and sectors of fire or EAs of weapons covering key areas and allow the platoon leader to select the exact locations. He may, for example, order a platoon leader to position his antiarmor weapons on the flank of his position. This allows the platoon leader to tie in with the attached or supporting TOWs or those of an adjacent unit, ensuring an area is covered. Regardless of who assigns the positions and sectors of fire, the CO checks and adjusts weapon positions to ensure there are no gaps and to see that units and weapons have mutual support. The CO also does this with machine guns. The Dragon's nightsight should be integrated into the company's R&S plan. Under certain conditions (at twilight or with artificial illumination), both the daysight and the nightsight for the Dragon may be used at the same time.

(b) Tube-launched, optically tracked, wire-guided missiles. TOWs are normally employed by section (two TOWs). The CO or weapons platoon leader assigns them positions. He also assigns their primary and secondary sectors of fire or EAs. When possible, at least a 300-meter separation should exist between TOWs so that no two weapons can be suppressed by the same enemy indirect fire. Positions should allow for mutual support between TOWs, and between TOWs and other antiarmor weapons. Some security is gained for TOWs by having them positioned near infantry units. The TOW sights (day and night) are excellent for observation and should be integrated into the company R&S plan. Some TOWs may be positioned temporarily near or forward of the FEBA to have early, long-range fire at enemy vehicles. As the enemy closes on them, the TOWs move to the rear or on the flanks. If this technique is used, the CO must consider their vulnerability to direct and indirect fires and the loss of surprise in the main battle area. If one of the battalion TOW sections are supporting the company, the CO depends on the senior section sergeant for controlling the TOWs. If both sections support the company, the TOW platoon leader controls them.

b. **Indirect Fires.** The CO and company FSO plan indirect-fire targets to support the company scheme of maneuver. A detailed discussion of company indirect-fire planning is in Chapter 7. They plan targets on all likely enemy approaches and on areas the enemy may use in the attack, such as enemy OPs, support positions, avenues of approach, assault positions, and defiles. Targets are also planned in front, on top of, and behind friendly positions to stop likely penetrations or to support a counterattack. It is possible to plot too many targets. Plan targets on prominent terrain and adjust fire from them. During the defense, the company may be supported by the company mortars, the battalion mortars, or any of the artillery units supporting the battalion.

(1) The CO and the company FSO plan the exact locations for any FPF. An FPF is a barrier of fire planned on the most dangerous enemy avenue of approach to provide immediate close protection for defending soldiers during an enemy assault. It must be integrated with the direct-fire plan (particularly any machine gun FPLs) and the company obstacle plan. It is adjusted as close as possible to friendly soldiers without endangering them. Once the FPF is called for by codeword over the radio or by pyrotechnic signal, it is fired continuously until the CO orders it stopped or the firing unit is out of ammunition. The company has an FPF from its mortar section and may have FPFs from the battalion mortars or supporting artillery.

(2) A target list of indirect fire targets planned by the CO and company FSO is sent to the battalion FSO. The battalion FSO consolidates and coordinates the company fire plans and returns the consolidated list to the CO or company FSO. The target list is then distributed to the platoon leaders and their FOs. This is bottom-up fire planning. For a discussion of top-down fire planning, see FM 7-20.

(3) The company mortar section is positioned where it can place fires on its assigned targets (Appendix E). It should be far enough to the rear so the mortar's minimum range does not prevent hitting targets within the company sector or BP. This allows mortars to help stop an enemy that has penetrated the defense or to help support a counterattack. A rule of thumb for positioning mortars is to have one-half to two-thirds of their range forward of the company position. However, the distance at which the company can observe and identify targets must be considered. Firing positions should be in defilade and concealed.

c. **Mines and Obstacles.** Engineers, if available, or the company constructs tactical obstacles to support the commander's concept and maximize the effect of the company's fires. Obstacles are placed to disrupt the enemy formations, force the enemy into EAs with turning obstacles, and hold the enemy in engagement areas with fixing or blocking obstacles.

(1) For best results, obstacles are employed in depth and existing obstacles are reinforced to increase their effectiveness. The company constructs protective obstacles to defeat the enemy's final assault. A certain type of obstacles are oriented against the most severe close combat threat—antipersonnel obstacles against dismounted infantry and antitank obstacles against an armored force. As with tactical obstacles, protective obstacles are sited according to the terrain and covered by fires. During limited visibility, soldiers are repositioned to ensure obstacles are still covered by fire, and are not covertly breached. (See Appendix C and FM 7-20.)

(2) Protective obstacles are usually located beyond hand grenade distance (40 to 100 meters) from the soldier's fighting position. Protective wire (Figure 5-6) may be a

complex obstacle providing all-round protection of a platoon perimeter, or it may be a simple wire obstacle on the likely dismounted AA into a squad ambush position. Protective minefields may be integrated into the protective wire or used separately.

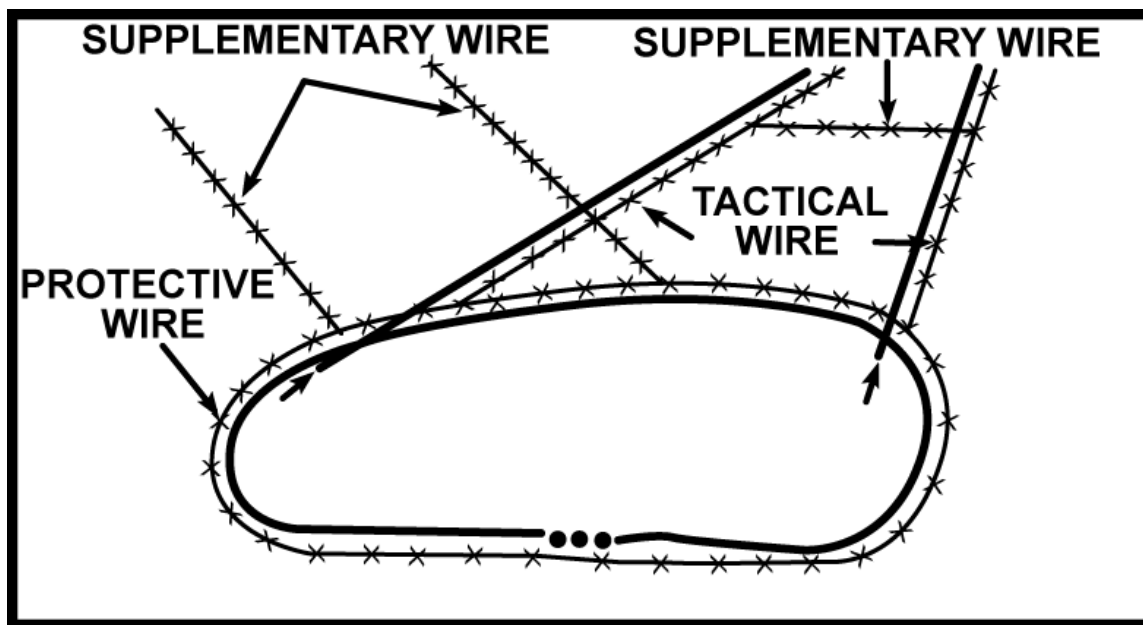

Figure 5-6. Wire obstacles.

(3) Tactical obstacles are positioned to increase the effectiveness of the company's fires. Tactical wire is usually positioned along the friendly side of the machine gun FPLs. Tactical minefields may also be integrated into these wire obstacles or used separately.

(4) Supplementary wire obstacles are used to break up the line of tactical wire to prevent the enemy from locating friendly weapons (particularly the machine guns) by following the tactical wire.

(5) When planning obstacles, the CO should consider the amount of time required to prepare them, the burden on the logistical system, the soldiers' loads, and the risk of the enemy detecting the obstacles and the resulting loss of surprise.

## 5-7. SECURITY REQUIREMENTS

The company may receive taskings as part of the battalion security plan. There will also be additional security taskings resulting from the CO's concept for the company defense. These taskings may be oriented on friendly units (screen, guard, or secure), on the enemy/terrain (reconnaissance), or on the enemy's reconnaissance assets (counterreconnaissance). The CO establishes a security plan to keep the enemy from observing or surprising the company. This security is established before moving the company into the area and is continuously maintained. He bases this plan on tasks received from the battalion, on the enemy situation, the terrain, and on the visibility conditions. The plan provides active and passive measures and counterreconnaissance.

a. **Active Measures.** These include OPs, stand-tos, and patrols. The CO can require each platoon to have a set number of OPs. If not, the platoon leaders decide what they need; there should be at least one OP for each platoon. In close terrain or during limited visibility, there may be one for each squad.

(1) The CO can also require a set number of men to be on security at all times. The number varies with the enemy situation, terrain, visibility and the unit's need for rest. As a guide, at least one-third of the soldiers should be on security at all times.

(2) When an attack is expected, the entire company should be on alert; however, this should not be maintained for long periods. The CO must keep in mind that his soldiers need rest to function in future operations. A sleep plan must be established and enforced. Security, however, cannot be sacrificed for rest.

(3) A stand-to is held both morning and evening to ensure that each man adjusts to the changing light and noise conditions, and is dressed, equipped, and ready for action. The stand-to should start before first light in the morning and continue until after light. It should start before dark in the evening and last until after dark. The starting and ending times should vary to prevent establishing a pattern, but the stand-to must last long enough to accomplish its purpose.

(4) The battalion can have its companies dispatch patrols whose missions contribute to battalion security. The CO can dispatch patrols in addition to those required by the battalion to satisfy the security needs. He may have the patrols reconnoiter dead space in the sector, gaps between platoons, gaps between the company and adjacent units, or open flanks. The company reserve may provide these patrols.

(5) Platoons may dispatch similar security patrols. All patrols sent out by the company or its platoons must be coordinated with battalion. (For more information on patrolling, see FM 7-8.)

b. **Passive Measures.** These measures include camouflage, movement control, light and noise discipline, proper radiotelephone procedures, and the use of ground sensors. REMSs can be used to give warning of enemy movement. TOW and Dragon gunners, with their daysights and nightsights, can add to the security effort both day and night. The company should also use its NVDs for surveillance.

(1) To ensure effective coverage, the CO may direct platoons to cover specific areas with specific RSTA devices (NVDs, thermal sights, PEWS). He may also specify how many NVDs will be in use (for example, one-half of the soldiers on security will use a NVD).

(2) Sector sketches should indicate the locations of key RSTA devices to include all thermals (AN/PAS-7, Dragon and TOW nightsights, and PEWS).

c. **Counterreconnaissance.** This operation entails denying enemy reconnaissance elements from gaining accurate information on friendly preparations through destruction of enemy recon or through deception. It is seldom possible to deny all information to the enemy. Based on the expected enemy reconnaissance action, the CO decides what information and locations he must protect. He also considers what information would make the enemy act the way he wants him to (such as, to deploy prematurely, deploy too late, attack a false objective, or move into a kill zone). The CO should determine the priorities for the counterreconnaissance effort and focus his efforts toward denying that information to the enemy.

(1) The company's counterreconnaissance plan is integrated into the concept of the operation and coordinated with the battalion's plan. At times, the company may be the counterreconnaissance force for the battalion. (For more details, see FM 7-20.)

(2) An example of the use of counterreconnaissance is a defense along a river line against a motorized force. The CO determines the importance of denying the enemy

knowledge of the crossing sites along the river. He then focuses his counterreconnaissance effort on the crossing sites. The CO employs ambushes, mines, obstacles, false fighting positions, security patrols, OPs, indirect fires, camouflage, demonstrations, and other measures to destroy or deceive the enemy's reconnaissance elements.

(3) The concept for the defense must address the counterreconnaissance battle. If the battalion order does not provide sufficient detail, the rifle company commander must decide how to defeat the enemy's reconnaissance effort. There are two general approaches to this task.

(a) The first is to identify and destroy all reconnaissance assets before they can reach the company's MBA. This may be very difficult and may reduce the chance of gaining surprise against the enemy's main body. To fight the counterreconnaissance battle in this manner requires—

- Unity of command. All assets / units involved in this effort must be controlled by one leader.
- A well-planned concept. It must include clear taskings, effective task organizations, and detailed fire planning and engineer support. The CSS plan must provide the required maintenance, resupply, and casualty evacuation support.
- A mix of finders and fighters. Certain units are tasked to find the enemy reconnaissance assets. Once located, they report/call for fires. Other units are responsible for destroying these enemy units. They may need to be mobile to cover the entire area.
- A withdrawal plan. The rearward passage or repositioning of the units in the counterreconnaissance force must be planned and coordinated with all units involved. The timing for this event is critical and normally depends upon early identification of the enemy's attack forces to be successful.

(b) The second option is to allow the reconnaissance to move through the area in order to achieve surprise on the enemy main body. This option requires battalion's consent and the maximum use of camouflage and concealment. A variation of this technique would be to allow the enemy's reconnaissance assets to move through the company area and destroy them in the rear. Although the main body may be alerted, they will not have a sound understanding of the defensive scheme.

d. Limited Visibility Security. During limited visibility, the CO must increase security measures to ensure that the company is not surprised by the enemy. He can do this by—

- Increasing the number of OPs and patrols.
- Occupying supplementary positions if they allow better coverage of obstacles and probable limited visibility avenues of approach.
- Employing trip flares and other early warning devices.
- Employing thermal night sights/NVDs.
- Employing platoon early warning systems.
- Adjusting fire control measures.
- Increasing the number of soldiers on security in each position.
- Maintaining noise/light discipline.
- Limiting movement.



(1) At night, the CO may plan for illumination (by artillery, mortars, hand-held flares, and grenade launchers) forward of the company's position to expose an attacking enemy force. If the company has an open flank, the CO plans for illumination there also. However, all plans for the use of illumination must be coordinated with the adjacent units and approved by the battalion.

(2) The CO must not fire illumination or allow his soldiers to initiate direct fire too soon. The enemy may employ small patrols to probe the company's defense to find a weak point or to cause soldiers to reveal their positions by initiating fire. If enemy patrols are detected, units should use grenade launchers, Claymore mines, or indirect fire to engage them. They do not fire direct-fire weapons, particularly crew-served weapons, until the enemy attacks. When the enemy does attack, the CO may call for illumination if the battalion approves it, and the company defends as in daylight.

### **5-8. EMPLOYMENT OF THE RESERVE**

A company may be the battalion or brigade reserve. When a company maintains a reserve, the battalion commander may direct the CO not to commit his reserve without permission. (For a discussion of these situations, see paragraph 5-17 of this chapter or Chapter 4 of FM 7-20.) Discussed herein is the employment of a reserve designated and controlled by the company commander.

a. Even at company level, the CO should strive to retain a reserve—even if it is only a squad. The reserve should be used at the critical point in the battle. It may be used to complete the destruction of the enemy or for other decisive action.

b. The size of the reserve may be as large as a platoon or as small as a squad, depending on the flexibility required by the CO to react to the enemy situation. If the enemy has few choices within the company area of operations, one or two squads may be enough. If, however, the enemy's most probable COA is hard to predict and he has many avenues of approach, the CO may decide to retain an entire platoon as a reserve. Some situations may require committed forces to be prepared to act as the company reserve. Therefore, the CO's estimate will indicate which platoon has the least dangerous mission. This platoon will be tasked to be prepared to be the company reserve and given prioritized missions for planning purposes.

c. The reserve is assigned a BP or AA near its most likely place of commitment. It should be located where it can support the main effort and accomplish its be-prepared missions. However, it should also be in a covered and concealed location where soldiers are likely to remain uncommitted until necessary and mentally and physically ready until committed. An example of a be-prepared mission assigned to the leader of the reserve is: "In priority, be prepared to block an envelopment to the west to protect the company flank, destroy enemy forces in EA Green to prevent enemy penetration of PL Blue, and occupy BP 5 to destroy enemy attempting to envelop 3d platoon." In the absence of these be-prepared missions, the leader of the reserve begins his planning based on his own estimate.

d. The reserve can assist the CO with other tasks not related to its primary defensive mission, such as resupply or reconnaissance. However, the CO must ensure the reserve has enough preparation and rehearsal time for its probable missions and is immediately available when required. The reserve can perform any critical task for the CO. The

following are some common tasks; they are always assigned in priority. The purpose of each task must be clearly stated.

(1) *Block a penetration.* The reserve blocks an enemy penetration by fire or by maneuver (Figure 5-7). The defending platoons help by firing across the flanks of the penetration when possible. When the company reserve is blocking a penetration, the battalion reserve may counterattack to destroy the penetrating force. Indirect fire helps to contain and reduce the penetration.

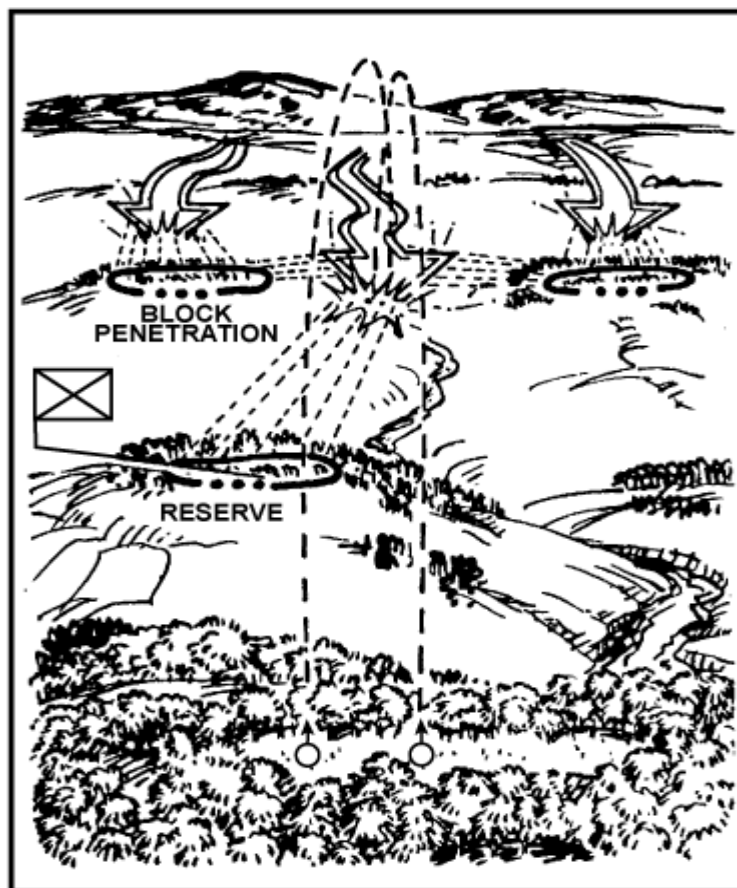

**Figure 5-7. A reserve blocking a penetration.**

(2) *Secure the company flanks and rear.* The reserve prepares supplementary positions to secure the company flanks and rear (Figure 5-8). The CO selects which approach to secure. The reserve's position must tie in with the supplementary positions of the forward platoons and with adjacent units. The reserve may have to occupy a supplementary position to secure a flank when the sector of an adjacent company has been penetrated.



**Figure 5-8. A reserve securing the company flanks and rear.**

(3) *Support a forward platoon by fire.* For this mission, the reserve is positioned where it can fire into unoccupied areas between forward platoons and on their flanks and rear (Figure 5-9). The reserve's position must be close enough to the forward platoon's primary position so that it can hit enemy soldiers who bypass that position. The reserve is normally kept intact and is moved by the CO as the situation dictates.

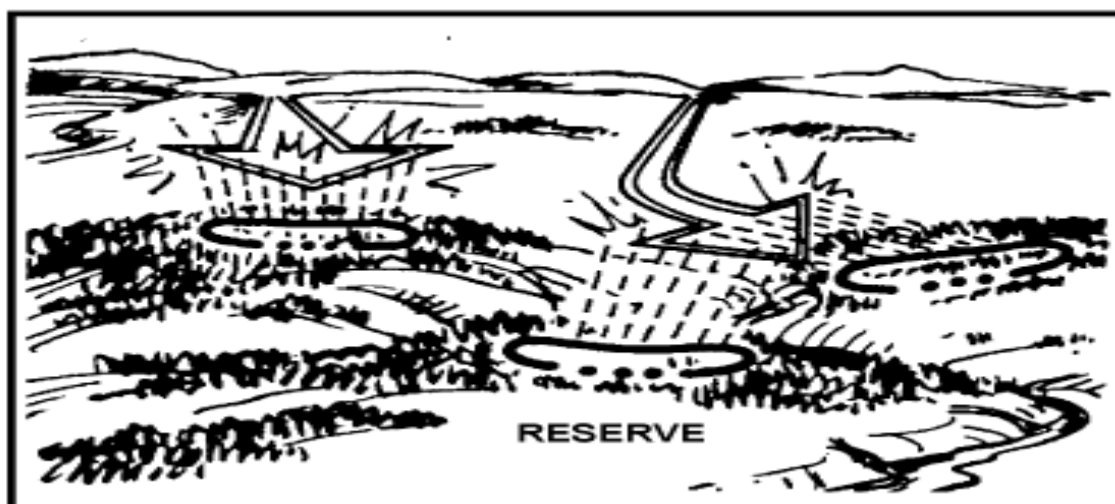

**Figure 5-9. A reserve supporting a forward platoon.**

**NOTE:** The following paragraph describes company-directed and company-controlled counterattacks. For a discussion of the company counterattacking as the battalion reserve, see paragraph 5-17 or FM 7-20.

(4) *Counterattack.* The objective of a counterattack is normally the complete destruction of the enemy. That is to reinforce success, not failure (Figure 5-10). The CO plans for a counterattack on one or more possible penetrations. Each is a complete attack plan and has a tentative objective and a direction of attack. A plan may have an LD, a route to the LD, an attack position, an LOA, or an RFL with defending platoons. With

time, each counterattack plan is rehearsed in order of priority. At least a dry run or a walk-through of the attack is performed. This helps synchronize the plan with the forward platoon's actions. The reserve executes its other tasks until the CO gives the counterattack order. When initiated, it becomes the main effort and gets priority of all available supporting assets.

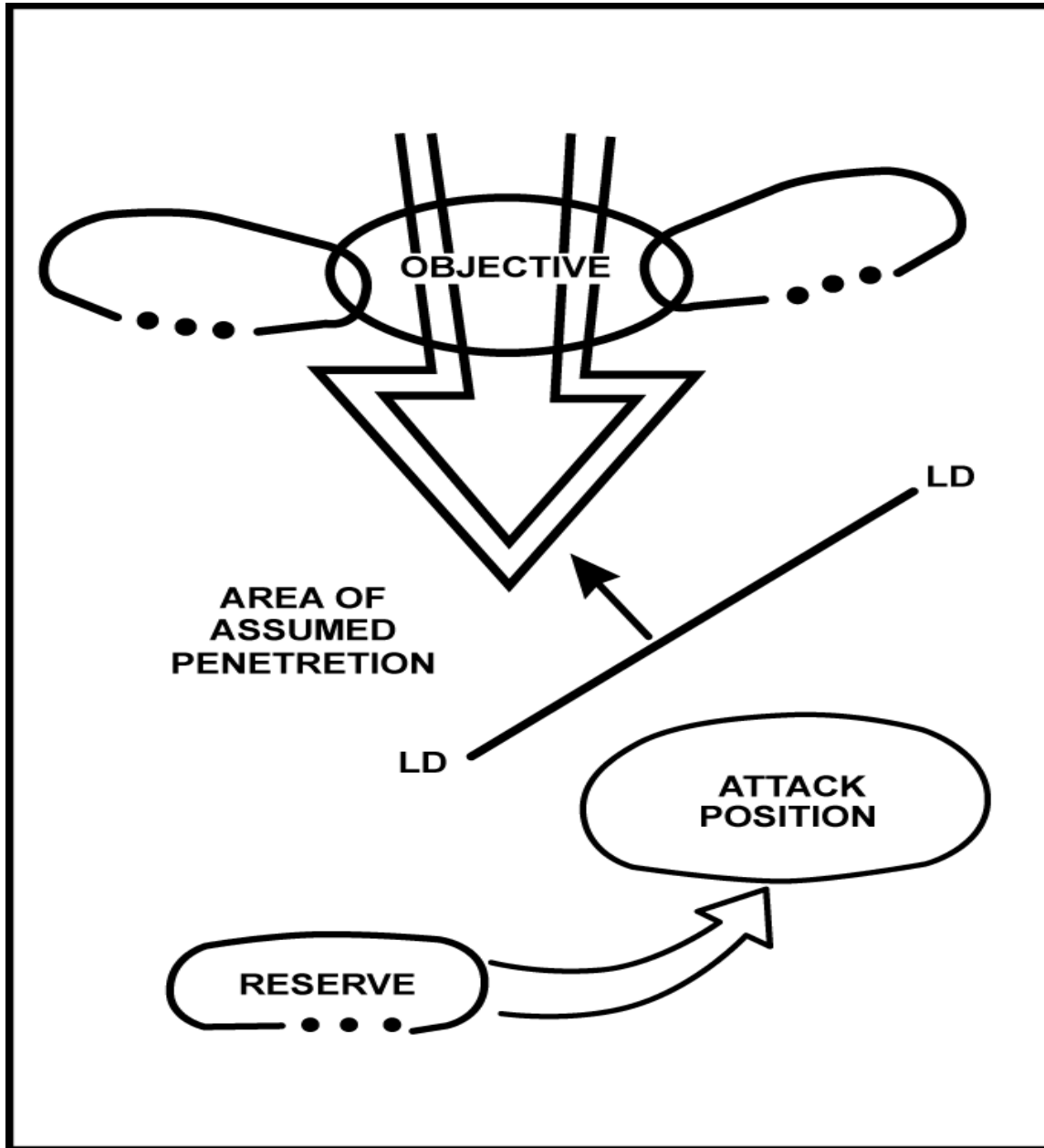

Figure 5-10. A reserve counterattacking.

**5-9. LOGISTICS CONSIDERATIONS**

The CO selects the general locations for the company trains, the company casualty collection point, and the EPW collection point.

a. The company trains are usually split—some elements join the company and other elements join battalion combat trains. If augmented with medical/transportation assets from battalion, only those vehicles, personnel, and supplies needed to immediately support the company are forward with the company. The forward elements of the company trains should be in defilade (in a covered and concealed position) behind the company.

b. Equipment that is not constantly needed by soldiers, such as rucksacks, sleeping gear, and personal items, should be maintained in the battalion field trains and brought forward only when needed.

c. The company casualty collection point and the EPW collection point are normally in defilade to the rear of the company. The CO should consider the likely movement of casualties to the rear, generally following the natural lines of drift, to select the casualty collection points.

### **5-10. COMMAND POST LOCATION**

The CO locates a CP where he can best control the battle (Figure 5-11). The CO must also consider security and communications requirements when positioning the CP (see Chapter 2).

a. The CP should be in defilade and concealed from air and ground observation. The CO also selects covered and concealed routes to and from the CP. The CP normally provides its own security with headquarters personnel; however, more security may be obtained by positioning the CP near the reserve. Fighting positions are prepared at the CP.

b. The company may establish an alternate CP to assume command of the company if the CP is destroyed or ineffective. Normally, the XO, 1SG, and possibly the senior medic locate there. This may also be the casualty collection point. In this case, the alternate CP bunker should be large enough to provide overhead cover for the casualties.

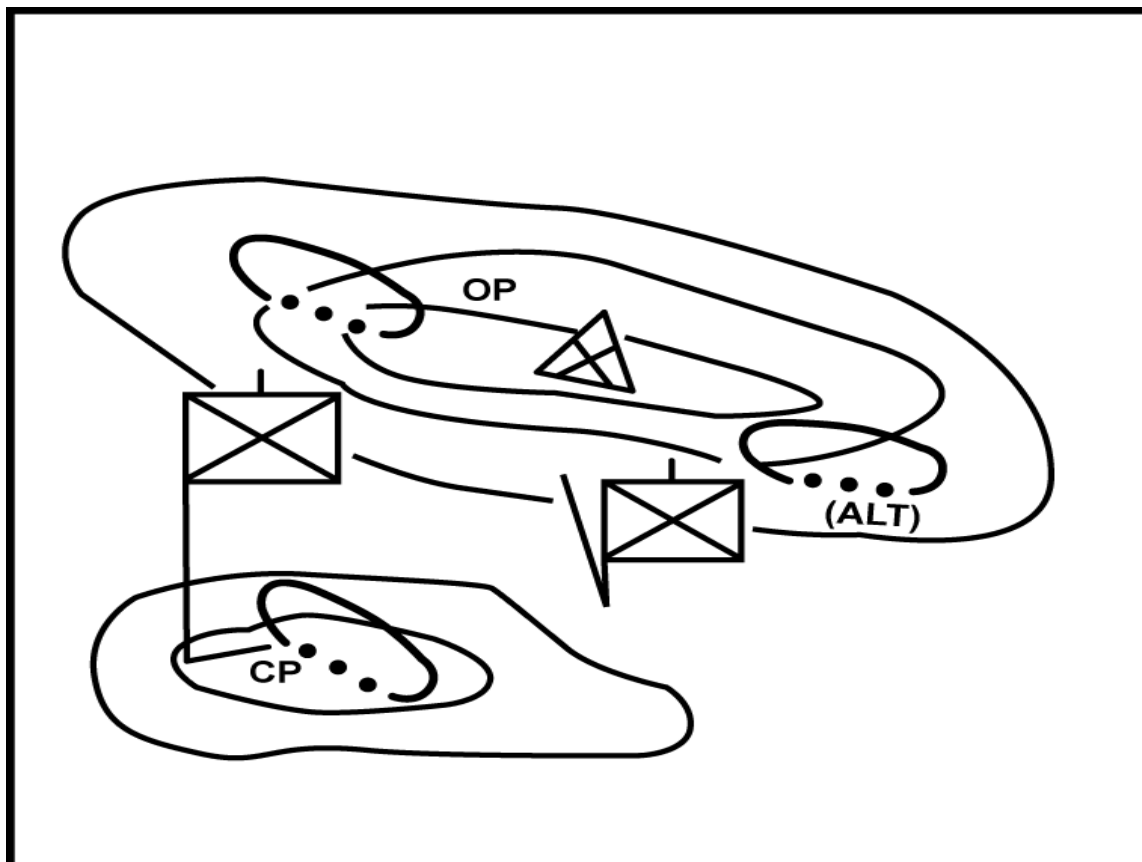

Figure 5-11. Command post.

### Section III. CONDUCT OF OPERATIONS

This section discusses the sequence of actions that an infantry company normally follows to conduct a defensive mission. The company conducts a reconnaissance before occupying the area. The unit immediately begins its preparations IAW a detailed priority of work. The use of time, particularly daylight hours, is critical to the success of the defense. Once the enemy attacks, the battle is fought IAW the CO's concept, which may include a counterattack as the decisive action. The company reorganizes throughout the fight to maintain its effectiveness.

#### 5-11. RECONNAISSANCE

Before occupying a defensive position, the CO normally halts the company short of the position, establishes local security, and assembles his platoon leaders for a reconnaissance of the position. The reconnaissance may be conducted in many different ways. The CO may first reconnoiter the defensive position without his platoon leaders and then reconnoiter again with them. The time available will have a major impact on the conduct of the reconnaissance. In extreme cases, a map reconnaissance may be the only means available to the CO.

a. As in any tactical operation, the reconnaissance plan is developed to confirm or deny the concept for the defense. The specific requirements for the leader's reconnaissance must be identified and prioritized. Once this is completed, the CO may

assemble the key leaders and plan one reconnaissance patrol, or he may assign missions to each subordinate unit.

b. Normally the key leaders involved in the leader's reconnaissance include the CO, FSO, platoon leaders, section leaders, and the leaders of any attached units/weapons. In addition to the key leaders, additional personnel will be required to provide communications and security. The size of the leaders reconnaissance is dependent upon the plan to conduct the reconnaissance; the need for security, speed, and stealth; and also the occupation plan for the defense.

c. During the reconnaissance, he confirms enemy avenues of approach; primary, alternate, and supplementary positions for platoons and weapons; dead space in front of the positions; and locations for the company CP, OP, trains, and the EPW collection point.

## **5-12. OCCUPATION OF THE DEFENSE**

The CO must plan the occupation of the defense. This is the movement of the company from their present locations into the assigned area for the defense. Occupation plans for various defensive techniques may be SOP (see paragraph 5-12b). The plan must be based on the defensive concept; it may include a simple route, order of movement, and platoon/section release points. Or it may be a detailed plan involving the leader's reconnaissance, a helicopter insertion into company areas, and an immediate transition to the defensive mission.

a. All occupation plans should logically support the defensive concept and provide for the security of the force. They take advantage of cover, concealment, and limited visibility periods and maximize the use of available time for the preparation of the defense.

b. In a company occupation of a battle position, the company halts in a covered and concealed location to the rear of the battle position, and local security is established. The leader's reconnaissance is conducted. Security elements/guides may be left in position as the leaders return to the company. Then the company moves forward as a unit or by platoons/sections to occupy their positions. At a designated place, the CO releases control of the platoons to the platoon leaders, who move their platoons forward and occupy their positions (FM 7-8). They follow the priority of work established by the CO in preparing their defensive positions.

## **5-13. PRIORITY OF WORK**

This is a set method of controlling the preparation and conduct of a defense. It should be prescribed by SOP to include individual duties. The CO changes priorities based on the situation. The leaders in the company should all have a specific priority of work for their duty position.

a. Although listed in sequence, several tasks may be performed at the same time. An example priority of work sequence is as follows:

- Establish the company R&S operation.
- Post local security.
- Position TOWs, Dragons, machine guns, and soldiers and assign sectors of fire.
- Position other assets (CP, mortars, vehicles ).

- Designate FPLs/FPFs.
- Clear fields of fire and prepare range cards/sector sketches.
- Adjust indirect-fire FPFs. The firing unit FDC should provide a safety box that is clear of all friendly units before firing any adjusting rounds.
- Prepare fighting positions.
- Install wire communications, if applicable.
- Emplace obstacles and mines.
- Mark/improve marking for TRPs and direct fire control measures.
- Improve primary fighting positions such as overhead cover.
- Prepare alternate and supplementary positions.
- Establish sleep/rest plan.
- Reconnoiter movements.
- Rehearse engagements/disengagements.
- Adjust positions/control measures as required.
- Stockpile ammunition, food, and water.
- Dig trenches between positions.
- Reconnoiter routes.
- Continue to improve positions.

b. Routine priorities for various duty positions are as follows:

(1) *Company commander*. Many of these duties can be delegated to subordinates, but the CO must ensure they are done. The CO must—

(a) Establish local security. Set up OPs if not already done and establish a company perimeter.

(b) Conduct a leader's reconnaissance with the platoon and section leaders. Confirm or deny significant deductions or assumptions from the estimate. Designate primary, alternate, and supplementary positions for platoons, sections, and supporting elements. Require platoons to conduct coordination. Designate kill zones, engagement areas, major barriers, and the general CP location. Position key weapons.

(c) Check the CP and brief the 1SG/XO on the situation and logistics requirements.

(d) Upon receipt of the platoon sector sketches, make two copies of a defensive sector sketch and a fire plan. Retain one and send one to the battalion (Figure 5-12).

(e) Confirm the platoon positions before digging starts. Coordinate with the left and right units.

(f) Check with the battalion commander for any changes or updates in the orders.

(g) Finish the security, deception, counterattack, and barrier plans.

(h) Walk the company positions after they are dug. Assume a position behind key weapons to confirm clear fields of fire, complete coverage of the sector of fire, and adequate tracking time for wire-guided missiles. Look at weapons from an enemy point of view.

(i) Check dissemination of information, interlocking fires, dead space, and security. Correct deficiencies immediately.



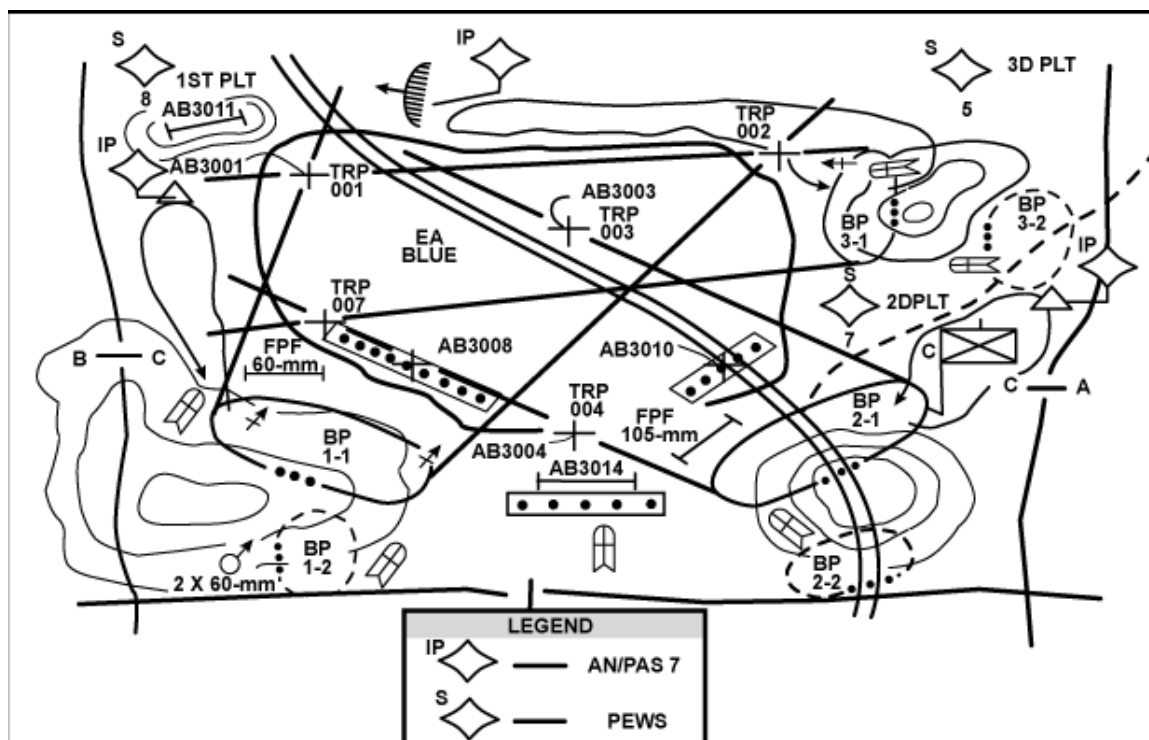

**Figure 5-12. Company defensive sector sketch.**

- (2) *First sergeant and executive officer.* One of them must—
- Establish the company CP. Ensure wire communications link the platoons, sections, and attached elements and send a guide to battalion communications, if applicable.
  - Establish casualty collection points, company logistic release points, and EPW collection points.
  - Brief platoon sergeants on the CP location, logistics plan, and routes between positions.
  - Assist the CO with the sector sketch.
  - Request and allocate pioneer tools, barrier material, rations, water, and ammunition.
  - Walk the positions with the CO. Start supervising emplacement of the platoons and sections, and check range cards and sector sketches.
  - Establish routine security or alert plan, radio watch, and sleep plan. Brief the CO.
  - Supervise continuously and assist the CO with other duties as assigned.
- (3) *Fire support officer.* The FSO must—
- Assist the CO in planning the indirect fires to support the defense.
  - Advise the CO on the current status of all firing units and on the use of smoke or illumination.
  - Coordinate with the battalion FSO, firing units, and platoon FOs to ensure the fire plan is synchronized and fully understood.
  - Ensure the platoon FO's equipment is fully operational.
  - Ensure the indirect fire plan is rehearsed as fully as possible.
  - Ensure all FPFs are adjusted in as soon as possible.

(g) Coordinate and or rehearse any repositioning of FOs within the company sector to ensure they can observe targets or areas of responsibility.

(4) *Mortar platoon/section leader*. He must—

(a) Choose a tentative firing position(s) and OP(s). Complete his portion of the fire plan (based on the company OPORD and his own estimate).

(b) Take part in the company leader's reconnaissance. Confirm or adjust the firing position, select OPs, and coordinate the indirect fire plan with the company FSO.

(c) Issue FRAGOs to squads. Conduct a section leader's reconnaissance with squad leaders. Require squad leaders to coordinate with platoons and squads for security and logistic support.

(d) Direct the mortar section to begin digging.

(e) Establish internal and external wire communications, if applicable.

(f) Assist the FSO in completing the fire plan and overlays.

(g) Register/adjust the FPF.

(h) Inspect the mortar position.

(i) Reconnoiter routes to alternate firing positions.

(5) *Antiarmor section leader*. He must—

(a) Select tentative firing positions based on the OPORD, estimate, and map reconnaissance, if the section is acting in an antiarmor role.

(b) Take part in the company leader's reconnaissance to confirm or switch firing positions and to coordinate with platoon leaders.

(c) Issue FRAGOs to teams. Conduct a section leader's reconnaissance with team leaders. Require team leaders to coordinate with platoons and squads for security and logistic support.

(d) Devise an antiarmor fire plan. Assist with the company sector sketch. Brief the CO and 1SG or XO.

(e) Ensure the required section equipment and supplies (batteries and bottles) are available and coordinate the resupply requirements.

(f) Inspect positions. Check sight pictures, cover and concealment, range cards, and communications. Correct deficiencies.

(g) Ensure the fire control measures are understood and clearly marked for observation during limited visibility.

(6) *Communications NCO*. He must—

(a) Supervise setting up wire and radio communications with the battalion, platoons, and sections.

(b) Organize a radio watch.

(c) Supervise the performance of PMCS on the radios.

(d) Check the platoon RATELOs for PMCS and their knowledge of SOI.

(e) Brief the CO.

(f) Assist the 1SG/XO, as required. Help organize local security for the CP, dig fighting positions, prepare OPORDs, and so forth.

(7) *NBC NCO*. He must—

(a) Assist the CO with an updated MOPP analysis.

(b) Ensure that chemical detection and monitoring procedures are established and maintained.

(c) Coordinate for hasty decontamination support.

- (d) Coordinate smoke support.
- (e) Supervise decontamination operations.
- (f) Provide guidance on operations in nuclear, biological, and chemical conditions.

#### **5-14. TIME MANAGEMENT**

A critical aspect of defensive planning is managing available time. The CO decides what must be accomplished during daylight to allow platoon and squad defensive preparation to continue during darkness. Because there is never enough time to prepare the defense, the CO must make the best use of time available.

a. Platoon and squad positions identified and prepared during hours of limited visibility may not be completely effective during daylight. The CO's initial estimate of the time available must include the amount of daylight needed for subordinate leaders to identify primary positions.

b. The CO may establish a detailed time schedule for completing key actions/events in the priority of work. This ensures that all units are generally at the same point in the priority of work. This also allows rehearsals to be scheduled for the entire unit. An example of this time schedule might be:

- 1000—Primary fighting positions dug and camouflaged.
- 1500—Company rehearsal for the counterattack.
- 1600—Leaders' sandtable rehearsal of the indirect fire plan.
- 1900—Primary positions complete, platoons rehearse disengagement and movement to supplementary positions.
- 2200—Limited visibility rehearsal for the counterattack.

#### **5-15. DAYLIGHT SCENARIO**

A planning scenario is provided herein for conducting an estimate when the limited hours of daylight are a significant factor.

a. The CO receives the defensive OPORD at 0900 on Day 1 in an AA 5 kilometers from the defensive positions. The enemy is not expected to attack within 48 hours, which is no earlier than 0900 on Day 3. BMNT is at 0700 and EENT is at 1800. The CO's one-third of the time would allow him to complete issuing the OPORD at 0100 on Day 2. This, however, will waste the available time for position preparation the first night and, at first light, platoon leaders will still be reconnoitering to site key weapons and squad positions. In the best case, personnel will be just starting to prepare fighting positions two hours after daylight (0900, Day 2), leaving them only 24 hours to prepare.

b. A better use of the available daylight hours in the above scenario follows:

- Day 1, 0900–1000: Upon receipt of the battalion OPORD, the CO conducts a quick METT–T analysis. He then issues an immediate FRAGO to move to and occupy a position in the defensive area; places the XO in charge of the preparation and movement of the company; and departs to the defensive area with his platoon leaders, FSO, and security elements from each platoon.
- 1100: The CO and platoon leaders (with security) arrive on site.
- 1115: The CO dispatches platoon leaders (with security) to reconnoiter key points of their tentative positions/sectors as determined from the map reconnaissance.
- 1115 to 1300: The CO makes a tentative plan.

- 1300: Upon the return of the platoon leaders, the CO revises the tentative plan based upon the reconnaissance reports.
- 1330 to 1400: The CO issues the OPORD to the available orders group. Platoon leaders then continue their planning process.
- 1530: When the rest of the company arrives, the platoon leaders have reconnoitered their positions and completed their platoon OPORDs.
- 1600: Squad leaders designate primary, alternate, and supplementary positions during daylight. The platoon leader and CO have two hours of daylight left to make adjustments before position preparation is final.

### **5-16. DEFENSIVE BATTLE**

The defensive battle starts when the planned signal/event for initiating fires occurs. In a very non-linear fight, the authority for the initial engagement may be delegated to the lowest level. This initial engagement may be a squad ambush, massed fires in an EA, or by engaging the enemy at maximum effective range of each system. The platoon and squad leaders then conduct the fight in accordance with the CO's concept. The following is a discussion of a centralized company defense. Remember, this does not apply when conducting a decentralized, nonlinear defensive battle consisting of squad and platoon actions.

a. All company weapons fire at appropriate targets as they come within range IAW the fire plan. Leaders and FOs are alert to direct and control fire where it is needed to avoid wasting ammunition.

b. The rate of fire increases as the enemy approaches. If tanks and infantry are attacking, fire is placed to force the tanks to button up and separate foot soldiers from the tanks.

c. If attacking formations are not broken up forward of the company's position, the enemy will assault. The CO then calls for his FPF. Machine guns that have an FPL fire on that FPL; those that do not, fire along their PDF. Mortars and artillery fire their FPFs if allotted. All other weapons fire within their sectors until the assault has been halted.

(1) An arranged signal, such as a flare, is used to stop the firing when the assault has been halted. The FPF may be repeated, as needed. Since the FPF expends a lot of ammunition, it should only be called for to stop an enemy assault from closing on the position. If the enemy gets through the FPF, he is repelled by close combat and or counterattack.

(2) If the company is threatened from the flanks or the rear, the CO may move platoons or the reserve to fight from supplementary positions. If platoons and squads are forced from their primary positions, they move to their alternate positions.

d. Throughout the conduct of the defense, the platoon leaders keep the CO informed of their situation. He, in turn, must keep the battalion commander informed of the company's situation.

e. Once the enemy is repelled, the CO reestablishes OPs and sends patrol units forward to maintain enemy contact. Indirect fire is called on areas where the enemy is apt to regroup. In some situations, a spoiling attack against this force may be appropriate. The company reorganizes and prepares for another enemy attack.

## 5-17. COUNTERATTACK

The same principles for any attack apply for counterattacks. Timing is critical. To be decisive, the counterattack is conducted when the enemy is overextended, dispersed, and disorganized during his attack. Counterattacks may be conducted by a designated counterattack unit, by the reserve, or by a subordinate unit with a be-prepared mission to conduct a counterattack. It may be a planned action in the CO's concept or it may be an immediate action by a subordinate unit based on the situation. All counterattacks should be rehearsed in the same conditions that they are expected to fight in. Counterattacks are most effective against an enemy force that is has been stopped.

a. Counterattacks may be extremely effective when conducted by small units as part of a decentralized, nonlinear defense. When combined with an ambush to halt and disorganize an attacker, a small counterattack force can achieve superior combat power. If the attack is not decisive, the force can disengage and seek out another part of the enemy to attack.

b. Larger scale counterattacks that are key to the CO's concept require additional planning, coordination, and rehearsals. Normally, the defense is organized to force the enemy into a position where the counterattack can be decisive. The timings, responsibilities, and fire plan must be understood by the entire company. Ideally, the counterattack force is located in a covered and concealed location requiring minimal movement to begin the assault or fires. The farther they must move, the more likely the enemy will be able to identify them and react to their attack.

c. When the company reserve conducts the counterattack, it normally becomes the main effort and is given priority of fire from all available fire support. The reserve avoids friendly positions, makes a quick decisive assault, and clears the penetrated area. Any soldiers from the forward platoon who stay in the penetrated area come under the control of the reserve when it comes into this. Once the counterattack is ordered, a new reserve should be constituted. When the CO decides to commit his reserve in a counterattack, he notifies the battalion commander at once.

d. Any subordinate unit may conduct an immediate counterattack if they are in position with adequate combat potential to be effective and it supports the CO's concept. Simple contingency plans designating rally points and likely support positions and or kill zones will provide this flexibility.

## 5-18. REORGANIZATION

Reorganization must begin automatically at the lowest levels. As soon as the engagement begins, the leaders in the company must be aware of the status of their units and reorganize immediately when required. However, some of the considerations in this section must wait until a lull in the battle.

a. **Man Key Weapons.** Assign personnel to replace key soldiers lost during the fight; for example, ensure crew-served weapons are manned and the chain of command is reestablished.

b. **Reestablish Security.** If soldiers withdrew from the OPs to their fighting positions, return them to their OPs. If some did not get back to the platoon position, check their status and replace casualties. Coordinate with adjacent units to determine the situation in their areas. As soon as feasible, reestablish the security system.

c. **Treat or Evacuate Casualties.** Treat casualties as far forward as practical. Those who can continue to fight are returned to their positions; evacuate the others. Report the dead and evacuate the bodies as soon as practical.

d. **Redistribute Ammunition and Supplies.** Distribute remaining ammunition and supplies equally among the soldiers, including ammunition from casualties. Issue any stockpiled ammunition to the squads; take a quick inventory of other needs. Submit status reports to the company headquarters, including ammunition, barrier materials, and medical supplies. Consider the use of any enemy arms and ammunition that may be available from their casualties.

e. **Reposition.** During the assault, the enemy may have pinpointed some of the positions. Move to an alternate or supplementary position, rarely can surprise be achieved twice from the same location. If certain positions are in danger or depend upon surprise to be effective, reposition soldiers and weapons (particularly crew-served weapons) that are vulnerable or do not have good observation and fields of fire. Adjust positions to maintain mutual support.

f. **Reestablish Communications.** Provide a status report to the CO. If radio contact is impossible and landline not available, send a messenger. The unit SOP should allow for units to continue operations without communications. Only send a messenger when unable to continue the mission or when changing the plan. If a phone line was cut during the attack, soldiers on each end of the line try to find and repair the break. If they cannot, they lay new wire. If a signal, such as a green star cluster, was used to initiate fire, consider changing that signal since the enemy may know what it means. These signals must be coordinated with adjacent units to prevent confusion.

g. **Repair Fighting Positions.** Each soldier checks and, if needed, replaces the camouflage, overhead cover, and sandbags on existing positions and camouflages new positions.

h. **Repair/Replace Damaged/Breached Obstacles, Mines, and Booby Traps.** Replace these devices only if enemy soldiers are far enough away so it can be done safely. This is risky, especially if the enemy has snipers. Wait for poor visibility to do so or use smoke to hinder observation.

i. **Use Snipers.** Before an attack is initiated and after it has been stopped, the defending unit may add to its security by using snipers. They should be allowed to move anywhere in the position. They find and hit targets such as enemy reconnaissance parties, infiltration teams, leaders, obstacle-breaching teams, weapon crews, stragglers, and enemy snipers. If no dedicated snipers are available, use the best marksmen in the unit. They are effective out to 560 meters when armed with the M16A2.

#### **Section IV. DEFENSIVE TECHNIQUES**

There are many different defensive techniques that an infantry company may employ. A properly conducted estimate will focus the defensive concept by identifying the potential decisive points. The commander then determines the most effective means of positioning/maneuvering his units/weapons to generate overwhelming combat power at these points. The techniques discussed in this section should be used only as basic approaches to developing a defensive concept. The ideal concept may be a combination of several different techniques or, like Chamberlain's successful defensive bayonet charge down Big Round Top at Gettysburg, it may not even be discussed in a doctrinal manual.

### 5-19. NONLINEAR DEFENSE

The nonlinear defense is the most decentralized and dynamic defense conducted by an infantry company. It is frequently used when operating against an enemy force that has equal or greater firepower and mobility capabilities. This type of defense is almost exclusively enemy oriented and is not well-suited for retaining terrain. This defense depends on surprise, offensive action, and the initiative of small unit leaders to be successful (Figure 5-13). It is a very fluid defense with little static positioning involved.

a. Normally, this defensive technique is directed by battalion when the battalion concept does not focus the company at a single decisive point. An example is when the battalion assigns the company a sector and a mission that focuses the company on the enemy force. Mutual support is achieved solely through the linkage of purposes in the mission statements.

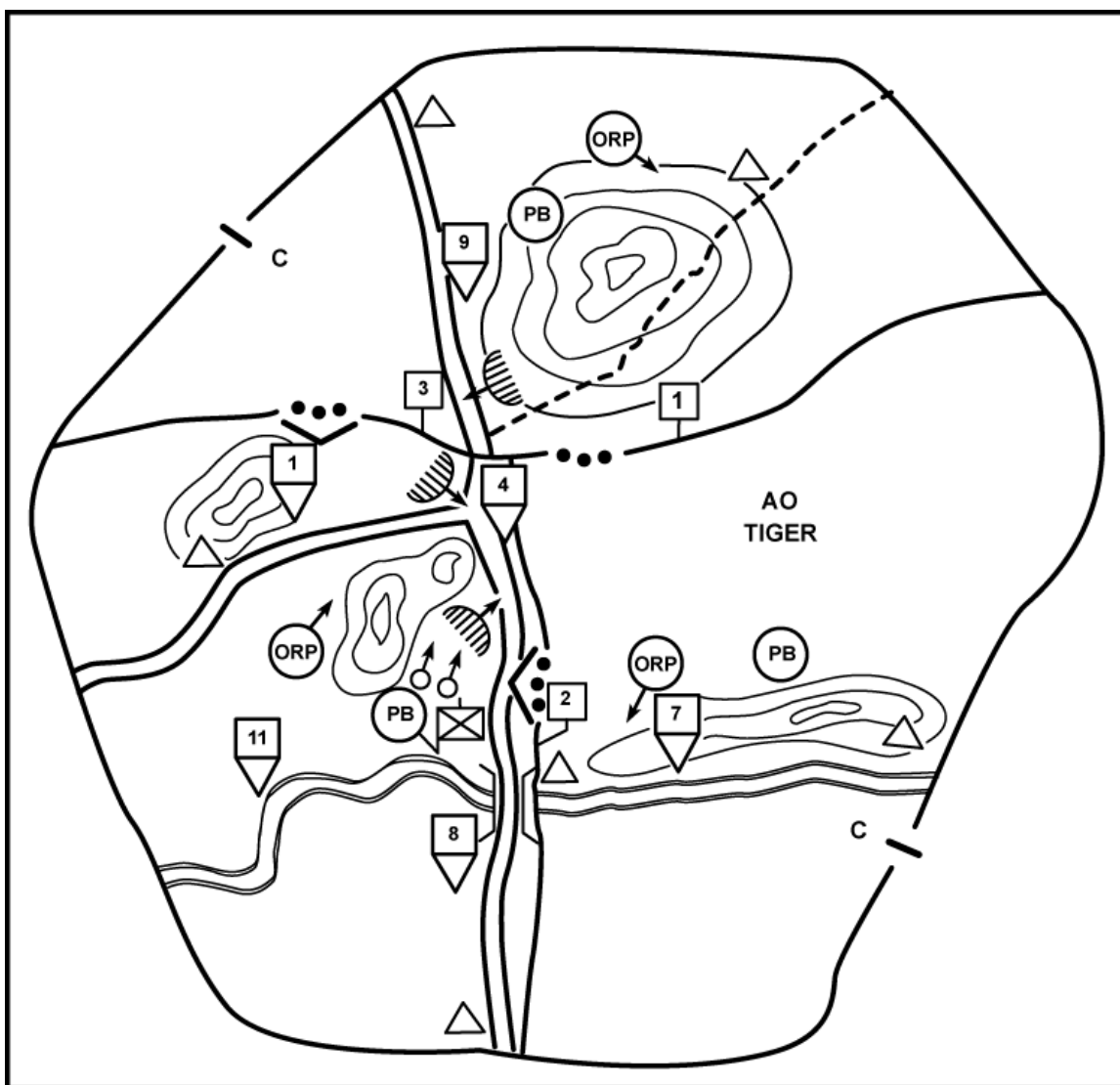

Figure 5-13. Nonlinear defense.

b. The CO may decide to conduct a nonlinear defense when he is unable to identify a single decisive point that will allow the company to concentrate combat power and achieve its mission. Terrain that prevents mutual support between platoons and or an enemy force capable of directing overwhelming firepower against identified friendly positions also support conducting a defense in this manner.

c. The reconnaissance and security plan for this type of defense will focus on avoiding detection by the enemy's reconnaissance assets. Operating in smaller units supports this requirement. Preparation and activity along likely reconnaissance routes must be closely controlled. Ideally, the enemy reconnaissance will be allowed to move through the area before they are destroyed.

d. The CO assigns platoon sectors and may also identify likely ambush positions and rally points for each platoon. He identifies a main effort and assigns the supporting efforts missions that provide mutual support and degrade the enemy's ability to generate combat power against the main effort. The main effort may be weighted by assigning priority of fires; by the allocation of mines, barrier materials, and other supplies; and by locating the CP, casualty collection point, and most of the caches in their vicinity.

e. The platoons conduct numerous squad and platoon ambushes, raids, and counterattacks—but they avoid decisive engagement. Before the enemy is able to react and concentrate against these small units, they disengage and seek out another enemy weak point. The synchronization for this defense may be event oriented or accomplished by assigning ambush locations and initiating times or signals. The event-oriented synchronization involves identifying key enemy assets or vehicles that, if destroyed/disrupted, will have the greatest effect on the enemy.

f. A company reserve is normally quite small. Due to the extended distances that the company and platoons are operating over, the timely employment of the company reserve in a decisive action is not likely. Generally, the platoons will be able to employ the resources more effectively. A squad-sized company reserve could be employed under the control of the 1SG as a logistics squad, for casualty evacuation, or as a reaction force to support the main effort.

g. Other concerns include the difficulty of conducting resupply operations/casualty evacuation when defending in this manner. The resupply can be affected through repositioning of the critical supplies (Chapter 8). Casualty evacuation will require detailed planning and battalion support. Casualty collection points must be identified well forward to support each platoon. The evacuation from these points to the BAS or the company collection point is normally accomplished by litter teams moving on routes that avoid the enemy. If possible, vehicular evacuation begins at the company collection point or as far forward as possible. Request that treatment teams from the BAS be positioned at the company collection point particularly if it is expected that casualties may have to be held until darkness for evacuation.



**5-20. DEFENSE IN SECTOR**

This disposition may consist of platoon sectors, a series of mutually supporting BPs on armor-restrictive terrain, or a combination of the two (Figure 5-14). Positions are arrayed in depth. The strength of this defense comes from its flexibility. This defense normally orients on the enemy force and not retaining terrain. It is effective because it allows the enemy to expose his flanks and critical C2 and CS assets through his own maneuver into the depth of the defense.

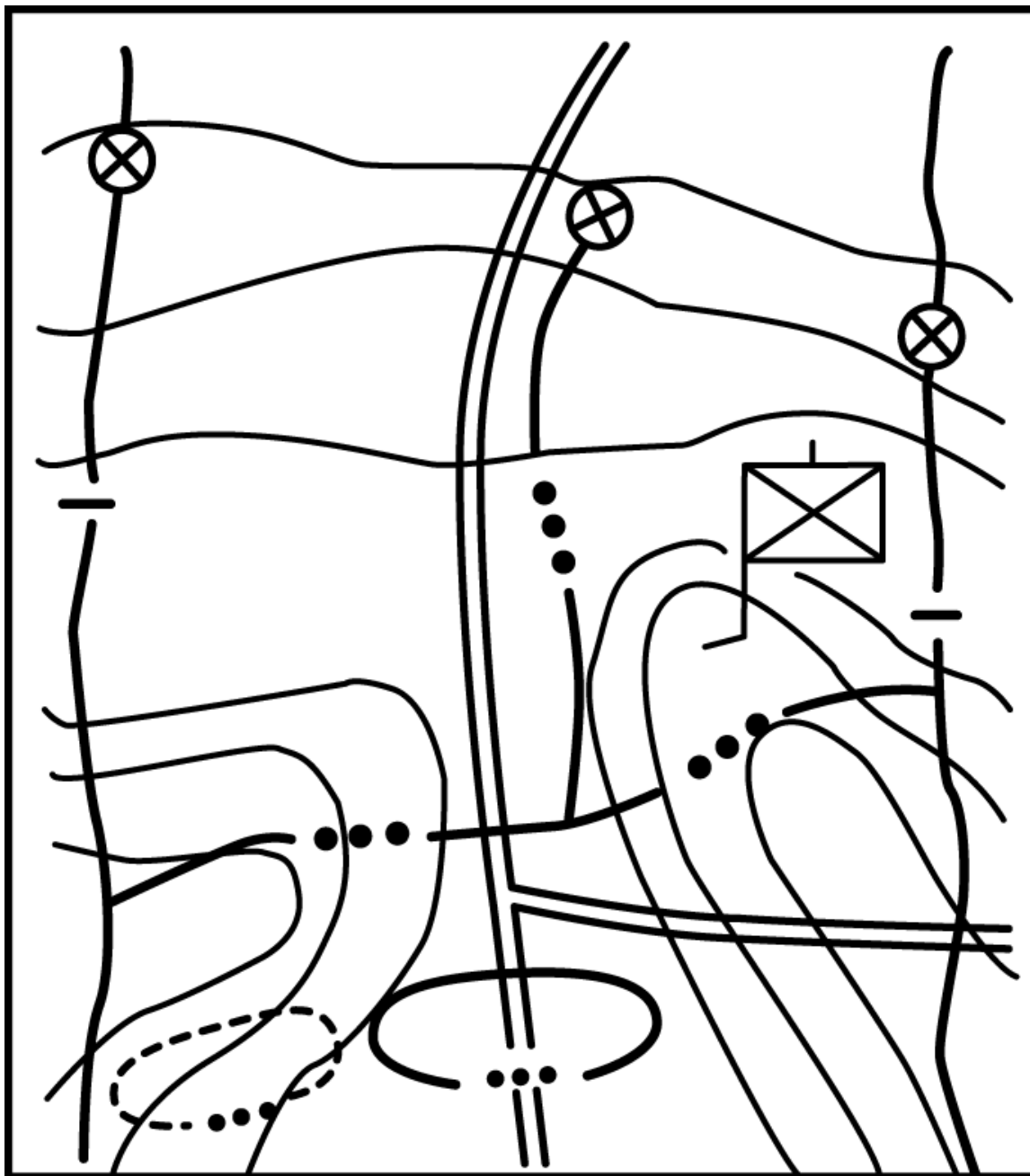

Figure 5-14. Defense in sector.

a. The company defense in sector may be fought very similar to the nonlinear defense. This is done by assigning platoon sectors. This decentralized technique for conducting a defense in sector requires greater initiative and delegates more of the control to subordinate leaders. The small-unit actions are very similar to the nonlinear defense. When required, squads or platoons may disengage independently and move to another location within the sector to continue the fight. Considerations for the company R&S plan and employment of a reserve are also very similar to the nonlinear defense.

b. When fighting a company defense in sector from platoon battle positions, the concept is to defeat the attacker through the depth of his formation, confronting him with effective fires from mutually supporting BPs as he attempts to maneuver around them. Mines, other obstacles, infantry positions, patrols, and PEWs cover gaps that, due to terrain masking or heavy woods, cannot be covered effectively by fire. Units remain in place except for local or internal movement to alternate or supplementary positions. If certain positions become untenable during the battle, the CO may withdraw them according to prepared plans.

(1) One technique is to allow the enemy to move into the EA and destroy him with massed fires. Another technique is to engage the attacker at maximum range with fires from tactical aircraft, attack helicopters, field artillery, and mortars. Then engage with organic antiarmor weapons positioned to deliver fires at maximum effective ranges from flanks and rear. As the enemy closes, antiarmor weapons may move to alternate and supplementary firing positions within the BP to continue firing and to avoid being bypassed.

(2) The company defense in sector from platoon battle positions generally requires the CO to be able to see and control the battle. It also requires good fields of fire to allow mutual support to be achieved. If the terrain or the expected enemy course of action would prevent this, the defense may be more effective if control was more decentralized and the platoons were fighting in sector.

c. A significant concern, particularly when fighting from BPs, is the enemy's ability to isolate a part of the company, fix, and then destroy them. Without effective mutual support between the BPs, this will likely occur. Even with mutual support, responsive and effective fire support may be critical to defending the BPs. Without immediately available fire support, a capable enemy will quickly concentrate combat power against any BP that is identified.

## **5-21. DEFENSE FROM BATTLE POSITIONS**

Fighting from battle positions is a more centralized technique and also more linear at the company level (Figure 5-15). Although this defensive technique tends to be more linear and centralized, it should not be a static defense. Battle positions should be positioned to achieve surprise and to allow maneuver within and between BPs. It is effective in concentrating combat power into an engagement area. It prevents the enemy from isolating one part of the company and concentrating his combat power in this area. Normally, platoons are assigned mutual supporting battle positions that cover the enemy likely avenue of approach. These BPs are located on terrain that provides cover and concealment and restricts vehicular movement.

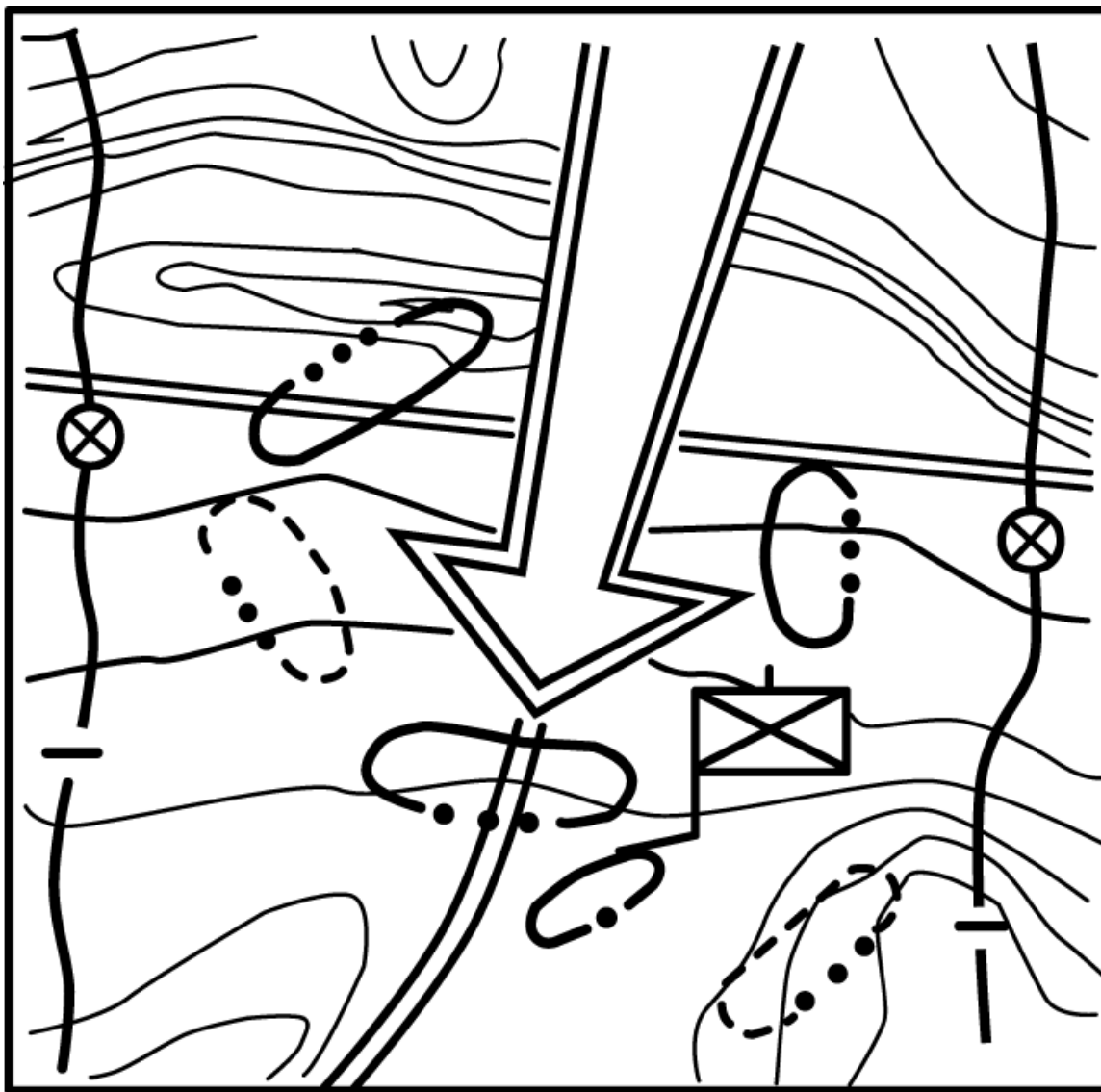

**Figure 5-15. Mutually supporting BPs.**

a. The commander's concept for fighting this type of defense should concentrate on achieving surprise from each of the BPs. This is accomplished by conducting an effective counterreconnaissance effort to prevent the enemy from locating the BPs and by initiating fires from one BP and waiting for the enemy to react to this engagement prior to engaging from the other BPs (Figure 5-16). Fighting in this manner will cause confusion among the enemy and disrupt his C2 process.

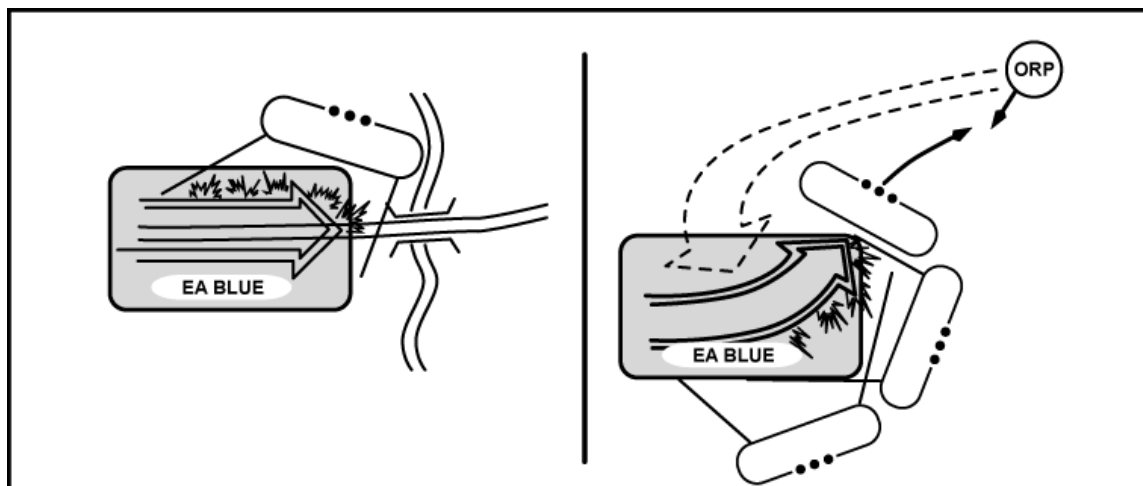

**Figure 5-16. Opening fire to achieve surprise.**

b. When the terrain provides a large EA and the commander's concept allows most of the enemy into the EA, the company may engage with massed fires from all of the platoon BPs. A disadvantage to this technique is that if there are still uncommitted enemy forces outside the EA, they will know the locations of the BPs and will attempt to isolate and concentrate against them. Contingency plans to disengage from these BPs and reorganize to continue the fight must be developed. This may involve displacing to alternate BPs or disengaging to conduct counterattacks/spoiling attacks against identified enemy C2, CS, or CSS assets.

c. Instead of one company EA, multiple EAs may be identified to provide flexibility to the plan (Figure 5-17). The plan must clearly state when platoons must reorient fires into the alternate engagement area.

## **5-22. DEFENSE ON A REVERSE SLOPE**

An alternative to defending on the forward slope of a hill or a ridge is to defend on a reverse slope (Figure 5-18). In such a defense, the company is deployed on terrain that is masked by the crest of a hill from enemy direct fire and ground observation. Although some units and weapons may be positioned on the forward slope, the crest, or the counterslope (a forward slope of a hill to the rear of a reverse slope), most of them are on the reverse slope. The key to this defense is control of the crest by fire.

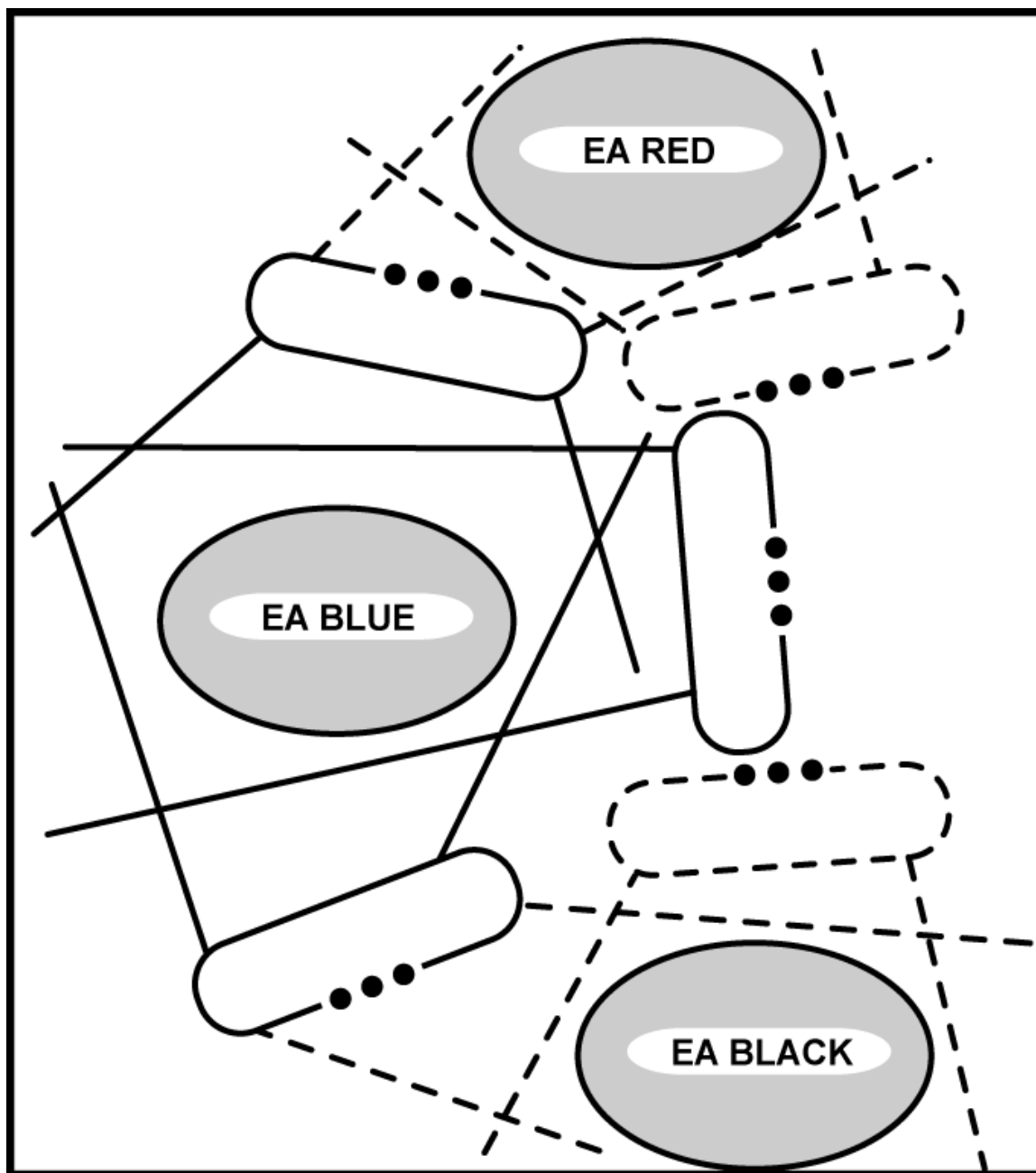

**Figure 5-17. Multiple engagement areas.**

a. **Considerations.** The following considerations apply when defending on a reverse slope.

(1) The crest protects the company from direct fire. This is a distinct advantage if the attacker has greater weapons range than the defender. The reverse slope defense can eliminate or reduce the "stand off" advantage of the attacker. It also makes enemy adjustment of his indirect fire more difficult since he cannot see his rounds impact. It keeps the enemy's second echelon from supporting the first echelon's assault.

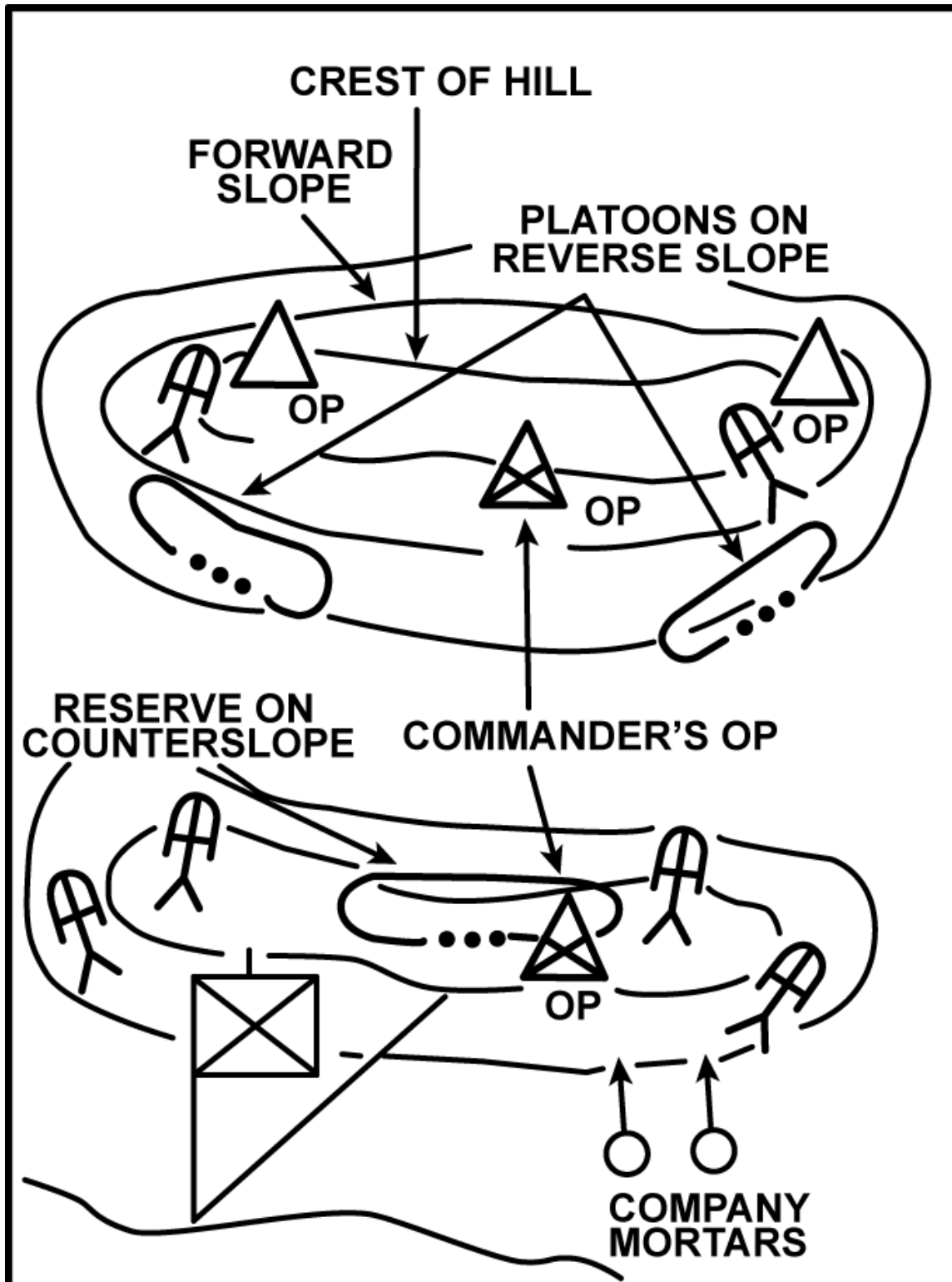

**Figure 5-18. Company defense on a reverse slope.**

(2) The enemy may be deceived and may advance to close contact before he discovers the defensive position. Therefore, the defender has the advantage of surprise.

(3) The defender can improve positions, build obstacles, and clear fields of fire without disclosing his positions.

(4) The defender may use dummy positions on the forward slope to deceive the enemy.

(5) Resupply and evacuation (when under attack) may be easier when defending on a reverse slope.

(6) Enemy target acquisition and jamming efforts are degraded. Enemy radar, infrared sights, and thermal viewers cannot detect soldiers masked by a hill. Radios with a hill between them and the enemy are less vulnerable to jamming and direction finders.

(7) Enemy use of CAS and attack helicopters is restricted. Enemy aircraft must attack defensive positions from the flank or from the rear, which makes it easier for friendly air defense weapons to hit them.

(8) A counterattacking unit has more freedom of maneuver since it is masked from the enemy's direct fire.

(9) It may allow antiarmor shots at the thinner armor on top of armored vehicles.

(10) The crest can provide protection from the blast effect of a nuclear explosion.

b. **Special Considerations.** The following considerations may apply when defending on a reverse slope.

(1) Observation of the enemy is more difficult. Soldiers in this position see forward no farther than the crest. This makes it hard to determine exactly where the enemy is as he advances, especially when visibility is poor. OPs must be placed forward of the topographic crest for early warning and long-range observation.

(2) Egress from the position may be more difficult.

(3) Fields of fire are normally short.

(4) Obstacles on the forward slope can be covered only with indirect fire or by units on the flanks of the company unless some weapons systems are initially placed forward.

(5) If the enemy gains the crest, he can assault downhill. This may give him a psychological advantage.

(6) If OPs are insufficient or improperly placed, the defenders may have to fight an enemy who suddenly appears in strength at close range.

c. **Feasibility.** A defense on a reverse slope may be effective when—

(1) The enemy has more long-range weapons than the defender.

(2) The forward slope has little cover and concealment.

(3) The forward slope is untenable because of enemy fire.

(4) The forward slope has been lost or not yet gained.

(5) There are better fields of fire on the reverse slope.

(6) It adds to the surprise and deception.

d. **Plans.** The fundamentals of the defense apply to a defense on a reverse slope.

(1) Forward platoon positions should be within 200 to 500 meters of the crest of the defended hill or ridge and sited so they block enemy approaches and exploit existing obstacles. They should permit surprise fire on the crest and the approaches around the crest. Forward fighting positions should have rear and overhead cover to protect friendly soldiers from fratricide.

(2) Post OPs, including FOs, on the crest or the forward slope of the defended hill. At night, OPs and patrol units should be increased to prevent infiltration. Machine guns may be attached to OPs.

(3) Position the company depth platoon/reserve where it can block the most likely penetration, support the forward platoons by fire, protect the flanks and the rear of the company, and, if necessary, counterattack. It may be positioned on the counterslope to the rear of the forward platoons if it can fire and hit the enemy when he reaches the crest of the defended hill.

(4) Position the company CP to the rear where it will not interfere with the reserve or supporting units. The CO may have an OP on the forward slope or crest and another on the reverse slope or counterslope. He uses the OP on the forward slope or crest before the battle starts when he is trying to determine the enemy's intentions. During the fight, he moves to the OP on the reverse slope or counterslope.

(5) Plan indirect fire well forward of, on, and to the flanks of the forward slope, crest, reverse slope, and counterslope. Plan indirect FPF on the crest of the hill to control the crest and stop assaults. Put the mortar section in defilade to the rear of the counterslope.

(6) Reinforce natural obstacles. A hasty protective minefield on the reverse slope—just down from the crest where it can be covered by fire—can slow the enemy's advance and hold him under friendly fire.

(7) The CO normally plans counterattacks. He plans to drive the enemy off the crest by fire, if possible. But he must also be prepared to drive the enemy off by fire and movement.

### **5-23. PERIMETER DEFENSE**

The rifle company prepares a perimeter defense when there are no friendly units adjacent to it (Figure 5-19). A perimeter defense may be used in a reserve position, in an assembly area or patrol base, on a semi-independent operation, during resupply, or when the company is isolated. The following actions constitute setting up a perimeter defense.



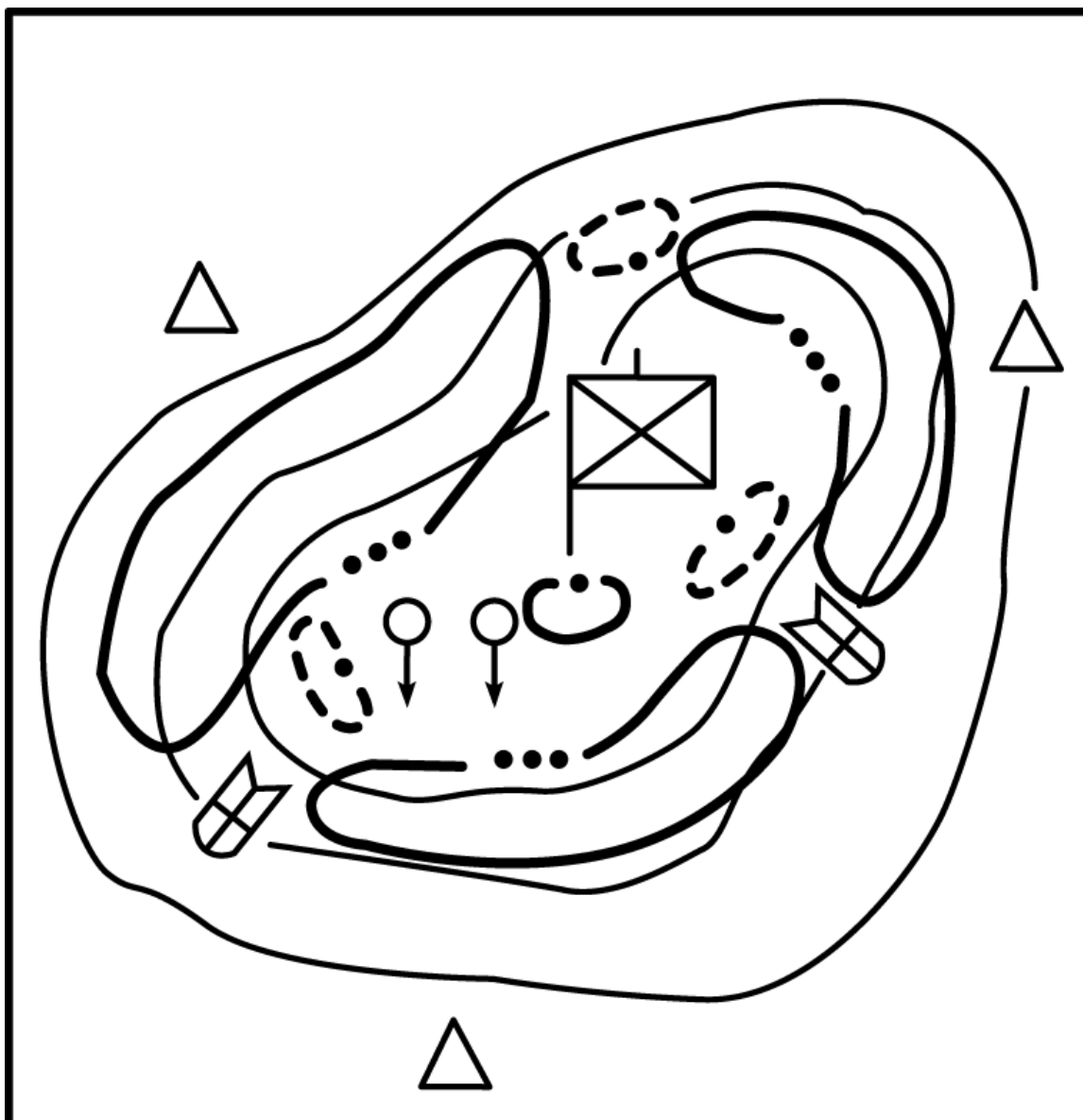

**Figure 5-19. Company perimeter defense.**

a. Prepare a perimeter defense as any position defense, but disperse the company in a circular configuration for all-round security; its actual shape depends on the terrain. The company must be prepared to defend in all directions.

b. The CO assigns the rifle platoon covering the most likely approach a smaller sector than the other platoons. He prepares alternate and supplementary positions within the perimeter.

c. If available, TOWs and tanks cover armor approaches. They may use hide positions and move forward to fire as the enemy appears. TOWs and tanks should be assigned several firing positions. If there are few positions for them, they are assigned a primary position and are dug in.

d. Keep the mortars near the center of the perimeter so their minimum range (70 meters) does not restrict their ability to fire in any direction. They should be dug in and

have covered ammunition storage bunkers. They communicate by phones (the wire should be buried). The FDC is dug in with overhead cover.

e. Hold at least one rifle squad in reserve. The CO assigns a primary position to the rear of the platoon, covering the most dangerous avenue of approach. It may also be assigned supplementary positions since it must be prepared to fight in all directions.

f. Prepare obstacles and mines in depth around the perimeter.

g. Plan direct and indirect fire as for any type of defense. Plan and use fire support from outside the perimeter when available.

h. Counter enemy probing attacks by area fire weapons (artillery, mortars, Claymores, and grenade launchers) to avoid revealing the location of fighting positions. If the enemy continues to advance, have the machine gunners and riflemen fire.

i. If the perimeter is penetrated, the reserve blocks the penetration and covers friendly soldiers while they move to their alternate or supplementary positions. Even though the company's counterattack ability is limited, it must strive to restore its perimeter.

j. CSS elements may support from within the perimeter or from another position. Supply and evacuation may be by air. Consider the availability of LZs and DZs (protected from enemy observation and fire) when selecting and preparing the position.

k. A variation of the perimeter defense to effectively use the terrain is the Y-shaped perimeter defense. This defense is used when the terrain, cover and concealment, or the fields of fire do not support the physical positioning of the platoons in a circular manner. The Y-shaped perimeter defense (Figure 5-20) is named this because the platoon battle positions are positioned on three different axes radiating from one central point. It is still a perimeter defense because it is effective against an attack from any direction. This defense provides all-round perimeter fires without having to position soldiers on the perimeter. It is most likely to be effective in mountainous terrain, but it also may be effective in a dense jungle environment due to limited fields of fire. All of the fundamentals of a perimeter defense previously discussed apply but some adjustments and special considerations are required.

(1) Although each platoon battle position has a primary orientation for its fires, each platoon must be prepared to reorient to mass fires into the kill zone to its rear.

(2) When there is not a most likely enemy approach identified or during limited visibility, each platoon may have half of its soldiers oriented into the kill zone to the front and half into the kill zone to the rear. Ideally, supplementary individual fighting positions are prepared to allow the soldiers to reposition when required to mass fires into one kill zone.

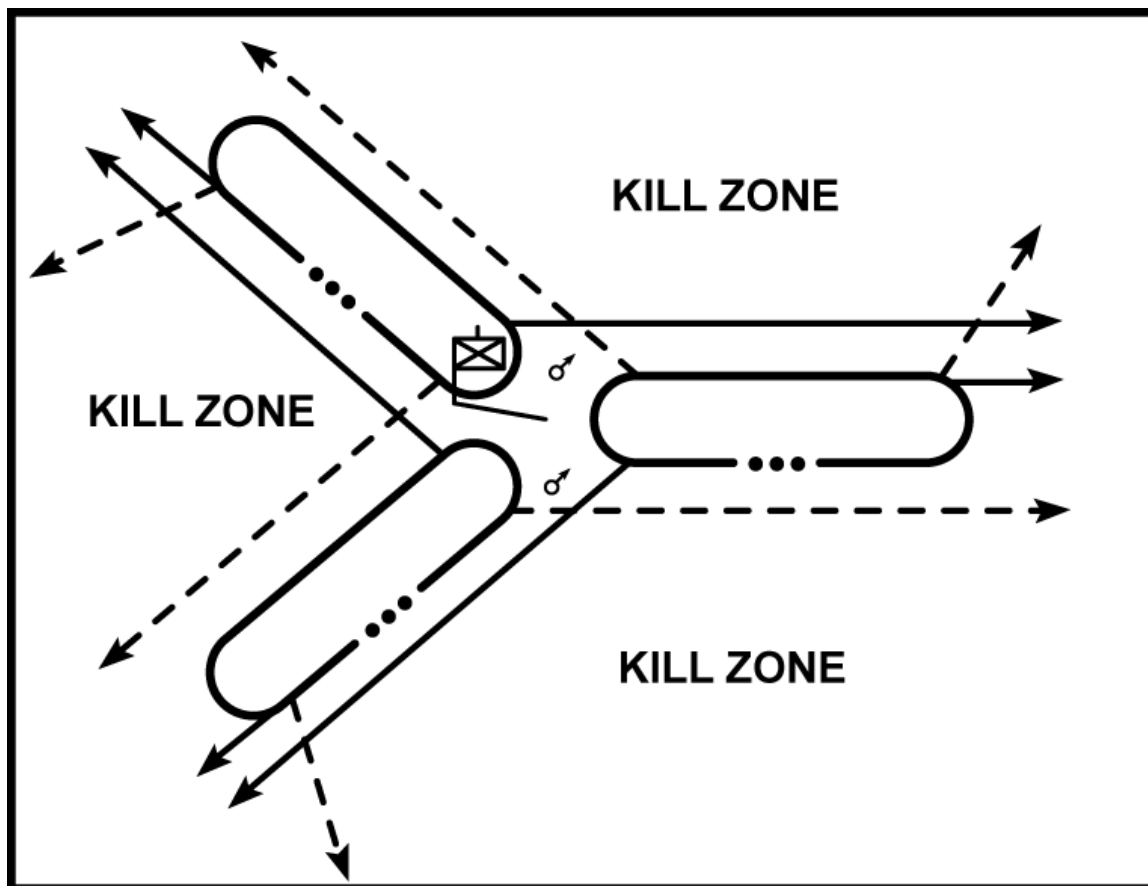

**Figure 5-20. Y-shaped perimeter defense.**

(3) When a most likely enemy avenue of approach is identified, the CO may adjust the normal platoon orientations to concentrate fires (Figure 5-21). This entails excepting risk in another area of the perimeter. The company security plan should compensate for this with additional OPs, patrols, or other measures.

(4) The positioning of the CP, mortars, a reserve, or any CSS assets is much more difficult due to a lack of depth within the perimeter.

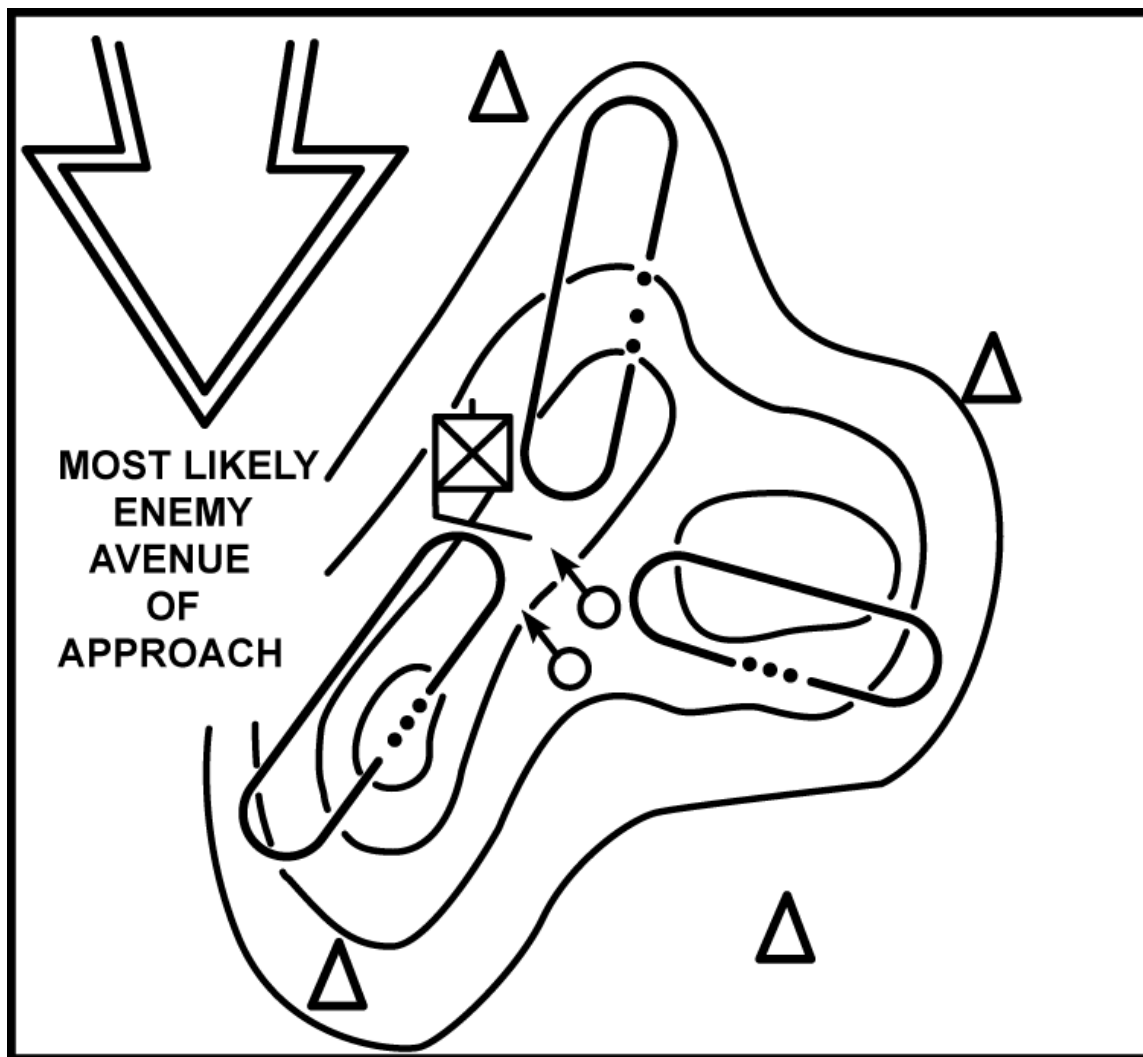

**Figure 5-21. Modified Y-shaped perimeter defense.**

(5) The most difficult aspect of this type defense is the fire control measures that must be established. To safely fight this defense without casualties from friendly fires, the leaders must ensure the limits of fire for each weapon do not allow fires into the adjacent platoon position. In a mountainous environment this may be simpler due to firing downward into the kill zones. Some measures to consider include:

(a) Position machine guns near the apex of the Y to allow an FPL that covers the platoon front while firing away from the adjacent platoon.

(b) Cover the areas of the kill zones closest to the apex with Claymores, other mines, or obstacles to reduce the need for direct fires in these areas.

(c) Identify those positions at most risk to friendly fires and prepare the fighting position to protect the soldier from fires in this direction.

(d) The loss of one platoon position may threaten the loss of the entire company. Plan and rehearse immediate counterattacks with a reserve or the least committed platoon to prevent this.

(e) Consider allowing the enemy to penetrate well into the kill zones and destroy him as though this was an ambush.

(f) Be aware that if this type defense is established on the prominent terrain feature and the enemy has the ability to mass fires, he may fix the company with direct fires and destroy it with massed indirect fires.

#### **5-24. LINEAR DEFENSE**

This technique allows interlocking and overlapping observation and fields of fire across the company's front (Figure 5-22). The bulk of the company's combat power is well forward. Sufficient resources must be available to provide adequate combat power across the sector to detect and stop an attack. The company relies on fighting from well-prepared mutually supporting positions. It uses a high volume of direct and indirect fires to stop the attacker. The reserve is usually small, perhaps a squad.

a. The main concern when fighting a linear defense is the lack of flexibility and the difficulty in both seizing the initiative and seeking out enemy weaknesses. When the enemy has a mobility advantage, a linear defense may be extremely risky. It is difficult to reposition forces, both laterally and in depth, to reinforce areas or to prevent a penetration. Obstacles, indirect fires, and effective contingency planning are key to this maneuvering. The company depends upon surprise, well-prepared positions, and deadly accurate fires to defeat the enemy. Therefore the company usually fights in this manner because the battalion plan requires it. The battalion then compensates for these weaknesses with other resources.

b. A linear defense may be used when defensible terrain is available in the forward portion of the company's sector or to take advantage of a major linear natural obstacle. It is also used when the enemy is mainly infantry, for conducting a security mission such as counter-infiltration, or when directed by battalion.

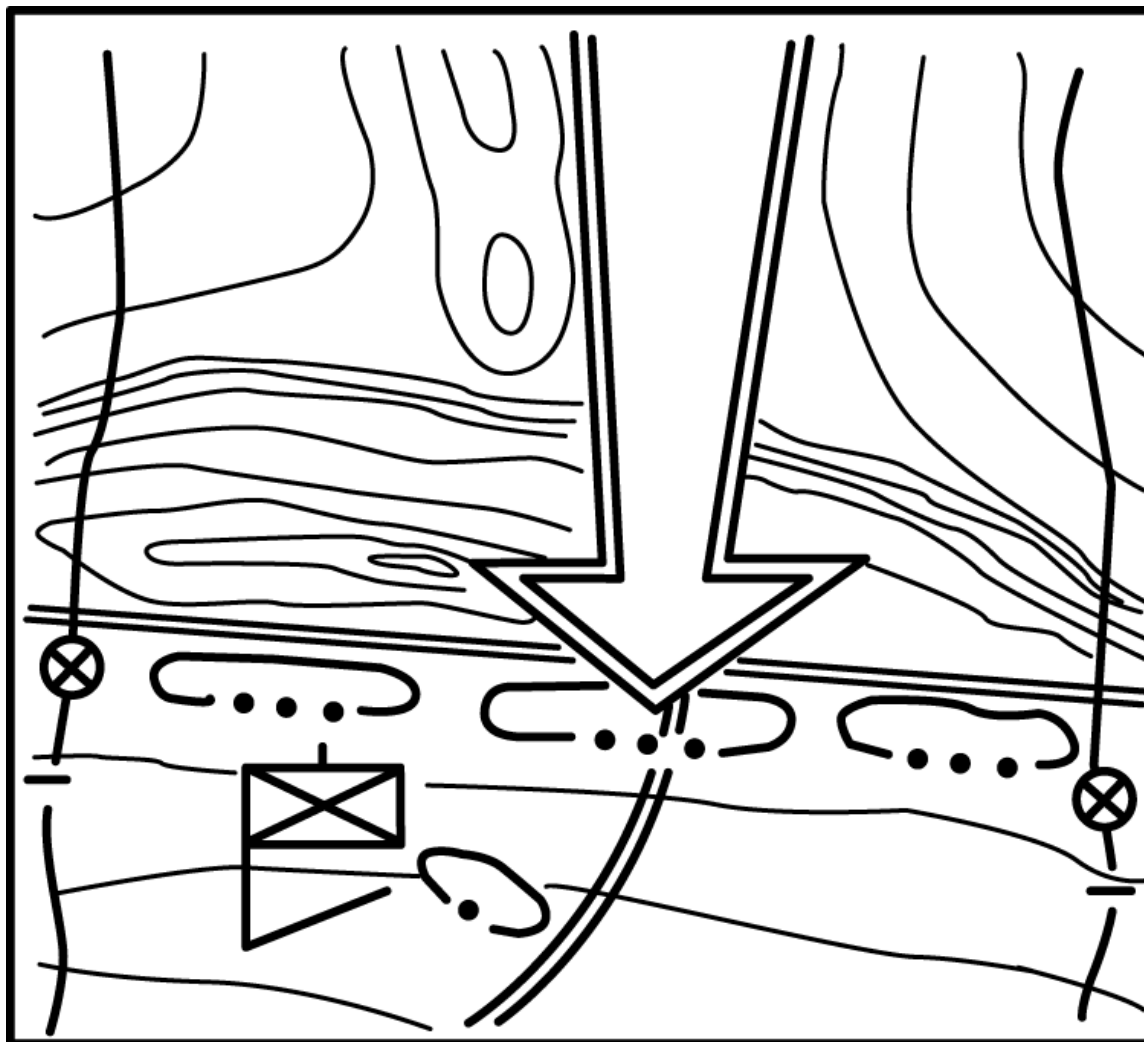

**Figure 5-22. Linear defense.**

c. Minefields and other obstacles are positioned and covered by fire to slow the attacker and to inflict casualties on him. Initially, engage him at long range by supporting fires (tactical air, attack helicopters, and field artillery) to disrupt the momentum of his attack. Use fires from mortars, machine guns, and small arms as he comes into range. If he penetrates the defense, block his advance with the reserve and shift fire from the forward platoons onto the enemy flanks. Then counterattack (either by the company reserve or the least committed platoon) with intense fires to destroy isolated or weakened enemy forces and regain key terrain.

d. The counterreconnaissance effort is critical when fighting a linear defense to deny the enemy the locations of the company's forward positions. If the enemy is able to locate the forward positions, he will concentrate combat power where he desires while fixing the rest of the company to prevent their maneuver to disrupt his attack. This effort may be enhanced by initially occupying and fighting from alternate positions forward of the primary positions. This will enhance the security mission and also deceive the enemy reconnaissance that may get through the security force.

### 5-25. DEFENSE OF A STRONGPOINT

A company may be directed to construct a strongpoint as part of a battalion defense (Figure 5-23). In order to do so, it must be augmented with engineer support, more weapons, and CSS resources. A strongpoint is defended until the unit is formally ordered out of it by the commander directing the defense.

a. The specific positioning of units in the strongpoint depends on the CO's mission analysis and estimate of the situation. The same considerations for a perimeter defense apply in addition to the following:

(1) Reinforce each individual fighting position (to include alternate and supplementary positions) to withstand small-arms fire, mortar fire, and artillery fragmentation. Stockpile food, water, ammunition, pioneer tools, and medical supplies in each fighting position.

(2) Support each individual fighting position with several others. Plan or construct covered and concealed routes between positions and along routes of supply and communication. Use these to support counterattack and maneuver within the strongpoint.

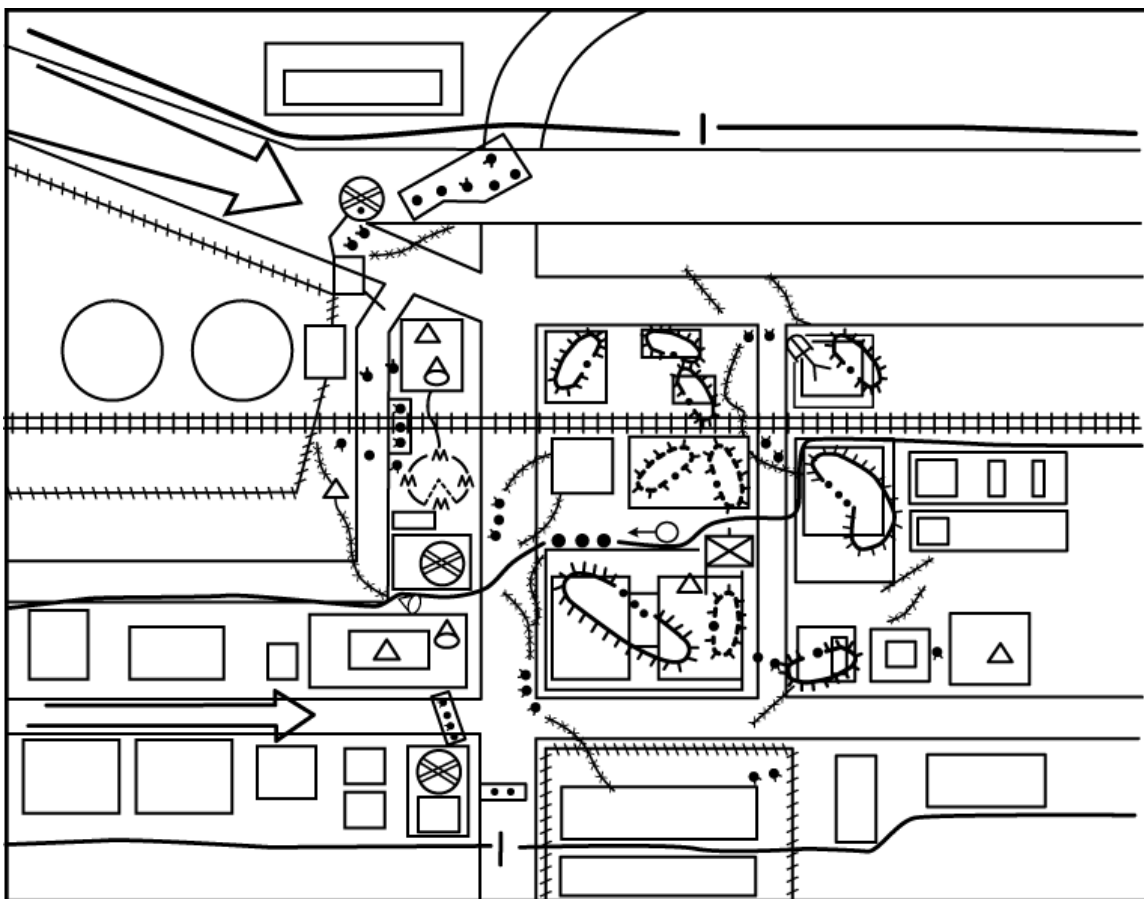

**Figure 5-23. Company strongpoint.**

(3) Divide the strongpoint into several independent, but mutually supporting, positions or sectors. If one of the positions or sectors must be evacuated or is overrun, limit the enemy penetration with obstacles and fires and support a counterattack.

(4) Construct obstacles and minefields to disrupt and canalize enemy formations, to reinforce fires, and to protect the strongpoint from the assault. Place the obstacles and mines out as far as friendly units can observe them, within the strongpoint, and at points in between where they will be useful.

(5) Prepare range cards for each position and confirm them by fires. Plan indirect fires in detail and register them. Indirect fires should also be planned for firing directly on the strongpoint using proximity fuses.

(6) Plan and test several means of communication within the strongpoint and to higher headquarters. These are radio, wire, messenger, pyrotechnics, and other signals.

(7) Improve or repair the strongpoint until the unit is relieved or withdrawn. More positions can be built, tunnels and trenches dug, existing positions improved or repaired, and barriers built or fixed.

b. A strongpoint may be part of any defensive plan. It may be built to protect vital units or installations, as an anchor around which more mobile units maneuver, or as part of a trap designed to destroy enemy forces that attack it.

c. The strongpoint is molded to the terrain, and natural camouflage and obstacles are used. Mountains, rivers, swamps, and forests can support formidable strongpoints, providing cover, concealment, and obstacles. Urban areas are also easily converted to strongpoints. Stone, brick, or steel buildings provide cover and concealment. Buildings, sewers, and some streets provide covered and concealed routes and can be rubble to provide obstacles. Also, telephone systems can provide communications.



## CHAPTER 6 OTHER TACTICAL OPERATIONS

*In the final analysis and once the force is engaged, superior combat power derives from the courage and competence of soldiers, the excellence of their training, the capability of their equipment, and above all the quality of their leadership.*

FM 100-5, 1986

*This chapter discusses operations requiring special planning considerations. These operations may be critical tasks that a company must accomplish to complete its mission, such as a passage of lines or a relief in place. In other situations (a raid or a delay), the mission itself may require special planning considerations.*

### Section I. PASSAGE OF LINES

A passage of lines is an operation in which one unit passes through the lines of another unit. When a unit moving toward the enemy passes through a stationary unit, it is a forward passage. When a unit moving away from the enemy passes through a stationary unit, it is a rearward passage.

#### 6-1. PURPOSE

This operation is conducted when the company's mission requires a movement through terrain occupied by another unit. A company may conduct a passage of lines—

- To initiate or continue the attack.
- To begin an infiltration.
- To conduct reconnaissance operations.
- To conduct a counterattack.
- To conduct retrograde operations.

#### 6-2. GENERAL CONSIDERATIONS

In planning for a passage of lines, the CO should consider the following to reduce the disruption of both the passing unit's movement and the stationary unit's defense.

- Conduct the passage as quickly as possible.
- Avoid masking the fires of the stationary unit.
- Coordinate early in the planning process and maintain the coordination/liaison during execution.
- Maximize the support from the stationary unit.
- Plan for likely contingencies.
- When possible, bypass the stationary unit.
- When possible, avoid passing through a unit that is in contact with the enemy.

#### 6-3. SPECIFIC CONSIDERATIONS

Each tactical situation presents certain considerations for both the passing and the stationary company commanders. These considerations result from the commanders'

estimate of the situation. A passage of lines to begin an attack will vary from a passage of lines to begin an infiltration. The passage of lines is planned to support the company's mission.

a. **Command and Control.** Due to the mixing of units during the passage, C2 considerations for a passage of lines are unique. Coordination must begin early in the planning process. The positioning of key leaders and the proper use of control measures will also facilitate effective C2.

(1) Coordination between the passing and stationary companies may include the following:

- Exchange of intelligence.
- Exchange of tactical plans.
- The reconnaissance plan.
- Selection of passage points and provisions for guides.
- Time or event when responsibility for the control of the area of operations is transferred.
- Fire and other combat support to be provided by the company in contact.
- Exchange of information on minefields and other obstacles.
- Exchange of liaison personnel.
- Exchange of frequencies, call signs, challenge and passwords, and recognition signals.

(2) The location of the key leaders for both the passing and the stationary company is critical. The commanders and their FSOs should collocate where they can best observe and control the passage. The other key leaders (XO, 1SG) should be positioned where they can best assist the commander, possibly at the passage point or along the passage lanes.

(3) The passage of lines should be supported by the proper graphics to provide both the required control and flexibility during execution. These may be designated by the higher commander or either of the company COs. The following control measures are often used to support a passage of lines:

(a) Assembly areas. These are used more often in a rearward passage to allow the passing company to reorganize before continuing movement. These may be designated but occupied only when required.

(b) Attack position.

(c) Battle handover line. A phase line used in a rearward passage to designate the point where the stationary unit assumes responsibility for the battle is the BHO line. The stationary unit must be able to engage with direct fires out to the BHO line and assist the passing unit's disengagement, if required.

(d) Contact point. A contact point should be designated for each passage point or lane by the stationary company CO. He may plan both a primary and an alternate contact point.

(e) Passage lanes. These should pass through unoccupied terrain between positions and completely through all obstacles. There may be multiple lanes or primary and alternate ones.

(f) Passage points. These may be used instead of a passage lane when the stationary units positioning and obstacles do not require a lane. They may also be designated along a passage lane to increase control.

- (g) Routes.
- (h) Release points.
- (i) Start points.

(j) **Signals.** Recognition signals to facilitate the linkup at the contact point must be determined. Considerations for identifying enemy from friendly (particularly for a rearward passage) include marking of personnel/vehicles, chemical lights, turret orientation (turrets should be pointed toward the enemy), and the use of challenges and passwords.

b. **Reconnaissance.** The passing commander ensures that a physical reconnaissance is conducted early in the planning process. If the CO is unavailable, then the XO or another leader conducts the reconnaissance and the initial coordination with the stationary company. When possible, subordinate leaders also conduct a reconnaissance of their areas of concern. Specific requirements may include reconnoitering the following locations:

- Passage points/lanes.
- Enemy positions.
- Obstacles (friendly and enemy).
- Friendly positions.
- Contact points, start points, release points, routes, and assembly areas.
- CS and CSS elements, (trains, aid stations, mortars, GSRs).

c. **Security.** Preparatory actions must not reveal an increase in activity in the vicinity of the passage area. To maintain OPSEC, limit the size of the reconnaissance party. Contact points, passage points and lanes, assembly areas, and routes should use all available cover and concealment. When possible, conduct the passage and the preparatory activities during limited visibility. The stationary unit should continue to operate as normal. Although normally planned above company level, it may be possible to use a simple deception operation to focus the enemy's attention away from the passage site.

d. **Fire Support.** The COs and FSOs must coordinate their fire support plans. The stationary company plans to support the passing company with direct and indirect fires; the FSOs exchange target lists. If a transfer of responsibility for the area forward of the stationary company is not required, such as during an infiltration, then additional fire control measures may be required to prevent fratricide. Both direct and indirect fires must be addressed, and these control measures must be disseminated to all units involved.

e. **Combat Service Support.** The stationary company should provide CSS to the passing company. This normally includes evacuating casualties, handling EPWs, recovering and evacuating vehicles, and resupplying fuel and ammunition.

f. **Guides.** The stationary company must provide guides to link up with the passing company at the contact points. These guides remain with the passing company throughout the stationary company's area of operations. The passing CO provides the guide with the number of personnel and vehicles of each separate unit passing through each passage point. The guide counts them as they pass to ensure they all pass through and that no enemy has infiltrated their formations.

#### 6-4. CONDUCT OF THE FORWARD PASSAGE

At the scheduled time, the passing company approaches the contact point(s) and

exchanges the recognition signals with the guide (s). Figure 6-1 depicts a forward passage of lines. The guide then leads the passing unit through the stationary company's positions along the coordinated routes or passage lanes. At the passage point or at the beginning of the passage lane, a representative of the stationary company counts the passing unit through. The passing unit moves through quickly without stopping. The COs and their FSOs collocate where they can observe critical areas, make timely decisions, and issue instructions. The guides release the passing units at the release point of a route or the end of the passage lane.

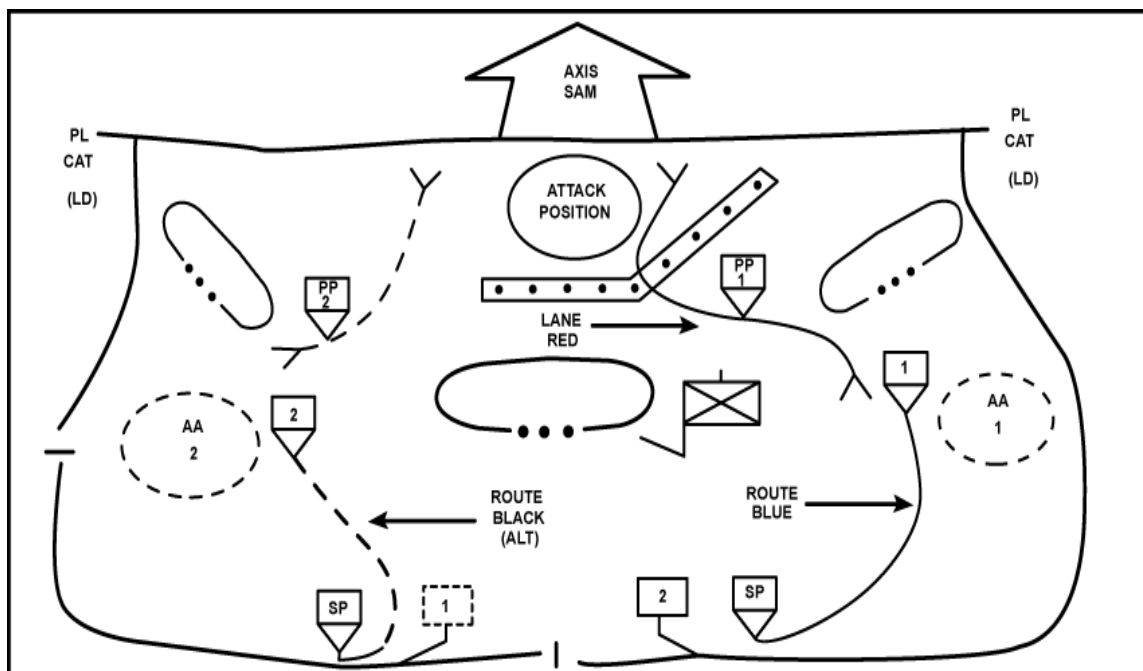

**Figure 6-1. Forward passage of lines.**

#### **6-5. CONDUCT OF A REARWARD PASSAGE**

The fundamentals of a rearward passage are the same as the forward passage. A rearward passage may include a battle handover. To conduct battle handover, the stationary unit positions weapons and units where they can engage enemy forces out to the BHO line. As the passing unit soldiers approach the BHO line, they attempt to disengage from the enemy and move along their assigned passage routes or lanes. The stationary unit assists their disengagement with direct and indirect fires. A rearward passage under these conditions may get very confusing. Friendly and enemy units may be intermixed, or the enemy may actually arrive first. To reduce this confusion, the company COs should collocate. Figure 6-2 depicts a rearward passage of lines.

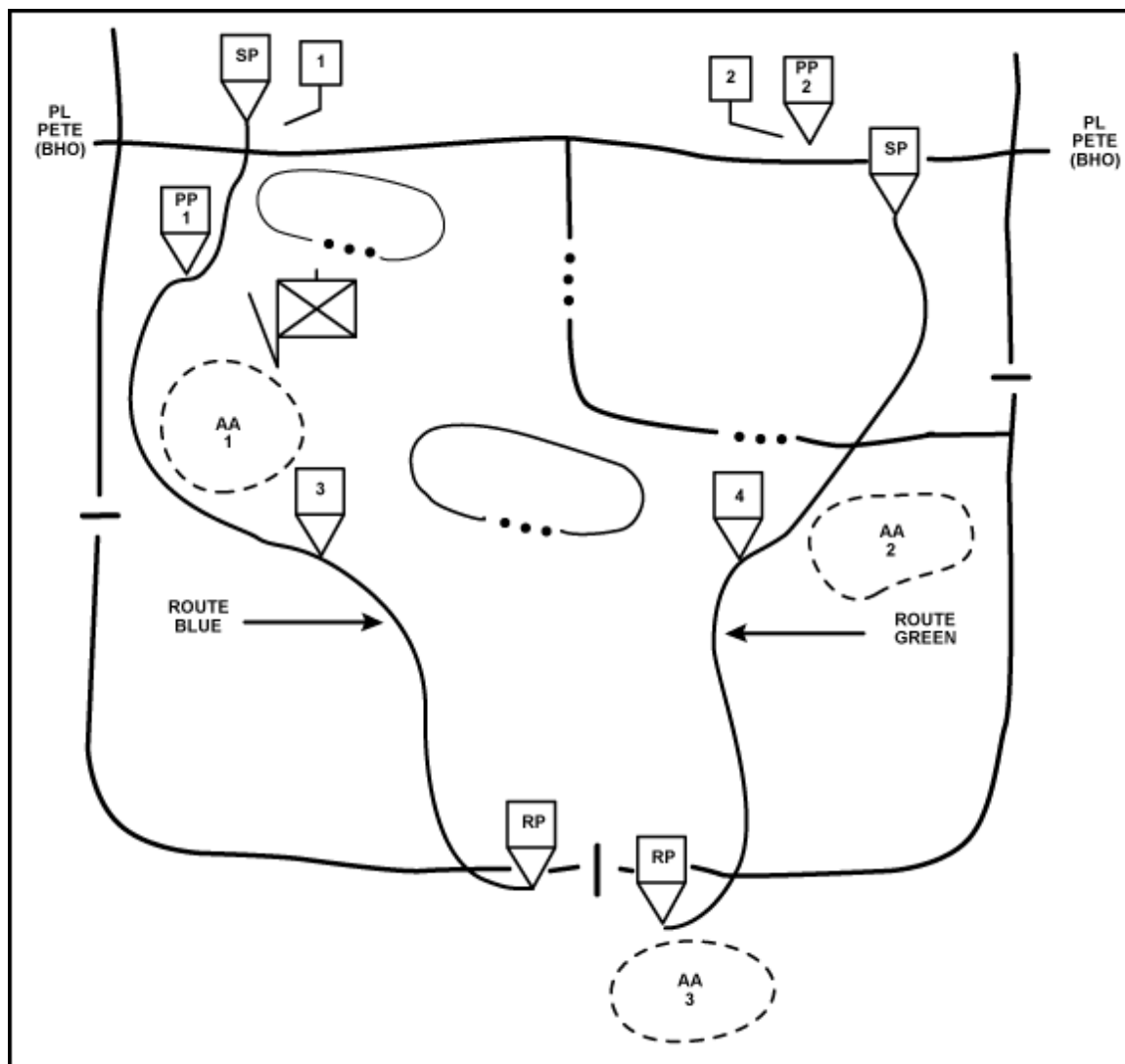

Figure 6-2. Rearward passage of lines.

## Section II. RELIEF IN PLACE

A relief in place is an operation in which one unit replaces another unit and assumes the relieved unit's responsibilities.

### 6-6. PURPOSE

The primary purpose for a relief in place operation is to maintain the combat effectiveness of committed units. A relief in place may also be conducted—

- To reorganize, reconstitute, or re-equip a unit that has sustained heavy losses.
- To rest units that have conducted sustained operations.
- To establish the security force or the DLIC during a withdrawal operation. (In this case, there are additional requirements addressed in Section III, Retrograde Operations.)
- To allow the relieved unit to conduct another operation.

## 6-7. PLANNING CONSIDERATIONS

If the time and location of the coordination meeting was not directed, the relieving unit CO must contact the relieved unit CO to coordinate these specifics. The COs, XO, platoon leaders, and FSOs should attend the meeting.

a. **Mission Specific.** Each tactical situation presents unique considerations for both the relieving and the relieved commanders. The missions for each company, the enemy situation, and the amount of time available are a few of the specifics that will impact on the plan.

b. **Command and Control.** The C2 requirements during a relief are unique because of the mixing of units. To ensure effective C2, detailed coordination must occur early in the planning process. The positioning of key leaders and use of effective control measures will also ensure effective C2.

(1) Coordination between the relieving and the relieved units may include—

- Exchange of intelligence.
- Arrangements for reconnaissance.
- Exchange of tactical plans and sector sketches.
- Sequence and timing for each subunit's relief.
- Time or circumstance when the responsibility for the relieved unit's area of operations is transferred.
- The use of guides and liaison personnel.
- Security measures.
- Fire support.
- Transfer and exchange of equipment, supplies, ammunition, and minefields.
- Control measures.
- Exchange of frequencies, call signs, challenge and passwords, and recognition signals.

(2) The locations of the key leaders for both units are critical. The COs and their FSOs normally collocate at a location where they can best observe and control the relief. Other key leaders should be positioned where they can assist the commander. These may include areas along routes, assembly areas, points of possible congestion, or locations of greatest enemy threat.

(3) The relief in place should be supported by control measures to provide control and flexibility during execution. The specific method of relief will determine the number and type of control measures required. The following control measures are routine:

(a) Assembly areas. The relieved unit may designate platoon and company AAs to the rear of their positions. The relieving unit may also designate AAs, but they should move directly into position. To avoid confusion, separate AAs must be identified for each unit.

(b) Contact points. Contact points are normally designated by the relieved company commander to facilitate the initial linkup between the companies. Multiple contact points may be required to support certain relief operations.

(c) Release points. The relieved CO normally designates the platoon release point for the relieving company. When required, squad release points may be designated by the relieved company commander or platoon leader.

(d) Routes. All units should move along designated routes to avoid confusion and fratricide. When possible, separate routes for both the relieving and the relieved units

should be designated. It is the responsibility of the relieved CO to ensure that all movements are controlled.

c. **Reconnaissance.** The relieving CO conducts a physical reconnaissance as soon as possible. The commanders and leaders of both companies should reconnoiter together to ensure coordination of movement plans. It is critical that leaders down to squad level reconnoiter to ensure full understanding of movements, control measures, and responsibilities. Specific reconnaissance requirements may include—

- (1) The relieved unit's disposition (to include locations of all OPs, minefields, land lines, PEWS, and crew-served weapons).
- (2) Enemy dispositions when the relieved unit is in contact.
- (3) Locations for AAs, release points, contact points, and routes.
- (4) Locations of the CP, trains, mortars, TOWs and tanks.

d. **Method of Relief.** The method of relief is determined by the specific situation; however, regardless of the method of relief, the following actions normally occur. The relieving company occupies an AA to the rear of the relieved company or is guided along a route directly to the platoon release point. Guides are provided by the relieved unit for each relieving subordinate unit. The company CPs collocate prior to commencing the relief. The relief begins with the depth positions of the relieved company. The relieving company's trains and mortars will normally be positioned before any relief begins. The relieved company's trains and mortars, will normally remain in position until responsibility for the area has passed to the relieving company. The methods for conducting the relief are as follows:

(1) *Relieving one unit at a time.* This method takes longer; however, it may be required when covered and concealed routes are limited and all platoons must use the same route. The relieving company occupies an AA to the rear of the relieved company and relieves by platoon according to the coordinated sequence of relief (Figure 6-3). Each platoon moves forward (with guides provided by the relieved unit) to the squad release point. The squads are led to a covered and concealed location to the rear of the relieved squad's position, the necessary equipment is exchanged, and members of the relieving squads relieve the soldiers from the relieved squad. The relieved squad moves directly to the platoon AA, links up with the remainder of their platoon, and continues to the company AA. Once the entire relieving platoon assumes responsibility from the relieved platoon, the next platoon begins their relief.

(2) *Relieving units simultaneously.* Although this method is the fastest, enemy detection is more likely since all units move at once. This method may be appropriate when—the mission requires a rapid relief, enemy detection is not likely, and the terrain provides multiple covered and concealed routes. All relieving platoons move forward at the same time along their designated routes to the squad release points. The squad's actions are the same as in the preceding paragraph.

(3) *Relieving by occupying in-depth or adjacent positions.* This method requires the relieving unit to occupy positions to the flank or rear of the relieved unit. The relieving unit should be able to cover the relieved unit's direct-fire control measures (TRPs and EAs). This method is useful when the relieved unit is chemically or nuclear contaminated. It may also be appropriate when the units involved do not have similar TOEs, such as a light unit relieving a heavy unit. The relieving unit may occupy its

positions one at a time or all at the same time, depending on the situation. Once the relieving unit is in position, the relieved unit withdraws along designated routes.

e. **Sequence of Relief.** To determine the most effective sequence of relief, consider the following:

(1) *The combat effectiveness of the units.* If one subordinate unit has suffered heavy losses in men or equipment, it may need to be the first relieved.

(2) *The terrain.* The subordinate unit most likely to be detected during the relief should be relieved last. This allows the most relieving units to be in position before the enemy is aware of the relief operation.

(3) *The enemy.* The subordinate unit that is positioned on the most likely or most dangerous avenue of approach, should be considered for early relief.

(4) *Control.* When two adjacent units must use the same route to conduct the relief, select a method and sequence of relief that reduces congestion and confusion. Avoid massing units in a small area.

(5) *Subsequent mission.* The subordinate unit with the most critical task may need to be relieved first. For example, a relieving subordinate unit may need to establish an OP forward of their position to provide security for the rest of the relief operation. Or when the company being relieved is moving to a LZ for an air assault operation, the platoon tasked to secure the LZ should be relieved first.



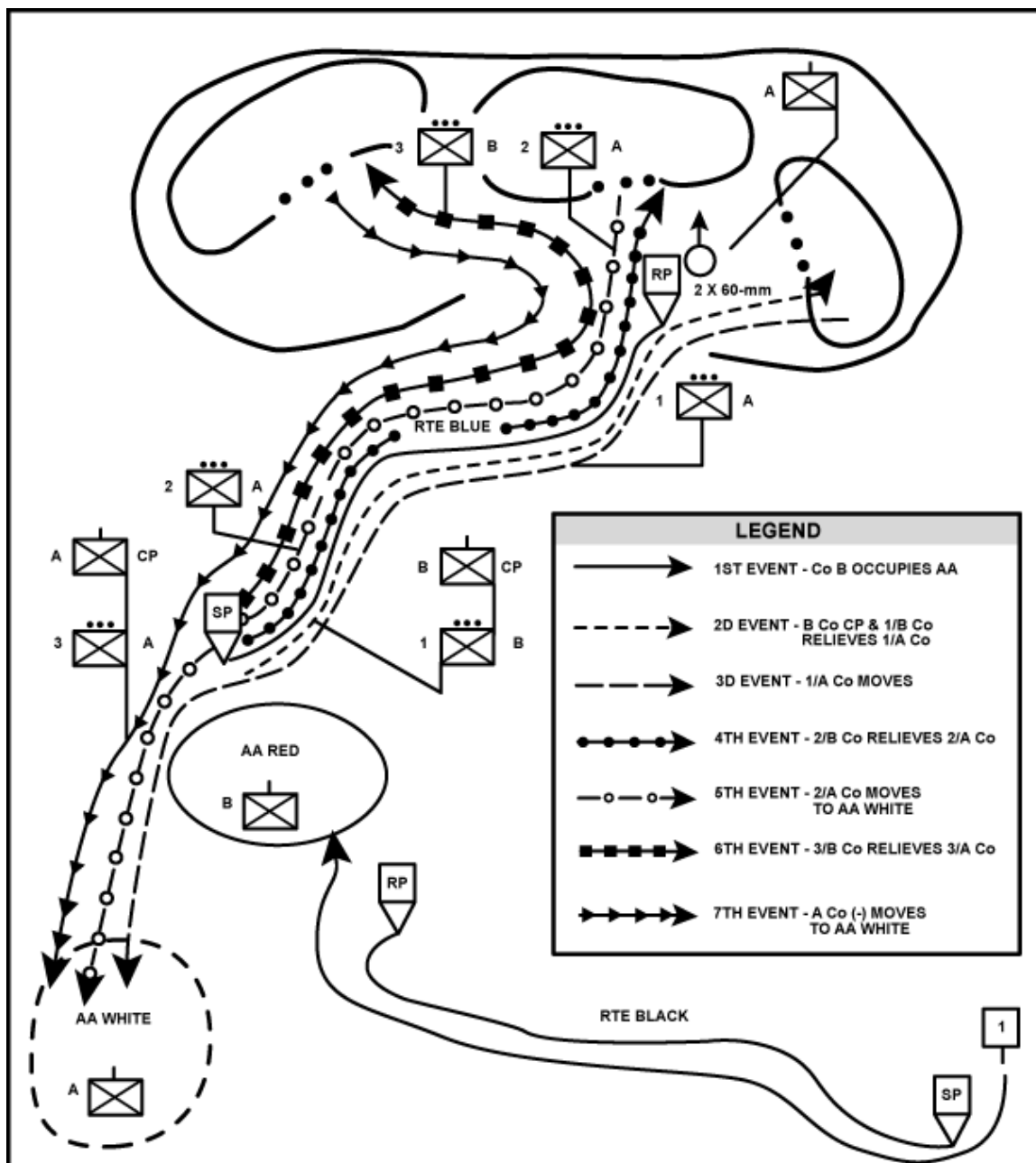

Figure 6-3. Concept sketch for relief in sequence.

f. **Transfer of Responsibility.** The time for the transfer of responsibility must be agreed to by both commanders. Normally, this occurs once two-thirds of the relieving company are in position and have established communications and control.

g. **Transfer/Exchange of Equipment and Supplies.** To simplify the relief and maintain the OPSEC, certain equipment and supplies may need to be transferred between the two units. These include machine gun tripods, mortar baseplates and aiming stakes, camouflage nets, M8 alarms, and PEWS. Supplies that may need to be transferred include barrier materials; excess or stockpiled supplies and ammunition; and bulky or heavy supplies, which would slow the relief if the relieved unit attempted to carry them out. The

prepared range cards, sector sketches, and minefield records must also be transferred to the relieving unit.

h. **Operations Security and Deception.** Every effort must be made to keep the enemy from knowing the relief is taking place. The relief should be conducted during limited visibility.

(1) The dispositions, activities, and radio traffic of the relieved unit must be maintained throughout the relief.

(2) Both companies should be on the relieved company's net. The relieved company maintains routine traffic while the relieving company monitors. Once the relief is complete and on a prearranged signal, the relieving company changes to their assigned frequency.

(3) Security activities (OPs and patrols) must maintain the established schedule. This may require some personnel from the relieving unit being placed under OPCON of the relieved unit before the relief.

(4) Additional planning and coordinating is required when a relief is conducted between a mechanized unit and an infantry company, and relief by the depth or adjacent position method is not possible. If the relieving company is a mechanized unit, the company should dismount, conduct the relief with the dismounts, and position the vehicles once the relieved company has withdrawn. If the relieved company is a mechanized unit, the relieving company should relieve the dismounts, and then the vehicles move to the rear. The dismounts from the relieved unit may mount their vehicles or move to the rear on foot and occupy AAs until they linkup with their vehicles. If possible, the relieved company uses routine vehicle movements to reposition some vehicles to the rear before the relief. This may be possible when the unit has been using the out-of-position resupply technique. All vehicles would move to the resupply point, but only half return to their positions.

i. **Contingency Plan.** The COs should collocate where they can best observe and control the relief. The conduct of the relief is under the control of the relieved company commander until the conditions for the transfer of responsibility are met. If the enemy attacks before the transfer of responsibility, the subordinate units of the relieving company, which are in the area, become OPCON to the relieved company commander. If the enemy attacks after the transfer, the relieving commander assumes operational control of all units of the relieved company still in the area. Plans should be developed to cover these contingencies. A clear understanding of when units would become OPCON must be agreed upon. These contingency plans should address how the uncommitted OPCON units will be employed. A technique that provides flexibility to the relief plan is to designate the last relieving unit as the reserve.

## **6-8. CONDUCT OF THE RELIEF**

At the time set for the start of the relief, the relieving company moves to the contact point and makes contact with the company guide from the relieved company (Figure 6-4). The guide leads the company to the RP where it links up with the platoon and section guides. The platoon guides lead the platoons to their respective RPs where the squad guides link up with their squads.

a. In the sequence specified in the order, each platoon conducts its relief. The platoon leader releases control of his squads, and the squad guides lead the squads to a

location just to the rear of their defensive positions. The squad leaders then begin relieving a few men at a time until the relief is complete. Before each relieved soldier or leader leaves his position, he orients the relieving soldier or leader on the position and the area around it.

b. As each soldier or leader is relieved, he moves to his squad's AA. When each squad is assembled, it moves to its platoon's AA. When each platoon is assembled and its leader is relieved of his responsibility for the defense, it moves to the company AA. After the company is assembled and the transfer of responsibility is complete, the relieved CO moves his company as directed by the battalion commander.

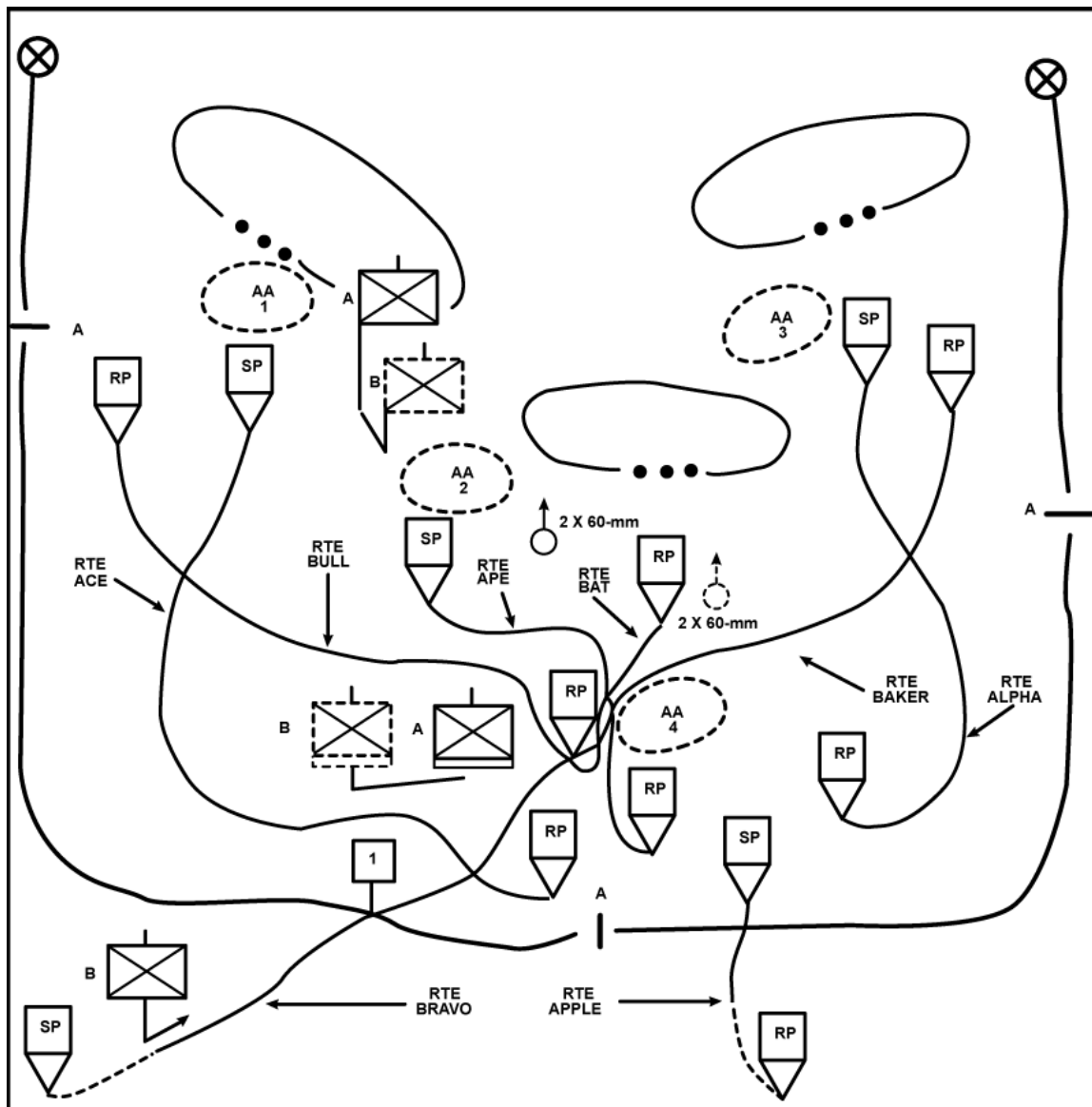

Figure 6-4. Relief in place (company graphics).

### Section III. RETROGRADE OPERATIONS

A retrograde operation is an organized movement away from the enemy. It may be forced or voluntary; but, in either case, the higher commander approves the rearward movement.

These operations (delays, withdrawals, and retirements) are conducted to harass, exhaust, disrupt, delay, or damage the enemy. Such operations gain time, avoid combat under unfavorable conditions, or draw the enemy into an unfavorable position. They are also used to reposition forces, to shorten lines of communications, or to permit the use of a force elsewhere. All retrograde operations are difficult; delays and withdrawals are also inherently risky. To succeed, they must be well organized and well executed.

### **6-9. DELAYS**

The intent of a delay is to slow the enemy, cause enemy casualties, and stop him (where possible) without becoming decisively engaged. This is done by defending, disengaging, moving, and defending again. The company may also delay to draw the enemy into a vulnerable position. Delaying units are expected to aggressively fight within the framework of the higher commander's concept. This often means conducting counterattacks/spoiling attacks whenever possible. Companies do not conduct delays independently, they fight as part of their battalion. The company may delay in sector or from battle positions.

a. A delay against a mounted force is a difficult operation. The company may easily become decisively engaged, and it runs the risk of being destroyed or surrounded. The company must reduce the enemy's mobility advantage with obstacles, fires, and the effective use of the terrain. The battalion commander should give the CO clear instructions on the criteria for disengagement and when decisive engagement may be required.

b. The battalion commander normally assigns the company a sector when there is no dominating terrain on the enemy avenues of approach, where there are multiple enemy avenues of approach, or when the battalion sector is extremely wide. He may also assign one or more phase lines, which the company must prevent the enemy from crossing until a certain time.

c. The company commander may assign sectors or initial and subsequent delay positions for his platoons (Figure 6-5). He defends and withdraws by platoons, bounding them to the rear.

d. Delay positions must have the same characteristics as good defensive battle positions. They should have effective fields of fire to the front and covered withdrawal routes to the rear. If good routes are not available, plan for smoke to screen the withdrawal.

e. The battalion commander normally assigns the company a series of battle positions when one of the following two situations occur. The battalion is delaying in restrictive terrain where the enemy can be canalized into selected areas. There is terrain that dominates the avenues of approach, or the battalion sector is narrow.

f. When the battalion commander assigns the company a series of battle positions from which to delay (Figure 6-6), the company moves from one battle position to another as directed by him. If it coincides with the battalion plan, the CO may pick platoon battle positions and fight a delay action between assigned company battle positions. The CO must decide which positions require preparation and allocate time and resources to them.

g. If a delay is conducted over a long distance, both methods may be used. No matter which one is used, the CO picks the platoon positions and the routes to them. If

there is terrain that is defensible forward of a phase line (set by the battalion commander), the CO may decide to defend there for the required time stated for that line.

h. In both type delays, the CO supplements the company's fire by supporting fire, smoke, minefields, and obstacles.

i. In both a delay in sector and a delay from battle positions, the CO sends a quartermaster party to reconnoiter routes and positions. The party may mark the routes and battle positions, and select positions for machine guns, Dragons, TOWs, and mortars. It may also guide the arriving units into their positions and pre-position supplies, water, and ammunition at each position. They may also coordinate with any units to the rear of the the company when a passage of lines is required. If the company has thoroughly reconnoitered and rehearsed the delay, the quartermaster party may not be required.

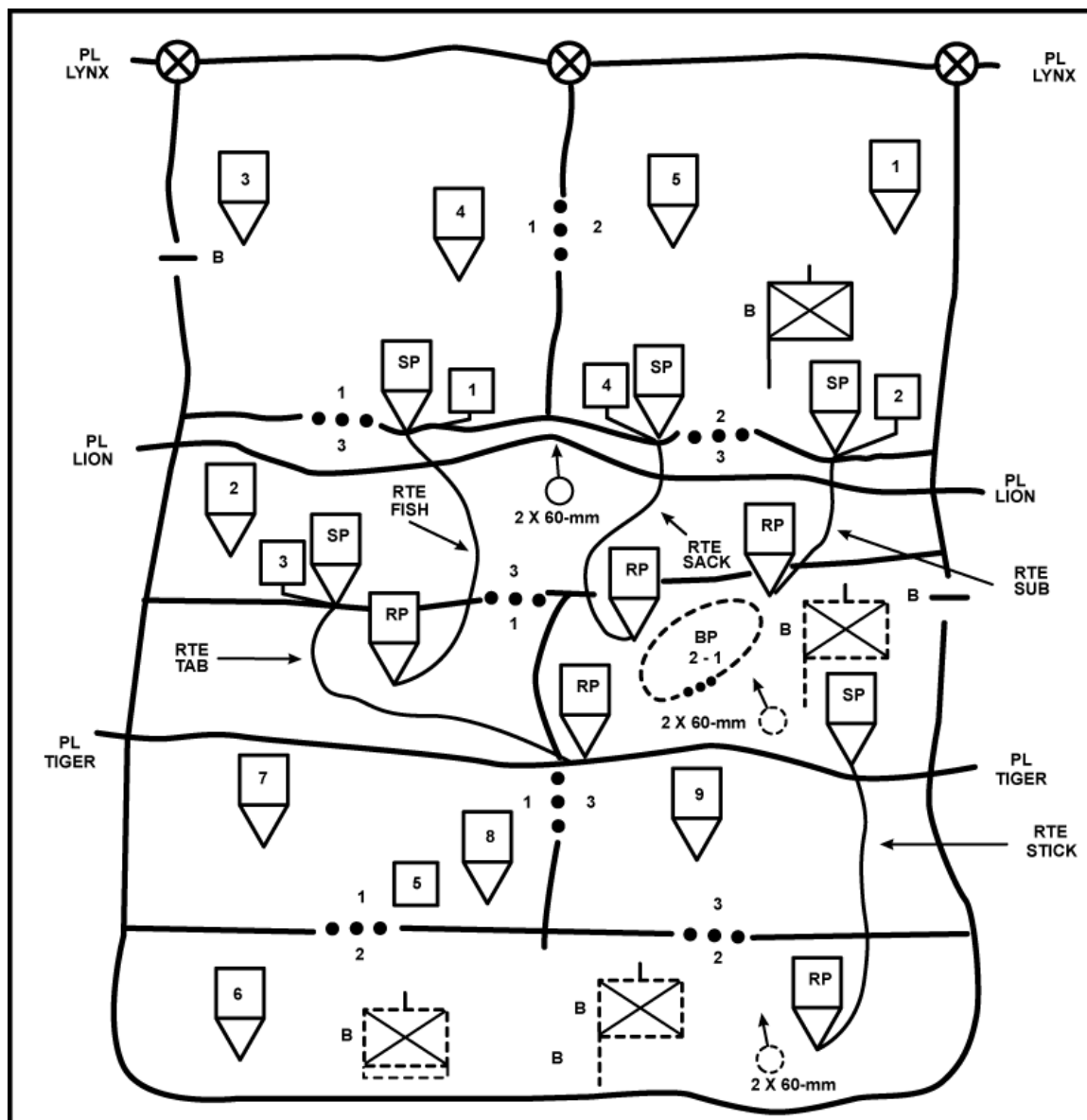

Figure 6-5. Delay in sector.

j. The battalion commander has greater control of the delay when delaying from battle positions. The CO has more control of the delay when delaying in sector. However, the battalion commander can impose more control on the company's rearward movement by assigning phase lines and times for these lines.

k. If all means of communicating with the battalion are lost, the CO may withdraw on his own if he has delayed for the required time or if his withdrawal will not endanger the mission. He must inform the battalion commander of the action he has taken. If a platoon leader loses communications with the company, he does the same. At times, decisive engagement may be required to meet the time requirement.

l. The CO and the platoon leaders should reconnoiter positions and routes before the delay begins. Plans and rehearsals are as detailed as time permits.

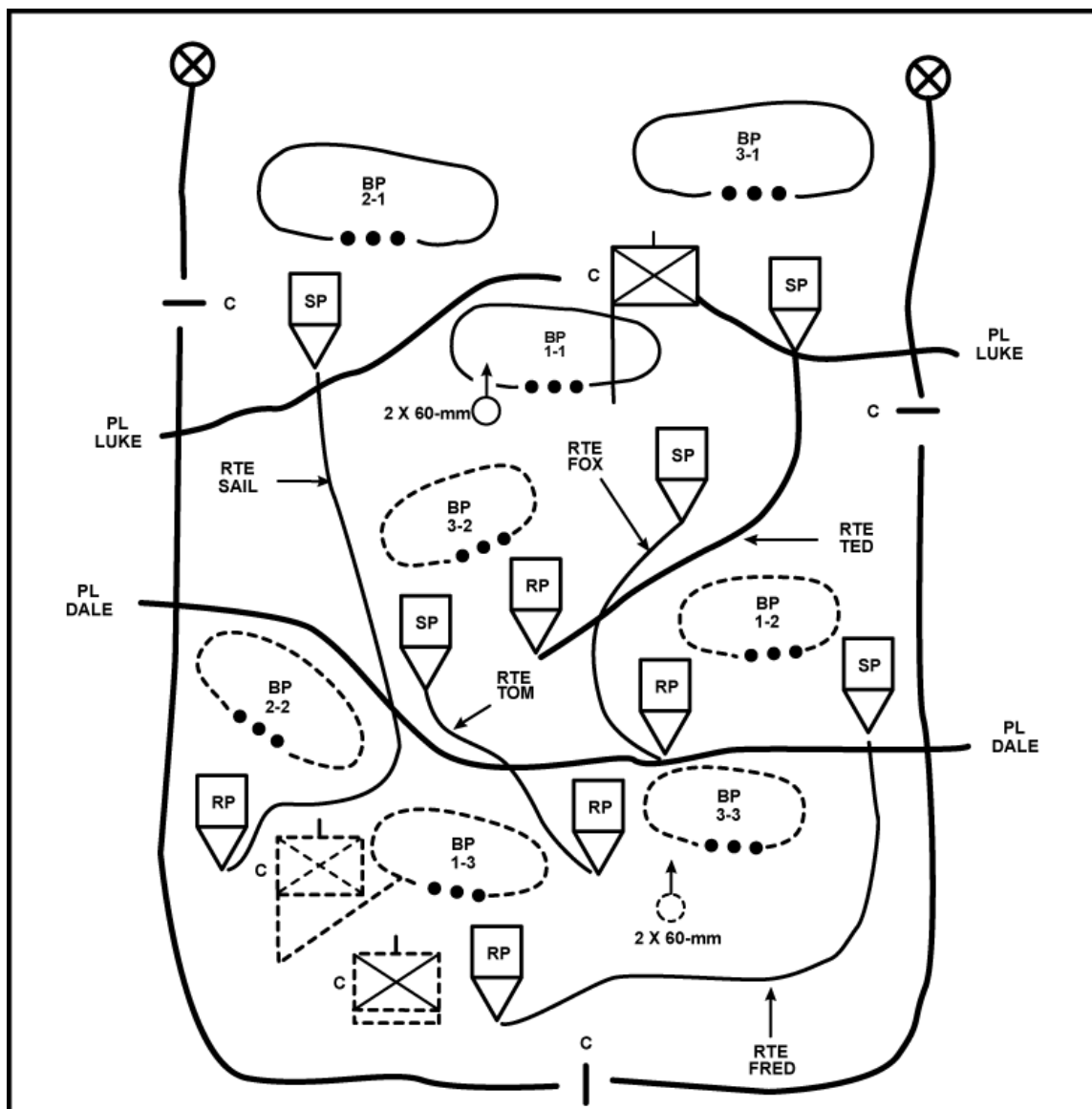

Figure 6-6. Delay from battle positions.

m. The battalion commander normally gives the company commanders a complete 5-paragraph OPORD that includes:

- (1) The battalion task organization, mission, and concept.
- (2) The company mission. In a decentralized battalion concept, this may be a delay task that allows the company commander maximum flexibility in conducting the mission. In other cases, the company should receive more specific tasks such as:
  - Block enemy movement south for 1 hour.
  - Destroy enemy in EA FIRE.
  - Disrupt enemy forces on avenue of approach 2A.
- (3) Their initial delay positions.
- (4) His plan for controlling the engagements, disengagements, and movements.
- (5) Either a sector or battle positions.
- (6) The locations of the company AAs (if used).
- (7) General routes to follow from position to position (when delaying from battle positions).
- (8) Instructions about the quartering party (if used).
- (9) Any special instructions concerning the control of the TOWs and mortars, and the movement of the company vehicles.
- (10) Priorities for efforts of the supporting engineers.

n. The company commander normally gives the platoon leaders a complete 5-paragraph OPORD that includes:

- (1) The platoon missions. Normally, not a delay task. The CO should develop a concept that clearly states the platoon missions.
- (2) Their initial battle positions to defend.
- (3) His plan for controlling the engagements, the sequence and criteria for disengagement, and the movement instructions.
- (4) Subsequent positions to the rear.
- (5) General routes to follow from position to position.
- (6) Instructions about the company quartering party (if used).
- (7) Any special instructions concerning the control of the TOWs and mortars.
- (8) Instructions on the movement of supplies, equipment, and vehicles.
- (9) Priorities for efforts of the supporting engineers.

## 6-10. WITHDRAWALS

In a withdrawal, the company disengages from the enemy and repositions for some other mission. That mission may be to delay the enemy, to defend another position, or to attack some place else. There are two types of withdrawals: not under pressure and under pressure. In a withdrawal not under pressure, the company disengages and moves to its rear while the enemy is not attacking. The company must be ready to fight its way to the rear or to resume the defense should the enemy attack. In a withdrawal under pressure, the company disengages and moves to its rear while in contact with the enemy. The enemy contact may be anything from a major attack to small patrol actions.

a. **Withdrawal Not Under Pressure.** A withdrawal not under pressure is conducted with secrecy and deception. It is best done at night or during other limited visibility (fog, snow, rain, or smoke). Usually, all platoons move to the rear at the same time. However, the company leaves a force called the detachment left in contact, which is part of the

battalion DLIC, to cover the withdrawal by deception and maneuver, when required (Figure 6-7).

(1) The size, composition, and mission of the battalion DLIC are directed by the battalion commander. He also designates the battalion DLIC commander, who is normally the battalion XO, the HHC commander, or one of the rifle company commanders.

(2) The battalion commander may decide to leave one company as the battalion DLIC or have each company leave a company DLIC. The three company DLICs make up the battalion DLIC.

(3) The size, composition, and mission of the company DLIC are directed by the company commander. He also designates the DLIC commander, who is normally the company XO or a platoon leader.

(4) If the company is selected as the battalion DLIC, the CO must reposition platoons and weapons to cover the battalion's withdrawal (Figure 6-8). This normally includes repositioning a platoon in each of the other company positions (relief in place) to cover the most dangerous avenues of approach into those positions, and repositioning weapons to cover the most dangerous avenues of approach into the battalion's sector. As a rule, the DLIC company is reinforced by about half of the battalion's TOWs, mortars, Stingers, tanks, and GSRs.

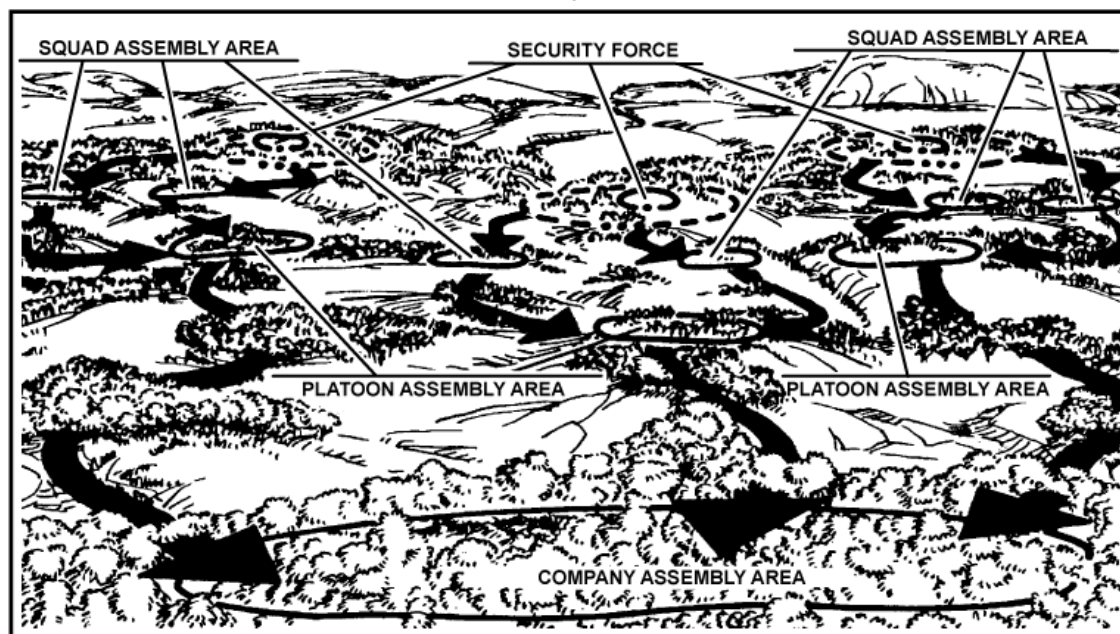
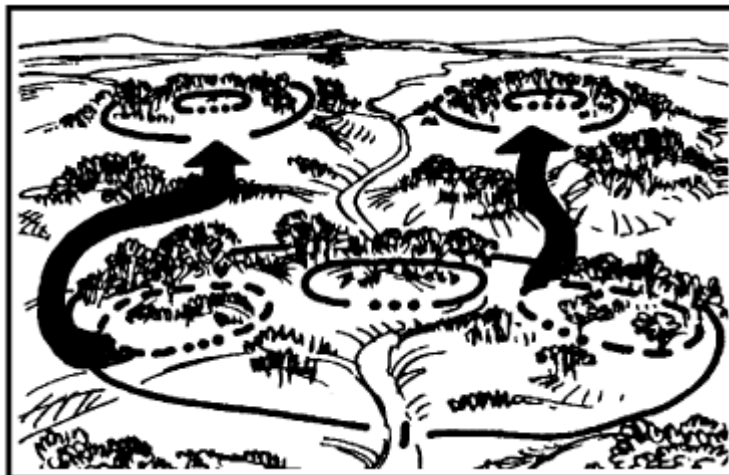

Figure 6-7. Withdrawal not under pressure.





**Figure 6-8. Repositioning units.**

(5) If the company is directed to have a company DLIC, it normally consists of one-third of the company's rifle strength (one platoon) and half of the company's crew-served weapons. The CO may, however, have each platoon leave a platoon DLIC. The three platoon DLICs make up the company DLIC.

(6) If a platoon is selected as the company DLIC, the platoon leader repositions squads and weapons to cover the company's withdrawal. This normally includes repositioning a squad in each of the other platoon positions to cover the most dangerous avenue of approach into that position, and repositioning weapons to cover the most dangerous avenues of approach into the company's position.

(7) If each platoon is to have a DLIC (part of the company DLIC), each platoon leader leaves one-third of his rifle strength (one squad) and half of his key weapons (one machine gun and one Dragon). The platoon DLIC leader is normally the squad leader of the squad left in position. When the withdrawal starts, each platoon DLIC comes under the control of the company DLIC commander. The withdrawing units use the same techniques and control measures as the relieved units in a relief in place.

(8) The DLIC, whether the battalion's or the company's, strives to conceal the withdrawal and deceive the enemy by continuing the normal operating patterns of the unit. If the enemy attacks during the withdrawal, the DLIC covers the main body's withdrawal by fire. Once the main body is at its next position or a designated distance or time from the old position, the DLIC commander orders the withdrawal of the DLIC. These orders should be given by telephone or radio. The DLIC withdraws using the same basic plan as the main body used. If under attack, the DLIC may have to delay to the rear until it can disengage, and then withdraw to the rear. The company mortars may be part of the DLIC. Part of their ammunition may be carried by the main body.

(9) The battalion commander may send a quartering party to the next position before the withdrawal starts. This party is normally made up of the battalion headquarter's personnel and representatives from each company (company quartering parties). Company representatives (under the control of the company XO) are usually the 1SG, company headquarters personnel, platoon sergeants, and a guide from each squad.

(10) When the company's quartering party reaches the next position, its members reconnoiter and, as appropriate, pick positions, sectors, routes, and OPs for the company.

When the company arrives, the squad guides meet and guide their squads into position. The platoon sergeants meet and brief the platoon leaders on the positions and any other important information. The 1SG meets and briefs the CO.

(11) The battalion commander normally tells the company commanders—

- When the withdrawal will start.
- Where the battalion AA is (if used), and what each company is to do on arrival in it.
- Where each company AA is.
- What routes to take from the company AAs to the battalion AA or the next position.
- The size, composition, mission, and the commander of the battalion DLIC.
- Upcoming battalion and company missions.
- When to move company vehicles to the rear.
- Any special instructions on the control of TOWs and mortars and the use of radio nets for deception.

(12) Based on the information received from the battalion commander, the CO plans for and tells the platoon leaders, the XO, and the first sergeant—

- When and where the withdrawal will start.
- Where the company AA is, and what each platoon is to do upon arrival in it.
- Where each platoon AA is.
- What routes to take from the platoon AAs to the company AA.
- The size, composition, mission, and commander of the company DLIC.
- The withdrawal and linkup plan for the DLIC.
- Upcoming company and platoon missions.
- When to move company vehicles to the rear.
- Any special instructions.

(13) If the company DLIC is to occupy the OPs and the positions of other companies, the COs concerned coordinate the time and the sequence of the relief. The relief must occur at the designated time and before the companies withdraw.

(14) The DLIC FSO (one of the company FSOs) obtains the consolidated battalion fire plan and coordinates all indirect fire for the DLIC. In some cases, however, the battalion FSO may remain with the DLIC.

(15) Before the withdrawal starts, all company vehicles and or equipment not needed for the withdrawal are moved to the rear. They may be moved to the next position or to an AA where they will link up with the company. The mortars are also moved where they can support the withdrawal. Several positions may be assigned to the mortars along the withdrawal route to allow continuous coverage.

(16) At the time specified in the battalion order, the withdrawal begins. Soldiers move from their fighting positions to their squad's AA, and the squads then move to their platoon's AA. The platoons then move to the company AA. When all personnel and equipment are accounted for, the company moves as directed by the battalion commander. The complete move is characterized by stealth and secrecy.

(17) When the battalion's main body is at a designated location, after a designated length of time, or on command from the battalion commander, the DLIC withdraws. It follows the same basic plan that the main body used.

b. **Withdrawal Under Pressure.** A withdrawal under pressure is conducted when a company under enemy pressure is directed to withdraw from its sector or is forced from its defensive positions by the enemy (Figure 6-9). The company may move to another position to continue the defense or to disengage and move elsewhere for another mission. Each company tries to disengage from the enemy by maneuver to the rear. Once a company has disengaged and moved to the rear of its original position, the battalion commander may direct what it is to do next. This may include covering the rearward movement of other companies, occupying a new defensive position, or moving to perform another mission.

(1) There is usually no time to make detailed plans or to rehearse a withdrawal under pressure. The commander plans quickly and gives FRAGOs.

(2) The CO controls the sequence in which the platoons withdraw. His decision is usually based on where the enemy attacks and how heavily each platoon is engaged. Once the battalion commander directs the company to withdraw, the CO normally withdraws his least heavily engaged platoon first. He usually directs that platoon to disengage and move into a position where it can overwatch the disengagement of the more heavily engaged platoons. The platoons then change roles and bound to the rear, using maneuver.

(3) At some point in this action, the company stops maneuvering and begins bounding overwatch (to the rear). This occurs when the company is no longer under enemy direct fire, or when another company is covering its move. Once the company has disengaged, it moves as directed by the battalion commander.

(4) If the withdrawing company is to make a passage of lines through a friendly unit to its rear, the CO sends a quartering party to coordinate with that unit. The quartering party should arrange recognition signals, communications, the battle handover, contact points, passage points, passage lanes, AAs, guides, traffic control, fire support, and CSS prior to the rearward passage (Section I, Chapter 6).

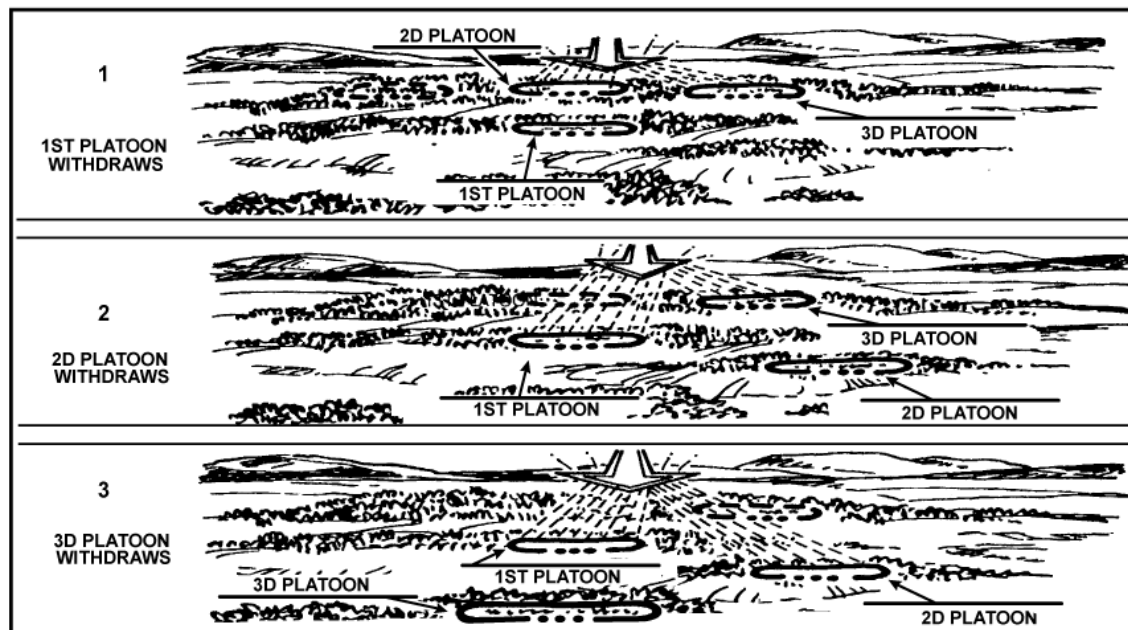

**Figure 6-9. Withdrawal under pressure.**

### 6-11. RETIREMENTS

A retirement is a retrograde operation in which a force that is not engaged with the enemy moves to the rear in an organized manner. Companies perform retirements as part of larger units. They use tactical movement techniques, foot marches, and vehicular road marches. Retirements may follow withdrawals or they may begin before contact with the enemy.

### Section IV. LINKUPS

Linkups normally occur in enemy controlled areas. They depend on control, detailed planning, coordination, and stealth.

### 6-12. PLANNING

The plans for a linkup must be detailed; they must cover the following items:

a. **Site Selection.** Identify both a primary and an alternate site. They should be easy to find at night, have cover and concealment, and be off the natural lines of drift. They must also be easy to defend for a short time and offer access and escape routes.

b. **Recognition Signals.** Far and near signals are needed to keep friendly units from firing on each other. Although the units conducting the linkup exchange radio frequencies and call signs, the radio should be avoided as a means of recognition due to the threat of compromise. Visual and voice recognition signals are to be planned.

(1) One is a sign and countersign exchanged between units. This can be a challenge and password or a number combination for a near signal. It could also be an exchange of signals using flashlights, chemical lights, infrared lights, or VS-17 panels for far recognition signals.

(2) There also are signals that are placed on the linkup site. Examples are stones placed in a prearranged pattern, markings on trees, and arrangements of wood or tree limbs. These mark the exact location of the linkup. The first unit to the linkup site places

the sign and positions the contact team to watch it. The next unit to the site then stops at the signal and initiates the far recognition signal.

c. **Fires.** Indirect fires are always planned. They support the movement by masking noise, deceiving the enemy of friendly intent, and distracting the enemy. Plan indirect fires along the infiltration lanes and at the linkup sites to support if chance contact is made. Restrictive fire lines or areas control fires around the linkup site. Phase lines may serve as RFLs; they are adjusted as two forces approach each other.

d. **Contingency Plans.** The unit SOP or the linkup annex to the OPORD must cover the following contingencies:

- Enemy contact before linkup.
- Enemy contact during linkup.
- Enemy contact after linkup.
- How long to wait at the linkup site.
- What to do if some elements do not make it to the linkup.
- Alternate linkup points and rally points.

### 6-13. CONDUCT OF THE LINKUP

In a linkup, the procedure begins as the unit moves to the linkup point. If the radio is used, the unit reports its location using phase lines, checkpoints, or other control measures. Each unit picks a small contact team to go to the linkup point; the remainder of the unit stays in the linkup rally point. The leader fixes individual duties of the contact team and coordinates procedures for integrating the linkup units into a single linkup rally point. Full rehearsals are conducted if time permits. Figure 6-10 depicts a company linkup between the 3d Platoon, which infiltrated early, conducted the reconnaissance of the objective, and established the ORP, and the rest of the company, which infiltrated later.

a. The unit stops and sets up a linkup rally point about 300 meters away from the linkup point. A contact team is sent to the linkup point; it pinpoints the point and observes the area. If the unit is the first at the site, it clears the immediate area and marks the linkup point, using the agreed-upon recognition signal. It then takes up a covered and concealed position to watch the linkup point.

b. The next unit approaching the site repeats the steps above. When its contact team arrives at the site and spots the recognition signal, they then initiate the far recognition signal, which is answered by the first team, and they exchange near recognition signals.

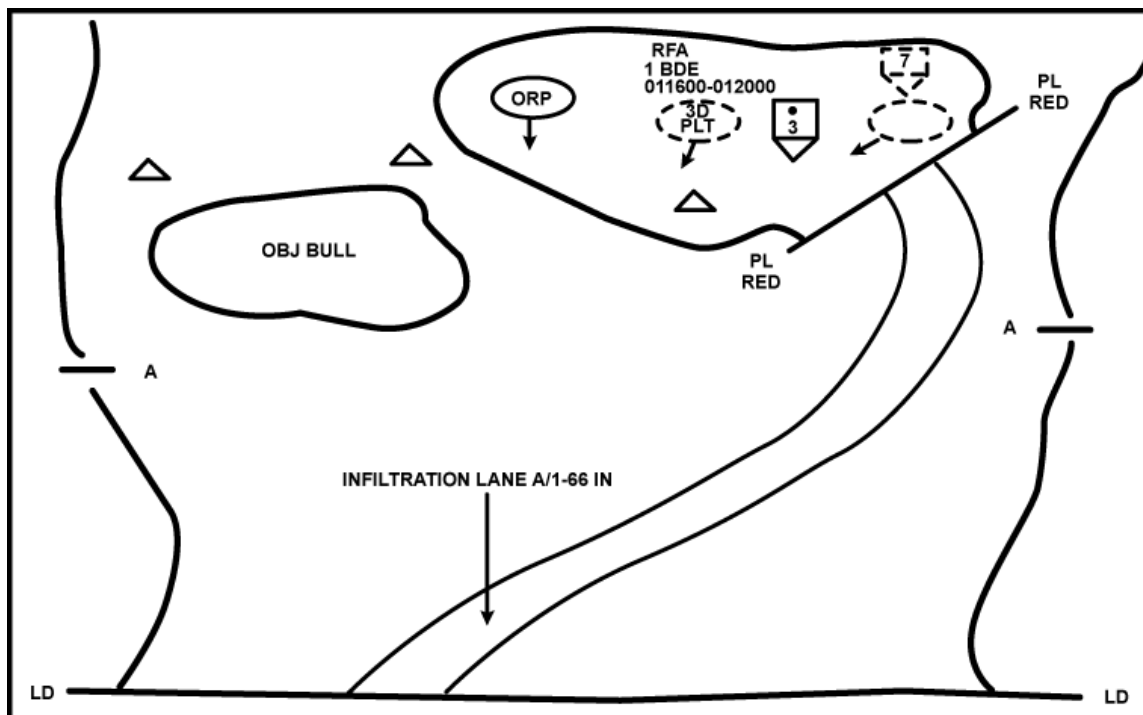

Figure 6-10. Company linkup graphics.

c. The contact teams coordinate the actions required to link up the units, such as to move one unit to the other unit's rally point, or to continue the mission.

### Section V. WATER CROSSING

The company may be required to cross water obstacles, ranging from small streams to major rivers. Commanders cannot lose the initiative by letting the water obstacle delay them; they must cross it as quickly as possible. A thorough reconnaissance by map, air, or ground is the key to this operation. If the water obstacle is significant (due to depth or speed of current), the rifle company must carry the necessary special equipment, or it will not be able to accomplish its mission. Limited visibility offers the most secure conditions for all water crossing operations.

#### 6-14. WITH OPPOSITION

A crossing may be conducted against enemy opposition. In this case, the crossing sites are selected to avoid the enemy's fires. The company uses the same procedure for breaching any obstacle. The plan must include suppressing the enemy, obscuring the enemy, securing a foothold on the far side of the obstacle, and reducing the obstacle to allow the company through. The enemy's positions and weapons that can engage the crossing force must be suppressed. If the crossing is made under fire, the CO must use preplanned indirect fires and smoke to suppress the enemy and obscure his observation of the crossing site. If smoke is used, deception smoke should be fired at other likely crossing sites too. Small boats (RB-3, RB-15, zodiac), 120-foot climbing ropes, or poncho rafts can be used for crossing water obstacles that are not fordable by unaided infantrymen. The security techniques and planning considerations are the same. A rifle company would normally conduct a crossing under fire as part of a larger force.

### **6-15. WITHOUT OPPOSITION**

During an unopposed crossing, an element from the company will cross and secure the far side. Preplanned suppressive fires are used only if enemy resistance is encountered. The bridge team (if a rope crossing is made) must be well rehearsed. FM 90-5 discusses rope bridge construction.

a. The company XO or another designated leader should be assigned duties as crossing site commander. He is responsible for the physical operation of the crossing site. He determines the water obstacle conditions, which include the following:

- Width and depth of the obstacle.
- Current velocity.
- Bank conditions and landing points.
- Enemy situation surrounding the planned crossing.

b. The following must be planned and coordinated:

- Communications.
- Security on the near and far side of the crossing site.
- Ground guides familiar with the crossing site.
- Assembly areas on both sides.
- Overwatch positions to protect the crossing site.
- Emergency signals in case the crossing must be aborted.
- Navigational aids between landing points (if boats are used).
- Control measures as appropriate (contact points, phase lines, rally points, and so forth).

c. Safety considerations should include posting lifeguards, identifying weak/nonswimmers, and inspecting the bridge and safety lines.

## **Section VI. PATROLLING**

A patrol is a detachment sent out by a larger unit to conduct a combat or reconnaissance operation. A patrol may be a fire team, squad, platoon, or company.

### **6-16. INVOLVEMENT**

The CO may be involved in patrolling in one of three ways. He may lead a company-size patrol, provide small patrols from his company (as directed by battalion), or send out patrols to support his company's operation. The company routinely conducts patrols as part of the company/battalion R&S plans. FM 7-8 discusses squad and platoon patrols.

a. When preparing for a company-size patrol, the CO is given a mission by the battalion commander. He obtains enemy information from the S2, conducts troop-leading procedures and coordinates and develops a plan.

b. When providing a patrol for a battalion mission, the CO ensures the unit is prepared and properly organized and equipped for the mission. He assists the leader with preparations, coordinations, and final inspections before they depart.

c. When the CO plans to use a patrol to support a company operation, he decides on its mission, organization, time(s) and places(s) for departure and return, and (possibly) routes. Or he may just assign a mission and allow the platoon leader to plan the patrol. He also assists in planning fire support, logistic support, and communications.

d. The planned action at the objective determines the type of the patrol.

(1) A reconnaissance (area or zone) patrol collects information or confirms or disproves the accuracy of information previously gained.

(2) A combat (ambush, raid, or security) patrol provides security and harasses, destroys, or captures enemy troops, equipment, and installations. A combat patrol also collects and reports information, whether related to its mission or not.

(3) Regardless of the type of the patrol, there are several key principles to successful patrolling. These are detailed planning, thorough reconnaissance, positive control, and all-round security.

### **6-17. ORGANIZATION**

The CO decides what elements and teams are needed for his mission, selects men or units for these elements and teams, and decides what weapons and equipment are needed. He should, however, use his unit's normal organization (squads and platoons) and chain of command (squad and platoon leaders) as much as possible to meet these needs. For example, a combat patrol may be organized as such: the company headquarters is the patrol headquarters; the 1st platoon is the assault element; the 2d platoon is the security element; and the 3d platoon and weapons platoon make up the support element. When task-organizing a company patrol, only the required number of personnel should participate. For example, if the security element only requires three security teams, the CO should task the platoon for a security element HQ and three fire teams.

a. A patrol generally consists of a patrol headquarters and the elements needed for the mission.

(1) *Headquarters.* The headquarters of a company-size patrol may consist of the same number of men as a regular company headquarters. However, regardless of a patrol's size, the CO tailors the headquarters to meet mission needs. The patrol headquarters has the same responsibilities as any other command element.

(2) *Elements.* In an area reconnaissance (Figure 6-11), a patrol has a reconnaissance element and a security element. In a zone reconnaissance, a patrol has several reconnaissance elements (Figure 6-12). Each one provides its own security. A combat patrol normally has an assault element, a security element, and a support element (Figure 6-13). At times, the support element may be omitted by combining it with the assault element or a reserve element may be required.

b. Each element of a patrol may be further organized into the teams needed to perform various tasks (Figure 6-14).



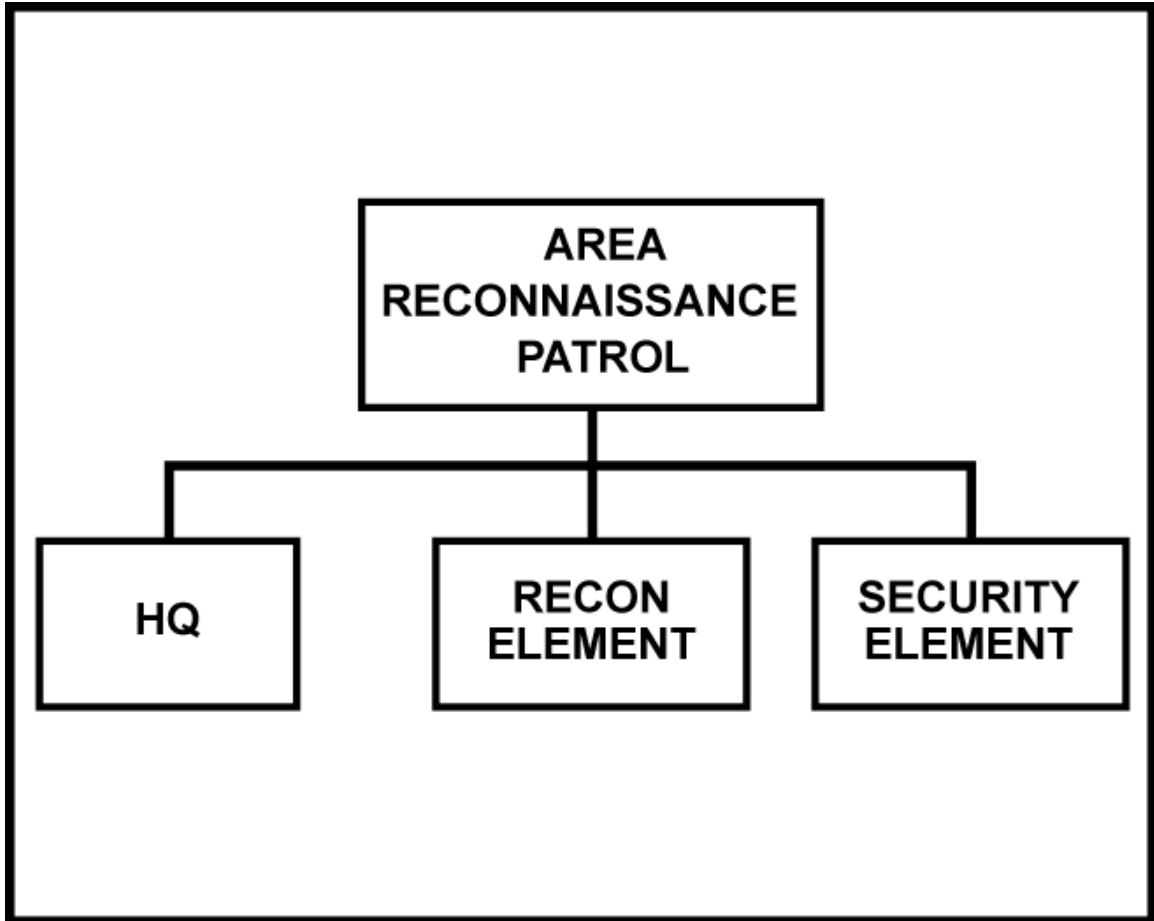

Figure 6-11. Area reconnaissance patrol.

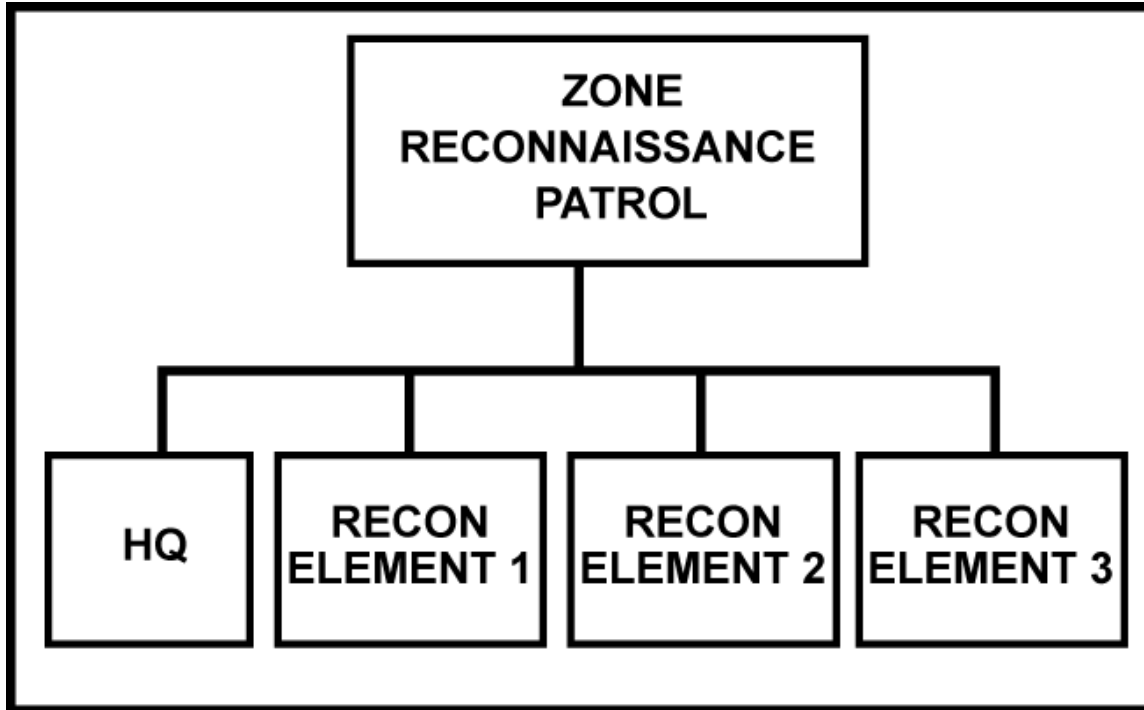

Figure 6-12. Zone reconnaissance patrol.

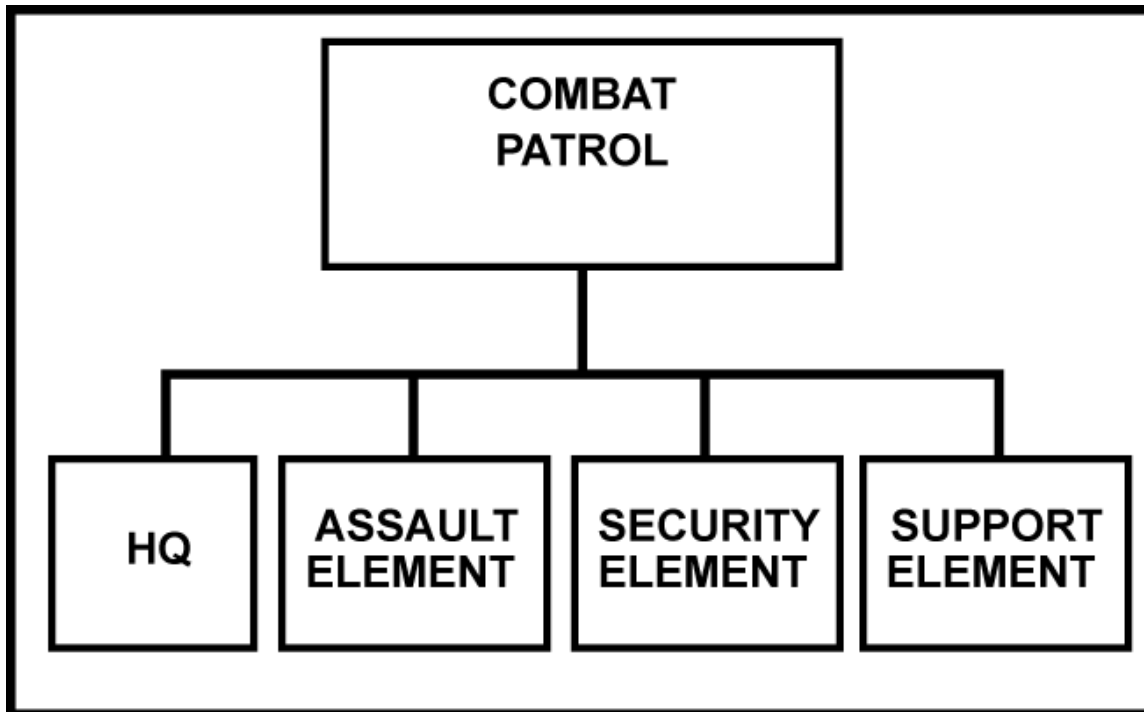

Figure 6-13. Combat patrol.

(1) Reconnaissance patrol elements are organized into several reconnaissance teams in an area reconnaissance, or into R&S teams in a zone reconnaissance. R&S teams provide their own security while reconnoitering. Security elements are organized into the number of security teams needed to secure the objective area.

(2) Combat patrol elements are also organized into the teams needed for various tasks (assault, security, support, and special purpose).

(a) Two or more assault teams are organized when all of the assault element cannot be directly controlled by the assault element leader. This may be the case when the objective is to be assaulted from more than one location.

(b) Security teams are organized as needed to secure and or isolate the objective area.

(c) Two or more support teams are organized when all of the weapons of the support element cannot be directly controlled by the support element leader. This may be the case when there are many supporting weapons, or they are too far apart for direct control by the element leader.

(d) Special purpose teams may also be organized for missions involving the use of scout dogs, demolitions, litters for wounded, and EPW handling.

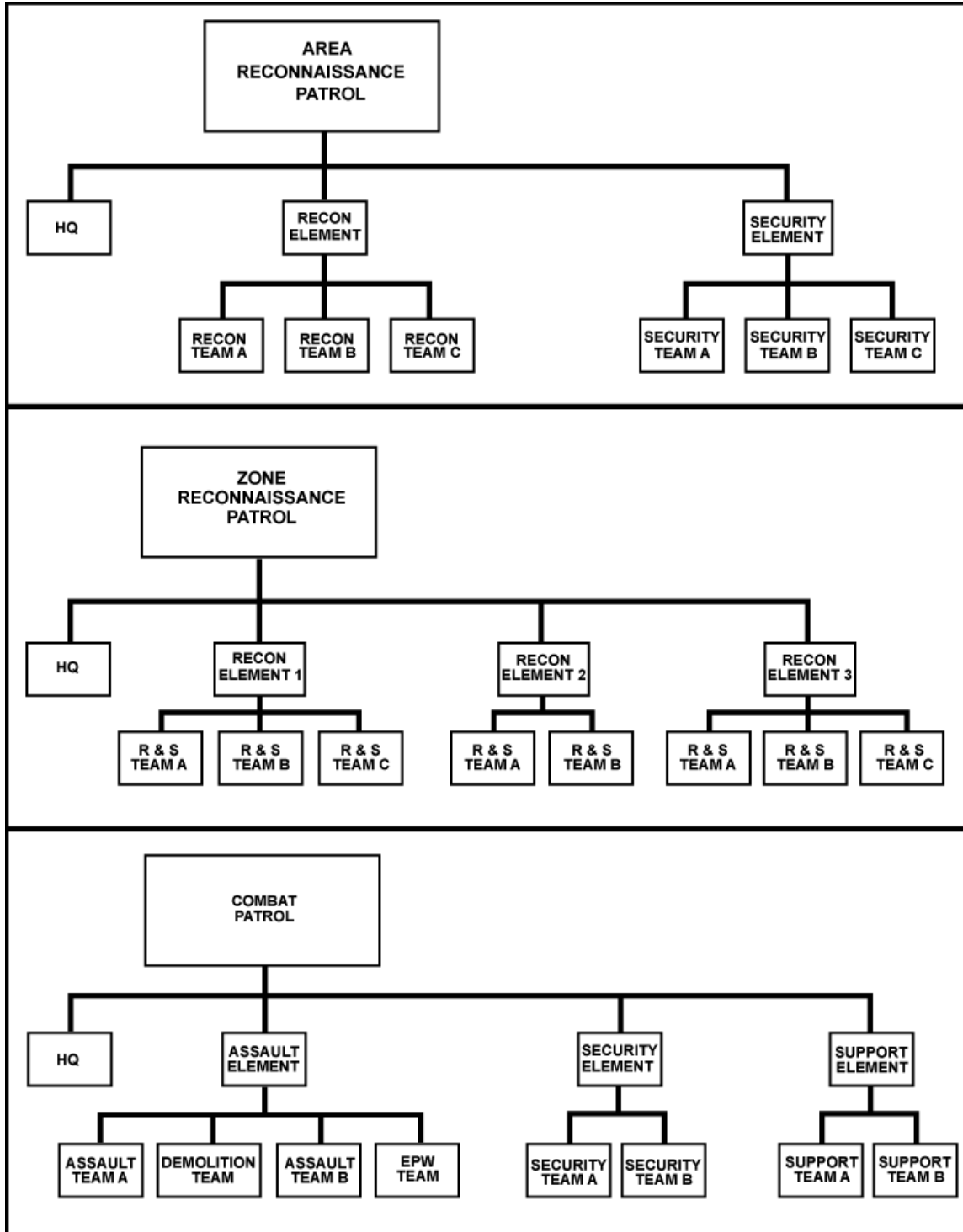

Figure 6-14. Organization of elements.

**6-18. RAID**

A raid is a surprise attack against a position or installation for a specific purpose other than seizing the terrain. It is conducted to destroy a position or installation, to destroy or capture enemy soldiers or equipment, or to free friendly prisoners.

a. **Key Characteristics.** Surprise, firepower, and violence are the key characteristics for a successful raid. Surprise is best achieved by attacking when the enemy least expects an attack, when visibility is poor, and from an unexpected direction. Firepower is concentrated at critical points to suppress and kill the enemy. Violence is best achieved by gaining surprise, by using massed fire, and by attacking aggressively.

b. **Planning Considerations.** Although the planning process discussed in Chapter 4 for the attack applies for a raid, there are some differences. Because a raid is normally conducted in enemy controlled territory and often conducted against an enemy of equal or greater strength, the plan must ensure the unit is not detected prior to initiating the assault. An extraction or withdrawal plan must also be developed and coordinated to ensure the unit's survival after successfully accomplishing the actions on the objective. There may also be greater complexity involved with the fire support plan, depending on the depth of the raid. This may include a greater reliance on artillery, CAS, AC-130 gunships, and attack helicopters than usual. Finally, a raid often requires more detailed intelligence of the objective area. This may be provided by higher units, or the company may be required to develop this information through reconnaissance.

c. **Actions on the Objective.** The objective of the raid is normally a valuable asset that the enemy is prepared to defend. Often, the enemy will have additional forces in position to react against any threat to this asset. It is essential that the assault element conduct a rapid and precise assault into and through the objective. It must spend the least amount of time possible on the objective. The task organization of this element should consist of only those personnel and teams that are essential to complete the assigned mission. This is particularly important during limited visibility to reduce confusion and friendly casualties. The assault must be thoroughly rehearsed to ensure precise execution.

d. **Preparations.** To achieve the surprise, violence, and speed of execution required, the unit's preparation is crucial to the success of the operation. The following requirements are key to the success of a raid mission.

(1) *Maximum use of intelligence information.* The gathering and disseminating of information must be continuous, and it must be provided to the raid force even while en route to the target area. To ensure mission accomplishment, the unit must be kept informed of the latest enemy developments in the objective area to prevent being surprised.

(2) *Plan development.* The reverse planning sequence and the planning process discussed in Chapter 2 will assist in conducting the detailed planning required for a raid. The plan must address the following phases:

- PHASE 1. The unit is inserted or it infiltrates into the objective area.
- PHASE 2. The objective area is then sealed off from outside support or reinforcement, to include the enemy air threat.
- PHASE 3. Any enemy force at or near the objective is overcome by surprise and violent attack, using all available firepower for shock effect.
- PHASE 4. The mission is accomplished quickly before any surviving enemy can recover or be reinforced.
- PHASE 5. The unit quickly withdraws from the objective area and is extracted, or it infiltrates to link up with friendly units or to conduct a new mission.

(3) *Coordination*. Coordination is normally conducted through the battalion headquarters. At times, the company may coordinate directly with adjacent, supporting, or host nation/allied forces.

(4) *Rehearsals*. Rehearsals validate all aspects of planning for the raid and ensure precision in execution. They allow changes to be made in the plan before it is carried out. Full-scale rehearsals should be conducted under the most realistic conditions possible.

e. **Favorable Conditions**. A successful raid is ensured by—

(1) Launching the raid at an unexpected time or place by taking advantage of darkness and limited visibility and moving over terrain that the enemy may consider impassable.

(2) Avoiding detection through proper movement techniques and skillful camouflage and concealment to include taking advantage of natural cover of the terrain.

(3) Timing the operation as close as possible.

(4) Using all available support, both organic and nonorganic, to include use of special weapons, such as Air Force smart bombs and artillery cannon-launched guided projectiles, with the unit using laser target designators.

(5) Performing quick, violent, precise, and audacious actions that focus full combat power at the decisive time and place.

(6) Disengaging quickly upon mission completion.

(7) Withdrawing swiftly using planned routes and including a deception plan.

f. **Functions**. Four functions are normally performed by the unit when conducting a raid. Each subelement is organized and equipped to do a specific part of the overall mission. Depending upon the specific mission, nature of the target, enemy situation, and terrain, the functions are as follows:

(1) The command group controls movement to and actions at the objective. This unit normally consists of the company commander, other subordinate leaders, and communications to support these leaders.

(2) The security element, whose organization is determined by the mission of the raid force, size and type of the enemy force and its mobility and state of alert, terrain and avenues of approach into the area, and the time needed to seal off the objective area. The security element may—

- Secure the ORP.
- Give early warning of enemy approach.
- Block avenues of approach into the objective areas.
- Prevent enemy escape from the objective.
- Provide overwatch for the units at the objective and suppressive fires for their withdrawal.
- Provide short-range air defense.

(3) The support element provides the heavy volume of fire needed to neutralize the objective. Because fires from this unit are violent and devastating, they must be closely controlled to ensure the precision needed. On order or as planned, fires are lifted and shifted to cover the maneuver of the assault element by suppressing enemy fire from the objective or aerial fires. The support element may also be given specific locations to cover by fire in support of the security element if an enemy quick-reaction force moves toward the objective area. These may include routes into and out of the objective site, key terrain features, or installations adjacent to the main objective. Once the assault has been

completed, or on order from the raid force commander, the support element displaces to the next planned position. Organization of the support element is determined by the following:

(a) Size of the objective, the geography of surrounding area, and the enemy threat (to include air) in the area. This element should be able to neutralize the objective (when supported by air or naval gunfire) and to lift or shift fires either when the assault is launched or when ordered to by the raid force commander.

(b) Mission of the assault unit.

(c) Suitable firing positions.

(d) Size and nature of the enemy force in the objective area and those enemy forces capable of reinforcement at the objective.

(e) Fire support from other units (air strikes, NGF, surface-to-surface missiles, and artillery fire).

(4) The assault element seizes and secures the objective and protects demolition teams, search teams, prisoner-of-war teams, and other teams.

(a) The organization of the assault element is always tailored to the mission. Each objective must be examined carefully. The element's mission is to overcome resistance and secure the objective and to destroy the installation or equipment. Other specialized teams may also be needed. For example, sniper teams could be needed to remove key sentries. To capture prisoners, liberate personnel, and seize or destroy equipment, the assault element could be organized into assault teams, prisoner teams, search teams, medical teams, demolition teams, or breach teams.

(b) To destroy a point target or installation in a heavily defended area where the USAF cannot get close enough to be effective, the assault element might be organized with one small team equipped with laser target designators. From covered and concealed positions, members of this team could then provide guidance for USAF delivery of laser-guided munitions from a safe distance.

g. **Site Selection.** The site chosen for the raid LZ or DZ must support the planned actions at the objective. There are two options when choosing sites.

(1) The unit can land on or near the objective and seize it before the enemy can react. This avoids forced marches over land carrying heavy combat loads. If there is no suitable landing area near the objective, or the enemy has a strong reaction force nearby, this option is not favored.

(2) The unit can land unseen far from the objective. It then assembles, reorganizes, and moves into an ORP near the objective. The objective is seized after security and support elements are in place. This option makes coordinated action easier by setting up control of small units before engaging the enemy.

h. **Conduct of a Raid.** The unit moves to the ORP. The ORP is secured, the leaders' reconnaissance is conducted, and the plan is confirmed. Elements and teams then move to their positions.

(1) The teams of the security element move to positions (Figure 6-15) where they can secure the ORP, warn of enemy approach, and block avenues of approach into the objective area. They also situate themselves where they can prevent enemy escape from the objective area and perform any combination of these tasks within their capability.

(2) As the assault element and support element move into position, the security element keeps the leader informed of all enemy action. It fires only if detected, or on the leader's order.

(3) Once the assault starts, the security element prevents enemy entry into, or escape from, the objective area.

(4) When the assault is over, the security element covers the withdrawal of the unit to the ORP. It withdraws on order or on a planned signal.

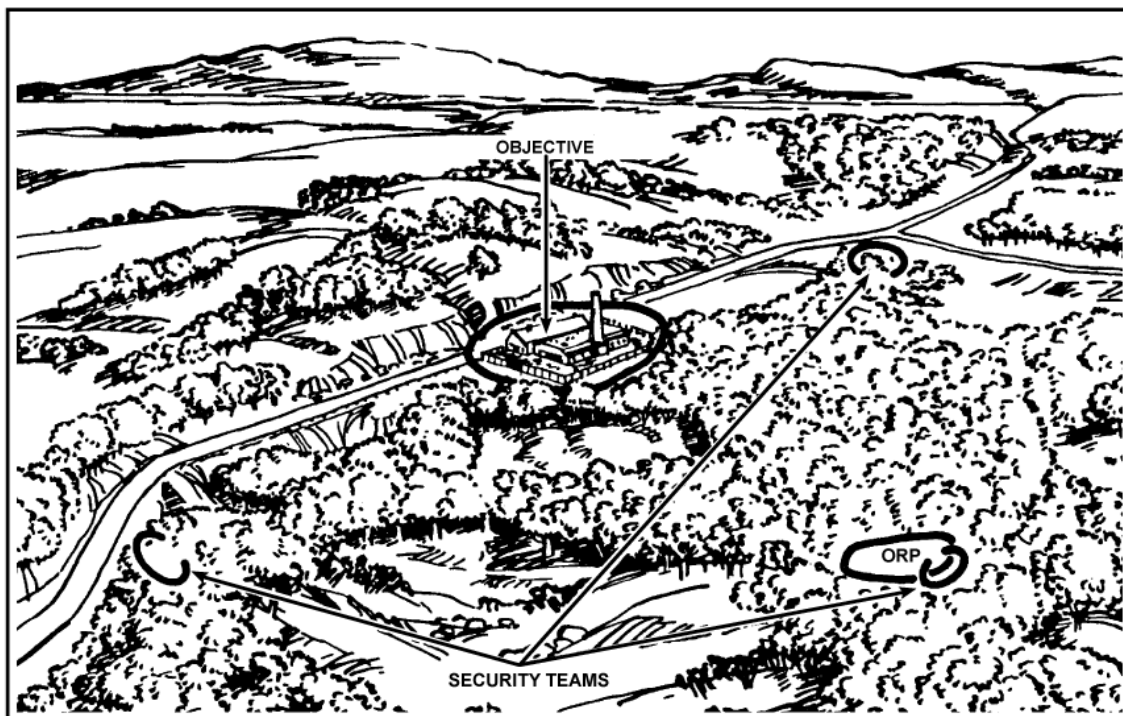

**Figure 6-15. Security elements move into position.**

(5) The support element moves into position before the assault element (Figure 6-16). From its position, it suppresses the objective and shifts its fire when the assault starts. It normally covers the withdrawal of the assault element from the immediate area of the objective. It withdraws on order or on signal.

(6) The assault element deploys close enough to the objective to permit immediate assault if detected by the enemy. As supporting fire is lifted or shifted, the assault element attacks and secures the objective. It protects demolition teams, search teams, and other special teams while they work. On order, the assault element withdraws to the ORP. The assault element should be as small as possible and conduct thorough rehearsals to avoid confusion on the objective.

(7) At the ORP, the patrol unit assembles and moves a safe distance away to reorganize and disseminate information. They then return to friendly lines or continue the mission.

## **6-19. AMBUSH**

An ambush is a surprise attack from a concealed position on a moving or temporarily halted target. It may include an assault to close with and destroy the target, or the attack



may be by fire only. It does not require that ground be seized and held. The company plans, prepares, and conducts ambush patrols the same as a platoon (FM 7-8). An ambush is a useful tactic because—

- Small, well-trained, disciplined forces with limited weapons and equipment can destroy much larger enemy forces.
- It reduces the enemy's overall combat effectiveness by destroying and harassing his forces.
- Enemy morale and effectiveness suffer heavily at little cost to the force executing the ambush.

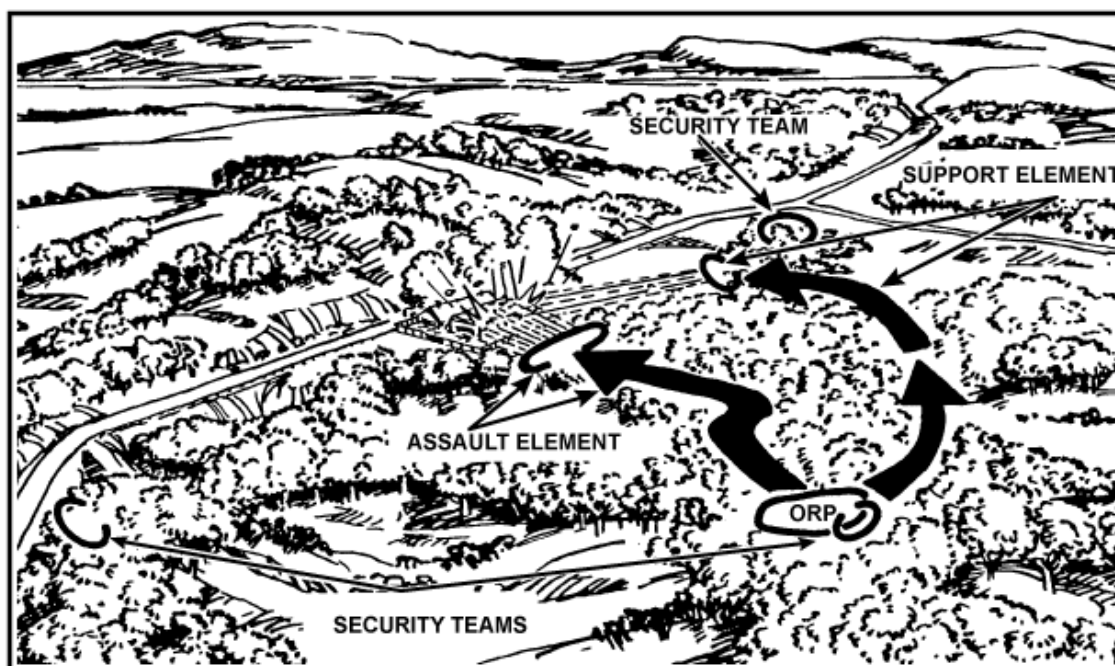

**Figure 6-16. Support and assault elements move into position.**

a. **Execution.** A successful ambush must be executed with precision, violence, speed, and audacity. For success, ambush operations must emphasize the following:

(1) *Surprise.* Surprise, more than any other single aspect, enhances the value of an ambush. Surprise increases the potential for inflicting damage on the enemy with less risk to the unit.

(2) *Coordinated firepower and shock effect.* Coordinated firepower is used for maximum shock effect.

(a) Massive volumes of accurate fire, explosives, and mines, coupled with an aggressive attack, break the enemy's spirit to fight back. Surprise increases shock effect and the chances for success. Shock effect can cover unexpected defects in an ambush—for example, ambushing a much larger force than expected.

(b) All weapons must be sited with interlocking fires in the kill zone and along likely avenues of entrance or exit. Mortars should be used if the terrain permits. Tripods and traversing and elevating mechanisms are normally used with machine guns to lock in fires. All riflemen use firing stakes to mark left and right limits, and elevation stakes.

There is a tendency to shoot high in an ambush—especially at night. The M203 grenade launchers are sited to cover the dead space and routes of escape.

(3) *Control*. Control is essential; leaders must have contact with all members of their unit to alert them to the oncoming enemy.

(a) Leaders should not move around the ambush site during this crucial period. A method used to alert members can be to tie strings or vines to soldiers' legs or arms. By a series of light tugs, all members of the ambush can be alerted to enemy presence.

(b) The leader must initiate the ambush with a casualty-producing device. A bank of Claymore mines on a double-ring main is an excellent device to spring an ambush. Other good techniques are to use a 90-mm recoilless rifle firing antipersonnel (APERS) rounds or a machine gun. Whistles or pyrotechnics must not be used. They will give the enemy time to react.

- As soon as the enemy is hit, he reacts. The ambush force has only a few seconds to destroy the enemy before he recovers from the initial shock and leaves the kill zone—either with a direct counterattack or withdrawal. Subsequent fires and other banks of Claymore mines must be planned.
- The leader initiates the ambush except when a member of the ambush knows he has been discovered. He then has the authority to execute—with killing fire, not by yelling.
- The cease-fire must be controlled by the leader. A whistle or other device may be used to get attention and then cease-fire is signalled.

(4) *Security*. The flanks and rear of an ambush site are open to counterattack. Flank and rear security may be enhanced by—

- Echeloning in depth.
- Designating sectors of observation.
- Positioning of RSTA devices.
- Enforcing noise and light discipline.
- Having a good withdrawal plan.
- Securing routes of withdrawal.
- Executing with speed and violence.
- Positioning a security force to seal off the ambush area.
- Having good camouflage.

(5) *Simplicity*. A simple, direct plan improves the chance of success. The ambush plan must be clear yet concise to offer the greatest likelihood of success. For example:

(a) Mission statements for security, support, and assault elements must be clear, concise, and direct.

(b) Tasks to be performed by the ambush elements should be easy to understand.

(c) Contingency plans should be simple.

(d) Routes into positions and withdrawal routes should not cross. They should be the shortest, most secure routes.

(6) *Training and self-discipline*. All advantages must be exploited. Discipline must be strict. There must be no sleeping, talking, eating, or smoking in the ambush site. If an ambush is to be set up for long periods, then the elements of the ambush must be pulled back to the ORP at set times for rest. Extended ambushes of 24, 36, or 48 hours require six- or eight-hour shifts. It may take a company to man an extended platoon ambush

position. Tired troops cannot man an ambush well; they cannot perform vigorous operations all day and be alert on an ambush all night.

b. **Organization.** A unit conducting an ambush must be task-organized to perform the following functions: assault, security, and support. The ambush forces should be task-organized according to the TOE—by platoons, squads, and fire teams. The TOE should not be changed to create smaller elements for an ambush. The TOE formations may be reinforced with machine gun or recoilless rifle teams, or a 60-mm mortar squad.

(1) *Assault.* The elements assigned the assault mission either move directly into their positions or move through a release point. The mission may include any combination of the following actions:

- Conduct the main assault.
- Halt an enemy's motorized column or any moving target.
- Kill or capture personnel.
- Recover supplies and equipment.
- Destroy vehicles and supplies.

Search teams are not always used; the leader must decide how and when to use them. When soldiers leave the security of their well-chosen, concealed ambush position, they are subject to the fires of the enemy who may also be hidden and ready. If it is at night, do not use tripflares or illumination to light the search area as this will also expose the search team to the enemy. Always assume there is hidden enemy—the ambush will not kill them all. Night vision devices or a red-filtered flashlight taped to M16s should be used to make a quick search. However, a white light flashlight is faster if loss of night vision is not critical. If the return fire from the enemy is great or if the ambush missed the main body, then the leader may choose to break contact and leave without searching the kill zone.

(2) *Security.* The elements assigned the mission of security may move to their positions directly or by way of a release point. Their missions may include any or all of the following actions:

- Secure flanks, rear, or ORP.
- Provide early warning.
- Seal off the kill zone to prevent the enemy from escaping or reinforcing.
- Assist in executing the ambush.
- Cover withdrawal of main ambush force.

(3) *Support.* The units assigned a support mission provide fires that may include employment of—

- Heavy automatic weapon fires.
- Antitank fires.
- Mortar fires.
- Mines.
- Flame munitions.

c. **Ambush Site.** When choosing an ambush site, all sources of information must be used to enhance surprise, exploit the enemy's weak points, and take advantage of the terrain. Emphasis is on—

- Natural cover and concealment for the ambush force.

- Routes of entry and withdrawal (at least two) that should be direct and easy to reach.
- Good observation and fields of fire.
- Harmless-looking terrain.
- Few enemy escape routes.
- Limited enemy reinforcement ability.
- Nearby assembly or rendezvous area.
- Terrain that will canalize enemy into kill zones, and natural obstacles to keep him there.

**NOTE:** Try to select a site covered by friendly supporting indirect fires.

(1) *Take advantage of the terrain.* Emphasis must be on exploiting all natural cover and concealment afforded by the terrain. Site the ambush and individual positions based on the terrain rather than trying to adapt the terrain to a fixed geometric design.

(2) *Restrict enemy movement.* Restricting enemy movement by natural or man-made obstacles should also be planned.

d. **Types of Ambushes.** Ambushes have two basic categories—area ambush and point ambush.

(1) Area ambushes may be set up by platoons, companies, or battalions. They are used to interdict enemy movement in a given area or inflict casualties on his forces. Area ambushes consist of a series of point ambushes. The size and location of the ambushes are dictated by the METT-T analysis.

(a) Companies may conduct area ambushes independently or as part of a battalion area ambush. The company may receive very specific guidance or only an area of operations and a mission statement. The CO may develop a very detailed concept with a central ambush supported by smaller ambushes for security/isolation. Or, the CO may assign platoon areas of operation and allow decentralized execution.

(b) Considerations in selecting point ambush sites as part of a company area ambush include:

- Ensuring fires from one ambush force do not endanger other ambush units
- The enemy's likely course of action both before and after initiating the ambush.
- The withdrawal/ linkup plan after completing the ambush mission.

(c) The CO must establish clear criteria to each ambush site leader on when to initiate fires.

(2) Point ambushes are set at the most ideal location to inflict damage on the enemy. Such ambushes must be able to accept the enemy force from more than one direction. The ambush site should enable the unit to execute an ambush in two or three main directions. The other directions must be covered by security that gives early warning of enemy attack.

(a) Most of the different types of point ambushes are found in FM 7-8.

(b) However, another type is the mechanical ambush. It consists of Claymore mines set in series with a double-ring main. It is command detonated or detonated by a triggering device activated by the enemy. Mechanical ambushes are normally manned. Soldiers prepare to engage the enemy with direct fire if the mechanical ambush does not

detonate or if it is wholly or partially ineffective. Mechanical ambushes are an effective way to interdict a large area using a small force. If the mechanical ambush is effective and our soldiers do not reveal their presence, the enemy is confused. This has a devastating effect on his morale and effectiveness.

e. **Execution of the Ambush.** Stealth and security are important factors; the following are various ways to accomplish these factors:

- Position security teams and early warning detection devices first.
- Use the best route to main ambush position consistent with security.
- Quickly occupy the ambush position and set up communications and signaling devices.
- Position key weapons (automatic and antiarmor).
- Rig Claymore mines, tripflares, and booby traps.
- Ensure that all weapons are correctly positioned. Assign sectors of fire to provide mutual support and cover dead space.

(1) *Camouflage.* During mission preparation, each man camouflages himself and his equipment, and secures his equipment to prevent noise. At the ambush site, prepare positions with minimum change in the natural appearance of the site. Conceal all resulting debris to prevent any evidence of occupation.

(2) *Movement.* Keep movement to a minimum. Closely control the number of men moving at a time. Keep every man as quiet as possible, especially at night. Enforce light discipline rigidly at night and forbid smoking.

(3) *Signals.* Change audible and visual signals, such as whistles or pyrotechnics, often to avoid setting patterns and alerting the enemy. Three or four simple signals are needed to execute the ambush. Signals are used—

(a) To provide early warning of an enemy approach. A signal by the security force to alert the patrol leader to the correct direction of enemy approach may be given. This includes arm-and-hand signals, radio, or field telephone.

(b) To initiate the ambush. This may be the detonation of mines or explosives. Fire is then delivered at once in the heaviest, most accurate volume possible. Properly timed and delivered fires add to the achievement of surprise, as well as to the destruction of the target.

(c) To lift or shift fires if the kill zone is to be assaulted. Voice commands, whistles, or pyrotechnics may be used. When the kill zone is assaulted, the lifting or shifting of fires must be as precise as when starting the ambush. Otherwise, the assault is delayed and the enemy has a chance to recover and react.

(d) To withdraw. The signal for withdrawal can be voice commands, whistles, or pyrotechnics.

(4) *Objective rally point.* Locate the ORP far enough from the ambush site so that it will not be overrun if the enemy manages to attack the ambushers. Leave sustainment loads in the ORP and scout the withdrawal routes to the ORP (when possible by each man). Withdrawal routes should provide cover and concealment for the unit and hinder enemy pursuit; they are a main consideration in the selection of the ambush site. They may be the key to survival after executing the ambush. On signal, the ambush force quickly (but quietly) withdraws to the ORP. If pursued, the withdrawal may be by bounds with mines or hasty ambushes used to delay pursuing forces.

(5) *Ambush variety*. Use more than one ambush method. If one method is used predominantly, the enemy will develop an effective defense against it and will be affected less by the shock of the ambush since he knows what to expect. No single method will fit all combinations of terrain, equipment, weather, and enemy capabilities. Use a variety of signals as well, both audible and visual. Use weapons fire, mines, and RSTA when possible and vary signals to avoid compromise.

(6) *Swift action*. Speed in the execution of the ambush and the withdrawal should prevent enemy reaction forces from engaging the ambush force. Speed is often a shield against casualties and failure. If there is contact with reaction forces, speed may enhance quick disengagement.

f. **Successful Ambush**. Emphasize the following to succeed:

(1) Intelligence. This ensures the enemy is ambushed at a time and place when he least expects or is least prepared to fight.

(2) Detailed planning, thorough training, and rehearsing of all elements in all phases of the ambush. This ensures maximum shock effect through swift, precise execution.

(3) All available RSTA devices. This permits daytime effectiveness at night when moving, shooting, or detecting enemy movement. To avoid detection, active RSTA devices should not be used until after the ambush has been triggered.

(4) All available firepower with emphasis on antiarmor, area and automatic weapons, and precision-guided munitions.

(5) Speed. This helps to achieve surprise and enhance security of the force.

(6) Cover, concealment, and overall protection afforded by the terrain when moving or when occupying ambush positions.

## 6-20. PATROL BASE

A patrol base is a position set up when the patrol unit halts for an extended period. When the unit must halt for a long time in a place not protected by friendly troops, it takes active and passive security measures. The time the patrol base may be occupied depends on the need for secrecy. It should be occupied only as long as necessary, but not for more than 24 hours—except in an emergency. The unit should not use the same patrol base more than once. The company selects and occupies a patrol base for the same reasons and in the same manner as the platoon (FM 7-8). The considerations for a perimeter defense (Chapter 5) also apply for establishing a company patrol base.

## Section VII. STAY-BEHIND OPERATIONS

Stay-behind operations can be used as a part of defense or delay missions. In the defense, the enemy can bypass a friendly force. This offers the opportunity to attack the enemy's weakest point, thus delaying him.

## 6-21. PURPOSE

The unit that stays behind can inflict casualties on the enemy throughout the depth of his formations. They can disrupt the enemy's offensive cohesion by attacking key command, control, communications, CS, or CSS elements; and by blocking communications and supply lines. Their presence can detract the enemy's main effort by forcing him to allocate combat forces for rear area operations. Members of the stay-behind forces can

furnish HUMINT on enemy forces in its area and call for and adjust indirect fires and air fires.

## 6-22. TYPES

There are two types of stay-behind operations.

a. **Unplanned.** An unplanned stay-behind operation is one in which a unit finds itself cut off from other friendly elements for an indefinite time without specific planning or targets.

b. **Deliberate.** A deliberate stay-behind operation is one in which a unit plans to operate in an enemy-controlled area as a separate and cohesive element for a certain time or until a specified event occurs. This requires extensive planning for the establishment, operation, and linkup phases.

(1) *Establishment phase.* In this phase, combat, CS, and CSS units and their required logistics are positioned in the desired area of operations. Unnecessary vehicles and equipment are evacuated. This phase can be either overt or covert.

(a) If overt, the unit continues to fight from its present defensive positions while the enemy advances and other friendly forces withdraw. This technique is viable only if the stay-behind unit has massive firepower and the ability to control or retain key or decisive terrain from its defensive position.

**NOTE:** This technique is least desirable since the enemy will use his knowledge of friendly positions to suppress, isolate, and overrun them.

(b) If covert, the unit moves its elements into position using clandestine techniques to avoid detection. The unit allows the enemy to bypass it without making contact with him until the unit is ready to start attacking vulnerable targets.

(2) *Operation phase.* This phase begins once the stay-behind units are positioned and other friendly forces have withdrawn. During this phase, units conduct combat operations to support their mission and the commander's intent. The combat operations often include reconnaissance, raids, and ambushes against targets of opportunity. If commanders wish to exercise greater control, they can set a priority of targets by type or assign tasks according to avenues of approach.

(3) *Linkup phase.* This phase includes any plans to link up with friendly forces and end the stay-behind operation. It does not include linkups between stay-behind units to conduct missions during the operation phase. The linkup can be done after reconsolidation, but involves small units infiltrating into friendly units.

**NOTE:** The stay-behind unit can either wait in place until friendly forces counterattack to their location, or it can move through the enemy to friendly positions.

## 6-23. PLANNING

The troop-leading procedures apply to stay-behind operations. Planners must pay strict attention to the following:

a. **Task Organization.** The stay-behind unit includes only the soldiers and equipment needed for the mission. It can provide its own security, can hide easily, and can move through restrictive terrain.

**NOTE:** Depending on METT-T, small units can be augmented as needed with CS or CSS. Who makes this decision depends on the level of operation; the goal is for each element to be as self-sufficient as possible.

b. **Reconnaissance.** This is always important—in a stay-behind operation, it is even more so. Reporting tasks/information requirements can include suitable sites for patrol bases, OPs, caches, water sources, dismounted and mounted avenues of approach, kill zones, engagement areas, and covered and concealed approach routes.

c. **Combat Service Support.** Because the stay-behind unit will not be in physical contact with its supporting unit, rations, ammunition, radio batteries, water, and medical supplies are cached. Provisions for casualty and EPW evacuation depend on the company and battalion plans.

d. **Deception Plan.** Most stay-behind operations are set up covertly. It is essential to mislead the enemy during this effort to cause him to act in a manner favorable to the unit's plan of action. Deception can continue throughout the mission.

e. **Concept of the Operation.** In most cases, units operate in small groups in their own area of operation. The actual concept, however, depends on the commander's intent.

#### **6-24. BREAKOUT FROM ENCIRCLEMENT**

A breakout from encirclement may be necessary when a stay-behind force is detected and encircled by the enemy or from other situations that result in the encirclement of the company.

a. **General Considerations.** The specific situation at the time of the encirclement will determine the proper actions to be taken by the encircled force. If the company is still combat effective and in a position to continue the mission according to the higher commander's concept, a breakout may not even be considered. If a breakout is required or directed by higher headquarters, the senior officer within the encirclement assumes control of all encircled forces. He then decides whether to conduct a breakout attack or to conduct an exfiltration to prevent the capture/destruction of the force. Whichever technique is selected should be conducted during limited visibility and as soon as possible to prevent the enemy from establishing his positions and concentrating additional forces against the encircled force.

b. **Breakout Attack.** A breakout attack is planned as any other attack with the following special considerations. The friendly force is normally in a defensive posture and the consolidation of this defense is the first requirement. This is accomplished as a perimeter defense as described in Chapter 5. Once the force is secured, the CO directs reconnaissance to identify enemy weaknesses or gaps that can be exploited by the attack. Then he plans the attack and integrates all available fire support to include assets outside the encirclement if possible. The plan may incorporate a feint to deceive the enemy of the true location for the main attack. This may be difficult unless there are considerable friendly forces available. The plan must carefully consider the timings required to disengage units from their positions on the perimeter to follow the main attack. If they move too soon and are detected by the enemy, the breakout may fail because of the premature collapse of the perimeter defense. Contingency plans to switch to a decentralized exfiltration by the remaining forces may be effective in this case.



c. **Breakout by Exfiltration.** The initial actions are identical to the breakout attack. Once the reconnaissance has identified enemy gaps and weaknesses, the CO decides how to exploit them. He must also decide what size elements will conduct the exfiltration. If appropriate, a technique similar to the withdrawal not under enemy pressure may be used. This entails thinning the units on the perimeter, leaving a DLIC for each platoon to deceive the enemy, and providing a security force in the event the enemy attacks. At a given time or on order, these DLICs would then disengage and begin exfiltration on their designated lanes. The CO must also decide how many lanes to use and whether or not to plan for linkups before reentering friendly lines.

## CHAPTER 7

# COMBAT SUPPORT

*Tactical leaders must understand the techniques of controlling and integrating fire, maneuver, and protection; coordinating direct and indirect fires; utilizing air and naval fires; and substituting massed fires for massed troops.*

FM 100-5, 1986

*In addition to knowing how to employ his organic direct and indirect fire support assets, the company commander must know how to employ nonorganic combat support elements that support his company.*

### Section I. RELATIONSHIPS

The company commander must also understand the command or support relationships established between his company and supporting units.

#### 7-1. COMMAND RELATIONSHIPS

Command responsibility and authority are established routinely through the following standard relationships:

a. **Organic.** This is a unit that forms an essential part of an Army organization and is listed in its table of organization and equipment or table of distribution and allowances.

b. **Assigned.** This is a unit that is placed in an organization on a permanent basis and is controlled and administered by the organization to which it is assigned.

c. **Attached.** In this relationship, a unit is assigned temporarily to a command other than its parent unit. The attached unit is under the command of the commander of the unit to which it is attached.

(1) The CO exercises the same degree of C2 as with his organic units.

(2) It is subject to limitations specified by the commander directing the attachment.

This relationship includes the responsibility for CSS, UCMJ, training, and operations. (The responsibility for transfer and promotion is retained by the parent unit.) It does, however, impose an administrative and logistical burden on the unit to which the attachment is made.

d. **Operational Control.** This relationship places a unit under the control of a commander for specific operations. The relationship is limited by function, time, or location. OPCON does not imply responsibility for administration, logistics, discipline, internal organization, or training. The commander's relationship with OPCON units is otherwise the same as with organic or attached subordinate units.

#### 7-2. SUPPORT RELATIONSHIPS

This is the action of an element or unit that aids, protects, complements, or sustains another unit IAW an order requiring such support. A supporting unit assists another unit, but is not under the command of that unit. The commander's relationship with supporting units is as follows:

- He ensures that the supporting unit establishes liaison and communications with his unit.
- He keeps the supporting unit informed of the situation and the support needed.
- He is advised of the employment considerations for the supporting unit by its leader.

Requests to a supporting unit for support are honored as an order. In case of a conflict, the supporting unit leader refers the matter to his parent unit commander. The request or order in question will, however, be honored until the conflict is resolved.

a. **Direct Support.** This is when one unit, under command of its parent unit commander, supports another specific unit. The supporting unit answers directly to the supported unit's requests. The CO may not suballocate, reassign, or task-organize the force supporting him.

b. **General Support.** Units in GS to battalion are under control of their parent unit commander. They support the battalion as a whole, not any specific company. Company commanders request support from the GS unit through the battalion.

## Section II. NONORGANIC ASSETS

Combat support of an infantry company is provided by the battalion and supporting units. It may include fires from the battalion mortar platoon and the antiarmor platoon, or supporting fire by field artillery, tactical aircraft, and naval guns. Air defense is provided by the division ADA battalion. The battalion scout platoon may also support the company. Other CS is provided by engineer units, NBC units, and MI units.

### 7-3. BATTALION

The battalion mortar platoon and antiarmor platoon respond to support requests from rifle companies according to the battalion fire plan. The battalion scout platoon and snipers normally work directly for the battalion; however, at times they may operate in the company's AO.

a. The battalion's antiarmor platoon is normally assigned areas of responsibility for the battalion.

(1) When TOWs are positioned in the company's sector, the TOW section or squad leader coordinates his positions and sectors of fire with the CO. The commander may have the leader tie in to the company wire net or enter the radio net. A TOW section or squad may be attached to or under OPCON of the rifle company. In this case, the CO assigns missions and positions it to support his concept. He employs these systems to make the most of their long-range, armor-killing capability. The TOW sight is an effective asset for the company R&S plan.

(2) Many antiarmor platoons have the capability to replace the TOW weapon system with either a MK19 (40-mm grenade machine gun) or the M2 (caliber .50 machine gun). This allows the platoon to provide fire support when there is no threat of enemy armor. Both of these weapon systems can be fired from the HMMWV, using the HMMWV interchangeable mount system (HIMS) and also ground mounted on a tripod. FM 7-20 discusses the MK19 in more detail.

(a) The MK19 is effective at 1,500 meters against point targets and out to 2,200 meters against area targets. The weapon has a sustained rate of fire of 40 rounds each minute and a rapid rate of fire of 60 rounds each minute. The weapon system (gun,

---

tripod, and T&E) weighs about 120 pounds. A container of 48 rounds weighs 64 pounds. The weight of this system precludes manpacking for other than short distances. The AN/TVS-5 can be mounted on the weapon to provide effective night fires.

(b) The standard round of ammunition is HEDP, which can defeat 50-mm of RHA or 16 inches of concrete. An HE round is also available for engaging troops in the open or other soft targets. Both rounds have a bursting radius of 15 meters and a flat trajectory out to 800 meters. The weapon can be employed in an indirect-fire role to engage targets from 800 meters out to the maximum effective range. The methods of controlling indirect fires is the same as the 60-mm mortar—direct lay, direct alignment, or an observer to provide corrections and the use of the T&E mechanism to apply these corrections to the gun.

(c) In the offense, the MK19 can be employed similar to the 60-mm mortar in the indirect-fire role and similar to the TOW in the direct-fire role. The MK19 can be employed from an overwatch position to provide responsive suppressive fires if enemy contact is made. The weapon can also suppress/destroy enemy weapons and positions on the objective prior to the infantry assault. It may also support the isolation of the objective area by blocking likely avenues of approach with concentrated destructive fires. When employed from the M3 tripod with the T&E, the gun is very accurate for an area type weapon.

(d) In the defense, the MK19 can be effective in both the direct and indirect-fire roles. It can be assigned a priority target or an FPF just like a 60-mm mortar. The enemy will attempt to locate and destroy these weapons early in his attack. Unless the MK19s are employed from defilade/fire from prepared dug-in firing positions, they are very vulnerable. The mobility capability for the MK19 when mounted on the HMMWV must be balanced against the vehicle's vulnerability to detection and destruction.

b. The company receives supporting fires from the battalion mortars. The battalion order designates the priority of fires and allocates priority targets. The CO considers his priority in the battalion plan. If he is first in priority, his calls for fire take precedence over all other battalion units. This may allow the CO to depend less on the company mortars or even move without them to lighten the soldiers' loads. The battalion commander should be aware that the company is without its mortars. Also, the CO must understand the risks involved; for example, the priority of fires may change. If a priority target is allocated to the company, the CO plans to employ it when and where it will be most effective.

c. The battalion scout platoon is organized and equipped for reconnaissance—not to seize/retain terrain. Its primary missions are to reconnoiter and screen. When the scout platoon is operating near the company, the CO may communicate with the scout platoon leader on the battalion command net, or he may use visual signals. Necessary signals and contact procedures are arranged between the CO and the scout platoon leader. If scouts must pass through the company (or vice versa), contact points, passage points, passage lanes, guides, and procedures must be arranged. The scout platoon may be attached to the company for a counterreconnaissance mission. Scouts serve as the commander's eyes and ears (not fists) on the battlefield. Scouts provide continuous battlefield information on operations; they should only use their organic weapons in self-defense.

d. Snipers may operate in support of the company for specific missions. They are most effective when tasked to kill specific enemy soldiers and when allowed to operate with few restrictions.

#### 7-4. SUPPORTING UNITS

Artillery and, in some cases, tactical aircraft/attack helicopters supporting the battalion respond to calls for fire from the companies based on the priority of fire.

a. **Field Artillery.** Artillery fire is planned (to support the battalion commander's concept of the operation) by the battalion FSO in coordination with the plans developed by the battalion S3. Company indirect fire support is planned by the company FSO and approved by the CO. The integration of indirect fires is critical to the success of the company. The effects of these fires on an enemy force are much greater than the effects of the company's organic weapons. Artillery provides the most destructive, accurate, and flexible combat multiplier the CO has to employ. Table 7-1 lists the capabilities of the indirect fire systems that may support an infantry company.

(1) Field artillery can fire high explosive, illumination, and white phosphorous ammunitions. The 155-mm units can also fire dual-purpose improved conventional munitions and scatterable mines. The DPICM is a lethal antipersonnel and antiarmor munition containing bomblets that are dispersed over a wide area because they are ejected high above the target during the flight of the carrier projectile. The bomblets have an antipersonnel effect and can also penetrate up to 7 centimeters of armor. FASCAM rounds contain a number of mines with self-destruct features, which are set to detonate at specific times (Table 7-2). The rounds may contain either antipersonnel or antiarmor mines that arm shortly after impact. Companies do not normally plan/employ FASCAM, but the CO should be familiar with these weapons (FM 7-20).

(2) Mortars and artillery fire can be combined to cover targets. For example, mortars can fire illumination while artillery fires high explosives or DPICMs. It is the CO's responsibility to ensure each system (mortars, artillery, and direct fire) is employed when and where it has the greatest effect on the enemy.

| CALIBER  | 60-mm                  | 81-mm                  | 81-mm<br>(improved)        | 107-mm                 | 120-mm                 | 105-mm   | 105-mm  | 155-mm  |
|--|------------------------|------------------------|----------------------------|------------------------|------------------------|--|---|---|
| <b>MODEL</b>   | M224                   | M29A1                  | M252                       | M30                    | M285                   | M102   | M119  | M198  |
| <b>MAX RANGE<br/>(HE) (m)</b>  | 3,490                  | 4,595                  | 5,608                      | 6,840                  | 7,200                  | 11,500   | 14,000  | 18,100  |
| <b>PLANNING<br/>RANGE (m)</b>  |                        |                        |                            |                        |                        | 11,500   | 11,500  | 14,600  |
| <b>PROJECTILE</b>  | HE,<br>WP,<br>ILLUM    | HE,<br>WP,<br>ILLUM    | HE,<br>WP,<br>ILLUM,<br>RP | HE,<br>WP,<br>ILLUM    | HE,<br>SMK,<br>ILLUM   | HE,WP,<br>ILLUM,<br>HEP-T,<br>APICM,<br>CHEM,<br>APERS,<br>RAP | HE<br>M760<br>ILLUM,<br>HEP-T<br>APICM,<br>CHEM,<br>RAP | HE,WP,<br>ILLUM,<br>SMK,<br>CHEM,<br>NUC, RAP,<br>FASCAM,<br>CPHD,<br>AP/DPIC-M |
| <b>MAX RATE OF<br/>FIRE</b>  | 30 RPM<br>FOR<br>1 MIN | 30 RPM<br>FOR<br>1 MIN | 30 RPM<br>FOR<br>2 MIN     | 18 RPM<br>FOR<br>1 MIN | 15 RPM<br>FOR<br>3 MIN | 10 RPM<br>FOR<br>1 MIN   | 10 RPM<br>FOR<br>1 MIN                                  | 4 RPM<br>FOR<br>1 MIN   |
| <b>SUSTAINED<br/>RATE OF FIRE<br/>(rd/min)</b>   | 20                     | 8                      | 15                         | 3                      | 5                      | 3  | 3   | 2   |
| <b>MINIMUM<br/>RANGE (m)</b>   | 70                     | 70                     | 83                         | 770                    | 180                    | ←  | <b>FIRE<br/>DIRECT</b>                                  | →   |
| <b>FUZES</b>   | MO                     | PD,VT,<br>TIME,<br>DLY | PD,VT,<br>TIME,<br>DLY     | PD,VT,<br>TIME,<br>DLY | MO                     | PD,<br>VT,MT<br>MTSQ,<br>CP, DLY                               | PD,VT,<br>MTSQ,<br>CP,MT<br>DLY                         | PD,VT,<br>CP,MT,<br>MTSQ, DLY   |
| <b>LEGEND</b><br>AP-Armor Piercing<br>APERS-Antipersonnel<br>APICM-Antipersonnel Improved Conventional munitions<br>CHEM-Chemical<br>CP-Concrete Piercing<br>CPHD-Copperhead<br>DLY-Delay<br>DPICM-Dual Purpose Improved Conventional Munitions<br>FASCAM-Family of Scatterable Mines<br>HE-High Explosive<br>HEP-T-High Explosive Plastic Tracer<br>ILLUM-Illumination<br>MIN-Minute<br>MO-Multioption-VT,PD,DLY<br>MT-Mechanical Time<br>MTSQ-Mechanical Time Super Quick<br>NUC-Nuclear<br>PD-Point Detonating<br>RAP-Rocket Assisted Projectile<br>RP-Red Phosphorus<br>RPM-Rounds per minute<br>SMK-Smoke<br>TIME-Adjustable Time Delay<br>VT-Variable Time<br>WP-White Phosphorous |                        |                        |                            |                        |                        |  |   |   |

**Table 7-1. Indirect-fire capabilities.**

| TYPE OF MINE   | ARMING TIME | SELF-DESTRUCT TIMES |
|----------------|-------------|---------------------|
| Adam (AP)      | 2 minutes   | 4 hours or 48 hours |
| RAAM (AT)      | 45 seconds  | 4 hours or 48 hours |
| GEMSS          | 45 minutes  | 5 days or 15 days   |
| MOPMS          | 2 minutes   | 4 hours             |
| Gator/ Volcano | 2 minutes   | 48 hours or 15 days |

**Table 7-2. FASCAM arming and self-destruct times.**

b. **Air Defense.** Air defense support, if provided, is normally a MANPAD (Stinger) team in or near the company's position. The two-man team carries six missiles in its vehicle (HMMWV). It should be positioned to provide air defense for critical assets the commander feels are enemy air targets (for example, the company trains). These positions should cover the most likely avenue of enemy air approach.

(1) The Stinger's planning range is 5,000 meters. The weapon's firing signature may pinpoint its position if enemy pilots see the blast area signature (front and rear). Soldiers must be kept clear of the launch area to avoid the blast and detection by enemy pilots.

(2) Each MANPAD team receives early warning of incoming aircraft through the AD early warning net. The CO should have the team tie in to the company net so the team can alert him when enemy aircraft approach. The warning is then given to the entire company.

(3) When the company is moving, the missile team can support either by overwatching or by moving within the company formation. In the overwatch, the missile team will be positioned 500 to 1,000 meters behind the lead elements, providing two thirds of the missiles' range forward of the protected company. If integrated, the missile team normally moves dismounted using the best terrain to support the air defense mission. Missile teams can be split with one gunner in the overwatch and one moving with the unit.

(4) Normally, these ADA assets are DS to the battalion and collocate with part of the company for security.

(5) Other air defense units may also support the battalion. Chaparral platoons from the corps' ADA brigade and Vulcan batteries from the division's ADA battalion are deployed to protect critical division assets. If a Chaparral/Vulcan unit is located near the company, the company should coordinate weapons positions, security, and aircraft early warning. By exchanging frequencies or by tying in to the company wire net, a better defense and early warning system can be established. In emergencies and when there is no air threat, a Vulcan may be used in a ground support role against dismounted or motorized enemy troops. Its maximum effective range in a direct-fire mode is 2,200 meters and in an indirect-fire role, it is 4,500 meters.

(6) An infantry company will not normally receive any dedicated air defense assets. It is therefore imperative that it apply the fundamentals of passive air defense measures during all phases of the tactical mission. Organic weapons can be extremely effective if

the principles of small arms for air defense are adhered to (FM 7-8). The CO must ensure that his soldiers know the correct weapons control status. These are used to protect friendly aircraft and to prevent soldiers from engaging enemy aircraft and disclosing the company's location.

(7) The CO considers the following factors to determine his AD priorities.

(a) Enemy air threat. The CO considers the threat of CAS and attack helicopters--their likely air avenues of approach and their effect on his operation. The AD warning status provides the probability of and the basic level of an enemy air attack. The status may be—

- Red—Attack is imminent or in progress.
- Yellow—Attack is probable.
- White—Attack is not probable.

The weapon control status dictates the freedom to engage enemy aircraft. It protects friendly aircraft while still providing air defense. The status may be—

- Weapons free. Units may fire at any aircraft not positively identified as friendly. (This is the least restrictive status.)
- Weapons tight. Units fire at only those aircraft positively identified as hostile.
- Weapons hold. Units do not fire except in self-defense.

**NOTE:** Hostile criteria refers to how an aircraft may be identified and designated as hostile or friendly. This criteria will normally be disseminated through ADA channels, but may also be sent to the company through the battalion command net. However, any aircraft seen committing a hostile act may normally be designated as hostile.

(b) Vulnerability. The CO determines which of his units are more likely to be attacked. Vehicles are more easily detected than personnel, moving units more likely than stationary.

(c) Criticality. The CO determines which unit, weapon, or asset is more critical to the operation.

(d) Recuperability. Some units are more likely to suffer damage/casualties as a result of an air attack. They may also take longer to recover.

c. **Close Air Support.** CAS is normally provided by the Air Force, but may also be provided by Navy and Marine aircraft. CAS aircraft carry a variety of munitions, to include bombs (free-fall and guided), cluster bomb units, antiarmor missiles, napalm, rockets, and scatterable mines. In general, CAS ordnance is most effective against tanks and other armored vehicles, moving targets, and troops (exposed and protected). Some CAS aircraft carry the 20-mm cannon, which is effective against lightly armored vehicles. The A-10 airplane carries the 30-mm cannon, which is effective against tanks and other armored vehicles. Although the company FSO is not the primary designator, he has the capability to employ laser designators to guide CAS precision munitions.

d. **Naval Gunfire.** This support is planned and controlled by an element of the air and naval gunfire liaison company, which is supporting the operation. A shore fire control party from the ANGLICO may support an infantry battalion when naval gunfire is available. The SFCP consists of a naval gunfire liaison team and a naval gunfire spot team. The liaison team assists the battalion FSO in planning and controlling naval gunfire



support. The spot team, which is similar to the company's FSO, may operate with one of the maneuver companies.

e. **Engineer.** An engineer platoon may be placed in DS of a battalion. The engineers supporting dismounted infantry units are usually sappers. Although each platoon has mine detectors, demolition kits, and chain saws, they use field expedients, ingenuity, and specialized training to accomplish many of their tasks. In situations where heavy earthmoving equipment is available, the M9 ACEs and SEEs from the engineer battalion may be attached to engineer elements. The ACE is most effective for digging vehicle survivability positions and for countermobility tasks. The SEE is best used to dig weapon positions or trench lines.

(1) Engineer support to the rifle company is broken down into three major mission areas: mobility, countermobility, and survivability. Engineers provide this support either by performing the job themselves or providing expertise and assistance to the infantry company. The tasks normally provided within each of these categories are shown in Table 7-3.

| <b>MOBILITY</b>   |
|---|
| Breaching obstacles.<br>Clearing routes.<br>Expedient gap crossing.<br>Constructing combat roads/trails.                                |
| <b>COUNTERMOBILITY</b>  |
| Constructing obstacles to turn, fix, block, or disrupt enemy forces.  |
| <b>SURVIVABILITY</b>  |
| Constructing crew-served weapons and vehicle fighting positions.<br>Constructing protective emplacements.<br>Constructing strongpoints. |

**Table 7-3. Engineer missions.**

(2) Engineers supporting the company during offensive operations are normally attached or DS to the unit. The CO determines how they can best support his company's maneuver. The technical expertise of the engineers is a capability that must be used. The CO ensures engineers are involved in reconnaissance missions or with the lead unit in a movement. If a breach is required, involve the engineers in the planning. Normally, the breach element is an infantry platoon. If an engineer squad is attached to the company, they should be attached to the breach element. The engineers can also be used during rehearsals to train the infantry soldiers in employing breaching equipment. During consolidation, the engineers can prepare obstacles to support the company fire plan. The responsibility for requesting and transporting Class IV and V for engineer tasks is always the supported unit's, regardless of the command or support relationship.

(3) Engineers supporting the company during defensive operations are normally in DS to the unit. An engineer squad or platoon without earthmoving equipment is most effective with countermobility tasks. They can prepare minefields, wire obstacles, and other obstacles, such as abatis, log cribs, and log hurdles. The engineer leader must be

---

involved in the planning process to ensure the obstacle plan is integrated with the scheme of maneuver and scheme of fires. The obstacle plan supports the maneuver and fire plans in several ways.

- The obstacles can disrupt the enemy's movement, resulting in more effective fires and additional time to maneuver forces.
- The obstacles may fix or block the enemy so he can be destroyed by fire.
- Obstacles can turn the enemy or prevent him from using terrain for protection. This allows direct-fire weapons to achieve a flank or rear shot on an armored vehicle.

**NOTE:** The location of obstacles is critical; they are more effective when the enemy is unaware of them. If he is able to locate them during his reconnaissance, he will plan a bypass or breach.

Although the CO determines the most effective use of engineer assets and prioritizes their work, he depends on the engineer leader for advice and recommendations.

f. **Nuclear, Biological, and Chemical.** Reconnaissance and decontamination support is provided by the corps or divisional NBC defense company. An NBC defense platoon from the NBC defense company can be attached to each brigade. The brigade commander can control the entire platoon or have a decontamination squad support each battalion.

(1) Most NBC operations are initiated and controlled at battalion and higher echelons. Rifle companies execute assigned tasks, take designated protective measures, send and receive reports, and provide personnel and teams as requested. Rifle companies perform hasty decontamination of their own personnel and equipment. The NBC NCO assists the commander by recommending decontamination, supervising the decontamination team and process, and coordinating with the XO/ISG and battalion staff for the necessary augmentation to perform hasty decontamination.

(2) Within the battalion, there is a chemical officer and a noncommissioned officer. They advise and assist the battalion commander on the planning and conduct of NBC training and operations. At company level, there is an NBC defense team, which includes an officer and two NCOs. The officer position is an additional duty assigned to one of the company officers. One of the NCO positions (NBC operations NCO) is authorized by the TOE. The other (assistant NBC operations NCO) is an additional duty assigned to one of the company NCOs. The company NBC defense team is responsible for advising and assisting the CO on the planning and conduct of NBC training and operations, and for the organizational maintenance on NBC equipment.

(3) Because of the capability of a growing number of nations to employ nuclear and chemical weapons and the apparent willingness of some nations to use them, infantry companies must plan from the outset to fight in an NBC environment.

(4) The CO is responsible for preparing his unit to operate in an NBC environment. He does this by—

(a) Continuing normal operations and reducing his unit vulnerability through terrain shielding and increased protective measures while positioning elements to accomplish the mission.

(b) Specifying a level of protection that will reduce the risk of mass casualties when faced with an NBC threat.

(5) The NBC NCO and designated monitor and survey teams are responsible for—

(a) Determining the presence of an NBC hazard by using observation, chemical alarms, detection devices, and warning personnel to take proper defensive action.

(b) Conducting monitoring and survey efforts to determine the extent and degree of contamination of a given area in support of company or battalion operations.

(c) Decontaminating personnel and equipment.

(d) Recommending operational exposure guidance designed to minimize casualties due to nuclear radiation hazards.

(e) Conducting area damage control operations to minimize the impact of enemy-delivered NBC weapons.

g. Military Intelligence. The infantry battalion S2 plans the employment of the supporting MI elements, which come from the division MI battalion. When they are in the company's area, the CO coordinates their positioning. MI support normally consists of remote sensors and radars for day and night RSTA.

(1) REMS may supplement the platoon early warning systems by covering dead space or pinpointing enemy movement. REMS operators detect moving enemy soldiers and can assist FOs in calling for and adjusting indirect fire on them. They also can estimate the number of enemy soldiers or vehicles detected by their equipment.

(2) Radar teams can also be positioned in the company area. Each team has AN/PPS-15 or AN/PPS-5A radar. The AN/PPS-5A can detect moving personnel out to 6,000 meters and moving vehicles out to 10,000 meters. The AN/PPS-15 is man portable and can detect moving personnel out to 1,500 meters and moving vehicles out to 3,000 meters. They both can scan a wide area or monitor a small area or point target (for example, a bridge). They can guide friendly soldiers in a night attack or guide returning or lost patrol units to passage points.

(3) The radar should be positioned where it can use a narrow beam to reduce its chance of being detected by the enemy. It is an active system easily located by enemy DF systems. It is located in a secure position, but away from other units. The team ties in to the company wire net to pass along any enemy information.

### **Section III. FIRE SUPPORT PLANNING**

Fire planning begins with the brigade commander and his FSCOORD. This top-down planning also includes prioritizing and allocating fire support assets. The responsibility for planning/ executing the critical brigade targets may be assigned to battalion commanders and subsequently, a company commander. However, their plans must clearly focus on the critical targets/decisive points. Thus only those critical targets within the brigade, as developed by battalion and company commanders, are formally planned and passed to the artillery FDC. Additional targets are informally planned by the FSO for possible use, depending on enemy actions.

#### **7-5. MANEUVER COMMANDER'S INTENT**

The CO ensures the intent for maneuver and fire support is clearly understood by the FSO. He identifies the role of fire support in the scheme of maneuver (when, where,

what, and why) by explaining in detail the concept of the operation, scheme of maneuver, and tasks for fire support to the FSO.

a. Providing this level of guidance is not easy. Artillery fires are not instantaneous; three to seven minutes are required to process routine targets and get fires in the target area. Planning must allow for this lag time. While wargaming the maneuver, the CO refines the critical targets or EAs, priority of targets, priority of engagement, sequence of fires, and results desired. Then he can see when and how to synchronize direct and indirect fires to destroy the enemy and protect the force.

b. The CO normally designates the company's main effort to have priority of fires. This prioritizes requests when two or more units want fires at the same time. He also designates where to place obscuration or illumination, suppressive fires, and preparation fires.

#### **7-6. PLANNING PROCESS**

While the CO is developing and refining the tactical plan, the FSO is concurrently developing and refining the fire support portion of that plan. The FSO does not wait for the CO to complete the scheme of maneuver, he builds the fire plan using deliberate or hasty fire support planning, depending on the time available. In either case, targets must be placed in the fire support planning channels as soon as possible, so they can be processed at the battalion FSE or battery FDC. Regardless of which planning method is used, the company fire support plan must include:

- Target number and location.
- A description of the expected target.
- Primary and alternate persons responsible for shooting each target.
- The effect required (destroy, suppress, disrupt, or button-up armor) and purpose.
- Radio frequency and call sign to use in requesting fires.
- When to engage the target.
- Priority of fires.
- Size, location, code word, and emergency signal to begin FPF.

Other information may be included as necessary or appropriate.

a. The company FSO does most of the company fire planning; however, he may receive targets and target information from platoon leaders, platoon FOs, and the battalion FSO. The commander and FSO should not plan too many targets.

(1) The number of targets planned by the company and included in the formal fire plan depends upon the company's priority for fire support and the number of targets allotted to them. The total number of FA targets in the brigade fire support plan or the battalion mortar plan may be constrained as an excessive number of targets tends to dilute the focus of fire planning, and it can lead to increases in response time. However, these target allocations constraints do not constrain planning.

(2) Informal planning continues with target locations being recorded on terrain sketches, the FSO's map, or stored in the buffer group of the digital message device for quick reference and transmission. Fire planning for the company mortars should complement these plans; the primary constraint is normally ammunition availability and the rapid resupply ability. Care must be taken to ensure that planning focuses on the critical fire support requirements identified by the CO.

b. The company FSO completes the fire plan and briefs the CO. He may alter the plan or approve it as is; he makes the final decision. When the plan is approved by the CO, the FSO makes sure the targets are passed to the battalion FSE where the fire plans are integrated into the battalion scheme of maneuver.

c. The FSO must make sure platoon leaders and FOs are thoroughly familiar with the fire plan. He also provides target overlays to the platoon leaders, FOs, and the commander. The company fire support plan may also be disseminated as a target list and a fire support execution matrix. This must be done in sufficient time to allow subordinates to brief their platoons and sections. (A good plan given with the company order is better than a perfect plan handed out at the line of departure.)

d. Battalion fire support plans may be distributed in matrix format. The fire support execution matrix is a concise, effective tool showing the many factors of a detailed plan. It may aid the company FSO and the CO in understanding how the fire plan supports the scheme of maneuver. It explains what aspects of the fire support plan each FSO or FO is responsible for, and at what time during the battle these aspects apply. For more information on the battalion fire support matrix, see FM 7-20.

e. The advantage of the matrix is that it reduces the plan to one page and simplifies it. The company fire support matrix (Figure 7-1) also directs execution responsibilities and reduces the possibility that planned fires will not be executed. Dissemination of the fire plan is the responsibility of the CO. The CO and his key subordinate leaders must understand the categories of targets and how to engage those targets to create the desired result.

f. Figure 7-1 is an example of a completed fire support matrix for a company deliberate attack. In the AA, a field artillery FPF is allocated for 1st and 2d platoons; 3d platoon has been allocated a mortar FPF; 2d platoon has priority of mortar fires from the LD to Checkpoint 7. From Checkpoint 7 to Objective Green, 3d platoon has been allocated a mortar priority target and has designated it as CA3017; 2d platoon is backup for execution. 1st platoon has been allocated a mortar FPF; 2d and 3d platoons have been allocated field artillery FPFs. At company level, information in each box of the matrix includes—

(1) Priorities of indirect fire support to a platoon will appear in the upper left corner of the appropriate box (FA).

(2) If a unit is allocated an FPF, the type of indirect fire means responsible for firing the FPF will appear next to the indicator (FA FPF).

(3) The target number of priority targets allocated to a platoon will appear in the box preceded by the means of fire support responsible for engaging the target, and followed by the target number (MORT PRI TGT CA3014).

(4) If the company FSO is responsible for initiating specific fires, the target number, group, or series designation will be listed in the box for the FSO (CA3012). Specific guidelines concerning fires not included on the target list work sheet will be included in that box.

(5) Alternate element responsible for execution of specific fires will be listed in the lower right hand corner of the box (2D PLT). If fires have not been initiated when they were supposed to have been, that unit initiates them (unless ordered not to).

(6) Each fire support measure to be placed in effect, followed by a word designated for the measure, will be shown in the box (CFL CHUCK). For airspace coordination

areas, the time for the arrival of the planned CAS or attack helicopters is listed (ACA 1400Z).

(7) Other factors that apply to a certain platoon during a specific time may be included in the appropriate box. General guidance is issued in the written portion of the operation order.

|         | AA                      | LD                               | CP 7                           | OBJ GREEN       |
|---------|-------------------------|----------------------------------|--------------------------------|-----------------|
| FSO     | INITIAL PREP<br>1ST PLT | FIRE CA 3012 CFL CHUCK<br>2D PLT | FIRE C1A GROUP<br>3D PLT       | ACA (CAS) 1400Z |
| 1ST PLT | FA FPF                  | CFL CHUCK                        |                                | MORTAR FPF      |
| 2D PLT  | FA FPF                  | MORT PRI TGT CA 3014 CFL CHUCK   |                                | FA FPF          |
| 3D PLT  | MORTAR FPF              | CFL CHUCK                        | MORT PRI TGT CA 3017<br>2D PLT | FA FPF          |

Figure 7-1. Company fire support execution matrix.

**7-7. TARGETS**

A target can be personnel, vehicles, materiel, or terrain that is designated and numbered for reference or firing. Every target can be classified as either a target of opportunity (appears during combat, no attack has been planned) or a planned target (fire is prearranged). Individually planned targets may be further subdivided into either scheduled or on-call targets. A scheduled target is a planned target to be attacked at a specified time. An on-call target is a planned target on which fire is delivered when requested.

a. A priority target is one that could decisively affect the unit mission. The brigade commander may allocate artillery priority targets to battalions. Battalion commanders may in turn allocate priority targets to his subordinate companies. Normally, company priority targets are designated by the company commander (with recommendations provided by the FIST).

b. When the battalion commander designates priority targets, he provides specific guidance to the FSO and his subordinate companies as to when certain targets become priority targets, when they cease to be priority targets, the desired effects on the targets, and any special type of ammunition to be used. Firing units lay the guns on priority targets when they are not engaged in a fire mission; this reduces reaction time. Each field

artillery battery usually lays on one priority target. FPF is an example of a priority target in a defensive situation.

c. A target number is assigned to each planned target by the company FSO. Blocks of alphanumeric target numbers (two letters and four numbers) are provided for all fire-planning agencies. They serve as an index to all other information regarding a particular target, such as location, description, and size. All TRPs that are targeted by the company FSO are assigned target numbers. Mortar sections have blocks of target numbers, so they can assign a target number when an observer directs "record as target" upon completion of a registration.

d. A standard target is an area about 100 meters in radius. The symbol for a standard target is a cross. It may be canted if several targets are close to each other, or if the symbol might be mistaken as a grid intersection. The intersection of the lines marks the center of the target. The target list describes the nature of the target and other pertinent information. (This applies to targets planned for conventional and improved conventional ammunition.)

(1) *Offensive application.* These targets should be used to attack known, suspected, or likely enemy positions such as OPs, antitank sites, road intersections, or terrain that dominates attack axes.

(2) *Defensive application.* These targets should be selected to destroy the enemy as he attacks. Plan targets at fording sites, bridges, narrow defiles restricting movement, road intersections, obstacles, and possible overwatch positions.

e. When the expected target will be moving, extra planning is required. Determine a trigger point that will allow the FO sufficient time to initiate the call for fire, the firing unit time to prepare and fire, and the projectiles time to reach the target. The FO calls for fire as the vehicles/unit reaches the trigger point and the enemy continues moving to the target. If timed properly, enemy and projectiles will arrive at the target at the same time.

f. Other types of targets (linear, groups, series) are discussed in FM 7-20.

## **7-8. FINAL PROTECTIVE FIRES**

FPFs are immediately available planned fires that block enemy movement, especially dismounted infantry approaching defensive lines or areas. These areas are integrated with defensive plans. The pattern of FPF plans may be varied to suit the tactical situation; they are drawn to scale on the target overlay. The size of the FPF is determined by the number and type of weapon used to fire on it (Figure 7-2). The CO is responsible for the precise location of FPFs. The company FSO will—

- Report the desired location of the FPF to the supporting FDC.
- Adjust indirect fire on the desired location, by weapon.
- Transmit the call to fire FPF to the supporting FDC.

The authority to call for the FPF is given to the leader (normally the CO or platoon leader) in whose area the FPF is located. The FPF has the highest priority of any target assigned to a fire support means. The FPF is only fired when required to repel the enemy's assault. Premature firing wastes ammunition and allows the enemy to avoid the impact area.

| WEAPONS                        | SIZE (METERS) |
|--------------------------------|---------------|
| 60-mm Mortar (2 tubes).....    | 60 X30        |
| 81-mm Mortar (4 tubes) .....   | 100 X 35      |
| 105-mm Howitzer (6 guns) ..... | 180X 40       |
| 107-mm Mortar (3 tubes) .....  | 150 X40       |
| 107-mm Mortar (6 tubes) .....  | 300 X 40      |
| 155-mm Howitzer (4 guns) ..... | 200 X 50      |
| 155-mm Howitzer (6 guns) ..... | 300 X 50      |
| 155-mm Howitzer (8 guns) ..... | 400 X 50      |

**Figure 7-2. FPF dimensions.**

### 7-9. SPECIAL MUNITIONS

Obscuration fires use smoke and white phosphorus ammunition to degrade the enemy by obscuring his view of the battlefield. (High explosive ammunition may also obscure his view with dust and fires, but it should not be relied on as the primary means.) Because smoke is subject to changes in wind direction and terrain contours, its use must be coordinated with other friendly units affected by the operation. Used properly, obscuration fires can—

- Slow enemy vehicles to blackout speeds.
- Obscure the vision of enemy direct-fire weapons crews.
- Reduce accuracy of enemy-observed fires by obscuring OPs and CPs.
- Cause confusion and apprehension among enemy soldiers.
- Limit the effectiveness of the enemy's visual command and control signals.

a. Screening fires are closely related to obscuration fires; they also involve the use of smoke and WP. However, screening fires mask friendly maneuver elements to disguise the nature of their operations. For example, they are used to screen river crossings for an enveloping force. Screening fires may assist in consolidating an objective by placing smoke in areas beyond the objective. They may also be used to deceive the enemy into believing that a unit is maneuvering when it is not. Screening fires require the same precautions as obscuration fires.

b. Special munitions may be used for illumination, which may be scheduled or on-call. It is used to allow the use of friendly direct-fire weapons and adjustment of indirect fires, to illuminate areas of suspected enemy movement, or to orient moving units.

### 7-10. FORWARD OBSERVER'S POSITIONS

To ensure indirect fire can be called on a specific target, FOs must be in the proper position. As indirect-fire targets are planned to support the operation and passed from the company to the platoon, specific FOs are positioned to observe the target, the associated trigger line, or the TRP. The primary observers are the FOs that support each rifle platoon. However, other soldiers can perform this function as long as they have the communications capability and training, and they understand the mission.

a. Once the target has been passed to the platoon or included by the platoon in the fire support plan, the platoon leader must position the observer and make sure he understands the following in precise terms:



- (1) The nature and description of the targets he is expected to engage.
- (2) The terminal effects required (destroy, delay, disrupt, suppress, and so forth) and purpose.
- (3) The communications means, radio net, call signs, and FDC to be called.
- (4) When or under what circumstances targets are to be engaged.
- (5) The relative priority of targets.
- (6) The method of engagement and method of control to be used in the call for fire.
  - (a) Method of engagement (adjust fire or fire for effect). The need to adjust fires should be anticipated when the target location has been derived strictly through map-spot procedures. Using this technique, target location errors of up to 500 meters can be reasonably expected. First-round fire for effect should be employed when the target can be precisely located through previous adjustment, target area survey, or the use of laser range finders from known locations. When fires must be adjusted, the additional time that will be required to complete the fire mission, 2 to 4 minutes for each adjustment, must be considered in the planning process.
  - (b) Method of control (time on target, at my command, or when ready). The method of control should reflect the degree of synchronization required. While time on target and at my command provide the observer greater control of the precise timing of fires, this is done at the expense of flexibility in the firing units and can result in fewer missions being fired over a given period of time.
    - b. If the observer can not be positioned to see the target and trigger line or TRP under the visibility conditions expected at the time the target is to be fired, the headquarters that planned the target must be notified and a new target must be planned at a location that will meet the commander's purpose for fire support.

### **7-11. REHEARSAL AND EXECUTION**

Once the fire support plan has been developed and coordinated, it should be rehearsed. As the company rehearses the maneuver, it rehearses the fire plan. The target list is executed as the maneuver is conducted, fires are requested (though not actually executed by the firing units) just as they would be during the operations. Under ideal circumstances, FPF could be adjusted during the rehearsal. Rehearsals on the terrain will reveal any problems in visibility, communications, and coordination of the fire support plan. Rehearsals should be conducted under degraded conditions (at night, in MOPP4) to make sure the plan can be executed in all circumstances.

- a. If time or conditions do not permit full-scale rehearsals, key leaders can meet, preferably at a good vantage point, and brief back the plan. A sand table depiction of the terrain can be used. Each player explains what he does, where he does it, and how he plans to overcome key-leader casualties. The fire support plan execution is integral to this process and is rehearsed in exactly the same way.
- b. As the operation is conducted, the fire plan is executed. Targets are fired as required and adjustments are made because of enemy reactions. Priority targets are cancelled as they are passed by friendly units or no longer relevant to the maneuver.

### **7-12. COMMUNICATIONS**

The FSO can monitor three of four possible radio nets. The company's mission and priority determines the specific nets.

a. **Company Command Net FM (Voice).** Platoon leaders, the XO, and attachments use this net to send reports, receive instructions, and request fires. Any COLTs attached to the company will monitor this net. The company headquarters is the NCS. The company FSO will monitor it if he is separated from the command FSO.

b. **Battalion Mortar Fire Direction Net FM (Voice).** Observers use this net to request fires of the battalion mortar platoon. Other stations on the net include the FIST headquarters and the battalion FSE. The battalion mortar platoon is the NCS.

c. **Company Mortar Net (Voice).** Observers or the company FSO use this net to request fire from the company mortars.

d. **FA Fire Direction Net FM (Voice).** This net is used for FA fire direction. The FIST headquarters may digitally forward calls for fire from its observers on this net. The direct support battalion FDC is the NCS. When a COLT is present, it will use this net to request FA fires. The battery FDC and battalion FSE are also on this net.

### 7-13. INDIRECT FIRES IN CLOSE SUPPORT

Effective indirect fire support often requires artillery and mortar fires near our infantry soldiers. A safe integration of fires and maneuver this close demands careful planning, coordination, and knowledge of the supporting weapons. These close supporting fires are most commonly FPFs in a defensive operation and suppression/obscuration fires to support an assault on an enemy position. When planning these fires, the commander considers—

a. **The Effect Required.** In the defense, this may to destroy enemy soldiers and to degrade the effectiveness of enemy vehicles by causing them to fight buttoned-up. In the attack, the suppression/obscuration of enemy positions to allow the breach and seizure of a foothold on the objective is probably the desired effect.

b. **The Accuracy of the Delivery System.** There are many variables that impact on the accuracy of the weapon. The FSO has the technical knowledge to assist the commander. These weapons are area weapons systems; this means that every round fired from the same tube will impact in an area around the target or aiming point. This dispersion is greater in length than in width. The weather conditions (wind, temperature, and humidity), the condition of the weapon, and the proficiency of the crew also will affect the accuracy.

c. **The Protection of his Unit as the Rounds are Impacting.** If in well-prepared defensive positions with overhead cover, an FPF could be adjusted very close (just beyond bursting range). If required, the CO could even call for artillery fires right on his company position using proximity or time fuses for air bursts. It is much more dangerous to call for close indirect fires during an attack. The CO considers the terrain, the breach site, and the enemy positions to determine how close to adjust his supporting indirect fires.

d. **The Integration of Indirect Suppressive Fires.** When integrating indirect suppressive fires to support the breach and assault, the following points are key:

(1) The danger increases with the size of the weapons. Use artillery to isolate the objective, use the battalion mortars on enemy positions away from the breach site, and use the 60-mm mortars, M203s, and direct fire weapons for close suppression.

(2) Safety is increased by assaulting perpendicular to the GT line. If the rounds are coming over the head of the assault element, the margin of safety is reduced.

(3) Company mortars firing direct lay or direct alignment are the most responsive system. They are able to observe the rounds impact and adjust accordingly. The safest method is when firing the 60-mm mortars with bipods.

(4) Ideally, the firing units will register prior to firing close-support missions. If not, the first rounds fired may be off target by a considerable distance. Once the firing units are adjusted on a target, then any shifts from that target are much more reliable.

e. **Timings and Control.** The final requirement for integrating these fires is to establish timings and control to ensure these targets are initiated, adjusted, and shifted properly. If possible the company FSO should locate where he can observe these targets (possibly with the support element). A detailed execution matrix that assigns responsibility for each target to the leader or FO who is in the best position to control them should be developed. These soldiers must know when each target/series/group is fired, what effect is desired on which enemy positions, and when to lift or shift the fires. Consider the use of pyrotechnic or other signals to ensure communication.

#### **7-14. TACTICAL AIR SUPPORT**

At company level, the only concern with tactical air support is close air support. CAS missions are air strikes against hostile targets that are close to friendly forces. CAS missions must be carefully controlled to achieve the most benefit with the least risk to friendly forces. They usually support attacks in preparing an enemy-held objective for assault. In the defense, CAS will engage targets in the EAs and may assist as the enemy closes on defensive positions.

a. CAS missions are either preplanned (at battalion) or immediate. Preplanned missions are normally controlled by the Air Force forward air controller. Using specialized radios available to him, the ground FAC positions himself where he can see the target. If the FAC is unavailable or cannot reach the area in time, the FSO or FO can control the CAS mission. At company level, CAS concerns consist of the following:

(1) Mark friendly positions or vehicles to preclude accidental attack. This may be done with air recognition panels, colored smoke, other pyrotechnics, or similar devices recognizable from the air.

(2) Designate enemy positions or targets to assist the aircrew in acquisition and identification. This can be done with tracer fire, WP, smoke, or illumination rounds at night. Air panels and smoke or light can also be used to point toward the enemy from friendly positions.

(3) Use SEAD as a priority mission during friendly air strikes. Enemy air defense missile and gun systems are vulnerable to ground fire and suppression. SEAD can dramatically improve the survivability of aircraft and helicopters because it allows them to be more accurate with their weapons and remain on station longer.

(4) Protect and assist the ground FAC if necessary. The extent and priority of this task depends on the guidance in the battalion order. For example, when the company is the lead element, the FAC may move with it in an offensive maneuver. The company would provide security and resupply to the FAC while he remains with it.

b. Figure 7-3 is an example of a nine-line CAS request. It provides the information required to safely and accurately guide aircraft to the target. These considerations should be noted when filling out this request:

(1) Sometimes the marking round is not directly on the target. In this case, the requester gives an adjustment as soon as the round impacts, such as FROM THE MARK SOUTHWEST 150 METERS.

(2) If the mark is on the target, the requester gives HIT THE MARK.

(3) If multiple aircraft are engaging, the second aircraft can be given an adjustment from the first aircraft bombs, FROM LEADS' HITS, 400 METERS SOUTH.

(4) For the first eight lines, give only the information; do not read the title or line number. For line nine, always state the title EGRESS before the information.

(5) To stop the mission at any time before the bomb release, the requester states, ABORT, ABORT, ABORT.

|   |  |
|---|--|
| <b>1. INITIAL POINT:</b>  | <u>HILL 425</u>                        |
| (This is the initial point the aircraft uses to position for the bomb run. It must be a well-defined point easily located from the air.)  |  |
| <b>2. HEADING:</b>  | <u>95°</u> MAG    OFFSET: L <u>X</u> R |
| (This is the heading from the IP to the target; it is given in degrees magnetic. At this time, the requester also gives the offset as either right or left. This is used—   |  |
| <ul style="list-style-type: none"> <li>● To assist the pilot in acquiring the target.</li> <li>● To position the aircraft parallel or nearly parallel to friendly forces.</li> <li>● To position the aircraft for laser acquisition.</li> <li>● To position the aircraft to avoid enemy ADA weapons)</li> </ul> |  |
| <b>3. DISTANCE:</b>   | <u>5.7</u>                             |
| (This is the distance (to the nearest tenth) from the IP to the target in nautical miles.)  |  |
| <b>4. TARGET ELEVATION:</b>   | <u>340</u> FEET MSL                    |
| (This is the target elevation given in feet above mean sea level.)  |  |
| <b>5. TARGET DESCRIPTION:</b>   | <u>7 ARMORED VEHICLES</u>              |
| (This is a short concise statement describing the target and what the pilot should look for.)   |  |
| <b>6. TARGET LOCATION:</b>  | <u>NJ 572895</u>                       |
| (This is the six-digit grid of the target.)   |  |
| <b>7. MARK TYPE:</b>  | <u>WP</u> CODE <u>(N/A)</u>            |
| (This is the method of target marking to be used. Ideally, within 300 meters and 30 seconds prior to aircraft's time on target. The code is only required when laser designation to identify the pulse  |  |
| <b>8. FRIENDLIES:</b>   | <u>WEST 600 METERS</u>                 |
| (This is the cardinal direction and distance in meters from the target to the nearest friendlies, such as WEST 350 METERS.)   |  |
| <b>9. EGRESS:</b>   | <u>SOUTH</u>                           |
| (This is the direction of departure from the target area, given as a cardinal direction.)   |  |

Figure 7-3. Nine-line CAS request.

## CHAPTER 8

# COMBAT SERVICE SUPPORT

*Tactical commanders can only realize the full combat potential of their units and achieve synchronization in their operations by effective use of their sustainment system. They must assure that their tactical plans realistically reflect logistics limitations and fully exploit their CSS capabilities.*

FM 100-5, 1986

*Combat service support operations are a vital part of infantry operations. The effectiveness of the CSS may determine the success or failure of the unit. Like CS, CSS is a combat multiplier. The CSS issue that has the greatest impact on the rifle company's tactical operations is the soldier's load.*

During the Normandy Invasion, many casualties were attributed to the excessive loads carried by US soldiers as they tried to get ashore and across the beach. E Company, 16th Infantry suffered 105 casualties that day. Of these, 104 occurred on the beach, and most of them were due to their overloads. Many soldiers fell prone at the water's edge and were drowned by the incoming tide. The mens' packs were so heavy that they were able to walk only a few feet before falling to the sand. It took the company more than an hour to move 250 meters across the beach.

The paratroopers that jumped into Normandy carried the following:

|                         |                           |
|-------------------------|---------------------------|
| 1 carbine or M1 rifle   | 1 steel helmet with liner |
| 80 rounds of ammunition | 1 knit cap                |
| 2 hand grenades         | 1 change of underwear     |
| 1 mine                  | 2 pairs of socks          |
| 6 K-rations             | 1 gas mask                |
| 1 impregnated jumpsuit  | 1 first-aid packet        |
| 1 complete uniform      | 1 spoon                   |
| 1 entrenching tool      | 2 gas protective covers   |
| 1 field bag             | 1 packet of sulfur        |
| 1 escape kit            | 1 set toilet articles     |

Although they were required to jump heavy, once on the ground the individual soldier discarded all unnecessary items and traveled light. They understood from their training that their success depended on mobility, stealth, and surprise.

Even though these airborne units were without resupply for days, there is only one recorded incident where an airborne unit gave up ground due to ammunition shortages. This action involved 84 men from the 506th PIR at the LePort Bridge on the Douve River. This detachment conducted one of the most courageous stands of the invasion. (This bridge was later the site where V and VII Corps were linked up.) After three days of fighting to hold the bridge, the unit was forced to withdraw to the nearside of the river

until the ammunition bundles were found. Once found, the unit counterattacked to regain the lost ground.

There is no standard solution to the problem of overloading soldiers. The only doctrinal solutions available are the guidelines discussed later in this chapter and the realization that this is a command responsibility. Commanders must accept certain risks in every operation to prevent their soldiers from becoming pack animals who are unable to fight due to fatigue resulting from carrying overloaded rucksacks. The leaders must also enforce the load discipline required in every infantry unit.

### **Section I. FUNDAMENTALS**

Sustaining his company in battle is one of the greatest challenges an infantry company commander faces. His CSS assets help him meet this challenge.

#### **8-1. AIRLAND BATTLE IMPERATIVES**

The AirLand Battle sustainment imperatives apply at company level. The application of these imperatives aids in increasing the combat power of the company. The sustainment imperatives are anticipation, integration, continuity, responsiveness, and improvisation.

a. **Anticipation.** All leaders in the company must anticipate the CSS requirements for their units. They must know the current status of their units and how fast each resource (water, food, ammunition, and so forth) is being expended. Due to the limited CSS structure supporting the company, the commander must plan ahead and submit requests as soon as the situation permits. This will allow the battalion to better configure packages of supplies to "push" to the company.

b. **Integration.** Every operation the company conducts must have a complete and fully integrated plan for CSS. Because of the relationship between the commanders tactical plan, the soldier's load, and the resupply requirements, the commander must consider them and casualty evacuation as he develops each course of action.

c. **Continuity.** The CSS for the company must be continuous. It is critical during the fight, but after the mission is accomplished, CSS activities become the focus for the company. The company SOP should cover resting and retraining soldiers, maintaining equipment, conducting resupply, holding religious services, handling mail, and conducting other administrative activities.

d. **Responsiveness.** The CSS structure for the company must quickly respond to changes in the situation or mission. To develop this ability, the company needs aggressive CSS operators and effective SOPs. Because the supply sergeant is the only company representative at the battalion trains, he must monitor the tactical situation and adjust the CSS plan as required.

e. **Improvisation.** Because of the austere CSS system and the way the company fights (continuous operations, dispersed formations, and long movements through difficult terrain), effective CSS depends on the initiative and creativity of those responsible to support infantry soldiers. The CSS system will often be pushed to its limit to support the plan.

## 8-2. BATTALION SUPPORT

The battalion S1 and S4 sections and the support, maintenance, medical, and communications platoons provide combat service support to the company. The detailed explanation of these sections and platoons is found in FM 7-20.

a. **Administration.** The company submits all requests and status reports involving personnel management, morale, discipline, and law and order to the battalion S1 section. The S1 section provides all administrative support to the company.

b. **Logistics.** The battalion S4 section and support platoon are responsible for providing the company with the supplies and equipment required for sustainment. The company submits all requests and statuses regarding supplies and equipment to the S4. The S4 and support platoon personnel plan, coordinate, and assist in the distribution of supplies and equipment to the company.

c. **Communications.** The company evacuates inoperative communications equipment to the communications platoon through the 1SG during resupply, where they perform maintenance or turn in the equipment to a higher level maintenance activity.

d. **Maintenance.** The supporting maintenance structure for infantry companies is austere in both organization and capabilities. The preferred method of direct exchange for weapons and equipment will not always be possible. Infantry companies must ensure their unit maintenance is effective and continuous to reduce the requirement for direct support maintenance.

e. **Medical.** The battalion medical platoon treats and evacuates the sick and wounded. It maintains the basic load of medical supplies for the battalion and provides an aidman to each rifle platoon. Ambulances are usually in direct support of the companies to provide evacuation. The treatment squad establishes and operates the battalion aid station. The medical platoon must be employed well-forward in many situations to assist the company casualty evacuation effort.

## 8-3. RESPONSIBILITIES AND ORGANIZATION

The company headquarters is responsible for the coordination and execution of CSS functions within the company. This includes reporting current statuses, requesting supplies or support, and then conducting effective CSS operations within the unit. The primary CSS functions required by the company include casualty evacuation, resupply operations, maintenance activities, and personnel service support.

a. **Planning.** Plans and key decisions on CSS are made by the battalion and company commanders and the battalion S4. They are implemented by the S4, support platoon leader, company first sergeant, company executive officer, company supply sergeant, platoon sergeants, and squad leaders. Platoon leaders plan and make CSS decisions to accomplish their assigned missions according to guidance from higher headquarters and SOPs. Unit SOPs should address planning, implementation, and responsibilities in detail as well as standardizing as many routine CSS operations as possible.

b. **Trains.** The company trains is the focal point for company sustainment operations. The size and composition of the company trains will vary depending upon the tactical situation. It may consist of nothing but preplanned locations on the ground (a control measure such as a checkpoint) during fast-paced offensive operations, or it may contain two to five tactical vehicles during resupply operations. The company trains

normally are established only when its functions of evacuation (WIA, weapons, equipment) and resupply are required. When the company has been allocated an ambulance, it will usually be in the company trains too. Company trains are located in a covered and concealed position, close enough to the company to provide responsive support, but out of enemy direct fire. Security is provided by the small size and tactical signature, by only establishing trains for a short time or when required, and by positioning the trains close to the combat platoons and sections.

**c. Personnel Responsibilities.** The following personnel have the primary responsibility for company CSS.

(1) *Company commander.* He ensures that CSS operations sustain his company's fighting potential. He integrates the CSS activities into the tactical plan, and he provides guidance to the CSS operators.

(2) *Company executive officer.* He coordinates and supervises the company's logistical effort. During the planning, he receives status reports from the platoon leaders/sergeants/1SG, reviews the tactical plan with the commander to determine company CSS requirements, and coordinates these needs with the battalion S4. During execution, the XO is at the second most important place in the battlefield as determined by the commander. At times, this will be supervising sustainment operations. Also, he ensures the CSS needs of supporting units are met.

(3) *First sergeant.* In addition to the tactical responsibilities listed in Chapter 2, the 1SG is the primary CSS operator for the company. He executes the company CSS plan and supervises the company trains. He makes sure the XO receives current status reports from all subordinate units, helps the XO prepare reports/requests to battalion, and helps the XO/CO prepare paragraph 4 of the OPORD.

(a) The 1SG receives, consolidates, and forwards all logistics, personnel, and casualty reports to the combat trains CP. He supervises the evacuation of casualties, EPWs, and damaged equipment, and he establishes and supervises company resupply activities.

(b) The 1SG also monitors the company maintenance activities. He orients new replacements and assigns them to squads and platoons IAW the commander's guidance. He maintains the battle roster for the company, and he submits other CSS reports as required by the unit's tactical SOPs.

(c) The 1SG gets his information from the platoon and or section sergeants. These NCOs are responsible for providing all CSS reports IAW the company SOP.

(4) *Supply sergeant.* He is the company representative in the battalion field trains. He assembles the LOGPAC and moves it forward to the company. He assists the 1SG with resupply and coordinates the company's CSS requirements with the support platoon leader, S4, and HHC commander. He is responsible for evacuating KIAs, EPWs, and damaged equipment, and he picks up replacement personnel and brings them forward to the unit. The supply sergeant may control the medical ambulance when it is unable to remain forward with the company. He monitors the tactical situation and adjusts the CSS plan as appropriate. He may assist the commander by establishing caches. He forecasts the company's consumption of food, water, ammunition, and batteries, based on the operation.



---

## Section II. RESUPPLY OPERATIONS

Resupply operations normally occur once a day. When possible, they are conducted during limited visibility. There are many ways to conduct resupply operations; this section describes some of them. The commander considers his situation to decide on the best means of resupplying his company.

### 8-4. REQUIREMENTS

Company resupply is mainly a "push" system. This means the company will receive a standard package of supplies from battalion based on past usage factors and planning estimates. Figure 8-1 defines the classes of supply.

a. The contents of a LOGPAC are planned by the S4. The supplies are normally organized and assembled in the battalion field trains by the company supply sergeant under the supervision of the HHC commander and support platoon leader. The LOGPAC should, if possible, provide all supplies, equipment, and personnel needed to sustain the company for the next 24 hours or until the next scheduled LOGPAC delivery.

b. Adjustments to the LOGPAC are sent to the battalion S4, who is located in the combat trains CP. They may be sent to the S4 over the admin/log net, through the company supply sergeant, or by a company messenger. If the battalion admin/log net is used and is not secure, the reports should be encoded using the SOI.

c. Company status reports often translate into supply requests, or they provide information to allow the S4 to anticipate company needs. An example is the personnel daily summary, which is sent to the S1; it provides the number of personnel in the field, which the S4 can use to plan Class I resupply.



**Figure 8-1. Supply classes.**

### 8-5. DISTRIBUTION OF SUPPLIES FROM BATTALION TO COMPANY

The company receives supplies from battalion delivered as a LOGPAC or pre-positioned in appropriate locations. See FM 7-20 for more on this process.

a. **Logistics Package.** Once the company LOGPAC has been formed in the field trains, it is ready to move forward under the control of the company supply sergeant. The support platoon leader normally organizes a convoy for moving the LOGPACs along a supply route to the LRP where the 1SG or unit guide takes control. The LRP must be near enough to the company position to facilitate resupply since the company has no organic vehicles. The 1SG or guide controls distribution using the resupply techniques discussed in paragraph 8-6. The 1SG informs the supply sergeant of requirements for the next LOGPAC and ensures that personnel and equipment requiring movement to the rear, as well as out-going mail, return with the supply sergeant. The LOGPAC then follows unit SOP and returns to the LRP or the combat or field trains.

b. **Pre-positioned Supplies.** Pre-positioned resupply occurs when the battalion places supplies on the battlefield and directs the companies to them so they can pick them up when they are moving from one place to another.

## 8-6. COMPANY RESUPPLY TECHNIQUES

Company resupply techniques are those methods of employing company logistical assets (personnel and equipment) to effect resupply with subordinate elements. These techniques are independent from the methods in which the company receives supplies from higher headquarters; they are solely concerned with distribution of supplies to the platoons and sections. There are three company resupply techniques: in position, out of position, and pre-position.

a. **In Position.** The company executes in-position resupply by moving the required supplies or equipment forward while the platoons remain in their fighting positions. This technique is used when it is essential to maintain combat power forward (during contact or when contact is imminent) or when the company is dispersed over a wide area. If vehicles are not able to move near the platoons because of enemy fire, some platoon members may have to assist the resupply personnel in moving the supplies and equipment forward.

b. **Out of Position.** The company executes out-of-position resupply by directing the platoons to the supplies and equipment as follows:

- The company establishes a resupply point in a covered and concealed position to the rear of a platoon position.
- Platoons move from their fighting positions to the resupply point.
- Platoons pick up the supplies.
- Platoons move back to their fighting positions.

This technique is used when the situation does not necessitate all combat power being forward (contact is not likely). Company SOPs establish whether all or part of the platoon moves to resupply at one time. A variation of this technique would be to establish a resupply point for each platoon and reposition the LOGPAC.

c. **Pre-position.** The company or battalion pre-positions supplies and equipment along the route to or at the location to which the platoons are moving, and they direct the platoons to them. These supplies or equipment may be uploaded on a vehicle or on the ground, secured or unsecured, concealed or in the open. The factors of METT-T will determine exactly what measures are required. This technique is most often used during defensive operations when supplies are positioned in subsequent battle positions. A cache is a pre-positioned and concealed supply point. It can be used in any operation.

(1) Caches can be set up for a specific mission or as a contingency measure. They are an excellent tool for reducing the soldier's load. Cache sites have the same characteristics as an ORP or patrol base. The supplies may be concealed above or below ground. An above ground cache is easier to get to, but is more likely to be discovered by the enemy, civilians, or animals. There is always a security risk when returning to a cache. A cache site should be checked out for signs of enemy presence and secured before being used; it may have been booby trapped, or it may be under enemy observation.

(2) In the offense, a cache may be set up along the intended route of advance to the objective by advance elements. They may also be set up in zone to conduct continuous operations without requiring air or ground resupply that may allow the enemy to locate the company. Caches may be limited by the soldiers' loads. Do not let the cache activities jeopardize the offensive mission. In some cases, special forces, allied forces, or partisans may set up caches.

(3) In the defense, caches may be set up throughout the area of operation by the defending unit during the preparation phase. A cache should also be in each alternate or subsequent position throughout the depth of the defense sector. During stay-behind operations, or in an area defense on a fluid battlefield where the enemy is all around, caches may be the only source of supply for extended periods.

d. **Security.** While these techniques are used in both offensive and defensive operations, the transfer of supplies to the company is usually conducted from a defensive posture. As such, the security considerations for a resupply operation are like those for a perimeter defense.

## **8-7. CONSIDERATIONS**

The techniques described in paragraph 8-6 provide the normal methods for resupply within the company. However, a basic understanding of nonstandard techniques, different modes of delivery, and specific supply issues is also required for the successful execution of the sustainment function.

a. **Foraging and Scavenging.** Two resupply techniques not discussed earlier because of their infrequent use are foraging and scavenging. Infantry forces should not use these techniques except under other than normal conditions. Foraging is the gathering of supplies and equipment necessary to sustain basic needs (food, water, shelter, and so forth) from within the area of operations. Scavenging is the gathering of supplies or equipment (friendly or enemy) from within the area of operations to help the user accomplish his military mission. Leaders must ensure the safety of their soldiers by determining if the food or water is safe or the equipment is booby trapped. They must also make sure their actions are permissible under the Law of Land Warfare, FM 27-10.

b. **Aerial Resupply.** This method of delivery may be used to provide supplies and equipment to the company. Unless conducting the resupply in an area under friendly control and away from direct enemy observation (reverse slope of a defensive position with recon well forward), the resupply should be conducted away from the main unit in an area that can be defended for a short time. The delivered supplies should be quickly transported away from the DZ/LZ. The company supply sergeant is responsible for packaging airdrops originating in the field trains. The commander must consider the enemy's ability to locate his unit by observing the aircraft.

c. **Cross-Leveling.** Cross-leveling is simply a redistribution of supplies throughout the unit. Usually done automatically between fire teams and squads after every engagement, the company may cross-level supplies between platoons when resupply cannot be effected. In some instances, supplies may not be evenly redistributed. For example, during preparation for an assault of an enemy trench system, the platoon with the task of support by fire may be required to give its hand grenades to the platoon with the task of clearing the trench.

d. **Backhauling.** Backhauling is a method used to make the most use of vehicular or manpack capabilities moving rearward. Backhauling returns supplies, equipment, or trash to the rear for disposition.

e. **Water.** Ensuring that soldiers receive and drink enough water is one of the prime CSS and leadership functions at all levels in the company chain of command. Even in cold areas, everyone needs to drink at least two quarts of water a day to maintain efficiency. Soldiers will drink water at an increased rate in a combat environment.

(1) Water is delivered to the unit under company or battalion control in 5-gallon cans, backpacks, or collapsible containers. When a centralized feeding area is established, a water point is set up in the mess area, and each soldier fills his canteen as he goes through. When rations are distributed by the company, water can be resupplied either by collecting and filling empty canteens or by distributing water cans to the platoons.

(2) Water is habitually included in LOGPACs. The ability of the command to supply water is limited by the ability of the division support command's water section to purify it and store it, plus the ability of the logistics system to transport it. The logistics system may not always be able to meet unit needs, particularly during decentralized operations. There are a variety of ways, however, that the unit can ensure that it is supplied.

(3) When water is not scarce, leaders must urge soldiers to drink water even when not thirsty. This is because the body's thirst mechanism does not keep pace with the loss of water through normal daily activity. The rate at which dehydration occurs will depend on the weather conditions and the level of physical exertion.

(4) If water is in short supply, be sparing in its use for hygiene purposes. Water used for coffee or tea may also be counterproductive since both increase the flow of urine. When in short supply, water should not be used to heat MREs. However, soups are an efficient means of getting both water and nutrition when water is scarce. This is especially true in cold weather when heated food is desirable. A centralized heating point can be used to conserve water yet provide warmed MREs.

(5) In most environments, water is available from natural sources. Soldiers should be trained to find, treat (chemically or using field expedients), and use natural water sources. See FM 21-76 for more information.

## **8-8. TRANSPORTATION**

Movement of supplies, equipment, and personnel with the limited vehicle assets available requires careful planning and execution. Light infantry, airborne, air assault, and ranger companies have no organic transportation. Vehicle assets are provided to these companies from battalion or higher levels. Normally one vehicle is dedicated to the company.

a. When vehicles are provided to the company, they must be employed to capitalize on their capability to execute the mission requirement, and they must be returned for

follow-on company or parent-unit missions. Transportation assets are scarce, often resulting in trade-offs. For example, upload increased quantities of ammunition and less water, or carry unit rucksacks and be unavailable for resupply. The company commander must ensure that the asset is being employed to accomplish the most important mission. Time is critical and the company must reduce on-station time so that all company requirements can be met. Most vehicles do not have radios; leaders must ensure that drivers know where they are going and how to get there. Land navigation training, marked routes, and strip maps referenced to landmarks are all ways to keep drivers from getting lost.

b. Because of the limited ground transportation, company personnel must know how to conduct aerial resupply. (See FM 90-4.) An understanding of PZs/LZs selection, sling loading, bundle drops, and allowable cargo loads may be critical to company sustainment.

### **8-9. MAINTENANCE**

The maintenance of weapons and equipment is continuous. Every soldier must know how to maintain his weapon and equipment in accordance with the related technical manual. The CO, XO, and 1SG must understand maintenance for every piece of equipment in the company.

a. The unit SOP should detail when maintenance is performed (at least once a day in the field), to what standards, and who inspects it (usually the squad leader with spot checks by the platoon sergeant, platoon leader, 1SG, XO, and CO). One technique is for each to spot check a different unit; another is for each to check a single type of weapon or piece of equipment in all units daily. These instructions must be integrated into the SOP for patrol bases, assembly areas, defenses, and reorganization. This is to ensure that maintenance is done without jeopardizing unit security, and also so it will become a habit for the soldiers.

b. In addition to operator maintenance, selected soldiers are trained to perform limited maintenance on damaged weapons and to direct exchange parts from destroyed weapons.

c. Inoperative equipment is fixed as far forward as possible. When a piece of equipment is damaged, it should be inspected to see if it can be repaired on the spot. The company armorer keeps a small-arms repair kit in the battalion trains or on the dedicated company vehicle. The battalion communications section has a limited capability to repair radios. If it cannot be fixed forward, it is evacuated immediately (in an assembly area or defense area), or turned in using the backhaul method when other supplies are brought forward. Even if the item cannot be evacuated at once, the CSS system is alerted to generate a request for a replacement. If a replacement is available (from an evacuated soldier or scavenged equipment), it will be sent forward. If not, the leader must work around it by prioritizing the use of remaining equipment; for example, using a squad radio for the company command net if the platoon radio is broken.

d. Maintenance applies to all equipment. Items such as magazines, ammunition, and batteries are also maintained and inspected. While test firing in an assembly area, mark the magazines of weapons that have stoppages. If a magazine is marked more than twice, the magazine may be causing stoppages. Inspect the ammunition belts for M60s and

---

M249s along with the weapons. Dirty or corroded ammunition may also cause weapon malfunctions.

### **Section III. SOLDIER'S LOAD**

The soldier's load is a crucial concern of the leader. How much is carried, how far, and in what configuration are important mission considerations. Army research indicates that a soldier can carry an amount equal to 30 percent of his body weight and still retain a high percentage of his agility, stamina, alertness, and mobility. Success and or survival in the operations a rifle company will conduct demand that soldiers retain these capabilities. When unable to move with stealth, agility, and alertness, the unit is at risk. For the average soldier (weighing 160 pounds), this would be a 48-pound load. For each pound over 30 percent, the soldier loses a proportional amount of his functional ability. When his load exceeds 45 percent of his body weight, or 72 pounds, his functional ability drops rapidly and the chance of him becoming a casualty increases. Research also indicates that training can improve load-carrying capability by 10 to 20 percent at best. The solution is command emphasis. COs must ensure soldiers carry no more than 48 pounds when in contact with the enemy or when enemy contact is expected. At other times, the soldier's load should not exceed 72 pounds. Sometimes soldiers may have to carry more than the recommended combat weight. Leaders must realize how that excess weight impacts on the unit's effectiveness. Appendix A in FM 21-18 has additional information on the soldier's load.

#### **8-10. LOAD PLANNING**

The purpose of load planning is two-fold. First, it allows the commander to use the estimate of the situation to determine what ammunition, supplies, and equipment are essential. Second, it recognizes the potential impact of the soldier-load problem and emphasizes the need to carry only what is necessary. The commander then arranges for the remainder of the load to be secured or transported. To do this, the soldier and unit equipment must be echeloned. For this purpose, the commander breaks the company's equipment and supplies into three echelons—combat (approach march and fighting loads), sustainment, and contingency loads (Figure 8-2).

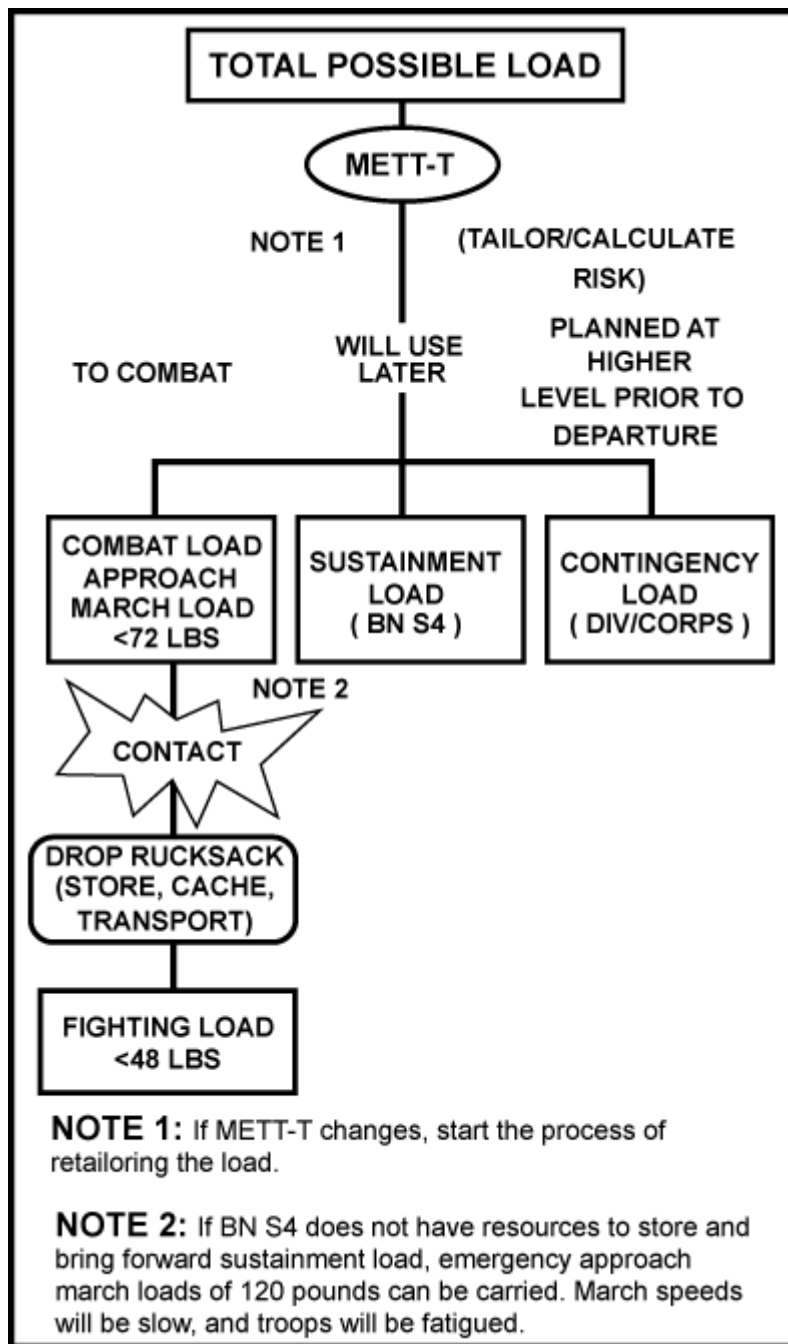

**Figure 8-2. Load echelon diagram.**

a. **Combat Load.** A combat load consists of the minimum mission–essential equipment, as determined by the mission commander. This includes only what is needed to fight and survive immediate combat operations. There are two levels of combat load: fighting loads, carried on dynamic operations where contact with the enemy is expected; and approach march loads, carried when transportation cannot be provided for equipment over and above fighting loads.

(1) *Fighting load.* This is what the soldier carries once contact has been made with the enemy. It consists of only essential items the soldier needs to accomplish his task



during the engagement. For close combat and operations requiring stealth, any load at all will be a disadvantage. Cross-loading of machine gun ammunition, mortar rounds, antitank weapons, and radio equipment will cause most combat loads to be over 48 pounds. This is where risk analysis is critical. Excessive combat loads of assaulting troops must be configured so that the excess can be redistributed or shed (leaving only the fighting load) before or upon contact with the enemy.

(2) *Approach march load*. This is the load that the soldier carries in addition to his fighting load. These items are dropped in an assault position, ORP, or other rally point before or upon contact with the enemy. On long dynamic operations, soldiers must carry enough equipment and munitions to fight and exist until a planned resupply can take place. These loads will vary and may exceed the goal of 72 pounds. Heavier approach march loads can be carried successfully in an emergency. When the mission demands that soldiers be used as porters, 100-pound loads can be carried 20 kilometers a day for several days. Loads up to 150 pounds are possible, but they present an increased risk of fatigue and injury. However, when such loads are carried—contact with the enemy must be avoided, march rate must be very slow, and soldiers must be rested before combat.

b. **Sustainment Load**. This load consists of the equipment required by the commander for sustained operations. This equipment should be stored by battalion, normally at the BSA, and brought forward when needed. It may include rucksacks, squad duffel bags, and spare equipment, such as PEWS and sleeping bags. In combat, protective items for specific threats, such as armored vests and chemical suits, may be stored in pre-configured unit loads. Equipment, such as Dragon night sights, grappling hooks and ropes, and pioneer tools, also needs to be stockpiled at a location from which the battalion support platoon can push them forward on demand. Commanders must coordinate with the S4 to ensure that those items are available.

c. **Contingency Load**. The contingency load includes all other items that are not necessary for ongoing operations, such as extra clothing, personal items, or even Dragons and TOWs in a nonarmor threat environment. The critical element is for commanders to determine what goes in those loads and who will be responsible for the storage and delivery of them.

## 8-11. LOAD CALCULATION

The combat load for each soldier consists of three components: common essential items carried (worn) by all soldiers regardless of threat, environment, or mission; duty position load, consisting of the soldier's assigned weapon (or components of the weapon system) plus ammunition; and variables, consisting of all other items carried, based on the commander's estimate of the situation. The latter are items that constitute the environmental, threat protection, and mission loads.

a. Adjust combat loads so soldiers carry less than 72 pounds and divide combat loads into fighting loads and approach march loads; have soldiers pack rucksacks and assault packs accordingly. All other company equipment goes into the sustainment or contingency load.

Example: Rifleman's combat load.

| <b>1. Common Items</b>                      | <b><u>Pounds</u></b> |
|---|----------------------|
| Battle dress uniform (BDU), boots.....      | 8.20                 |
| Pistol belt, straps, and first-aid kit..... | 1.60                 |
| Canteen, cup and cover; with water.....     | 3.30                 |
| Poncho.....                                 | 1.70                 |
| Gloves.....                                 | 0.30                 |
| Socks.....                                  | 0.30                 |
| Meals ready to eat (MRE) (1).....           | 1.00                 |
| Bayonet with scabbard.....                  | <u>1.30</u>          |
| Total:                                      | 17.70                |
| <br>  |                      |
| <b>2. Duty Load</b>                         |                      |
| M16A1 (A2) with 30-round magazine.....      | 8.20                 |
| Two ammunition pouches.....                 | 1.80                 |
| Six magazines/180 rounds.....               | 6.30                 |
| Two grenades.....                           | <u>2.00</u>          |
| Total:                                      | 18.30                |
| <br>  |                      |
| <b>3. Variables</b>                         |                      |
| <i>Environment</i>                          |                      |
| Field jacket.....                           | 3.00                 |
| Pile cap.....                               | 0.26                 |
| 2-quart canteen, cover, water.....          | 4.80                 |
| Poncho liner.....                           | <u>1.60</u>          |
| Total:                                      | 9.66                 |
| <br>  |                      |
| <i>Threat</i>                               |                      |
| Protective mask.....                        | 3.00                 |
| Helmet.....                                 | <u>3.40</u>          |
| Total:                                      | 6.40                 |
| <br>  |                      |
| <i>Mission</i>                              |                      |
| ALICE pack with frame.....                  | 6.30                 |
| Round, 60-mm mortar (1).....                | 3.50                 |
| Grenade, smoke, HC (1).....                 | 2.56                 |
| LAW (1).....                                | 4.70                 |
| Compass.....                                | <u>0.25</u>          |
| Total:                                      | 17.31                |

| <b>4. Total Combat Load</b> | <b>Pounds</b> |
|-----------------------------|---------------|
| Common items .....          | 17.70         |
| Duty load.....              | 18.30         |
| <i>Variables</i>            |               |
| Environment.....            | 9.66          |
| Threat .....                | 6.40          |
| Mission.....                | <u>17.31</u>  |
| Total:                      | 69.37         |

b. Once it has been decided what items are to be carried on the mission, the leader decides how they will be carried. Some items must always be immediately available to the soldier, while others can be carried in his rucksack.

## **8-12. LOAD MANAGEMENT TECHNIQUES**

The key is to carry only what is necessary to accomplish the mission. The following techniques will assist the commander in load management.

a. Make sure soldiers distribute their loads evenly over the body and LBE; they are easier to carry this way.

b. Carry critical items within easy reach; water, ammunition, and a first-aid pouch are carried on the LBE, other items in BDU pockets. Placement of all items should be standardized within the unit, but nothing must be allowed on the firing side of the LBE that prevents the soldier from taking a well-aimed shot.

c. Distribute loads throughout the unit. If it is necessary to manpack bulk ammunition, rations, water, or demolitions, divide them into small loads consistent with METT-T; however, ensure they can be distributed on the battlefield where needed.

d. Rotate heavy loads among several soldiers. Radios, M60s, mortars, and Dragons can all be rotated if enemy contact is not imminent. Ensure that the assigned gunner is nearby when weapon system components are rotated.

e. Always consider use of augmented transportation assets in-theater to carry loads. Host nation or allied force's vehicles, animals, civilians, and even bicycles can be used to carry soldiers and equipment; however, do not procure them without authority.

f. Drop rucksacks on enemy contact, or leave them in an ORP, an assault position, or the assembly area. The leader requests they be brought to his unit by battalion or division transportation assets when possible. Soldiers mark their rucksacks by unit to facilitate quick recovery.

g. Share or consolidate items; if the weather dictates sleeping bags be carried, carry only enough for those who will sleep at the same time. Soldiers share the bags as they take turns rotating security duty. In the same manner, two or three soldiers can share a rucksack and take turns carrying it.

h. Consider cutting rations to two or even one MRE per man per day for short periods. Use foraged or locally purchased food to extend the shortened rations.

i. While carrying the rucksack, use water and rations carried in or on it first. If soldiers must drop their rucksacks, what they carry in their BDUs and on the LBE remains available. Replace ammunition, water, and rations carried on LBE or in BDU pockets as soon as possible.

j. When carrying radios in rucksacks, keep them attached to the backpack for access and use when rucksacks are dropped.

k. Consider caches, supply linkups, captured stocks, and foraging to provide food, water, shelter, weapons, and equipment to reduce the need to manpack supplies.

l. Avoid unnecessary movement and displacements. To conserve the soldier's stamina, plan the mission as efficiently as possible. Do not move a platoon when moving a squad can do the job. The leader, if lost, stops and determines his unit's location before moving and, if necessary, sends out someone to confirm the unit's location.

m. Supervise the soldier's load closely. Soldiers may carry unnecessary items when they start on a mission and throw essential items away when they are tired. Packing lists for rucksack management and leader inspections before and during the mission ensure that only necessary items are carried. Rucksack management results in efficient use of a soldier's energy and ensures that essential items are available when needed in combat.

n. The company net does not always need the COMSEC equipment to function effectively. Ensure the threat warrants the extra weight on the RATELOs.

o. Consider distributing the approach march or sustainment loads to only two platoons. This allows the lead platoon to move with more stealth and alertness, and also unburdened in case of contact. Platoons could then quickly swap rucksacks as they assume the lead.

#### **Section IV. PERSONNEL SERVICE SUPPORT**

Expedient handling of company paperwork is necessary for both efficiency and morale. The battalion PAC provides most of the company's administrative support. Information is passed from the company to the PAC through the S1 or the PAC supervisor. Though the system is informal, the information must be accurate and timely. Company administration consists of personnel services and replacement operations.

#### **8-13. PERSONNEL SERVICES**

These services include strength accounting; casualty reporting; replacement procedures; personnel records maintenance; personnel actions, such as awards, promotions and reductions, and classifications and reclassifications; and religious support.

a. The company is responsible only for casualty reporting or requesting personnel actions.

b. Based on local SOP, a strength accounting report is sent to battalion combat trains over the admin-log net detailing strength by officer, enlisted, and attached personnel. Data for this report must be gathered as quickly and accurately as possible because this critical information assumes increasing importance in decision-making as it is passed to the rear. Strength reports help determine the quantity of rations, water, and ammunition to send to each company. These reports are also used to analyze the company's strength, posture, and status. At higher echelons, they are used to determine which units receive priority when replacements arrive.

c. A casualty report, DA Form 1156 (Figure 8-3), is filled out when a casualty occurs or as soon as the tactical situation permits. This is usually done by the soldier's squad leader and turned in to the platoon sergeant, who passes it along to the first sergeant. A brief description of how the casualty occurred, to include the place, time, and activity being performed, and who or what inflicted the wound is included. If the squad leader does not have personal knowledge of how the casualty occurred, he gets this information from any soldier who does. Pocket-size witness statements, DA Forms 1155

(Figure 8-4), are used to report missing or captured soldiers or when remains are not recovered. The form is completed by the soldier with the most knowledge of the incident. This information is used to inform the soldier's next of kin and to provide a statistical base for analysis of friendly or enemy tactics. The commander writes a letter to the soldier's next of kin.

|   |   |   |   |   |
|---|---|---|---|---|
| UNIT CASUALTY FEEDER REPORT   |   | CONTROL NO.<br><b>1</b>                                     | TYPE OF CASUALTY<br><input checked="" type="checkbox"/> Battle <input checked="" type="checkbox"/> Individual<br><input type="checkbox"/> Nonbattle <input type="checkbox"/> Multiple |   |
| REPORTING UNIT<br><b>C BATTERY 3/21ST FA</b>  |   |   | INFLECTING FORCE<br><input checked="" type="checkbox"/> Enemy <input type="checkbox"/> Allied<br><input type="checkbox"/> US <input type="checkbox"/> Other                           |   |
| DATE / TIME OF INCIDENT<br><b>12 NOV 82</b>   |   | LOCATION OF INCIDENT<br><b>AB/22344.FULDA. FBG</b>          |   |   |
| INDIVIDUAL DATA   |   | <input type="checkbox"/> SEE ATTACHED ROSTER OF _____ NAMES |   |   |
| NAME<br><b>FOE, ROBERT</b>  |   |   |   |   |
| SSN<br><b>000-00-0000</b>   |   | RANK<br><b>SP4</b>  | UNIT<br><b>C BATTERY 3/21ST FA</b>  |   |
| Killed in Action / Injured  |   | <input checked="" type="checkbox"/>                         | Missing in Action / Injured   |   |
| Wounded in Action / Injured   |   |   | Captured  |   |
| Duty Status<br><b>PDY</b>   | Rec'd Religious Ministration<br><input type="checkbox"/> YES <input checked="" type="checkbox"/> NO |   | Remains Recovered<br><input type="checkbox"/> YES <input checked="" type="checkbox"/> NO  | Remains Identified<br><input type="checkbox"/> YES <input checked="" type="checkbox"/> NO |
| Evacuated <input checked="" type="checkbox"/> NO <input type="checkbox"/> YES, to   |   |   |   |   |
| DA FORM 1184  |   |   |   |   |
| UNIT ACTIVITY AT TIME OF INCIDENT<br><b>NIGHT TIME DEFENSIVE POSITION.</b>  |   |   |   |   |
| INDIVIDUAL CIRCUMSTANCES<br><b>SP4 FOE WAS THE RADIO OPERATOR FOR SGT. JONES, WHO WAS ATTACHED TO OUR UNIT FOR A MISSION. THEY LEFT THE PERIMETER AT 2000 ON 12NOV 82 TO CONDUCT A PATROL. NEITHER ONE RETURNED THEY DONT ANSWER THE RADIO. FIRING WAS HEARD FORWARD OF OUR POSITION AT 2200 HOURS.</b> |   |   |   |   |
| Line of Duty (Nonbattle only)<br><input type="checkbox"/> YES <input type="checkbox"/> NO <input type="checkbox"/> UNDETM   |   | LOD Authentication (Cdr or Med Pers only)                   |   |   |
| VEHICLE INVOLVED (Nonbattle only) <input type="checkbox"/> YES <input type="checkbox"/> NO  |   |   |   |   |
| TYPE  | OWNERSHIP   | POSITION ABOARD VEHICLE                                     |   |   |
| AUTHENTICATION  |   |   |   |   |
| NAME<br><b>SMITH, JACK C</b>  | RANK<br><b>1SG</b>  | SSN<br><b>000-00-0000</b>                                   | UNIT<br><b>C BATTERY 3/21ST FA</b>  |   |
| DATE<br><b>13 NOV 82</b>  | SIGNATURE OF INDIVIDUAL PREPARING REPORT<br><b>Jack C. Smith</b>                                    |   |   |   |

Figure 8-3. Casualty report.

|   |                            |   |                              |                    |
|---|----------------------------|---|------------------------------|--------------------|
| <b>WITNESS STATEMENT ON CASUALTY INCIDENT</b><br>(AR 800-10)  |                            | <b>CHECK APPLICABLE BOX</b><br><input type="checkbox"/> Killed in Action/Dead (remains not recovered)<br><input type="checkbox"/> Wounded in Action/Injured<br><input checked="" type="checkbox"/> Missing in Action/Missing<br><input type="checkbox"/> Captured |                              |                    |
| 1. LAST NAME, FIRST NAME MI (of casualty)<br><b>FOE, ROBERT</b>   |                            | 2. SSN  | 3. RANK<br><b>SPC</b>        | 4. SEX<br><b>M</b> |
| 5. ORGANIZATION<br><b>C BATTERY 3/2/ST FA</b>   |                            | 6. DATE OF DEATH OR WHEN LAST SEEN<br><b>2030, 12 NOV 82</b>  |                              |                    |
| 7. GEOGRAPHICAL LOCATION OF INCIDENT (Include grid coordinates and nearby town)<br><b>AB 122 344 FULDA, FBG</b>   |                            | 9. OTHER PERSONS WHO MAY HAVE WITNESSED THIS INCIDENT OR HAVE FURTHER INFORMATION<br><b>1SG SMITH C BATTERY FA</b>  |                              |                    |
| 9. CIRCUMSTANCES SURROUNDING INCIDENT (If known, include cause of death or condition when last seen, or how identified)<br><b>SP4 FOE WAS THE RADIO OPERATOR FOR 2LT JONES WHO WAS ATTACHED TO OUR PLATOON FOR A MISSION.</b>                       |                            |   |                              |                    |
| DA FORM 1156 <span style="float: right;">REPLACES EDITION OF 1 JUN 66, WHICH WILL BE ISSUED AND USED UNTIL EXHAUSTED.</span>  |                            |   |                              |                    |
| 9. CIRCUMSTANCES SURROUNDING INCIDENT (Continued)<br><br><b>HE WENT ON PATROL WITH SGT JONES ON 12 NOV 82. HE LEFT OUR LINES AT 2030. NEITHER ONE RETURNED. THEY DONT ANSWER THE RADIO. FBG WAS HEARD FORWARD OF OUR POSITION ABOUT 2200 HOURS.</b> |                            |   |                              |                    |
| 10. NAME OF PERSON MAKING STATEMENT<br><b>Q.T. WILLIAMS</b>   |                            | 11. RANK<br><b>PSG</b>  | 12. SSN<br><b>000-00-000</b> |                    |
| 13. UNIT<br><b>C BATTERY 3/2/ST FA</b>  | 14. DATE<br><b>13NOV82</b> | 15. SIGNATURE<br><b>Q.T. Williams</b>   |                              |                    |

Figure 8-4. Witness statement.

### 8-14. REPLACEMENT OPERATIONS

Integrating replacements into a company is important. A new arrival on the battlefield may be scared and disoriented as well as unfamiliar with local SOPs and the theater of operations.

a. The company commander should meet them and welcome them to the unit. This will normally be a brief interview. The commander must have an SOP for reception and integration of newly assigned soldiers.

b. The platoon leader and platoon sergeant will welcome them to the unit, inform them of unit standards, and introduce them to their squad leaders.

c. The squad leader introduces them to the squad and briefs them on their duty positions. He also ensures that each replacement has a serviceable, zeroed weapon; ammunition; MOPP gear; and other essential equipment. The in-briefing should cover squad and platoon recent, current, and planned activities.

d. The new arrival is told about important SOPs and special information concerning the area of operations. He may be given a form letter to send to his next of kin. The letter should tell them where to mail letters and packages, tell them how to use the Red Cross in emergencies, and introduce them to the chain of command.

## **Section V. MEDICAL SUPPORT**

At company level, health services support addresses three areas: preventive medicine, medical treatment, and evacuation of casualties. Each rifle company has at least three aidmen from the battalion medical platoon's combat medic section attached to perform routine and emergency combat medical services.

### **8-15. PREVENTIVE MEDICINE**

Emphasis is placed on prevention since soldiers may become combat ineffective from disease or nonbattle injury as well as from combat wounds. By understanding and applying the principles of field hygiene, preventing weather-related injuries, and paying attention to the soldiers' overall condition, some casualties may be prevented. (See FMs 21-10 and 21-11.)

### **8-16. TREATMENT**

Casualties are a certainty in war, and the leader must assure health service support is available. The platoon medic is trained to evaluate, triage, and treat casualties. The treatment of serious casualties usually means stabilizing the soldier until he can be evacuated to the battalion aid station. The unit SOP should call for at least one infantryman per squad to be trained as combat lifesavers to assist the medic in treating and evacuating casualties. Since aidmen and combat lifesavers cannot be everywhere on the battlefield, every soldier must be trained to provide basic first aid.

### **8-17. EVACUATION OF CASUALTIES**

Effective casualty evacuation will provide a major increase in the morale of a unit. Casualties are treated where they fall (or under nearby cover and concealment) by a medic, combat lifesaver, or fellow soldier.

a. During the fight, casualties often are left where they received initial treatment (self-aid, buddy-aid). As soon as the situation allows, casualties are moved to the platoon collection point. They can then be evacuated directly to the battalion aid station or to the company collection point, which is designated by the commander during the OPORD. The unit SOP should address this activity and include marking casualties during limited visibility operations. Small, standard, or IR chemical lights work well for this purpose. Once the casualties have been collected, evaluated, and triaged, further evacuation to the battalion casualty collection point or aid station begins. Normally, the battalion aid station is collocated with the battalion casualty collection point.

b. An effective technique, particularly during an attack, is to task-organize a logistics team under the ISG. These soldiers carry additional ammunition forward to the

platoons and evacuate casualties to either the company or the battalion casualty collection point. The size of the team is determined by the leader during his estimate.

c. When the company is widely dispersed, the casualties may be evacuated directly from the platoon casualty collection point by vehicle or helicopter. Often, helicopter evacuation is restricted due to the enemy ADA threat. In some cases, the casualties must be moved to the company casualty collection point before evacuation. When the battalion's organic ambulances are not enough to move all the wounded, unit leaders may direct supply vehicles to "backhaul" casualties to the battalion aid station after supplies are delivered. In other cases, the platoon sergeant may direct platoon litter teams to carry the casualties to the rear.

d. Leaders must minimize the number of soldiers required to evacuate casualties. Casualties with minor wounds can walk or even assist carrying the more seriously wounded. Field expedient litters can be made by cutting small trees and putting the poles through the sleeves of buttoned BDU blouses. A travoise, or skid, may be used for casualty evacuation. This is a type of litter on which wounded can be strapped, and it can be pulled by one person. It can be locally fabricated from durable, rollable plastic on which tie-down straps are fastened. FM 7-20 discusses a SKEDS litter that is available for issue.

e. In rough terrain (or on patrols), casualties may be evacuated to the battalion aid station by litter teams, carried with the unit until transportation can reach them, or left at a position and picked up later.

f. Unit SOPs and OPODs must address casualty evacuation in detail. They should cover the duties and responsibilities of key personnel; the evacuation of chemically contaminated casualties (on separate routes from noncontaminated); and the priority for manning key weapons and positions. They should specify preferred and alternate methods of evacuation and make provisions for retrieving and safeguarding the weapons, ammunition, and equipment of casualties. Slightly wounded personnel are treated and returned to duty by the lowest echelon possible. Sick soldiers are evaluated by medics in the platoon and either treated or evacuated as necessary. Remains are kept covered, separated from the wounded, and evacuated by backhaul on supply vehicles as soon as possible. Casualty evacuation should be rehearsed like any other critical part of an operation.



## APPENDIX A

# LOW INTENSITY CONFLICT

*The possibility of US forces becoming involved in a low intensity conflict is ever increasing. This appendix discusses the categories of LIC and possible missions in each category; an environmental overview; conducting roadblocks, checkpoints, and searches; and special considerations, including working with SOF when conducting LIC operations.*

### Section I. OPERATIONAL CATEGORIES

Military operations in LIC fall under four operational categories. The roles within each category often overlap. This section discusses each category. It also identifies the types of operations and missions the infantryman can be given in each category.

#### **A-1. SUPPORT FOR INSURGENCY AND COUNTERINSURGENCY**

The primary objective in an insurgency is to gain support for a revolution. In counterinsurgency, the objective is to counter the revolution.

a. Within this category, US interest may lie with an incumbent government or with an insurgent. The infantry company will usually be involved only in counterinsurgency operations.

b. Possible missions for infantry companies include:

- Advising and training host nation forces.
- Security of US/host nation facilities and equipment.
- Joint/combined training exercises.
- Humanitarian or civic assistance.
- Populace and resource control.
- Combat and security patrols.
- Defense of operational support bases.
- Establishing roadblocks.
- Establishing checkpoints.
- Cordon and search parties.
- Hasty attacks.
- Deliberate attacks.
- Movements to contact.

#### **A-2. PEACEKEEPING OPERATIONS**

These PKOs are military operations conducted with the consent of the belligerent parties to maintain a negotiated truce and to facilitate a diplomatic resolution. The US may take part in PKOs under the control of an international organization, in cooperation with other countries, or independently.

a. The US has very seldom committed forces in a peacekeeping role. The UN normally employs international peacekeeping forces composed of non-aligned nations

who can be neutral. If employed, the US force will probably be a battalion-sized task force or larger.

b. As part of a PKO, an infantry company can expect to perform the following missions:

- Manning check points/OPs.
- Patrolling.
- Controlling traffic.
- Preventing or dispersing prohibited demonstrations.
- Searching for missing persons.
- Clearing mines.
- Gathering information.
- Marking buffer zones.
- Receiving and transferring POWs and KIAs.
- Providing humanitarian assistance.

### **A-3. PEACETIME CONTINGENCY OPERATIONS**

PCOs are politically sensitive military operations normally characterized by a rapid deployment of forces in response to a specific problem.

a. The forces employed are tailored to the situation. They are employed as joint, combined, or both. Infantry companies will usually be a part of a larger task force; however, an infantry company could be the only maneuver force in country in some PCOs.

b. Some PCOs an infantry company may support or take part in are as follows:

- Show of force/demonstration.
- Strike and raid operations.
- Noncombatant evacuation operations.
- Rescue and recovery operations.
- Support to US civil authorities.
- Disaster assistance.
- Counterdrug operations.
- Civil disturbance operations.

### **A-4. COMBATting OF TERRORISM**

The aim of combatting terrorism is to protect installations, units, and individuals. Combatting terrorism involves coordinated action before, during, and after terrorist incidents.

a. The infantry company combats terrorism through the integration of higher headquarters physical security, crime prevention, and OPSEC programs.

b. In any tactical environment, a terrorist attack is possible. The CO must take the appropriate actions to protect his unit from acts of terrorism. See FM 100-37 for terrorism counteraction.

---

## **Section II. ENVIRONMENT**

Low intensity conflict can occur in any part of the world. Units must have the ability to operate in any terrain and climate, be it jungle, mountain, desert, swamp, or arctic tundra. In addition, LIC is most likely to develop in a nation with social, political, economic, and psychological factors that contribute to political instability. Each developing nation is unique; each has its own history, culture, goals, and problems. Due to unstable systems, the US forces deployed into these areas are subject to rapid and drastic changes in missions and situations. The infantry company commander must understand this environment and plan for rapid changes in mission. The following are considerations peculiar to a LIC environment.

### **A-5. COMMAND RELATIONSHIP**

The command relationship normally follows the guidelines of standard levels of command. However, there are situations in which the CO could find himself receiving directives from the theater commander, CINC, or even the president. In addition, as forces react to a situation, the on-site infantry company commander (or even platoon leader) could be in charge of several different organizations that include senior officers.

### **A-6. RULES OF ENGAGEMENT/RULES OF CONFRONTATION**

The ROE are based on political considerations, the threat, and the tactical situation. They are directed by higher military authorities. At times, the ROE may conflict with the protection of US forces. Infantry companies will have to operate in this highly constrained and stressful environment. This requires the utmost patience, training, and discipline. Commanders must ensure that the ROE are complied with. This may require modifying many combat skills and will require establishing extensive training and awareness programs. In addition to the ROE, the infantry company may receive ROC, which provide guidance for dealing with confrontations short of combat engagements. Every soldier must understand the ROE/ROC and the actions to take in every possible confrontation.

### **A-7. SOCIOLOGY**

In LIC, operations are conducted in an environment with foreign languages, customs, practices, and religions. Each soldier is considered an ambassador of the US. Company commanders must ensure their soldiers understand their role and conduct themselves in a manner that gains the support of the local populace.

### **A-8. LEGAL STATUS**

Company commanders and their subordinates must be familiar with the legal basis for their presence in a foreign country. They should understand the basic rules of international and domestic law, and the major restrictions imposed upon them by law.

### **A-9. INTELLIGENCE GATHERING**

In LIC, every individual is an intelligence-collecting instrument. This includes friendly forces, enemy elements, and the local populace. From the friendly standpoint, each soldier must be familiar with local PIRs and IRs. The collection of information is a continuous process and all information must be reported. The enemy are continuously seeking intelligence on US actions, and they often blend easily with the civilian population. The US soldiers must be aware of this ability and use OPSEC at all times.

### **Section III. ROADBLOCKS, CHECKPOINTS, AND SEARCHES**

Roadblocks, checkpoints and searches are all used to control the movement of vehicles, personnel, or materiel along a specific route. Established infantry doctrine, tactics, techniques, and procedures still apply when operating in a LIC environment, but they may require changes to fit the circumstance. For additional information, see FMs 7-8 and 7-20.

### **A-10. ROADBLOCKS AND CHECKPOINTS**

A roadblock is used to limit the movement of vehicles along a route or to close access to certain areas or roads. Checkpoints are manned locations used to control movement. A roadblock is used with a checkpoint to channel vehicles and personnel to the search area. Roadblocks may be set up on a temporary, surprise basis or may be semi-permanent in nature. They are used—

- To maintain a continuous check on road movement, to apprehend suspects, and to prevent smuggling of controlled items.
- To prevent infiltration of unauthorized civilians into or through a controlled area.
- To check vehicles for explosive devices.
- To ensure proper use of routes by both civilian and military vehicles.
  - a. Since roadblocks cause considerable inconvenience and even fear, ensure that the civil population understands the roadblocks are a preventive and not a punitive measure.
  - b. Armored vehicles make very effective mobile roadblocks and checkpoints. Local security must be provided.
  - c. Roadblocks and checkpoints may be either deliberate or hasty. The deliberate roadblock or checkpoint is a relatively fixed position in a town or in the open country, often on a main road. It acts as a useful deterrent to unlawful movement. The hasty roadblock or checkpoint is highly mobile and is quickly positioned in a town or in the open country. Its actual location is designed to achieve surprise.
  - d. Conceal the roadblock or checkpoint when possible. The location should make it difficult for a person to turn back or reverse a vehicle without being observed. Culverts, bridges, or deep cuts may be suitable locations. Positions beyond sharp curves have the advantage that drivers do not see the checkpoint in sufficient time to avoid inspection. However, it should not be positioned so that it is such a sudden surprise drivers will not have enough time to stop safely.
  - e. A roadblock/checkpoint requires adequate soldiers to provide security. A security force is concealed an appropriate distance (100 to several hundred meters in the direction of approaching traffic) from the roadblock or checkpoint to prevent the escape of any vehicle or person attempting to turn back upon sighting the checkpoint. The vehicle, driver, and passengers are searched. If the roadblock or checkpoint is manned for any

length of time, part of the force is allowed to rest. The rest area is located near the search area so that the soldiers can be assembled quickly as a reserve force. If possible, the area designated for searching vehicles is below ground level (for example, "turret down") to deflect an explosive blast upward.

f. For a roadblock/checkpoint to achieve maximum results, special equipment is required.

(1) *Signs*. Portable signs in the native language and in English must be available. Signs should denote the speed limit of approach, vehicle search area, vehicle parking area, male and female search areas, and dismount point.

(2) *Lights*. Adequate lighting is essential for the search area at night.

(3) *Communication*. Radio or land line communication is required between the various locations supporting the checkpoint operation. These include the security position, the rest area, the search area, and the company commander.

(4) *Barriers*. Obstacles across the road and around the search area should be provided. Clearly marked barbed wire, busses parked sideways in the road, felled trees, or any other readily available strong object will work. Obstacles must be strong and big enough to prevent motorists from driving through or around them.

(5) *Firepower*. Soldiers must have adequate firepower to withstand an attack or to halt a vehicle attempting to flee or crash through the checkpoint.

(6) *Linguists*. Soldiers familiar with the native language are essential on all roadblocks or checkpoints.

#### **A-11. ESTABLISHMENT OF CHECKPOINTS AND ROADBLOCKS**

The checkpoint and roadblock is established by placing two parallel obstacles across the road. In addition to having barriers large enough to prevent someone from running over or through them, barriers should have a gap negotiable only by slowly moving vehicles.

a. The separation between obstacles depends on the amount of traffic that is held in the search area. The blocked section of road can be used as the search area. If possible, there should be a place adjacent to the road where large vehicles can be searched without delaying the flow of traffic.

b. Areas are required for searching female suspects and detaining persons for further interrogation. If possible, the personnel manning a checkpoint should include a member of the civil police; an interpreter; and a trained, female searcher. When searching a vehicle, all occupants are made to get out and stand clear of the vehicle. The driver should be made to watch the search of his vehicle. The searcher always has an assistant to watch the passengers and provide additional security. Politeness and consideration should be shown at all times when searching. The occupants of the vehicle can be searched at the same time if sufficient searchers are available.

#### **A-12. SEARCHES**

A search may be oriented on people, on materiel, on buildings, or on terrain. It usually involves both civil police and military personnel.

a. **Considerations**. Since misuse of search authority can adversely affect the ultimate outcome of operations, seizure of contraband, evidence, intelligence material, supplies, or minor items during searches must be accomplished lawfully and properly recorded to be of future legal value. Proper use of authority in searches gains the respect

and support of the people. See FM 7-20 for more information concerning search authorization.

(1) Military personnel must be aware that they perform searches only in areas within military jurisdiction (or where otherwise lawful) for purposes of apprehending suspects or securing evidence that tends to prove an offense has been committed.

(2) Search teams have detailed instructions on controlled items. Lists of prohibited or controlled distribution items should be distributed.

(3) Search operations involving US forces may be ineffective when language differences prevent full communication with the indigenous population. Platoons and squads given a search mission are provided with interpreters as required.

(4) The pace of a search operation is slow enough to allow for an effective search, but rapid enough to prevent the enemy from reacting to the threat of the search.

(5) If active resistance develops, use the least force possible to respond. If the threat is high, the search may be conducted more like a tactical mission. For example, when searching a building, the unit is organized and prepared to assault the building. But the searchers only initiate fires in self defense. The search teams are organized in 2- to 3-man teams. They use the same basic techniques for clearing a room (FM 90-10-1) as in combat; however, instead of coming through a window or kicking in the door, they knock and inform the occupants of their actions. They cover each other as they search the rooms and are prepared to fight at any time.

b. **Search of Individuals.** Anyone in an area to be searched can be an insurgent or a sympathizer. However, searchers must avoid making an enemy out of a suspect who may, in fact, support the host country government. It is during the initial handling of a person about to be searched that the greatest caution is required. One member of a search team always covers the other one who is making the actual search. FM 7-8 covers procedures for searching individuals.

c. **Search of Females.** The enemy may use females for all tasks where search may be a threat. If female searchers cannot be provided, consider using the medic to search female suspects. When male soldiers must search females, take every possible measure to prevent accusations of sexual molestation or assault.

### A-13. CORDON AND SEARCH OPERATIONS

A basic principle when searching a built-up area is to limit the inconvenience to the population. They should be inconvenienced to the point where insurgents and sympathizers are discouraged from remaining in the locale, but not to the point that they collaborate with the enemy as a result of the search. Avoid physical reconnaissance of the area just before a search.

a. **Command and Control.** Normally, a search is controlled by the civil police with the military in support. A search involving a large force may be controlled by the military commander with the civil police in support. Regardless of the controlling agency, the actual search is performed by host country police when they are available in adequate numbers and have been trained in search operations.

b. **Rehearsal.** Search techniques in built-up areas are required for searching either a few isolated huts or buildings, or for searching well-developed urban sections. Therefore, search operations in built-up areas require thorough preparation and rehearsal.

c. **Conduct of the Search.** During searches of built-up areas, divide the area into zones and assign a search party to each. A search party consists of a search element (to conduct the search), a cordon element (to encircle the area to prevent entrance and exit, and to secure open areas), and a reserve element (to assist, as required).

(1) The search element conducts the mission assigned for the operation. Normally, it is organized into special teams. These teams may include personnel and special equipment for handling of prisoners, interrogation, documentation (recorder with camera), demolitions, PSYOPS/civil affairs, mine detection, fire support, scout dog employment, and tunnel reconnaissance.

(2) The cordon element surrounds the area while the search element moves in. Members of the cordon element orient primarily to prevent escape from the search areas; however, they must also keep out any insurgents trying to reinforce. Checkpoints and road blocks are established.

(3) The reserve element is a mobile force located nearby. Its specific mission is to assist the other two elements. In addition, it is capable of replacing or reinforcing either of the other two elements should the need arise.

d. **Additional Considerations.** Any enemy material found, including propaganda signs and leaflets, may be boobytrapped; consider it so until inspection proves it safe. Thoroughly search underground and underwater areas. Suspect any freshly excavated ground; it could be a hiding place. Use mine detectors to locate metal objects underground and underwater.

#### **Section IV. SPECIAL CONSIDERATIONS**

In LIC, the infantry will use the same individual and collective skills for conducting combat operations as in a conventional war. The only difference is the restrictions placed on operations. Combat techniques and procedures are modified to correspond with the ROE and ROC.

#### **A-14. ATTRIBUTES**

There are a number of special skills, talents, and attributes that must be developed to be sensitive to the needs of the local population as well as to be protective of US forces in accomplishing the mission. The attributes of leadership and discipline are important in all military operations. In LIC, they have added significance.

a. **Leadership.** The leaders within the company must be innovative, imaginative, flexible, and disciplined. They must be able to conduct small-scale operations over extended distances. They must execute assigned missions within the established ROE/ROC while at the same time protecting their subordinates. They must make quick decisions that are within the established guidelines and do not jeopardize US interests and objectives. Leaders must instill a high level of discipline within their soldiers.

b. **Discipline.** Disciplined soldiers are a critical element in the performance of US forces in LIC. Soldiers must comply with the rules of engagement. They must have the discipline to cope with the stress of day-to-day operations, adjust psychologically to enemy operations that may include acts of terrorism, and display acceptable practices to the local populace. The CO must take the following actions to instill the needed discipline.

(1) Train every soldier for possible contingencies based on METT-T.

(2) Maintain a continuous training program on the threat and the US relationship with the local government and civilian populace.

(3) Keep the soldiers informed of what is required of them, the current situation, and the reasons for actions taken by the unit.

(4) Establish recreational, educational, and other training programs.

(5) Encourage and establish communication between soldiers and home stations, families, and personal affairs personnel.

#### **A-15. SPECIAL OPERATING FORCES**

Because of the decentralized nature of LIC, it is probable that an infantry company may work with SOF. These missions are usually coordinated at brigade level; however, there may be times when the SOF unit coordinates directly with the company. The key to the success of such operations is to decentralize the requirements to ensure a quick response to the situation without time-consuming coordination and a need for approval that may result in a lost opportunity.

a. Special operating forces, particularly special forces personnel because of their expertise with the language and the area, may be able to provide the infantry unit valuable information about the local populace. During operation "Just Cause", an infantry rifle company from the 3rd Brigade, 7th Infantry Division was supported by a navy SEAL team in crossing a waterway into Colon to clear the city. SOF may support infantry units—

(1) By interfacing with the local people/agencies.

(2) By interfacing with other US agencies in the area.

(3) By providing limited PSYOPs and civil affairs support.

(4) By providing language capability or expertise of the local area.

b. Another example, also during "Just Cause", is when a rifle company from the 3d Battalion, 27th Infantry worked directly with a SF A-Team. The rifle company isolated a village while the SF personnel talked the PDF commander into surrendering his force. This was accomplished without a shot being fired because the rifle company's show of force was complemented by the SF team's language capability and knowledge of the local area and people. Likely missions for an infantry company working with SOF include:

(1) Providing a reaction force or reinforcement during direct action or special reconnaissance missions.

(2) Conducting a linkup/relief in place.

(3) Isolating areas or objectives.

(4) Augmenting/supporting civil affairs or PSYOPs personnel.

#### **A-16. TRAINING PROGRAMS**

Company training programs must emphasize physical and mental conditioning and provide acclimation to the operation environment. Emphasis must be placed on the required combat skills. In addition to common skills, sustainment training is required for—

- Cross-training of personnel in all types of weapons, communications, and other unit equipment.
- Training in the use of nonorganic/indigenous country equipment, such as shotguns, boats, hand-held automatic weapons, and mine detectors.



- Training in identifying/dismantling mines and booby traps.
- Learning a few words in the native language.
- Understanding threat tactics, techniques, and procedures.
- Understanding ROE/ROC.
- Gaining knowledge of local inhabitants, to include customs, religion, courtesies, and drinking/food habits.

## APPENDIX B

# LIGHT/HEAVY OPERATIONS

*Infantry units are often supported by heavy forces. An estimate of the tactical situation will determine the mixture and command relationship (attached versus OPCON). Tactics and techniques explained in this appendix are for infantry working with such armored vehicles as the M1 (series), M60A3, M551, M2, and M3. They also apply in the event the infantry rifle company is attached to a heavy battalion. The fundamentals and principles stated previously in this manual for offense, defense, and other tactical operations still apply. Additionally, infantry leaders must understand the tactical doctrine for employing a heavy company-team (FM 71-1), a tank platoon (FM 17-15), and a mechanized infantry platoon (FM 7-7, FM 7-7J).*

### **B-1. VEHICLE CHARACTERISTICS**

To effectively employ any unit, the leader must understand the specific capabilities and limitations of the unit and its equipment.

a. **Tanks.** The M1 series and M60A3 tanks provide rapid mobility combined with excellent protection and highly lethal, accurate fires. They are most effective in generally open terrain with extended fields of fire.

(1) *Mobility.*

(a) Capabilities. The tank's mobility comes from its capability to move at high speed both on and off road. The ability to cross ditches; ford streams and shallow rivers; and to push through small trees, vegetation, and limited obstructions allows effective movement in various types of terrain.

(b) Limitations. Tanks (especially the M1) consume large quantities of fuel. They are very noisy (especially the M60A3), and all tanks must be started periodically in cold weather or when using the thermal night sight and radios to ensure the batteries stay charged. The noise, smoke, and dust generated by tanks make it difficult for the infantry in their vicinity to capitalize on stealth to achieve surprise. Tanks cannot cross bodies of water deeper than 4 feet without deep water fording kits or bridging equipment.

(2) *Firepower.*

(a) Capabilities. The tank's main gun is extremely accurate and lethal at ranges out to 2,500 meters. Tanks with stabilized main guns can fire effectively even when moving at high speeds cross-country. The tank remains the best antitank weapon on the battlefield. The various machine guns (tank commander's caliber .50 and 7.62-mm coax and the loader's 7.62-mm MG on the M1) provide a high volume of supporting fires for the infantry. The target acquisition capabilities of the tank exceed the capability of all systems in the infantry battalion. The thermal sight provides a significant capability for observation and reconnaissance. It can also be used during the day to identify heat sources (personnel and vehicles) even through light vegetation. The laser range finder provides an increased capability for the infantry force to establish fire control measures (such as trigger lines and TRPs), and to determine exact locations.

(b) Limitations. The normal, basic load for the tanks main gun is primarily APDS antitank rounds. These rounds are not as effective against light armored or wheeled vehicles, bunkers, trenchlines, buildings, or enemy personnel. They also present a safety problem when fired over the heads of exposed infantrymen due to the discarded sabot pieces that fall to the ground. (See paragraph B-2) HE ammunition will provide better destructive effects on the above mentioned targets except enemy personnel, which the tank's machine guns are most effective against. The resupply of all tank ammunition is difficult and requires logistic support from the heavy battalion.

(3) *Protection.*

(a) *Capabilities.* Generally, the tank armor provides excellent protection to the crew. Across the frontal 60-degree arc, the tank is impervious to all weapons except heavy AT missiles or guns and the main gun on enemy tanks. When fighting with the hatches closed, the crew is impervious to all small arms fire, artillery rounds (except a direct hit), and AP mines. The tank's smoke grenade launcher and on-board smoke generator provide rapid concealment from all but thermal observation.

(b) *Limitations.* The tank is most vulnerable to lighter AT weapons from the flanks, top, and rear. The top is especially vulnerable to precision-guided munitions (artillery or air delivered). AT mines can also destroy/disable the vehicle. When fighting with hatches closed, the tank crew's ability to see, acquire, and engage targets (especially close-in infantry) is greatly reduced.

b. **Infantry Fighting Vehicle.** The M2/M3 provide good protection and mobility combined with excellent firepower. They operate best on the same terrain as the tank; however, their reduced protection when compared to the tank is a major employment consideration.

(1) *Mobility.*

(a) *Capabilities.* The mobility of the M2/M3 is comparable to the tank. Unlike the tank, the M2/M3 can swim large bodies of water in current up to 6.4 kilometers per hour. Entry and exit points must be available or prepared. In addition to the three-man crew, the vehicle is designed to carry six additional infantrymen.

(b) *Limitations.* The M2/M3 consume significant quantities of fuel. They are louder than the M1, and the engine must be started periodically in cold weather or when using the thermal night sight and radios to ensure the batteries stay charged. The noise, smoke, and dust generated by mechanized forces make it difficult for the infantry to capitalize on their ability to move with stealth and avoid detection when moving on the same approach.

(2) *Firepower.*

(a) *Capabilities.* The primary weapon on the M2/M3 is the 25-mm chain gun that fires APDS, HEI-T, and TPT. This weapon is extremely accurate and lethal against lightly armored vehicles, bunkers, trenchlines, and personnel at ranges out to 2,000 meters. The stabilized gun allows effective fires even when moving cross-country. The TOW provides an effective weapon for destroying enemy tanks or other point targets at extended ranges. The 7.62-mm coax provides a high volume of suppressive fires for self defense and supporting fires for the infantry. The combination of the stabilized turret, thermal sight, high volume of fire, and mix of weapons and ammunition (TOW, 25-mm, and 7.62-mm), makes the M2/M3 an excellent suppression asset supporting infantry assaults. The target acquisition capabilities of the M2/M3 exceed the capability of the other systems in the infantry battalion. The thermal sight provides a significant capability for observation and reconnaissance. It can also be used during the day to identify heat sources (personnel and vehicles) even through light vegetation.

(b) *Limitations.* When operating the thermal sight with the vehicle engine off, a "clicking" sound can be heard at a considerable distance from the vehicle. The resupply of ammunition is more difficult and will require external logistic support.

(3) *Protection.*

(a) **Capabilities.** Overall, the M2/M3 provides good protection. When fighting with the hatches closed, the crew is well protected from small-arms fire, fragmentation munitions, and AP mines. The M2/M3 smoke-grenade launcher and on-board, smoke generator provide rapid concealment from all but thermal observation.

(b) **Limitations.** The vehicle is vulnerable from all directions to any AT weapons and especially enemy tanks. AT mines will destroy/disable the vehicle. When the crew is operating the vehicle with the hatches open, they are vulnerable to small-arms fire.

c. **M551 Sheridan.** The M551 is a light reconnaissance vehicle that provides good firepower and mobility, but somewhat limited protection because of relatively thin armor.

(1) *Mobility.* Except for its dash speed, the Sheridan's mobility is roughly comparable to the M2/M3.

(2) *Firepower.* The primary weapon on the M551 is a 152-mm gun/launcher. It fires HEAT and HEP rounds and also a Shillelagh antitank missile. It also has a 7.62-mm coax MG and a caliber .50 MG for suppression. Although the M551 has an antitank capability, it is not designed to fight enemy main battle tanks. The fire control system is not stabilized.

(3) *Protection.* The M551's protection is about the same as the M2/M3.

d. **M113.** The M113 is a lightly armored personnel carrier that provides good mobility combined with fair firepower and protection.

(1) *Mobility.* The mobility of the M113 is significantly less than the M2/M3 in both speed and obstacle negotiating capability. A nine-man squad can ride inside and additional soldiers can ride on top if rope is lashed on to allow them to hold on. The M113 consumes significantly less fuel than the M2/M3. It is designed to swim deep bodies of water provided the current is minimal (1.5m/sec) and entry/exit points are available.

(2) *Firepower.* The M113's primary weapon system is the caliber .50 MG. It is not stabilized, requires the gunner to be exposed while firing, and is not accurate when fired on the move. From a stationary position, it can suppress area targets out to its maximum effective range of 1,800 meters. Most gunners can suppress point targets out to 700 meters. There is also a tripod and T&E mechanism available for dismounting the weapon and firing from a well-prepared fighting position. Although it is heavy, the weapon system can be broken down into manageable soldier loads and carried for short distances cross country.

(3) *Protection.* The M113 provides protection from small-arms fires (7.62-mm and smaller) and fragmentation munitions.

## **B-2. SAFETY CONSIDERATIONS**

Infantry leaders at all levels need to be aware of safety when operating with armored vehicles. Leader awareness and involvement is particularly important if the infantry unit has had little training with armored vehicles. All personnel in the unit must be aware of these considerations and remain alert during light/heavy operations to prevent any unnecessary casualties.

a. Armored vehicle, especially tank, crews are unable to see infantry soldiers close to the vehicle. This is compounded when operating during limited visibility or when the hatches are closed. The crews' observation is focused on the enemy or potential enemy

locations and not on avoiding soldiers in their vicinity. It is the infantry soldier's responsibility to be alert and to maintain a safe position in relation to the vehicle.

b. Infantry soldiers close to armored vehicles are also exposed to the effects of any fire that the enemy may direct against the armored vehicles. This is true during movements and in stationary positions. The infantry's ability to avoid detection is severely degraded when in the vicinity of the armored vehicles. Even when required to provide security or close support to the vehicles, the infantry can usually maintain enough distance to avoid the effects of fires directed against the vehicles.

c. There are additional considerations when infantry is working near vehicles with reactive armor. Reactive armor is designed as an explosive charge inside a steel cassette. When struck by a chemical warhead, it explodes, disrupting the formation of the chemical jet to prevent it from penetrating the armor. During this explosion, the cassette plates become projectiles capable of killing unprotected infantry within 35 meters of the vehicle.

d. The high-velocity, armor-piercing, discarding sabot round fired by tanks and the 25-mm gun on the M2/M3 present a safety problem due to the discarded sabot that falls to the ground shortly after leaving the muzzle. The danger area extends out 400 meters along the gun-target line and along an arc of 10 degrees from the muzzle out to 400 meters on either side of the gun-target line. Infantry soldiers in this area require overhead cover and protection (a berm or tree) from the rear.

e. The exhaust from the M1 tank may be in excess of 1700 degrees. Soldiers following behind the tank must position themselves off to the side of the exhaust grill or at a safe distance if directly behind the tank.

f. Infantry should avoid riding on tanks unless this is required by the situation. If so, there are several safety concerns that must be addressed. For more information concerning riding on armored vehicles, see paragraph B-11. FM 7-8 discusses equipment required for rigging a vehicle and carrying soldiers on top.

### **B-3. EMPLOYMENT CONSIDERATIONS**

The rifle company fights as part of a combined arms team, which often includes armored units. Armored vehicles provide unique capabilities to supported infantry units; these should be considered during the planning process. The CO must know how to employ and support these units. Generally, armored vehicles can contribute to the dismounted battle—

- By providing heavy suppressive fires and a mobile base of fire for dismounted infantry. The vehicles MGs can suppress enemy positions, kill personnel, and destroy lightly armored targets.
- By using their speed and shock effect to assist the infantry in rapidly executing an assault. Stabilized gun systems can provide accurate direct fires even while the vehicle is moving at high speeds.
- By providing effective antitank fires. Main armaments can destroy tanks, armored vehicles, and fortifications such as bunkers.
- By providing limited mobility to the dismounted force. Armored vehicles can rapidly move cross-country over trenches, trees, and small obstacles.
- By using their technical assets (thermal viewers, range finders, and so forth) to assist in target acquisition and ranging at long distances, day or night.

- By providing additional communication assets. The vehicle radios and the crew's use of arm-and-hand signals allow orders to be communicated rapidly between crews and dismounted troops.

#### **B-4. SPECIAL CONSIDERATIONS**

Armored vehicles have the following limitations and vulnerabilities that affect their employment in support of infantry forces.

- They are vulnerable to antitank guided missiles, guns, and mines; tanks; and aircraft.
- They require daily resupply of POL products in large quantities.
- They require extensive maintenance, skilled operators, and mechanics.

a. Existing or reinforcing obstacles can restrict or stop armored vehicle movement. Since armored vehicles often work with dismounted infantry in dense woods, urban areas, or other restricted terrain, infantry leaders must understand the mobility characteristics of the vehicles that are supporting the unit.

(1) When forced to fight buttoned-up (hatches closed), the crews' visibility is downgraded to only what they can see through their vision blocks.

(2) In close terrain, turret traverse may be restricted by trees, buildings, and so forth.

(3) In jungle or swampy areas, soft ground easily traversed by infantry may have to be bypassed by armored vehicles.

b. Depending on the situation, the ammunition basic load may also be a limitation. Bradley vehicles use a mix of 25-mm SABOT (kinetic energy) rounds and HE ammunition. The M1 and M60A3 tank's basic loads usually contain only SABOT and HEAT rounds. The M551 has both HEAT and HEP rounds available.

#### **B-5. COMBINED OPERATIONS WITH ARMORED VEHICLES**

Leaders must know what heavy and light forces can do for each other. They must know how to communicate by radio, phone, and visual signals.

a. Infantrymen help heavy forces by finding and breaching or marking antitank obstacles. They detect and destroy or suppress enemy antitank weapons. Infantrymen may designate targets for armored vehicles and protect them in close terrain.

b. Heavy forces help infantry by leading infantrymen in open terrain and providing them a protected, fast-moving assault weapons system. (This depends on the enemy's antitank capability.) They suppress and destroy enemy weapons, bunkers, and tanks by fire and maneuver. They may provide transport when the enemy situation permits.

#### **B-6. MOVEMENT TO CONTACT**

Infantry companies use one of two techniques to conduct a movement to contact: the approach-march technique and the search-and-attack technique (Chapter 4).

a. **Approach-March Technique.** The company team uses normal movement techniques (traveling, traveling overwatch, and bounding overwatch).

(1) Armored vehicles may follow and provide overwatch for the rifle platoons in traveling or traveling overwatch at a distance determined by the terrain and visibility. This allows the rifle platoons to move by stealth while being overwatched by the tanks.

(2) The armored vehicles may lead in traveling or traveling overwatch when speed is required and when in open terrain. When armored vehicles lead, they normally use

(platoon) bounding overwatch. Some infantrymen may ride with the overwatching armored vehicle section; these men provide security for the vehicle at halts, and they dismount to clear danger areas.

(3) In bounding overwatch, the armored vehicles are normally part of the overwatch element. In open terrain, the vehicles may be the bounding element.

b. **Search-and-Attack Technique.** The armored vehicles are normally employed under the battalion's scheme of maneuver. They may work with the company to concentrate combat power, isolate enemy positions, or attack enemy base camps. They may also escort convoys through terrain occupied by enemy forces.

## **B-7. ATTACKS**

All attacks involving armored vehicles and infantry must be well - planned, thoroughly coordinated, and fully rehearsed. The communications procedures require special considerations to ensure mutual support and flexibility.

a. **Attacking on Converging Routes.** In this method, armored vehicles and infantry move on separate routes that meet on the objective. They each move on routes suitable for their movement. Armored vehicles may first support the infantry by fire, then close on the objective in time to assault it with the infantry (Figure B-1). This may require the infantry to breach obstacles/destroy certain antiarmor systems to help the armored vehicles reach the objective. Tanks are the only armored vehicles that should assault on to the objective unless the enemy has no antiarmor capability.





**Figure B-1. Attacking on converging routes.**

b. **Attacking on the Same Route.** When armored vehicles and infantry attack on the same route (Figure B-2), the two elements may move at the same speed or at different speeds.

(1) They use the same speed when there are no good overwatch positions or when there is a need for close, mutual support. For example, mutual support may be required when it is known that the enemy has antitank weapons and tanks, but their location is unknown. When attacking at the same speed, the infantry may be slightly ahead of (but not directly in front of), even with, or just to the rear of the armored vehicles.

(2) They move using different speeds when there are obstacles that the infantry must clear for the armored vehicles, or when the route offers good cover and concealment for the infantry but not for the armored vehicles. In these cases, the armored vehicles (first) support by fire while the infantry moves to its assault position. The armored vehicles then move forward to assault with the infantry. The armored vehicles may, however, lead the infantry against an enemy that is being suppressed, that does not have well-prepared positions with overhead cover, or that does not present a great antiarmor threat.

c. **Armored Vehicles Supporting by Fire Only.** This method is used when obstacles keep the armored vehicles from closing on the objective. The armored vehicles occupy positions where they can support the attacking infantry (Figure B-3). As soon as the obstacles are breached or a suitable bypass is found, the armored vehicles rejoin the infantry.

d. **Consolidation and Reorganization.** When a company team has seized an objective, the team consolidates. The CO either directs the armored vehicle leader to

position his vehicles in overwatch positions behind the infantry so they are ready to move forward when needed, or he directs them to hull-down positions with the infantry to block armor counterattack approaches. If the withdrawing enemy can be seen and is still in range, the armored vehicles continue to fire. Throughout the attack, the team reorganizes and replaces any lost leaders.



Figure B-2. Attacking on the same route.



**Figure B-3. Armored vehicles support by fire.**

#### **B-8. DEFENSE**

Armored vehicles add strength, depth, and mobility to the defense. The CO may initially position them forward to engage the enemy at long ranges and then move them back to cover armor approaches. However, the CO must move the vehicles where needed to concentrate fire against an enemy attack. He should also use them to add strength to the counterattack force.

a. The commander may temporarily position his armored vehicles (with infantry for security) forward of the company's defensive positions. When so deployed, they can force the enemy to deploy early. This forward deployment of armored vehicles may deceive the enemy as to the location of the company's defensive positions. As soon as the enemy is close enough to threaten them, the armored vehicles must withdraw to their defensive positions. Smoke is used to screen their withdrawal. Since the tank platoon has no FO, the CO may attach an FO to them (deployed forward) to assist in calling for and adjusting indirect fire and CAS.

b. There are two basic ways for the defending rifle company CO to employ armored vehicles. In both, the CO selects their general positions and sectors of fire. The armored vehicle leader advises the CO and selects the exact positions and controls fire and movement.

(1) The first way is to integrate the vehicles throughout the company defense, both laterally and in depth, to cover armor avenues of approach (Figure B-4). This may be done when there are only a few good firing positions or when the terrain restricts fast vehicle movement. Each vehicle should have mutual support with at least one other vehicle. The armored vehicles remain under the control of the armored vehicle platoon leader. (Appendix J discusses the employment of antiarmor weapon systems.)

(2) The second way to employ armored vehicles is to hold them in reserve in a position behind the forward infantry platoons (Figure B-5). This may be done when there

are several armor AAs into the company sector. There must, however, be sufficient vehicle firing positions and routes to them. When targets appear, the armored vehicles move to forward or flank firing positions. This allows quick concentration of the vehicles at a critical point to repel an attack. The CO should determine his decision points/criteria for initiating the armored unit's move. The leader of this unit should know when to move in case communication is not possible.

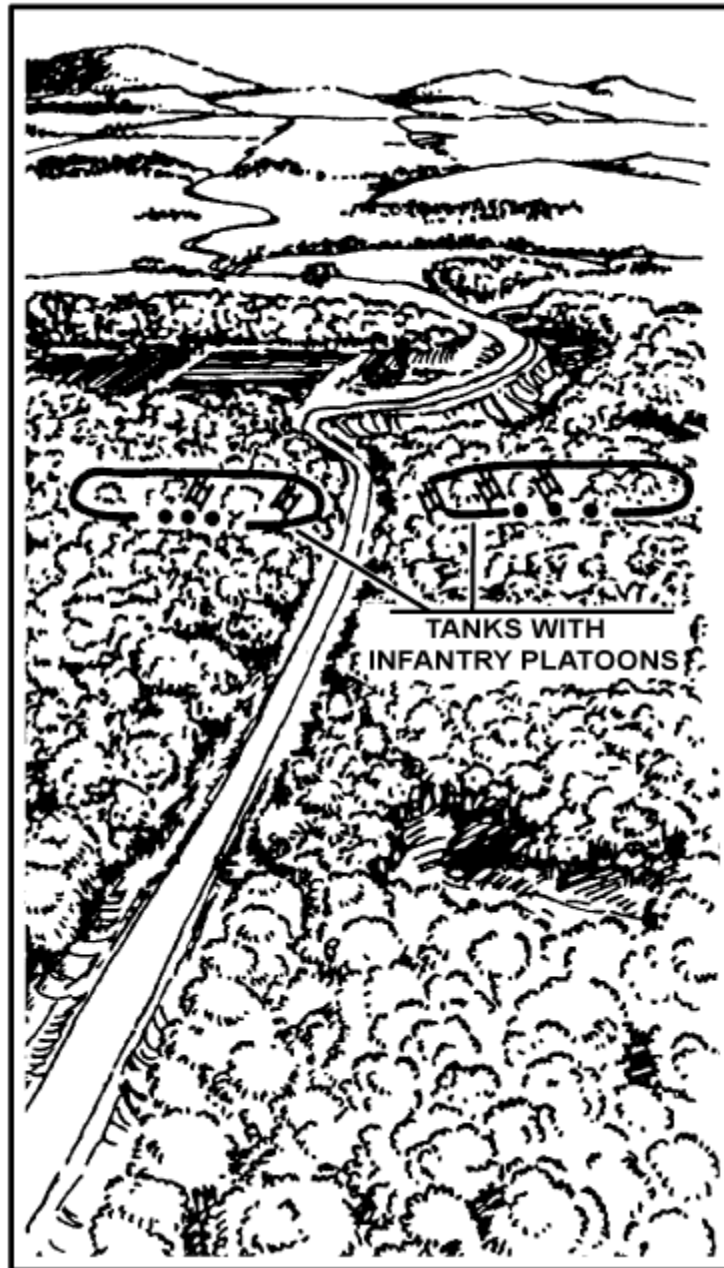

**Figure B-4. Armored vehicles integrated throughout the position.**

c. With either employment method, the armored vehicle platoon leader selects covered (hull-down) primary, alternate, and supplementary firing positions for each vehicle. If covered firing positions are not available, he may assign them hide positions.

**B-9. RETROGRADE OPERATIONS**

In retrograde operations, armored vehicles may be used to support the infantry when the terrain or the enemy force makes it mainly an infantry fight. In other situations, the infantry may protect the armor or the two may be employed separately on different AAs. When fighting together on the same AA, the infantry may first disengage to a nearby covered position. The armored vehicles can then disengage and move to overwatch positions where they continue to cover the infantry's withdrawal. If the retrograde operation is conducted when visibility is poor, some infantrymen may stay with the armored vehicles to provide security.



Figure B-5. Armored vehicles held in reserve.

---

**B-10. LOGISTICAL SUPPORT**

An armored vehicle platoon, under OPCON of the rifle company, receives fuel, maintenance and recovery support, and ammunition from its parent company. The platoon normally comes to the rifle company with its own fuel tanker and ammunition vehicle. If the parent company cannot provide recovery assets to the armored vehicle platoon, the platoon can perform self-recovery. The platoon leader can communicate with his CO for support; however, he must coordinate with the infantry company CO for a place and time to conduct his logistical activities.

**B-11. INFANTRY RIDING ON ARMORED VEHICLES**

There may be times when armored vehicles and infantry must move quickly from one place to another to accomplish their mission. In such cases and providing that there is little likelihood of making enemy contact along the way, soldiers may ride on the decks of the armored vehicles.

a. Riding on the outside of the vehicles is hazardous. Infantry should only ride on vehicles when the risk of enemy contact is minimal and or the need for speed is great. By riding on the vehicle, the infantry has given up its best protection—its ability to move with stealth and avoid detection. Soldiers riding on armored vehicles are vulnerable to all types of fire. Also, soldiers must watch for obstacles, which may cause the tanks to turn suddenly; for tree limbs, which may knock them off; and for the traversing of the turret gun, which may also knock them off.

b. The only advantage the infantry gains is speed of movement and increased haul capability. In this case, the following apply:

(1) Avoid riding on the lead vehicle of a section or platoon. These vehicles are most likely to make contact, and they can react quicker without soldiers on top.

(2) Position the infantry leaders with the armored vehicle leaders. Discuss and prepare contingency plans for chance contact or danger areas. Infantry should dismount and clear choke points or other danger areas.

(3) Assign air guards and sectors of responsibility for observation. Ensure all personnel remain alert and stay prepared to dismount immediately. In the event of contact, the armored vehicle will immediately react as required for its own protection. The infantry on top are responsible for their own safety. Rehearse a rapid dismount of the vehicle.

(4) Consider putting rucksacks, ammunition, and other equipment on the vehicles and having the infantry move on a separate AA. This will increase the mobility of the infantry, and they can move through more suitable terrain.

c. Riding on tanks reduces tank maneuverability and may restrict firepower. Infantrymen may be injured if the tank must slew its turret to return fire on a target. Consequently, soldiers must dismount to clear danger areas (FM 7-8) or as soon as enemy contact is made.



**B-12. COMMUNICATING WITH TANKS**

Before an operation, infantry and tank unit leaders must coordinate communications means. This should include the use of radios; phones; and visual signals such as arm-and-hand signals, panels, lights, flags, and pyrotechnics. Most tanks (except the M1) have an external phone on the rear for infantrymen to use; the user can talk to the tank crew over the tank intercom system. When an infantryman wants to talk to the tank crew, he picks up the phone, presses the push-to-talk button, and talks to the crew. When the tank commander wants to talk to nearby infantrymen, he activates an orange flashing light on the outside phone. On the M1, the infantryman can run communication wire to the TC through the turret. This wire can be hooked in to the tanks communication system to provide a means of communication for nearby soldiers.

## APPENDIX C

# OBSTACLES

*An obstacle is any natural or man-made obstruction that disrupts, turns, fixes, or blocks movement.*

### C-1. EMPLOYMENT

Obstacles are most useful in the defense, but can be used in all operations. A variety of obstacles should be used to keep the enemy from finding, clearing, or bypassing all of them.

a. In the offense, the company uses obstacles—

- To aid in flank security.
- To limit enemy counterattacks.
- To isolate objectives.
- To cut off enemy reinforcement or routes of withdrawal.

b. In the defense, obstacles are employed to reduce the enemy's ability to maneuver, mass, and reinforce; and to increase his vulnerability to fires. Individual obstacles do this by performing one of four tactical obstacle functions—disrupt, turn, fix, or block.

(1) *Disrupt*. These obstacles disrupt march formations, break up operation timing, exhaust breaching assets, and cause separation between forward combat elements and wheeled supply vehicles. Obstacles also are used to disrupt assault formations, attacking the low-level command and control while the attacker is under direct fire.

(2) *Turn*. Turning obstacles move and manipulate the enemy to the force's advantage by enticing or forcing him to move in a desired direction, by splitting his formation, by canalizing him, or by exposing his flank.

(3) *Fix*. Fixing obstacles slow and hold the enemy in a specific area so that he can be killed with fires, or they can generate the time necessary for the force to break contact and disengage.

(4) *Block*. By themselves, obstacles never serve to block an enemy force. Blocking obstacles are complex, employed in depth, and integrated with fires to prevent the enemy from proceeding along a certain avenue of approach (or to proceed only at unacceptable costs). Blocking obstacles serve as a limit, beyond which the enemy will not be allowed to go.

c. In retrograde operations, the company uses obstacles to gain or increase a mobility advantage over the enemy or to strengthen delay positions.

d. Obstacles are normally constructed by engineers with help from the company. There may be times when the company must build obstacles without engineer help. In such cases, the commander should seek engineer advice on the technical aspects.

### C-2. TYPES

The company commander is normally concerned with the following types of obstacles: reinforcing and existing.

a. **Reinforcing**. These are man-made obstacles constructed by units. They include road craters, abatis, log cribs, antitank ditches, log hurdles, minefields, and wire obstacles.

b. **Existing.** These include obstacles (either natural or cultural) that are already there. Natural obstacles are created by nature. They include such things as steep slopes, ravines, gullies, ditches, rivers, streams, swamps, and forests. Cultural obstacles are man-made, such as buildings, fences, and canals.

### C-3. PLANS

The battalion receives a copy of the brigade plan that may specify obstacle belts, limiting the battalion to employing tactical obstacles within these belts and focusing the defense within the brigade. These belts consist of a system of obstacles designed to perform one of the four primary obstacle functions. This allows brigade-level maneuver outside of obstacle belts. Protective obstacles are the only obstacles that can be employed outside of designated belts. Or brigade may allow the battalion maximum flexibility and specify the battalion is free to employ tactical obstacles throughout its sector. Additionally, the plan may include brigade- or higher-directed obstacles critical to the plan at this level. These become priority obstacles and may be reserve obstacles. The brigade plan specifies allocation of resources, the priority of effort, and required completion times. (See FM 5-100).

a. After receiving the brigade obstacle plan, the battalion begins planning for the execution of its portion of the plan. The battalion commander and staff also consider METT-T and determine what additional obstacles are needed to support the battalion tactical plan. The battalion's obstacle plan is then distributed to the company commanders for execution. The battalion commander will also allocate engineer assets as required to support the plan.

b. Upon receiving the battalion plan, the company commander begins planning for the execution of his portion of it. He also considers METT-T and determines what additional obstacles are needed to support his tactical plan. (These obstacles, however, must be approved by battalion before their construction.) When planning for obstacles, the company commander considers:

(1) *Mission.* What does the company have to do (defend, attack, withdraw, or delay) and for how long?

(2) *Enemy.* From where will the enemy come? Will he be mounted, dismounted, or both? Where can he be forced to go?

(3) *Terrain and weather.* What are the existing obstacles and how will they affect the enemy? How can existing obstacles be reinforced? When there are no existing obstacles, how can obstacles be made to support the company's tactical plan? How can these obstacles be observed and covered by direct and indirect fire? How will weather conditions affect the use of obstacles?

(4) *Troops and time available.* Will engineer support be available? How much work can be done by infantry troops? How much material, equipment, and transport are available? Is field artillery and helicopter support available for emplacing minefields? How much time is available for constructing obstacles?

c. The CO applies the following principles when planning obstacles:

(1) *Support the tactical plan.* The use of obstacles must support the tactical plan. The CO uses them to supplement his combat power, to decrease the mobility of the enemy, and to provide security for his unit. While considering enemy avenues of approach, he

also considers his own movement requirements, such as routes for resupply, withdrawal, counterattacks, patrols, and observation posts.

(2) *Tie in.* He must tie in his reinforcing obstacles with existing obstacles. This increases the enemy's difficulty in bypassing the obstacles. He must also tie in the obstacle plan with his plans for fire support.

(3) *Cover by observation and fire.* He ensures that all obstacles are covered by observation and fire. This reduces the enemy's ability to remove or breach the obstacles and increases the possibilities of placing fire on the enemy when he encounters the obstacles. It is preferable that obstacles be covered by direct fire, but if this is not possible, they may be covered by indirect fire. In such cases, however, the obstacles must be covered by observation in order to call for and adjust the fire. Units must often reposition during limited visibility to cover the obstacles.

(4) *Construct in depth.* Although the company has limited assets to construct obstacles, he should attempt to construct them so that the enemy will encounter several obstacles before reaching the company's position.

(5) *Camouflage and conceal.* The company camouflages and conceals its obstacles to deny the enemy the ability to detect them and plan for breaching or bypassing them. A degree of camouflage or concealment can be achieved by properly siting the obstacles and by delaying the execution of demolition obstacles.

(6) *Afford no advantage to the enemy.* The company should use barbed wire, mines, and booby traps to deny the enemy the use of any cover and concealment that might be provided by an obstacle.

(7) *Provide for lanes and gaps.* He must plan lanes and gaps through obstacles to allow movement of friendly units. He must, however, ensure that these are constantly secured and that plans are made to close them before enemy contact.

d. As there are seldom enough resources to construct all the desired obstacles, priorities must be set to wisely use time, equipment, and materiel. Normally, those obstacles that improve the defense against armored vehicles are constructed first; then those that improve the close-in defense; and last, those that improve flank and rear security.

#### C-4. ENEMY OBSTACLES

When confronted by an enemy obstacle, the company will either bypass or breach it. The decision on what to do is based on the mission, the situation, and the assets available. Obstacles intended to stop dismounted soldiers usually are made of mines and barbed wire. They are normally covered by fire. Dismounted soldiers can bypass many obstacles designed to stop or canalize mechanized and armor units. However, dismounted soldiers may have to breach these obstacles so that tanks and support vehicles can follow them. While breaching these obstacles, soldiers must look for antipersonnel mines as well as antitank mines.

a. **Bypassing.** When bypassing an obstacle, the CO must report its type and location to the battalion commander. As the enemy may cover the bypass routes by fire, the commander must be alert for unexpected enemy contact. Suppress places from where the enemy can cover the obstacle by fire.

b. **Breaching.** A breach is the employment of any means available to break through or secure a passage through an enemy obstacle (Figure C-1).

(1) There are two types of breaches: hasty and deliberate.

(a) In the hasty breach, the company attacks quickly using smoke to conceal its movement and well-rehearsed battle drills to get through the obstacle while controlling the far side by suppressive fires. The commander synchronizes his combat elements, making the most of surprise and initiative, to get through the obstacle with a minimum loss of momentum.

(b) A deliberate breach is done after detailed reconnaissance, planning, and preparation. It is normally planned by battalion and done with engineer assistance.

(2) The company may breach different obstacles using different techniques and types of equipment and explosives. Some of the equipment and explosives that may be used include rocket-propelled line charges, mine detectors, bangalore torpedoes, surface-launched fuel-air explosives, direct fire weapons (such as the combat engineer vehicle), and hand-emplaced explosives. When using such things, the company should seek engineer advice and assistance.

(3) The fundamentals for breaching any obstacle are:

- Suppress—the enemy to allow the breach element to create a breach.
- Obscure—the breach site from enemy observation.
- Secure—the breach site, execute the breach, and secure the far side.
- Reduce—the obstacle to facilitate follow-on forces.

(4) The company SOP should discuss breach operations. A breach kit can be prepared and carried in the battalion trains. It may include grappling hooks, ropes, bolt cutters, wire cutters, engineer tape, chemical lights, smoke grenades, and a demolition kit.

(5) When the company must breach an obstacle, the company commander will normally organize his unit into support, breach, and assault elements.

(a) The support element has the primary mission of suppressing enemy fires to support the breach and assault elements as they cross through the obstacle and move on to eliminate the enemy overwatching the obstacle.

- It suppresses the far side with direct and indirect fires.
- It may also coordinate and control the weapons/equipment used for obscuration of the breach site.

(b) The breach element has the primary mission of reducing the obstacle (create lanes) to pass the force through to the far side.

- It creates a lane through any type of obstacle.
- It provides local security for personnel creating the lanes.
- It marks the lane.
- It guides a force through the lane.
- It hands off the lane to trailing forces.
- It may assist the assault element in securing the far side.

(c) The assault element has the primary mission of destroying or dislodging the enemy on the far side of the obstacle.

- It physically attacks through the lane created by the breach element.
- It ultimately secures the far side by occupation.
- It protects the passage of the breach and support elements.

(6) The CO may elect to have some portion of his unit perform dual functions, such as conduct both the breach and assault.

(7) The procedures for breaching minefields, abatis, log cribs, tank ditches, craters, and wire entanglements are explained in FMs 7-8 and 20-32.

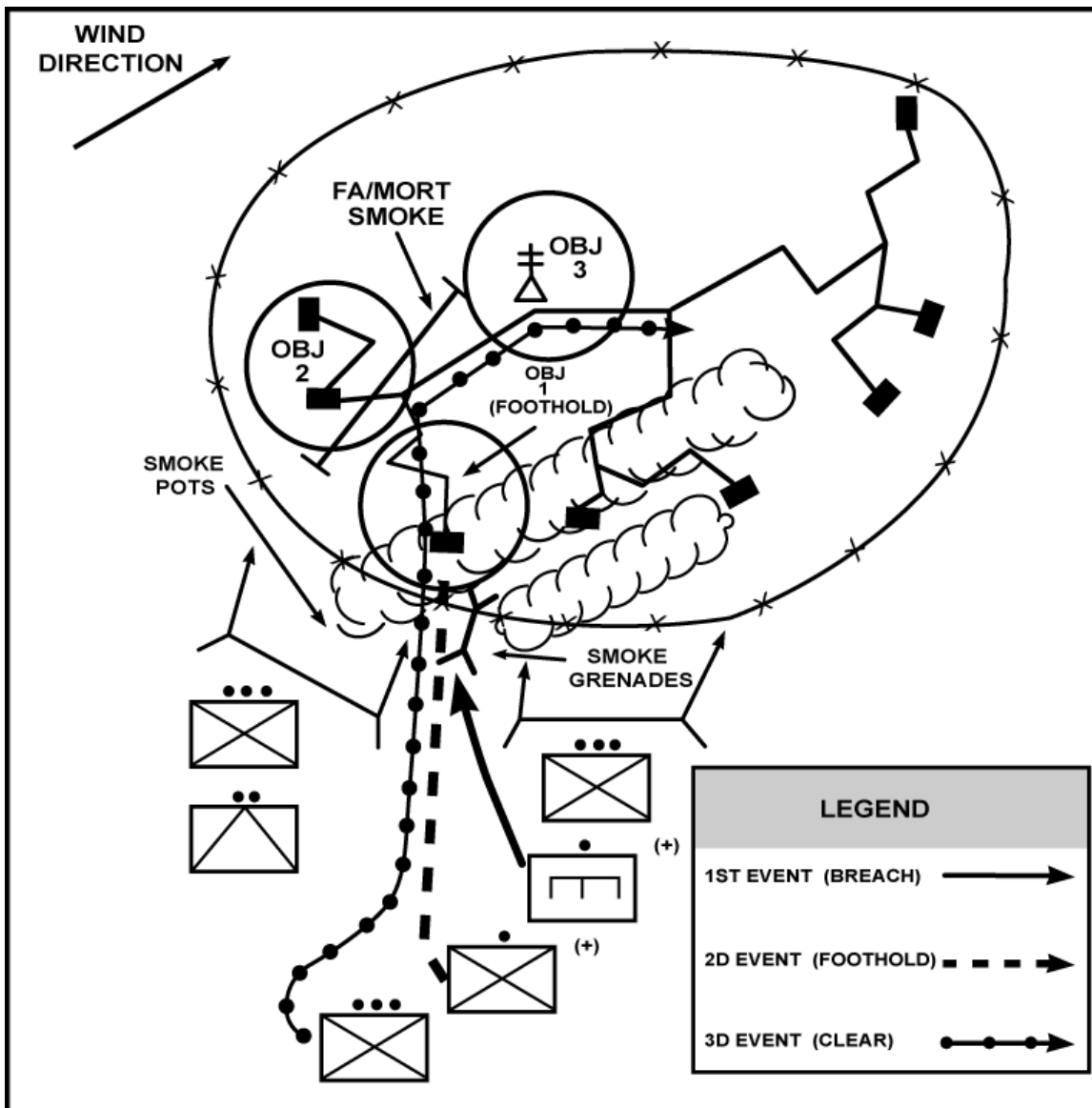

Figure C-1. Breaching an obstacle.

## APPENDIX D

# HELICOPTER SUPPORT

*The company may conduct air assault operations either as part of the battalion or as a separate unit when conducting raids, counter guerrilla operations, or other special missions. These operations, covered in detail in FM 90-4, are planned primarily by the battalion staff. This appendix covers the information the company commander needs to know to fulfill his responsibilities during such operations.*

### D-1. USAGE

The CO may use helicopters when inserting or extracting patrol units, positioning weapons and crews, conducting resupply, and evacuating casualties. The company should have an SOP for working with helicopters. The SOP should cover the following:

- LZ and PZ selection.
- LZ and PZ security.
- LZ and PZ operation and activities.
- LZ and PZ marking procedures.
- Downed aircraft procedures.
- Load plan preparation.
- Loading procedures.
- Organization for an air assault operation.

a. Air assaults involve assault forces (combat, CS, and CSS) using the firepower, mobility, and total integration of helicopter assets and maneuver on the battlefield to engage and destroy enemy forces or to seize and retain key terrain.

b. Air movement operations involve the use of Army airlift assets for other than air assaults.

### D-2. HELICOPTER TYPES

There are several types of helicopters that may be used in air assault operations: observation, utility, cargo, and attack.

a. **Observation.** The OHs are organic to the aviation brigade found within the division. For assault helicopter operations, the cavalry squadron or AHB will normally provide the OHs. The OHs are used to provide—

- Command and control.
- Aerial observation and reconnaissance.
- Aerial target acquisition.

b. **Utility.** The UHs are the most versatile of all helicopters. They are available in almost every unit possessing aircraft because they perform a variety of tasks. UH support normally comes from the assault company or battalion of the aviation brigade. UHs are used to conduct combat assaults and to provide transportation, command and control, and resupply. When rigged with special equipment, they may be used—

- To provide aeromedical evacuations.
- To conduct radiological surveys.
- To dispense scatterable mines.

c. **Cargo.** These aircraft are organic to corps aviation units. They normally provide transportation, resupply, and recovery of downed aircraft.

d. **Attack.** AH organizations vary in size from company to battalion, but they can be task-organized to meet mission needs. However, they are not normally employed lower than battalion level. AH units are assigned to cavalry regiments, divisions, and corps.

They may be used—

- To provide overwatch.
- To destroy point targets.
- To provide security.
- To suppress air defense weapons.

### **D-3. GROUND TACTICAL PLAN**

The foundation of a successful air assault operation is the commander's ground tactical plan, around which subsequent planning is based. It specifies actions in the objective area and addresses subsequent operations. The ground tactical plan for an air assault operation is essentially the same as for any other infantry operation. It differs in that it capitalizes on speed and mobility of helicopters to achieve surprise. Army aviation assets are integrated into the plan, coordinated, and controlled by the battalion staff under the battalion commander's guidance. One additional requirement is that aircrews must know this ground tactical plan and the ground commander's intent.

### **D-4. LANDING PLAN**

The landing plan must support the ground tactical plan. This plan sequences elements into the area of operations. It makes sure units arrive at designated places and times, and that they are prepared to execute the ground tactical plan.

a. **Significant Factors.** Consider the following factors while developing the landing plan.

- (1) The availability, location, and size of potential LZs are key factors.
- (2) The company is most vulnerable during landing.
- (3) Multiple insertions require multiple LZs. Do not use the same LZ twice.
- (4) Elements must land with tactical integrity.
- (5) Soldiers are easily disoriented if they are not informed when the briefed landing direction changes.
- (6) There may be no other friendly units in the area initially. The company must land prepared to fight in any direction.
- (7) The landing plan should offer flexibility so a variety of options are available in developing a scheme of maneuver.



(8) Supporting fires (artillery, naval gunfire, CAS, and attack helicopters) must be planned in and around each LZ.

(9) Although the objective may be beyond the range of supporting artillery fire, artillery or mortars may be brought into the LZ(s) early to provide fire support on the objective for subsequent lifts.

(10) The plan should include provisions for resupply and medical evacuation by air.

b. **Landing Zone Selection Criteria.** LZs are selected by the battalion commander (or his S3) with technical advice from the AMC or his liaison officer. They do so using the following significant factors:

(1) *Location.* Locate the LZ on, near, or away from the objective, depending on the situation.

(2) *Capacity.* Determine how much combat power can be landed at one time by the size of the LZ. This also determines the need for additional LZs or separation between aircraft.

(3) *Alternates.* Plan at least one alternate LZ for each primary LZ selected to ensure flexibility.

(4) *Enemy disposition and capabilities.* Consider enemy troop concentrations, their air defenses, and their capability to react to a company landing nearby when selecting an LZ.

(5) *Cover and concealment.* Select LZs that deny enemy observation and acquisition of friendly ground and air elements while they are en route to or from (and in) the LZ.

(6) *Obstacles.* If possible, land the company on the enemy side of obstacles when attacking, and use obstacles to protect LZs from the enemy at other times. Keep landing zones free of obstacles. Organize and attach engineers for contingency breaching of obstacles.

(7) *Identification from the air.* Make landing zones readily identifiable from the air. Mark them with chemical lights (preferably infrared-type) if the assault is conducted with personnel wearing night vision goggles.

(8) *Approach and departure routes.* Avoid continuous flank exposure of aircraft to the enemy on approach and departure routes.

(9) *Weather.* Consider the weather. Reduced visibility or strong winds may preclude or limit the use of marginal LZs. Consider the impact of limited visibility and inclement weather restrictions on flying.

c. **Options to Consider.** If there are options available in selecting LZs, choose the ones that best aid mission accomplishment. This choice involves whether to land on or near the objective, to land away from it and maneuver forces on the ground to the objective, or to use single or multiple LZs. Significant factors to be considered are as follows:

(1) *Combat power.* This includes maneuver elements, firepower, and CS assets that can be introduced into the area early in the operation (usually dependent upon the number of aircraft employed and availability of suitable LZs).

(2) *Enemy.* This includes enemy strength and disposition in and around the objective area, to include air defense systems.

(3) *Surprise.* This is a goal that may be attained by careful use of terrain cover and concealment, darkness, or reduced visibility created by weather or smoke. Surprise is sometimes achieved by landing on the objective.

(4) *Time*. This is the time that is available for mission accomplishment. Limited time to complete the mission generally favors landing on or near the objective.

(5) *Advantages of a single LZ*. The use of a single LZ allows concentration of forces in one location if the LZ is large enough. It also—

- Aids control of the operation.
- Concentrates supporting fires in and around the LZ. Firepower is diffused if more than one LZ preparation is required.
- Provides better ground security for subsequent lifts.
- Requires fewer attack helicopters for security.
- Reduces the number of flight routes in the objective area, making it more difficult for enemy intelligence sources to detect the air assault operation.
- Centralizes any required resupply operations.
- Concentrates efforts of limited LZ control personnel and engineers on one LZ.

(6) *Advantages of multiple LZs*. The use of multiple LZs avoids grouping assets in one location, which would create a lucrative target for enemy mortars, artillery, and CAS. Multiple LZs also—

- Allow rapid dispersal of ground elements to accomplish tasks in separate areas.
- Reduce the enemy's abilities to detect and react to initial and subsequent lifts.
- Force the enemy to fight in more than one direction.
- Eliminate aircraft congestion.
- Make it difficult for the enemy to determine the size of the air assault force, the exact location of supporting weapons, or the objective of the air assault.

**NOTE:** If the objective is designated by a number, the LZ should be designated by a letter or code word to avoid confusion and mix-ups. This avoids having an objective and LZ with the same designator; for example, LZ 1 and OBJ 1.

d. **Landing Zone Operations.** Just as there is a priority of work for defensive operations, there is a priority of actions upon landing in an LZ.

(1) *Unloading*. Do not begin unloading the aircraft until directed by the crew chief or pilot (Figure D-1).

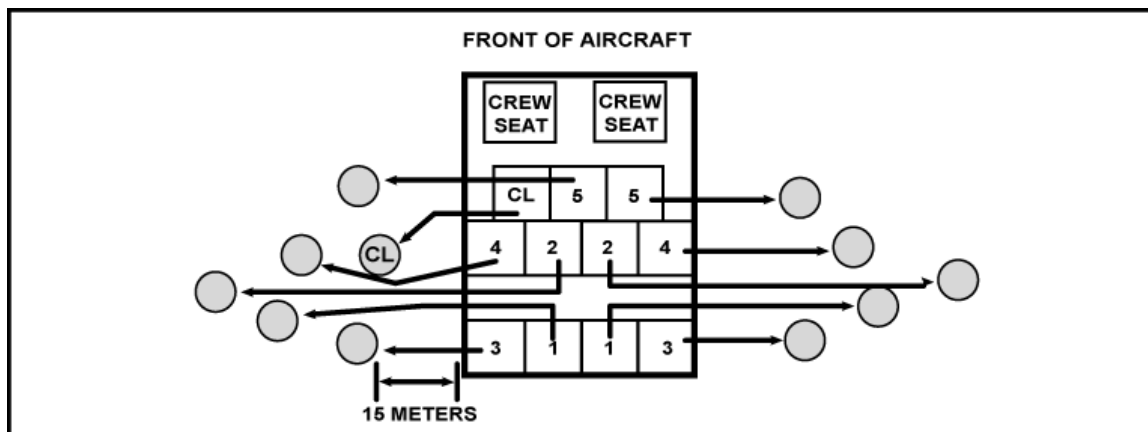

**Figure D-1. UH-60 unloading diagram.**

(a) Before leaving the aircraft, the chalk leader checks the landing direction and grid coordinates with the pilot if they were not determined during the approach. This aids in orientation to the LZ, particularly at night.

(b) Once the aircraft lands, the soldiers unbuckle their seat belts and get off (with all equipment) as fast as possible.

(c) They move 15 to 20 meters out from the side of the aircraft and assume the prone position, facing away from the aircraft with weapons at the ready until the aircraft has left the LZ.

(2) *Immediate action on hot LZ.* If the decision is made to use a hot LZ, or contact is made upon landing, soldiers quickly dismount and move 15 to 20 meters away from the aircraft and immediately return fire to protect the aircraft departure.

(a) If the situation allows, soldiers fire and move off the LZ to the closest cover and concealment. If this is not feasible and the enemy positions are near, they assault immediately.

(b) The ground or air element first detecting the enemy initiates the preplanned supporting fires.

(c) Once disengaged from the enemy force, the chalk leader moves the unit to a covered and concealed position, accounts for personnel and equipment, assesses the situation, and tries to link up with other elements of his lift. If unable to link up or if in a single chalk LZ, the senior man present issues a FRAGO to continue the mission or abort it.

(3) *Chalk assembly on cold LZ.* When unloading on a cold LZ, the chalk leader moves the chalk to its preset locations using traveling overwatch movement techniques. All soldiers move at a fast pace to the nearest concealed position. Once at the concealed assembly point, the chalk leader counts personnel and equipment and then proceeds with the mission.

#### **D-5. AIR MOVEMENT PLAN**

The air movement plan is based on the ground tactical and landing plans. It specifies the schedule and details for air movement of soldiers, equipment, and supplies from PZs and LZs. It also coordinates instructions regarding air routes; air control points; and aircraft speeds, altitudes, and formations.

**D-6. LOADING PLAN**

This paragraph serves as a small-unit (company and below) leader's guide for the safe, efficient, and tactically sound conduct of operations in and around pickup zones.

a. **Selection and Marking of PZs and LZs.** Small-unit leaders should be proficient in the selection and marking of PZs and LZs, and in the control of aircraft. Tactical and technical aspects must be considered when selecting an LZ/PZ.

(1) Methods available for marking PZs and LZs include the following:

(a) Day. A ground guide marks the PZ or LZ for the lead aircraft by holding an M16A1 rifle over his head, by displaying a folded VS-17 panel chest high, or by some other identifiable means. Ground guides must wear eye and ear protection.

(b) Night. Use the code letter Y (inverted Y) to mark the landing point of the lead aircraft at night (Figure D-2). Use chemical light sticks or beanbag lights to maintain light discipline. When more than one aircraft is landing in the same PZ or LZ, use an additional light for each aircraft. For observation, utility, and attack aircraft, mark each additional aircraft landing point with a single light emplaced at the exact point that each aircraft is to land. For cargo aircraft (CH-47, CH-53, and CH-54), mark each additional landing point with two lights. Place the two lights 10 meters apart and align them in the aircraft direction of flight.

(2) Obstacles include any obstruction that might interfere with aircraft operation on the ground that cannot be reduced, such as trees, stumps, and rocks. During good light, the aircrew is responsible for avoiding obstacles on the PZ or LZ. For limited visibility operations, mark all obstacles with red lights. The following criteria will be used in marking obstacles.

- If the obstacle is on the aircraft approach route, mark both the near and far sides of the obstacle.
- If the obstacle is on the aircraft departure route, mark the near side of the obstacle.
- If the obstacle protrudes into the PZ or LZ, but is not on the flight route of the aircraft, mark the near side of the obstacle.
- Mark large obstacles on the approach route by circling the obstacles with red lights.

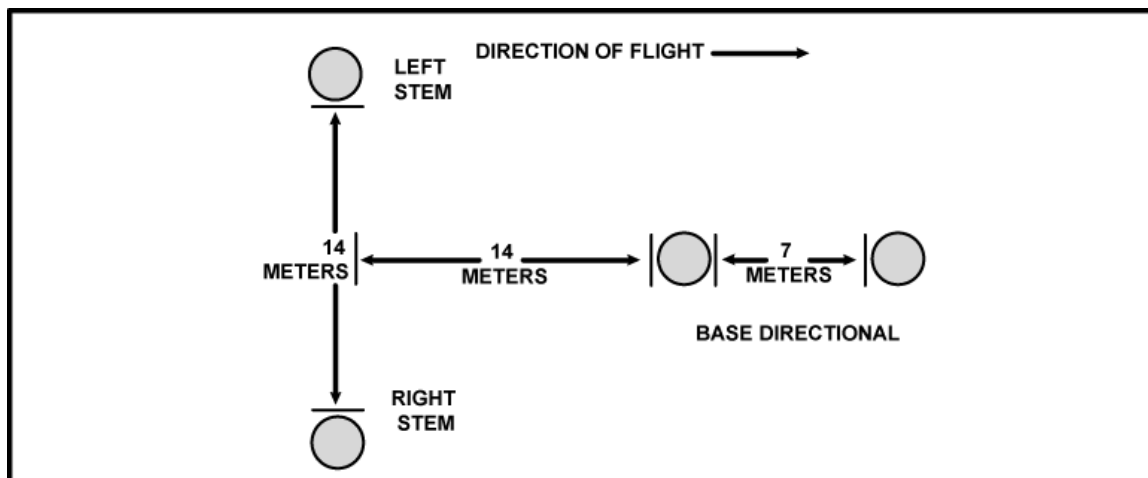

**Figure D-2. Inverted Y marker.**

b. **Control of Aircraft.** Control approaching aircraft by the use of arm-and-hand signals to transmit terminal guidance for landing. Position the signalman to the right front of the aircraft where he can be seen by the pilot. Give signals at night with a lighted baton or flashlight in each hand. When using flashlights, take care to avoid blinding the pilot. Keep batons and flashlights lighted at all times when signaling. The speed of arm movement indicates the desired speed of aircraft compliance with the signal.

c. **Assembly Areas.** Before the aircraft arrives, secure the PZ, position the PZ control party, and position the soldiers and equipment in a unit assembly area.

(1) *Occupation of unit assembly area.* While in a unit assembly area, unit leaders should—

- Maintain all-round security of the assembly area.
- Maintain communications.
- Organize soldiers and equipment to chinks and loads in accordance with the unit air movement plan.
- Conduct safety briefings and equipment checks.
- Establish priority of loading for each man and identify bump personnel.
- Identify the locations of the straggler control points.

(2) *Organization of units into chinks.* Make sure the chink organization supports the ground tactical plan. Adhere to the following principles for loading the aircraft.

- Maintain tactical integrity by keeping fire teams and squads intact.
- Maintain self-sufficiency by loading a weapon (Dragon) and its ammunition on the same aircraft.
- Ensure key men, weapons, and equipment are cross-loaded among aircraft to prevent the loss of control or all of a particular asset if an aircraft is lost.

(3) *Occupation of chink assembly areas.* Linkup guides from the PZ control party meet the designated units in the unit assembly area and coordinate movement of chinks to a release point. As chinks arrive at the release point, chink guides move each chink to its assigned chink assembly area. (To reduce the number of personnel required, use the same guide to move the unit from the unit assembly area to the chink assembly area.) If part of a larger air assault, locate no more than three chinks in the chink assembly area at one time. Maintain noise and light discipline throughout the entire movement in order to

maintain the security of the PZ. Do not allow personnel on the PZ unless they are loading aircraft, rigging vehicles for slingload, or being directed by the PZ control. While remaining in chalk order, assign each soldier a security (firing) position in the prone position, weapon at the ready, and facing out (away from the PZ) to provide immediate close-in security.

(a) An example of a large, one-sided PZ is depicted in Figure D-3.

**NOTE:** Artillery and mortar fire support is planned 360 degrees around the PZ with priority to the far side of the large, open area.

(b) An example of a small, two-sided PZ with the unit and chalk assembly area is depicted in Figure D-4.

(c) Final preparations are made in the chalk assembly area. The chalk leader ensures all gear is tied down and checked, and short antennas are placed in radios, folded down, and secured before loading. He makes sure all squad and team leaders check the equipment of their men to ensure it is complete and operational. He also makes sure radios are on and a communications check is performed (unless directed otherwise). Then he assigns specific aircraft seats to each man.

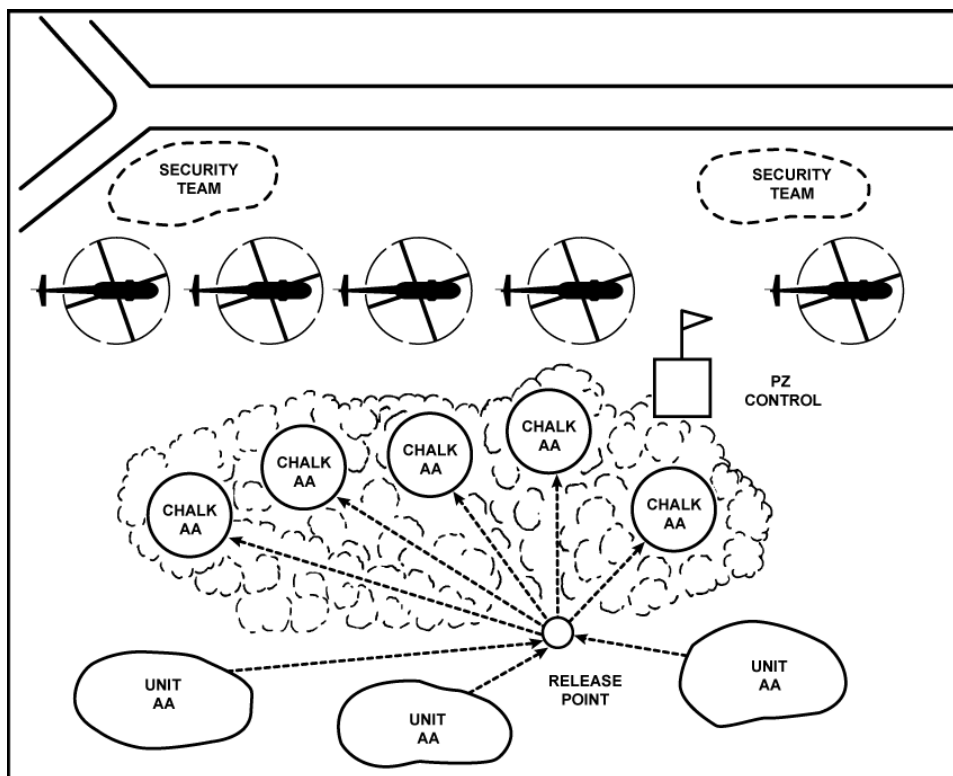
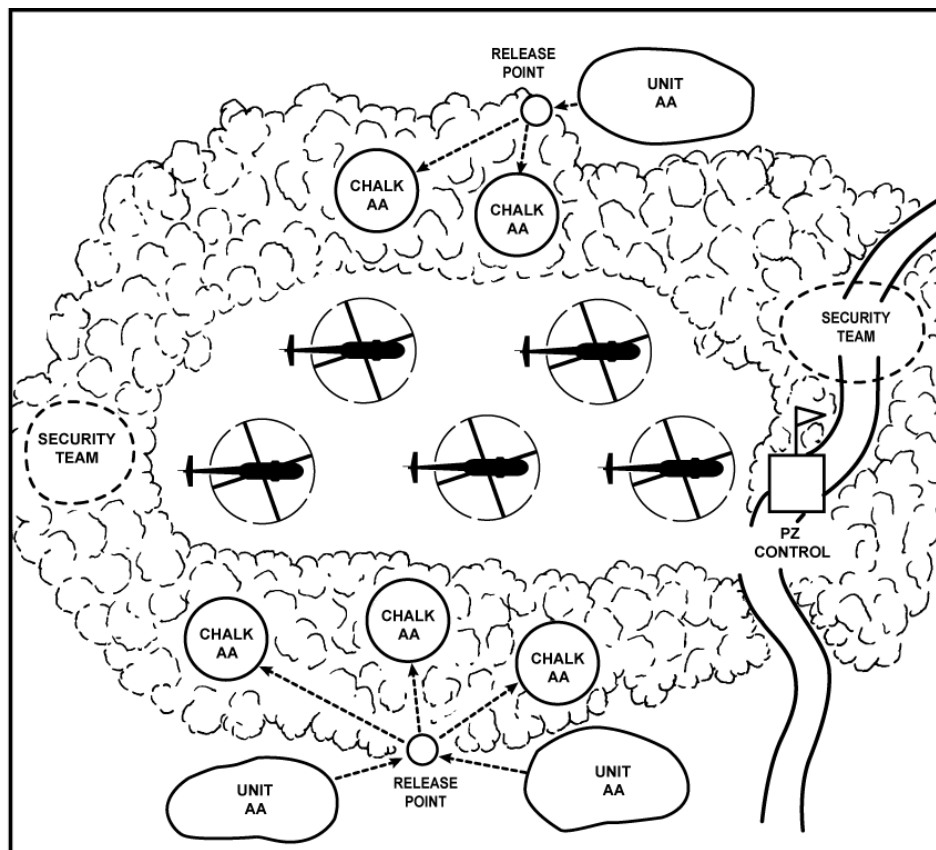

Figure D-3. Large, one-sided PZ.



**Figure D-4. Small, two-sided PZ.**

(4) *Bump plan.* The least important chalk in each lift is designated for bump in case too few aircraft arrive at the PZ. These personnel report to a bump/straggler control point to be rescheduled for movement to the LZ.

(5) *Pickup zone closure.* The CO designates a single man to be responsible for PZ closure. This may be the PZ control officer, the PZ control NCOIC, or another designated soldier. He ensures all company men and equipment are loaded and that security is maintained.

(a) *Single lift.* The designated man positions himself at the last aircraft and collects bumped men, if required. He is the last man to board the aircraft. Once on the aircraft, he notifies the crew chief/AMC (using the CO's radio handset) that all personnel and equipment are loaded. Aircraft door gunners provide close-in security.

(b) *Multiple lift.* The duties of the PZ closure soldier are the same as for a single lift. However, during a multiple lift, the security teams maintain security of the PZ and depart last with the PZ closure man.

(6) *The UH-60 loading sequence.* Figure D-5 depicts the loading procedure for a UH-60. For combat operations, up to 24 soldiers may be loaded in a UH-60. See FM 7-20 for a detailed discussion of "seats-out" operations.

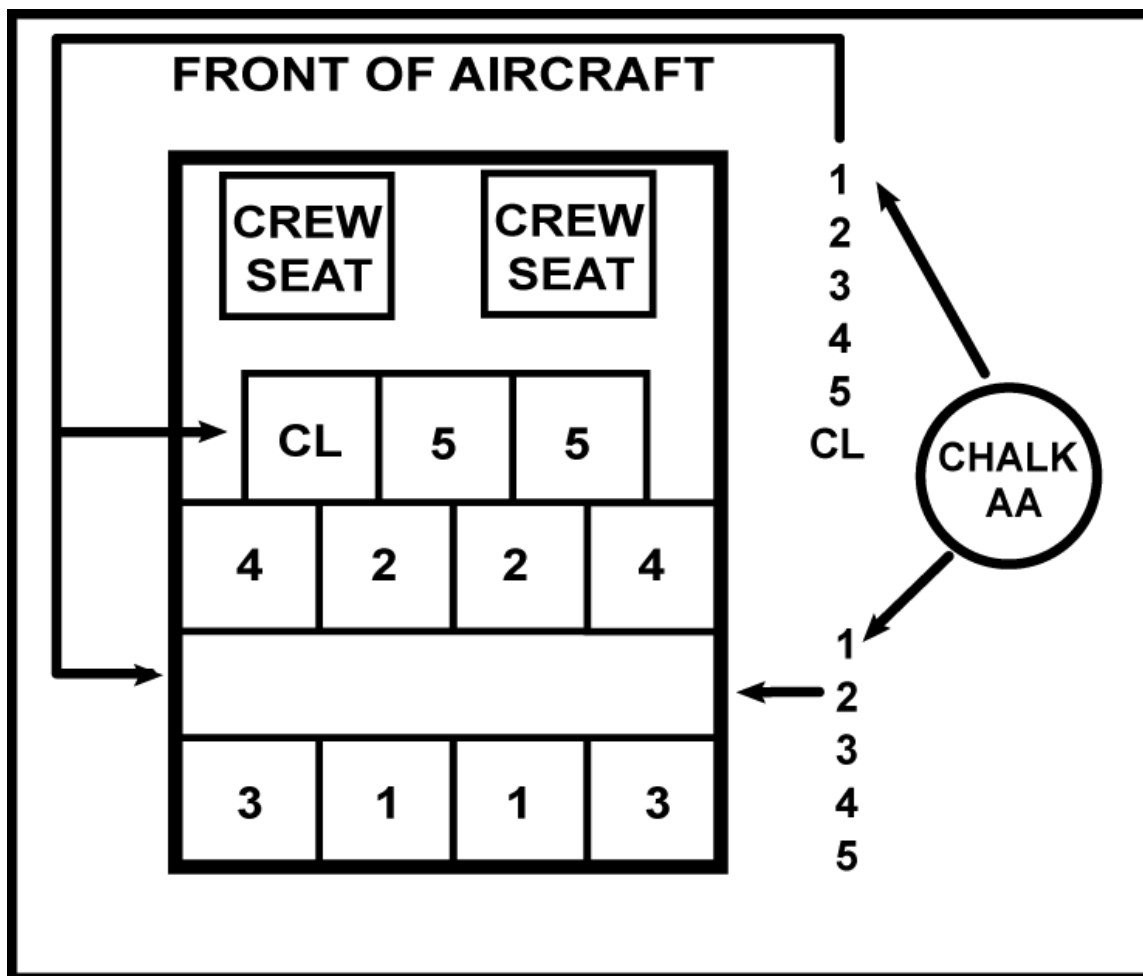

**Figure D-5. UH-60 loading diagram.**

(a) The chalk leader initiates movement once the aircraft has landed. The CO and platoon leaders normally occupy position 5, with the FSO/FIST in the other position 5.

(b) The far-side and near-side groups move to the aircraft in file, with the number one man leading the load to the appropriate side.

**NOTE:** The far-side group always moves around to the front of the aircraft.

(c) The chalk leader stops at the near side of the aircraft to ensure the near-side group loads properly; then he moves around the front of the aircraft to the far side and checks the other half of the chalk.

(d) All personnel buckle up as soon as they are seated in the correct seat.

(e) The chalk leader hands the chalk card to the pilot and answers any questions the pilot may have. They use the aircraft's intercommunication (troop commander's) handset.



## D-7. STAGING PLAN

This plan synchronizes the arrival of soldiers, aircraft, equipment, and logistic support at the PZs. The staging plan is based upon the loading plan. At company level, the staging plan is primarily concerned with the movement of the company to the PZ unit assembly area. It also addresses the linkup of company PZ control personnel with the battalion PZ control party (in larger operations) before the main body arrives. The staging plan should allow the company to be ready to start loading operations 15 minutes before the aircraft arrival time.

## D-8. DUTIES OF KEY PERSONNEL

To ensure that an air assault is executed in an effective and efficient manner, designate key personnel to perform specific duties.

a. **Air Assault Operations.** In a company air assault, the following duties and responsibilities are assigned.

(1) *Company commander.* The CO has overall responsibility for the operation. He plans the operation, briefs subordinate leaders, issues the OPORD, and conducts rehearsals. He rides in the AMC's aircraft to ensure better command, control, and communication.

(2) *Executive officer or first sergeant.* One of these two will—

- Set up the PZ. He supervises the marking of the PZ and the clearing of obstacles from the PZ.
- Brief all chalk leaders.
- Supervise all activity on the PZ, such as PZ security, movement of troops and equipment, and placement of chinks and slingloads.
- Devise and disseminate the bump plan and control the bumped soldiers.
- Ride in the last aircraft for control purposes and ensure that the PZ is cleared.

(3) *Chalk leader.* He briefs his personnel on their respective tasks and positions inside the aircraft. He also—

- Ensures that the lights or panels (if required) for his aircraft are properly emplaced.
- Assigns respective areas of security to his personnel. Ensures that each soldier goes to his proper area.
- Supervises the loading of his chalk and attachments into the aircraft to ensure that all personnel assume assigned positions and buckle their lap belts.
- Keeps current on location by using his map and communicating with the aircraft crew during air movement.
- Ensures upon landing that all personnel exit the aircraft quickly, rush to a safe distance (15 to 20 meters) from the aircraft, assume the prone position, and prepare to return enemy fire.

b. **Pickup Zone Control Party.** The PZ control party is responsible for the organization, control, and all coordinated operations in the PZ. (See FM 90-4 for more details on C2 techniques and responsibilities of key leaders.) Keeping in mind the CO's duties and responsibilities previously stated, a PZ control party for a company air assault operation could be organized as follows:

(1) *Pickup zone control officer.* He may be the XO, 1SG, or a platoon leader.

(2) *Pickup zone control NCOIC*. He is the ISG, a platoon sergeant, a section sergeant, or a squad leader.

(3) *RATELO with two radios*. One radio monitors the combat aviation net for communication with the aircraft. The second operates in the company command net or a PZ control net.

(4) *Chalk-linkup guides*. There is one guide per chalk. Their primary duties are to assist in linkup and movement of chinks from the unit assembly area to the chalk assembly area. For company air assault operations, these guides should come from the same chalk they are assigned to.

(5) *Lead aircraft signalman*. He is responsible for visual landing guidance for the lead aircraft. This signalman should come from the chalk loading on the lead aircraft.

(6) *Slingload teams*. A team includes a signalman and two hookup men.

#### **D-9. AIR MISSION BRIEFING**

The air mission briefing is the last coordination meeting of all key participants for an air assault mission. It ensures that all personnel are briefed and that all details are finalized. It is coordinated by the battalion S3 Air and normally conducted at the battalion TOC. If the company commander is the ground tactical commander, he must attend. If the battalion commander is the ground tactical commander, the company may not have a representative. The format in Figure D-6 is a guide; it will help ensure that essential information is included in air assault mission briefings.

- I. Situation.**
  - a. Enemy forces (especially troop concentrations and locations and types of ADA assets).
  - b. Friendly forces.
  - c. Weather (ceiling, visibility, wind, temperature, pressure and density altitude, sunrise and sunset, moonrise and moonset, percent of moon illumination, EENT, BMNT, PZ and LZ altitudes, and weather outlook).
- 2. Mission. Clear, concise statement of the task that is to be accomplished (who, what, and when, and, as appropriate, why and where).**
- 3. Execution.**
  - a. Ground tactical plan.
  - b. Fire support plan to include suppression of enemy air defenses.
  - c. Air defense artillery plans.
  - d. Engineer support plan.
  - e. Tactical air support.
  - f. Aviation unit tasks.
  - g. Staging plan (both primary and alternate PZs).
    - (1) PZ location.
    - (2) PZ time.
    - (3) PZ security.
    - (4) Flight route to PZ.
    - (5) PZ marking and control.
    - (6) Landing formation and direction.
    - (7) Attack and air reconnaissance helicopter linkup with lift elements.
    - (8) Troop and equipment load.
  - h. Air movement plan.
    - (1) Primary and alternate flight routes (SPs, ACPs, AND RPs).
    - (2) Penetration points.
    - (3) Flight formations and airspeeds.
    - (4) Deception measures.
    - (5) Air reconnaissance and attack helicopter missions.
    - (6) Abort criteria.
    - (7) Air movement table.
  - i. Landing plan (both primary and alternate LZs).
    - (1) LZ location.
    - (2) LZ time.
    - (3) Landing formation and direction.
    - (4) LZ marking and control.
    - (5) Air reconnaissance and attack helicopter missions.
    - (6) Abort criteria.
  - j. Laager plan (both primary and alternate laager sizes).
    - (1) Laager location.
    - (2) Laager type (air or ground, shut down or running).
    - (3) Laager time.
    - (4) Laager security plan.
    - (5) Call forward procedure.

**Figure D-6. Air mission briefing format.**

- k. Extraction plan (both primary and alternate PZs).
  - (1) Pickup location.
  - (2) Pickup time.
  - (3) Air reconnaissance and attack helicopter missions.
  - (4) Supporting plans.
- l. Return air movement plan.
  - (1) Primary and alternate flight routes (SPs, ACPs, and RPs).
  - (2) Penetration points.
  - (3) Flight formations and airspeed.
  - (4) Air reconnaissance and attack helicopter missions.
  - (5) LZ locations.
  - (6) LZ landing formation and direction.
  - (7) LZ marking and control.
- m. Coordinating instructions.
  - (1) Mission abort.
  - (2) Downed aircraft procedures.
  - (3) Vertical helicopter instrument flight recovery procedures.
  - (4) Weather decision by one-hour increments and weather abort time.
  - (5) Passenger briefing.
- 4. Service Support.**
  - a. FARP locations (primary and alternate).
  - b. Ammunition and fuel requirements.
  - c. Backup aircraft.
  - d. Aircraft special equipment requirements, such as cargo hooks and command consoles with headsets.
  - e. Health service support.
- 5. Command Signal.**
  - a. Command.
    - (1) Location of commander.
    - (2) Point where air reconnaissance and attack helicopters come under OPCON as aviation maneuver elements.
  - b. Signal.
    - (1) Radio nets, frequencies, and call signs.
    - (2) Signal operation instructions in effect and time of change.
    - (3) Challenge and passwork.
    - (4) Authentication table in effect.
    - (5) Visual signals.
    - (6) Navigational aids (frequencies, locations, and operational times).
    - (7) Identification friend or foe (radar) codes.
    - (8) Code words for PZ secure, hot, and clean; abort missions; go to alternate PZ and LZ; fire preparation; request extraction; and use alternate route.
- 6. Time Hack. All watches are synchronized.**

**Figure D-6. Air mission briefing format, continued.**

#### **D-10. SAFETY**

The CO and his subordinate leaders must enforce strict safety measures when working with helicopters. Primary safety measures include the following:

- Keeping the body low when approaching and departing a helicopter, especially on slopes.

- Keeping safety belts fastened when airborne (for training).
- Keeping weapons unloaded (no round in chamber) and on SAFE. Keeping the muzzle down on UH-60, OH-58, and CH-47 and up on the UH-1.
- Keeping radio antennas down and secured.
- Keeping hand grenades secured.
- Not jumping from a hovering helicopter until told to do so by a crewmember.
- Not approaching from, or departing to, the rear of a helicopter.

## APPENDIX E

# COMPANY MORTARS

*This appendix provides the company commander and other leaders guidance on the tactical employment of the company mortar section/platoon. The mortar section provides the company with immediate suppression and marking capabilities and limited smoke and illumination capabilities. The section's missions are to provide close-in, immediate, indirect fire to kill or suppress the enemy, and to obscure or illuminate the battlefield. (See FM 7-90 for details on employing mortars.)*

### **E-1. ORGANIZATION**

In most infantry units, mortar sections are made up of two squads, each consisting of one 60-mm mortar and its crew (Figures E-1 and E-2). The section leader is also one of the squad leaders. He is directly responsible to the CO. While there is not an FDC in the section, the section leader establishes and operates an FDC whenever the mortar section occupies static positions or makes a lengthy halt. The mortar section leader must work closely with the CO and his FSO to maximize the section's fires. In some units, the 81-mm mortar (Figure E-3) is found. The platoon has five vehicles to move its equipment, ammunition, and personnel; it also has an organic FDC.

### **E-2. RESPONSIBILITIES OF KEY PERSONNEL**

Team work is the key to an efficient mortar section. Duties must be constantly drilled and personnel cross-trained.

a. The mortar section leader is responsible (overall) to the CO for the mortar section. His duties include—

- Advising the CO on employing and positioning the mortar section.
- Assisting the FIST chief in planning fire support for the company.
- Keeping the CO informed of the location of the mortar section and the status of the mortars and ammunition.
- Maintaining a situation map showing all supported units' locations, mortar positions, maximum range lines, and targets.
- Planning, initiating, and supervising the timely displacement of the section.
- Supervising security, resupply, and communications for the section.
- Seeing that preparations are made for special firing techniques, such as direct lay and direct alignment.
- Performing the duties of chief computer.
- Cross-checking target plots.
- Maintaining ammunition records and submitting resupply requests.
- Recommending to the CO when the mortars should displace, and controlling their displacement.
- Relaying enemy information from forward observers to the company and others, as directed.

b. The mortar squad leader and gunners' responsibilities include—

- Moving and positioning the mortar as directed.
- Seeing that the mortar is properly laid.
- Checking overhead and mask clearance, and camouflage.
- Maintaining a map showing positions, sectors, and targets (needed for independent operations or when displacing by squads).
- Computing firing data for independent operations.
- Ensuring that ammunition is properly stored.
- Checking rounds for indexing and charges.
- Maintaining communications with the FDC, when applicable.

### **E-3. POSITIONS**

Based on the CO's guidance, mission, and terrain, the mortar section leader reconnoiters and selects mortar firing positions. In the 81-mm mortar platoon, a representative from the base gun and one man from the FDC may help reconnoiter and prepare the new position.

a. A mortar section position should—

(1) Allow firing on targets throughout the company's sector/zone or the supported platoon's sector/zone. (In the offense, one-half to two-thirds of the range of the mortars should be forward of the lead platoon. This reduces the number of moves needed.)

(2) Be in defilade to protect the mortars from enemy observation and direct fire. (Places, such as the reverse slope of a hill, a deep ditch, the rear of a building, and the rear of a stone wall, are well-suited for mortar positions. The reverse slope of a hill may even protect mortars from some indirect fire.)

(3) Have concealment from air and ground observation. (Vegetation is best for breaking up silhouettes. Vehicles should be positioned in defilade where natural camouflage conceals them. When the location of the firing position provides little concealment, consider the use of a hide position, which provides good cover and concealment and allows the mortar crews to quickly occupy their firing positions when required).

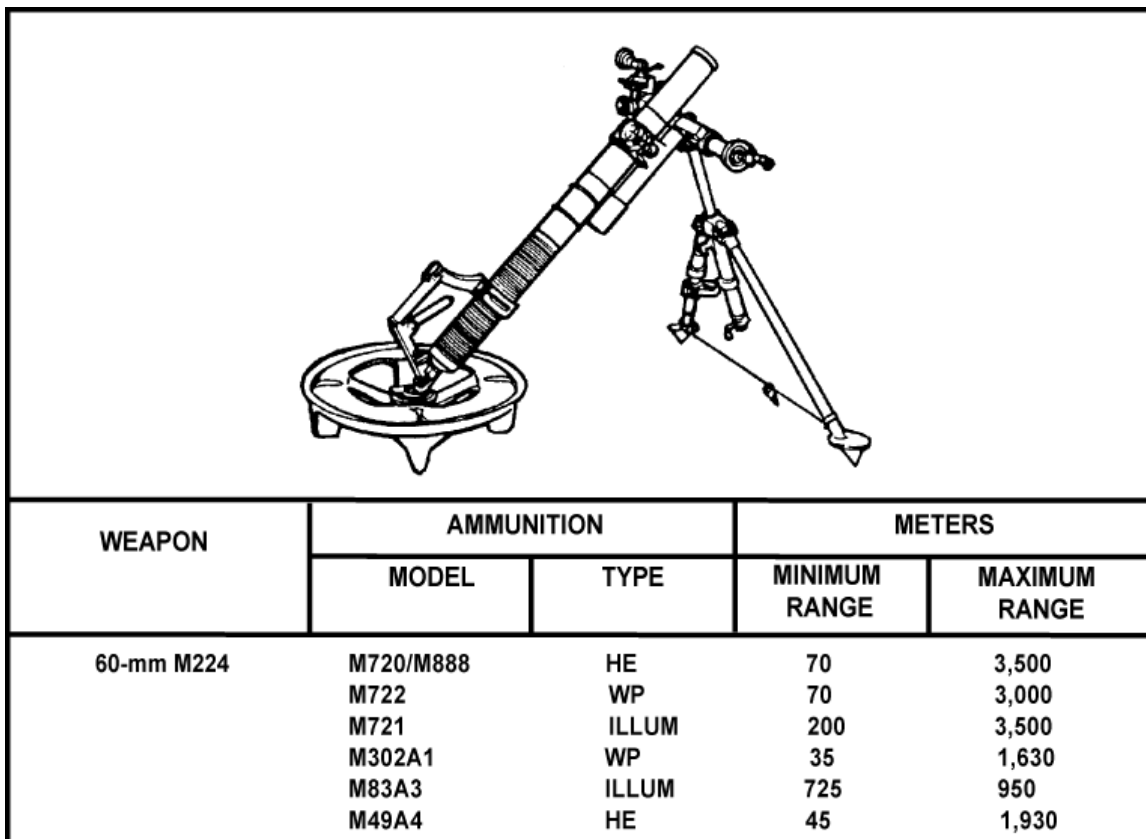

**Figure E-1. M224, 60-mm mortar and ammunition data.**

(4) Have overhead and mask clearance. (Overhead clearance is checked by setting the sight at maximum elevation and looking along the mortar tube. Mask clearance is checked the same way, but at minimum elevation.)

(5) Have solid ground that supports vehicle movement and precludes excessive settling of baseplates. (On soft ground, put sandbags under the baseplate to reduce settling.)

(6) Have 25 to 30 meters between 60-mm mortars and 35 to 40 meters between 81-mm mortars. (This reduces the chance of having more than one mortar hit by one enemy round. It also provides proper sheaf dispersion without plotting for each gun.)

(7) Have routes in and out. (These routes should ease resupply and displacement.)



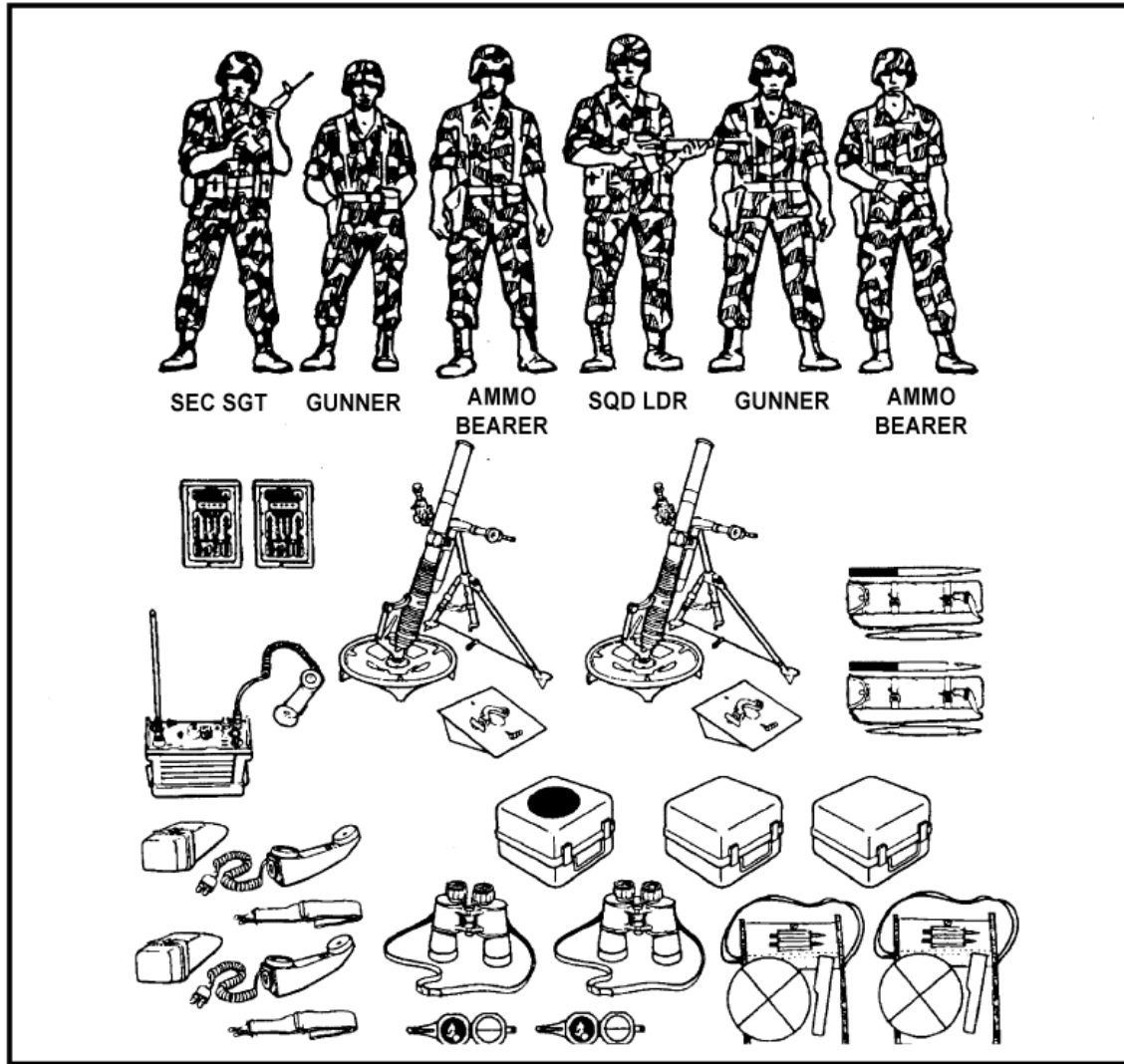
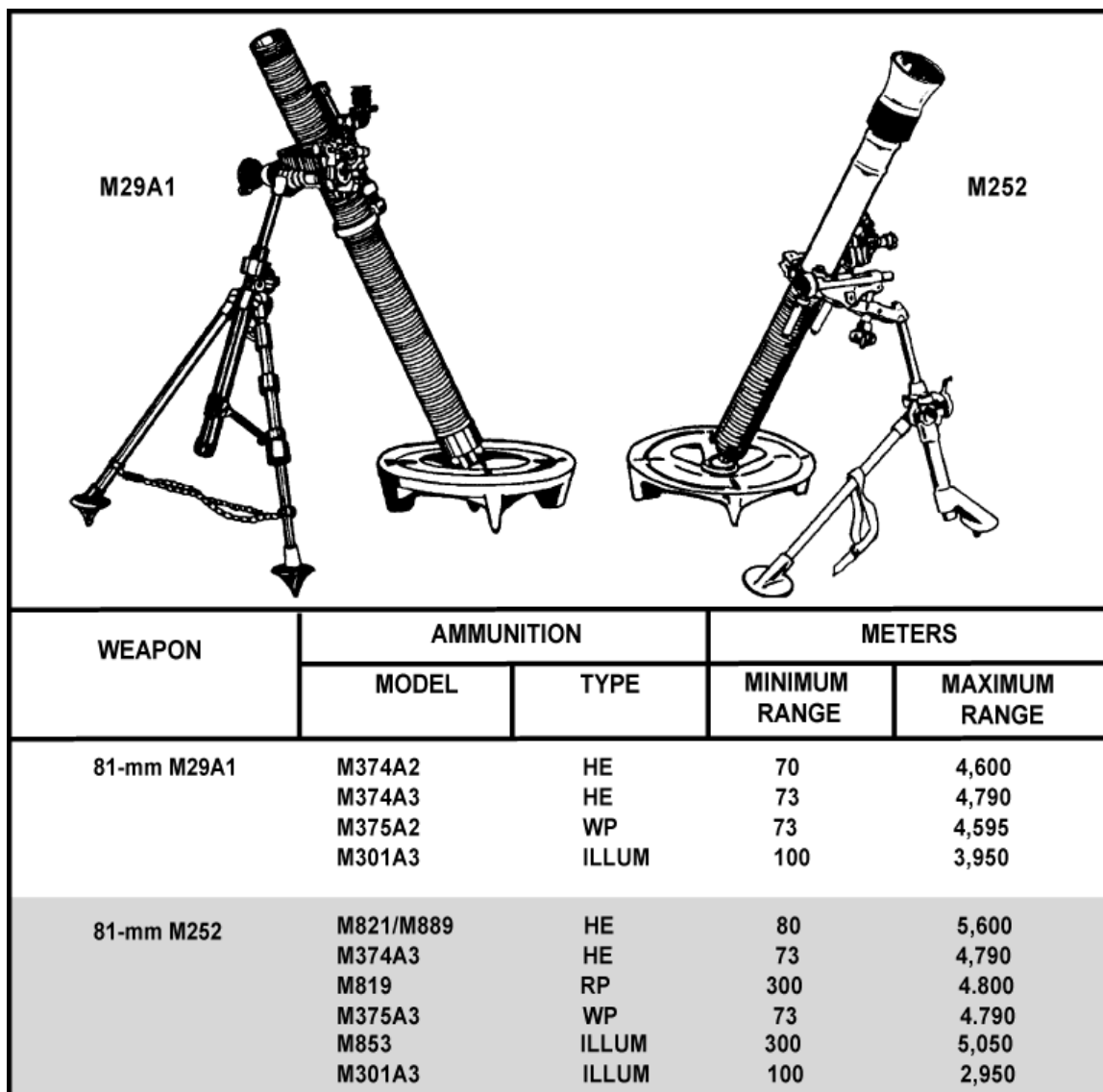

Figure E-2. Equipment and organization.



**Figure E-3. 81-mm mortar.**

(8) Be secure. (The section may have to provide its own local security. Being near other friendly units will improve security.)

(9) Avoid overhead fire of friendly soldiers when possible.

b. The FDC may be in voice-distance of the squads; however, telephone wire should be laid from the FDC to each squad for security purposes and because battle noise may be so intense that the commands cannot be heard.

c. The 81-mm platoon normally provides its own security. It does this by posting OPs, employing early warning devices, and digging mortar positions.

d. The 60-mm mortar section has a very limited capability to secure itself. Normally, it collocates with other elements, or it has a security element attached.

e. Mortar crews prepare mortar positions to protect themselves and to serve as firing positions for the mortars. The crews construct the positions with sandbags, ammunition boxes, earth, or any other available materials. (FM 7-90 describes these dug-in positions.)

**E-4. EMPLOYMENT**

In a movement to contact, the mortar section usually supports the company with priority of fire to the lead platoon. The section normally displaces one squad at a time so that at least one squad is always in position and ready to fire. The section's displacement is based on the company's movement. The leader keeps the CO informed of the location and status of his weapons and ammunition. The FOs report their locations (in code) to the FDC.

a. In an attack, initial firing positions are prepared, and ammunition may be stockpiled. Positions are occupied at the last moment before the attack. The section must remain ready throughout the attack to respond to calls for fire and to displace, if necessary.

b. In the defense, mortars are farther to the rear than in the offense. The CO plans his mortar section's final protective fire on a dangerous, dismounted enemy avenue of approach. Extra ammunition is stockpiled (if feasible). The mortars have some security when behind forward troops, but they still prepare to defend their positions.

c. To avoid being suppressed, a number of mortar positions are designated, prepared (if feasible), and occupied as required during the battle.

d. In a withdrawal not under enemy pressure, one or more mortars may be left in position to support the DLIC.

e. No matter where the platoon/section is located, it does everything it can for its own security. It may be able to post one or two security elements (equipped with Claymores and LAWs) on the most dangerous approaches. Early warning devices are also used. If attacked, the security elements give warning, kill as many of the enemy as they can, and then rejoin their squads. The rest of the unit defends them from the dug-in mortar positions. The company reserve may be employed for a counterattack or to improve the security and defense of the mortar section.

f. The mortar section leader coordinates the section defense plan with the company reserve. Targets are planned around the section's position so other mortars or artillery can support.

**E-5. DISPLACEMENT**

Mortars displace to provide continuous support and to evade suppression whether the company is attacking or defending. This paragraph applies to both 60-mm and 81-mm mortars when manpacked by the platoon or section. When displacing the 81-mm platoon with vehicles, refer to Chapter 3 and FM 7-90.

a. The displacement plan and the position of the mortar platoon/section in the company formation should not disrupt the maneuver elements, should be responsive to the commander, and should provide the mortar section with local security. It should also allow the mortars to go into action quickly using the desired method of engagement, and provide ammunition resupply for the mortars. The displacement plan flows logically from other decisions made by the CO, the company FSO, and the mortar platoon/section leader.

b. If the CO determines that operations (offensive or defensive) will move slowly enough to stay within mortar range, and that continuous indirect fires must be available, he may order the mortars to displace to a suitable support position before the company moves out and not move them again until the company reaches its next position. The

choices available for displacement are displacement by platoon/ section and displacement by squad.

(1) *Displacement by platoon/ section.* This means that the whole platoon/section displaces at the same time. This allows the section to mass fires and the section sergeant to keep good control of his section. Moving as a platoon/section maximizes the limited FDC capability. It also is the fastest method of displacement. While the section is moving, its fire support is not immediately available unless it is positioned to fire using the direct lay or direct alignment method. But even using the hip shoot, it can be available with only minimum delay.

(2) *Displacement by squad.* This method allows continuous coverage of at least part of the company's sector. Because there is only one PRC-77 in the mortar section and six men for the 60-mm, it is difficult to provide continuous indirect fire coverage even when displacing by squad. It is possible, though, for the company to attach one squad to each of two bounding platoons so that while using the direct lay or direct alignment methods, one squad is always in overwatch of the company's movement. This may allow increased mortar coverage of the company sector during decentralized operations. It may also be the most effective means of infiltrating the mortars. It also reduces the difficulty of transporting the mortar ammunition. Each platoon carries the ammunition for the attached gun squad.

(3) *Attached or separate.* The CO also decides whether to move the mortars as a separate element in the company formation or to attach each gun squad to a subordinate element.

(a) The mortars are attached to a subordinate element when the situation requires that task organization (on a patrol or with the company support element, for example), or when the mortars need additional control, security, and load carrying capacity (during an infiltration, for example).

(b) The mortars move as a separate element in the company formation when the CO wishes to control them directly and keep them together for massed use. When the mortars move as an element, they can displace by platoon/section or by squad.

## E-6. ENGAGEMENTS

There are various engagement methods: direct lay and direct alignment (which do not require a fire direction center), the conventional indirect fire, and the hip shoot. Direct lay and direct alignment are the primary methods of engagement for the 60-mm mortar.

a. **Direct Lay.** This method is used when the gunner can see the target. The mortar may be hand-held or bipod-mounted. An initial fire command is required to designate the target and (if desired) specify the shell-fuse combination and number of rounds. The gunner then adjusts fire and fires for effect without additional instructions. Its advantages are: the target can be engaged immediately when using the hand-held mode (the mortar only weighs 18 pounds and is therefore highly portable); it can be used by relatively untrained gunners, such as cross-trained infantrymen; and it does not require an FDC. Its disadvantages are: it requires the mortar crew to be relatively close to the enemy and therefore susceptible to direct and indirect fires; and it is less effective at night (targets that cannot be seen by the gunner cannot be engaged).

b. **Direct Alignment.** This method is used to allow the mortar crew to fire from full defilade positions without an FDC. It requires that an FO be within 100 meters of the

gun-target line and, if possible, within 100 meters of the guns. It can be used only when mounted on the bipod or held in the hand, although the bipod-mounted is much more accurate. Its advantages are: the target is engaged more quickly than with either of the FDC methods; the crew has more protection than in the direct lay method; and it does not require an FDC. Its disadvantages are: it is slightly slower than the direct-lay method; it requires the mortar crew to be relatively close to the enemy and therefore vulnerable to indirect fires or assault; it requires a trained FO to be within 100 meters of the guns or at least within 100 meters of the gun-target line; and the FO must also be in direct communication with the gun crew by voice, arm-and-hand signal, land-line, or radio. The gun must also be relaid to engage each different target.

c. **Conventional Indirect Fire.** This method is used when the mortars have been laid for direction and an FDC established with positions plotted on the M19 plotting board or the mortar ballistic computer. In this situation (for the 60-mm mortar), the section leader operates the MBC or the M19 plotting board, and the radio as the FDC. Its advantages are: the mortars can fire accurately at any target within range as long as it is observed by an FO who can communicate with the FDC; plotted targets can be accurately engaged during limited visibility; and the mortar crew can be located well away from enemy direct fires. Its disadvantages are: there is no designated FDC in the light infantry mortar section; and the fires are not as responsive as direct lay.

d. **Hip Shoot.** When a call for fire is received during movement and the target cannot be engaged by either the direct-lay or direct-alignment method, a hip shoot is initiated. A hip shoot is a hasty occupation of a firing position; it requires both an FDC and an FO. The section leader normally acts as the FDC (60-mm only). The FO's corrections may be sent over the radio or by a wire net. The platoon leader/section leader must quickly determine an azimuth of fire by map inspection. He then gives this direction to the mortar squads. The second squad leader uses the M2 compass (for the 60-mm section) to lay the base mortar. The section leader uses either the MBC, the graphical firing scale, or the firing tables to determine the appropriate elevation and charge. He uses either the MBC or the M19 plotting board to refine the firing data based on the FO's corrections. The section leader may use the aiming-point deflection method, depending upon the terrain. The second mortar is laid either by sight-to-sight or M2 compass. Its advantages are: a hip shoot allows fire support when other methods of engagement are not usable; and the mortar section is able to move at the same time as the unit and still provide adequate fires. Its disadvantages are: it is the slowest method of fire and least accurate.

APPENDIX F  
**NUCLEAR, BIOLOGICAL, OR CHEMICAL  
ENVIRONMENT OPERATIONS**

*Nuclear, biological, and chemical weapons can cause casualties, destroy or disable equipment, restrict the use of terrain, and disrupt operations. They may be used separately or in combination to supplement conventional weapons. The company must be prepared to fight on an NBC-contaminated battlefield. This appendix prescribes active and passive protection measures to avoid or minimize the effects of NBC weapons. The CO designates principal NBC defense trainers and advisors on NBC defense operations and NBC equipment maintenance. These trainers include an NBC defense officer, a chemical NCO (MOS 54B), and an enlisted alternate. The CO ensures all personnel in his command can operate and perform maintenance on all organic NBC equipment.*

**Section I. NUCLEAR ENVIRONMENT**

Given the massive destructive and disruptive effects of a nuclear blast, it is imperative the rifle company train to reduce the effect of such a blast on operations as much as possible.

**F-1. NUCLEAR WEAPONS EFFECTS**

Nuclear detonations produce the following main effects: blast, thermal radiation, nuclear radiation, and electromagnetic pulse. The danger from each of these effects depends on the type of weapon, the yield of the weapon, the height of burst, the distance from the detonation, and the hardness of the target.

a. **Blast.** Immediately after a nuclear detonation, a high-pressure shock wave develops. It travels away from the point of detonation in all directions at the speed of sound. This shock wave causes most of the destruction created by a nuclear detonation.

(1) Strong winds caused by the passage of the shock wave propel objects such as tree limbs and debris through the air, turning them into destructive missiles.

(2) Exposed soldiers and structures are vulnerable to blast effects. Personnel inside structures can be hurt by the collapse of the structures; those outside can be hurt by flying debris or be picked up and thrown downwind by the blast wave.

b. **Thermal Radiation.** Intense heat and extremely bright light occur instantaneously with a nuclear detonation.

(1) *Heat.* The intense heat starts fires in buildings, forests, and flammable materials. Such fires may spread quickly because of the burning debris scattered by the blast. The heat can also burn exposed skin, even at long ranges.

(2) *Light.* The light produced by the detonation can cause temporary or permanent blindness. Temporary blindness, called dazzle, from a detonation in daylight may last 5 to 10 minutes. At night, the loss of vision will last longer because the eyes will probably have adapted to the dark. The light can injure eyes permanently if it causes burns within the eye itself. This is apt to occur to those soldiers who are looking in the direction of the fireball at the instant of detonation.

c. **Nuclear Radiation.** A nuclear detonation produces two types of nuclear radiation--initial and residual. Both types can injure or kill soldiers.

(1) *Initial.* This is radiation emitted within the first minute after detonation. It travels at the speed of light and damages human tissue and blood-forming cells. Since initial nuclear radiation travels so fast, the only way to be protected from it is to be in a protected position before the detonation.

(2) *Residual.* This is radiation that lasts after the first minute. It consists mostly of neutron-induced radiation and fallout.

(a) Neutron-induced radiation is produced by high-speed neutrons produced by the explosion. It exists only in the vicinity of the point of detonation. The intensity and extent of this radiation depends on the type of soil at the point of detonation, the height of the burst, and the type and yield of the weapon. The only significant source of residual radiation from an airburst weapon is neutron-induced radiation in the soil in a symmetrical pattern beneath the point of detonation.

(b) Militarily significant fallout is produced with a surface burst when material from the earth is drawn into the fireball, vaporized, and combined with radioactive material to form radioactive particles, which condense then fall back to earth. The larger particles fall back right away near the point of detonation. The smaller particles are carried by the winds until they gradually settle to the earth's surface. The area contaminated by fallout may extend over many thousands of square kilometers.

d. **Electromagnetic Pulse.** This is a massive surge of electrical power, similar to an extremely strong radio signal. It occurs within seconds of a nuclear detonation and is transmitted through the air in all directions from the point of detonation. EMP can damage electrical (especially solid-state) components of equipment (radios, radars, computers, and vehicles) and weapon systems (TOWs and Dragons).

## F-2. NUCLEAR BURSTS

The different types of nuclear bursts are airbursts, surface bursts, and subsurface bursts.

a. An airburst occurs when a weapon detonates above the ground so that the fireball does not touch the earth's surface. Fallout or radioactive material from an airburst is military insignificant unless rain or snow falls through the radioactive cloud and brings the material to earth. Neutron-induced radiation is the major radiation hazard.

b. A surface burst occurs when a nuclear weapon detonates at such a height that the fireball touches the surface of the earth. Blast, thermal radiation, and initial nuclear radiation are not as widespread as from an airburst. Induced radiation is present, but it is masked by fallout. The fallout produced by a surface burst is a dangerous hazard because it can cover a large area with high levels of radioactivity.

c. A subsurface burst occurs when a nuclear weapon detonates beneath the surface of the earth. If the fireball breaks through the earth's surface, local fallout can be produced. Thermal radiation will not be a significant hazard because it is absorbed by the soil. Blast effects are also reduced, but shock waves passing through the ground or water will extend for some distance. Residual radiation will occur in and around the crater.

---

### **F-3. NUCLEAR HAZARD WARNING**

To warn the company of a friendly nuclear detonation, the battalion normally issues a warning message. The format for this warning is normally prescribed by unit SOP and should contain a proword indicating that the message is a nuclear strike warning. It also prescribes what protective measures to take or gives the orders to evacuate the area. The warning indicates the expected time and general location of the detonation. Once the warning is received by the company, the CO disseminates it through the company using the chain of command. He also specifies the protective measures.

### **F-4. NUCLEAR HAZARD ALARM**

The company SOP should prescribe a nuclear hazard alarm and also a signal to indicate that the hazard is no longer present.

a. The standard nuclear hazard alarm is the vocal alarm, FALLOUT. The standard signal for indicating that the hazard is no longer present is the vocal signal, ALL CLEAR.

b. As soon as a nuclear hazard is detected, the nuclear hazard alarm should be given. It can be given by any soldier detecting the hazard. Once the alarm has been initiated, it must be passed throughout the company as quickly as possible. When the hazard no longer exists, the ALL CLEAR signal is given. This is normally initiated by the CO and then passed throughout the company as quickly as possible.

### **F-5. PROTECTION**

The best protection from the immediate effects of a nuclear detonation is to take cover in fighting positions, culverts, ditches, or behind hills. Soldiers should drop immediately, face down with their head towards the blast, close their eyes, and cover all exposed skin. They must stay down until the blast wave passes and until the debris stops falling. Then they check for (and treat) injuries, check damage to equipment and supplies, and prepare to continue the mission.

a. Radiation is the only nuclear effect that remains after a nuclear detonation. It may last for days or even years, and it may cover a large area. Since radiation cannot be detected by human senses, radiac equipment must be used to detect its presence. The procedures for radiological monitoring, surveying, and reporting must be prescribed by SOP ( FMs 3-3 and 3-4 ).

b. If the company must stay in a fallout area, all soldiers should stay in positions with overhead cover as much as possible. They should cover their mouths and noses with scarves or handkerchiefs to keep from inhaling radioactive particles. The company continually monitors the radiation level in the area.

c. Once the fallout has passed, soldiers brush the radioactive dust off their clothing and scrape the dirt from the area immediately around them. Radiacmeter operators continue to monitor and report radiation levels. All soldiers should wash themselves and their equipment whenever possible. The time the company may stay in a contaminated area depends on the amount of radiation to which its soldiers have been exposed, the intensity of the radiation, the protection available, and the needs of the mission.



## F-6. RADIATION LEVELS

When fighting in a nuclear environment, the company closely monitors the amount of radiation that its soldiers have already absorbed (dose) and the amount to which they are being exposed (dose rate). To do this, the company uses the IM-93A/UD dosimeter and the IM-174A/PD radiacmeter. The IM-93A/UD dosimeter is normally carried by a small-unit leader.

a. **IM-93A/UD Dosimeter.** This meter indicates the total radiation dose received by soldiers. It is the size of a fountain pen and easy to read. Each platoon is normally assigned two of IM-93s. Platoon leaders maintain a record of the times and amounts of each reading. The frequency of the readings and reports is set by the company SOP. At prescribed time intervals, the platoon leaders report their readings to the CO. The company NBC NCO consolidates these reports from the platoons and sends the consolidated report to battalion. The format for this report is normally prescribed by SOP (FM 3-3).

**NOTE:** For military purposes, one roentgen equals one centigray. The radiation received by a man is measured and expressed in cGys.

b. **IM-174A/PD Radiacmeter.** This is used for area monitoring and survey. It measures gamma radiation in units from 0 to 500 cGys per hour.

(1) All soldiers must be trained in the use and maintenance of these devices and in techniques of radiological monitoring and survey.

(2) Radiological monitoring and survey starts on the order of the CO or IAW the SOP. When a contaminated area is detected, the radiological monitoring and survey personnel mark the area with radiological contamination markers. They also record and report to the CO the radiation dose rates and the time and location of each reading. The company NBC NCO consolidates these reports and sends the information to battalion, using the NBC 4 report.

(3) The radiological monitoring and survey personnel conduct either periodic or continuous monitoring (FM 3-3). During periodic monitoring, they monitor different points within the company area at least once each hour. They conduct continuous monitoring when—

- The company gets a fallout warning.
- The company is moving.
- A nuclear detonation is reported, seen, or heard.
- Radiation above 1 cGy per hour is detected by periodic monitoring.
- Ordered by the commander.

(4) Continuous monitoring stops on order from the commander or when the dose rate falls below 1 cGy per hour (except for units on the move, since they could enter a contaminated area anytime en route).

---

## **Section II. CHEMICAL OR BIOLOGICAL ENVIRONMENT**

Since many possible enemy forces have chemical/biological weapons, the company may have to fight under active CB conditions. These weapons may be used alone or with nuclear or conventional weapons. Regardless of how these weapons are used, the company must be able to survive and continue its combat mission. To ensure this, the company must be trained to meet the NBC standards of proficiency prescribed in AR 350-42.

### **F-7. CHARACTERISTICS OF CHEMICAL AGENTS**

Chemical agents are used to kill or injure humans. They can cover large areas and may be placed on a target as a vapor, liquid, or aerosol. A mixture of agents can be used to cause confusion and casualties. Chemical agents can be disseminated by artillery, mortars, rockets, missiles, aircraft spray, bombs, and landmines.

### **F-8. CHARACTERISTICS OF BIOLOGICAL AGENTS**

Biological agents are disease-producing germs. These agents may be dispersed as aerosols by generators, explosives, bomblets, missiles, and aircraft. Harmful germs may also be spread by the release of infected insects, such as flies, mosquitos, fleas, and ticks.

### **F-9. EFFECTS ON SOLDIERS**

CB agents may enter the body through the eyes, nose, mouth, or skin; they can cause sickness or death. Liquid agents may be dispersed in water and on equipment, terrain, and foliage. The agent may stay for hours or days, causing a hazard to unprotected soldiers.

### **F-10. EFFECTS ON EQUIPMENT**

CB agents have little direct effect on the mechanical operation of equipment. However, liquid chemical-agent contamination on equipment can restrict the equipment use until it is decontaminated. The company must be prepared to decontaminate its vehicles and equipment. The CO should use information from FM 3-5 to assist in decontamination of his vehicles, equipment, and personnel.

### **F-11. EFFECTS ON TERRAIN**

Liquid chemical agents may restrict the use of terrain and buildings. The company does not decontaminate terrain. Therefore, the company should bypass contaminated areas when possible. When this is not possible, the company may cross contaminated areas after soldiers put on appropriate pieces of protective clothing.

**F-12. DETECTION OF CHEMICAL AGENTS**

The senses may not be able to detect chemical agents because some agents are odorless, colorless, and tasteless. Therefore, chemical agents must be detected by using the M8A1 manpacked, automatic chemical-agent alarm; the ABC-M8 chemical-agent detector paper; or the M256 chemical-agent detector kit (FM 3-4). Observation of the delivery system may also provide early warning. Aerial spraying by fixed or rotary wing aircraft and munitions that do not detonate with the usual HE blast are indicators of possible chemical attack.

**F-13. DETECTION OF BIOLOGICAL AGENTS**

Biological agents are extremely difficult to detect. Soldiers must be alert to any indication that biological agents are being used. Any unusual sickness in soldiers or civilians should be reported promptly.

**F-14. PROTECTIVE MEASURES**

The best protective measure against NBC attacks is avoidance. The CO ensures his company is prepared for and protected against an NBC attack. He uses the terrain and disperses his unit to protect it. He also ensures that detection and monitoring equipment is used properly. Other protective measures include warning signals, protective equipment and clothing, and treatment of casualties.

a. **Warning Signals.** Company SOP should prescribe a primary and alternate warning signal for alerting soldiers that chemical or biological agents have been detected. The warning signals must be disseminated throughout the company and understood by all soldiers. Anyone detecting the use of chemical or biological agents should give the warning signal.

b. **Protective Equipment and Clothing.** A soldier's primary protection against a CB attack is his protective mask that protects his face, eyes, and respiratory tract.

(1) *Chemical attack.* For full protection against liquid chemical agents, soldiers must wear their protective masks and hoods and chemical-protective overgarments, overboots, and gloves (FM 3-4).

(a) Once chemical agents have been used or while the threat of a chemical attack exists, the CO must decide whether the protective mask and the chemical-protective clothing will be worn (this is called mission-oriented protective posture), carried, or stored in the trains. When feasible, the CO specifies the degree of protection before a mission. (The minimum degree of protection may be prescribed by battalion or higher level.) Later, he may direct that the protection be modified according to the threat, temperature, and workload.

(b) The MOPP level directed by the CO will determine what equipment and clothing must be worn and used, and what precautionary measures must be applied. Therefore, it is essential that the CO and his subordinate leaders be familiar with MOPP levels (Figure F-1). (See Chapter 2, FM 3-4 for a detailed discussion on MOPP and the use of MOPP tables.) MOPP procedures should be stated in the company's SOP.

(2) *Biological attack.* The best defense against biological agents is strict enforcement of all preventive medical and field sanitation measures along with high standards of personal hygiene. The duty uniform and gloves protect against bites from insects (such as mosquitoes and ticks) that may carry disease-causing germs. Clothing should be buttoned

and trouser legs should be tucked into the boots. Covering the skin reduces the possibility of biological agents entering the body through cuts and scratches. It also keeps disease-carrying insects from reaching the skin. Insect repellents and insecticides are effective against most disease-carrying insects. High standards of sanitation also improve protection against some insects.

c. **Treatment of Chemical-Agent Casualties.** The casualties from a chemical attack must be treated as soon as possible to prevent further injuries or complications. This treatment includes both first-aid measures and decontamination. Casualty treatment and evacuation plans must ensure that contaminated casualties are separated from noncontaminated casualties. The symptoms and first-aid steps for chemical agents are as follows:

(1) *Nerve agents.* The symptoms of nerve-agent poisoning are unexplained runny nose, blurred vision, tightness in the chest, difficulty in breathing, drooling, nausea, twitching, and convulsions. The injection of a nerve agent antidote is the first-aid measure for soldiers showing symptoms of nerve-agent poisoning. A soldier gives himself the contents of one nerve agent antidote kit when he experiences these symptoms. If symptoms persist after 5 to 10 minutes, a buddy may administer additional kits as required.

| MOPP | OVERGARMENT                                 | OVERBOOTS         | MASK/HOOD                                   | GLOVES            |
|------|---|-------------------|---|-------------------|
| 0    | Readily available                           | Readily available | Carried                                     | Readily available |
| 1    | Worn, opened or closed based on temperature | Carried           | Carried                                     | Carried           |
| 2    | Same as MOPP 1                              | Worn              | Carried                                     | Carried           |
| 3    | Same as MOPP 1                              | Worn              | Worn, opened or closed based on temperature | Carried           |
| 4    | Worn, closed                                | Worn              | Worn  | Worn              |

**Table F-1. Protective equipment and clothing for MOPP levels.**

(2) *Blister agents.* The symptoms of blister-agent poisoning are redness of the skin in 4 to 6 hours and blisters in 6 to 12 hours after exposure. These symptoms may be delayed for several hours or days, depending on the type agent used. There is no first aid for blister-agent poisoning other than decontamination. If burns or blisters develop after decontamination, soldiers cover the area with sterile gauze or a clean cloth to prevent infection. The blisters should not be broken. However, if they break, they should be treated as open wounds.

(3) *Blood agents.* The symptoms of blood-agent poisoning are increased breathing rate, dull throbbing headache, and nausea. There is no self-aid or buddy treatment for blood agent symptoms; victims must seek medical treatment.

(4) *Choking agents.* The symptoms of choking - agent poisoning are coughing, choking, nausea, and headache. The first aid for choking-agent poisoning is to keep the affected soldier still, warm, and comfortable. He should not be moved unless necessary.

d. **Decontamination of Soldiers and Their Equipment.** All soldiers must know decontamination procedures.

(1) *Chemical agent.* A soldier has an M258A1 skin decontaminating kit. (See FM 3-5 for instructions on the use of this kit.)

(2) *Biological agent.* Soldiers decontaminate themselves by showering with soap and hot water. Germicidal soaps are used if available. The nails should be thoroughly cleaned, and the hairy parts of the body should be scrubbed. Contaminated clothing is washed in hot, soapy water if it cannot be sent to a field laundry; cotton items may be boiled. Soldiers wash their contaminated equipment in hot, soapy water and allow it to air out.

(3) *Equipment and vehicles.* Equipment, individual weapons, and clothing can be decontaminated with the M258A1 decon kit.

(a) Overgarments need to be exchanged after becoming contaminated. The MOPP gear exchange is a safe method for removing overgarments and all gross contamination from individual soldiers. (FM 3-5 provides detailed instructions for MOPP gear exchange.)

(b) Gross contamination can be removed from vehicles by washing them. Battalion-level decontamination apparatus and crew supervised by a 54B chemical specialist link up with the contaminated elements as they move between fighting positions. They spray the vehicles with hot, soapy water. This limits the spread of contamination. MOPP gear exchange and vehicle washdown are the two techniques in hasty decontamination (FM 3-5).

(c) When the situation permits, the MOPP gear exchange suits and equipment should be repositioned in the vicinity of the company. This will allow the flexibility to rotate squads or platoons to the hasty decontamination site.

e. **Crossing Contaminated Areas.** The company should cross a contaminated area only when it is essential to accomplish the mission or for the survival of the unit. When directed to cross a contaminated area by battalion, the CO should carefully select a route that minimizes the unit's exposure. (FM 3-3) Information from battalion and reconnaissance by the company will provide the required information to plan the crossing.

(1) *Chemical contamination.* Before conducting the crossing, the CO must plan for a hasty decontamination on the far side of the contaminated area, requiring clean MOPP suits and decontamination equipment. The unit must either carry this equipment or have it delivered to the decontamination site. The company crosses in MOPP4 using M9 chemical detection paper to indicate the presence of a liquid agent. After moving a safe distance beyond the contaminated area, the CO decides if he will conduct hasty decontamination by testing with the unit's detection equipment. If contamination is present, he must decide whether to continue the mission and decontaminate later or to do it now. To decontaminate now, the company conducts MOPP gear exchange and decontaminates their individual equipment. The unit then moves a minimum of 500 meters to a clean location and tests for chemical contamination. If no chemical contamination is detected, the company begins unmasking procedures to reduce the MOPP level. When they finish, the CO establishes the appropriate MOPP level and continues the mission. If the company has excessive amounts of liquid contamination on their weapons and equipment, it may be impossible to decontaminate properly with the

available decontamination kits and equipment. If this occurs, the unit will be required to continue the mission while still in MOPP4.

(2) *Radiological contamination.* The primary concern is to avoid the areas of highest radioactivity and to cross the others as quickly as possible. The soldiers must avoid inhaling radioactive dust or particles by covering their mouths with a damp rag or wearing their protective masks if nothing else is available. If the crossing is expected to be very dusty, the MOPP suits may be worn to assist the decontamination on the far side. During the crossing, check individual soldier's dosimeters to ensure the OEG is not exceeded. Once across, the unit moves a safe distance away from the area (500 meters) where the CO determines the extent of soldier/vehicle contamination and decides whether to perform decontamination now or later. Decontamination is conducted by removing all dust and dirt that may have been picked up by the unit during its crossing. If MOPP suits were worn, they must be discarded. If protective masks were worn during the crossing, the filters must be replaced.

f. **Field Expedient MOPP Suits.** When the CO conducts his risk assessment, he may have decided the threat of chemical attack was low; therefore, the unit's MOPP gear may not be immediately available. Or, the unit may have used all of its MOPP suits and be waiting for resupply. In either case, if this unit encounters a chemical hazard, it must use one of the following field expedient protective measures.

(1) *Wet weather gear with chemical gloves, wet weather boots, and protective masks.* This ensemble protects the soldier well against all vapor agents, but not well against liquids. Liquid agents penetrate these garments much quicker than the MOPP suit. Once contaminated, the wet weather clothing is discarded because it cannot be decontaminated and reused.

(2) *BDUs with chemical gloves, wet weather boots, and protective masks.* The BDUs should be taped to the gloves and boots. This ensemble gives marginal protection against liquids and mustard agent vapors. Once contaminated, the BDU material is penetrated very quickly and must be removed and discarded.

(3) *Poncho with wet weather boots and protective mask.* The poncho can be used as a garment, or over a fighting or sleeping position as a disposable cover. It is penetrated very quickly by liquid agents and must be discarded after being contaminated.

(4) *MOPP suits are not always essential.* When attacked with nonpersistent nerve, choking, riot control, and blood agents—the protective mask alone will provide adequate protection as long as no liquid agent is present.

g. **Field Expedient Decontamination Measures.** A unit may also conduct field expedient decontamination. In the absence of issued decontaminants, any bleach or organic solvent will work. Earth, fire, water, and even sunlight can also be used for this purpose. A point to remember is to decontaminate something, it does not necessarily have to be chemically neutralized. It is only necessary to remove, seal, or cover the agent.

## APPENDIX G

# ORDERS FORMATS AND SUPPLEMENTS

*The Army's authority for staff procedures and formatting orders is FM 101-5 and the formats contained herein are consistent with it. Although these formats are written, company commanders will normally receive their orders orally from the battalion and will give them orally to their companies. They will use operations overlays, terrain models, and execution matrixes to supplement the order.*

### **G-1. WARNING ORDER**

Warning orders give subordinates advance notice of operations that are to come. This gives them time to prepare. The order should be brief, but complete. A sample format follows:

1. **SITUATION.**

Brief description of the enemy and friendly situations. Attachments and detachments to the company.

2. **MISSION.**

Use the restated mission from the mission analysis.

3. **GENERAL INSTRUCTIONS.**

a. Special teams or task organization within the company.

b. Uniform and equipment common to all (changes from SOP; for example, drop rucks, drop or pick up helmets).

c. Special weapons, ammunition, or equipment (different from SOP). (For example, mines, satchel charges, grappling hooks, drop or pick up night vision devices.)

d. The tentative time schedule is formed on the basis of mission analysis.

It includes at least:

(1) Earliest time of move.

(2) Time and place of OPORD.

(3) Probable execution time.

(4) Inspection times and items to be inspected different from SOP.

(5) Rehearsal times and actions to be rehearsed. (For example, actions at the objective, special teams for bridges, searches, EPWs, or other actions as time allows.)

e. Additional general instruction as needed or by SOP.

4. **SPECIAL INSTRUCTIONS.**

a. To subordinate leaders:

- Executive officer.
- First sergeant.
- Company FSO.
- Platoon leaders.
- Mortar section sergeant.
- Antiarmor section sergeant.
- RATELO.

- Medic.
- Attachments.
- b. To persons helping prepare OPORD (SOP).
- c. As needed or by SOP.
- d. Acknowledgement. All subordinates verify receipt of the warning order to ensure the required personnel are notified.

## G-2. OPERATIONS ORDER

An OPORD gives the subordinate leaders the essential information needed to carry out an operation. OPORDs use a five-paragraph format (shown below) to organize thoughts and ensure completeness. They also help subordinate leaders understand and follow the order. Use a terrain model or sketch along with a map to explain the order. The order should be given while observing the objective area.

### TASK ORGANIZATION:

|                  |            |         |
|------------------|------------|---------|
| 1st PLT(-)       | 2nd PLT(+) | 3rd PLT |
| 2 Antiarmor Tms  | 1/1st PLT  |         |
| Antiarmor SEC(-) | CO Control |         |
|                  | 60-mm SEC  |         |

1. SITUATION. (The company task organization for the mission is stated at the start of the OPORD so that the subordinates know what assets they will have during the operation.)

a. Enemy Situation.

(1) Composition, disposition, and strength.

(2) Recent activities.

(3) Capabilities.

(4) The enemy's most probable COA. A sketch or enemy overlay is normally included to clarify this description.

b. Friendly Situation.

(1) Mission and concept for the battalion.

(2) Mission for the unit on the left.

(3) Mission for the unit on the right.

(4) Mission for the unit to the front.

(5) Mission for the unit to the rear or following.

(6) Mission for the battalion reserve.

(7) Mission for any units supporting battalion if they impact on the company mission.

c. Attachments and Detachments. Changes to the task organization during the operation. For example, if the task organization changes during the consolidation phase of an attack, it would be indicated here.

2. MISSION.

The mission essential task(s) and purpose(s). It normally includes Who, What, When, Where, and Why. The where is described in terms of terrain



features/grid coordinates. If objective names are used, they are secondary references and placed in parentheses.

### 3. EXECUTION.

a. Concept of the Operation. This paragraph describes how the CO intends to accomplish his mission. At company level, a maneuver and fires subparagraph will always be included. When needed to clarify the concept or to ensure synchronization, additional subparagraphs, such as engineering, Intelligence, EW, and counterair operations, may be included. The operation overlay/concept sketch is referenced here.

(1) Maneuver. The maneuver paragraph should be focused on the decisive action. At company level, a maneuver paragraph that assigns the missions to each platoon and or section and identifies the main effort normally, requires no additional clarification. If it should, the CO may clarify it in the concept of the operation paragraph (paragraph 3a).

(2) Fires. This paragraph describes how the CO intends for the fires to support his maneuver. It normally states the purpose to be achieved by the fires, the priority of fires for the company, and the allocation of any priority targets. A target list, fires execution matrix, or target overlay may be referenced here.

(3) Engineering. Often, especially in defensive operations, this paragraph is required to clarify the CO's concept for preparing obstacles, mines, and fortifications. When the company is supported by engineer equipment or units, the CO states his guidance for employing these assets here. He may do this by stating his priority for the engineer effort (survivability, countermobility, and mobility) and the priority for supporting his subordinates, (3d PLT, 1st PLT, AA section, 2d PLT, mortar section, and the CP).

b. Tasks to Maneuver Units. This paragraph lists each of the platoons' tasks/ limitations. Each of these subordinate units will have a separate paragraph.

c. Tasks to Combat Support Units. This paragraph lists the tasks and limitations for the mortar and antiarmor sections and any attached combat support units. Each unit will have a separate paragraph.

d. Coordinating Instructions. These are the tasks and limitations that apply to two or more subordinate units. If they do not apply to all the subordinate units, then those units that must comply are clearly stated.

### 4. SERVICE SUPPORT.

This paragraph provides the critical logistical information required to sustain the company during the operation.

a. General. It provides current and future trains locations.

b. Materiel and Services. It may have a separate subparagraph for each class of supply, as required.

c. Casualty Evacuation.

d. Miscellaneous.

### 5. COMMAND AND SIGNAL.

a. Command. This paragraph states where the C2 facilities and key personnel will be located during the operation and adjustments to the unit

SOP, such as a change to the succession of command or the standard wire plan.

b. **Signal.** It provides critical communication requirements such as radio listening silence in effect forward of the LD, signals for specific events or actions, emergency/visual signals for critical actions, and SOI information.

ACKNOWLEDGE. Use the message reference number.

ANNEXES

A — Intelligence/Intelligence Overlay(s).

B — Operation Overlay/ Concept Sketches.

C — As required, such as road march, truck/ boat movement, air assault, and river crossing.

### **G-3. FRAGMENTARY ORDER**

These provide timely changes to existing orders. Elements normally found in a complete order may be omitted when these elements have not changed, when they are not required to the mission, when they might delay transmission, or when they are unavailable or incomplete at the time of issue. Fragmentary orders are normally used to issue supplemental instructions or changes to a current OPORD while the operation is in progress.

### **G-4. SUPPLEMENTS TO ORDERS**

The company orders can be supplemented by overlays, concept sketches, execution matrixes, and operation schedules.

a. **Overlays.** Overlays are used to show both friendly and enemy information, such as indirect fire support; scheme of maneuver; mobility/ countermobility plan; air, small boat, or tactical road movement; logistics sites; and reconnaissance and surveillance plans. Separate overlays can be made for each plan, or the information can be combined on a single overlay unless this is confusing. Overlays are drawn to scale using the symbols shown in FM 101-5-1 (Figure G-1). Information shown on the overlay, except the mission statement, need not be repeated in the OPORD or FRAGO. Overlays can be combined with a written mission statement and an execution matrix (both written on the overlay) to produce a complete OPORD.

b. **Concept Sketch.** The company area of operations or objective area is often so small that on a 1:50,000 map, overlays are not sufficiently clear. The commander then makes a concept sketch or terrain model that accomplishes the same purpose (Figure G-2). He begins by sketching the terrain of the area of operations or objective area. He does this by free-handing the dominant terrain features from the military map onto the sketch paper. Additional details of terrain and vegetation are added based on reconnaissance and a more detailed examination of the map. The enemy situation, scheme of maneuver, fires, mobility/ countermobility, or other pertinent data as desired are then superimposed. If possible, the synchronization of units in time and space is represented by using modified graphic symbols (explained by a legend) that show the order of occurrence.

c. **Execution Matrix.** An execution matrix shows the most critical tasks or events in a matrix format (Figure G-3). The matrix is used to help the commander during the conduct of the mission, as well as to supplement the operations overlay and oral order.

The execution matrix does not replace the mission-type order that the commander gives to his subordinates; it assists their understanding of the mission.

(1) To construct a basic execution matrix for an attack, the commander lists his subelements in their task-organized form along one axis of the matrix. He breaks into steps his selected COA from his estimate of situation and lists it along the other axis. He then fills in the boxes with information that tells him and his subunits what each element of the company is doing during each step of the attack.

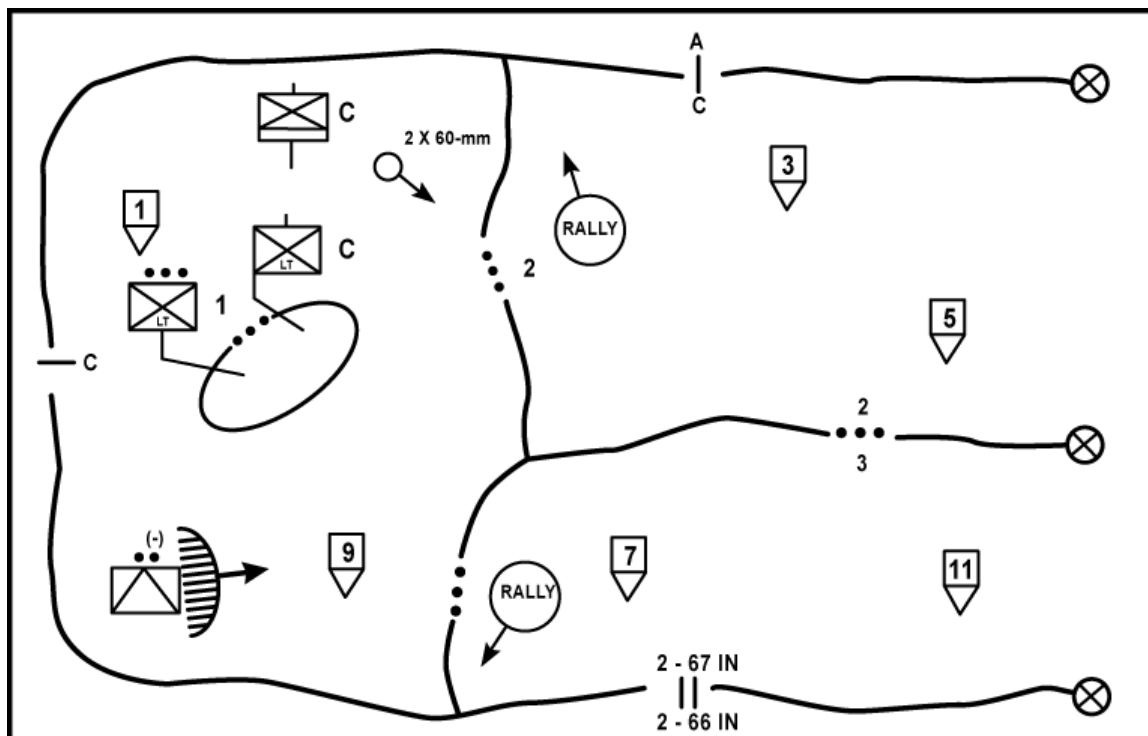

**Figure G-1. Company operation overlay.**

(2) Useful variations to the basic matrix include integrating operation schedules, brevity codes, or signals into the matrix so that a series of synchronized events can be ordered by short radio commands or signals. In the defense, a priority of work and designated positions could be added. Finally, an execution matrix is an excellent way to prepare contingency plans or counterattack plans.

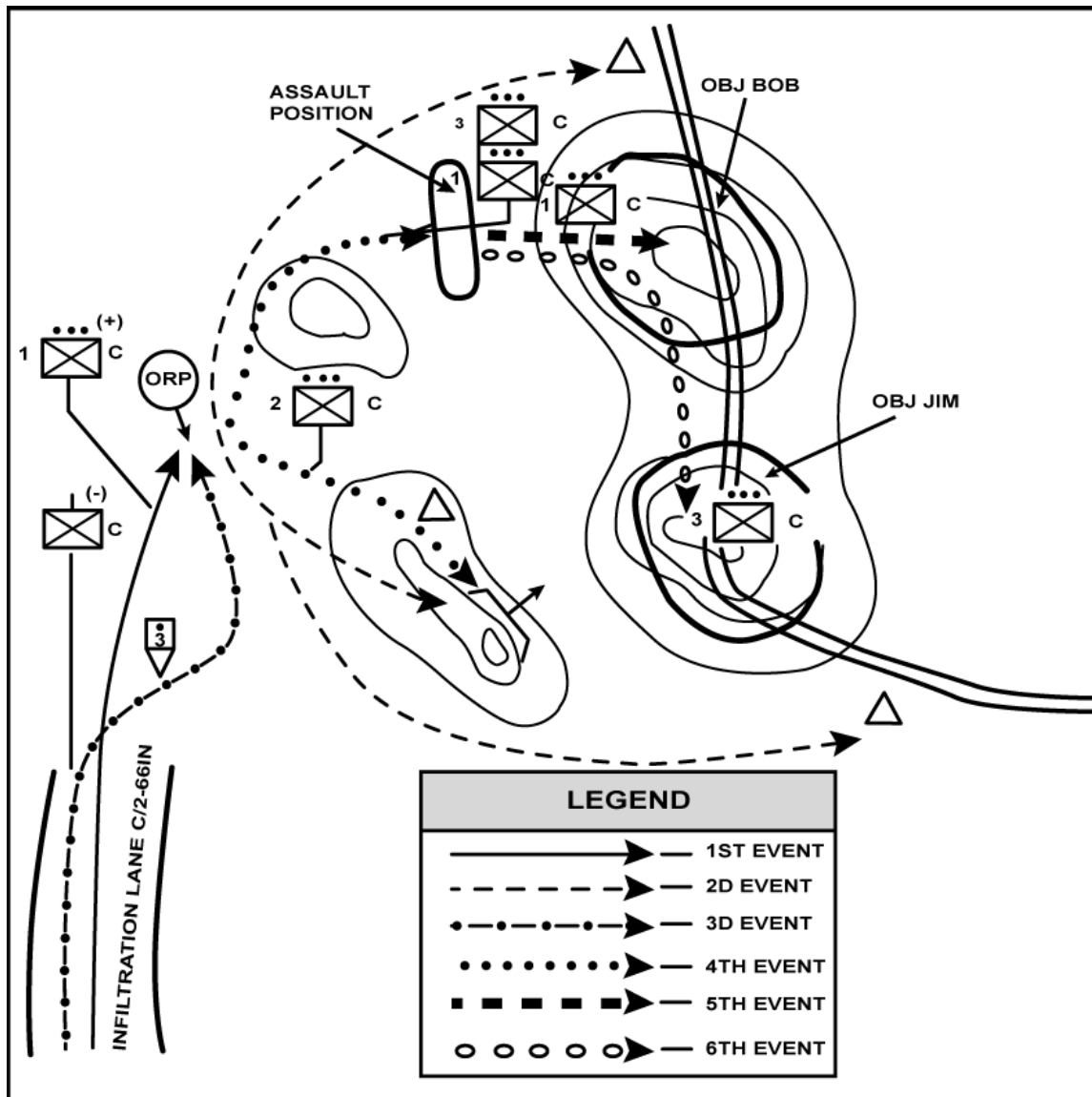

Figure G-2. Company concept sketch.

d. **Operation Schedule.** An operation schedule (OPSKED) is a sequential list of events designated by numbers. An operation schedule is different from a brevity code in that each number is a cue for several events, even if the number is often a report as opposed to an order. For example, 2d Platoon reaches their support position and reports 101; the company FSO automatically calls for suppressive fires, and the 1st Platoon automatically begins movement to the assault position. Operation schedules can be used separately or in conjunction with execution matrixes.

| PHASES<br>SUBELEMENTS | AA<br>TO<br>LD | PL<br>BLUE    | ASSLT<br>PSN | OBJ<br>SECURE | CONTINGENCY<br>PLAN 1 | CONTINGENCY<br>PLAN 2 |
|-----------------------|----------------|---------------|--------------|---------------|-----------------------|-----------------------|
| 1ST PLT               |                |               |              |               |                       |                       |
| 2D PLT                |                |               |              |               |                       |                       |
| 3D PLT                |                |               |              |               |                       |                       |
| ANTIARMOR<br>SECTION  |                | <b>SAMPLE</b> |              |               |                       |                       |
| MORTARS               |                |               |              |               |                       |                       |
| COMMAND<br>POST       |                |               |              |               |                       |                       |
| FSO                   |                |               |              |               |                       |                       |
| OPSKED                | A10            | A11           | A12          | A13           | A14                   | A15                   |

Figure G-3. Execution matrix.

## APPENDIX H

# ROAD MARCHES AND ASSEMBLY AREAS

*When the company conducts a road march as part of the battalion, the march is planned by the battalion staff. When the company conducts a road march alone, the company commander plans the march.*

### H-1. DEFINITIONS

The following definitions apply to marches.

- a. **March Unit.** A unit that moves and halts at the command of a single commander; it is normally a platoon, but may be a company.
- b. **Serial.** A group of march units under a single commander; it is given a number or letter designation to aid planning and control.
- c. **Arrival Time.** This is the time the head of a column reaches a designated point or line.
- d. **Clearance Time.** This is the time the tail of a column passes a designated point or line.
- e. **Column Gap.** This is the space, time, or distance between two consecutive elements following each other on the same route. It is stated in units of length (meters) or units of time (minutes) and is measured from the rear of one element to the front of the following element.
- f. **Vehicle Distance.** This is the space between two consecutive vehicles.
- g. **Start Point.** This is a well-defined point on a route where the units come under the control of the movement commander and start the move. At this point, the column is formed by the successive passing of the units.
- h. **Release Point.** This is a well-defined point on a route where the elements of a column leave the control of the movement commander and return to the control of their respective commanders/ leaders.
- i. **Completion Time.** This is the time the tail of a column passes the release point.
- j. **Critical Point.** This is a point on the route of march, such as a busy intersection, used for reference in giving instructions. It may also designate a point on the route where interference with troop movement might occur.
- k. **Length of a Column.** This is the length of roadway occupied by a column, including the gaps, measured from front to rear of the column.
- l. **Pace Setter.** This is a person or vehicle in the lead element that is responsible for regulating movement speed.
- m. **Pass Time.** This is the time between the moment the first element passes a given point and when the last element passes the same point.
- n. **Rate of March.** This is the average distance traveled in a given period of time (speed in kmph), including short halts or delays.
- o. **Time Distance.** This is the time it takes the head of a column to move from one point to another at a given rate of march.
- p. **Traffic Density.** This is the average number of vehicles that occupy 1 kilometer or 1 mile of road space; it is expressed in VPK or VPM.

**NOTE:** FM 21-18 explains formulas to compute movement time.

## **H-2. FOOT MARCHES**

The company moves prepared to fight at all times. It is normally organized into platoon-size march units for control and unit integrity. The normal march formation is the column; however, the commander may decide to use another formation based on the factors of METT-T.

a. When moving along a road, the company moves with one file on each side of the road. Do not split squads by placing a fire team in each file, because if there is contact, these teams will have a danger area between them. When moving cross-country, the company moves with two files 5 meters apart. There should be 2 to 5 meters between soldiers and 50 meters between platoons. The normal rate of march for an 8-hour march is 4 kmph. The interval and rate of march depend on the length of the march, time allowed, likelihood of enemy contact (ground, air, or artillery), terrain and weather, condition of the soldiers, and the weight of the soldiers' loads.

b. If the company is marching to a secure area, the company vehicles (if applicable) and mortars may precede the company as a separate march unit. This permits those elements to be operational when the company arrives. If the vehicles move with the company, the last vehicle should have a radio so the commander can be contacted in emergencies.

c. The CO may use the company's vehicles to shuttle the company. The vehicles take as many men as they can carry to the detrucking point, while the remainder of the company starts the march on foot. The vehicles unload, drive back to where they meet the marching company and pick up another load of soldiers. They repeat this process until the entire company is at its destination.

## **H-3. MOTOR MARCHES**

A company must be given additional vehicles to conduct a motor march. These will normally come from the division supply and transportation battalion; however, the company commander is responsible for and must plan the air and ground security. He must also tell the drivers where to go and what action to take if the company is attacked.

a. The CO normally organizes the platoons into march units. When moving as part of the battalion, the company is normally a serial. To provide all-round security, the CO assigns security tasks to each march unit. Some tasks may be assigned by SOP; for example, every vehicle will have an airguard with a sector of observation. When supported with vehicles armed with MK19s or M2 machine guns, the CO positions these vehicles to provide quick fire support.

b. The formations used in a motor march are close column, open column, and infiltration. Before the move, the CO should designate a maximum catch-up speed (greater than the prescribed march rate) for vehicles regaining lost distance. To control the column, the CO should use guides, escorts, and route markers. He should use radios, arm-and-hand signals, flags, and flashlights for communications.

(1) A close column is one in which the vehicles are spaced about 20 meters apart in daylight to increase its density and to reduce pass time. During limited visibility, they are spaced so that each driver can see the blackout markers of the vehicle to his front. This

column may be used for movement through congested areas or over poorly marked routes.

(2) The vehicles in an open column are widely spaced as a passive defense measure, normally 75 to 100 meters apart. This permits other vehicles (not a part of the march unit) to overtake and enter the column, if necessary. It is normally used in daylight and on roads having civilian traffic. It may also be used on dusty roads to overcome the effects of the dust. Drivers do not get as tired and the chances of accidents are less than in close-column marches.

(3) During infiltrations, vehicles are usually dispatched singly or in small groups at irregular intervals and at a speed that reduces traffic density. Infiltration increases control problems, but is the best passive defense against enemy observation and attack. It is used when time and road space are available and maximum security, deception, and dispersion are required.

#### **H-4. CONDUCT OF A ROAD MARCH**

The company normally moves in a column. The lead platoon (march unit) maintains the rate of march. Usually, the commander is positioned in the formation where he can best command and control the unit's movement.

a. Before the road march, the route should be reconnoitered and march orders issued. The march order should include a strip map (Figure H-1). The strip map should show the assembly areas, SP, route, and RP. The CO may identify critical points on the route and post guides at those points to help control movement and to provide security. (See FM 21-18 for details on planning and preparing march orders.)



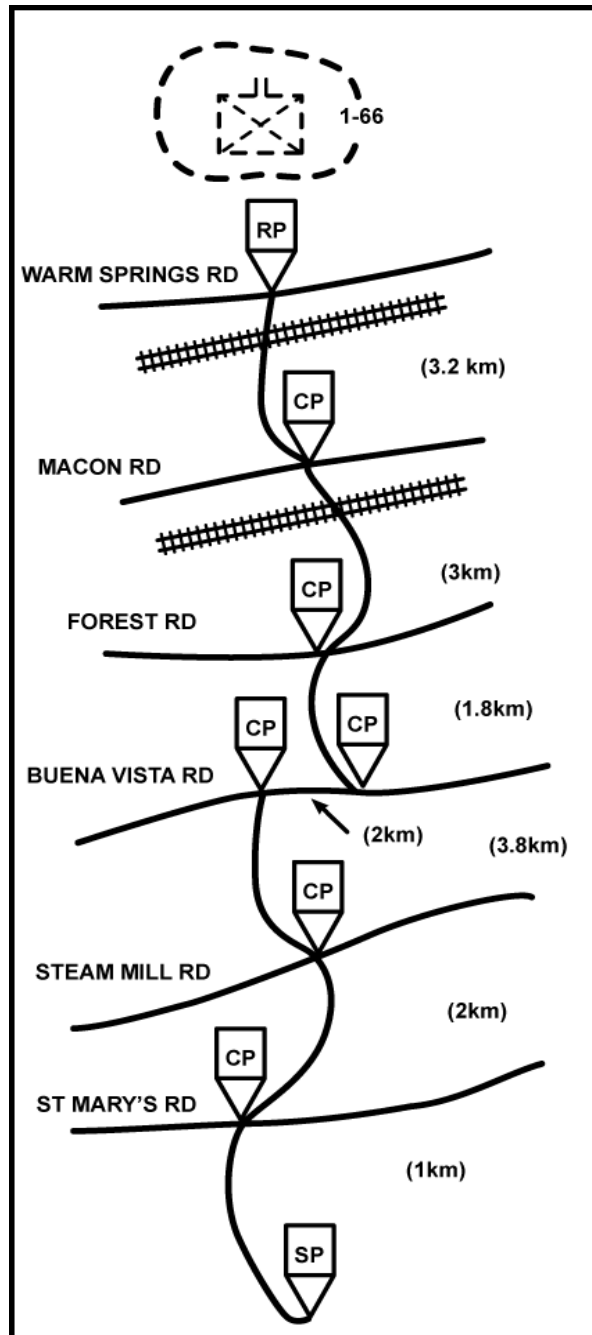

Figure H-1. Strip map.

b. The battalion scout platoon may reconnoiter the route. For motor marches, the scout platoon may prepare a hasty route classification. This may include hasty bridge classifications, ford site locations and conditions, road restrictions, sharpness of curves, and the slope percentage of steep hills. (For classification symbols and their meanings, see FM 5-36 and GTA 5-2-5.)

c. Arrival time at the start point is critical. The company must cross and clear the start point on time so that other units are not delayed. The CO should reconnoiter and

time the route from his assembly area to the start point, so he can determine when the company must move to meet its start point time.

d. After crossing the start point, platoons report crossing each critical point. When moving as part of the battalion, the company commander, in turn, reports to the battalion commander when his company crosses and clears these points.

e. Before the company departs the assembly area it is occupying, the CO should send a quartering party to the new assembly area. The XO or 1SG leads the party, which may consist of the platoon sergeants, squad representatives, and the required headquarters personnel. This party provides its own security and follows the same route of march as the company will to the new assembly area. At the assembly area, the quartering party does the following:

- (1) Reconnoiters the area.
- (2) Locates and marks or removes obstacles and mines.
- (3) Marks platoon and squad sectors.
- (4) Selects a position for the mortar section.
- (5) Selects a command post location.
- (6) Selects a company trains location.
- (7) Provides guides for the incoming unit(s).

#### **H-5. MARCH SECURITY**

The CO must plan for the security of the company when moving. This includes security against both air and ground threats.

a. He assigns each platoon the responsibility for a security sector. For example, he may assign the lead platoon the front, the middle platoon the flanks, and the trail platoon the rear. The platoon sectors must overlap to provide all-round security.

b. He plans indirect fire to support the move. He plans targets along the route as he does for all other moves. He designates warning signals and battle drills (usually SOP).

(1) A Stinger section may support the company from positions along the route or by moving within the company column. Each Stinger team that is on the early warning net, can warn the company of an air attack. For that reason, each team should be within voice distance of someone having a radio on the company command net.

(2) The mortar section must be ready to go into action and fire quickly. The FO teams should be in continuous contact with the mortar and artillery fire direction centers. The lead FO should keep the FDC informed of the lead element's location.

#### **H-6. ASSEMBLY AREAS**

An assembly area is a location where the company prepares for future operations. The company receives and issues orders, services and repairs vehicles and equipment, receives and issues supplies, and feeds and rests soldiers in the assembly area. When used to prepare for an attack, the assembly area is usually well forward.

a. **Characteristics.** Cover and concealment are important if the company is to remain in the area for any length of time. Vehicles, equipment, entrances, and exits should be camouflaged to keep the enemy from detecting the location of the company. Consideration should be given to the following:

- Concealment.
- Cover from direct and indirect fire.

- Defendable terrain.
- Drainage, and a surface that will support vehicles.
- Exits and entrances, and adequate internal roads or trails.
- Space for dispersion of vehicles, personnel, and equipment.
- A suitable landing site nearby for helicopters.

b. **Planning.** The CO plans for an assembly area as he does for a perimeter defense (Chapter 5). He organizes the assembly area into a perimeter and assigns each platoon a sector of that perimeter. He also assigns positions to the TOW (if attached) and mortar sections, and selects positions for the company CP and trains. The commander and the FSO plan indirect fire in and around the assembly area.

c. **Actions in the Assembly Area.** Before the company moves into an assembly area, the CO should send a quartering party to reconnoiter and organize it (as discussed earlier).

(1) When the company arrives at the RP, the platoon guides link up with their platoons and immediately lead them to their positions. The company headquarters guide links up with the headquarters personnel and leads them to their positions. The movement from the RP to the positions should be continuous.

(2) Once in position, the platoons establish OPs and conduct patrols to secure the area. The platoon leaders then plan the defense of their sectors. Machine gunners, Dragon gunners, and TOW crews prepare range cards. Fighting positions are prepared according to available time. Other defensive measures are taken as appropriate.

d. **Communications.** Wire may be the primary means of communications within the assembly area; however, it may be supplemented by messenger, radio, and prearranged signals.

## APPENDIX I DEMOLITION GUARD

*Some critical points, such as key bridges and mountain passes, within the division or brigade area may be vital to the tactical plan. Such points need to be controlled to permit friendly units to use them and to prevent the enemy from using them. If there is a plan to turn these critical points into obstacles by use of demolitions, they are called reserved obstacles or reserved demolitions. The commander designating these obstacles normally reserves their execution to his order.*

### **I-1. DESIGNATION**

When the division or brigade commander designates a reserved demolition, he also designates a demolition firing party (normally made up of engineers) to prepare and execute the demolitions. Likewise, he designates a demolition guard (normally a rifle company or part of its subordinate elements) to secure the area until the demolitions are fired and the obstacle is completed.

a. If the rifle company is the demolition guard, its company commander is the demolition guard commander. He is under the command of and reports directly to a senior commander who will be designated as the authorized commander. The senior man in the demolition firing party is the demolition firing party commander. However, the demolition guard commander has overall responsibility.

b. The headquarters initiating the demolition guard mission prepares and provides an order to the demolition guard commander (Figure I-1) (annex A of STANAG 2017/QSTAG 508) and an order to the demolition firing party commander (Figure I-2) (annex B of STANAG 2017/QSTAG 508).

**NOTE:** The procedures outlined in this appendix conform to NATO's STANAG 2017/QSTAG 508. If the unit is operating within a NATO force, the doctrine, procedures, and printed forms shown in this appendix will be complied with. If the unit is operating outside of NATO, the doctrine and procedures will be complied with, and the necessary printed forms may be provided locally by the authorized commander who designates the reserved demolition, or else the NATO forms may be used.

**NOTE:** Upon arrival at the site of the reserve demolition, the commander of the demolition guard and the commander of the demolition firing party should compare their orders to ensure that they are correct and complete.

c. The headquarters initiating the mission also prepares and provides the demolition firing party commander with a target folder. The target folder normally contains a description of the target, the location of the target, and the technical data needed for the placement of the charges. The demolition guard commander must become familiar with the information in the target folder and use it when inspecting the demolitions.

**NATO-UNCLASSIFIED**

ANNEX 'A' (D of A) of STANAG 2017  
(Edition No.2)

Serial No ..... Security Classification .....

**ORDERS TO THE DEMOLITION GUARD COMMANDER**

**NOTES:** 1. This form will be completed and signed before it is handed to the Commander of the Demolition Guard.  
2. In completing the form, all spaces must either be filled in or lined out.  
3. The officer empowered to order the firing of the demolition is referred to throughout as the "Authorized Commander".

From ..... To .....

**PART I-PRELIMINARY INSTRUCTIONS**

1. a. Description of target .....

A. Location:

Map Name and Scale ..... Sheet No. ....

Grid Reference. ....

c. Code word or code sign (if any) of demolition target .....

2. The Authorized Commander is .....  
(give appointment only). If this officer should delegate his authority you will be notified by one of the methods shown in paragraph 4, below.

3. The DEMOLITION FIRING PARTY COMMANDER has been / will be provided by .....

4. All messages, including any code words or code signs (if any) used in these orders, will be passed to you by:

a. normal command wireless net, or

b. special liaison officer with communications direct to the Authorized Commander, or

c. telephone by the Authorized Commander, or

d. the Authorized Commander personally, or

e. ....  
(Delete those NOT applicable)

**NOTES:** All orders sent by message will be prefixed by the code word or code sign (if any) at paragraph 1c and all such messages must be acknowledged.

**NATO-UNCLASSIFIED**

A(D of A)-1

Figure I-1. Order to the demolition guard commander.

**NATO-UNCLASSIFIED**

**PART II-CHANGING STATES OF READINESS**

5. The demolition will be prepared initially to the State of Readiness.....  
by..... hours, on..... (date).
6. On arrival at the demolition site, you will ascertain from the Commander of the Demolition Firing Party the estimated time required to change from State "1" (SAFE) to State "2" (ARMED). You will ensure that this information is passed to the Authorized Commander and is acknowledged.
7. Changes in the State of Readiness from State "1" (SAFE) to State "2" (ARMED) or from State "2" to State "1" will be made only when so ordered by the Authorized Commander. However, the demolition may be ARMED in order to accomplish emergency firing when you are authorized to fire it on your own initiative.
8. A record of the changes in the State of Readiness will be entered by you in the table below, and on the firing orders in possession of the commander of the demolition firing party.

| State of Readiness ordered "1" (SAFE) or "2" (ARMED) | Time and date change to be completed | Authority | Time and date of receipt of order |
|--|--------------------------------------|-----------|-----------------------------------|
|  |                                      |           |                                   |
|  |                                      |           |                                   |

NOTES: If the order is transmitted by an officer in person, his signature and designation will be obtained in the column headed "Authority".

9. You will report completion of all changes in the State of Readiness to the Authorized Commander by the quickest means.

**PART III-ORDERS FOR FIRING THE DEMOLITION**

10. The order for firing the demolition will be passed to you by the Authorized Commander.
11. On receipt of this order you will immediately pass it to the Commander of the Demolition Firing Party on his demolition orders form ("Orders to the Demolition Firing Party Commander").
12. After the demolition has been fired you will report the results immediately to the Authorized Commander.
13. In the event of a misfire or only partially successful demolition you will give the firing party protection until such time as it has completed the demolition and report again after it has been completed.

**NATO-UNCLASSIFIED** A(D of A)-2

**Figure I-1. Continued.**

**NATO-UNCLASSIFIED**

**PART IV-EMERGENCY FIRING ORDERS**

NOTES: 1. One sub-paragraph of paragraph 14 must be deleted.

2. The order given herein can only be altered by the issue of a new form, or in emergency by the appropriate order (or code word if used) in Part V.

14. *a.* You will order the firing of the demolition only upon the order of the Authorized Commander, or

*b.* If the enemy is in the act of capturing the target you will order the firing of the demolition on your own initiative.

**PART V-CODE WORDS (IF USED)**

|    | Action to be taken   | Code Word |
|----|--|-----------|
| a. | Change State of Readiness from "1" to "2"<br>(see paragraph 7)   |           |
| b. | Change State of Readiness from "2" to "1"<br>(see paragraph 7)   |           |
| c. | Fire the demolition<br>(see paragraph 10)  |           |
| d. | Paragraph 14.a. is now cancelled:<br>You are now authorized to fire the demolition if the enemy is in the act of capturing it. |           |
| e. | Paragraph 14.b. is now cancelled. You will order the firing of the demolition only upon the order of the Authorized Commander. |           |
| f. | Special authentication instructions, if any.   |           |

**PART VI**

Signature of officer issuing these orders .....

Name (printed in capital letters).....

Rank..... Appointment .....

Time of issue..... hours, .....(date)

**NATO-UNCLASSIFIED** A(D of A)-3

**Figure I-1. Continued.**



**NATO-UNCLASSIFIED**

**PART VII-DUTIES OF THE COMMANDER OF THE  
DEMOLITION GUARD**

15. You are responsible for :-

- a. Command of the demolition guard and the demolition firing party.
- b. The safety of the demolition from enemy attack or sabotage.
- c. Control of traffic and refugees.
- d. Giving the orders to the demolition firing party in writing to change the state of readiness.
- e. Giving the orders to the demolition firing party in writing to fire the demolition.
- g. Keeping the Authorized Commander informed of the operational situation at the demolition site.

16. You will acquaint yourself with the orders issued to the Commander of the Demolition Firing Party and with the instructions given by him.

17. The Demolition Guard will be so disposed as to ensure at all time complete all-round protection of the demolition against all types of attack or threat.

18. The Commander of the Demolition Firing Party is in technical control of the demolition. You will agree with him the site of your HQ and of the firing point. These should be together whenever practicable. When siting them you must give weight to the technical requirements of being able to view the demolition and have good access to it from the firing point.

19. You will nominate your deputy forthwith and compile a seniority roster. You will ensure that each man knows his place in the roster, understands his duties and knows where to find this form if you become a casualty or are unavoidably absent. The seniority roster must be made known to the Commander of the Demolition Firing Party.

20. Once the State of Readiness "2 ARMED" has been ordered, either you or your deputy must always be at your HQ so that orders can be passed on immediately to the Commander of the Demolition Firing Party.

**NATO-UNCLASSIFIED**  
(Y 1457/64) 360 9064 Sl. S. 52770-1

A(D of A)-4

**Figure I-1. Continued.**

| <p style="text-align: center;">ANNEX "B" (D of A) of STANAG 2017<br/>(Edition No. 2)</p> <p>Serial No. .... Security Classification .....</p> <p style="text-align: center;"><b>ORDERS TO THE DEMOLITION FIRING PARTY COMMANDER</b></p> <p>NOTES :- Parts I, II and III will be completed and signed before this card is handed to the Demolition Firing Party Commander. Paras. 4 and 5 can only be altered by the authority issuing these orders. In such cases a new form will be issued and the old one destroyed.</p> <p>From ..... To .....</p> <p style="text-align: center;"><b>Part I-Orders for preparing and changing the demolition target</b></p> <p>1. a. Description .....</p> <p style="margin-left: 20px;">.....</p> <p style="margin-left: 20px;">.....</p> <p>b. Location :-<br/>Map Name and Scale .....</p> <p style="margin-left: 20px;">Sheet No. .... Grid Referenced .....</p> <p>c. Code word of Demolition Target (if any).....</p> <p>d. Attached photographs and special technical instructions<br/>.....</p> <p>2. The DEMOLITION GUARD is being provided by (Unit)</p> <p>3. You will prepare and charge the demolition target to the STATE OF READINESS ..... by ..... hours on ..... (date)<br/>Any changes may only be made on the order of the issuing authority, or by the officer designated in para. 4. d. and will be recorded below.</p> <table border="1" style="width: 100%; border-collapse: collapse; margin-top: 10px;"> <thead> <tr> <th style="width: 25%;">STATE OF READINESS ORDERED<br/>"1 (SAFE)" or "2 (ARMED)"</th> <th style="width: 25%;">Time and date changes to be completed</th> <th style="width: 25%;">Authority</th> <th style="width: 25%;">Time and date of receipt of order</th> </tr> </thead> <tbody> <tr> <td> </td> <td> </td> <td> </td> <td> </td> </tr> <tr> <td> </td> <td> </td> <td> </td> <td> </td> </tr> </tbody> </table> <p>NOTES :- All orders received by message will be verified by the code word at para. 1. c. If the order is transmitted by an officer in person, his signature and designation will be obtained in the column headed "Authority".</p> <p style="text-align: right;">B (D of A)-1</p> | STATE OF READINESS ORDERED<br>"1 (SAFE)" or "2 (ARMED)"  | Time and date changes to be completed          | Authority                         | Time and date of receipt of order                              |  |  |  |  |  |  |  |  | <p style="text-align: center;"><b>NATO-UNCLASSIFIED</b></p> <p>Security Classification .....</p> <p style="text-align: center;"><b>Part II-Orders For Firing</b></p> <p>NOTES :- The officer issuing these orders will strike out the sub-para. of paras. 4. and 5 which are not applicable. When there is a Demolition Guard, sub-para. 4. d. will always be used, and para. 5 will always be struck out.</p> <p>4. a. You will fire the demolition as soon as you have prepared it.<br/>b. You will fire the demolition at ..... hours on ..... (date).<br/>c. You will fire the demolition on receipt of the code word .....</p> <p>d. You will fire the demolition when the officer whose designation is ..... has signed para. 8. below.</p> <p style="text-align: center;">Emergency Firing Orders (ONLY applicable when there is NO Demolition Guard).</p> <p>5. YOU WILL NOT FIRE the demolition in any circumstances except as ordered in para. 4 above. or<br/>YOU WILL FIRE the demolition on your own initiative if the enemy is in the act of capturing it.</p> <p style="text-align: center;"><b>Part III-Orders for Reporting</b></p> <p>6. After firing the demolition you will immediately report results to the officer who ordered you to fire. In the event of a partial failure, you will warn him, and immediately carry out the work necessary to complete the demolition.</p> <p>7. Finally you will immediately report the results to your Unit Commanding Officer (see para. 13).</p> <p style="margin-left: 20px;">Signature of Officer<br/>issuing these orders .....</p> <p style="margin-left: 20px;">Name (in capitals) ..... Designation .....</p> <p style="margin-left: 20px;">Time of issue ..... Date of issue .....</p> <p>8. Being empowered to do so I order you to fire NOW the demolition described in para. 1.</p> <p style="margin-left: 20px;">Signature .....</p> <p style="margin-left: 20px;">Name (in capitals) ..... Designation .....</p> <p style="margin-left: 20px;">Time of issue ..... Date of issue .....</p> <p style="text-align: center;"><b>NATO-UNCLASSIFIED</b></p> <p style="text-align: right;">B (D of A)-2</p> |
|---|--|--|-----------------------------------|--|--|--|--|--|--|--|--|--|--|
| STATE OF READINESS ORDERED<br>"1 (SAFE)" or "2 (ARMED)"   | Time and date changes to be completed  | Authority                                      | Time and date of receipt of order |  |  |  |  |  |  |  |  |  |  |
|   |  |  |                                   |  |  |  |  |  |  |  |  |  |  |
|   |  |  |                                   |  |  |  |  |  |  |  |  |  |  |
| <p style="text-align: center;"><b>READ THESE INSTRUCTIONS CAREFULLY</b></p> <p style="text-align: center;"><b>Part V-General Instructions</b></p> <p>9. You are in technical charge of preparation, charging and firing of the demolition target described. You will nominate your deputy forthwith, and compile a seniority roster of your party. You will ensure that each man knows his place in the roster, understand these instructions, and knows where to find this form if you are hit or unavoidably absent. You will consult with the Demolition Guard Commander on the siting of firing point.</p> <p>10. You must understand that the DEMOLITION GUARD Commander (where there is one) is responsible for:-</p> <ol style="list-style-type: none"> <li>a. Operational command of ALL troops at the demolition site. (You are therefore under his command).</li> <li>b. Preventing the capture of the demolition site, or interference by the enemy with demolition preparations.</li> <li>c. Controlling all traffic and refugees.</li> <li>d. Giving you the order to change the STATE OF READINESS from ("1 SAFE") to "2 (ARMED)" or back to "1 (SAFE)" again. You will inform him of the time required for such a change.</li> <li>e. Passing to you the actual order to fire.</li> </ol>  | <p>11. When there is no demolition guard and you are instructed in para. 4 to accept the order to fire from some particular officer, it is important that you are able to identify him.</p> <p>12. If you get orders to fire other than those laid down in para. 4 you should refer them to the Demolition Guard Commander or if there is no Demolition Guard Commander, to your immediate superior. If you cannot do this, you will ONLY depart from your written instructions when you are satisfied as to the identity and over-riding authority of whoever gives you these new orders, and you will get his signature in para. 8 whenever possible.</p> <p>13. The report to your Unit Commanding Officer, as called for in para. 7 should contain the following information (where applicable):-</p> <ol style="list-style-type: none"> <li>a. Identification reference of demolition.</li> <li>b. Map reference.</li> <li>c. Time and date when demolition was fired.</li> <li>d. Extent of damage accomplished, including:-             <table style="margin-left: 20px;"> <tr> <td style="border: none;">Estimated width of gap<br/>Number of spans down</td> <td style="border: none;">} In the case of a bridge.</td> </tr> <tr> <td style="border: none;">Size and location of craters in road or runway.<br/>Mines laid.</td> <td style="border: none;"></td> </tr> </table> </li> <li>e. Sketch showing effect of demolition.</li> </ol> <p style="text-align: right;">B (D of A)-3</p> | Estimated width of gap<br>Number of spans down | } In the case of a bridge.        | Size and location of craters in road or runway.<br>Mines laid. |  |  |  |  |  |  |  |  |  |
| Estimated width of gap<br>Number of spans down  | } In the case of a bridge.   |  |                                   |  |  |  |  |  |  |  |  |  |  |
| Size and location of craters in road or runway.<br>Mines laid.  |  |  |                                   |  |  |  |  |  |  |  |  |  |  |

**Figure I-2. Order to the demolition firing party commander.**

## I-2. COMMON TERMS AND DEFINITIONS

The following terms and definitions should be familiar to infantry leaders.

a. **Reserved Demolitions.** These are demolitions (intended to create obstacles) that play a vital part in the tactical plan, and thus, their firing must be controlled.

b. **Authorized Commander.** This is the officer empowered to authorize the firing of a reserved demolition (normally the division commander; however, authority can be delegated to the brigade commander and down to the battalion commander as the battle progresses).

c. **Demolition Guard.** This is the unit tasked to ensure that the site of a reserved demolition is not destroyed or captured by the enemy.

d. **Demolition Firing Party.** This is the unit technically responsible for emplacing and firing the demolitions. It is normally an engineer unit and often commanded by a noncommissioned officer. Depending upon the engineer work effort in sector, the engineers may emplace the demolitions and hand over the target detonation to the guard force. Such action will be coordinated.

e. **Uncharged.** This is the state of a reserved demolition when it has been prepared to receive charges. The charges are packaged and stored in a nearby, safe place.

f. **Charged.** This is the state of a reserved demolition when charges have been placed. The charges are maintained at one of the following states of readiness:

(1) *State of Readiness 1 (SAFE).* The charges have been placed and secured, but are not yet armed.

(2) *State of Readiness 2 (ARMED).* The charges have been placed and armed and are ready to fire. The danger of premature firing (caused by the close explosion of a bomb or shell when the charges are armed) must be balanced against the time required to change from State of Readiness 1 to State of Readiness 2.

g. **Completion.** This means that the demolitions were fired, were effective, and that all related tasks in the area, such as mining approaches to the target, have been completed. It is incorrect to think, however, that the firing of the demolitions necessarily completes the intended destruction. Engineers must ensure that the demolition was effective before reporting that the mission is complete. In the event of a misfire or only partial destruction of the target, the demolition guard must continue to provide protection while the charges are reset or more charges are placed on the target and fired.

h. **Contact Point.** This is the place where withdrawing friendly units make initial contact with the demolition guard and make their final approach to the site.

i. **Roadblock.** This is a position occupied by a friendly unit that controls access into the area.

j. **Firing Point.** This is the location from which the demolition firing party commander physically executes the demolition.

k. **Bridge Guard.** This is the unit stationed on and around the bridge to protect it against sabotage or an enemy attack.

l. **Chain of Command Roster.** This is a list indicating the chain of command within a unit. There is one for the demolition firing party and one for the demolition guard.

## I-3. RESPONSIBILITIES

The guard and firing party commanders' duties are designated as follows.

- 
- a. **Demolition Guard Commander.** He is responsible for the following:
    - Commanding all soldiers at the site of the reserved demolitions.
    - Guarding the site from enemy attack or sabotage.
    - Controlling traffic and refugees.
    - Giving the order to the demolition firing party commander (in writing [annex B of STANAG 2017/QSTAG 508]) to change the state of readiness of the demolition charges.
    - Giving the order to the demolition firing party commander (in writing [annex B of STANAG 2017/QSTAG 508]) to fire the demolitions.
    - Keeping the authorized commander informed on the status of the demolitions and the defense.
    - Informing the authorized commander on the estimated time required to change from State of Readiness 1 to State of Readiness 2.
    - Maintaining a chain of command roster for both the demolition guard and the demolition firing party, and ensuring the information is exchanged between the two groups.
    - Reporting the effectiveness of the demolition to the authorized commander.
  - b. **Demolition Firing Party Commander.** He is responsible for the following:
    - Preparing the demolitions.
    - Maintaining the state of readiness ordered.
    - Firing the demolitions (after receiving a written order [annex B of STANAG 2017/QSTAG 508]) and ensuring that the demolition is successful.
    - Reporting results of the demolition to the demolition guard commander.

#### I-4. PLANNING CONSIDERATIONS

Upon receiving the mission to guard a reserved demolition site the company commander (demolition guard commander) initiates his troop-leading procedure. He considers the METT-T factors and develops a defense plan (Chapter 5). He must prepare for a continuous 360-degree defense. The commander may be given additional assets (such as medical, recovery, evacuation, engineer, air defense, attack helicopters, antiarmor, and military police) to assist in the defense. For ease of reference, this discussion uses a bridge as the site of the reserved demolition.

a. **Rifle Platoons.** The commander initially positions his rifle platoons to provide an all-round defense. He should position one platoon on the enemy side of the bridge to occupy roadblocks on avenues of approach leading to the area. This platoon is responsible for all actions on the enemy side. The commander should position another platoon on and around the bridge to defend it and the demolitions. This platoon is responsible for all actions on and around the bridge. The commander should position any other platoons in locations (normally on the friendly side) from which they can support the platoon defending the bridge and the platoon defending the enemy side. The commander also assigns subsequent positions, which are on the friendly side, to both the platoon defending the enemy side and the platoon defending the bridge.

b. **TOW Section.** The commander positions the TOW section, if attached, in overwatch positions on the friendly side of the bridge. If the armor threat is such that TOWs are needed on the enemy side, they should be positioned there. Then they are

withdrawn to the friendly side when the demolition charges are placed at State of Readiness 2.

c. **Dragons.** The commander must ensure that the platoon leaders position their Dragons to tie in with tank (if available) and TOW fire. At first, he may detach some Dragons from the platoons defending the friendly side and attach them to the platoon defending the enemy side. He must also ensure that some Dragons are in position to provide continuous coverage of the bridge itself.

d. **Tanks.** The commander normally positions his tank platoon (when present) in overwatch on the friendly side. Depending on the armor threat, he may at first position a tank section on the enemy side, supported by a section on the friendly side, to increase the antiarmor capability on the enemy side. (The tank platoon leader must, however, maintain control of both sections.) At least one tank on the friendly side should be tasked to block any enemy armor that tries to cross the bridge. If the commander positions tanks on the enemy side, he must withdraw them to the friendly side when the demolition charges are placed at State of Readiness 2. Upon being withdrawn to the friendly side, the tanks occupy overwatch positions.

e. **Fire Support.** The commander and company FSO plan indirect fire on the bridge and on the enemy and friendly sides of it. This includes ford sites and other surrounding key terrain features. They plan for illumination in case the enemy attacks at night and for smoke to conceal the withdrawal of friendly units.

f. **Observation Posts and Patrols.** The commander plans for OPs and patrols in order to provide early warning of an enemy attack. He should also use sensors and other early warning devices. He should position OPs near the water and have patrol units reconnoiter the river banks. In addition to watching for activity on land, the OPs and patrol units should watch for activity in the water, such as floating pressure-detonated or command-detonated explosives, or swimmers trying to knock out the bridge. When possible, the commander should place some type of barrier material (such as submerged wire or net screens) in the water to stop floating mines and swimmers.

g. **Landing Zones and Pickup Zones.** The commander should reconnoiter to determine the locations of all LZs/PZs in the area. He should then consider them from two viewpoints. First, he should consider them from the enemy's viewpoint. Since the enemy may conduct an air assault into the area, the commander should establish OPs at all likely LZs/PZs. Secondly, the commander should consider the LZs/PZs from the viewpoint of how he can use them to support his mission. He may be able to use them for evacuation of casualties, for resupply, or for bringing in reinforcements.

h. **Air Defense.** When air defense assets are available, the commander should assign them positions from which they can best support the defense. They should be dispersed and positioned to provide mutual support. If likely LZs/PZs have been identified, the commander should ensure that they are covered by the air defense assets.

i. **Traffic Control.** The commander must plan measures to ensure the control of withdrawing units and refugees. He should establish a contact point, traffic control points, unit holding areas, refugee holding areas, a passage lane, routes, and a guide system (when necessary). He must maintain separation between tactical units and refugees and ensure that the refugees do not interfere with tactical units. When military or civilian police are available, the commander should use them to assist in traffic control.

j. **Contact Point.** The commander must establish a contact point on the enemy side of the bridge. The contact point should be in a place that all withdrawing units will naturally pass through before crossing the bridge (for example, on the last single approach). If the units are withdrawing from several different directions, the contact point may have to be close to the bridge. If they are withdrawing from one general direction, the contact point may be well forward. It may be collocated with a roadblock or in a separate position. The contact point must be manned at all times by a unit from the demolition guard, and the unit manning it must maintain communications with the command post. The commander must select a responsible subordinate leader to be in charge of the contact point. He normally selects his XO, ISG, or one of his platoon leaders or platoon sergeants. The unit manning the contact point monitors, controls, and informs the commander on the passage of the withdrawing friendly units. Each withdrawing unit should send a liaison officer to the contact point (before the unit's arrival) to coordinate the rearward passage.

k. **Traffic Control Point.** The commander must identify points along the routes in the area that may present a traffic control problem. He should then establish a TCP at each of these points or on the approaches to these points. This includes points on both the enemy and friendly sides of the bridge. The units manning the TCPs must maintain communications between themselves and with the commander. The TCPs are responsible for controlling the flow of traffic in the area.

l. **Holding Areas.** The commander must identify areas on the enemy and the friendly sides of the bridge that can be used as holding areas for units and refugees. The unit holding areas must, however, be separated from the refugee areas. The commander uses these areas to help reduce the massing of units and refugees at the bridge. If the lane across the bridge becomes congested as units or refugees approach the contact point, the commander has the element at the contact point direct the units or refugees to their respective holding areas. They will remain there until directed to cross.

m. **Passage Lane.** The commander selects a passage lane across the bridge.

n. **Routes.** The commander selects and marks two separate routes through the passage lane. There will be one route for tactical units and one route for the refugees.

o. **Guide System.** There may be times such as during limited visibility when it will be necessary for the commander to establish a guide system to lead the withdrawing units and refugees through the area. If guides are used, they should link up with the units and refugees at the contact point.

p. **Mines and Obstacles.** The commander employs mines and obstacles to disrupt and block enemy movement. He plans them near the bridge, on approaches to it, and on likely fords and crossing sites. He also sets up roadblocks on major avenues of approach. Some minefields may be armed and some obstacles may be blown or constructed while the defense is being prepared. However, the commander must maintain open lanes through which withdrawing units and refugees can pass. Once all friendly units have passed through the area, the commander arms the minefields and completes construction of other obstacles. He should consider using field artillery-delivered scatterable minefields or MOPMS once friendly units have passed through the area.

q. **Firing Points.** The demolition guard commander and the demolition firing party commander select primary and alternate locations for the firing point. These --

- Are on the friendly side of the bridge.

- Are slightly to a flank so that the demolitions can be observed.
- Are collocated with the primary and alternate CPs.
- Provide protection to the demolition firing party.

r. **Command Post.** The commander selects a primary and an alternate CP on the friendly side of the bridge that allows him to observe and control the defense. Since the CP and firing point should be collocated, the commander may have to select a position more suited for the firing point than for the CP. If this happens, the commander should move to the alternate CP once the demolitions have been fired.

s. **Recovery and Evacuation.** The commander places recovery and evacuation assets near and on the friendly side of the bridge. These assets must ensure that the passage lane remains clear.

t. **Chain of Command Roster.** The demolition guard commander must prepare a chain of command roster for his unit. This roster includes all officers and senior NCOs in the company. The demolition firing party commander must also prepare a chain of command roster for his unit. This roster must include every soldier (officer, NCO, and enlisted) in the demolition firing party. These rosters are maintained at the command post/firing point and must be kept current. The rosters are used to determine who is in command at all times in the event of casualties, or in the event that key personnel are removed from the site for any other reason.

u. **Withdrawal of Demolition Guard Units.** The demolition guard commander is required to fire the demolitions immediately on receipt of the code word (prearranged to mean fire the demolitions) from the authorized commander unless he has previously received authority to delay the firing. (For example, if the commander needs time to withdraw his units from the enemy side or to move soldiers out of the danger areas before firing the demolitions, he must coordinate this with the authorized commander before receiving orders to fire. This must be done as soon as possible after arriving at the site.) While most of the demolition guard units will be withdrawn to the friendly side before firing the demolitions, the commander may leave some elements on the enemy side until the mission is complete. These elements may be required to continue to provide security or to complete some of the final demolition tasks on the enemy side. The commander must plan for a way to withdraw these elements after their tasks have been completed.

v. **Crossing Means.** The commander must plan for with-drawing his units from the enemy side of the obstacle, both primary and alternate crossing means. The means used depends on the type obstacle being crossed. These means may include boats, rafts, ferries, rope bridges, helicopters, and vehicles (before the bridge is blown).

w. **Warning Signal.** The commander should plan signals to warn friendly soldiers that the demolitions are about to be fired. He should plan a signal to use during good visibility and one to use during limited visibility. Information detailing the type signals to be used must be disseminated and understood by all.

---

## I-5. FIRING PROCEDURE

On receipt of the order (a code word from the authorized commander) to change the state of readiness of the demolition charges, the demolition guard commander notifies the firing party commander and fills in paragraph 8 of annex A of STANAG 2017/QSTAG 508 (orders to the demolition guard commander) and paragraph 3 of annex B of STANAG 2017/QSTAG 508 (orders to the demolition firing party commander). On receipt of the order, the demolition firing party commander has his personnel change the state of readiness of the demolition charges. When the change is complete, the demolition guard commander reports its completion to the authorized commander in accordance with paragraph 9 of annex A of STANAG 2017/QSTAG 508.

a. **Order to Fire.** On receipt of the order to fire the demolitions, the demolition guard commander notifies the firing party commander, fills in paragraph 8 to annex B of STANAG 2017/QSTAG 508, and follows the instructions in part III of annex A of STANAG 2017/QSTAG 508.

b. **Misfire Procedure.** If the demolitions fail to fire, the demolition guard commander must continue to provide security while the demolition firing party makes further arrangements to fire the demolitions.

c. **Inspection and Reporting.** The demolition firing party commander must inspect the demolition after the charges have been fired, report the results on the engineer communications net in accordance with paragraph 13 of annex B of STANAG 2017/QSTAG 508, and give the annex to the demolition guard commander. The demolition guard commander must also report the results immediately to the authorized commander. After all work has been completed (and before departing the area), both the demolition guard commander and demolition firing party commander must report the completion or abandonment of work on the obstacle to their respective commanders.



## APPENDIX J

# EMPLOYMENT OF ANTIARMOR WEAPONS

*This appendix introduces concepts and tactics for the integrated employment of antiarmor weapons against enemy armored forces. It discusses how the fires of these weapons are integrated into offensive, defensive, and retrograde operations.*

### J-1. PLANNING CONSIDERATIONS

This paragraph discusses the basic considerations for the integrated employment of organic or attached antiarmor weapons in the combined arms team against an armored enemy force. These considerations are fundamental and apply to all phases of combat.

a. **Employment of Dismounted Infantry Units.** Armored units have the advantages over dismounted infantry units of mobility, firepower, and armored protection.

(1) To offset this vulnerability to artillery and other fires, dismounted infantry units must either fight from well-prepared positions, deny the enemy knowledge of their location, or effectively suppress enemy fires during maneuver.

(2) To offset advantages of the speed of movement, firepower, and shock effect of armor massed in formation, dismounted infantry must operate on terrain that severely restricts the movement of armored vehicles deployed in formation, such as built-up areas, dense forests, mountains, or marshlands. If dismounted infantry forces must be employed in open terrain, they can be successful only if they fight from a series of mutually supporting, well-prepared defensive positions. These need to be reinforced with a strong system of antitank mines and other obstacles, which will break up the integrity of attacking armor formations or blind and suppress the enemy to prevent effective fire.

(3) When operating on an armor dominated battlefield, dismounted infantry forces will often be employed in defensive roles, such as holding critical terrain, defending key installations, or securing the movement of armored spearheads by blocking enemy armored approaches on the flanks and rear.

(4) Offensive operations in which dismounted infantry forces can be employed are: to reduce pockets of resistance, which have been bypassed by the armor spearheads; to infiltrate overland, by helicopter, or by parachute to attack critical soft targets (command posts, logistic installations, and road and rail nets); or to seize critical terrain in the enemy rear.

(5) In retrograde operations, dismounted infantry, because of its lack of mobility and protection against all types of fires, is not suited for the conduct of delaying actions against an armored force unless the terrain severely impedes and restricts the movement of armored vehicles.

(6) The helicopter allows the commander to rapidly deploy infantry forces to critical points in the battle. In the case of TOW and Dragon, which can both be easily transported with their crews by helicopter, the commander can quickly mass the antiarmor fires of these weapons.

b. **Types of Antiarmor Weapons.** In general, all weapons can be effective against armored vehicles. These weapons can be classified into three categories, according to the way in which they are employed in the tactical scheme:

(1) *Munitions designed to disrupt the enemy's formations, slow or canalize his movements, and inflict some casualties.* This category includes mines and fires that cause him to button up or otherwise restrict his vision and seriously restrict command and control of the formation. They include VT artillery, smoke, and tactical air-delivered mine-fields and smoke. Man-made obstacles, such as tank ditches, abatis, stumps and posts, "dragon teeth," and wire, also fall into this category.

(2) *Weapons that are employed to suppress enemy direct fire weapons and artillery fires, causing their fires to be less effective.* These include automatic weapons, small arms, artillery and mortar fires, tank APERS rounds, smoke, and tactical air-delivered cluster bomb units and general purpose bombs.

(3) *Weapons designed to kill armored vehicles.* These include ATGM, antitank guns, tank guns, LAW, 40-mm HEDP rounds, and tactical air-delivered Maverick air-ground missiles, Rockeye CBU, laser-guided bombs, and some mines.

(4) *Field expedient weapons.* These are discussed in paragraph J-9

## **J-2. EMPLOYMENT CONSIDERATIONS**

Proper employment of antiarmor weapons includes making the most of their strong points. Effective fires require proper positioning, proper movement techniques, fire control, command and control, and logistics. FM 7-91 provides a detailed discussion of the employment of antiarmor weapons.

a. **Positioning.** The key point to remember in positioning antitank weapons is that of ambush. Position antitank weapons so that they can fire from a concealed and, if possible, a protected position. They should be able to gain surprise and engage the enemy vehicle in its flank or rear. Finally, they must avoid observation from overwatching enemy tanks, antitank guided missiles, or artillery forward observers. Concealment, cover, surprise, engagement criteria, and flank shots are the main considerations for positioning antitank weapons. Other considerations are dispersing, providing mutual support, and, in the case of the TOW, taking advantage of its standoff range against most tanks.

(1) *Cover and concealment.* Protection against automatic weapons and artillery suppression is critical for TOW and Dragon gunners because of the gunners' tracking time required. The TOW missile time of flight to maximum range (3,750 meters) is about 21 seconds. The Dragon missile takes about 12 seconds to travel 1,000 meters. Any fires that cause the gunner to flinch or to take his eye from the sight or target may cause him to miss the target.

(a) One of the major causes of gunner error is enemy suppressive fire. No matter how well concealed a position may be, it can still be detected by the enemy if the personnel in the position are careless. The most often neglected aspects of camouflage with respect to antiarmor weapons are movement of personnel in and around the position and failure to conceal from overhead observation. Both are dead giveaways of what might otherwise be well-concealed positions. It is impossible for the enemy to place suppressive fires on the gunners if he cannot find them.

(b) Cover and concealment go hand in hand. Use every fold in the ground for protection against enemy fires. Overhead cover should be constructed. If engineer support is not available or time does not permit the construction of complete positions,

---

field expedients gathered from battlefield debris can be used. The important thing is to get some kind of cover.

(2) *Dispersion*. Under ideal visibility conditions, TOW sections that are separated by as much as 6 kilometers can fire at the same target. To reduce vulnerability to enemy fire, antiarmor weapons should be dispersed both laterally and in depth so that no two weapons covering the same sector of fire can be suppressed at the same time by the fire from a single enemy weapon.

(a) In the case of a TOW section, the distance between squads should be at least 300 meters, so that no two can be suppressed by a single volley from one battery of enemy artillery. Sometimes this may not be practical because of terrain restriction or the difficulty of the section leader in controlling the fires of the two squads when separated this far.

(b) In Figure J-1, the size of a 152-mm howitzer battery open sheaf, drawn to scale, would be only about 600 meters in width. From this, it is obvious it would take large volumes of artillery to effectively suppress such dispersed ATGMs.

(3) *Mutual support*. Mutual support is the help two weapons or units give one another (Figure J-2). TOW squads and tanks are rarely employed individually. Whenever possible, TOW sections and tank platoons are employed intact to ensure mutual support within the section/platoon. The other aspect of mutual support that concerns antitank weapons crews is protection against dismounted attack. Infantry can provide this support.

(4) *Flank engagement*. Avoid frontal fire. An antitank weapon firing from the front must be regarded as an exception. A frontal engagement not only attacks the thickest armor on the vehicle, but also is most likely to be detected because the vehicle crew is oriented to the front.

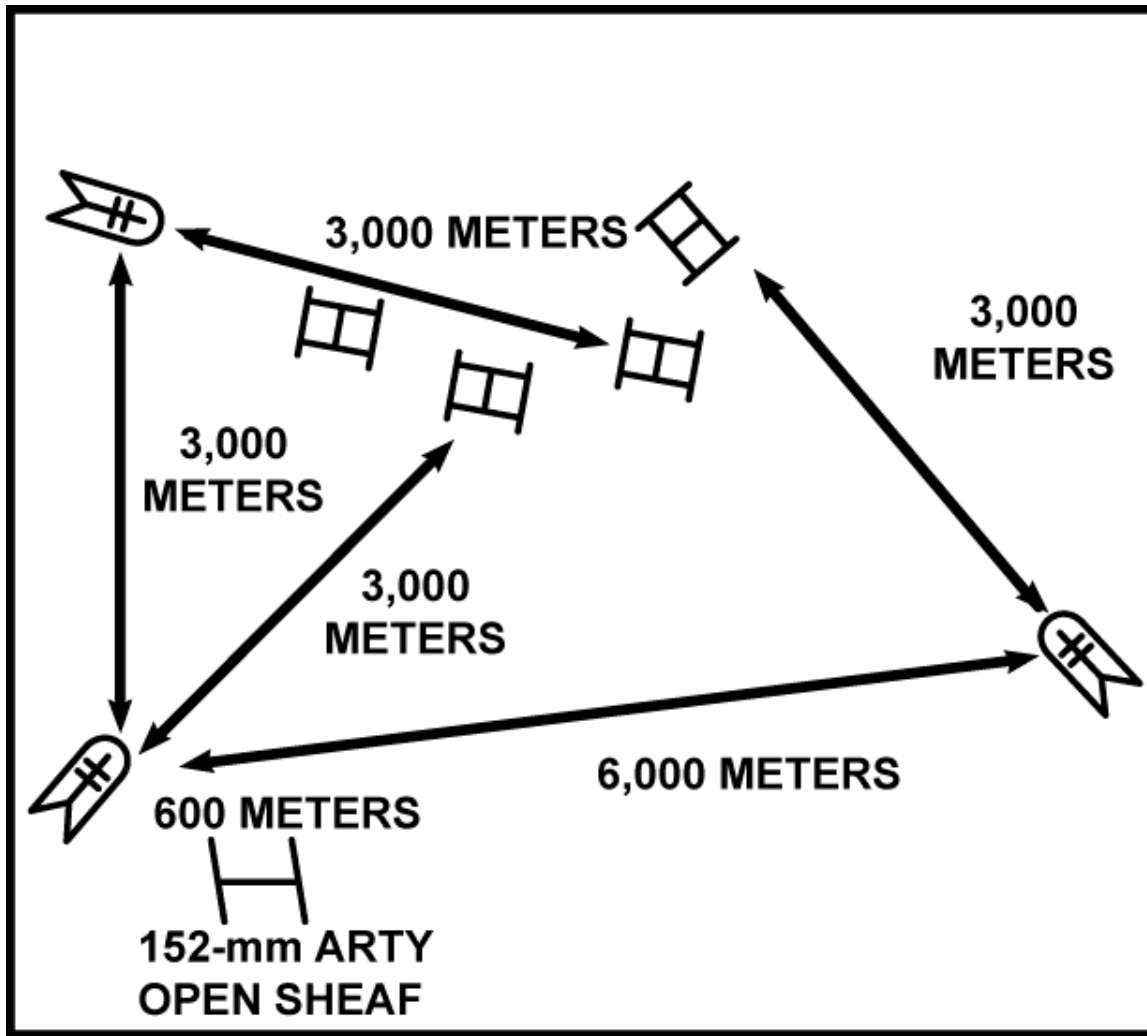
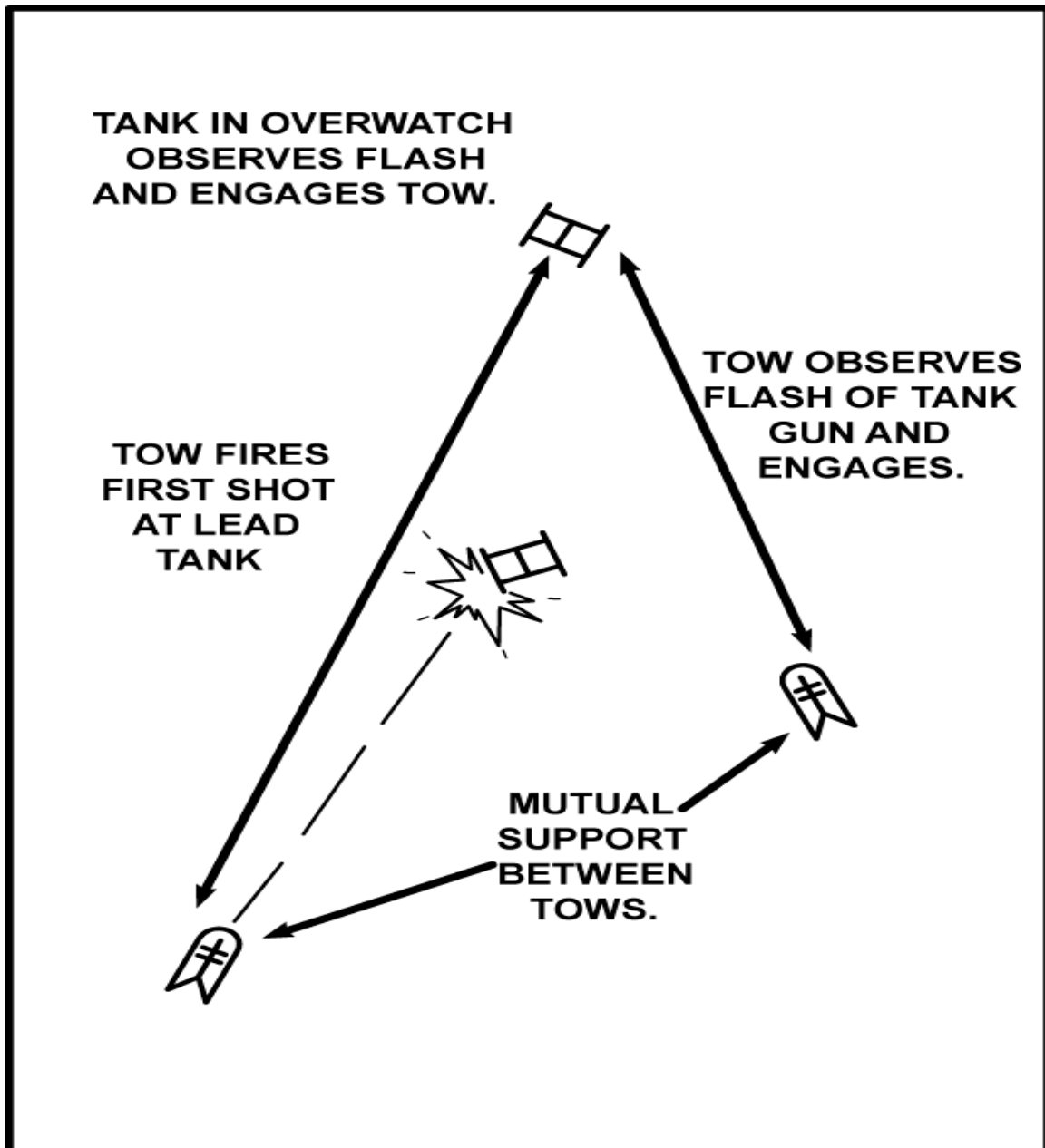
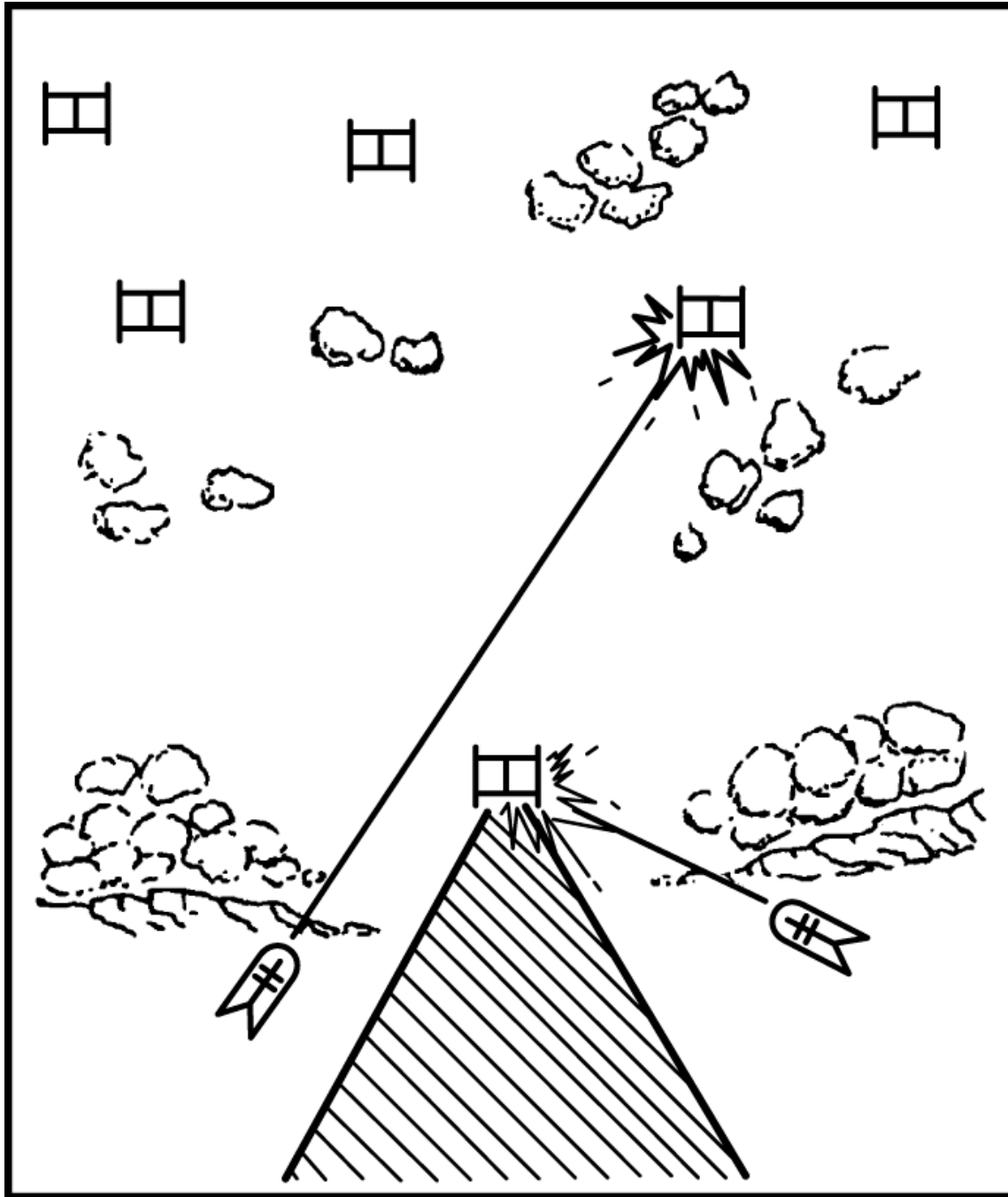

Figure J-1.  
Dispersed ATGMs 152-mm artillery battery open sheaf comparison.



**Figure J-2. Mutual support between weapons.**

(a) Flank engagement is vital at ranges of less than 2,000 meters (the range at which the enemy tank gun has a better than 50/50 chance of a first-round hit). Also, when advancing, a tank's firepower and observation are generally oriented to the front, making it difficult to detect and retrace an ATGM launched from its flank (Figure J-3).



**Figure J-3. Flank engagement.**

(b) However, a trailing tank may see the launch signature or movement. Therefore, position the weapon so that there is something between the weapon and the tanks not being fired on—a parapet, or wall, or natural cover. Flank concealment is necessary, but flank defilade is preferable. Concealment of flash is essential, not only from the following tanks, but from the enemy's OPs as well. A weapon seen is a weapon lost.

(5) *TOW standoff*. When positioning a TOW, its standoff advantage against enemy infantry carriers should be exploited. As tanks close with infantry in prepared positions, their vulnerability to the infantry increases greatly. This is especially true if the tanks do not have accompanying infantry.

b. **Movement on the Battlefield.** Movement of antiarmor weapons is coordinated with the maneuver of other forces. When moving between firing positions, use the terrain to conceal/cover movement from enemy observation and direct fires. Use smoke to obscure the enemy gunners' vision or use artillery and automatic weapons to suppress known or suspected enemy weapons positions. When moving against ATGM fires, protection is gained by moving through wooded areas or by quick rushes between folds in the ground.

### **J-3. FIRE CONTROL**

The increased ranges of antiarmor weapons permit the shifting and massing of fires from positions that are widely dispersed, both laterally and in depth. Coupled with increased ranges, fire control is further complicated by the number and variety of antiarmor weapons that may be supporting the company.

- a. Effective fire control procedures will ensure that units—
  - (1) Use each weapon in its best role (Figure J-4).

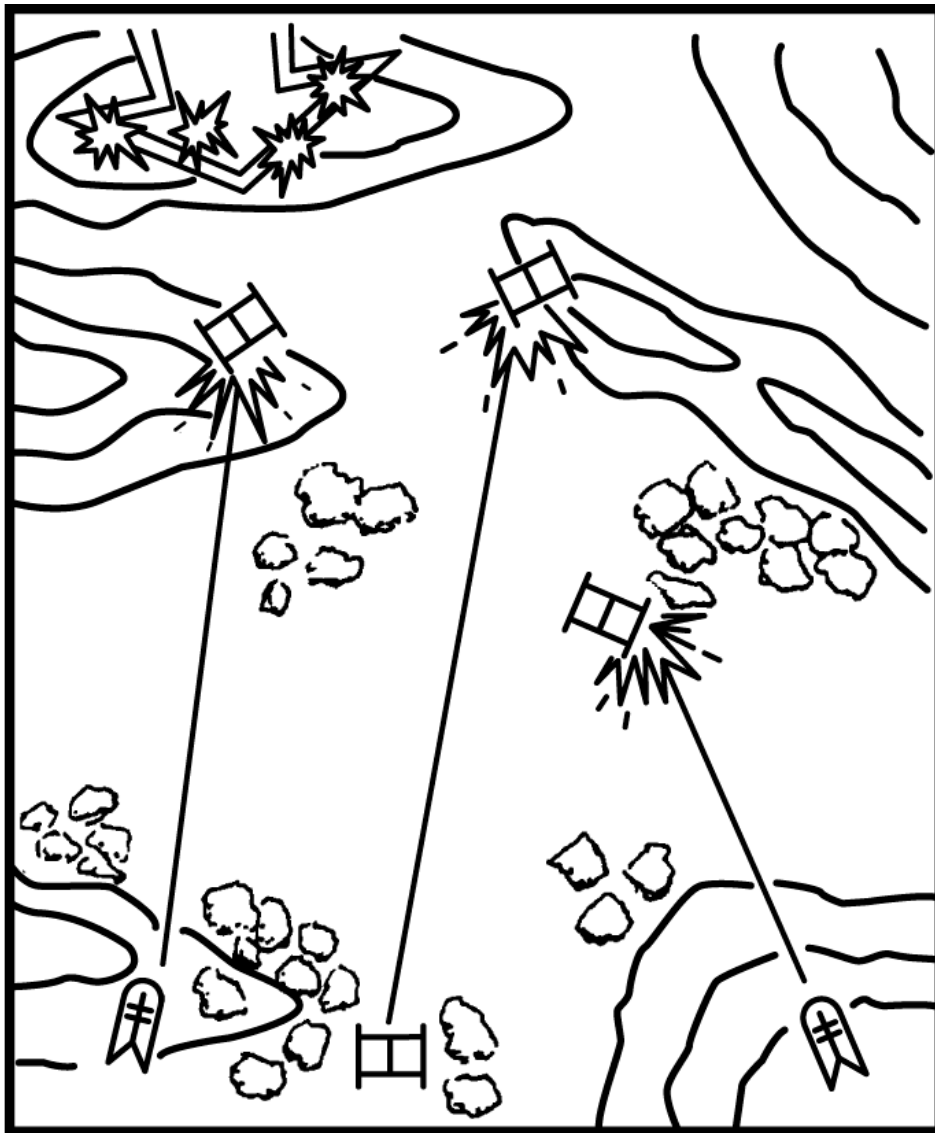
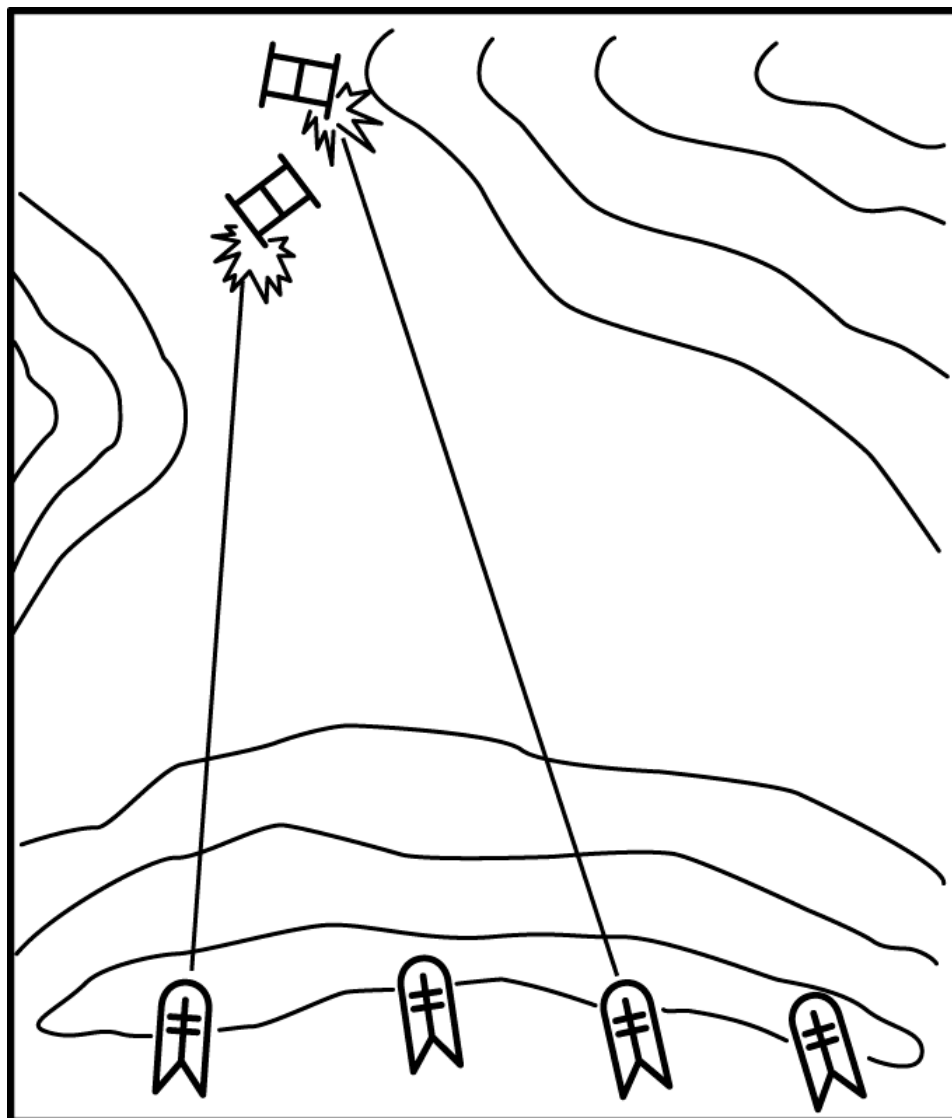

Figure J-4. Use of weapons.

- (2) Engage the enemy as rapidly as possible. The enemy will try to reduce his exposure time.
- (3) Expose only those weapons actually needed to fire (Figure J-5).





**Figure J-5. Exposure of weapons.**

- (4) Distribute fires to ensure complete coverage of enemy targets (Figure J-6).
- (5) Engage most dangerous threats first.
- (6) Coordinate artillery and obstacles with direct fires.
  - b. Fire control also—
    - (1) Permits the massing of fire from widely dispersed firing positions (both laterally and in depth).
    - (2) Prevents firing that gives away the position before a more opportune moment for engagement, thereby retaining the advantage of first shot.
  - c. Proper fire control also prevents erroneous engagement of friendly tanks by friendly TOWs. A T62 and an M60 look very similar at a range of 3,000 meters. Also, covering forces withdrawing from the security echelon could be engaged by weapons in the MBA if proper fire control procedures are not used.
  - d. Fire control measures must be easily understood, responsive, and flexible. The most commonly used measures for controlling fires are sectors of fire; engagement areas,

target reference points, priorities of engagement, phase lines, checkpoints, and trigger points.

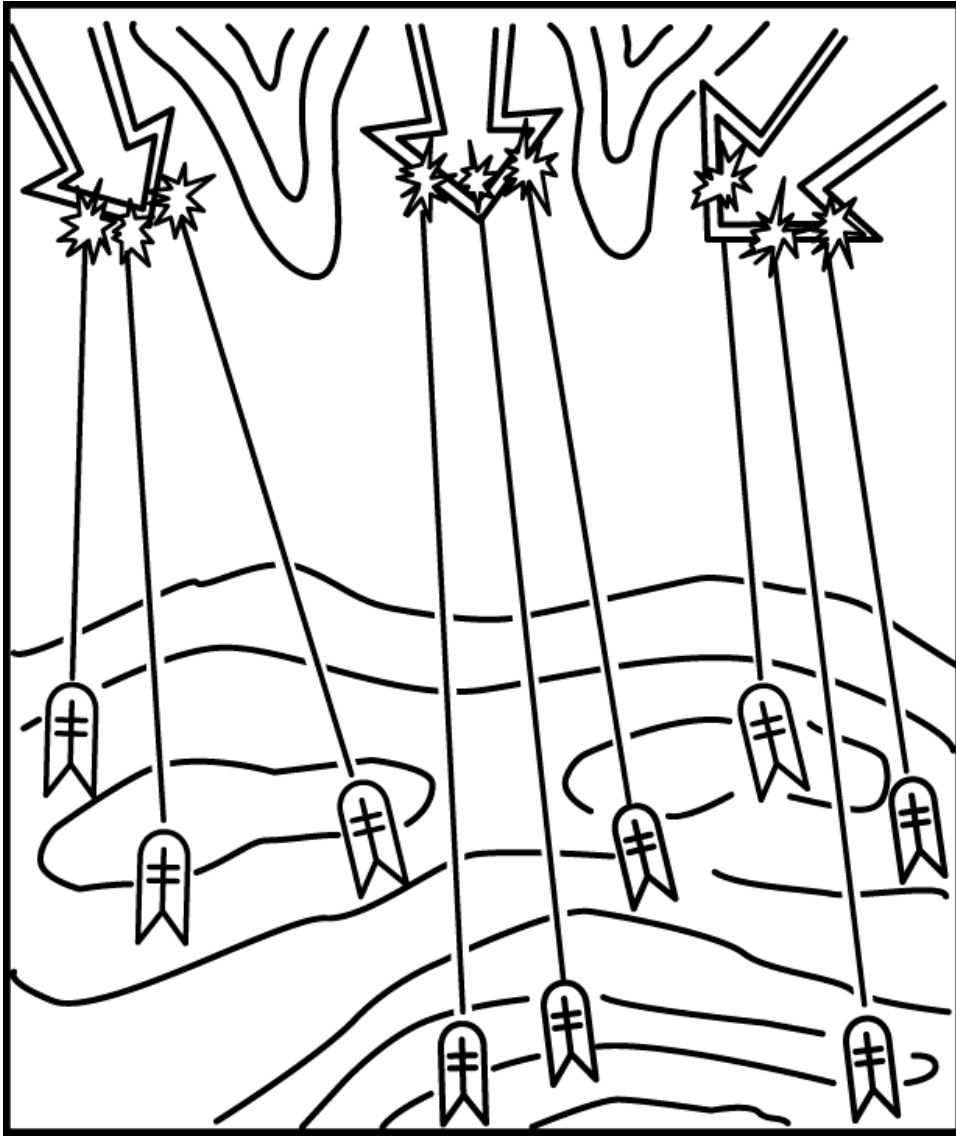
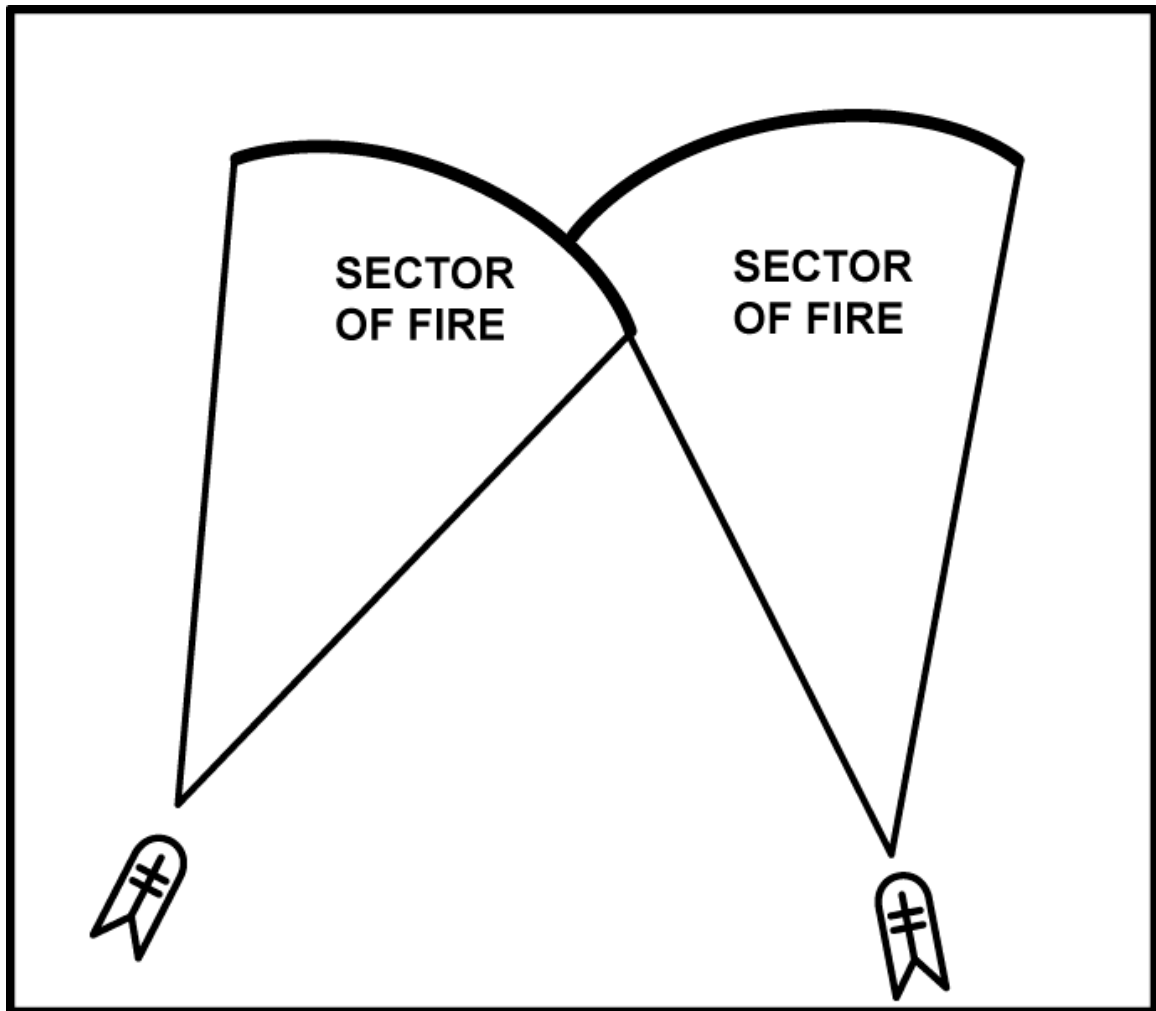

Figure J-6. Distribution of fires.

(1) *Sectors of fire.* A sector of fire (Figure J-7) is the area of responsibility for fire assigned to a weapon or unit. They are used to ensure adequate distribution of fires of all weapons throughout the battle area. They are normally identified by assigning TRPs for the left and right limits.



**Figure J-7. Sectors of fire.**

(2) *Engagement area.* An EA (Figure J-8) is usually an open area along an enemy avenue of approach. It is used to mass the fires of platoons and sections. Normally, additional fire control measures are assigned to each weapon to distribute fires within the EA.

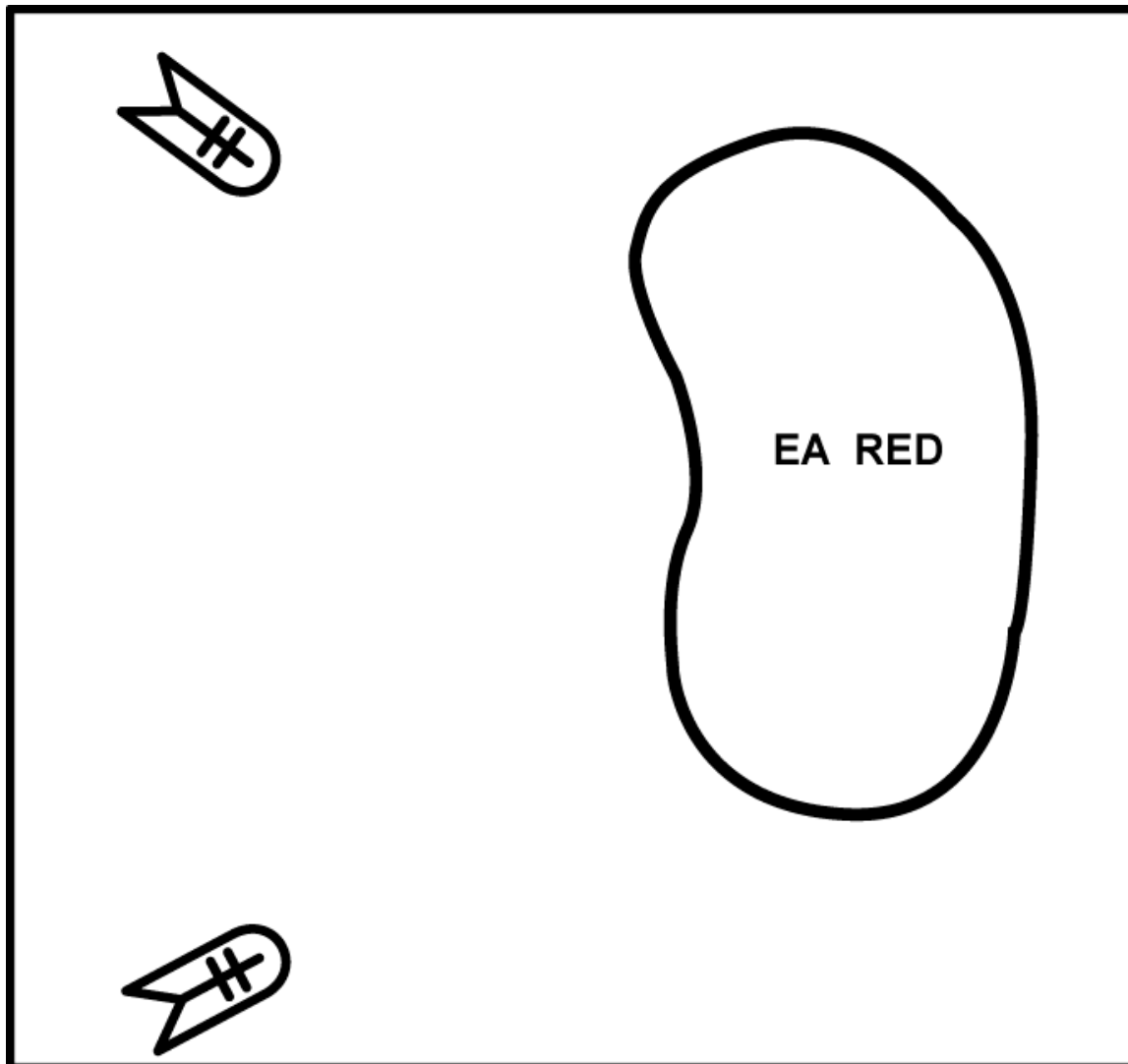

Figure J-8. Engagement areas.

(3) *Target reference point.* A TRP is an easily recognizable point on the ground, either natural or man-made (Figure J-9). It is used as a battlefield reference point for identification of targets and for controlling the fires of weapons or units firing into the sector. Leaders ensure that the TRP is visible under any conditions (day, night, fog), or that the weapon system can orient on the TRP by other means, such as aiming stakes, range card data, or direction markings on the interior of the turret. Field expedient TRPs must be addressed in the unit SOP. Engineer stakes, VS-17 panels, and similar items are effective daylight marking techniques. For night, use chemical lights (visible/IR) or heat-producing techniques such as coals in ammunition cans or batteries to mark the TRPs. The TRP marking technique must be unnoticeable from the enemy side.

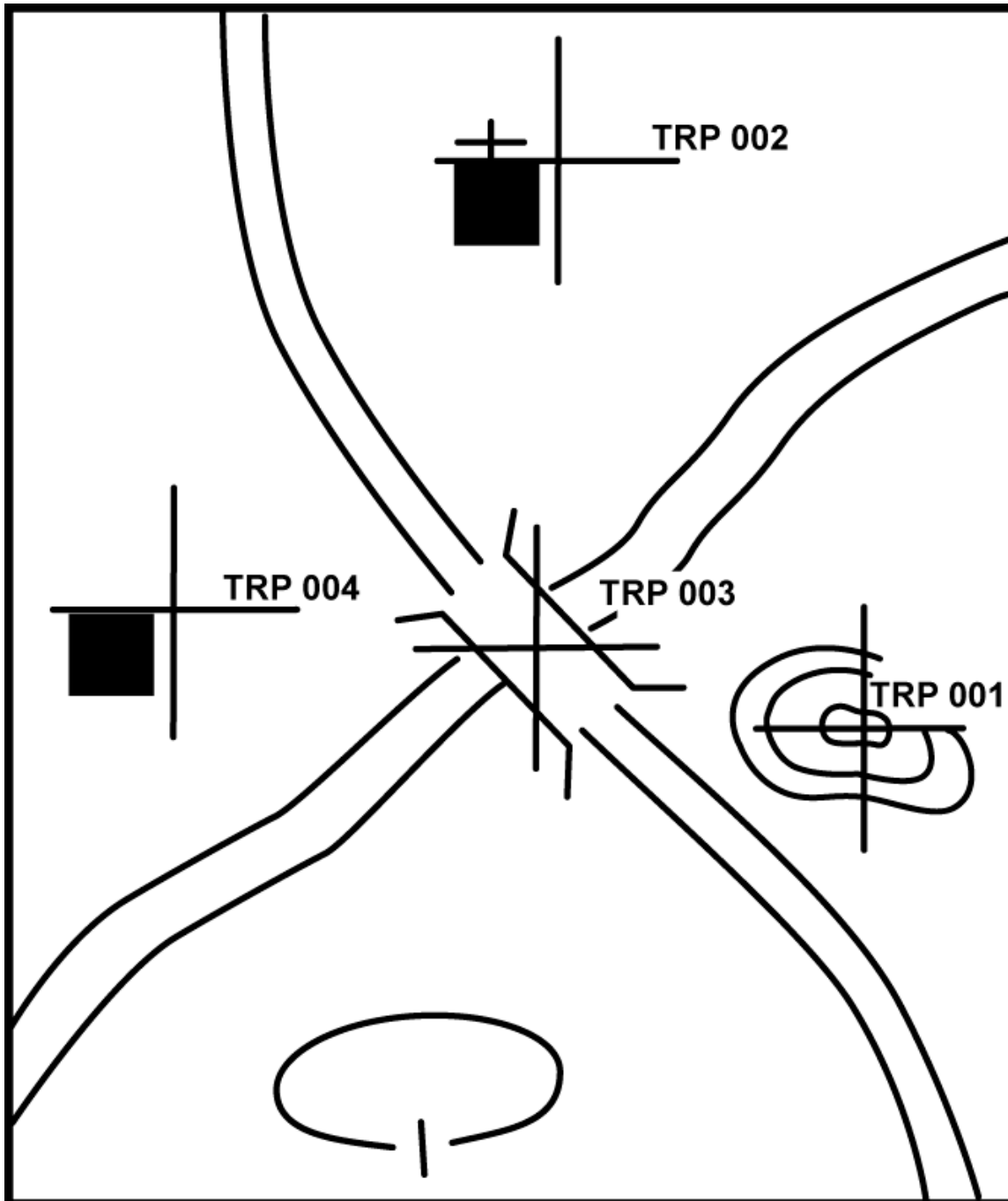

Figure J-9. Target reference points.

(4) *Priority of engagement.* The enemy formation may consist of tanks, armored personnel carriers, ATGM launchers, C2 vehicles, air defense weapons, and so forth. In any case, fires can be effectively distributed by assigning each weapon/section a type vehicle (priority of engagement). For example, "Tanks engage BMP, TOW engage tanks," or, "Section 1 engage BMP, Section 2 engage tanks." Since tanks are the backbone of the armored formation, they should be engaged on a priority basis by all antiarmor weapons within range if a priority has not been announced. Under certain

circumstances, a priority of engagement by type vehicle may be assigned by higher headquarters. For example, if enemy antiaircraft fire is preventing the Air Force or attack helicopters from operating in the MBA, destruction of these weapons may be given a priority. If long-range enemy ATGMs are reducing effective tank employment, they may be assigned as a priority target. Once the engagement criteria has been met, antitank crews engage targets as required by their fire control measures. In the case of multiple targets, engage the most dangerous first.

(5) *Trigger points.* Trigger points are TRPs or phase lines (trigger line) where a unit or weapon system begins engaging targets. Every weapon should be assigned a trigger point. If not directed by higher, the squad leader should select trigger points for each weapon to ensure gunners do not engage targets beyond maximum effective range. Properly selected trigger points can make mutually supporting positions more effective because of the enemy reaction to the first engagement. Backup signals to initiate fire should be coordinated in event the responsible unit fails to initiate fire at the assigned trigger point.

(6) *Phase lines and checkpoints.* Phase lines and checkpoints are used to control fires between units, usually when one or the other of the units is moving such as in the attack or retrograde. An example of the use of phase lines is given in Figure J-10. Checkpoints could be used in a similar manner as phase lines to control fires between two units.

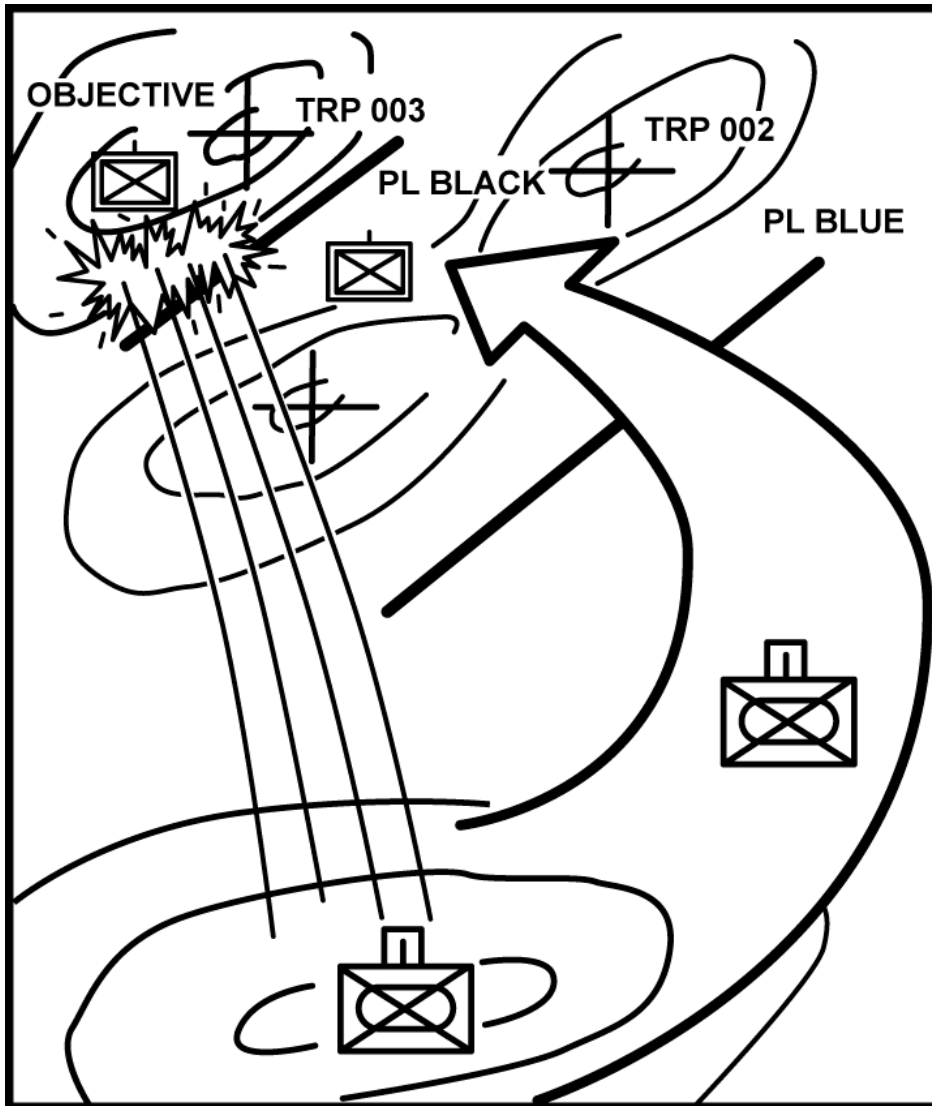

Figure J-10. Phase lines.

#### J-4. COMPANY FIRE CONTROL PLAN

The CO develops the company fire plan to support his scheme of maneuver. The following example is one technique to apply the fundamentals discussed in this appendix.

a. **Situation.** C Company's mission is to destroy the enemy reinforced company team to prevent the envelopment of the battalion main effort (A Co). The troops available are three infantry platoons, one tank platoon (OPCON), a TOW section, and the organic AA and mortar sections. The combined obstacle overlay (Figure J-11) shows the results of the CO's terrain analysis.

**NOTE:** Battalion directed that the bridge be prepared for demolition and that C Co would control the firing.



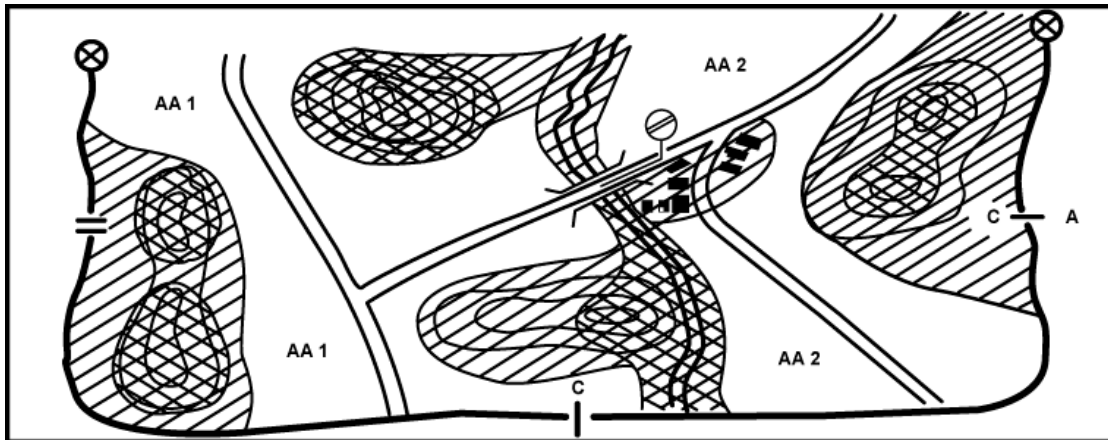

Figure J-11. Combined obstacle overlay.

b. **The Enemy.** The enemy situational template (Figure J-12) shows the enemy's main attack on AA 2 (one tank platoon, two infantry platoons in column) and a supporting attack on AA 1 (one infantry platoon). The enemy will plan artillery on the prominent hilltops to suppress direct-fire systems. He will also plan smoke to screen his movement, particularly from the key terrain in the rear of our sector, which controls both AAs.

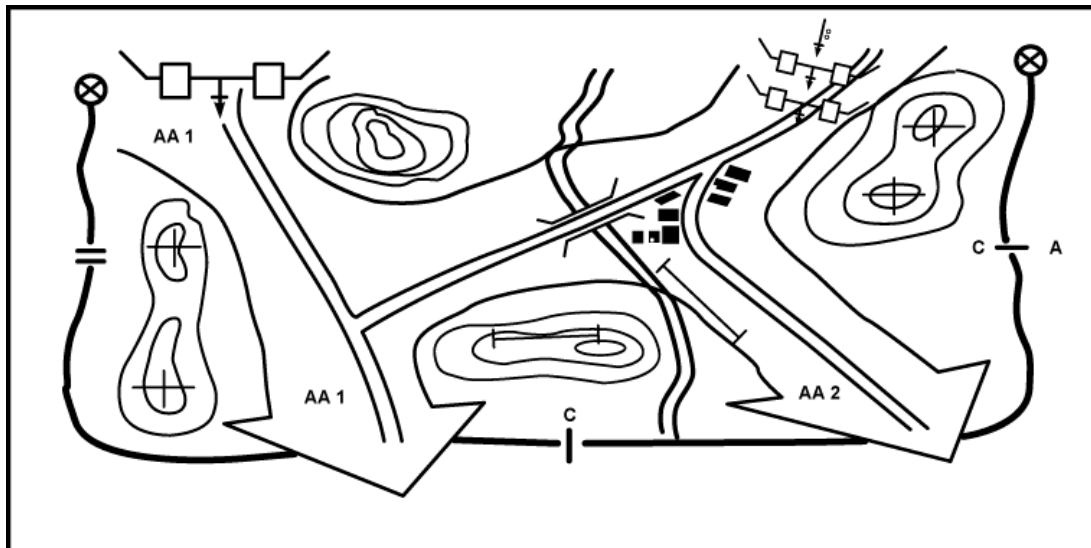

Figure J-12. Enemy situational template.

c. **Potential Decisive Points.** The CO now determines where in the sector to mass his fires; possible locations are all along the AAs. The CO uses other considerations and facts from his estimate to select these locations. For example, he considers how to surprise the enemy and how to avoid their artillery fires. The CO now selects TRPs (Figure J-13) where he wants to destroy the enemy. Other TRPs may be added later on, or some of these may be deleted as the fire planning continues. The key point is that the locations for massing fires are determined first, and then weapons are positioned to achieve this--not vice versa.

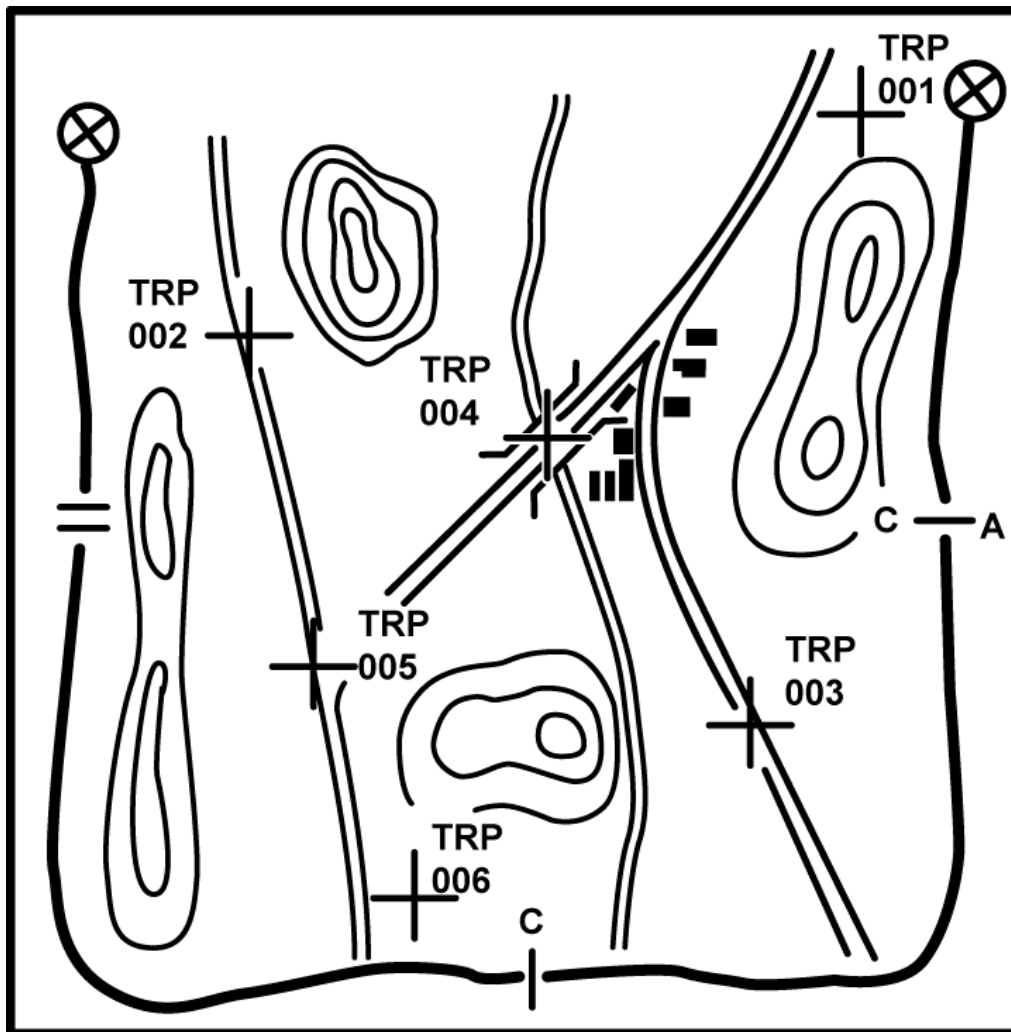
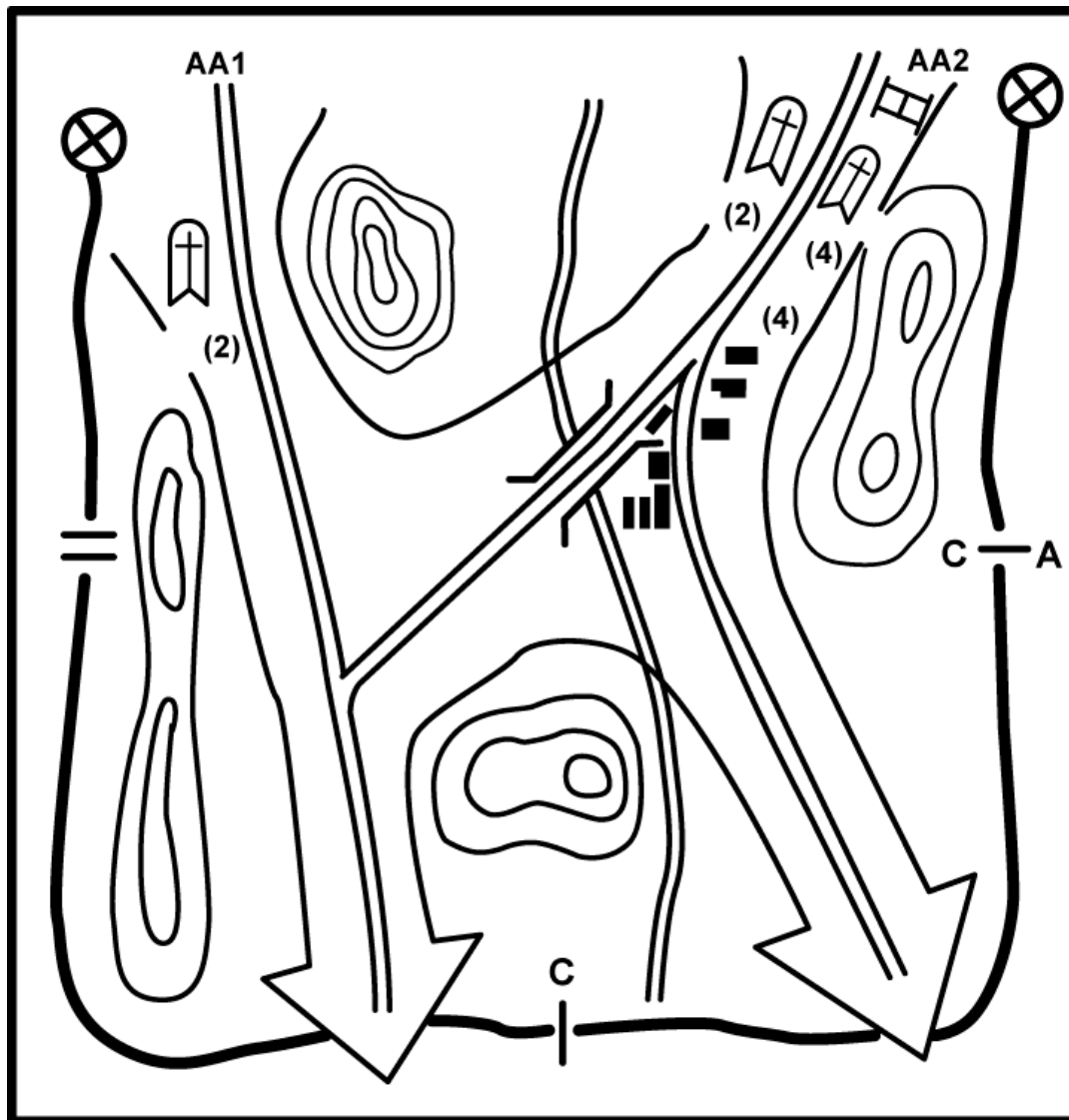

Figure J-13. Selection of TRPs.

d. **General Concept Development.** The CO now begins to array weapon systems, based on the enemy most probable COA, to mass combat power at the TRPs. Since the enemy threat is mounted, the CO focuses on arraying his antiarmor systems (Figure J-14), and he allocates infantry squads to protect them, provide security, secure obstacles, and provide depth to the defense. The CO considers the enemy main effort first and decides to fight this force from the FEBA to disrupt the enemy plan and to draw this enemy force into the sector where he can gain flank and rear shots. The tanks are

obviously the best system to fight this force in depth, so the four tanks are arrayed on this avenue along with the TOW section and four Dragons. The remaining two Dragons are arrayed against the supporting attack on AA 1.

**NOTE:** At this point, the CO would normally develop several COAs, wargame and compare these, and select the best one as his concept. In this example, the one COA is expanded into the complete plan.



**Figure J-14. Allocation of antiarmor systems.**

e. **Detailed Concept and Initial Fire Planning.** The CO's concept is to disrupt the synchronization between the enemy's main and supporting attack by delaying against the main attack with the tank platoon and destroying the supporting attack in EA Red. The enemy's main attack will then be destroyed in EA Blue. The tank platoon delays in sector and disengages on order along Route Tank to BP 4-1. 2d Platoon in BP 2-1 will execute the bridge demolition after four enemy vehicles cross or when enemy infantry attempt to

secure and clear the bridge. As the enemy bypasses the town and continues south on AA 2, 2d Platoon and the TOW section will engage once the enemy reaches TRP 009. The enemy will use his indirect fires to suppress these positions and screen his movement south. 3d Platoon and the Tank Platoon will destroy the enemy in EA BLUE (Figure J-15). An execution matrix is an effective tool for the commander (Table J-1).

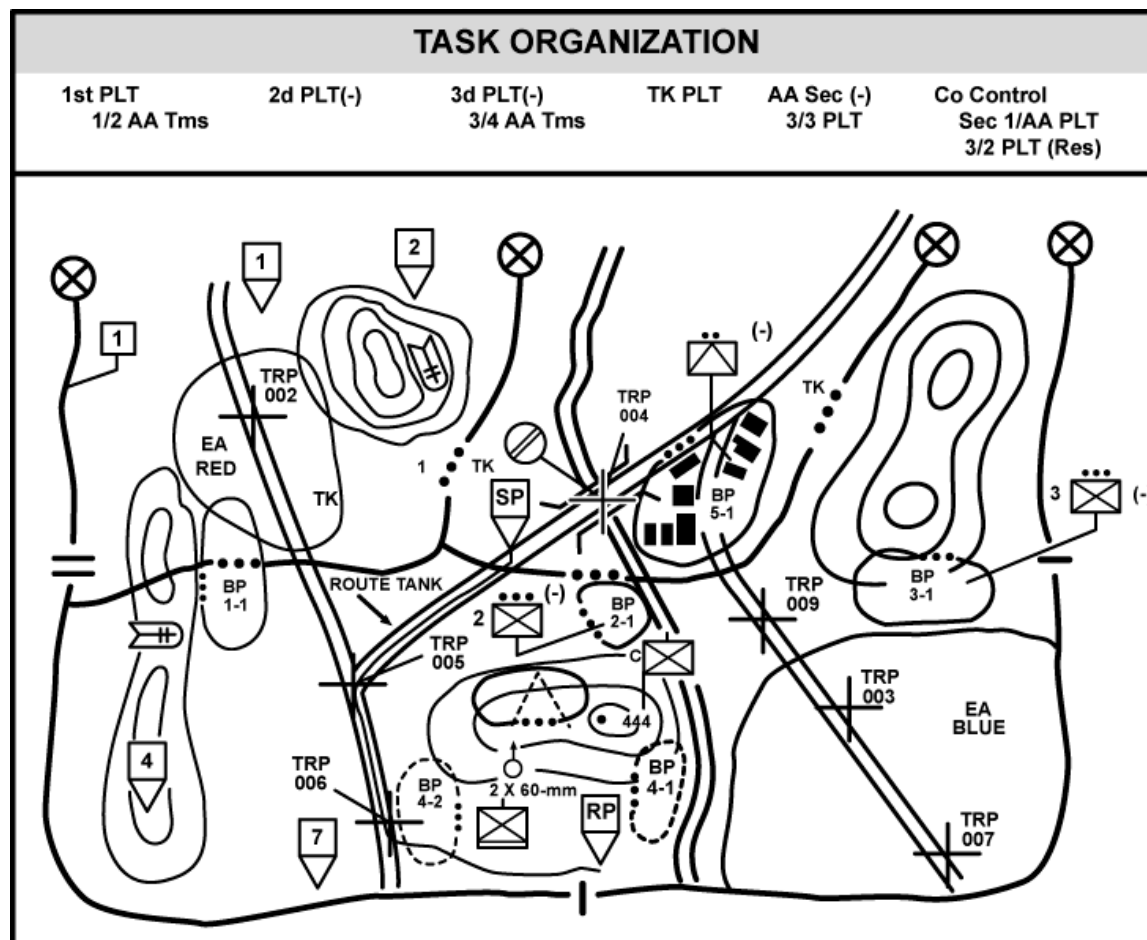

Figure J-15. Company operations overlay.

f. **Fire Planning.** This concept applies the fundamentals for employing antiarmor assets in the following ways:

(1) Antiarmor weapons and units are positioned off of the prominent terrain; therefore, they are less likely to be suppressed by preplanned indirect fires. They are also less likely to be detected once they begin engaging.

(2) The enemy is allowed to penetrate into a position where his flanks and rear will be exposed to the massed fires of the company.

(3) The TOW section is positioned at a distance from its EA; this allows flank and rear shots, better survivability, and engagement with TOWs, Dragons, LAWs, M203s, and MGs at the same time (massing of fire).

(4) Mutual support is achieved by employing antiarmor weapons in pairs. When the CO positioned the TOW squads, he made sure they were dispersed but had overlapping sectors of fires.

(5) The terrain is used to mask the weapons from enemy detection and fires. The river is used to canalized the enemy into EA BLUE.

(6) Engagement priorities are assigned to weapons and units to ensure the best weapon engages each target.

| ACTIVITY UNIT            | OCCUPY                              | MISSION   | FIRE CONTROL MEASURES   | PREPARE                       | RECON                         |
|--------------------------|-------------------------------------|---|---|-------------------------------|-------------------------------|
| 1ST PLT                  | Sector<br>TRP 002                   | Destroy enemy in sector to prevent envelopment of TK PLT.   | Trigger Point-TRP002.   | BP 2-1<br>TRP 005             |                               |
| 2D PLT                   | BP 2-1<br>TRP 004 to TRP 009        | Block enemy crossing of river to prevent enemy control of Hill 444.   | Trigger Point-TRP 009<br>Engagement priority - BTRs, C <sup>2</sup> vehicles.     | BP 2-1<br>TRP 005 check point | BP 4-1                        |
| 3D PLT                   | BP 3-1<br>TRP 003                   | Destroy enemy in EA BLUE to prevent envelopment of Co A.  | Trigger Point-TRP 007<br>(or when TK PLT engages in EA BLUE                       |                               |                               |
| TK PLT                   | Sector<br>AA2                       | Delay enemy forces on AA2 to disrupt the enemy attack.<br>On order, occupy BP 4-1 to destroy enemy in EA BLUE to prevent envelopment of Co A. | Engagement Priority-Tanks, BTRs, C <sup>2</sup> vehicles<br>Trigger Point-TRP 007 | BP 4-1<br>TRP 003 to TRP 007. | BP 4-2<br>TRP 005 to TRP 006. |
| ANTIARMOR SEC            | BP 5-1<br>TRP 009                   | Destroy enemy forces to prevent enemy use of town   | Engagement Priority-BTRs, Tanks.  |                               |                               |
| 1ST SEC OF ANTIARMOR PLT | Firing positions<br>TRP 009 EA BLUE | Destroy enemy vehicles to prevent Tank/Inf assault against 3d PLT   | Destroy enemy vehicles to prevent Tank/Inf assault against 3d PLT                 |                               |                               |
| 3 /2D PLT ( RES )        | BP 4-2<br>AA1                       |   |   | BP 4-1<br>EA BLUE             |                               |

Table J-1. Company execution matrix.

(7) TRPs are assigned to distribute fires in EA BLUE and to prevent friendly fires on friendly positions.

(8) Trigger points are established, which will ensure effective fires from the assigned weapon systems, but also the expected enemy reaction will make subsequent engagements more effective.

(9) Additional fire control measures and positions are planned to provide flexibility to the plan.

(10) The CO centralized the control in EA BLUE more than in EA RED because there was only one unit responsible for EA RED. The 1st Platoon leader is responsible for establishing the required fire control measures for EA RED.

g. **Complete the Plan.** To complete the preparation for this battle, the indirect fires and obstacles would be integrated to support the CO's concept. The subordinate leaders would position weapons and units and assign specific sectors or other control measures to each weapon. A complete rehearsal should also be conducted to ensure the soundness of the CO's concept and that all soldiers understand their responsibilities. If time was limited, the company would rehearse the disengagement and movement of the tank platoon to BP 4-1. During the battle, the CO or other leaders will adjust the fire control measures due to enemy actions, friendly losses, or other factors. This is done by using FRAGOs or by prearranged signals.

#### **J-5. COMMAND AND CONTROL OF TOW/DRAGON**

TOW and Dragon employment may be either centralized or decentralized. The TOW sections of the battalion antitank platoon may be attached to a rifle or tank company (decentralized), or they may be retained under battalion control (centralized). The Dragon may be controlled the same way. The gunners may be controlled by the platoon leader or platoon sergeant (centralized), or placed under squad leader control (decentralized).

a. In situations that are characterized by a number of decentralized actions, such as a movement to contact or delaying action, or when units are widely dispersed, employment is normally decentralized for both TOW and Dragon.

b. When antiarmor weapons are to support a maneuver element, rapid employment of weapons is aided if the supported unit selects the firing positions for them before they arrive. This procedure applies both in the attack and retrograde, when the antiarmor crews may not have had time to reconnoiter and select firing positions, and in the defense when firing positions have not been reconnoitered.

#### **J-6. TOWS AND TANKS**

TOWs will often be employed in coordination with tanks. When employing these two weapons, remember—the tank is an assault weapon; the TOW is not! The tank is a better weapon than TOW against enemy armor at ranges less than 2,000 meters. This is because of the armor protection for its crew which, unlike TOW, enables it to move and fire despite enemy small arms and artillery fires, a more rapid rate of fire, and a larger on-board basic load of ammunition.

a. When operating with tanks, TOWs will normally overwatch and support (from behind or from the flanks) the movement of the tanks as they close with the enemy.

b. When displacing to the rear, TOWs move back first, covered by the tanks. Once the TOWs are in good firing positions from which they can overwatch the movement of the tanks, the tanks displace to new positions.

### **J-7. LAWs/AT4s**

The employment techniques for LAWs differ considerably from those used for ATGMs because of the following differences in capabilities between the LAW and ATGMs.

a. Because it has a warhead with a lesser capability than the TOW and Dragon, flanking engagements against armored vehicles are critical for successful LAW engagement. Flanking engagements take advantage of the tank's thinner armor to the flanks and rear. Likewise, multiple hits—not desirable for TOW and Dragon—are necessary for LAWs to ensure a good probability of crippling or destroying an enemy tank. Unlike ATGMs, the LAWs/AT4s are short-range systems. Its probability of hit on a target decreases as the range to the target increases. Therefore, close range engagements—again not desirable for ATGMs—are highly desirable for the LAW.

b. The effectiveness of light antiarmor weapons is significantly increased when they are employed by multiple firings--volley, pair, or sequence firing. The principles of LAW tactical employment can be summarized as—

- Blind the enemy. Slow or stop him, then destroy him.
- Use concealed firing positions.
- Hold your fire until you can get a sure hit.
- Engage from flank or rear with multiple firings (pair, sequence, or volley).

### **J-8. PROTECTION CONSIDERATIONS**

The effective use of antiarmor weapons to defeat an enemy armored attack depends on the coordinated use of all elements of the company.

a. Infantry protects antiarmor weapons from dismounted assaults by enemy infantry and from mounted armored assaults along terrain where long-range ATGM are not effective. This paragraph examines some of the considerations for protecting infantry forces. As infantry forces are vulnerable to all types of enemy direct and indirect fire and to armored assaults, and as an armored enemy will use massed armored assaults supported by massive supporting fires, such protection is an absolute necessity.

b. The techniques of protecting infantry forces are covered in Chapter 4 and Chapter 5 of this manual. When facing an armored force, added emphasis should be given to the following techniques of protection:

- Make maximum use of the terrain, for example, armor restrictive terrain.
  - Use cover and concealment.
  - Use mortars, artillery, and other supporting fires to avoid exposure.
- c. Indirect fires can be used—
- To blind or destroy enemy OPs and FOs.
  - To obscure movement through exposed areas with smoke.
  - To reduce the effectiveness of an armored attacker by 50 percent by damaging armored vehicles and forcing them to button up. This slows their movement and reduces their fields of vision. Given the visual deadspace inherent in an armored vehicle when buttoned up, it is of great advantage to the dismounted

infantryman to force this action (Figure J-16). Figure J-17 depicts a view as seen through the vision blocks of a typical threat tank (white area).

- To blind an armored formation with smoke, slowing it down and breaking the mutual support between elements of the formation.
- To suppress enemy direct - fire weapons.

d. Dug-in infantry is more than five times better protected against artillery fire, and far better able to defeat a mounted armored attack, than when it is exposed. To survive, infantrymen must be able to rapidly prepare individual positions. The longer a unit is in position the better protected it should become. Leaders must ensure that preparation of positions takes place.

e. Armored units have a mobility advantage over dismounted infantry units. The ability to meet an attack from any direction is essential. Even a few minutes of warning of such an attack can make the difference between an armored assault overrunning an infantry force or of it being defeated by the infantry. To provide adequate warning, all-round security must be maintained at all times. The security should be put out as far as practical to give timely warning. Emergency signals that warn of armored attack should be established as a matter of SOP to ensure quick warning to as many personnel as possible.

#### **J-9. FIELD EXPEDIENT ARMOR KILLING**

The infantry has always relied on certain field expedient measures to destroy enemy armor. Many of these are still effective.

a. The specific measures are discussed in FM 7-8. The infantry rifle company CO must understand these techniques and develop his plans to allow the soldiers to use them effectively. Most of these techniques are flame devices, or they use large amounts of explosives (40 pounds). They require the infantryman to get very close to the vehicles.

b. The CO attempts to develop situations that allow the company to fight armor in very restrictive terrain or at night. He also separates the armor from its supporting infantry. His plans also attempt to slow or stop the vehicles with obstacles, fires, or deceptions to allow the field expedient techniques to be more effective.



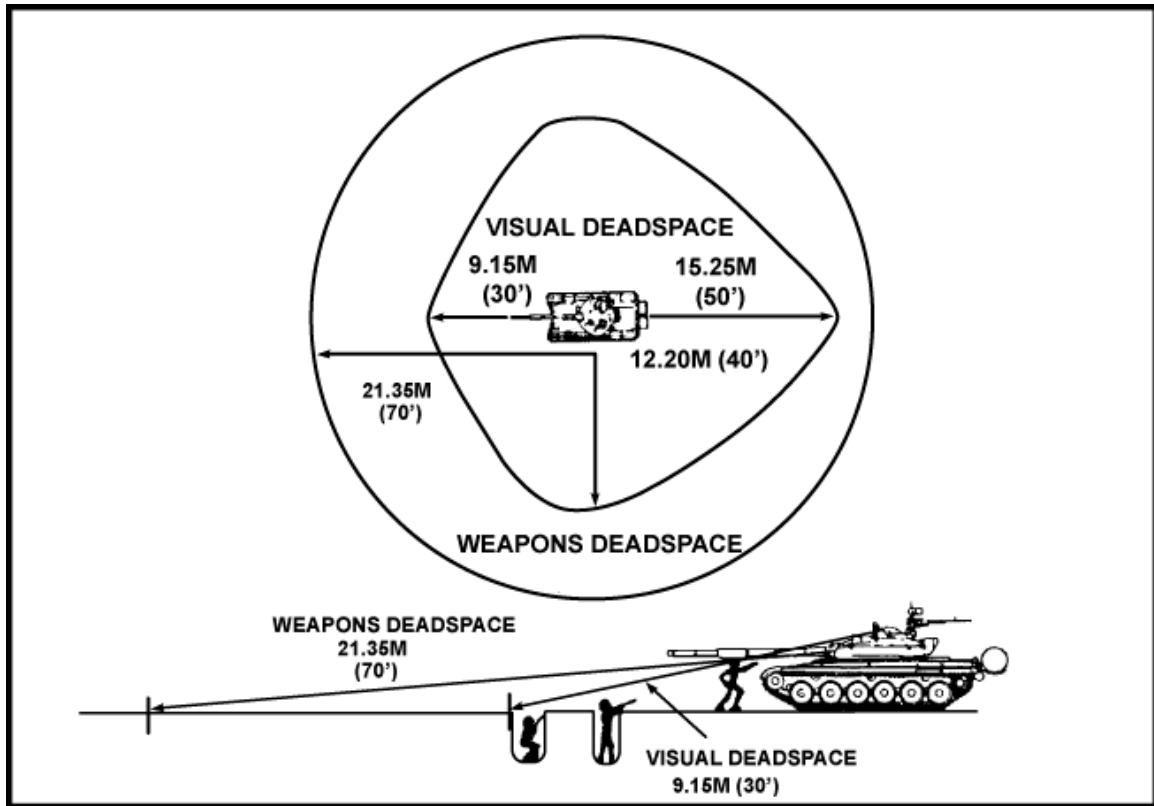

Figure J-16. Weapons deadspace.



Figure J-17. Limits of view through vision blocks.

## APPENDIX K

# DIRECTED-ENERGY WEAPONS

*This appendix introduces directed-energy weapons and gives an overview of how to defend against them. These new weapons are radically different in operation and effect from any other weapon in use. DEWs provide friendly forces target acquisition and engagement capabilities by detecting and locating enemy vehicles and soldiers rapidly, by providing early warning, and by degrading the enemy's fire control.*

### **K-1. CHARACTERISTICS**

Directed-energy weapons include lasers, microwave radiation emitters, and particle beam generators. These weapons produce casualties and damage equipment by depositing energy on the target. Conventional weapons rely upon the kinetic/chemical energy of a sizable projectile to defeat a target. DEWs depend upon subatomic particles or electro-magnetic waves impacting on the target at or near the speed of light.

a. For the foreseeable future, DEWs will be able to damage only soft targets, to include personnel or soft components of hard targets, such as the optics. Measures to preclude damage or destruction to currently fielded equipment and personnel from DEW engagement are limited, but by no means impossible or complicated.

b. In the future, equipment will be manufactured with built-in defenses against known DEWs, and older equipment may be refitted with protective devices. For the present, units can employ the measures discussed in this appendix to protect themselves from attack by DEWs.

### **K-2. LASERS**

Lasers are DEWs that may be used against US forces in the near future. The presence of laser devices in the inventories of all major armies is increasing, and any laser-emitting device, such as a target designator or a range finder, can be employed as a weapon if it is aimed at a type of target it can damage.

a. The most probable target of laser weapons will be optical and electro-optical systems—specifically, fire control devices such as sights and the personnel behind the sights.

b. A laser beam entering a direct-view optical system, such as a telescope, has its power increased by the magnification of that system. Anyone looking through the system will suffer burns to the eye(s). The severity of the burns, the permanence of the damage, and the time required for the eye to heal itself depends on weather conditions, the intensity of the laser, the magnification of the optical device, the range to the laser source, the frequency of the laser, and the duration of the eye's exposure to the laser. Eye injury may range from temporary flash blinding and mild burns to total, permanent blindness. A soldier subjected to this type of injury may be incapacitated and unable to aim his weapon. It is anticipated that a laser weapon will fire at a target for a split second at most before laying on another target.

c. A laser beam entering a non-see-through electro-optical device, such as a night vision sight or thermal imagery device, will deposit its energy in the form of heat on the

sensor screens inside. If the heat is intense enough, it can burn out the screen, making the device useless. Some of the electrical circuits inside will also be burned out from the heat and from a sudden surge of electricity caused by the laser's energy.

d. Laser weapons may also be directed against individuals, but that is a very inefficient way to employ them. Effects on individuals are burns, with the eyes being most susceptible to injury. To be effective against soldier's eyes, the individual must be looking at the laser source. Because the eye is more sensitive to light at night, laser energy entering the eye during darkness will have a greater effect than it would during daylight. Some types of lasers will be hazardous to soldiers' eyes even though the laser cannot be seen.

e. Any uncovered glass surface (such as eyeglasses, vision blocks, or binoculars) has the potential to attract or alert an antielectro-optical weapon's target acquisition system.

### **K-3. DEFENSIVE AND PROTECTIVE MEASURES**

Apply the following techniques to avoid detection by antielectro-optical weapon systems:

a. Use artillery, mortars, or direct fire weapons to suppress known or suspected antielectro-optical weapons locations. Smoke rounds are especially good for temporarily defeating laser devices.

b. When operating from static positions within line of sight of known or suspected enemy locations, minimize the exposure of glass surfaces in the direction of the enemy by positioning vehicles and weapons in covered or concealed positions.

c. When the mission requires maneuver and, consequently, the possible exposure of many glass surfaces, block the line of sight between friendly forces and known or suspected enemy locations with smoke or by planning routes to minimize exposure time.

d. Sound tactics will prevent friendly weapons locations from being pinpointed and subsequently targeted for attack by laser devices.

e. All devices that have external glass surfaces that are not in use should be covered or shielded until needed. Even vision blocks and headlights can alert antielectro-optical weapon target acquisition systems, so these must be included when taking protective measures. Tape, canvas, empty sandbags, or other materials can be used as covers.

f. Limit the number of personnel in observation positions to reduce the possibility of injuries. Use night vision goggles and thermal night sights when possible to protect these observers.

g. Gunners can use the AN/TAS-4 to scan for enemy laser devices. Blooming of the image is indicative of the presence of a laser. Gunners should be instructed to find and then avoid the threat laser device. Indirect fire should be used to neutralize the devices once they are located.

h. Tubular extensions over optical lenses will lessen their chances of being detected except from almost head on. These may be made from tubular ammunition packaging or other scrap materials.

i. Low energy antielectro-optical weapons will work only if they have line of sight to their target. They are just as effective at night as during the day; however, smoke, fog, snow, and dust will degrade their effectiveness. Another excellent countermeasure against some laser devices is to cover part of your optical lens with tape or some other type of cover (Figure K-1). Some degradation to viewing may exist; however, the benefit in reducing your vulnerability could be significant.

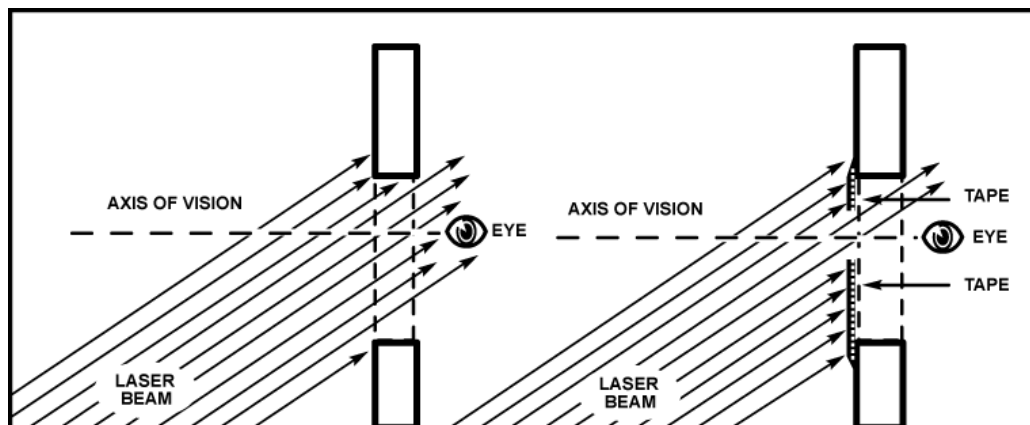

**Figure K-1. Tape on vision blocks.**

j. Soldiers should be aware of the potential hazard from laser devices currently in use in the US Army inventory. Devices most likely to be found in the vicinity of friendly soldiers are laser range finders.

k. Laser range finders are used on the M551A1, M60A3, and M1 tanks. They are also used a lot by the artillery. Artillery FISTs for airborne, ranger, and special forces units use the lightweight target designator; FISTs for mechanized, infantry, and air assault units use the ground-locating laser designator in either the ground-mounted or vehicle-mounted mode; and all FIST members use the GVS-5, binocular type, laser range finder. Some attack helicopters use a laser designator to direct the hellfire and copperhead systems. Additionally, artillery survey parties use laser devices for surveying in gun positions. Scout platoons are equipped with GVS-5 laser range finders.

l. Air Force and Navy aircraft may also carry laser target designators for aiming precision-guided munitions. The F-4, F-7, F-111, F-105, F-16, and A-6 aircraft may be equipped with these designators.

m. Operators of laser firing devices are given extensive training in their safe employment. The devices themselves cannot be activated without conscious, deliberate action on the part of the operator. While the possibility of an accident is extremely remote, it can happen. A victim might suddenly and unexpectedly move directly into the path of a laser beam and look directly at it, or a laser beam might reflect off a shiny surface and strike a victim in the eyes.

(1) To preclude such accidents, operators of laser firing devices must be kept constantly aware of friendly soldier locations, and they must positively identify targets before lasing them. Lasers should not be fired at reflective surfaces, and the warning "lasing" should be given before activating the laser.

(2) Conversely, commanders of soldiers operating in areas near friendly lasing must ensure that the commanders of laser-operating units are constantly aware of the friendly

soldier locations. Soldiers should be made aware of the presence of friendly lasers in their area and of the location of those lasers if possible. They should be warned not to look in the direction of laser-emitting devices unless specifically told it is safe to do so. Whenever possible, soldiers should wear laser protective goggles matched to the wave length of the friendly lasers. The ballistic and laser protective spectacles are currently issued through normal supply channels. BLPS are intended to be worn by individual soldiers day and night in both training and combat. When worn, BLPS protect the eyes from fragments and also reduce the risk of eye injury due to lasers.

#### **K-4. DIRECTED ELECTROMAGNETIC PULSE**

Electromagnetic pulse is electromagnetic radiation having frequencies ranging from 10 MHz to 4 GHz.

a. EMP may originate from nuclear detonations (nondirected EMP), from detonation of conventional explosives coupled with focusing electromechanical devices, and from electrically powered EMP generators on or above the ground.

b. EMP can severely damage or destroy sensitive electronic components, such as microchips, coils, and fuses, by overloading them with electrical current. Any equipment containing electronic components is subject to damage or destruction from EMP attack. FM radios are particularly susceptible to EMP damage. The amount of damage to equipment depends on its distance from the source of the pulse.

c. EMP may be projected into target areas from extremely long ranges. EMP can enter a targeted device through any opening and attack sensitive components inside even if the device is disconnected or turned off. For example, it may enter a radio set through the louvres over the cooling fans and destroy circuitry inside, making the radio useless. It may also enter through unshielded cables for antennas, power lines, and so forth.

d. An EMP attack lasts only for a split second and affects a tremendously large area. Protecting equipment from its attack is extremely difficult. The only totally reliable way to do it is to completely encase susceptible equipment in some type of heavy gauge metal shielding, or to completely surround it with special metal screening. Burying or covering with sandbags or other nonmetallic materials will not provide adequate protection. Terrain masking is ineffective because EMP follows the curve of the earth.

e. When operating from combat vehicles, sensitive equipment not absolutely needed for use at the moment should be disconnected and moved to the center of the vehicle. Smaller pieces of equipment should be placed in empty ammunition cans. Hatch covers should be kept closed unless someone is entering or exiting the vehicle. By doing this, only a minimum of equipment is susceptible to destruction, and the remainder is available for use after the attack.

f. Known or suspected locations of enemy ground-based EMP-generating weapons should be attacked by direct or indirect fire weapons within range.

---

### **K-5. MICROWAVE RADIATION EMITTERS**

In the future, high-intensity microwaves may be used to severely damage or destroy miniaturized electronic components such as microchips by overloading them with electrical current. Microwaves enter targeted devices in the same manner as EMP. Long-term exposure to high intensity microwaves may also produce physical and psychological effects on humans, such as warmth, pain, erratic heartbeat and blood pressure, nose bleed, disorientation, headaches, fatigue, weakness, and dizziness.

a. Defense measures employed against EMP are also effective against microwaves. Additionally, terrain masking will provide some, but not complete protection. During maintenance operations, the operator must be careful not to damage or neutralize the EMP/HPM hardening techniques that may have been built into the equipment.

b. Ground-based microwave radiation emitters can be suppressed by direct and indirect fire.

### **K-6. PARTICLE BEAM WEAPONS**

A particle beam is a directed flow of atomic or subatomic particles. These highly energetic particles, when concentrated into a beam that can interact with a target, can melt or fracture target material and generate X-rays around the point of impact. Should a particle beam weapon be developed sufficiently for use in ground combat, the same kind of defensive measures taken against any direct fire weapon will protect against its effects.

### **K-7. TRAINING**

Commanders at all levels will have to mentally condition their subordinates to face the threat of DEWs. While DEWs appear at first glance to have devastating effects on men and equipment and effective defense against them seems nearly impossible, a basic understanding of what they are and how they work reveals them to be not nearly as bad as first supposed.

a. Laser, microwave, and EMP weapons damage their targets by attacking their soft electronic components. Their terminal effects are not as violent or destructive as those of conventional kinetic or chemical energy munitions. Even though they render their targets just as combat ineffective, the blast, fire, and fragmentation associated with conventional munitions is totally absent. The personal danger to the individual is significantly less from an attack by laser, microwave, or EMP weapons than it is in an attack by conventional munitions.

b. In the case of lasers, while the thought of eye injuries may be psychologically repulsive to the soldier, the extent of injury and subsequent recovery time for a laser injury is less than that for a gunshot wound. Also, permanent blindness in the affected eye is not a certainty, and it will occur in only a small percentage of incidents.

c. The advantage of particle beam weapons (if ever perfected) lies in their flat trajectory, long range, and large magazine capacity. Other than these advantages, they are similar to conventional tank cannons in employment and effect. Whether a vehicle is struck by a HEAT round, an APDS round, or a particle beam hardly matters; the effect on the vehicle and its occupants is essentially the same in all cases. At present, there is no known countermeasure against a particle beam weapon system.

d. Until such time as equipment is factory-hardened against DEWs, the defensive techniques discussed in this appendix will provide it with some protection from

directed-energy attack. Since DEWs that can injure people are line-of-sight systems, standard defensive techniques employed against any direct fire weapon will provide equal or better protection against personal injury from them because DEWs have no bursting radius.

---

\*Appendix L  
**URBAN OPERATIONS**

*“We finally reached the front of the company where the lead APC was stopped and learned that the fire was coming from the large hotel on the left side of the street, about 50 meters to the front of the lead platoon. I guided the MK 19 HMMWV up onto a steep sidewalk so the gunner could get an effective shot and told him to watch my M16 tracer rounds and to work the building from top to bottom. I fired several tracers into the hotel; he fired a spotting round into one of the top story windows and then fired the grenade launcher on automatic, hitting every single window in the building. The effects were devastating. Concrete fragments flew everywhere, and one or two Somalis fell out of the building.”*

CPT Charles P. Ferry  
Mogadishu, October 1993:  
Personal Account of a Rifle Company XO  
*Infantry Magazine, Sep-Oct 94*

### **Section I. INTRODUCTION**

Urban operations (UO) are operations planned and conducted in an area of operations (AO) that includes one or more urban areas. An urban area is a topographical complex where manmade construction or high population density are the dominant features. The increasing world population and accelerated growth of cities means that UO in future conflicts will be very likely. The Infantry brigade will be the primary headquarters around which units will be task-organized to perform UO. Combat operations in urban areas usually occur when—

- The assigned objective lays within an urban area and cannot be bypassed.
- The urban area is key (or decisive) in setting and or shaping the conditions for current or future operations.
- An urban area is between two natural obstacles and there is no bypass.
- The urban area is in the path of a general advance and cannot be surrounded or bypassed.
- Political or humanitarian concerns require the control of an urban area or necessitate operations within it.
- Defending from urban areas supports a more effective overall defense or can not be avoided.
- Occupation, seizure, and control of the urban area will deny the threat control of the urban area and the ability to impose its influence on both friendly military forces and the local civilian population. Therefore, friendly forces can retain the initiative and dictate the conditions for future operations.

#### **L-1. SPECTRUM OF OPERATIONS**

The Infantry company normally conducts offensive, defensive, stability, and support (ODSS) operations as part of a task force (TF). These operations comprise the spectrum



of UO that the Infantry company must be prepared to conduct (Figure L-1). In some cases, companies may conduct stability and support operations independently. Infantry companies must plan and be prepared to conduct combat operations at all times. UO are routinely conducted against enemy forces that may be mixed in among civilians or where the civilian population density is high. Therefore, the ROE is often more restrictive than for other mission environments. How Infantry companies prepare for and execute ODSS operations is determined by the factors of METT-TC (mission, enemy, terrain, time and troops available, and civil considerations). (The ROE has significant importance within the mission and civil portions of METT-TC considerations.)

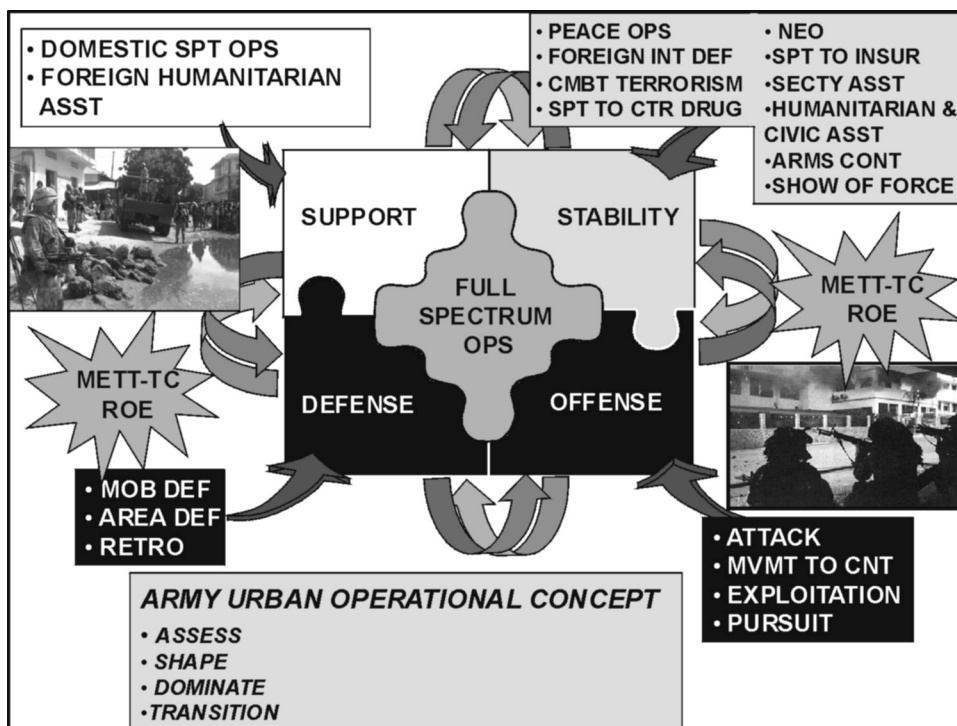

Figure L-1. UO spectrum of operations.

**L-2. URBAN BATTLESPACE**

Company commanders can enhance situational understanding by maintaining a clear understanding of their urban battlespace. Urban battlespace includes urban airspace, supersurface (buildings), surface (street level), and subsurface (sewers, tunnels, subways) areas. Commanders must be able to identify building types, construction materials, and building design and must understand the effectiveness and limitations of weapons against these factors. (See FM 90-10-1.) Commanders must also understand that combat under urban conditions will require them to visualize a three-dimensional battlespace. Commanders must be aware of how their urban battlespace is changing as friendly and enemy forces and civilians move, and as weather and environmental conditions change. Commanders can react to changes within the company’s battlespace with the timely movement of assault, support, and breaching elements in the offense; repositioning of

platoons in the defense; and synchronization of CS and CSS assets. Other factors that impact battlespace are:

- CASEVAC and resupply procedures.
- Handling EPWs and noncombatants.
- Rules of engagement. (See paragraph L-3.)
- Weather conditions.
- Battlefield obscuration.
- Communications.
- Movement of vehicles. (How will the battlespace affect movement and target engagement?)

### **L-3. RULES OF ENGAGEMENT**

Companies will always be faced with adhering to ROE of some kind. ROE have a significant impact on how missions are executed during UO. They must provide clear guidance to soldiers about when and how to employ force to accomplish the mission and to defend themselves.

a. The ROE will be much more restrictive under certain conditions of UO than under others. For example, a particular mission might require ROE that limit the use of indirect fire weapons. On the other hand, a mission to clear a building may require ROE that authorize force to clear rooms, and include authoritative guidance concerning measures to protect noncombatants, breach obstacles, and react to snipers.

b. One of the most significant issues of UO is collateral damage. Collateral damage is unintended and undesirable civilian personnel injuries or material damage adjacent to a target produced by the effects of friendly weapons. ROE will provide guidance concerning how to minimize collateral damage. For example, ROE may require use of nonlethal capabilities to the maximum extent possible before use of lethal weapons and munitions, or may restrict use of indirect fire weapons. The ROE will establish when certain types of weapons and munitions can be used (Table L-1).

**Note:** Nonlethal capability battalion kits will be in contingency stocks by September 2000 and will be issued to units on an as needed basis. Kits contain nonlethal weapons, devices, and munitions that are designed to incapacitate personnel or materiel.

c. A mission can transition quickly from stability or support to offense or defense. This transition may be caused by threat actions or the actions of noncombatants. Commanders must be prepared to react to this situation and request changes in the ROE when necessary.

d. ROE differentiate between the use of force for self-defense and for mission accomplishment. Commanders always retain the inherent authority and obligation to use necessary and proportional force for unit and individual self-defense in response to a hostile act or demonstrated hostile intent. The ROE used during Operation JUST CAUSE in Panama are shown at Table L-1.

| <b>ALL ENEMY MILITARY PERSONNEL AND VEHICLES TRANSPORTING THE ENEMY OR THEIR SUPPLIES MAY BE ENGAGED SUBJECT TO THE FOLLOWING RESTRICTIONS:</b>   |
|---|
| <ul style="list-style-type: none"> <li>a. Armed force is the last resort.</li> <li>b. When possible, the enemy will be warned first and allowed to surrender.</li> <li>c. Armed civilians will be engaged only in self-defense.</li> <li>d. Civilian aircraft will not be engaged without approval from above division level unless it is in self-defense.</li> <li>e. Avoid harming civilians unless necessary to save US lives. If possible, try to arrange for the evacuation of civilians prior to any US attack.</li> <li>f. If civilians are in the area, do not use artillery, mortars, armed helicopters, AC-130s, tube- or rocket-launched weapons, or M551 main guns against known or suspected targets without the permission of a ground maneuver commander, LTC or higher (for any of these weapons).</li> <li>g. If civilians are in the area, all air attacks must be controlled by a FAC or FO.</li> <li>h. If civilians are in the area, close air support (CAS), white phosphorus, and incendiary weapons are prohibited without approval from above division level.</li> <li>i. If civilians are in the area, do not shoot except at known enemy locations.</li> <li>j. If civilians are not in the area, you can shoot at suspected enemy locations.</li> <li>k. Public works such as power stations, water treatment plants, dams, or other utilities may not be engaged without approval from above division level.</li> <li>l. Hospitals, churches, shrines, schools, museums, and any other historical or cultural site will not be engaged except in self-defense.</li> <li>m. All indirect fire and air attacks must be observed.</li> <li>n. Pilots must be briefed for each mission on the location of civilians and friendly forces.</li> <li>o. No booby traps. No mines except as approved by division commander. No riot control agents except with approval from above division level.</li> <li>p. Avoid harming civilian property unless necessary to save US lives.</li> <li>q. Treat all civilians and their property with respect and dignity. Before using privately owned property, check to see if any publicly owned property can substitute. No requisitioning of civilian property without permission of a company-level commander and without giving a receipt. If an ordering officer can contract for the property, then do not requisition it. No looting. Do not kick down doors unless necessary. Do not sleep in their houses. If you must sleep in privately owned buildings, have an ordering officer contract for it.</li> <li>r. Treat all prisoners humanely and with respect and dignity.</li> <li>s. Annex R to the OPLAN provides more detail. Conflicts between this card and the OPLAN should be resolved in favor of the OPLAN.</li> </ul> |
| <b>DISTRIBUTION:</b> 1 per every trooper deployed to include all ranks.   |

**Table L-1. ROE used during Operation JUST CAUSE.**

| <b>SUPPLEMENTAL RULES OF ENGAGEMENT FOR SELECTED RECURRING OPERATIONS:</b>   |
|--|
| <p>1. CONTROL OF CIVILIANS ENGAGED IN LOOTING.</p> <p>a. Senior person in charge may order warning shots.</p> <p>b. Use minimum force but not deadly force to detain looters.</p> <p>c. Defend Panamanian (and other) lives with minimum force including deadly force when necessary.</p>  |
| <p>2. ROADBLOCKS, CHECKPOINTS AND SECURE DEFENSIVE POSITIONS.</p> <p>a. Mark all perimeter barriers, wires, and limits. Erect warning signs.</p> <p>b. Establish second positions to hastily block those fleeing.</p> <p>c. Senior person in charge may order warning shots to deter breach.</p> <p>d. Control exfiltrating civilians with minimum force necessary.</p> <p>e. Use force necessary to disarm exfiltrating military and paramilitary.</p> <p>f. Attack to disable, not destroy, all vehicles attempting to breach or flee.</p> <p>g. Vehicle that returns or initiates fire is hostile. Fire to destroy hostile force.</p> <p>h. Vehicle that persists in breach attempt is presumed hostile. Fire to destroy hostile force.</p> <p>i. Vehicle that persists in flight after a blocking attempt IAW instruction 2b is presumed hostile. Fire to destroy hostile force.</p> |
| <p>3. CLEARING BUILDINGS NOT KNOWN TO CONTAIN HOSTILE FORCE.</p> <p>a. Warn all occupants to exit.</p> <p>b. Senior person in charge may order warning shots to induce occupants to exit.</p> <p>c. Do not attack hospitals, churches, shrines, or schools, museums, and any historical or cultural sites except in self-defense.</p> <p>d. Respect and minimize damage to private property.</p> <p>e. Use minimum force necessary to control the situation and to ensure the area is free of hostile force.</p>   |

**Table L-1. ROE used during Operation JUST CAUSE (continued).**

#### **L-4. HANDLING NONCOMBATANTS AND DETAINED PERSONNEL**

Combat in urban terrain will often involve handling noncombatants during the conduct of operations. Noncombatants may be encountered during offensive operations as a result of clearing buildings and city blocks, when preparing for defensive operations, and during stability and support operations. In all cases, the commander will have to deal with the noncombatants. Handling noncombatants can be as simple as moving them out of immediate harm's way or as complicated as noncombatant evacuation operations (NEO).

**a. Definitions.**

(1) **Combatants.** Combatants are uniformed enemy forces and other individuals who take an active part in the hostilities in a way that poses a direct threat to U.S. personnel.

(2) **Noncombatants.** Noncombatants are civilians in the area of operations who are not armed and are not taking an active part in the hostilities in a way that poses a direct threat to U.S. personnel. Noncombatants can include refugees, local inhabitants affected by combat operations, civilian personnel belonging to US governmental agencies, civilian personnel from nongovernmental organizations (NGOs), and media personnel. Military chaplains, medical personnel, prisoners of war, and the wounded and sick also are noncombatants.

(3) **Prisoners of War (PWs).** A prisoner of war is an individual, such as a member of the armed forces or militia, a person who accompanies the armed forces without being a

member, or other category of person defined in the Geneva Convention Relative to the Treatment of Prisoners of War, who has fallen into the power of the enemy.

(4) ***Detained Personnel.*** A detained person is any individual who is in custody for committing hostile acts against U.S. forces or committing serious criminal acts.

**Note:** Experience in Somalia has shown that civilians can be hostile, friendly, or neutral. Hostile civilians do not necessarily become detained personnel if they are not perceived as a threat to friendly forces. For example, political opponents of U.S. involvement may be hostile towards the U.S. military presence but do not pose a threat to U.S. forces.

b. **Considerations for Handling Civilians.** Company commanders should consider using CA, PSYOP, MPs, chaplains, and civil leaders/authorities if their mission involves handling civilians. Other considerations include the following:

(1) Carefully analyze the ROE concerning when deadly force can be used and what type of weapons may be employed (for example, using lethal as opposed to nonlethal weapons and capabilities).

(2) Do not assume that civilians will be predisposed for or against U.S. troops. Always treat civilians with dignity and respect. Use force against civilians only in self-defense or otherwise in accordance with the ROE. Detain civilians only in accordance with command directives.

(3) When conducting offensive operations, plan to move any civilians that are encountered away from firefights. Normally this task will be given to the support element after rooms and buildings have been secured. When available, PSYOP, civil affairs, and MPs can assist with this task. A covered and concealed location away from the immediate combat area should be chosen. Civilians should be controlled and not permitted to enter the immediate combat area, unless they have been cleared to do so and will not compromise combat operations, for example, media personnel or governmental or NGO personnel that have a reason and authority to enter the combat area.

(4) When conducting defensive operations, plan to move civilians away from the immediate combat area. Companies will normally escort personnel to a designated location where they will be turned over to civil authority, battalion, or higher control. In many cases, friendly or nonhostile civilians may be directed to a clearing point and allowed to go there without escort.

(5) Security is not normally provided for media or NGO personnel if they are permitted in the immediate combat area. Security requirements for civilians should be clarified at the mission briefing.

(6) Based on the factors of METT-TC, commanders may have to render some type of immediate humanitarian assistance (medical attention and feeding). If this type of assistance is necessary, clarify questions in the mission briefing. Additional Class VIII and Class I can be requested, as appropriate.

c. **Determining the Status of Personnel.** Infantry companies do not determine the status of individuals in the combat area. Any persons that are initially detained should be treated as PWs and higher headquarters should be notified with a request for assistance in evacuating these individuals.

## Section II. OFFENSIVE OPERATIONS.

The brigade commander's (two levels up) primary responsibility is to set the conditions for tactical success for his subordinate units. Whenever possible, close combat by maneuver units is minimized and the brigade commander attempts to move from shaping to transition. (Figure L-2 depicts the operational framework for offensive UO. The tactical tasks of subordinate units during offensive operations are also shown in Figure L-2.) While the elements of offensive operations are not phases, tactical tasks may become phased at the company level, based on the factors of METT-TC. There is no clear line of distinction that delineates when the company moves from one task to another. Properly planned and executed offensive operations usually involve all the tactical tasks shown. They may be conducted simultaneously or sequentially, depending on the factors of METT-TC. Infantry companies will be used as maneuver elements to execute the tactical tasks. During offensive operations, the brigade commander's intent normally includes:

- Synchronizing precision fires (lethal and nonlethal effects) and information operations.
- Isolating decisive points.
- Using superior combat power to destroy high pay-off targets.
- Using close combat, when necessary, against decisive points.
- Transitioning quickly to stability/support operations.

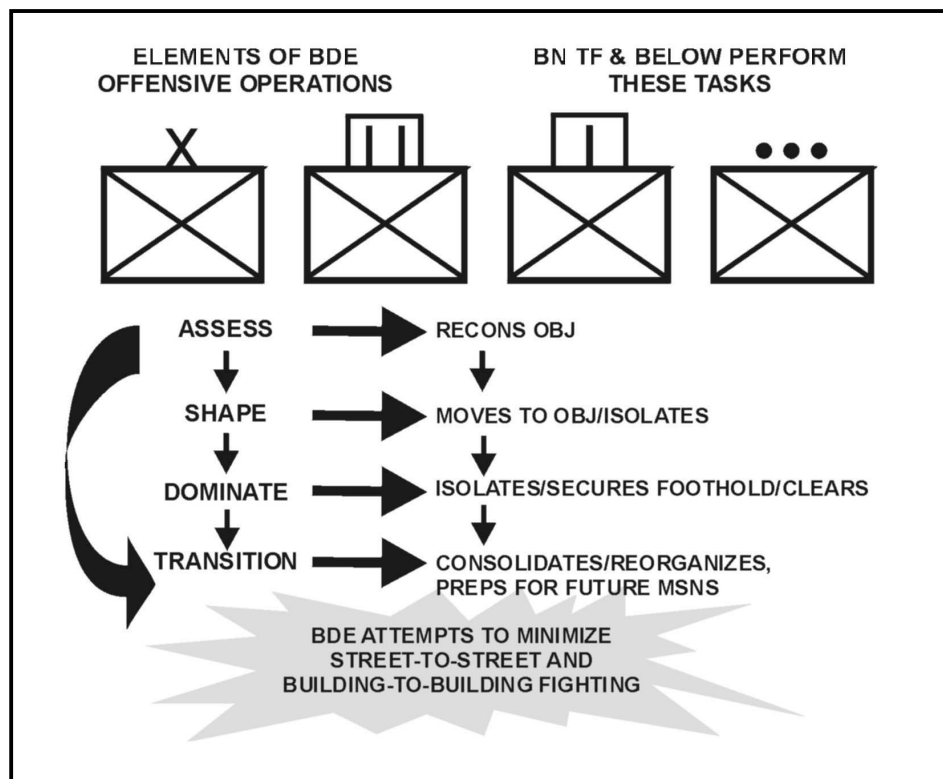

**Figure L-2. Offensive urban operational framework.**

**L-5. TYPES OF OFFENSIVE OPERATIONS**

At company level, the offense takes the form of either a hasty or deliberate attack. Both hasty and deliberate attacks are characterized by as much planning, reconnaissance, and coordination as time and the situation permit.

a. **Hasty Attack.** Infantry companies conduct hasty attacks as a result of a movement to contact, a meeting engagement, or a chance contact during a movement; after a successful defense or part of a defense; or in a situation where the unit has the opportunity to attack vulnerable enemy forces. Companies may also be required to conduct hasty attacks as a result of deteriorating conditions from stability and support operations, which require them to conduct hasty attacks for force protection. The hasty attack in an urban area differs from a hasty attack in open terrain because the close nature of the terrain makes command, control, and communications difficult. Also, massing fires to suppress the enemy may be difficult. In urban areas, incomplete intelligence and concealment may require the maneuver unit to move through, rather than around, the friendly unit fixing the enemy in place. Control and coordination must address reducing congestion at the edges of the urban area.

b. **Deliberate Attack.** A deliberate attack is a fully synchronized operation that employs all available assets against the enemy's defense, IAW with the ROE. It is necessary when enemy positions are well prepared, when the urban area is large or severely congested, when the element of surprise is lost, or when the ROE requires the precise application of combat power and lethal force. Deliberate attacks are characterized by detailed planning based on available information, thorough reconnaissance, preparation, and rehearsals. Given the nature of urban terrain, the deliberate attack of an urban area is similar to the techniques employed in assaulting a strong point. Attacking the enemy's main strength is avoided and combat power is focused on the weakest point of his defense. At the company level, a deliberate attack of an urban area usually involves the sequential execution of the tactical tasks below.

(1) **Reconnoiter the Objective.** This involves making a physical reconnaissance of the objective with company assets and those of higher headquarters, as the tactical situation permits. It also involves a map reconnaissance of the objective and all the terrain that will affect the mission, to include the analysis of aerial imagery, photographs, or any other detailed information about the building(s) or other urban terrain, which the company is responsible for. Additionally, any human intelligence (HUMINT) collected by reconnaissance and surveillance units, such as the battalion reconnaissance platoon, snipers, and so forth, should be considered during the planning process.

(2) **Move to the Objective.** This may involve moving the company tactically through open and or urban terrain. Movement should be made as rapidly as possible without sacrificing security. Movement should be made along covered and concealed routes and can involve moving through buildings, down streets, subsurface areas, or a combination of all three. Urban movement must take into account the three-dimensional aspect of the urban area.

(3) **Isolate the Objective.** Isolating the objective involves seizing terrain that dominates the area so that the enemy cannot supply, reinforce, or withdraw its defenders. It also includes selecting terrain that provides the ability to place suppressive fire on the objective. (This step may be taken at the same time as securing a foothold.) If isolating the objective is the first step, speed is necessary so that the defender has no time to react.

Companies may be required to isolate an objective as part of a battalion operation or may be required to do so independently. Depending on the tactical situation, an Infantry company may isolate an objective by infiltration and stealth.

(4) **Secure a Foothold.** Securing a foothold involves seizing an intermediate objective that provides cover from enemy fire and a location for attacking troops to enter the urban area. The size of the foothold is METT-TC dependent and is usually a company intermediate objective. In some cases a large building may be assigned as a company intermediate objective (foothold). As the company attacks to gain a foothold, it should be supported by suppressive fire and smoke.

(5) **Clear an Urban Area.** Before determining to what extent the urban area must be cleared, the factors of METT-TC must be considered. The ROE will influence the TTP platoons and squads select as they move through the urban area and clear individual buildings and rooms.

(a) The commander may decide to clear only those parts necessary for the success of his mission if—

- An objective must be seized quickly.
- Enemy resistance is light or fragmented.
- The buildings in the area have large open areas between them. In this case, the commander would clear only those buildings along the approach to his objective, or only those buildings necessary for security. (See Figure L-3.)

(b) An Infantry company may have a mission to systematically clear an area of all enemy. Through detailed analysis, the commander may anticipate that he will be opposed by a strong, organized resistance or will be in areas having strongly constructed buildings close together. Therefore, one or two platoons may attack on a narrow front against the enemy's weakest sector. They move slowly through the area, clearing systematically from room to room and building to building. The other platoon supports the clearing units and is prepared to assume their mission.

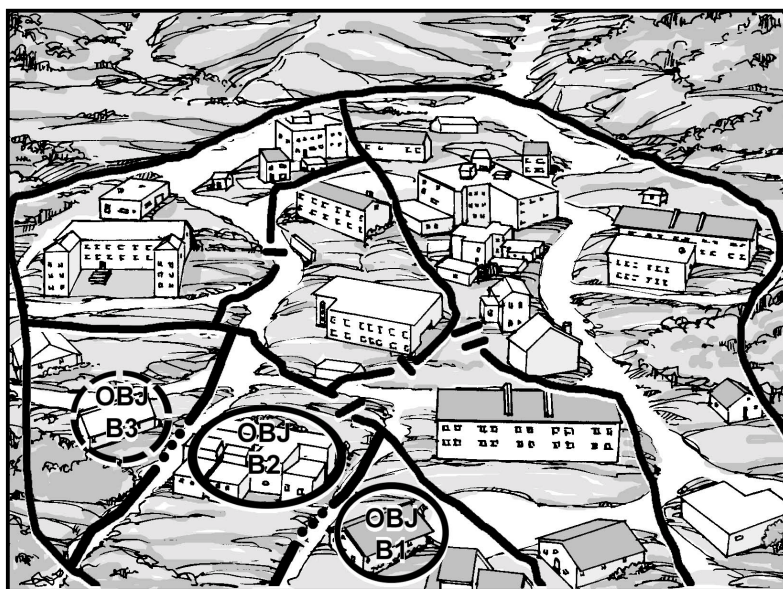

Figure L-3. Clearing selected buildings within sector.



(6) ***Consolidate/Reorganize and Prepare for Future Missions.*** Consolidation occurs immediately after each action. Consolidation is security and allows the company to prepare for counterattack and to facilitate reorganization. It is extremely important in an urban environment that units consolidate and reorganize rapidly after each engagement. The assault force in a cleared building must be quick to consolidate in order to repel enemy counterattacks and to prevent the enemy from infiltrating back into the cleared building. After securing a floor, selected members of the assault force are assigned to cover potential enemy counterattack routes to the building. Priority must be given to securing the direction of attack first. Those soldiers alert the assault force and place a heavy volume of fire on enemy forces approaching the building. Reorganization occurs after consolidation. Reorganization actions prepare the unit to continue the mission; many actions occur simultaneously.

(a) ***Consolidation Actions.*** Platoons assume hasty defensive positions after the objective has been seized or cleared. Based upon their specified and implied tasks, assaulting platoons should be prepared to assume an overwatch mission and support an assault on another building, or another assault within the building. Commanders must ensure that platoons guard enemy mouseholes between adjacent buildings, covered routes to the building, underground routes into the basement, and approaches over adjoining roofs.

(b) ***Reorganization Actions.*** After consolidation, the following actions are taken:

- Resupply and redistribute ammunition, equipment, and other necessary items.
- Mark the building to indicate to friendly forces that the building has been cleared.
- Move support or reserve elements into the objective if tactically sound.
- Redistribute personnel and equipment on adjacent structures.
- Treat and evacuate wounded personnel.
- Treat and process PWs.
- Segregate and safeguard civilians.
- Re-establish the chain of command.
- Redistribute personnel on the objective to support the next phase or mission.

(c) ***Prepare for Future Missions.*** The company commander anticipates and prepares for future missions and prepares the company chain of command for transition to defensive and/or stability and support missions.

**Note:** Friendly force situational understanding is significantly improved in digitally equipped units through the use of Force XXI Battle Command Brigade and below (FBCB2) assets.

## **L-6. TASK ORGANIZATION**

The company commander will normally task organize his company into two elements: an assault element and a support element. The support element may be given a number of tasks that are conducted on order or simultaneously; specifically, support by fire, isolate the objective, and conduct other support functions. The tactical situation will dictate whether or not separate elements need to be task-organized in order to conduct these support missions. The mission to breach is METT-TC dependent and may be given to the assault or support element; or a separate element may be formed to conduct this task. If

available, engineers will usually be task organized into the element that will perform the breach. The size and composition of the elements are determined by METT-TC. If the company is part of a battalion operation, the company could be given the mission to conduct one or more of the tasks mentioned above. If conducting an urban attack independently, the Infantry company will perform both assault and support tasks.

a. **Assault Element.** The purpose of the assault element is to kill, capture, or force the withdrawal of the enemy from an urban objective. The assault element of an Infantry company may consist of one or more platoons usually reinforced with engineers, BFVs, and possibly tanks. Building and room clearing are conducted at the platoon and squad level. The assault element must be prepared to breach to gain entry into buildings.

b. **Support Element.** The purpose of the support element is to provide any support that may be required by the assault element. The support element at company level normally consists of the company's organic assets (platoons, mortars, and antitank weapons), attachments, and units that are under the OPCON of the company commander. This assistance includes, but is not limited to, the following:

- Suppressing and obscuring enemy within the objective building(s) and adjacent structures.
- Isolating the objective building(s) with observation and direct or indirect fires to prevent enemy withdrawal, reinforcement, or counterattack.
- Breaching walls en route to and in the objective structure.
- Destroying or suppressing enemy positions with direct fire weapons.
- Securing cleared portions of the objective.
- Providing squads to assume assault element missions.
- Providing resupply of ammunition, explosives, and personnel.
- Evacuating casualties, EPWs, and noncombatants.

c. **Reserves.** (See Chapter 4, paragraph 4-4c for more information.) Companies fighting in urban terrain may not be able to designate a reserve, based on the number of troops required to conduct offensive operations. A platoon(s) may be detached from the company to form a battalion reserve. The company reserve, if one is designated, should be mobile and prepared for commitment. Because of the available cover in urban areas, the reserve can stay close to forward units. The reserve normally follows within the same block so that it can immediately influence the attack. The size of the reserve is METT-TC dependent, but at company level, the reserve normally consists of a squad, detached from an organic platoon, or attached elements. In addition to the tasks discussed in Chapter 4, the reserve may be called upon to perform one or more of the following tasks based on the commander's priority of commitment:

- Assuming the mission of the assault element.
- Clearing bypassed enemy positions.
- Moving behind the assault element to provide security in cleared buildings, allowing the assault element to continue to move.

d. **Breaching Element.** At the company level, breaching is normally conducted by the assault element. However, a separate breaching element may be created and a platoon may be given this mission and task organized accordingly. The purpose of breaching is to provide the assault element with access to an urban objective. Breaching can be accomplished using explosive, ballistic, thermal, or mechanical methods. Ballistic breaching includes using direct fire weapons; mechanical breaching includes the use of

crowbars, axes, saws, sledgehammers, or other mechanical entry devices. Thermal breaching is accomplished through the use of a torch to cut metal items such as door hinges. Attached engineers, or a member(s) of the assault element who has had additional training in mechanical, thermal, ballistic, and explosive breaching techniques, may conduct the breach.

e. **Sample Task Organizations.** Task organization of the company will vary based on the factors of METT-TC and the ROE.

(1) **Light Infantry Task Organization.** An Infantry company conducting this mission might task-organize as follows:

|         |  |
|---------|--|
| Assault | Two rifle platoons and one rifle platoon(-) reinforced with engineers (attached to the platoons).                          |
| Reserve | A squad from one of the platoons.  |
| Support | The company AT weapons, 60-mm mortar section, and M240 machine guns. (Other support provided by the battalion task force.) |

(2) **Light/Heavy Task Organizations.** Different METT-TC factors might produce the following light/heavy task organizations:

**Example 1:**

|         |  |
|---------|--|
| Assault | Two rifle platoons, each reinforced with engineers.  |
| Reserve | One rifle platoon.   |
| Support | BFV platoon and the company AT weapons and 60-mm mortar section. (Other support provided by the battalion task force.) |

**Example 2:**

|         |  |
|---------|--|
| Assault | Two rifle platoons reinforced with engineers.                      |
| Reserve | One rifle platoon.   |
| Support | One tank platoon. The company AT weapons and 60-mm mortar section. |

**Example 3:**

|         |   |
|---------|---|
| Assault | Two rifle platoons, each with engineers. One tank section OPCON to an Infantry platoon.   |
| Reserve | One rifle platoon.  |
| Support | A tank section and the company AT weapons under the tank platoon leader's control. The company 60-mm mortar section. (All available direct and indirect fire weapons should be used to isolate objective buildings. Direct fire down streets and indirect fire in open areas between buildings will help in the objective isolation.) |

**Note:** The company commander may use the company executive officer, tank platoon leader, BFV platoon leader, or first sergeant to control the support element, as the task organization and situation dictate. Based on METT-TC factors, a BFV platoon can perform any of the missions described above (assault, support, reserve). Unit integrity should be maintained at the platoon level. If the tactical

situation requires the employment of sections, it should be for a limited duration and distance.

### **L-7. ISOLATE AN URBAN OBJECTIVE**

Infantry companies isolate an urban objective to prevent reinforcement of, or a counterattack against, the objective and to kill or capture any withdrawing enemy forces. When planning the isolation, commanders must consider three-dimensional and in-depth isolation of the objective (front, flanks, rear, upper stories, rooftops, and subsurface). All available direct and indirect fire weapons, to include attack helicopters and CAS, should be employed, consistent with the ROE. Isolating the objective is a key factor in facilitating the assault and preventing casualties. The company may perform this mission as the support element for a battalion operation, or it may assign the task to its own internal support element for a company attack. In certain situations, Infantry companies may be required to isolate an objective or an area for special operations forces or for stability/support operations. When possible, the objective should be isolated using stealth and or rapid movement in order to surprise the enemy. Depending on the tactical situation, Infantry companies may use infiltration in order to isolate the objective. Likely tasks include, but are not limited to, the ones described below.

**Note:** Combat experience and recent rotations at the CTCs have shown that many casualties can be sustained when moving between buildings, down streets, and through open areas in order to gain entry into a building either to gain a foothold or to clear it. One of the purposes of isolation at the company level must be to dominate the outside area that leads to the point of entry in order to allow assaulting troops to enter the building without receiving effective fire from the enemy. This is accomplished by the effective use of direct and indirect fires, obscurants, maintaining situational understanding, and exercising tactical patience prior to movement.

a. **Isolating the Objective (Battalion Attack).** An Infantry company may isolate the objective as the support element for a battalion operation. When an Infantry company is given this mission, the objective will normally be a larger structure, a block, or group of buildings. The company commander will task organize his platoons and assign them support by fire positions based on the factors of METT-TC. In addition to isolating the objective, the company (support element) may be given additional tasks that will be conducted on order or simultaneously. Examples of these additional tasks include assuming assault element missions, securing cleared buildings, handling noncombatants and EPWs, and CASEVAC.

b. **Isolating the Objective (Company Attack).** When an Infantry company conducts an attack, the task organization and tasks given to the company support element will be determined by the factors of METT-TC. If the company conducts a company attack, the objective can be a building, a block or group of buildings, a traffic circle, or a small village (Figure L-4).

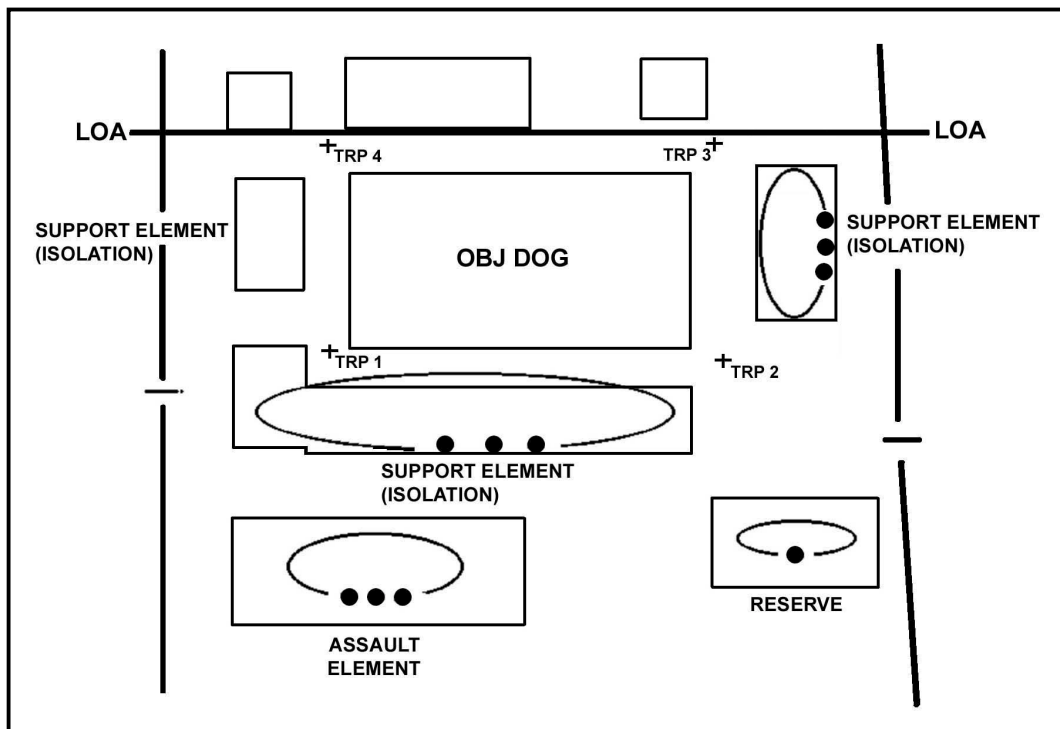

**Figure L-4. Isolating an urban objective**

c. **Tasks.** The company commander will isolate the objective with direct and indirect fires prior to and during the assault element's execution of its mission. The company will-

- Suppress known, likely, and suspected enemy targets, consistent with the ROE, with direct and indirect fire weapons. Under restrictive ROE, suppression may be limited only to actual enemy locations.
- Cover mounted avenues of approach with antiarmor weapons.
- Cover dismounted avenues of approach with automatic weapons.
- Control key terrain near or adjacent to the objective in order to prevent the enemy from reinforcing his positions, withdrawing, or counterattacking.
- Be prepared to move to other locations in order to suppress enemy fires and neutralize enemy positions as the assault element performs its tasks.

(1) Company commanders must give specific instructions to subordinate leaders concerning where to place fires in support of the assault element. For example, "from TRP 1 to TRP 2", "along the third and second floor windows on the east side of Building 21", "shift fires to the west side of the objective from TRP 1 to TRP 4 when you see the green star cluster", etc. Once suppressive fires on the objective begin, they will normally be increased and continued until masked by the advancing assault element. Suppressive fires may or may not be used from the beginning of the assault depending on the ROE. Targets can be marked and identified with tracer rounds; M203 smoke, HE, or ILLUM rounds; voice and hand or arm signals; laser pointers; or similar devices.

(2) The precise well-placed volume of fire, as opposed to a volume of fire, will suppress the enemy. The volume of fire and types of weapons employed will be ROE

dependent. Once masked, fires are shifted to upper or lower windows and continued until the assault force has entered the building. At that time, fires are shifted to adjacent buildings to prevent enemy withdrawal or reinforcement. If the ROE are restrictive, the use of supporting fires will normally be limited to known enemy locations that have engaged the unit.

**Note:** Care must be taken in urban areas when WP, ILLUM, or tracers are used since urban fires can be caused. Care must also be exercised if sabot rounds are used by armored vehicles, based on their penetration capability. Sabot rounds can penetrate many walls and travel great distances to include passing through multiple buildings, creating unintended damage, casualties, and fratricide.

d. **Direction of Assault Technique of Direct Fire Planning and Control.** In this technique, the company commander assigns building numbers in a consistent pattern in relation to the direction of assault. In the example shown in Figure L-5, the commander numbered the buildings consecutively, in a counterclockwise manner. Further, the sides of the buildings were color coded consistently throughout the objective area (WHITE—direction of assault side; GREEN—right side; BLACK—rear side; RED—left side; BLUE—roof). An odd shaped building is also shown. Note that a “four-sided” concept was retained to minimize confusion. Further designations of WHITE 1, WHITE 2, WHITE 3, and so on from left to right can be added to specify which wall will be engaged. Apertures on the buildings are also labeled consecutively using rows and columns, as shown. In the example, “OBJ 4, WHITE, window A1” is the lower left-hand window on the direction of assault side of OBJ 4. All designations are labeled in relation to the direction of assault. (See FM 34-130 for additional information on building shapes and structural labeling.)

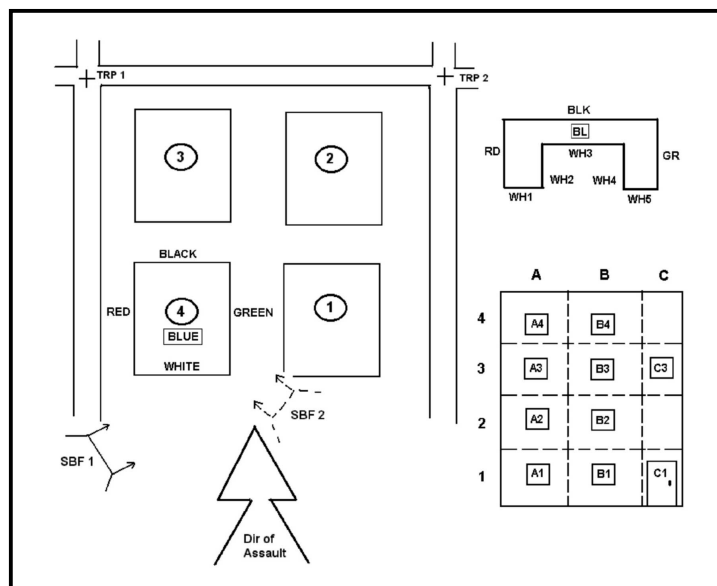

**Figure L-5. Direction of assault technique of direct fire planning and control.**

### L-8. ASSAULT A BUILDING

The company will conduct this mission as part of the assault element of a battalion task force or independently. (Independently is defined here as a company having to provide its own support element, as opposed to conducting an operation without flank and rear support, such as a raid or ambush.) If it is conducted as the assault element of a battalion task force, it will probably be conducted against a large building defended by a strong enemy force, for example, a reinforced platoon. Company commanders will need to clearly understand the specified and implied tasks required to accomplish the mission, as well as the brigade/battalion commanders' intent and the desired mission end-state. This will allow the company commander to task organize and issue specific missions to his subordinate elements concerning which floors and rooms to clear, seize, or bypass. As an example, Figure L-6 depicts an Infantry TF assigned the mission of clearing the objectives in its sector (DOG and TAIL). Company B has been given the TF supporting effort of seizing and clearing OBJ TAIL. The company commander has decided to assign an intermediate objective (WING) to 1st platoon. 3d platoon is the support element with the mission of isolating WING (1st and 2d squads) and providing one squad to act as the company reserve (3d squad). 2d platoon has the mission of passing through 1st platoon, which will mark a passage lane and seize TAIL.

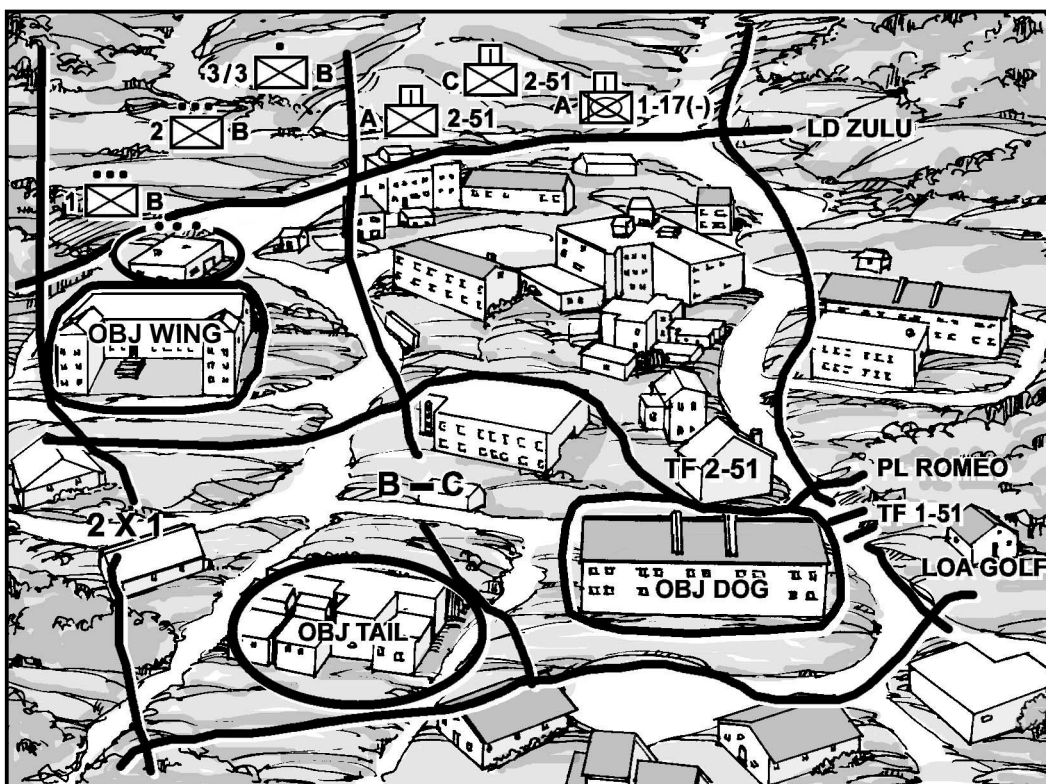

Figure L-6. Assault of a building.

a. **Execution.** Platoons should move by bounds by floor when clearing a multistory building. This permits troops to rest after a floor has been cleared. It is likely that

platoons will be required to leave security on floors and in cleared rooms and also facilitate the passage of another platoon in order to continue the assault. The assault element must quickly and violently execute its assault and subsequent clearing operations. Once momentum has been gained, it is maintained to prevent the enemy from organizing a more determined resistance on other floors or in other rooms. If platoons come across rooms/hallways/stairwells that are barricaded with furniture or where obstacles have been placed, they should first attempt to bypass the barricade/obstacle and maintain the momentum of the attack. If they cannot bypass the barricade/obstacle, security should be placed on the barricade/obstacle, it should be checked for booby traps, and should then be reduced. Also, sealing doors and floors may be an option in order to maintain momentum. Subordinate leaders should continue the momentum of the assault, yet not allow the operation to become disorganized.

b. **Ammunition and Equipment.** METT-TC factors and the ROE will determine how the assault element is equipped and armed. The assault element will carry only a fighting load of equipment and as much ammunition as possible, especially grenades (fragmentation, smoke, concussion, and stun consistent with the building construction and the ROE). The support element maintains control of additional ammunition and equipment not immediately needed by the assault element. An often-overlooked munition in an urban battle is the light antitank weapon such as the M72 LAW and the AT-4. Soldiers can use these for a variety of purposes such as suppressing a manned position or supporting the breaching or assault elements. Resupply should be pushed to the assault element by the support element. Commanders must carefully manage the soldier's load during the assault. Normally, ammunition, water, special assault weapons/equipment, and medical supplies/litters are the only items carried in the assault. Attached or OPCON tank or BFV platoons should also configure their ammunition load to support their mission, consistent with the ROE.

c. **Assault Locations.** The assault may begin from the top or bottom of the building.

(1) **Top Entry.** Entry at the top and fighting downward is the preferred method of clearing a building. This method is only feasible, however, when access to an upper floor or rooftop can be gained by ladder; from the windows or roofs of adjoining, secured buildings; or, when enemy air defense weapons can be suppressed and troops can be transported to the rooftops by helicopter. Rooftops should be treated as danger areas when surrounding buildings are higher and the element will be exposed to fire from those buildings. Helicopters should land only on those buildings that can support the weight of the helicopter such as rooftop heliports or parking garages. However, soldiers can dismount as the helicopter hovers a few feet above the roof. Troops can then breach the roof or common walls. They may use ropes, ladders, or other means to enter the lower floors through the holes created. Ladders can be used to conduct an exterior assault of an upper level if soldiers' exposure to enemy fire can be minimized.

(2) **Bottom Entry.** Entry at the bottom is common and may be the only option available. When entering from the bottom, breaching a wall is the preferred method because doors and windows may be booby-trapped and covered by fire from inside the structure. If the assault element must enter through a door or window, entry from a rear or flank position is preferred. Under certain situations, the ROE may not permit the use of certain explosives, therefore entry through doors and windows may be the only option available. Armored vehicles can be especially useful in supporting bottom entry.



d. **Breaching.** Squads and platoons will have to conduct breaching. Engineers may be attached to the unit responsible for breaching. Depending on the factors of METT-TC, company commanders may need to designate specific breaching locations or delegate the task to platoon leaders. The ROE will also influence whether mechanical, thermal, ballistic, or explosive breaching will be used. For example, if BFVs are attached to the company and the ROE permit their use, they can breach the wall by main gun fire for the initial entry point.

e. **Assault Tasks.** Once inside the building, the priority tasks are to cover the staircases and to seize rooms that overlook approaches to the building. These actions are required to isolate enemy forces within the building and to prevent reinforcement from the outside. The assault element clears each room on the entry floor and then proceeds to clear the other floors to include the basement. If entry is not made from the top, consideration may be given to rushing/clearing and securing a stairwell and clearing from the top down, if the tactical situation permits. If stairwell use is required, minimize their use and clear them last. If there is a basement, it should be cleared as soon as possible, preferably at the same time as the ground floor. The procedures for clearing a basement are the same as for any room or floor, but important differences do exist. Basements may contain entrances to tunnels such as sewers and communications cable tunnels. These should be cleared and secured to prevent the enemy from infiltrating back into cleared areas.

**DANGER**  
**A SAFETY CONSIDERATION FOR CLEARING**  
**BUILDINGS IS THE HIGH PROBABILITY OF**  
**RICOCHET.**

f. **Suppressive Fires During the Assault.** The support element provides suppressive fire while the assault element is systematically clearing the building. It also provides suppressive fire on adjacent buildings to prevent enemy reinforcements or withdrawal. Suppressive fire may consist of firing at known and suspected enemy locations; or, depending on the ROE, may only include firing at identified targets or returning fire when fired upon. The support element destroys or captures any enemy trying to exit the building. The support element must also deal with civilians displaced by the assault. Armored vehicles can be especially useful in providing heavy, sustained, accurate fire.

g. **Clearing Rooms.** Company commanders must ensure that clearing platoons carry enough room marking equipment and plainly mark cleared rooms from the friendly side IAW unit SOP (Figure L-7). Also, if the operation occurs during limited visibility, marking must be visible to friendly units. The support element must understand which markings will be employed and ensure that suppressive fires do not engage cleared rooms and floors. Maintaining situational understanding concerning the location of the assault teams and which rooms/floors have been cleared is imperative and a key command and control function for the company commander. Radios can be consolidated, if necessary, with priority going to the squads and platoons clearing rooms. When exiting cleared buildings friendly troops should notify supporting elements using the radio or other preplanned signals.

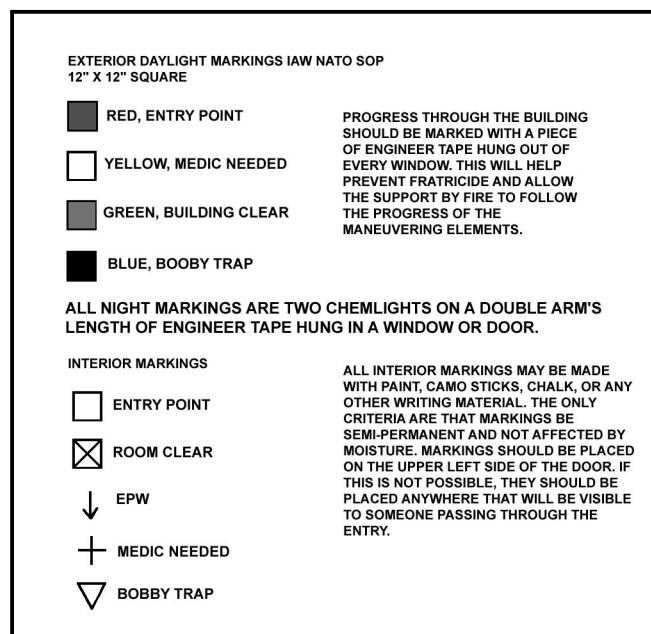

**Figure L-7. Sample marking SOP.**

### L-9. ATTACK A BLOCK OR GROUP OF BUILDINGS

An Infantry company will normally attack a block or group of buildings as part of a battalion task force. To attack a block or a group of buildings, an Infantry company may need to be reinforced with BFVs or tanks and engineers, consistent with the ROE and the enemy situation.

a. **Execution.** The execution of this mission is characterized by platoon attacks supported by both direct and indirect fires. Success depends on isolating the enemy positions which often become platoon objectives, suppressing enemy weapons, seizing a foothold in the block, and clearing the block's buildings room by room.

b. **Direct Fire Weapons.** BFVs, tanks, machine guns, and other direct fire support weapons fire on the objective from covered positions, consistent with the ROE. These weapons should not be fired for prolonged periods from one position. The gunners should use a series of positions and displace from one to another to gain better fields of fire and to avoid being targeted by the enemy. Direct fire support tasks can be assigned as follows:

- Machine guns fire along streets and into windows, doors, mouseholes, and other probable enemy positions. ROE may restrict firing only to known enemy locations.
- BFVs, tanks, and antitank weapons fire at enemy tanks and other armored vehicles. They can also provide a countersniper capability due to their range and target acquisition capability.
- Tanks fire at targets protected by walls and provide protection against enemy tanks, as required.

- BFVs may be used to create breaches with the 25-mm gun and TOW.
- Riflemen engage targets of opportunity.

c. **Obscuration and Assault.** Before an assault, the company commander should employ smoke to conceal the assaulting platoons. He secures their flanks with direct fire weapons and by employment of the reserve, if necessary. Concealed by smoke and supported by direct fire weapons, an assaulting platoon attacks the first isolated building. The assault element utilizes the cover of suppressive fires to gain a foothold. The company commander must closely coordinate the assault with its supporting fire so that the fire is shifted at the last possible moment. The squads and platoons then clear each designated building. After seizing the block, the company consolidates and reorganizes to repel a counterattack or to continue the attack. Periods of limited visibility may provide the best conditions to attack, especially if NVGs provide the company a technological advantage over the threat.

**Note:** Obscuration rounds may cause uncontrolled fires in the city and must be carefully planned.

#### **L-10. HASTY ATTACK OF A VILLAGE**

The Infantry company may find itself moving to an urban area or conducting a movement to contact with a mission of clearing a village of enemy. The following discussion provides a technique for conducting a hasty attack on a village. The company commander makes a quick assessment of the factors of METT-TC and reacts appropriately to support the higher level commander's intent.

a. **Establish Support.** If attached or OPCON, tanks, BFVs, MK19s or M2HBs mounted on HMMWVs, and TOWs assume support-by-fire positions from which they can fire on the village, prevent the enemy from withdrawing, and destroy any reinforcements (support element functions). If these assets are not available, then the company commander moves Infantry elements into position to accomplish the same tasks. The company 60-mm mortar and AT sections also provide fire support. Armored vehicles can reposition during the assault, if necessary, to gain better fields of fire and provide better support.

b. **Assault the Village.** The rifle platoons assault from a covered route so as to hit the village at a vulnerable point (Figure L-8). As the platoons approach the village, smoke is employed to screen their movement and supporting fires are shifted. Once the platoons close on the village, they clear the buildings quickly, consistent with the ROE, and consolidate. The company is then ready to continue operations.

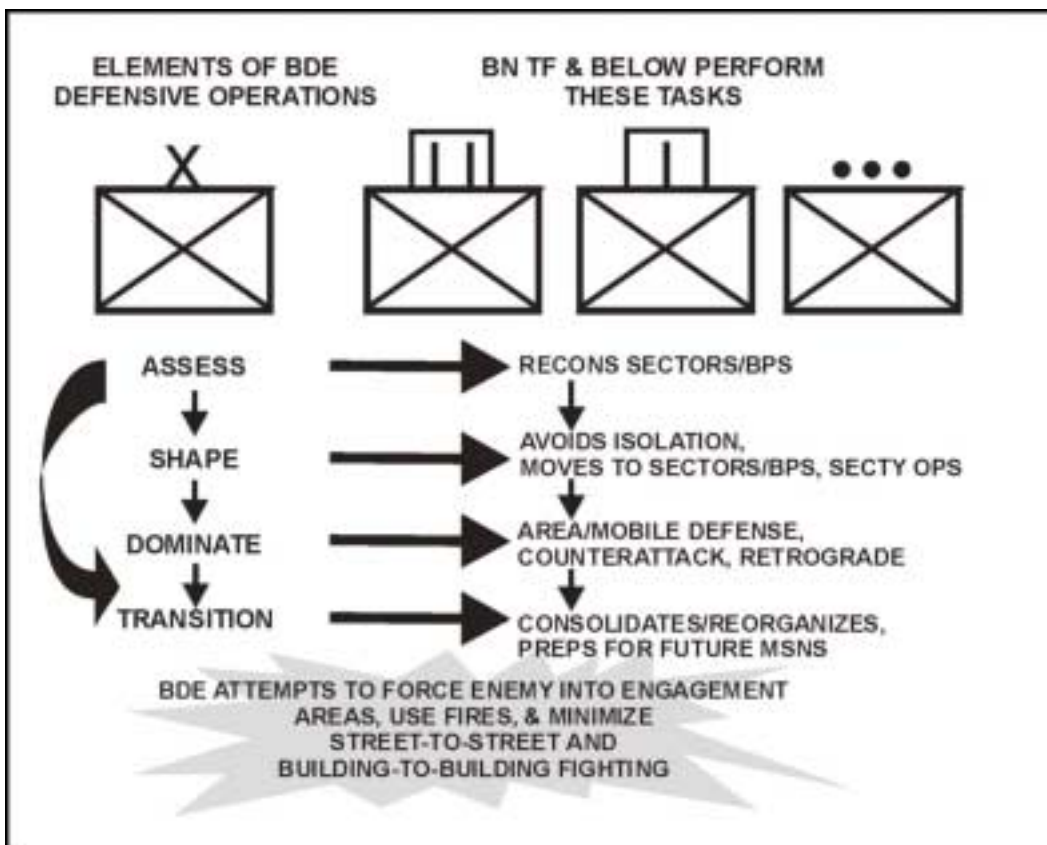

**Figure L-8. Hasty attack of a village.**

### **Section III. DEFENSIVE OPERATIONS**

The company will normally conduct defensive operations as part of a battalion task force. Defensive operations may be performed as part of a purely defensive mission to retain terrain or destroy attacking enemy forces, or they may be performed as part of stability and support operations. The elements shown in Figure L-9 will normally be incorporated as part of the urban defensive planning process. The elements are similar to those in offensive operations in that the brigade commander (two levels up) tries to avoid isolation, through security operations; defensive missions are assigned to companies in order to achieve the brigade commander's intent and desired end-state; and finally, the brigade transitions to stability and or support actions. During urban defensive operations, the transition to stability and support operations may not be clear to the soldiers. Commanders must offset this tendency with clear mission type orders and updated ROE. Again, as in offensive operations, the elements are not phases. They may occur simultaneously or sequentially. Well planned and executed defensive operations will have all four elements present. During defensive operations the brigade commanders seek to—

- Avoid being isolated by the enemy.
- Defend only the decisive terrain, institutions, or infrastructure.
- Use offensive fire and maneuver to retain the initiative.



**Figure L-9. Elements of defensive urban actions.**

### L-11. GENERAL CONSIDERATIONS

Of the two patterns of defense, area and mobile, the area defense will probably be the pattern most used since most of the reasons for defending an urban area are focused on retaining terrain. The mobile defense pattern is more focused on the enemy and the commander may decide to use it based on his estimate of the situation. In an urban area, the defender must take advantage of the abundant cover and concealment. He must also consider restrictions to the attacker's ability to maneuver and observe. By using the terrain and fighting from well-prepared and mutually supporting positions, a defending force can inflict heavy losses on, destroy, delay, block, or fix a much larger attacking force.

### L-12. ORGANIZATION OF THE DEFENSE

The factors of METT-TC and the ROE will determine how the company plans, prepares, and executes the defense. The defense is organized into three areas: the security force area, main battle area, and rear area. (See Figure 5-1, page 5-4 and paragraph 5-3 for more information.) A company defending in urban areas may have missions in any one of these defensive areas, depending on the nature of the operation. Infantry companies are well suited to conduct defensive operations in close urban terrain where engagement

ranges will be short, where there is abundant cover and concealment, and where the enemy's assault must be repelled.

**Note:** This defensive organization will likely be used against a conventional enemy force that may threaten US forces with mechanized and dismounted Infantry supported by other combined arms. This defensive organization may also occur in a brigade area of operation (AO) where there are multiple threats. For example, one part of the AO may require linear features; other parts may require the use of other defensive techniques, such as a perimeter defense, against different types of threats in the same brigade AO.

a. **Security Operations.** The defensive battle normally begins with a combined arms force conducting security actions well forward of the main body. Company missions consist of security, reconnaissance, and counter-reconnaissance tasks. Infantry companies assigned counter-reconnaissance missions to support these security operations employ ambushes, mines, obstacles, deception, security patrols, OPs, indirect fires, camouflage, demonstrations, and other measures to destroy or deceive the enemy's reconnaissance elements. (See Chapter 5, paragraph 5-7, for further discussion of counterreconnaissance.) Again, urban areas are well suited for Infantry counter-reconnaissance operations because of the abundance of cover and concealment which permits Infantry to move by stealth.

b. **Main Battle Area (MBA).** The decisive battle is normally fought in the MBA. Depending on the threat, company commanders can deploy their platoons on the forward edges of the urban area or in battle positions in depth (Figure L-10). In either case, the defense is made stronger by including forces that are defending on close terrain or on the flanks into the defensive scheme.

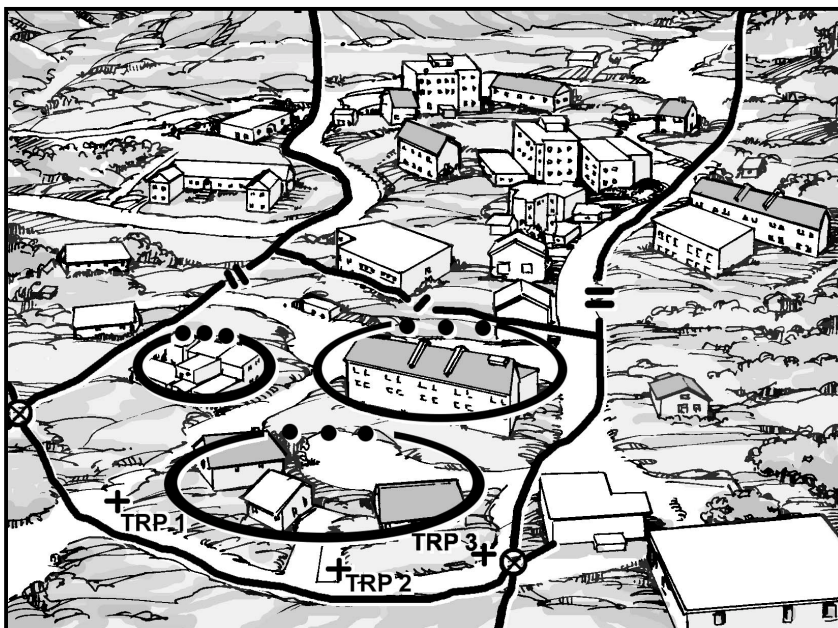

Figure L-10. Platoon battle positions in a urban area.

(1) **Size of Battle Positions.** The size and location of battle positions within the AO depends mainly on the type of enemy encountered and the ability to move between positions to block threatened areas. It may be desirable to place small antiarmor elements, secured by Infantry, on the forward edges while the main defense is deployed in depth.

(2) **Considerations.** Companies assigned battle positions on the forward edge of an urban area should—

- Provide early warning of the enemy's advance.
- Engage the enemy at long range.
- Deceive the enemy as to the true location of the defense.

(3) **Sectors.** Depending on the factors of METT-TC, commanders may also assign platoons sectors to defend instead of battle positions. In certain instances, the company commander may employ both. Sectors would normally be assigned when blocks and streets provide a grid type pattern and boundaries can be clearly delineated. (See Chapter 5, paragraph 5-5, for detailed information on when to assign either or both.)

(4) **Actions on Contact.** When enemy forces enter and maneuver to seize initial objectives, the defender should employ all available fires to destroy and suppress the direct-fire weapons that support the ground attack. Tanks and enemy APCs should be engaged as soon as they come within the effective range of antiarmor weapons. As the enemy attack develops, the actions of small-unit leaders assume increased importance. Squad and platoon leaders are often responsible for fighting independent battles. Thus, it is important that all leaders understand their commander's concept of the defense. Situational understanding must be maintained and where the enemy's efforts are likely to result in a gaining a foothold, violent counterattacks must be employed to deny him access into the MBA.

c. **Rear Area.** Infantry companies may be deployed in the rear area to protect CSS elements and to defend high payoff assets, lines of communications, C2 nodes, and other key locations.

d. **Counterattacks.** Small Infantry-heavy reserves supported by BFVs and or tanks, if available, should be prepared to counterattack to regain key positions, to block enemy penetrations, to provide flank protection, and to assist by fire the disengagement and withdrawal of endangered positions. It is especially important for enemy footholds to be repelled violently. When the reserves are committed to counterattack to reinforce a unit, they may be attached to the unit in whose sector the counterattack is taking place. Otherwise, the counterattack becomes the main effort. This makes coordination easier, especially if the counterattack goes through the unit's positions.

e. **Defense During Limited Visibility.** Company commanders can expect the attacker to use limited visibility conditions to conduct necessary operations to sustain or gain daylight momentum.

(1) Commanders should employ the following measures to defend against attacks during limited visibility:

(a) Defensive positions and crew-served weapons should be shifted from an alternate position or a hasty security position just before dark to deceive the enemy as to the exact location of the primary position.

(b) Unoccupied areas between units, which can be covered by observed fire during daylight, may have to be occupied, blocked, or patrolled during limited visibility. Early warning devices and obstacles need to be installed.



(c) Radar, remote sensors, and night observation devices should be emplaced to cover streets and open areas. Thermal imagery devices, such as the one found on the TOW weapon system, are excellent for observation during limited visibility.

(d) Noise-making devices, tanglefoot tactical wire, and LP/OPs should be positioned on all avenues of approach for early warning and to detect infiltration.

(e) Artificial illumination should be planned, to include the use of street lamps, stadium lights, pyrotechnics, visible and IR ILLUM, and so forth.

(f) Indirect fire weapons, grenade launchers, and hand grenades should be used when defenses are probed to avoid disclosure of defensive positions.

(g) Tank and BFV platoons must know the locations of friendly positions. The use of thermal recognition signals and markers can help decrease the possibility of fratricide.

(2) Commanders should initiate FPFs through the use of a planned signal. Crew-served weapons, armored vehicle-mounted weapons if available, and individual riflemen fire within their assigned sectors. Grenades and command-detonated mines should be used to supplement other fires as the enemy approaches the positions.

(3) Defenders should move to daylight positions before BMNT. Buildings should be marked from the friendly side IAW unit SOP in order to facilitate movement. Armored vehicles can be used to cover the movement of friendly troops.

f. **Communications Restrictions.** Radio communications will initially be the primary means of communication for controlling the defense of an urban area and for enforcing security. Structures and a high concentration of electrical power lines may degrade radio communication in urban areas. Wire should be emplaced and used as the primary means of communications as time permits. However, wire can be compromised if interdicted by the enemy. Messengers can be used as another means of communication. Visual signals may also be used but are often not effective because of the screening effects of buildings and walls. Signals must be planned, widely disseminated, and understood by all assigned and attached units. Increased battle noise makes the effective use of sound signals difficult.

### **L-13. HASTY DEFENSE**

A very likely defensive mission for the Infantry company in urban terrain will be to conduct a hasty defense. This mission is characterized by reduced time for the preparation of the defense. All of the troop leading procedures are the same. The priorities of work will basically be the same, but many will take place concurrently. Units will be deployed, weapons emplaced, and positions prepared in accordance with the mission analysis and amount of time the company commander has available. Companies must be prepared to conduct a hasty defensive mission as part of stability and support operations.

a. **Occupation and Preparation of Positions.** Preparations for the hasty defense will vary with the time available. The preparations described below will generally take between two to four hours. In a hasty defense, the primary effort is to camouflage and conceal the presence of the hasty fighting positions and provide as much protection as possible for the soldiers manning them. Positions are constructed back from the windows in the shadows of the room using appliances, furniture, and other convenient items and materials. The emphasis on fortifying positions and making major alterations to the environment is reduced. These actions will occur after security has been established.



(1) **Position Crew-Served and Special Weapons.** Generally, they will be employed from the inside of buildings, unless an outside position is preferable and can be protected and camouflaged. Armored vehicles can exploit longer fields of fire or a reverse slope engagement using buildings to protect the vehicle's position.

(2) **Emplace Barriers and Obstacles.** Lack of time means there will be two belts established and they will not be as extensive as in a defense that permits more time. Cover all obstacles with observation and fire.

(a) **First Belt.** The first belt will usually be between 50-100 meters from and parallel to the defensive trace. It will normally consist of wire obstacles, improvised barriers, road craters, and minefields. For example, burning tires and trash have proven to be effective obstacles on urban terrain. Antitank and command detonated mines will be used consistent with the ROE. This belt will block, fix, turn, or canalize the enemy; disrupt attack formations; and inflict casualties.

(b) **Second Belt.** The second belt is the denial belt. It consists of wire obstacles placed around, through, and in the defensive buildings and close-in mine fields as well as in subsurface accesses. It impedes and complicates the enemy's ability to gain a foothold in the defensive area. Command detonated Claymores should be used extensively consistent with the ROE. Claymores should be placed where they will not cause friendly casualties.

(c) **Field-Expedient Obstacles.** Field-expedient obstacles made from available materials, such as rubble, cars and light poles, should be employed.

(3) **Prepare Positions.** Squads and platoons will prepare positions using whatever materials are available; for example, filling dressers or other furnishings with earth or other materials.

(4) **Rehearsals.** Conduct rehearsals with leaders and soldiers concerning the orientation of the defense, unit positions, location of crew served weapons, CASEVAC, resupply, execution of counterattack plans, withdrawal plan, and so on. One of the more important rehearsals to conduct is the synchronization of direct and indirect fires to accomplish the commander's intent.

(5) **Movement Enhancement.** There will not be much time to improve movement within the defense. Units should plan to use subsurface and supersurface (through buildings) routes. Priority should be given to removing obstructions to alternate positions and to the counterattack route.

(6) **Communications.** Check communications. Communications will initially be radio. Plans should be made for messengers, and routes improved for them. Wire is emplaced as an improvement to the defense as time and the terrain allow.

**Note:** The digital force has the potential to provide accurate threat information that can enhance situational understanding, which helps facilitate targeting and obstacle placement. JSTARS; GUARDRAIL; unmanned aerial vehicles, if present; and other reconnaissance assets will significantly improve the threat situational understanding and targeting capability of the unit.

b. **Improving the Defense.** As time permits, the following areas can be given consideration and prioritized in accordance with METT-TC.

- Sleep plan.
- Barrier and obstacle improvement.

- Improvement of primary and alternate positions.
- Preparation of supplementary positions.
- Additional movement enhancement efforts.
- Initiation of patrols.
- Improvement of camouflage.
- Maintenance/refueling.
- Continued rehearsals for counterattack and withdrawal.

#### **L-14. DEFENSE OF VILLAGE**

An Infantry company may be given the mission to defend a village. Once the company commander has completed his reconnaissance of the village, he scouts the surrounding terrain and, with the information assembled, he develops his plan for the defense. One of his first decisions is whether to defend with his Infantry on the leading edge of the village or farther back within the confines of the village. Normally, defending on the leading edge will be more effective against an armor heavy force, where the defending company can take advantage of longer range observation and fields of fire. Defending in depth within the village will be more effective against a primarily Infantry heavy force, in order to deny the enemy a foothold. This decision will be based on the factors of METT-TC. This mission is usually characterized with the company defending an urban area that is surrounded by open terrain. The company may need to coordinate with adjacent units to plan for the defense or control of this terrain.

a. **Influencing Factors.** Several factors influence the commander's decision. First, he must know the type of enemy that his company will defend against. If the threat is mainly Infantry, the greater danger is allowing them to gain a foothold in the town. If the threat is armor or motorized Infantry, the greatest danger is that massive direct fire will destroy the company's defensive positions. The company commander must also consider the terrain forward and to the flanks of the village from which the enemy can direct fires against his positions.

b. **Platoon Battle Positions.** Based on the mission analysis, platoons are normally given a small group of buildings in which to prepare their defense, permitting the platoon leader to establish mutually supporting squad-sized positions. This increases the area that the platoon can control and hampers the enemy's ability to isolate or bypass a platoon. A platoon may be responsible for the road through the village. The rest of the company is then positioned to provide all-round security and defense in depth.

c. **Company Mortars and Antitank Weapons.** A position for the company mortars must be chosen that protects mortars from direct fire and allows for overhead clearance. Antitank weapons are placed where they can engage targets at maximum ranges with alternate firing points. Infantry should protect antitank weapons (see paragraphs L-25 and L-27).

d. **BFVs.** Based on METT-TC considerations, BFVs may be placed along the forward edge of the urban area to engage enemy armored vehicles. Friendly armored vehicles can also be placed in positions to the rear of the buildings and interior courtyards where their weapon systems can provide added rear and flank security. Combat vehicles are assigned primary, alternate, and supplementary positions as well as primary and secondary sectors of fire. They should be positioned in defilade behind rubble and walls or inside buildings for movement into and out of the area. Armored vehicles can also be

used for resupply, CASEVAC, and rapid repositioning during the battle. BFVs can also provide a mobile reserve for the company. If a mechanized Infantry platoon is attached, it is controlled through its chain of command. If a mechanized Infantry section is attached, it can be controlled through the senior squad leader.

e. **Tanks.** If a tank platoon is available from the battalion task force, the company commander could place the tanks along the leading edge where rapid fire would complement the antitank weapons. The tank platoon leader should select exact firing positions and recommend engagement areas. If faced by enemy Infantry, the tanks move to alternate positions with the protection of friendly Infantry. These alternate positions allow the tanks to engage to the front as well as the flanks with as little movement as possible. Positions can be selected within buildings and mouseholes can be constructed. After they are withdrawn from the leading edge of the village, the tanks could provide a mobile reserve for the company.

f. **Rubbling.** If he has the authority and the ROE permit, the company commander will also decide if buildings should be rubble to increase fields of fire. However, rubble the buildings too soon or rubble too many may disclose his exact locations and destroy cover from direct fire. Because rubble may take more resources than are available to a company, careful consideration of available resources must be made prior to rubble. Additionally, care must be taken not to rubble areas that are necessary to support operations, such as MSRs. Buildings are normally rubble with engineer assistance; engineers will usually employ explosives and engineer equipment to accomplish this task. If available, armored vehicles can be used to rubble buildings.

g. **FPFs.** FPFs are planned to address the biggest threat to the company—the enemy's Infantry. When firing an FPF inside an urban area is required, mortars are more effective than artillery. This is due to their higher angle of fall that gives them a greater chance of impacting on the street.

h. **Barriers and Obstacles.** Obstacles are easily constructed in an urban area. The company commander must stop enemy vehicles without interfering with his own movement in the village. Therefore, the company detonates cratering charges at key street locations on order. Mines are laid on the outskirts of the town and along routes the company will not use. Barriers and obstacles are normally emplaced in three belts. If attached or OPCON, the tank or BFV platoon leader can assist the commander by giving advice on where to place antivehicular obstacles.

i. **Engineers.** The supporting engineers use C4 and other explosives to make firing ports, mouseholes, and demolition obstacles. Based upon his priority of work, the commander tells the engineer squad leader to assist each of the Infantry platoons preparing the village for defense and to execute the company team's obstacle plan. The engineer squad leader's mission is to tell the Infantrymen exactly where to place the demolitions and how much is needed for the desired effect. He assists in preparation of charges. He also assists in the emplacement and recording of the minefields as well as the preparation of fighting positions.

j. **Service Support.** Ammunition expenditure is usually high when fighting in an urban area. To avoid moving around the village with ammunition resupply during the battle, the commander directs that ammunition be stockpiled in each occupied platoon and squad position. He also orders the platoons to stockpile firefighting equipment,

drinking water, food, and first-aid supplies at each squad position. Other factors the company commander must consider are:

- Resupply/pre-positioning of caches.
- Casualty evacuation.
- Firefighting/ventilation. (See FM 90-10-1.)
- Security.

k. **Communications.** To ensure adequate communications, redundant verbal and nonverbal communications are planned and checked. The company installs a wire net and develops a plan for pyrotechnic signals. Backup wire should be laid in case primary lines are cut by vehicles, fires, or the enemy. The commander also plans for the use of messengers throughout the village.

### L-15. DEFENSE OF A BLOCK OR GROUP OF BUILDINGS

An Infantry company operating in urban terrain may have to defend a city block or group of buildings in a core periphery or residential area. The company conducts this operation in accordance with the battalion task force's defensive scheme of maneuver. The operation should be coordinated with the action of security forces charged with delaying to the front of the company's position. The defense should take advantage of the protection of buildings that dominate the avenues of approaches into the MBA. This mission differs from defense of a village in that it is more likely to be conducted completely on urban terrain, without surrounding open terrain that characterizes the defense of a village. An Infantry company is particularly well suited for this type of mission, since the fighting will require the enemy to move Infantry into the urban area in order to seize and control key terrain. Table L-2 describes the frontages that are normally occupied when defending on this type of terrain. The density of buildings, rubble, and street patterns will dictate the company's frontage.

| UNIT        | FRONTAGES     | DEPTHS        |
|-------------|---------------|---------------|
| BN or BN TF | 4 to 8 Blocks | 3 to 6 Blocks |
| CO or CO TM | 2 to 4 Blocks | 2 to 3 Blocks |
| Platoon     | 1 to 2 Blocks | 1 Block       |

**Table L-2. Approximate frontages and depths.**

**Note:** An average city block has a frontage of about 175 meters. These minimum figures apply in areas of dense, block type construction; multi-story buildings; and underground passages. The factors of METT-TC must be applied to the defense of buildings and frontages can be extended or reduced accordingly.

- a. **Task and Purpose.** A well-organized company defense in the urban area-
- Defeats the enemy's attack on the streets and city blocks by using obstacles and fire.
  - Destroys the enemy by ambush and direct fire from prepared positions within defensible buildings.
  - Clears the enemy from footholds or remains in place for a counterattack.

b. **Reconnaissance and Security.** The execution of the mission will be more effective if the terrain is reconnoitered and obstacles and fire lanes are prepared. The LP/OPs should be supplemented by patrols, mainly during periods of limited visibility, and wire communications should be used. Platoons should be given the mission to provide one LP/OP in order to provide spot reports concerning the size, location, direction and rate of movement, and type of enemy assaulting the company sector or battle position.

c. **Task Organization.** METT-TC factors will determine how the company will be task organized to accomplish the mission. A possible task organization might be:

(1) **Rifle Platoons.** Three platoons (one platoon minus a squad) occupy the defensive sector.

(2) **Reserve.** Detached squad from one of the rifle platoons. The reserve should be given priority of commitment missions such as reinforcing the fires of the defense, reacting to a danger on the flank, or counterattacking to throw the enemy from a foothold. The biggest threat to the company is for the enemy to gain a foothold and use it to begin clearing buildings. Any foothold should be counterattacked and the enemy must be quickly and violently expelled.

(3) **Fire Support.** Company 60-mm mortar and antitank weapons.

(4) **Company Control.** An engineer squad, with priority to the company obstacle plan, then reverts to company reserve. Engineers should be controlled at company level. They construct obstacles, prepare access routes, and assist in preparing defensive positions. Additional attachments or OPCON units, such as BFVs, tanks, and TOWs may be placed under company control. For example, a BFV Infantry element can be used to defend a sector or battle position. The BFVs can stay under the control of the platoon sergeant and support by fire and or conduct other missions as determined by the company commander. A platoon or section of tanks attached or OPCON to the company should provide heavy direct-fire support, engage enemy tanks, and support counterattacks. An attached or OPCON tank platoon can initially attack by fire and then revert to a mobile reserve role. The company executive officer can be used to control a reserve with multiple elements.

d. **Execution.** The defensive forces should ambush on the avenues of approach, cover the obstacles by fire, and prepare a strong defense inside the buildings. Counterattack forces should be near the front of the company sector in covered and concealed positions with an on order mission to counterattack. Rehearsals should be conducted both day and night. Counterattack forces should also be given specific instructions of what their actions will be after the enemy assault has been repelled; for example, stay in sector or revert back to reserve status.

## **L-16. DEFENSE OF KEY URBAN TERRAIN**

An Infantry company may find itself having to defend key urban terrain. This defense may be part of defensive operations or may be an adjunct mission to stability and support operations. In many cases, this mission may be characterized by an unclear enemy situation and extremely restrictive ROE. The key terrain may be a public utility, such as gas, electrical, or water plants; a communications center, such as radio and or television; transportation center; a traffic circle; and so forth. When assigned a mission of this type, a company commander may often find his company having to defend a piece of terrain

that he would rather not have to occupy. Often the facilities previously described are sited for their centrality of location and convenience and not for the defensibility of the terrain.

a. **Task Organization.** The factors of METT-TC will determine the task organization of the company. Figure L-11 depicts an Infantry rifle company reinforced with an additional rifle platoon to defend the objective (water purification plant). Additional assets will be given to the company commander as they are requested or assigned, based on mission requirements and availability. In the situation depicted in Figure L-11, the organic weapons of the Infantry company are sufficient to accomplish the mission. The only additional requirement was for another rifle platoon to defend the objective.

b. **Tasks.** In the situation shown in Figure L-11, the company commander has determined that in order to properly defend the objective, he needs to deploy platoons on the defensible terrain available. Therefore, he is defending urban terrain (left), high ground (top), and low vegetated terrain (right, bottom). Additionally, it may be necessary to perform some of the tasks listed below:

- Provide inner and outer security patrols.
- Conduct counterreconnaissance.
- Establish LP/OPs.
- Establish checkpoints and roadblocks.
- Conduct civilian control and evacuation.
- Conduct coordination with local authorities.
- Prevent collateral damage.
- Supervise specific functions associated with operation of the facility, such as water purification tests, site inspections, and so forth.

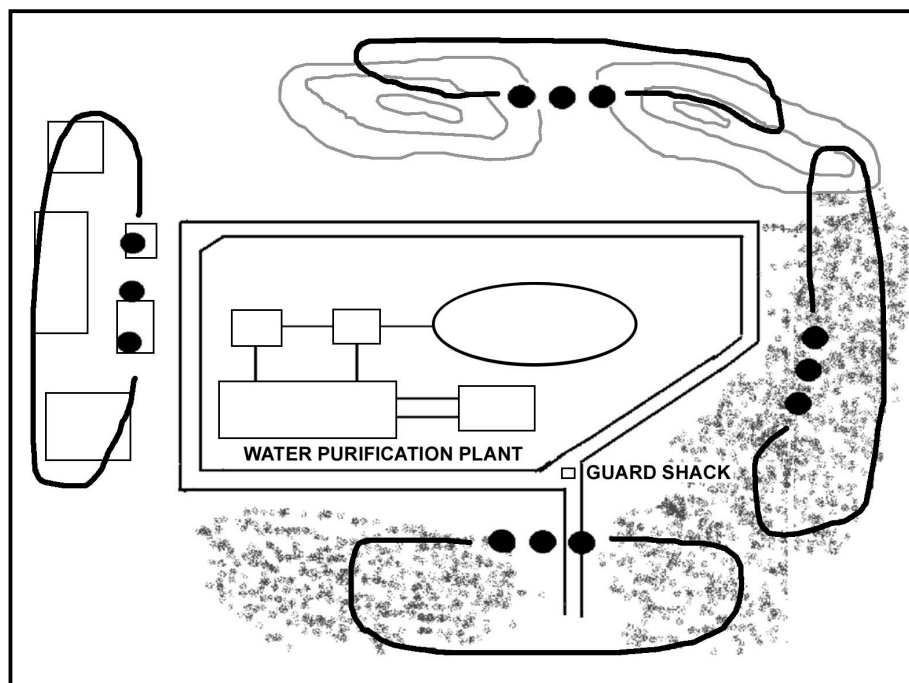

Figure L-11. Perimeter defense of key terrain

c. **Execution.** The company commander will normally deploy platoons in a perimeter around the objective in order to dominate key terrain and cover the mounted and dismounted avenues of approach into the objective. (See Chapter 5, paragraph 5-23, for further information.) Machine guns and antitank weapons will be emplaced to cover the dismounted and mounted avenues of approach into the objective, respectively. Wire obstacles will normally be used to restrict and deny entry into the objective area. Obstacles should be covered by fire and rigged with detection devices and trip flares. Antitank and command-detonated mines will be used consistent with the ROE. The company will have to be prepared to defend against a direct attack, such as a raid, or sabotage against key facilities within the objective, for example, water filtration system, pump station, and so forth. The commander will have to make an assessment as to the overall importance of the key facilities within the objective and prioritize security requirements. The 60-mm mortar section will be positioned to provide 360-degree fire support. The AT section will be positioned to engage vehicular targets. If the threat does not require the employment of mortars or AT weapons, these sections can be given other tasks.

d. **Other Considerations.** Depending on the mission requirements and threat, the company commander may have to consider the need for the following.

- Artillery and attack helicopter support.
- ADA assets to defend against air attack.
- Engineer assets to construct obstacles.
- Interpreters to assist in the functioning of the facility and operation of the equipment.
- MP, civil affairs, and or PSYOP assets for civilian control and liaison/coordination with local police and or authorities.
- BFVs or tanks to act as a mobile reserve or reaction force, or integrated into the company plan.

e. **Force Protection.** The company may be required to conduct a perimeter defense as part of a force protection mission, such as defending a friendly base camp on urban terrain. The same techniques of establishing a perimeter defense would be used. The company will maintain the appropriate level of security (100, 50, 30 percent, etc.), consistent with the commander's plan and the enemy situation. Additional tasks may include:

- Setting up roadblocks and checkpoints.
- Searching individuals and vehicles prior to entry into the camp.
- Maintaining a presence as a show of force to the population outside the base camp.
- Conducting inner and outer security patrols.
- Clearing potential threats from any urban terrain that overwatches the base camp.
- Conducting ambushes to interdict any enemy forces moving towards the base camp.
- Restricting access to locations within the base camp. Conducting surveillance of these locations from within or from adjacent structures or positions.
- Conducting reaction force duties inside and outside the perimeter of the camp.

**Note:** See Appendix A and TC 7-98-1 for detailed information on roadblocks, checkpoints, and searches.

f. **Defense of a Traffic Circle.** An Infantry company may be assigned the mission of defending a key traffic circle in an urban area, or similar terrain, to prevent the enemy from seizing it or to facilitate movement of the battalion task force or other units (Figure L-12).

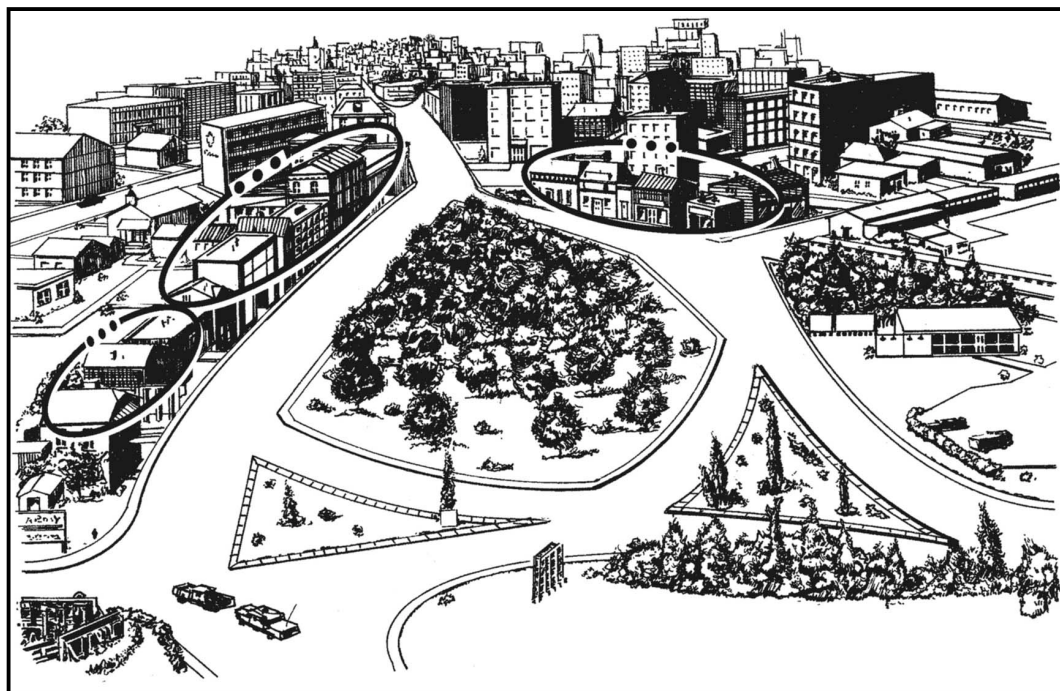

**Figure L-12. Defense of a traffic circle.**

(1) The company commander with this mission should analyze enemy avenues of approach into the objective and buildings that dominate those avenues. He should plan direct and indirect fires, consistent with the ROE, on to the traffic circle itself and on the approaches to it. He should also plan for all-round defense of the buildings that dominate the traffic circle to prevent encirclement. The company should prepare as many covered and concealed routes between these buildings as time permits. This makes it easier to mass or shift fires and to execute counterattacks.

(2) Obstacles can also deny the enemy the use of the traffic circle. Obstacle planning, in this case, must take into account whether friendly forces will need to use the traffic circle.

(3) Antitank weapons can fire across the traffic circle if fields of fire are long enough. Tanks should engage enemy armored vehicles and provide heavy direct-fire support for counterattacks. BFVs should engage enemy armored vehicles and provide direct fire to protect obstacles.



**L-17. DEFENSE OF AN URBAN STRONGPOINT**

See Chapter 5, paragraph 5-25 for information on defending an urban strongpoint.

**L-18. DELAY**

The intent of a delay is to slow the enemy, cause casualties, and stop him, where possible, without becoming decisively engaged. This is done by defending, disengaging, moving, and defending again. A company delay is normally conducted as part of the battalion task force's plan. The delay destroys enemy reconnaissance elements forward of the outskirts of the urban area, prevents the penetration of the urban area, and gains and maintains contact with the enemy to determine the strength and location of the main attack by trading space for time. Infantry companies are well suited for this operation, because they can take advantage of the cover and concealment provided by urban terrain and inflict casualties on the enemy at close range. Delays can be planned by assigning platoon battle positions, platoon sectors, or both. Figure L-13 depicts a company delay in urban terrain with the company commander assigning platoon battle positions. Routes are planned to each subsequent battle position or within the sector. Routes also are planned to take advantage of the inherent cover and concealment afforded by urban terrain, such as going through and hugging buildings, using shadows, subsurface areas, and so forth. (See Chapter 6, paragraph 6-9, for detailed information concerning delays.)

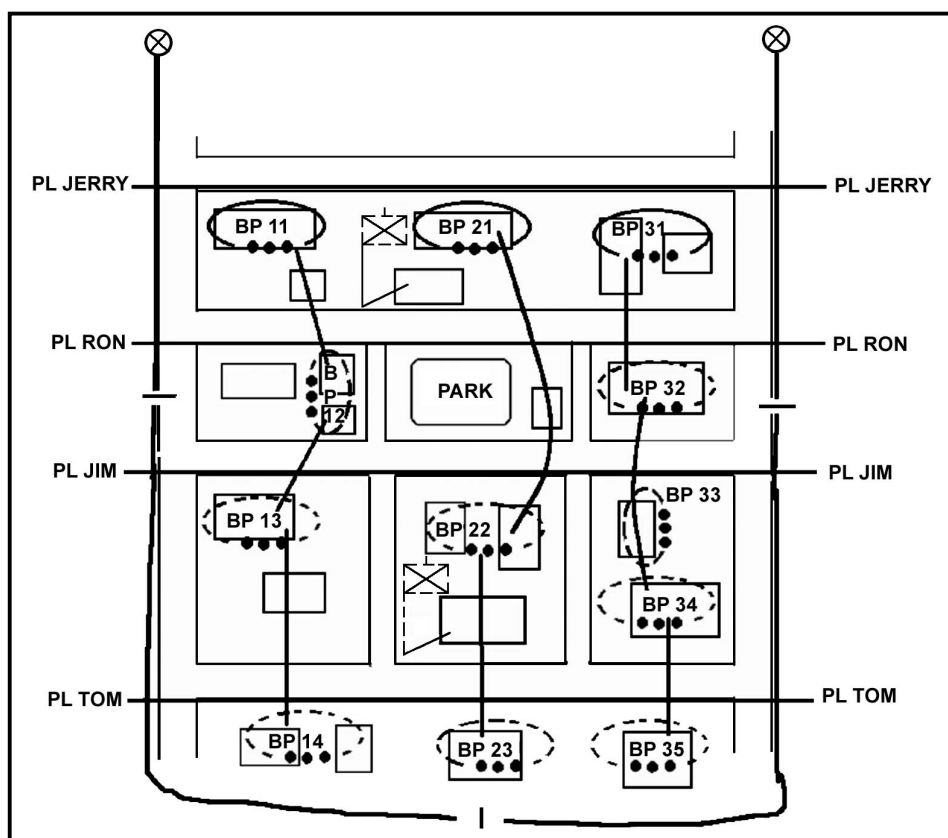

Figure L-13. Company delay in a urban area.

a. The company's sector should be prepared with obstacles to increase the effect of the delay. Engineers prepare obstacles on main routes but avoid some covered and concealed routes that are known by the friendly troops for reinforcement, displacement, and resupply. These routes are destroyed and obstacles are executed when no longer needed.

b. Antiarmor weapon systems, tanks, and BFVs should be positioned on the outskirts of the urban area to destroy the enemy at maximum range. They should be located in defilade positions or in prepared shelters. They fire at visible targets and then fall back or proceed to alternate positions. Platoons should be assigned sectors from 100 to 300 meters (one to two blocks) wide. If available, they should be reinforced with sensors or GSRs, which can be emplaced on the outskirts or on higher ground to attain the maximum range in the assigned AO. Platoons delay by detecting the enemy early and inflicting casualties on him using patrols, OPs, and ambushes and by taking advantage of all obstacles. Each action is followed by a disengagement and withdrawal. Withdrawals occur on covered and concealed routes through buildings or underground. By day, the defense is dispersed; at night, it is more concentrated. Close coordination and maintaining situational understanding are critical aspects of this operation.

#### **Section IV. STABILITY AND SUPPORT**

Companies may have to conduct operations in environments that do not involve traditional combat. A company may be called upon to conduct a stability or support contingency operation and then have to quickly transition into offensive or defensive missions. The company may also be utilized in a stability or support operation at the successful conclusion of a combat mission. When assigned a stability or support mission, a well-trained company must be able to rapidly shift its focus from war fighting to stability and support and also from stability and support to war fighting. During a stability or support operation, the company performs numerous activities. Essentially, the company accomplishes these activities through execution of tactical tasks, such as security patrols, establishing road blocks and check points, force protection, and so forth. The company normally operates as part of a battalion TF during the execution of stability and support operations. While stability and support operations can occur anywhere, they will most likely occur in an urban environment. (See Appendix A and TC 7-98-1 for additional considerations and TTP.)

#### **L-19. STABILITY OPERATIONS**

The purposes of stability operations are to—

- Protect national interests.
- Promote peace or deter aggression.
- Satisfy treaty obligations or enforce agreements and policies.
- Reassure allies, friendly governments, and agencies.
- Encourage a weak or faltering government.
- Maintain or restore order.
- Protect life and property.
- Demonstrate resolve.
- Deter or respond to terrorism.

- Reduce the threat of conventional arms and WMD to regional security.
- Eliminate or contain subversion, lawlessness, and insurgency.

a. **Considerations for Stability Operations.** Conducting stability operations is fundamentally identical to conducting combat operations. While each stability operation is different, the military decision-making process (MDMP) and troop-leading procedures methodologies apply. The considerations listed below supplement those processes and can help the company commander in developing the concept of the operation for stability operations.

- Understand the potential for unintended consequences of individual and small unit actions.
- Display the capability to use force without threatening the population.
- Act decisively to prevent escalation.
- Apply force selectively and discriminately.
- Stress force protection.
- Emphasize information gathering through surveillance and reconnaissance.

b. **Types of Stability Operations.** Table L-3 depicts the types of stability operations that a battalion TF may be called upon to conduct and the missions it will issue its subordinate companies/company teams in order to execute the stability operation(s).

| TYPE                                      | MISSIONS  |
|---|---|
| <b>Peace Operations</b>                   | <p><b>Peacekeeping:</b> employ patrols, establish checkpoints, roadblocks, buffer zones, supervise truce, EPW exchange, reporting and monitoring, negotiation and mediation, liaison, investigation of complaints and violations, civil disturbance missions, act as quick reaction force (QRF), and offensive and defensive missions.</p> <p><b>Peace Enforcement:</b> separation of belligerents; establishment and supervision of protected zones, sanction enforcement, movement denial and guarantee, restoration and maintenance of order, area security, humanitarian assistance, civil disturbance missions, act as QRF, and offensive and defensive missions.</p> <p><b>Operations in Support of Diplomatic Efforts:</b> military to military contacts, exercises, security assistance, restore civil authority, rebuild physical infrastructure, provide structures and training for schools and hospitals, and reestablish commerce.</p> |
| <b>Foreign Internal Defense</b>           | <p><b>Indirect Support:</b> military to military contacts, exercises, area security.</p> <p><b>Direct Support:</b> civil-military operations, intelligence and communications sharing, and logistical support.</p> <p><b>Combat Operations:</b> offensive and defensive missions.</p>   |
| <b>Support to Insurgencies</b>            | Show of force, defensive missions, raids, area security, employ patrols, and provide CSS.   |
| <b>Counterdrug Operations</b>             | Liaison and advisor duty, civic action, intelligence support, surveillance support, reconnaissance, logistical support, and information support.  |
| <b>Combating Terrorism</b>                | Conduct force protection, offensive and defensive missions.   |
| <b>Noncombatant Evacuation Operations</b> | Attack to seize terrain that secures evacuees or departure area, guard, convoy security, act as QRF, delay, and defend. See FM 90-29.   |
| <b>Arms Control</b>                       | Seize and destroy weapons, convoy escort, assist and monitor inspection of arms, and conduct surveillance.  |
| <b>Show of Force</b>                      | Perform tactical movement, demonstration, defensive operations, and perform training exercises.   |

**Table L-3. Types of stability operations, missions.**

## L-20. SUPPORT OPERATIONS

Support operations provide essential supplies and services to assist designated groups. They are conducted to help foreign and civil authorities respond to crises. Companies normally conduct support operations as part of a larger battalion operation to save or protect lives, reduce suffering, recover essential infrastructure, improve the quality of life, and restore situations to normal. Again, planning for support operations is fundamentally identical to planning for combat and stability operations. While each support operation is different, the military decision making process (MDMP) and troop leading procedures methodologies apply. Considerations that can assist the company commander in developing plans for support operations are:

- Provide essential support to the largest number of people.
- Coordinate actions with other agencies, as applicable (normally done by the battalion staff).
- Hand over to civilian agencies as soon as feasible.
- Conduct robust information operations.
- Secure the force.

a. **Types of Support Operations.** The two types of support operations are domestic support operations (DSO) and foreign humanitarian assistance (FHA). Companies conduct DSO in the US and its territories and FHA outside the US and its territories. Stand-alone FHA operations are conducted only in a permissive environment. In uncertain and hostile environments, companies conduct FHA operations as part of larger stability or offensive and defensive operations.

b. **Forms of Support Operations.** During DSO, companies perform relief operations, provide support to incidents involving WMD, provide support to law enforcement, and provide community assistance. In FHA, companies most often conduct relief operations; however, FHA may also involve support to incidents involving WMD and community assistance. Table L-4 depicts the more common missions that the battalion TF will assign to subordinate companies/company teams.

| FORMS OF SUPPORT OPERATIONS               | MISSIONS   |
|---|--|
| <i>Relief Operations</i>                  | Search and rescue, food & water distribution, providing temporary shelter, transportation support, medical support, sanitation, area security.   |
| <i>Support to Incidents Involving WMD</i> | Assisting law enforcement, area security, protection of critical assets (utilities, transportation, banking, telecommunications), responding to WMD casualties, establishing roadblocks/checkpoints.                           |
| <i>Support to Civil Law Enforcement</i>   | Civil disturbance missions; support to counterterrorism and counterdrug operations; providing resources, training, and augmentation; assisting with cordon and search; security patrols; establish roadblocks and checkpoints. |
| <i>Community Assistance</i>               | Search and rescue, fire fighting, assistance in safety and traffic control, emergency snow removal, providing temporary shelter.   |

**Table L-4. Types of support operations, missions.**

c. **Other Agencies.** Because of the nature of support operations, the company can expect to interact with other units and agencies such as engineers, MPs, and nongovernment organizations (NGOs). Support actions rely on a partnership with other government and nongovernment agencies. Liaison with these agencies and between local governments is critical. Regardless of the positive relationships built, force protection always remains a top priority.

## L-21. TRANSITION TO COMBAT OPERATIONS

Stability, and to a lesser extent, support operations are missions that may transition to combat. The company commander must always keep in mind that the pendulum can also shift from a stability or support operation to combat. An escalation to combat is a clear indicator that the stability or support operation failed. The company must always retain the ability to conduct offensive and defensive operations. Preserving the ability to transition allows the company to maintain initiative while providing force protection.

a. **Plan for Contingencies.** The commander must plan for contingency operations that factor in what actions the company will perform if combat cannot be averted; for example, reverting to a hasty defense in the event that a stability or support mission deteriorates.

b. **Balanced Mindset.** A balance must be achieved between the mindset of peace operations and the mindset of war fighting. Soldiers can not become too complacent in their warrior spirit, but also must not be too eager to rely on the use of force to resolve conflict. This balance is the essence of peace operations and the fundamental aspect that will enable the company to perform its mission successfully and avoid an escalation to combat. Proactive leaders that are communicating and enforcing the ROE are instrumental to achieving this mindset.

c. **Combat Skills Training.** If the stability or support operation extends over prolonged periods of time, training should be planned that focuses on the individual and collective combat tasks that would be performed during transition to offensive and or defensive missions.

## Section V. COMBAT MULTIPLIERS

The first and most fundamental lesson learned from recent operations in urban areas is the value of the fully integrated combined arms team. There is no denying the value of light Infantry forces during urban combat. However, urban combat never should be considered a pure Infantry task. Urban combat by units composed entirely of Infantrymen is a historical anomaly. Across the spectrum of combat action in urban areas, powerful combined arms teams produce the best results. Infantry units operating alone suffer from critical shortcomings that can be compensated for only by appropriate task organization with mechanized Infantry, armor, and engineers. These teams must be supported by closely integrated aviation, fire support, communications, and logistical elements. This paragraph discusses the more common combat multipliers available to the Infantry company for the execution of UO.

## L-22. ARMORED VEHICLES

See Appendix B for additional considerations and TTP.

**a. Capabilities.**

(1) The thermal sights on armored vehicles can detect enemy activity through darkness and smoke, conditions that limit even the best-equipped Infantry. They also provide greater range (4,000+ meters) in most instances.

(2) Armored forces, can deliver devastating fires, are fully protected against antipersonnel mines, fragments and small arms, and have excellent mobility along unblocked routes.

(3) Armored vehicles project a psychological presence, an aura of invulnerability that aids the friendly forces in deterring violence. Mounted patrols by armored vehicles can monitor large areas of a city while making their presence known to the entire populace, both friendly and unfriendly.

(4) BFVs can move Infantrymen rapidly to points where, together, they can dominate and isolate the cordoned area. Armored vehicles can also support troop convoy movements in wheeled vehicles. With their long-range sights and weapons, armored vehicles can dominate large expanses of open area and thus free Infantry to isolate closer terrain and visual dead space.

(5) The mobile protected firepower of armored vehicles can be used to add security to resupply convoys and to extract wounded personnel under fire. The armored vehicle's smoke grenade launcher capability can aid this and other small-unit actions.

**b. Limitations.**

(1) Crewmen in armored vehicles have poor all-round vision through their vision blocks; they are easily blinded by smoke or dust. Tanks cannot elevate or depress their main guns enough to engage targets very close to the vehicle or those high up in tall buildings.

(2) If isolated or unsupported by Infantry, armored vehicles are vulnerable to enemy hunter/killer teams firing light and medium antiarmor weapons. Because of the abundance of cover and concealment in urban terrain, armored vehicle gunners may not be able to easily identify enemy targets unless the commander exposes himself to fire by opening his hatch or Infantrymen directing the gunner to the target.

(3) Armored vehicles are noisy. Therefore, there is little chance of them arriving in an area undetected. Improvised barricades, narrow streets and alleyways, or large amounts of rubble can block armored vehicles.

(4) Due to the length of the tank main gun, the turret will not rotate if a solid object is encountered, for example, a wall, post, and so forth. Heavy fires from armored vehicles cause unwanted collateral damage or can destabilize basic structures.

(5) The main gun of an M1A2 can only elevate (+)20 degrees and depress (-)9 degrees. Examples of standoff distances for buildings where a HEAT round is used are:

- Ground floor—2.5 meters from the target.
- 3d story—23 meters from the target.
- 18th story—132 meters from the target.

**Note:** Figure L-14 shows the difference in the capabilities of the BFV and the M1 tank with regard to fields of fire on urban terrain. Note that the BFV can engage a target 9 to 10 stories high at 20 meters, whereas an M1 tank requires 90 meters. Although the tank main gun has these limitations, targets can be engaged by the M2HB and M240 machine guns that are part of the tank's weapon system.

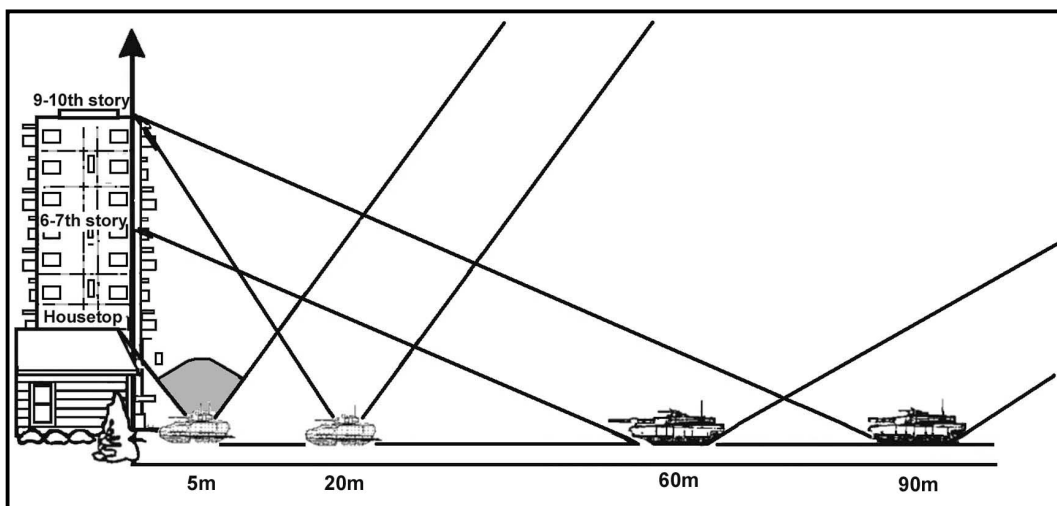

**Figure L-14. Fields of fire on urban terrain.**

c. **Employment.** Armored vehicles can support Infantry during urban combat operations by:

- Providing shock action and firepower.
- Isolating objectives with direct fire to prevent enemy withdrawal, reinforcement, or counterattack.
- Neutralizing or suppressing enemy positions with smoke, high explosive (HE), and automatic weapons fire as Infantry closes with and destroys the enemy.
- Assisting opposed entry of Infantry into buildings when doorways are blocked by debris, obstacles, or enemy fire.
- Smashing through street barricades or reducing barricades by fire.
- Obscuring enemy observation using smoke grenade launchers.
- Holding cleared portions of the objective by covering avenues of approach.
- Attacking by fire any other targets designated by the Infantry.
- Establishing roadblocks or checkpoints.
- Suppressing identified sniper positions.

**Note:** The information below refers to tank platoons. An attached or OPCON BFV platoon will have Infantry squads that can be employed in the scheme of maneuver. Therefore, platoon integrity with a BFV platoon should be maintained in urban combat and the BFV platoon should be used as a maneuver element.

d. **Task Organization at Company Level.** Normally, a tank platoon would be OPCON to a light, airborne, or air assault Infantry company during combined arms operations at the company team level. There are four basic techniques of task organizing the tank platoon into the light Infantry company for urban combat.

(1) **Tank Platoon as a Maneuver Element.** In this technique, the tank platoon leader is responsible for maneuvering the tanks IAW the company team commander's intent.

With this task organization, likely missions for the tanks would be to support by fire or to overwatch the movement of the Infantry. This task organization is the most difficult to maneuver tanks with the Infantry. However, the tank platoon leader can choose to maneuver the platoon by sections in order to execute the mission. This would provide greater flexibility in supporting the Infantry during the close fight.

(2) ***Tank Sections Under Infantry Platoon Control.*** In this technique, tanks would be broken down into two sections and each section would be placed under the OPCON of an Infantry platoon, and maneuvered IAW the company team commander's intent. The company team commander relinquishes direct control of the tank maneuver to the Infantry platoon leaders. This technique is very effective in maintaining the same rate of progress between the tanks and the Infantry. However, Infantry platoon leaders are burdened with the additional responsibility of maneuvering tanks. The general lack of experience with tanks and the overall battlefield focus of the Infantry platoon leader can also affect this technique. This technique is best suited when contact with the enemy is expected and close continuous support is required for movement or clearing buildings.

(3) ***Tank Sections Under Company and Platoon Control.*** The tank platoon can be broken down into two sections, one under company control, the other under platoon control. The selected maneuver Infantry platoon would have a tank section available to support the close fight. With this technique, the company team commander has a tank section to deploy at the critical place and time of his choosing. This task organization still allows support to the Infantry close fight while keeping additional support options in reserve for the commander to employ. The disadvantages to this technique are that an Infantry platoon leader is maneuvering tanks, instead of the tank platoon leader, and the tanks directly available to the company team commander are cut in half. This must be accomplished by detailed planning, coordination, and rehearsals between the Infantry platoons and tank sections.

(4) ***Infantry Squad(s) Under Tank Platoon Control.*** In this technique, the company team commander has the option of placing one or more Infantry squads under the OPCON of the tank platoon leader. He may also retain all tanks under the control of the tank platoon leader or place a tank section under the OPCON of an Infantry platoon leader. This technique will give the company team commander a fourth maneuver platoon, and involves the tank platoon leader in the fight. It can work well in a situation where a mobile reserve that needs Infantry protection is required. This must be accomplished by detailed planning, coordination, and rehearsals between the Infantry squads and tank platoon/sections.

(5) ***Guidelines.*** None of the techniques described above are inherently better than the other. The task organization has to be tailored to accomplish the mission. Regardless of the technique selected, the guidelines below should be followed:

(a) Tanks should be used as sections. Single tanks may operate in support of Infantry, however it is preferable for tanks to operate as sections. If using tanks to shield squads and teams from building to building as part of the maneuver plan, the leader of the forward element needs to control the tanks.

(b) If the company commander is controlling the tanks, he needs to move forward to a position where he can effectively maneuver the tanks in support of the Infantry.



(c) The task organization should support the span of control. If the company commander is going to control the tanks, then there is no reason to task-organize the tanks by section under Infantry platoons.

(d) Tanks need Infantry support when the two elements are working together. Do not leave tanks alone because they are not prepared to provide local security during the operation. Tanks are extremely vulnerable to dismounted attack when operating on urban terrain.

### L-23. ENGINEERS

Normally an engineer squad will be attached to an Infantry company. Most engineer manual-labor tasks (for example, preparing fighting positions) will have to be completed by Infantry units, with reinforcing engineer heavy-equipment support and technical supervision.

a. **Offensive Missions.** Engineers may perform the following missions during offensive operations in an urban area:

- Conduct a technical reconnaissance to determine the location and type of enemy obstacles and minefields, and to make breaching recommendations.
- Clear barricades and heavy rubble with earth-moving equipment or explosives to assist forward movement.
- Use explosives to destroy fortifications and strongpoints that cannot be reduced with the maneuver unit's organic assets.
- Use engineer equipment, if available, to destroy structures or to clear rubble.
- Lay mines to protect flanks and rear areas.
- Conduct mobility operations (gap crossing).
- Locate and remove mines that may hamper the unit's movement.
- Conduct breaching operations.
- Conduct route reconnaissance.

b. **Defensive Missions.** Engineers may perform the following missions during the defense of an urban area.

- Construct complex obstacle systems.
- Rubble buildings.
- Lay mines.
- Develop and provide mine/obstacle overlays to leaders.
- Assist in the preparation of defensive positions and strongpoints.
- Maintain counterattack, communications, and resupply routes.
- Enhance movement between buildings, catwalks, bridges, and so on.
- Crater roads.
- Clear fields of fire.
- Fight as Infantry, when needed.

c. **Defense Against Armor.** In defensive situations, when opposed by an armor-heavy enemy, priority should be given to the construction of antiarmor obstacles throughout the urban area. Use of local materials, where possible, makes obstacle construction easier and reduces logistics requirements. Streets should be barricaded in front of defensive positions at the effective range of antitank weapons. These weapons are used to increase the destruction by antiarmor fires, to separate enemy Infantry from

their supporting tanks, and to assist in the delay and destruction of the attacker. Antitank mines in and around obstacles and covered by fires, help synchronize a defensive fire plan.

#### **L-24. FIELD ARTILLERY**

Appropriate fire support coordination measures should be carefully considered since fighting in urban areas results in opposing forces fighting in close combat. When planning for fire support in an urban area, the company commander, in coordination with his FIST chief, should consider the following:

a. Target acquisition may be more difficult because of the increased cover and concealment afforded by the terrain. Ground observation is limited in urban areas, therefore FOs should be placed high. Adjusting fires is difficult since buildings block the view of adjusting rounds; therefore, the lateral method of adjustment may be most useful.

b. Initial rounds are adjusted laterally until a round impacts on the street perpendicular to the FEBA. Airburst rounds are best for this adjustment. The adjustments must be made by sound. When rounds impact on the perpendicular street, they are adjusted for range. When the range is correct, a lateral shift is made onto the target and the gunner fires for effect.

c. Special consideration must be given to shell and fuze combinations when effects of munitions are limited by buildings.

(1) Careful use of VT is required to avoid premature arming.

(2) Indirect fires may create unwanted rubble and collateral damage.

(3) The close proximity of enemy and friendly troops requires careful coordination.

(4) WP may create unwanted fires and smoke.

(5) Fuze delay should be used to penetrate fortifications.

(6) Illumination rounds can be effective; however, friendly positions should remain in shadows and enemy positions should be highlighted. Tall buildings may mask the effects of illumination rounds.

(7) VT, TI, and ICM are effective for clearing enemy positions, observers, and antennas off rooftops.

(8) Swirling winds may degrade smoke operations.

(9) Scatterable mines (SCATMINE) may be used to impede enemy movements. SCATMINE effectiveness is reduced when delivered on a hard surface.

d. Target acquisition is difficult in urban terrain because the enemy has many covered and concealed positions and movement lanes. The enemy may be on rooftops and in buildings, and may use sewer and subway systems. Aerial observers are extremely valuable for targeting because they can see deep to detect movements, positions on rooftops, and fortifications. Targets should be planned on rooftops to clear away enemy FOs as well as communications and radar equipment. Targets should also be planned on major roads, at road intersections, and on known or likely enemy positions. Employing artillery in the direct fire mode to destroy fortifications should be considered, especially when assaulting well prepared enemy positions. Also, restrictive fire support coordination measures, such as a restrictive fire area or no-fire area may be imposed to protect civilians and critical installations.

e. 155-mm self-propelled howitzers are effective in neutralizing concrete targets with direct fire. Concrete-piercing 155-mm rounds can penetrate 36 inches of concrete at

ranges up to 2,200 meters. The mounted .50-caliber machine gun can also be used as direct fire support. This howitzer must be closely protected by Infantry when used in the direct-fire mode, since the howitzers do not have any significant protection for their crews.

f. Forward observers must be able to determine where and how large the dead spaces are. This area is a safe haven for the enemy because he is protected from indirect fires. For low-angle artillery, the dead space is about five times the height of the building. For high-angle artillery, the dead space is about one-half the height of the building.

g. Aerial observers are effective for seeing behind buildings immediately to the front of friendly forces. They are extremely helpful when using the ladder method of adjustment because they may actually see the adjusting rounds impact behind buildings. Aerial observers can also relay calls for fire when communications are degraded due to power lines or masking by buildings.

h. Radar can locate many artillery and mortar targets in an urban environment because of the high percentage of high-angle fires. If radars are sited too close behind tall buildings, some effectiveness will be lost.

i. The use of airburst fires is an effective means of clearing snipers from rooftops. HE shells with delay fuzes may be effective against enemy troops in the upper floors of buildings, but, due to the overhead cover provided by the building, such shells have little effect on the enemy in the lower floors.

## L-25. MORTARS

Mortars are the most responsive indirect fires available to company commanders. Their mission is to provide close and immediate fire support to the maneuver units. Mortars are well suited for combat in urban areas because of their high rate of fire, steep angle of fall, and short minimum range. Company commanders must plan mortar support with the FIST chief as part of the total fire support system. (See FM 7-90 for detailed information on the tactical employment of mortars.)

a. **Role of Mortar Units.** The role of mortar units is to deliver suppressive fires to support maneuver, especially against dismounted Infantry. Mortars can be used to obscure, neutralize, suppress, or illuminate during urban combat. Mortar fires inhibit enemy fires and movement, allowing friendly forces to maneuver to a position of advantage. The most common and valuable use for mortars is often harassment and interdiction fires. One of their greatest contributions is interdicting supplies, evacuation efforts, and reinforcement in the enemy rear just behind his forward defensive positions. During both World War II and recent Middle East conflicts, light mortar HE fires have been used extensively during urban combat to deny the use of streets, parks, and plazas to enemy personnel. Finally, mortars can be used, with some limitations, against light armor and structures. Effectively integrating mortar fires with dismounted maneuver is key to successful combat in an urban area.

b. **Position Selection.** The selection of mortar positions depends on the size of buildings, the size of the urban area, and the mission. Rubble can be used to construct a parapet for firing positions. Positions are also selected to minimize counterbattery fire.

(1) **Existing Structures and Masking.** The use of existing structures (for example, garages, office buildings, or highway overpasses) for positions is recommended to afford maximum protection and minimize the camouflage effort. Proper masking can enhance

survivability. If the mortar has to fire in excess of 885 mils to clear a frontal mask, the enemy counterbattery threat is reduced. These principles can be used in both the offense and the defense.

(2) **Use of Sandbags.** Mortars should not be mounted directly on concrete; however, sandbags may be used as a buffer. Sandbags should consist of two or three layers; be butted against a curb or wall; and extend at least one sandbag width beyond the baseplate.

(3) **Placement.** Mortars are usually not placed on top of buildings because lack of cover and mask makes them vulnerable. They should not be placed inside buildings with damaged roofs unless the structure's stability has been checked. Overpressure can injure personnel, and the shock on the floor can weaken or collapse the structure.

c. **Communications.** Initially, radio may be the primary means of communication during urban combat. An increased use of wire, messenger, and visual signals will be required. However, wire should eventually be the primary means of communication between the forward observers, fire support team, fire direction center, and mortars since elements are close to each other. Also, FM radio transmissions in urban areas are likely to be erratic. Structures reduce radio ranges; however, placing antennas on upper floors or roofs may improve communications and enhance operator survivability. Another technique that applies is the use of radio retransmissions. A practical solution is to use existing civilian systems to supplement the unit's capability, understanding that this method of communication is not secure.

d. **Magnetic Interference.** In an urban environment, all magnetic instruments are affected by surrounding structural steel, electrical cables, and automobiles. Minimum distance guidelines for the use of the M2 aiming circle (FM 23-90) will be difficult to apply. To overcome this problem, an azimuth is obtained to a distant aiming point. From this azimuth, the back azimuth of the direction of fire is subtracted. The difference is indexed on the red scale and the gun manipulated until the vertical cross hair of the sight is on the aiming point. Such features as the direction of a street may be used instead of a distant aiming point.

e. **High-Explosive Ammunition.** During urban combat, mortar HE fires are used more than any other type of indirect fire. Although mortar fires are often targeted against roads and other open areas, the natural dispersion of indirect fires will result in many hits on buildings. Leaders must use care when planning mortar fires during UO to minimize collateral damage.

(1) High-explosive ammunition, especially the 120-mm projectile, provides good results when used against lightly built structures within cities. However, it does not perform well against reinforced concrete found in larger urban areas.

(2) When using HE ammunition in urban fighting, only point-detonating fuzes should be used. The use of proximity fuzes should normally be avoided, because the nature of urban areas causes proximity fuzes to function prematurely. Proximity fuzes, however, are useful in attacking some targets, such as OPs, on tops of buildings.

f. **Illumination.** Based on the close nature of urban combat, consideration should be given to the use of infrared (IR) illumination if the factors of METT-TC permit its use and friendly forces have a technological advantage over the enemy in terms of night vision devices (NVDs). Both IR and standard illumination rounds may cause unwanted urban fires if they come in contact with flammable structures or materials. Planning considerations must also include building height and the probability of rounds drifting

and making contact with the sides of buildings, thus reducing their effectiveness. In some cases, ground burst may be more advantageous. In the offense, illumination rounds are planned to burst above the objective. If the illumination were behind the objective, the enemy troops would be in the shadows rather than in the light. In the defense, illumination is planned to burst behind friendly troops to put them in the shadows and place the enemy troops in the light. Buildings reduce the effectiveness of the illumination by creating shadows. Continuous illumination requires close coordination between the FO and FDC to produce the proper effect by bringing the illumination over the defensive positions as the enemy troops approach the buildings.

g. **Special Considerations.** When planning the use of mortars, commanders must consider the following:

(1) FOs should be positioned where they can get the maximum observation so target acquisition and adjustments in fire can best be accomplished. This is not necessarily on tops of buildings

(2) Commanders must understand ammunition effects to correctly estimate the number of volleys needed for the specific target coverage. Also, the effects of using WP may create unwanted smoke screens or limited visibility conditions that could interfere with the tactical plan.

(3) FOs must be able to determine dead space in urban terrain. Dead space is the area in which indirect fires cannot reach the street level because of buildings. This area is a safe haven for the enemy. For mortars, the dead space is about one-half the height of the building.

(4) Mortar crews should plan to provide their own security.

(5) Commanders must give special consideration to where and when mortars are to displace while providing immediate indirect fires to support the overall tactical plan. Combat in urban areas adversely affects the ability of mortars to displace because of rubble and the close nature of urban combat.

## L-26. HELICOPTER SUPPORT

a. **Attack Helicopters.** Infantry units may be supported by a variety of attack helicopters ranging from fully modernized AH-64s to lightly armed but agile OH-58Ds. Regardless of the specific type of attack helicopter available, the same missions and tasks can be accomplished due to the inherent flexibility of Army aviation units. Due to the increased risk of small arms and man-portable air defense systems (MANPAD) engagements, aviation forces normally support UO by operating away from urban areas (for example, isolation of objective); however, if the risk analysis determines that the payoff is higher than the risk, aviation forces can be employed in and around the urban area.

(1) **Common Missions.** The most common missions assigned to attack helicopters during urban operations are the following:

- Escort of troop-carrying aircraft during air assaults.
- Overwatch and support attacks integrated with the ground commander's maneuver.
- Interdiction and destruction of enemy armored vehicles moving against friendly forces.
- Isolation of urban objectives.

- Reconnaissance.
- Security of friendly locations.
- Convoy escort duty.
- Precision engagement of hardened point targets.
- Participation in show-of-force operations.
- Escort of NEO mission aircraft.

(2) **Other Missions.** In addition to the missions listed above, attack helicopters may be called on to perform some additional, nontraditional roles during urban operations. This is particularly true during support operations and stability operations in urban areas. Additional missions may include the following:

- Assisting, for limited periods, in the control and coordination of fires with the maneuver of ground forces.
- Providing limited relay of radio messages from isolated ground units.
- Marking or identifying specific buildings and areas by smoke, fires, or targeting lasers.
- Videotaping routes or objectives for later analysis by ground commanders.
- Providing navigational and directional assistance to ground units.
- Providing limited area illumination by infrared or white light using either on-board sources or illumination rockets.
- Providing countersniper and countermortar armed reconnaissance patrols around friendly unit locations.

(3) **Weapons Limitations.** Urban terrain limits weapons employment.

(a) Weapons use may be limited by the short arming/slant ranges within the urban area. Precision weapons, such as Hellfire missiles, require about 500 meters minimum range to reliably arm and stabilize on the intended target. Often, fire from longer ranges actually improves accuracy. The shaped charge of the Hellfire produces less damage and over-pressurization than the TOW's high-explosive round, when fired against buildings. Window engagements are generally not recommended, since the missile will usually impact the far wall of the structure, expending its blast energy away from the structure. Missile impact on the facing structure will normally cause over-pressurization inside the structure (near impact) as well as secondary fragmentation of wood/concrete, which can neutralize or stun occupants in the vicinity of the impact.

(b) Extensive use of precision weapons by several units in close proximity may cause coordination problems with target identification and designation.

(c) Laser designation by both ground and aerial systems may be degraded by the large expanses of polished, flat reflective surfaces common in many urban areas. The high volumes of smoke and dust associated with burning buildings and urban combat can prevent the accurate laser designation required for precision engagements.

(d) Aircraft cannon fire against buildings can be devastating. These fires provide excellent suppression and can drive enemy forces away from firing positions or fix the enemy in place until ground maneuver forces can destroy him. Enemy positions that have been struck by fire can normally be reoccupied quickly by the enemy. Ricochets from these rounds are common in urban structures. They can cause additional collateral damage and pose a danger to nearby friendly forces.

(e) Target identification and marking may be difficult because of heavy smoke and dust rising from urban fires and explosions. Some smoke from fires in industrial areas

may be highly toxic or irritating. Pilots may have to don chemical protective equipment that hinders target detection and engagement. Friendly unit locations and personnel can be marked with colored panels, glint tape, strobe lights, and colored smoke. Targets can be marked with infrared laser pointers, such as the GCP-1 Ground Commander Pointer/Illuminator, colored M203 smoke rounds, M203 or mortar flares burning on the ground, or tracer fires. In some situations, improvised spotlights can also be used.

(f) Although fire from stationary positions is more accurate, running fire is normally safer for the aircraft due to enemy ground fire. If possible, ground commanders should avoid directing pilots along a gun-target line that passes over friendly troops. Gun-target runs that are perpendicular to the friendly unit's front are normally best.

(g) 2.75 rockets (area fire) with HE warheads have a burst radius in excess of 50 meters and are effective in the destruction of C4 structures, thin-skinned vehicles, and ADA and can damage/breach concrete and wood structures. But, when fired in pairs or more, the rockets have a large dispersion pattern and pose a potential accuracy and fratricide problem.

b. **Assault and Lift Helicopters.** Infantry units may be supported by a variety of assault or lift helicopters, normally the UH-60 or CH-47. These assets can be crucial for the flexible and responsive movement of troops and supplies and C2.

(1) **Common Missions.** The most common missions assigned to assault/lift helicopters during urban operations are the following:

- Air assaults.
- CASEVAC/MEDEVAC.
- Air movement of troops and supplies.
- Emplace logistical resupply points.
- Conduct C2 operations.
- Conduct NEO.

(2) **Other Missions.** Assault/lift helicopters may be called on to perform some additional, nontraditional roles or roles requiring special mission equipment. Additional missions may include the following:

- Conduct EW operations.
- Combat search and rescue (CSAR).
- Emplace Volcano mines.
- Emplace large/heavy obstacles (abandoned vehicles, concrete dividers, and so on).

c. **Aircraft Power Limitations and Time on Station.** The need to deliver hovering fires from temporary battle positions may require the aircraft to carry less than a full load of munitions or fuel. This is especially true in hot climates and high altitudes. Reduced loads mean more frequent trips to forward area refuel and rearm points and less time on station. Long route distances during air movements may require the establishment of forward arming and refuel points (FARP) along the route prior to operations. Climate will also affect the number of troops or amount of supplies the aircraft can transport.

d. **Command and Support Relationships.** From the ground unit perspective, helicopters are most effective when they operate under the OPCON of the ground unit commander closest to the enemy. Normally, the Infantry battalion is the lowest level granted formal OPCON of helicopters. During attack helicopter operations, the Infantry battalion commander is rarely able to identify the precise location of enemy forces or to

coordinate aerial fires with friendly squad and platoon maneuver. He often must pass the responsibility for close coordination of attack helicopter fires to the company commander or platoon leader on the scene. This ground maneuver leader can direct the efforts of only a few aircraft at a time. It may be more effective for the aviation unit to retain control of its individual aircraft and operate by continuously rotating attack helicopter elements into the battle area where they then coordinate their attacks with the ground commander's maneuver. Generally, the smaller and more decentralized the combat actions, the better it is to have armed aircraft coordinate directly with the small-unit leader on the ground. The larger, more centralized the combat action, the better it is to retain control of armed aircraft by the aviation headquarters. Whichever command and support relationship is chosen, both the ground and the aviation headquarters must understand what is expected of the other. Close liaison and clear, concise verbal communications are important.

### **L-27. ANTIARMOR WEAPONS**

The urban environment will not change the tactical use of these weapons, but it can limit how they are employed. Some of those limitations are: stand-off; obstructions for wire-guided missiles; displacement after engagements; firing in-depth engagements; increased obstacles; increased danger zones; and all around security. Although antiarmor weapons are primarily designed to destroy armored vehicles, they also can be used to damage or destroy some urban fortifications. Additionally, they can be used for ballistic breaching of doorways that are being used for entry points to buildings, or by creating deceptions, just before the assault element enters the actual initial breach (entry) point. The larger systems that have highly magnified day and thermal sights can be used to detect snipers and to disrupt or kill them with long range missiles. Most medium and heavy antiarmor weapons have their own local security since they are crew served, thus eliminating the need to assign additional security. Commanders should ensure platoon leaders emplace the weapons in a mutually supporting manner that also provides all round security for the antiarmor weapons. When these weapons fire, they quickly become priority targets, making them susceptible to enemy fire. Major considerations for planning offensive and defensive operations are as follows.

a. **Offensive Operations.** When employing antiarmor weapons in the offense, assign them to an area that over watches the assault force and where ambushes are likely, such as roads, road intersections, alleys, and large open areas. Place them so they can establish a blocking force along main access routes to the objective and where they can isolate the objective against armor counterattacks. When selecting positions, pick the areas that-

- Offer cover and concealment for the weapon and crew. Urban terrain will, in most cases, limit maximum range shots, making the weapon and crew more vulnerable to small arms weapons.
- Have no ground and overhead obstacles.
- Provide mutual support with other crew-served weapons.
- Offer escape routes.

**Note:** Overhead wire obstructions are the main concern when firing guided missiles. Wire obstacles will be prevalent throughout urban areas causing problems with in flight missiles, wire guided missiles, and rockets. Overhead wires can deflect



guided missiles from their flight path when their control fins make contact with the wire. Firing a wire-guided missile over power lines can burn the tracking wires, causing the loss of the missile, and, possibly, causing damage to the weapon system and crew. Most missiles are armed 50 meters or more from the weapon.

b. **Defensive Operations.** When assigning the antiarmor weapons their engagement areas, ensure that they are positioned for maximum fields of fire. They are also positioned in-depth to exploit their maximum ranges. This may not always be possible within urban areas, with the amount of obstacles and short engagement ranges. Close engagement areas that limit standoff will only give the crew time for one shot, with no time for reloading if they have to fire multi-engagements. For this reason, antiarmor weapons should always be employed in pairs. One fires and the other supports by fire. When selecting firing positions consider:

- Positioning the weapons so they have interlocking fires.
- When engaging armor or light armor, have the antiarmor fire first, giving the crew time to displace for other engagements.
- Use organic weapons to mask the initial engagement to distract the threat from knowing where the round or rounds came from.
- Establishing ambushes along choke points. Light antiarmor weapons that are individually operated work best at short ranges.

c. **TOW.** No TOW systems are organic to light Infantry companies. They may be attached down to company and platoon levels. All BFV platoons have organic TOWs on each BFV. These weapon systems are used to defeat heavy or light armor threats from outside or inside the urban area, in lieu of assigned armored vehicles. They cannot apply the same amount of firepower as tanks but, when employed in pairs, they can destroy and disrupt armored units long enough to give commanders time to bring other assets into play. The TOW can engage targets at a range of 3,750 meters using a 13X day sight or thermal sight.

(1) **Advantages:** Some of the advantages of the TOW system are:

- (a) Offers greater range, accuracy, and lethality than other antiarmor weapons.
- (b) Will destroy all known armor vehicles.
- (c) Gives leaders far-seeing OP capabilities day or night using the AN/TAS 4 12X day or night 24X zoom thermal sight.
- (d) The HMMWV TOW carrier has an M2 .50 caliber machine gun or MK 19 grenade launcher for crew safety, and can be used against dismounted enemy troops. This gives the leader a two-fold weapon when used to over watch assault elements or when isolating buildings.
- (e) The HMMWV carrier has a HIMS (HMMWV interchangeable mount system) that allows the TOW system to be in a ready-to-fire configuration with the addition of the M249 or the M2 .50 caliber also mounted. The HIMS can also mount an M19 grenade launcher but not at the same time as the TOW.

(f) The TOW system can assist in detecting enemy snipers and destroy or disrupt them. When engaging a sniper in a building, aim at the wall next to the window or fortified position he is firing from. The structure will set off the missile warhead, causing inner spalling of the wall and tremendous heat within the room. If a missile is fired

through a window and impacts on a back wall, debris and heat from the explosion will permeate the room.

(2) **Disadvantages.** Some of the disadvantages of the TOW system are:

(a) The missile is wire guided, which restricts firing from elevated positions where power lines cross the engagement areas.

(b) The crew is vulnerable to small arms fire when mounted on the HMMWV carrier.

(c) The missile has a noticeable firing signature that can give away positions.

(d) The missile has dangerous backblast areas that restrict firing inside of structures.

d. **Javelin.** The Javelin is a crew-served, medium range, fire-and-forget system. Unlike conventional wire-guided missiles, the Javelin automatically guides itself to the target after launch. Soldiers can reposition immediately after firing or reload to engage another threat. The Javelin has two attack modes, the top attack and the direct attack. The Javelin sight uses passive surveillance, day or night, at ranges of 2,000 meters, in most weather conditions.

(1) **Advantages.** Some of the advantages of the Javelin are:

(a) Has a soft launch design, which allows it to be safely fired from inside buildings or covered fighting positions.

(b) Will destroy all known armored vehicles.

(c) Gives leaders far-seeing OP capabilities day or night using the 4X day sight and 4X and 9X thermal sight

(d) Offers more range, accuracy, and lethality, than the Dragon.

(e) Fire-and-forget, with no attached wires.

(f) In lieu of the TOW, the Javelin can assist in locating enemy snipers and destroy or disrupt them. When engaging a sniper in a building, aim at the wall next to the window or fortified position he is firing from. The structure will set off the missile warhead, causing inner spalling of the wall and tremendous heat within the room. If a missile is fired through a window and impacts on a back wall, debris and heat from the explosion will permeate the room.

(2) **Disadvantages.** Some of the disadvantages of the Javelin are:

(a) Overhead wires can impede the missile flight.

(b) The missile requires a large overhead clearance from launch point to target.

e. **Dragon.** The Dragon is a crew-served medium range antiarmor weapon that can be employed to track and engage targets at a range of 1,000 meters, with a 4X day sight or 4X thermal sight.

(1) **Advantages.** Some of the advantages of the Dragon are:

(a) Will destroy most armored vehicles.

(b) Can track and engage targets day or night.

(2) **Disadvantages.** Some of the disadvantages of the Dragon are:

(a) System is wire guided, which restricts firing from elevated positions where power lines cross the engagement areas.

(b) It has noticeable firing signatures that can give away positions.

(c) It has dangerous backblast areas that restrict firing inside structures.

## L-28. SNIPERS

Company commanders can make effective use of snipers during UO. They should be considered an important combat multiplier, and integrated into the fire plan and scheme of maneuver. Snipers are a precision weapon and must be used as such.

a. **Missions.** Snipers can be used as part of the support element to provide precise long and short range fires. Snipers can provide significant input to reconnaissance and counterreconnaissance efforts. They can be dedicated to the countersniper role or be assigned priority targets. Snipers can also overwatch breaching operations and call for indirect artillery fires. They can also be used effectively as a screening force against limited threats.

b. **Positions.** General areas (a building or group of buildings) are designated as sniper positions, but the sniper selects the best position for engagement based on the mission given him. Masonry buildings that offer the best protection, long-range fields of fire, and all-round observation are preferred. The sniper also selects several secondary and supplementary positions to cover his areas of responsibility. The sniper selects positions that provide him with engagement areas but do not compromise his security. He selects positions that allow him to displace to other firing positions.

c. **Targets.** Engagement priorities for snipers are determined by the relative importance of the targets to the effective operations of the enemy. Priority targets can include:

- Enemy officers or other leaders.
- Enemy snipers.
- Enemy RTOs.
- Vehicle commanders or drivers.
- Enemy crew served weapons members.
- Enemy special weapons personnel (engineers, ADA, and so forth).

If available, the XM107 .50-caliber heavy sniper rifle (HSR) can provide snipers with an antimateriel capability and improve countersniper effectiveness. The HSR is also an excellent weapon for penetrating sandbag barriers and most urban construction materials. Possible targets that can be engaged are:

- Radar systems.
- Missile systems.
- Fuel distribution systems.
- Aircraft (stationary, fixed, or rotary winged).
- Communications equipment.
- Generators.
- Light-skinned vehicles.

d. **Limitations.** Urban areas often limit snipers to firing down or across streets, but open areas permit engagements at longer ranges. Snipers can be employed to cover rooftops, obstacles, dead space, and gaps in FPFs.

e. **Countersniper TTP.** If the Infantry company operates in an area where enemy sniper contact is likely, the commander should consider the following:

(1) Task organize trained snipers by placing them into platoons most likely to make contact and give them counter-sniper missions.

(2) Identify trained unit marksmen to act in the counter-sniper role.

(3) Plan movement on the most covered and concealed routes.

(4) If operating with BFVs or tanks, place them in a position during movement that can support the Infantry in countersniper actions. The target acquisition capabilities of armored vehicles make them excellent countersniper weapons.

(5) Plan passive countermeasures and enforce them. (Ensure that soldiers wear protective equipment and request additional smoke.)

(6) Request additional 40-mm HE ammunition, 7.62-mm ammunition, AT4s, LAWs, and so forth, consistent with the ROE, METT-TC, and load planning considerations.

### **L-29. SERVICE SUPPORT.**

The company first sergeant and supply sergeant normally share the responsibility for coordinating all supply and transportation requirements for the company. Generally, the priorities of resupply for Infantry companies in urban combat are ammunition, medical supplies, water, and food. These priorities may change based on the factors of METT-TC. Resupply operations normally occur once a day during periods of limited visibility. Company resupply is primarily a “push” system accomplished through the reception of a logistics package (LOGPAC) from battalion.

a. **Distribution of Supplies.** The first sergeant takes control of LOGPACS at the logistics release point (LRP). This should be a covered and concealed position that offers protection to those distributing supplies; for example, a large enough building that can be secured locally. The LRP should be positioned close enough to the combat area so that LOGPACS can be off-loaded and carried to the platoons. LOGPACS should be broken down into 50- to 75-pound loads to be carried in rucksacks. Litters can be used to carry heavier loads. The company should plan for carrying supplies and identify soldiers to do this. The platoon sergeant assumes control of the supplies once they arrive in the platoon area. Carrying parties should use covered and concealed routes through buildings to move from the LRP to the company sector. Porters should be prepared to provide their own security to and from the LRP. The first sergeant has three options for resupplying the platoons:

(1) **In Position.** This is the most common technique used in urban terrain when the company is conducting operations that require platoons to maintain combat power forward (during contact or when contact is imminent). For example, this technique would probably be used during the consolidation and reorganization phase of an offensive operation where a counterattack is expected. Ammunition, medical supplies, and water are brought forward by the support element and resupplied directly to the platoons in cleared buildings. All the assaulting platoons remain in position.

(2) **Out of Position.** This technique is used when the situation does not necessitate all combat power being forward (contact is not likely). The first sergeant establishes a resupply point in a covered and concealed position (a cleared building with overhead cover) to the rear of the platoon. Platoons send selected personnel back to the resupply point, pick up the supplies, and move back to position.

(3) **Pre-position.** This technique is most often used during defensive operations when supplies are often cached (pre-positioned and concealed) in buildings throughout the company sector or subsequent battle positions.

b. **Medical Treatment and Evacuation.** The first sergeant must plan to expedite the evacuation of wounded out of the urban area. Rubble in the streets, barricades, and demolition of roads impede the use of ground ambulances, requiring a heavy reliance on

litter teams. Snipers may present a significant problem for medical evacuation from front line positions. The company casualty collection point (CCP) should be placed in a covered and concealed location with overhead cover (usually a heavy clad building that has not collapsed). The CCP should be located at a point where the field ambulances can reach them, yet close enough to the combat area so that casualties do not have to be carried great distances. Higher numbers of head and chest wounds should be expected, along with increased trauma injuries due to falling objects and glass. Increased casualties may require the stockpiling of medical supplies and augmentation of medical personnel from higher headquarters. The role of combat lifesavers at the company level takes on greater significance. The commander should anticipate increased nonbattle injuries (NBI) due to poor field sanitation or falls from building, as well as contact with TIM. The close nature of urban combat may cause an increased mental health case load. Additional considerations include:

- Marking the CCP. (See Figure L-7.)
- Carrying additional medical supplies to include intravenous (IV) fluids, bandages, poleless litters, SKEDCO litters, and lightweight blankets.
- Planning for aid and litter teams within the assault and support elements and supplying them with sledgehammers, axes, crowbars, ropes, pulleys, and ladders in order to extricate casualties from difficult situations.
- Placing selected combat life savers from the support element under the control of the first sergeant to assist with triage and treatment at the CCP.
- Requesting appropriate medications for nonbattle-related illnesses (for example, dysentery).
- Rehearsing the CASEVAC plan with platoon sergeants. Rehearsals should include company CCP location and marking, CASEVAC routes, priority of CASEVAC, and medical resupply. Aid and litter teams should rehearse carrying techniques based on the nature of the injury.

# GLOSSARY

|           |   |
|-----------|---|
| AA        | assembly area, avenue of approach (in figures only) |
| ACA       | airspace coordination area                          |
| ACE       | armored combat earthmover                           |
| AD        | air defense   |
| ADA       | air defense artillery                               |
| admin/log | administrative/logistics                            |
| AGS       | automatic grenade launcher (Soviet)                 |
| AH        | attack helicopter                                   |
| AHB       | attack helicopter battalion                         |
| alt       | alternate   |
| AMC       | air mission commander                               |
| ammo      | ammunition  |
| ANGLICO   | air and naval gunfire liaison company               |
| AO        | area of operations                                  |
| APC       | armored personnel carrier                           |
| APDS      | armor-piercing discarding sabot                     |
| APERS     | antipersonnel                                       |
| ATGM      | antitank guided missile                             |
| atk       | attack  |
|           |   |
| BAR       | Browning automatic rifle                            |
| BAS       | battalion aid station                               |
| bde       | brigade   |
| BDU       | battle dress uniform                                |
| BFV       | Bradley fighting vehicle                            |
| BHO       | battle handover                                     |
| BLPS      | ballistics/laser eye protection system              |
| BMNT      | beginning morning nautical twilight                 |
| BMP       | Soviet fighting vehicle                             |
| bn        | battalion   |
| BP        | battle position                                     |
| BSA       | brigade support area                                |
| BTR       | Soviet personnel carrier (wheeled)                  |
|           |   |
| C2        | command and control                                 |
| CAS       | close air support                                   |
| CB        | chemical biological                                 |
| CBU       | cluster bomb units                                  |
| cdr       | commander   |
| CFL       | coordinated fire line                               |
| cGy       | centigray   |
| CL        | chalk leader  |
| CINC      | commander in chief                                  |
| co        | company   |

|         |   |
|---------|---|
| CO      | commanding officer (used to designate company commander in this book) |
| COLT    | combat observation and laser team                                     |
| commo   | communications  |
| COMSEC  | communications security   |
| CONOP   | continuous operations   |
| CP      | command post  |
| CRP     | combat reconnaissance patrol (Soviet)                                 |
| CS      | combat support  |
| CSS     | combat service support  |
|         |   |
| decon   | decontamination   |
| DEWS    | directed energy weapon system   |
| DF      | direction finding   |
| div     | division  |
| DLIC    | detachment left in contact  |
| DOA     | direction of attack   |
| DPICM   | dual-purpose improved conventional munition                           |
| DS      | direct support  |
| DZ      | drop zone   |
|         |   |
| EA      | engagement area   |
| ECCM    | electronic counter-countermeasures                                    |
| EENT    | end of evening nautical twilight                                      |
| EM      | enlisted men  |
| EMP     | electromagnetic pulse   |
| EPW     | enemy prisoner of war   |
| EW      | electronic warfare  |
|         |   |
| FA      | field artillery   |
| FAC     | forward air controller  |
| FASCAM  | family of scatterable mines   |
| FCL     | final coordination line   |
| FDC     | fire direction center   |
| FEBA    | forward edge of battle area   |
| FIST    | fire support team   |
| FM      | field manual, frequency modulation                                    |
| FO      | forward observer  |
| FPF     | final protective fires  |
| FPL     | final protective line   |
| FSCoord | fire support coordinator  |
| FSE     | fire support element  |
| FSO     | fire support officer  |
|         |   |
| GHz     | gigahertz   |
| GL      | grenade launcher  |
| GS      | general support   |
| GSR     | ground surveillance radar   |

---

|        |   |
|--------|---|
| GT     | gun-target  |
| GTA    | graphic training aid                                |
| HC     | hexachloroethane (smoke)                            |
| HE     | high explosive                                      |
| HEAT   | high-explosive antitank                             |
| HEDP   | high-explosive dual-purpose                         |
| HEI-T  | high-explosive incendiary-tracer                    |
| HEP    | high-explosive plastic                              |
| HHC    | headquarters and headquarters company               |
| HMMWV  | high-mobility, multipurpose, wheeled vehicle        |
| HPM    | high power microwave                                |
| hqs    | headquarters  |
| HUMINT | human intelligence                                  |
| hwy    | highway   |
| IAW    | in accordance with                                  |
| IFV    | infantry fighting vehicle                           |
| illum  | illuminate  |
| IN     | infantry  |
| IP     | initial point                                       |
| IR     | information requirements                            |
| KIA    | killed in action                                    |
| kmph   | kilometers per hour                                 |
| LAW    | light antitank weapon                               |
| LBE    | load bearing equipment                              |
| lbs    | pounds  |
| LD     | line of departure                                   |
| LIC    | low intensity conflict                              |
| LOA    | limit of advance                                    |
| LOGPAC | logistics package                                   |
| LP     | listening post                                      |
| LRP    | logistics release point                             |
| LWCM   | lightweight company mortar                          |
| LZ     | landing zone  |
| M-OC2  | mission-oriented command and control                |
| mag    | magnetic  |
| MANPAD | man-portable air defense                            |
| MBA    | main battle area                                    |
| MBC    | mortar ballistics computer                          |
| METT-T | mission, enemy, terrain, troops, and time available |
| MG     | machine gun   |
| MHz    | megahertz   |
| MI     | military intelligence                               |



|       |  |
|-------|--|
| MIJI  | meaconing, intrusion, jamming, and interference        |
| mm    | millimeter   |
| MOPMS | modular-packed mine system                             |
| MOPP  | mission-oriented protection posture                    |
| MORT  | mortar   |
| MRB   | motorized rifle battalion (Soviet)                     |
| MRC   | motorized rifle company (Soviet)                       |
| MRE   | meal ready-to-eat                                      |
| MSL   | mean sea level   |
|       |  |
| NATO  | North Atlantic Treaty Organization                     |
| NBC   | nuclear, biological, and chemical                      |
| NCO   | noncommissioned officer                                |
| NCOIC | noncommissioned officer in charge                      |
| NCS   | net control station                                    |
| NLT   | not later than   |
| Nov   | November   |
| NVD   | night vision device                                    |
| NW    | northwest  |
|       |  |
| obj   | objective  |
| Oct   | October  |
| OFF   | officers   |
| OH    | observation helicopter                                 |
| OIC   | officer in charge                                      |
| OP    | observation post                                       |
| OPCON | operational control                                    |
| OPORD | operation order  |
| OPSEC | operation security                                     |
| ORP   | objective rally point                                  |
|       |  |
| PAC   | personnel and administration center                    |
| PB    | patrol base  |
| PCO   | peacetime contingency operation                        |
| PDF   | principal direction of fire, Panamanian Defense Forces |
| PEWS  | platoon early warning system                           |
| PIR   | priority intelligence requirement                      |
| PKO   | peacekeeping operation                                 |
| PL    | phase line   |
| PLD   | probable line of deployment                            |
| plt   | platoon  |
| PMCS  | preventive maintenance checks and services             |
| POL   | petroleum, oils, and lubricants                        |
| POW   | prisoner of war  |
| PP    | passage point  |
| prep  | preparation  |

---

|         |   |
|---------|---|
| pri     | primary   |
| PZ      | pickup zone   |
| QSTAG   | Quadripartite Standardization Agreement               |
| R&S     | reconnaissance and security                           |
| RATELO  | radiotelephone operator                               |
| rd      | road  |
| recon   | reconnaissance  |
| REDCON  | readiness condition                                   |
| REMS    | remotely employed sensor                              |
| res     | reserve   |
| RFL     | restrictive fire line                                 |
| RHA     | rolled homogeneous armor                              |
| ROC     | rules of confrontation                                |
| ROE     | rules of engagement                                   |
| RP      | release point   |
| RSTA    | reconnaissance, surveillance, and target acquisition  |
| rte     | route   |
| SEAD    | suppression of enemy air defenses                     |
| sec     | second  |
| SEC     | section   |
| SEE     | small emplacement excavator                           |
| SFCP    | shore fire control party                              |
| sgt     | sergeant  |
| SITREP  | situation report                                      |
| SL      | squad leader  |
| SOI     | signal operation instructions                         |
| SOP     | standing operating procedure                          |
| SP      | start point, strongpoint                              |
| sqd ldr | squad leader  |
| STANAG  | standardization agreement                             |
| SW      | southwest   |
| TBMED   | technical bulletin medical                            |
| TCP     | traffic control point                                 |
| tgt     | target  |
| tk      | tank  |
| TLP     | troop-leading procedure                               |
| tm      | team  |
| TOC     | tactical operations center                            |
| TOE     | table of organization and equipment                   |
| TOW     | tube-launched, optically tracked, wire-guided missile |
| TP-T    | target practice-tracer                                |
| TRP     | target reference point                                |

|      |                                     |
|------|-------------------------------------|
| TTP  | tactics, techniques, and procedures |
| UCMJ | Uniform Code of Military Justice    |
| UN   | United Nations                      |
| US   | United States                       |
| vic  | vicinity                            |
| vpk  | vehicles per kilometer              |
| vpm  | vehicles per mile                   |
| VS   | visual signal                       |
| VT   | variable time                       |
| XO   | executive officer                   |
| WIA  | wounded in action                   |
| WP   | white phosphorous                   |
| ISG  | first sergeant                      |
| 2IC  | second in charge                    |

# REFERENCES

## SOURCES USED

These are the sources quoted or paraphrased in this publication.

- FM 5-36. Route Reconnaissance and Classification. 10 May 1985.  
FM 5-100. Engineer Combat Operations. 22 November 1988.  
FM 7-7. The Mechanized Infantry Platoon and Squad (APC).  
15 March 1985.  
FM 7-7J. The Mechanized Infantry Platoon and Squad (Bradley).  
18 February 1986.  
FM 17-15. Tank Platoon. 7 October 1987.  
FM 20-32. Mine/Countermine Operations. 9 December 1985.  
FM 21-10. Field Hygiene and Sanitation. 11 October 1989.  
FM 22-9. Soldier Performance in Continuous Operations.  
8 December 1983.  
FM 24-18. Tactical Single-Channel Radio Communications Techniques.  
30 September 1987.  
FM 26-2. Management of Stress in Army Operations. 29 August 1986.  
FM 71-1. Tank and Mechanized Infantry Company Team.  
22 November 1988.  
FM 90-5. Jungle Operations. 16 August 1982.  
FM 100-2-3. The Soviet Army: Troops, Organization, and Equipment.  
July 1984.  
FM 100-37. Terrorism Counteraction. 24 July 1987.  
GTA 5-2-5. Engineer Reconnaissance. 1970.  
ST 100-9. A Guide to the Application of the Estimate of the Situation in  
Combat Operations. 1988.

Depuy, General (Ret) William E. "Concepts of Operation: The Heart of Command, The Tool of Doctrine." Army. August 1988: 26-40.

Director, CAC, CGSC, Fort Leavenworth, Kansas. Memorandum on Guidance for Command and Control, Planning, and Orders Instruction. CY 1987-1988.

Marshall, S. L. A. "The Mobility of One Man." Infantry Journal. October 1949: 6-25.

McMichael, Scott R. "A Historical Perspective on Light Infantry. Combat Studies Institute. Research Survey #6. 1987.

Moore, Lynn D. "Night Attack." Infantry Magazine. May-June 1990: 39-41.

Spigelmire, Major General Michael F. Commandant's Note. "The Essence of Infantry." Infantry Magazine. March-April, 1990.

Student Monograph. Donovan Technical Library. United States Army Infantry School. Fort Benning, Georgia.

### **DOCUMENTS NEEDED**

These documents must be available to the intended users of this publication.

|                 |   |
|-----------------|---|
| AR 350-42.      | Nuclear, Biological, and Chemical Defense and Chemical Warfare Training. 14 October 1988.   |
| ARTEP 7-10-MTP. | Mission Training Plan for the Infantry Rifle Company. 3 October 1988.                       |
| DA Form 1155.   | Witness Statement on Individual.  |
| DA Form 1156.   | Casualty Feeder Report.   |
| FM 3-3.         | NBC Contamination Avoidance. 30 September 1986.   |
| FM 3-4.         | NBC Protection. 21 October 1985.  |
| FM 3-5.         | NBC Decontamination. 24 June 1985.  |
| FM 7-8.         | The Infantry Platoon and Squad (Infantry, Airborne, Air Assault, Ranger). 31 December 1980. |
| FM 7-20.        | The Infantry Battalion (Infantry, Airborne, and Air Assault). 28 December 1984.             |
| FM 7-90.        | Tactical Employment of Mortars. 11 June 1985.   |
| FM 7-91.        | Tactical Employment of Antiarmor Platoons, Companies, and Battalions. 30 September 1987.    |
| FM 21-11.       | First Aid for Soldiers. 27 October 1988.  |
| FM 21-18.       | Foot Marches. 1 June 1990.  |
| FM 21-76.       | Survival. 26 March 1986.  |
| FM 22-100.      | Military Leadership. 31 October 1983.   |
| FM 25-100.      | Training the Force. 15 November 1988.   |
| FM 27-10.       | The Law of the Land Warfare. 18 July 1956.  |
| FM 90-4.        | Air Assault Operations. 16 March 1987.  |
| FM 90-10-1.     | An Infantryman's Guide to Urban Combat. 30 September 1982.                                  |
| *FM 100-5.      | Operations. 5 May 1986.   |
| FM 101-5.       | Staff Organization and Operations. 25 May 1984.   |
| FM 101-5-1.     | Operational Terms and Symbols. 21 October 1985.   |

\*This source was also used to develop this publication.

### **READINGS RECOMMENDED**

These readings contain relevant supplemental information.

#### **Army Publications**

|                    |  |
|--------------------|--|
| FM 6-20.           | Fire Support in AirLand Battle. 17 May 1988.           |
| FM 100-20.         | Low Intensity Conflict. 16 January 1981.               |
| Gugeler, Russel A. | Combat Actions in Korea. Army Historical Series. 1970. |

#### **Nonmilitary Publications**

- 
- English, John A. *On Infantry*. New York. Praeger Publishers. 1981.
- Fehrenbach, T.D. *This Kind of War: A Study in Unpreparedness*. New York. MacMillan Company. 1963.
- Keegan, John. *The Face of Battle*. New York. Viking Press. 1976.
- MacDonald, Charles B. *Company Commander*. New York. Ballentine Books. 1947.
- MacDonald, Charles B. *The Battle of the Huertgen Forest*. Philadelphia. J. B. Lippincott Company. 1963.
- Malone, Dandridge M. *Small Unit Leadership: A Commonsense Approach*. Novato, CA. Presidio Press. 1983.
- Marshall, S.L.A. *Men Against Fire*. New York. Wm. Morrow Company. 1947.
- Marshall, S.L.A. *The Soldier's Load and the Mobility of a Nation*. Washington, DC. Combat Forces. 1950.
- Marshall, S.L.A. *The River and the Gauntlet*. New York. Wm. Morrow Company. 1953.
- Newman, Aubrey S. *Follow–Me: The Human Element in Leadership*. Novato, CA. Presidio Press. 1981.
- Rommel, Erwin. *Attacks*. Vienna, VA. Athena Press. 1979.
- Shaara, Michael. *The Killer Angels*. New York. McKay. 1974.
- Summers, Harry G. *On Strategy: The Vietnam War in Context*. New York. Dell. 1984.

# INDEX

- actions on the objective, 4-5 (*illus*), 4-25, 4-26, 4-30, 4-40, 6-26, 6-27
- agility, 1-4
- air defense, 1-7, 7-5, I-9
- AirLand Battle, 1-1
  - concepts, 1-2
  - imperatives, 1-5
  - tenets, 1-4
- ambush, 6-30 to 6-35
  - control, 6-26
  - execution, 6-33, 6-35
  - organization, 6-36
  - site, 6-34
  - types, 6-34
- antiarmor
  - employment, J-1 to J-21
  - execution matrix, J-18 (*illus*)
  - fire control, J-4, J-5, J-6, J-9
  - perimeter defense, 5-40
  - section, 3-3, 3-7
  - section leader, 2-9, 5-23, to 5-26
  - weapons, J-1, see also individual weapons
- antijamming, 2-18
- approach march, 4-20 to 4-22 (*illus*)
- armored vehicles, see also vehicles
  - combined operations, B-5
  - employment, B-4
  - infantry, riding on, B-12
  - safety, B-3
  - special considerations, B-5
  - assault element, 4-31, 4-37, 4-38, 4-40, 4-42, 6-27 to 6-32, C-4 (*illus*)
- assembly areas
  - actions, H-6
  - characteristics, H-5
- attack drills, 4-30
- attacks, 4-6, 4-9
  - ambushes, 4-22, 4-30
  - counterattacks, 4-30
  - deliberate, 4-30
  - frontal, 4-14
  - hasty, 4-30
  - light/heavy, B-5 (*illus*), B-6 (*illus*)
  - main, 4-7

- raids, 4-30
- spoiling, 4-30
- supporting, 4-6
- techniques, 4-44 to 4-48
- base platoon, 3-3
- battle handover line, 6-2, 6-4 (illus)
- battle positions
  - alternate, 5-7
  - defense from, 5-25 (illus)
  - delay from, 6-10, 6-12 (illus)
  - primary, 5-7
  - supplementary, 5-8
- battlefield operating systems, 1-6
- breach
  - elements, 4-37, 4-39, 4-43
  - isolate the site, 4-31, 4-32 (illus)
  - kit, C-4
  - sites, 4-42
  - types, C-3
- briefbacks, 2-13
  
- casualty collection, 5-21, 5-32
- casualty evacuation plan, 2-39, 4-13, 5-32
- close air support, 7-6, 7-15(*illus*)
- combat potential, 1-2, 4-5
- combat power, 1-2 to 1-5, 2-35, 4-5, 4-7, 4-17, 4-31, 5-4, 5-28, 6-1
- combat service support (CSS), 1-7, 4-35, 5-7, 6-3
  - battalion support, 8-2
  - company trains, 8-3
  - fundamentals, 8-2
  - personnel duties, 8-4
  - planning, 8-3
  - resupply, 8-4 to 8-8
- command and control, 1-8, 2-1
  - delays, 6-11, 6-13
  - mission-oriented, 2-4
  - passage of lines, 6-1
  - process, 2-8
  - relief in place, 6-5
  - system, 2-3
- commander's concept, 2-5, 2-16
  - defense from a BP, 5-34
  - development, 4-29



- commander's intent, 1-2, 2-4, 2-5, 2-16
- commander's position, 1-5, 2-5, 2-6, 2-9
- command post, 2-9, 3-2, 5-22, 5-28, I-10
- communications, 2-13, 6-21
  - messenger, 2-18
  - radio, 2-14, 4-17, 4-43, 7-13
  - security, 2-18
  - sergeant, 2-8, 5-19
  - sound, 2-18
  - visual signals, 2-17
  - wire, 2-16(*illus*), 4-53
  - with tanks, B-9
- continuous operations, 2-10, 2-40, 2-41, 4-16
- control measures, 5-13, 6-6
- counterattack, 5-20(*illus*), 5-28
- counterreconnaissance, 5-16, 5-17, 5-28
- courses of action (COA)
  - analysis, 2-28
  - comparison, 2-31
  - decision, 2-32
  - defensive, 2-30, 2-32, 2-33
  - development, 2-24, 2-30
  - enemy's, 2-22, 2-33
  - matrix, 2-32 (*illus*)
  - offensive, 2-30
  - sketch, 2-26, 2-28 to 2-30, 2-31(*illus*), 2-32(*illus*)
  - statement, 2-30
  - war game, 2-29 to 2-35

## deceptions

- demonstrations, 4-45
- feints, 4-45

decisive point, 1-4, 2-22, 2-28, 2-36, 4-5, 5-30

defense

- battle positions, 5-8, 5-33, 5-34, 5-42
- characteristics, 5-3
- concept development, 5-6
- contingency plan, 5-7
- CSS plan, 5-8, 5-17
- fundamentals, 5-3
- framework, 5-4, 5-5, 5-7
- light/heavy, B-7, B-8 (*illus*)
- occupation plan, 5-8, 5-23
- patterns

- area, 5-4
- mobile, 5-4
- sequence of actions, 5-16 to 5-23
- types
  - linear, 5-3, 5-45, 5-46
  - nonlinear, 5-3, 5-30, 5-31(*illus*)
  - reverse slope, 5-1, 5-39
- defense in sector, 5-25, 5-33, 5-34
- defensive characteristics
  - concentration, 5-1 to 5-4
  - disruption, 5-3
  - flexibility, 5-4
  - preparation, 5-3
- delay in sector, 6-11, 6-12(*illus*)
- demolitions
  - firing procedure, I-11
  - planning, I-9, I-10
  - reserved, I-1
  - responsibilities, I-8
- depth, 1-4
- detachment left in command (DLIC), 6-5, 6-14 to 6-17, 6-37
- directed-energy weapons
  - characteristics, K-1
  - electromagnetic pulse, K-4
  - lasers, K-1
  - microwaves, K-4
  - particle beams, K-4
  - protective measures, K-2, K-3
  - training, K-5
- Dragons, 4-25, 4-49, 5-13, 5-14, 5-24, 6-11, I-8, J-16, J-18
- duties of key personnel
  - air assault operations, D-10
  - demolition guard, I-2, I-7, I-8, I-10
  - infantry operations, 2-6 to 2-9
  - mortar section, E-1 to E-7
  
- elements, patrol organization, 6-22 (*illus*)
- employment, I-8
- engineer support, 7-6 (*illus*)
- envelopment, 4-9, 4-11 (*illus*)
- estimate process, 2-19, 2-20
- exfiltration, 6-37
- exploitation, 4-5

- final protective fires, 4-27, 5-11, 5-21, 5-28, 7-2, 7-9 to 7-15
- fire control, 4-47
- fire plan
  - defensive, 5-7, 5-9
  - direct fire, 5-9, 5-29
  - indirect fire, 4-27, 5-14, 5-28, 7-4 (illus), 7-15
  - offensive, 4-25, 4-30
  - priorities, 4-36
  - suppressive, 4-28, 4-38, 4-40, 4-48
- firepower, 1-3, 1-6, 2-33, 6-26, 6-27
- fire support
  - enemy suppression, 4-28, 7-14
  - execution matrix, 7-10 (illus), 7-11, 7-15
  - indirect fire, 4-17, 4-27, 4-35, 4-36, 5-14
  - mortar locations, 4-28
  - plans, 4-25, 4-27, 4-28, 5-9, 6-3, 7-8 to 7-15
  - priority of fire, 4-32, 4-35, 4-36
- fire support officer, 2-7, 3-2, 4-27, 5-11, 5-19, 6-3, 6-5, 7-2, 7-3, 7-8 to 7-15
- follow-and-support element, 4-41, 4-51
- formations, movement, 3-3 to 3-6 (illus)
- foothold, secure a, 4-31, 4-33 (illus)
- forward observer, 7-13

## helicopters

- air assault, D-1
- aircraft control, D-5
- air mission briefing, D-12, D-13 (illus)
- air movement plan, D-4, D-6, D-13
- ground tactical plan, D-2, D-6, D-12
- landing plan, D-2, D-4, D-12
- loading plan, D-4, D-10
- safety, D-13
- staging plan, D-10
- types, D-1

## illumination

- attacks, 4-45, 4-48, 4-52
- defense, 5-14, 5-18, 5-25

## infiltration, 4-10 (illus)

- actions on contact, 4-26

- considerations, 4-15
- phases, 4-15
- rehearsals, 4-13
- initiative, 1-1 TO 1-5, 1-8, 2-6, 4-5
- intelligence, 1-6
  - preparation of the battlefield, 2-18

- LAWS/AT4s, J-20
- leadership, 1-1, 1-3, 2-4, A-5
- limited visibility, 4-17, 5-11, 5-13
  - attack, 4-4, 4-14, 4-21, 4-22, 4-30, 4-37, 4-44
  - fire control, 4-47
  - movements, 3-11
  - night vision devices, 3-15, 3-16
- linear assault, 4-45, 4-47, 4-49, 4-51 TO 4-53
- linear defense, 5-3, 5-30, 5-45 TO 5-46
- linkups, 6-18 (illus)
- locations
  - key personnel, 3-2, 6-2, 6-5
  - weapons, 3-2, 3-3
- low intensity conflict (LIC)
  - command relationship, A-2
  - operations, 5-10
    - combatting terrorism, A-2
    - counterinsurgency, A-1
    - insurgency support, A-1
    - peacekeeping, A-1
    - peacetime contingency, A-2
  - roadblocks, A-3, A-4
  - rules of confrontation, A-2, A-5
  - rules of engagement, A-2, A-5
  - searches, A-4, A-5
  - sociology, A-2
  - special operating forces, A-6
  - training programs, A-6

- main effort, 1-4 TO 1-6, 2-6, 4-7, 4-24, 4-26, 5-5, 5-6, 5-7, 5-24
- maneuver, 1-3, 1-6, 2-38, 2-39
  - forms of, 4-8
- marches
  - foot, H-1
  - motor, H-2

- road, H-1
- security, H-3
- medical support
  - evacuation, 8-18
  - preventive medicine, 8-18
  - treatment, 8-18
- mission, 1-7, 2-5
  - analysis, 2-222-16
  - orders, 2-9, 4-5
  - statement, 2-17, 2-20, 2-30, 2-38
- mobility, 1-6
  - mortars, 1-6, 1-7, 1-9, 3-2, 3-15, 4-22, 4-25, 4-38, 5-14, 5-15, 5-26, 5-40, 7-12, E-1, J-6
- mortar section
  - displacement, E-5
  - duties, E-1
  - employment, E-5
  - engagement methods, E-6
  - equipment, E-1, E-2 (illus), E-3 (illus), E-4 (illus)
  - organization, E-1, E-3 (illus)
  - positions, E-2
- MOUT operations, 5-13
- movement
  - conducting reconnaissance, 3-1, 3-15
  - formations, 3-3 to 3-6 (illus)
  - maintaining security, 3-2
  - making contact, 3-2
  - security, 3-8
  - techniques, 3-6, 3-8, 3-11, 3-15
  - to the objective, 4-29
  - using squads and platoons, 3-1
  - using terrain and weather, 3-1, 3-8
- movement to contact, 4-18, B-5
  
- naval gunfire, 7-6
- NBC, 2-8, 2-9, 2-40, 3-2, 5-26, 5-72, 7-7, 7-8
  - chemical or biological environment
    - agents, F-5
    - decontamination, F-6, F-7, F-8
    - detection, F-5
    - effects, F-1, F-4
    - field expedient MOPP suits, F-7
    - protective measures, F-4, F-5 (illus)
    - treatment, F-5, F-6

- nuclear environment
  - bursts, F-2
  - decontamination, F-6, F-7, F-8
  - effects, F-1
  - hazard alarm, F-2
  - hazard warning, F-2
  - protection, F-3
  - radiation levels, F-3
- night vision devices, 3-8, 3-15, 3-16, 4-17, 4-36, 4-39, 5-12, 7-2
- nonilluminated attacks, 4-36
- nonlinear defense, 5-3, 5-28, 5-30, 5-31, 5-33
  
- obscuration fires, 7-13, 7-15
- obstacles, 5-19, 5-29, 5-30, 5-39, 5-45, C-1, C-3, I-1, I-8
  - breaching enemy obstacles, C-3, C-4 (illus)
  - combined, 2-23
  - company plan, 5-11, C-2
  - engineer support, 7-6
  - existing, 2-23, 2-24, C-1
  - overlay, 2-23, 2-39 (illus)
  - protective, 5-15
  - reinforcing, 2-23, C-1
  - supplementary, 5-16
  - tactical, 5-16, C-1
  - water crossing, 6-20
- offense
  - actions on the objective, 4-33
  - characteristics, 4-4
  - concept development, 4-20, 4-32, 4-37
  - consolidation, 4-26
  - forms of maneuver, 4-8 to 4-10
  - framework, 4-5
  - phases, 4-5
  - reorganization, 4-34
- orders, formats, G-1
  - fragmentary, G-3
  - mission, 2-6, 4-4, 4-5
  - operations, G-2
  - supplements, G-4
    - concept sketch, g-3, g-4
    - execution matrix, G-4, G-7 (illus)
    - operations schedule, G-7
    - overlays, G-4, G-5 (illus)
  - warning, G-2

orders group, 2-9, 2-14  
organization, 1-8 to 1-10 (illus)

patrol, combat, 6-24 TO 6-25  
patrol base, 6-35 TO 6-36  
penetration, 4-8, 4-37, 4-40, 4-42, 4-44  
perimeter defense, 5-40

personnel, key  
    duties, 2-6 to 2-9  
    locations, 1-5, 2-5, 3-2  
    succession of command, 2-9  
personnel services, 8-15  
    casualty report, 8-15 (illus)  
    replacements, 8-15, 8-17  
    witness statement, 8-15 (illus)

priority  
    of fires, 7-3, 7-9  
    of targets, 4-28, 7-9, 7-13  
    of work, 5-23, 5-24, 5-27  
pursuit, 4-6

quartering party, 6-11, 6-14, 6-16, 6-17

raid, 6-26  
readiness positions, 3-3  
reconnaissance, 3-1, 4-6, 4-23, 4-25, 4-29, 5-3, 5-11, 6-2,  
    6-5  
    leaders, 2-14, 2-19, 6-31  
    limited visibility, 4-21, 4-22, 4-30, 4-37, 4-44  
    plan, 2-12, 2-13, 2-24, 5-10, 5-23, 6-1, 6-19  
rehearsals, 2-13, 4-6, 4-25, 5-20, 5-21, 6-22, 7-13  
relationships, combat support  
    command  
        assigned, 7-1  
        attached, 7-1  
        operational control, 7-1  
        organic, 7-1  
    support  
        direct, 7-2  
        general, 7-2  
reorganization, 5-29, B-6  
reserves, 4-7, 4-15  
    battalion, 4-53, 4-55

- defense, 5-5
- employment, 5-18 (illus), 5-32, 5-33
- leader, 4-8
- missions, 4-8, 5-14
- size, 4-8, 5-14
- resupply plan, 2-34, 5-24, 5-27, 8-4, 8-6
  - aerial, 8-6, 8-7
  - backhauling, 8-7
  - cross-leveling, 8-7
  - foraging, 8-7, 8-14
  - scavenging, 8-7
  - transportation, 8-7
- reverse planning, 2-11
- reverse slope defense, 5-1, 5-2, 5-39
  
- screening fires, 7-13
- search and attack, 4-20, 4-22, 4-24
- sector sketch, 5-12, 5-24 TO 5-26
- security, 4-5, 4-6, 4-19, 4-54, 6-3, 6-30, 6-32, 6-33
  - active measures, 5-16
  - defense, 5-3, 5-5, 5-13
  - during movement, 3-2, 3-8, 3-9 (illus), 4-14, H-3
  - elements, 4-42
  - operations, 4-44
  - passive measures, 5-16
  - plan, 4-25
- security elements, 4-30, 4-40, 4-46, 6-24, 6-30
- sleep plan, 2-41
- soldier's load, 1-5, 2-14, 2-26, 4-5, 4-16, 5-12, 8-1
  - calculation, 8-12
  - combat load, 8-12, 8-13
  - contingency load, 8-12
  - management techniques, 8-13
  - planning, 8-10
  - sustainment load, 8-12
- standing operating procedures, 1-2, 1-4, 2-9, 2-11, 4-5, 4-22, 4-26
  - contingencies, 6-19
  - CSS, 8-3, 8-8, 8-9
  - medical support, 8-18
  - security, 3-2, 3-10, 3-11, 3-15
  - tactical, 2-9, 2-15, 2-16
- strongpoint
  - assault of, 4-37



- defense of, 5-47
- urban areas, 5-48
- supply
  - classes, 8-4 (illus)
  - distribution
    - caches, 8-6, 8-7, 8-14
    - in position, 8-5
    - logistics packages, 8-5, 8-7
    - out of position, 8-6
    - pre-positioned, 8-5, 8-6
    - water, 8-7
  - sergeant, 2-8
- support, battalion assets
  - antiarmor, 7-2, 7-3, 7-6
  - HMMWV, 7-2
  - M2, 7-2
  - MK19, 7-2, 7-3
  - mortars, 7-2, 7-3
  - scouts, 7-2, 7-3
  - snipers, 7-2, 7-3
  - TOW, 7-2
- support element, 4-29, 4-30, 4-31, 4-34, 6-20, 6-23, 6-24, 6-25 (illus), C-3, C-4 (illus)
- support units
  - air defense, 7-2, 7-5
  - close air support, 7-6
  - engineers, 7-6
  - field artillery, 7-3, 7-4 (illus)
  - military intelligence, 7-8
  - naval gunfire, 7-6
  - NBC defense company, 7-7
- sustainment techniques, 2-35
  - synchronization, 1-4, 1-5, 2-3 TO 2-5, 4-33
  
- tasks, mission-essential, 2-17
- task organization, 4-29
- techniques
  - control, 3-15
  - movement, 3-11
- tentative plan, 2-12, 2-38
- time schedule, 2-11, 2-12, 2-20, 2-28, 2-39
- TOW, 4-48, 5-14, 5-16, 5-17, 6-10, 6-13, 6-14, 7-2, I-7, J-2, J-3, J-11
- training, unit, 1-2
- troop-leading procedures, 2-10 to 2-13

turning movement, 4-9 (illus)

vehicles, heavy, I-7

M1 series tank, B-1

M2/M3 infantry fighting vehicle, B-2

M60A3 tank, B-1

M113 APC, B-3

M551 sheridan tank, B-2

war game, 2-33

defensive COAs, 2-32, 2-33

offensive COAs, 2-30

techniques, 2-27

weapons, locations, 3-2

withdrawals

not under pressure, 6-14, 6-15 (illus)

under pressure, 6-14, 6-17 (illus), 6-18

**FM 7-10**  
**14 DECEMBER 1990**

**By Order of the Secretary of the Army:**

**CARL E. VUONO**  
*General, United States Army*  
*Chief of Staff*

**Official:**

**THOMAS F. SIKORA**  
*Brigadier General, United States Army*  
*The Adjutant General*

**DISTRIBUTION:**

Active Army, USAR, and ARNG: To be distributed in accordance with DA Form 12-11E, requirements for FM 7-10, The Infantry Rifle Company (Infantry, Airborne, Air Assault, Ranger) (Qty rqr block no. 78)