

ARMY, MARINE CORPS, NAVY, AIR FORCE



**AIR LAND SEA
APPLICATION
CENTER**

TACTICAL RADIOS

***Multiservice Communications
Procedures for Tactical Radios
in a Joint Environment***

**FM 6-02.72 (FM 11-1)
MCRP 3-40.3A
NTTP 6-02.2
AFTTP(I) 3-2.18**

JUNE 2002

DISTRIBUTION RESTRICTION: Approved
for public release; distribution is unlimited.

MULTISERVICE TACTICS, TECHNIQUES, AND PROCEDURES

FOREWORD

This publication has been prepared under our direction for use by our respective commands and other commands as appropriate.

JOHN N. ABRAMS
General, USA
Commander
U.S. Army Training and Doctrine
Command

EDWARD HANLON, JR.
Lieutenant General, USMC
Commanding General
Marine Corps Combat
Development Command

R. G. SPRIGG
Rear Admiral, USN
Commander
Navy Warfare Development
Command

DAVID MACGHEE, JR.
Major General, USAF
Commander
Headquarters Air Force
Doctrine Center

**This publication is available on the
General Dennis J. Reimer Training
and Doctrine Digital Library at
www.adtdl.army.mil**

PREFACE

1. Scope

This publication discusses current voice and data tactical radio systems in common use between the services. It describes recent updates to the Single-Channel Ground and Airborne Radio System (SINCGARS), including the Advanced System Improvement Program (ASIP) and the Internet controller (INC). It also reviews the operational procedures for SINCGARS for both analog and digital operations in a joint environment. This manual also describes the Enhanced Position Location Reporting System (EPLRS).

2. Purpose

This publication standardizes joint operational procedures for SINCGARS and provides an overview of the multiservice applications of EPLRS.

3. Application

This publication applies to the Army, Navy, Air Force, and Marine Corps. It may also be used by multiservice and service components of a joint force to conduct SINCGARS and EPLRS training and operations. Procedures herein may be modified to fit specific theater command and control (C²) procedures, and allied and foreign national electromagnetic spectrum management requirements.

4. Implementation Plan

Participating service command offices of primary responsibility (OPRs) will review this publication, validate the information, and reference and incorporate it within service manuals, regulations, and curricula as follows:

Army. The Army will incorporate the procedures in this publication in U.S. Army doctrinal and training publications as directed by the Commander, U.S. Army Training and Doctrine Command. Distribution is in accordance with IDN 115419.

Marine Corps. The Marine Corps will incorporate the procedures in this publication in U.S. Marine Corps doctrinal and training publications as directed by the Commanding General, U.S. Marine Corps Combat Development Command. Distribution is in accordance with the Marine Corps Publication Distribution System (MCPDS).

Navy. The Navy will incorporate these procedures in U.S. Navy doctrinal and training publications as directed by the Commander, Navy Warfare Development Command (NWDC). Distribution is in accordance with the MILSTRIP Desk Guide and NAVSOP Pub 409.

Air Force. The Air Force will validate and incorporate appropriate procedures in accordance with applicable governing directives. Distribution is in accordance with Air Force instruction (AFI) 33-360.

5. User Information

a. The Air Land Sea Application (ALSA) Center developed this publication with the joint participation of the approving service commands. ALSA will review and update this publication as necessary.

b. This publication reflects current joint and service doctrine, C² organizations, facilities, personnel, responsibilities, and procedures. Changes in service protocol that should be reflected in joint and service publications will be incorporated in revisions to this document, as appropriate.

c. Recommendations and comments for improving this publication are encouraged. Key your comments to the specific page and paragraph and provide a rationale for each recommendation. Send comments and recommendations directly to the contacts listed below.

Army

Commander
U.S. Army Training and Doctrine Command
ATTN: ATDO-A
Fort Monroe, VA 23651-5000
DSN 680-3153 COMM (757) 727-3153

Marine Corps

Commanding General
U.S. Marine Corps Combat Development Command
ATTN: C42 (Director)
3300 Russell Road, Suite 318A
Quantico, VA 22134-5021
DSN 278-6234 COMM (703) 784-6234

Navy

Commander
Navy Warfare Development Command
ATTN: N5
686 Cushing Road
Newport, RI 02841-1207
DSN 948-2763 COMM (401) 841-2763
E-mail Address: webdoctrine@nwdc.navy.mil

Air Force

HQ Air Force Doctrine Center
ATTN: DJ
216 Sweeney Boulevard, Suite 109
Langley AFB, VA 23665-2722
DSN 574-8091 COMM (757) 764-8091
E-mail Address: afdc.dj@langley.af.mil

ALSA

ALSA Center
ATTN: Director
114 Andrews Street
Langley AFB, VA 23665-2785
DSN 575-0902 COMM (757) 225-0902
E-mail Address: alsa.director@langley.af.mil

*FM 6-02.72 (FM 11-1)
 *MCRP 3-40.3A
 *NTTP 6-02.2
 *AFTTP(I) 3-2.18

FM 6-02.72 (FM 11-1)	U.S. Army Training and Doctrine Command Fort Monroe, Virginia
MCRP 3-40.3A	U.S. Marine Corps Combat Development Command Quantico, Virginia
NTTP 6-02.2	Navy Warfare Development Command Newport, Rhode Island
AFTTP(I) 3-2.18	Headquarters Air Force Doctrine Center Maxwell Air Force Base, Alabama

14 June 2002

TACTICAL RADIOS

Multiservice Communications Procedures for Tactical Radios in a Joint Environment

TABLE OF CONTENTS

	Page
EXECUTIVE SUMMARY	vii
CHAPTER I SINGLE-CHANNEL GROUND AND AIRBORNE RADIO SYSTEM (SINGGARS).....	I-1
Section A. System Overview	I-1
Background.....	I-1
System Description.....	I-2
System Components	I-3
Advanced System Improvement Program (ASIP) Radio....	I-5
Internet Controller	I-7
Section B. Radio Operations	I-9
Modes of Operation	I-9
FH NET Operations	I-10
Loadset Distribution (FH and COMSEC Data)	I-10
Net Opening.....	I-10
FH Sync Time Management	I-11

*This publication supersedes FM 11-1, dated May 1996, MCRP 6-2.2.2, NDC TACMEMO 3-13.1, ACCPAM/PACAFPAM/USAFEPAM 33-154.

	Late Net Entry	I-11
	FH Mixed Net Operation	I-12
CHAPTER II	MULTISERVICE OPERATIONAL PROCEDURES	II-1
	Section A. Functions and Responsibilities	II-1
	Joint Chiefs of Staff (JCS)	II-1
	Joint Force Command (JFC).....	II-1
	C ⁴ Systems Directorate (J-6).....	II-1
	Section B. Planning	II-3
	Frequency Management Responsibilities	II-3
	Equipment	II-5
	SINGARS Loadset Data	II-6
	Section C. SINGARS Data Distribution	II-8
	General	II-8
	Physical Distribution	II-9
	Electronic Distribution.....	II-9
	Distribution within the JTF	II-9
	Distribution within Services and Components.....	II-11
CHAPTER III	SUPPORT EQUIPMENT	III-1
	Army Equipment.....	III-1
	Marine Corps Equipment	III-4
	Navy Equipment	III-6
	Air Force Equipment.....	III-8
CHAPTER IV	ENHANCED POSITION LOCATION REPORTING SYSTEM (EPLRS).....	IV-1
	Introduction	IV-1
	EPLRS Context and Capabilities	IV-1
	EPLRS Planning	IV-1
	EPLRS Network Management	IV-2
	EPLRS Applications.....	IV-2
	EPLRS Technical Description and Characteristics.....	IV-2
	Future Upgrades	IV-2
	Joint Services Considerations	IV-3
	Service Applications.....	IV-4
APPENDIX A	EQUIPMENT LISTING	A-1
APPENDIX B	COMPARISON OF ICOM AND NON-ICOM RADIOS	B-1
REFERENCES	References-1	
GLOSSARY	Glossary-1	
INDEX	Index-1	

FIGURES

I-1	Joint Forces Communications Overview	I-1
I-2	Radio Set Components.....	I-3
I-3	Airborne AN/ARC-210 RT-1794.....	I-4
I-4	Front Panel ICOM Radio RT-1523/A/B/C/D.....	I-5
I-5	Front Panel ICOM Radio RT-1523E.....	I-5
I-6	Tactical Internet	I-8
II-1	Standard Frequency Action Format (SFAF) Example	II-4
II-2	SFAF Example for SINCGARS.....	II-4
II-3	Echelons Capable of Generating FH Data	II-6
II-4	Task by Echelon in Joint Operations.....	II-10
II-5	Loadset Data Distribution within Army Units	II-11
II-6	Loadset Data Distribution within Marine Corps Units.....	II-14
II-7	Loadset Distribution within Naval Forces	II-15
II-8	Loadset Data Distribution within Air Force Units	II-16
III-1	ACMES Functional Elements	III-2
III-2	ACMES Phase II.....	III-3
III-3	Basic RBECS System	III-6
III-4	NKMS Functional Components	III-8
III-5	AFKDMS Functional Components	III-9
IV-1	Host Tactical System Interfaces to an EPLRS RS	IV-3
IV-2	Army TI Brigade and Below Architecture	IV-4
IV-3	Integration of FBCB2.....	IV-5
IV-4	Marine Corps Application	IV-6
IV-5	Amphibious Assault Direction.....	IV-8
IV-6	SADL.....	IV-9

TABLES

II-1	COMSEC/FH Data Distribution within a JTF/Theater	II-7
II-2	Summary of Transfer Methods for Units without an ANCD	II-9
III-1	Sample CEOI/SOI.....	III-5
B-1	Common Fill Devices Used with SINCGARS	B-1
B-2	Voice Transmission Maximum Planning Ranges.....	B-2

EXECUTIVE SUMMARY

Tactical Radios

Overview

Joint Vision (JV) 2020, a conceptual template for America's armed forces, will guide the application of combat power in the information age. JV 2020 predicts that joint and, where possible, combined operations will be paramount in defeating postulated threats in the future. The key to effective employment of joint and/or combined forces lies in the JV 2020 tenet of information dominance. This concept envisions using modern communications capabilities and computers to enable commanders, planners, and shooters to acquire and share information rapidly. The enhanced ability to share information improves the ability to find and target the enemy quickly and precisely.

Joint and combined operations mandate the requirement for the exchange of information, both voice and data, among and between participating forces. The fielded capabilities of the Single-Channel Ground and Airborne Radio System (SINCGARS) tactical radio have been effective in providing secure, low probability of intercept/electronic attack voice communications in the frequency hop (FH) mode for the implementing forces. Enhancements to SINCGARS provide for the exchange of secure data through the evolving Army and Marine Corps tactical Internets, enabling increased situational awareness and more expedient engagement of the enemy while reducing the probability of fratricide. In addition, the Enhanced Position Location Reporting System (EPLRS) is used by military forces to provide command and control (C²) data distribution, battlefield situation awareness, and position location services.

Operations

This publication provides an overview of the doctrinal procedures and guidance for using the SINCGARS tactical radio on the modern battlefield. This manual serves as a reference document for employing SINCGARS as a secure, low probability of intercept/electronic attack FH communications system. It briefly addresses the SINCGARS capability to transmit data as part of the combat net radio (CNR) system. This manual also provides operators and supervisors with basic guidance and reference to operating instructions. It gives the system planner the information necessary to plan the SINCGARS network, including interoperability considerations and equipment capabilities. This manual also reviews the multiservice applications of EPLRS. This manual does not replace field manuals or technical manuals governing tactical deployment or equipment use.

System Characteristics

The CNR network is designed around the SINCGARS, the high frequency (HF) radio, and the SC tactical satellite (TACSAT). Each system has different capabilities and transmission characteristics. SINCGARS is a family of user-owned and operated, very high frequency-frequency modulation (VHF-FM) CNRs. As a part of the CNR network,

the SINCGARS' primary role is voice transmission for C² between surface and airborne C² assets. SINCGARS has the capability to transmit and receive secure data and facsimile transmissions through simple connections with various data terminal equipment. SINCGARS electronic attack security features provide multiservice, Army, Marine, Navy, and Air Force communications interoperability, thus contributing to successful combat operations. SINCGARS is consistent with North Atlantic Treaty Organization interoperability requirements.

This publication provides the approved multiservice SINCGARS communication procedures for both physical and electronic interservice transfer of SINCGARS electronic protection (EP) information and communications security (COMSEC) keys necessary for jam-resistant and secure operations.

Effective command, control, and communications among all the services is possible because common characteristics are available among all SINCGARS versions to permit interoperability.

Planning and Execution

The heart of this publication is the information on the planning and execution of operational procedures for employing SINCGARS. These procedures include the necessary responsibilities of the joint communications staff in managing SINCGARS. They also cover the availability, distribution, and management of EP variables and COMSEC keys. This publication also provides updated information on the application of EPLRS by each of the services.

Chapter I

Single-Channel Ground and Airborne Radio System (SINGGARS)

In line with digitization efforts, the Single-Channel Ground and Airborne Radio System (SINGGARS) has evolved over the past decade with improved and enhanced capabilities and performance. As the services deploy the tactical Internet, SINGGARS will be there to provide the gateway to and connectivity with other communications systems.

Section A. System Overview

1. Background

Air, land, and sea forces all require effective communications for command and control (C²). For a wide variety of combat forces, single-channel (SC) very high frequency-frequency modulation (VHF-FM) combat net radio (CNR) systems provide this capability. The VHF-FM channels are especially important for support of ground operations and forces. Figure I-1 illustrates the various combat forces that rely on VHF-FM for C².

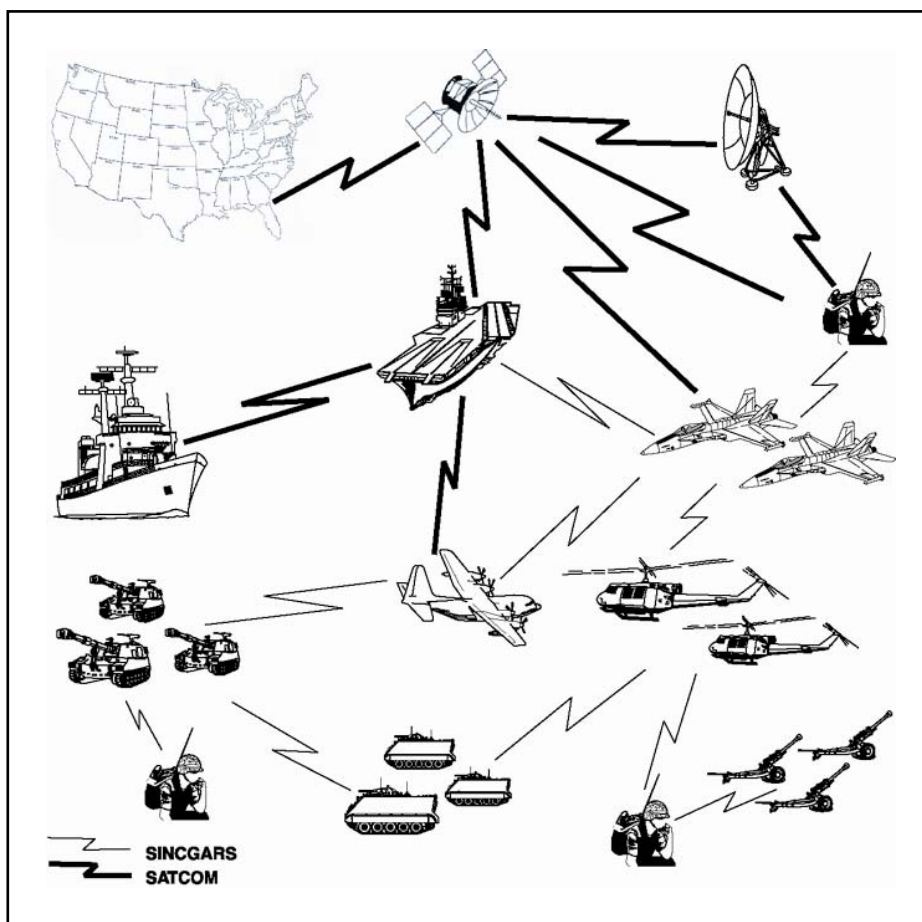

Figure I-1. Joint Forces Communications Overview

2. System Description

a. The SINCGARS is a family of VHF-FM radio sets. Originally a voice-only system, the SINCGARS has evolved into a total communications system that combines data and voice with a networking capability. It is designed to operate in various hostile (including nuclear) environments.

b. The SINCGARS is designed on a modular basis to achieve maximum commonality among various ground, maritime, and airborne configurations. A common receiver-transmitter (RT) is used in the ground configurations. The modular design also reduces the burden on the logistics system to provide repair parts.

c. The SINCGARS can operate in either the SC or frequency hop (FH) mode, and stores both SC frequencies and FH loadsets. The system is compatible with all current U.S. and allied VHF-FM radios in the SC, non-secure mode.

d. The SINCGARS operates on any of 2320 channels between 30 and 88 megahertz (MHz) with a channel separation of 25 kilohertz (kHz). It accepts either digital or analog inputs and superimposes the signal onto a radio frequency (RF) carrier wave. In FH mode, the input changes frequency about 100 times per second over portions of the tactical VHF-FM range. These continual changes in frequency hinder threat intercept and jamming units from locating or disrupting friendly communications.

e. The SINCGARS provides data rates up to 16,000 bits per second. Enhanced data modes provide packet and RS-232 data. The enhanced data modes available with the System Improvement Program (SIP) and Advanced System Improvement Program (ASIP) radios also enable forward error correction (FEC), and increased speed, range, and accuracy of data transmissions.

f. Most ground SINCGARS radios have the ability to control output power; however, most airborne SINCGARS radio sets are fixed power.

g. Those RTs with power settings can vary transmission range from approximately 200 meters (660 feet) to 10 kilometers (km) (6.2 miles). Adding a power amplifier increases the line of sight (LOS) range to approximately 40 km (25 miles). (These ranges are for planning purposes only; terrain, weather, and antennae height have an effect on transmission range.) The variable output power level allows users to operate on the minimum power necessary to maintain reliable communications, thus lessening the electromagnetic signature given off by their radio sets. This ability is of particular importance at major command posts, which operate in multiple networks.

h. SC CNR users outside the FH network can use a hailing method to request access to the network. When hailing a network, a user outside the network contacts the network control station (NCS) on the cue frequency. In the active FH mode, the SINCGARS radio gives audible and visual signals to the operator that an external subscriber wants to communicate with the FH network. The SINCGARS operator must change to the cue frequency to communicate with the outside radio system.

i. The network can be set to a manual frequency for initial network activation. The manual frequency provides a common frequency for all members of the network to verify that the equipment is operational. During initial net activation, all operators in the net tune to the manual frequency. After communications are established, the net

switches to the FH mode and the NCS transfers the hopping variables to the out stations.

j. SINCGARS is capable of retransmission in SC, FH, and combined FH and SC modes.

3. System Components

a. Figure I-2 shows the components of the SINCGARS. Service-specific radio set component information can be found in appendix A, Equipment Listing.

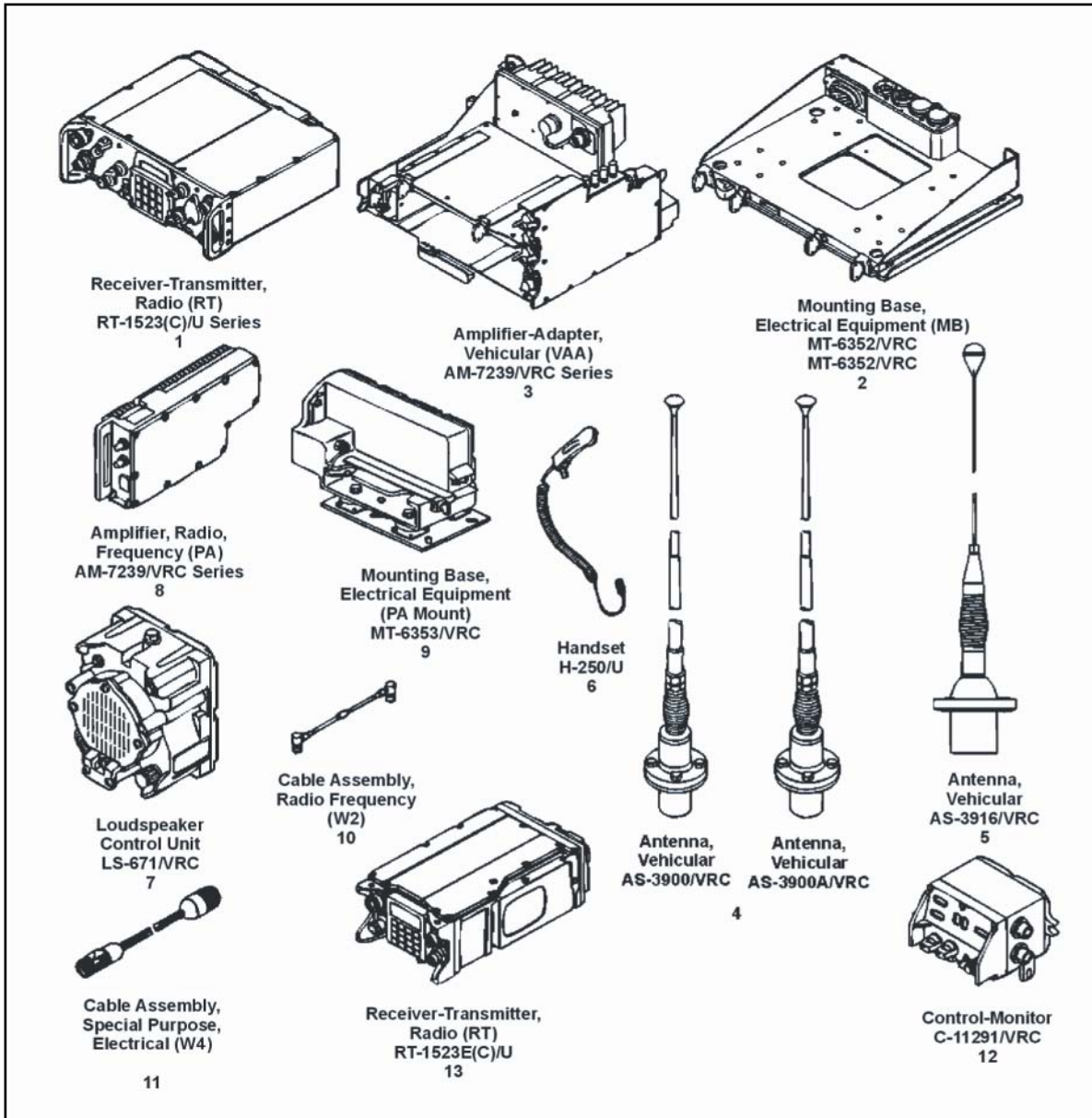

Figure I-2. Radio Set Components

b. The RT is the core component of the SINCGARS. There are several airborne, ground, and maritime versions of the RT. Most airborne versions require external communications security (COMSEC) devices. Figure I-3 shows a typical airborne RT configuration. Most ground-based and maritime radio sets use the RT-1523/A/B/C/D (Figure I-4) or the RT-1523E (Figure I-5). The RT-1523, RT-1794, and RT-1824 series have internal COMSEC circuits, which give these RTs integrated communications security (ICOM) designation. The ground versions of the RT-1523 are equipped with a whisper (WHSP) mode for noise restriction during patrolling or while in defensive positions. The operator whispers into the handset and is heard at the receiver in a normal voice. Airborne, maritime, and ground versions are interoperable in FH and SC operations. However, the installation procedures and data-capable terminal requirements for airborne versions differ from those of the maritime and ground versions.

Note: In this manual, the term SINCGARS pertains to all ground, maritime, and airborne versions. Exceptions are noted in the text.

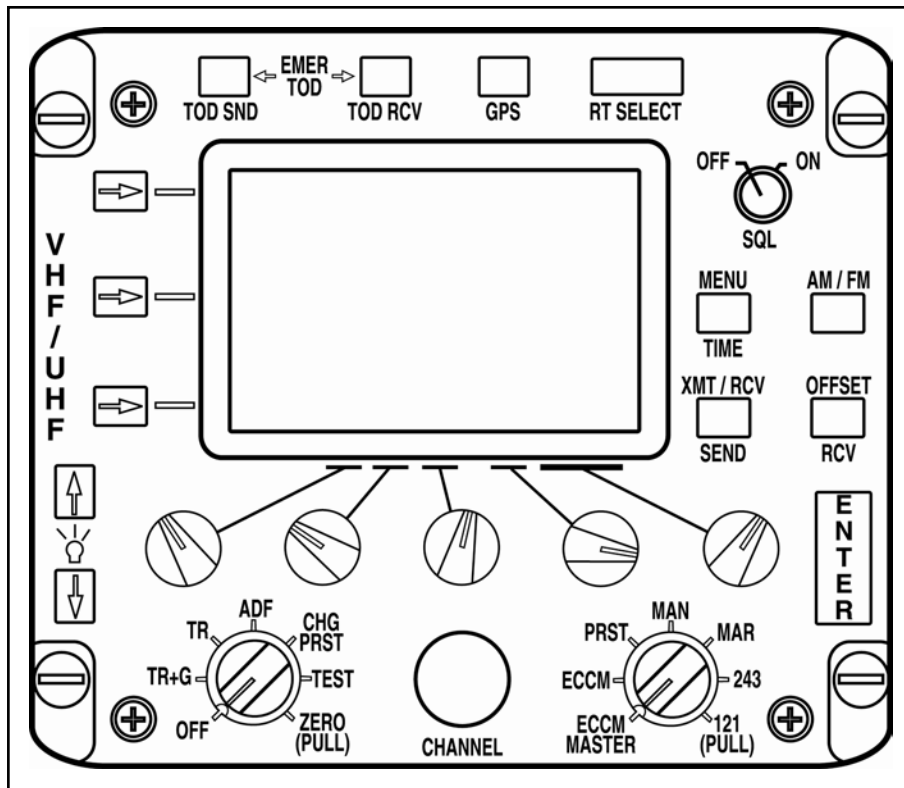

Figure I-3. Airborne AN/ARC-210 RT-1794

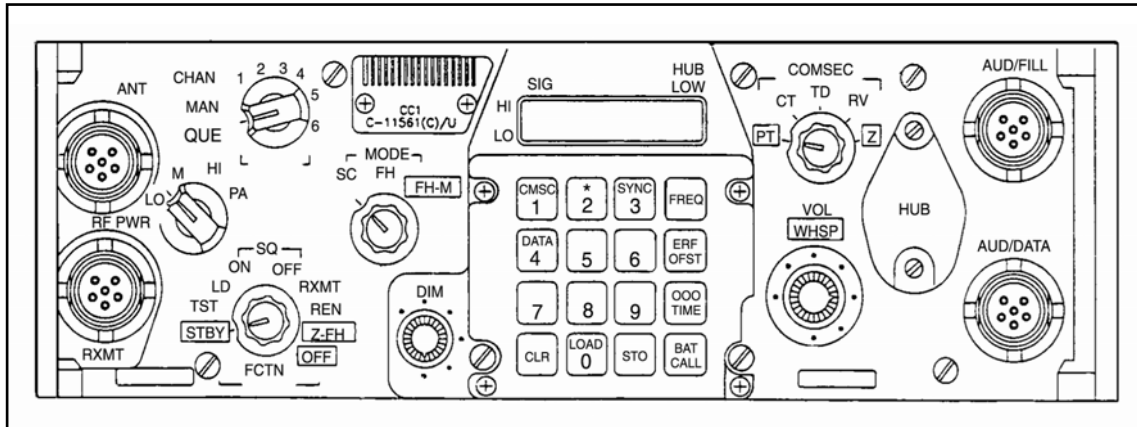

Figure I-4. Front Panel ICOM Radio RT-1523/A/B/C/D

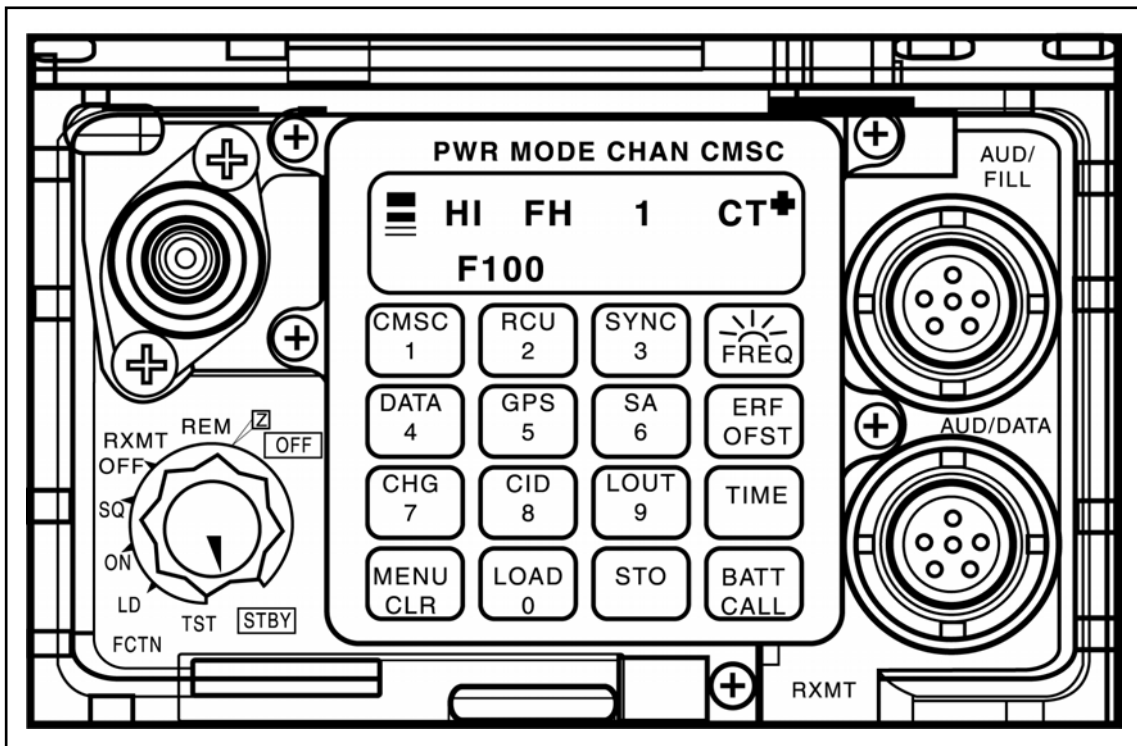

Figure I-5. Front Panel ICOM Radio RT-1523E

4. Advanced System Improvement Program (ASIP) Radio

a. Background. The SIP increased the communications functionality and capability of the SINCGARS. The SIP radio incorporated features such as an interface to an external precision lightweight global positioning system receiver (PLGR), improved FEC, and packet routing. These improvements, along with the introduction of the Internet controller (INC) card, provided the mechanics for Internet Protocol (IP) routing between radio nets and other communications systems (Enhanced Position Location Reporting

System (ELPRS), local area networks (LANs), etc. The introduction of IP routing revolutionized the way data is moved across the battlefield.

b. The Advanced System Improvement Program (ASIP) radio is a repackaged RT-1523C SIP radio. It is physically one-half the width, and one-third the weight of a full size radio. Along with the INC, the ASIP represents a major leap forward from the SIP's ability to access and distribute data across the battlefield. Another significant improvement to the radio is its reduction in weight and size over the existing SINCGARS radios. This reduction is mainly attributable to the internal redesign of the radio and to taking advantage of a software-based digital signal processing (DSP) architecture. SINCGARS participated in the Army's Task Force XXI Advance Warfighter Exercises in which the utilization of the tactical Internet and packet data were deployed for the very first time. Although this deployment proved that the concept of the tactical Internet was achievable, there were many factors that affected the performance of the communication systems. Chiefly among them were the effects of co-site, intranet surfing, voice and data contention, and the amount and frequency of data being placed on the net. To address these deficiencies, the ASIP radio incorporates an enhanced system improvement program (ESIP) waveform. This waveform implements faster synchronization between radios, which reduces the interference between voice and data transmissions, thus reducing voice and data contention problems associated with shared voice and data networks. The ESIP waveform includes optimizations to the algorithms of the noisy channel avoidance (NCA) scheme, the time of day (TOD) tracking scheme, and the end of message (EOM) scheme. The enhancements to these algorithms are described below.

(1) NCA scheme. NCA is a synchronization detection scheme in which the radio monitors a certain frequency every two seconds looking for synchronization information. If the RF environment is noisy, the radio invokes the NCA scheme. In previous radio models, the NCA algorithm would direct the radio to continue searching for other frequencies with less noise or interference. The new NCA algorithm instructs the ASIP radio to revert to a known good frequency, thus increasing the FH synchronization probability in high noise and jamming conditions.

(2) TOD tracking scheme. The ASIP radio uses an improved TOD tracking algorithm to minimize TOD error in high traffic conditions. The new algorithm makes use of a known reference bit between the transmitter and receiver's RF transmission, thus assuring that the time constants are the same during each transmission.

(3) EOM scheme. The ASIP radio includes extra EOM hops to increase the detection of transmissions and probability of synchronizing radios on the net. In a high noise environment, this feature reduces the effects of a condition known as "fade bridging"—a condition in which the receiver experiences a five-second noise burst (white noise), even though the message transmission is completed.

c. The ASIP radio also implements both a new FEC feature and an external interface to the PLGR. These features allow for the utilization of an accurate time standard to aid in the frequency hopping algorithm and provide a position reporting system among SINCGARS nets. With a PLGR attached, the user can enable a situational awareness (SA) mode on the radio, which allows the operator to report his position every time a push-to-talk (PTT) is initiated.

d. The ASIP radio incorporates all the same functionality and features of the full size SIP radio. Range performance is the same as the existing SINCGARS SIP radios in both dismounted and vehicular configurations. Power consumption is reduced, therefore increasing the usefulness of the primary battery to over 33 hours of mission life at a 9:1 duty cycle. The ASIP radio, much like the INC, is fully field re-programmable, and is capable of supporting future growth or hosting a different waveform.

5. Internet Controller

The INC card was introduced as part of the SINCGARS Vehicular Amplifier Adapter (VAA). This card is required to allow access to the tactical Internet. The INC card acts as an IP router, providing access to and distribution of packet data. The packet mode of operation must be selected in order for the system to operate correctly. In packet mode, the card either routes data to a member within the same operational net (intranet) or, acting as a gateway, routes data to members outside the SINCGARS net (Internet). The INC performs switching and buffering of data inputs between computer hosts, the SINCGARS, the EPLRS, and other communication systems. A typical configuration of a communications node participating in the tactical Internet is shown in Figure I-6.

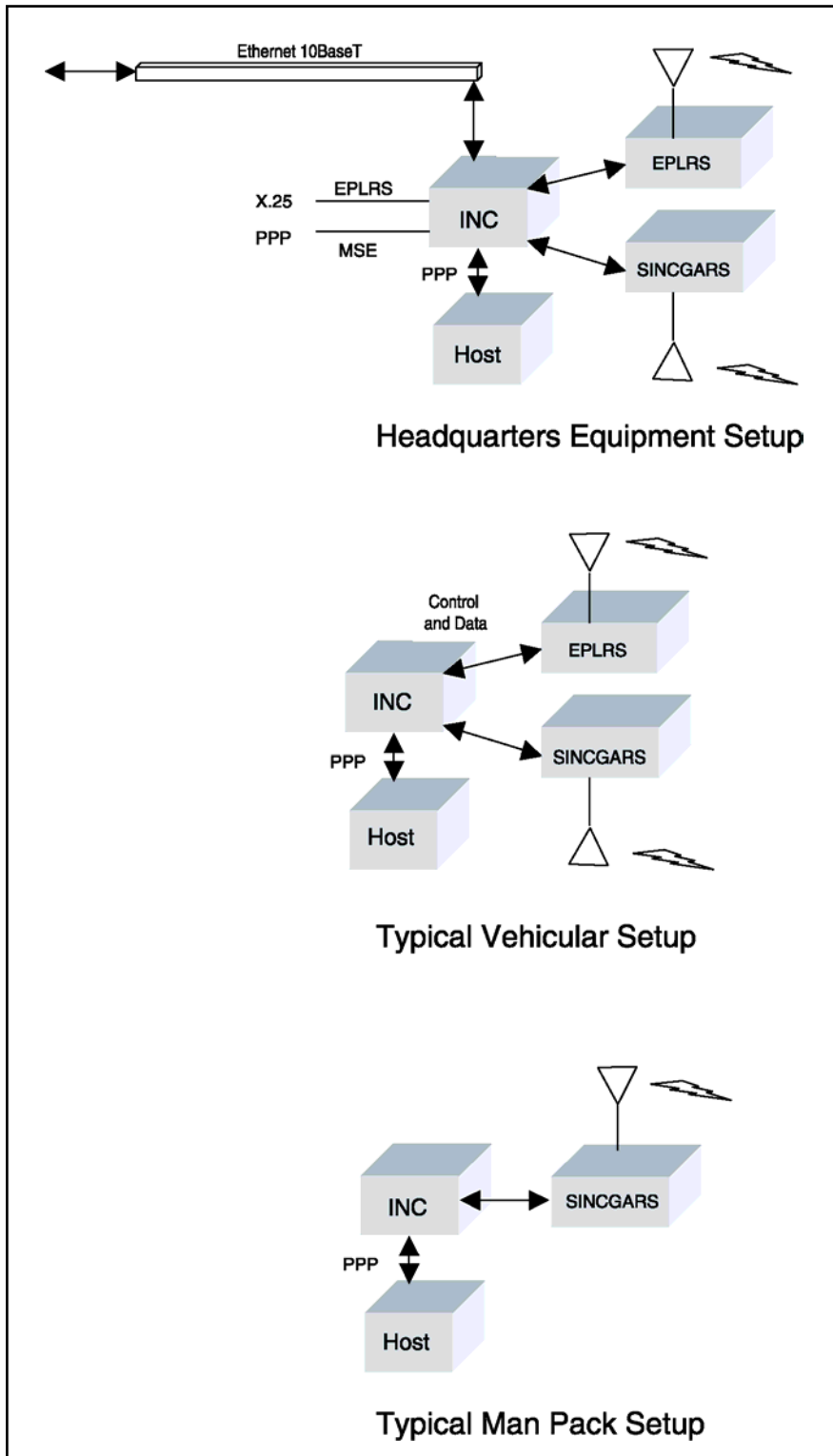

Figure I-6. Tactical Internet

Section B. Radio Operations

1. Modes of Operation

a. Operating Modes. SINCGARS radios offer a range of operating modes to commanders. These modes include SC and FH in both cipher text (CT) and plain text (PT).

b. Considerations. When establishing SINCGARS nets, commanders must consider the mission, availability, and capabilities of SINCGARS communications equipment, electronic attack (EA) capabilities of adversary forces, and U.S. national security policy. SC PT operations provide ease of operation but no security or protection. FH CT operations provide both message traffic security and EA (jamming and direction finding) resistant transmissions. FH CT communication protects both the message and the sender.

c. SC Mode. SINCGARS radios can store SC frequencies and offsets. SC frequencies and offsets (plus or minus 5 or 10 kHz) are entered manually through the radio's keypad. When operating in the FH mode, two of the SC presets are reserved for the manual and cue channels (non-ASIP ICOM only). SINCGARS is voice interoperable with all SC radios operating in the SINCGARS frequency range and channel spacing.

d. FH Mode. SINCGARS radios can store FH data for unique FH nets. SINCGARS radios require four data elements to communicate in the FH mode. The data elements are: hopsets/lockouts; net identification (ID); net sync time; and transmission security key (TSK). Once FH data is loaded, the user moves from one FH net to the other by selecting another FH net using the channel selector switch (non-ASIP ICOM only). In addition, users in nets sharing a common hopset, TSK, and sync time can also move from net to net by entering the appropriate net ID. The ASIP ICOM radio does not have a channel select switch. With the ASIP ICOM radio, switching hopsets is accomplished by switching to the NCS mode. Move the position select knob to "load", press "freq", press "menu clear", enter the last two numbers of the hopset, press "STO" and select the channel where the hopset is to be stored.

(1) Hopsets/lockouts. The hopset is the set of frequencies (2320 frequencies minus protected frequencies) on which an FH net hops. Hopsets are electronically loaded and stored in the radio. SINCGARS radios have the capability of storing a unique hopset in each preset FH channel. Lockouts provide frequency exclusions in conjunction with a hopset.

(2) Net IDs. The net ID is a three-digit number from 000 to 999 that distinguishes one FH net from another when all other FH data elements are the same. Unique net IDs may be stored in each FH preset channel. Net IDs, embedded in the hopset data, are loaded electronically with a fill device or by electronic remote fill (ERF) and may be changed using the keypad or control panel of the SINCGARS RT.

(3) Sync time. Sync time is required for synchronization of the frequency hops. Sync time consists of the last two digits of the Julian date (SINCGARS Julian Date) plus a six-digit time (hours:minutes:seconds). Each station in the FH radio net must be within plus or minus four seconds of the net sync time to communicate.

(4) TSK. The TSK is a generated variable that controls the pseudo-random FH pattern. A TSK must be loaded into the SINCGARS radio prior to opening an FH net.

TSKs are electronically loaded into the radio with a fill device. After net opening, the TSK may be transferred by ERF.

(5) FH-Master (FH-M) mode. Only one radio in each FH radio net will use this mode. The FH-M radio maintains the radio net's sync time and performs the ERF. Normally the designated NCS or alternate NCS will operate in the FH-M mode.

(6) CT communications. CT operations require a traffic encryption key (TEK). A key encryption key (KEK) is required for over-the-air rekey (OTAR). TEK and KEK are electronically loaded and stored in the radio or external security equipment.

(7) The TEK is used in CT operation and encrypts/decrypts operational voice and digital data transmissions

(8) The KEK encrypts/decrypts TEKs and is used for OTAR of TEKs.

e. PT Operation. SINCGARS radios are also capable of PT operation (either SC or FH). When operating with radios that do not have a CT capability and/or are operating in PT, a SINCGARS radio in the CT mode can monitor PT communications. A beep tone informs the SINCGARS operator that the incoming message is in PT rather than CT.

2. FH NET Operations

The joint task force (JTF) command, control, communications, and computer (C⁴) systems directorate of a joint staff (J-6) has overall responsibility for ensuring interoperability of SINCGARS nets. All services currently have, and are continuing to deploy, SINCGARS and/or SINCGARS-compatible FH CNRs. Forces assigned to a JTF will follow these SINCGARS procedures provided in the following paragraphs.

3. Loadset Distribution (FH and COMSEC Data)

a. A SINCGARS radio loadset consists of FH and COMSEC data. Only designated operators may transfer FH and COMSEC data physically from device to device, transmit the data electronically, or use a combination of physical and electronic means. The lowest operational echelon will normally distribute and store loadsets consistent with the availability of fill devices, security arrangements, and operational needs.

b. The controlling authority (CONAUTH) and JTF J-6 provide COMSEC and FH data to users. However, the CONAUTH provides only that amount necessary to satisfy operational requirements consistent with distribution capabilities. Organizations will deploy with the amount of data necessary to satisfy initial operational requirements consistent with distribution capabilities. The storage of reserve loadsets at selected echelons facilitates rapid distribution, reduces risk, and minimizes the impact of loss of a storage device in the forward area

4. Net Opening

a. NCS can open FH nets using either hot or cold start net opening procedures. The preferred method is to open the net using hot start procedures. Before opening a net, the NCS must receive FH and COMSEC data.

b. Hot start net opening. Each member in the net loads all FH and COMSEC data into the radio, including sync time. The operator enters the net by contacting the NCS.

c. Cold start net opening. Net stations receive their ERF from their NCS on the manual channel in the FH CT modes, store it in the appropriate channel, switch over to that channel, and enter the net. Operators load all FH and COMSEC data, except sync time, into the radio prior to cold start net opening.

5. FH Sync Time Management

a. SINCGARS radio operators will open and maintain their nets on precise time zone indicator for universal (global positioning system (GPS) ZULU) time. Use of GPS ZULU time ensures ease of FH net opening, late net entry, and commanders' ability to enter and monitor all their FH nets. NCSs manage time for their nets. To prevent FH radio nets from drifting off precise GPS ZULU time (plus or minus four seconds), the NCS will update sync time daily from GPS to ensure cross-net communications capabilities. Each time the NCS radio transmits, all radios on the net that receive the transmission are incrementally resynchronized to NCS sync time. As a minimum, the NCS will transmit every four hours in FH-M mode.

b. A net member can obtain FH sync time from any one of three methods. The model/version of SINCGARS and the available time sources (e.g., PLGR or automated net control device (ANCD)) determine the method for loading time. Methods are—

(1) ERF (net opening and update).

(2) Electronic fill from:

(a) ANCD (RT-1523A and B versions).

(b) GPS receivers, such as the AN/PSN-11, AN/ARN-151, PLGR (RT-1523A, and RT-1523B versions).

(3) Entering time manually. Time can be entered manually (by obtaining a GPS time hack) through the SINCGARS radio front panel keypad.

6. Late Net Entry

A radio loaded with all FH and COMSEC data that drifts off sync time may be resynchronized by one of three methods:

a. Entering GPS ZULU time.

b. Enabling passive late net entry. The SINCGARS radio has a built-in capability to resynchronize itself when out of synchronization by more than plus or minus 4 seconds but less than plus or minus 60 seconds. When the operator enables the late net entry mode, the radio is brought back into the net without further action by the operator.

c. Activating cue and ERF. If a SINCGARS station must enter an FH CT net and has the correct TSK and TEK, the station may contact the net by changing to the cue frequency, pressing PTT and waiting for the NCS to respond. This action by the operator causes the message cue indicator to appear in the display of the NCS radio. Normally only selected NCSs, their alternate NCSs, or other designated stations, will load, monitor, and respond on the cue frequency.

7. FH Mixed Net Operation

When operating with SC radios, a SINCGARS mixed-mode retransmission site/station can provide communications between an SC station/net and an FH net without requiring all stations to operate in the vulnerable SC mode. To reduce the risk of being targeted by enemy direction finding equipment, locate mixed-mode retransmission sites away from any friendly position.

Note. Operate SINCGARS radios in the SC mode only when absolutely necessary.

Chapter II

Multiservice Operational Procedures

Achieving effective communications among all users of SINCGARS-compatible radios on the modern battlefield requires detailed planning and coordination at multiple echelons within a JTF. This chapter describes the respective functions and responsibilities of the joint forces, services, and key personnel, with respect to SINCGARS operations.

Section A. Functions and Responsibilities

1. Joint Chiefs of Staff (JCS)

The JCS provides overall guidance on joint U.S. military frequency engineering and management. The JCS have delegated certain authority to carry out this responsibility to the chairman of the Military Communications-Electronics Board (MCEB). The Chairman of the Joint Chiefs of Staff (CJCS) reserves the authority to resolve disputes.

2. Joint Force Command (JFC)

The JFC is responsible for all facets of communications in the area of operations. The JFC delegates the authority for communications coordination to the communications or signal special staff office J-6. Multiservice coordination maintains interoperability, establishes total force requirements, and reconciles the unique needs of each service.

3. C⁴ Systems Directorate (J-6)

a. The JFC's J-6 is a functionally organized staff that controls and coordinates joint signal services for all elements in the joint operation or exercise. Normally, the J-6 is responsible for the following when a joint force is using SINCGARS-compatible radios:

- (1) Designating and distributing joint net FH data variables.
- (2) Publishing standing operating procedures (SOPs) for communications.
- (3) Providing frequency management.
- (4) Coordinating with the host government for frequencies.
- (5) Controlling COMSEC assignment and use.
- (6) Establishing and assigning net ID numbers for joint nets.

b. The J-6 publishes procedures for the following actions in the operations plans (OPLANs) and operations orders (OPORDs):

- (1) Operating in SC and FH modes.
- (2) Using loadsets.
- (3) Assigning and using TSKs.
- (4) Determining applicable dates for net configurations.
- (5) Assigning net ID numbers for joint nets.

- (6) Establishing common network time.
- (7) Developing key management plans.
- (8) Developing emergency destruction plans.

c. In joint operations, all services in the same tactical operating area will use SINCGARS-compatible radios. Frequency management must occur at the highest multiservice command level. For effective operations, a communications coordination committee should be composed of assigned J-6 personnel and necessary augmentation personnel. The communications coordination committee should include:

- (1) The COMSEC custodian and/or communications-electronics operating instruction (CEOI) manager from the appropriate staff section.
- (2) The special plans officer from the operations directorate of a joint staff (J-3) plans section.
- (3) The host-country frequency coordinator.
- (4) Frequency managers from the joint and service frequency management office.
- (5) The aviation officer from the operations directorate of a joint staff (J-3) office.

d. The communications coordination committee should be identified and available prior to the execution of the operations plan. They must be knowledgeable of service-unique communications requirements. They must also be knowledgeable about the operation and management of SINCGARS computer-based data management systems (i.e., the Joint Automative CEOI System (JACS) or Revised Battlefield Electronics CEOI System (RBECS), the Air Force key data management system (AFKDMS), etc.) and fill devices.

e. The communications coordination committee liaisons with the intelligence directorate of a joint staff (J-2) and the J-3 section for planning electronic warfare (EW). The J-3 establishes the joint commander's electronic warfare staff (JCEWS) for planning EW operations. The JCEWS normally consists of the J-2, J-3, electronic warfare officer (EWO), J-6, and representatives from component services.

f. The JCEWS coordinates all EW emissions in the joint arena. After coordination is complete, the J-6 publishes a joint restricted frequency list (JRFL). It specifies the frequency allocations for communication and jamming missions restricted from use by anyone except those performing the jamming mission. The JFC has final approval of the JRFL, which must be continually updated to maximize effectiveness of EW assets and communications systems. The JFRL should contain only those frequencies that, when jammed, would jeopardize the mission and endanger personnel. A JFRL that contains too many frequencies defeats the purpose of the JFRL.

g. Working with host-nation authorities, the communications coordination committee also builds the frequency list for the mission sets. In building the list, the committee should use JACS or RBECS software to produce a SINCGARS data set complete with COMSEC key and FH data (loadset/lockout, TSK, and net IDs). JACS or RBECS software is recommended because it can generate CEOI/ signal operation instructions (SOI) and SINCGARS loadset data.

Section B. Planning

1. Frequency Management Responsibilities

a. **Frequency Management.** Joint force operations require frequency management at theater levels for interoperability. Combined operations will also require frequency management if allies use SINCGARS-compatible radios. Inside the borders, airspace, or territorial waters of foreign countries, U.S. forces have no independent authority to use radio frequencies during peacetime. They are subject to existing international agreements. The U.S. Department of State (DoS) and the theater commander-in-chief (CINC) coordinate these agreements with allied governments.

b. **Frequency Allocations.** Frequency allocations are area dependent; thus, net planning must address and implement timely updates to minimize disruptions in the operation when units change their area of operation. The J-6 frequency manager must contact the area frequency coordinator for frequencies. The area frequency coordinator is a designated person who has attended the frequency manager's course and possesses an additional skill identifier. The area frequency coordinator maintains regulatory authority for all spectrum management and is the focal point for all frequency spectrum assignments. Due to the long lead time required to coordinate spectrum assignments, users should submit their requests for frequencies early in their planning cycle. After receiving assignments, the J-6 frequency manager will generate editions needed for CEOI/SOI, print out a hard copy for issue and usage, and create loadsets needed for operations. The majority of allied communications do not have the capability to FH. If the allied elements are not fitted with FH equipment, SC is to be used for communications with allied forces. A digital CEOI/SOI copy and loadset will be transferred to an ANCD. Follow loadset data distribution to lower echelons as described in section C, SINCGARS Data Distribution, below.

c. **Reporting.** Multiservice components must submit a standard frequency action format (SFAF) (see Figures II-1 and II-2) for VHF-FM needs for their organization, and any other special communication requirements to the J-6 frequency manager. The frequency manager will then validate the master net list and net group assignments prior to generation.

d. Each service component representative will develop a master net list and net group assignment through JACS or RBECS, the systems planning, engineering, and evaluation device (SPEED), or AFKDMS for all lower echelon distribution. Service components can provide these nets and other information, such as standard call words and frequency restrictions. The J-6 frequency manager can only edit call signs.

Minimum Format Items

- 005. Security Classification (UE)
- 010. Type of Action (T) = Training
- 110. Frequencies - Type and Quantity (M30-M88) Number needed
- 113. Station Class (ML) for ground
- 114. Emission Designator (25K00F1E)
- 115. Transmitter Power (in watts) (W18)
- 140. Required Date (YYMMDD)
- 141. Expiration Date (YYMMDD)
- 200. Agency
- 203. Location to use
- 204. Command (Unit)
- 207. Operating Unit
- 300. Transmitter Location, State
- 301. Transmitter Antenna Location
- 303. UTM or Mil Grid for location
- 340. Transmitter Equipment Nomenclature
- 343. Transmitter Equipment Allocation Status (JF-12 number from DD 1494)
- 400. Receiver Location, State
- 401. Receiver Antenna Location
- 403. UTM or Mil Grid of Location
- 440. Receiver Equipment Nomenclature
- 443. Receiver Equipment Allocation Status (JF-12 number from DD 1494)
- 502. Description of Requirement
- 803. Requester Data (Name, Telephone number, E-mail)

Figure II-1. Standard Frequency Action Format (SFAF) Example

- 005. U
- 010. T
- 110. M30-M88 (300)
- 113. FB/FA/MLR/ML/MA
- 114. 36K00F3E
- 115. W35
- 140. 010430
- 141. 010530
- 200. U.S.ARM Y
- 204. UNIT INFORMATION (SMD)
- 207. UNIT INFORMATION (RS)
- 300. CA
- 301. FT IRWIN
- 340. G, AN/VRC-89
- 343. 4167/6
- 400. CA
- 401. FT IRWIN
- 440. G, AN/VRC-89
- 443. 4167/6
- 502. REQUIRED FOR COMMAND AND CONTROL DURING ROTATION
- 803. POC: SGT Jon Doe, 123-4567, 123-45681. jon.doe@somewhere.army.mil

Figure II-2. SFAF Example for SINCGARS

e. The JFC J-6 staff coordinates with air, ground, and maritime operations planners to allocate sufficient SINCGARS nets for essential air, ground, and maritime communications. In addition, dedicated SINCGARS communication nets will be identified for close air support (CAS), combat search and rescue (CSAR), and other missions that are critically dependent on effective inter-service communications. Once identified, the appropriate staff publishes these essential nets in the air tasking order (ATO) and makes them available to aircrews and controlling agencies.

f. To support SINCGARS compatibility and interoperability between all service components, planners must coordinate with the J-6 and their subordinate organizations. This coordination ensures that all combat and combat support elements have the following:

(1) A generated CEOI/SOI consisting of cue and manual frequencies, net IDs (FH only) for all SINCGARS-compatible radio nets.

(2) Authentication procedures for accessing all essential SINCGARS-compatible radio nets.

(3) Applicable loadsets and COMSEC data.

g. Contingency Plan. The J-6 generates four editions of every CEOI/SOI: A, B, C, and D. Editions A and B are designated primary. Although they are generated, editions C and D are not issued unless edition A or B is compromised. Editions A and B, with loadset, will be stored in a different ANCD. Edition C and D, with loadset, can be issued only to the service element controlling authority.

2. Equipment

a. De-Confliction. Planning must include provisions to prevent interference between collocated radios operating in the same frequency bands (co-site interference). The potential for interference exists in both SC and FH modes. When planning the CEOI/SOI, the J-6 frequency manager must assess co-site interference and consider the types of radios available in subordinate or allied units, cryptographic equipment, key lists, and frequency allocations available from the host nation for the particular area of operations. Additionally, plans and decisions must comply with applicable international standardization agreements (ISA).

b. Interoperability. Equipment interoperability is a major issue in network planning for VHF-FM systems. The planning must cover FH, if applicable, and SC modes of operations. While many U.S. forces use SINCGARS-compatible radios, the radios of allied nations may not be interoperable with SINCGARS. Therefore, plans should address interfaces between SC and FH radios or lateral placement of interoperable radios in allied command posts. In retransmission mode, SINCGARS radios will automatically provide communications linkage between FH and SC radios or nets.

c. Cryptographic Management. The J-6 should manage the use of cryptographic materials (key lists and devices) to ensure security and cryptographic interoperability at all levels. U.S. forces may need to augment allied forces with U.S. equipment and personnel for cryptographic interoperability, as appropriate. Prior coordination is essential for mission accomplishment.

3. SINCGARS Loadset Data

a. FH Data. The J-6 frequency manager is responsible for managing and generating multiservice FH data. (See Figure II-3.)

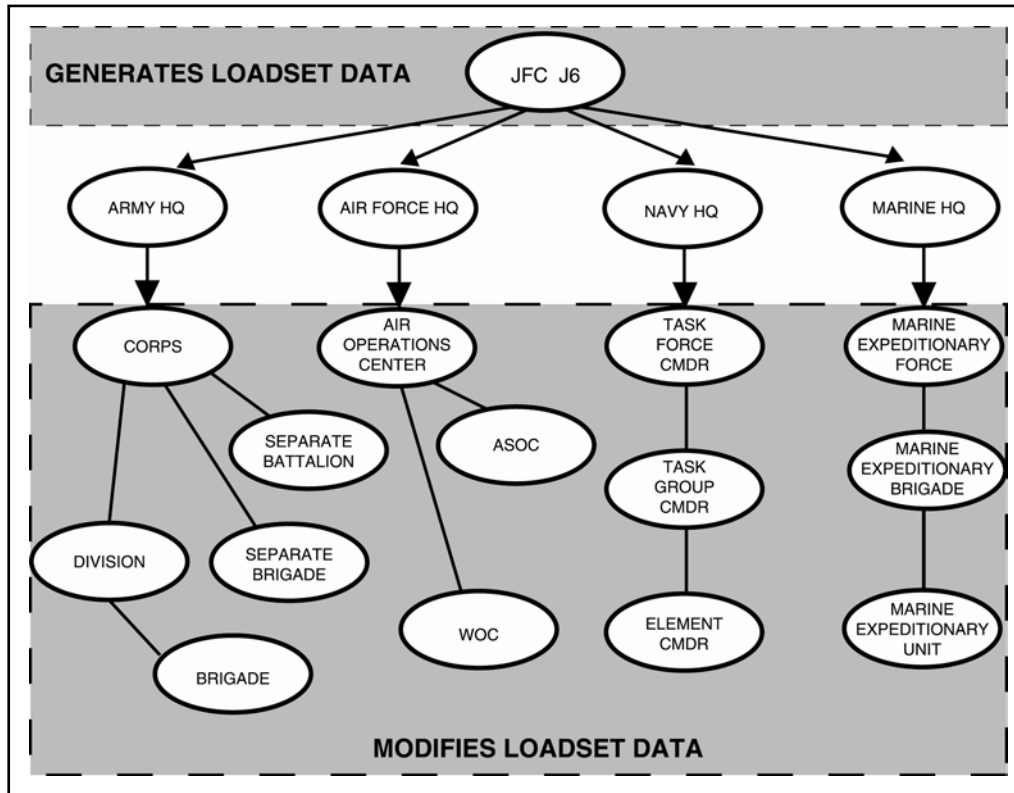

Figure II-3. Echelons Capable of Generating FH Data

(1) Loadsets and lockouts. The J-6 frequency manager generates the loadset. The service component generally modifies unique loadsets at the corps or service equivalent level. To maximize effectiveness of FH, loadsets should use the largest possible number of frequencies in the SINCGARS frequency range. This FH range and the user frequency requirements determine the assignment of loadsets. After the frequency manager generates loadsets, TSKs and net IDs are assigned. If a force's area of operation or its task organization changes, it is the responsibility of the higher headquarters to pass the required loadset to the moving unit.

(a) The larger the number of frequencies and wider the distribution across the SINCGARS frequency range, the better SINCGARS will perform when in FH mode. The minimum size for an effective loadset is situation-dependent. Loadset performance is a function of many factors, including interference from friendly emitters, other electromagnetic interference, and the enemy's EA capability. Typically, loadsets of 1200 or more frequencies, spread across the frequency range, will adequately support both voice and data FH SINCGARS operations. As loadset size decreases, FH performance rapidly degrades. FH data performance is particularly sensitive to loadset size. In addition, as loadset size decreases, frequency spread becomes critical for providing effective FH data. Aggressively scrutinizing frequency restrictions and using the largest possible

number of frequencies per loadset ensures the best possible SINCGARS FH performance.

(b) To obtain sufficient numbers of frequencies, J-6 frequency managers will limit the number of restricted frequencies in the SINCGARS frequency range. With an optimum loadset combined with the limited range of SINCGARS, most SC users can effectively share frequencies with no discernable effect. The widest possible application of common loadsets provides ease of operation and frequency management.

(c) Search and rescue (SAR), CSAR, joint air attack team (JAAT), joint suppression of enemy air defenses (J-SEAD) missions, Special Operations, EW missions, and mobile FH nets require special consideration in planning by J-6s. Mobile forces conducting operations over large geographic areas require one or more loadsets that incorporate all of the frequency restrictions imposed across the entire area of operations.

(d) The SINCGARS radio is capable of storing a unique loadset, as well as all other FH and COMSEC data, in each channel preset.

(2) TSK and net ID. When more than one unit shares a common loadset (e.g., corps, theater, or task force), the J-6 can assign additional TSKs. When the number of FH nets exceeds the number of available net IDs (normally all 1000 per TSK), the J-6 will assign additional TSKs as shown in Table II-1. Net IDs have no effective period and need not change unless otherwise required.

Table II-1. COMSEC/FH Data Distribution within a JTF/Theater

(JTF)				
LOADSET I				
TEK 1				
TSK A				
(ARFOR) loadset I TEK 3 TSK C	(MARFOR) loadset I TEK 2 TSK B	(NAVFOR) loadset I TEK 5 TSK E	(AFFOR) loadset I TEK 4 TSK D	(JSOTF) loadset I TEK 6 TSK F

(3) Sync time. SINCGARS radios operate on precise GPS ZULU time (two-digit Julian date and hours: minutes: seconds [plus or minus four seconds]). Sync time is a variable only in the sense that time passes and Julian dates change. Use of GPS ZULU time provides a common time reference that simplifies FH net opening, late net entry, and commander's monitoring. Use of GPS ZULU time in conjunction with a common loadset, TSK, and TEK enables operators to readily enter different nets by simply changing the net ID using the radio's front panel keypad.

(4) Use of the GPS. Maintaining accurate time is best accomplished using the GPS. NCSs will update time in SINCGARS-compatible radios using GPS ZULU time from PLGR or other time sources.

(5) Time hacks. As required, the J-6 will establish a daily theater time hack for SINCGARS NCS system net station time (NST). The hour that the J-6 chooses to pass this time hack each day will depend on the needs of all users of SINCGARS-compatible radios within the area of responsibility. The J-6 must coordinate this time hack with all

theater services and echelons of command. An NCS can distribute this time hack using dual SINCGARS-compatible radios if the J-6 approves. The J-6 will establish the procedures for passing time hacks using dual SINCGARS-compatible radios.

(a) Active nets. Most tactical procedures require radio checks from the NCS to net members at a minimum of once every 24 hours, which is sufficient to maintain accurate radio and net time. However, it is recommended that the NCS transmit on each FH net a minimum of every four hours to keep all stations in the net.

(b) Manual setting. Radio operators may manually enter time into most SINCGARS-compatible radios using the keypad. Operators update sync time by contact with their NCS (FH-M function), receipt of an ERF, reloading time using an ANCD or PLGR, or manually changing the sync time in the radio by use of the keypad.

(c) Julian date. SINCGARS radios require a two-digit Julian date. For example, 1 July in a non-leap year, day 182, is Julian date 82 for SINCGARS. Operators must base all times and dates on GPS ZULU time. When a normal form of date (for example, day, month, year) is entered into an ANCD or PLGR, the data is automatically converted to a two-digit Julian date suitable for SINCGARS use. The only time the Julian date must be changed is 1 January each year.

b. COMSEC Data. All SINCGARS radios, whether SC or FH capable, will operate in the CT mode whenever possible. SINCGARS radios have either integrated COMSEC or can use an external COMSEC device (non-ICOM). The JFC normally designates the CONAUTH for all crypto-net operations, and the J-6 will provide overall staff supervision. COMSEC data includes TEK and KEK.

(1) TEK. The normal effective period for the TEK is 30 days; however, the CONAUTH may extend the period under emergency conditions.

(2) KEK. KEKs have an effective period of 90 days. Unit SOPs will describe routine loading of KEKs in all radios or the storing of the KEK in a fill device until needed. It is advisable to store the KEK in one of the channels, such as position 6. This can be done only if there is an available channel or unused position on the SINCGARS system.

c. Keying Material Compromise. When substantial evidence exists of a compromise of COMSEC keying material for SINCGARS radios, the CONAUTH will take immediate action. There is a range of options, including immediate implementation of new keys and, if necessary, continued use of compromised key(s) until an un-compromised key can be implemented. In addition to superceding COMSEC key(s), the CONAUTH will normally supercede compromised TSK (s). CONAUTH will consider the tactical situation, the time needed to distribute reserve data, and the time required to reestablish communications after COMSEC key(s) are superceded.

Section C. SINCGARS Data Distribution

1. General

The J-6 will manage the overall distribution of FH and COMSEC data throughout the area of operations. FH data will be distributed using the JACS or RBECS loadset format files. COMSEC data will be distributed via service component COMSEC SOPs. FH and COMSEC data are merged in the ANCD and distributed to operators as a loadset. (A loadset is the total package of all FH and COMSEC data.) Subordinate commu-

communications staff offices are responsible for forwarding their net requirements to their higher headquarters. Staffs at each echelon must distribute data appropriately packaged for their users, whether routine or under emergency conditions, to ensure critical combat communications are not disrupted. Staffs can distribute the data physically, electronically, or use a combination of both.

2. Physical Distribution

Physical distribution is the most secure means for disseminating FH and COMSEC data. It is the primary distribution method for ground units at lower echelons. Units equipped with the ANCD can readily distribute loadsets in a single transaction from ANCD to ANCD, and subsequently load their radios in one transaction. Units not equipped with the ANCD require a combination of devices in several transactions to distribute the loadset. (See Table II-2.) Besides the ANCD, other distribution and fill devices include—

- a. MX-18290, FH fill devices (ICOM only).
- b. KYK-13, KYX-15, KOI-18 common fill device (COMSEC data only).
- c. MX-10579, EP fill device (non-ICOM only).
- d. Any GPS receiver (including AN/PSN-11 PLGR) (Precise GPS ZULU time only).
- e. AN/CYZ-10 (ANCD/data transfer device (DTD)).

Table II-2. Summary of Transfer Methods for Units without an ANCD.

TYPE OF TRANSFER	FH DATA					COMSEC		SOI
	NET ID	SYNC TIME	LOCK-OUT	LOAD-SET	TSK	TEK	KEK	SOI
Physical	Yes	Yes	Yes	Yes	Yes	Yes	Yes	Yes
Broadcast	Yes	Yes	Yes	Yes	Yes			
ERF	Yes	Yes	Yes	Yes				
OTAR						Yes	Yes	

3. Electronic Distribution

There are a number of techniques available to electronically disseminate COMSEC and FH data to widely dispersed forces. However, COMSEC data should be distributed only in accordance with National Security Agency (NSA)-approved methods, including the KG-84A/C, OTAR, and secure telephone unit III (STU-III). Electronic distribution methods for FH data include ERF and electronic file transfer. Communications paths for electronic file transfer include telephone modem, LAN or wide area network (WAN), satellite communication (SATCOM), etc. When using OTAR, there is an inherent risk of losing communications with stations that are not active on the net at the time, or, for whatever reason, they fail to receive the OTAR.

4. Distribution within the JTF

a. Responsibilities. In joint force operations, the J-6 has responsibility for generating or importing the joint CEOI/SOI, COMSEC keys, and FH data. The J-6 distributes this data directly to the component communications staffs (see Figure II-4). If appro-

appropriate, the J-6 can delegate the generation and distribution of FH and COMSEC data to the service components.

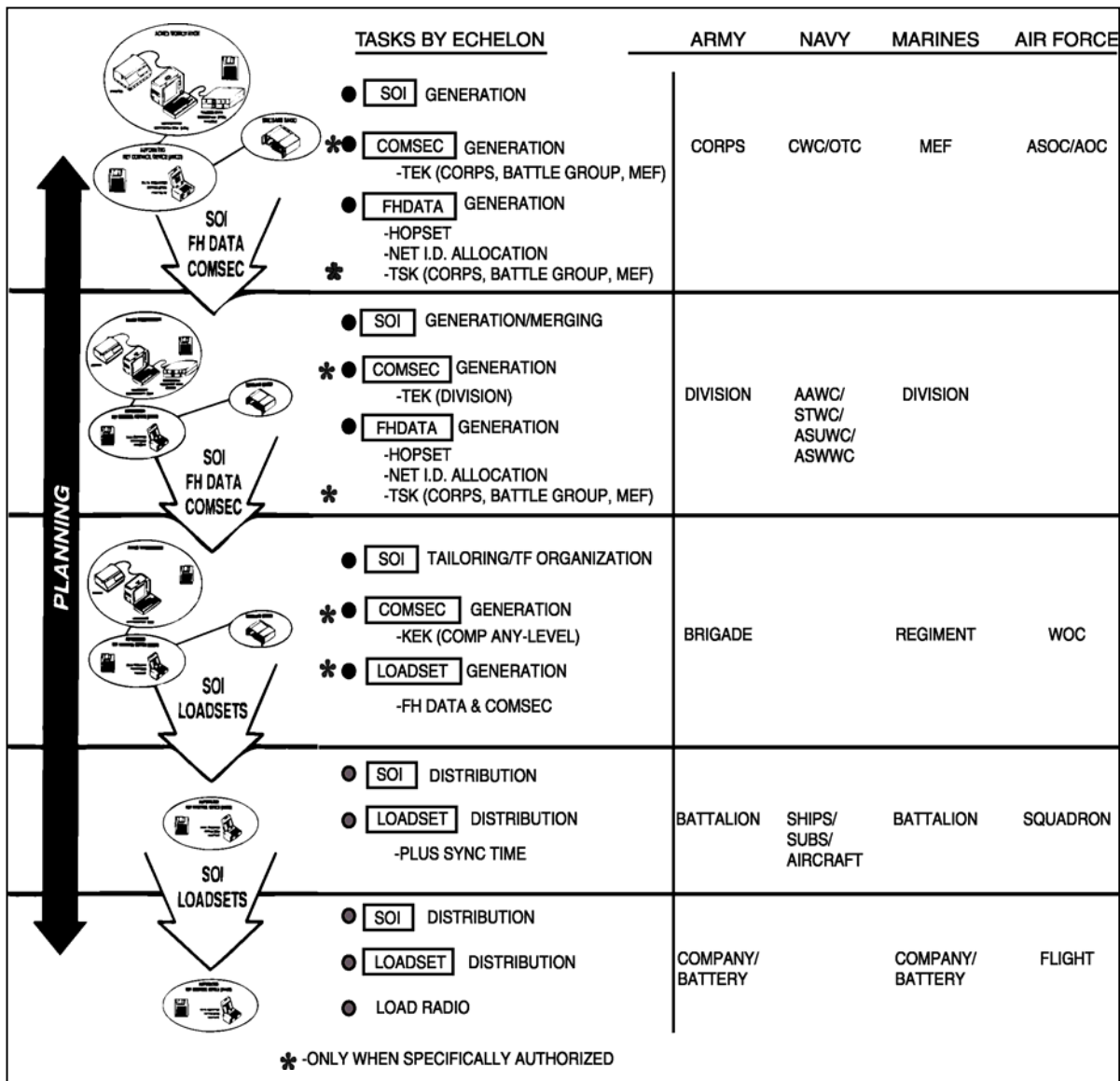

Figure II-4. Task by Echelon in Joint Operations

b. Liaison. The J-6 staff is responsible for providing the joint frequencies, SINGARS FH data, and other CEOI to the service liaison personnel. Liaison personnel include ground liaison officers at air units, air liaison officers to ground units, battle-field coordination elements, etc. These individuals and agencies are important links to the service or headquarters they support. Upon receiving the FH and COMSEC data from their service or functional component, liaison personnel can then distribute the data to the unit they support.

c. Intratheater COMSEC Package (ICP). ICPs are prepackaged COMSEC material packages, normally held by the warfighting CINCs that are used to support JTF opera-

tions. They are theater-specific for a wide range of standing OPLANs and contingency plans. Preplanned SINGARS FH data should be generated and included with the COMSEC material in the ICPs to result in complete, prepackaged FH nets.

5. Distribution within Services and Components.

a. Army Forces (ARFOR). (See Figure II-5.) The Army component CONAUTH receives and disseminates the FH and COMSEC data to subordinate echelons. Depending on the situation, the CONAUTH may be at the field army, corps, or division level. Most often, the CONAUTH will be at the corps level.

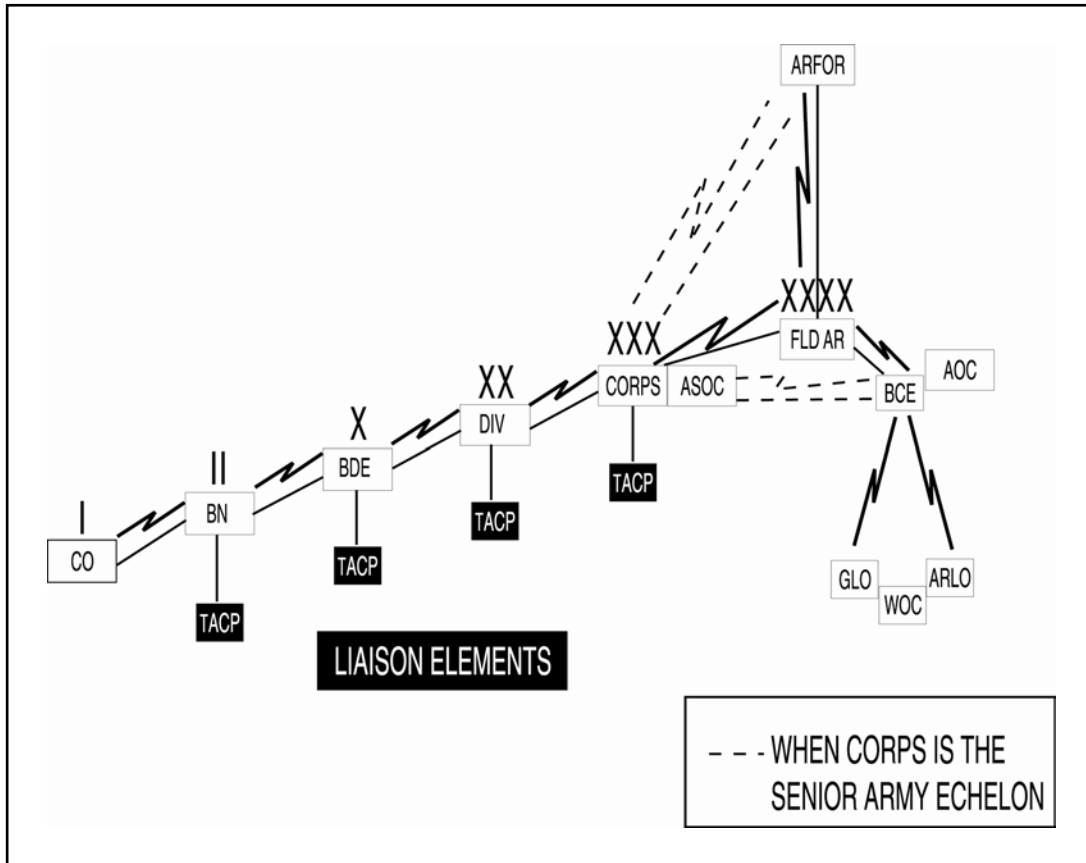

Figure II-5. Loadset Data Distribution within Army Units

(1) Corps. The corps communications staff may generate and disseminate the data or may delegate those responsibilities to subordinate divisions. Specifically, the corps communications staff (G-6) can generate:

- (a) SOI data.
- (b) COMSEC data (corps' TEK and corps' KEK).
- (c) FH data (corps-wide loadsets, net ID, corps' TSK).

(2) Division. The division either uses the data the corps generates or, if authorized, generates its own FH and COMSEC data. The division communications staff office (G-6) has the equipment and capability to:

- (a) Generate and merge SOI data.
- (b) Generate COMSEC data (division TEKs and KEKs).
- (c) Generate FH data (net IDs and division TSKs).

Note. Generation of SOI, COMSEC data, TSKs, and net ID assignments normally does not occur below division/separate brigade level. When authorized to do so, brigade and separate battalion lightweight computer unit (LCU) operators may generate TEKs to meet emergency requirements. When TEKs are generated at a lower echelon, they are forwarded through higher headquarters to the joint force command.

(3) Brigade. The brigade receives SOI, FH, and COMSEC data from the division. Typically, the brigade communications staff (S-6) is responsible for coordinating, preparing, and distributing the SOI data, and for preparing loadsets.

Note: Generation of the SOI is typically done above the brigade level.

(4) Battalion. The battalion and its subordinate units are recipients and users of generated data. The battalion S-6 responsibilities are limited to distributing SOI data, loadsets, and FH sync time.

(5) Most echelons can distribute FH and COMSEC data using physical or electronic means. Time, distance, security, and urgency dictate the most appropriate means of distributing data.

(6) Army contingency planning. When Army component staffs are energized to a possible contingency, they will begin planning and preparing for operations simultaneously. Once the task organization is identified, commanders fine tune and determine the specific elements needed. Concurrently, J-6 frequency managers coordinate with higher-level frequency managers to obtain usable frequencies. Mission specific TSKs are generated and disseminated through JACS or RBECS managers to the supporting forces. A separate message indicates specific TSK usage. During this time, COMSEC custodians coordinate COMSEC key needs and produce a COMSEC callout message that identifies specific keys for joint, ARFOR, corps, or division use. ARFOR subordinate units identify a specific net requirement and the master net list is compiled. Upon receipt of approved frequencies from J-6, the ARFOR G-6 generates SOIs for use by ARFOR. In support of joint operations, Army JACS or RBECS managers pass a list of specific units and nets to the J-6. Once the J-6 provides FH data to the G-6, the G-6 disseminates the FH data to subordinate commands. Each level then prepares loadsets. Files can be transferred back to the next higher level at this point for archiving. Finalization is effected upon receipt of the COMSEC callout message and specific TSK use message. Prepared SOIs may be passed to subordinate units by secure electronic or physical means.

b. Marine Corps Forces (MARFOR). Currently, the Marine Corps uses RBECS as the primary system for generating, distributing, and storing CEOI information. When fully fielded, the new JACS will replace the RBECS at the Marine expeditionary force (MEF) level and become the standard system for these CEOI processes. The new JACS will be able to perform FH functions as well, but only after a cable that links it to the CSZ-9 and CYZ-10 is developed and fielded. Until then, FH data generation, distribu-

tion, and storage is accomplished using the RBECS, the AN/CSZ-9 random data generator (RDG), and the AN/CYZ-10. Although the JACS will soon replace the RBECS at the MEF and higher echelons of command, the RBECS will remain the primary system for CEOI and FH development at the regiment/group, battalion/squadron and Marine expeditionary unit (MEU) levels (see Figure II-6). In order to employ the communications assets of the Marine Air-Ground Task Force (MAGTF) effectively, the communications officer also uses the SPEED software to create accurate terrain analysis and wave propagation studies that allow for the optimum selection of antenna sites. This personal computer (PC) compatible software can be loaded on any International Business Machine (IBM) compatible PC that meets the following minimum requirements: Windows 2000 or NT operating system with a Pentium 266 MHz microprocessor (450 MHz recommended), 64 megabytes (MB) of RAM (128 MB recommended), and a 7 gigabyte (GB) hard drive (10 GB recommended). After Phase II of the Navy Key Management System (NKMS) is implemented, SPEED will be installed on a UNIX-based local management device (LMD). The AN/CSZ-9 RDG will perform all FH and CEOI data generation until the NKMS key processor is fully fielded. The Marine Corps will use the ANCD to transfer, store, and fill both SINCGARS TEK and FH data at all levels. The ANCD will utilize one of two software programs, JACS or RBECS DTD software (RDS) to fill the RT-1523 or the consolidated SC EP package (CSEP) to load AN/ARC-210. Marine aircraft groups using the AN/ARC-210 radio will be required to convert SPEED loadset files into CSEP/ARC-210 data utilizing the ARC-210 fill program (AFP) software. AFP also allows the entry of Have Quick and SC data for the ARC-210. AFP software has the same hardware requirements as SPEED.

(1) Ashore.

(a) MARFOR receives joint FH and COMSEC data from the JTF J-6 and provides the MAGTF command element (CE) with required frequency resources.

(b) The MAGTF CE generates MAGTF FH data, publishes COMSEC data, and allocates net IDs for all major subordinate commands (MSC) and supporting units.

(c) The ground combat element (GCE) receives all joint and MAGTF FH data from the MAGTF CE. The GCE is capable of loadset generation down to the regimental level only when directed.

(d) The aviation combat element (ACE) receives all joint and MAGTF FH data from the MAGTF CE. The MAGTF CE provides special loadset files for the ARC-210. The ACE is capable of loadset generation down to the group level only when directed.

(e) The MAGTF combat service support element (CSSE) receives all joint and MAGTF FH data from the MAGTF CE. The CSSE is capable of loadset generation at the CSSE headquarters only when directed.

(2) Afloat.

(a) Navy forces (NAVFOR) provide the MAGTF CE with required frequency resources and joint FH data.

(b) The MAGTF CE generates MAGTF FH data, publishes COMSEC data, and allocates net IDs for all MSCs and supporting units.

(c) The GCE receives all joint and MAGTF FH data from the MAGTF CE. The GCE is capable of loadset generation down to the regimental level only when directed.

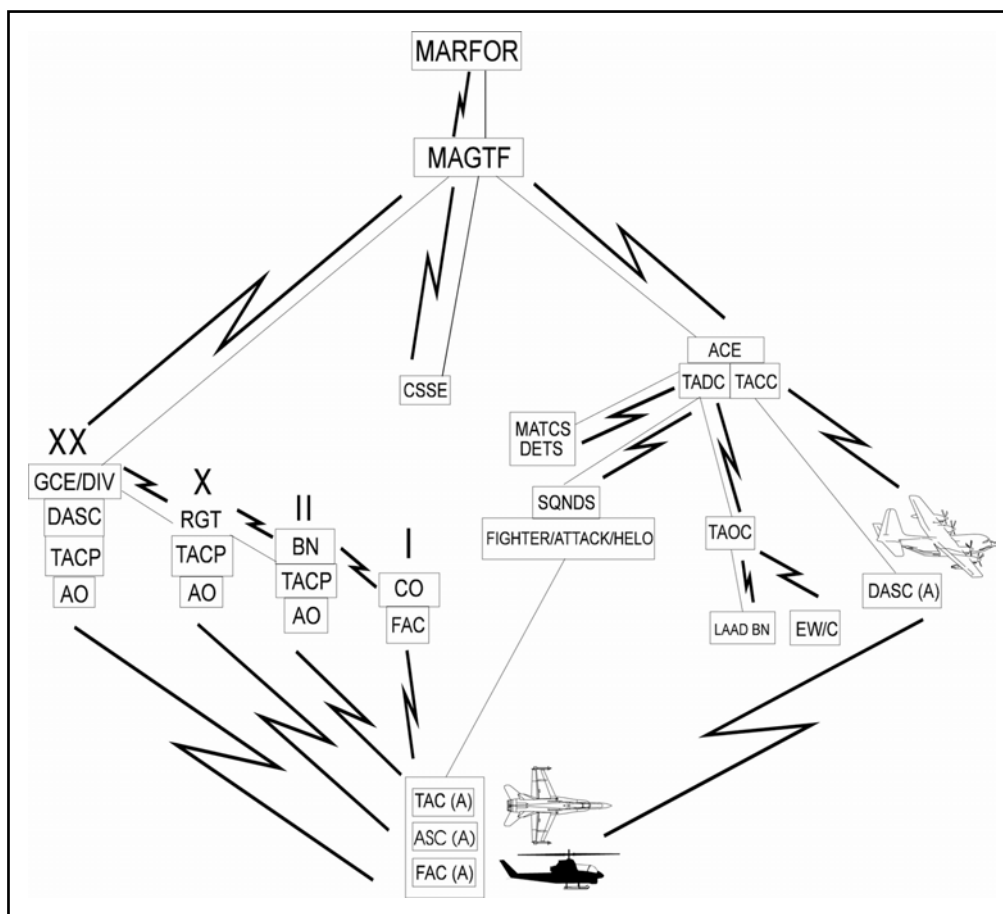

Figure II-6. Loadset Data Distribution within Marine Corps Units

(d) The ACE receives all joint and MAGTF FH data from the MAGTF CE. It provides loadset files for ARC-210 users. The ACE is capable of loadset generation down to the group level only when directed.

(e) The CSSE receives all joint and MAGTF FH data from the MAGTF CE. The CSSE is capable of loadset generation at the CSSE headquarters, if directed.

c. Navy Forces (NAVFOR). (See Figure II-7.) Distribution of FH and COMSEC data within NAVFOR depends on the task organization. The initial implementation of SINCGARS in the Navy is primarily intended to support amphibious warfare operations. In an amphibious battle group scenario, the communications staff of the commander, amphibious task force (CATF) acts as the deconfliction point for FH and COMSEC data received from the MAGTF, elements of the amphibious task force, the composite warfare commander (CWC), and the carrier battle group (CVBG) commander. Figure II-7 illustrates this bottom-up flow of data to the deconfliction point and the top-down dissemination of deconflicted data to every SINCGARS equipped element involved in the operation. In a conventional CVBG scenario, the CWC/officer in tactical command (OTC) communications staff will act as the deconfliction point for FH and COMSEC data.

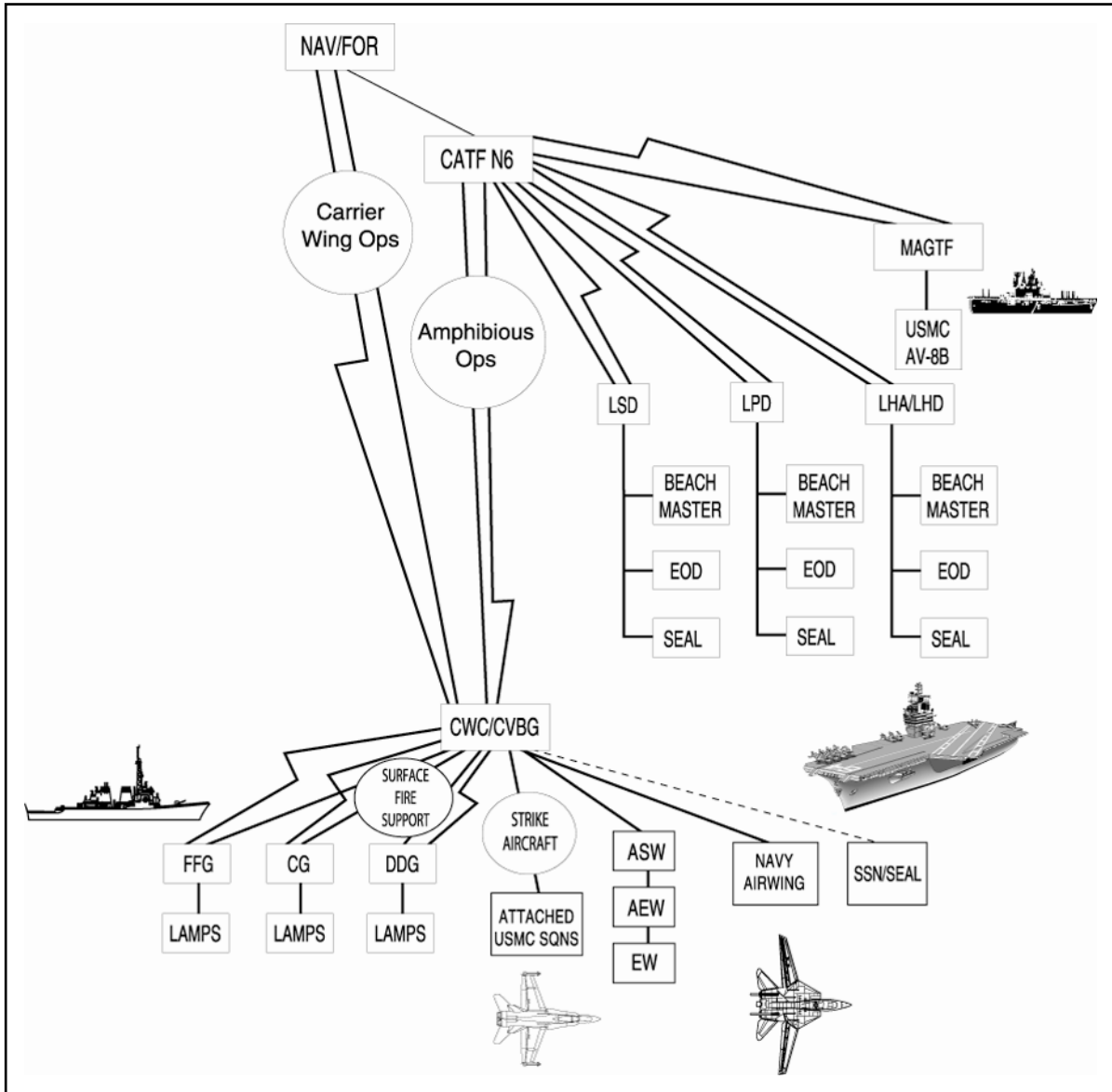

Figure II-7. Loadset Distribution within Naval Forces

(1) The Navy component CONAUTH receives and disseminates the FH and COMSEC data to subordinate echelons. Depending on the situation, the CONAUTH may be at either the CWC/OTC or the warfare commander level. Most often, the CONAUTH will be at the CWC level.

(2) CWC/OTC. The CWC/OTC communications staff may generate and disseminate the data or may delegate those responsibilities to subordinate warfare commanders. Specifically, the CWC/OTC communications staff can generate:

- (a) Operational tasking (OPTASK) communications data.
- (b) COMSEC data (battle group TEKs).
- (c) FH data (battle group loadsets, net IDs, battle group TSKs).

(3) Warfare commanders. Warfare commanders will either use the data the CWC/OTC generates or, if authorized, generate its own FH and COMSEC data. The warfare commander has the equipment and capability to:

- (a) Generate and merge OPTASK communications data.
- (b) Generate COMSEC data (battle group TEKS).
- (c) Generate FH data (net IDs and battle group TSKs).

(4) Generation of TEKS, TSKs, and net ID assignments does not occur below the warfare commander level. When the warfare commander generates the data, it forwards the data to the CWC/OTC and/or CATF/NAVFOR for consolidation and deconfliction.

d. Air Force Forces (AFFOR) (See Figure II-8.)

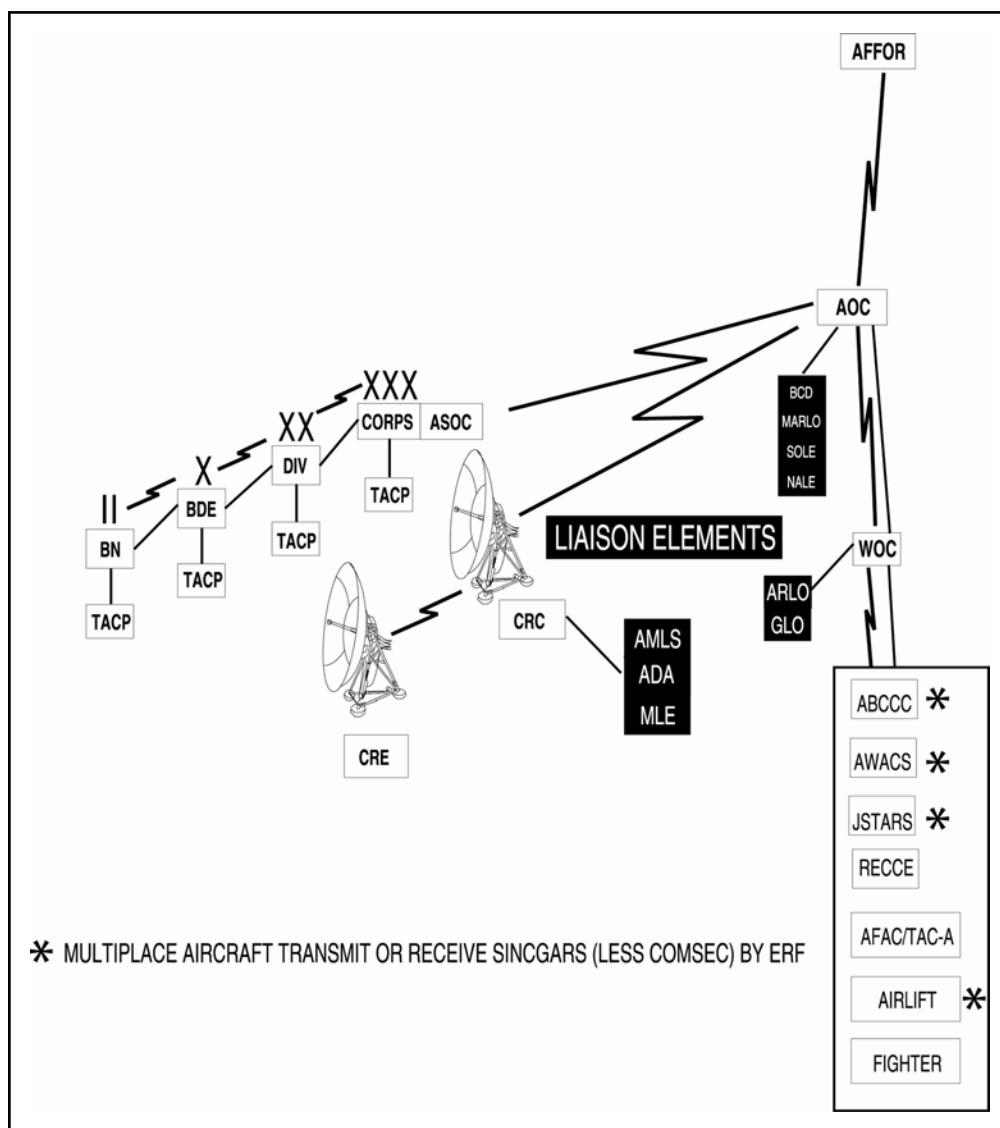

Figure II-8. Loadset Data Distribution within Air Force Units

(1) Air operations center (AOC). The AOC is the operations control agency for the joint force air component (JFAC). As such, the AOC will provide overall management of SINGGARS net data for the Air Force components using AFKDMS, and coordinate the SINGGARS net data with other service components via the ATO. In this capacity, the AOC:

(a) Provides the joint force land component commander (JFLCC) communications staff with the total air component SINGGARS net requirements (CAS, CSAR, J-SEAD, etc.).

(b) Receives initial and follow-on CEOI/SOI—including the SINGGARS FH and associated COMSEC data—from the JFLCC, and distributes it to air component users (deployable radar, CRC, MAGTF ACE CVBG, CWC/OTC, etc.).

(c) Provides guidance to Air Force SINGGARS users regarding loading and employment of SINGGARS nets.

Note. The AOC, in conjunction with generating the ATO, will identify the particular SINGGARS net data, TSKs, and COMSEC key identifiers, call signs, and call words for the specific CAS mission tasking. In addition, the AOC will identify both the SINGGARS data required by the control reporting center (CRC) and the deployable radar. The Contingency Theater Automated Planning System (CTAPS) or the Theater Battle Management Core System (TBMCS) running the AFKDMS will be used to manage the SINGGARS fill data identification requirements. The actual SINGGARS FH data and communications identifiers will be transferred to the wing operations center (WOC) via the Wing Command and Control System (WCCS).

(2) CRC. The CRC will develop and distribute loadsets for CRC and deployable radar SINGGARS assets.

(3) Air Support Operations Center (ASOC). The ASOC is the corps' focal point for execution of U.S. Air Force air support missions in support of U.S. Army ground forces. In this capacity, the ASOC:

(a) Coordinates Air Force agreements with the Army for ANCDs and SINGGARS data for all tactical air control party (TACP) SINGGARS radio assets. Currently, the Army has agreed to provide the RDS for installation on the TACP ANCDs. Also the Army has agreed to provide the SINGGARS CEOI/SOI to the aligned TACP units.

(b) Ensures SINGGARS net requirements for immediate CAS are correctly specified. Immediate CAS will be conducted on a uniquely specified standing net.

(4) WOC. The WOC executes the ATO as published by the AOC. Operations personnel of tasked units configure mission sets from the SINGGARS data and the linking SINGGARS identifiers contained in the ATO to support the specified mission. The WOC specifically:

(a) Develops procedures for integrating the construction of mission sets into the wing mission planning process using the WCCS and the AFKDMS.

(b) Develops and implements a SINGGARS standard loading scheme.

(c) Develops and implements procedures for transferring loadsets to the key data system (KDS) ANCD at the squadron/unit level and for subsequent loading of SINGARS radios in specific aircraft assigned to the mission.

(d) Special tasking operations. Pre-mission planning requirements for small scale contingency unilateral and interservice operations demand the operational commander provide all SINGARS FH and COMSEC fill data or identifiers for Air Force assets before deployment. Physical and electronic distribution of the SINGARS and COMSEC communications packages will be accomplished as early as possible using the best means available for the particular situation (i.e., STU-III, SATCOM, ICP, and/or ERF).

Chapter III

Support Equipment

The services tailor their particular radio designs to satisfy service-unique requirements. This chapter describes the individual services' support equipment required to operate SINCGARS in a multiservice environment, ensuring interoperability in multiple nets.

1. Army Equipment

a. The Army Key Management System (AKMS) integrates all functions of cryptographic management and engineering, SOI, electronic protection (EP), and cryptographic key generation, distribution, accounting, and audit trail recordkeeping into a total system designated as the Automated COMSEC Management and Engineering System (ACMES).

b. ACMES provides commanders the necessary tools to work with the widely proliferating COMSEC systems associated with the mobile subscriber equipment (MSE), echelon above corps (EAC) communications, Joint Tactical Information Distribution System (JTIDS), EPLRS, SINCGARS and other keying methods (electronic key generation, OTAR transfer, and electronic bulk encryption and transfer) being fielded by the Army.

c. ACMES is a two-phase program.

(1) ACMES (Phase I) focuses primarily on requirements for CNR frequency management, a common fill device (CFD), and electronic SOI. ACMES provides users with enhanced capabilities for SOI, FH data, and COMSEC key generation. An ANCD makes it possible to electronically store and rapidly distribute SOI and key material. In addition, the ANCD enables radio operators to load all FH and COMSEC data plus sync time into the SINCGARS radio in one simple procedure. (See Figure III-1.) Phase I consists of two functional elements: the ACMES workstation, and the ANCD, which are illustrated in Figure III-1.

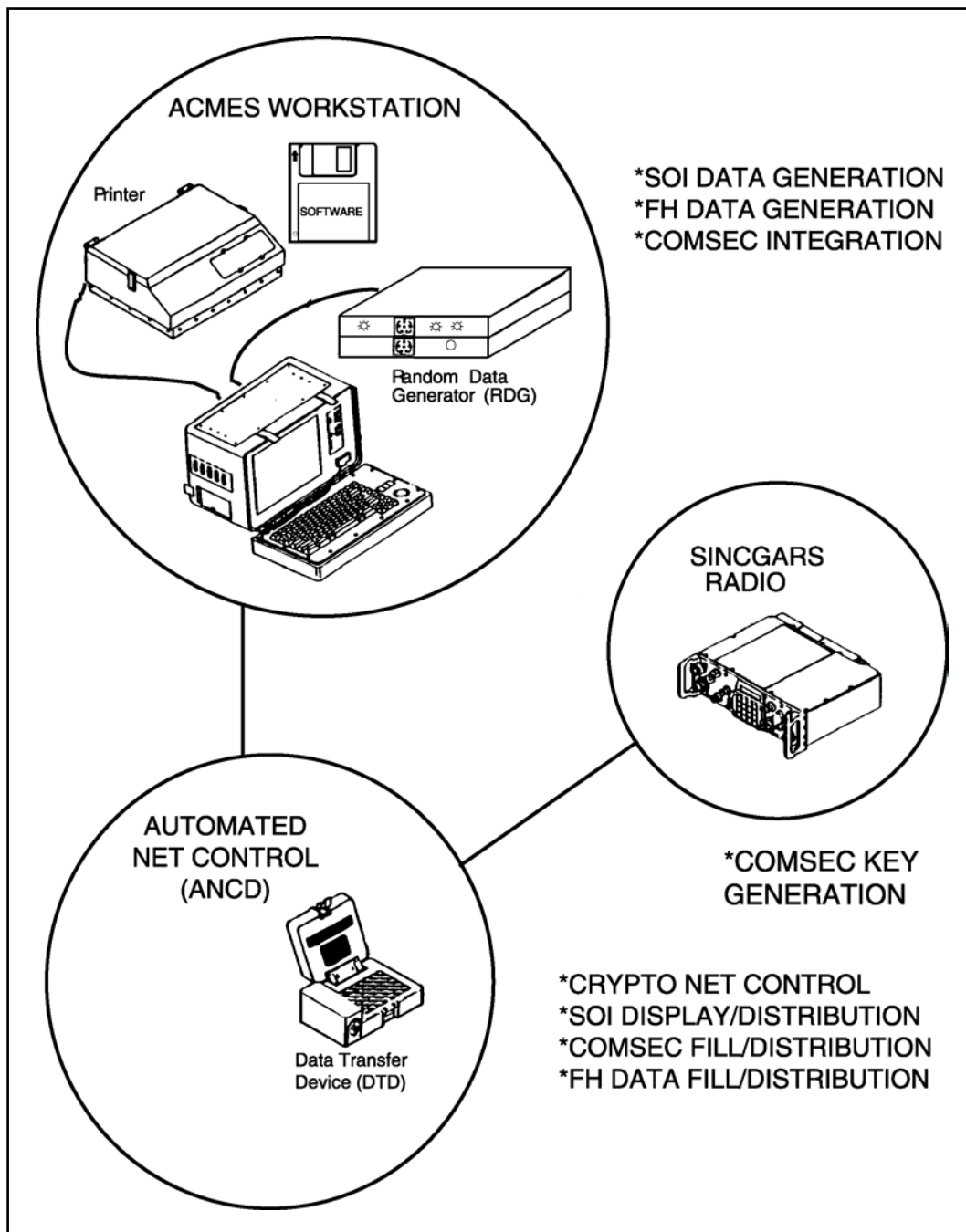

Figure III-1. ACMES Functional Elements

(a) ACMES Workstation. The ACMES workstation generates SOI and FH data and integrates COMSEC cryptographic keys. The workstation consists of the AN/GYK-33A, LCU (a rugged desktop computer with a 486 MHz microprocessor), and the AN/CSZ-9, RDG. The LCU, in conjunction with the RDG, generates SOI and FH data (TSK, net IDs, and loadsets). The ACMES workstation replaces the AN/GYK-33 basic generation unit (BGU). Workstations with the RDG are organic to corps, divisions, and separate brigades.

(b) ANCD, system designation AN/CYZ-10. The ANCD is an electronic data storage and CFD procured by the NSA and configured by the Army with unique application JACS or RBECS and RDS. The ANCD performs the full range of CNR cryptonet support functions to transfer and store data. In addition, the ANCD serves as an electronic SOI and replaces the need for most paper SOI products. The ANCD replaces the KYK-13, KYX-15, MX-18290, and MX-10579 in support of SINGARS.

(2) ACMES (Phase I) is a follow-on system with enhanced and expanded capabilities. The system is illustrated in Figure III-2. Phase II consists of three functional elements: the ACMES workstation, the ANCD, and the key distribution device (KDD).

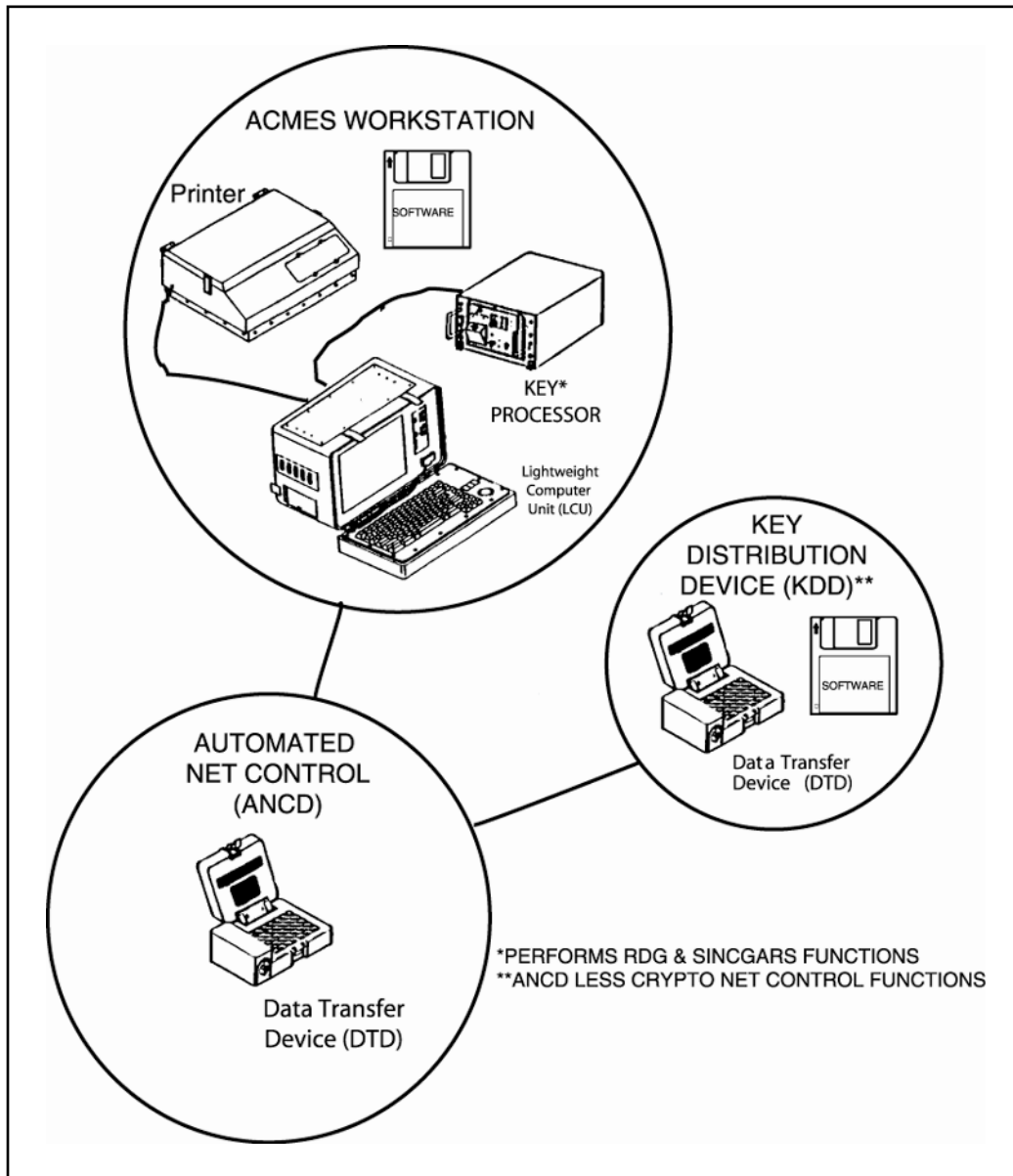

Figure III-2. ACMES Phase II

(a) Phase II ACMES Workstation. When implemented, the Phase-II ACMES workstation will provide commanders with a fully automated capability to plan, control, and generate FH data and COMSEC keys, and manage complex cryptonets. This workstation will also provide cryptonet managers with the means to distribute cryptographic key, SOI, and FH data; perform database audits; design crypto nets; configure networks; accommodate key supersession; and manage all operational keys and SOI. The workstation will be fully interoperable with all Electronic Key Management System (EKMS) elements.

(b) ANCD. The Phase-II ANCD will be essentially a software-improved version of the Phase I ANCD.

(c) KDD. The KDD ANCD is a limited-keypad version of the DTD. Its application software can perform the tasks performed by an ANCD without NCS functionality.

2. Marine Corps Equipment

The JACS or RBECS FH module and the CEOI (less call signs) module are software applications within a higher-level SPEED system. A third module, frequency assignment, completes the total functionality of SPEED. This module accesses multiple databases to achieve frequency de-confliction and minimize cosite interference. SPEED resides on the Fleet Marine Forces end user computing equipment (FMF EUCE), AN/UYK-83/-85, and lightweight computer units at the MEF and MSC levels. The Marine Corps uses the AN/CYZ-10 DTD for both COMSEC and TSK fills at all levels. SPEED produces the following two SINCGARS-related products:

- a. Classified, paper printout containing unit identification, frequencies, and call signs.
- b. FH parameters in electronic format for downloading via the DOS "shell" into a DTD. In the future, the Navy key distribution system (NKDS) will provide the call sign variable as well as TSK and COMSEC keys to support the SINCGARS program for the Marine Corps. The NKDS LMD loads COMSEC and TSK keys into the SPEED (AN/UYK-85, LCU). NSA provides both keys, but the COMSEC custodian controls them. The example in Table III-1 provides an illustration of what a typical CEOI/SOI generated by JACS or RBECS/SPEED looks like on paper. The units described in this sample CEOI/SOI are notional units only.

Table III-1. Sample CEOI/SOI

52ID	52ID_BB	UNCLASSIFIED	COPY	OF		
NG023 - 1 BDE/52ID EXTRACT			TIME PERIOD 01			
NET:	CALLWORD	C/S:	ID:	CUE:	MAN:	
1 BDE/52 IN	EXCALIBUR	V6W				
1 BDE/52IN CMD	EXCALIBUR	V6W	0401	36.700	51.225	
1 BDE/52IN RTS	EXCALIBUR	V6W	0402	59.250	76.350	
1 BDE/52IN INT	EXCALIBUR	V6W	0403	41.500	37.325	
1 BDE/52IN NRI	EXCALIBUR	V6W	0404	50.550	41.625	
1 BDE/52IN AJ 1	EXCALIBUR	V6W	0406	50.600	42.375	
1 BDE/52IN AJ 2	EXCALIBUR	V6W	0407	69.550	69.725	
HHC/1 BDE/52IN	EXCALIBUR	U5C				
1 BDE/52IN A/L	EXCALIBUR	V6W	0405	55.200	57.325	
AVN/1 BDE	WILEY	A6L	0692	42.750	45.575	
52 IN DIV A/L	BUCKSTER	E3I	0307	39.700	33.425	
1-77 IN	EQUALIZER	H7A				
1-77 IN CMD	EQUALIZER	H7A	0410	67.350	46.225	
2-77 IN	EXECUTIONER	K8B				
2-77 IN CMD	EXECUTIONER	K8B	0442	45.800	70.025	
1-62 AR	EAGLE	F9D				
1-62 AR	EAGLE	F9D	0474	49.500	33.975	
52 IN DIV CMD	AVENGER	E3I	0300	33.250	57.275	
52 IN DIV RTS 1	AVENGER	E3I	0301	54.650	57.925	
DTOC/52IN SSB P	AVENGER	E3I		26.9000		
DTOC/52IN SSB A	AVENGER	E3I		6.1950		
2 BDE/52IN CMD	CENTURION	Z2K	0500	56.250	68.325	
3 BDE/52IN CMD	HURRICANE	B0G	0700	43.950	70.325	
4 BDE/52IN CMD	RAWHIDE	D1H	0901	33.300	57.525	
DIVARTY CMD	VALIANT	U0Y	0626	70.650	55.225	
DIV EARLY WARN		A7H	0999	39.400	56.925	
MEDEVAC (WAR)			0000	42.650	38.925	
MEDEVAC (PEACE)				35.600		
	UNCLASSIFIED	ITEM NO: 023				

3. Navy Equipment

a. There are four major JACS or RBECS components for the Navy in joint operations. These components, which are illustrated in Figure III-3, are the unclassified JACS or RBECS software package, a PC, an RDG, and a DTD. Only the software, the computer, and the RDG are necessary to design, generate, and produce joint CEOI (JCEOI)/CEOI material.

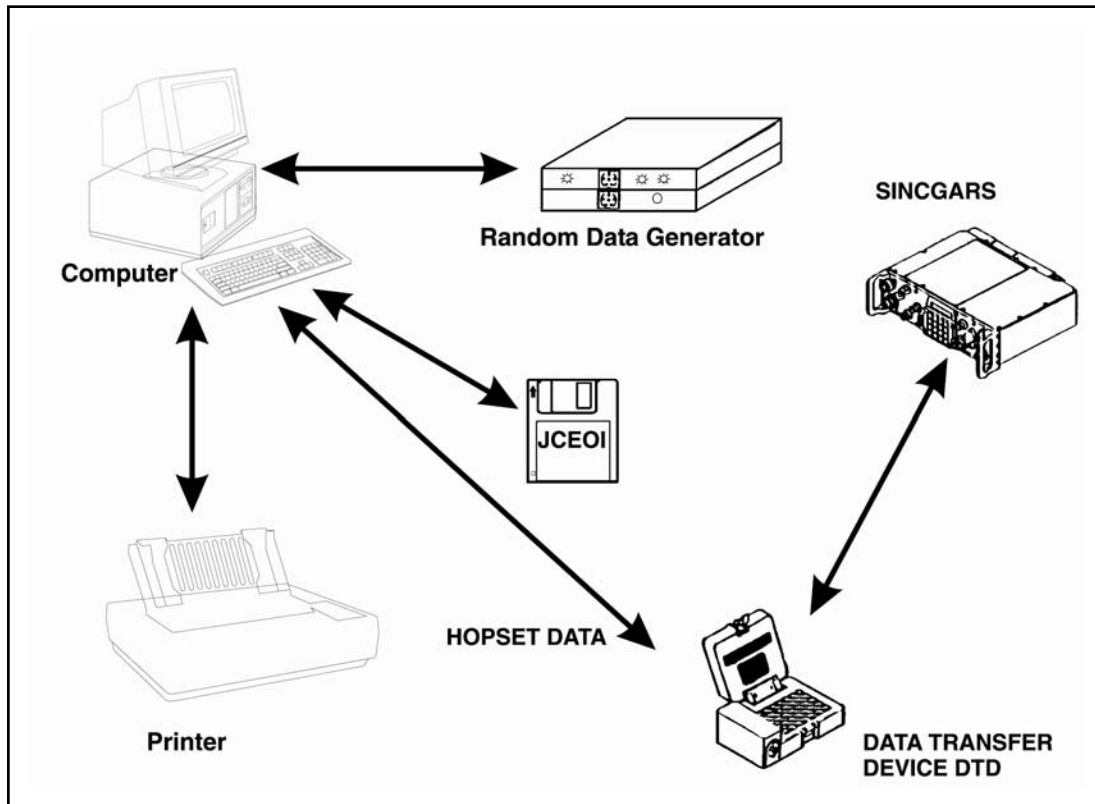

Figure III-3. Basic RBECS System

(1) The RBECS or JACS software package enables communication planners to generate electronic/electromagnetic counter-countermeasure (ECCM) fill information and transmission security (TRANSEC) keying material (loadsets) for SINGARS radios.

(2) The RBECS software can run on any MS-DOS-based computer system with the following characteristics: MS-DOS operating system 3.30 or higher, PC/AT 386 or higher, 4 MB RAM (minimum available for program execution), 10 MB hard disk storage

(3) The RDG is necessary to generate the JCEOI/CEOI and SINGARS TRANSEC variables. The RDG consists of three components: the AN/CSZ-9 (a non-deterministic generator), the battery power pack, and its connecting cable system. The power pack requires five BA-30/"D" cell batteries for operation. The computer must have at least one serial communications port (RS-232) available for the RDG and DTD.

(4) The DTD is a storage device that is loaded by the PC with all JCEOI/CEOI data, SINCGARS EP data, loadsets, lockouts, etc., and TRANSEC keys. The ANCD/DTD is also loaded with COMSEC keys (TEKs and KEKs) when used in conjunction with an ICOM SINCGARS radio or KY-57/58 equipment. The ANCD/DTD is intended to replace the KYX-15/KYX-15A and KYX-13 devices. An ANCD/DTD can transfer data from one ANCD/DTD to another, as well as send selective data over the air via VHF-FM broadcast using SINCGARS.

b. For the ARC-210, the Navy uses the ARC-210 AFP running on an MS-DOS based PC or tactical aircraft mission planning system (TAMPS) to generate an ARC-210 loadset file. The AFP user can manually enter Have Quick, single-channel, and aircraft selection data. The AFP user can also import SINCGARS loadset files from the JACS or RBECs system. The ARC-210 loadset file is loaded into an AN/CYZ-10, DTD running consolidated CSEP application or Common Tier 3 (CT3) software. The DTD can then load ARC-210 radio(s) using the DS-101 interface.

c. The NKMS will provide an automated key management system for the distribution and management of encrypted keys within and between the CINCs and services in accordance with EKMS and Joint Key Management System (JKMS). NKMS is being implemented in two phases.

(1) Phase I. In Phase I, distributed LMD was installed with automated Navy COMSEC reporting system (ANCRS)/COMSEC automated reporting system (CARS) software, STU-III telephones, and an AN/CYZ-10 to all account holders. As a part of Phase I, software at the office of the director, COMSEC material system (DCMS) and the COMSEC material issuing office (CMIO) has also been updated.

(2) Phase II. In Phase II, the key processing equipment (KPE), X.400 communications software, and bar code readers will be distributed. ANCRS/CARS software will be replaced with local COMSEC management software (LCMS), which will allow the LMD to communicate with the KPE. Figure III-4 illustrates the major functional components of the NKMS, which include the Key Distribution Management System (KDMS) PC subsystem, DTD, and SINCGARS radio (ICOM/non-ICOM),

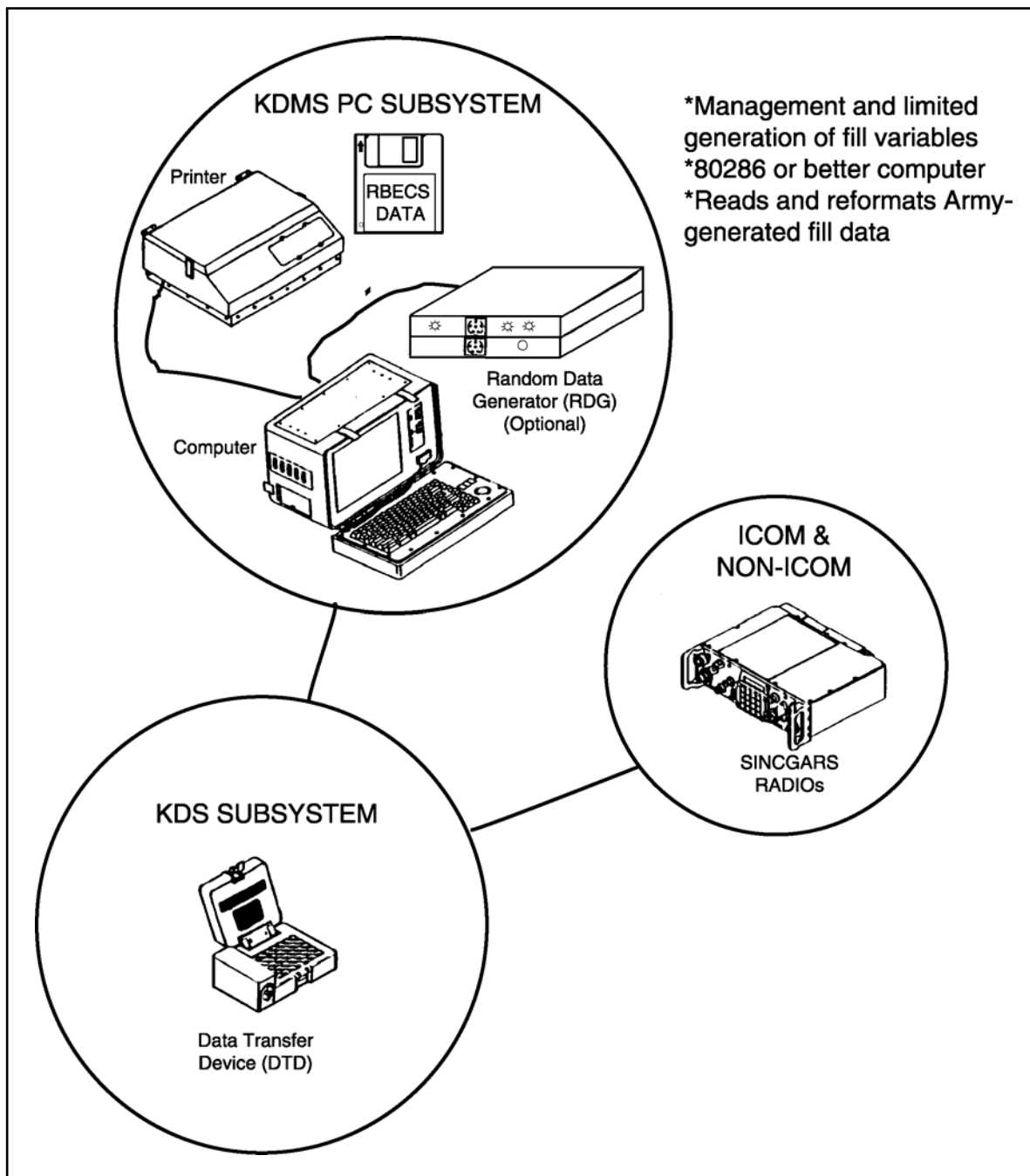

Figure III-4. NKMS Functional Components

4. Air Force Equipment

a. The Air Force is developing the AFKDMS to meet its special needs (See Figure III-5). AFKDMS is composed of two subsystems: the KDMS PC subsystem and the KDS DTD subsystem. The KDMS software is designed to manage and, to a limited extent, generate fill variables for the Air Force SINGGARS radio assets (AN/ARC-222,

Army ICOM (RT-1523) and non-ICOM (RT-1439) radios). The software runs on the MS-DOS. To ensure interoperability with the other services in the SINGARS mode, it incorporates the revised SINGARS ICOM/non-ICOM support software (RSINISS) and other selected modules from JACS or RBECS. It is menu-driven and contains on-line, context-sensitive help. The AFKDMs:

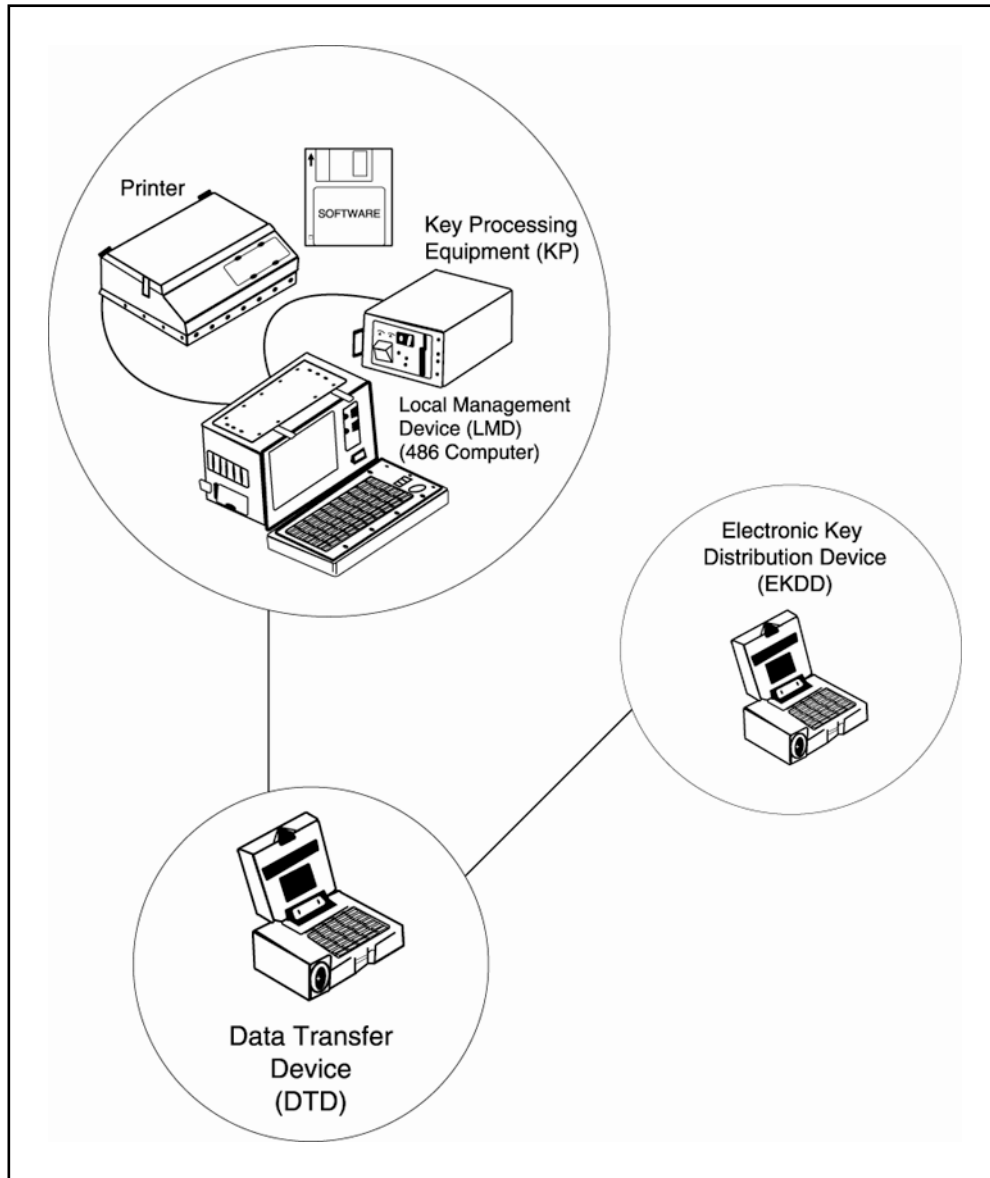

Figure III-5. AFKDMs Functional Components

(1) Imports Army or multiservice net information from JACS or RBECS 3.5 inch diskettes provided by the JFC J-6 or Army Corp units. The KDMS extracts net information by reading data elements from the ACMES files and reformats the data for use in the AFDMS system.

(2) Provides information to establish Air Force CAS, CSAR, etc., operational nets. The AFKDMs allows the net planner to enter SC frequencies and to manage FH

data for FH nets. When a baseline ground force CEOI/SOI is available, the Air Force net planner can develop Air Force unique nets for unilateral Air Force operations, including training, if required.

(3) Provides information to construct mission sets. The AFKDMS has the capability to build mission sets consisting of 20 FH nets, 20 cue frequencies, and 20 SC frequencies to provide for the primary mission and multiple contingency missions.

(4) Loads the DTD fill device (KDS subsystem) with multiple-loadsets for the assigned aircraft and ground radio assets. The KDS operator uses the KDS fill device (AN/CYZ-10) to fill designated radios using the common fill device mode used in other common fill devices (e.g., KYK-13, KYX-15, KOI-18, etc.).

b. AFKDMS is a fast, flexible, and secure method of generating, managing, distributing, and auditing cryptologic materials using electronic communications and peculiar subsystem auxiliary devices. It is the Air Force cryptologic support center (AFCSC) implementation of the NSA-developed EKMS. The DTD subsystem is expandable and can be used to support various Air Force communications via unique user application software (UAS) implementations. AFKDMS components include:

(1) KPE. The KPE generates, encrypts, and decrypts keys as required to support the COMSEC distribution system in accordance with AFCSC policy and procedures. The encrypted keys are passed to the LMD for further transfer to the DTD.

(2) LMD. The LMD is a PC (i486) installed at base-level COMSEC account facilities. It is provided by the AFCSC specifically for cryptographic material management support. The LMD interfaces with the KPE for the generation of keys.

(3) DTD. The DTD (AN/CYZ-10) is a generic key management and distribution device that incorporates NSA electronic-fill data format standards and interface protocols. It is backward compatible with fielded cryptographic devices, it contains a two-line character display and functional keyboard, and the software-configurable menus are user friendly.

(4) Electronic key distribution device (EKDD). The EKDD is a modified UAS DTD that services several Air Force communications systems. UAS is written for specific communications equipment. The Air Force ground and airborne SINCGARS radios require extensive EP fill parameters, including TSK keys; therefore, they require unique UAS. Currently, this application requires a separate DTD software modification, hence, a unique nomenclature KDS.

Chapter IV

Enhanced Position Location Reporting System (EPLRS)

EPLRS is a primary enabler for network-centric warfare. EPLRS supports the Army's transformation brigades, and is interoperable with the U.S. Air Force, U.S. Marine Corps and U.S. Navy. EPLRS mobile networks are used by Army Battle Command System(s) (ABCS) and Force Battle Command Brigade and Below (FBCB2) host computers for situational awareness and C². The Situation Awareness Data Link (SADL) integrates U.S. Air Force close air support aircraft with the digitized battlefield via EPLRS. With its inherent position and status reporting for situational awareness, SADL provides an effective solution to the long-standing air-to-ground combat identification problem.

1. Introduction

a. EPLRS is a wireless tactical communications system that automatically routes and delivers messages, enabling accurate and timely computer-to-computer communications on the battlefield. Using time division multiple access (TDMA), FH, and error correction coding technologies, the EPLRS provides the means for high-speed horizontal and vertical information distribution. The system, comprised of many radios and one or more network controllers, provides multiple concurrent communications channels.

b. A typical EPLRS system for a division consists of 1,300 radio sets (RSs) and four network controllers, called NCSs. Radios are networked together to provide automatic, secure, jam-resistant relay of host-to-host data throughout the network. The EPLRS has automatic relay capabilities that are transparent to the user for beyond LOS coverage.

c. The network controller provides integral position location and navigation services to the user as well as secure OTAR functionality. EPLRS provides programmable waveforms, selectable data rates, and multiple types of communications services. EPLRS, employed by all four branches of service, serves as the brigade and below backbone of the emerging tactical Internet.

2. EPLRS Context and Capabilities

Top level capabilities of EPLRS include:

- a. Communications services.
- b. Position location services.
- c. Navigation services.

3. EPLRS Planning

The objective of EPLRS predeployment network planning is to develop a detailed signal support plan that is flexible enough to support users conducting operations on a dynamic battlefield. System planning and control require coordination between the functional users and the signal community. The four basic elements of EPLRS planning are:

- a. Planning network operations.
- b. Developing unit library data. A list of the participants/units. Each one requires that a military identification code (MILID) be entered into a database.
- c. Developing message library data. Determines the types of message to be exchanged among the users
- d. Establishing needline library data. Determines user privileges to communicate with others.

4. EPLRS Network Management

Successful EPLRS network management requires close coordination between communications support personnel throughout the network and the users requiring their support. In the deployment phase, the planning function changes. The system planner in the EPLRS network operations security center (NOSC) must anticipate EPLRS network needs to keep pace with the changing dynamics of the battlefield.

5. EPLRS Applications

EPLRS is the wide-band data radio network being used by the military forces to provide C² data distribution, battlefield situational awareness, and position location services. Applications of EPLRS include—

- a. FBCB2 system.
- b. ABCS.
- c. SADL.
- d. Joint services.

6. EPLRS Technical Description and Characteristics

The two main components of EPLRS are:

- a. NCS. The NCS contains tactical computers that enable automated technical control and centralized dynamic network management of EPLRS. The NCS is the primary technical control interface. NCS software provides dynamic network monitoring and resource assignment that satisfies requirements for communications, navigation, identification data distribution, and position location.
- b. RS. The RS provides secure, jam-resistant digital communications and accurate position location capabilities. The RS accepts and implements NCS-issued commands and reports its status to the NCS. These reports are essential for accomplishing the automatic control of EPLRS. The RS consists of an RT, a user readout (URO) device, and an appropriate installation kit for ground, vehicle, or airborne use.

7. Future Upgrades

Several enhancements are under development that will further increase EPLRS performance. The end result will be a system with programmable waveforms and network protocols, layered software, commercial off-the-shelf (COTS) and third party software, and standard interfaces. In short, EPLRS will provide users with a programmable next-

generation wideband communications device. Planned improvements to EPLRS include—

- a. EPLRS Lite (E-Lite). E-Lite is a smaller, lighter, less expensive version of the traditional EPLRS networked data communication system. It offers the critical functions of EPLRS, fits in a warfighter's pocket, and reduces the dismounted warfighter's equipment load by more than 20 pounds.
- b. EPLRS network manager (ENM). Replaces the NSC. Deploys with a smaller footprint than the NCS; requires less maintenance and less of an infrastructure.
- c. IP routing.
- d. Higher data rate.
- e. Host interfaces. EPLRS supports four types of host interfaces: the Army data distribution system interface (ADDSI), which is the standard Army host interface, MIL-STD-1553B, point-to-point protocol (PPP), and Ethernet. Figure IV-1 shows host tactical system interfaces to an ADDSI RS and MIL-STD-1553B RS.

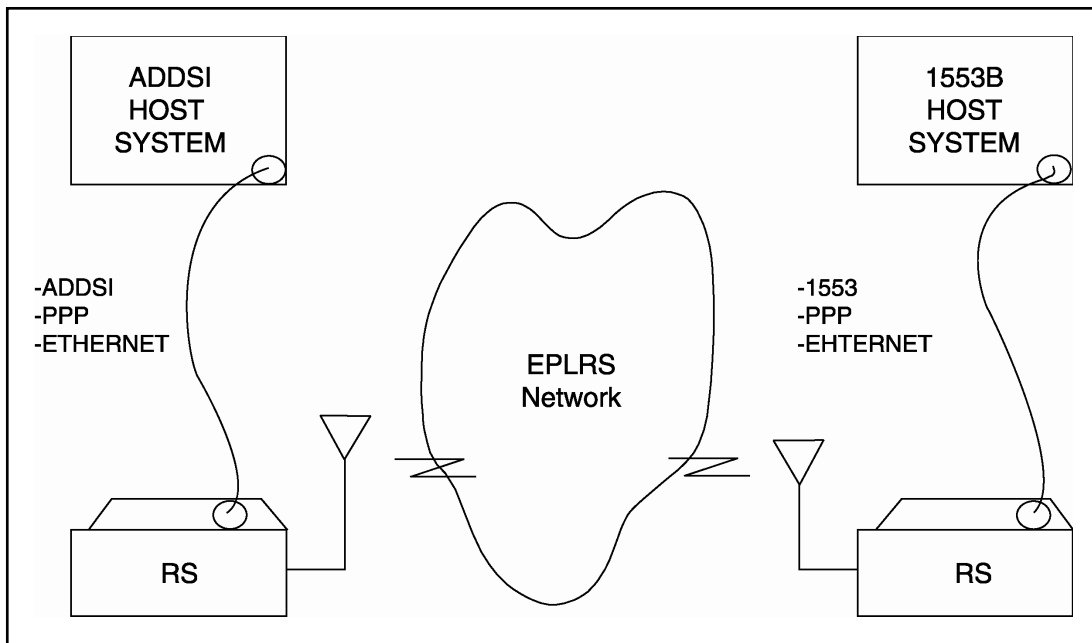

Figure IV-1. Host Tactical System Interfaces to an EPLRS RS

8. Joint Services Considerations

EPLRS is used in all services for data link communications applications. The system is interoperable across the services. Joint services using EPLRS include:

- a. Army. The Army uses EPLRS to provide the communications backbone for the tactical Internet for Army FBCB2-equipped forces.
- b. Marine Corps. The Marine Corps uses EPLRS in its version of a tactical Internet known as the tactical data network (TDN).

c. Navy. The Navy uses EPLRS in the Amphibious Assault Direction System (AADS), AN/KSQ-1, to support communications and movement for members of the Amphibious Task Force.

d. Air Force. The Air Force uses modified EPLRS radios, called SADL, an intra-flight datalink, and an air-to-ground/ground-to-air datalink with position information from/to an EPLRS ground community for CAS and CSAR.

9. Service Applications

a. Army Application

(1) The architecture for the Army's tactical Internet (TI) is defined at the brigade level so TI components within brigades are generally similar. The TI is broken up into an upper TI and a lower TI. The upper and lower TIs come together at the tactical operation centers (TOCs). Generally, communications between TOCs and at brigade and above use the upper TI. Communications within the brigade and below Force XXI FBCB2 use the lower TI, as illustrated in Figure IV-2.

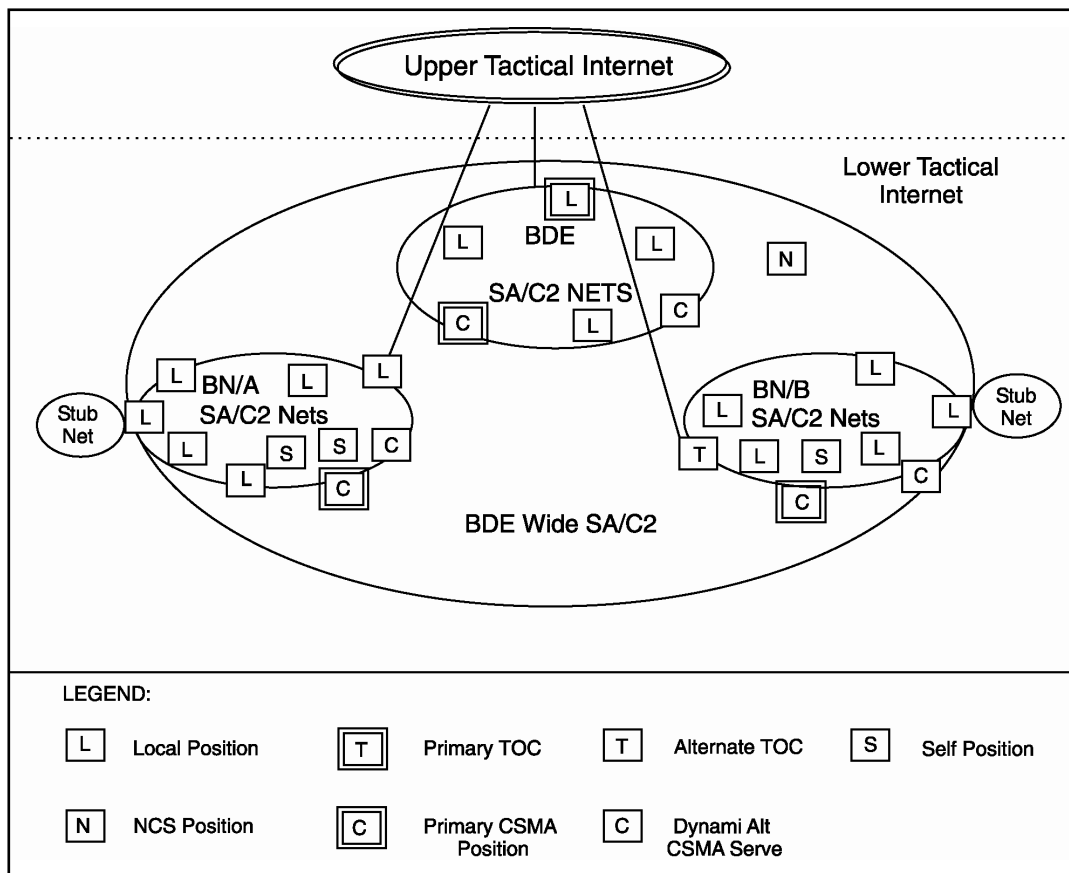

Figure IV-2. Army TI Brigade and Below Architecture

(2) The EPLRS and SINCGARS voice/data RSs form the communications network for the lower TI. SINCGARS nets are used within companies and below for C² (voice only). EPLRS is used within the brigade and battalions and to network companies with their battalions, and battalions with their brigades. EPLRS is used to dis-

seminate SA and C² data above, between, and within brigades. The SA data includes both friendly and enemy position reports, and the C² data is mainly made up of warnings, alerts, and fire support information.

(3) The FBCB2 is a hardware component of the ABCS. It is a digital battle command information system that can be used across all battlefield functional areas (BFA), from brigade level down to the soldier/platform level. The FBCB2 provides mounted/dismounted tactical combat, combat support, and combat service support commanders, leaders, and soldiers with integrated, on the move, real-time/near real-time, and battle command and SA information. Figure IV-3 shows an example of the integration of FBCB2 within the division.

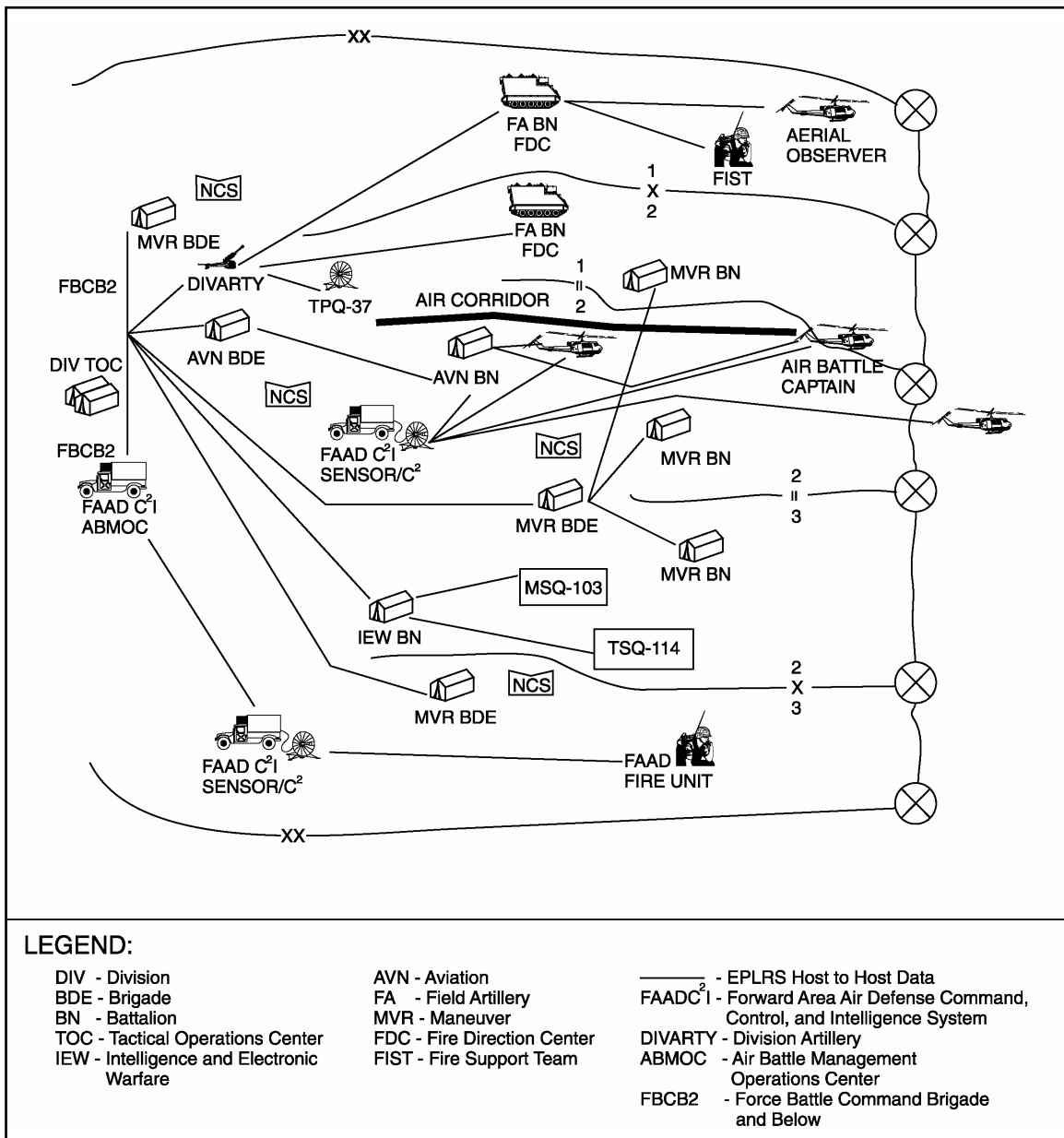

Figure IV-3. Integration of FBCB2

(4) EPLRS is the data communications system for the FBCB2, the backbone of the tactical Internet. The FBCB2 integrates with Army tactical command and control systems (ATCCS) located within the brigade and battalion, and it provides real-time battlefield pictures at the strategic level. Using EPLRS communications and position location features, the FBCB2 integrates emerging and existing communications, weapon, and sensor systems to facilitate automated status, position, situation, and combat awareness reporting.

b. Marine Corps Application

(1) The Marine Corps' TDN architecture, like the Army architecture, is divided into an upper and lower TI. EPLRS is the communications backbone for the lower TI, which supports communications between the regiment and battalions, as well as between the battalions and subordinate company command levels. EPLRS links the dynamic MAGTF C⁴I tactical data systems with a user-transparent, data communications network. Figure IV-4 shows an example of a Marine Corps application.

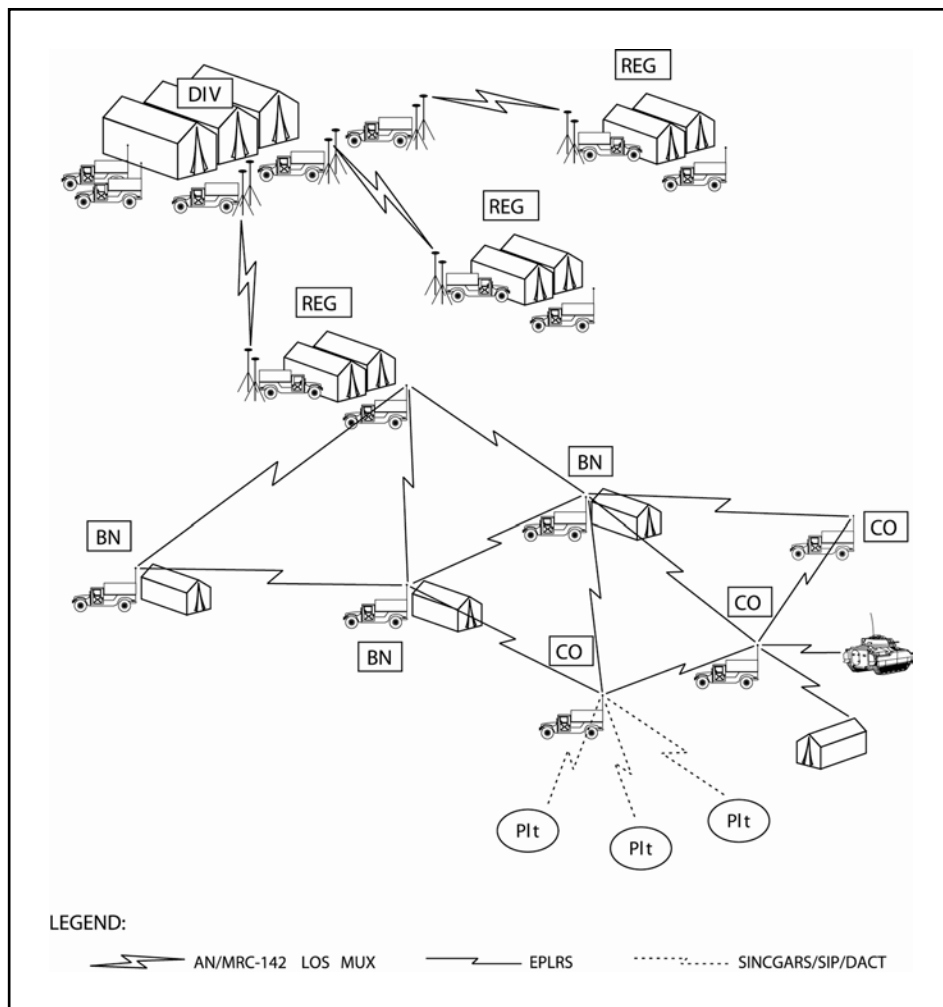

Figure IV-4. Marine Corps Application

(2) The TDN, consisting of COTS new technology (NT) servers and routers, is used to create a WAN at the regiment and battalion organizations. Currently, the Marine Corps employs a high data rate (HDR) duplex architecture designed to exchange C² messages and overlays consisting of IP datagrams, normal e-mail with attachments, and continuous updates to the situation database. EPLRS HDR duplex needlines provide the communications connectivity between each node.

(3) The data automated communication terminal (DACT) is a tactical handheld computer connected to the EPLRS (via Ethernet) at the company level. Data rates assigned to communicate between company and battalion nodes are 3,600 and 7,200 kbps.

c. Navy Application

(1) The AADS, AN/KSQ-1, provides real-time information to the amphibious command ship (ACS), primary control ship (PCS), and the secondary control ship (SCS) on the position and movement of naval surface landing craft in the amphibious task force (ATF). The AN/KSQ-1 allows the ACS, PCS, and SCS to identify, track, communicate with, and control amphibious landing craft from launch through transit over-the-horizon, off-coast, and return while conducting maneuver warfare from the sea. Figure IV-4 shows an example of an amphibious assault direction.

(2) EPLRS provides the jam-resistant and low probability of intercept communications links for the exchange of preformatted and free text messages among members of the ATF. The AN/KSQ-1 combines position data received from the EPLRS with data from the GPS and existing ship and landing craft equipment at ranges up to 100 nautical miles. During the ship-to-shore phase of the amphibious assault, EPLRS radios installed in the landing force operations center (LFOC) will link the landing force commander with other Marine Corps command elements ashore. EPLRS radios installed on the landing craft air cushion (LCAC) augmented by airborne relays (as required) provide necessary connectivity. (See Figure IV-5.)

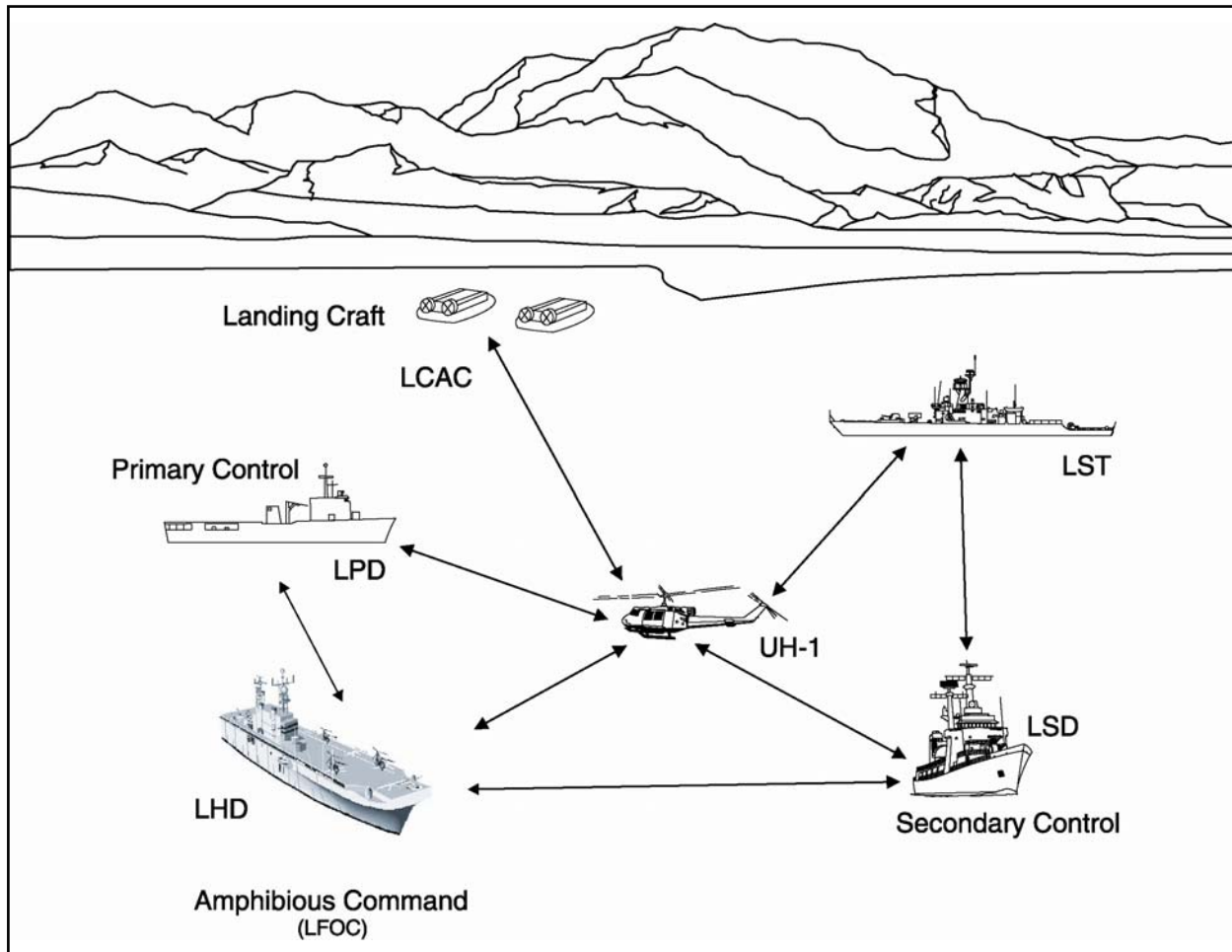

Figure IV-5. Amphibious Assault Direction

d. Air Force Application

(1) SADL is the integration of the modified EPLRS radio with a MIL-STD-1553B host interface and an aircraft avionics over the aircraft MIL-STD-1553B multiplex bus. It allows data from other SADL equipped fighters and ground EPLRS locations to be seen in cockpit displays. Figure IV-6 shows an example of a SADL.

(2) The SADL air-to-air network, consisting of two to sixteen members, is self-reliant and functions independent of the presence or absence of a ground-based NCS. Fighter positions, target positions, and weapons and fuel status are shared among the net members. NSA-approved secure data communications provide a secure, low probability of intercept system. Automated fighter-to-fighter relay and adaptive power control capabilities ensure connectivity, jam resistance, and low probability of detection (LPD).

(3) In the air-to-ground mode, the pilot uses cockpit controls to synchronize the SADL radio with a ground division network. After synchronization, the fighter's SADL radio returns to sharing fighter-to-fighter data while recording SA from the TI's SA

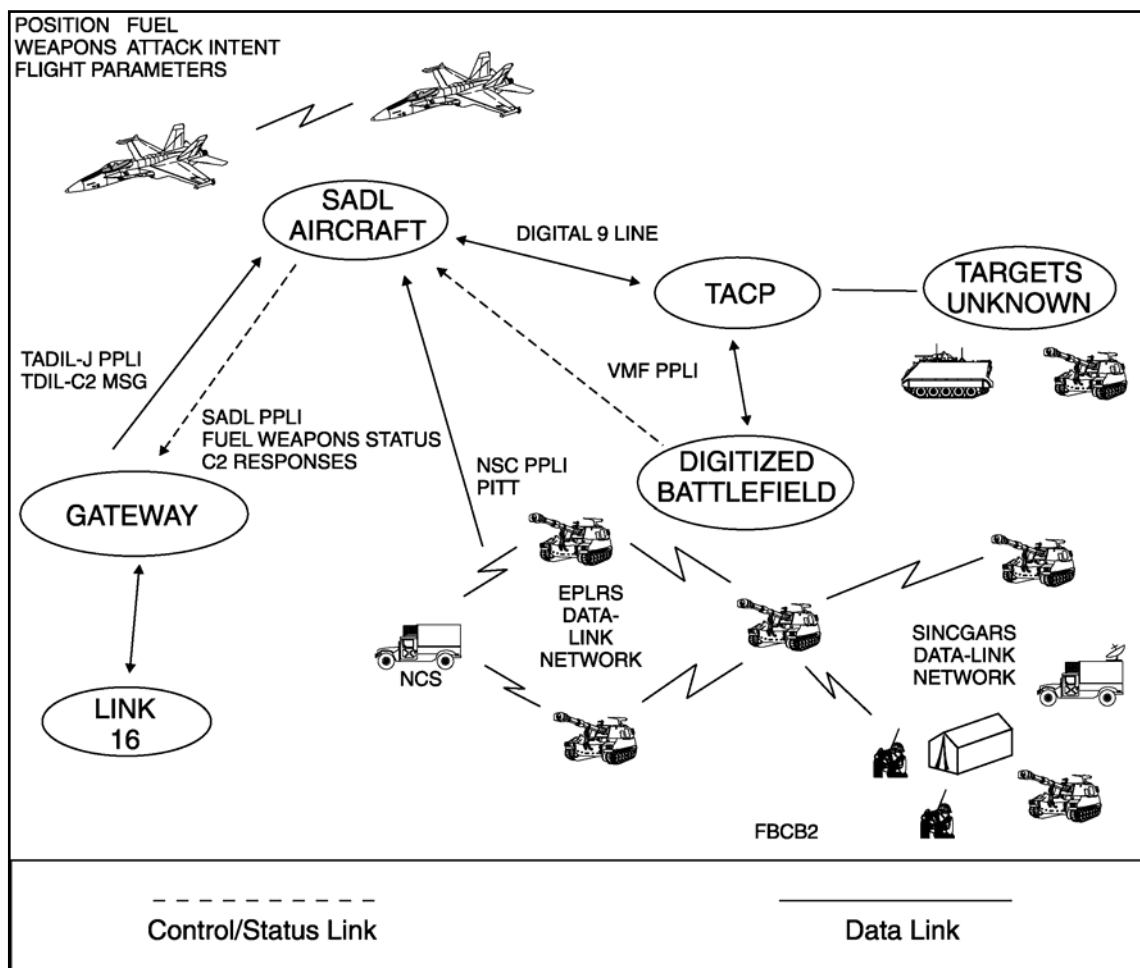

Figure IV-6. SADL

communications services. The ground NCS tracks the fighter using EPLRS and provides the fighter position and altitude to EPLRS-equipped ground forces. When the fighter begins an attack on a target, the pilot uses a switch on the control stick to provide the aircraft avionics with the five closest EPLRS positions. SADL provides the pilot SA and combat identification of EPLRS-equipped positions. These positions are displayed in the head-up display and multi-function displays as X's overlaid on top of the actual friendly positions. The pilot uses the proximity of EPLRS positions in relation to the target area as one of the factors in deciding whether to expend munitions.

(4) As part of the Army led Joint Tactical Radio System (JTRS) Cluster 1 program, the Air Force is developing a multi-band, software-defined vehicular communications system with Link 16 and EPLRS capabilities. When these JTRSs are deployed, the TACP ground forward air controllers will be able to send target information, friendly positions, and other data to Link 16-equipped and SADL-equipped platforms. This will enable Link 16-equipped aircraft to display SADL precise participant location and identification (PPLI) data and SADL-equipped aircraft to display Link 16 PPLI.

Appendix B

Comparison of ICOM and Non-ICOM Radios

Table B-1 compares and contrasts the functions and capabilities of integrated COMSEC (ICOM) and non-integrated COMSEC (non-ICOM) SINCGARS radios. Table B-2 lists the different types of radios and the maximum planning ranges for voice transmission.

Table B-1. Common Fill Devices Used with SINCGARS

Device	SINCGARS Radio						
	RT-1523 (ICOM)	RT-1523A/E (ICOM)	RT-1439 (Non-ICOM)	ARC-201 (Non-ICOM)	ARC-201A (ICOM)	AN/ARC-210 (ICOM)	RT1730SRC (ICOM)
<i>FILL COMSEC (Embedded or External Device) [KY-57/ -58]</i>							
1. AN/CYZ-10	Yes	Yes	Yes	Yes	Yes	Yes	Yes
2. KYK-13	Yes	Yes	Yes	Yes	Yes	No	No
3. KYX-15	Yes	Yes	Yes	Yes	Yes	No	No
<i>FILL FH DATA</i>							
1. AN/CYZ-10	Yes	Yes	Yes	Yes	Yes	Yes	Yes
2. MX-18290	Yes	Yes	Yes	Yes	Yes	No	No
3. MX-10579	No	No	Yes	Yes	No	No	No
<i>FILL SYNC TIME</i>							
1. AN/CYZ-10 (see note)	Yes	Yes	No	No	No	No	Yes
2. AN/PSN-11 (PLGR)	No	Yes	No	No	No	Yes	Yes
3. GPS	No	No	No	No	No	Yes	Yes
<i>FILL COMSEC/ FH (Embedded/External COMSEC) [KY-57/ -58]</i>							
AN/CYZ-10	Yes	Yes	Yes	Yes	Yes	Yes	Yes
<i>FILL COMSEC/ FH DATA/SYNC TIME</i>							
AN/CYZ-10	No	Yes	No	No	No	Yes	Yes
Note. Not recommended to use time from AN/CYZ-10 for SINCGARS operations. Time should be taken from AN/PSN- 11 (PLGR).							

Table B-2. Voice Transmission Maximum Planning Ranges

Type Radio	RF PWR Position	Planning Ranges*
MANPACK/VEHICULAR	LO (low) 1 W MED (medium) 10 W HI (high) 25 W	200 m – 400 m 400 m – 5 km 5 km – 10 km
VEHICULAR/SHIPBOARD ONLY	PA (power amp) 50 W	10 km – 40 km
AIRBORNE	MED (medium) 10 W	400 m – 5 km
<p>*Note. Planning ranges are based upon line of sight and are average for normal conditions. Ranges depend on location, sighting, weather, and surrounding noise level, among other factors. Using OE-254 antenna will increase the ranges for both voice and data transmissions. Enemy jamming and mutual interference conditions will decrease these ranges. In data transmissions, using lower data rates will increase the range.</p>		

REFERENCES

Joint

Joint Pub 1-02, *Department of Defense Dictionary of Military and Associated Terms*, 12 April 2001.

Joint Pub 3-09.3, *Joint Tactics, Techniques, and Procedures for Close Air Support*, 1 December 1995.

Joint Pub 5-00.2, *Joint Task Force Planning Guidance and Procedures*, 13 January 1999.

Other

ACP 190(A), *Guide to Frequency Planning*, 1 April 1996.

CJCSI 3220-01, *Electromagnetic Spectrum Use in Joint Military Operations*, 1 May 2000.

National Telecommunications and Information Agency Administration, *NTIA Manual of Regulations and Procedures for Federal Radio Frequency Management (January 2000 Edition with January/May/September 2001 Revisions)*.

Army

FM 11-32, *Combat Net Radio Operations*, 15 October 1990. (Will be revised as FM 6-02.53)

FM 11-45, *Signal Support to Theater Operations*, 30 June 1999. (Will be revised as FM 6-02.01)

FM 11-50, *Combat Communications within the Division (Heavy and Light)*, 4 April 1991. (Will be revised as FM 6-02.50)

FM 24-2, *Spectrum Management*, 21 August 1991. (Will be revised as FM 6-02.70)

Marine Corps

MCWP 3-40.1, *MAGTF Command and Control*, 13 January 2000.

MCWP 3-40.3, *Communications and Information Systems*, 16 November 1998.

MCRP 3-40.3B, *Radio Operator's Handbook*, 2 June 1999.

Navy

OPNAVINST 2300.44F, *Communications Characteristics for Navy Ships, Military Sealift Command Ships, Major Fleet Flag Ships, Coast Guard Cutters, Transportable Facilities, and Designated Craft*, 23 March 1995.

OPNAVINST 2400.20E, *Navy Management of the Radio Frequency Spectrum*, 19 January 1989.

Air Force

AFI 33-106 *Managing High Frequency Radios, Land Mobile Radios, Cellular Telephones, Personal Wireless Communication Systems, and the Military Affiliate Radio System*, 9 January 2002.

AFI 33-118 *Radio Frequency (RF) Spectrum Management*, 3 April 2002.

AFI 33-360(V1), *Publications Management Program*, 29 December 2000.

GLOSSARY

PART I - ABBREVIATIONS AND ACRONYMS

A

AADS	Amphibious Assault Direction System
ABCCC	airborne battlefield command and control center
ABCS	Army battlefield command systems
ABMOC	air battle management operations center
ACE	aviation combat element (MAGTF)
ACMES	Automated Communications Security Management and Engineering System
ACS	amphibious command ship
ADA	air defense artillery
ADDSI	Army data distribution system interface
AEW	airborne early warning
AFAC	airborne forward air controller
AFCSC	Air Force cryptologic support center
AFEKMS	Air Force Electronic Key Management System
AFFOR	Air Force forces
AFI	Air Force instruction
AFKDMS	Air Force Key Data Management System
AFP	ARC-210 Fill Program
AFR	Air Force regulation
AJ	anti-jamming
AKMS	Army Key Management System
ALSA	Air Land Sea Application Center
AMLS	Airspace Management Liaison Section
ANCD	automated net control device
ANCRS	Automated Navy COMSEC Reporting System
ANGLICO	air/naval gunfire liaison company
AO	air officer (USMC)
AOC	air operations center
ARFOR	Army forces
ARLO	air reconnaissance liaison officer
ASIP	advanced system improvement program
ASOC	air support operations center
ASW	anti-submarine warfare

ATCCS	Army tactical command and control systems
ATF	amphibious task force
ATO	air tasking order
AVN	aviation
AWACS	Airborne Warning and Control System
B	
BCE	battlefield coordination element
BDE	brigade
BFA	battlefield functional areas
BGU	basic generation unit
BN	battalion
BPS	bits per second
C	
C²	command and control
C⁴	command, control, communications, and computers
C⁴I	command, control, communications, computers, intelligence
CARS	Communications Security Automated Reporting System
CAS	close air support
CATF	commander, amphibious task force
CE	command element (MAGTF)
CEOI	communications-electronics operating instruction
CFD	common fill device
CG	guided missile cruiser
CINC	commander-in-chief
CJCS	chairman of the Joint Chiefs of Staff
CMDR	commander
CMIO	COMSEC material issuing office
CNR	combat net radio
CO	company
COMMS	communications
COMSEC	communications security
CONAUTH	controlling authority
COTS	commercial off-the-shelf
CRC	control reporting center
CSAR	combat search and rescue
CSEP	consolidated single channel electronic protection package

CT	cipher text
CT3	common tier 3
CTAPS	Contingency Theater Automated Planning System
CVBG	carrier battle group
CWC	composite warfare commander
D	
DA	Department of Army
DACT	data automated communication terminal
DASC	direct air support center
DCMS	Director, COMSEC material system
DCT	digital communications terminal
DDG	guided missile destroyer
DIV	division
DIVARTY	division/artillery
DOS	disk operating system
DoS	Department of State
DSP	digital signal processing
DTD	data transfer device (AN/CYZ-10)
E	
EA	electronic attack
EAC	echelon above corps
ECCM	electronic counter countermeasures
EKDD	electronic key distribution device
EKMS	Electronic Key Management System
E-Lite	EPLRS-Lite
ENM	EPLRS network manager
EOD	explosive ordnance disposal
EOM	end of message
EP	electronic protection
EPLRS	Enhanced Position Location Reporting System
ERF	electronic remote fill; ECCM remote fill
ESIP	enhanced system improvement program
EUCE	end user computing equipment
EW	electronic warfare
EW/C	early warning/control
EWO	electronic warfare officer

F

FA	field artillery
FAAD	forward area air defense
FAADC²I	forward area air defense command, control, and intelligence system
FAC	forward air controller
FBCB2	force battle command brigade and below
FEC	forward error correction
FDC	fire direction center
FFG	guided missile frigate
FH	frequency hop
FH-M	frequency hop-master
FIST	fire support team
FLD	field
FM	frequency modulation; field manual
FMF EUCE	Fleet Marine Force end user computing equipment
FMF	Fleet Marine Force
FREQ	frequency
FSK	frequency shift keying

G

G-6	component signal staff officer
GCE	ground combat element (USMC)
GHz	gigahertz
GLO	ground liaison officer
GPS	global positioning system

H

HDR	high data rate
HF	high frequency
HQ	headquarters
Hz	hertz

I

ICOM	integrated communications security
ICP	intratheater communications security package
ID	identification
INC	internet controller
IP	Internet Protocol

ISA	International Standardization Agreement
IEW	intelligence and electronic warfare
J	
J-2	intelligence directorate of a joint staff
J-3	operations directorate of a joint staff
J-6	command, control, communications, and computer systems directorate of a joint staff
JACS	Joint Automative CEOI System
JAAT	joint air attack team
JCEOI	joint communications-electronic operating instructions
JCEWS	joint commander's electronic warfare staff
JCS	Joint Chiefs of Staff
JFAC	joint force air component
JFACC	joint force air component commander
JFC	joint force commander
JFCEWS	joint force commander's electronic warfare staff
JFLCC	joint force land component commander
JIEO	joint interoperability electronic office
JKMS	Joint Key Management System
JRFL	joint restricted frequency list
J-SEAD	joint suppression of enemy air defenses
JSTARS	Joint Surveillance Target Attack Radar System
JTF	joint task force
JTIDS	Joint Tactical Information Distribution System
JTRS	Joint Tactical Radio System
JV	Joint Vision
K	
Kb	kilobit
Kbps	kilobits per second
KDD	key distribution device
KDMS	Key Distribution Management System
KDS	key data system
KEK	key encryption key
kHz	kilohertz
km	kilometer
KPE	key processing equipment

L

LAAD	low altitude air defense (USMC)
LAMPS	light airborne multipurpose system
LAN	local network area
LCAC	landing craft, air cushion
LCMS	local communications security management software
LCU	lightweight computer unit; landing craft utility
LE	late entry
LFOC	landing force operations center
LHA	amphibious assault ship – general purpose
LHD	amphibious assault ship – multipurpose
LMD	local management device
LOS	line of sight
LPD	low probability of detection
LSD	landing ship, dock

M

MAGTF	Marine air-ground task force
MARFOR	Marine Corps forces
MARLO	Marine liaison officer
MATCS	Marine air traffic control squadron
MB	megabyte; mounting base
MCE	modular control equipment
MCEB	Military Communications-Electronics Board
MCPDS	Marine Corps Publication Distribution System
MCWP	Marine Corps Warfighting Publication
MD	mission day
MEF	Marine expeditionary force
MEU	Marine expeditionary unit
MHz	megahertz
MILID	military identification code
MIL STD	military standard
MILSTRIP	military standard requisitioning and issue procedure
MSC	major subordinate command
MS-DOS	Microsoft-Disk Operating System
MSE	mobile subscriber equipment
MVR	maneuver

N

NALE	naval and amphibious liaison element
NATO	North Atlantic Treaty Organization
NAVFOR	Navy forces.
NAVSOP	Navy standard operating procedure
NCA	noisy channel avoidance
NCS	network control station
net ID	network identification
NKDS	Navy Key Distribution System
NKMS	Navy Key Management System
non-ICOM	non-integrated COMSEC
NOSC	network operations security center
NSA	National Security Agency
NST	net station time
NT	new technology

O

OPLAN	operations plan
OPORD	operations order
OPTASK	operational tasking (USN)
OTAR	over-the-air rekey
OTC	officer in tactical command
OPR	office of primary responsibility

P

PACAF	Pacific Air Force
PC	personal computer
PCS	primary control ship
PLGR	precision lightweight global positioning system receiver
PPLI	precise participant location and identification
PPP	point-to-point protocol
PRC	portable radio communications
PSC	portable satellite communications
PSN	packet switch node
PT	plain text
PTT	push-to-talk

R

RAM	random access memory
RBECS	Revised Battlefield Electronics Communications-Electronic Operating Instruction System
RCU	remote control unit
RDG	random data generator
RDS	Revised Battlefield Electronics Communications System (RBECS) data transfer device (AN/CYZ-10) (DTD) software
RECCE	reconnaissance
RF	radio frequency
RS	radio set
RSINISS	revised SINCGARS integrated communications (ICOM) security/non-integrated communications (non-ICOM) support software
RT	receiver-transmitter

S

S6	brigade communications staff
SA	situational awareness
SADL	Situation Awareness Data Link
SAR	search and rescue
SAS	single audio system
SATCOM	satellite communication
SC	single channel
SCRU	secure remote control unit
SCS	secondary control ship
SFAF	standard frequency action format
SINCGARS	Single-Channel Ground and Airborne Radio System
SIP	system improvement program
SIU	ship interface unit
SOI	signal operation instructions
SOLE	special operations liaison element
SOP	standing operating procedures
SPEED	systems planning engineering and evaluation device
SRU	shop replaceable unit
STANAG	standardization agreement
STU-III	secure telephone unit generation III

T

TACFIRE	Tactical Fire Direction System
TACP	tactical air control party
TACS	Tactical Air Control System
TACSAT	tactical satellite
TADC	tactical air direction center
TAMPS	Tactical Air Mission Planning System
TAOC	tactical air operations center (USMC)
TBMCS	Theater Battle Management Core System
TDMA	time division multiple access
TDN	tactical data network
TEK	traffic encryption key
TI	tactical Internet
TOC	tactical operation center
TOD	time of day
TRADOC	U.S. Army Training and Doctrine Command
TRANSEC	transmission security
TSK	transmission security key

U

UAS	user application software
UHF	ultra high frequency
URO	user readout
UTC	universal time, coordinated

V

VAA	Vehicular Amplifier Adapter
VHF	very high frequency
VHF-FM	very high frequency-frequency modulation
VRC	vehicle radio communications

W

W	watts
WAN	wide area network
WCCS	Wing Command and Control System
WHSP	whisper mode
WOC	wing operations center

PART II - TERMS AND DEFINITIONS

Buffered. Temporary storage used to compensate for the difference in rates of flow and acceptance of data or time of reception.

Cold start. Process to initially open a net. The net users require the same TRANSEC and manual frequency. The NCS RT should be fully loaded with all the variables.

Cold-start ERF. A process for initially opening a net. Users need a common coldstart designated TRANSEC key and manual frequency for this process. (*See also* Electronic remote fill (ERF).)

Common lockout. A collection of data words (defined in Joint Tactical Command, Control and Communications Agency (JTC3A) Specification 9001) that provide net definition (frequencies) by locking out frequencies on all preset nets within the radio. (*See also* Lockout.)

Cosite interference. Cosite interference refers to two or more transmitters located near each other that cause jamming or degraded operations

Cue frequency. An SC frequency listed in the CEOI; the primary means of alerting a net into which entry is desired. Users who may lack some of the necessary EP variables to enter an established net directly cue members of an active FH net on this frequency. Users can load the cue frequency into the radio's cue channel through the keyboard. Users employ the cue channel when they have missed the initial net opening and need an ERF, or when they want to enter an alternate net.

Electronic remote fill (ERF). A method of loading an RT with FH data over a radio frequency data link. The electronic remote filled data is transmitted by a radio in the FH master mode, usually the net controller. The two types of ERFs are in-net and cold start. The former is performed in an established FH net, the latter when an FH net is not available. Lockouts and loadsets with an appended TRANSEC key can be electronic remote filled between two or more SINCGARS radios.

EP variables. The electronic fill data that supports EP operations. This includes loadset, net ID, lockout, TRANSEC keys, Julian date and net sync time information. This excludes COMSEC keys, cue channels, manual channels, and single channel frequencies.

Electronic fill data. The initialization parameters for the radio that are loaded via SINCGARS fill device. As a minimum, all SINCGARS radios can electronically load fill data that cannot practically be loaded manually into the RT. This includes fill data such as lockouts, loadset, and TRANSEC key. Some SINCGARS equipment can also receive SC frequencies, cue frequencies, manual frequencies, frequency offsets, TRANSEC key "locations," COMSEC key "location," Julian date, and NST. This data is entered through the front panel.

Electronic fill data tag. An alphanumeric character that identifies a set or subset of SINCGARS electronic fill data; used like a COMSEC short title to identify data sets for association with contents, effective periods, controlling and originating authority, and regions where use is authorized.

GPS ZULU time. ZULU time as acquired by the global positioning satellite (GPS) receiver.

Hop sequence. The pattern of frequencies transmitted and received over radios in the net hop. The net ID, mission day (MD), and time of day (TOD) are input to the linear sequence generator. The linear sequence generator output and the TRANSEC are input to the KGV-10, whose output determines the pattern of hop.

Joint restricted frequency list. A time and geographical listing of prioritized frequencies essential to an operation and restricted from targeting by friendly EP to minimize frequency conflicts between friendly units.

Joint Tactical Information Distribution System (JTIDS). A secure antijam point-to-point information distribution system used by all services to provide the big picture. JTIDS platforms can exchange location for friendly, hostile, and neutral platforms and navigation information. Terminals are flexible and can limit the amount of information relayed or received.

Key Distribution Management System (KDMS). Software that manages the EP fill variables, transmission security keys (TSKs), communication security keys (key encryption keys (KEKs), and traffic encryption keys (TEKs)) for SINCGARS-operative radios.

Late net entry or late entry (LE). A method of joining an operational net. LE requires the correct TRANSEC, net ID, loadset, and lockouts.

Loadset. An FH preset; a structured set of data words that, when combined with lockout net definition data words, determine the frequencies on which a SINCGARS FH net will operate. The actual net frequencies are known as the net frequency map.

Lockout. A collection of data words, defined in JTC3A Specification 9001, that provide net definition (frequencies) by excluding, or locking out, frequencies from use within the radio. The two primary types of lockout are common lockout and net selectable lockout. The former, L1 through L6, apply to all preset nets; the latter, L7 and L8 are enabled or disabled by each preset net. The frequencies excluded by the lockout data words combine with those excluded by the loadset data words. All frequencies not excluded by these combined data words make up the selected preset net's frequency map.

Manual channel frequency. A single-channel frequency loaded into the manual channel in the Army's SINCGARS radio and into the "manual" preset in the AN/ARC-222. It is loaded into the manual channel by keyboard actions. The frequency is listed in the CEOI and is used for communications and ERF during cold start net opening.

Mission day. The date of the operation; corresponds to the Julian date.

Mission set. A block of fill data generated from the Air Force KDMS for loading into a specific radio to perform a specific mission.

Needline. A requirement for two or more users to communicate. Needlines are defined by a source, destination, rate, priority, and acknowledgement. They must be either duplex or simplex.

Net ID. A net variable unique to a particular FH net, analogous to a phone number or a single channel frequency in the SC mode. It is a three-digit number from 000 through 999. It assists in net definition since it is also used by the radio as a net EP parameter, which allows nets with identical loadset, lockouts, MD/TOD, and TRANSEC key to operate on different FH nets. It is assigned by the delegated office of responsibility

(JFC J6 for joint nets) using one of the computer-based net management tools: RBECS, KDMS, Navy Automatic Key Management System.

Net ID band. A group of 100 net IDs (X00 through X99).

Net ID band definition unique lockout. A group of frequencies whose use in a specific FH band of nets are excluded. The lockouts are interfaced with common lockouts and associated with a preset on the radio.

Network control station (NCS). The network control station is a function supported by certain hardware, located where needed, to perform network design and management.

OPTASK COMMS. Provides communications-electronics guidance and requirements, assigns planning and execution responsibilities for communication during joint operations, contingencies, training operations, or day-to-day naval operations in an effort to standardize the communications plans of subordinate commanders.

Pseudo-random. A process with an extremely long period before it repeats itself. It appears to be random but is actually seed dependent.

Spectrum management. For SINCGARS and RBECS, limited in scope from optimization of the frequency spectrum to include computation and assignment of those EP variables and SC frequencies required to operate concurrently within an assigned area of operation. Frequency co-site interference and resolution are taken into account but only after the division-corps frequency manager has identified potential conflicts to the software.

Tempest. The study and control of decipherable electronic signals unintentionally emitted from equipment.

Time of day (TOD). The ZULU-based time reference that can be manually entered into the radio from the front panel. Time is automatically maintained within the radio but can be updated through the reception of in-net FH messages or ERF. For normal in-net synchronization, all stations must be within plus or minus 4 seconds of the sending radio's time. The LE mode of operation may be selected to extend the acquisition time window to plus or minus 60 seconds.

Traffic encryption key (TEK). A COMSEC key that encrypts normal voice and data traffic.

Transmission security (TRANSEC) key. Similar to COMSEC key. It scrambles the hopping pattern in a pseudo-random sequence so that it looks random to anyone without the key. All members of an FH net need a common TRANSEC key in order to communicate.

Zero out. An operating procedure performed to clear COMSEC or TRANSEC keys from the radio's internal variable storage registers. This process ensures that all data has been removed and cannot be recovered from the radio.

ZULU time. Also called Greenwich Mean Time or Universal Time. A measure of time that conforms, within a close approximation, to the mean diurnal rotation of the earth and serves as the basis of civil timekeeping. Accepted by many nations and independent of time zones, it is the standard time base for TOD in SINCGARS FH nets.

INDEX

A

AADS, IV-4, IV-7
ABCS, IV-2, IV-5
ACE, II-13, II-14
ACMES, III-1, III-4
ACMES (figure), III-2, III-3
ACS, IV-7
AFKDMS, II-2, II-3, II-17, III-8, III-9, III-10
AFKDMS (figure), III-9
Air Force
 EPLRS, IV-4, IV-8
 loadset distribution, II-16
 loadset distribution (figure), II-16
 support equipment, III-8
air operations center. *See* AOC
Air Support Operations Center. *See* ASOC
air tasking order. *See* ATO
air-to-air, IV-8
air-to-ground, IV-1, IV-4, IV-8
AKMS, III-1
algorithms, I-6
allies, II-3, II-5
ALSA, ii
Amphibious Assault Direction System. *See* AADS
AN/ARC-201, A-1
AN/ARC-210, II-13, A-1, B-1
AN/ARC-210 (figure), I-4
AN/ARC-222, III-8, A-1
AN/CSZ-9, II-13, III-2, III-6
AN/CYZ-10, II-9, II-13, III-3, III-4, III-7, III-10, B-1
AN/GYK-33A, III-2
AN/KSQ-1, IV-4, IV-7
AN/PRC, A-1
AN/PRC-119, A-1
AN/PSN, B-1
AN/PSN-11, II-9
AN/UYK-83, III-4
AN/UYK-85, III-4
AN/VRC-87, A-1
AN/VRC-88, A-1
AN/VRC-89, II-4, A-1
AN/VRC-90, A-1
AN/VRC-91, A-1
ANCD, II-8, II-9, II-13, III-1, III-3, III-4
ANCD/DTD, III-7
ANCRS, III-7
AOC, II-17

ARC-201, A-1, B-1
ARC-210, II-13, II-14, III-7
Army
 EPLRS, IV-3, IV-4
 loadset distribution, II-11
 loadset distribution (figure), II-11
 support equipment, III-1
 tactical Internet (figure), IV-4
Army Key Management System. *See* AKMS
ASIP, I-2, I-5, I-6, I-7
ASOC, II-17
ATF, IV-7
ATO, II-5, II-17
authentication, II-5
Automated COMSEC Management and Engineering System. *See* ACMES
automated net control device. *See* ANCD
aviation combat element. *See* ACE

C

C⁴I, IV-6
call sign, II-3, II-17, III-4
CAS, II-5, II-17, III-9, IV-4
CATF, II-14, II-16
contingency planning, II-5, II-12
CEOI, II-2, II-12, III-4, III-6
CEOI (table), III-5
Chairman of the Joint Chiefs of Staff (CJCS), II-1
CINC, II-10
cipher text. *See* CT
cockpit, IV-8
cold start, I-10, I-11
combat support, II-5
commander, amphibious task force. *See* CATF
communications coordination committee, II-2
composite warfare commander. *See* CWC
compromised material, II-8
computer equipment specifications, II-13, III-6, III-9
COMSEC, I-10, II-8, II-9, II-12, II-16, II-18, III-4, III-10
consolidated SC EP package. *See* CSEP
Contingency Theater Automated Planning System. *See* CTAPS
cryptographic management, II-5, II-8, III-3, III-4, III-10
CSAR, II-5, II-7, III-9, IV-4
CSEP, II-13
CSZ-9, II-12
CT, I-9, I-10, I-11, II-8
CTAPS, II-17
cue frequency, I-2, I-11, II-5
CWC, II-14, II-15, II-16
CYZ-10, II-12

D

DACT, IV-7
data automated communication terminal. *See* DACT
data transfer device. *See* DTD
DoS, II-3
DTD, II-9, III-6, III-10

E

ECCM, III-6
electronic/electromagnetic counter-countermeasure. *See* ECCM
EKDD, III-10
EKMS, III-4
electronic key distribution device. *See* EKDD
Electronic Key Management System. *See* EKMS
electronic remote fill. *See* ERF
electronic warfare officer. *See* EWO
E-Lite, IV-3
end of message. *See* EOM
ENM, IV-3
EOM, I-6
EPLRS application, sample (figure), IV-5, IV-6, IV-8, IV-9
EPLRS network interfaces (figure), IV-3
EPLRS network manager. *See* ENM
EPLRS, sample (figure), IV-4
ERF, I-9, I-11, II-9
ESIP, I-6
EWO, II-2

F

FBCB2, IV-1, IV-2, IV-3, IV-5, IV-6
FBCB2 (figure), IV-5
FEC, I-5, I-6, IV-1
FH mode, I-2, I-3, I-9, II-5
FH-M, I-11, II-8
FH-Master. *See* FH-M
Force Battle Command Brigade and Below. *See* FBCB2
forward error correction. *See* FEC
frequency hop mode. *See* FH mode
frequency management, II-1, II-2, II-3, II-6, II-7, III-1, III-4
frequency range, I-9, II-6, II-7

G

G-6, II-11, II-12
GCE, II-13
global positioning system. *See* GPS
GPS ZULU, I-11, II-7, II-8
ground combat element. *See* GCE

H

hailing, I-2
Have Quick, II-13, III-7
hopset, I-9
host country, II-2
hot start, I-10

I

ICOM, I-4, II-9
ICP, II-10
INC, I-5, I-6, I-7
INC (figure), I-8
integrated communications security. *See* ICOM
interference, minimizing, I-6, II-5, III-4
interoperability, II-5
intratheater COMSEC package. *See* ICP
IP routing, I-5, I-6, I-7, IV-3

J

J-2, II-2
J-3, II-2
J-6, JFC, II-1, II-2, II-3, II-5, II-7, II-8, II-10, III-9
J-6, JTF, I-10, II-9, II-12, II-13
JACS, II-2, II-8, II-12, III-3, III-4, III-6, III-9
JCEWS, II-2
JCS, II-1
JFC, II-1, II-2
Joint Chiefs of Staff. *See* JCS
joint commander's electronic warfare staff, II-2
Joint Force Command. *See* JFC
joint restricted frequency list, II-2
Joint Tactical Information Distribution System. *See* JTIDS
JRFL, II-2
JTIDS, III-1
Julian date, I-9, II-8
JV 2020, vii

K

KDD, III-3, III-4
KDMS, III-7, III-8, III-9, A-1
KDS, II-18, III-8
KEK, I-10, II-8
key data system. *See* KDS
key distribution device, III-10, *See* KDD
Key Distribution Management System. *See* KDMS
key encryption key. *See* KEK
key processing equipment. *See* KPE

KG-84A/C, II-9
KPE, III-7, III-10
KYK-13, II-9, III-3, III-10, B-1
KYX-13, III-7
KYX-15, II-9, III-3, III-7, III-10, B-1
KYX-15A, III-7

L

landing craft air cushion. *See* LCAC
landing force operations center. *See* LFOC
late net entry, I-11
LCAC, IV-7
LCU, II-12
LFOC, IV-7
lightweight computer unit. *See* LCU
Link 16, IV-9
lockouts, II-6
LMD, II-13, III-4, III-7, III-10
loadset, III-6
loadset distribution, I-10, II-8, II-9, II-11, II-12, II-14, II-16, II-17
loadset distribution (figure), II-10
loadset distribution (table), II-7, II-9
loadset generation, II-6, II-12, II-13, II-14, II-15, II-17, III-7
loadset generation (figure), II-6
loadset size, II-6
loadset storage, I-10, II-7
loadsets, I-10, II-8, II-9, II-18
local management device. *See* LMD
lockouts, I-9
lower TI, IV-4, IV-6

M

MAGTF, II-13
Marine Air-Ground Task Force. *See* MAGTF
Marine Corps, IV-6
 EPLRS, IV-3, IV-6
 loadset distribution, II-12, II-14
 support equipment, III-4
 tactical Internet (figure), IV-6
Marine expeditionary force. *See* MEF
Marine expeditionary unit. *See* MEU
master net list, II-3, II-12
MCEB, II-1
MEF, II-12
message library, IV-2
MEU, II-13
MILID, IV-2
Military Communications-Electronics Board. *See* MCEB
mixed-mode operation, I-3, I-12

mobile subscriber equipment. *See* MSE
MSE, III-1
MX-10579, II-9, III-3, B-1
MX-18290, II-9, III-3, B-1

N

National Security Agency. *See* NSA

Navy

- EPLRS, IV-4, IV-7
- loadset distribution, II-14
- loadset distribution (figure), II-15
- loadset generation, II-13
- support equipment, III-6

Navy Key Management System. *See* NKMS

NCA, I-6

NCS, I-3, I-9, I-10, I-11, II-8, IV-1, IV-2, IV-8, IV-9

headline library, IV-2

net ID, I-9, II-1, II-7, II-12, II-13, II-15, II-16

net station time. *See* NST

network activation, I-2

network control station. *See* NCS

network controller, IV-1

network controller (EPLRS). *See* NCS

network management, IV-2

NKDS, III-4

NKMS, II-13, III-7

NKMS (figure), III-8

noisy channel avoidance. *See* NCA

NOSC, IV-2

NSA, II-9, III-3, III-4, III-10, IV-8

NST, II-7

O

officer in tactical command. *See* OTC

operations order. *See* OPORD

operations plan. *See* OPLAN

OPLAN, II-1

OPORD, II-1

OTAR, I-10, II-9

OTC, II-14

over-the-air rekey. *See* OTAR

P

paper printout, II-3, III-4, III-5

PCS, IV-7

Phase I

- ACMES, III-1
- ACMES (figure), III-2
- NKMS, II-13

NKMS, III-7
Phase II
ACMES, III-3, III-4
ACMES (figure), III-3
NKMS, II-13, III-7
plain text. *See* PT
planning, I-9, II-1, II-3, II-5, II-7, II-11, II-12, II-17, II-18, IV-1, IV-2, B-1
PLGR, I-5, I-6, B-1
PPLI, IV-9
precision lightweight global positioning system receiver, I-5
PT, I-9, I-10
PTT, I-6, I-11

R

radio set. *See* RS
random data generator. *See* RDG
RBECS, II-2, II-8, II-12, III-3, III-4, III-6, III-9
RBECS (figure), III-6
RDG, II-13, III-2, III-6
revised battlefield electronics CEOI system. *See* RBECS
revised SINCGARS ICOM/non-ICOM support software. *See* RSINISS
RS, II-4, IV-1, IV-2, IV-3
RSINISS, III-9
RT, I-2, I-4, IV-2, B-1
RT-1439, III-9, A-1, B-1
RT-1523, I-4, II-13, III-9, A-1, B-1
RT-1523 (figure), I-5
RT-1523A, I-11
RT-1523C, I-6
RT-1523E, I-4
RT-1523E (figure), I-5
RT-1794, I-4
RT-1794 (figure), I-4
RT-1824, I-4

S

S-6, II-12
SADL, IV-1, IV-2, IV-4, IV-8, IV-9
SADL (figure), IV-9
SC mode, I-2, I-3, I-9, I-12, II-5
SCS, IV-7
secondary control ship. *See* SCS
secure telephone unit III. *See* STU-III
SFAF, II-3
SFAF (figure), II-4
signal operation instructions. *See* SOI
SIP, I-2, I-5, I-6, I-7
Situation Awareness Data Link. *See* SADL
situational awareness, I-6, IV-2

SOI, II-2, II-12, III-3, III-4
SOP, II-8
SPEED, II-3, II-13, III-4
standard frequency action format. *See* SFAF
State, Department of. *See* DoS
STU-III, II-9
subscriber access, I-2
sync time, I-9, I-11, II-7, II-8, II-12, III-1

T

TACP, IV-9
tactical air control party. *See* TACP
tactical aircraft mission planning system. *See* TAMPS
tactical data network. *See* TDN
tactical Internet, I-6, I-7, IV-1, IV-3, IV-4, IV-6, IV-8
tactical Internet (figure), I-8, IV-4, IV-6
tactical operation center. *See* TOC
TAMPS, III-7
TBMCS, II-17
TDMA, IV-1
TDN, IV-3, IV-6, IV-7
TEK, I-10, II-8, II-12, II-13, II-16
Theater Battle Management Core System. *See* TBMCS
time division multiple access. *See* TDMA
time hack, I-11, II-7
time of day. *See* TOD
TOC, IV-4
TOD, I-6
traffic encryption key. *See* TEK
TRANSEC, III-6
transmission security key. *See* TSK
TSK, I-9, II-7, II-12, III-4
transmission security. *See* TRANSEC

U

upper TI, IV-4

V

VHF-FM, I-1, I-2, II-3
VHF-FM (figure), I-1

W

WCCS, II-17
whisper mode. *See* WHSP
white noise, I-6
WHSP, I-4
Wing Command and Control System. *See* WCCS

wing operations center. *See* WOC
WOC, II-17

Z

ZULU. *See* GPS ZULU

FM 6-02.72 (FM 11-1)
MCRP 3-40.3A
NTTP 6-02.2
AFTTP(I) 3-2.18

14 JUNE 2002

By Order of the Secretary of the Army:

Official:

ERIC K. SHINSEKI
General, United States Army
Chief of Staff

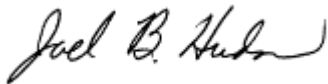

JOEL B. HUDSON
Administrative Assistant to the
Secretary of the Army
0220010

DISTRIBUTION:

Active Army, Army National Guard, and U.S. Army Reserve: Distribute in accordance with the initial distribution number 115419, requirements for fm 6-02.72.

By Order of the Secretary of the Air Force:

DAVID F. MACGHEE, JR.
Major General, USAF
Commander
Headquarters Air Force Doctrine Center

Air Force Distribution: F

