

PATHFINDER OPERATIONS
Contents

	Page
Preface	vi
 Chapter 1. INTRODUCTION	
1-1. Employment	1-1
1-2. Equipment	1-3
1-3. Communications Security	1-4
1-4. Training	1-5
 Chapter 2. OPERATIONS	
Section I. Planning	2-1
2-1. Warning Order	2-1
2-2. Initial Preparation	2-1
2-3. Coordination	2-2
2-4. Linkup with Supported Unit	2-4
2-5. Final Preparations	2-4
Section II. Organization for Combat	2-4
2-6. Insertion	2-4
2-7. Overland Movement	2-6
2-8. Stay-Behind Operation	2-6

DISTRIBUTION RESTRICTION: Approved for public release;
distribution is unlimited.

*This publication supersedes FM 57-38, 9 October 1968.

	Page
Section III. Conduct of Operations	2-6
2-9. Daylight Assault	2-6
2-10. Night Assault	2-7
2-11. Extraction	2-7
2-12. Staging Areas	2-8
2-13. Artillery Displacement	2-8
2-14. Support of Ground Operations	2-8
2-15. Support of Air Force	2-8
2-16. Mixed Operations	2-9
2-17. Radio Communications	2-9
2-18. Terminal Guidance by Supported Units	2-10
Section IV. High-Threat Environment	2-11
2-19. Control and Navigation	2-11
2-20. Tactical Instrument Flights	2-11
2-21. Air Routes	2-12
CHAPTER 3. AIR TRAFFIC CONTROL	
Section I. Pathfinder ATC Communication	3-1
3-1. Safety	3-1
3-2. Voice Control	3-1
3-3. Formats	3-2
3-4. Numbers	3-3
3-5. Phrases	3-4
Section II. Landings	3-7
3-6. Traffic Patterns	3-7
3-7. Methods of Entry	3-8
3-8. Traffic Pattern Legs	3-9
3-9. Advisory Service	3-9
3-10. Spacing Techniques	3-10
3-11. Final Landing Instructions	3-12
3-12. Taxiing Aircraft	3-12
3-13. Minimum Aircraft Separation Requirements	3-12
Section III. Ground-to-Air Communications	3-13
3-14. Electronic Warfare Environment	3-14
3-15. Ground-To-Air Transmissions	3-15

CHAPTER 4. HELICOPTER LANDING ZONES

	Page
Section I. Site Selection and Landing Points	4-1
4-1. Requirements	4-1
4-2. Alternate Sites	4-5
4-3. Landing Points	4-5
Section II. Organization and Duties	4-8
4-4. Control Center	4-8
4-5. Landing Site Party	4-9
Section III. Landing Site Operations	4-10
4-6. Communications	4-10
4-7. Flight Formations	4-10
4-8. Landing Zone and Obstacle Marking	4-11
4-9. Air Assaults	4-17
4-10. Intercept Heading	4-19
Section IV. Landing Zone Operations	4-19
4-11. Communications Checkpoint	4-20
4-12. Air Control Points	4-21
Section V. Night Operations	4-22
4-13. Tactical Landing Lights	4-22
4-14. External Loads	4-24
4-15. Multi-Helicopter Operations	4-24
4-16. Night Vision Goggles	4-24
Section VI. Environmental Considerations	4-25
4-17. Pilot Input	4-25
4-18. Cold Weather Operations	4-25
4-19. Jungle Terrain	4-29
4-20. Desert Terrain	4-30
4-21. Mountains	4-31
Section VII. Approach Path Considerations	4-33
4-22. Vertical Air Currents	4-33
4-23. Escape Routes	4-33

	Page
4-24. Terrain Contour and Obstacles	4-33
4-25. Position of the Sun	4-34

CHAPTER 5. EXTERNAL LOADS

5-1. Landing Points	5-1
5-2. Types of Loads	5-1
5-3. Unit Responsibilities	5-1
5-4. Equipment	5-2
5-5. Service Life of Aerial Delivery Slings	5-4
5-6. Aircraft Load Limitations	5-11
5-7. Standard Weights	5-14
5-8. Air Items Required for Common Standard Loads	5-15
5-9. Sling Load Theory	5-16
5-10. Hookup and Release Procedures	5-18

CHAPTER 6. DROP ZONES

Section I. Selection Factors	6-1
6-1. Air Drop Airspeeds	6-1
6-2. Drop Altitude	6-2
6-3. Drop Zone Time Requirement Estimation	6-4
6-4. Methods of Delivery	6-4
6-5. Obstacles	6-5
6-6. Access	6-6
6-7. Size	6-6
6-8. Approach and Departure Routes	6-13
Section II. Drop Zone Support Team	6-13
6-9. Organization	6-14
6-10. Missions	6-14
6-11. Equipment Familiarization	6-14
6-12. Coordination	6-16
6-13. Support Requirements	6-18
6-14. Drop Zone Support Team Leader's Duties	6-19
6-15. Control Center	6-20
6-16. Signals	6-21
6-17. Determination of Release Point Location	6-21
6-18. Ground Marking Release System	6-23

	Page
6-19. Army Verbal Initiated Release System	6-28
6-20. Air Force Verbal Initiated Release System	6-30
6-21. Air Force Computed Air Release Point	6-31
6-22. Assault Zone Availability Report	6-35
6-23. Drop Zone Survey	6-35
6-24. Tactical Assessment	6-38
6-25. Airdrop/Airland/Extraction Zone Control Log . . .	6-39
6-26. Air Medical Evacuation Requests	6-42
Appendix A. OPERATIONAL FORMATS	A-1
Appendix B. ARMY HELICOPTER SPECIFICATIONS	B-1
Glossary	Glossary-1
References	References-1
Index	Index-1

PREFACE

This manual provides a reference for the training and employment of pathfinder and terminal guidance personnel. The tactics, techniques, and procedures describing the conduct of various missions are guides that may be modified for pathfinder/terminal guidance personnel as required by various air assault operations.

A glossary of acronyms and terminology that are peculiar to air assault and pathfinder operations, and to Army-Air Force air traffic control are included. Users are urged to read and refer to this glossary as an aid to understanding the text.

This publication implements the following international agreements:

STANAG 2863

Navigational and Communication Capabilities for Helicopters in Multinational Land Operations, 26 SEP 88

STANAG 3117

Aircraft Marshaling Signals, 17 OCT 85

STANAG 3281

Personnel Locator Beacons, 3 APR 78

STANAG 3570

Drop Zones and Extraction Zones— Criteria and Markings, 26 MAR 86

STANAG 3619

Helipad Marking, 10 JUL 80

QSTAG 585

Marshaling Helicopters in Multinational Land Operations, 23 April 81.

Unless this publication states otherwise, masculine nouns and pronouns do not refer exclusively to men.

The proponent for this publication is the US Army Infantry School. Send comments and recommendation on DA Form 2028 directly to Commandant, US Army Infantry School, ATTN: ATSH-TTP-A, Fort Benning, GA 31905-5560.

CHAPTER 1 INTRODUCTION

Army pathfinders primarily provide navigational assistance and advisory services to military aircraft in areas designated by supported unit commanders. Their secondary missions include providing advice and limited assistance to units planning air assault/airdrop operations.

1-1. EMPLOYMENT

The pathfinder provided navigational assistance and air traffic advisories for Army aircraft encompass any phase of an air assault or a ground operation that requires sustained support by Army aircraft. For some missions, employment may be on a short-term basis as pathfinders are redeployed upon completion of a major troop lift or airdrop.

a. Primary Employment. Ideally, a pathfinder team is assigned to each combat aviation battalion. This enhances the relationship between aviators and pathfinders; an understanding between the two is important to the successful completion of a mission. However, with the reduction of pathfinder units and the assignment of pathfinder coded positions within ground units, it is still important to maintain this relationship.

(1) Personnel who are not pathfinder qualified are trained by the pathfinder and formed into a pathfinder team at company level. The team will provide navigational assistance, air traffic advisories, and information on an around-the-clock basis for any type air movement or resupply operation conducted by or for the ground unit and supported by an aviation unit.

(2) Pathfinders are trained and equipped to select, mark, improve, and control landing sites. Engineers in direct support of lifted ground units may assist pathfinders in improving LZs. In most situations, pathfinders perform two or more of the functions at the same time, with priority given to establishment of GTA radio communications. Pathfinders should be combat lifesaver qualified to provide additional internal medical support.

b. Secondary Employment. When not performing duties for supported units, pathfinders (with equipment) stay near and in communication with the supported ground unit command post. When pathfinders are awaiting further missions, the command post of the parent or supported unit may task them to assist in aviation unit base airfield control, in minor demolition work, or in staff sections by performing map and aerial photographic work. However, training and maintenance of equipment take priority over the performance of secondary missions.

c. Capabilities. Appropriately equipped and trained pathfinders can fulfill the following responsibilities.

(1) Reconnoiter areas selected by supported unit commanders and select LZs and DZs.

(2) Infiltrate areas of operation by foot, vehicles, or watercraft, and airland, rappel or parachute from aircraft.

(3) Prepare LZs and DZs to include establishing and operating visual and electronic navigational aids and removing minor obstacles.

(4) Employ GTA radio communications to provide pilots with guidance and air traffic advisories within an area of operations.

(5) Advise pilots concerning friendly mortar and artillery fires through direct coordination with fire support units.

(6) Provide technical assistance for the assembly of supplies, equipment, and troops before aircraft loading for deployment to LZs and DZs.

(7) Advise and provide limited physical assistance in preparing and positioning supplies, equipment, and troops for air movement.

(8) Conduct limited NBC monitoring and surveying of designated areas.

(9) Provide limited weather observations, to include wind velocity and direction, cloud cover, visibility, and approximate cloud ceiling.

(10) Operate, by agreement with the USAF, DZs and airfields for USAF aircraft in the absence of CCT.

(11) Survey DZs for use by USAF and Army aircraft. (In this situation, it maybe necessary to provide pathfinders with radios [UHF or VHF] that are compatible with USAF radio equipment. Aviators and pathfinders must coordinate to ensure they understand ground markings and radio procedures to be used.)

d. Limitations. Pathfinders are restricted in their employment to aircraft guidance and related primary tasks. Pathfinders must be augmented when they—

- Provide security.
- Remove major obstacles.

- Recover and assemble equipment and supplies.
- Operate additional radio nets and telephones.
- Transport items of equipment.
- Conduct detailed NBC monitoring and surveying.

1-2. EQUIPMENT

A wide variety of equipment is used by the pathfinder. Although the aviation unit SOP may specify the type of equipment, the mission will dictate what will be taken on the operation.

a. Navigation Aids. Navigation aids are used to help aviators locate and identify an exact area.

(1) Electronic navigation aids include homing beacons, transponders, radios, and other electronic devices that assist in aircraft navigation. These aids have a greater signaling range than visual navigation aids.

(2) Visual navigation aids are used to designate specific areas or points on LZs and DZs. They are also used as GTA signals. Daylight visual aids include panels, smoke, signal mirrors, and colored gloves for signalmen. Night visual aids include light beacons, lanterns, baton flashlights, strobe lights, and pyrotechnics. Field-expedient visual aids may also be used effectively day or night. Visual aids are vulnerable to detection because the enemy can also see them.

(3) Infrared navigation aids are used as NVG compatible items to assist in night navigation.

b. Communications Equipment. Pathfinders use FM radios with secure capability and limited wire equipment. These radios allow pathfinders to communicate with aircraft, other pathfinder elements, and supported units. They have incorporated homing capabilities to provide navigation assistance to aircraft.

c. Assembly Aids. Assembly aids are used to designate troop and supply assembly areas. As with navigation aids, assembly aids may be either electronic or visual. Field expedients may also be employed. All assembly aids can attract the threat force's attention; therefore, care must be exercised to avoid compromise.

(1) Electronic assembly aids include radios and homing devices employing a radio signal. All electronic signals can be intercepted by direction-finding equipment and attract enemy attention.

(2) Visual assembly aids are usually simple to employ. They include panels, smoke, and armbands for day operations; and lanterns, flashlights, light beacons, strobe lights, chemical lights, and pyrotechnics for night operations. They afford positive identification of assembly areas; however, they can also be seen by the enemy. Close coordination of their

use is required to prevent misunderstandings. (See TM 9-1370-206-10, FM 21-60, and STANAGs 3117 and 3281.)

(3) Infrared light sources can be used as assembly aids; but, they dictate the use of night vision devices.

d. **Miscellaneous Equipment.** Pathfinder equipment also includes vehicles, binoculars, night (starlight) scopes, nonelectric demolition kits, wind-measuring equipment, parachutes, NBC detection equipment, NVDs, and thermal sights.

1-3. COMMUNICATIONS SECURITY

Pathfinders and terminal guidance personnel must be aware of hostile data collection and exploitation activities, which seek to disrupt, deceive, harass, or otherwise interfere with the command and control of pathfinder operations.

a. Enemy Interception. All signal equipment that radiates electromagnetic energy (such as radios, radars, and electro-optical devices) is vulnerable to enemy interception, analysis, direction finding, and exploitation. Such exploitation may be aimed at gaining intelligence for enemy fire and maneuver elements and for collecting data for electronic countermeasures.

(1) Enemy exploitation of pathfinder emissions may not include an immediate enemy response. The enemy collection and analysis of data gained by interception maybe used to plan operations for a later, more advantageous time. Enemy jamming or deception may not be used either; the enemy may pretend that he has not detected pathfinder electronic signals.

(2) The enemy's capability to exploit signal intelligence in support of his ground operations is limited to some degree by time-distance factors. He may use a reaction force or a direction-finding fix. If he uses a DF, he may use electronic countermeasures (jamming and deception) against electronic aids used in pathfinder operations.

b. Pathfinder Awareness. Pathfinders must anticipate enemy DF capabilities. Automated DF systems determine line bearings for each signal detected. Line bearings are continuously processed and compared, and fixes are plotted for signals. Depending on the size of the DF base and the number of DF systems available, the enemy may be able to accurately determine a position with little difficulty.

(1) Enemy actions to gain signal intelligence may indicate their intended reaction to the opposing force. Some factors to consider in combating enemy DF systems are:

(a) The high priority given to aviation-related missions.

- (b) The amount of time their transmitter is in use (on the air).
 - (c) The number of their transmitters.
 - (d) The distance of friendly forces from enemy DF systems, fire and maneuver elements, and collection and jamming resources.
 - (e) Friendly actions to mask pathfinder operations.
- (2) The vulnerability of signal devices to enemy exploitation is significantly reduced through strict signal security practices to include electronic warfare. (For more information on communications and EW, see FM 24-18, FM 34-40, FM 90-2, and FM 100-26.)

1-4. TRAINING

Personnel become pathfinder-qualified by completing the Pathfinder Course at the US Army Infantry School, Fort Benning, GA. Every pathfinder training program emphasizes development of individual proficiency in air traffic control procedures and an understanding of supported aviation unit SOP. The training program also stresses mission accomplishment in an electronic warfare environment.

a. **Commander's Responsibilities.** Major unit commanders employing pathfinders are responsible for sustaining their training and proficiency. Pathfinder training is most beneficial when it is integrated with the training of supported aviation and ground units.

b. **Pathfinder's Responsibilities.** The assigned, qualified, and trained pathfinder must ensure that the nonqualified personnel assigned to his unit team are adequately trained before they attempt a mission.

THIS CHAPTER IMPLEMENTS STANAGs 2863, 3117, AND
3570.

CHAPTER 2 OPERATIONS

Pathfinders conduct many different missions, many of which are additional requirements of the ground units' operation.

Section I. PLANNING

Pathfinder missions must be planned in detail to ensure success of the ground units' mission. The amount of detail is dictated by the amount of time allotted to plan.

2-1. WARNING ORDER

Upon notification of a pending operation, the senior pathfinder gives a mission alert as early as possible and follows it with a warning order. The warning order includes sufficient information to permit initial preparations for the operation. It should include:

- A roll call.
- A brief statement of the enemy and friendly situations.
- The mission.
- The chain of command and task organization.
- The individual uniform and equipment (if not in the SOP).
- The required equipment.
- The time schedule to complete work priorities; includes place, time, and personnel required.
- Specific instructions and personnel attached.
- Time coordination.

2-2. INITIAL PREPARATION

Inspection of personnel and equipment begins upon receipt of the alert or the warning order. Personnel or equipment augmentation, if required, is also accomplished at this time.

- a. Equipment is normally prepared in the following priority:
 - Radios.
 - Navigation aids, both electronic and visual.
 - Weapons and essential individual equipment.
 - Assembly aids.
 - Miscellaneous items.

b. The pathfinder element leader or his representative and the air mission commander initiate their liaison with the supported aviation and or ground unit(s).

c. As more information is received, personnel and equipment are reorganized to better accomplish the mission. Time permitting, rehearsals are conducted using available briefing aids and terrain that most nearly resembles the operational area.

d. Security is mandatory for the success of an operation; therefore, personnel are given only the minimum essential information needed to complete each phase of an operation. Individuals who have received detailed information are isolated (for security). Operational situations dictate security requirements.

2-3. COORDINATION

Ground and aviation commanders coordinate and plan the details of operations that require pathfinder assistance. The pathfinders may be required to recommend the exact location of DZS or LZs, the time schedule, the landing formations, and the techniques to be employed. These recommendations are likely for any type of operation (combat assault, reinforcement, artillery displacement, resupply, or evacuation). The DZ or LZ is selected by the supported unit commander after considering the factors of METT-T, and the advice of the pathfinder and aviation commanders or their representatives.

a. While preparing for an operation, aviation liaison officers and ground unit commanders coordinate factors used to formulate an air movement table with the pathfinders. Their responsibilities include:

- (1) Operational location (coordinates). (ALO & GUC)
- (2) Location of the communications checkpoint and alternate communication checkpoint (coordinates). (ALO)
- (3) Location of release point (coordinates and whether manned or unmanned). (ALO)
- (4) Time the site is to be operational. (ALO & GUC)
- (5) Aircraft information (formation, time interval, number of flights, drop speed, and drop altitude). (ALO)
- (6) Pathfinder transportation and time available for briefing. (ALO)
- (7) Pathfinder transportation station time. (ALO)
- (8) Routes into the objective area. (ALO & GUC)
- (9) Call signs (aircraft, pathfinders, supported units, other friendly units). (ALO & GUC)
- (10) Primary and alternate frequencies (aircraft, pathfinders, supported units, other friendly units, homing beacon). (ALO & GUC)
- (11) Fire support (artillery, tactical air support). (ALO & GUC)

- (12) Weather forecast (ceiling, visibility, temperatures [high, low]). (ALO)
- (13) Logistical support (locations of medical aid station, prisoner collection point, fuel, ammunition, rations). (ALO & GUC)
- (14) Alternate plan (evacuation plan, escape and evasion). (ALO & GUC)
- (15) Friendly unit locations. (ALO & GUC)
- (16) Authority to implement mission change. (ALO & GUC)
- (17) Support personnel required. (GUC)
- (18) No-land or no-drop signals. (ALO)
- (19) Markings for obstacles. (Done only on request of flight commander.)
- (20) Marking objective site for identification from the air. (ALO)
- (21) Time allowed for approval. (ALO & GUC)

b. The pathfinder needs this information because he participates in all planning coordination and uses the information to prepare final plan for the pathfinder phase of the operation. He must know the air movement phase of an operation to ensure that he can safely and efficiently control all aircraft in and around the DZs or LZs. Aviation and ground commanders keep pathfinders informed of all changes in plans and landing sites or any emergencies. The pathfinder ensures that all pathfinder activities are coordinated with all agencies or units involved and that information is disseminated to all pathfinders involved in the operation.

c. When the pathfinder gets to the objective site, he may decide that it is not suitable, as regards the coordinated landing formation, heading, drop altitude, or the ground site itself. He then coordinates with the ground and or aviation commander(s) if any of the original requirements are to be amended. Depending upon the situation (METT-T), the commander(s) determines what, if any, changes may be made to accomplish the mission. The pathfinder can also coordinate for authority to change requirements if contact with the GUC or aviation commander is not possible or practical.

d. Based upon coordinated plans for an operation, the pathfinder requests augmentation in personnel and equipment. He considers the following:

- Mission.
- Use of personnel and equipment for security.
- Requirement to assist in the assembly of personnel, supplies, and equipment of supported units.
- Need for assistance in removing obstacles.
- NBC survey or monitoring requirements.

- Assistance required for transporting and operating navigational aids under pathfinder direction.

e. Augmentation is kept to a minimum, in keeping with the transportation to be used in delivering the pathfinder team. When reinforced, the pathfinder team remains under the command of the pathfinder leader who is responsible for the functions of the team.

2-4. LINKUP WITH SUPPORTED UNIT

Pathfinders join the supported unit in sufficient time to allow final coordination between pathfinder, aviation, and lifted ground unit representatives. However, if pathfinders enter an LZ or DZ ahead of the assault echelon, and have been designated to accompany and provide continuous support to a ground unit, then the linkup with the supported unit normally occurs after the initial phase of the air movement.

2-5. FINAL PREPARATIONS

The pathfinder leader issues his operation order. If he issued it prior to linkup with the supported unit, he should issue any changes as a fragmentary order. If the unit SOP does not describe each member's duties, the order must do so. Team members are given an opportunity to study maps, aerial photos, and terrain models of the area. The order must contain detailed information on the location and the operation of proposed air delivery facilities, flight routes, flight formations, time schedules, RPs, and CCPs.

a. A final, detailed check is made of the equipment to be used in the operation. A decision is made on the exact manner in which the equipment is to be transported into the objective area. All items of equipment are prepared for rapid displacement.

b. A final weather and operation briefing is held for the pathfinders just before departure. Final coordination between the pathfinders and supported units is accomplished at this time.

Section II. ORGANIZATION FOR COMBAT

Pathfinders are organized to meet specific requirements of the mission. In most operations, three to six men make up the average size pathfinder *element* at an LZ or DZ or when in continuous support of an infantry battalion. A pathfinder *section* is seldom employed as a unit at a single location. The pathfinder leader plans for widely separated and disconnected operations by his elements.

2-6. INSERTION

Pathfinders can be inserted into an area by a variety of air, sea, or land transportation.

a. Landing by Helicopter. More personnel and equipment can be delivered in a better state of operational readiness when landed by helicopter. This delivery is more precise and more flexible than parachute delivery and can be carried out in marginal weather. In some areas, terrain may preclude helicopter landings. Trained personnel can rappel from helicopters hovering over unsuitable landing areas. The use of troop ladders from hovering helicopters also allows personnel to be inserted or withdrawn from such areas. Helicopters can also—

- (1) Furnish a means of aerial radiological monitoring.
- (2) Rapidly shift or evacuate pathfinders.
- (3) Enable nonparachutists to accompany pathfinders in a supporting role.
- (4) Be a delivery means when rain or low ceilings prohibit parachuting.

b. Parachute Delivery. Parachute delivery by fixed-wing aircraft normally affords greater range and speed of movement than landing by helicopter. However, for short-distance operations, helicopters may be used as the jump aircraft.

- (1) Depending upon wind conditions, pathfinders should compute their desired parachute RPs before arrival over the DZ. For accuracy and security, parachute jumps are made at the lowest practical altitude. Jump altitudes and procedures for personnel are prescribed in SOPS for the types of aircraft involved and vary in accordance with peacetime and wartime restrictions (FM 57-230).
- (2) Pathfinders are highly trained parachutists who can be inserted into unimproved and marginal DZs. Their training in emergency landing procedures, canopy control of the maneuverable parachute, and expertise in rough terrain DZs provides flexibility when planning parachute delivery.
- (3) When parachuting, pathfinders carry essential operational items of equipment. This gives them immediate access to needed equipment upon landing. Special care is taken by padding and carefully arranging items into equipment containers during the preparation phase.
- (4) Parachute entry has its greatest application during nonilluminated, nonsupported night operations when secrecy is the primary consideration.
- (5) The need for comparatively large, secure, and obstacle-free landing areas, however, limits the landing of fixed-wing airplanes for pathfinder delivery.

c. Water and Land Delivery. Delivery of pathfinders by watercraft is considered secure up to the point of debarkation from the craft. The

pathfinders still have to move from the landing point (debarkation) to their final destination. This is done by land infiltration.

2-7. OVERLAND MOVEMENT

Infiltration by land is generally the least desirable means of pathfinder delivery. It is usually limited to short movements by small elements. Land infiltration is used when visibility is limited over difficult terrain, when the enemy's lines are overextended, when the combat zone is fluid, or when portions of enemy boundaries are not secured. Conversely, a well-organized, stable, and close-knit enemy defense in depth may prohibit land infiltration. When time is available, overland movement to an objective may be used in conjunction with parachute or airdropped infiltration to increase security of an operation.

2-8. STAY-BEHIND OPERATION

This involves positioning pathfinder elements within an operational area while a friendly force withdraws from the area. Stay-behind operations may be considered when the enemy has the capability of overrunning friendly areas and an air assault attack has been planned to reoccupy the area, or as a deceptive measure to lure enemy forces into a vulnerable position.

Section III. CONDUCT OF OPERATIONS

In addition to providing air traffic advisories and navigation assistance for airplanes and helicopters, pathfinders can perform limited physical improvement and NBC monitoring and surveying within LZs or DZs. Their support is dictated by the availability of pathfinders, the tactical plan, the complexity of the operation, the terrain, and the air assault proficiency of the supported ground unit. In any air assault operation, however, positive aircraft control is essential. During an air-assault operation, pathfinders should be cross-loaded when accompanying the initial assault elements into an LZ.

2-9. DAYLIGHT ASSAULT

During daylight air assaults, pathfinders should accompany designated pathfinder aircraft or the initial assault elements into an LZ. Air traffic control and other pathfinder assistance is then provided to all subsequent lifts of troops, supplies, and equipment. If pathfinders precede assault elements, the time may vary from a few minutes to several hours, depending upon the situation. The tactical plan, to include strikes in and around the LZ (by artillery, USAF aircraft, or armed helicopters), dictates this time, or precludes the early entry of pathfinders altogether.

In daylight operations, pathfinders are not inserted into an LZ before the initial assault echelon unless the LZ requires extensive improvement or unless unusual control problems are anticipated.

2-10. NIGHT ASSAULT

The method of delivering pathfinders at night is determined by security and operational requirements. Pathfinders may move cross-country on foot, airdrop onto or near objective areas, airland in total blackout, or airland with minimum natural illumination. During such operations, pathfinders may be delivered ahead of the main body to reconnoiter the LZ, install visual and electronic aids, and establish air traffic control. Personnel from the supported ground unit may accompany pathfinders to provide security and to assist in clearing obstacles. The on-site pathfinder element remains concealed and observes the objective. Pathfinder analysis of the situation includes the planned landing formation, heading, and assembly area. To avoid mission compromise, movement on the DZ/LZ is avoided until the incoming aircraft reach the CCP.

2-11. EXTRACTION

As the size of the ground force decreases at an LZ, vulnerability to attack increases. Therefore, employ pathfinders to expedite air assault extraction (withdrawal or pickup) operations.

a. Planned artillery fires/air strikes, as well as the maintenance of ground security to the last possible moment, make it essential that positive control of supporting aircraft be maintained throughout the extraction operation. Aircraft are carefully controlled to ensure they land at specific points within the extraction site (covered by ground security). This enhances the expedition and safe withdrawal of personnel, equipment, and aircraft from the area.

b. If not already on the ground with the lifted unit, pathfinders must arrive at the extraction site in time to reconnoiter the area thoroughly and coordinate with the lifted unit.

c. During the planning stage, near and far rally points are designated for use if the LZ or DZ becomes untenable. Pathfinders may have to fight their way to these rally points and reorganize. Far rally points, several kilometers from the LZ or DZ, are designated to facilitate survival, evasion, resistance, and escape operations.

2-12. STAGING AREAS

Pathfinders can be employed in staging areas to provide air traffic advisories in the absence of ATC units. They may also act as liaison between the aviation and ground units and assist the ground unit commander in the preparation and positioning of troops, supplies, and equipment for air movement. When a temporary staging area is established to support an operation of short duration, pathfinders should be in the staging area before the operation begins to ensure adequate reconnaissance, marking, coordination, and establishment of positive ATC. Positive ATC in staging areas is essential to safe, efficient, and expeditious movement of helicopters or airplanes. The need for positive ATC increases when the weather deteriorates, when the number of aircraft increases, or when changes in the situation or plans require it.

2-13. ARTILLERY DISPLACEMENT

Pathfinders should be employed to assist the rapid and safe displacement of artillery, day or night. Coordination with ground and aviation unit commanders and an understanding of their SOPS ensures accurate and efficient delivery of equipment, personnel, and ammunition.

2-14. SUPPORT OF GROUND OPERATIONS

Pathfinders may provide continuous assistance and control of aircraft during ground operations requiring sustained Army aviation support. Pathfinders attached to infantry battalions may be further attached to companies to provide support consistent with availability of personnel and equipment. Continuous support improves operational efficiency and aviation safety during all types of air assault operations; however, it cannot be continuously provided by aviation units that have only limited pathfinder resources. In such cases, pathfinders are normally employed on a short-term, priority basis wherever they can assist in the accomplishment of major unit missions. In the absence of pathfinders, selected personnel within ground units are trained and prepared to provide minimum assistance to supporting aircraft.

2-15. SUPPORT OF AIR FORCE

By joint US Army and USAF agreement, Army pathfinders may provide day or night control for USAF aircraft on airfields, DZs, and LZs in the absence of USAF CCTs. However, it may be necessary to provide pathfinders with UHF and VHF communications equipment compatible with that of USAF aircraft.

2-16. MIXED OPERATIONS

Situations may require the simultaneous control of mixed air traffic at the same location, such as resupply parachute drops into forward helicopter LZs. As a rule, helicopter traffic can be expected at all fixed-wing airfields. Mixed air traffic often presents difficult control problems; strict control measures must be applied. Landing, parking, loading, unloading, refueling, and rearming areas are designated, coordinated, and clearly identified to ensure control.

2-17. RADIO COMMUNICATIONS

An essential element of a successful pathfinder operation is communication by GTA voice radio. *This is the first item placed in operation at an LZ or DZ, and it should be the last item taken out of operation.*

a. Pathfinders must have a thorough understanding of radio procedures to include phraseology unique to ATC (Chapter 3). Communications must be clear, concise, applicable, accurate, and correctly timed. To achieve speed and clarity of transmission, radio discipline is practiced by pathfinders and aviators. Unnecessary messages are not transmitted. Pathfinder ATC frequencies (Figure 2-1) should only be used for ATC, except in emergencies.

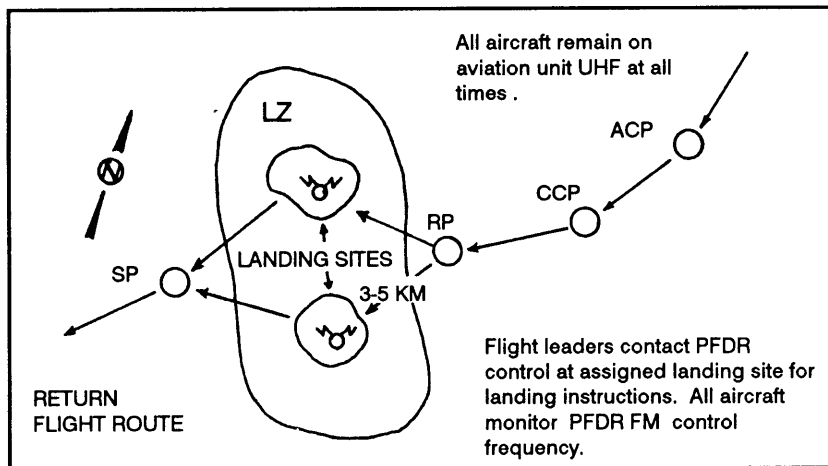

Figure 2-1. En route communication procedures with pathfinders in an LZ.

b. Because of the amount of vital information exchanged, aircraft crews normally record the important portions of GTA messages to ensure that instructions are understood and followed.

c. Pathfinders use electronic homing beacons, visual aids, and arm-and-hand signals to complement voice communications. Pilots and transported troops must understand the purpose and meaning of the aids displayed and the techniques employed (STANAG 3570). (Arm-and-hand signals and visual aids are discussed in FM 21-60.)

d. Whenever possible, pathfinders monitor supported unit command radio nets to keep abreast of changing situations that could influence pathfinder operations.

e. Positive communications are established between pathfinder ATC facilities and collocated fire support elements. This ensures that timely and accurate information concerning friendly fires is available to aircraft.

f. The constant use of radios in pathfinder operations gives the enemy frequent opportunities for intercepting, analyzing, and exploiting friendly transmissions to gain intelligence and conduct electronic jamming and deception. Defeating enemy jamming or imitative deception lies largely with the radio operator. He must be proficient in recognizing and reporting this deliberate interference and combating it by employing electronic counter-countermeasures. Provisions for defense against electronic countermeasures, including transmission security and the use of alternate means of communication, are part of the planning and execution of tactical missions.

2-18. TERMINAL GUIDANCE BY SUPPORTED UNITS

Terminal guidance is information and minimal guidance provided to pilots by other than qualified pathfinders within a ground unit. It is normally furnished by selected personnel within the supported unit using organic and improvised equipment.

a. Terminal guidance personnel should be familiar with the supporting aviation unit SOP and should be able—

(1) To operate electronic and visual navigation aids to assist aircraft in locating LZs and DZs.

(2) To provide essential information through GTA radio to guide and control Army aircraft.

(3) To reconnoiter and recommend suitable LZs and DZs.

(4) To determine, recommend, or accomplish ground-clearing pioneer work to prepare LZs and DZs.

b. When pathfinders accompany ground units, terminal guidance personnel may be used to augment pathfinder elements,(if directed by aviation unit SOP).

Section IV. HIGH-THREAT ENVIRONMENT

Threat comes in many forms, and all must be considered to ensure mission success. Anything that may disrupt, delay, or cause mission failure is considered a threat.

2-19. CONTROL AND NAVIGATION

Voice control of aircraft by pathfinders is limited, thus close coordination between the ground unit commander and the air mission commander is important. Navigation presents special problems because of the low altitudes that aviators must maintain to avoid detection. Time, distance, routes, and tactical instruments are critical in a high-threat environment.

a. Two pathfinders with beacons, for example, could be placed along a route in advance of the initial flight to provide pilots with air control points. If the pilot needs the beacon turned on (because of error in navigation), a prearranged signal or codeword could be transmitted.

b. Or, pathfinders might discover a threat along the primary route (such as an antiaircraft weapon); then pilots would be alerted by prearranged code word or signal to change to an alternate route.

2-20. TACTICAL INSTRUMENT FLIGHTS

Flights under instrument meteorological conditions pose special problems in a high-threat environment. This threat precludes controlled instrument flight rules (IAW with the aviation series manuals) by forcing aircraft to fly at altitudes well below the minimums established for normal instrument flight.

a. Weather variances may create a tactical emergency that requires the commander to use aviation assets under instrument conditions well below altitudes specified by standard instrument flight rules. Special considerations and factors enter into a commander's decision to send aircraft on a mission within a high-threat environment under these conditions. Tactical instrument flight is a combat situation that meets the following criteria:

- (1) The mission cannot be postponed until favorable weather.
- (2) The mission will be conducted in a high-threat environment.
- (3) Low visibility en route precludes nap-of-the-earth flight.

b. Since the aviation and ground commanders can expect tactical instrument flight to be a standard requirement for around-the-clock operations on the high-threat battlefield, it must be a standard, well-rehearsed technique in which aircrews and pathfinders are proficient. The commander employs this technique when weather or time and distance considerations preclude mission completion in other flight modes.

c. Aircraft flight altitudes are flown in two basic modes.

(1) *Mode 1*. When flight altitude is restricted by the air defense threat to altitudes below those established by AR 95-1 (for standard instrument flight), then a minimum clearance of 1,000 feet over mountainous terrain and 500 feet over flat terrain is possible.

(2) *Mode 2*. When flight altitude is restricted to absolute minimum clearances, altitudes varying from 50 to 500 feet above the ground, regardless of terrain, are possible.

2-21. AIR ROUTES

The enemy situation plus the terrain and weather conditions determine what airways may be subject to rapid relocation if the enemy can intercept aircraft using them. Aircraft traffic management personnel (and pathfinders) can expect to move their equipment as often as every four hours, depending on the threat. Factors considered in establishing tactical instrument flight airways include:

a. Threat and Terrain. Straight-line flight between the takeoff (lift-off) point and the destination (in both modes 1 and 2) is precluded in many instances by the threat and terrain (Figure 2-2).

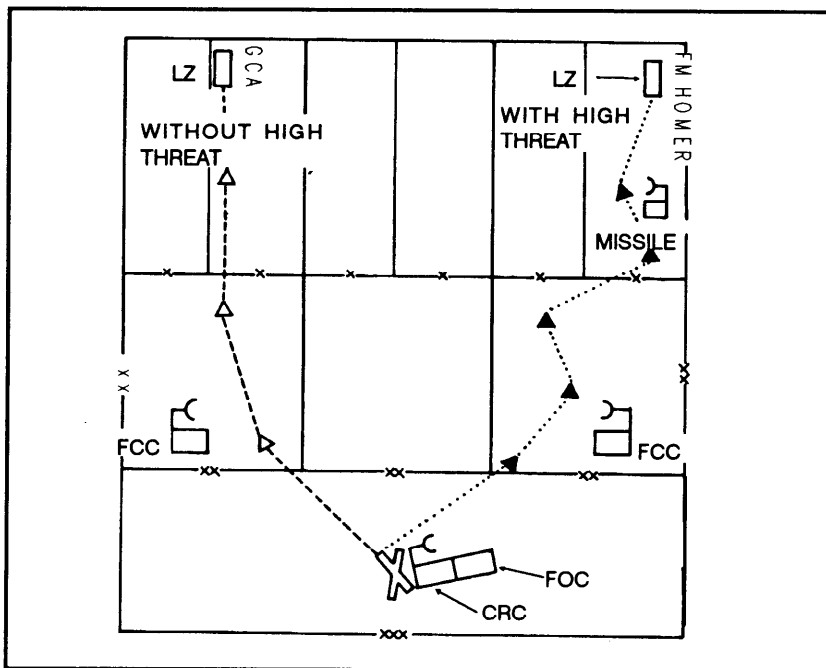

Figure 2-2. Comparison of air routes with and without a high threat environment.

b. Flight Monitoring and LZ Approach. Enemy presence precludes pathfinder use of nondirectional beacons, and visibility must be such that pilots can proceed visually when approaching an LZ and when landing. Using radio homing signals for directional guidance is questionable. In any event, the electronic device should be oriented so that it emits its signal away from the forward edge of the battle area (if possible) to minimize detection.

CHAPTER 3

AIR TRAFFIC CONTROL

Air traffic control, as used in this manual, should not be interpreted to imply that path finders have the same role and mission as regular air traffic controllers. With the lack of sophisticated radar, weather monitoring equipment, and aircraft guidance equipment, the pathfinder can only advise and inform the pilot. The final decision to land, take off or drop equipment and personnel lies with the pilot.

Section I. PATHFINDER ATC COMMUNICATION

Air traffic control communication prevents collisions, expedites traffic, and provides flight information, using radio or directional light signals.

3-1. SAFETY

Pathfinders issue specific commands regulating vehicles, equipment, or personnel in the movement area. They aid in search-and-rescue operations (STANAGs 2863 and 3281), and they promote the safe and expeditious flow of air traffic by issuing clearances, instructions, and information.

a. Pathfinders, as ATCs, provide control service based upon observed or known traffic and airfield conditions that might constitute a hazard. These conditions include surface conditions; parachutists within control zones; vehicular traffic temporary obstructions on or near the LZ, DZ, or airfield; other aircraft; and enemy or friendly activities.

b. Pathfinders are responsible for surveillance of all *visible air traffic* operating within and around the airspace of the LZ, DZ, or airfield. They are also responsible for all aircraft, vehicles, and personnel in the movement area of the LZ, DZ, or airfield.

NOTE: Terms peculiar to ATC tasks are included in this chapter and the glossary.

3-2. VOICE CONTROL

Pathfinders and pilots must speak clearly and listen to each other to communicate vocally. A clear, decisive tone of voice is the best indication that the situation is well in hand. If a pathfinder sounds vague/hesitant, pilots may be reluctant to follow their instructions. A firm, confident

voice and the use of standard words and phrases are necessary to facilitate the safe and orderly flow of traffic.

NOTE: The phonetic alphabet is used to indicate single letters, initials, or for spelling words whenever similar sounds or difficulties in communication make it necessary.

a. A voice transmission is a brief, concise, and uniform flow of communication. The pathfinder controller must speak distinctly and pay special attention to numerals. When the accuracy of a message is doubted, the complete message or essential parts are repeated. Radiotelephone communications use the following speech techniques.

- (1) Speak directly into the microphone.
- (2) Speak in a normal, conversational tone.
- (3) Avoid monotonous voice pitch.
- (4) Avoid speaking too slow or too fast.
- (5) Avoid emotion, nervousness, and indecision in voice tone.
- (6) Speak with confidence, especially in emergencies.

b. Transmitted messages must be necessary for control or to otherwise contribute to safety. Specific procedures and control techniques vary, but the following rules apply regardless of techniques used.

(1) The pathfinder is responsible for issuing instructions and information relative to all known traffic conditions.

(2) At least one component of a standard traffic pattern (final approach) will be used by the pilot, consistent with instructions issued by the pathfinder.

(3) Pilots have the final authority on whether to accept clearances issued by a controller or not.

3-3. FORMATS

A pathfinder controller uses the following formats and sequences for ground-to-air radio communication.

a. He sets up his initial call-up sequence to an aircraft as follows:

- (1) Identification of the aircraft being called.
- (2) The words, THIS IS.
- (3) Identification of the calling unit.
- (4) The type of message to follow (when this will assist the pilot).
- (5) The word OVER.

TANGO TWO SIERRA TWO SIX (T2S26), THIS IS CHARLIE THREE DELTA THREE SIX (C3D36) (short pause), OVER.

b. His sequence of reply to an initial call-up by an aircraft is as follows:

- (1) Identification of aircraft initiating the call-up.
- (2) The words, THIS IS.

(3) Identification of the pathfinder control unit.

(4) The word OVER.

SIERRA TWO SIX, THIS IS DELTA THREE SIX, OVER.

c. The controller always prefaces a clearance (instruction) intended for a specific aircraft with the identification of that aircraft.

SIERRA TWO SIX, WIND CALM, CLEAR TO LAND., OVER.

d. He may shorten the transmissions when no confusion is likely to occur. He may use just the last three numbers (or letters) of an aircraft's identification once communication is established with aircraft.

SIERRA TWO SIX, WIND CALM, CLEAR TO LAND,OVER.

e. He may omit THIS IS from his reply.

SIERRA TWO SIX, DELTA THREE SIX, OVER.

f. He may omit the facility identification after communication is established.

SIERRA TWO SIX, TURN TO HEADING ZERO FOUR FIVE, OVER.

g. He may transmit a message immediately after call-up (without waiting for aircraft reply) when it is short and receipt is ensured.

SIERRA TWO SIX, EXTEND DOWNWIND, OVER.

h. He may omit OVER if the message obviously requires a reply.

SIERRA TWO SIX, WHAT IS YOUR LOCATION?

i. He may emphasize appropriate numbers, letters, or words to distinguish between similar aircraft identifications.

j. He does not transmit to an aircraft during the final approach, touchdown, landing roll (touchdown), takeoff (lift-off), initial climb, or turn away from the field. It is very important that the pilot give his undivided attention to flying the aircraft at these times. However, any observed condition or known information that may affect the safety of the aircraft is transmitted immediately. *Under no circumstances* is information pertaining to hazardous runway, field, weather, or traffic conditions withheld from the pilot of an approaching aircraft.

3-4. NUMBERS

A pathfinder controller verbalizes numbers when transmitting by number units or digits.

a. He transmits ceiling heights and flight altitudes using either way.

CEILING FIVE HUNDRED (one unit); or CEILING FIVE ZERO ZERO (digits for emphasis).

ALTITUDE ONE THOUSAND THREE HUNDRED (two units) or ALTITUDE ONE THREE ZERO ZERO (digits).

b. When expressing time, he uses the word TIME followed by the number.

0115 HOURS
1315 HOURS

TIME, ZERO ONE ONE FIVE,
TIME, ONE THREE ONE FIVE.

c. When transmitting elevation numbers, he uses the words FIELD ELEVATION and the number.

Elevation
17 (feet)
50 (feet)

Radio Communication
FIELD ELEVATION SEVENTEEN.
FIELD ELEVATION FIFTY

d. When transmitting wind speed, he uses the word WIND followed by compass direction and velocity (knots).

WIND TWO SEVEN ZERO AT FIVE.

e. When giving the heading, he uses the word HEADING followed by compass numbers (degrees); he omits the word DEGREES.

HEADING ONE TWO ZERO.

HEADING ZERO ZERO FIVE.

HEADING THREE SIX ZERO. (Indicates north [direction] heading.)

3-5. PHRASES

A pathfinder controller uses set phrases to control aircraft. Familiarity with the terminology and phrase style is essential.

a. Instruction Examples.

(1) To issue takeoff (lift-off, departure) clearance when a delay is not desired.

SIERRA TWO SIX CLEARED FOR IMMEDIATE TAKEOFF (DEPARTURE), OVER.

(2) To issue takeoff (lift-off) clearance when aircraft is delaying on the runway.

SIERRA TWO SIX, TAKE OFF (DEPART) IMMEDIATELY OR TAXI OFF THE RUNWAY, OVER.

(3) To authorize a requested straight-in approach after landing instructions have been issued.

SIERRA TWO SIX, STRAIGHT - IN APPROACH (to landing strip or LZ) APPROVED, OVER

(4) To authorize a right-hand traffic pattern.

SIERRA TWO SIX, RIGHT TRAFFIC APPROVED, OVER.

(5) To issue the landing sequence.

SIERRA TWO SIX, YOU ARE NUMBER THREE TO LAND; FOLLOW THREE EIGHT FIVE (aircraft identification number) ON DOWNWIND, OVER.

(6) To instruct an aircraft to extend downwind leg to obtain necessary aircraft separation.

SIERRA TWO SIX, EXTEND DOWNWIND FOR TRAFFIC SPACING, OVER.

(7) To advise an aircraft of information not included in landing instructions but important to aircraft safety.

SIERRA TWO SIX, BE ADVISED WE ARE RECEIVING AUTOMATIC FIRE FROM THE EAST OVER.

(8) To try to establish communication with and learn the identification of an aircraft in his area.

UH-ONE, TWO MILES WEST OF BLUE STRIP, STATE CALL SIGN, OVER.

(9) To instruct aircraft to circle the LZ or landing strip.

SIERRA TWO SIX, MAINTAIN LEFT (RIGHT) CLOSED TRAFFIC, OVER.

(10) To issue a clearance to land.

SIERRA TWO SIX, CLEAR TO LAND, OVER.

(11) To instruct an aircraft on final landing approach that clearance has been cancelled.

SIERRA TWO SIX, CONDUCT GO-AROUND, OVER.

(12) To inform an aircraft to continue its approach to the landing area.

SIERRA TWO SIX, CONTINUE APPROACH, OVER.

(13) To inform pilot of observed aircraft condition upon request or when necessary.

SIERRA TWO SIX, LANDING GEAR APPEARS DOWN AND IN PLACE, OVER.

(14) To describe vehicles, equipment, or personnel in the movement area in a manner that will assist pilots in recognizing them.

SIERRA TWO SIX, AIRCRAFT TO LEFT OF RUNWAY, OVER.

SIERRA TWO SIX, VEHICLES ON TAXIWAY, OVER.

(15) To describe military traffic as appropriate.

SIERRA TWO SIX, BE ADVISED HELICOPTER ON DEPARTURE END, OVER.

SIERRA TWO SIX, BE ADVISED CH-FOUR SEVEN (CH-47) ON RIGHT SIDE OF RUNWAY, OVER.

(16) To describe the relative positions of traffic using the clock direction-and-distance method.

SIERRA TWO SIX, U-SIX, YOUR THREE O'CLOCK, FIVE HUNDRED METERS, OVER.

b. Terminology.

(1) *Abort*. Do not complete landing or takeoff (lift-off).

(2) *Acknowledge*. Was message received and understood?

(3) *Affirmative*. Yes.

(4) *Be advised*. Indicates additional information is forthcoming, such as an unusual condition or hazard to flight.

- (4) *Be advised* Indicates additional information is forthcoming, such as an unusual condition or hazard to flight.
- (5) *Break* Indicates the separation of back-to-back transmissions to two separate aircraft; or indicates the separation of the text (message) from other portions of a transmission.
- (6) *Conduct go-around.* Do not land, circle the landing area, and begin another approach.
- (7) *Correction.* An error has been made in transmission; the correct data is forthcoming.
- (8) *Execute.* Drop personnel or equipment.
- (9) *Form your own approach.* Authorizes pilot to enter traffic pattern at his discretion. (Most suitable for aircraft with a slingload or or flights of aircraft.)
- (10) *Go ahead.* Instructions to proceed with message.
- (11) *I say again.* Prefaces a message repeated by request.
- (12) *Last calling station.* Identity of station attempting to establish communication unknown.
- (13) *MAYDAY* Emergency, clear airways.
- (14) *Negative.* No.
- (15) *No drop.* Do not drop personnel or equipment.
- (16) *Out.* Transmission ends and no response required.
- (17) *Over.* End of transmission; response is expected.
- (18) *Read back.* Repeat message.
- (19) *Report.* Pilot contacts control facility when reaching a designated location, for example, REPORT ONE MILE OUT.
- (20) *Roger.* Transmission received and understood
- (21) *Say Again.* Request repetition of a message.
- (22) *Standby.* Pause for a few seconds; or, prepare to drop personnel or equipment.
- (23) *State call sign.* Requests the aircraft's identify.
- (24) *State intentions.* Requests the aircraft's plans.
- (25) *State location.* Requests the aircraft's exact location.
- (26) *Unable to approve.* Pilot's request refused.
- (27) *Verify.* Check with originator.
- (28) *Words twice.* Communication difficult; transmit each phrase twice.
- (29) *WILCO.* I understand and will comply.
- (30) *You are unreadable (broken, garbled).* Transmission cannot be understood.

Section II. LANDINGS

The safe landing of aircraft requires control of the airspace around the site as well as the area on the ground. Managing air traffic involves using traffic patterns and maintaining separation of aircraft.

3-6. TRAFFIC PATTERNS

A traffic pattern is a means of control used by the pathfinder to assist in airspace management over his location, which is in and around a landing site, airfield, LZ, or DZ (Figure 3-1). A traffic pattern normally extends out to one mile from the final approach of the landing area in all directions, depending on the type of aircraft or size of the facility.

a. In a normal (left) traffic pattern, the aircraft makes all left turns, keeping airfield, landing site, LZ, or DZ to the pilot's left. In a right traffic pattern, the aircraft makes all right turns, keeping everything to the pilot's right.

b. The traffic pattern is used to control aircraft separation around a no-threat landing site. Rotary-wing aircraft may enter the pattern from any direction as long as safety requirements are met. (Refer to Chapter 4 for fixed-wing procedures.) The altitude is determined by the height of the obstacles or aircraft requirement, and maybe adjusted as the situation dictates.

c. The altitude flown while in the traffic pattern is normally between 1,000 and 1,200 feet, but may vary depending on the nature and requirements of the mission.

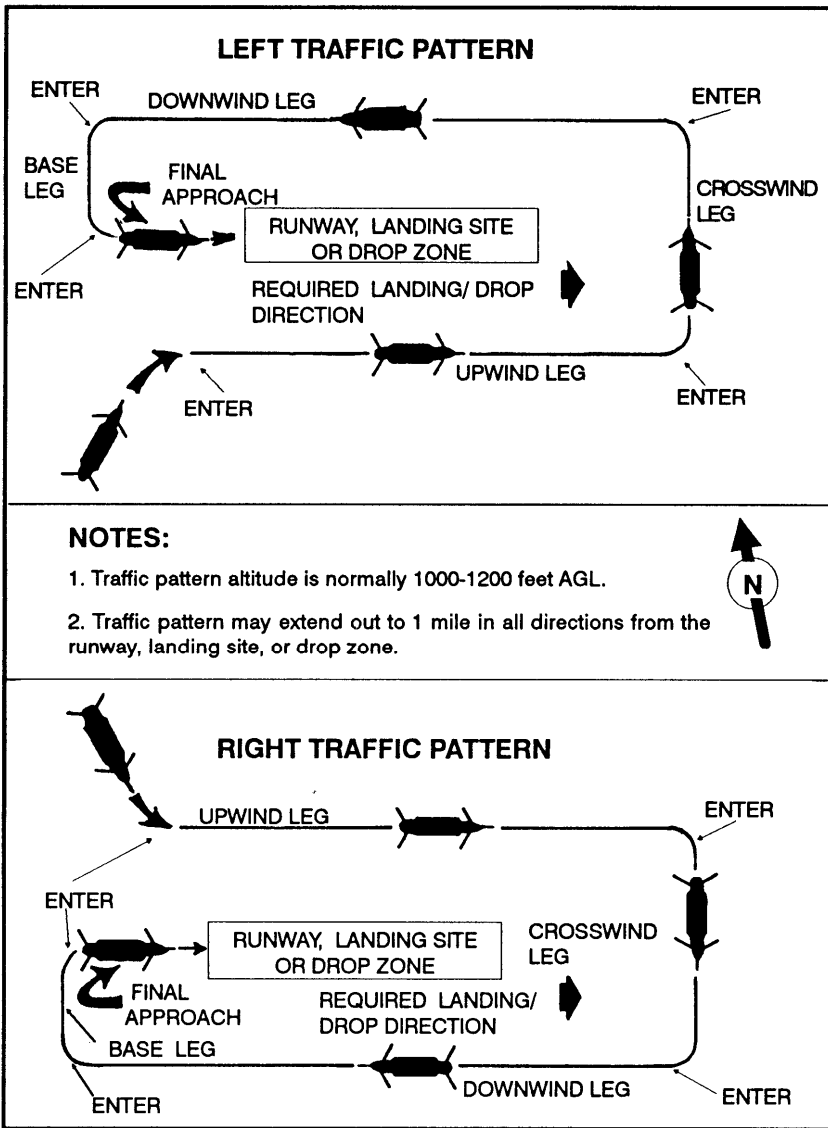

Figure 3-1. Air traffic patterns.

3-7. METHODS OF ENTRY

An aircraft may enter the traffic pattern from any point and from any direction within the area surrounding the landing strip/zone, consistent with safety requirements.

a. Entry into the traffic pattern normally occurs in the first one third of the closest leg at an angle no greater than 45 degrees.

b. A straight-in approach may be expeditious to a pilot as long as it is within safety requirements. The criteria for a straight-in approach is that the aircraft is within 30 degrees on either side of the land heading.

c. A circling approach is when an aircraft approaches the location from any direction, overflies the landing site, and circles to the direction of landing. Normally, the pathfinder advises the pilot which direction to circle to expedite the approach and to avoid other traffic in the same airspace. This is the type approach often encountered by the pathfinder.

d. Departing aircraft normally leave on the same heading as landing or as close to it as possible, depending upon the wind direction. When the aircraft's destination is not in the direction of departure, the aircraft may fly a portion of the traffic pattern. The pathfinder's responsibility is to ensure that arriving and departing traffic does not conflict.

e. Closed traffic is used when an aircraft does not land on the first approach, or during DZ operations when an aircraft is required to make more than one pass over the DZ.

f. A go-around is used when for some reason it is not desirable for the aircraft to land after the pilot has reached the final approach leg of the traffic pattern.

3-8. TRAFFIC PATTERN LEGS

There are five possible legs to a traffic pattern; however, they are not all used every time. The minimum pattern that can be flown is the final approach leg; regardless of the type approach made, the final approach is always flown.

a. Upwind Leg. A flight course parallel to the land heading in the direction of landing.

b. Crosswind Leg. A flight course at a right angle to the land heading off its upwind leg.

c. Downwind Leg. A flight course parallel to the land heading in the direction opposite of landing.

d. Base Leg. A flight course at a right angle to the landing runway off its approach, extending from the downwind leg to the intersection of the runway centerline (extended).

e. Final Leg (Approach). A flight course in the direction of landing along the runway centerline, extending from the base leg down to the runway.

3-9. ADVISORY SERVICE

The pathfinder controller issues advisories in his area of responsibility for the safe operation of aircraft. Such information may include temporary or permanent conditions on the landing field.

a. Temporary conditions may include construction work on or immediately adjacent to the movement area; rough portions of the movement area; degraded braking conditions caused by ice, snow, mud, slush, or water on the runway; or parked aircraft on the movement area.

b. No two landing areas and situations are identical. Each location presents its own problems with respect to environmental conditions, peculiar weather, preferred landing directions, and so forth.

(1) The final approach to a particular runway may require a glide slope angle that is higher than normal.

(2) Unusual terrain features near the airfield may, under certain wind conditions, create turbulence that can be hazardous to aircraft operating nearby. Also, helicopters operating nearby can create turbulence that maybe hazardous to light aircraft.

(3) Prohibited areas, mountains, or other obstacles directly in line with the end of the runway may require abrupt turns immediately after takeoff (lift-off).

(4) Friendly artillery or mortar fire within the control zone may require that the pathfinder give the pilot information pertaining to the origin, range, direction, and maximum ordinate of the firing. Air strikes within the control zone, especially those involving high-performance aircraft, must be included. Information pertaining to the enemy situation must also be given to the pilot.

3-10. SPACING TECHNIQUES

Spacing provides more Separation between aircraft in the traffic pattern to alleviate traffic congestion. There are basically two methods used to obtain the separation required: the 360-degree turnout and the traffic pattern extension.

a. Instructions for the 360-degree turnout (a 2-minute maneuver) may be issued at any point in the traffic pattern except on the final approach. When a pilot receives instructions to begin a 360-degree turnout, he turns away from the center of the landing site, makes a wide circle, and reenters the traffic pattern at about the same point from which he left it (Figure 3-2). Subsequent turnouts maybe required if adequate space is not obtained from the first one. An example of the radio dialogue between the pathfinder and the pilot is as follows:

Pathfinder: DELTA THREE SIX, BEGIN THREE SIX ZERO DEGREE TURNOUT FOR SPACING AND REPORT REENTRY.

Pilot: ROGER. (After turnout is complete) LIMA ONE SIX, DELTA THREE SIX HAS REENTERED.

Pathfinder: DELTA THREE SIX, ROGER, REPORT BASE.

Pilot: ROGER.

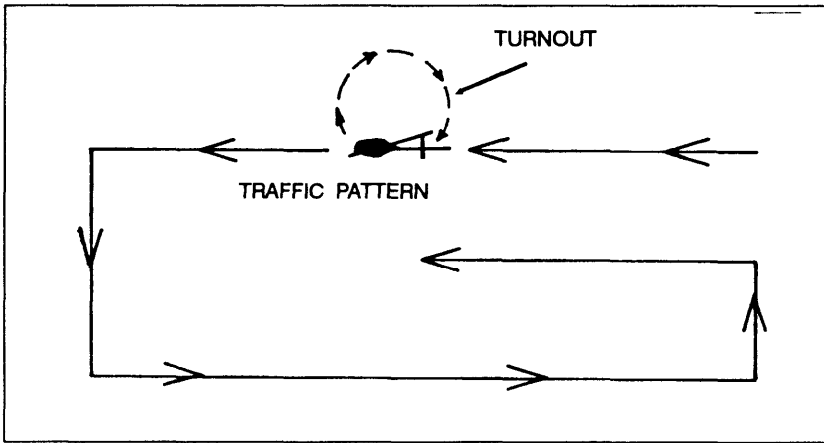

Figure 3-2. A 360-degree traffic pattern turnout.

b. Extension of the traffic pattern is limited to three legs: upwind, crosswind, and downwind (Figure 3-3); however, only one leg may be extended at a time. The base leg and final approach cannot be extended because they run back into the traffic pattern itself. Instructions to extend the traffic pattern will include the length of the extension; it is normally twice the original length of that leg. Care is taken not to extend the leg too far where you lose visual contact with the aircraft.

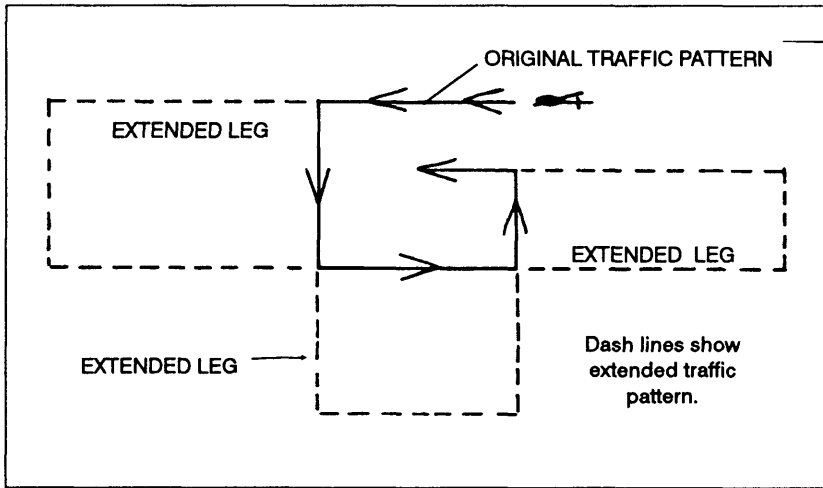

Figure 3-3. Traffic pattern extension.

3-11. FINAL LANDING INSTRUCTIONS

Final landing instructions consist of a current wind reading (direction and velocity) and clearance to land. Any change to the situation may be included in the final landing instructions. Final landing instructions should be issued as soon as the pilot reports from the designated point, but not too early. As a rule, once an aircraft has been cleared to land, that clearance cannot be rescinded except in extreme situations. The optimum reporting points vary, depending on the situation.

Situation	Reporting Point
Aircraft in traffic pattern.	Base leg of traffic pattern.
Straight-in approach.	Final.
Aircraft authorized to form own approach.	Final.

- a. Flights of aircraft flying in formation (other than in trail) and aircraft with a slingload usually form their own approach.
- b. In-flight emergencies have top priority to land, followed by medical evacuation aircraft. Next priority is given to multiple aircraft and slingloaded aircraft in the event two or more missions arrive at the same time. All other flights follow these.

3-12. TAXIING AIRCRAFT

When issuing taxiing instructions, the pathfinder includes a route for the aircraft to follow in the movement area plus instructions to hold at a specific point, if necessary. However, movement of aircraft within loading, maintenance, dispersal, or parking areas is the pilot's responsibility, although he might be assisted by signalmen.

- a. The controller holds a taxiing aircraft short of an active runway by at least two airplane lengths. This procedure ensures that landing aircraft have sufficient clearance.
- b. The controller issues concise and easy-to-understand information.
SIERRA TWO SIX, TURN RIGHT AT SIGNALMAN.
TANGO THREE SIX TURN LEFT AT END OF RUNWAY, OVER.

3-13. MINIMUM AIRCRAFT SEPARATION REQUIREMENTS

The following minimum separation criteria should be followed during normal operations. Combat situations, however, may dictate less separation.

- a. **Arriving Aircraft.** The preceding aircraft (A) has taxied off the landing strip before the arriving aircraft (B) crosses the approach end on its final glide (Figure 3-4, A).

b. Departing Aircraft. The preceding aircraft has either crossed (A) the opposite end of the runway or turned away (B) from the projected path of the departing (C) aircraft before the latter begins its takeoff run (Figure 3-4, B).

c. Departing and Arriving Aircraft. The departing aircraft (A) has crossed the opposite end of the runway before the arriving aircraft (B) crosses the approach end on its final glide (Figure 3-4, C).

d. Departing, Preceding, and Arriving Aircraft. The preceding aircraft (A) and arriving aircraft (B) taxied off the runway before the departing aircraft (C) begins takeoff run (Figure 3-4, D).

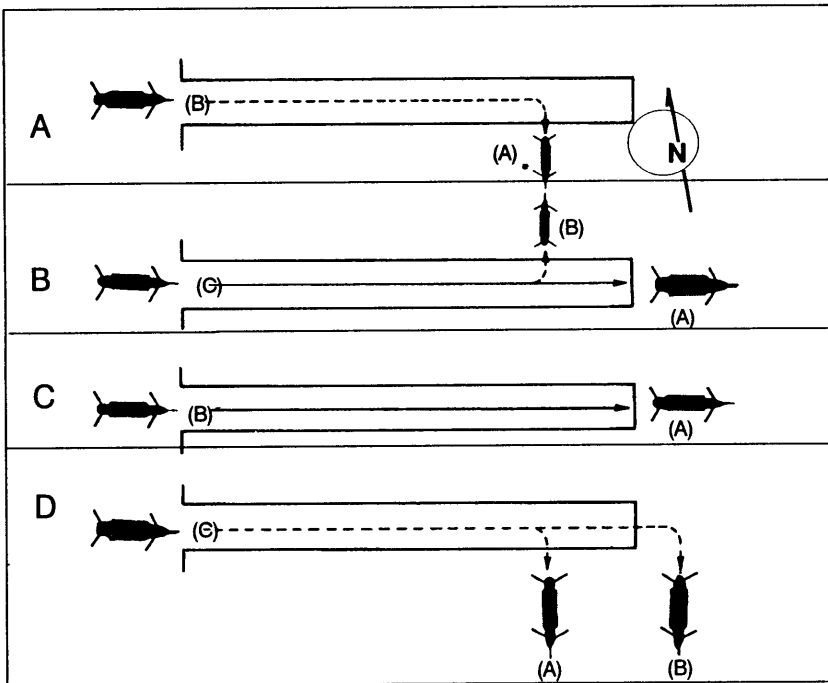

Figure 3-4. Minimum separation requirements.

Section III. GROUND-TO-AIR COMMUNICATIONS

A rapid and efficient means of communication between aircraft and ground stations is necessary in air traffic control. Two-way radio is the best means since information can be exchanged quickly and there is little doubt as to the intent of the messages. All aircraft may not be equipped with operational radios; therefore, a system of visual signals has been established. The visual system also serves as a standby or

backup means of communication in case of radio failure in the aircraft or at the control center, or if an aircraft desires to land and does not have the control frequency (Table 3-1, page 3-14). Colored smoke signals may also be used, but their use must be coordinated between the pathfinder and the aviation unit.

COLOR AND TYPE OF SIGNAL LIGHTS	AIRCRAFT ON THE GROUND	AIRCRAFT IN FLIGHT
Steady green	Cleared for takeoff (lift-off)	Cleared to land
Flashing green	Cleared to taxi	Return for landing (to be followed by steady green at proper time)
Steady red	Stop	Give way to other aircraft and continue circling
Flashing red	Taxi clear of landing area or runway in use	Airport unsafe do not land
Flashing white	Return to starting point (on airfield)	
Alternating red and green (general warning signal)	Use extreme caution	Use extreme caution
Red pyrotechnic (red flare)		Do not land for the time being, previous instructions not withstanding

Table 3-1. ATC light signals on or near LZ.

3-14. ELECTRONIC WARFARE ENVIRONMENT

The pathfinder should anticipate an active electronic warfare environment for all operations and ensure that he is familiar with the proper counter-countermeasures to be used. These include prowords that indicate a switch to an alternate radio frequency, transmission authentication procedures, brevity codes, and required reports to be initiated when enemy interference is suspected. Proper radiotelephone procedures and SOI are used during all operations.

a. To limit the possibility of compromise, pathfinders reduce the electronic signature at the LZ/DZ by depending on thorough mission planning and coordination to develop control procedures that enable the mission to be executed under radio listening silence. This is the goal of all pathfinder missions.

b. When mission planning time is limited, or tactical and or meteorological conditions present a constantly changing influence on the operation, it is likely that GTA communications will be required to resolve possible conflicts between friendly airspace users and to advise of previously unknown restrictive landing conditions (wind gusts, hazardous slopes, obstacles, soft landing surfaces, or limitations in the number of landing points available). Training and close liaison with aviation aircrews enables the pathfinder to develop an understanding of what information is pertinent to the situation. This reduces transmission time to the minimum.

c. When an unknown influence causes any variation in the mission plans, it is managed as an exception to established procedures. The most questionable part of the mission is the exact location of the landing site. A variety of influences may necessitate its relocation. For instance, ground fog may cause a delay unless the landing site is moved to a higher elevation. Unless the proposed landing site is secured and has been surveyed by either air or ground reconnaissance, its suitability to provide an adequate number of landing points or an assembly area for the ground unit is questionable.

d. If the mission is to reinforce or to resupply a ground unit in contact, a change in the tactical situation may also make the proposed location unsuitable. The closer the proposed site is to the enemy activity, the more questionable it is that any specific location will remain suitable to mission requirements from the time of planning through execution.

e. Therefore, maintaining radio silence within the LZ is important. Because of this, most air movements require the establishment of a CCP to ensure a common point from which the pathfinders and the aircraft can reference their relative positions and provide each other time to adjust to any additional changes.

f. The GTA net is strictly for communications, but the pathfinder cannot assume that all transmissions are from aircraft. A log of arrivals is kept in the event an aircraft is overdue at a destination. The headquarters in charge of flight plans contacts intermediate stop points to identify the last known location and to aid in search-and-rescue operations.

3-15. GROUND-TO-AIR TRANSMISSIONS

The list of possible situations a pathfinder may encounter while using GTA is endless. However, if he can master the following four most common ones, he will be able to handle just about anything.

a. Situation 1—Known Aircraft Location.

(1) *Initial contact.* Pilot radios transmission at coordinated time and location.

- (a) Pilot: ALPHA ONE LIMA ONE SIX (A1L16), THIS IS ROMEO TWO BRAVO TWO SEVEN (R2B27), OVER.
- (b) Pathfinder: ROMEO TWO BRAVO TWO SEVEN, THIS IS ALPHA ONE LIMA ONE SIX, OVER.
- (c) Pilot: THIS IS BRAVO TWO SEVEN, CCP INBOUND, OVER.
- (d) Pathfinder: THIS IS LIMA ONE SIX, STATE TYPE, NUMBER, AND INTENTIONS, OVER.

NOTE: After establishment of two-way communications, call signs may be abbreviated. With multiple flights, instructions issued by pathfinder GTA communication should identify the particular situation by including that station's call sign at the beginning of the transmission.

- (e) Pilot: THIS IS BRAVO TWO SEVEN, FOUR UH-SIXTIES (UH-60s), TROOP DROP-OFF AND SLINGLOAD FOR YOUR SITE, OVER.
- (f) Pathfinder: THIS IS LIMA ONE SIX, ROGER, HEADING THREE TWO FIVE (325), THREE THOUSAND (3,000) METERS. LAND THREE TWO FIVE, SIGNAL ON CALL, LAND ECHELON RIGHT SLINGLOAD AIRCRAFT USE NUMBER FOUR LANDING POINT CONTINUE APPROACH FOR VISUAL CONTACT, OVER.

(2) *Air traffic control information.*

(a) HEADING THREE TWO FIVE, (distance) THREE THOUSAND METERS, OVER.

(b) LAND THREE TWO FIVE, OVER.

(3) *Pertinent information.*

(a) SIGNAL ON CALL (prepare to establish positive visual contact).

(b) FOUR UH-SIXTIES (UH-60s) IN ECHELON RIGHT (advise pilot of the size of landing site).

(c) SLINGLOAD POINT ON NUMBER FOUR TOUCHDOWN POINT (night only).

(d) GSI SETTING SEVEN (approach angle from the glide slope indicator).

(e) FIELD ELEVATION, FOUR TWO FIVE FEET (actual field elevation).

(4) *Advisory information.*

(a) Flight advisories include the enemy situation (if a threat to the aircraft).

(b) Landing advisories include surface conditions on the landing site (sand, mud, or blowing snow), and GSI setting nine or above (steep approach).

(c) Departure advisories include obstacles in path of aircraft leaving the site (obstacles above the obstacle departure lights).

(5) *Aircraft in sight.*

(a) Pathfinder: BRAVO TWO SEVEN, THIS IS LIMA ONE SIX, I AM AT YOUR TWELVE O'CLOCK, FIVE HUNDRED METERS, IDENTIFY SIGNAL, OVER.

(b) Pilot: THIS IS BRAVO TWO SEVEN, I IDENTIFY GREEN SMOKE, OVER.

NOTE: At night during specialized activity such as external load drop-off or pickup, or when unsafe surface conditions require the marking of specific landing points, that arrangement must be known by the flight leader to enable him to organize the flight for landing. Alight gun with a dot-dash sequence is used to identify the site.

(c) Pathfinder: THIS IS LIMA ONE SIX, VISUAL CONTACT (and once the pilot identifies the site), WIND THREE TWO FIVE AT EIGHT, CLEAR TO LAND, OVER.

NOTE: Once the pilot identifies the site, the pathfinder issues final landing instructions. If a traffic pattern has been established and is in use, the aircraft is placed in the traffic pattern at a safe and expeditious location and the pilot is instructed to report base. When the pilot reports base, the pathfinder issues final landing instructions. For special situations, the pathfinder may elect to require the pilot to circle left or right in lieu of placement in the traffic pattern, and then he issues final landing instructions.

(6) *Departure Instructions.*

(a) Pilot: LIMA ONE SIX, THIS IS BRAVO TWO SEVEN, READY FOR DEPARTURE, OVER.

(b) Pathfinder: THIS IS LIMA ONE SIX, WIND THREE TWO FIVE AT EIGHT CLEAR TO DEPART STATE INTENTIONS, REPORT CLEAR OF LANDING ZONE, OVER.

NOTE: If the departure heading is different from the land heading, the departure heading must be given as the first element of the departure instructions.

(c) Pilot: THIS IS BRAVO TWO SEVEN, RIGHT BREAK AFTER DEPARTURE, OVER.

(d) Pathfinder: THIS IS LIMA ONE SIX, ROGER, OVER.

(e) Pilot: THIS IS BRAVO TWO SEVEN, CLEAR TO THE WEST, OVER.

(f) Pathfinder: THIS IS ALPHA ONE LIMA ONE SIX, ROGER, OUT.

b. Situation 2—Aircraft Reporting from a Cardinal Direction and Distance.

(1) Quite often, mutually supporting helicopter operations are conducted to increase the security of an LZ operation; for example, a team of observation and attack helicopters maybe acting as a screen for the LZ. The team may not contact the pathfinder because there is no intention of landing and the utility or lift aircraft know of their location because they communicate over internal UHF and or VHF radio nets. The need could arise that aircraft not originally expected by the pathfinder may require landing at the LZ. In this instance, the initial contact requires a different response by the pathfinder.

(2) Because of possible conflict with aircraft departing the landing site in the same direction, it is necessary to track the inbound aircraft's course and to include this unexpected arrival as an advisory to mission aircraft. To accurately track the aircraft, the pathfinder uses a commonly known point (in the direction of the aircraft) to control the situation. This point can be a prominent terrain feature, a checkpoint, or an aerial control point previously established by the ground unit for maneuver control. This situation is identical to situation 1 except the heading and distance are not given.

c. Situation 3— Aircraft with an In-Flight Emergency.

(1) An in-flight emergency occurs when an aircraft develops a mechanical problem that challenges the pilot's ability to maintain control. Due to the pilot's preoccupation with his immediate problem, the pathfinder assists by moving the other air traffic away from the aircraft with the emergency, who has priority. If the emergency develops before initial contact, operational security requires a full information exchange as in a standard transmission.

(2) After the emergency has been declared by the pilot, the situation continues as follows.

(a) Pilot: ALPHA ONE LIMA ONE SIX (A1L16), THIS IS CHARLIE ZERO WHISKEY ZERO TWO (C0W02), IN-FLIGHT EMERGENCY (MAYDAY), OVER.

(b) Pathfinder: THIS IS LIMA ONE SIX, WIND ZERO THREE FIVE AT SIX, CLEAR TO LAND, STATE INBOUND HEADING, OVER.

(c) Pilot: THIS IS WHISKEY ZERO TWO, HEADING TWO SIX ZERO, OVER.

(d) Pathfinder: ALL STATIONS, THIS IS ALPHA ONE LIMA ONE SIX, BE ADVISED, IN-FLIGHT EMERGENCY APPROACHING FROM THE EAST, REMAIN CLEAR OF LANDING SITE AND MAINTAIN RADIO SILENCE UNTIL EMERGENCY HAS BEEN TERMINATED BREAK - WHISKEY ZERO TWO, CAN I BE OF FURTHER ASSISTANCE, OVER.

- (e) Pilot: THIS IS WHISKEY ZERO TWO, NEGATIVE, OVER.
- (f) Pathfinder: THIS IS LIMA ONE SIX, ROGER, OVER.

NOTE: Advise the emergency aircraft of any aircraft remaining on the landing site. For example, WHISKEY ZERO TWO, BE ADVISED, TWO UH-ONEs ON NORTH END OF SITE. After the emergency has been terminated and normal operations can continue, transmit a net call. The emergency may be terminated only by the pilot declaring the emergency.

(g) Pathfinder: ALL STATIONS, THIS IS ALPHA ONE LIMA ONE SIX, EMERGENCY HAS TERMINATED, I CAN ACCEPT TRAFFIC, OVER.

(3) Departure instructions are the same as in situation 1.

d. Situation 4— Disoriented Aircraft.

(1) During limited visibility, adverse weather, in-flight emergencies, or when a map is not accessible, pilots may become unsure of the location of the landing site and they may not be at an easily identifiable land point. In such cases, the pathfinder is able to assist the pilot by directing him to either a known location or the landing site. At terrain flight altitudes, the misorientation may be as little as 200 meters in some environments. The pathfinder may hear the aircraft but cannot see it. Pilots whose aircraft have the proper equipment may use FM homing techniques and may get a proper orientation during the initial contact without requesting a long or short count. For signal security, FM homing is one of the least desirable methods for navigation because of the increased requirement for the ground station to transmit. If the pilot can identify his point in relation to a known point, the pathfinder can recommend an inbound heading.

(2) In this example, an aircraft at the CCP is unable to establish voice communication with the pathfinder due to low altitude or radio interference. Knowing the landing zone location, but unsure of the exact location of the landing site, the pilot continues his flight closer to the center of the zone.

(a) Pilot: ALPHA ONE LIMA ONE SIX (A1L16), THIS IS CHARLIE TWO ECHO THREE FOUR (C2E34), OVER.

(b) Pathfinder: CHARLIE TWO ECHO THREE FOUR, THIS IS ALPHA ONE LIMA ONE SIX, OVER.

(c) Pilot: THIS IS ECHO THREE FOUR, FOUR UH-ONEs INBOUND FOR LANDING, REQUEST NAVIGATIONAL ASSISTANCE, OVER.

(d) Pathfinder: THIS IS LIMA ONE SIX, DO YOU HAVE FM HOMING CAPABILITY?

(e) Pilot: THIS IS ECHO THREE FOUR, AFFIRMATIVE, OVER.

(f) Pathfinder: THIS IS LIMA ONE SIX, SHORT COUNT FOLLOWS (1-2-3-4-5-5-4-3-2-1), END SHORT COUNT STATE INBOUND HEADING, OVER.

(g) Pilot: THIS IS ECHO THREE FOUR, SAY AGAIN, OVER.

(h) Pathfinder: THIS IS LIMA ONE SIX, ROGER, ORBIT PRESENT LOCATION, DESCRIBE PROMINENT TERRAIN FEATURES, STATE LAST KNOWN LOCATION, HEADING, AND DISTANCE FLOWN, OVER.

(i) Pilot: THIS IS ECHO THREE FOUR, CCP HEADING THREE SIX ZERO, TWO THOUSAND METERS, I SEE A THREE-ACRE POND WITH DAM ON THE SOUTH, ORIENTED EAST-WEST OVER.

NOTE: The pathfinder plots the course correction and continues with the standard transmission.

(j) Pathfinder: THIS IS LIMA ONE SIX, HEADING TWO NINE ZERO, EIGHT HUNDRED METERS (advisories if any), OVER

(3) The standard ATC information continues as in situation 1 and ends with DESCRIBE PROMINENT TERRAIN FEATURES EN ROUTE, OVER.

**THIS CHAPTER IMPLEMENTS STANAGs 3218 AND 3619
AND QSTAG 585.**

CHAPTER 4

HELICOPTER LANDING ZONES

Helicopter landing zones contain one or more helicopter landing sites. A control center is established at each landing site and a release point (manned or unmanned) is normally selected for the LZ (STANAG 3619).

**Section I. SITE SELECTION
AND LANDING POINTS**

The ground unit commander, in coordination with the supporting aviation unit, selects the location of helicopter LZs that support the ground tactical plan.

4-1. REQUIREMENTS

Minimum landing space requirements and minimum distance between helicopters on the ground depend upon a number of variables. These requirements are covered by aviation unit SOPS, or they are prearranged by the aviation unit commander in coordination with the pathfinder leader. The final decision concerning minimum landing requirements rests with the aviation unit commander. In selecting helicopter landing sites from maps, aerial photographs, and actual ground or aerial reconnaissance, the commander considers the following factors.

a. **Number of Helicopters.** An important factor is the number of helicopters required to land at one time at one site to accomplish the mission. It may be necessary to provide another landing site(s) nearby or to land helicopters in successive lifts at the same site.

b. **Landing Formations.** When they can, helicopters should land in the same formation in which they are flying. However, planned formations may require modification for helicopters to land in restrictive areas. If a modification in flight formation is required for landing, use the change requiring the least shift in the formation (Figure 4-1, page 4-2).

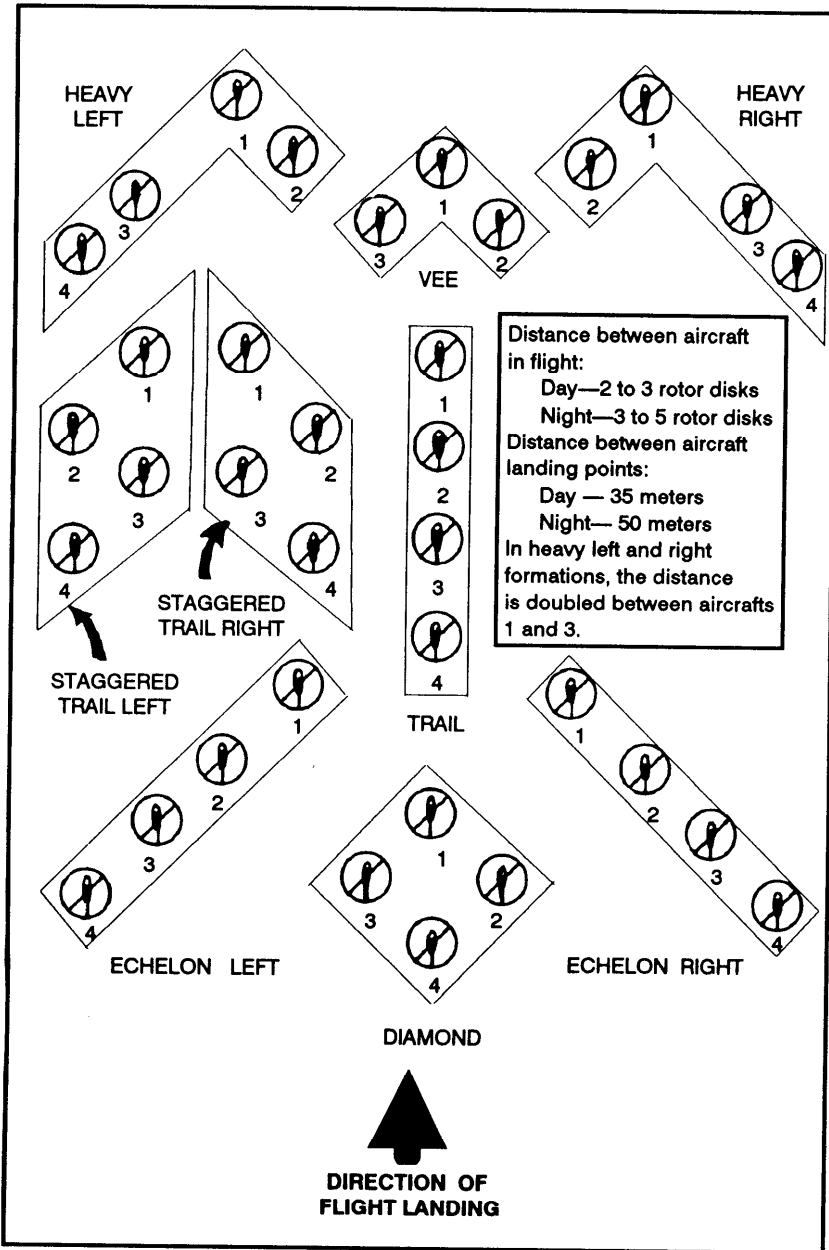

Figure 4-1. Standard flight and landing formations.

c. Surface Conditions. Surfaces must be firm enough to prevent helicopters from bogging down, creating excessive dust, or blowing snow. Rotor wash on dirt, sand, or snow-covered surfaces may obscure the ground and should be avoided, especially at night. Remove from landing points debris that could damage the rotor blades or turbine engine(s).

d. Ground Slope. The ground should be relatively level and the slope should not exceed 7 degrees if the helicopter is to land safely (Figure 4-2, page 4-4). However, observation and utility helicopters can terminate at a hover over ground slopes exceeding 7 degrees to load or to off-load personnel or supplies. Large utility and cargo helicopters can also land on terrain with a slope ranging from 0 degrees to 7 degrees. From a 7- to 15-degree slope, direct pilots to hover, as appropriate. Make landings upslope whenever possible and avoid landing downslope.

NOTE: To determine slope in percentage or degrees, all measurements may be expressed in feet or meters. If the elevation on the map sheet is expressed in meters, convert meters into feet by multiplying by three. If in feet, convert to meters by dividing by three.

e. Approach and Departure Directions. The direction of landing should be over the lowest obstacles and generally into the wind, especially at night. However, if there is only one satisfactory approach direction, or if it is desired to make maximum use of the available landing area, most helicopters can land with a crosswind of 6 to 9 knots or a tailwind of 0 to 5 knots. For wind stronger than 9 knots, the pilot lands into the wind. The same considerations apply to departures from landing sites.

f. Prevailing Wind. Consideration of approach and or departure routes is more important than that of prevailing wind *unless a crosswind velocity exceeds 9 knots*. The ability to land crosswind or downwind depends on the type of helicopter. Small helicopters can accept less crosswind or tailwind than larger, more powerful helicopters.

g. Density Altitude. The density altitude is determined by altitude, temperature, and humidity. For planning, as density altitude increases, the size of the LZ must also be increased because high, hot, and humid conditions decrease the lift capabilities of helicopters using that site.

h. Loads. Most helicopters cannot climb or descend vertically when fully loaded. Therefore, a large area and better approach/departure routes are required for fully loaded helicopters than for empty or lightly loaded ones.

GROUND SLOPE EXPRESSED IN DEGREES

The approximate slope angle may be calculated by multiplying the gradient by 57.3. This method is reasonably accurate for slope angles under 20 degrees.

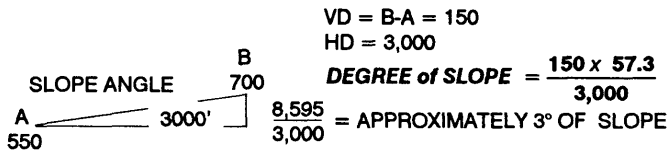

GROUND SLOPE EXPRESSED AS PERCENTAGE

To determine the percent of ground slope, divide the vertical distance (VD) by the horizontal distance (HD) and multiply by 100.

$$\text{PERCENT of SLOPE} = \frac{VD}{HD} \times 100$$

Vertical distance is the difference in field elevation between the two ends of the landing site. Always round number up to the next whole number.

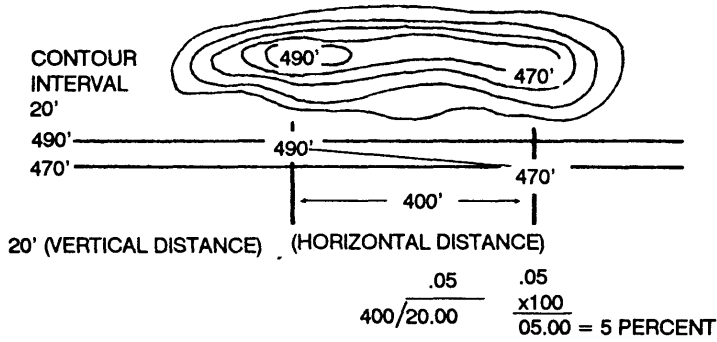

PATHFINDER SLOPE LANDING RULES

Utility and observation aircraft will not be landed on slopes exceeding 7 degrees. Large utility and cargo aircraft will be given an advisory if ground-slope is between 7-15 degrees. Always advise pilot when landing wheeled aircraft on a sideslope.



Figure 4-2. Determining ground slope.

i. Obstacles. Landing zones should be free of tall trees, power lines, and similar obstructions on the approach/departure ends of the landing site. Obstacles within the landing site, such as rocks, stumps, holes, and thick grass or brush (over 0.45 meter or 18 inches), must be removed. For planning, an obstacle ratio of 10 to 1 should be used; that is, a landing point requires 100 feet of horizontal clearance from a 10-foot tree if helicopters must approach or depart directly over the tree.

NOTE: The helicopter unit commander makes the final decision on minimum landing requirements based on the effects of air density, slope, and surface conditions. These requirements should be available in oral instructions during early mission planning.

4-2. ALTERNATE SITES

Enemy action, unfavorable terrain, or changes in the tactical or logistical situation may require alternate landing sites. These are selected primarily by the ground unit commander to support the tactical plan. On the recommendations of the aviation unit commander and the pathfinder on the site, the ground commander (or his representative) decides when alternate sites will be used. Instructions concerning their use must be given to pathfinders by the fastest means available. Pathfinder and aviation unit commanders do not have the authority to shift to an alternate LZ(s) unless such authority has been specifically delegated by the supported ground unit commander.

4-3. LANDING POINTS

These are areas/points (designated by the pathfinder leader) that can support the weight of a helicopter. As a guide, a helicopter requires a relatively level, cleared, circular area from 25 to 100 meters in diameter for landing. This depends on the type of helicopter. The area around the landing point must be cleared of all trees, brush, stumps, or other obstacles that could damage the helicopter. Generally, a helicopter requires more landing area during darkness than during daylight. Considerations such as helicopter type, nature of load, climate, and visibility affect what size landing point is used for a particular landing site.

a. The surface of the landing point center must be level and sufficiently firm to allow a fully loaded helicopter to land and, if necessary, to shut down, restart, and depart without sinking into the ground. The term "hard surface" indicates the proper condition.

b. The entire landing point must be cleared of any loose material that could be blown up by the rotors. The term is "cleared to ground level."

It would not, for instance, be necessary to clear grass up to 0.3 meter (1 foot) high that might cover a level field unless a fire risk existed. A dusty surface can be stabilized with water, if available. Snow can be packed to reduce the amount of blowing snow and removed to reveal hazards.

c. If ground obstructions cannot be cleared, some helicopter operations can be performed without the helicopter landing. The same dimensions for clearing and ground markings are required, but the helicopter hovers above ground obstructions that prevent it from landing. However, every effort is made by ground troops to improve landing point surfaces to allow the aircraft to land.

d. Recommended minimum distances between landing points within a landing site are measured from center to center as follows:

Size 1 landing point . . .25 meters.

Size 2 landing point . . .35 meters.

Size 3 landing point . . .50 meters.

Size 4 landing point . . .80 meters.

Size 5 landing point . . .100 meters.

Use a 100-meter separation between all landing points if the aircraft are of varying sizes (Figure 4-3).

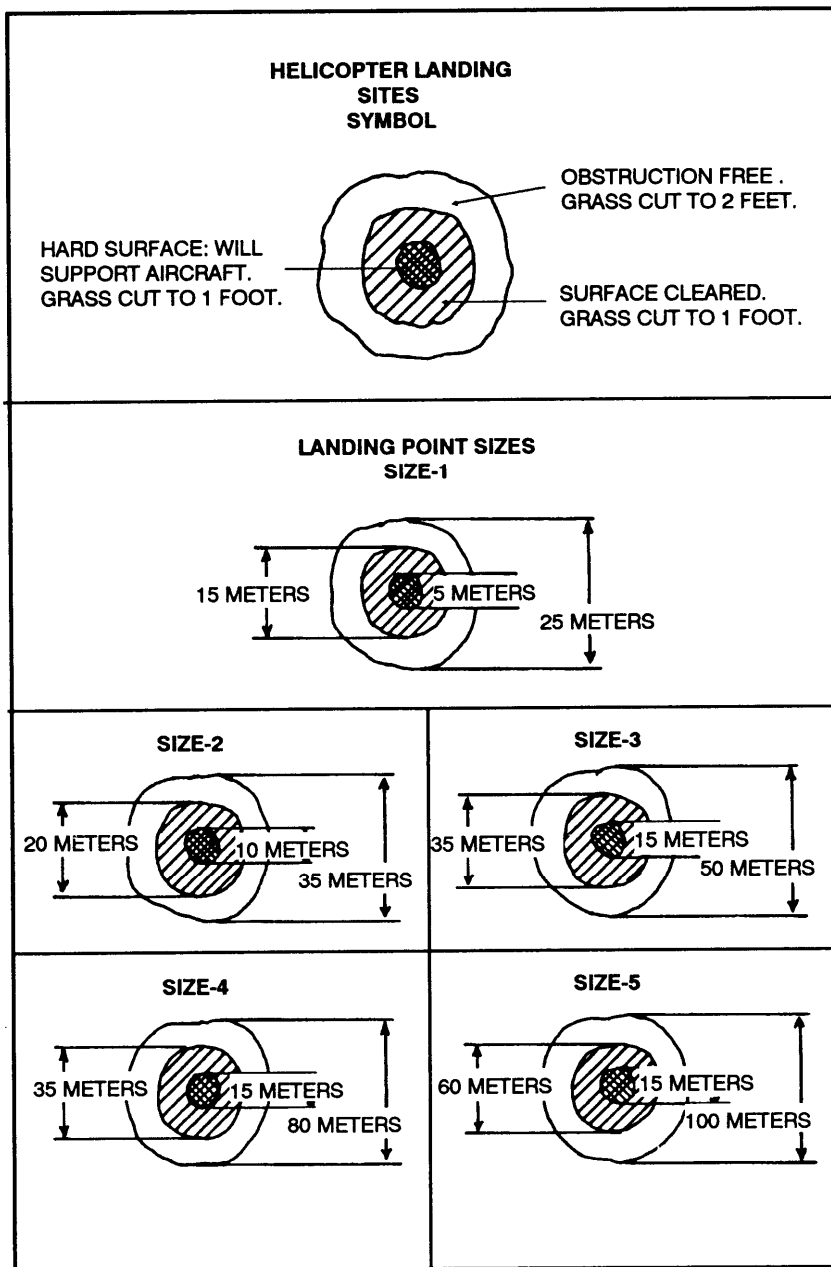

Figure 4-3. Landing points.

Section II. ORGANIZATION AND DUTIES

The pathfinder element is task-organized to establish and operate the installations required by the tactical plan of the supported unit(s). These facilities may be within a single LZ or widely separated throughout a large area of operations. The pathfinder leader is normally at the most important site. For the establishment and operation of one helicopter LZ, the pathfinder element is organized in two working parties—a control center and a landing site party (also called the marking party). A landing site party is required for each site in the landing zone. The control center party and the RP party provide the same function for LZs or DZs.

4-4. CONTROL CENTER

The purpose of the CC is to coordinate aircraft in and around an LZ or DZ and to promote a safe, orderly, and expeditious flow of air traffic. The pathfinder leader selects the exact location of the CC upon arrival in the area. The CC is positioned to facilitate visual control of aircraft in and around the LZ or DZ.

a. For helicopter landing zones, the most desirable CC location is along the aircraft flight route, but displaced from the landing site. This will reduce compromise of the actual landing site location by enemy electronic warfare assets, although the tactical situation might dictate that the pathfinder leader be on the site for control purposes. When an LZ has more than one landing site, or during reduced visibility, the CC may be located to perform as a manned release point, or final approach fix, to provide positive navigational assistance to arriving aircraft.

(1) The RP is an established traffic control checkpoint and the final navigational checkpoint for aircraft approaching the landing site or air delivery facilities within an LZ or DZ.

(2) The RP is also used by helicopter serials as a final coordination point for control of planned ground or aerial supporting fires in and around LZs during the air movement phase of an air assault operation. The RP is normally not manned unless extremely difficult navigational problems are anticipated by the air movement commander. The location is tentatively selected from map or air photograph studies as an easily identifiable point on the planned flight route to the landing site. If manned, the RP should be on terrain that allows maximum effective use of long-range electronic and visual navigation aids.

b. For single helicopter landing sites within a single LZ, the most desirable GTA communication location is on the site. Such a position (particularly at night) enables the pathfinder ATC to observe the final

approach of helicopter formations, and it ensures correct alignment with the required landing direction and sufficient obstacle clearance.

c. A control center is organized to meet mission requirements. It may consist of a single pathfinder operating the GTA radio for a limited period at a small site, or it may be staffed as follows:

(1) *LZ or DZ commander*. He supervises aircraft landings and departures, airdrops, and other pathfinder activities in the LZ or DZ. He may also be the GTA radio operator.

(2) *GTA radio operator*. He operates the radio used to maintain communications with pilots and provides the necessary advisories for his airspace.

(3) *Internal radio net recorder*. He operates the radio used to communicate with other pathfinder elements (when such a net is applicable and required). He aids in the control of aircraft by observation and maintains a record of aircraft arrivals/departures and the type loads (if required).

4-5. LANDING SITE PARTY

The landing site party consists of a site team leader and additional pathfinders/attached personnel, as required. However, a single pathfinder may establish and operate a small landing site for limited periods.

a. The site team leader is responsible for the reconnaissance, establishment, and operation of the landing site. He supervises the site and, at any time, may supervise the GTA radio operator. Some of his responsibilities include:

- (1) Organizes at an objective rally point.
- (2) Reconnoiters to determine:
 - (a) Long axis.
 - (b) Usable area.
 - (c) Ground slope (compute).
 - (d) Land heading.
- (3) Determines best landing formation.
- (4) Designates slingload point(s).
- (5) Emplaces and briefs GTA radio operator.
- (6) Clears touchdown and slingload points.
- (7) Organizes personnel and loads for air movement.
- (8) Clears or marks obstacles.
- (9) Prepares for night/day missions.
- (10) Continues to improve site.

b. The number of additional pathfinders employed is dictated by the size of the landing site, the expected density of air traffic, the number and type of visual and electronic aids to be used, and the tactical situation.

Additional pathfinders operate the GTA radio and the pathfinder internal radio net (if established), position and operate navigation and assembly aids, and clear or mark obstacles.

c. Other personnel from supported units may be attached to the landing site party to provide security, assist pathfinders in establishing and operating the landing site, reconnoiter and mark assembly areas, and operate assembly aids. Attached personnel must be briefed and rehearsed. If they are given a reconnaissance assignment, it should not include actual landing areas; these areas are reconnoitered by pathfinders.

Section III. LANDING SITE OPERATIONS

Once a site has been selected and communications established, the operation of the site begins. Additional markings and improvements are continually made until the site is ready to support the ground tactical plan.

4-6. COMMUNICATIONS

Communications are established in the GTA net and the pathfinder internal net (if used) immediately upon arrival at the landing site. These radio nets are monitored at all times (unless otherwise directed) until operations at the site are completed.

a. Each helicopter landing site should be within ground communication range of the other sites and RPs (if manned). However, the tactical situation may preclude this requirement. The range of available radios dictates the ability of facilities within the LZ to communicate with each other.

b. The utility cargo helicopter landing site commander rapidly reconnoiters the area to determine the exact direction of landing. He calculates an intercept heading from the RP, if necessary. He selects the location of the landing point of the lead helicopter of each flight and determines if the terrain or situation dictates any change to the planned landing formation. The site commander must also ensure that landing instructions are compiled for transmittal to inbound helicopters, and that obstacles in or around the site are removed or marked.

4-7. FLIGHT FORMATIONS

Helicopters should land simultaneously in a planned flight formation. If it becomes necessary to land in a formation different from that in which they are flying, the landing site commander ensures that this information is given to the flight leader as part of the landing instructions. The exact layout of the landing site depends upon helicopters not flying directly over other aircraft on the ground, available landing space, number and type of obstacles, unit SOPS, and prearranged flight formations.

4-8. LANDING ZONE AND OBSTACLE MARKING

Normally, no LZ marking is used for day operations except smoke or some other minimum identification means. For night operations, lanterns or field expedients are used to indicate the direction of landing and to mark individual landing points (Figures 4-4 through 4-9, pages 4-11 through 4-16). However, obstacles should be marked for daylight and night air assault operations.

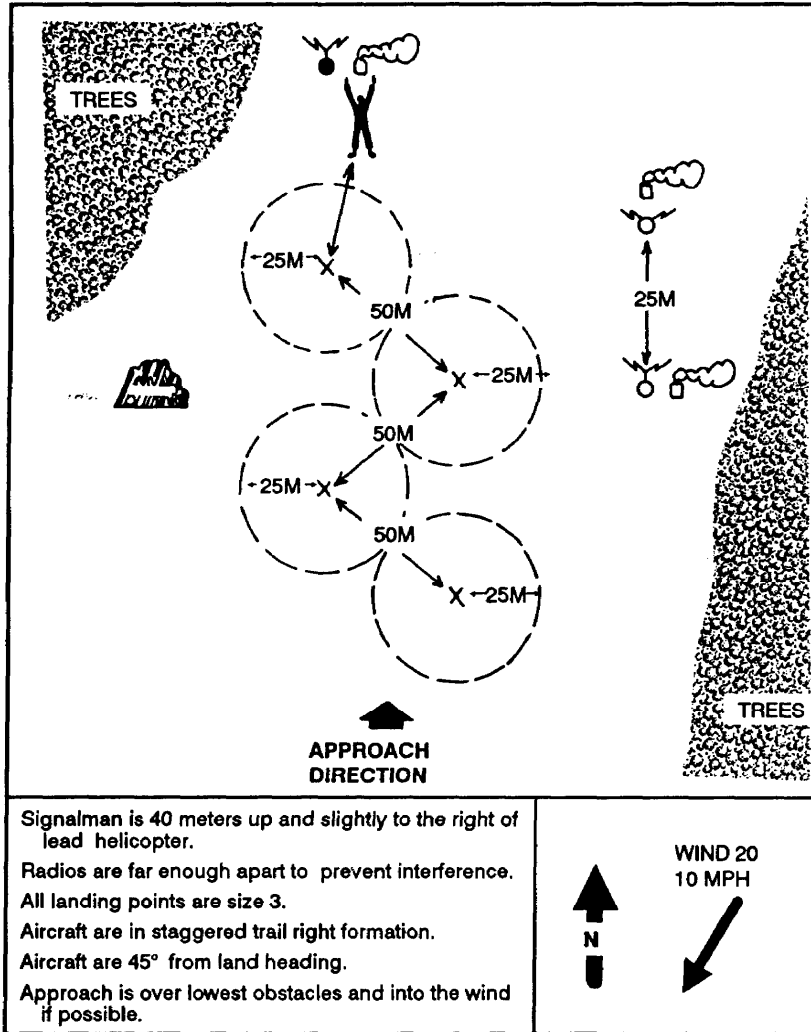

Figure 4-4. Helicopter day landing site, staggered trail-right formation.

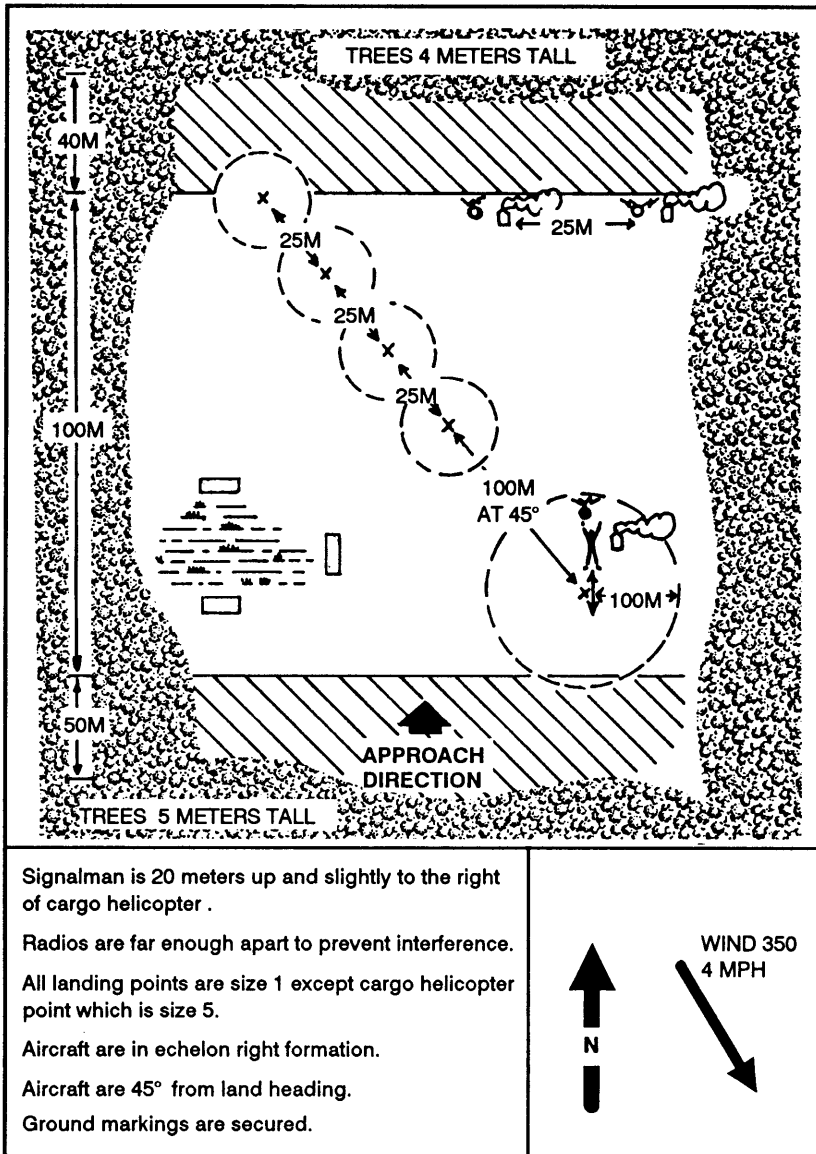

Figure 4-5. Helicopter day landing site, echelon right formation.

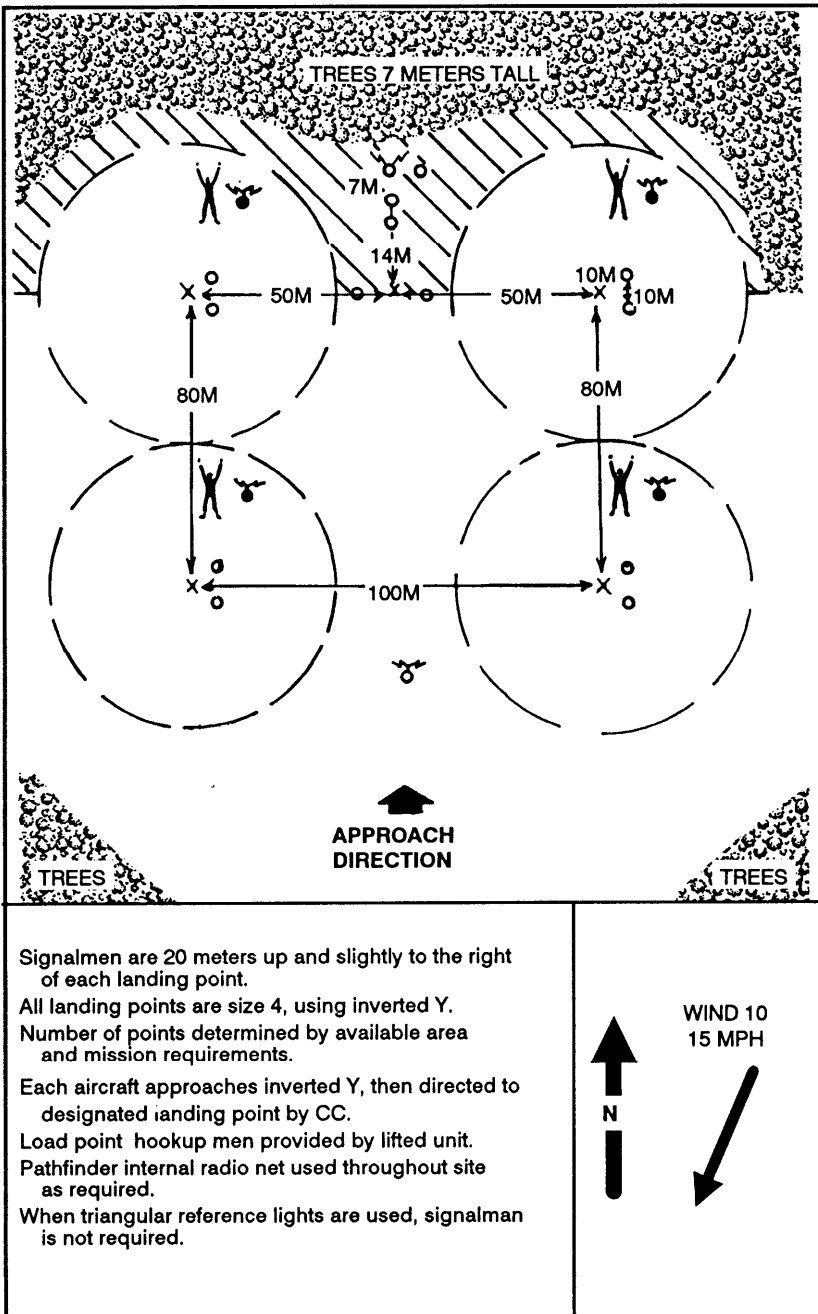

Figure 4-6. Day or night slingload operational site.

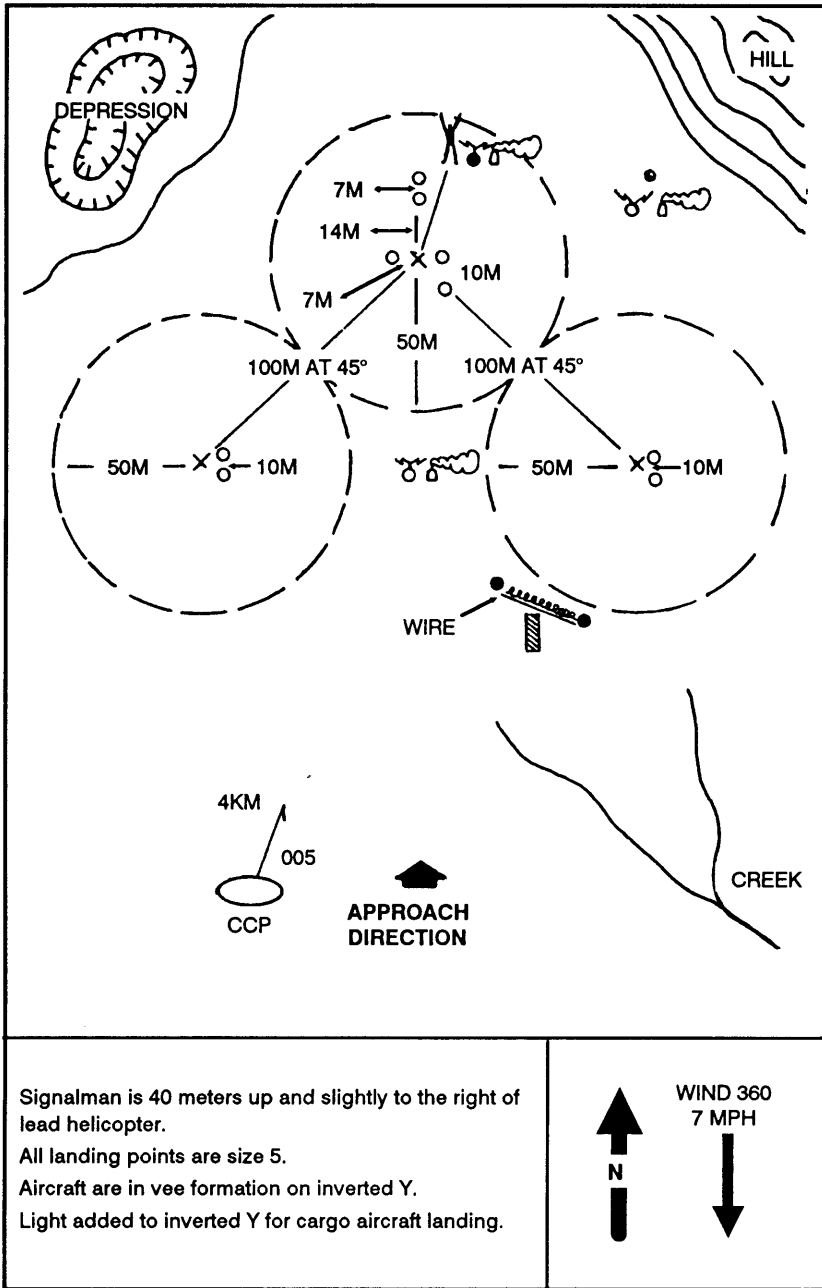

Figure 4-7. Day or night cargo landing site, vee formation.

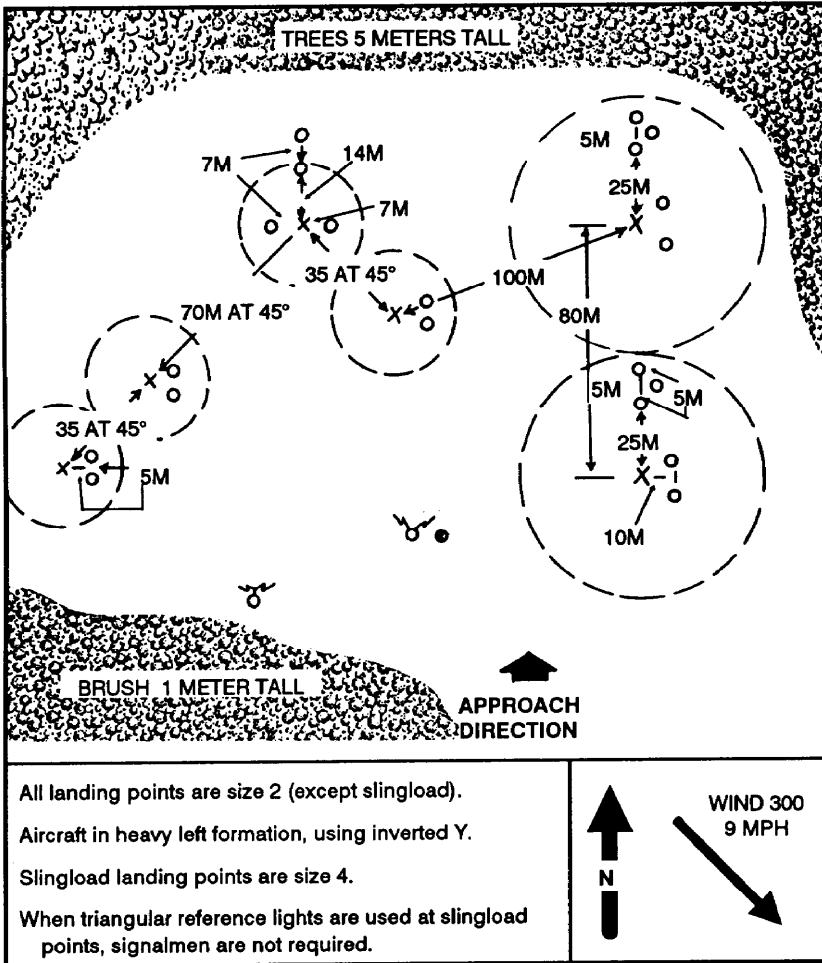
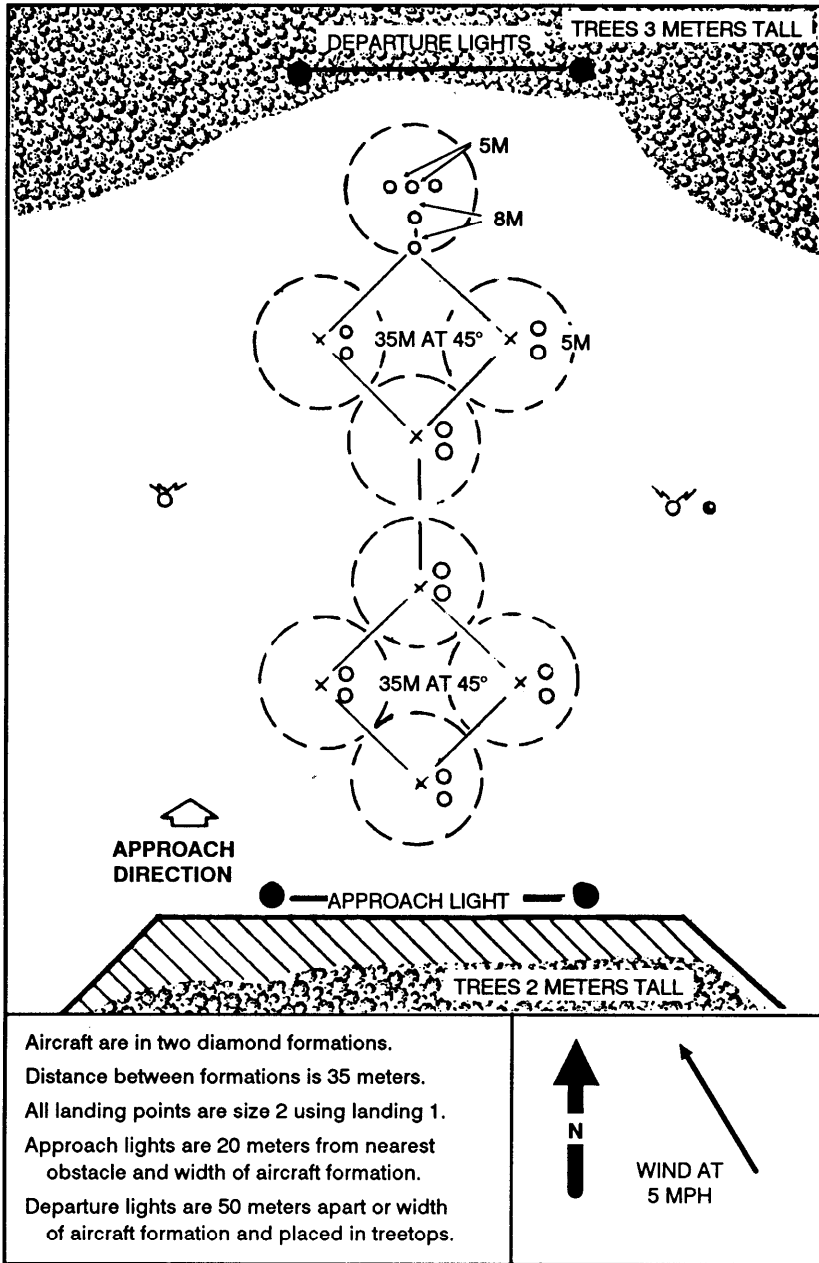

Figure 4-8. Night landing site with landing points for aircraft and slingloads.



Aircraft are in two diamond formations.
 Distance between formations is 35 meters.
 All landing points are size 2 using landing 1.
 Approach lights are 20 meters from nearest obstacle and width of aircraft formation.
 Departure lights are 50 meters apart or width of aircraft formation and placed in treetops.

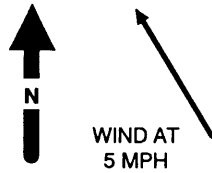

Figure 4-9. Utility helicopter night landing site, diamond formations.

a. At night, lights of different colors may be used to designate different helicopter sites or to separate flights within a larger formation. Alighted T or inverted Y indicates the landing point of the lead helicopter of each flight and the direction of approach (Figure 4-10, page 4-18). Additional lights are provided for touchdown points of other helicopters in the flight. Helicopters should land with the right landing gear or skid just to the left of the light. (Red lights are avoided because they mark obstacles.)

b. When helicopters are inbound, all lights should be hooded or turned upside down for security until the last practical moment. Lights should be beamed in the direction from which the helicopters approach. A signalman should be used to direct the landing of the lead helicopter.

CAUTION

The intensity of lights may be too bright for NVGs, and colors cannot be seen through the NVGs; therefore, an aircrew member may have to look under the NVGs to distinguish the colors.

4-9. AIR ASSAULTS

During daylight air assault operations, obstacles that may be difficult to detect and impossible to remove (such as wires, holes, stumps, and rocks) are marked with colored panels or any other easily identifiable means (colored red). During night air assault operations, red lights are used to mark all obstacles within a landing site that cannot be easily eliminated.

a. In most combat situations, the need for security prohibits the use of red lights to mark the tops of trees on the departure end of a landing zone. In training, however, or in a rear area landing site, red lights should be used whenever possible. If obstacles or hazards cannot be marked, aviators should be fully advised of existing conditions by GTA radio. In any case, the pathfinder landing site leader ensures that the most dangerous obstacles are marked first and, if possible, eliminated.

b. Pathfinders may mark initial assembly points for troops, equipment, and supplies if required by the supported unit. These points are located to facilitate assembly and clearing of the helicopter site quickly and efficiently. If unit assembly areas are to be used, they are selected by the ground unit commander. If necessary, supported ground unit personnel accompany the pathfinders to reconnoiter and mark the unit assembly areas, establish assembly aids, act as guides, and assist in landing and unloading operations. Such help for pathfinders ensures the rapid clearing of troops, supplies, and equipment from the landing points.

c. Pathfinders have a limited capability to secure a landing site. If they precede the initial assault elements into a landing site, personnel from the supported ground unit may accompany them for security.

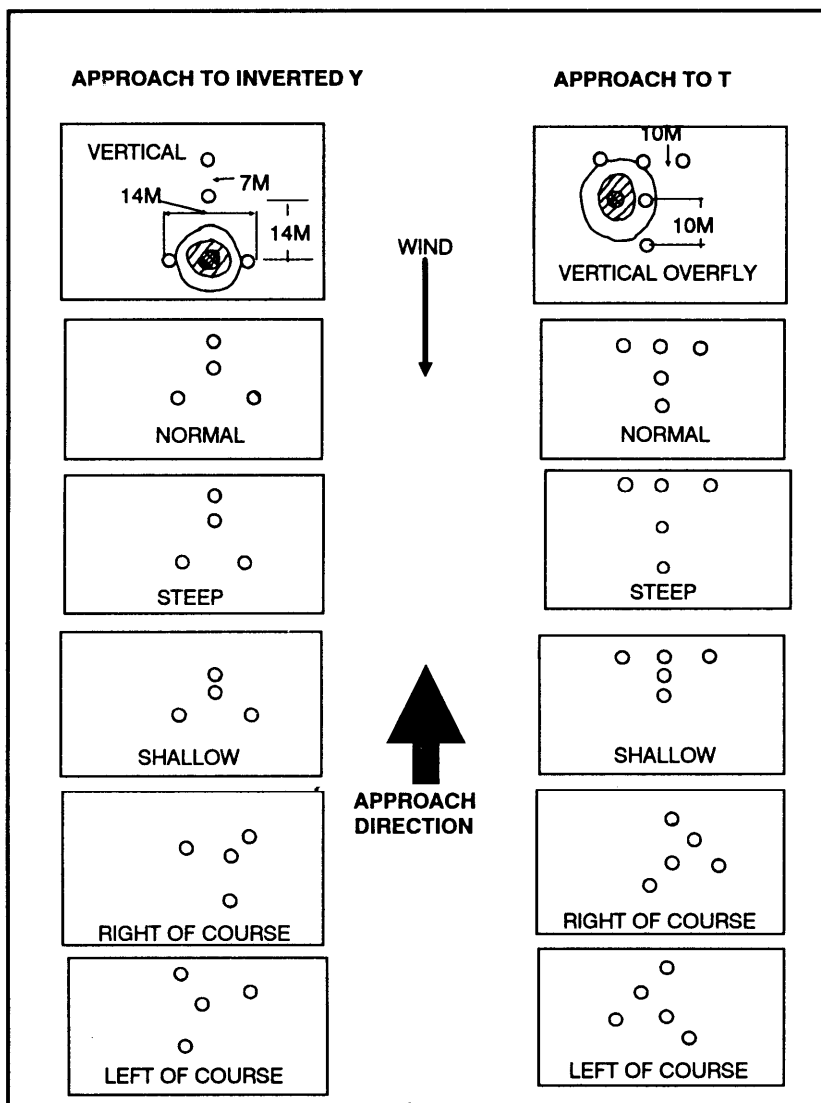

Figure 4-10. Lighted night landing symbols as seen by the pilot from different approach angles.

4-10. INTERCEPT HEADING

The heading from the RP (or CCP if no RP is used) to the landing site coincides as closely as possible with the landing direction to preclude sharp turns by helicopter formations. The larger the formation, the more important this becomes. If a straight-in landing approach is not possible, then an intercept heading should be established (Figure 4-11). The intercept point should be far enough from touchdown that it allows helicopters in formation a final approach of at least 1 to 2 miles. Visual steering commands, time and distance, terrain features, and electronic or visual navigation aids may be required by flight leaders to determine the intercept point and the landing direction at the landing site.

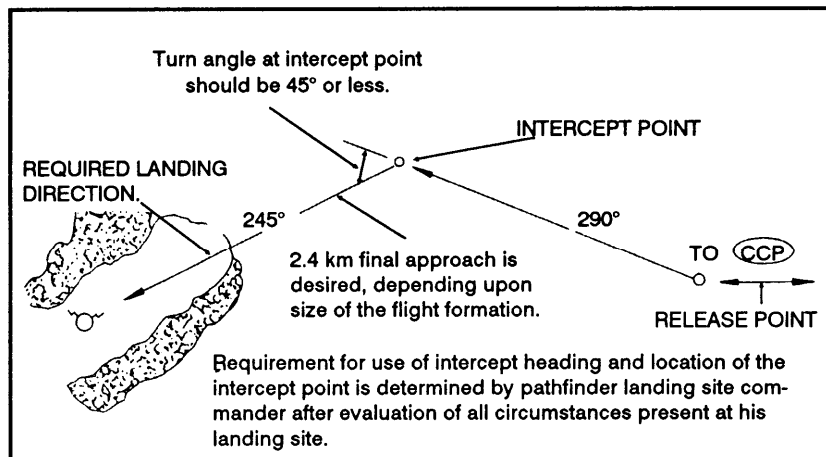

Figure 4-11. Intercept heading technique.

Section IV. LANDING ZONE OPERATIONS

Helicopters approach the LZ along a designated flight route. They are normally organized into serials containing four or five helicopters but may be platoon-size lifts. One serial may contain a flight for each helicopter site. However, flights of medium or heavy transport helicopter (CH-47 and CH-54), carrying artillery or other bulk cargo, can often be expected to arrive at LZs in increments of one or two helicopter (Figure 4-12, page 4-20). Subsequent flights follow at minimum time intervals, which depend on the number of helicopters per flight, the configuration and conditions of the landing site, and the nature of the cargo to be loaded or unloaded. The aviation unit commander determines the time between successive flights during planning. Once an operation is in progress, pathfinders at the site may

recommend changes to ensure helicopter safety or to expedite operations. (Night operations may increase the time and distance between formations.)

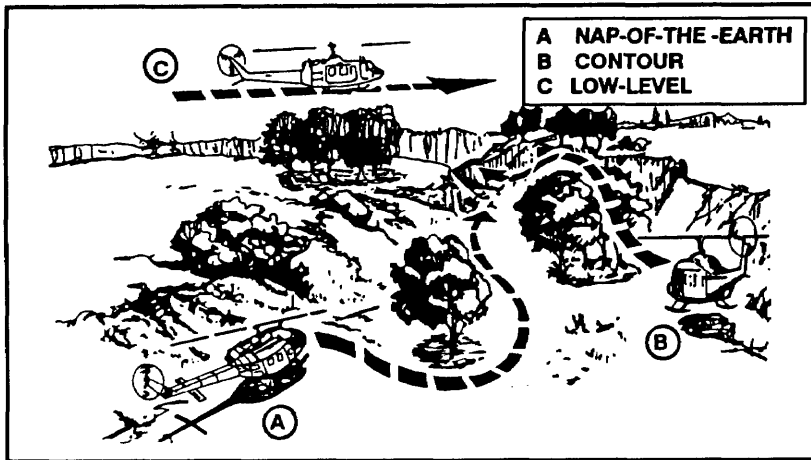

Figure 4-12. Flight techniques.

4-11. COMMUNICATIONS CHECKPOINT

As each helicopter serial reaches the CCP on the flight route, the flight leader contacts the appropriate helicopter landing site control center. The CC then gives the flight leader the heading from the CCP to the landing site, the landing direction, and the following other pertinent information:

- The enemy situation.
- Friendly fires.
- Field elevation.
- Landing formation.
- Terrain conditions.
- Traffic situation.
- Obstacles.
- Availability of smoke or light gun.
- Visual approach path indicator setting.
- The next reporting point.

a. All helicopters in a flight switch to the pathfinder control frequency on instructions from the flight leader before reaching the CCP.

NOTE: Pathfinders are prepared at all times to provide ATC and navigation assistance to all aircraft in and around the landing site in the event those aircraft do not follow a specified flight plan.

b. The helicopter formation continues along the flight route to the RP. Pilots are assisted by the electronic and visual navigation aids at the RP (if manned). All helicopters pass over or near the RP, and each flight

RP (if manned). All helicopters pass over or near the RP, and each flight serial leader reports passage of the RP to his respective landing site CC and then flies directly to his assigned landing site. The individual landing site CC assists any flight that cannot locate its site, using visual signals, steering commands, or electronic homing techniques.

(1) *Day operation signals.* For daylight operations, a specified smoke color may be assigned to identify different landing sites. Since the number of smoke colors is limited, the same color may have to be used by more than one helicopter site. Sites that use the same color should be farther apart. Smoke is employed sparingly because it marks a location not only for friendly forces, but for enemy observers as well. Generally, smoke is used only in response to a pilot's request for help in identifying or locating his helicopter site.

(2) *Night operation signals.* For night operations, pyrotechnics or other visual signals are used in lieu of smoke. As in daylight, red signals mean *do not land*, or they indicate other emergency conditions. Emergency codes must be planned and understood by all concerned. Each flight lands at its assigned site in the manner indicated by CC messages and the visual aids displayed. Pathfinders may use arm-and-hand signals to assist in controlling the landing, hovering, and parking of helicopters.

4-12. AIR CONTROL POINTS

As required, pathfinders maybe tasked to manage ACPs to assist aircraft en route to the LZ.

a. The ACP party consists of two or three pathfinders, or at least one pathfinder with assistants. They position and operate the electronic and or visual navigation aids. They also operate radios in the pathfinder internal net (if used) and the GTA net. Monitoring the GTA net permits ACP personnel to respond immediately to requests from pilots for assistance in locating an ACP.

b. The pathfinder in charge of the ACP (assisted by available personnel as needed) installs navigation aids immediately upon arrival at the site (or according to plan). Whenever possible, aids should be established concurrently. If a priority for installing these aids is required due to limited personnel or other factors, then the following priority is used.

(1) **GTA radio** This is placed into operation first. The electronic homing beacon is then installed, if requested by the aviation unit commander, since it affords long-range guidance. If used, the beacon must be far enough away to prevent excessive interference with the radios

and to reduce the possibility of enemy fire destroying the radios and the beacon simultaneously.

(2) **Visual navigation aids.** These navigation aids vary in number and type depending upon aviation unit SOPs and requirements, and the need for security. Grass or brush masking these aids is removed, but a method of concealing the markings is necessary if enemy aircraft is sighted.

(3) **Pathfinder internal net recorder** He establishes communication with the landing zone CCs as quickly as possible to report the state of ACP readiness and to provide information on the enemy situation near his location (if appropriate). He constantly monitors the radio unless directed to operate a beacon on a definite time schedule.

(4) **Security personnel.** The ACP party may include attached personnel from supported units who are used to provide security. They move to assigned locations and take up security positions or assist in establishing and operating navigation aids and communications equipment.

Section V. NIGHT OPERATIONS

Daytime visual references (checkpoints for positive identification) are difficult to see at night. Visual aids for night navigation emit illumination. Too few visual references may cause pilots to concentrate on a single light or a group of lights in a concentrated area. This may induce visual illusions and can cause vertigo. To eliminate this unsafe phenomenon, avoid marking LZs with a single light. Landing areas should always be lighted with two or more lights that are widely separated.

4-13. TACTICAL LANDING LIGHTS

The tactical landing light system provides visual cues for landing in a tactical landing site. The inverted Y is the recommended system when the approach is made from terrain flight altitudes. Approaches to a tactical landing site are normally made without the aid of the search landing light. The lighting for a tactical landing zone may consist of hand-held flashlights or "beanbag" lights arranged on the ground. Regardless of the type lighting device used, a minimum of two lights will be used to identify the touchdown point.

a. At night, lights of different colors maybe used to designate different helicopter sites or to separate flights within a larger formation- A lighted (inverted) Y indicates the landing point of the lead helicopter in the flight (Figure 4-13). At additional touchdown points, helicopter should land with the right landing gear or skid just to the left of the light. All lights should be hooded or turned upside down for security until the last practical moment when helicopters are inbound. Lights should be beamed in the direction from which

the helicopters approach. A signalman should be used at a slingload point.

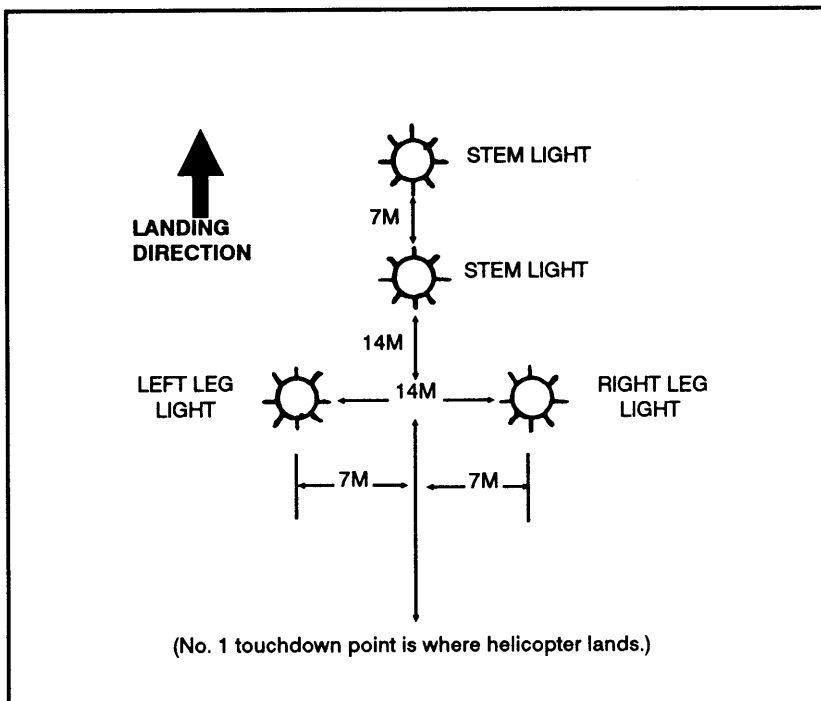

Figure 4-13. Inverted Y.

b. During darkness, approaches are slightly steeper and slower than a daylight approach.

CAUTION

When fully night-adapted, the eyes become extremely sensitive to light, and exposure to a light source causes partial or complete loss of night vision. Caution must be taken to avoid exposure of pilots to light sources. When pilots are wearing NVGs, pathfinders must either avoid shining the light directly at the aircraft, or else use only NVG compatible light sources.

c. One example of emergency night lighting is to use vehicle headlights. Place two vehicles about 35 meters apart and 35 meters downwind of the landing point with their headlight beams intersecting at the center of the landing point (Figure 4-14). The helicopter approaches into the wind, passes between the vehicles and lands in the lighted area. This method is not suitable for large helicopters.

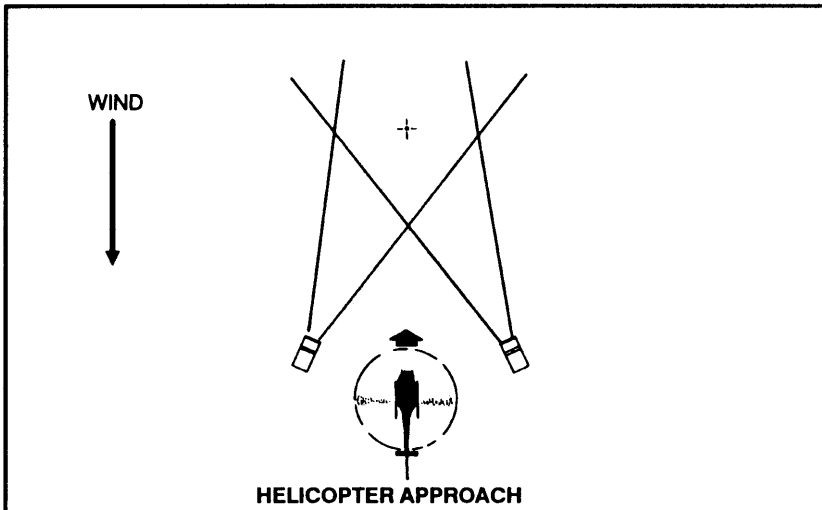

Figure 4-14. Emergency night lighting by vehicle headlights.

4-14. EXTERNAL LOADS

External load employment can be difficult during darkness; however, several methods are available to the pathfinder. In the absence of sufficient signalmen, reference lights (three lights spaced triangularly 5 meters apart) are positioned 25 meters in front of the load as a marker. This lighting configuration aids the flight-crew during hookup, lift-off, and landing. Upon lift-off, the aircraft climbs vertically until the load clears the ground. As the helicopter begins forward movement, sufficient power is applied to maintain a climb that allows the slingload to clear obstacles along the lift-off path. The shorter the sling, the less altitude required to clear obstacles. Sling length should be added to obstacle height for computation of the distance required for departure clearance.

4-15. MULTI-HELICOPTER OPERATIONS

Due to reduced vision at night, formation flying cannot be safely conducted in a complete blackout mode at terrain flight altitudes unless the unit is equipped with night vision goggles.

4-16. NIGHT VISION GOGGLES

To operate at terrain flight altitudes during low-or mid-light levels, use night vision goggles. Because the lights in the tactical lighting set are too bright for these goggles, place a filter over the clear lens cover. If a filter is not available, paint the lens cover or cover it with plastic tape to reduce light intensity.

Section VI. ENVIRONMENTAL CONSIDERATIONS

The pathfinder unit can anticipate supporting the aviation commander and ground unit commander in a variety of climates and terrains. The requirements for establishing a landing site or zone are similar. However, some land areas require extra precautions and care in the selection and preparation of an LZ to safely and expeditiously receive aircraft.

4-17. PILOT INPUT

It is important to remember that the pilot (based on his experience and responsibilities to aircraft and crew) determines whether or not a proposed landing site is safe.

a. Climatic and terrain environments include cold weather, jungle, desert, and mountainous terrain. (For more detailed information on the climate, terrain, and operational aspects of these areas, see FM 90-3, FM 90-5, and FM 90-6.)

b. Each area requires special procedures on the part of the pilot. The pathfinder who is knowledgeable regarding these procedures can better advise and assist aviators and the supported ground unit.

4-18. COLD WEATHER OPERATIONS

Cold weather flying conditions may be encountered in many parts of the world. Extreme cold and blowing snow pose special problems in ground operations and flight conditions. The problems presented by ice, snow, or rain are incorporated into pathfinder mission planning. The pathfinder's knowledge of flight procedures enables him to advise the pilot on the existing surface conditions.

a. **Communications.** Radio communications are generally good, but may be disrupted by electrical disturbances (the aurora borealis). Some frequencies may be blocked while other frequencies will not always permit operators to transmit clearly. Communications are often limited or restricted by mountainous terrain. Relay stations may have to be established. Conditions of "radio skip" are prevalent in cold weather areas, and it is common to experience long-distance radio traffic on tactical frequency modulated networks.

b. **Navigation.** In snow-covered areas with flat terrain, pilots may require RPs to be reamed and marked. When flight is over loose snow, the movement of the air picks the snow up and circulates it, forming a snow cloud. If this condition exists, a phenomenon referred to as "whiteout" may occur. Visibility is reduced to zero as the aircraft descends or climbs through a snow cloud. The occurrence of whiteout conditions places additional requirements on the landing site party (Figure 4-15, page 4-26).

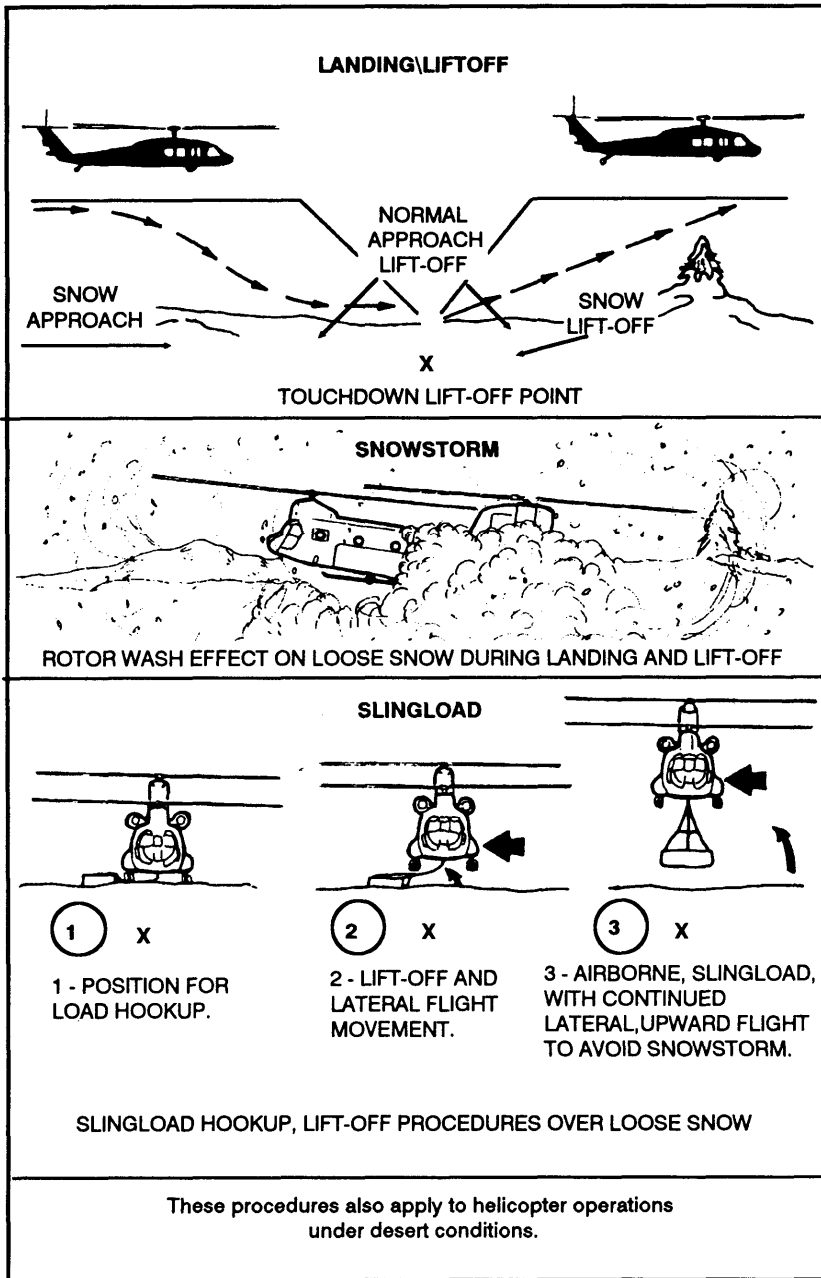

Figure 4-15. Lessening the effects of loose ground snow.

c. Surface Conditions. The surface must be evaluated to determine if aircraft can land without sinking too deep into the snow. Testing the snow surface hardness can be done with a tactical vehicle. The landing site party should also try to determine the degree of ground slope and whether or not there are any obstacles beneath the snow cover at each landing point.

(1) The distance between aircraft is increased along with the size of the landing point: 100-meter-diameter landing point with 100 meters between aircraft.

(2) Marking the landing points presents other problems. Pilots lose depth perception in snow-covered areas. A signalman on the ground provides a good reference for estimating height. Touchdown points in daytime are marked so the pilot has references to clear and safe landing areas.

(3) The GTA radio operator, if the tactical situation permits, advises the pilot of the surface conditions so he may anticipate how to make an approach. The echelon left or right landing formation is preferred to reduce the chances of snow clouds or whiteouts for the other aircraft. The pathfinder should also plan to stagger aircraft arrivals to the landing site to allow for the settling of snow clouds from preceding aircraft.

(4) Depending on the mission requirements, climatic conditions, and the time the landing site is used, the pathfinder leader considers the use of multiple landing sites instead of only one site.

(5) Aircraft making night approaches to snow sites require a reference point on-the ground (tactical landing lights or runway lights). These lights provide the pilot with a reference for judging angle of descent and rate of closure. The pilot plans his approach to land short of the touchdown point to ensure that he will not overshoot the point and have to decelerate rapidly in a snow cloud. Approaching short allows the pilot to maintain airspeed after the level-off, thus keeping the aircraft in front of the snow cloud until touchdown.

(6) The pathfinder, if coordinated with the flight commander, may adjust his inverted Y forward 10 meters in front of his designated number 1 touchdown point. This allows the landing site party to employ all usable areas on the site.

(7) If personnel are available, they may be positioned to act as signalmen for aircraft approaching additional touchdown points. Caution is exercised to ensure that signalmen are in safe areas as aircraft approach and land. Additional signalmen should also control the loading of personnel on the aircraft (as instructed by the crew chief or the crew) when the aircraft is ready to be loaded.

d. Signalman The technique for landing on snow with a slingload is similar to other type approaches, but the pilot must hover at a higher

altitude due to the load. It is difficult for the pilot to judge the height of the slingload (from the ground) as it nears the snow surface, therefore, a signalman keeps him informed. To avoid the buildup of a snow cloud, the pilot puts the load on the ground as quickly as possible.

e. **Slingload Operations.** Hookup and lift-off with a slingload over snow can be unsafe unless the pilot anticipates being engulfed by a snow cloud. (The CH-47 requires a sling length of at least 60 feet. The sling length for other aircraft is shorter.) The usual technique of hovering the helicopter over the load and attaching the sling to the hook may not be used over snow-covered terrain.

(1) An alternate procedure for hooking up a slingload is for the pilot to land the helicopter to the left of the load but close enough so that the sling can be attached to it.

(2) When ready for lift-off, the pilot initiates a slow, vertical ascent with enough lateral movement to position the aircraft over the load. He continues a vertical ascent until the load is off the ground and a hover-power check is completed. When the load is clear, the pilot begins acceleration while continuing to climb.

WARNING

Ground personnel should be properly dressed and equipped with face mask and goggles due to the increased danger of frostbite from the rotor wash.

f. **Static Electricity.** During cold weather, static electricity creates serious problems. It can be generated by the movement of an aircraft through the air, by brushing snow and ice from the aircraft, or by dragging steel cables over the snow. During external load operations, aviators should key the FM radio immediately before load pickup to discharge the aircraft's static electrical charge. However, the charge rapidly builds up again. Therefore, hookup personnel should use a grounding device to avoid electrical shock (Chapter 6, static probe).

g. **Safety Considerations.** The accumulation of ice on aircraft structural and moving parts may be dangerous to nearby ground personnel. The aircraft may accumulate ice up to three-quarters of an inch thick during flight in temperatures and altitudes where icing conditions exist. During flight at less extreme temperatures, this ice begins to loosen and fall off. Ice may shed while the helicopter is losing altitude during the landing approach and during touchdown, and pieces of ice shed by the main rotor may travel up to 300 feet. Ground personnel should stay a safe distance away from helicopters during landing and shutdown (after flight in icing conditions), and passengers should not get out until the rotor blades have stopped.

4-19. JUNGLE TERRAIN

Jungle areas impede military operations and tend to obstruct military lines of communication. Jungle areas may be characterized by heat, humidity, rainy seasons, and other weather conditions that affect the performances of aircraft. Thick vegetation, irregular terrain, and adverse atmospheric conditions screen radio transmissions. Radio relays may have to be used. The CCP may have to be manned and marked, and GTA communications provided to advise and direct the pilot to the landing site if communications are limited in range.

a. Landing sites in the jungle are generally small and may accommodate only a few aircraft. The ACL will be drastically reduced. The surface conditions of the landing site should be evaluated to ensure that the aircraft will not sink or bog down in the soil. The site is surveyed for vines, trees, and other obstructions in the approach path and near the touchdown point.

b. On the approach, the pilot avoids a high rate of descent. The aircraft angle of descent should be steep enough to permit clearance of any obstacles. Normally, a 10-to-1 obstacle ratio is used, but the ratio can be reduced to no less than 5 to 1. The pathfinder leader considers obstacle height on approach and departure ends. Due to density altitude problems in tropical areas, the aircraft may not be able to develop enough lift to clear tall obstacles. When the size of the site and terrain conditions permit, the pilot may consider running lift-offs and landings. However, a running-type lift-off may not be possible in the jungle due to the size of the site, soft terrain, and obstacles.

c. Depending on the tactical situation, the use of lights in night jungle LZ operations may be restricted.

d. Site security is critical to the success of the ground unit commander's mission. Due to the cover and concealment provided by jungle terrain, landing site security is difficult to accomplish. The pathfinder team leader coordinates with the flight commander to set a specific time period to light the site.

e. It is important that the site is oriented to the direction of the wind and that departure obstacle ratios are as low as possible due to climatic conditions, jungle vegetation, and reduced lift capability of the helicopter. The pilot will hover as low as possible and no longer than necessary due to the aircraft's decreased lift efficiency caused by ground effects.

4-20. DESERT TERRAIN

The typical desert is a dry, barren region, generally treeless and sandy. A region of environmental extremes, it has violent and unpredictable changes in weather and contains terrain that does not conform to any particular model. While frequent clear days offer unequaled visibility and flight conditions, a sandstorm can quickly halt all operations. Therefore, successful desert operations require special training, acclimatization, and a lot of self-discipline.

a. **Communications.** In desert operations, the radio is usually the prime means of communication. Radio range normally is good due to the low, rolling terrain. However, because of the increased distance involved with military operations in the desert, FM radio communications may be inadequate, especially when using the higher FM frequencies. High-frequency radio equipment is essential. Factors attributed to communication problems include poor electrical ground, and sand and dust entering equipment. Because of increased distances between land force units engaged in desert operations, helicopters may be used to provide air or ground relay, or to help deploy ground radio rebroadcast facilities.

b. **Navigation Assistance.** Many of the conditions experienced in cold weather operations are similar to desert operations. Distances and altitudes are also difficult to judge in the desert. The lack of definable terrain features makes navigation difficult, especially at night and over long distances. The sameness of the terrain makes it easier for a pilot to become less attentive to his surroundings, and it may be necessary to mark and man release points.

c. **Landing Sites.** The climatic conditions in the desert will have a profound impact on establishing and operating landing sites. The three most important factors to consider are density altitude, wind, and sand (dust). Sand on a landing site could produce brownout conditions similar to those found in snow areas, and the same precautions are applicable. Therefore rocky areas are preferable to sandy areas, hollows, depressions, and sandy valleys.

d. **Wind.** Desert wind generally dies down about sundown for an hour or two, and there is also a calm before sunrise. At times the wind can achieve hurricane force. In all deserts, rapid temperature changes invariably follow a strong wind that often raises dense clouds of dust and sand. Consideration should be given to the time of day when the landing site will be operational.

(1) The extreme heat often experienced in the desert also affects the aircraft's ACL. When in support of a ground unit, the pathfinder leader coordinates with the aviation element to determine the ACL per type of

aircraft. The distance between aircraft and landing point size are increased in desert operations (100 meters between aircraft, 100-meter-diameter landing points). In daylight hours, the touchdown points are marked (sandbags painted a bright color or other expedient method). The use of signalmen, if available, is encouraged.

(2) When establishing a landing site, the pathfinder leader considers taxi procedures. When it is necessary to taxi, the pilot gets the aircraft into a vertical position as quickly as possible to minimize sand (dust) intake by the engines and to avoid a brownout. He should avoid taxiing over the same area repeatedly.

e. **Lift-offs.** Pilots will not attempt a normal lift-off in a sandstorm. A running-type takeoff is preferred for airplanes and wheel-equipped helicopters. A maximum performance lift-off is preferred for skid-equipped helicopters.

f. **Landings.** Running-type landings should be used when possible to minimize sand intake. If a running landing can be made, the touchdown roll is kept to a minimum to prevent overloading the landing gear. If the terrain does not permit a running landing, the pilot makes a landing using an approach angle that is greater than the angle used for normal approaches. *A landing should not be made from a hover.*

g. **Safety Considerations.** Ground crew personnel should wear clothing that affords adequate protection from the blowing sand created by rotor wash. Special care should be taken to keep sand out of the eyes, ears, nose, and mouth. The use of goggles, ear plugs, and cloth masks provide adequate protection for facial areas. Other ground crew procedures are similar to cold weather operations.

4-21. MOUNTAINS

Mountains are characterized by rugged, divided terrain with steep slopes and few natural or man-made lines of communication. Weather in the mountains is seasonal and fluctuates from extreme cold with ice and snow to extreme heat. Although these weather extremes are important planning considerations, the variability of weather over short periods of time also influences operations.

a. **Communications.** Communications are often limited or restricted by mountain terrain. To maintain them within the area of operations, aircraft may have to restrict operations to the vicinity of the unit or be assisted by additional aircraft employed as radio relay stations. Pathfinder units may have to establish radio relays at the RP and or CCP.

(1) Mountain operations are the most demanding on aviation and require the pilot to use large-scale terrain maps for precise flying.

(2) Since GTA communication is degraded by intervening terrain, navigation assistance and control over extended ranges may be difficult.

b. Wind. The principal weather hazard experienced in the mountains is wind. Even moderate wind (11 to 20 knots) can produce significant turbulence over mountain ridges. Predicting wind conditions is difficult. On the windward side of mountains, the direction of air flow is normally steady even though its strength may vary. On the leeward side of crests, wind is turbulent with strong vertical currents. Turbulence may preclude assault landings and require aircraft to be flown at higher altitudes, increasing the risk of detection and destruction.

c. Density Altitude. In the mountains, density altitude can vary significantly between pickup points and landing zones and also at different times during a 24-hour period. For example, density altitude will normally peak in the late afternoon and reach its low point at dawn.

d. Mobility. The helicopter is the principal vehicle for rapidly moving forces in the mountains. During the offense, air assault operations may be conducted to infiltrate forces into the enemy's rear area and to bypass or envelop his defenses. In the defense, reinforcements and reserves can be moved rapidly by helicopter.

e. Landing Sites. Airfields for fixed-wing aircraft and multiple helicopter LZs in mountainous regions are limited. When only single aircraft LZs are available, in-flight spacing between helicopters is increased; this places an additional load on each crew. When conducting multiship operations into a small LZ, the pathfinder controller should allow sufficient time between lift-off and landing for the turbulent air generated by the aircraft during departure to stabilize. The pilot will experience a loss of lift and turbulent conditions if spacing between lift-offs and landings is inadequate.

(1) Mountain LZs are generally sloped, rough, and small. Because of this, pilots must use extreme care during touchdown. Depending on the angle of slope and available torque, a normal slope landing maybe made. Due to the size of cargo helicopters, some difficulty may be experienced in positioning the entire fuselage in the available area. The pilot loses visual reference to the ground when the cockpit extends over the landing area. Direction must be given by the crew chief and the signalman regarding the direction in which the helicopter should be maneuvered. LZs should be established on the windward side since the wind is more stable. However, location of the enemy is more important than placing the LZs on a leeward or windward side.

(2) During a mountain approach with uneven terrain surrounding the LZ, the pilot receives a poor visual clue as to the actual aircraft altitude and rate of closure. Where the terrain slopes up to the LZ, a visual

illusion occurs, giving the pilot an impression that the aircraft is too high and the rate of closure is too slow. If the terrain slopes down to the LZ, the feeling is that the aircraft is too low and that the rate of closure is too fast. The employment of a signalman on the ground will provide a visual reference for pilot control adjustments. It may be necessary to provide more than one signalman.

f. **Assessing Sites.** The following information should be determined during the reconnaissance and selection of a mountain site.

(1) Determine the size, slope, amount of surface debris, and the area covered by shadows and obstacles in and around the site.

(2) Determine the approximate direction, speed, and characteristics of the wind.

(3) Assess the inbound route if necessary. The aircraft may terminate at a hover to off-load troops and supplies if the slope is too great to permit a landing.

(4) Assess the departure route. Lift-off routes should be into the wind and over the lowest obstacles.

Section VII. APPROACH PATH CONSIDERATIONS

It is desirable to land the aircraft into the wind; however, the terrain and its effect on the wind may require that the pilot execute a crosswind landing. When making a crosswind landing, the approach path should be planned so that the wind is from the left side of the aircraft for single-rotor helicopters. This condition assists the pilot in overcoming the effects of torque, reduces power requirements, and aids in heading control. Other considerations include vertical air currents, escape routes, terrain contour and obstacles, and the position of the sun.

4-22. VERTICAL AIR CURRENTS

It is desirable to have updrafts on the approach path. The severity of the vertical currents encountered (updrafts or downdrafts) may be more critical than landing into the wind and may require a downwind approach.

4-23. ESCAPE ROUTES

There should be one or more escape routes along the approach path that can be used if a go-around is required.

4-24. TERRAIN CONTOUR AND OBSTACLES

The terrain and obstacles along the approach path should be low enough to permit the pilot to conduct a shallow approach angle into the landing site. When possible, select a landing point on or near the highest terrain feature.

4-25. POSITION OF THE SUN

Although the wind direction and nature of the terrain are the primary factors in selecting an approach path, consideration should be given to the location of the sun relative to the approach path and the presence of shadows on the landing site. If the landing point is in a shadow, the approach path should also be in a shadow. This would eliminate problems encountered by the pilot when adjusting from one light condition to another. An approach directly into the sun must be avoided when the sun is low on the horizon.

CHAPTER 5

EXTERNAL LOADS

The external air transport method of carrying cargo and equipment by helicopter overcomes many of the obstacles that hinder other modes of transportation. Helicopters move cargo as external slingloads when—

- *The cargo compartment is too small for the load.*
- *The helicopter's center-of-gravity limitation is exceeded by the characteristics of an internal load.*
- *Maximum speed is required to load and unload.*
- *Conditions on the LZ prevent touchdown of the aircraft.*

Pathfinder qualified personnel are prepared to organize and control external load pickup or drop-off sites as an integral part of LZ operations. A detailed load plan to include approximate weights and sequences of load movement, is provided by the supported unit to ensure the correct and expeditious movement and placement of cargo.

5-1 LANDING POINTS

All slingloading operations use size 4 or 5 landing points (80- to 100-meter diameter) regardless of type or size of helicopter. Conditions of the area, such as a dusty surface or obstacles, often require increasing the minimum spacing between loads, reducing the number of helicopters that can safely operate at the site at the same time, and decreasing the overall speed of the operation.

5-2. TYPES OF LOADS

All external loads are divided into three categories: high density, low density, and aerodynamic. Each load exhibits different characteristics in flight. The high density load offers the best stability; the low density load the least. The aerodynamic load is unstable until load-streamlining occurs; then it becomes stable. Pathfinders determine the category, size, and weight of the load during the planning phase of the operation.

5-3. UNIT RESPONSIBILITIES

There are three elements involved in most slingload operations: The supported unit (the unit whose equipment will be moved), the supporting unit (the aviation unit that will fly the loads), and the pathfinder element.

Rigging the loads is the responsibility of the supported unit. However, pathfinders should check weight, rigging, and positioning of all external loads to ensure helicopter safety. Ideally, the supported unit provides hookup men for individual loads. Their specific responsibilities are:

a. Supported Unit.

- (1) Coordinating in advance with the supporting unit.
- (2) Actual rigging of the loads.
- (3) Furnishing slings, straps, clevises, and any other slingload equipment required for the move.
- (4) Ensuring that the loads are properly rigged and do not exceed the allowable cargo load of the aircraft.

b. Supporting Unit.

- (1) Providing advice and technical assistance to the supported unit as required.
- (2) Ensuring that the loads do not exceed the ACL of the transporting aircraft.

c. Pathfinder Element.

- (1) Providing advice and assistance to the supporting unit and the supported unit.
- (2) Providing expertise in the planning and execution of both PZ and HLZ operations.
- (3) Supervising the rigging and inspection of all the loads.
- (4) Providing ground guidance and air traffic control during the slingload.
- (5) Ensuring that the loads do not exceed the ACL of the aircraft.

5-4. EQUIPMENT

Cargo nets and slings are an essential part of the external load operation and must be given the same attention during inspection that the cargo receives. Any evidence of frayed or cut webbing justifies replacing the component. Because of the critical strength requirements, field sewing of nylon and substitution of nonstandard parts should not be done when assembling slings. The sling assembly must meet load requirements (paragraph 5-6 and FM 55-450-3).

a. Sling Assembly. The Army's inventory has a variety of equipment that is either adapted for use or designated for use in slingload operations.

(1) *Aerial delivery slings*. These slings were originally designed for airborne delivery of heavy loads, but they have been adopted for use in air assault operations. There are a variety of ADS sizes and strengths:

(a) Type X nylon slings are issued in 3-, 8-, 9-, 11-, 12-, 16-, and 20-foot lengths for slingload operations.

(b) Rated tensile strengths for Type X nylon ADS used as a pendant are

- Two-loop slings: 5,500 pounds with 4 thicknesses.
- Three-loop slings: 8,300 pounds with 6 thicknesses.
- Four-loop slings: 11,100 pounds with 8 thicknesses.

(c) Rated tensile strength for Type X nylon ADS used as part of a sling set are:

- Two-loop slings: 3,500 pounds with 4 thicknesses.
- Three-loop slings: 5,250 pounds with 6 thicknesses.
- Four-loop slings: 7,000 pounds with 8 thicknesses.

(d) Two loop Type XXVI nylon is identified by a colored thread stitched lengthwise down the middle of the strap. Slings are issued in 3-,9-, 11-, 16-,20-, and 120-foot lengths for slingload operations.

(e) Rated tensile strengths for Type XXVI nylon ADS used as a pendant are:

- Two-loop slings: 8,900 pounds with 4 thicknesses.
- Three-loop slings: 13,500 pounds with 6 thicknesses.
- Four-loop slings: 17,000 pounds with 8 thicknesses.
- Six-loop slings: 27,000 pounds with 12 thicknesses.

(f) Rated tensile strength for Type XXVI nylon ADS when used as part of a sling set are:

- Two-loop slings: 5,600 pounds with 4 thicknesses.
- Three-loop slings: 8,500 pounds with 6 thicknesses.
- Four-loop slings: 11,200 pounds with 8 thicknesses.
- Six-loop slings: 17,000 pounds with 12 thicknesses.

(g) Three-loop Type XXVI nylon slings are issued in 60-foot and 140-foot lengths.

(h) Four-loop Type XXVI nylon slings are issued in 3-,9-,11 -,12-, 16-,20-, and 28-foot lengths.

(i) Six-loop/Multiloop Type XXVI nylon slings are issued in the following lengths: 60-foot and 120-foot lengths.

(j) Three-foot ring tensile strength is 10,000 pounds for either the three-loop Type X nylon or two-loop Type XXVI nylon. Dual rings have a tensile strength of 17,500 pounds.

(2) *Hitches*. When connecting ADS to metal air items or directly to the load, use one of the following hitches (Figure 5-1, page 5-4):

(a) Choker hitch. Pull the free running end of the sling around the point of attachment and draw it between the loops of the sling's standing end. After ensuring that the cotton buffer is properly in place, milk the keeper of the standing end down to secure the sling.

over the suspension point. Ensure that the cotton buffer is emplaced properly, then milk the keeper down towards the suspension point to secure the sling.

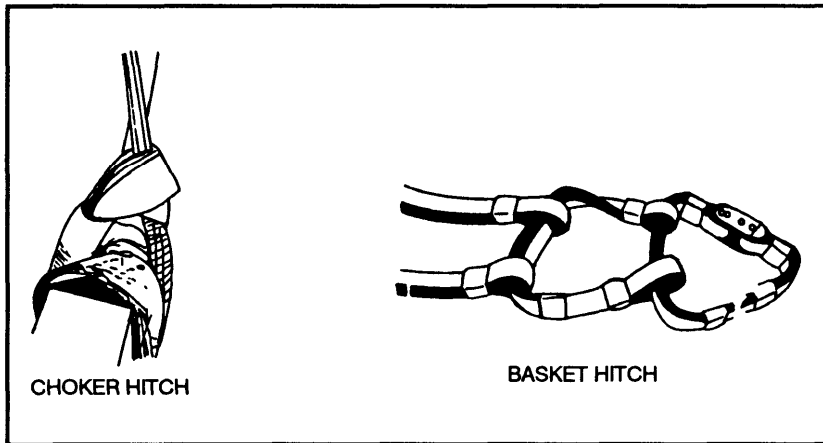

Figure 5-1. Hitches

b. **Nets and Containers.** There are two sizes of cargo nets (5,000-pound capacity and 10,000-pound capacity) and a variety of cargo containers in the Army system. The 5,000-pound capacity net (NSN 1670-01-058-3811, LIN N02776), the 10,000-pound capacity net (NSN 1670-01-058-3810, LIN N02781), and the A-22 cargo bag are the most common external load facilitators in the Army.

(1) The 10,000-pound capacity cargo net, which is 18 feet by 18 feet, is used for external transport of boxed or bulky loads. The net has a maximum capacity of 10,000 pounds and will not be flown with a load that is less than the prescribed weight determined by the aviation unit. Do not drag the net across the ground. Use a canvas insert when carrying items small enough to slip through the netting.

(2) The A-22 cargo bag is used to externally transport standard palletized loads, loose cargo, ammunition, oil drums, and other general items. Its maximum capacity is 2,200 pounds. The minimum capacity for external operations is determined by the aviation unit. The A-22 may be used with or without the canvas cover.

NOTE: For inspection of cargo net and A-22 cargo bag, refer to Chapter 7, FM 55-450-3. Rigging instructions are also in FM 55-450-3.

5-5. SERVICE LIFE OF AERIAL DELIVERY SLINGS

The date that the sling was put into service will be stamped on the sling in one-inch letters near the first keeper at both ends using an orange-yellow or strata blue parachute tube-type marker only. This date will be used to determine the date of the next inspection.

Slings will be inspected every six months by the user, and the date of the inspection will be stenciled on the sling using different color ink or tube marker. First, line out the old date. If the old date is in strata blue, cover the date with strata blue and remark it in orange-yellow. Only one date should appear on the sling. Slings will also be inspected both before and after each use. If the condition of the sling is questionable the sling will be removed from service (Figure 5-2).

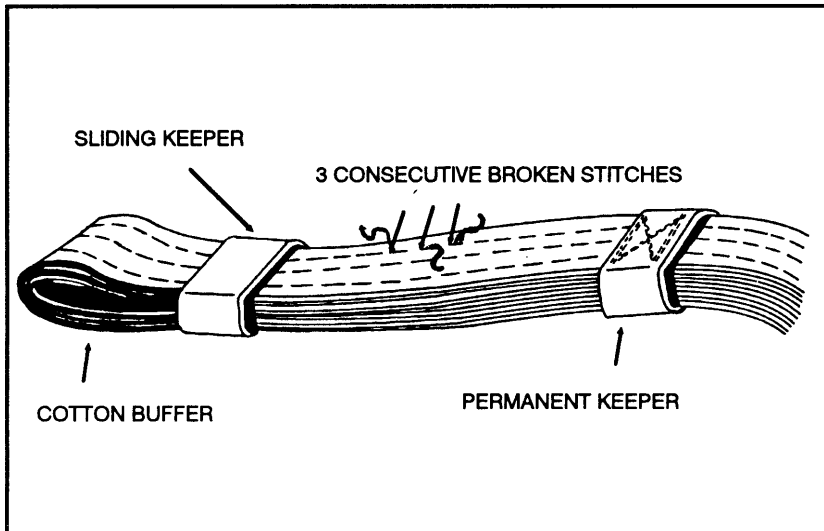

Figure 5-2. Unserviceable slings.

a. General Inspection. When inspecting nylon air items, look for any indications of the following:

- (1) Overdue inspection date.
- (2) Evidence of foreign matter: mildew, paint, grease, oil, or any other deteriorating chemical.
- (3) cuts.
- (4) Frays.
- (5) Burns.
- (6) Broken stitches (more than two consecutive broken or loose stitches, or five or more broken stitches overall in the sewn portion will render the item unserviceable).
- (7) Cotton buffers, sliding keepers, or permanent keepers missing.
- (8) Rust.

NOTE: When using any nylon air item, ensure that once the load is rigged, cotton buffers are in place and there is no nylon-to-nylon or nylon-to-metal contact.

b. **Cargo Strap.** The A7A is a cotton or nylon cargo strap that is 188 inches long, and each has a rated capacity of 500 pounds. Located on one end of the strap is a friction adapter with a thick-lipped metal floating bar. The strap is issued with one metal D-ring. Inspect this piece of equipment for cuts or frays.

c. **Cargo Tie-Down Equipment.** Check the tie-downs for serviceability.

(1) The CGU-IB cargo tie-down device has a rated capacity of 5,000 pounds. Its length is adjustable.

(2) The 15-foot cargo tie-down strap with a quick-fit strap fastener has a rated capacity of 5,000 pounds.

(3) The 5,000-pound and 10,000-pound load binders have their rated capacity stamped on their sides.

d. **Metal Air Items.** The following metal air items are commonly used in slingload operations. Inspect them thoroughly for rust, stripped threads on the nuts or bolts, burrs, cracks, bent or twisted metal, or oil on them.

(1) The Type IV link assembly is used to construct the 3-foot donut or to connect one ADS to another. It has a rated capacity of 12,500 pounds, and its NSN is 1670-00-783-5988. When inspecting the Type IV link assembly, look for the following deficiencies:

- Aluminum buffers not rotating freely.
- Posts that are bent or cracked.
- Bent slide connectors.
- No metallic “click” when locked.

(2) The following clevis assemblies are used as points of attachment from the aircraft to the load in slingload operations.

(a) Large suspension clevis (NSN 1670-00-090-5354). It has a rated capacity of 12,500 pounds (pendant); 7,875 pounds sling to lifting provision point of attachment. It is used with CH-54 aircraft.

(b) Medium suspension clevis (NSN 1670-00-678-8562). It has a rated capacity of 6,250 pounds (pendant); 3,750 pounds sling to lifting provision.

(c) Small suspension clevis (NSN 1670-00-360-0304). It has a rated capacity of 6,250 pounds (pendant); 3,750 pounds sling to lifting provision.

NOTE: When using any clevis assembly, tighten the nut HAND TIGHT only! Then tape both ends of the nut/bolt assembly to prevent slippage during use. Use only case hardened nuts and bolts and never mix items. Case hardened marks (ticks/numbers/letters) will be located on the bolt heads.

e. 15,000-Pound Capacity, Multi-Leg Sling Set. The nylon and chain multi-leg sling set has an overall length of 23 feet and a rated capacity of 15,000 pounds. It weighs 94 pounds complete. It includes a 12-inch nylon web ring, consisting of seven thicknesses of nylon webbing secured with a connector link, four 15-foot nylon slings, a 10-inch grab link assembly with coupling link (each leg), and a 6-foot chain (each leg) with 64 links (Figure 5-3). Each component of the multi-leg chain set has a rated capacity of 5,560 pounds when used as a pendant. When inspecting the multi-leg chain set, inspect all metal and nylon items as per paragraph 5-6d; inspect the connector link; inspect the gate of the grab link assembly and ensure it is under spring tension. Inspect the chain for 64 links. (Reference FM 55-450-3.)

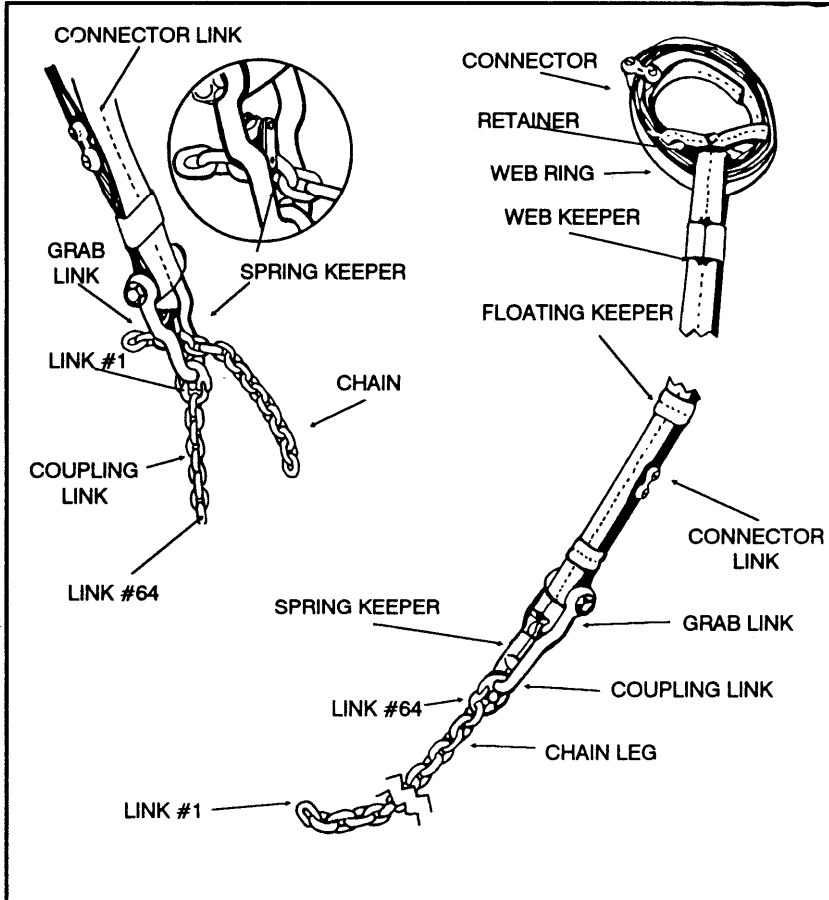

Figure 5-3. Parts of the multi-leg sling set.

f. **Large Capacity Sling Sets.** The new 10,000-pound (Figure 5-4) and 25,000-pound capacity sling sets appear similar. However, all components of the sets are marked so take care not to mix components of the two sets. See Table 5-1 for identifying characteristics.

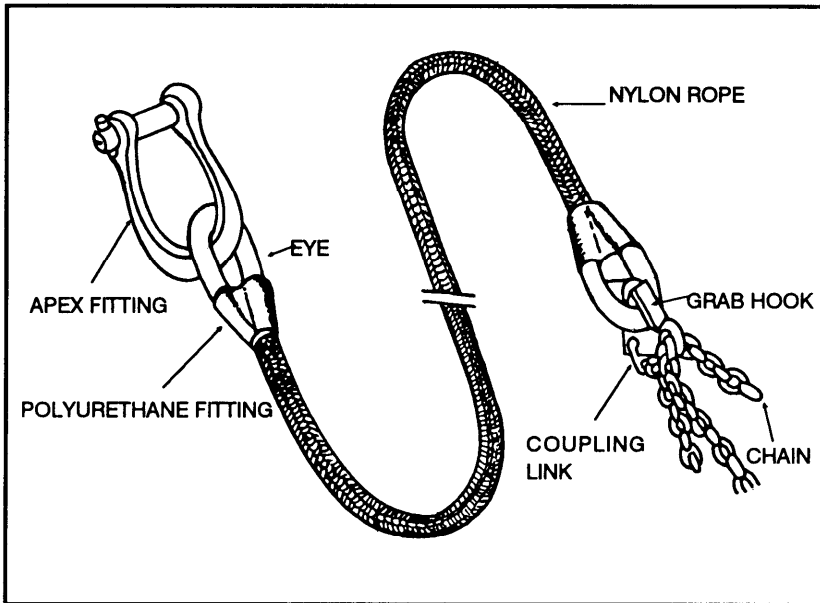

Figure 5-4. 10,000-pound capacity sling set.

Item	Capacity	
	10,000-pound	25,000-pound
Apex fitting (color)	brushed aluminum	gold steel
Apex fitting (pin)	1 1/8 inch diameter	1 1/2 inch diameter
Apex fitting (weight)	4 1/2 pounds	10 pounds
Sling rope (color)	olive drab	black
Sling rope (length)	12 feet	12 feet
Sling rope (diameter)	7/8 inch	1 1/4 inch
No. of chain links	110 to 115 links	86 to 88 links
NSN	1670-01-027-2902	1670-01-027-2900
Total weight	52 pounds	114 pounds

Table 5-1. Large capacity sling sets.

NOTE: Each set has four legs. Each of the legs has a rated capacity of 1/4th the total capacity of the set. It is common to use up to six legs on some loads. The extra two legs DO NOT increase the rated capacity of the entire set. When taping the apex fitting pin, it is only necessary to tape the side with the retaining bolt and nut. Unlike the clevis, the bolt and nut are tightened with a wrench.

(1) The nylon rope assembly for each set has an interwoven eye located at each end. This eye is covered with polyurethane potting to protect the leg from abrasion and ultraviolet radiation (Figure 5-4). Each rope is double braided and is connected to a grab hook assembly (Figures 5-5 through 5-7). The grab hooks for the two sets look alike, but they are not interchangeable because they have different ratings.

(2) Refer to Chapter 6, FM 55-450-3 to learn how to inspect the new rope sling sets and to Appendix D, FM 55-450-3 for sling conversion tables.

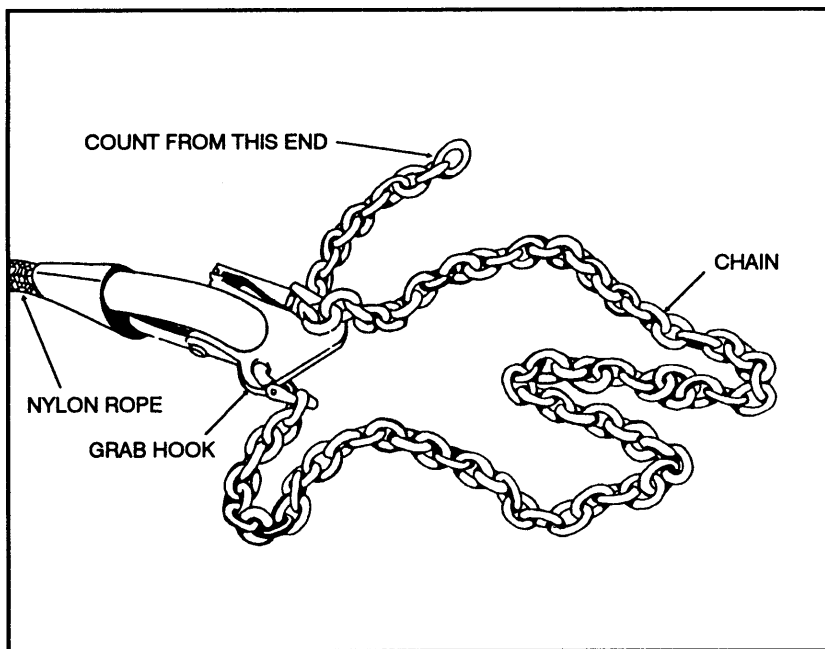

Figure 5-5. Coupling link.

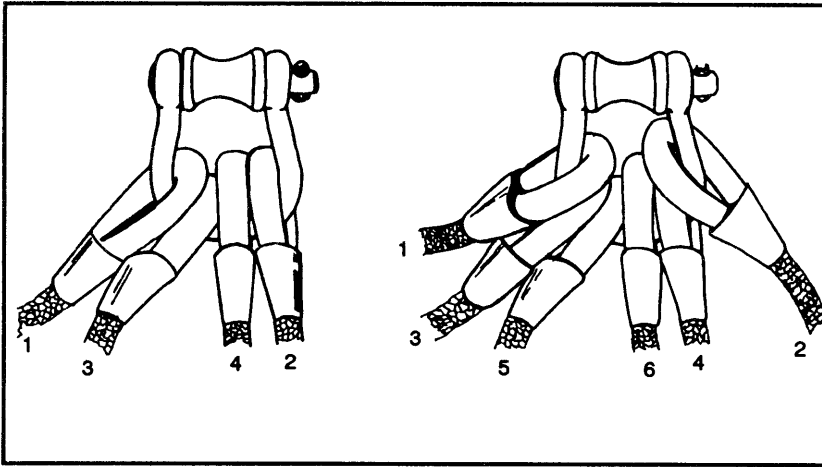

Figure 5-6. Sling leg numbering sequence.

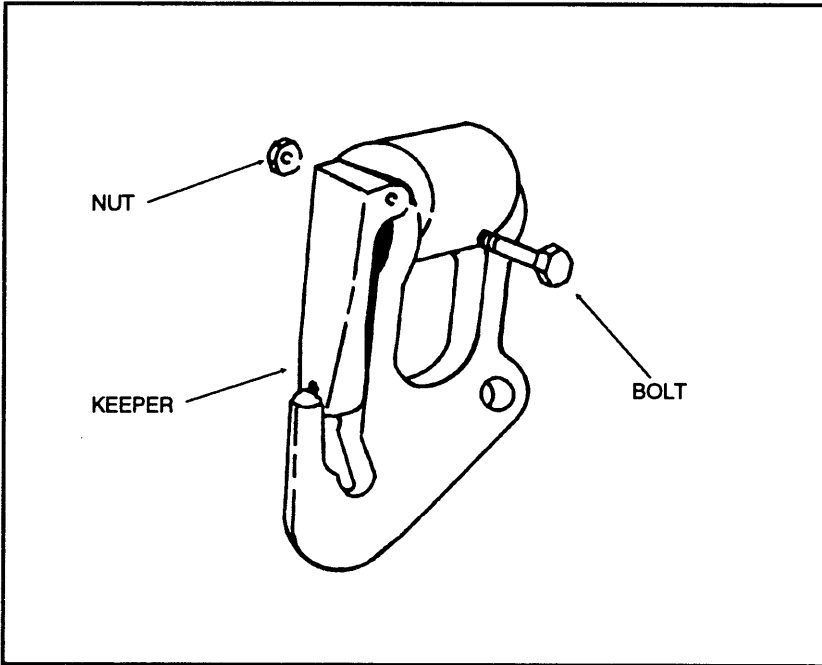

Figure 5-7. Grabhook.

5-6. AIRCRAFT LOAD LIMITATIONS

The maximum weight that any aircraft can carry via an external slingload is determined by the structural strength of the cargo hook assembly. In most cases, it is not the tensile strength of the hook that will limit the weight that an aircraft can lift—it is the allowable cargo load that is the limiting factor. The ACL will most always be less than the capacity of the cargo hook assembly (Figures 5-1 through 5-5).

a. Cargo hook tensile strengths for US Army aircraft (Figures 5-8 through 5-11) are:

UH-1H	4,000 pounds
UH-60	8,000 pounds
CH-47C	20,000 pounds
CH-47D	26,000 pounds
CH-54A	20,000 pounds
CH-54B	25,000 pounds

b. The ACL is based on the type of aircraft, age of the airframe, altitude above sea level, temperature, humidity, and the aviation unit's SOP.

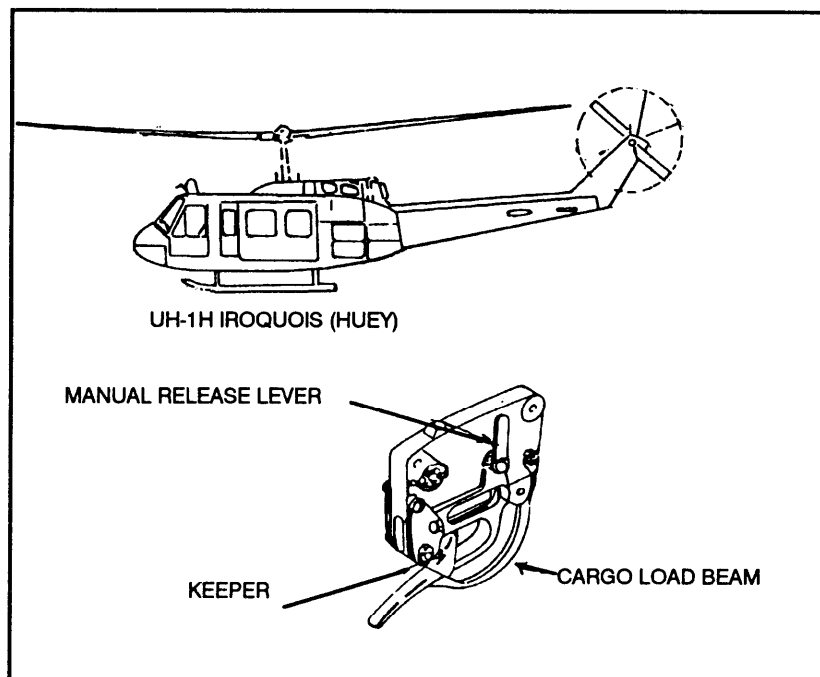

Figure 5-8. UH-1H Iroquois and its cargo hook.

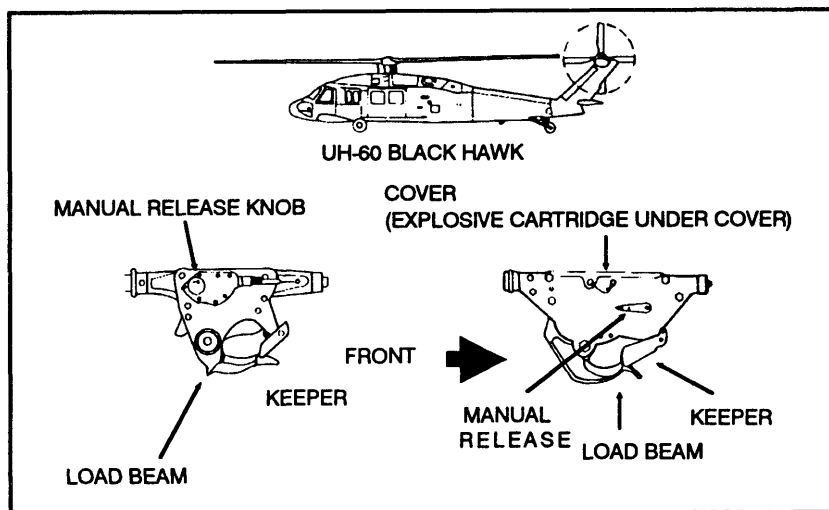

Figure 5-9. UH-60 Black Hawk and its cargo hooks.

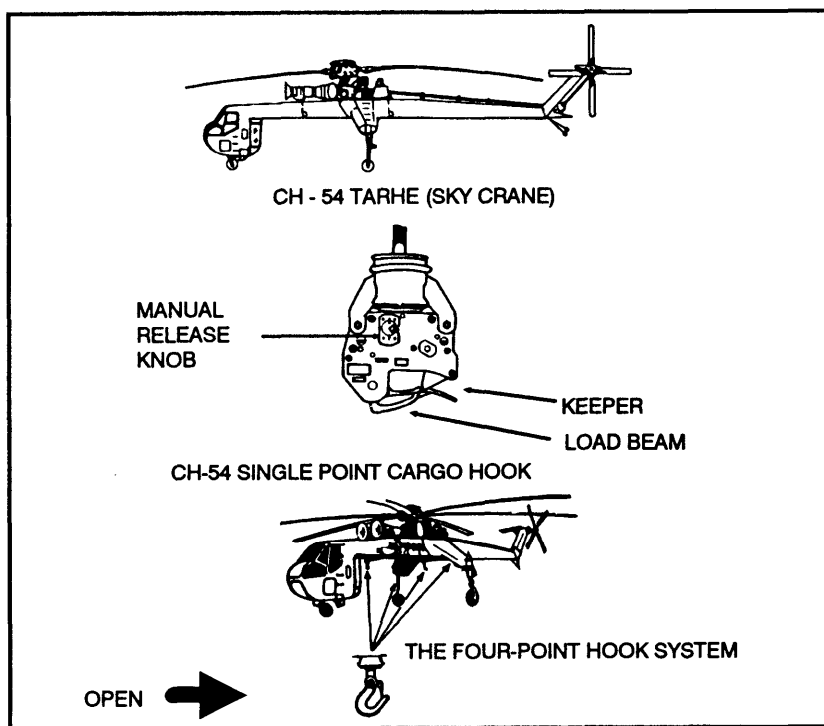

Figure 5-10. CH-54 Skycrane and its cargo hooks.

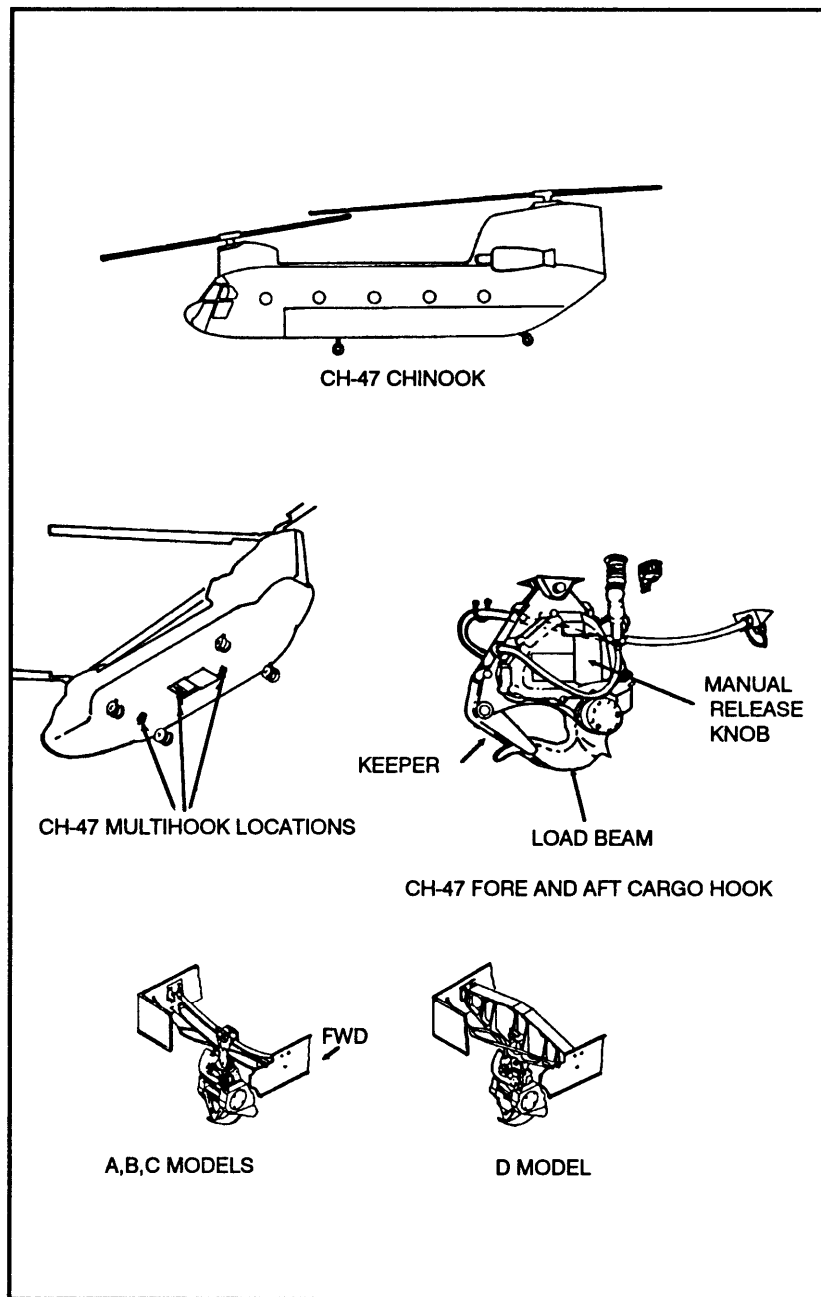

Figure 5-11. CH-47 Chinook and its cargo hooks.

5-7. STANDARD WEIGHTS

When using a UH60 Black Hawk for air lift, coordinate closely with the aviation unit for the ACL.

a. Vehicles.

- (1) M998/M1038 truck, cargo, 1 1/4-ton (HMMWV)
5,200 pounds empty
7,700 pounds loaded
- (2) M966 TOW missile carrier (HMMWV)
6,050 pounds empty
8,200 pounds loaded
- (3) M416 1/4-ton trailer
580 pounds
- (4) M101A2 3/4-ton trailer
1,350 pounds
- (5) M105A21 1 1/2-ton trailer
2,750 pounds
- (6) M35A22 1/2-ton truck
12,000 pounds
(add 500 pounds if equipped with a winch)
- (7) M149 1 1/4-ton water trailer
Empty: 2,540 pounds
Full: 6,060 pounds
- (8) M149A1 1 1/4-ton water trailer
Empty 2,540 pounds
Full: 6,060 pounds
- (9) M149A2 1 1/4-ton water trailer
Empty: 2,800 pounds
Full: 6,320 pounds

b. Artillery Equipment.

- (1) M101 105-mm Howitzer
4,600 pounds
(add 300 pounds if equipped with shields)
- (2) M102 105-mm Howitzer
3,160 pounds
(add 170 pounds for section equipment)
- (3) 105-mm ammunition, per round in box
60 pounds
- (4) 105-mm ammunition, per round in carton
47 pounds

c. POL (External Loads Only).

Fuel	55-Gallon Drum	500-Gallon Blivet
(1) Gasoline (MOGAS)	404 pounds	3,400 pounds
(2) Gasoline (JP4/JP8)	410 pounds	3,500 pounds
(3) Diesel fuel	457 pounds	3,800 pounds
(4) Lube oil (30 weight)	479 pounds	4,000 pounds

5-8. AIR ITEMS REQUIRED FOR COMMON STANDARD LOADS

Several types of expendable rigging supplies are necessary to complete the rigging of the following loads. These supplies include 1/4-inch cotton webbing, 1/2-inch diameter rope, Type III nylon cord (550 pound test), pressure sensitive tape, cellulose wadding or paperboard honeycomb, and canvas/felt padding. Sufficient supplies of these items should be on hand prior to rigging the loads.

a. For detailed preparation and rigging of the following loads, refer to FM 55-450-3.

b. Loads rigged with ADS and having more than one suspension point require that the ADS be twisted once for each 3 feet of sling length. This is to minimize vibration in the sling during flight. The nylon and chain multi-leg sling sets and the 10,000 and 25,000 pound capacity sling sets do not require the twists.

(1) 10,000-pound capacity nylon cargo net (18 feet by 18 feet):

- One A7A cargo strap.

(2) Perforated steel planking (PSP):

- Two 16-foot, 2- or 3-loop ADS.
- One 3-foot ADS with one Type IV link assembly (for doughnut).

(3) Drum, fabric, fuel 500-gallon capacity (blivet):

- One or two drums Sling set, 10,000-pound capacity.
- Refer to FM 55-450-4 for rigging instructions.

(4) Concertina wire: the items required to move this load will depend on the size of the load. Refer to FM 55-450-3.

(5) A-22 cargo bag:

- One A-22 kit.
- One A7A cargo strap.
- One 8-foot, 2- or 3-loop ADS.
- One 3-foot, 2- or 3-loop ADS with one TYPE IV link assembly (for doughnut).

5-9. SLING LOAD THEORY

The behavior of an external load while in flight can greatly affect the performance of the aircraft carrying it; therefore, it is important to minimize the load's drag on the aircraft. High drag coefficients will reduce the airspeed of the aircraft, will take longer to complete the task or cause it to be incomplete because allotted time has expired, and could possibly endanger the aircraft and its crew. (A helicopter pilot will not hesitate to "punch a load" if he feels that his aircraft is endangered.) To minimize drag, it is necessary to stabilize the load. The following methods can be used to accomplish this:

a. **Reduce the Airspeed of the Aircraft.** Having the aircraft fly slowly enough that the load does not become unstable is the least desirable method to use. This burns extra fuel and takes more time to do less work. Loads should be configured so that they will fly at speeds of 60 knots or more.

b. **Add Weight to the Load.** Heavier loads are less affected by the air pushing-against them while they fly, hence they tend to be more stable. However, make sure you do not exceed the rated capacity of your equipment or the ACL of the aircraft.

c. **Streamline the Load.** Long symmetric loads will fly crosswise to the direction of flight causing immense drag on the aircraft. Loads tend to stabilize if the center of gravity is located in the first one-third of the load. By adjusting the load and, if needed, adding weight, it is possible to move the CG toward one or the other end. The lighter tail end of the load will act much as the fins on a dart. The heavier end of the load will "seek" the direction of flight and the load will stabilize.

NOTE: The longer the slings that attach the load to the aircraft, the less stable the load will be in flight. Additionally, the closer the angle of the slings to *horizontal* the greater the stress put upon them. For example, a total vertical stress of only 3,000 pounds will put a stress of 4,242 pounds on a sling at an angle of 45 degrees. Be aware that as the angle decreases to 5 degrees, the stress on the sling reaches 34,419 pounds.

The chart in Figure 5-12, illustrates the variations of tension on one sling leg when applied to a constant 1000-pound load at various angles.

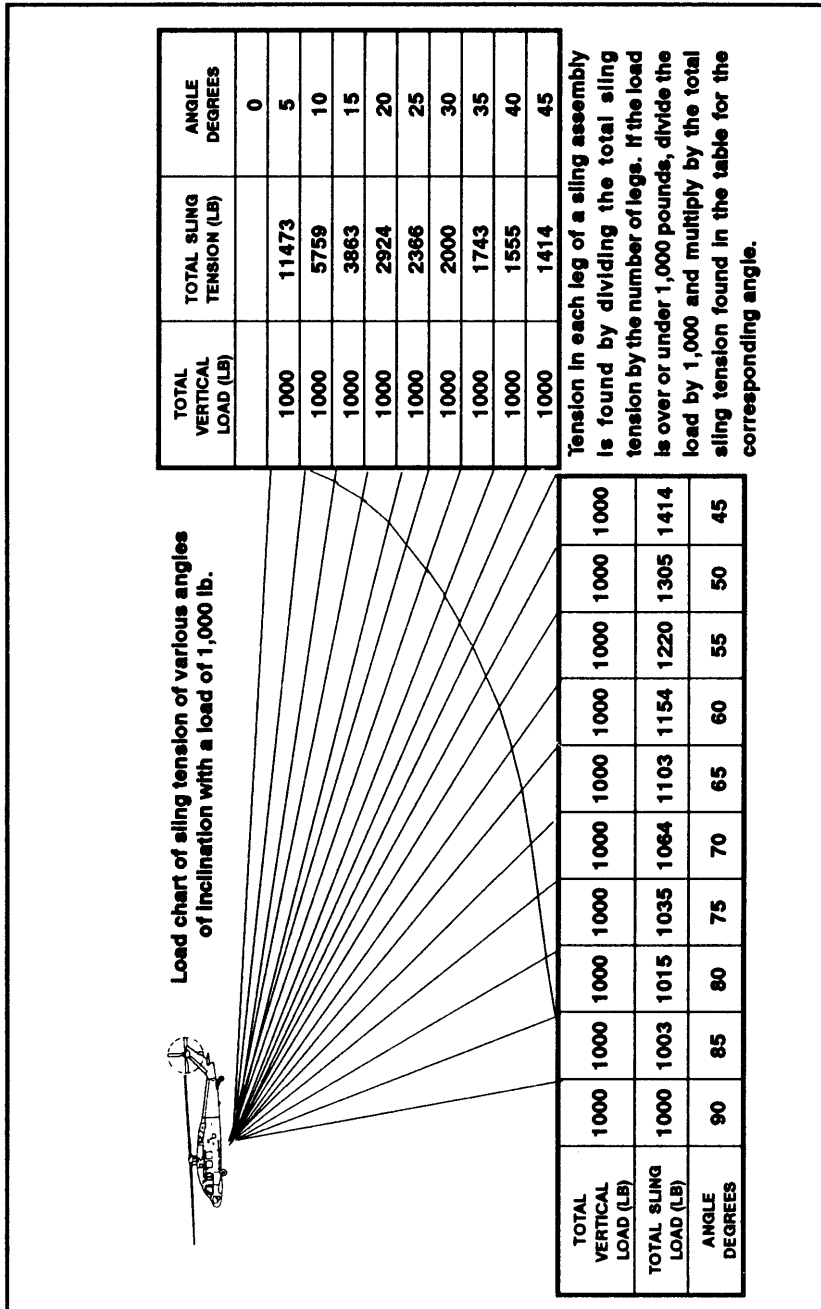

Figure 5-12. Tension variations on sling legs.

PROBLEM: A four-leg sling assembly with each leg lifting at an angle of 45 degrees will be used to lift 10,000 pounds of weight. What will be the tension on one leg?

PROCEDURE: From the chart the total sling tension on one leg at 45 degrees for 1,000 pounds is 1,414 pounds.

Total tension for 10,000 pounds = 14,140 *pounds*.

Tension on each leg = $\frac{14,140}{4} = 3,535$ *pounds*.

If all legs lifted vertically, the tension on each leg = $\frac{10,000}{(4)} = 2500$ *pounds*

5-10. HOOKUP AND RELEASE PROCEDURES

Hooking up a load requires a team effort. The signalman must position the aircraft over the load so that the slingload team can discharge the static electricity and attach the load to the aircraft as quickly and safely as possible. Release of the load is done by the air crew in most cases and does not usually require any ground crew except the signalman.

a. **Ground Crew Protective Measures and Equipment.** Ground crews working around hovering helicopters are exposed to a variety of hazards. The danger to the crews cannot be overemphasized, and measures to ensure their safety should be of the utmost importance. To protect the crews, the following equipment (Figure 5-13) is recommended or required.

(1) *Helmet.* It affords protection against head injuries from flying debris, from being caught between the aircraft and the load, and so forth. Helmets will be securely fastened.

(2) *Protective mask or dust goggles with respirator.* These assist the crew by protecting the face, eyes, and respiratory system against airborne particles stirred up by the rotor wash. The mask protects better, but it can cause problems with depth perception (important for signalmen). Masks or goggles are required in high dust/debris environments.

(3) *Ear plugs or a suitable substitute.* These protect against the excessive noise associated with hovering aircraft and prevent debris from entering the ear canal.

(4) *Hand protection.* Marine Corps and Navy personnel are required to wear electrical workers gloves for static discharge burn protection. All other personnel (USA USAF, and USCG) should wear leather gloves to help protect their hands and fingers. If electrical workers gloves are available, all static wand persons should wear them for added protection from static discharge burns.

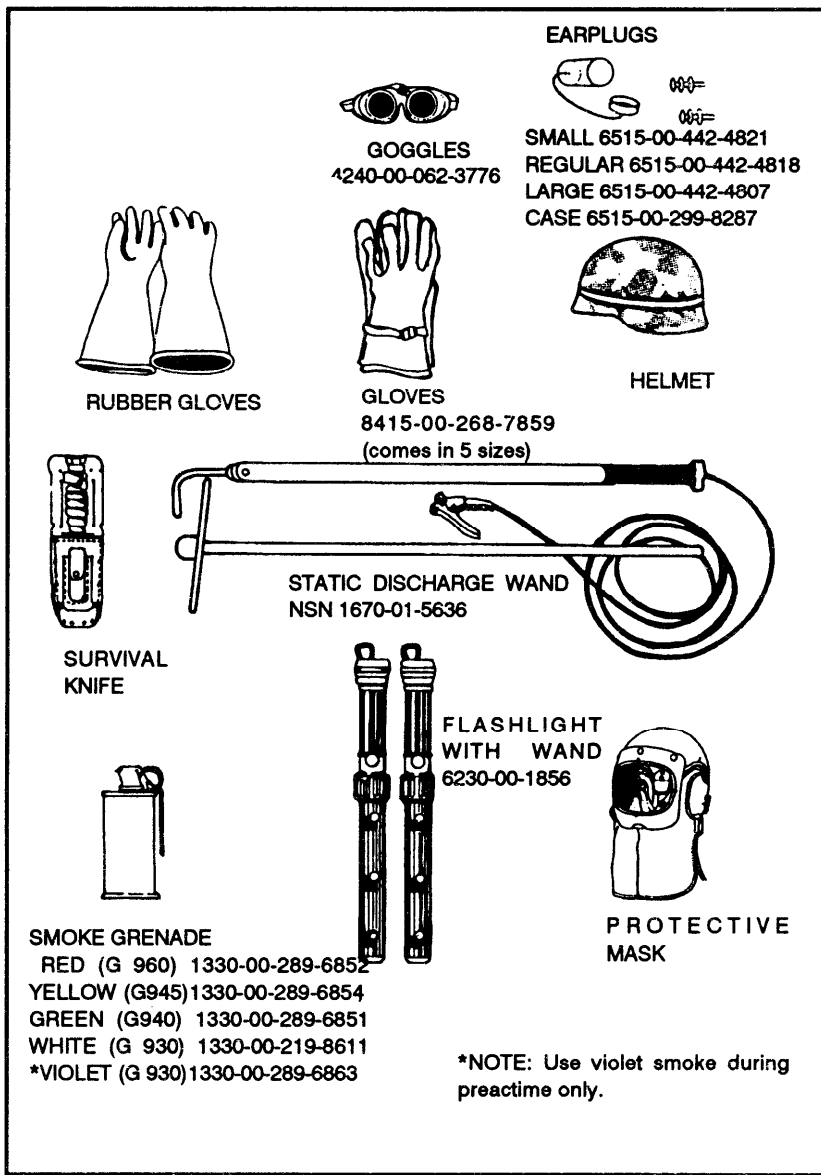

Figure 5-13. Protective equipment.

(a) To ensure adequate protection, these shockproof gloves must be inspected before and after each operation. They should be checked for excessive wear, fraying, holes, and tears. Do not use a torn glove.

(b) Even a small hole leaves a person unprotected from static electric shock. Gloves can be checked for holes by filling them with water and squeezing them while holding the open end closed, or by blowing air into them like a balloon and submerging them in water. Any holes will cause air bubbles.

(5) *Static discharge wand.* The static wand is used to protect the hookup man from static electric shock by grounding the cargo hook. In flight, the stored static electric energy of any helicopter increases with helicopter weight, low humidity, and amount of debris blown by the rotor system (dust, sand, or snow). Thunderstorms can cause extremely high static electric discharges. When the helicopter lands and touches the ground, this charge is grounded out. However, when the helicopter is in flight or hovering to make a slingload drop, the charge remains stored in the aircraft. A ground crewman provides a path for this charge to follow into the ground when he connects the apex fitting to the cargo hook. This charge may cause severe electrical burn or injury.

(a) To avoid the possibility of a static electric shock, ground crewmen use static discharge wands (field expedient and manufactured) and grounding stakes to ground the cargo hook. Since these wands connect the helicopter to the ground, the static electric charge is dissipated and the hookup man will not receive a shock when he connects the apex fitting to the cargo hook.

(b) Inspect the static discharge wand to make sure it is in serviceable condition. Select the grounding stake location; it should be on the opposite side of the ground crew's exit direction so they will not trip over the cable as they depart.

(c) Drive the stake into the ground until it is firmly seated—at least 6 to 8 inches in firm ground and 24 inches in sandy or loose soil. Drive the stake in at a 45-degree angle away from the side of the load in case someone falls on it. Connect the cable clamp to the vertical shaft of the stake.

(d) When operating on concrete or asphalt surfaces, position loads as close to the edge of the surface as possible so that the grounding stake can be driven into the ground.

(e) Do not hold the static discharge wand within 14 to 16 inches of the metal hook end—a strong static charge can jump up to 12 inches. To be effective, the static discharge wand must maintain contact with the cargo hook during the hookup operation. If contact is lost, all personnel will pull back from the hook until contact is reestablished between the wand and the aircraft's cargo hook.

(6) *Other equipment.* Smoke grenades are used to mark the location of the landing site or to indicate wind direction. Flashlights with wands are used to give arm-and-hand signals at night.

b. **Safety Measures.** In addition to using the proper equipment, the following safety measures will be enforced at the sling-load site.

(1) Wear long-sleeved shirts with the sleeves rolled down and fastened. Button the shirt collar. Tuck shirt tails or jacket bottoms into the trousers.

(2) Police the operational area thoroughly before conducting sling-load operations to reduce the amount of debris that can be thrown about by the rotor wash.

(3) Remain alert during hookup and release operations; sound judgment and common sense are the keys to success. Be ready at all times to get clear of the load; soldiers have been crushed between the aircraft and loads, have had loads dragged over them, or have taken an unwanted ride because they inadvertently became entangled with the load. Exercise particular care during hookup operations if the crew must mount the load to affect hookup. Slings under tension can easily crush an arm or leg against the load. Some of the particular hazards associated with loads are:

(a) Cargo extensions/projections. Gun tubes, landing gear, missile launchers, bridge planks, and so forth can interfere with or injure the ground crew by striking or tripping them. Crewmen should stand clear of such projections or position themselves so that they can immediately clear the load.

(b) Sharp projections, hooks, and protruding handles or levers, such as tarpaulin tie-down hooks, door handles, sparetire racks, and similar projections, should be avoided by the ground crew if possible. Serious injury can be caused by the sharp edges, and a crewman could easily become hooked to the load should his clothing or part of his equipment catch on one of these items. The crew should be alert and be prepared to move immediately to avoid injury.

(c) Top heavy or narrow-based loads that can fall over from the rotor wash should be treated with caution. If possible, position these loads on their side before hookup. If this is not feasible, position the crew on the side or end of the load that is least likely to tip. The crew should be prepared to clear the load immediately.

(d) High loads can cause serious injuries to crewmen who are required to climb to the top of the load to affect hookup. They may be swept off the load by the rotor wash, or they may find it necessary to jump to avoid a dangerous situation. Crewmen on top of a load must pay attention to where they stand. If at all possible, they should not stand on the top—rather on a lower projection or step so that should the aircraft make contact with the load they are not caught in between. The crew should work from a crouched position or from their hands and knees. If possible, have a vehicle backed up to the load that can be used as

a working platform. (Move the vehicle before lifting the load.) The crew should use solid footholds and handholds and be ready to clear the load immediately.

c. Ground Crew Emergency Conduct. When an aircraft hovering over a slingload suffers an emergency severe enough for the pilot to have to set the aircraft down, he will. This may occur very rapidly as in a controlled crash. For this reason, whenever it seems as if the aircraft is having trouble, all of the ground crew should move to the designated location coordinated with the aviation unit to try to clear the slingload point. Once far enough away, they should take up a prone position or seek cover until the aircraft is on the ground. Two situations require special note.

(1) The signalman will be facing the aircraft. He should move to a point where he will be safe.

(2) The hookup men may be under the aircraft at the time of the emergency. They should try to work along the RIGHT side of the load so that they do not have to climb over or go around the load to seek safety. They would then be able to move directly off and away from the load. If the load is a heavy piece of equipment, they may wish to keep the load between them and the aircraft while they are moving. This will offer them some protection should the aircraft crash.

d. Ground Crew Duties. The ground crew will normally have one ground crew signalman and two hookup men.

(1) *Duties of the signalman.*

(a) Before the arrival of the aircraft, the signalman directs the positioning of the load. He supervises the inspection of the load for proper routing of the slings and proper preparation. He also ensures that the load is ready to fly.

(b) As the helicopter approaches, the signalman stations himself 20 meters in front of the load to maintain eye contact with the crew and gives the arm-and-hand signal of "assume guidance." As the helicopter reaches the vicinity of the load, he uses arm-and-hand signals to position the cargo hook of the aircraft directly over the load and close enough to the load so the hookup men will be able to place the apex fitting onto the cargo hook. During this time, it is critical that the signalman positions himself so that the pilot can see his signals easily. Since the pilot of an Army aircraft is located on the aircraft's right side, the signalman will usually be located slightly to the aircraft's right. If terrain in the area forces him to place himself elsewhere, he must ensure that he is in the pilot's view at all times, regardless of where he is positioned.

(c) During the hookup process, the signalman must also observe the cargo hook and apex fitting. Once hookup has been accomplished, he must hold the aircraft at a hover until the hookup men are clear of the

load. When they are clear, the signalman signals the aircraft upward slowly so that the sling legs gradually take up the load. This is done to check that the sling legs are not fouled on the load. If they are fouled, the signalman motions the pilot downward and then instructs him to cutaway the load. If the load has been successfully suspended, the signalman will give the aircraft the signal to depart then move quickly aside to clear the helicopter's path.

DANGER
 AT NO TIME WILL THE SIGNALMAN OR ANY OTHER MEMBER
 OF THE SLINGLOAD TEAM ALLOW A SUSPENDED LOAD TO
 PASS OVER HIS HEAD.

(2) *Duties of the hookup men.*

(a) One man handles the static discharge wand and the cargo hook; the other controls the apex fitting of the slingload. Hookup must be done rapidly to reduce helicopter hover time and minimize the exposure time of the hookup men under the helicopter.

(b) The hookup men will be in position at the load when the helicopter arrives. As the helicopter hovers over the load, the hookup men position themselves so that the hookup can be quickly accomplished. They make sure the signalman can continually observe the operation.

(c) When the helicopter is in the correct position for hookup, the static wand man grounds the aircraft by contacting the static wand to the cargo hook (Figure 5-14) and maintains continuous grounding contact. The other hookup man then places the apex fitting onto the cargo hook and ensures that the hook is properly closed (and locked, if required).

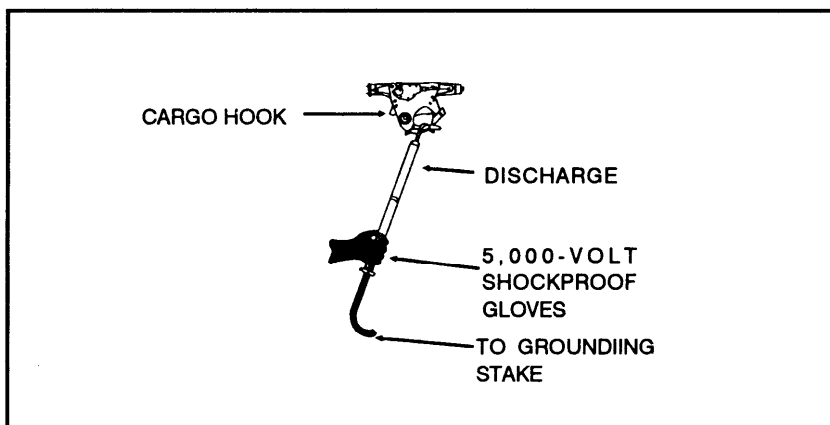

Figure 5-14. Grounding technique.

(d) After the load is properly hooked to the aircraft, the hookup team moves quickly aside to the designated location coordinated with the aviation unit. If any of the legs become fouled and it is necessary to rehook the load, the crew signalman notifies the pilot.

e. Release Procedures. For this mission, the hookup men will be called the cargo release team. As the helicopter approaches the site, it takes instructions from the signalman who guides the aircraft into position for cargo release. The cargo release team stands by unless they are needed to manually release the load. The signalman directs the aircraft to set the load on the ground, then gives the release signal. At this time, the apex fitting should fall free of the cargo hook. If it does not, the signalman has the aircraft hover, then directs the cargo release team to move under the helicopter and manually release the load from the hook. When the load is free of the hook (and the release men are no longer under the aircraft), the signalman directs the aircraft to depart and quickly moves out of the aircraft's path.

WARNING

If the cargo hook cannot be opened either by activating it from within the helicopter or by the action of the cargo release men, emergency cargo release procedures must be accomplished. Try to disassemble the doughnut and pass the ads through the hook. If a clevis or apex fitting is used as the attachment point to the cargo hook, unscrew the nut and remove the pin. In some cases, it may be necessary to quickly derig the load so the aircraft can set down and resolve the situation.

f. Hookup Procedures During White-Outs or Brown-Outs. Due to the nature of these conditions (snow or dust), a signalman is not required and a hover hookup is not safe.

(1) Rig the load with a 20-foot or a 40-foot extension as required using 20-foot, 2-or 3-loop ADS, and the appropriate number of Type IV link assemblies. Place an apex fitting at the end of the extension.

(2) Lay the extension to the *left* of the load, and the aircraft will approach normally then taxi to the location of the apex fitting and set down. Once the aircraft is on the ground, the hookup man moves to the aircraft and attaches the apex fitting to the cargo hook (Figure 5-15). The aircraft suspends the load normally and departs as directed by the GTA.

WARNING

When attaching the extension to skid-equipped helicopters (UH-1H for example), exercise care so that the sling does not pass through the skid. Route the sling forward of the skid and then attach it to the cargo hook.

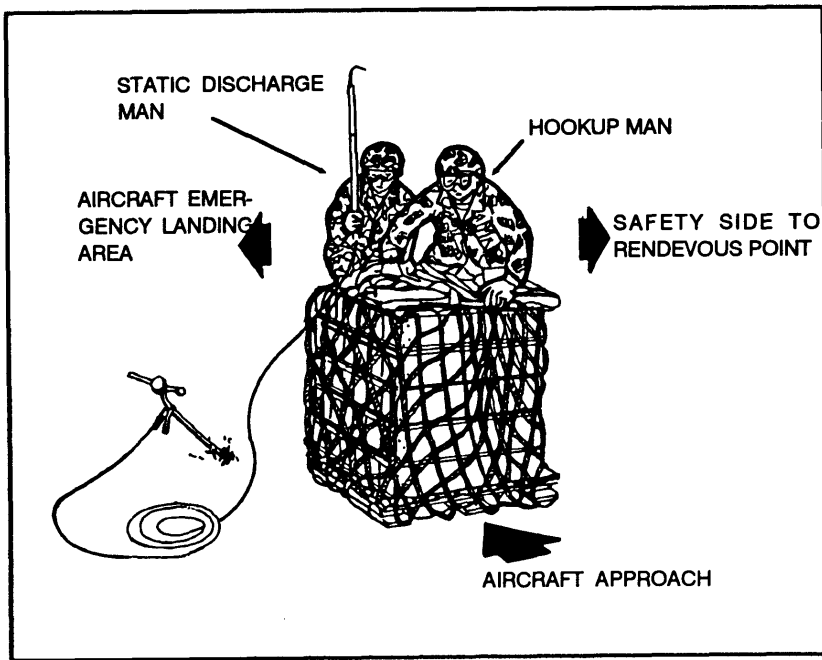

Figure 5-15. Hookup team's position.

WARNING

Coordinate the evacuation route of the ground crew to a rendezvous point with the liaison officer or helicopter crew before the start of the operation. Proper coordination will prevent any mix-up. Helicopter emergency procedures depend on terrain, wind direction, and pilot choice. Good prior coordination will prevent the helicopter and the ground crew from moving in the same direction.

THIS CHAPTER IMPLEMENTS STANAG 3570.

CHAPTER 6 DROP ZONES

A drop zone is any designated area where personnel and or equipment may be delivered by parachute or, in the case of certain items, by free drop. The DZ is located where it can best support the ground tactical plan. It is selected by the ground unit commander, usually on the technical advice of the DZST leader. For tactical training the USAF assault zones availability report should be checked for an approved DZ within the tactical area. If the selected DZ is not on the AZAR, a tactical assessment must be conducted.

Section I. SELECTION FACTORS

The drop zone selection factors discussed in this section are used to analyze the suitability of a drop zone.

6-1. AIRDROP AIRSPEEDS

The aircraft airspeed will determine the time over the drop zone. Table 6-1 provides the USAF airdrop and rotary-wing airdrop speeds in knots indicated airspeed. (Table 6-1 Airdrop speeds. Page 6-2)

	C-130	C-141/C-5
1. Personnel Static Line HALO and HAHO	130-135 130 (110 min; 150 max)	130-135 130-135 (130 min; 180 max)
2. Equip/Combination*	140	150
3. CDS/Combination* Free Fall High Velocity Wedge Ahkio Sled Combat Rubber Raiding Craft	140 (130 below 120,000 lbs GWT) (130 below 120,000 lbs GWT) (130 below 120,000 lbs GWT) (130 below 120,000 lbs GWT) (130 below 120,000 lbs GWT) (130 below 120,000 lbs GWT)	150
4. Door Bundle	130-140	130-150
5. TTB-Simulating Personel Equipment CDS	130-135 140 140 (130 below 120,000 GWT)	130-135 130-150 150
<p>Rotary wing airdrop airspeeds (KIA):</p> <p>UH-1H 50-70 knots UH-60 65-75 knots CH-47 80-110 knots CH-54 65-75 knots CH-53 80 knots (USMC) CH-46 80 knots (USMC) CH/HH-3 70-90 knots (USAF)</p> <p>*NOTE:Combination drops will use the highest airdrop KIA.</p>		

Table 6-1. Airdrop speeds.

6-2. DROP ALTITUDE

Drop altitude is measured from above ground level, which is from the highest field elevation on the drop zone to the drop aircraft. However, some drop aircraft may request the drop altitude in feet indicated, which is measured on the aircraft altimeter from sea level. To calculate feet indicated, take the field elevation and round it up to the nearest 50 feet

(537 feet becomes 550 feet), then add the drop altitude in feet AGL. For example, if the drop altitude is 800 feet AGL and the field elevation is 550 feet, then the drop altitude is 1,350 feet indicated. See Table 6-2 for the drop altitude for different type training missions. In combat (wartime) operations, the drop altitudes are determined jointly by airborne and airlift commanders.

PERSONNEL		
Tactical Training		800 feet
Basic Airborne Trainees		1,250 feet
HALO (Minimum Opening)		2,500 feet
SATB		500 feet
TTB	(Use stand drop altitude of simulated load.)	
CONTAINER DELIVERY SYSTEM		
G-12D	(1 to 6 bundles)(single parachute)	400 feet
	(7 or more bundles)(single parachute)	600 feet
	(cluster of 2 parachutes)	600 feet
G-12/13E	(single parachute)	400 feet
	(cluster of 2)	550 feet
G-13	(single parachute or cluster of 2)	400 feet
	(cluster of 3)	500 feet
G-14	(single parachute or cluster of 2)	300 feet
	(cluster of 3)	400 feet
12-foot high velocity		400 feet
26-foot high velocity		500 feet
SATB-C/TTB	(See parachute load to be simulated)	
HEAVY EQUIPMENT		
G-12D		650 feet
G-11A	(single parachute)	900 feet
	(cluster of 2 to 7)	1,100 feet
	(cluster of 8)	1,300 feet
G-11B	(single parachute)	700 feet
	(cluster of 2 to 4)	750 feet
	(cluster of 5 to 7)	1,100 feet

Table 6-2. Aerial delivery altitudes.

G-11B (cluster of 8)	1,300 feet
G-11C (cluster of 8)	1,300 feet
SATB-H/TTB (See parachute load to be simulated)	
NOTES: 1. Minimum drop altitude for heavy equipment using 5,000-pound parachute release system is 1,000 feet above ground level.	
2. Combination drops will use the highest airdrop altitude.	
ROTARY WING AERIAL DELIVERY	
Personnel Day or Night	1,500 feet
Bundles Day	300 feet
Night	500 feet

Table 6-2. Aerial delivery altitudes (continued).

6-3. DROP ZONE TIME REQUIREMENT ESTIMATION

For personnel, allow 1 second for each jumper to exit the aircraft; do not count the first jumper in the door. For example, 10 jumpers (minus 1) require 9 seconds. For equipment, allow 3 seconds per door bundle to exit; do not count the first bundle in the door. For example, 2 bundles (minus 1) requires 3 seconds.

6-4. METHODS of DELIVERY

When considering the method of delivery, take care when using high velocity airdrops or free drops around built-up areas or airfields because of the risk of damage to buildings or airstrips.

a. A low velocity airdrop is used for sensitive equipment and personnel. The parachute slows the rate of the descent for a soft landing.

b. A high velocity airdrop is the delivery of certain items of supply rigged in airdrop containers with an energy dissipater attached to the underside of the load and a ring slot parachute attached to the top of the load. The chute is designed to stabilize the load and reduce the rate of fall to ensure an acceptable landing shock.

c. A free drop is used for nonsensitive items only. No parachute is attached to stabilize or slow the rate of descent of the cargo.

NOTE: When determining the suitability of the DZ and considering the method of delivery around built-up areas or airfields, you must consider the additional risk of damage to buildings when using high-velocity or free-drop methods.

6-5. OBSTACLES

To ensure that the airdrop is safe, and that personnel and equipment can be recovered and employed to accomplish the mission, the DZ and adjacent areas should be free of obstacles.

a. Obstacles to personnel are any features, either natural or man-made, that would pose a hazard to a parachutist.

b. Obstacles to equipment are any features, either natural or man-made, that may hinder the recovery of equipment. Examples of such obstacles are:

(1) Trees 35 feet or higher, which would impede recovery of personnel or equipment.

(2) Water more than 4 feet deep within 1,000 meters of any edge of the drop zone.

(3) Any other conditions that may injure parachutists or damage equipment, such as barbed wire fences, swamps, rocks, ditches, and gullies.

(4) Power lines that are carrying active current of 50 volts or greater. Based on the reported altitude wind, a safety zone is created in which power must be interrupted to prevent accidental injury of a parachutist. Figure 6-1 shows the size of the safety zone for various altitude wind velocities during static line operations.

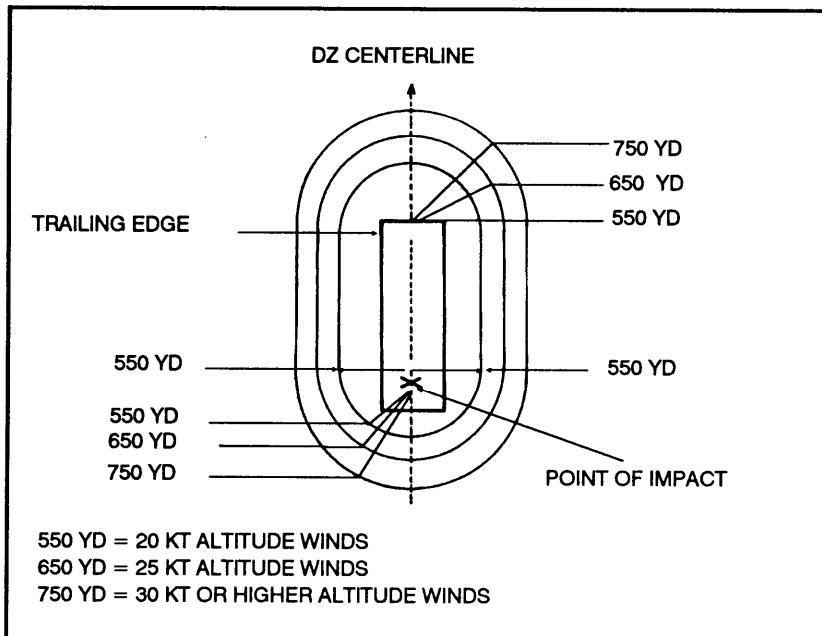

Figure 6-1. High tension lines criteria.

6-6. ACCESS

Avoid DZs with major obstacles between the DZ and the objective area. Ensure that adequate routes are available to conduct troop movement and equipment recovery.

6-7. SIZE

The size of computed air release point DZs during peacetime drop operations is determined by USAF doctrine.

a. The CARP DZ for one jumper will be a minimum of 549 meters (600 yards) by 549 meters (600 yards). Add 64 meters (75 yards) to the length of each additional jumper.

b. The CARP DZs for the containerized delivery system will be as indicated in Table 6-3.

CDS (C-130)				
ALTITUDE (AGL) (Feet)	WIDTH (See Note 1)	# OF CONTAINERS		LENGTH (See Note 2)
		Single	Double	
To 600	400 yards	1	1-2	400 yd
		2	3-4	450 yd
		3	5-6	500 yd
		4	7-8	550 yd
		5-8	9 or more	700 yd
Above 600	Add 40 yards to DZ width and length for each 100 feet above 600 feet (20 yards added to each side of the DZ.)			
CDS (C-141)				
ALTITUDE (AGL) (Feet)	WIDTH (See Note 1)	# OF CONTAINERS		LENGTH (See Note 2)
		Single	Double	
To 600	450 yards	1	1-2	590 YD
		2	3-4	615 YD
		3	5-6	665 YD
		4-8	7-16	765 YD
		9-14	17-28	915 YD
		15-20	30-40	1,065 YD
Above 600	Add 40 yards to DZ width and length for each 100 feet above 600 feet (20 yards added to each side of the DZ.)			

Table 6-3. Tactical airlift DZ size criteria.

HEAVY EQUIPMENT			
ALTITUDE (AGL) (Feet)	WIDTH (See Note 1)	LENGTH (See Note 2) 1 PLATFORM ADDITIONAL PLATFORMS	
To 1,100	600 yards	1,000 yards	Add 400 yards (C-130) or 500 yards (C-141 or C-5) to trailing edge for each additional platform.
Above 1,100	Add 30 yards to width and length for each 100 feet above 1,000 feet. (Add 15 yards to each side of the DZ.)		
PERSONNEL			
ALTITUDE (AGL) (Feet)	WIDTH (See Note 1)	LENGTH (See Note 2) 1 PLATFORM ADDITIONAL PLATFORMS	
To 1,000	600 yards	600 yards	Add 75 yards for each additional parachutist to trailing edge (100 yards when using CAPES)
Above 1,000	Add 30 yards to width and length for each 100 feet above 1,000 feet. (Add 15 yards to each side of the DZ.)		
<p>NOTE 1: a. For day visual formations, increase width by 100 yards (50 yards each side). b. For SKE formation, increase width by 400 yard (200 yards each side). c. Official sunset to sunrise, increase width by 100 yards for single ship visual drops (50 yards each side) or 200 yards for visual formations (100 yards each side)</p> <p>NOTE 2: Official sunset to sunrise, increase length by 100 yards for visual drops (50 yards each end).</p>			

Table 6-3. Tactical airlift DZ size criteria (continued).

c. The CARP DZs for heavy equipment will be at least 549 meters (600 yards) wide and 915 meters (1,000 yards) long for one platform. If using a C-130, add 366 meters (400 yards) to the length for each additional platform. If using a C-141, add 458 meters (500 yards) to the length for each additional platform.

d. If using more than one aircraft not in trail formation, add 92 meters (100 yards) to the width of all CARP DZs (46 meters/50 yards each side).

e. From official sunset to sunrise, add 92 meters (100 yards) to the length and width of all CARP DZs (46 meters/50 yards to each side and to each end).

NOTE: To convert yards to meters, multiply yards by .9144; to convert meters to yards divide meters by .9144.

f. To determine the required size of Army VIRS DZs, use the $D=RT$ formula, which is explained in detail after paragraph g. A 100-meter buffer zone is required at the leading and trail edge of the DZ when jumping personnel. The buffer zones may be waived by the local commander if local regulations permit.

g. For GMRS DZs, the minimum size is 275 meters by 275 meters (300 yards by 300 yards). Additional size requirements will be redetermined using the $D=RT$ formula. The 100-meter buffer (required for personnel drops only) at both the leading and trail edge of the DZ will be included in the minimum size.

$D = ?$ (length of DZ needed in meters)

R = Rate of the aircraft's speed expressed in meters per second.

To convert knots to meters per second, multiply the knots by .51.

Do not round this answer off. See Table 6-1 for aircraft speeds.

T = Amount of time it takes to exit each load. Parachutists require 1 second each. The first parachutist is free (10 parachutists take 9 seconds). Door bundles take 3 seconds each. The first bundle is free (3 bundle require 6 seconds).

EXAMPLE: How long must the DZ be for a C-130 dropping 10 parachutists on a GMRS DZ?

$D = ?$

$R = 66.3$ meters per second (130x.51).

$T = 9$ seconds (1 second per parachutist not counting the first).

SOLUTION: $D = R \times T$

R = 66.3 meters per second
 x 9 seconds
 596.7 meters

D = 597 meters of usable DZ required. For personnel drop zones, add a 200-meter buffer (100 meters on the leading edge and 100 meters on the trail edge) to total 797 meters for the drop zone. However, the commander can waive this requirement.

NOTE: Always round the answer up to the nearest whole number.

g. To calculate the number of parachutists or bundles that a GMRS DZ of given length can accept in one pass, use the $T = D/R$ formula. Type of aircraft must be known.

T = ? (Amount of time that the aircraft will be over the DZ in seconds.)

D = Distance of DZ in meters (length).

R = Rate of aircraft's speed expressed in meters per second. To convert knots to meters per second, multiply the knots by .51. Round this number up to the nearest whole number.

EXAMPLE: How many parachutists from a C-130 can a 750-meter long DZ accept per pass? This is a GMRS DZ.

T =

D = 750 meters usable drop zone.

R = 67 meters per second $130 \times .51 = 66.3$ rounded up to 67

SOLUTION: $T = D/R$

$D/R = 11.3$ (750/ 67)

T = 11 seconds (always round down)

DZ can accept 12 parachutists (11 parachutists at 1 per second and 1 parachutist free) per pass.

h. To calculate the amount of drift experienced by a load under a parachute use the $D = K \times A \times V$ formula.

D = ? The amount of drift in meters.

K = Load drift constant = 3.0 personnel.
 = 1.5 door bundle
 = 1.5 heavy equipment
 = 1.5 containerized delivery system.
 = 2.4 tactical training bundle

A = Drop altitude expressed in hundreds of feet (800 feet would be expressed as 8).

V=Velocity of the wind (either surface wind or mean effective wind may be used).

EXAMPLE: For a drop altitude of 800 feet and wind speed of 11 knots, calculate the amount of drift experienced by a jumper.

$$D = ?$$

$$K = 3.0 \text{ (parachutist)}$$

$$A = 8 \text{ (800 feet)}$$

$$V = 11 \text{ knots}$$

$$\text{SOLUTION: } D = K \times A \times V$$

$$K = 3.0$$

$$A = \frac{8}{24}$$

$$v = 11$$

$$D = 264$$

$$D = 264 \text{ meters of drift}$$

NOTE: Always round up to the next whole number.

i. Measuring wind on the drop zone entails surface wind and mean effective wind.

(1) Surface (ground) wind should be measured by using the AN/PMQ-3A anemometer. This is the only acceptable wind measuring device for personnel and heavy equipment DZ operations.

(2) Mean effective wind is the average wind from ground level to drop altitude. MEW is measured by using the PILOT balloon. PIBAL circumferences areas follows:

- 10 grams for day: 57 inches
- 30 grams for day: 78 inches
- 10 grams for night: 74 inches
- 30 grams for night: 94 inches

NOTE: The magnetic azimuth to the balloon is measured and the reciprocal heading noted. This will give the MEW direction to be reported.

At night a small liquid activated light is attached to the balloon to assist in observation. For PIBAL charts, refer to Table 6-4.

		10 GRAM HELIUM BALLOON																ASCENSION TABLE									
		INFLATE BALLOON TO 57" CIRCUMFERENCE FOR DAY AND 74" CIRCUMFERENCE FOR NIGHT								DROP ALTITUDE IN FEET																	
ELEVATION	ANGLE	500	750	1000	1250	1500	1750	2000	2500	3000	3500	4000	4500	500	750	1000	1250	1500	1750	2000	2500	3000	3500	4000	4500	TIME	ALT (FT)
		70		02	02	01	01	01	01	01	01	01	01	01	01	01	01	01	01	01	01	01	01	01	01	01	0:10
60		03	02	02	02	02	02	02	02	02	02	02	02	02	02	02	02	02	02	02	02	02	02	02	02	0:20	170
55		03	03	03	03	03	03	03	03	03	03	03	03	03	03	03	03	03	03	03	03	03	03	03	03	0:30	250
50		04	04	04	04	04	04	04	04	04	04	04	04	04	04	04	04	04	04	04	04	04	04	04	04	0:40	330
45		05	04	04	04	04	04	04	04	04	04	04	04	04	04	04	04	04	04	04	04	04	04	04	04	0:50	400
40		06	05	05	05	05	05	05	05	05	05	05	05	05	05	05	05	05	05	05	05	05	05	05	05	1:02	500
35		07	06	06	06	06	06	06	06	06	06	06	06	06	06	06	06	06	06	06	06	06	06	06	06	1:10	540
30		08	07	07	07	07	07	07	07	07	07	07	07	07	07	07	07	07	07	07	07	07	07	07	07	1:20	610
25		10	09	09	09	09	09	09	09	09	09	09	09	09	09	09	09	09	09	09	09	09	09	09	09	1:30	670
24		11	10	10	10	10	10	10	10	10	10	10	10	10	10	10	10	10	10	10	10	10	10	10	10	1:43	750
23		11	10	10	10	10	10	10	10	10	10	10	10	10	10	10	10	10	10	10	10	10	10	10	10	1:50	790
22		12	11	11	11	11	11	11	11	11	11	11	11	11	11	11	11	11	11	11	11	11	11	11	11	2:25	1000
21		12	11	11	11	11	11	11	11	11	11	11	11	11	11	11	11	11	11	11	11	11	11	11	11	2:44	1100
20		13	12	12	12	12	12	12	12	12	12	12	12	12	12	12	12	12	12	12	12	12	12	12	12	3:05	1250
19		14	13	13	13	13	13	13	13	13	13	13	13	13	13	13	13	13	13	13	13	13	13	13	13	3:49	1500
18		15	14	14	14	14	14	14	14	14	14	14	14	14	14	14	14	14	14	14	14	14	14	14	14	4:30	1750
17		16	15	15	15	15	15	15	15	15	15	15	15	15	15	15	15	15	15	15	15	15	15	15	15	5:11	2000
16		17	16	16	16	16	16	16	16	16	16	16	16	16	16	16	16	16	16	16	16	16	16	16	16	6:34	2500
15		18	17	17	17	17	17	17	17	17	17	17	17	17	17	17	17	17	17	17	17	17	17	17	17	7:58	3000
14		19	18	18	18	18	18	18	18	18	18	18	18	18	18	18	18	18	18	18	18	18	18	18	18	9:22	3500
13		21	20	20	20	20	20	20	20	20	20	20	20	20	20	20	20	20	20	20	20	20	20	20	20	10:44	4000
12		22	21	21	21	21	21	21	21	21	21	21	21	21	21	21	21	21	21	21	21	21	21	21	21	12:08	4500
11		24	23	23	23	23	23	23	23	23	23	23	23	23	23	23	23	23	23	23	23	23	23	23	23		
10		27	25	25	25	25	25	25	25	25	25	25	25	25	25	25	25	25	25	25	25	25	25	25	25		
09		30	27	26	26	26	26	26	26	26	26	26	26	26	26	26	26	26	26	26	26	26	26	26	26		

Table 6-4. Conversion chart for elevation angles to wind speed in knots.

j. Forward throw is the effect that inertia has on a falling object. When an object leaves an aircraft, it is traveling at a speed equal to the speed of the aircraft. The parachutist (or bundle) continues to move in the direction of flight until the dynamics of gravity and the parachute take effect. Forward throw for rotary-wing aircraft is half the aircraft speed expressed in meters. To determine the amount of forward throw when using a USAF aircraft, apply the following distances:

	C-130	C-141	C-5
Personnel/Door	229 meters/	229 meters/	229 meters/
Bundles	250 yards	250 yards	250 yards
Heavy Equipment	458 meters/ 500 yards	668 meters 730 yards	668 meters 730 yards
CDS	503 meters/ 550 meters	686 meters 750 meters	
TTB	147 meters/ 160 yards	147 meters/ 160 yards	
NOTE: To convert yards to meters, multiply yards by .9144. to convert meters to yards, divide meters by .9144.			

Table 6-5. USAF aircraft forward throw distances.

6-8. APPROACH AND DEPARTURE ROUTES

Routes for the aircraft into and away from the DZs must be adequate. To ensure this, consider the following factors:

- Enemy situation and location.
- Obstacles to the aircraft (TV towers, high tension lines).
- Terrain higher than the DZ.
- No-fly areas.

Section II. DROP ZONE SUPPORT TEAM

The drop zone support team will plan, establish, and operate day and night drop zones for personnel/resupply missions flown by Air Force and Army aircraft. The DZST is ultimately responsible for the accomplishment of the mission on the DZ. In operations in which the USAF combat control team is not present, the DZST has overall responsibility for the conduct of operations on the DZ. It represents both the airborne and airlift commanders. The DZST leader assumes all the responsibilities normally associated with the USAF CCT and the DZSO.

6-9. ORGANIZATION

The DZST will have at least two members. More personnel maybe required depending on the complexity of the mission; however, they may not have to be DZST qualified. The senior member of the DZST will function as the drop zone support team leader and he must bean NCO, sergeant or above officer; or civilian equivalent. He must have completed the appropriate initial training as a DZST member and satisfy current parent service requirements. He must also be a qualified and current jumpmaster to conduct personnel and heavy equipment drops. (See also paragraph 6-13.)

6-10. MISSIONS

Primary missions of the DZST include wartime CDS drops to battalion or smaller size units, and peacetime visual meteorological conditions drops involving one to three aircraft for personnel, CDS, and heavy equipment. Secondary missions include wartime drops of brigade size or larger units, peacetime drops of C-130 AWADS (all-weather aerial delivery system) involving one to three aircraft, or VMC drops of four or more aircraft.

6-11. EQUIPMENT FAMILIARIZATION

The DZST leader must have a working knowledge of the equipment he will use during the establishment, marking, and operation of his drop zone. The following basic equipment is used by the DZST, however, there may be more or less equipment, depending on the mission.

a. Anemometer. The AN/PMQ 3A (NSN: 6660-00-515-4339) is a calibrated, hand-held wind measuring device used for measuring surface wind. Oriented correctly, it will give wind direction in degrees by pressing the trigger. It is capable of reading the wind from 0 to 15 knots on the low scale and from 0 to 60 knots on the high scale. The anemometer must be calibrated every six months.

b. VS-17 Marker Panel Aerial. The VS-17 marker panel (NSN: 8345-00-174-6865) is a two-sided panel, 2 feet wide by 6 feet long. One side is fluorescent orange, sometimes referred to as international orange, and the other side is cerise, commonly referred to as red. It has six tie-down points used to attach the panel to stakes. It also has three snap fasteners on the short ends in the stow pocket. It should be folded up so that the olive drab green is showing. The color of the panel used should be the one that best contrasts with the surrounding area.

c. Light, Marker, Ground Obstruction. This marker (NSN: 6230-00-115-9996) is also known as the "beanbag light." It is powered by one BA-200 battery, and its color can be changed by using interchangeable colored plastic domes. The markers can be used in light

holes or on the surface and can be secured with tent pegs or by filling the bottom with sand or rocks.

d. Raised Angle Marker. The RAM is a locally constructed visual signal used to mark the PI on CARP DZs. It is constructed by assembling five VS-17 panels as shown in Figure 6-8.(page 6-26).

e. Whelen Light. This light is powered by either the BA-4368 or the lithium battery used in the PRC-77 radios. The light is placed on top of the battery and is ready for operation. The color of the light can be changed with different colored domes. It is a local purchase item.

f. M-2 Light Baton. The M-2 (NSN: 6230-00-926-4331) is a flashlight powered by two BA-30s. The color of the light can be changed with different lenses that are stored in its base compartment. This light is used in light holes or on top of the ground attached to a tent peg.

g. Aerial, Marker, Distress. This marker (NSN 6230-00-67-5209) is an omnidirectional flashing (strobe) light with a very long range. A directional cover can snap on the top for tactical operations. Colors can be changed with snap-on caps. The strobe light also has infrared capabilities.

h. Mirror, Emergency Signaling, Type II. The signal mirror (NSN 6350-00-105-1252) can be used to signal aircraft by reflected sunlight. There is a set of instructions on the back of the signal mirror for proper use and aiming. The signal mirror can still be used on hazy days. One misconception is that it can only be used when facing the sun. It can be used in all directions and can be seen as far as the horizon will go.

i. SE-11 Light Gun. This light gun is a long-range, directional, visual-signaling device used to signal aircraft to mark the release point on the drop zone. It is powered by five BA-3030 batteries and can be set up for remote operations. It has a red cap/lens, which is normally used as a no-drop signal. The Air Force has a light, traffic air B-2 (NSN 6210-00-578-67547) that is comparable to the SE-11 (NSN 5820-00-4074671).

j. Pilot Balloon. The PIBAL is a 10-or 30-gram rubber balloon that when filled with helium to the specified circumference is used to measure the mean effective wind, which is the average wind from the ground to drop altitude. The NSN for the Balloon Meteorological 10-Gram is 6660-00-663-7933. The NSN for the Balloon Meteorological 30-Gram is 6660-00-663-8159.

k. Lighting Unit. This light (NSN 6660-00-839-4927) is attached to the PIBAL for night operations. The PIBAL is over-inflated to compensate for the weight of the light so that the same ascension rate is achieved. The PIBAL light has a wet-cell battery that is activated by water or fluid. When temperatures fall below 50 degrees, the PIBAL light activates faster by using warm water.

l. **Drift Scale.** This slide-type scale uses a 90-degree angle to measure the ascent of the PIBAL for determining the mean effective wind. It is locally produced by TSC. (Also used for this purpose are the theodolite (NSN 6675-00-861-7939) pocket transit with built-in clinometer (NSN 6675-00-641-5735) or the clinometer (NSN 6675-01-313-9730).

m. **AN/PRC-119A Radio or SINCGARS.** This man-portable radio (NSN 5820-01-267-9482) is used for contacting the aircraft with FM communication capabilities. This radio can also be used for NAVAID with aircraft that have FM homing capabilities. It has a range of 4 to 16 kilometers without power increasing accessories.

n. **PRC-113 Radio.** This is a man-portable UHF/VHF AM radio (NSN 5820-01-136-1519) that has a quick, jam-resistant, ECCM transceiver. It is designed for short range (5 to 16 miles), tactical, ground-to-ground, or ground-to-air communication.

6-12. COORDINATION

The drop zone coordination checklist was designed so that the DZST leader could conduct a pre-mission coordination without communicating with the aircraft (Figure 6-2).

1. Confirm the following:
 - Mission
 - DZ location
 - DZ name
 - Number of bundles/parachutists
 - JA/ATT sequence number
 - Time on target
 - Weather decision time
2. Verify the current DZ survey (AMC Form 339):
3. Verify the following information:
 - Type drop (HE, CDS, PER)
 - Type/number of aircraft
 - Time between flights/passes
 - Number of racetracks
 - Drop speed/heading
 - Drop altitude: AGL IND
 - Type parachute
 - Ground quick disconnects
4. Confirm the following DZ information:
 - Type markings (GMRS, CARP, VIRS)
 - What code letter
 - Timing points
 - Primary drop signal
 - Alternate drop signal
 - Mission cancellation signal
 - Obstacle markings
5. DZ support capabilities:
 - Communications available
 - Frequencies/call signs
 - Acquisition aids available
 - NAVAIDS
 - MEW equipment
 - Airspace coordinated for:
6. Confirm aircraft (mission) commander's name, unit, telephone number:
7. Enter DZST leader's name, rank, unit, telephone number:
8. Drop zone scoring/incident/accident reporting procedures:

Figure 6-2. Drop zone coordination checklist.

6-13. SUPPORT REQUIREMENTS

The following support requirements apply to multiple aircraft formations (USAF aircraft), personnel, and equipment; or to single aircraft operations on DZs more than 2,100 meters in length.

a. The DZST leader ensures the DZ control group is in place on the DZ and operational one hour before the drop. The composition of a complete control group is as follows:

- DZST leader.
- Assistant DZST leader (must be DZST qualified).
- Malfunction officer or NCO (with camera).
- Parachute recovery detail (with saw and tree climbing equipment).
- Radios, one each for the DZST leader and the assistant leader (minimum).
- Anemometers, AN/PMQ-3A one each for the DZST leader and the assistant DZST leader.
- Smoke grenades/flares (as required).
- Vehicles (as required).
- Road guards (as required).
- Military police (if required to control vehicles and spectators)
- * • Two medical personnel with front line ambulance.
- * • Boat detail (if required). If water more than 4-feet deep is within 1,000 meters of any edge of the drop zone, at least one boat with operator and assistant operator is required. The boat must be in the water with the engine running, and there must be a life jacket on board for every parachutist on the first pass. For deliberate water jumps, each parachutist will wear a life vest.

*** INDICATES ITEMS NOT NECESSARY ON CDS DROPS.**

b. The units may supplement these requirements based on the type of drop, size of the airborne operations, number of aircraft involved, and number of parachutists.

c. If there are single aircraft (no more than 20 seconds exit time or 2,100 meters or less of usable DZ), a partial control group with at least the following personnel and equipment can handle the DZ.

- DZST leader.
- Assistant DZST leader (not necessarily DZSTL qualified).
- Anemometers, AN/PMQ-3A.
- * • One medic (with FLA).
- Malfunction officer or NCO (with camera).

NOTE: The DZST leader may perform this additional duty provided he has received specialized training in the duties outlined in Chapter 17, FM 57-230.

- Parachute recovery detail.
- Radio.
- Anemometer, AN/PMQ-3A.
- Compass.
- Smoke grenades/flares (as required).

*** INDICATES ITEMS NOT NECESSARY ON CDS DROPS.**

d. The DZST leader should maintain an inventory of the following basic equipment to support the mission.

- VS-17 panels.
- Smoke grenades/flares.
- White lights (Whelen or M-2 light baton).
- Air traffic control light (SE-11 or B-2).
- Signal mirror.
- Strobe light.
- Binoculars.
- Anemometer, AN/PMQ-3A (required for personnel and heavy equipment drops, recommended measuring for all types of drop).
- Compass.
- PIBAL kit with helium.
- Night vision goggles (for night drops).

NOTE: Other equipment may be needed as a result of pre-mission coordination or unit SOP. Refer to DZST equipment familiarization, paragraph 6-11.

6-14. DROP ZONE SUPPORT TEAM LEADER'S DUTIES

The DZST leader is responsible for the overall establishment and operation of the DZ. He selects the locations of the control center, point of impact, and release point. He is ultimately responsible for the accomplishment of the mission. Specifically, the leader ensures he

- a. Has the drop zone fully operational one hour before drop time and conducts pre-mission coordination.
- b. Opens the drop zone through range control and closes it when accountability of personnel, air items, and equipment is completed.
- c. Conducts ground or aerial reconnaissance of the drop zone for obstacles or safety hazards at least one hour before the drop.
- d. Establishes communication with departure airfield control officer no later than one hour before drop time.

- e. Controls all ground and air medical evacuations. (Refer to paragraph 6-26 for MEDEVAC format.)
- f. Submits post mission reports to appropriate agency.
- g. Operates all visual acquisition aids.
- h. Ensures no-drop signals are relayed to the drop aircraft.
- i. Ensures all DZ markings are correctly displayed.
- j. Establishes a 10-minute window. A continuous monitoring of the surface winds must commence no later than 12 minutes before TOT. For example, if the TOT is 0700 hours, then the window begins at 0648 hours (two minutes are added to allow adequate time to relay a no-drop signal if needed). If at any time during the 10-minute window the winds exceed allowable limits, the DZST leader will relay a no-drop to the aircraft. Once a no-drop has been called, a new 10-minute window is established. So, if the winds pick up at 0655 hours, a no-drop is called and a new window runs from 0655 to the new TOT of 0705 hours.
- k. Takes surface wind readings from the control center location and from the highest point of elevation on the DZ when the DZ exceeds 2,100 meters in length or when it is a multiple aircraft operation.
 - l. Calls a no-drop when surface winds exceed the following limits:

TYPE OF LOAD	SURFACE WIND KNOTS
Personnel (land)	13
Personnel (water)	17
HALO/HAHO	17
Equipment without ground disconnects	13
Equipment with ground disconnects	17
CDS/door bundles using G-13/14 type parachutes	20
USAF tactical training bundles	25
High-velocity CDS	No Restrictions

6-15. CONTROL CENTER

The control center is where the DZST leader controls and observes the airborne operation. This is one of the locations where wind readings are taken. The DZST leader should have all radios, signaling devices, and appropriate forms positioned at the control center. The location of the control center will be determined by the type of mission.

- a. For personnel drops, the control center will be located at the PI.
- b. For CDS drops, the control center is located 150 yards to the 6 o'clock of the PI.

c. For free drops, heavy equipment, and AWADS with a ceiling of less than 600 feet, the control center will be located off the drop zone. However, it should be located so that the approaching aircraft can be observed along with the PI. For example, the leading edge may be a poor location due to obstruction by the woodline.

d. For all GMRS and VIRS DZs, the control center will be located at the release point.

6-16. SIGNALS

When voice control of aircraft becomes limited, visual communication becomes a very important way to relay information to the aircraft. No-drop and mission cancellation situations are two of the most important of these visual signals.

a. To identify a no-drop situation to the aircraft, scramble the shape designator and remove the markings or any other pre-coordinated signal on the DZ.

(1) The drop aircraft should continue to do racetracks until a signal for clearance to drop is given. A no-drop may be given when winds exceed the maximum limitations for that type of drop, when there are vehicles moving on the drop zone, or when any other unsafe act is observed on the drop zone.

(2) In pre-mission coordination, it should be determined how many no-drop passes the aircraft will fly until the mission is cancelled and they begin their return to base.

b. Signals for, clear to drop should be covered also. Having the drop zone markings in place could indicate that it is clear to drop. This method could be used when smoke is not available. Any smoke other than red could indicate clear to drop.

c. At night, your clear-to-drop signals could include shape designator illumination, a flashing white light, a green light, or any other device available that was coordinated in advance.

6-17. DETERMINATION OF RELEASE POINT LOCATION

Procedures for determining a release point on a GMRS drop zone, Air Force VIRS drop zone, or Army rotary wing VIRS drop zone areas follows:

STEP 1. Determine the location of the point of impact which is where the first parachutist or load will land. The following criteria should apply. For door bundles the PI may be located at the leading edge of the tree line, centerline. For personnel, the PI should be on the leading edge of the 100-meter buffer zone, centerline. For CDS and heavy equipment, refer to MAC Form 339 for the surveyed PI location. For CDS and heavy equipment on nonsurveyed DZs, refer to the standard PI locations for tactical assessments.

STEP 2. Determine the drift direction and distance. Computes $D = KAV$ formula for your mission. Determine back azimuth of wind direction. From the PI location pace off the distance computed from $D = KAV$ formula into the wind. If the wind is blowing to an azimuth of 200 degrees, then the pace-off azimuth is 020 degrees.

STEP 3. Determine the forward throw. Once you have paced off the drift, walk off the forward throw. To do this, shoot a back azimuth of drop heading and walk the distance of the forward throw (for Air Force aircraft forward throw, refer to Table 6-5 (Page 6-13). For rotary wing aircraft, divide the drop airspeed in half, and express in meters. For example, the drop speed of 90 knots equals 45 meters of forward throw. The release point is at the end of the forward throw (Figure 6-3).

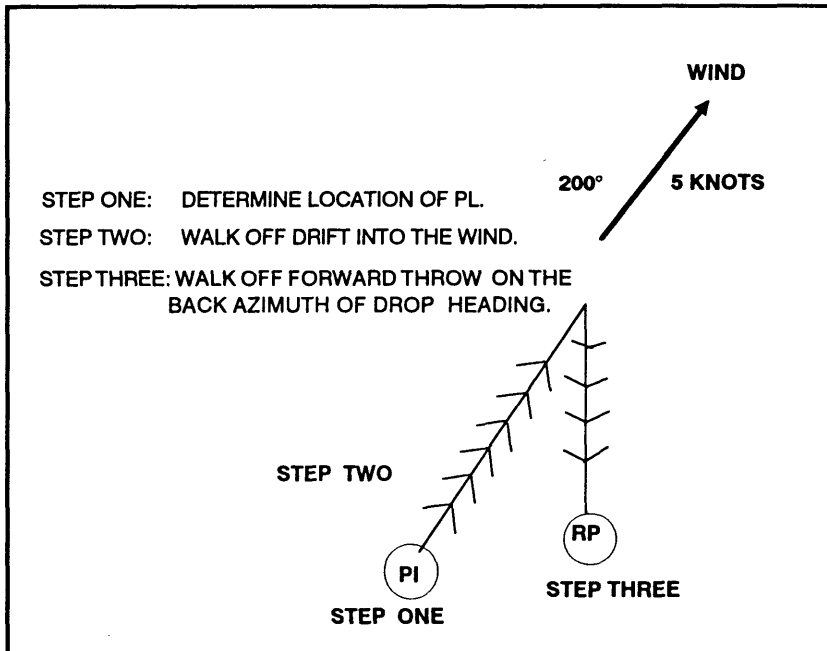

Figure 6-3. Release point location.

6-18. GROUND MARKING RELEASE SYSTEM

The GMRS is a means for the DZST to identify the release point to the drop aircraft. The pilot uses the markings to adjust his flight path 100 meters to the right of the corner panel/light and parallel to the approach-corer panel/light axis. (Wherever panel is used in the following subparagraphs, light may be substituted.) This method was designed for use without radio communication between the drop zone and the aircraft.

a. The DZ will be marked with an inverted "L" "H," or "T" pattern using VS-17 panels. The inverted L consists of 4 panels; the approach panel, the corner panel, the alignment panel, and the flanker panel. The corner panel is located 100 meters to the left (as seen from drop heading) of the release point. (Refer to Figure 6-4, page 6-22, for panel emplacement). All other panels are aligned with and oriented to the corner panel. For establishment of the seven panel "H" and six panel "T" pattern, which are recommended for C-141/C-5 airdrops due to the aircraft side-angle-vision limitations pattern, refer to Figure 6-4, page 6-24).

b. The alignment panel is 50 meters to the left of the corner panel. The approach panel is 50 meters in front of the corner panel as seen from drop heading. The flanker panel is 150 meters to the left of the alignment panel as seen from drop heading.

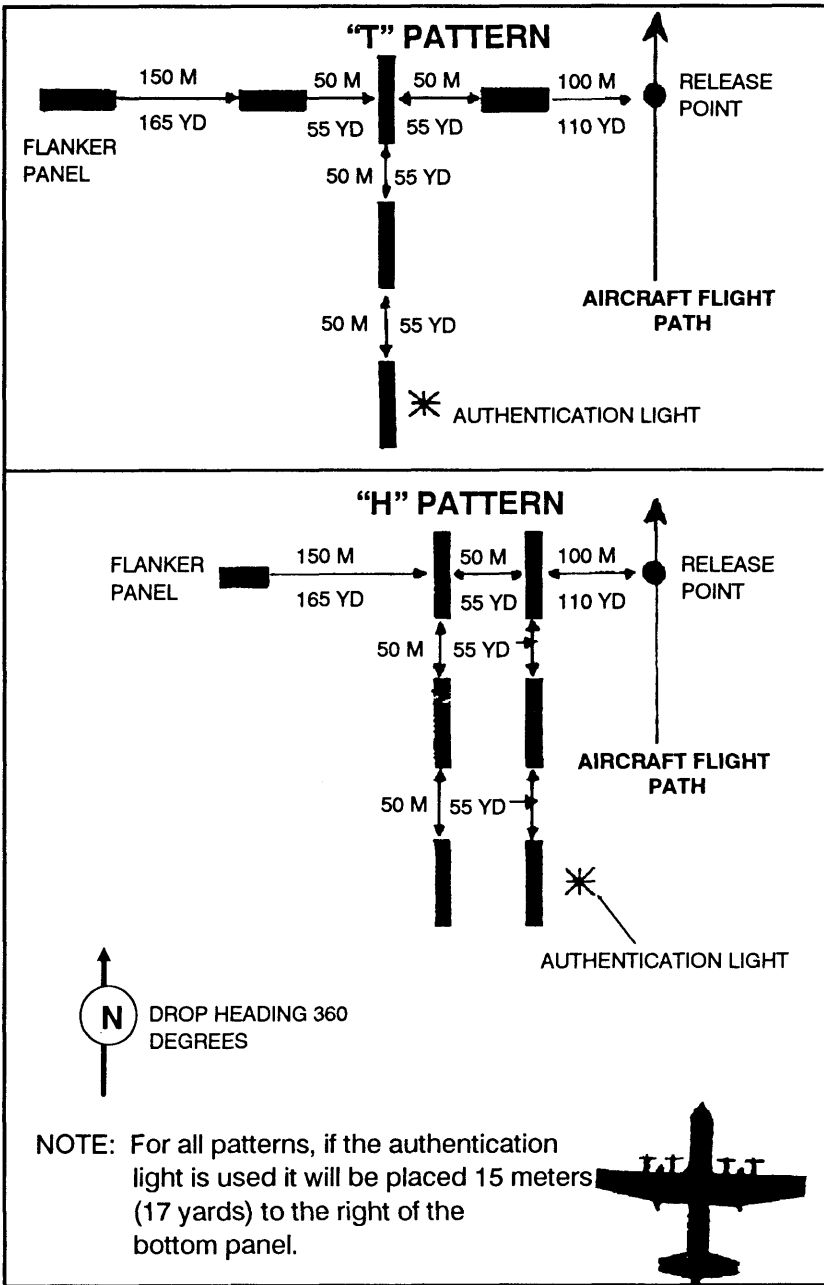

Figure 6-4. Panel emplacement.

c. The DZST places the markings where obstacles will not mask the pilot's line of sight. As a guide, he uses a mask clearance ratio of 1 to 15 units of horizontal clearance (Figure 6-5).

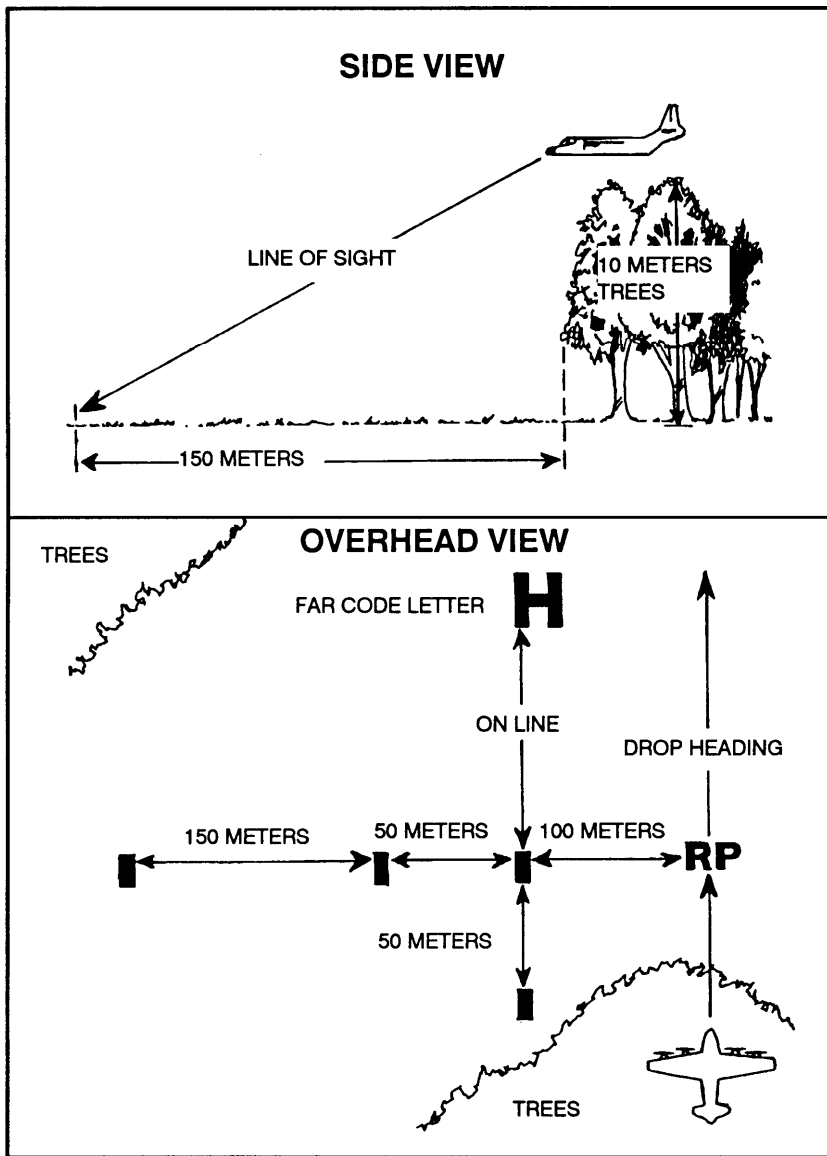

Figure 6-5. The 15.1 mask clearance ratio.

(1) For example, if you must position a drop zone marker near a terrain mask such as the edge of a forest that is on the drop zone approach, and the trees are 10 meters (33 feet) high, the markings would require 150 meters (492 feet) of horizontal clearance from the trees (Figure 6-6).

(2) If any of the GMRS markings fall within a 15:1 mask clearance ratio on the approach end of the drop zone, an Army code letter (H, E, A, T), or a far (marker) panel may be placed on the trailing edge of a drop zone if coordinated for during the DZST/aircrew mission briefing. If a code letter is used, it can be used to distinguish the drop zone from other drop zones in the area.

d. At night, panels will be replaced with lights (1 light per panel). Directional lights should be used for the approach, corner, alignment, and flanker. If necessary, the far code letter would use directional light holes and the base light would be on line with the corner light. (Refer to Figure 6-6 for construction requirements for Army code letters.)

e. The release point should be marked with some type of identifiable light source distinct from all other DZ markings.

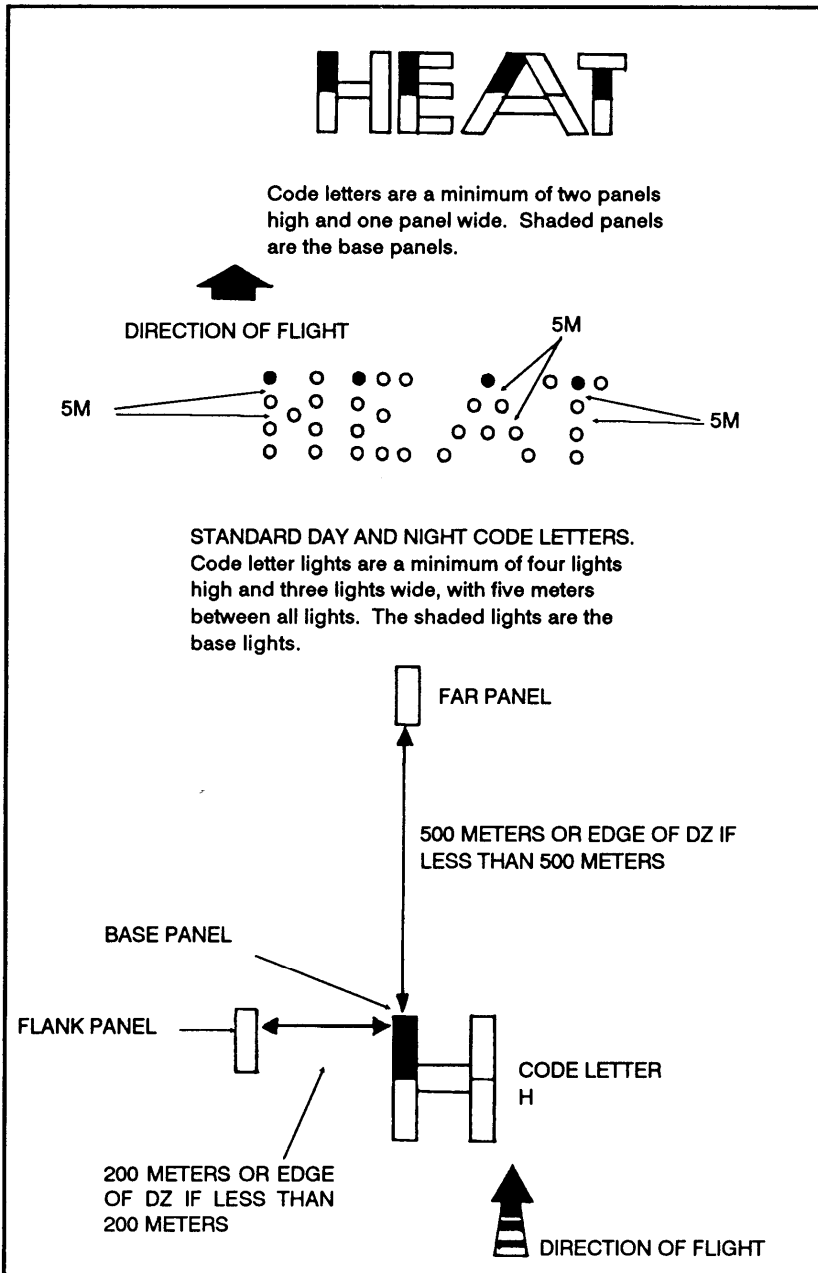

Figure 6-6. Horizontal clearance.

6-19. ARMY VERBAL INITIATED RELEASE SYSTEM

Army VIRS is a method of establishing the release point on the DZ by using radio communications. A code letter may mark the RP if this is tactically feasible, but the aircraft initiates the drop on verbal command from the ground.

a. A standard Army code letter using VS-17 panels for daytime operations will be emplaced at the release point. The base panel of this code letter will be positioned exactly on the RP. The code letter will be either H, E, A, or T and will be at least two panels high and one panel wide (Figure 6-6, page 6-27).

b. A flank panel is emplaced to the left of a code letter at a distance of 200 meters or the edge of the DZ, whichever is less. A far panel is emplaced 500 meters from the code letter along drop heading or at the end of the DZ, whichever is less. Both far and flank panels are positioned with the long axis parallel to drop heading and raised at 45 degrees back toward the code letter. The GTA radio operator will be positioned at the release point.

c. At night the panels in the code letter are replaced with lights. The code letter will be at least four lights high and three lights wide with 5 meters between each light. The code letter and far light will be placed in directional holes and the flank light will be in a bidirectional hole.

d. In case the release point (RP) falls off the DZ making the markings not visible, or the GTA operator cannot see the aircraft, the parachute drop can be changed to a jumpmaster-directed release operation using the wind streamer vector count (Figure 6-7).

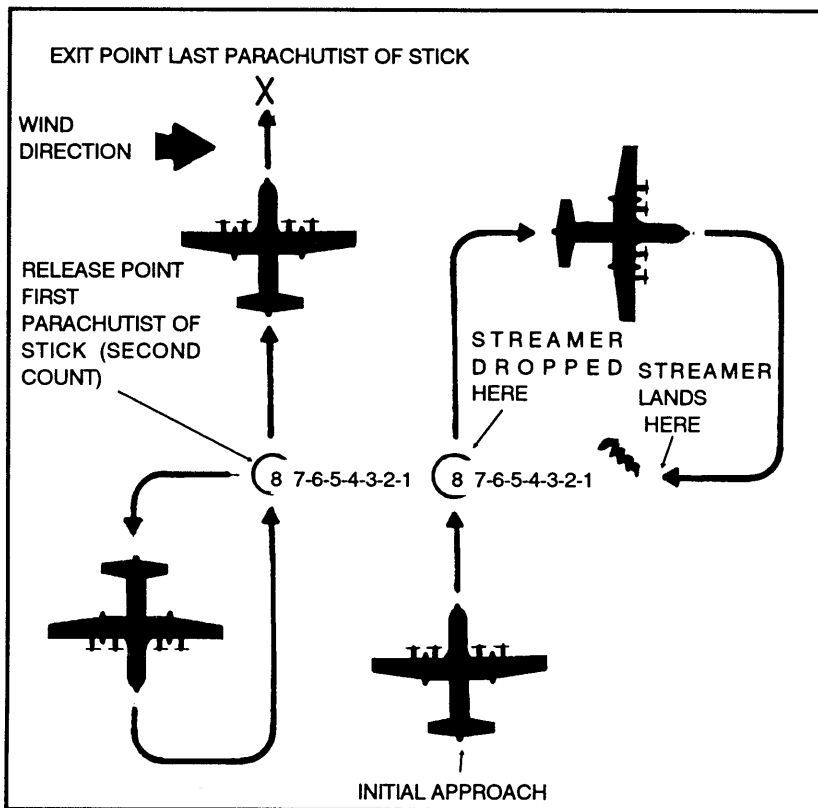

Figure 6-7. Wind streamer vector count.

e. In situations where the RP falls off the DZ and the jumpmaster is unable to conduct a wind streamer vector count, a delayed release or an early release maybe conducted. For example, a late release is done by determining how many seconds the aircraft must fly past the GTA operator before the release is initiated. An example with the drop speed of 70 knots is $70 \times .51 = 36$ meters per second of flight.

f. On an Army VIRS DZ where the RP is in the woodline, an off-set may be used (Figure 6-8, page 6-30). For example, a UH-1H is traveling 70 knots. Converted to meters per second, this is about 36 meters per second. If the RP is 108 meters into the woodline, the GTA operator will allow the aircraft to pass the code letter. As the aircraft passes over the code letter, the GTA operator will begin counting "one thousand, two thousand, three thousand." At the end of three seconds, the GTA operator will transmit, "Execute, execute, execute."

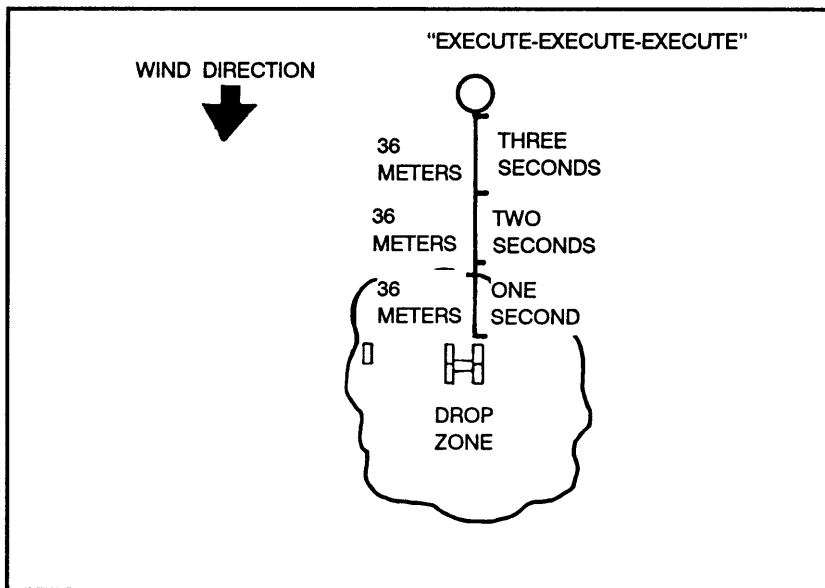

Figure 6-8. Army VIRS off-set.

6-20. AIR FORCE VERBAL INITIATED RELEASE SYSTEM

The USAF VIRS drop zone does not require markings. This specialized procedure is normally used when regular markings are not tactically feasible or would not be visible from the air. However, before considering a USAF VIRS DZ, you must have radio communications with the drop aircraft, and at least two FM/VHF/UHF radios should be on the DZ.

a. To establish a USAF VIRS drop zone, a release point is determined the same way as a GMRS or rotary-wing VIRS release point. (Refer to paragraph 6-17 and Figure 6-2 to determine release point location.)

b. At the release point location, the DZST leader will verbally guide the pilot over the release point to align the aircraft so the drop can be initiated.

c. Instructions transmitted to the aircraft must be concise: Left and right turns will be given to align aircraft on desired inbound heading. Stop turn is given when aircraft is on course. Standby is given about 5 seconds prior to release or as pre-briefed, and execute will be given three times when the aircraft reaches the predetermined release point.

An example of a USAF VIRS Transmission is as follows:

AIRCRAFT: T2S26, THIS IS HERC 30, OVER.

DZST: HERC 30, THIS IS T2S26, AUTHENTICATE DELTA FOXTROT, OVER.

AIRCRAFT: T2S26, THIS IS HERC 30, GOLF, OVER.

DZST: HERC 30, T2S26 - NOT IN SIGHT, CONTINUE OVER.

— ONCE THE AIRCRAFT IS ABOUT ONE MINUTE OUT —

DZST: HERC 30, THIS IS T2S26, HAVE YOU IN SIGHT, TURN LEFT.

DZST: (ELIMINATE CALL SIGNS) TURN LEFT. . . STOP TURN.

DZST: ON COURSE, STAND BY. (5 SECONDS FROM DROP).

DZST: EXECUTE, EXECUTE, EXECUTE, T2S26 OUT.

d. When transmitting the MEW to the aircraft, make sure that it is identified as the mean effective wind and that the altitude to which it was taken is included. Any indications of erratic winds or wind sheers reported by previous aircraft should also be reported at this time.

6-21. AIR FORCE COMPUTED AIR RELEASE POINT

The DZST leader and DZ party mark the point of impact on a surveyed DZ, and the aircraft navigator computes the release point from the air.

a. During day operations, the point of impact will be marked with a RAM (Figure 6-9) and a shape designator patterned in either a triangle (for personnel airdrop operations, or a square for CDS/HE airdrops (Figure 6-10).

b. Night markings will consist of a shape designator (made of lights) placed at the point of impact, one flanker light placed 200 yards/183 meters to the left and right of the shape designator, and a trailing edge light placed 1000 yards/915 meters from the shape designator, or at the trailing edge of the surveyed DZ whichever is closer to the PI (Figure 6-11).

c. During day operations, authentication or identification of different sites can be accomplished by specified drop times, alternating panel colors, or drop headings.

d. During night operations, authentication or identification of different sites can be accomplished by having one light in the shape designator replaced with any color light, except white.

NOTE: Authentication markings must be pre-coordinated with the aircrew.

e. Circular DZ markings must be coordinated 24 hours in advance to determine the desired drop heading.

f. Smoke, other than red, may be displayed adjacent to, and on the downwind side of the RAM/shape designator to assist in visual acquisition of the DZ and to indicate the surface wind direction.

NOTE: The panels in the shape designator are not elevated.

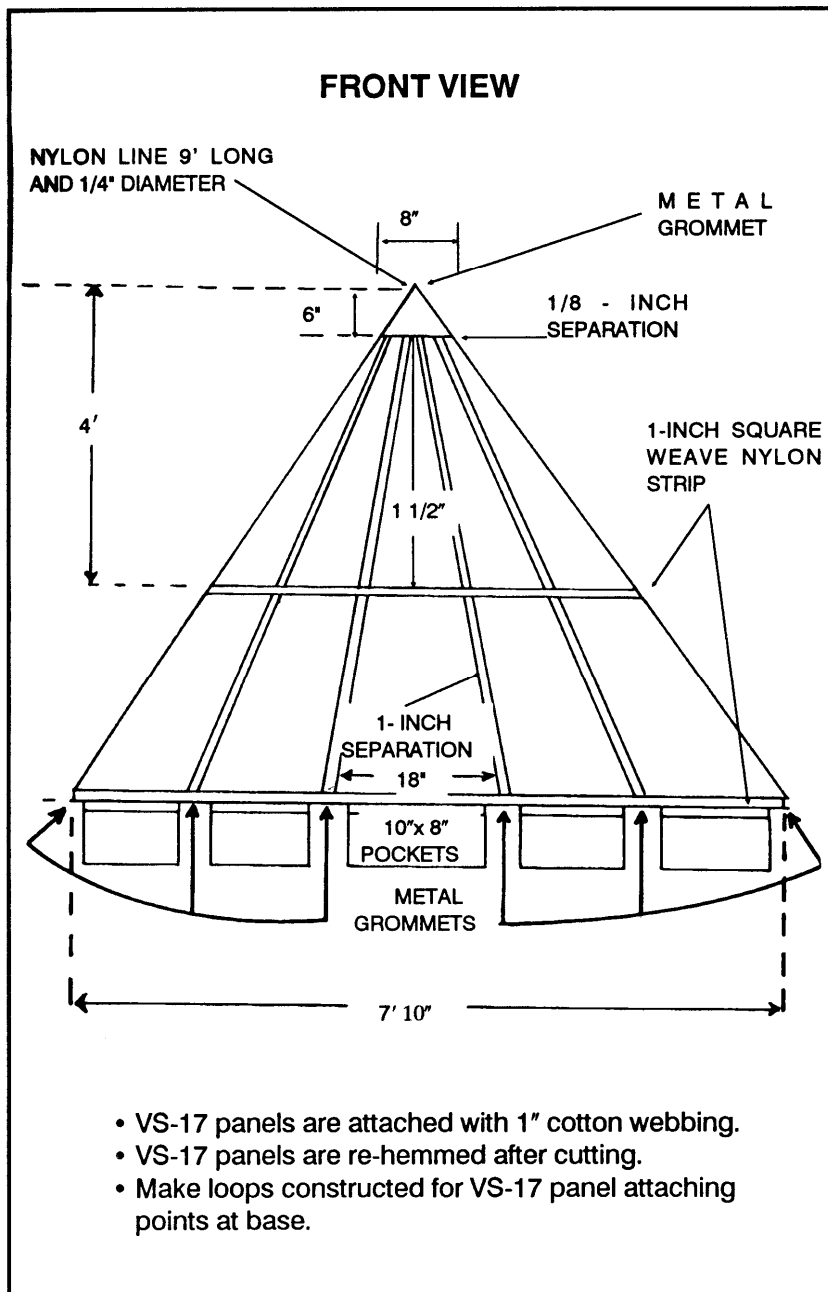

Figure 6-9. Raised angle marker.

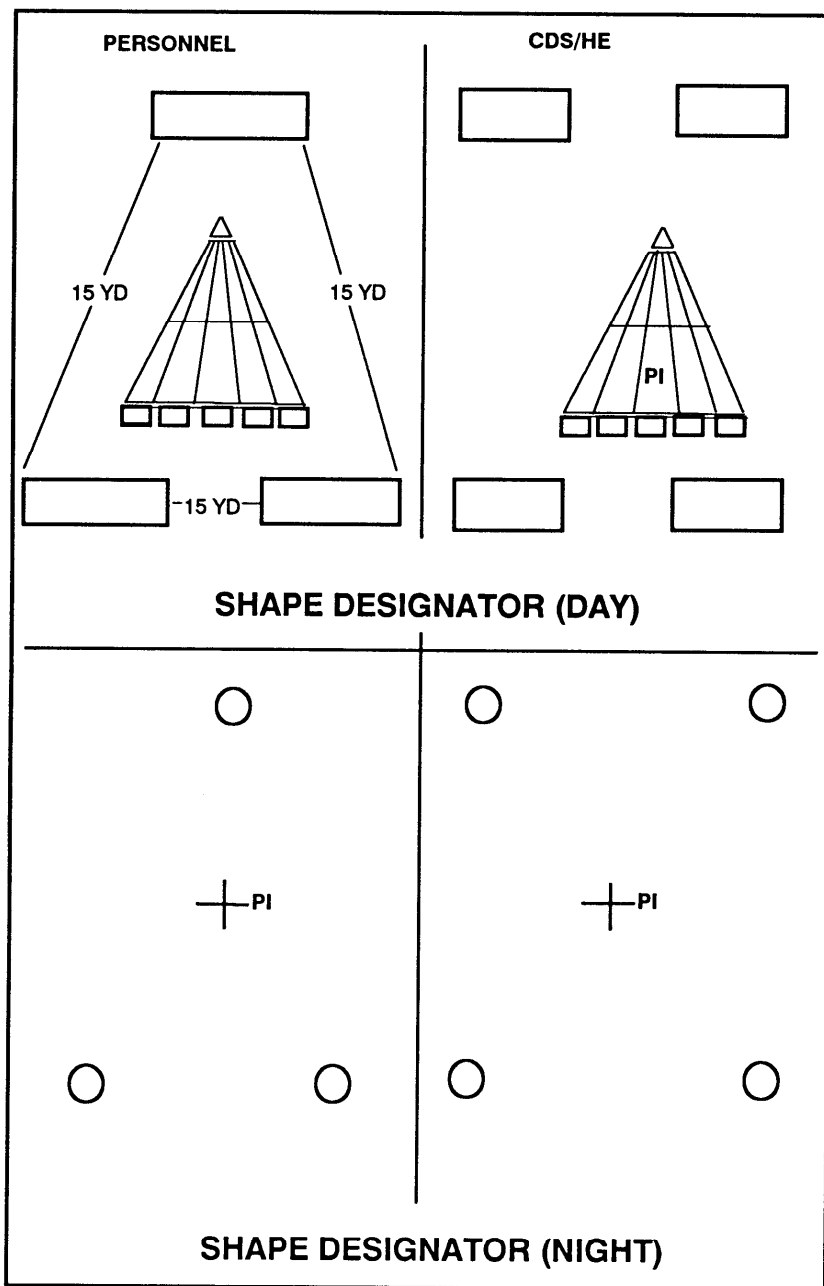

Figure 6-10. Shape designators.

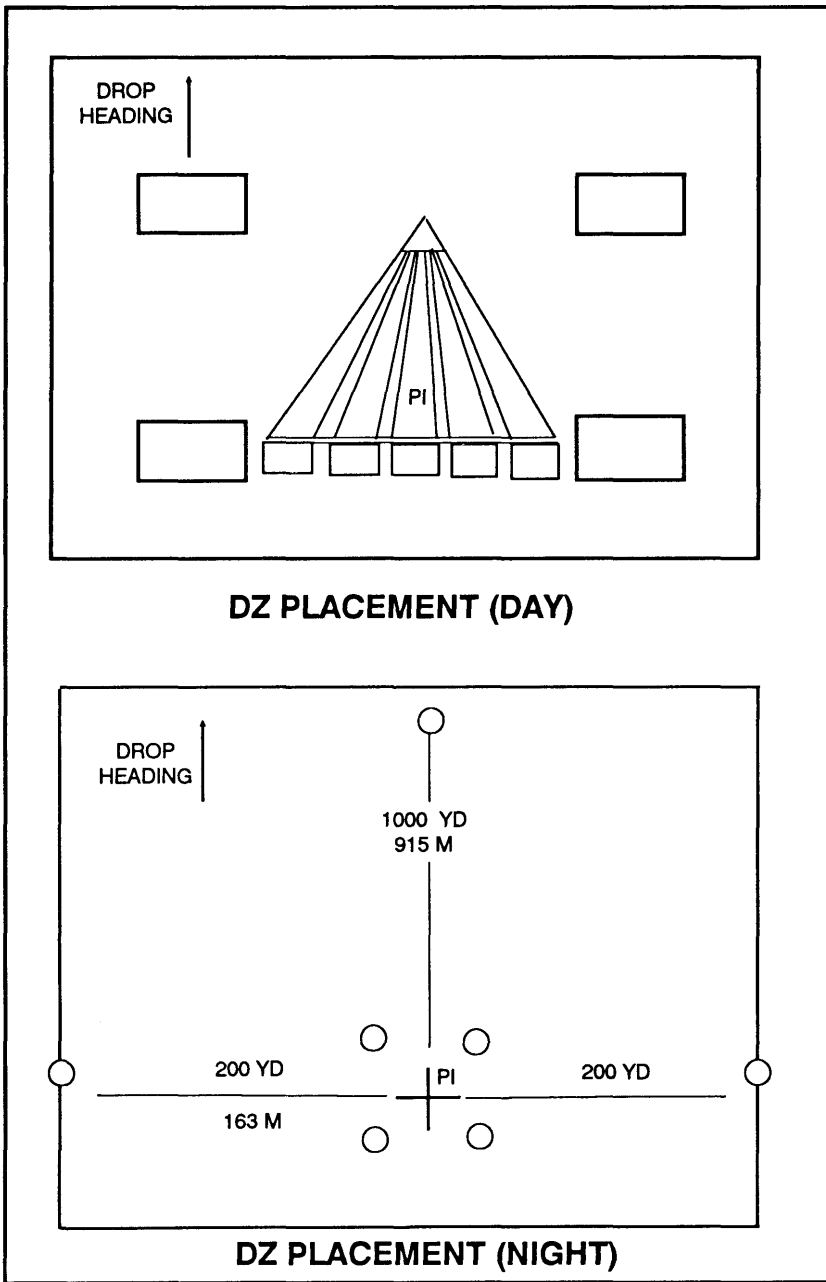

Figure 6-11. Drop zone placement.

g. The Army ground unit commander may position the PI anywhere on the “surveyed DZ” and insert his forces as necessary to accomplish the mission. He must make the PI location known to the supporting airlift and the DZST leader in sufficient time to plan the mission. The GUC accepts the responsibility for an off-the-DZ impact if he selects a PI closer than 300 yards from any edge of the surveyed DZ.

NOTE: A 200-yard buffer zone on the trail edge of the drop zone is required for personnel if the PI is located closer than 300 yards from any edge of the drop zone.

6-22. ASSAULT ZONE AVAILABILITY REPORT

The Air Force has a listing of all available drop zones that are approved for use. The list is called an Assault Zone Availability Report. The AZAR is compiled from input provided by 21 AF, McGuire AFB, NJ; and 22 AF, Travis AFB, CA. It identifies CONUS drop zones, landing zones, and extraction zones available for use by the Air Mobility Command.

6-23. DROP ZONE SURVEY

All needed information concerning the drop zone is on the Air Force AMC Form 339 (Figures 6-12 and 6-13, pages 6-36 and 6-37). The boxes on the AMC Form 339 are self-explanatory; however, a detailed explanation is in AMC Regulation 55-60.

DROP ZONE SURVEY	1. DZ NAME Example DZ		2. LOCATION Ft. Hunter-Liggett, CA	
	3. MAP NUMBER / SHEET NUMBER / EDITION / DATE OF MAP V 7955/Hunter-Liggett Special/1-DMATC/1971			
	4. SURVEY APPROVAL/DISAPPROVAL DATA			
5A. DATE SURVEYED 23 Dec 88	TYPED NAME AND GRADE OF SURVEYOR Mark a. Goodjob, Capt		PHONE NUMBER (AUTODIAL) 544-1212	UNIT OL-N 1702 MOBSS
5B. DATE REVIEWED 15 Jan 89	TYPED NAME AND GRADE OF REVIEWER John B. Closelook, Capt		PHONE NUMBER (AUTODIAL) 511-1313	SIGNATURE <i>John B. Closelook</i>
UNIT AND LOCATION 63 MAW/DOXT Norton AFB, CA 92409-5000				
6. DATE APPROVED 22 Feb 89	TYPED NAME AND GRADE OF APPROVING AUTHORITY Steve E. Okaysum, Maj		PHONE NUMBER (AUTODIAL) 555-1414	SIGNATURE <i>Steve E. Okaysum</i>
UNIT AND LOCATION 22 AF/DOXT Travis AFB, CA 94535-5002				
7. DZ AXIS DATA	8. MAGNETIC	9. GRID NORTH	10. TRUE	11. DATE OF MAGNETIC DATA
	274	288	289	1988
	12. GROUND POINT ELEVATION	13. GPR	14. IN FT	15. PER
1220	1220	1225	1378	
8. DZ COORDINATES				
17. SPHERE	18. GRID ZONE	19. EASTING	20. NORTHING	
Clarke 1866	10	6	39	
21. POINT OF IMPACT 105 FQ 5540 7860, San Miguelito Ranch House Ruins, 1350 mtrs at 075 degrees Mag to Hwy/CDS PI				
22. POINT	UTM COORDINATES		LONGITUDE (D-M-N)	
DE CENTERPOINT	5582 7892	N 35/56/38.6	W 121/16/20.7	
CDS N	5675 7862	N 35/56/28.3	W 121/15/44.0	
NE N	5692 7856	N 35/56/26.3	W 121/15/37.1	
SE N	5675 7862	N 35/56/28.3	W 121/15/44.0	
23. DZ CORNER UTM COORDINATES				
BY LEADING EDGE		RIGHT LEADING EDGE		
5712 7812		5734 7881		
BY TRAILING EDGE		RIGHT TRAILING EDGE		
5431 7903		5453 7973		
BY THUMB PT		RIGHT THUMB PT		
5774 7796		5794 7857		
24. ZONE MARKER (ZM) POSITION DATA (Enter Additional ZM Points in Remarks)				
25. PRIMARY POINT OF IMPACT MVY PI	26. DISTANCE FROM / AFTER PI (Yards)	27. DISTANCE LEFT / RIGHT OF PI (Yards)		
	200 yds Prior	100 yds Left		

Figure 6-12. Example of completed AMC Form 339, Drop Zone Survey.

<p>11. DZ DIAGRAM/12. REMARKS</p>	<p>DT NAME Example DZ</p>									
<p>1. DZ is located within R-2513. Contact Range Control for clearance into the restricted area or the CCT for entry. 2. Racetracks, if used, will be to the North. 3. Obstacles (From DZ center): a. Hill, 1830' MSL, 2.3 nm, 077° True. b. Hill, 2908' MSL, 1.8 nm, 243° True. c. Hill, 2188' MSL, 3.4 nm, 250° True. 4. Aircrews will use extreme caution for high terrain to the West and North of the DZ. 5. Users are requested to coordinate use of the DZ at least three months prior to use due to heavy scheduling. 6. Random PI placement area is 50 yds either side of centerline from the PERS PI to 1000 yds past the HVY/CDS PI. 7. Hilly terrain surrounds the DZ within 5 nm. Winds are normally from the SE. Winds shears may occur if winds are from the NW.</p>										
<p>13. PHOTOGRAPHY AVAILABLE</p> <table style="width: 100%;"> <tr> <td><input type="checkbox"/> YES</td> <td><input checked="" type="checkbox"/> NO</td> <td><input checked="" type="checkbox"/> LOW LEVEL ROUTES</td> </tr> <tr> <td></td> <td></td> <td><input type="checkbox"/> NONE AVAILABLE</td> </tr> <tr> <td></td> <td></td> <td><input type="checkbox"/> ROUTE DISAGREEMENT</td> </tr> </table>		<input type="checkbox"/> YES	<input checked="" type="checkbox"/> NO	<input checked="" type="checkbox"/> LOW LEVEL ROUTES			<input type="checkbox"/> NONE AVAILABLE			<input type="checkbox"/> ROUTE DISAGREEMENT
<input type="checkbox"/> YES	<input checked="" type="checkbox"/> NO	<input checked="" type="checkbox"/> LOW LEVEL ROUTES								
		<input type="checkbox"/> NONE AVAILABLE								
		<input type="checkbox"/> ROUTE DISAGREEMENT								
<p>MAC Form 134, Feb 80</p>										

Figure 6-13. Example of completed AMC Form 339 (reverse).

6-24. TACTICAL ASSESSMENT

During Contingency/wartime and major training exercise participation, DZST leaders may be expected to tactically locate and assess a potential drop zone for follow-on airdrop resupply/reinforcement missions.

a. Normally, the Air Force combat control teams would be tasked to accomplish this reconnaissance type mission using the AMC Form 339; but when a CCT is unavailable, the DZST leader may accomplish a tactical drop zone assessment using the tactical assessment checklist for a guideline (Figure 6-14).

1. DZ name or intended call sign.
2. Topographical map series and sheet number.
3. Recommended approach axis magnetic course.
4. Point of impact location (eight-digit grid).
5. Leading edge centerline coordinates (eight-digit).
6. DZ size in meters/yards.
7. Air traffic restrictions/hazards.
8. Name of surveyor and unit assigned.
9. Recommendation for approval/disapproval. (For disapproval cite reason.)
10. Remarks. (Include a recommendation for airdrop option, CARP, GMRS, VIRS, or blind drop).

Figure 6-14. Tactical DZ assessment.

b. Airdrop operations on tactically assessed DZs will be made ONLY under the following conditions:

(1) During training events, the airdrop will be located within a military reservation or upon US government leased property.

(2) The supported service will accept responsibility for any damage that occurs as a result of the airdrop activity.

(3) There must be adequate time for safe effective planning.

c. Once the tactical assessment has been done and approved by the Air Force, a guide line for CARP markings must be followed. For CDS drops, the point of impact will be at least 200 yards (C-130) and 225 yards (C-144) from the leading edge of the drop zone and centerline for daytime operations, and 250 yards (C-130) and 275 yards (C-141) at night. For personnel drops, the PI will be at least 300 yards from the leading edge of the drop zone and centerline (350 yards at night). For heavy equipment drops, the PI will be at least 500 yards from the leading edge of the drop zone and centerline (550 yards at night).

6-25. AIRDROP/AIRLAND/EXTRACTION ZONE CONTROL LOG

The AMC Form 168 is basically a scorecard for the Air Force. Since the release point is computed by the aircrew on the CARP drop zone, the Air Force must have some documentation of the crew's performance. The DZST leader fills it out.

a. The following is an explanation of the blocks on the AMC Form 168 (Figure 6-15, page 6-41). The individual named in blocks 2,3, or 4 may all be the same person or may be different people.

(1) *Location*. Name and grid coordinates of DZ/LZ/EZ.

(2) *CCT and unit*. Name of combat control team and unit controlling the DZ.

(3) *DZ/LZ/EZ control officer and unit*. Name of the individual and unit controlling the DZ.

(4) *DZ safety officer and unit*. Name of DZ safety officer and unit.

(5) *Legend*. Explanations of abbreviations used on this form.

(6) *Line number*. Each line number on any given DZ mission represents an individual pass over the DZ, even on a multiple aircraft DZ. For example, a three-ship operation uses three lines. No-drop passes should use a line number also, with the remarks column reflecting the reason for the no-drop.

(7) *Unit*. The unit of the flight crew, usually a number designator.

(8) *Call sign*. The correct call sign if you have radio communications with the pilot.

(9) *Pilot/navigator*. Last name and rank of pilot and navigator.

(10) *Type mission*. The letter designator in the legend for the type of mission.

(11) *ETA*. Estimated time of arrival over target; it can be a hard time or a block time.

(12) *ATA/ATD*. Actual time of arrival or departure.

(13) *Strike report*. The strike report yards/clock is the actual purpose of the 168. The DZST leader observes the first parachutist, bundle, or heavy equipment platform from the control center; he uses NVGs at night.

(a) He determines the distance to the first parachute in yards and the clock direction in relationship to the point of impact (12 o'clock is drop heading [magnetic]).

(b) If the first parachute lands within 25 yards of the point of impact, then he puts the letters PI in this block to indicate that a direct hit was made.

(c) If it was impossible to maintain visual contact with the first parachute, especially during multiple aircraft operations, then use an "S" or a "U" (satisfactory or unsatisfactory) to score them. If 90 percent of the

parachutes land on the DZ, then an “S” will be put in this column. If less than 90 percent land on the DZ, then a “U” will be put in this column.

(d) If radio communication is maintained with the drop aircraft, relay the strike reports to the drop aircraft so that the aircrew can make adjustments on following passes over the DZ.

(14) *AL/EX*. For an airland/extraction, enter an “S” or “U” as appropriate

(15) *Surface wind*. Should be the highest wind reading during the 10-minute window for that pass.

(16) *Score method*. Mark which method was used to determine the distance to the first parachute from the PI.

- E = Estimated
- P = Paced
- M = Measured

(17) *Mean effective wind*. If a pilot balloon is used on the DZ, a MEW will be determined and annotated in this block. A MEW is the average wind from the ground to drop altitude. If radio communications are established between you and the aircraft, give this information to the aircrew before the first pass to assist them in calculating their release point.

(a) Time. Note the time the MEW was determined.

(b) Alt: Note what altitude MEW was determined for.

(c) Direction and velocity. The magnetic azimuth to the pilot balloon is measured and the reciprocal heading noted. This will give the MEW direction to be reported. When transmitting the MEW, make sure that the altitude to which it was taken is included. Any indications of erratic winds or wind shears should also be reported at this time.

(18) *Remarks*. Anything pertaining to the DZ operation that can be useful to the Air Force during pilot debriefing.

b. The DZST leader forwards the AMC Form 168 to his air operations officer who in turn submits it through the chain of command to the Air Force representative.

6-26. AIR MEDICAL EVACUATION REQUESTS

The following information is necessary when requesting a MEDEVAC for casualties.

a. **Location.** Grid coordinates will contain the six-digit grid location and be preceded by the 100,000-meter grid identification.

b. **Radio/Frequency/Call Sign.** The frequency and call sign should be that of the radio at the site of the unit requesting the MEDEVAC.

c. **Patient Category of Precedence.** You should be prepared to classify the casualties priority to be evacuated.

(1) *Urgent:* Within 2 hours to save life or limb.

(2) *Priority:* When casualty's medical condition will deteriorate and become urgent within 4 hours.

(3) *Routine:* Requires evacuation, but when patient's condition is not expected to deteriorate for several hours.

(4) *Tactical immediate:* Evacuation needed so as not to endanger tactical mission.

d. **Special Equipment/Emergency Medical Supplies.** List your requirements.

e. **Number and Type of Casualties.** Self-explanatory.

f. **Security of Pickup Site.** Describe conditions of security.

g. **Site Marking.** Describe marking method used.

h. **Patient Nationality and Status.** Self-explanatory.

i. **NBC Contamination Area.** Give location of NBC area.

APPENDIX A

OPERATIONAL FORMATS

The pathfinder operational formats described herein may be used to plan and carry out pathfinder operations. They are intended as guides and should be modified as required.

A-1. OPERATIONAL PLANNING FORMAT

The pathfinder leader uses this format (Figure A-1) in organizing an operation. It consolidates information pertinent to each individual or element, and the leader can use it as a reference during his planning and briefing. The following definitions apply to the format.

- a. **Aircraft Number.** The chalk number or the last three digits of the number on the tail of the aircraft that transports the pathfinders.
- b. **Name.** The names of the pathfinders.
- c. **Load Time.** The time pathfinders are loaded on the aircraft with all of their equipment.
- d. **Takeoff (Lift-Off) Time.** The time the aircraft departs the staging area
- e. **Duty and Location.** The mission assignment and location within the operational area for each pathfinder.
- f. **Call Sign and Frequency.** The radio call sign and frequency for personnel operating radios.
- g. **Equipment.** Equipment other than individual that each pathfinder element will carry.
- h. **Remarks.** Other pertinent information.

CLASSIFICATION									
PATHFINDER OPERATION PLANNING FORMAT									
ACFT NO	NAME	LOAD TIME	TO TIME	DUTY AND LOCATION	CALL SIGN AND FREQUENCY	EQUIPMENT	REMARKS		
NA	HEITER	NA	NA	SECTION CO, STAGE FLD DEKKAR STRIP, GL 934730	11B85 34.50	2-PRC-112 RADIOS 1-DWYER METER 1-AN/PMQ-3A ANEMOMETER	BE PREPARED FOR MIXED TRAFFIC AND NIGHT OPERATIONS UNTIL RELIEVED HOMING BEACON FREQ 1750KC.	SUPPORTED UNIT: 1.188TH INF LIFT UNIT: A/21ST AVN BN ACL: 8 PAX LZ TIME: 31 0600 MAR DACOS: 53 AIR, 1:188TH INF, DFXX STRIP TYPE ACFT: UH-1H ARTY PREP AT LZ MACON AND ALBANY COMMENCES H.20 MIN: LIFTED H.5 MIN. ARTY PREP FIRED FROM GL 035725 CCP: GL 956696 RP: GL 015692 SIGNAL 1.188TH INF, RIGHT HALF 47.00 A/21ST AVN BN, DEADLY SERPENT 38.00 PFDR: DEKKAR CONTROL 34.50 ALBANY CONTROL 40.20 MACON CONTROL 51.30 RESERVE 37.30	
NA	MARSONNER	NA	NA	GTA RATELO, STAGE FLD	11B86R 34.50	3-PRC-113 RADIOS 3-PRC-77 RADIOS 1-AN / PRC 41A			
NA	COFFIN	NA	NA	INTERNAL NET RATELO, STAGE FLD	11B39 66.20	1-AN / TRN 30 (EX 1) 24VS / 17 PANELS			
NA	CASCALASIRA	NA	NA	SIGNALMAN, STAGE FLD	18B67 66.20	35MX / 290 LANTERNS 3 SETS OF BATONS 1-SE / 11 LIGHT GUN 3 COLORED JACKETS EXTRA SMOKE			
NA	LEACH	NA	NA	SIGNALMAN, STAGE FLD	11B29 66.20				
750	PRUITT	0540	0545	SITE CO, LZ ALBANY GL 055713	J7G38 40.20	1-PRC 41A RADIO	ACCOMPANY B 188TH ON MOVEMENT TO CONTACT OPERATION UNTIL COMPLETED	(REFER TO GLOSSARY FOR ACRONYMS)	
750	HODGES	0540	0545	GTA RATELO, LZ ALBANY	J7G38R 40.20	2-PRC77 RADIOS 12 MX290 LANTERNS 1-SE/11 LIGHT GUN 1 SET OF BATONS 6-VS/17 PANELS 8 SMOKE GRENADES			
750	CHURCHY	0540	0545	PATHFINDER, LZ ALBANY	NA				
777	CARTER	0535		SITE CO, LZ MACON GL075720	ASW38 51.30	SAME AS FOR LZ ALBANY			
777	DARGSECK	0535		GTA RATELO, LZ MACON	ASW38R51.30				
777	BOWER	0535		PATHFINDER, LZ MACON	NA				
NA	CARMEL	NA	NA	SITE CO, STANDBY RESERVE VIC DEKKAR STRIP	J4038 37.30		REMAIN WITH C 1 118TH (RESERVE) AT DEKKAR STRIP COMMITTED ON ORDER CALL SIGN WILL CORRESPOND WITH NAME OF LANDING SITE IF RESERVE IS COMMITTED		
NA	KENFIELD	NA	NA	GTA RATELO, STANDBY RESERVE	J4038R 37.30	SAME AS FOR LZ ALBANY			
NA	KEMP	NA	NA	PATHFINDER, STANDBY RESERVE	NA				
NA	CASSIE	NA	NA	NONDUTY	NA				

Figure A-1. Operation planning format.

A-2. LANDING ZONE AND DROP ZONE CONTROL RECORDS

This format may be used to maintain a record of aircraft arrivals, departures, and type loads. It serves as a source of information for both ground and aviation commanders. It aids in accounting for personnel and equipment, and it may be instrumental in initiating or assisting in search-and-rescue operations for overdue or downed aircraft. It is normally maintained by the pathfinder internal radio net(work) operator at the control center (Figure A-2).

PATHFINDER UNIT21 ST AVN BN PATHFINDER SECTION							
SUPPORTED UNIT1. 188TH INF							
PERIOD210001-212400 MARCH							
OPERATION (AFLD LZ, DZ)MASHER							
.(NAME OR LOCATION OF SITE)							
RECORDERPFC ROY S. COBB							

FLT OR ACFT NO	TYPE ACFT	TIME COMM ESTAB	TIME		TYPE LOAD		REMARKS
			ARR	DPRT	DELIVERED	EVAC	
(EXAMPLE FOR AFLD OPERATION)							
S7M50	U-1A	0600	0610	0625	RATIONS	2W1A	
L8M82	U-1A	0605	0615		AMMUNITION		DAMAGED PROPELLER TO DISPERSAL AREA
C6E91	C-123	0610	0620	0635	AMMUNITION	4W1A	
(EXAMPLE FOR DZ OPERATION)							
F1Y11	C-7A	1705	1710		3 BUNDLES AMMO		
T3M34	U-6A	1715	NA				ABORTED 2 MILES OUT
B6M78	U-6A	1720	1725		3 BUNDLES RATIONS		
(EXAMPLE FOR HELICOPTER DZ OPERATION)							
A2Y41	UH-1D	1230	1235	1236	PERSONNEL		CONTACTED CONTROL CENTER WITH A FLIGHT OF FOUR
D3S32	UH-1D	1230	1235	1236	PERSONNEL		
E4C23	UH-1D	1230	1235	1236	PERSONNEL	4W1A	
H1Y14	UH-1D	1230	1235	1236	MORTAR AMMO		
J1P67	CH-47	1245	1250	1252	AMMUNITION		
E9A21	CH-54	1300	1305	1307	NA	1 UH-1D	

(Refer to glossary for acronyms)

Figure A-2. LZ and DZ control record (sample extract).

a. **Format Headings.**

- (1) *Pathfinder unit.* Code or number designation (or F7 personnel).
- (2) *Supported unit.* Principal ground unit or aviation unit designation.
- (3) *Period.* Date and time operation commences until termination of operation or end of the day; 0001 until 2400 hours on succeeding days or until completion of operation.

(4) *Operation (AFLD, LZ, DZ).* Name or number of operation. Cross out items not applicable and add any special designation used.

- (5) *Recorder.* Name of person who records data on the form.

b. **Column Headings.**

- (1) *Flight or aircraft number.* Radio call sign of the flight or aircraft.
- (2) *Type aircraft.* Army or Air Force model designation.
- (3) *Time communication established.* Time aircraft acknowledges contact (radio and/or visual, as applicable).
- (4) *Time.* Arrival time of aircraft or when first of flight lands; departure time of aircraft or when last of flight clears the ground.
- (5) *Type load.* Delivered (supplies, equipment, or personnel); evacuated (supplies, equipment, or personnel).

A-3. TROOP LEADING PROCEDURES

Upon receipt of an order to conduct a pathfinder operation, the pathfinder leader follows, to the extent possible, the following troop leading procedures.

a. Issue section warning order, including the following.

- (1) Roll call.
- (2) A brief statement of the enemy and friendly situations.
- (3) The mission.
- (4) Chain of command and section structure.
- (5) Individual uniform and equipment (if not in SOP).
- (6) Equipment required.
- (7) Time schedule to complete work priorities with place, time, and personnel to be present.
- (8) Specific instructions and attached personnel.
- (9) Time hack.

b. Make tentative plan of operation, including the following.

- (1) Study map.
- (2) Check weather.
- (3) Study unit SOP.
- (4) Make a quick estimate of the situation: additional personnel needed from supported unit; additional equipment of materiel needed; communication requirements.
- (5) Begin planning.

- c. Arrange for movement and coordination, including the following.
 - (1) Movement of unit (inform second in command).
 - (2) Coordination (with ground and aviation units): ground tactical plan; landing and unloading plan; air movement plan; loading plan, additional personnel or equipment, if any, from supported unit.
- d. Prepare tentative operation plan, including the following.
 - (1) Reconnoiter when time permits (map, ground, air).
 - (2) Continue estimate and receive recommendations.
 - (3) Complete plan (work out details, formulate orders); present tentative plan to supported unit commander or his staff; prepare final plan based on desires of supported unit commander and his final order.
 - (4) Issue section order (normally an oral order).
 - (5) Join supported unit.
 - (6) Rehearse and inspect (if time and terrain permit).

APPENDIX B

ARMY HELICOPTER SPECIFICATIONS

To enable pathfinders to assist in the selection of landing sites, they must be familiar with the dimensions of Army aircraft that may be employed in US Army active and reserve aviation units. The following nine figures depict helicopters that are currently in the Army's inventory.

B-1. OBSERVATION HELICOPTERS

See Figures B-1 and B-2(pages B-2 and B-3.)

SPECIFICATIONS

Rotor diameter 35'

Length:

Rotors operating 42' 2"

Blades removed 33' 10"

Height: To top of turret 12' 9 1/2"

Tread of skids 6' 2"

Main rotor;

Disk area 962 square feet.

Blade area .. 38.26 square feet.

Cleared area needed

for rotors 12.5 meters

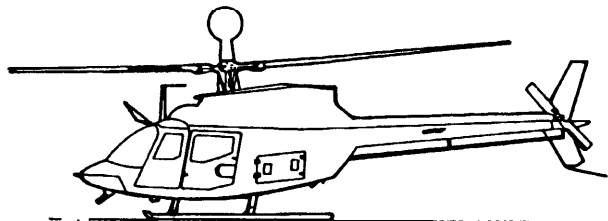
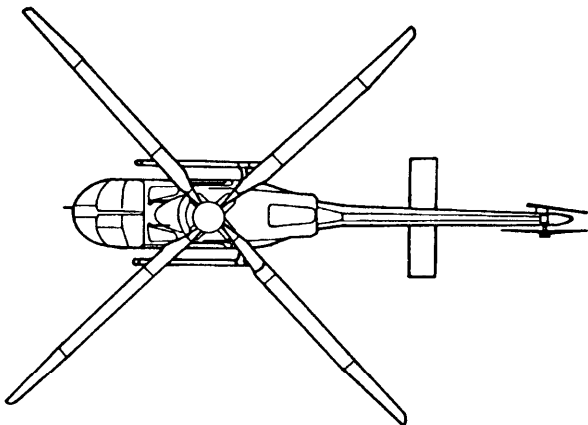
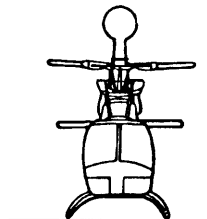

Figure B-1. OH-58D (Kiowa).

SPECIFICATIONS

Rotor diameter.....26' 4"
 Length:
 Rotor operating.....39' 3 3/4"
 Rotor folded22' 9 1/2"
 Height8' 9"
 Tread.....6' 3"
 Cleared area needed
 for rotors..... 9.3 meters

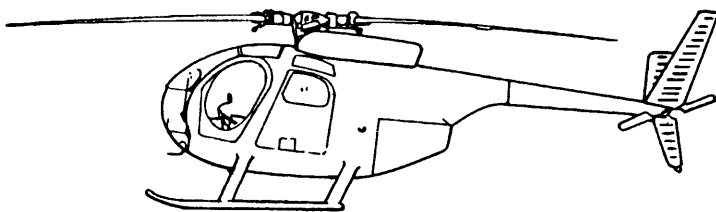
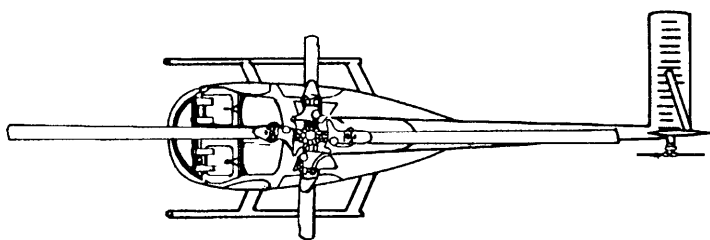
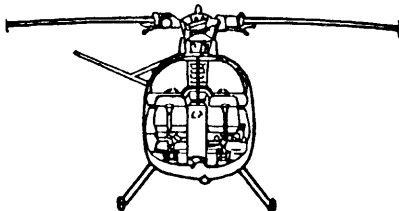

Figure B-2. OH-6A (Cayuse).

B-2. ATTACK HELICOPTERS

See Figures B-3 and B-4.

SPECIFICATIONS

Rotor diameter..... 44' 0"
Length:
 Rotors operating 53' 1"
 Fuselage 44' 9"
Span
 (maximum lateral) 11' 8"
Height..... 11' 7"
Tread 7'
Rotor ground clearance
 (static)..... 7'10"
Cleared area needed
 for rotors..... 16.18 meters

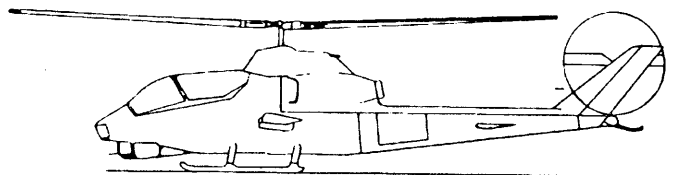
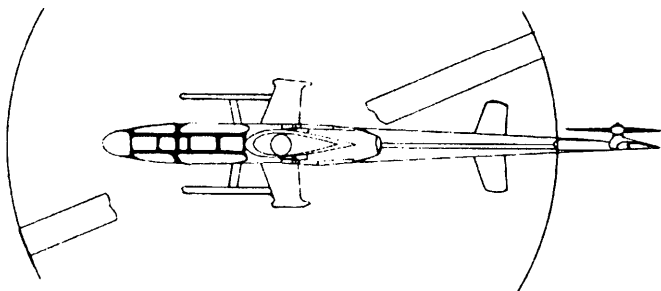
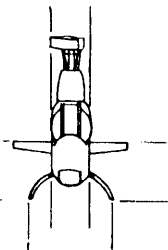

Figure B-3. AH-1S (Cobra).

SPECIFICATIONS

Rotor diameter 48'
 Length:
 Rotors operating 58' 3 1/8"
 Rotors static 57' 4"
 Fuselage 48'
 Span
 (maximum lateral) 3.96'
 Height 15' 3 1/2"
 Cleared area needed
 for rotors 17.9 meters

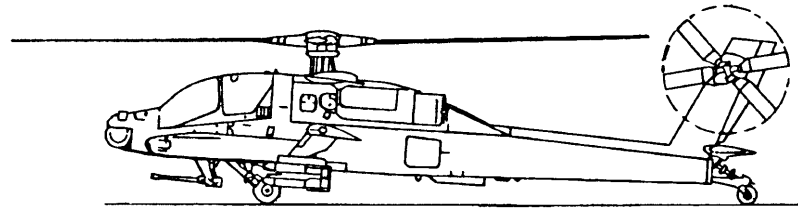
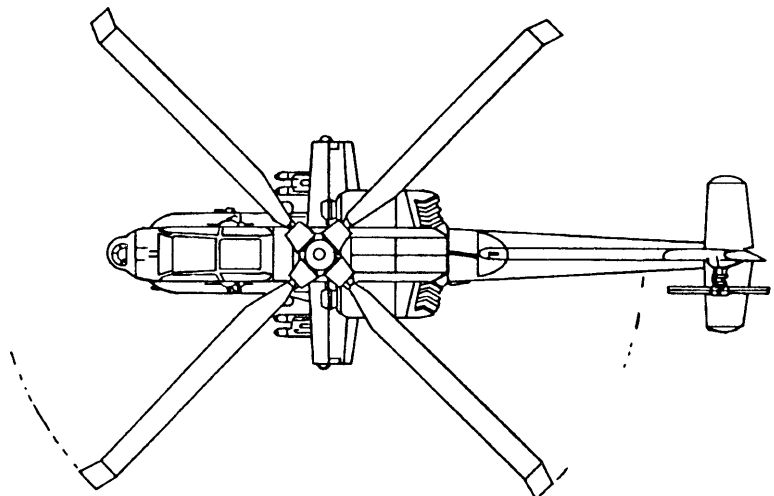
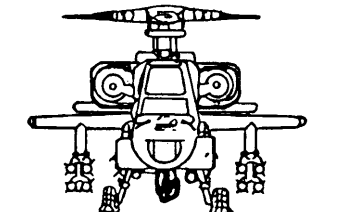

Figure B-4. AH-64A (Apache).

B-3. UTILITY HELICOPTERS

See Figures B-5 and B-6.

SPECIFICATIONS

Rotor diameter..... 48'
Length:
 Rotors operating 57' 1"
 Rotors static..... 57' 1"
 Fuselage..... 41' 10 3/4"
Span
 (maximum lateral) 9' 4"
Height..... 14' 6"
Tread 8' 6 1/2"
Ground Clearance
 (static, against stops) 6' 6"

Cleared area needed
 for rotors..... 17.4 meters

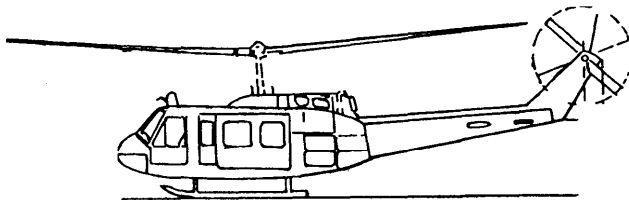
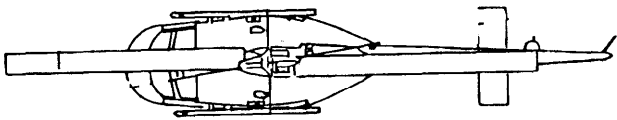
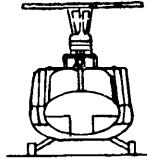

Figure B-5. UH-1H (Iroquois).

B-6

SPECIFICATIONS

Rotor diameter53' 8"
 Length:
 Rotors operating.....64' 10"
 Rotors static.....64' 10"
 Fuselage.....50' 7 1/2"
 Span
 (maximum lateral) 9' 8 1/2"
 Height16' 5"
 Tread..... 8' 10 1/2"
 Ground Clearance
 (static, against stops).....8' 9"

Cleared area needed
 for rotors 19.5 meters

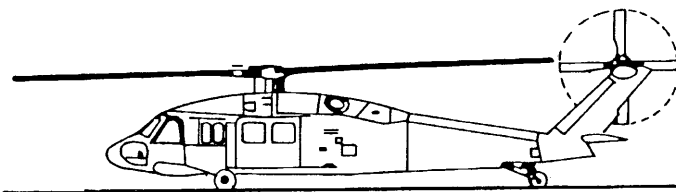
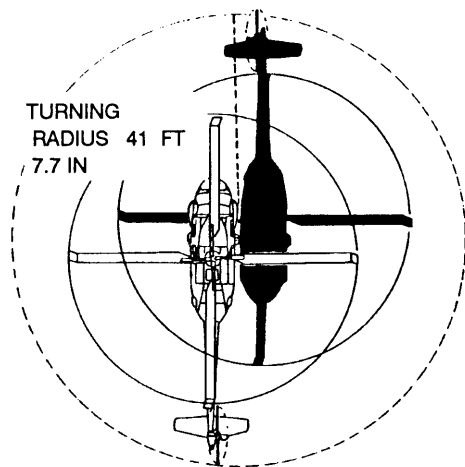

Figure B-6. UH-60A (Black Hawk).

B-4. CARGO HELICOPTERS

See Figures B-7 through B-9.

SPECIFICATIONS

Rotor diameter60'
 Length:
 Rotors operating..... 98' 10 3/4"
 Rotors folded50' 9"
 Height (overall) 18' 11 1/2"
 Tread..... 11' 11"
 Rotor ground clearance:
 Static forward.....7' 4 3/4"
 Idling forward10' 11"
 Cleared area needed
 for rotors30.4 meters

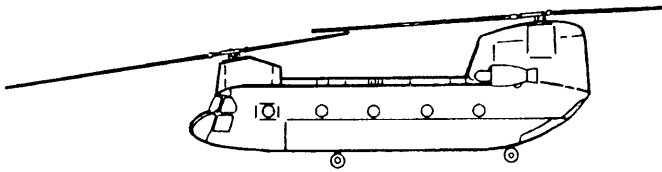
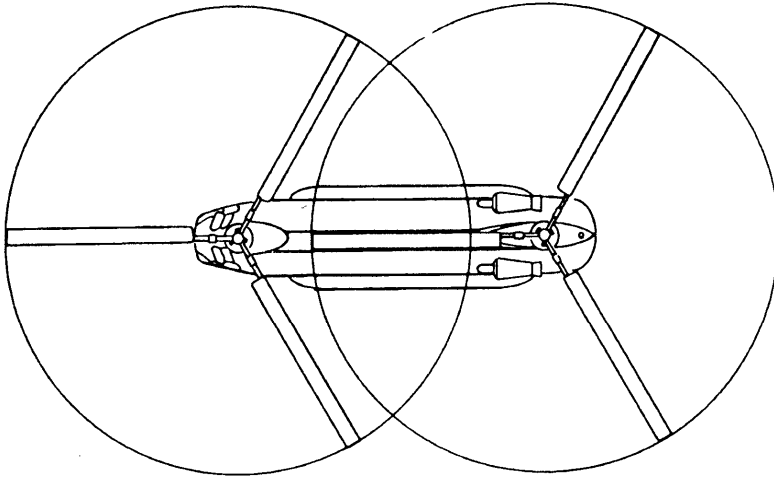
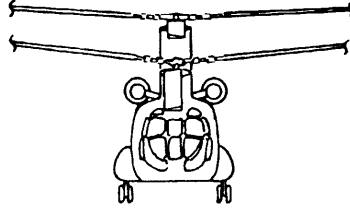

Figure B-7. CH-47B/C (Chinook).

SPECIFICATIONS

Rotor diameter 60'
 Length:
 Rotors operating 98' 10 3/4"
 Rotors folded 51'
 Fuselage 51'
 Height (overall) 18' 7 13/16"
 Tread 11' 11"
 Rotor ground clearance:
 static forward 7' 10 5/8"
 Idling forward 11' 7/8"
 Cleared area needed
 for rotors 30.4 meters

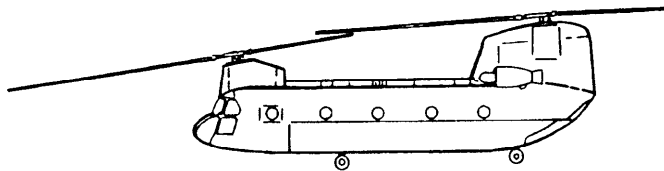
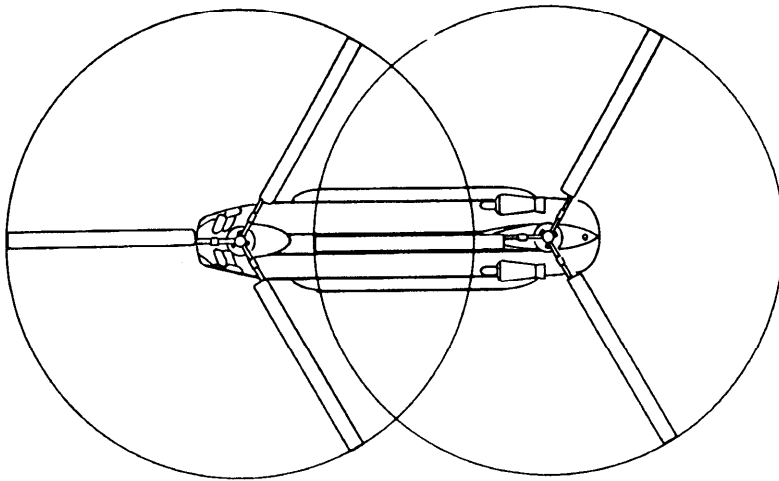
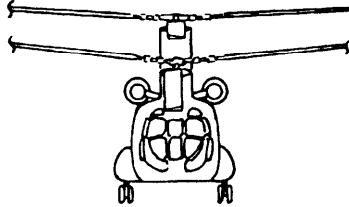

Figure B-8. CH-47B/D (Chinook).

SPECIFICATIONS

Main rotor diameter72'
 Length:
 Rotors operating..... 88' 6"
 Fuselage 70' 3"
 Height (static) 25' 5"
 Width (cockpit)..... 7' 7"
 Tread..... 21' 10"
 Ground clearance:
 Main rotor (idling)..... 15' 8"
 Tail rotor.....9' 4"
 Cleared area needed
 for rotors27.2 meters

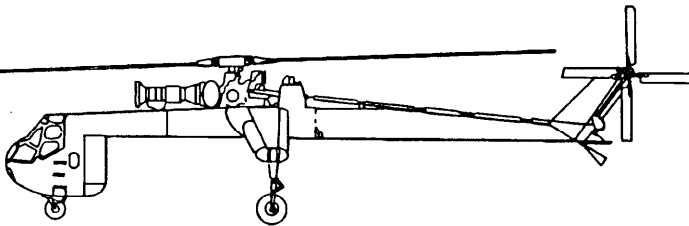
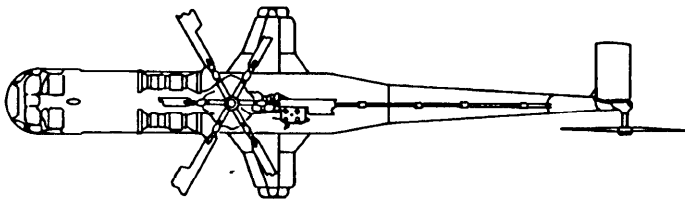
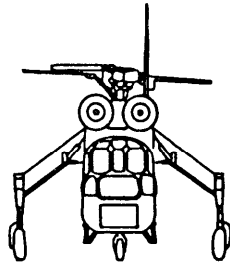

Figure B-9. CH-54B (Tarhe).

GLOSSARY

accompanying load—cargo suspended below a slingload, such as a cargo net carried beneath a howitzer

ACL—allowable cargo load

ACP—air control point

ADS—air defense sector

AFB—Air Force base

a fld—airfield

aft—toward the rear, behind, or toward the tail of the aircraft

aft cargo hook—cargo hook located aft of the center or main cargo hook

AGL—above ground level

AH—attack helicopter

AL—airland

ALO—air liaison officer

alt—altitude

AM—amplitude modulation

AMC—Air Mobility Command (replaces MAC)

AN/PRC—Army-Navy/portable radio component

apex fitting—the uppermost point (clevis, shackle, ring, or loop) that gathers the sling tension members and attaches to the cargo hook

apex fitting pin—a headed pin that extends through the two ends of the apex fitting clevis and is retained in place by a bolt and nut

apex fitting spacer—hourglass-shaped bushing that fits over the apex fitting pin, causing the apex fitting to stay centered on the cargo hook

apex ring—see apex fitting

apex shackle—see apex fitting

apex shackle fitting—see apex fitting

approach azimuth—direction of the aircraft approach to the landing point, usually expressed in degrees and measured clockwise from a reference point

ATA—actual time of arrival

ATC—air traffic controller

ATD—actual time of departure

AWADS—all-weather aerial delivery system

AZAR—assault zone availability report

basket hitch—type of attachment in which a flat web nylon strap is formed in the shape of the letter “U” with the two ends connected side by side

basket leg—the cable on a pallet sling that encircles the load

becket—a short length of rope with an eye on one or both ends, used to secure items such as eyelets or coils of rope

bight—a formed loop in a rope or cable

breakaway technique—using material with a low breaking strength, such as tape or cotton webbing, to temporarily restrain the sling equipment from becoming entangled on the load as the helicopter puts tension on the sling

breaking strength—(tensile strength) resistance to breaking, commonly measured in pounds

brownout—loss of orientation with respect to the horizon, caused by blowing sand, dust, or dirt

CA—combat assault

cable-suspended external cargo sling system—cargo hook attached to the bottom of the fuselage by a system of cables

cargo hoist—a device used to raise, lower, or winch cargo

cargo hook—suspension hook device on which the apex fitting is placed to transport an external load

cargo hook keeper—spring-loaded device used to prevent the apex fitting from sliding off the cargo hook load beam

cargo hook loading pole (shepherd’s hook)—a pole with a hook on one end used by the aircrew member to pick up the apex fitting and connect it to the cargo hook. Used for loads when the hookup team cannot stand on top of the load

cargo net—meshed arrangement of straps or cords that have been knotted or woven together at regular intervals and used to transport supplies and equipment

cargo sling—consists of multiple tension members which when properly rigged enable cargo and equipment to be suspended under a helicopter

cargotainers—pallets with wire mesh sides that fold down for compact storage

CARP—computed air release point
castle nut—hexagon-shaped nut with a slot in each of the six sides and secured in place by a cotter pin
CC—control center
CCP—communications checkpoint
CCT—combat control team
CDS—container delivery system
cellulose—cushioning or padding material used to protect the load or sling legs
center (main) cargo hook—cargo hook located in the center of the helicopter
center of balance—location about which an item would balance if it were possible to support the load at that point
center of gravity—see center of balance
centerline—an imaginary line that extends lengthwise and bisects the bottom of the helicopter fuselage
CG—center of gravity
CH—cargo helicopter
chemlite—plastic tube filled with a liquid chemical and a glass vial that when activated produces a glowing light
choker hitch—knot formed by placing a strap or cord around an item and passing the free end of the strap or cord through the loop formed by the other end
clevis—a U-shaped yoke device with a bolt or pin through the two ends
connector link—metal link device that joins the ends of a nylon web loop together, such as used on the web ring of the 15,000-pound capacity multileg sling
constant power—the point at which a helicopter engine produces a fixed level of performance
CONUS—continental United States
DF—direction finding
down wash—(rotor wash) high velocity of air movement under a hovering helicopter
dual-point load—cargo or equipment rigged and suspended from two cargo hooks
DZ—drop zone
DZSO—drop zone safety officer
DZST—drop zone support team

DZSTL—drop zone support team leader

ECCM—electronic counter countermeasures

end bar—the removable side of a connector link

ETA—estimated time of arrival

EX—extraction

exit path—the track or course of an aircraft departing the landing point

external air transport—movement of supplies or equipment that is rigged and suspended from a helicopter cargo hook

external load—consists of supplies or equipment properly rigged with either one or more slings, cargo bags, or cargo nets

eye sock—loop formed at both ends of a sling leg

EZ—extraction zone

field expedient drogue device—device locally fabricated and connected to an external load whose purpose is to increase the stability of the load

field expedient pendants—individual slings or sling legs used as a vertical riser or pendant

field expedient static discharge wand—a device fabricated from readily available material for the purpose of discharging the static electric charge from the helicopter

FLA—frontline ambulance

flat web nylon—flat nylon strap or sling fabricated in either concentric loops or single lengths

floating web keepers—see sliding keepers

FM—frequency modulation

fore—forward or front

forward cargo hook—cargo hook located forward of the center or main cargo hook

forward slope—ground whose surface forms an upward angle or incline with the horizon

free-swinging cargo hook—cargo hook attached to the end of a pendant or cable instead of attached directly to the helicopter fuselage

fuselage—central body portion of a helicopter designed to accommodate the crew, passengers, and cargo

GA—Georgia

GAIL—glide angle indicator light; a device that emits a three-color light beam that indicates a safe glide path over approach obstacles onto a landing site

glide path angle—approach angle of the helicopter to the landing point

GMRS—ground-marked release system

ground crew—personnel on the ground involved with preparing and rigging loads, guiding the helicopter, and connecting the load to the helicopter

GSI—glide slope indicator

GTA—ground-to-air

GUC—ground unit commander

gwt—gross weight

HAHO—high altitude high opening

HALO—high altitude low opening

HEAT—helicopter external air transport

HLZ—helicopter landing zone

HMMWV—high-mobility, multipurpose, wheeled vehicle

immediate mission—a task or support that arises during the course of a battle and which by its nature cannot be planned in advance

JATT—joint air attack team

JP—jet petroleum

keeper—a device that keeps something in position, such as a chain link in the grabhook or an apex fitting on the helicopter cargo hook

KIA—knots indicated airspeed

knotless nylon cord cargo net—cargo net manufactured from braided nylon cord joined by a knotless intersection method

landing point—a point within a landing site where one helicopter can land

landing site—a site within a landing zone that contains one or more landing points

landing zone—any specified area used for the landing of aircraft

lanyard—a short piece of rope or cable used to fasten something or an extension of a shorter device

lashing strap—flat web nylon strap with a D-ring on one end

latch bar—the movable top part of the pallet sling tensioner

lateral slope—ground whose surface forms an angle oriented from either right to left or left to right with the horizon

lifting eye—loop in a cable, rope, or other device used to lift an object

lifting leg hook—hook on the end of a sling leg, usually used with a hoisting sling

lifting point/lifting provision—an integral part of the equipment, commonly called a lug, eye, shackle, or ring, that provides a means of attaching a sling for safe lifting

lifting shackle—ring or clevis that provides a means of attaching sling for safe lifting

LIN—line item number

load beam—structural member of the cargo hook that supports the weight of the external load

load binders—locking device used to tighten and secure lashing straps

load oscillation—back and forth movement of an external load

locking detent—slot in the pallet sling tensioner stirrup that engages the release knob bar assembly on the latch bar

low-response external cargo sling system—cargo hook attached to a suspension frame below the fuselage by a system of cables and pulleys

lunette—towing eye on the trailer drawbar

LZ—landing zone

MAC—military airlift command (superseded by AMC).

main cargo hook winch—mechanical drum with a cable attached to raise and lower the cargo hook

manual release knob or lever—lever, knob, or other device that when actuated by either the ground crew or aircrew member causes the cargo hook to open

max—maximum

MEDEVAC—medical evacuation

METT-T—mission, enemy, terrain, troops, and time available

MEW—mean effective wind

min—minimum

Mk86 (mark 86)—designation given to the pallet sling that can accommodate a pallet load 29 to 40 inches high

Mk100 (mark 100)—designation given to the pallet sling that can accommodate a pallet load 48 to 70 inches high

MOGAS—motor gasoline

Glossary-6

multileg-pole pendant—reach pendant with one or more removable sling legs

NAVAID—navigation aid

NBC—nuclear, biological, and chemical

NCO—noncommissioned officer

night vision goggles—image intensification device which improves visibility in low light situations by amplifying the available light

NJ—New Jersey

no-load condition—situation during which there is no tension in the sling legs

no-sew fitting—a web keeper secured in place by a locking fork

NSN—national stock number

NVD—night vision devices

nylon donut—ring formed from joining two ends of a flat, web-nylon strap using a Type IV link or two-point link connector

oscillate—swing back and forth like a pendulum

pendant—high-strength sling constructed of multiple plies of nylon webbing with a remotely operated, manually released, full 360-degree releasable swivel hook

pendant cargo hook—cargo hook that is connected to the end of a strap and suspended below the fuselage

permanent keeper—a web keeper that encircles all of the loops of a nylon web strap and is either sewn or otherwise retained in place

PI—point of impact

PIBAL—pilot balloon

pickup zone—landing site designated where passengers or cargo are picked up

piggyback load—cargo suspended below a slingload, such as a cargo net carried beneath a howitzer

POL—petroleum, oils, and lubricants

port side—left-hand side looking forward

preplanned mission—a task or support in accordance with a program planned in advance of the operation

PSP—perforated steel planking

PZ—pickup zone

quick-fit strap fasteners—metal V-shaped device with a double bar and a friction grip crossbar used with lasing straps

RAM—raised angle marker

reach pendant—braided fabric rope assembly with an attached stiffened reach tube and a loop on each end

reach tube—length of tubing that encases the braided rope portion of a reach pendant

receiving unit—unit receiving the transported supplies and equipment

relative humidity—the ratio of absolute humidity to the maximum possible density of water vapor in the air at the same temperature

rendezvous point—a clearly defined and visible point or assembly area for the ground crew during helicopter operations

retainer strap—nylon web loop interwoven on the web ring of the 15,000-pound capacity multileg sling that retains the sling legs on the lower part of the web ring

retention pins—metal devices used to secure objects such as clevises or shackles to the vehicle frame

rope lay—individual grouping of wire strands woven or twisted together, which when braided together form a cable

rotor wash—see down wash

RP—release point

safe working load—the maximum capacity of a lifting device used in helicopter external load operations

SATB—standard Army training bundle

signal man—a member of the ground crew who communicates with the pilot by means of arm-and-hand signals

SINCGARS—single-channel ground and airborne radio system.

single-point load—cargo or equipment rigged and suspended from one cargo hook

SKE—station-keeping equipment

sliding keeper—a web keeper located near the ends of a flat web strap that encircles all of the loops and acts as a cinch

sling leg—individual tension member of the sling set

sling load—consists of supplies or equipment properly rigged with either one or more slings, cargo bags, or cargo nets

sling-to-clevis attachment—connecting a flat web nylon strap to a lift provision by means of inserting a clevis through the loop on the end of the strap and attaching the clevis to the provision

SOI—signal operation instructions

Glossary-8

SOP—standing operating procedures

spreader bar—device that prevents the sling legs from bearing against the load, which could cause damage

STANAG—standardization agreement

starboard side—right-hand side looking forward

static discharge wand crewman—member of the ground crew responsible for discharging the static electricity from the helicopter

static electricity—electrical charge produced and stored in the helicopter fuselage while in flight

supported unit—unit requesting the mission to transport supplies and equipment

swage stops—short lengths of metal tubing crimped on the pallet sling cables

tandem load—external load consisting of two pieces of equipment joined together, such as a prime mover and a howitzer

tensioner—locking device on the pallet sling cables used to adjust the overall length of the cable

tensioner stirrup—the fixed body of the pallet sling tensioner

tie-down provision—an integral part of the equipment commonly called a lug, eye, shackle, or ring that provides a means of attaching a hook, strap, or cable to restrain equipment during shipment

tie-down strap—device consisting of a flat web nylon strap with hooks on one or both ends and a ratchet device used to secure items

TM—technical manual

TOT—time on target

touchdown hover—helicopter landing with only part of the landing gear positioned on the ground

TOW—tube-launched, optically tracked, wire-guided missile

TSC—training support center

TTB—tactical training bundle

two-point link connector—device used to connect two ends of a flat web nylon strap together

Type III nylon cord—thin rope made of several strands of Type III nylon woven together

Type IV link connector—device used to connect two ends of a flat web nylon strap together

Type X nylon aerial delivery sling—sling consisting of two, three, or four consecutive loops of Type X nylon webbing

Type XXVI nylon multiloop line—sling consisting of two or more consecutive loops of Type XXVI nylon webbing

UH—utility helicopter

UHF—ultra-high frequency

USAF—United States Air Force

USMC—United States Marine Corps

VAPI—visual approach-path indicator

vertical pendant—a high-strength sling or strap used to increase the clearance between the helicopter and the load

vertical riser—a suspension member oriented in a vertical direction

VIRS—verbal initiated release system

VHF—very-high frequency

VMC—visual meteorological conditions

V-shaped approach path—the area within a designated arc or sector measured outward from the center of the landing point

web ring—the apex fitting of the 15,000-pound capacity, multileg sling set

web ring connector bar—metal connecting link that joins the two ends of the web ring strap on the 15,000-pound capacity, multileg sling

web ring strap—nylon web loop that forms the web ring on the 15,000-pound capacity, multileg sling

whiteout—loss of orientation, with respect to the horizon, caused by blowing snow, by the sun reflecting on the snow, or by an overcast sky

windchill factor—the cooling effect of moving air

REFERENCES

SOURCES USED

These are the sources quoted or paraphrased in this publication.

Army Publications

FM 21-60. *Visual Signals*. 30 September 87.

FM 24-18. *Tactical Single-Channel Radio Communication Techniques*. 30 September 87.

FM 34-40. *Electronic Warfare Operations*. 9 October 87.

FM 55-450-3. *Multiservice Helicopter External Air Transport Basic Operations and Equipment*. 11 February 91.

FM 55-450-4. *Multiservice Helicopter External Air Transport: Single-point Rigging Procedures*. 11 February 91.

TM 9-1370-206-10. *Operator's Manual: Pyrotechnic Signals*. 31 March 91.

Air Force Regulations

MACR 55-60. *Assault Zone Procedures*. 14 May 90.

DOCUMENTS NEEDED

These documents must be available to the intended users of this publication.

AMC Form 168. *Airdrop/Airland/Extraction Zone Control Log*.

AMC Form 339. *Drop Zone Survey*.

FM 57-230. *Advanced Parachuting Techniques*. 13 September 89.

FM 90-2. *Battlefield Deception*. 3 October 88.

FM 90-3. *(HTF)Desert Operations (How to Fight)*. 19 August 77.

FM 90-4. *Air Assault Operations*. 16 March 87.

FM 90-5. *(HTF)Jungle Operations (How to Fight)*. 16 August 82.

FM 90-6. *Mountain Operations*. 30 June 80.

FM 100-26. *The Air-Ground Operations System*. 30 March 73.

- FM 100-27. *US Army/US Air Force Doctrine for Joint Airborne and Tactical Airlift Operations*. 31 January 85.

- QSTAG 585. *Marshaling Helicopters in Multinational Land Operations*. 23 April 81.
- STANAG 2863 *Navigational and Communication Capabilities for Helicopters in Multinational Land Operations*. 26 September 88.
- STANAG 3117 *Aircraft Marshaling Signals*. 17 October 85.
- STANAG 3281 *Personnel Locator Beacons*. 3 April 78.
- STANAG 3570 *Drop Zones and Extraction Zones—Criteria and Markings*. 26 March 86.
- STANAG 3619 *Helipad Marking*. 10 July 80.

INDEX

- aerial delivery slings, 5-2, 5-4 thru 5-10 (illus)
- air control points, 4-21
- Air Force Computed Air Release Point (CARP), 6-31
- Air Force Verbal Initiated Release System (VIRS), 6-30, 6-31
- air medical evacuation requests, 6-42
- air traffic control communication
 - format, 3-2
 - numbers, 3-3
 - phrases, 3-4
 - safety, 3-1
 - terminology, 3-5, 3-6, and glossary
 - visual signals, 3-13, 3-14 (illus)
 - voice control, 3-1, 3-2
- AMC Form 168, 6-39 thru 6-41
- AMC Form 339, 6-35 thru 6-37
- anemometer, AN/PMQ 3A, 6-14
- approach path considerations
 - escape routes, 4-33
 - obstacles, 4-33
 - position of the sun, 4-34
 - terrain contour, 4-33
 - vertical air currents, 4-33
- Army Verbal Initiated Release System (VIRS), 6-28, 6-29, 6-30 (illus)
- artillery displacement
- assault zone availability report (AZAR), 6-35
- assaults
 - daylight, 2-6, 4-17
 - night, 2-7, 4-11 thru 4-18 (illus)
- assembly aids, 1-3

- cargo hooks, 5-11 thru 5-13 (illus)
- cargo straps, 5-6
- cargo tiedowns, 5-6
- communications checkpoint, 4-20
- communications equipment, 1-3

- communications security
 - combatting enemy DF systems, 1-4, 1-5
 - enemy interception, 1-4
 - pathfinder awareness, 1-4
- communications, GTA, 2-9, 2-10, 3-13 thru 3-20, 4-8, 4-9
- control center, 4-8, 4-9, 6-20, 6-21
- control log, 6-39, 6-40, 6-41 (illus)

- distress marker, aerial, 6-15
- drift scale, 6-16
- drop zone support team
 - coordination checklist, 6-17 (illus)
 - equipment, 6-14
 - mission, 6-14
 - organization, 6-14
 - support requirements, 6-18
 - team leader's duties, 6-19, 6-20
- drop zone survey, 6-35, 6-36 (illus), 6-37 (illus)
- drop zones selection factors
 - access, 6-6
 - airdrop airspeed, 6-1, 6-2 (illus)
 - approach and departure routes, 6-13
 - delivery method, 6-4
 - drop altitude, 6-2, 6-3, 6-4 (illus)
 - obstacles, 6-5 (illus)
 - size, 6-6, 6-7 (illus), 6-8 thru 6-13
 - time requirement estimation, 6-4
- DZ and LZ control records, A-3 (illus), A-4, A-5

- employment
 - capabilities, 1-2
 - limitations, 1-2, 1-3
 - primary, 1-1
 - secondary, 1-2

environmental considerations

cold weather, 4-25, 4-26 (illus) thru 4-28

desert terrain, 4-30, 4-31

jungle terrain, 4-29

mountains, 4-31 thru 4-33

equipment

assembly aids, 1-3

communications gear, 1-3

miscellaneous, 1-4

navigation aids, 1-3

extraction, 2-7

forward throw, 6-13 (illus)

ground-marking release system, 6-23, 6-24 (illus), 6-25 (illus), 6-26, 6-27 (illus)

ground-to-air communication, 2-9, 2-10, 3-13 thru 3-20

GTA radio, 4-21

helicopter specifications, all illustrated

AH-1S (Cobra), B-4

AH-64A (Apache), B-5

CH-47B/C (Chinook), B-8

CH-47B/D (Chinook), B-9

CH-54B (Tarhe), B-10

OH-58D (Kiowa), B-2

OH-6A (Cayuse), B-3

UH-1H (Iroquois), B-6

UH-60A (Black Hawk), B-7

high-threat environment

air routes, 2-12 (illus), 2-13

control, 2-11

flight altitudes, 2-12

navigation, 2-11

tactical instrument flights, 2-11

weather variances, 2-11

hitches, 5-3

horizontal clearance, 6-27 (illus)

insertion

- by helicopter, 2-5
- by land, 2-6
- by parachute, 2-5
- by staying behind, 2-6
- by water, 2-5, 2-6

intercept heading, 4-19 (illus)

internal net recorder, 4-22

landing site

- communications, 4-10
- flight formations, 4-10
- lighting, 4-17
- obstacle marking, 4-11 thru 4-17 (illus)
- personnel, 4-9, 4-10

landing zone selection considerations

- alternate sites, 4-5
- approach and departure directions, 4-3
- density altitude, 4-3
- formations, 4-1, 4-2 (illus)
- ground slope, 4-3, 4-4 (illus)
- landing points, 4-5, 4-6, 4-7 (illus)
- loads, 4-3
- obstacles, 4-5
- prevailing wind, 4-3
- space requirements, 4-1
- surface conditions, 4-3

landings

- advisory service, 3-9, 3-10
- final instructions, 3-12
- landing site party, 4-9
- separation requirements, 3-12, 3-13 (illus)
- taxiing instructions, 3-12

- traffic patterns, 3-7, 3-8 (illus)
 - entry methods, 3-8, 3-9
 - extension of, 3-11 (illus)
 - legs, 3-9
 - spacing, 3-10
 - turnout, 3-10, 3-11 (illus)
- light baton, (M-2), 6-15
- light gun, SE-11, 6-15
- light marker, ground obstruction, 6-14
- load limitations, aircraft (ACL), 5-11
- LZ and DZ control records, A-3 (illus), A-4, A-5

- mean effective wind, 6-10
- metal air items, 5-6
- mirror, signalling, 6-15

- navigation aids
 - electronic, 1-3
 - infrared, 1-3
 - visual, 1-3
- nets and containers, 5-4
- night operations
 - external loads, 4-24
 - multi-helicopter operations, 4-24
 - night vision goggles, 4-24
 - tactical landing lights, 4-22, 4-23 (illus)

- operational planning formats, A-1, A-2 (illus)

- pilot balloon (PIBAL), 6-10, 6-11, 6-12 (illus), 6-15

planning

- coordination, 2-2, 2-3
- final preparations, 2-4
- initial preparation, 2-1
- liaison, 2-2
- linkup, 2-4
- reorganizing, 2-2
- security, 2-2

procedures, hookup and release

- emergency conduct, 5-22
- equipment, 5-18 thru 5-20 (illus)
- ground crew duties, 5-22 5-25 (illus)
- measures, 5-21

radio, AN/PRC-119A or SINCGARS, 6-16

radio, PRC-113, 6-16

raised angle marker (RAM), 6-15, 6-31, 6-32 (illus)

release point, 4-8, 6-21, 6-22 (illus)

rigging supplies, 5-15

security personnel, 4-22

shape designator, 6-31, 6-33 (illus)

signal lights, 3-14 (illus)

sling load theory, 5-16 thru 5-18

sling sets

- coupling link, 5-9 (illus)
- grabhook, 5-10 (illus)
- large capacity, 5-8 (illus)
- multi-leg, 5-7 (illus)
- numbering sequence, 5-10 (illus)

slingloads

- equipment, 5-2 thru 5-10 (illus)
- landing points, 5-1
- types of loads, 5-1
- unit responsibilities, 5-1, 5-2

staging areas, 2-8

support of ground operations

Air Force, 2-8

Army aviation, 2-8

GTA communications, 2-9 (illus), 2-10, 3-13 thru 3-20, 4-8

mixed operations, 2-9

terminal guidance, 2-10

surface wind, 6-10

tactical assessment, 6-38

team, pathfinder

capabilities, 1-2

duties, 1-1

limitations, 1-2, 1-3

makeup, 1-1

training, 1-5

visual navigation aids, 4-22

VS-17 panel marker, 6-14

warning order, 2-1

weights, standard

artillery equipment, 5-14

POL, 5-15

vehicles, 5-14

Whelen light, 6-15

By Order of the Secretary of the Army:

Official:

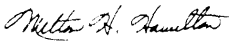
MILTON H. HAMILTON
Administrative Assistant to the
Secretary of the Army

03874

GORDON R. SULLIVAN
General, United States Army
Chief of Staff

DISTRIBUTION:

Active Army, USAR, and ARNG: To be distributed in
accordance with DA Form 12-11E, requirements
for FM 57-38, Pathfinder Operations (Qty rqr block
no. 0401