

Headquarters,
Department of the Army

By Order of the Secretary of the Army:

DENNIS J. REIMER
General, United States Army
Chief of Staff

Official:

JOEL B. HUDSON
Administrative Assistant to the
Secretary of the Army

DISTRIBUTION:

Active Army, Army National Guard, and US Army Reserve: To be distributed in accordance with the initial distribution number 115747, requirements for FM 5-170.

Change 1

Headquarters
Department of the Army
Washington, DC, 13 July 1998

Engineer Reconnaissance

1. Change FM 5-170, 5 May 1998, as follows:

Remove Old Pages

5-31 through 5-34

References-1 and References-2

Insert New Pages

5-31 through 5-34

References-1 and References-2

2. A bar (I) marks new or changed material.
3. File this transmittal sheet in front of the publication.

DISTRIBUTION RESTRICTION: Approved for public release; distribution is unlimited.

By Order of the Secretary of the Army:

DENNIS J. REIMER
General, United States Army
Chief of Staff

Official:



JOEL B. HUDSON

*Administrative Assistant to the
Secretary of the Army*

DISTRIBUTION:

Active Army, USAR, and ARNG: To be distributed in accordance with the initial distribution number 115747, requirements for FM 5-170.

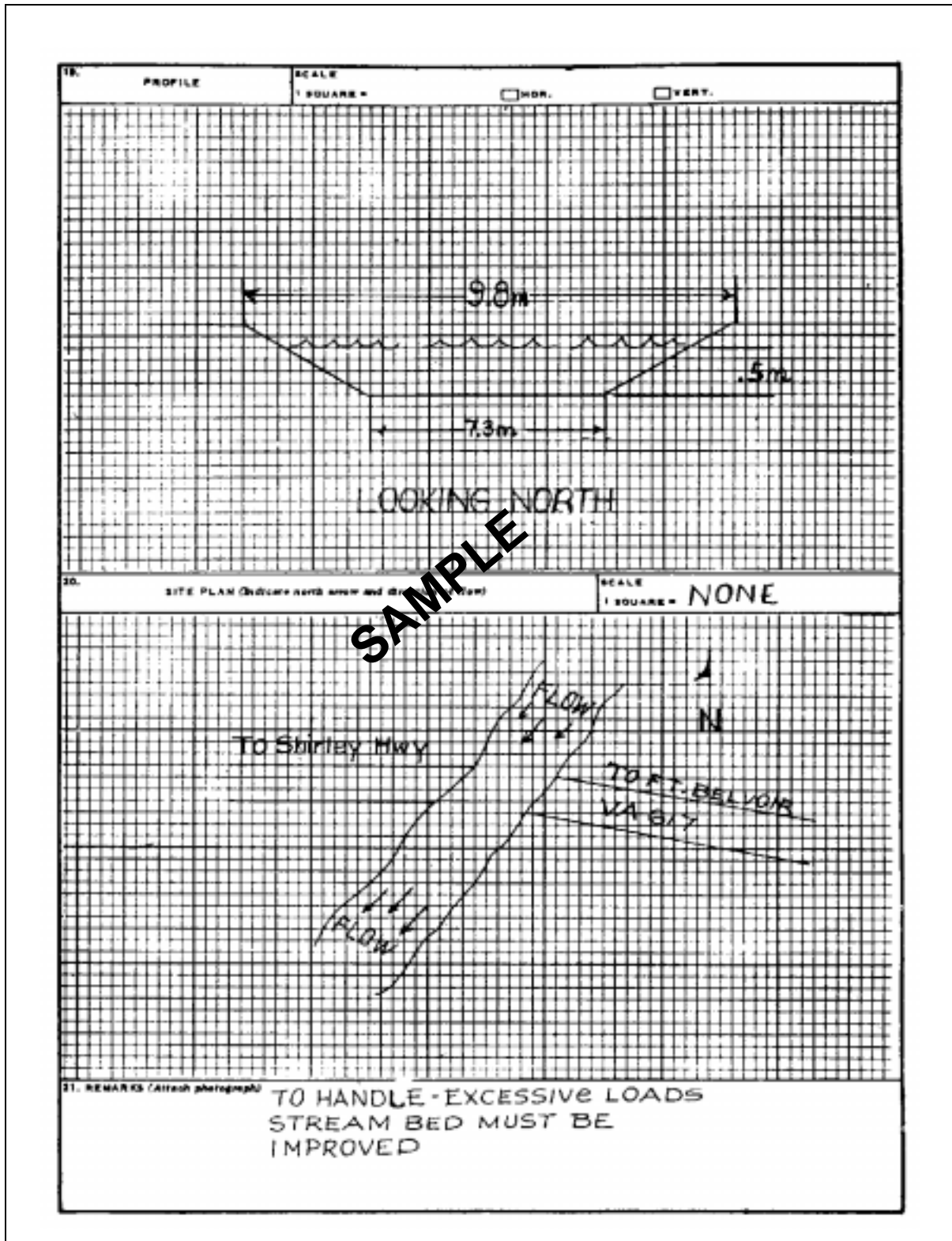

Figure 5-26. Sample Ford Reconnaissance Report (back)

recon and pick up divers when the operation is completed. Helicopters may be used to drop teams in the water or place teams on the far shore if the situation permits. Engineer light diving teams routinely conduct river recons at night.

To assist underwater recon teams in maintaining direction, weighted lines (transverse lines) may be placed across the bottom of the water obstacle. Buoys or other floating objects are attached to the lines to indicate the survey area for the underwater recon team(s). When the current is greater than 1.3 meters per second, underwater recon personnel will have difficulty maintaining a position along the line selected. To assist divers, another transverse line, parallel to the original line and with lateral lines connecting both lines, may be placed upstream.

Bottom conditions are easily determined during periods of good visibility and when the water is clear. However, under blackout conditions or when the water is murky, the recon is much slower because swimmers must feel their way across. If the tactical situation permits, divers may use underwater lanterns.

Environmental conditions (such as depth, bottom type, tides and currents, visibility, and temperature) have an effect on divers, diving techniques, and equipment. The length of time that divers can remain underwater depends on water depth, time at depth, and equipment used. When conducting a recon in a current, swimmers expend more energy, tire more easily, and use their air supply more quickly. In water temperatures between 73° and 85°F, divers can work comfortably in their swimsuits, but will chill in one to two hours if not exercising. In water temperatures above 85°F, the divers overheat. The maximum water temperature that can be endured, even at rest, is 96°F. At temperatures below 73°F, unprotected divers will be affected by excessive heat loss and become chilled within a short period of time. In cold water, the sense of touch and the ability to work with the hands are affected. Air tanks vary in size and govern how long divers can operate. Extra tanks should be available for underwater recon teams, and the facilities to recharge equipment should be located close enough to respond to team requirements.

Units complete a river-recon report to transmit important information about the river's location, near- and far-shore characteristics, and river characteristics. The information is recorded on DA Form 7398-R as shown in Figures 5-27 and 5-28, pages 5-33 and 5-34.

FERRY RECON

Ferries are considered obstructions to traffic flow and are indicated by the abbreviation "OB" in the route-classification formula. Ferryboat construction varies widely and ranges from expedient rafts to ocean-going vessels. Ferries differ in physical appearance and capacity depending upon the water's width, depth, and current and the characteristics of the traffic to be moved. Ferries may be propelled by oars; cable and pulleys; poles; the stream current; or steam, gasoline, or diesel engines.

CIVIL FERRIES AND FERRY SITES

Usually, the capacity of a civil ferryboat is expressed in tons and total number of passengers. In addition, it is often assigned an MLC number. Ensure that

RIVER RECONNAISSANCE REPORT						DATE
For use of this form, see FM 5-170. The proponent agency is TRADOC.						24 Nov 97
TO (Headquarters requesting recon) Cdr, ATTN: S2, 536 th Engr Bn			FROM (Name, grade, and unit of recon officer) MARK A. WILSON, SFC, A Co, 536 th Engr Bn			
1. ROUTE NUMBER AP Hill 004	2. FROM (Initial point) TT 945 209	3. TO (Terminal point) TT 938 180	4. DATE/TIME (of signature) 29 0800 Nov 97			
5. MAP SERIES NUMBER V 7345	6. SHEET NUMBER 5560 III	7. GRID REFERENCE TYPE 1: 50,000 COORDINATES TT 945 185		8. RECON NUMBER 1		
9. LOCATION OF NEAREST TOWN			10. CROSSING (Name of river or other body of water)			
DISTANCE 2KM	DIRECTION SW	NAME OF NEAREST TOWN Collins Crossing		Cattlet Creek		
11. CHARACTERISTICS OF NEAR SHORE						
BANK HEIGHT 1.8M	BANK SLOPE 6%	BANK STABILITY Firm	BANK SOIL TYPE Grass	MINES None	OBSTACLES (Type) None	
SLOPE TO DEPTH OF 2 METERS 10%	SOIL TYPE TO DEPTH OF 2 METERS Soft Mud		MINES TO DEPTH OF 2 METERS None	OBSTACLES TO DEPTH OF 2 METERS None		
12. CHARACTERISTICS OF RIVER						
GAP WIDTH 143M	VELOCITY (m/sec) 1.5 MPS	FLOW DIRECTION SW	BOTTOM COMPOSITION (Mud, sand, gravel/hard-packed or soft) GAP Soft Mud ½ GAP Soft Mud ¾ GAP Soft Mud			
MAX DEPTH ¼ GAP 12' ½ GAP 18'		ANCHORAGE SUITABILITY (Describe) Very Poor Recommend w/ wedge anchors		OBSTACLES None		
13. CHARACTERISTICS OF FAR SHORE						
BANK HEIGHT 0.8M	BANK SLOPE 9%	BANK STABILITY Firm	BANK SOIL TYPE Grass	MINES None	OBSTACLES (Type) None	
SLOPE TO DEPTH OF 2 METERS 9%	SOIL TYPE TO DEPTH OF 2 METERS Soft Mud		MINES TO DEPTH OF 2 METERS None	OBSTACLES TO DEPTH OF 2 METERS Stump located at 3'		
REMARKS: (Description of far- and near-shore approaches/assembly areas/available cover and concealment/overall assessment of crossing-site potential for freezing over or flooding.)						
Near-shore approach is approx 150M wide with firm soil and grass but no overhead cover.						
Far-shore approach is approx 80M wide with firm soil and grass.						
NOTE: Stump located at 3, measuring 26" in diameter. Stump needs to be removed before far shore can be utilized.						
Crossing site has no history of flooding, but has potential for freezing over in late January thru March.						

DA FORM 7398-R, JUN 98

Figure 5-27. Sample River Reconnaissance Report (front)

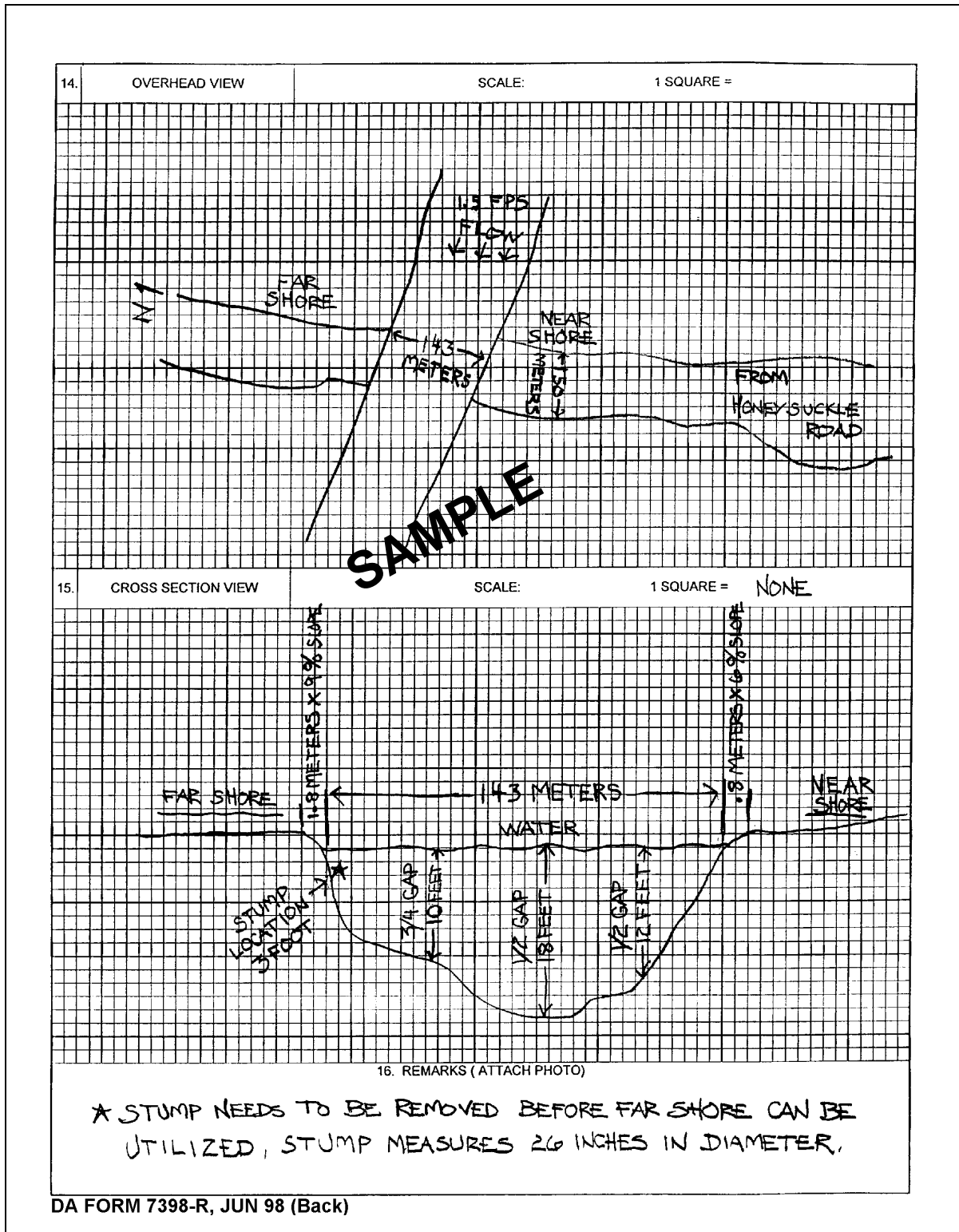

DA FORM 7398-R, JUN 98 (Back)

Figure 5-28. Sample River Reconnaissance Report (back)

you record the capacity of each ferry when more than one is used at a given site. The ferries may vary in capacity.

References

SOURCES USED

These are the sources quoted or paraphrased in this publication.

Army Publications

DA Pam 738-750. *Functional Users Manual for the Army Maintenance Management System (TAMMS)*. 1 August 1994.

FM 1-114. *Tactics, Techniques, and Procedures for the Regimental Aviation Squadron*. 20 February 1991.

FM 5-71-2. *Armored Task-Force Engineer Combat Operations*. 28 June 1996.

FM 5-71-3. *Brigade Engineer Combat Operations (Armored)*. 3 October 1995.

FM 5-71-100. *Division Engineer Combat Operations*. 22 April 1993.

FM 5-114. *Engineer Operations Short of War*. 13 July 1992.

FM 5-250. *Explosives and Demolitions*. To be published within 6 months.

FM 5-446. *Military Nonstandard Fixed Bridging*. 3 June 1991.

FM 6-20-40. *Tactics, Techniques, and Procedures for Fire Support for Brigade Operations (Heavy)*. 5 January 1990.

FM 6-30. *Tactics, Techniques, and Procedures for Observed Fire*. 16 July 1991.

FM 17-95. *Cavalry Operations*. 24 December 1996.

FM 17-95-10. *The Armored Cavalry Regiment and Squadron*. 22 September 1993.

FM 17-98. *Scout Platoon*. 9 September 1994.

FM 20-32. *Mine/Countermine Operations*. To be published within 6 months.

FM 21-26. *Map Reading and Land Navigation*. 7 May 1993.

FM 34-1. *Intelligence and Electronic Warfare Operations*. 27 September 1994.

FM 34-2. *Collection Management and Synchronization Planning*. 8 March 1994.

FM 34-2-1. *Tactics, Techniques, and Procedures for Reconnaissance and Surveillance and Intelligence Support to Counterreconnaissance*. 19 June 1991.

FM 34-130. *Intelligence Preparation of the Battlefield*. 8 July 1994.

FM 71-1. *Tank and Mechanized Infantry Company Team*. 22 November 1988.

FM 71-2. *The Tank and Mechanized Infantry Battalion Task Force*. 27 September 1988.

FM 71-3. *The Armored and Mechanized Infantry Brigade*. 8 January 1996.

FM 90-13. *River Crossing Operations*. 30 September 1992.

FM 90-13-1. *Combined Arms Breaching Operations*. 28 February 1991.

FM 100-5. *Operations*. 14 June 1993.

FM 100-7. *Decisive Force: The Army in Theater Operations*. 31 May 1995.

FM 100-16. *Army Operational Support*. 31 May 1995.

FM 101-5. *Staff Organization and Operations*. 31 May 1997.

FM 101-5-1. *Operational Terms and Graphics*. 30 September 1997.

Standardization Agreements

STANAG 2010. *Military Load Classification Markings*. 18 November 1980.

STANAG 2021. *Military Computation of Bridge, Ferry, Raft and Vehicle Classifications*. 18 September 1990.

STANAG 2027. *Marking of Military Vehicles*. 18 December 1975.

STANAG 2154. *Regulations for Military Motor Vehicle Movement by Road*. 19 June 1992.

STANAG 2174. *Military Routes and Route/Road Networks*. 25 February 1994.

STANAG 2253. *Roads and Road Structures*. 29 January 1982.
STANAG 2269. *Engineer Resources*. 14 May 1979.

DOCUMENTS NEEDED

These documents must be available to the intended users of this publication.

Department of the Army Forms

DA Form 1248. *Road Reconnaissance Report*. 1 July 1960.
DA Form 1249. *Bridge Reconnaissance Report*. 1 July 1960.
DA Form 1250. *Tunnel Reconnaissance Report*. 1 January 1955.
DA Form 1251. *Ford Reconnaissance Report*. 1 January 1955.
DA Form 1252. *Ferry Reconnaissance Report*. 1 January 1955.
DA Form 1711-R. *Engineer Reconnaissance Report*. May 1985.
DA Form 2028. *Recommended Changes to Publications and Blank Forms*. 1 February 1974.
DA Form 2404. *Equipment Inspection and Maintenance Worksheet*. 1 April 1979.
DA Form 2408-14. *Uncorrected Fault Record*. June 1994.
DA Form 7398-R. *River Reconnaissance Report*. June 1998.

READINGS RECOMMENDED

These readings contain relevant supplemental information.

Army Publications

FM 3-4. *NBC Protection*. 29 May 1992.
FM 3-5. *NBC Decontamination*. 17 November 1993.
FM 3-19. *NBC Reconnaissance*. 19 November 1993.
FM 19-40. *Enemy Prisoners of War, Civilian Internees, and Detained Persons*.
27 February 1976.

ENGINEER RECONNAISSANCE

Table of Contents

	Page
Preface	vi
Chapter 1. Introduction	1-1
Organization.....	1-1
Missions.....	1-1
Characteristics, Capabilities, and Limitations	1-2
General Organizational Characteristics	1-2
Engineer Recon Team Capabilities	1-2
Engineer Recon Team Limitations	1-3
Platform-Specific Capabilities	1-4
Command and Support Relationships	1-5
Attached	1-5
Operational Control (OPCON).....	1-6
Direct Support (DS) and General Support (GS).....	1-6
Chapter 2. Intelligence Preparation of the Battlefield and Reconnaissance and Surveillance Planning	2-1
Intelligence Preparation of the Battlefield (IPB)	2-1
R&S Planning.....	2-4
Chapter 3. Tactical Reconnaissance	3-1
Purpose and Fundamentals.....	3-1
Recon Techniques.....	3-3
Mounted Recon	3-4
Dismounted Recon.....	3-5
Recon by Fire	3-5
Indirect Fire	3-6
Direct Fire	3-6
Aerial Recon.....	3-6
Stealth Versus Aggressive Recon	3-7

DISTRIBUTION RESTRICTION: Approved for public release; distribution is unlimited.

*This manual supersedes FM 5-30, 22 September 1967, and FM 5-36, 10 May 1985.

	Page
Route Recon	3-7
Critical Tasks	3-8
Techniques.....	3-8
Example of a Route Recon	3-9
Zone Recon	3-21
Critical Tasks	3-21
Techniques.....	3-21
Example of a Zone Recon	3-22
Area Recon	3-32
Critical Tasks	3-32
Techniques.....	3-32
Example of an Area Recon.....	3-33
Chapter 4. Engineer Recon Team and Obstacle Reconnaissance.....	4-1
Personnel and Equipment.....	4-1
Training	4-1
Equipment	4-2
Vehicles	4-2
Communications Equipment	4-2
Weapon Systems.....	4-2
Additional Equipment	4-2
Engineer Recon Team	4-2
Dismounted Element	4-3
Mounted Element.....	4-3
Obstacle and Restriction Recon.....	4-3
Detection	4-4
Area Security and Recon	4-4
Obstacle Recon.....	4-5
COA Selection	4-5
COA Recommendation/Execution.....	4-7
Examples of Obstacles/Restrictions.....	4-7
Employment Concepts.....	4-17
Integrated as Part of the Brigade Intelligence-Collection Effort	4-17
Assigned Brigade NAIs in a TF's AO	4-18
Working Under a TF's Control.....	4-18
Support Considerations.....	4-19
Responsibilities.....	4-22
Chapter 5. Route Classification	5-1
Route-Classification Overlay	5-1
Route-Classification Formula.....	5-2
Route Width	5-3
Route Type	5-4
MLC.....	5-4
Overhead Clearance	5-5
Route Obstructions.....	5-5
Snow Blockage and Flooding	5-5
Examples of the Route-Classification Formula	5-5
Curve Calculations	5-6
Measuring Methods	5-6
Tape-Measure Method.....	5-6

	Page
Triangulation Method.....	5-6
Formula Method.....	5-8
Curve Symbol.....	5-9
Series of Sharp Curves.....	5-9
Slope Estimation.....	5-9
Percent of Slope.....	5-9
Clinometer Method.....	5-9
Map Method.....	5-10
Pace Method.....	5-10
Angle-of-Slope Method.....	5-12
Slope Symbol.....	5-13
Description of Slope Symbols.....	5-14
Constrictions.....	5-14
Underpasses.....	5-15
Tunnels.....	5-16
Tunnel Symbol.....	5-17
Overhead Clearance.....	5-18
Tunnel Reconnaissance Report.....	5-20
Stream Recon.....	5-24
Measurements.....	5-24
Preexisting Data.....	5-25
Stream Width.....	5-25
Compass Method.....	5-25
Aiming Circle, Azimuth Indicator, or Alidade.....	5-25
GPS.....	5-25
Direct Measurement.....	5-25
Current Velocities.....	5-26
Stream Approaches.....	5-26
Fords.....	5-27
Underwater Recon.....	5-29
Ferry Recon.....	5-32
Civil Ferries and Ferry Sites.....	5-32
Ferry Information.....	5-35
Military Ferry and Rafting.....	5-36
Road Recon Procedure.....	5-39
Base Course and Subgrade.....	5-39
Road-Capacity Computations.....	5-43
Road-Classification Formula.....	5-43
Examples of the Road-Classification Formula.....	5-46
Bridge-Classification Recon.....	5-46
Required Bridge Information for Classification Procedures.....	5-46
Required Information.....	5-49
Bridge Condition.....	5-51
Width and Height Restrictions.....	5-51
Bridge Traffic-Control Procedure.....	5-51
Full North Atlantic Treaty Organization (NATO) Bridge Symbol.....	5-52
The Bridge Reconnaissance Report.....	5-54
Other Information.....	5-58
Bridge Sketches.....	5-59
Bypasses.....	5-60

	Page
Chapter 6. Combat Support	6-1
Indirect-Fire Support	6-1
Mortar Support	6-1
Capabilities	6-2
Limitations.....	6-2
Available Munitions	6-2
Field Artillery.....	6-2
Capabilities	6-3
Limitations.....	6-3
Available Munitions	6-3
Fire-Support Team.....	6-4
Fire-Request Channels	6-4
Engineer Recon Team Working Under Brigade Control.....	6-4
Engineer Recon Team Working in a TF's Area or Under TF Control	6-6
Engineer Recon Team Working with a Cavalry Squadron or Under Troop Control.....	6-7
Air Defense.....	6-10
Passive Air Defense	6-10
Attack Avoidance.....	6-10
Damage-Limiting Measures.....	6-10
Active Air Defense.....	6-10
Air Support	6-11
Ground Surveillance Radar	6-12
Capabilities and Limitations.....	6-12
Employment	6-13
Chemical	6-13
Capabilities and Limitations.....	6-13
Employment	6-14
 Chapter 7. Combat Service Support	 7-1
Organization	7-1
Supply Operations	7-2
Basic Load	7-2
Classes of Supply	7-2
Class I.....	7-2
Class II	7-3
Class III and Class V.....	7-3
Class IV	7-3
Class VI	7-3
Class VII.....	7-3
Class VIII	7-4
Class IX	7-4
Techniques of Resupply	7-4
Maintenance Operations	7-4
Responsibilities	7-6
Team Leader	7-6
Assistant Team Leader	7-7
Unit Maintenance (Operator Level)	7-8
Evacuation.....	7-8
Destruction	7-9
Medical Treatment and Evacuation	7-9

	Page
Wounded Soldiers	7-9
Soldiers Killed in Action.....	7-10
Prisoners.....	7-10
Prisoners of War	7-10
Captured Enemy Documents and Equipment	7-14
Civilians	7-14
Appendix A. Metric Conversion Chart.....	A-1
Appendix B. Bridge Classification.....	B-1
Bridge Signs	B-1
Width and Height Restrictions.....	B-2
Classification Procedures	B-2
Appendix C Sample Reconnaissance OPORD.....	C-1
Appendix D. Engineer Recon	D-1
Appendix E. Signs	E-1
Military Route Signs	E-1
Hazard Signs.....	E-2
Regulatory Signs.....	E-3
Light Line	E-3
Bridge/Raft Signs	E-3
Rectangular Bridge Signs.....	E-4
Guide Signs	E-7
Directional Disks.....	E-7
Headquarters and Logistical Signs	E-7
Casualty Evacuation Route Signs.....	E-8
Unit Direction Arrow	E-9
Military Detour Signs	E-9
Road Markers in Areas of Heavy Snow	E-9
Vehicle Signs	E-9
Sign Lighting.....	E-11
Appendix F. Military Load Classifications	F-1
Requirement for Classification Numbers	F-1
Procedures for Vehicle Classification.....	F-1
Temporary Procedure for Vehicle Classification	F-1
Expedient Procedure for Wheeled-Vehicle Classification	F-1
Expedient Procedure for Tracked-Vehicle Classification	F-2
Appendix G. Symbols	G-1
Glossary.....	Glossary-1
References	References-1
Index	Index-1

Preface

Field Manual (FM) 5-170 describes how engineer recon teams support and augment a maneuver battalion or brigade's recon effort. It is designed as an engineer extension of FMs 17-95 and 17-98. This manual serves as a guide for both brigade and task force (TF) engineers, as well as for subordinate leaders (especially recon team leaders) in planning, integrating, and conducting recon operations. It also serves as a guide for the brigade and TF staffs and subordinate maneuver commanders on the organization, capabilities, and employment of engineer recon teams.

This manual sets forth the principles of conducting engineer recon activities supporting a maneuver brigade or TF. It addresses engineer tactics, techniques, and procedures (TTP) that highlight critical principles. However, the TTP are intended to be descriptive rather than prescriptive; they are not a replacement for the TTP and standing operating procedures (SOPs) that are unique to the supported unit.

FM 5-170 is fully compatible with Army doctrine as contained in FM 100-5 and is consistent with other combined-arms doctrine. This is not a stand-alone manual. The user must have a fundamental understanding of the concepts outlined in FMs 100-5, 100-7, 100-16, 71-1, 71-2, 71-3, 17-95, 17-98, 5-71-100, 5-71-2, 5-71-3, 34-1, 34-2, 34-2-1, 34-130, 90-13, 90-13-1, 101-5, and 101-5-1. This manual also implements Standardization Agreement (STANAG) 2269, Engineer Resources, Edition 3; STANAG 2027, Marking of Military Vehicles, Edition 3; STANAG 2253, Roads and Road Structures, Edition 4; STANAG 2174, Military Routes and Route/Road Networks, Edition 4; STANAG 2154, Regulations for Military Motor Vehicle Movement by Road, Edition 6; and STANAG 2010, Military Load Classification Markings, Edition 5.

Appendix A contains an English to metric measurement conversion chart.

The proponent of this publication is Headquarters, United States (US) Army Engineer School (USAES). Send comments and recommendations on Department of the Army (DA) Form 2028 directly to Commander, USAES, ATTN: ATSE-TD-D, Fort Leonard Wood, Missouri, 65473-6650.

Unless this publication states otherwise, masculine nouns and pronouns do not refer exclusively to men.

Chapter 1

Introduction

Combat power is generated by combining the elements of maneuver, firepower, force protection, and leadership within a sound plan and then aggressively, violently, and flexibly executing the plan to defeat an enemy. The key to using combat power effectively is gathering information about the enemy and the area of operations (AO) through recon. A recon provides current battlefield information that helps a commander plan and conduct tactical operations. A recon greatly enhances maneuver, firepower, and force protection when properly executed.

ORGANIZATION

Engineer recon elements may consist of an engineer platoon, squad, team, or other element. During military operations, the engineer may be called on to assist the maneuver force during recon missions. These missions are normally executed by engineer recon teams, which are organized according to unit SOPs. (See Chapter 4 for a complete discussion of the engineer recon team.) Engineer recon teams may operate independently; however, they normally augment cavalry scout platoons; mechanized, wheeled, or dismounted scout platoons; or other maneuver units directly involved in recon operations. The most prominent scout platoon in a force is the high-mobility, multipurpose wheeled vehicle (HMMWV) scout platoon.

If an engineer recon team is to augment a maneuver scout element, the team should be task-organized with equipment that is compatible with the supported maneuver recon force. The engineer team may use its own vehicle or ride in the vehicles of the scout, cavalry, or infantry unit it supports. It may move mounted or dismounted, depending on its current equipment, organization, command and control (C²) structure, and enemy situation.

MISSIONS

An engineer recon team's primary mission is collecting tactical and technical information for the supported or parent unit. The team must be able to perform this mission mounted or dismounted, during the day or at night, and in various terrain conditions.

A tactical recon is conducted in a high-threat environment and is a combined-arms effort to—

- Collect information about the enemy's location and obstacles and the terrain within the AO.
- Conduct limited marking of obstacles, routes, and demolition work.
- Conduct limited reduction of obstacles in conjunction with maneuver units.

A technical recon is conducted in a low-threat environment. It may or may not be a combined-arms effort to collect engineer-specific technical data on a point or area target or route (see Chapter 5).

CHARACTERISTICS, CAPABILITIES, AND LIMITATIONS

An engineer recon team normally conducts operations as part of a larger combined-arms force. This team has capabilities and limitations that must be considered when they are employed.

GENERAL ORGANIZATIONAL CHARACTERISTICS

Characteristics of a typical recon team include the following:

- The engineer recon team usually depends on both the parent and supported unit for combat support (CS) and combat service support (CSS).
- The scout platoon may perform a recon of two routes simultaneously (for trafficability only) if the engineer recon team is performing a recon with a HMMWV scout platoon.
- The engineer element will assist in reconning a zone 3 to 5 kilometers wide when working with a scout platoon during a zone recon mission. Mission, enemy, terrain, troops, and time available (METT-T) conditions may increase or decrease the zone's size.
- The engineer recon team must train and rehearse in detail with the unit it supports to ensure that all soldiers understand the recon TTP.

ENGINEER RECON TEAM CAPABILITIES

An engineer recon team has the following capabilities. It—

- Increases the supporting unit's recon capability concerning complex mine and wire obstacle systems, enemy engineer activities, and details of mobility along a route.
- Provides detailed technical information on any encountered obstacle.
- Conducts an analysis of what assets will be needed to reduce any encountered obstacle.
- Marks bypasses of obstacles based on guidance from the supported commander. This guidance includes whether to mark bypasses and in which direction the force should maneuver when bypassing an obstacle.
- Assists in gathering basic enemy information.
- Provides detailed technical information on routes (including classification) and specific information on any bridges, tunnels, fords, and ferries along the route.
- Assists in acquiring enemy engineer equipment on the battlefield.
- Assists in guiding the breach force to the obstacle to be reduced.

ENGINEER RECON TEAM LIMITATIONS

An engineer recon team has the following limitations:

- Engineer battalions do not have personnel and equipment listed on the table(s) of organization and equipment (TOE) and the modified table(s) of organization and equipment (MTOE) dedicated to conduct a recon (see Figures 1-1 through 1-5, pages 1-3 through 1-7).

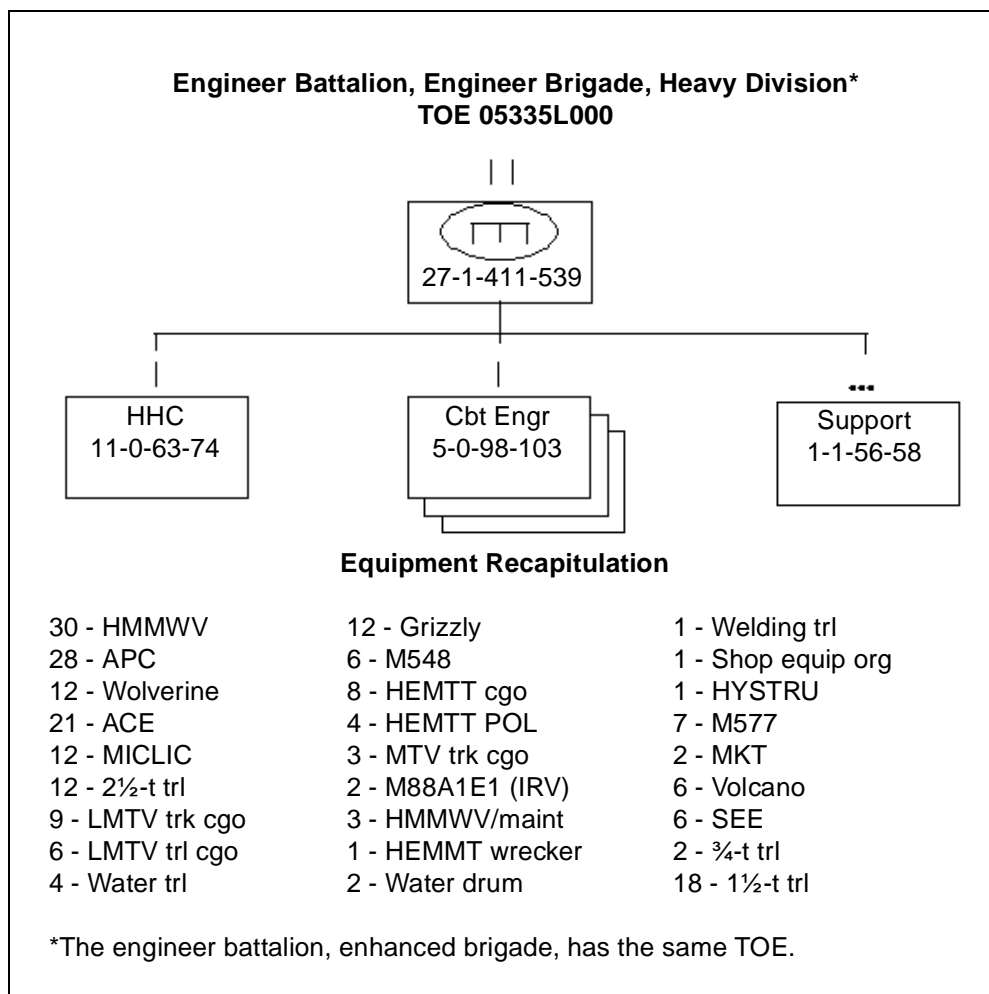

Figure 1-1. Engineer battalion, engineer brigade, heavy division

- The recon team has a limited ability to destroy or repel enemy recon units and security forces.
- The distance the engineer recon team can operate away from the main body is restricted to the range of communications, the range of supporting indirect fires, and the ability to perform CSS operations.
- The recon team has a limited communications capability. Based on the radio configuration of the vehicle used during the recon and whether the engineer recon team is working under a maneuver element's

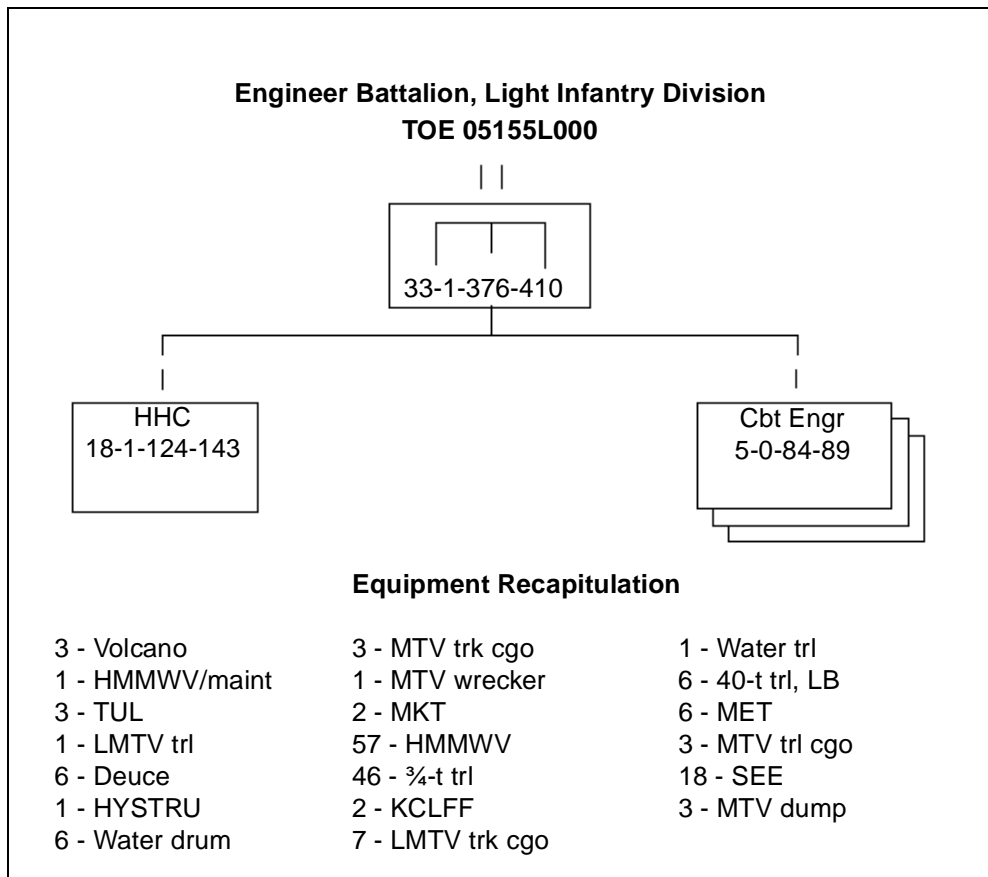

Figure 1-2. Engineer battalion, light infantry division

control, dedicated monitoring of engineer nets may be difficult. However, with the single-channel, ground-to-air radio system (SINCGARS), the recon team should be able to scan critical engineer nets or, at the very least, easily switch to the engineer net to report obstacle intelligence (OBSTINTEL).

- The engineer recon team has very limited obstacle creation and reduction ability. It normally carries only a light basic load of demolitions, according to the unit's SOP. Obstacle reduction is normally limited to manually reducing obstacles not covered by enemy fires and observation.

PLATFORM-SPECIFIC CAPABILITIES

An engineer recon team depends on its organic equipment and the equipment of the unit it supports. Both the engineers and the supported unit must determine the best combination of equipment based on METT-T.

The two engineer vehicles commonly used in recon operations are the M113A3 armored personnel carrier (APC) and the M998 HMMWV. Both vehicles are effective recon platforms when appropriately employed; however, security must come from the supported unit because the vehicles have limited firepower. The engineer must maximize his vehicle's capabilities and minimize

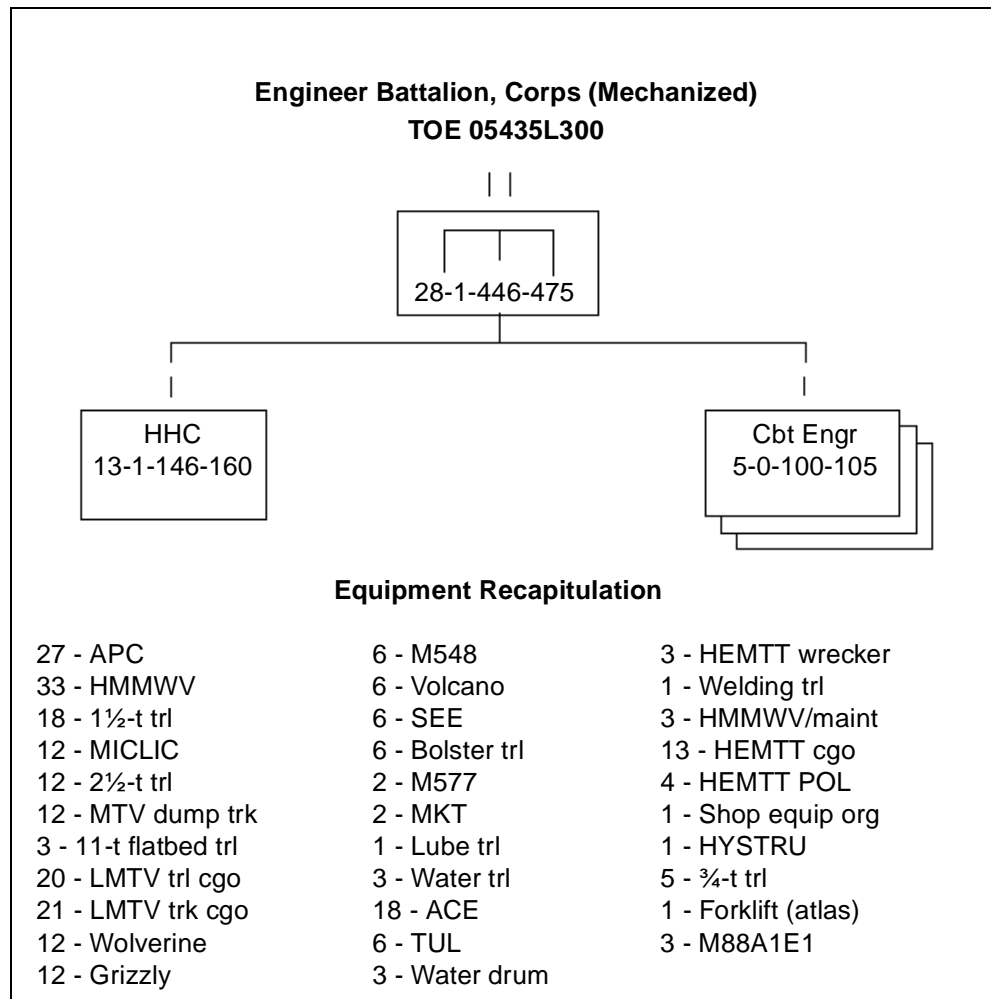

Figure 1-3. Engineer battalion, corps (mechanized)

its limitations. A third type of platform is that of a supported maneuver unit when it provides the engineer space on board its vehicle.

COMMAND AND SUPPORT RELATIONSHIPS

Engineers are task-organized a variety of ways, depending on the mission and current requirements. This task organization drives an engineer recon team’s command or support relationship.

ATTACHED

When attached, a recon team is temporarily placed in the unit it supports. The commander of the supported unit exercises the same degree of C² as he does over his organic units. In this relationship, the recon team receives all of its missions and support from the supported unit, not its organic engineer unit. Additionally, the supported-unit commander may task-organize the recon team as he feels is appropriate.

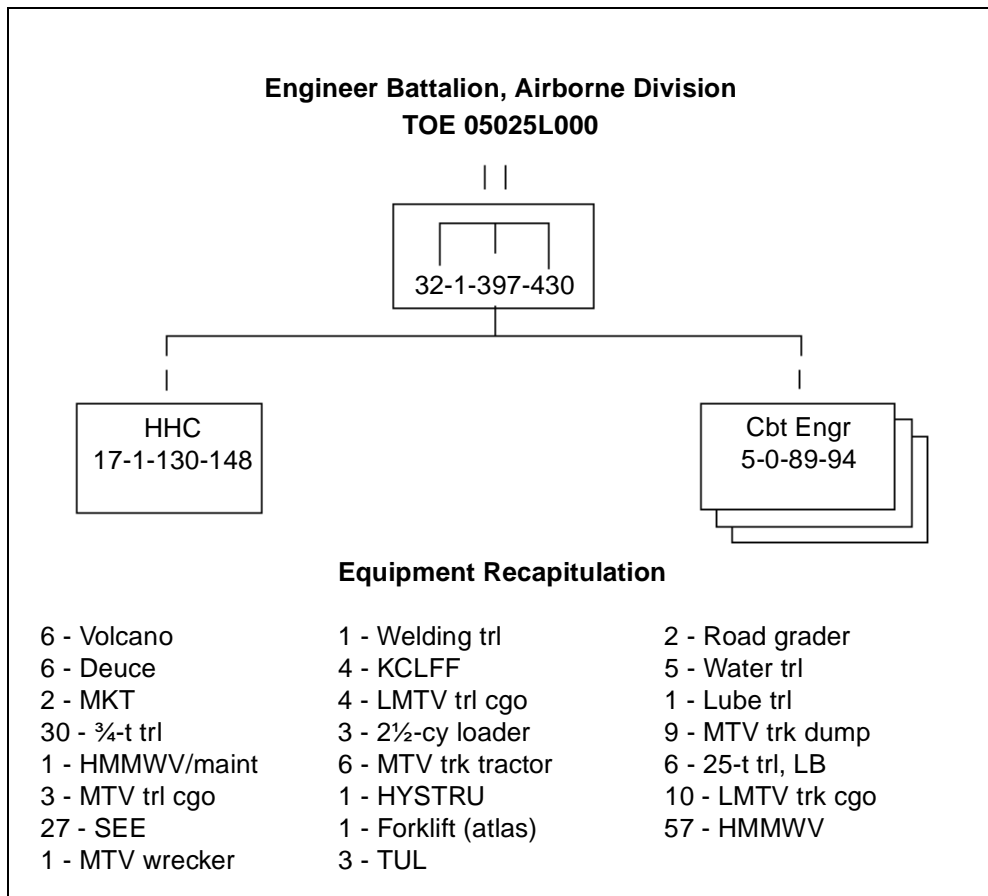

Figure 1-4. Engineer battalion, airborne division

OPERATIONAL CONTROL (OPCON)

In an OPCON relationship, a recon team receives all of its tasking and missions from the supported unit. The supported-unit commander retains the same authority over the recon team as over his organic units and may task-organize the recon team as he feels is appropriate. Logistical support comes from the parent engineer unit unless the engineer battalion has coordinated with the supported unit for certain classes of supply.

DIRECT SUPPORT (DS) AND GENERAL SUPPORT (GS)

In a DS relationship, a recon team answers directly to the supported unit's requests for support. Logistical support is provided by the parent engineer unit, and the recon team is commanded by its parent engineer unit commander. In a GS relationship, a recon team receives missions and all support from its parent engineer unit.

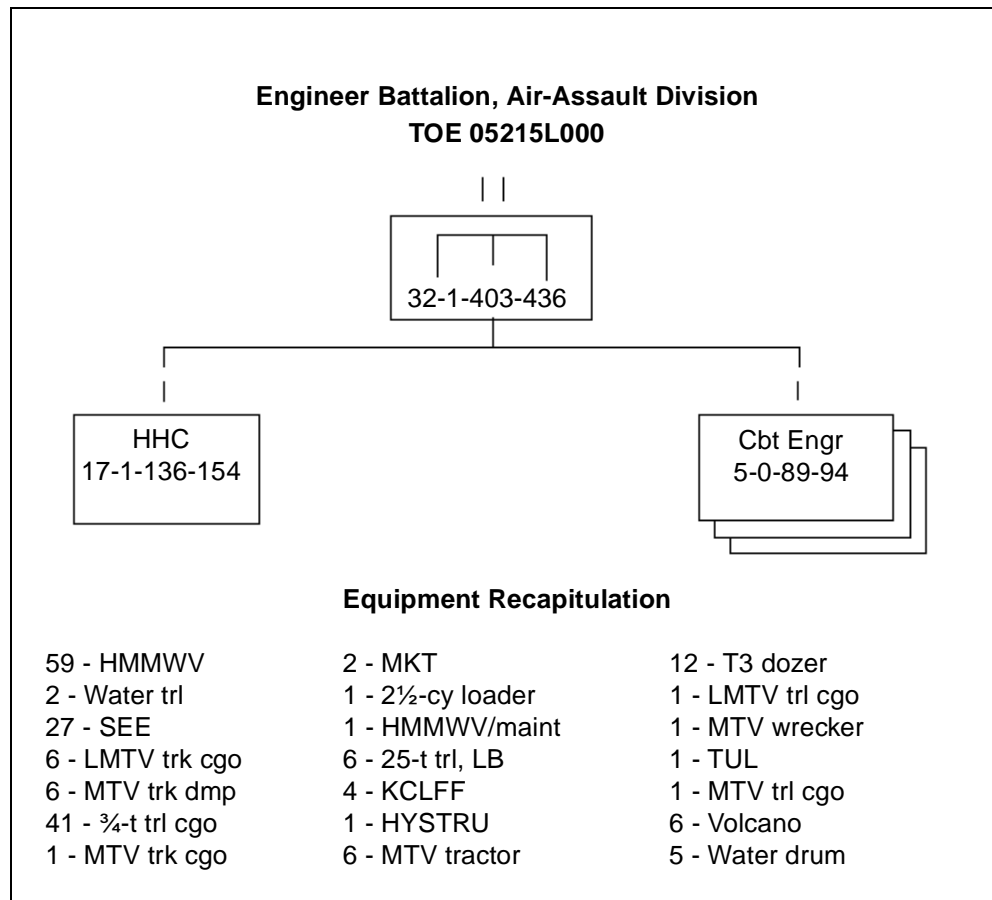

Figure 1-5. Engineer battalion, air-assault division

Chapter 2

Intelligence Preparation of the Battlefield and Reconnaissance and Surveillance Planning

An engineer recon team performs several critical tasks in support of the supported-unit commander's concept of an operation. The recon team's success or failure often results in the force's success or failure. As part of the commander's "eyes" and "ears", the recon team must maintain communication with the tactical operations center (TOC). This communication link is critical for the recon team to transmit intelligence gained to the TOC and for the TOC to pass to the recon team any current information on the friendly and enemy situations.

The engineer recon team leader must clearly understand the commander's intent and know what is expected of his team in each phase of the operation. Also, he must be given the specific named areas of interest (NAIs) that his team is to observe and the exact information he is expected to gather within each NAI. The engineer recon team must be focused on the NAIs that concern obstacles, mobility, or enemy engineer assets. However, the team should be prepared to report on non-engineer-specific information as part of the combined-arms recon effort. The team must be provided with all of the available information concerning the type of obstacles they may encounter during the recon.

The engineer recon team must be a part of the supported unit's reconnaissance and surveillance (R&S) plan. This ensures that commanders get the information they need to fight and win the battle. A maneuver brigade and its subordinate battalions will produce R&S plans. The brigade plan will task the subordinate battalions, as well as brigade assets, and these tasks will be incorporated into each subordinate battalion's plan.

NOTE: The R&S plan is developed very early in the planning process because it is critical to get recon assets into a mission as early as possible.

INTELLIGENCE PREPARATION OF THE BATTLEFIELD (IPB)

IPB is a systematic approach to analyzing the an enemy, the weather, and the terrain in a specific geographic area. It integrates enemy doctrine with the weather and terrain as they relate to the mission and the specific battlefield environment. This is done to determine and evaluate enemy capabilities, vulnerabilities, and probable courses of action (COAs). See FM 34-130 for a complete discussion of IPB.

Table 2-1 summarizes the engineer's participation in the IPB process. The Intelligence Officer (US Army) (S2) and the engineer staff conduct their analysis by applying enemy doctrinal templates (which include obstacle templates) to specific terrain. This becomes a situational template (SITEMP). A SITEMP is basically a doctrinal template with terrain and weather constraints applied. It is a graphic description of an enemy's disposition should he adopt a particular COA. It shows how enemy forces might deviate from doctrinal dispositions, frontages, depths, and echelon spacing to account for the effects of terrain and weather, and it focuses on specific mobility corridors. A SITEMP is a visual technique. By placing a doctrinal template over a segment of a mobility corridor, the analyst adjusts units or equipment dispositions to depict where they might actually be deployed in the situation. Time and space analysis is important in developing a SITEMP, which is used during the war-gaming process. For further discussion of a SITEMP, refer to FM 34-130.

Table 2-1. Engineer input to the IPB process

Engineer Input	IPB Steps	Output
Terrain data Available threat engineer assets	DEFINE THE BATTLEFIELD ENVIRONMENT	
Terrain analysis (OCOKA)	DESCRIBE THE BATTLEFIELD'S EFFECTS	MCOO
Threat engineer doctrine Engineer HVTs Threat engineer capabilities	EVALUATE THE THREAT	Intel estimate
Threat engineer support to each threat COA	DETERMINE THREAT COAS	SITEMP Listing of HVT Identify NAIs Event template

A SITEMP is the basis for event templating. An event template is a model against which enemy activity can be recorded and compared. It represents a sequential projection of events that relate to space and time on the battlefield and indicates the enemy's ability to adopt a particular COA. By knowing what an enemy can do and comparing it with what he is doing, it can be predicted what he will do next. This is an important analysis factor in determining the enemy's posture and movement. Knowing when and where enemy activity is likely to occur on the battlefield will provide indicators of enemy intentions or will verify that projected events did or did not occur.

As the threat visualization process develops, a number of critical locations will become apparent (key terrain and man-made features such as bridges and fords). These areas are important because significant events and activities will occur there. It is within these areas that targets will appear. These areas are designated as NAIs. NAIs must be observed to be effective. Therefore, the number and location of NAIs designated is tied to the unit's ability to observe them.

NAIs may also be developed when the staff produces the decision-support template (DST). The commander and his staff create a DST during the

decision-making process. A DST graphically represents the projected situation, identifying where a decision must be made to initiate a specific activity or event.

NAIs developed during the IPB and decision-making process are prioritized, and recon assets are tasked to collect information to support the commander's information requirements (IR). Engineer recon teams should be used for those NAIs requiring engineer expertise.

In the offense, a maneuver unit's S2, with the engineer staff's assistance, will determine how and where an enemy will fight, how enemy direct-fire systems and obstacles are arrayed, and what counterattack routes the enemy is likely to take. The assistant brigade engineer (ABE) and the brigade S2 will also provide input on enemy scatterable-mine (SCATMINE) capability and where the mines may be placed, based on how the enemy is predicted to fight. The ABE and the S2 provide any available information about existing obstacles on the avenue of approach or mobility corridor. The TF S2 and the engineer company executive officer (XO)/engineer platoon leader will incorporate this information into their IPB.

In the offense, an engineer recon team's primary focus should be on OBSTINTEL as discussed in FM 90-13-1, Chapter 2. This includes but is not limited to—

- Obstacle location.
- Obstacle orientation.
- The presence of wire.
- Gaps and bypasses.
- Minefield composition (buried or surface antitank [AT] and antipersonnel [AP] mines and antihandling devices [AHDs]) and depth.
- Mine types.
- The location of enemy direct-fire weapons.

In the defense, a maneuver unit's S2, with the engineer staff's assistance, conducts a terrain analysis to determine an enemy's avenues of approach. The ABE and the brigade S2 work closely with the TF S2 and the engineer company XO/engineer platoon leader in the TF's TOC to provide input on enemy engineer assets and enemy engineer COAs and to template the enemy's obstacle use. A recon team may be focused on—

- Obtaining information about planned routes to be used during counterattacks, repositioning, or retrograde operations.
- Augmenting the TF scouts to identify enemy engineer equipment and activity.
- Observing locations where friendly forces will emplace scatterable minefields to provide information on its effectiveness and to call fires on enemy vehicles.

- Observing NAIs where the enemy is expected to employ scatterable minefields.

R&S PLANNING

From an event template and a DST, the S2, in coordination with the Operations and Training Officer (US Army) (S3), prepares a detailed R&S plan that graphically depicts where and when the recon elements should look for enemy activity. The R&S plan must direct specific tasks and priorities to all R&S elements: company teams, scout platoons, engineer recon teams, combat observation and lazing teams (COLTs), ground-surveillance radar (GSR), and patrols. The supported battalion's S2 translates the R&S plan into operational terms and graphics. During recon operations, the S2 designates NAIs for the engineer recon team. The S3 maintains overall OPCON of the R&S plan; however, the S2 plans and monitors the R&S plan. The engineer recon team leader further refines the plan to include such things as checkpoints as control measures to guide the team's movement to these objectives.

The supported unit's S2 should brief the recon team leader on the disposition of friendly forces and the unit's scheme of maneuver. The S2 provides the team leader with the current (and projected) R&S and operational graphics and terrain-index-reference-system (TIRS) points to support additional graphics and fragmentary orders (FRAGOs). If the S3 does not brief the recon team leader, the S2 must ensure that the commander's intent is accurately portrayed as he briefs the team leader. The S2 should plan to employ the recon team throughout the mission's entire course. He should provide guidance on when to report, what actions to take on enemy contact, and what CS and CSS assets are available. The engineer commander must ensure that specifics concerning obstacles, terrain, and enemy engineer assets that may be encountered are also included in this briefing. The recon team leader should receive the S2's briefing before he departs the battalion area for his mission. Other options, although less desirable, include receiving this information over the radio or from a messenger sent by the commander.

The engineer staff in either the brigade's or the TF's TOC should do everything possible to assist the engineer recon team leader by coordinating with other battlefield operating system (BOS) elements. These types of coordination are discussed in the following paragraphs.

A fire-support element (FSE) stays abreast of what the team is doing while conducting the mission. This ensures that it provides responsive fire support to the recon team. The engineer staff should coordinate with the fire-support officer (FSO) to discuss the recon team's mission and the unique requirements the team has for fire support. The engineer staff finds out what support is available, where supporting units are located, and what fire-support restrictions exist. The team leader then recommends preplanned targets and target priorities that the FSO will incorporate into a recon team's fire-support plan. The team leader should depart the FSE with an approved target list and/or preplanned fire overlay.

The engineer staff may also coordinate with the appropriate signal officer (engineer battalion, brigade, or TF) if the mission requires communications

support. A retrans or relay support must be requested if the mission dictates. The engineer recon team should not perform relay duties as their primary mission; however, it is desirable for each vehicle used by the recon team to have the capability to act as a retrans station.

The engineer staff also coordinates with any additional elements that may be providing support to the recon effort (such as air-defense artillery [ADA], COLT, GSR, and aeroscouts). Ideally, any linkups should occur at the TOC during daylight and in sufficient time to conduct a thorough briefing and rehearsal with elements that the recon team is attached to or elements that are attached to the recon team. During a route recon, the engineer recon team must know the number, type (track or wheeled), and load classification of vehicles to be used on the recon routes. This information will determine route trafficability and help decide COAs during the recon.

The engineer staff coordinates with the appropriate unit Supply Officer (US Army) (S4) (from the engineer battalion, brigade, or TF) to ensure that a feasible CSS plan is in place and that the recon team leader understands where all of his logistical support will come from. Detailed discussion of CSS and recon operations is in Chapter 7.

The engineer recon team leader should, as a minimum, have the following materials on hand and available to his soldiers:

- Operational graphics.
- R&S graphics.
- The SITEMP, event template, and notes on the current enemy situation.
- The fire-support overlay.
- CSS plan (resupply, casualty evacuation, maintenance, and recovery) and CSS graphics.
- Communications plan.
- Compromise procedures.
- Disengagement criteria.
- Linkup plan.
- Contingency plan for NAI coverage.

Once in the vicinity of these recon objectives, the recon team confirms or denies the templated information. The team—

- Looks for engineer-specific information about the obstacle, such as the obstacle's composition and any bypasses around it.
- Considers limited obstacle reduction.
- Conducts an analysis of the terrain and soil composition to determine whether mine-clearing blades or mine-clearing line charges (MICLICs) will be successful.
- Recommends the location for obstacle reduction.

The information obtained by the engineer recon team must be relayed to the TOC quickly to allow the S2, the S3, and the engineer staff to analyze the information and ensure rapid dissemination to all units. The engineer staff should ensure that it has a system in place to track all incoming OBSTINTEL and the method of dissemination as well as a system to display confirmed OBSTINTEL graphically as opposed to templated obstacles.

Chapter 3

Tactical Reconnaissance

Engineers are active participants in recon operations that provide both maneuver and engineer commanders with information about the terrain, enemy engineer activity, obstacles, and weather effects within an AO. A tactical recon normally takes place in a high-threat environment. During a recon, engineers may assist maneuver units or scouts in reconning the terrain to determine its effect on maneuverability and the enemy situation. When the enemy is located, the engineers help determine his strengths and weaknesses with a focus on enemy engineer activities and obstacles. A recon team provides the information necessary to allow combined-arms forces to maneuver against the enemy, attack him where he is most vulnerable, and apply overwhelming firepower to destroy him. An engineer recon team ensures that the combined-arms forces have the freedom to maneuver and the knowledge of where they will encounter enemy obstacles. This chapter provides basic information on recon operations. Its focus is on providing the engineers the information needed to allow them to integrate into a maneuver force's recon effort. Although this information is most pertinent to tactical recon missions, the methods discussed should also be used by squads, platoons, and companies when conducting technical recons.

PURPOSE AND FUNDAMENTALS

A tactical recon is conducted to gain information forward of friendly lines or to provide current, accurate information about terrain, resources, obstacles, and the enemy within a specified AO. This information provides the follow-on forces with an opportunity to maneuver to their objective rapidly. Engineer recon teams are involved in three types of tactical recon: route, zone, and area. During a tactical recon, engineers may also be involved in various technical recons such as road, tunnel, and bridge recons.

There are six fundamentals common to all successful tactical recon operations. Every engineer leader should keep these fundamentals in mind when planning and executing recon missions.

- Using maximum recon force forward. During a recon, every scout, every engineer, and every pair of eyes make a difference. Engineer recon teams must not be kept in the reserve. They must be employed, executing their portion of recon tasks as soon as possible.
- Orienting on the recon objective. A recon team's scheme of maneuver is focused toward a specific objective or a set of objectives. An engineer recon team must know where to look for enemy obstacles and enemy engineer activity at the objective. The objective may be a terrain

feature, a specific area, or an enemy force; it may be designated by an NAI, a checkpoint, or an objective symbol. A recon team must maintain its orientation toward the objective until the mission is complete. The overall objective for an engineer recon team's mission is located in the supported commander's priority intelligence requirements (PIR), the R&S plan, and/or the commander's intent paragraph in the operations order (OPORD). It is critical that all recon personnel understand the purpose of a recon mission.

- Reporting all information rapidly and accurately. Commanders base their decisions and plans on the battlefield information that scouts, engineers, and other recon assets find and report. Information loses value over time. Scouts and engineers must report all information exactly as they see it and as fast as possible. They must never assume, distort, or exaggerate; inaccurate information is dangerous. Information that an enemy or an obstacle is not in a certain location is just as important as where the enemy or obstacle is.
- Retaining freedom of maneuver. All recon elements must be able to maneuver on the battlefield. If a recon element is fixed by the enemy, the element must regain its ability to maneuver or it can no longer accomplish its mission. Recon teams must continually maintain an awareness of tactical developments. They must employ proper movement techniques and react to unexpected situations appropriately. When contact is made, the recon team leader must develop the situation and retain the initiative and the ability to continue the mission.
- Gaining and maintaining enemy contact. Recon elements employ sound tactical movement, target-acquisition methods, and appropriate actions to make contact with an enemy, undetected, thereby retaining the initiative and control of the situation. Recon elements use the terrain and weather to their advantage to avoid detection. Examples include selecting covered and concealed routes, moving during rain, avoiding roads and danger areas, and selecting unlikely routes to their objectives. Once scouts find the enemy, they maintain contact using all available means (sensors, radar, sound, and visual) until the commander orders them to do otherwise or as required by their specific instructions.
- Developing the situation rapidly. Whether recon elements detect an obstacle or the enemy, they must analyze the situation quickly. If they detect the enemy, the recon elements determine the enemy's size, composition, and activity and locate the enemy's flanks. Scouts and engineers find any obstacles protecting the enemy's position. The engineers (with scout assistance) find and mark a bypass, perform an unopposed obstacle reduction, or conduct a detailed obstacle recon. It is imperative that any reduction/markings does not jeopardize the recon effort. It is also important that the engineers gain enough detail about the obstacle for future breaching operations. This must be done quickly with minimum guidance from higher headquarters. During a recon, time is a precious resource; it cannot be wasted if mission success is to be achieved.

RECON TECHNIQUES

Recon techniques achieve a balance between the acceptable level of risk and the security necessary to ensure mission accomplishment. This balance is often a tradeoff between speed and security. The faster the recon, the more risk a recon team accepts and the less detailed recon it conducts. A recon team must use all available resources when conducting its mission. The primary tools for any engineer recon team are its senses—particularly, sight, hearing, touch, and smell. Recon equipment supplements and complements these senses. The following are some examples of how these senses are used during recon missions:

- Sight. An engineer recon team looks for—
 - Evidence of digging activities, including fighting positions and tank ditches.
 - Movement or activity of enemy engineer vehicles.
 - Indications of buried mines.
 - Emplaced demolition charges on bridges, tunnels, and so forth.
 - Obstacle orientation, depth, composition, and width.
 - Enemy vehicles and aircraft.
 - Helicopter landing zones (LZs).
 - Sudden or unusual movement.
 - Smoke or dust.
 - Engine exhaust fumes.
 - Unusual movement of farm or wild animals.
 - Activity of the local populace.
 - Vehicle tracks.
 - Signs or evidence of enemy occupation.
 - Recently cut foliage or vegetation.
 - Lights, fires, or reflections.
 - Muzzle flashes.
- Hearing. An engineer recon team listens for—
 - Vehicle sounds indicating construction of survivability positions.
 - Exploding demolition charges.
 - Running engines.
 - Track sounds.
 - Voices.
 - Metallic sounds, especially sounds indicating wire emplacement.
 - Gunfire sounds (by type of weapon).

- Unusual calm or silence.
- Dismounted movement through brush or woods.
- Helicopter rotors.
- Touch. An engineer recon team feels for the presence of trip wires or AHDs.
- Smell. An engineer recon team smells for—
 - Cooking food.
 - Vehicle exhaust.
 - Burning petroleum, oils, and lubricants (POL).
 - Decaying food or garbage.

To reduce vulnerability on the battlefield, an engineer recon team rehearses recon techniques in detail. The knowledge and rehearsal of recon techniques, combined with an understanding of a mission's particular METT-T requirements, allow the recon team leader to mix and choose the methods that maximize security and mission accomplishment.

This section discusses several recon methods that have proven to be effective in most situations. They form the foundation for tactical recon. Use common sense when analyzing a given situation and employing or modifying the method based on METT-T.

MOUNTED RECON

Maneuver units frequently employ mounted recons. A fairly detailed recon can be conducted while maintaining speed and momentum. Normally, a mounted recon is used when—

- Time is limited.
- Long distances must be traveled.
- A very detailed recon is not required.
- Enemy locations are known.
- Enemy obstacles are known or not expected.
- Enemy contact is not likely.

In addition to speed, a mounted recon offers the advantages of a tactical vehicle. These advantages depend on the vehicle employed, but they can include firepower, armor protection, increased navigational aids, communication capabilities, and thermal optics. Recon teams must dismount and recon forward of their vehicles to provide security before moving through dangerous areas such as open areas, hilltops, curves, wadis, or other blind spots on the battlefield. Disadvantages include the loss of stealth due to the vehicle's visual, noise, and thermal signatures and the loss of some detail because of restricted vision and impairment of the senses of smell and hearing. These disadvantages increase the risk to personnel as they conduct a recon.

DISMOUNTED RECON

A dismounted recon's primary purpose is to obtain detailed information about terrain features, obstacles, or enemy forces. Engineer recon teams normally conduct a dismounted recon. A dismounted recon is conducted when—

- A detailed recon is required.
- Stealth is required.
- Enemy contact is expected or visual contact has been achieved.
- Vehicle movement through an area is restricted by terrain.
- Time is not limited.
- Security is the primary concern.

Recon teams set up short- or long-duration observations posts (OPs). Dismounted personnel must provide security for each other when moving. They should work together in pairs when operating dismounted. When only one person dismounts, he should never move out of supporting distance of the vehicle.

As a minimum, a recon team should carry the following when dismounted:

- SOPs, to include templated information on anticipated obstacles.
- Personal weapons.
- Communications equipment.
- Signal operating instructions (SOI) extracts.
- Maps.
- A compass.
- Binoculars (night-vision devices [NVDs], if necessary).
- Seasonal uniform and load-bearing equipment.
- A global positioning system (GPS).
- Radios.

RECON BY FIRE

In a recon by fire, a recon element places direct/indirect fire on positions where there is a reasonable suspicion of enemy occupation. The goal is to cause an enemy to disclose his presence by moving or returning fire. Recon elements conduct a recon by fire when enemy contact is expected and time is limited or when they cannot maneuver to develop the situation. This method eliminates any element of surprise the scouts may have had, and it is likely to give the enemy detailed knowledge of their location. However, it may reduce the chance of being ambushed within established kill zones. Recon by fire does not work in all cases. For example, disciplined troops in prepared positions will not react to the scout's fires. Examples of situations in which a recon by fire may be employed include—

- The presence of a natural or man-made obstacle.

- The existence of an obvious kill zone.
- A suspected enemy position that fits the SITEMP.
- Signs of recent activity (tracks, marks, or trash).
- Bunker complexes that may or may not be occupied.

When such evidence exists, the scouts should maneuver to observe from different directions. When the decision is finally made to conduct a recon by fire, weapons should be used in the following priority:

- Indirect fire.
- Dismounted machine gun.
- 25-millimeter (mm) chain gun, MK19, and mounted machine gun.
- Tube-launched, optically tracked, wire-guided missile (TOW).

Engineer recon teams do not normally provide a key weapon system during a recon by fire. They are better employed as an observation asset to the firing team.

A recon by fire does not mean indiscriminately using direct and indirect fires at all wood lines and hilltops in the hopes of causing the enemy to react. The enemy will recognize this for what it is; he will not react to it. This also wastes valuable ammunition.

Indirect Fire

Scouts can employ recon by indirect fire (see Figure 3-1). This technique provides them security because they do not disclose their exact position, and they are all available to observe the effects of fire.

A recon by indirect fire has disadvantages as well. Indirect fire requires more coordination and communication than direct fire. Indirect fire is subject to considerations beyond a recon team's control such as the supporting unit's Class V supply status, counterbattery threats, and command approval. Also, the effects of indirect fire may obscure a scout's vision.

Direct Fire

Scouts can use their organic weapons to place accurate direct fires on suspected enemy positions. This technique is likely to provoke a rapid enemy response, but it reveals the scout's position. Scouts must work together when employing direct fire. A scout who fires is normally not in the best position to observe because of obscuration and the necessity to move to a covered and concealed position after firing. Another scout must observe for an enemy reaction. The recon leader should also plan on placing indirect fires on suspected positions for use as suppression if the enemy responds in strength.

AERIAL RECON

An aerial recon is not normally available except in division cavalry organizations or when supporting an armored cavalry regiment. When available, however, an aerial recon can be employed to complement and augment a ground recon. An aerial recon, as conducted by air-cavalry elements, is the fastest form of recon. It is also terrain-independent and thus

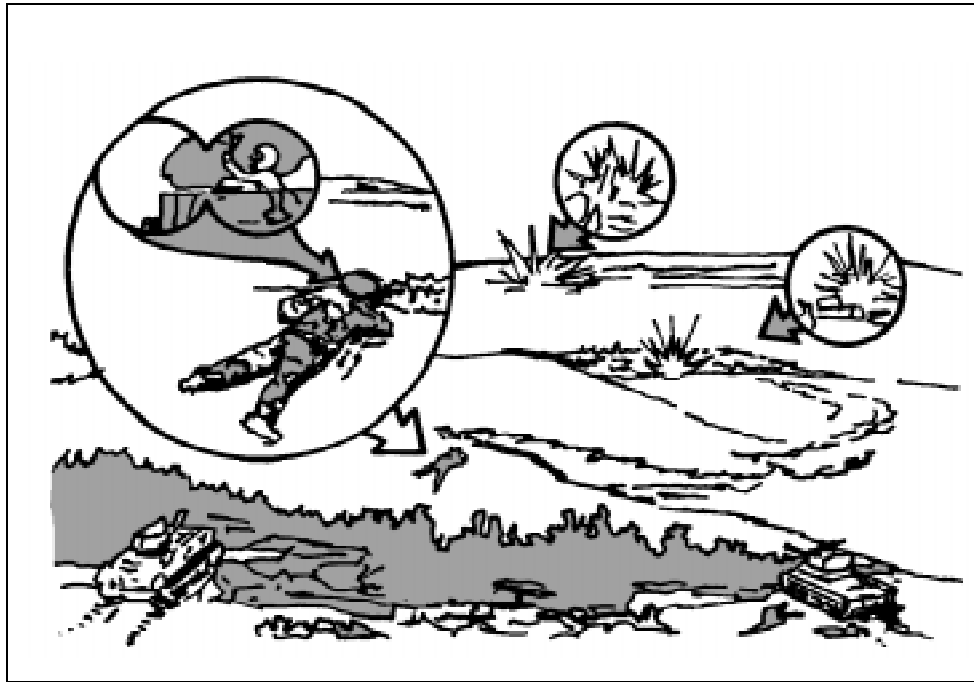

Figure 3-1. Recon by indirect fire

able to access areas that may be difficult or impossible for ground scouts to reach.

The advantage gained by employing air-cavalry assets is multifaceted and flexible enough to accommodate a broad range of ideas and missions. Refer to FMs 1-114 and 17-95-10 for more complete information.

STEALTH VERSUS AGGRESSIVE RECON

The recon team will use either aggressive or stealth recon techniques, based on METT-T. A stealth approach is time-consuming and emphasizes avoiding contact and engaging the enemy. To be effective, a stealth approach must rely on a dismounted recon and maximum use of covered and concealed terrain. An aggressive recon emphasizes the rapid identification of the enemy's combat power and is characterized by a mounted recon and a recon by fire.

ROUTE RECON

Maneuver units or scouts, augmented by engineers, conduct a route recon to gain detailed information about a specific route and the terrain on both sides of the route that the enemy could use to influence movement. When the commander wants to use a specific route, a maneuver unit or scout platoon with an engineer recon team conducts a route recon. This ensures that the route is clear of obstacles and enemy forces and that it will support his vehicles' movements. Engineers supporting division cavalry squadrons and armored cavalry regiments will routinely support these units in route recon missions.

CRITICAL TASKS

During a route recon, a recon element must accomplish a specified number of tasks unless directed to do otherwise. Based on time available and the commander's intent, the recon element may be directed to conduct a route recon to acquire specific information only. The recon leader must clearly understand which of the following critical tasks must be accomplished:

- Determining the route's trafficability. (For further information see Chapter 5.)
- Reconning to the limit of direct-fire range and terrain that dominates the route.
- Reconning all built-up areas along the route (includes identifying bypass routes, construction supplies and equipment, ambush sites, evidence of booby traps, and suitable sites for C²/CSS facilities).
- Reconning all lateral routes to the limit of direct-fire range.
- Inspecting and classifying all bridges on the route.
- Locating fords or crossing sites near all bridges on the route (includes determining fordability and locating nearby bypasses that can support combat and CSS units, marking bridge classifications and bypass routes, and being prepared to provide guides to the bypasses).
- Inspecting and classifying all overpasses, underpasses, and culverts.
- Reconning all defiles along the route.
- Locating obstacles along the route. (Cavalry units may be required to clear routes of obstacles. See FM 17-95.)
- Locating bypasses around built-up areas, obstacles, and contaminated areas.
- Reporting route information.
- Finding and reporting all enemy forces that can influence movement along the route.

TECHNIQUES

Because of the number of critical tasks that must be accomplished, a scout platoon with an engineer recon team can conduct a detailed recon of only one route. A scout platoon may be able to handle two routes if the recon is limited to trafficability only. The following discussion outlines one technique of accomplishing all tasks as rapidly and securely as possible.

The scout platoon leader receives an order specifying the route the platoon must recon and defining the route from start point (SP) to release point (RP). Additionally, the order may specify platoon boundaries, phase lines (PLs), lines of departure (LDs), and a limit of advance (LOA) or recon objective. These control measures specify how much terrain on both sides of a route that the platoon must recon and where the operation must begin and end. The boundaries are drawn on both sides. They include the terrain that dominates the route, usually extending out 2.5 to 3 kilometers. This ensures that the

scouts recon all terrain that the enemy could use to influence movement along the route. An LD is drawn from one boundary to the other behind the SP. This allows the platoon to cross the LD and be fully deployed before reaching the route. An LOA or objective is placed beyond the RP on the last terrain feature dominating the route or out to about 3 kilometers (see Figure 3-2, page 3-10).

The recon platoon leader may add additional PLs, contact points, and checkpoints to the graphics he receives from his commander. PLs are used to help control the platoon's maneuver. The contact points ensure that the teams maintain contact at particular critical points. Checkpoints are used along a route or on specific terrain to control movement or to designate areas that must be reconned. The engineer recon team leader should obtain this information during the scout platoon OPORD briefing.

The recon platoon leader will also coordinate with the FSO and plan artillery targets on known or suspected enemy positions and on dominant terrain throughout the AO. The engineer recon team leader must ensure that this information is included on his overlay.

The recon platoon leader evaluates the METT-T factors and organizes his platoon with an engineer recon team to meet mission needs. He ensures that at least one team is responsible for reconning a route. A three-team organization is usually the type best suited to recon a route. Team A reconns the terrain left of the route, Team B covers the terrain right of the route, and Team C and the engineer recon team recon the route and controls the movement of the other two teams. In this organization, the platoon leader's team has specific responsibility to clear the route (see Figure 3-3, page 3-11). The engineer recon team's tasks will likely include a technical recon of the route (including bridge load classification and possible locations for employing SCATMINES).

EXAMPLE OF A ROUTE RECON

The following example of a route recon is for a cavalry scout platoon with an engineer platoon attached.

When the scout platoon (with an engineer platoon) conducts a route recon, it often deploys in a V formation because of the mission's focused nature. Team A is positioned to the left of the route, Team B to the right, and Team C (with an engineer platoon) in the center of the zone along Route Saber. The platoon should deploy into the formation before reaching LD Patton so that it crosses the LD at the specified time. The platoon leader reports crossing the LD when the first element crosses it (see Figure 3-4, page 3-12).

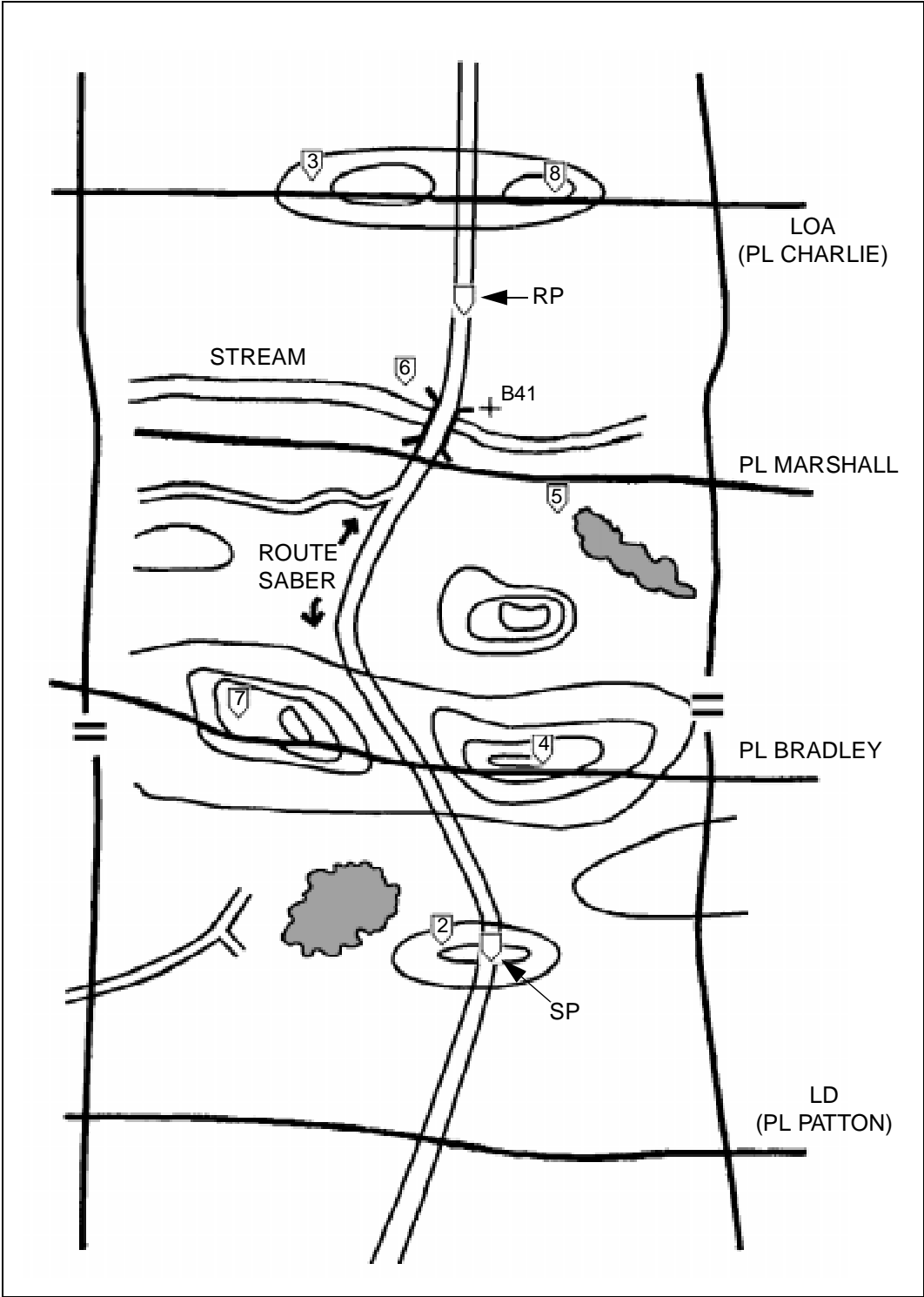

Figure 3-2. Control measures

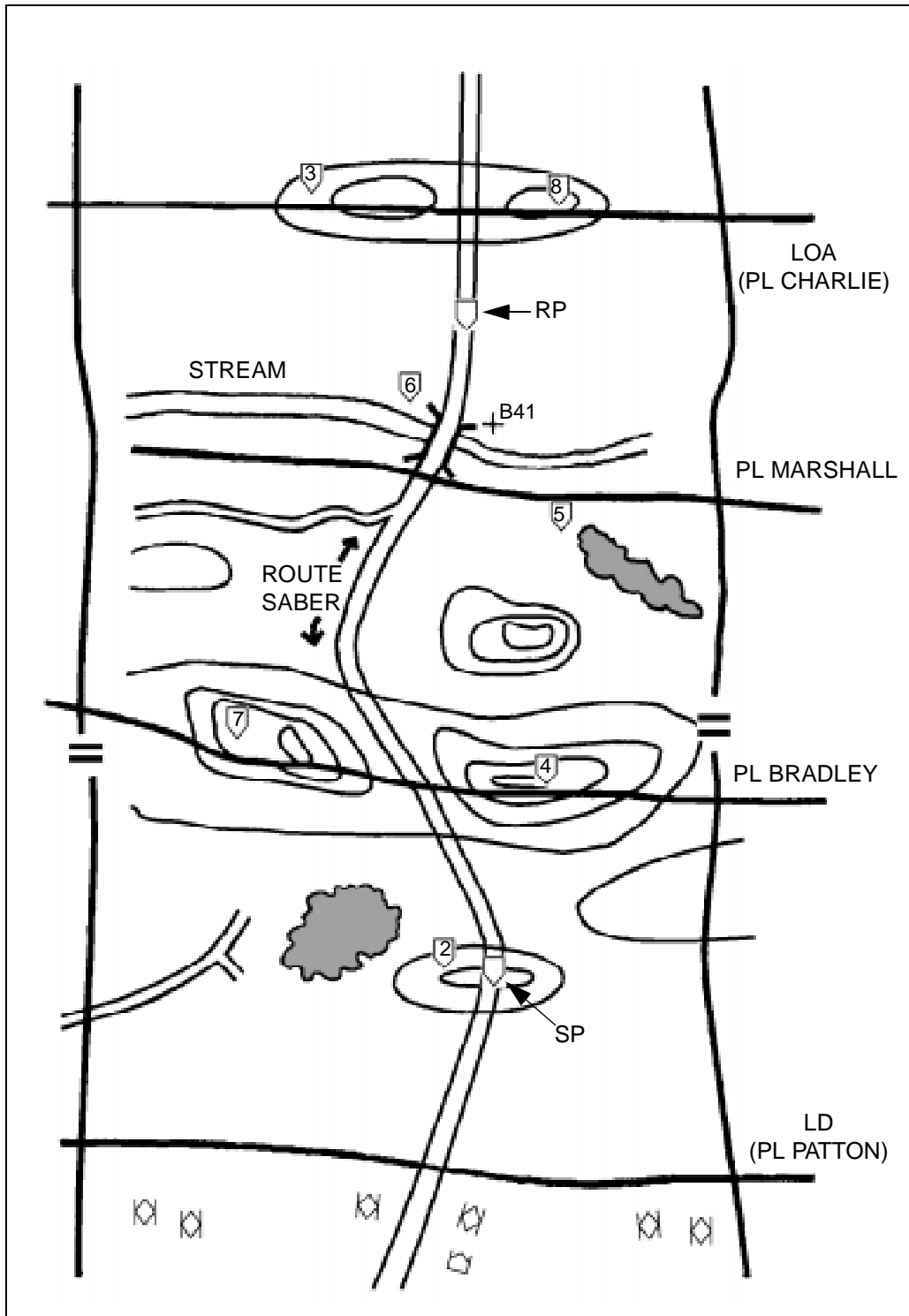

Figure 3-3. Conducting a route recon

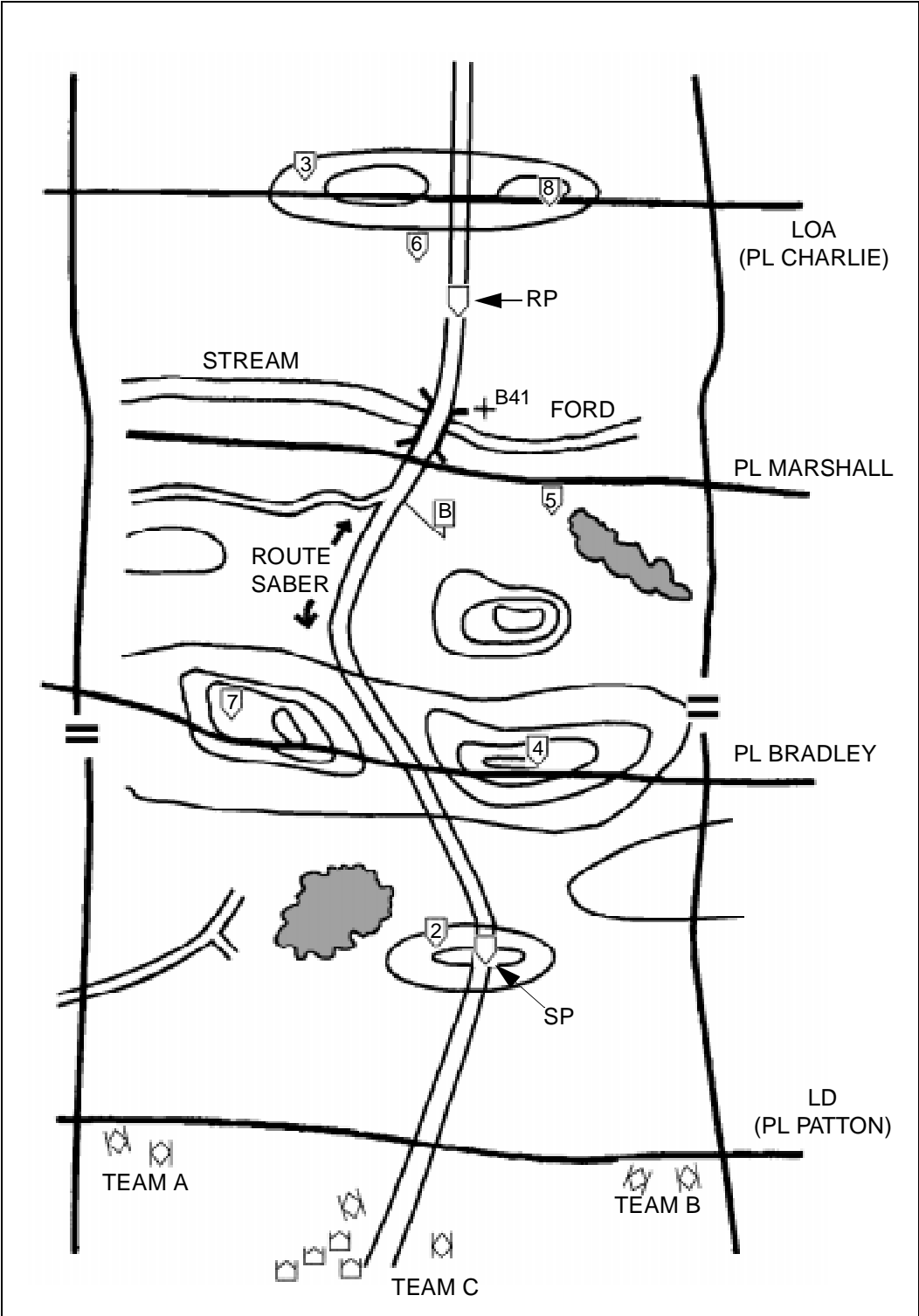

Figure 3-4. Route recon

The scout platoon leader is responsible for movement through the zone. He uses checkpoints to control the movement and to focus on obstacles, key terrain, or features that may influence movement along the route. The engineers focus on obstacles that must be located and cleared. Their efforts must focus on specific PIR to ensure that the recon occurs in a timely manner.

Team C should be positioned along the route so that it can observe the route, and one element of the team must physically drive the entire route. Unless the sector is very small or very open, the platoon will move as individual teams. As the sections move to the checkpoints, they maneuver in a zigzag pattern to clear the sector and accomplish all critical tasks of a route recon. The lead teams on the flanks must observe the route and report any restrictions or obstacles that may restrict movement along the route. Visually clearing the route before Team C travels along it provides for better security and allows Team C to concentrate on the critical recon tasks. As the teams maneuver toward the checkpoints, they maintain visual contact with the route (see Figure 3-5, page 3-14).

After both lead teams report "Set" and are in overwatch positions, Team C begins the route recon (see Figure 3-6, page 3-15). As the platoon leader moves along the route, his wingman maneuvers to provide overwatch for the platoon leader and the engineer platoon. As the engineer platoon leader travels along Route Saber, he is normally required to send a route classification of the trafficability at intervals designated by the commander. A route report may be required only if there is a significant or unexpected change in the route's makeup.

As Team C clears the route, the other teams move ahead, clearing and reconning critical and dominant terrain. The platoon leader controls and coordinates the teams' movements. He must ensure that the flank teams remain far enough forward of Team C to provide security. The flank teams are also assigned responsibility for covering lateral routes. Team A executes a lateral route and uses contact point B to tie with Team C on Route Saber (see Figure 3-7, page 3-16).

The platoon order must address actions on the approach to the stream. In this case, the two flank teams have been given the task of locating bypasses in the form of fords or unmapped bridges. Team B is successful in locating a ford; Team A is not. The engineer platoon sends one squad to checkpoint 5, links up with Team B, and conducts a ford recon. Team B focuses on the steps used for obstacle and restriction recon and continues its mission (see Figure 3-8, page 3-17).

The engineer squad moves back to contact point B and links up with Team C and the rest of the engineer platoon. Team C continues its route recon along the route until it approaches the bridge site. It then executes a bridge recon to establish the bridge's trafficability. Team A occupies an overwatch position while Team C and the engineer platoon recon the bridge. Team B continues its recon one terrain feature beyond the stream and then occupies a short-duration OP (see Figure 3-9, page 3-18).

Team C and the engineer platoon complete their bridge recon and establish local security on the approaches to the bridge's far side. The engineer platoon moves to checkpoint 6 and observes the bridge during the crossing. Once completed, Team A passes across the bridge and through Team C, continuing its recon to clear dominant terrain on the route's left flank (see Figure 3-10, page 3-19). Once Team A is set, the platoon resumes its route recon to the LOA (see Figure 3-11, page 3-20).

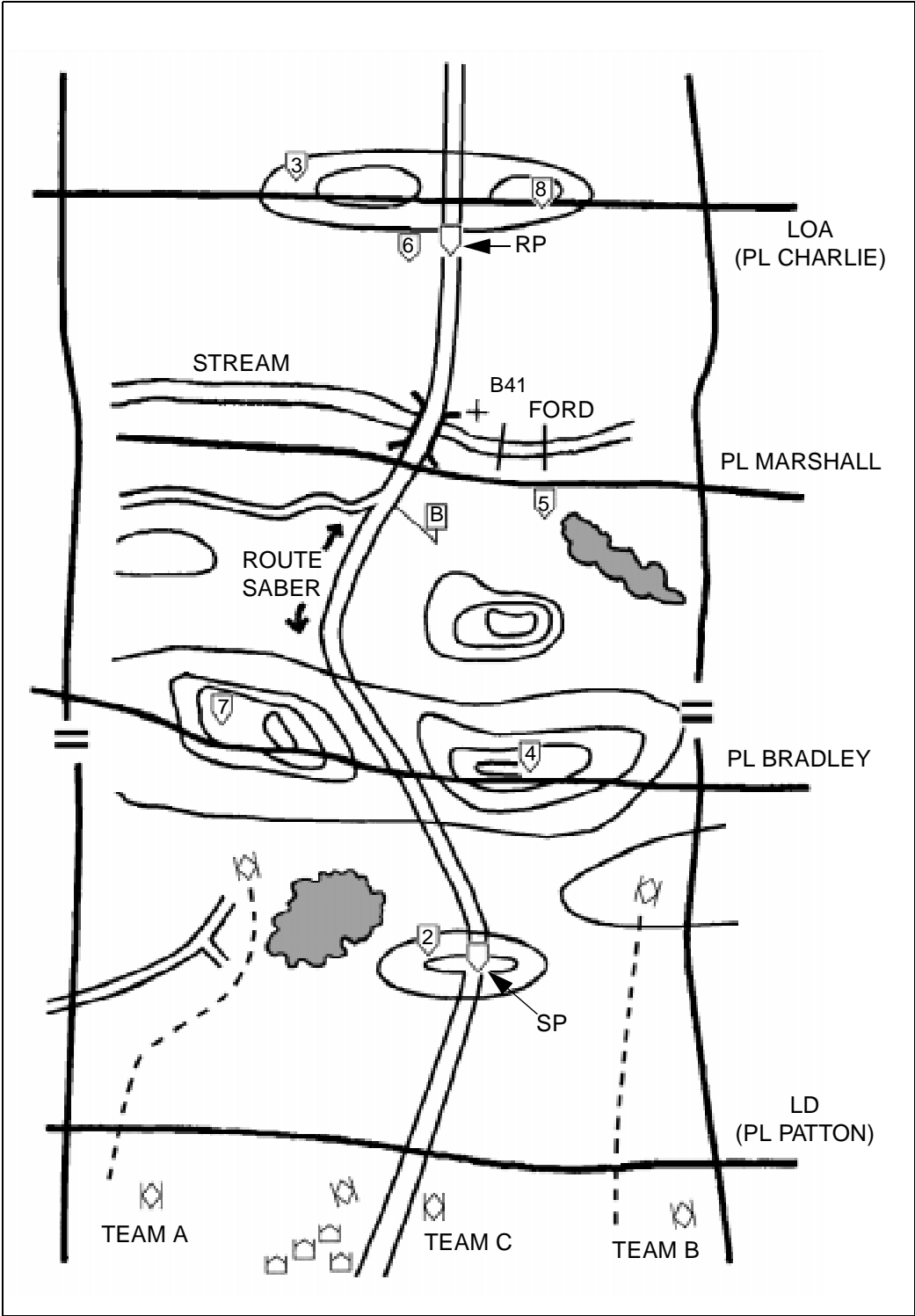

Figure 3-5. Route recon (continued)

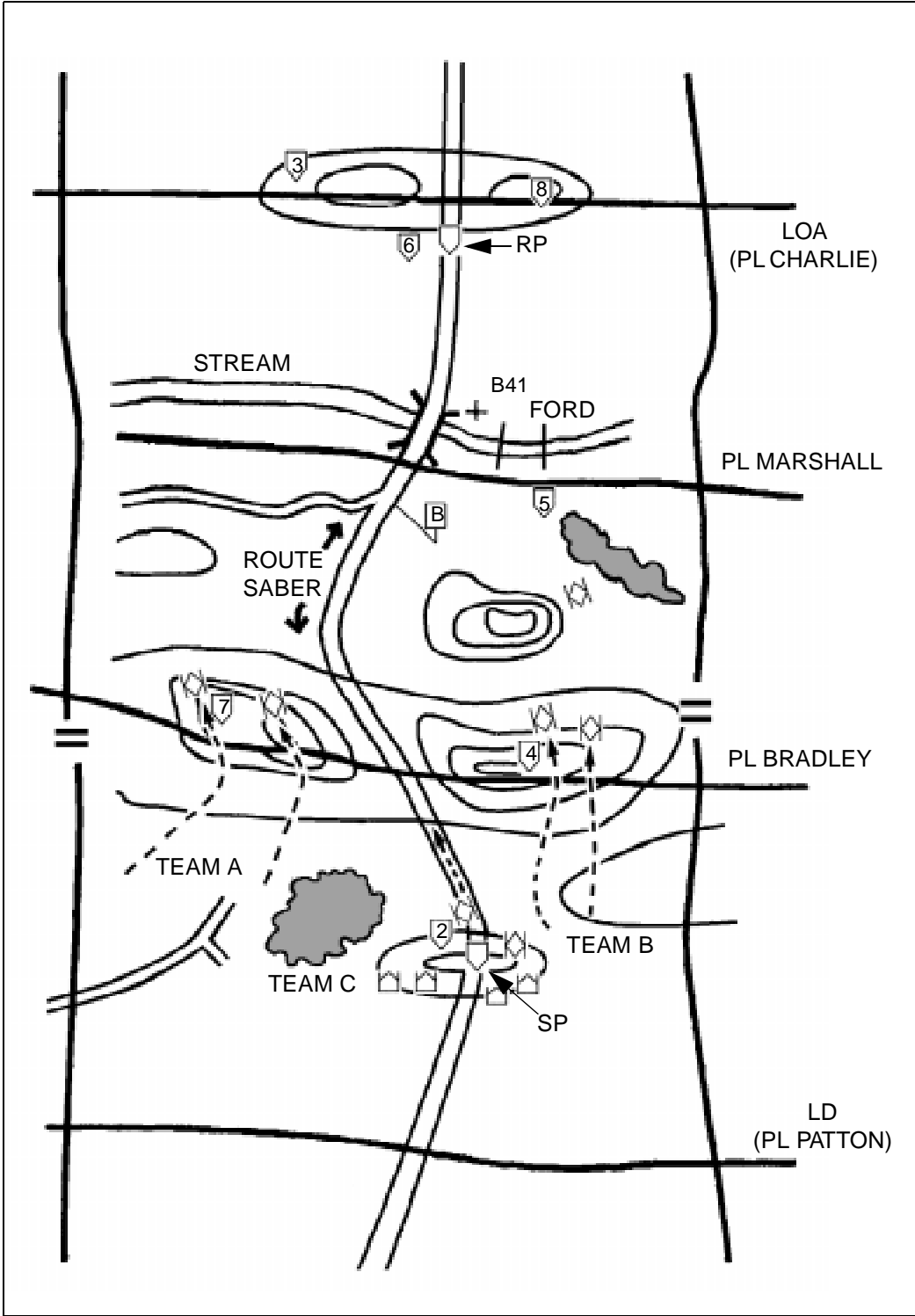

Figure 3-6. Team C begins route recon

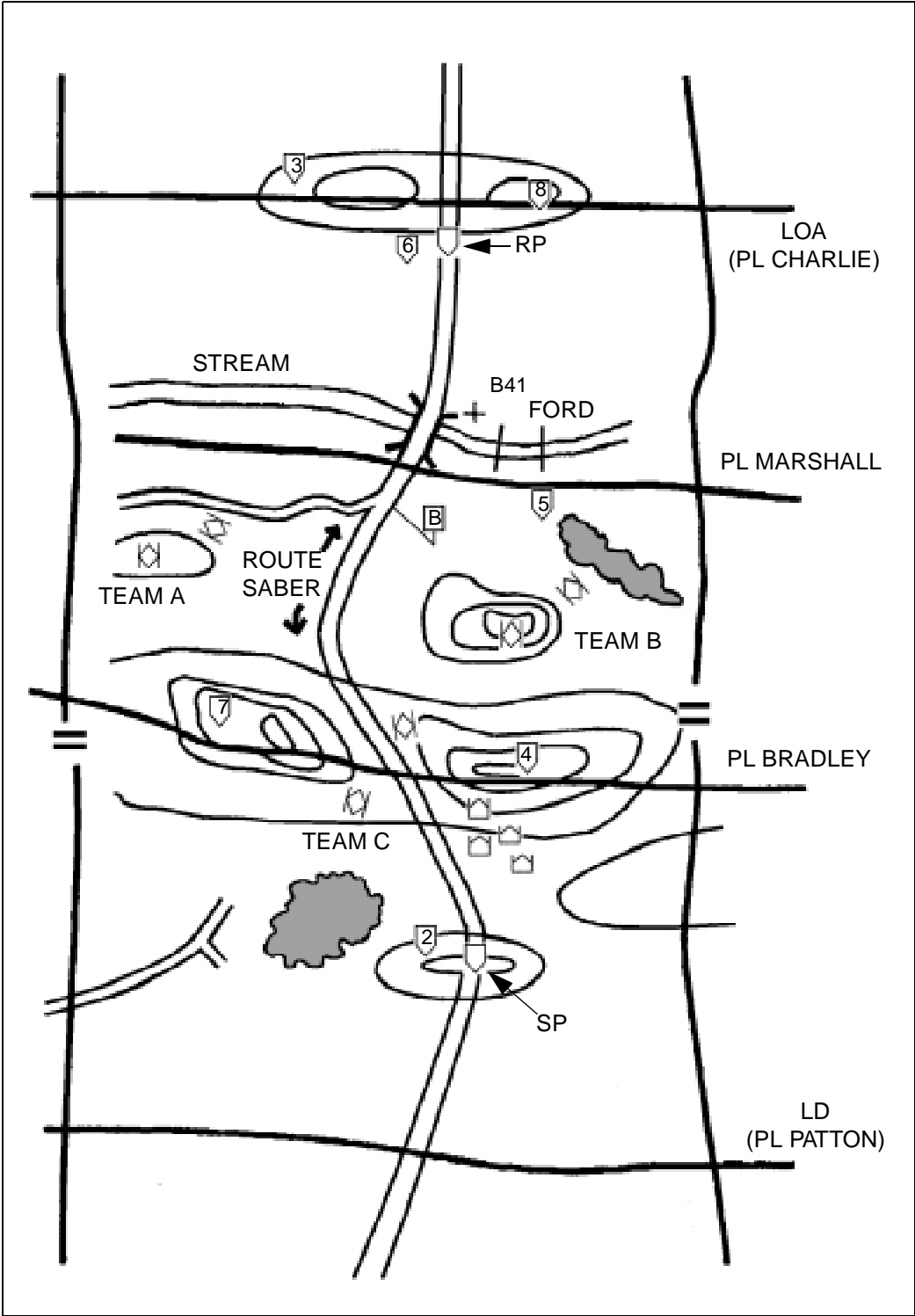

Figure 3-7. Team A executes lateral route

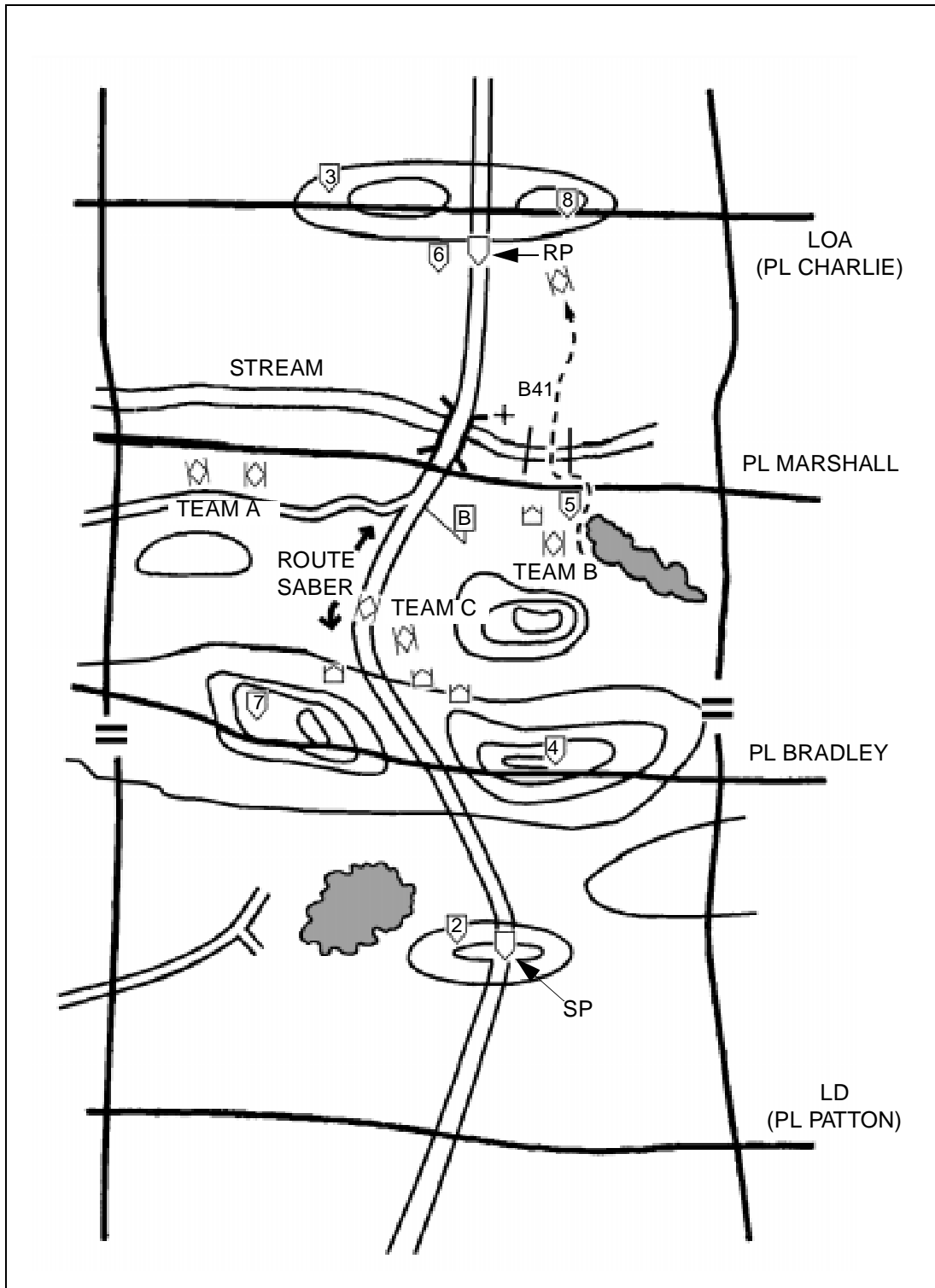

Figure 3-8. Team B (with engineers) conducts ford recon

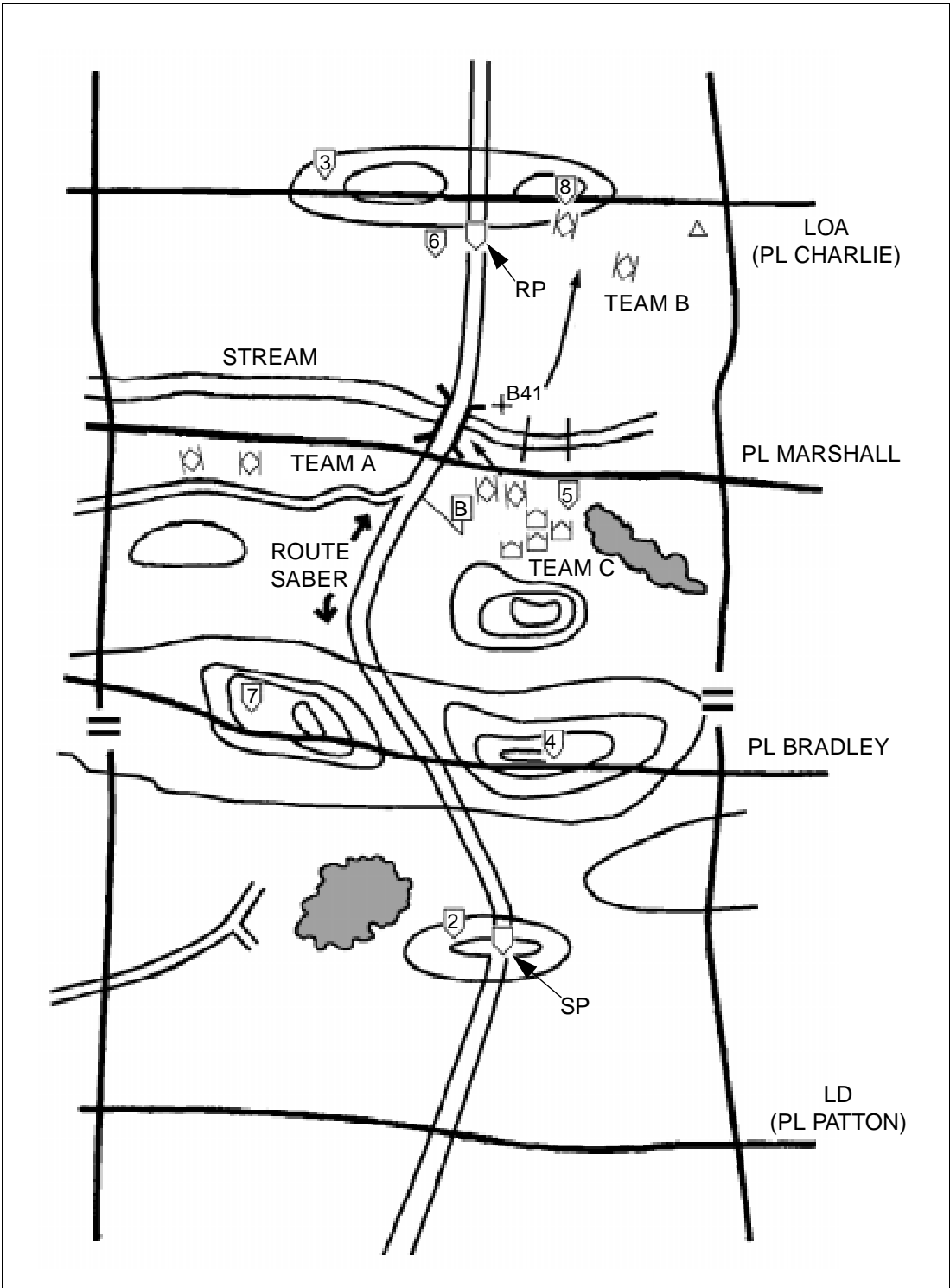

Figure 3-9. Team C (with engineers) conducts bridge recon

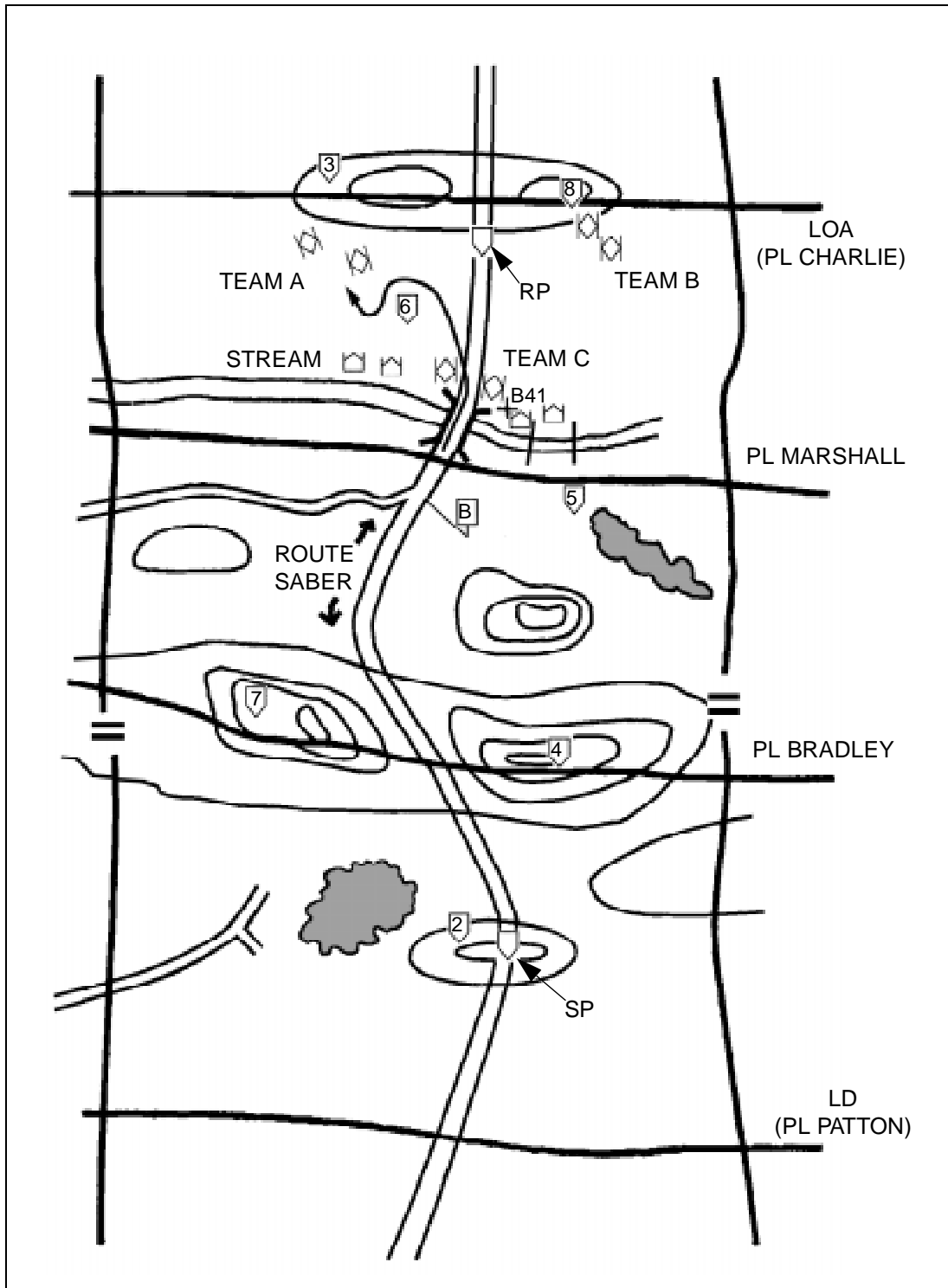

Figure 3-10. Team A crosses the bridge

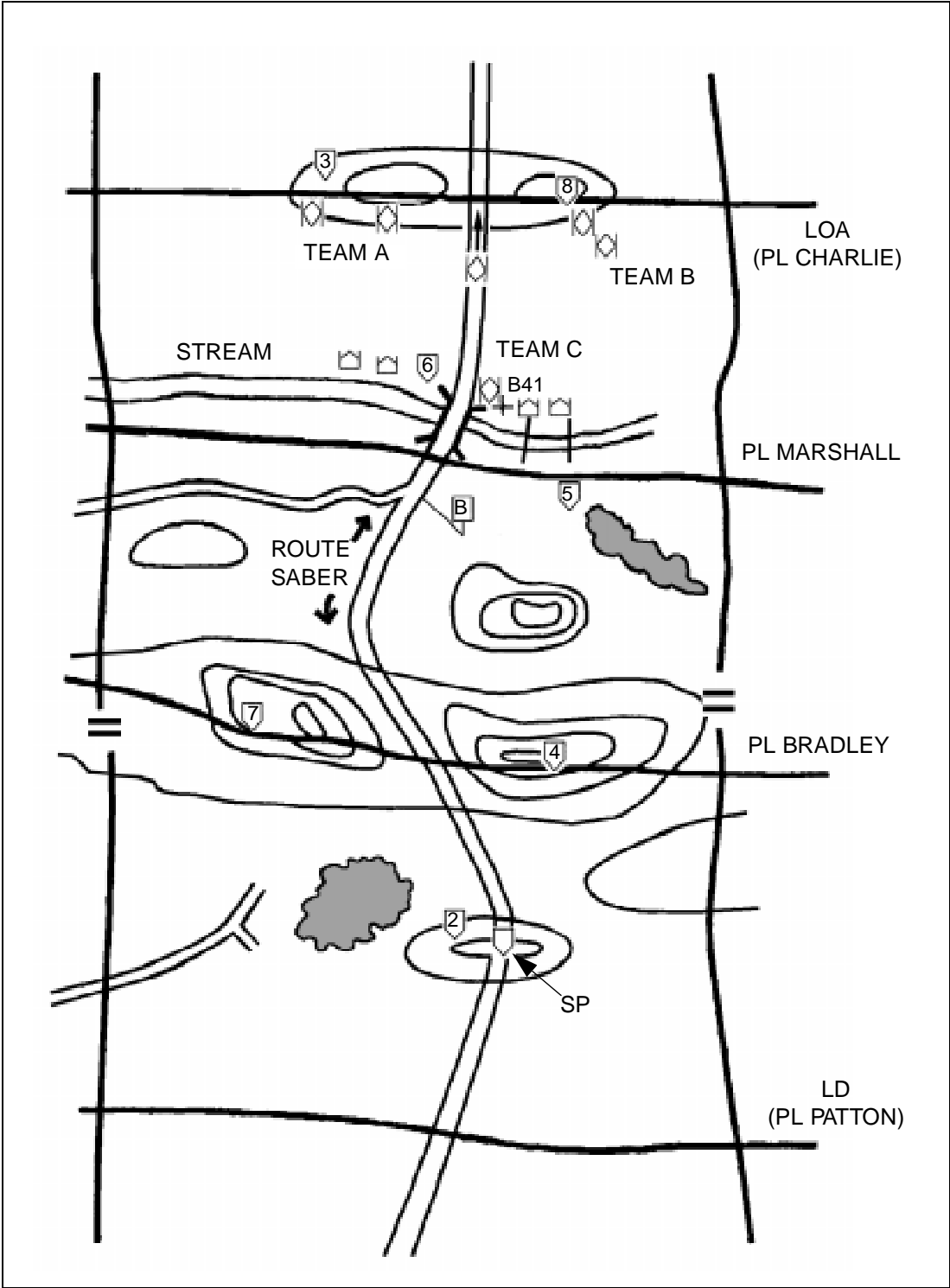

Figure 3-11. Team C moves to recon LOA

ZONE RECON

Maneuver units and scouts, with the assistance of engineers, conduct zone recon missions to gain detailed information about routes, terrain, resources, and enemy forces within a zone defined by lateral boundaries. Commanders normally assign a zone recon mission when they need information before sending their main-body forces through the zone. The recon produces information about the enemy situation and about routes and cross-country trafficability within the zone. Engineers play a primary role in obtaining route and cross-country trafficability information. This is the most thorough and complete recon mission; therefore, it is very time intensive. It is common for scouts executing a zone recon with engineer assistance to advance at only 1.5 kilometers per hour.

CRITICAL TASKS

During a zone recon, a recon element must accomplish a specified number of tasks unless directed to do otherwise. The recon leader must clearly understand which of the following critical tasks must be accomplished:

- Reconning key terrain in the zone.
- Inspecting and classifying all key bridges within the zone.
- Locating suitable fording or crossing sites near all bridges within the zone.
- Inspecting and classifying all overpasses, underpasses, and culverts.
- Locating obstacles in the zone; determining how to reduce obstacles (assets and time) when needed. (Cavalry units may be required to clear the zone of obstacles. See FM 17-95.)
- Locating bypasses around built-up areas, obstacles, and contaminated areas.
- Reporting enemy forces in the zone.
- Reporting recon information.

TECHNIQUES

A zone recon is a very time-consuming operation. Unless the orders specify otherwise, all critical tasks listed above are implied in the zone recon mission statement. Commanders who want a faster tempo of operations need to modify the mission statement and ensure that the recon element knows what its primary recon tasks are. For example, the TF commander may have critical bridges that need classification to ensure that the main body can move with freedom. However, he may have two other bridges within the zone that will not be used by the TF and do not need to be classified.

Mounted maneuver units and TF scouts with engineers can effectively recon a zone that is 3 to 5 kilometers wide. The zone's width is determined by the road network, terrain features, anticipated enemy activity, and time available to accomplish the mission. If the zone is wider than 3 to 5 kilometers, the recon element quickly loses the capability to accomplish the critical tasks and move securely.

When a recon leader receives a zone recon mission, the order will define the zone by lateral boundaries, an LD, and an LOA or objective. The parent unit may include additional PLs or other graphic control measures within the zone to help control the maneuver of the units.

The recon leader analyzes the mission to determine what must be accomplished. He analyzes any information about the enemy during the IPB to determine what enemy activity he should expect to encounter. The engineer commander should work with the recon leader, the S2, and the S3 to ensure that engineer recon tasks are identified and that enough engineers are attached to the recon element to accomplish the mission. The engineer commander will help analyze the terrain by—

- Assisting the S2 in map recon.
- Examining aerial photographs.
- Using an automated terrain-visualization tool.

Depending on the type of recon element, the experience of the attached engineer recon team, and METT-T considerations, the element can conduct the zone recon using a two-, three-, or four-team organization. The recon element must deploy to cover the entire zone. It usually operates in a zone it knows very little about, so the COA must allow for flexibility, responsiveness, and security as it moves. The recon leader deploys the scout teams on line across the LD. He uses PLs, checkpoints, contact points, or TIRS points to ensure that the element recons the entire zone and that teams maintain contact with each other. He ensures that scout teams remain generally on line, which prevents significant gaps that a moving enemy could exploit. Scouts and engineers dismount as necessary to gather detailed information, clear danger areas, or move through areas that are not accessible to the vehicles. The element continues to recon the zone until it reaches the LOA or the final recon objective.

EXAMPLE OF A ZONE RECON

The following example of a zone recon is for a battalion scout platoon augmented with an engineer recon team.

Although strict formations are not generally used by scout platoons forward of the forward edge of the battle area (FEBA), the platoon leader in this example starts out with his platoon on line. He will attempt to generally maintain this relationship even though the teams are not mutually supporting much of the time. The platoon should deploy into formation before crossing the LD. In this example, Team A is on the left, Team B is on the right, and Team C is in the center of the zone (see Figure 3-12).

The platoon crosses the LD at the time prescribed in the commander's OPORD, using the bounding-overwatch technique of movement within the teams. In this mission, the platoon leader has chosen to position himself and the engineers with Team A because of the importance of the route and bridge in Team A's AO. The teams maneuver through the zone in a zigzag pattern to ensure that the zone is properly reconned and to accomplish all critical tasks of a zone recon. Security is provided within teams because the zone's width and terrain prevent the teams from providing mutual support (see Figure 3-13, page 3-24).

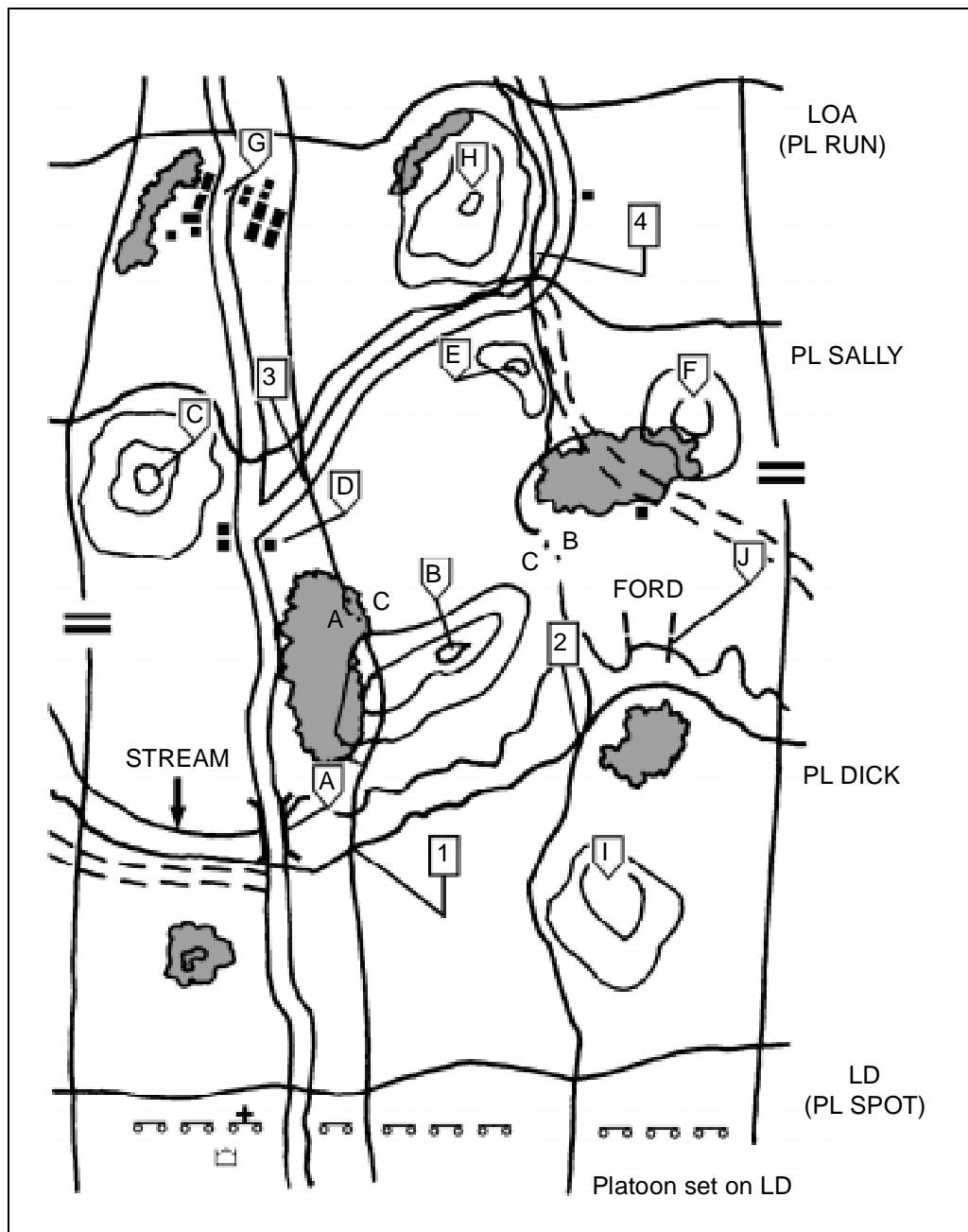

Figure 3-12. Scouts and engineers cross the LD

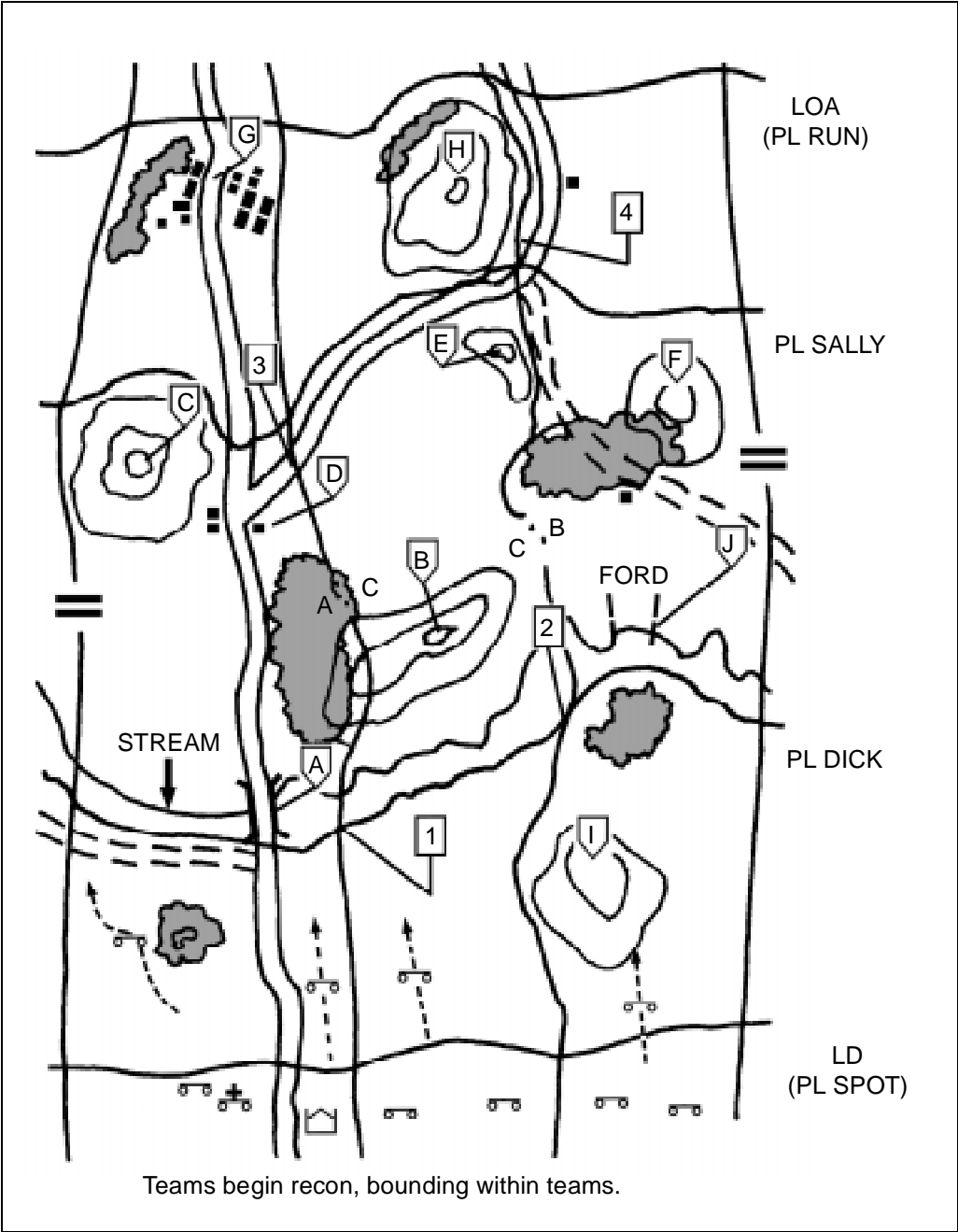

Figure 3-13. Zone recon

Depending on METT-T factors, the platoon leader chooses the movement technique best suited for C². He may choose to have the teams clear and set at all checkpoints, or he may have them bound through the checkpoints, report clear, and then set at the PLs. If the platoon leader has not assigned teams a particular checkpoint to orient on, the team leaders must plan their own measures to control the movement. They move team elements to contact points to ensure that the move is tied in with that of the other teams. The platoon leader does not allow any element to cross PL Dick until all elements have reported set (see Figure 3-14, page 3-26).

When the platoon is set on PL Dick, the leader gives the teams permission to execute PL Dick and move to PL Sally. The teams immediately begin reconning the stream to their front. Team A and the engineer recon team must execute a bridge recon and recon the stream for possible unmarked fords. They must conduct a ford recon at the known ford in zone.

Once Team C completes its recon of the stream and reports negative results, it moves to the vicinity of contact point 2 and awaits permission to cross the stream at Team B's ford. Team C is also prepared to cross at Team A's bridge, if necessary (see Figure 3-15, page 3-27).

As Team A (with an engineer recon team) and Team B complete their recon tasks at the bridge and ford, they revert to the bounding-overwatch movement technique and continue to recon. Team C moves across the team boundary and prepares to cross the stream at the ford (see Figure 3-16, page 3-28).

The zone recon continues with Teams A and B clearing checkpoints D and F, respectively. The platoon leader holds the teams at those control measures to allow time for Team C to clear checkpoint B and get on line with the other teams at checkpoint E. This prevents dangerous gaps from developing between the teams (see Figure 3-17, page 3-29).

Once Team C sets at checkpoint E, the platoon leader has all elements on line and set along PL Sally. Teams A and C ensure that they make contact at contact point 3. The platoon leader gives permission for all elements to execute PL Sally and move to and set at PL Run (see Figure 3-18, page 3-30).

As the teams move across PL Sally, Teams B and C make contact at contact point 4. The platoon uses the bounding-overwatch technique within each team. The teams continue the zone recon in this manner, accomplishing all critical tasks and reporting all control measures and other recon information, until they reach the LOA or recon objective (see Figure 3-19, page 3-31).

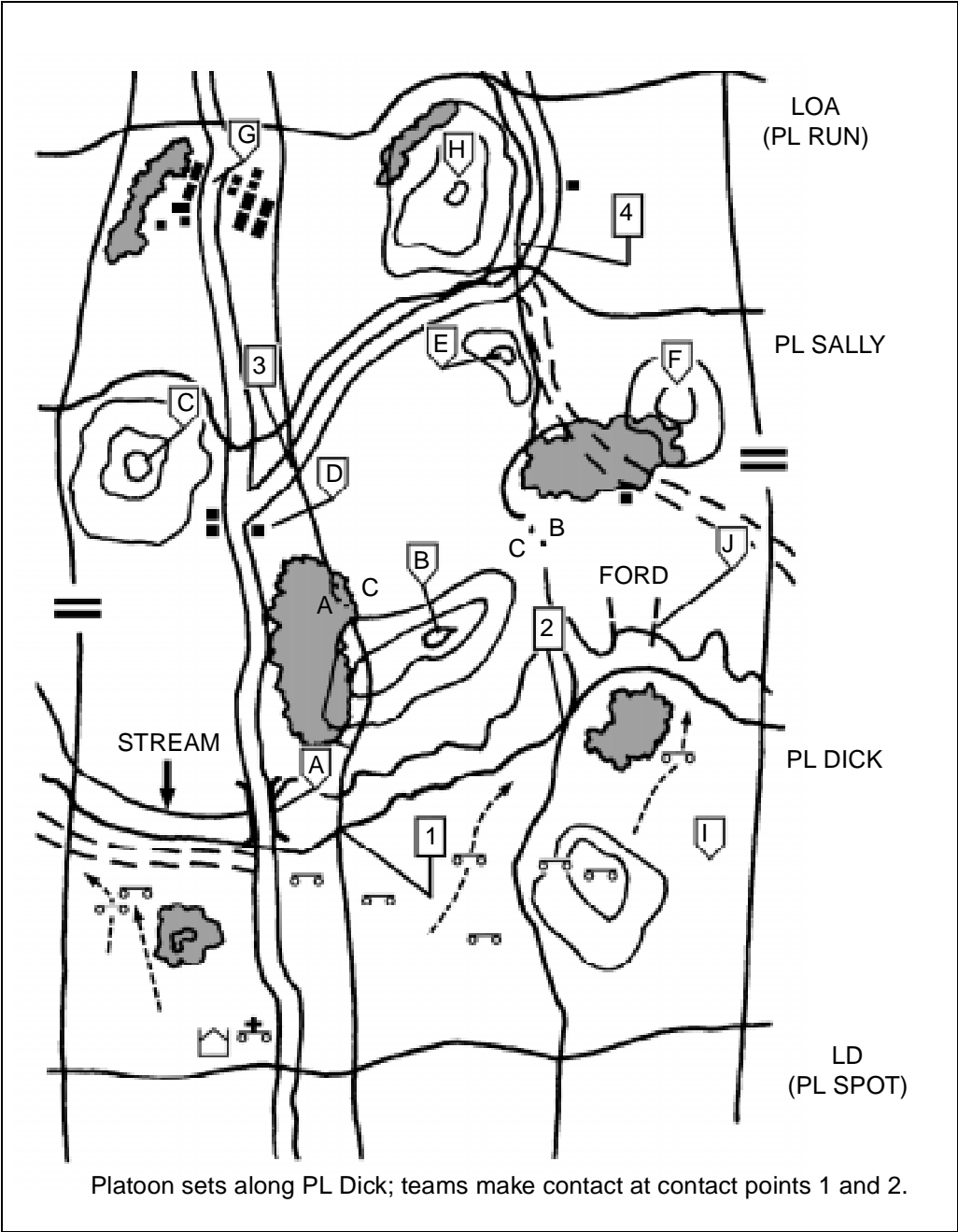

Figure 3-14. Teams set at PL Dick

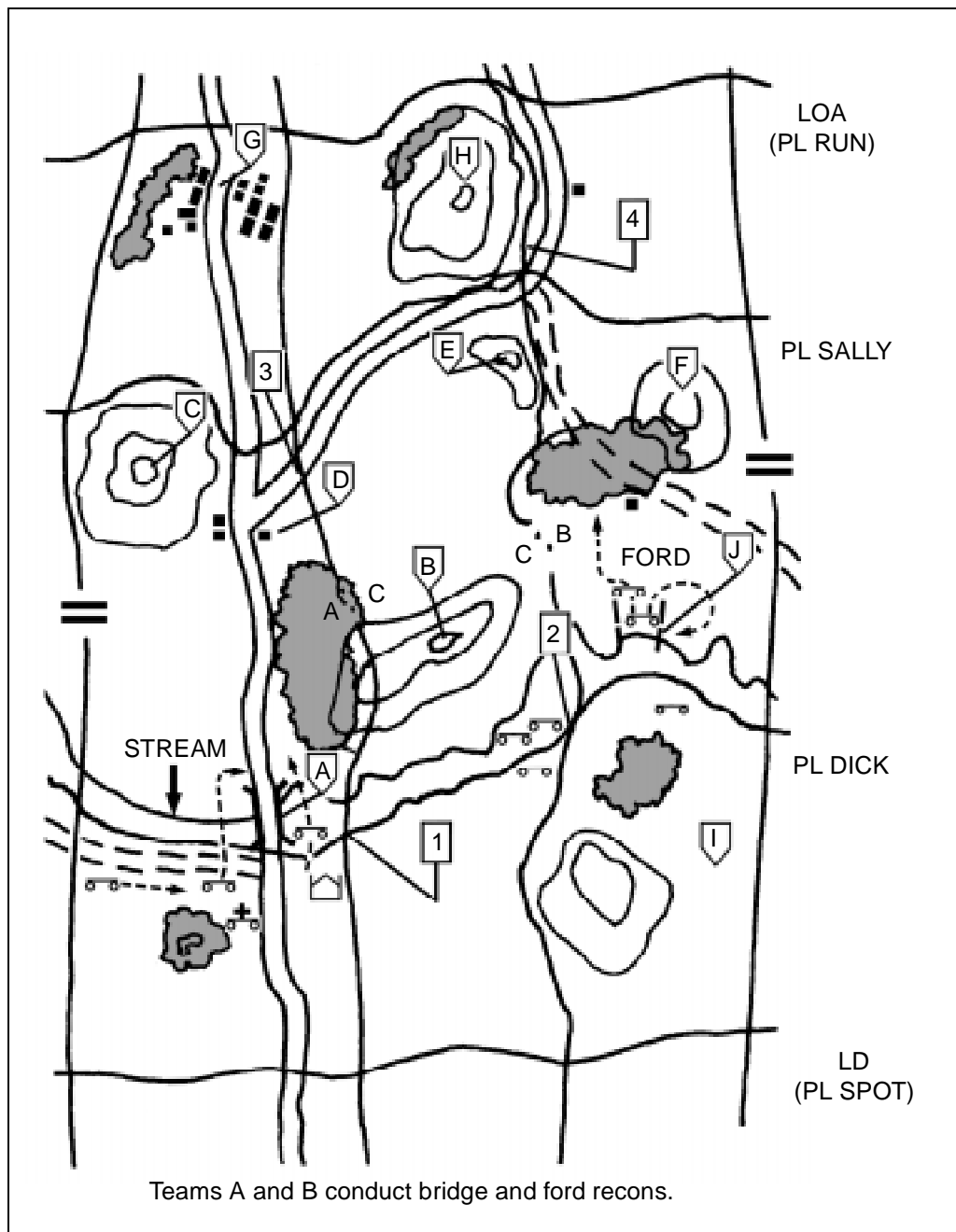

Figure 3-15. Team C completes recon

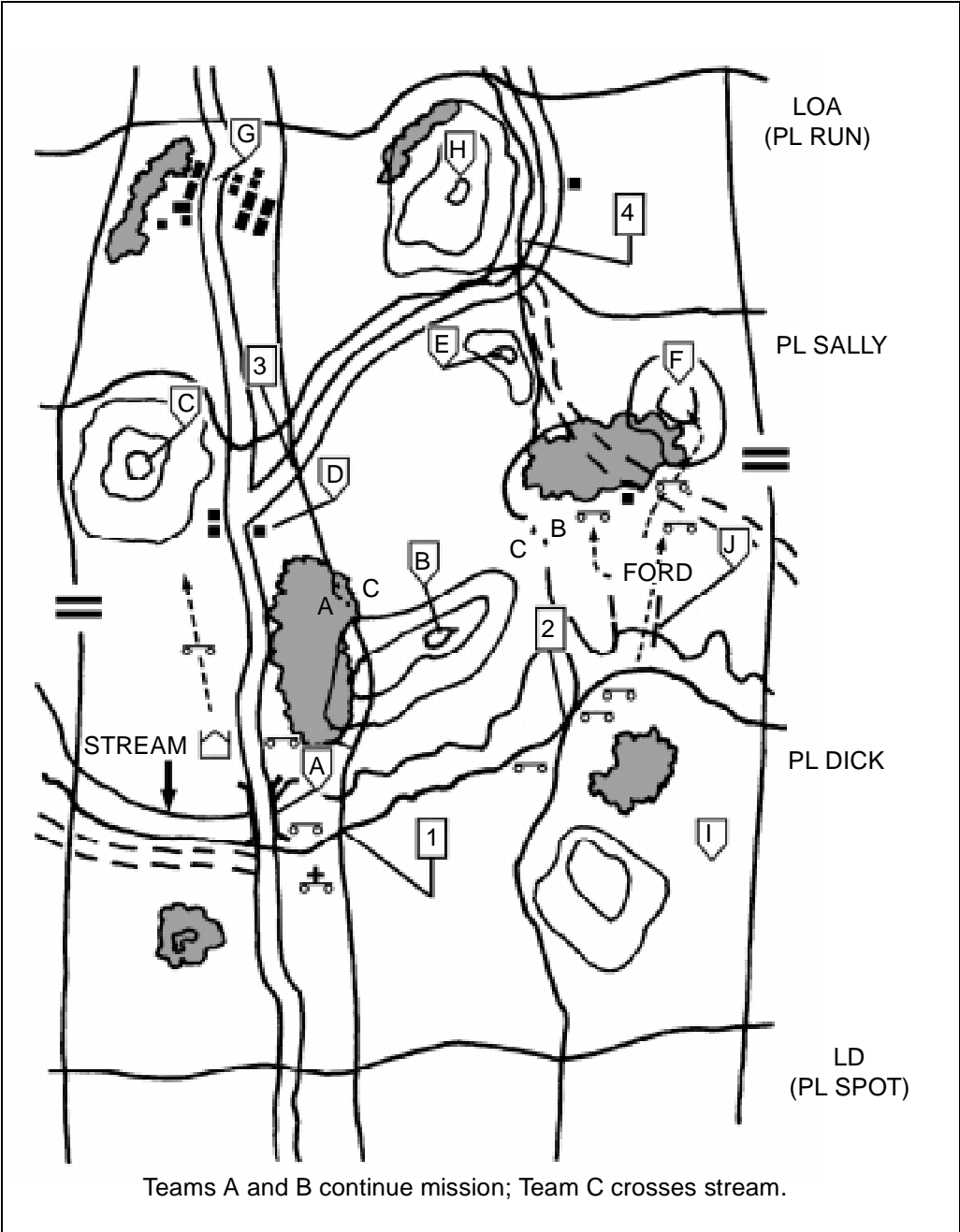

Figure 3-16. Teams A and B complete recon

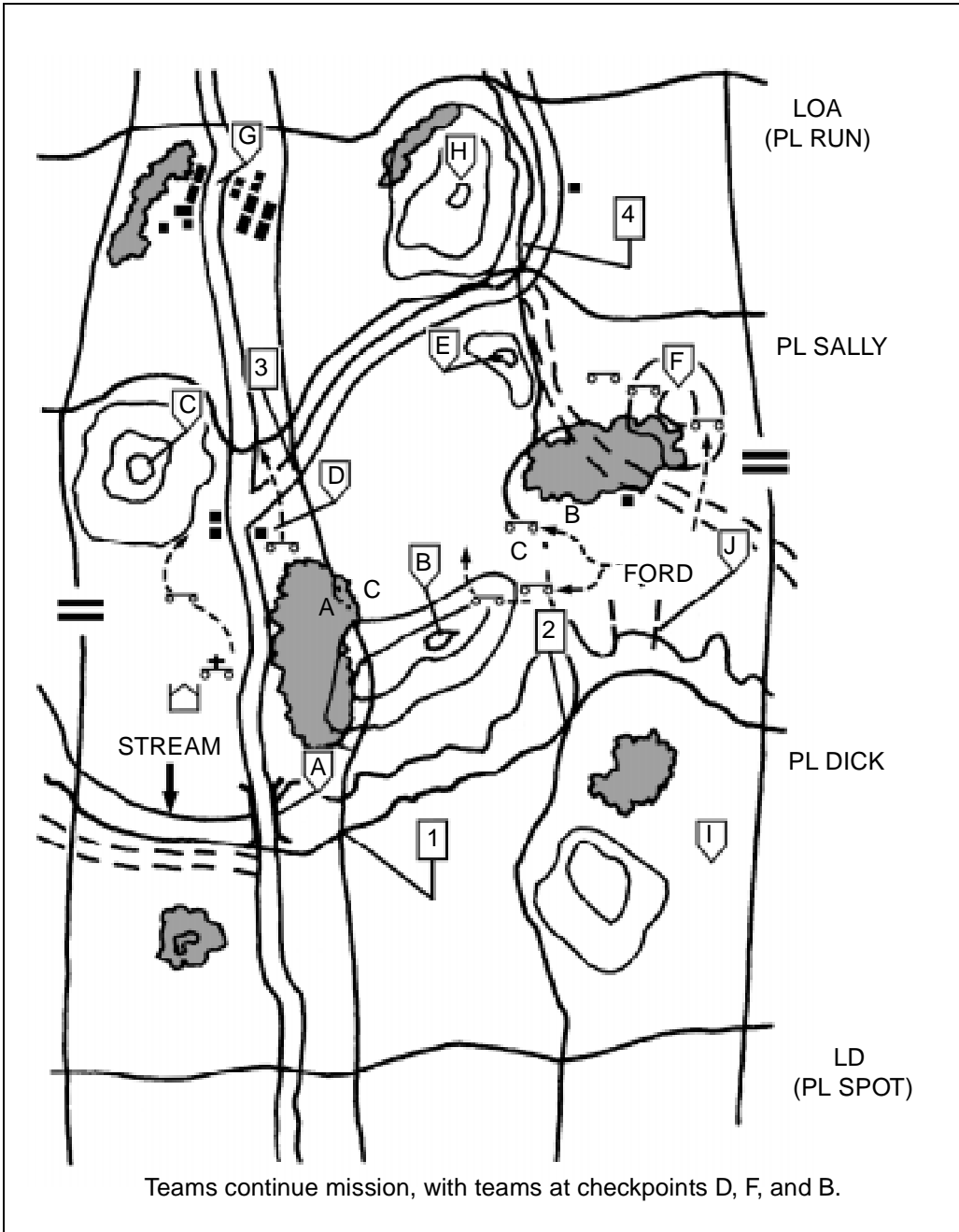

Figure 3-17. Teams A and B are halted

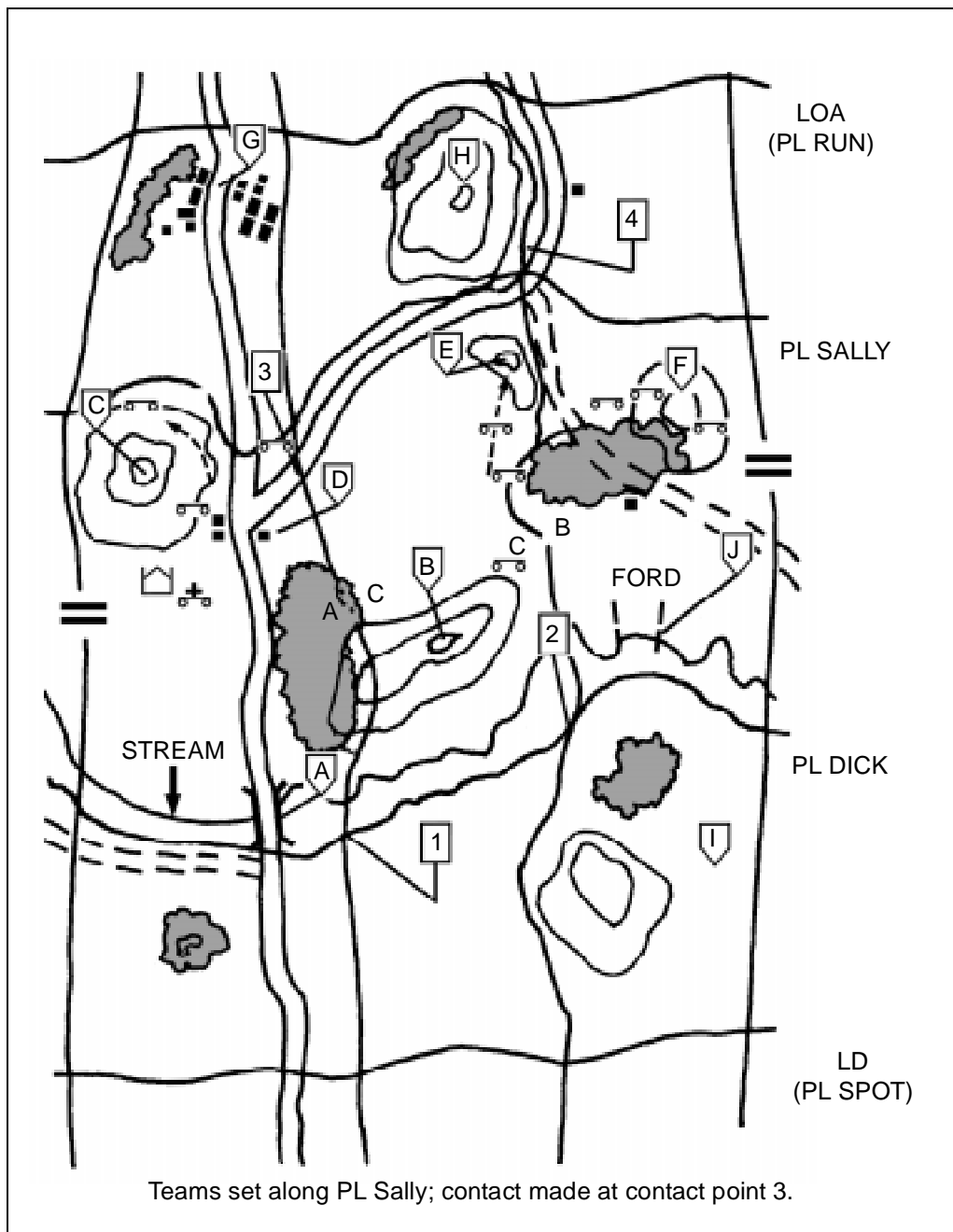

Figure 3-18. Begin movement to PL Run

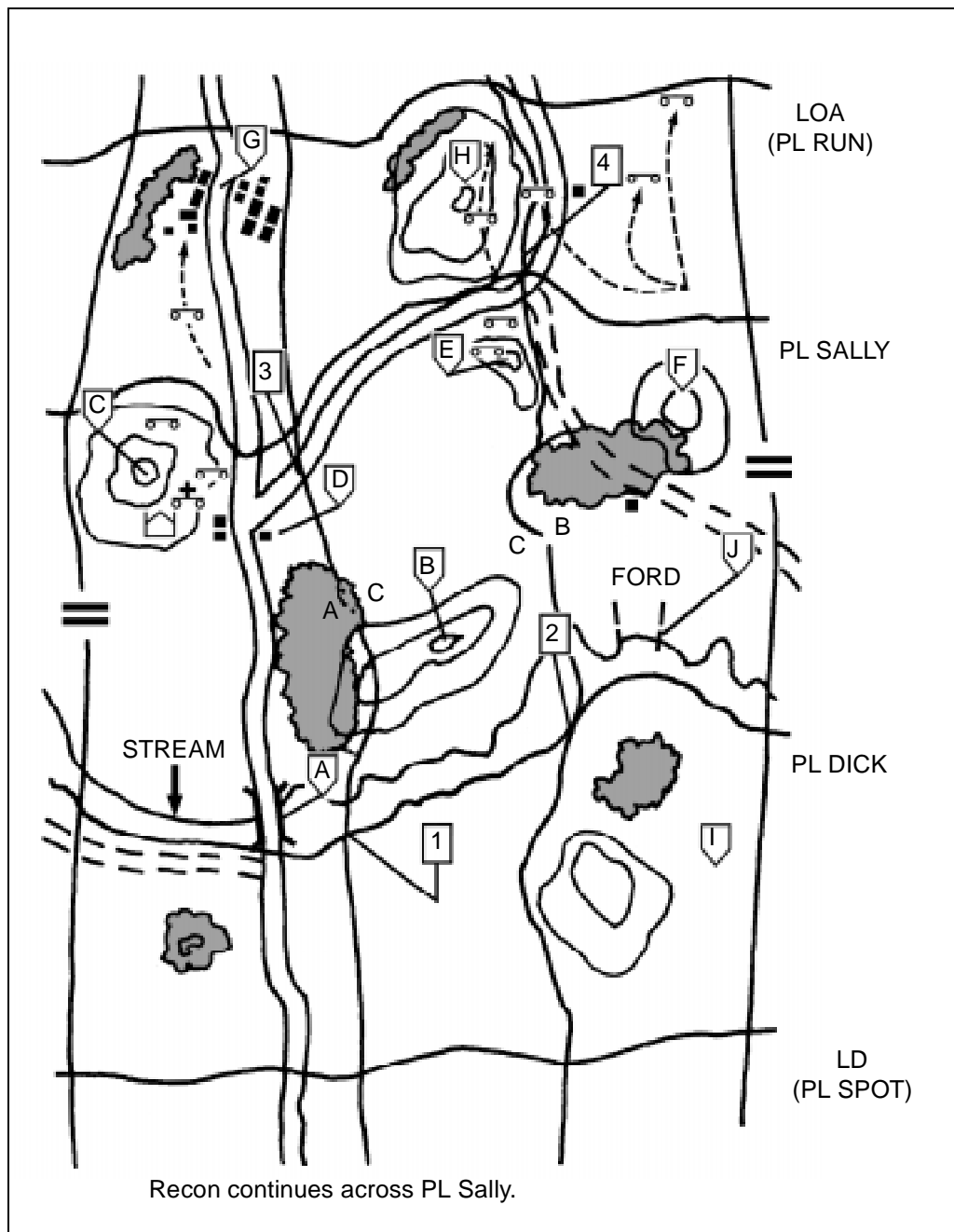

Figure 3-19. Zone recon complete

AREA RECON

Before moving forces into or near a specified area, commanders may call on their scouts or other recon element to conduct an area recon to avoid being surprised by unsuitable terrain conditions or unexpected enemy forces. The area could be a town, a ridgeline, woods, or other features that friendly forces intend to occupy or pass through. Area recon is frequently required for objective areas to confirm the IPB templates and provide detailed information regarding enemy dispositions. In addition, area recon within a zone of operation can be used to focus the scouts on the specific area that is critical to the commander. This technique of focusing the recon also permits the recon to be accomplished more quickly. Therefore, an area recon can be a stand-alone mission or a task to a team or platoon within the larger context of a platoon or troop recon mission.

CRITICAL TASKS

During an area recon, a recon element must accomplish a specified number of tasks unless directed to do otherwise. The recon leader must clearly understand which of the following critical tasks must be accomplished:

- Reconning all terrain within the area.
- Inspecting and classifying all bridges within the area.
- Locating suitable fording or crossing sites near all bridges within the area.
- Inspecting and classifying all overpasses, underpasses, and culverts.
- Locating obstacles in the area.
- Locating bypasses around built-up areas, obstacles, and contaminated areas.
- Finding and reporting all enemy forces within the area. (Cavalry units may be required to clear the area of obstacles. See FM 17-95.)

TECHNIQUES

The order to conduct an area recon mission identifies the area to be reconned within a continuous boundary. A recon leader completes his troop-leading procedures using METT-T. He also plans the movement to and, if necessary, from the area, following the basic rule of using different routes in and out of the area. The routes are specified for the recon element when it works as part of a larger unit such as a cavalry troop. The element's primary concern during movement to the area is security rather than recon. During movement to the area, it may be appropriate (depending on the commander's intent) for the recon element to avoid contact.

The recon leader encloses the given area within a zone; he uses boundaries, an LD, and an LOA. The recon leader can divide the area further by placing boundaries on identifiable terrain. This ensures that each team is responsible for specific terrain areas. The recon leader may also choose to orient and focus teams on checkpoints for both movement and recon. PLs may also be used to help control movement to the area. The recon leader places contact points at the intersections of PLs and boundaries and any other places he wants

physical contact and coordination between his teams. He uses TIRs as necessary. He works with the FSO to plan indirect fires to support the element's scheme of maneuver.

The recon leader deploys his teams abreast across the LD to accomplish their recon tasks. Formations are often not appropriate to this mission because of the irregular shape of the area and the wide variety of METT-T considerations.

EXAMPLE OF AN AREA RECON

The following example of an area recon is for a battalion scout platoon augmented by an engineer recon team.

The battalion scout platoon has been given the mission of performing an area recon of Objectives Lead and Iron. The platoon has not been assigned a specific route, and enemy dispositions are vague.

The platoon leader analyzes the terrain and his mission requirements and decides to use a four-team organization. He assigns Teams A, B, and C checkpoints on Objective Iron. Because of Objective Lead's smaller size, he assigns only Team D to recon it. The platoon leader decides that he and the engineer recon team will move with Team C to provide close control of the recon of Objective Iron. The platoon sergeant (PSG) will move with Team D and observe the recon of Objective Lead. The platoon leader decides to move the platoon using checkpoints that make maximum use of cover and concealment between the LD and the objectives (see Figure 3-20, page 3-34).

Using the four-team organization, the platoon crosses PL Bob at the time specified in the commander's OPORD. The platoon crosses in sequence, with the two lead teams executing and the following teams waiting until initial checkpoints are cleared before proceeding. No platoon formation is used. The lead teams, which have the longest distance to move to their recon objectives, use the bounding-overwatch technique to ensure maximum security (see Figure 3-21, page 3-35).

As the lead teams execute checkpoints C and H, the trail teams cross the LD. The movement technique is bounding overwatch within teams (see Figure 3-22, page 3-36).

The scout teams continue their move to the designated dismount points. Team D occupies its dismount point, checkpoint L. The team sets its vehicles in hide positions, organizes a patrol, and deploys local security (see Figure 3-23, page 3-37).

Team D's patrol moves on covered and concealed dismounted routes to Objective Lead and conducts a dismounted recon. The patrol uses the fan dismounted recon technique to thoroughly recon the objective. Teams A and B occupy their dismount points (checkpoints A and D, respectively). Team C continues to move (see Figure 3-24, page 3-38).

Team D's patrol completes its recon of Objective Lead. The team submits its report and establishes an OP in the vicinity of checkpoint J from which it can observe the objective area. Teams A and B dispatch their patrols to conduct dismounted recon on Objective Iron. The platoon leader has designated the checkpoints on the objective to focus the team's patrol. Teams A and B recon checkpoints G and F, respectively. Team C occupies its dismount point in the vicinity of checkpoint K (see Figure 3-25, page 3-39).

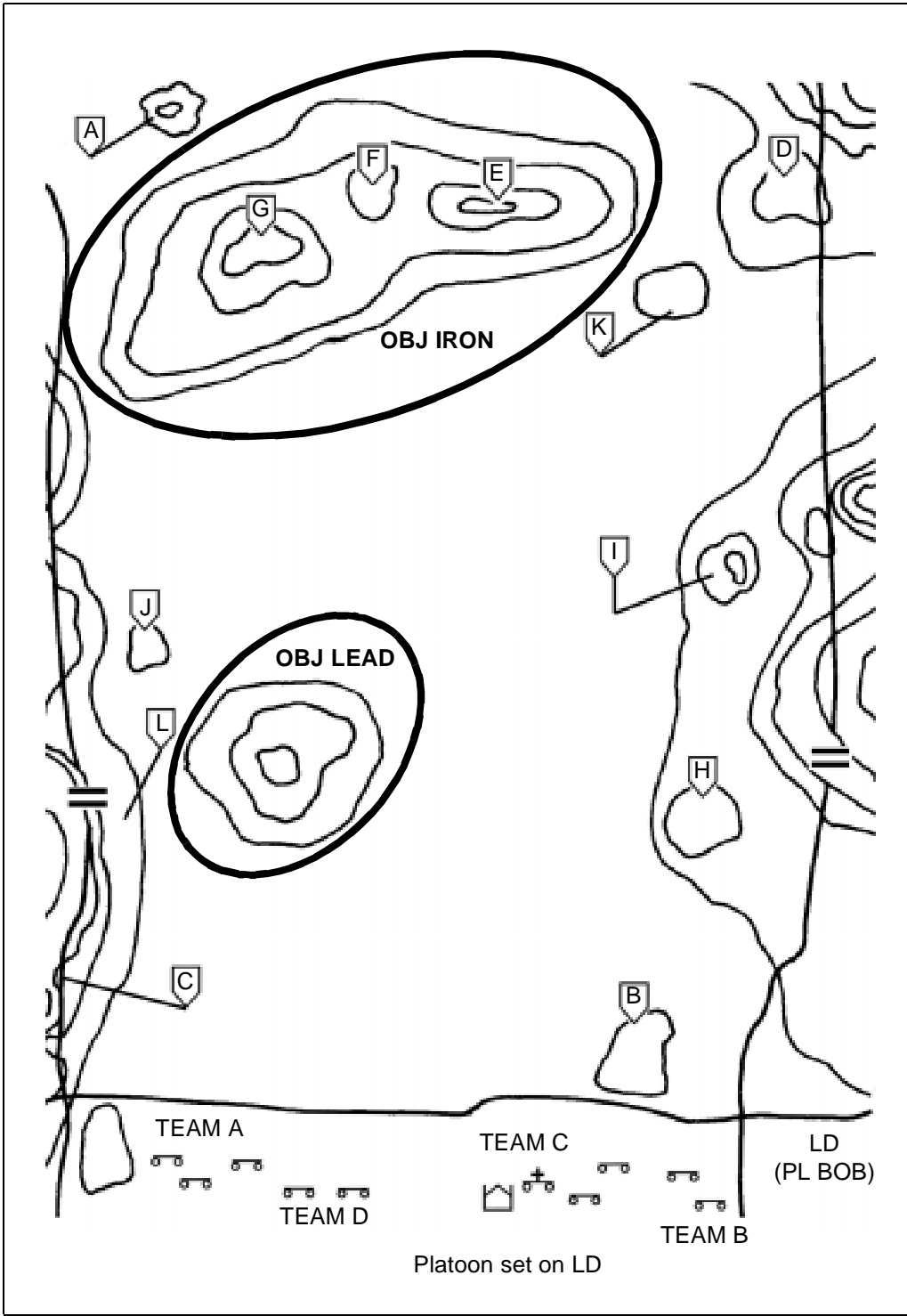

Figure 3-20. Area recon

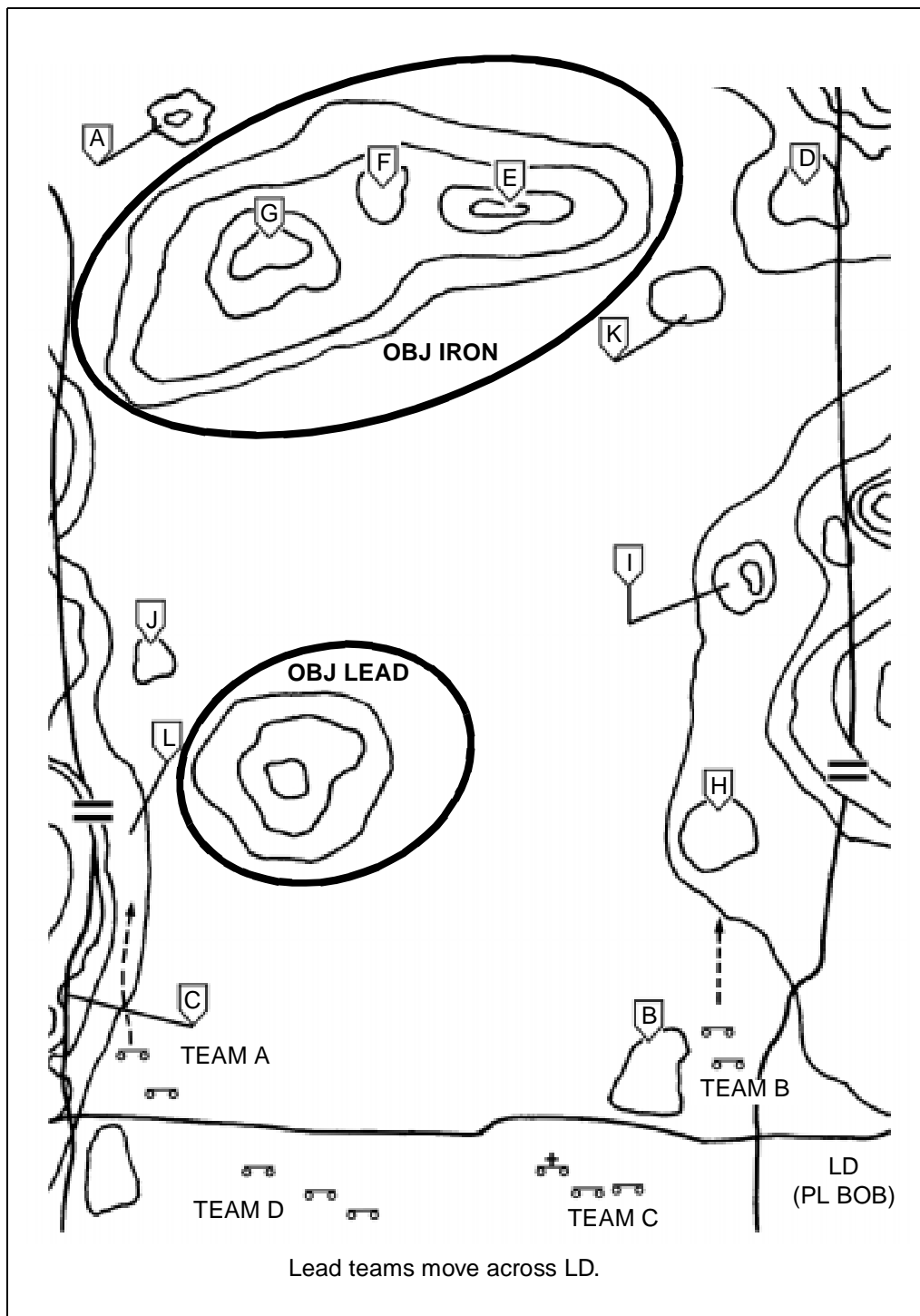

Figure 3-21. Teams A and B cross LD

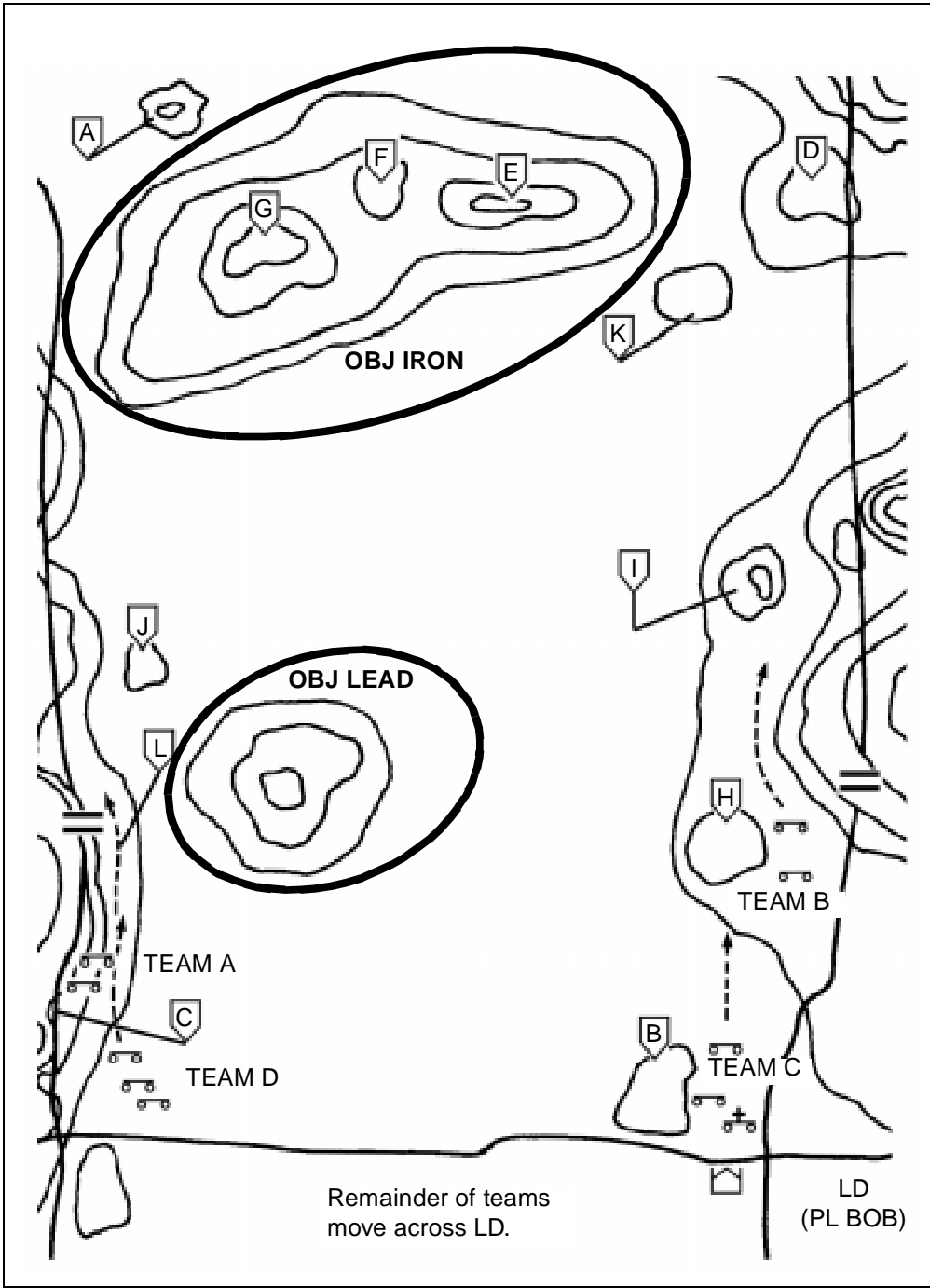

Figure 3-22. Trail teams cross LD

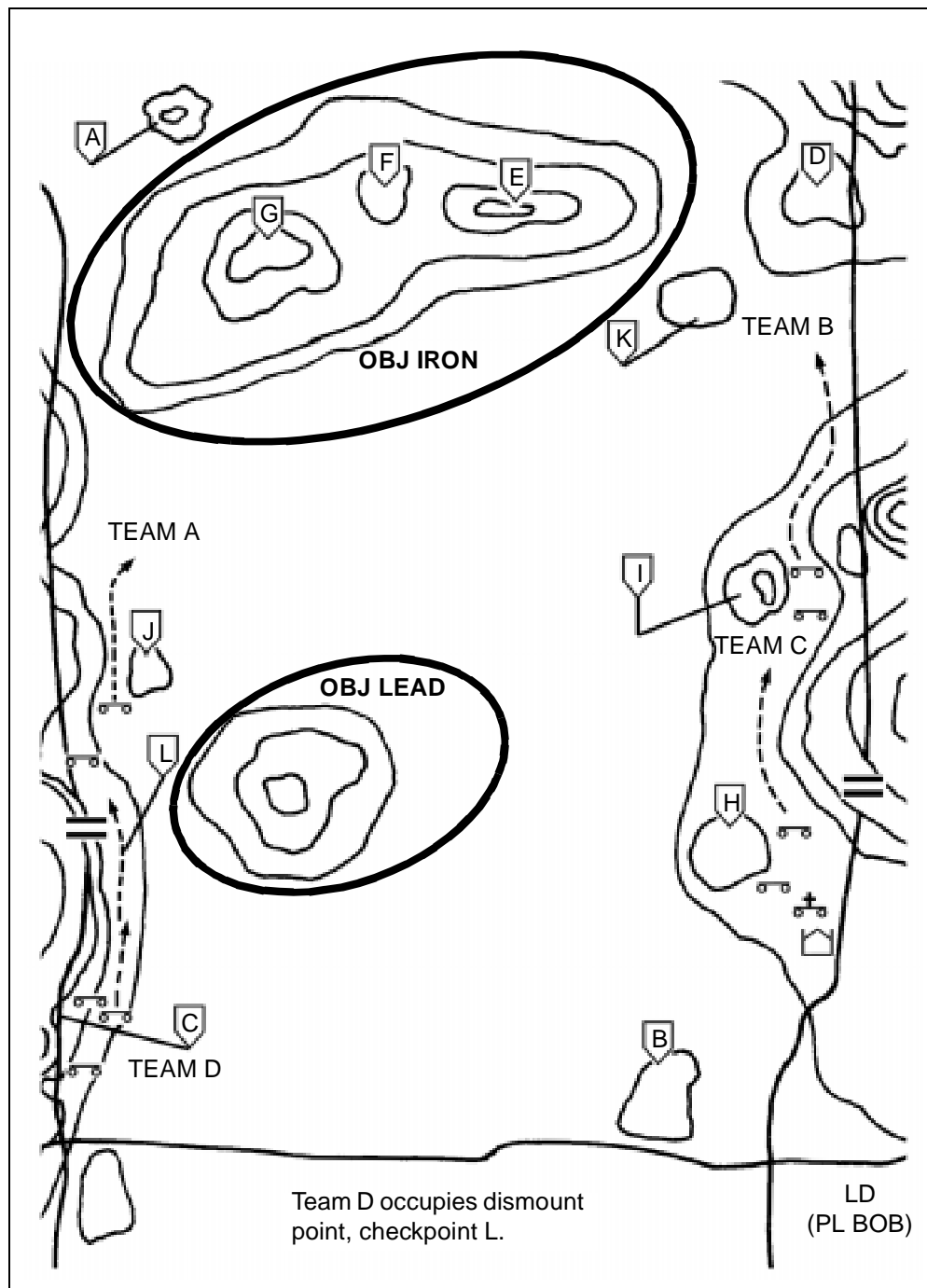

Figure 3-23. Team D deploys local security

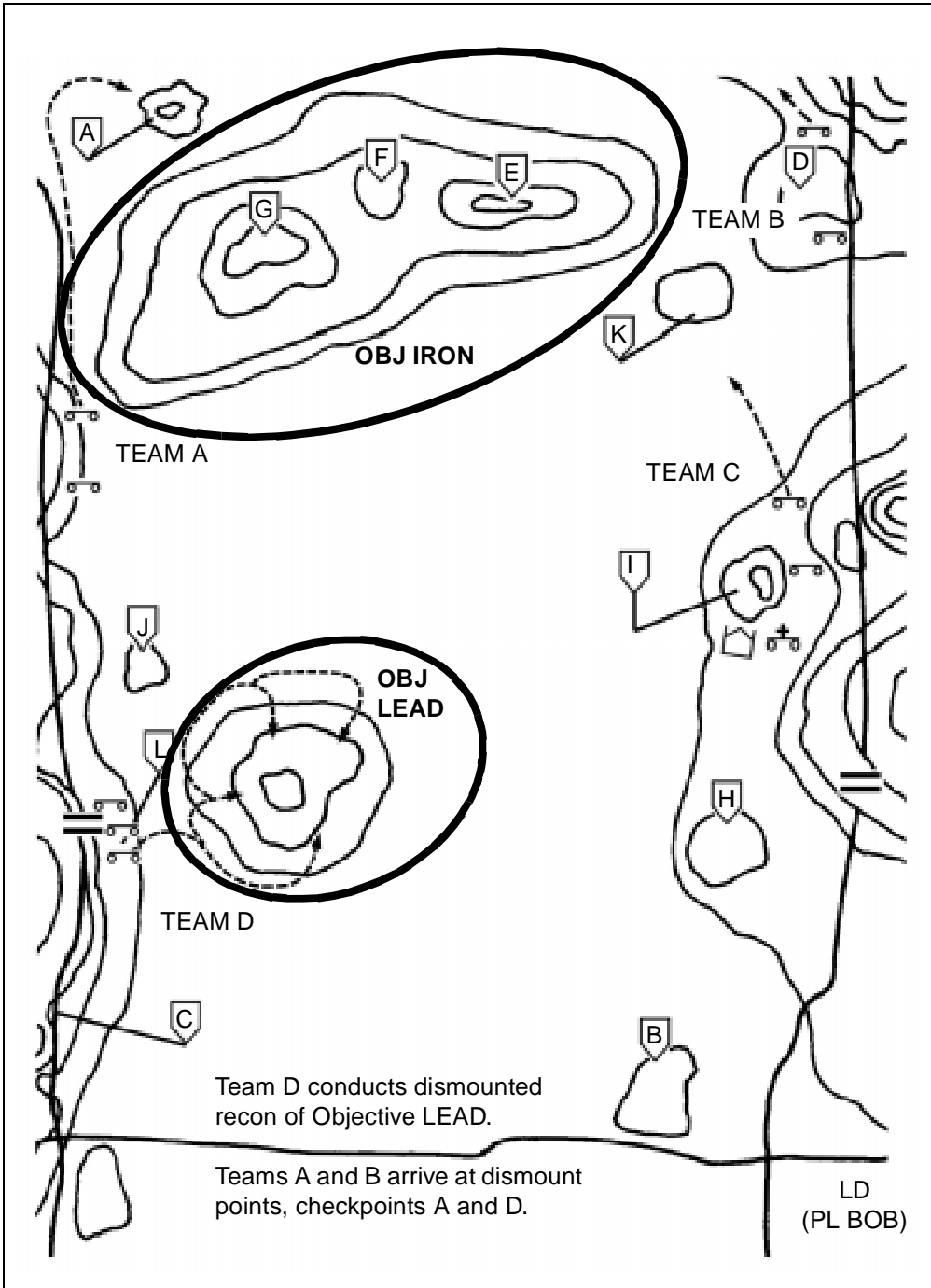

Figure 3-24. Team C continues to move

Teams A and B complete their recon of Objective Iron; they establish OPs from which they can observe into the objective and monitor any changes in the enemy situation. They also submit detailed reports on enemy dispositions through the platoon leader to their commander. Team C and the engineer recon team execute a dismounted patrol of checkpoint E, its portion of Objective Iron (see Figure 3-26).

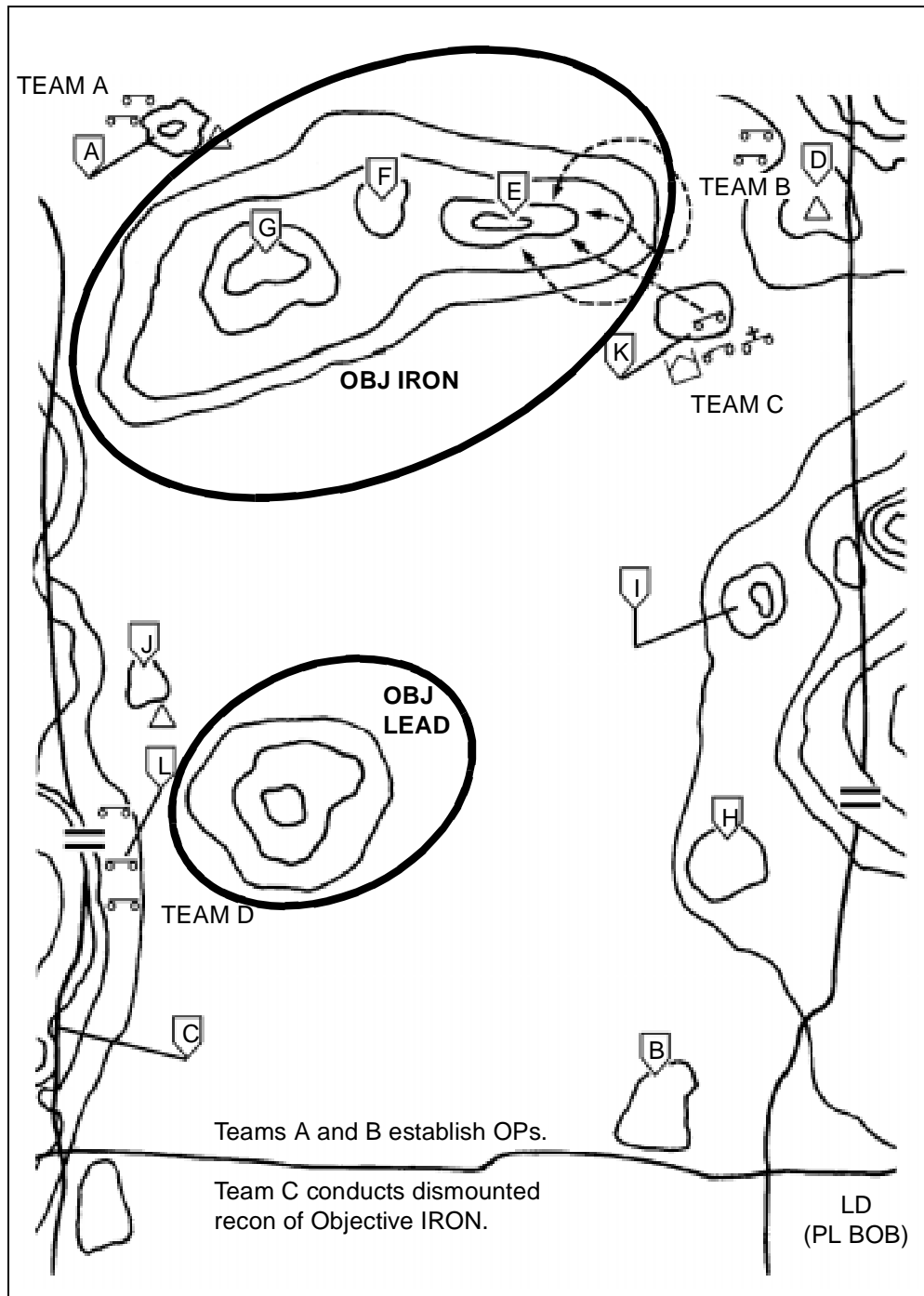

Figure 3-26. Team C and engineers execute patrol of checkpoint E

Team C and the engineer recon team complete their dismounted recon of checkpoint E. All teams observe the objective area and send updated spot reports as necessary. The platoon continues to observe the objective until relieved or assigned subsequent tasks by its higher headquarters (see Figure 3-27).

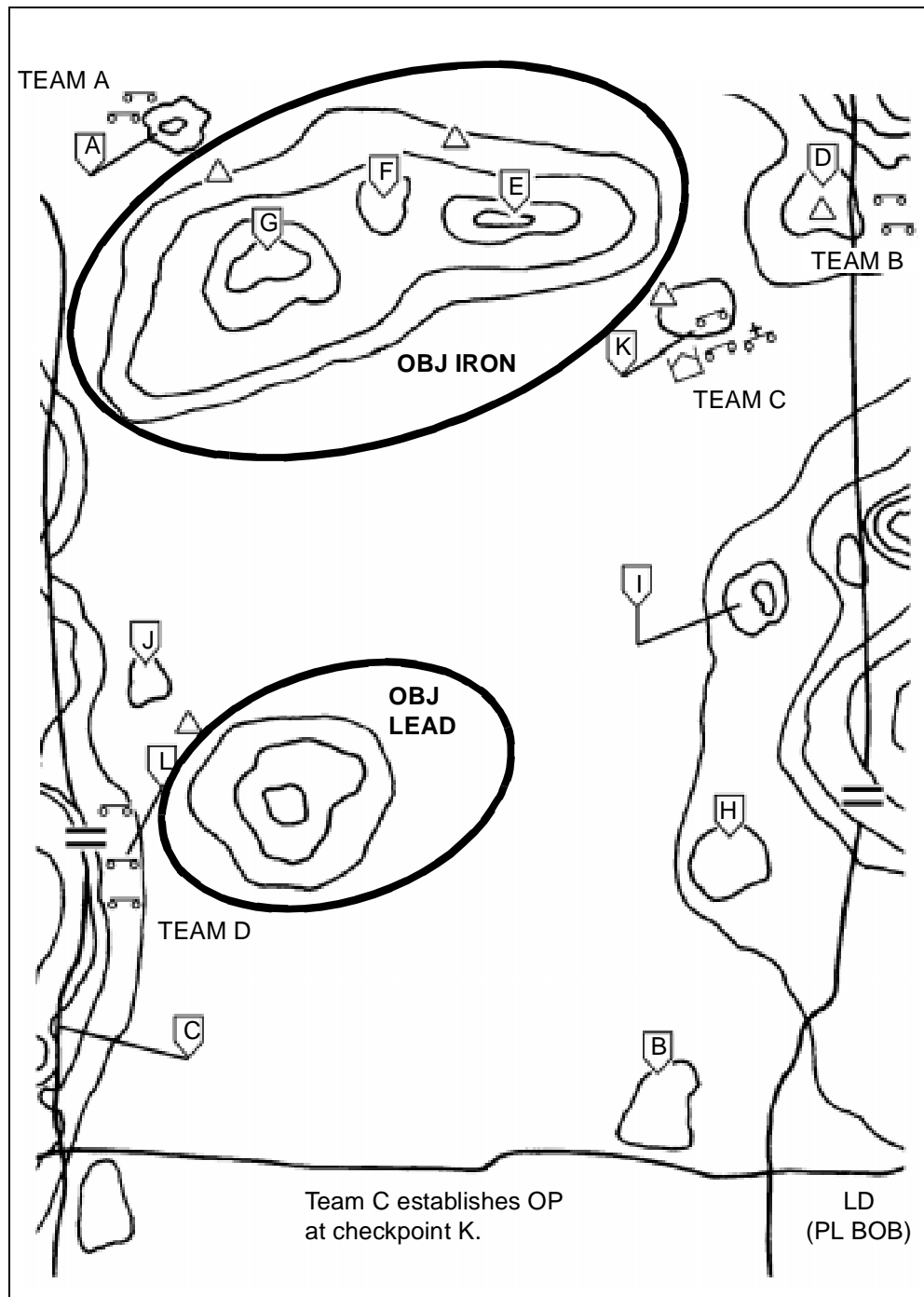

Figure 3-27. Area recon complete

Chapter 4

Engineer Recon Team and Obstacle Reconnaissance

As discussed in Chapter 1, engineer recon elements may be a team-, a squad-, a platoon-, or another-sized element. Regardless of the size, highly trained personnel are required for obstacle recon operations conducted forward of friendly lines and having extremely limited security and evacuation assets available. Engineer training must be focused on accomplishing the specific obstacle recon mission.

The current engineer force structure does not provide for personnel (other than a recon noncommissioned officer [NCO] in the S2 section) or equipment dedicated to recon efforts. However, experience has shown that engineer units that have dedicated personnel, equipment, and planning time to the recon effort have achieved great success. Successful employment of engineers in a recon role is a result of effective SOPs and highly trained staffs and recon teams. This chapter provides leaders with the key factors required for the formation of engineer recon teams as well as the C² necessary when using engineer scouts.

PERSONNEL AND EQUIPMENT

Because an engineer battalion has limited assets to draw from, the formation of engineer recon teams can subsequently degrade the capabilities of the organization from which they are drawn. The battalion commander must understand the trade-offs between using engineer assets in a recon role versus using them in a maneuver-support role.

TRAINING

Regardless of where the personnel come from to create the engineer recon teams, units will have to dedicate a large amount of training time toward developing an effective recon team. This training includes—

- Understanding how to apply the fundamentals of recon operations (see Chapter 3).
- Operating with brigade assets and the TF scouts in a habitual relationship to develop the trust and familiarity necessary to succeed on the battlefield.
- Reporting, calling for fires, first aid, land navigation, demolitions, minefield indicators, foreign-mine recognition, dismounted-movement techniques, vehicle and equipment maintenance, heliborne insertion, resupply, extraction, and relay and retrans procedures.
- Noise, light, and litter discipline and the using NVDs and camouflage.
- Rigorous physical training to meet mission requirements.

If the battalion leaders want to develop OBSTINTEL by using engineer scouts, adequate resources must be provided to ensure success.

EQUIPMENT

As with personnel, a decision must be made as to what equipment (vehicles, communications equipment, and weapon systems) the engineer recon teams will use.

Vehicles

The most common recon vehicles used are the HMMWV or the M113A3 APC. Both vehicles have distinct advantages and disadvantages and can be used effectively by trained recon teams. The choice of vehicles must best support the teams in the environment for which they are expected to operate. Advantages of the HMMWV are that it is much more stealthy, is less maintenance intensive, and can travel in more restricted terrain than the M113A3. However, the M113A3 can carry more personnel and equipment (such as marking materials and mine detectors) and is more survivable. Both vehicles can mount a weapon system such as the MK19 or the M2 machine gun. Another option available to engineer scouts is to ride in the back of a vehicle from the supported unit. This limits the engineer recon team's flexibility and control over what recon it can conduct.

Communications Equipment

The radio configuration in a recon team's vehicle depends on the availability of radio equipment and the radio nets the recon team will operate/monitor. The recon team should have a minimum of two radios in the vehicles; each vehicle should have the necessary equipment to act as a retrans vehicle to further extend the range of the dismounted element's radio system. In addition to the vehicle-mounted radio systems, each recon team should be resourced with one manpack radio specifically designated for use by the dismounted element. Since a large amount of data is passed when reporting OBSTINTEL, an effort should be made to establish connectivity to recon teams through the use of mobile subscriber equipment (MSE) or the Enhanced Position Location Reporting System (EPLRS) (as the system is fielded).

Weapon Systems

The M2 and the MK19 machine guns are available for mounting on an M113A3. The M2 provides greater range and rate of fire while the MK19 is an area-fire weapon and may produce better effects on targets. Each recon team should also have at least one M203 and one squad automatic weapon (SAW) or M60 (as well as antiarmor weapons) available to it.

Additional Equipment

Each recon team should be supplied with night-vision capability, a GPS, a hand-held laser range finder, and a digital camera.

ENGINEER RECON TEAM

An engineer recon team is the base engineer recon element. The team normally recon one NAI or multiple NAIs within the same vicinity on the battlefield. The battalion may employ more than one recon team if multiple

NAIs need to be observed in dispersed locations. In most instances, the recon team will conduct its recon dismounted. However, the team may arrive in the vicinity of the recon objective in many ways, including dismounted or by air or ground transportation. If the team travels dismounted or is air-inserted, it should consist of at least three personnel. If the team uses an organic vehicle to arrive in the vicinity of its recon objective, it should consist of at least five personnel—three with the dismounted element and two with the team's vehicle as the mounted element.

DISMOUNTED ELEMENT

A dismounted element consists of three or more personnel and is commanded by a recon team leader. The dismounted element's mission is to locate and report all necessary information required by the supported commander according to the R&S plan. This information can be transmitted directly to the supported unit's headquarters on the appropriate net (according to the SOP or the R&S order) or relayed through the mounted element.

MOUNTED ELEMENT

A mounted element consists of at least two personnel per vehicle—the vehicle operator and an assistant recon team leader. The mounted element's mission is to maintain communication with both the dismounted element and the supported unit. The mounted element is responsible for relaying any intelligence collected by the dismounted element to the appropriate C² node and ensures that the team's vehicle is not discovered by the enemy. (All OBSTINTEL collected by a recon team is sent to the engineer battalion, if possible. A mobile subscriber radio telephone (MSRT) is normally the best method.) The mounted element's secondary mission is to be prepared to go forward and conduct the recon if the dismounted element is unsuccessful.

OBSTACLE AND RESTRICTION RECON

One of the high-frequency tasks associated with recon missions is locating and reconning obstacles and restrictions that may affect the trafficability along a route or an axis. The purpose of this recon is to determine how best to overcome the effects of the obstacle: reduction or bypass. Tasks associated with this recon may be to estimate the reduction assets necessary to reduce the obstacle, to mark the best location to reduce, or to bypass the obstacle. If the obstacle is to be bypassed, the recon team should be prepared to provide guides. Obstacles and restrictions are either existing or reinforcing. Doctrine associated with the former Soviet Union emphasizes the use of man-made obstacles to reinforce natural obstacles and restrictions to slow, impede, and canalize friendly forces. These obstacles and restrictions include the following:

- Minefields.
- Bridges.
- Log obstacles.
- AT ditches.
- Wire entanglements.
- Defiles.

- Persistent agent contamination.

Although engineer recon teams have the capability to clear or reduce small obstacles that are not covered by fire or observation, an engineer recon team's primary task is reconning tactical and protective obstacles. The recon should include supporting enemy positions and possible reduction sites. Another important task is locating and marking bypasses around obstacles and restrictions.

Detection

During recon operations, engineers must help locate and evaluate obstacles and man-made and natural restrictions to support the supported unit's movement. Detecting obstacles and restrictions begins at the operation's planning phase when the S2 and the engineer conduct the IPB. The scouts combine the S2's work with the recon conducted during the troop-leading process (normally a map recon only) to identify all possible obstacles and restrictions within their AO. A recon team plans its recon based on the orders it receives, the IPB, and its own map recon.

While assisting in a recon mission, engineers will use visual and physical means to detect mines and obstacles. They visually inspect terrain for signs of emplaced minefields and other reinforcing obstacles. They must be alert to dangerous battlefield debris such as bomblets from cluster-bomb units (CBUs) or dual-purpose, improved conventional munitions (DPICM) and other unexploded ordnances (UXOs). Minefields and other obstacles can be difficult to detect while mounted. Most obstacle detection occurs dismounted. The engineer may dismount long distances from a suspected obstacle before conducting a recon. Engineer recon teams must carefully choose their dismount point. Dismount points should be covered and concealed locations out of direct-fire range of suspected enemy locations. Characteristics of dismount points are that they—

- Afford cover and concealment.
- Are easy to defend for a short period of time.
- Are away from natural traffic flow.
- Are easy to locate.
- Are within close proximity to the objective to ease C².
- Are out of sight, sound, and direct-fire range of the objective.

The engineer recon team should look for disturbed earth, unusual or out-of-place features, surface-laid mines, tilt rods, and trip wires. Maneuver units and scouts may assist in detecting mines by using the thermal sights in their vehicles. Recon elements should conduct additional visual inspections to ensure that the true extent of the obstacle is known.

Area Security and Recon

Enemy forces will cover their obstacles with observation and fire. When scouts and engineer recon teams encounter an obstacle, they must assume the enemy can observe and engage them. The scout or engineer recon team that detects the obstacle establishes overwatch before it proceeds with the recon. The

overwatching element looks for signs of enemy forces in and around the obstacle. The element visually searches the dominant terrain on the obstacle's far side for evidence of enemy positions or ambushes. Once it confirms the enemy situation from the near side, the engineers and scouts (not in overwatch) move mounted or dismounted to find bypasses around the obstacle and to establish OPs on the far side to provide 360-degree security of the obstacle. If the scouts and engineers are unable to find a bypass, they conduct their recon from the near side under the security of the overwatch elements.

Obstacle Recon

Once security is established, scouts and engineers move dismounted to the obstacle using great caution. Trip wires and other wire may indicate that the enemy is using booby traps or command-detonated mines to prevent friendly forces from determining the—

- Obstacle's location and orientation.
- Types of mines in the minefield or the type of obstacle.
- Obstacle's length and width.
- Existence of enemy coverage, including enemy strength, equipment, and fire support.
- Equipment necessary to reduce the obstacle.

The engineer recon team reconning the obstacle prepares an obstacle report with this information and forwards the report through the established channels to the supported unit's TOC.

COA Selection

After collecting the facts, the scout platoon/engineer recon team leader analyzes the situation and the METT-T factors to select a COA. There are four COAs: bypass, obstacle reduction, support of a deliberate breach, or continuing the mission.

Bypass

A bypass is the preferred method when it offers a quick, an easy, and a tactically sound means of avoiding the obstacle. A good bypass must allow an entire force to avoid the primary obstacle without risking further exposure to enemy fires and without diverting the force from its objective. Bypassing conserves reduction assets and maintains the supported unit's momentum. If a recon team locates a bypass and the commander approves its use, the scouts and engineers must mark it according to the supported unit's tactical SOP (TACSOP) and report it to their commander. At a minimum, this report should include the grid location to the far recognition marker and information on how the obstacle is marked even if it is just to confirm that the bypass is marked according to the TACSOP. If the recon team is tasked to mark a bypass, the team must emplace markers so they are not visible to the defending enemy. Engineers and scouts may be required to provide guides for the main body, especially if the bypass is difficult to locate or visibility conditions are poor.

Bypassing is not always possible, and breaching may be the best, or only, solution (such as in the following situations):

- The obstacle is integrated into a prepared defensive position, and the only available bypass moves friendly forces into the fire sack or ambush.
- The recon mission specifically tasks the recon team to clear the original route for follow-on forces.
- The best available bypass route will not allow follow-on forces to maintain their desired rate of movement, or it diverts the force from the objective.
- Improvements to the bypass may require more time and assets than breaching the primary obstacles.

Obstacle Reduction

Reducing an obstacle significantly degrades a recon team's ability to maintain the momentum of either the recon or the follow-on forces. Obstacles within the scout and engineer's ability to reduce include small minefields, simple wire obstacles, small roadblocks, and other similar obstacles. The supported commander should make the decision to have the recon team reduce an obstacle. The commander must consider the risk to the recon team and the potential for prematurely identifying the force's route. Obstacle reduction should not be attempted if the obstacle is part of an integrated defensive position.

Support of a Breaching Operation

When a large obstacle is located and cannot be easily bypassed, the alternative is to support a breaching operation. Scouts and engineers perform additional recon tasks in support of the breaching operation. These tasks include determining the assets and time needed to reduce the obstacle and the location of the best reduction sites. Scout and engineer recon effort focuses on the following:

- Trafficable routes to the reduction site and routes from the far side leading to the objective.
- Proposed locations for positioning the support force.
- Dispersed, covered, and concealed areas near the reduction site.
- The best locations at the obstacle for reduction effort. It is imperative that the reduction plan be sent to the recon teams once the scheme of maneuver is finalized. Information such as the number of lanes required and the distance between lanes will be needed for the recon forces to conduct the necessary recon.
- Positions on both sides of the obstacle that could provide enemy observation of the reduction site.
- Trafficability and soil conditions near the reduction site. This is especially important for minefield reduction because mine-clearing blades (MCBs) will not work properly in all soil conditions. This is also important information in support of river crossings. (See FM 90-13 for further details.)
- Soil type (loam, rocky, sandy, and so forth).

- The width, depth, and bottom conditions of wet and dry gaps and fords.
- The bank's height and slope and soil stability of wet and dry gaps.
- The water velocity and direction of flow of wet gaps and fords.
- The wind direction for using smoke to obscure the enemy's vision.
- The location of the forward edge of minefields to support MICLIC and MCB use.

This information can be obtained much easier if an engineer works closely with the other recon elements, especially the TF scouts. An engineer recon team must provide timely and valuable advice when large obstacles are encountered during a mission. The information is used by all elements of the breaching operation to finalize the suppression, obscuration, security, and reduction (SOSR) plans for the breaching operation. The scouts help maintain security and may call for and adjust indirect fires, as necessary, in support of the breaching operation.

COA Recommendation/Execution

Once the scouts and engineer recon teams have determined the best COA for a situation, they execute it or recommend it to higher headquarters for approval. Generally, the recon team will execute a particular COA without specific approval if it is addressed in the OPORD received from higher headquarters or in the unit's SOP. If the situation discovered is not covered by previous guidance, the recon team determines the best COA and recommends it to the commander before execution.

Examples of Obstacles/Restrictions

The following examples illustrate the recon of obstacles and restrictions in two tactical situations. They are organized using the five-step process (detection, area security and recon, obstacle recon, COA selection, and COA recommendation/execution).

Example 1: Reconning a Restriction (Not Covered by Fire or Observation)

Detection. The recon team detects a bridge when a dismounted element observes it from an overwatch position (see Figure 4-1, page 4-8). The bridge was expected because it was also identified during the recon element's map recon. The dismounted element confirms that the bridge is there and is intact.

Area Security and Recon. The dismounted scouts and engineers bring their vehicles into covered and concealed overwatch positions; the scouts establish near-side security of the bridge. A dismounted patrol with engineers is organized and conducts recon up to the bridge while overwatched by the vehicles (see Figure 4-2, page 4-9). The dismounted element recons for both mounted and dismounted bypasses. It must determine quickly if it is possible to bypass the bridge by using a ford in the local area. The recon leader monitors the situation and may direct other elements to assume the mission of locating other bridges or fords to serve as bypasses, as necessary.

If the water obstacle can be forded, the dismounted scouts use the ford to move to the far side. On the far side, they recon the terrain that dominates the bridge. Far-side security is established on terrain where they can observe enemy approach routes to

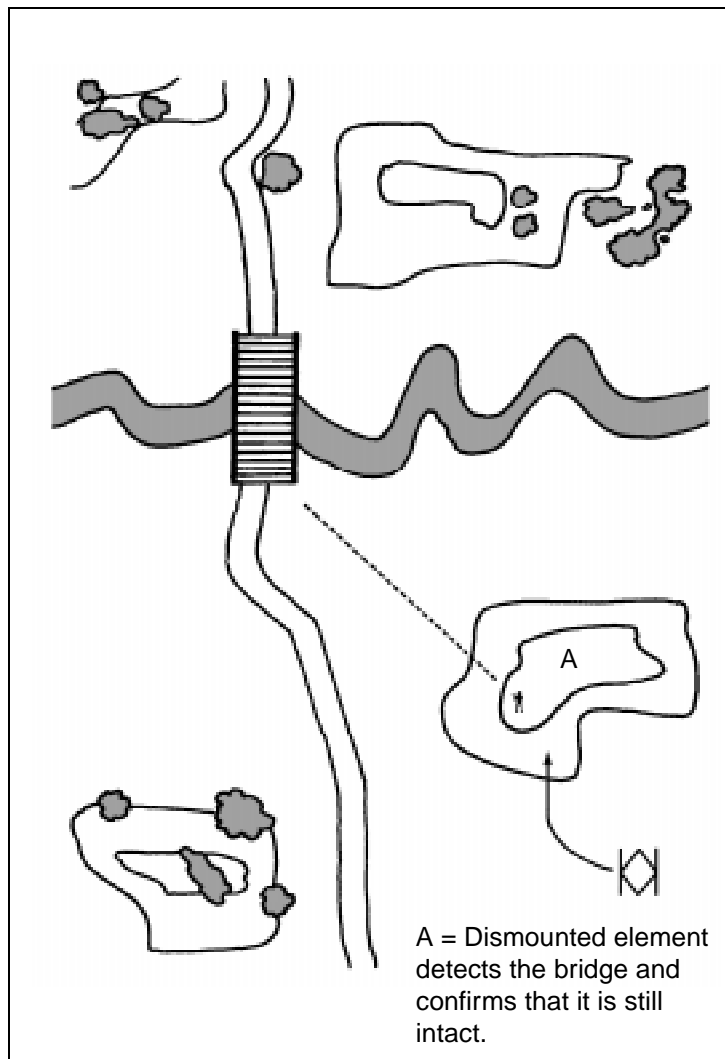

Figure 4-1. Detection

the bridge. Once the far side is secure, the scouts/engineers can recon the bridge itself.

If the water obstacle cannot be easily forded in the local area, the recon team may have to cross the bridge itself. Before crossing, the dismounted team (with engineers) visually examines the bridge for structural damage and rigged explosives and mines. If the bridge appears intact, the dismounted team crosses the bridge one scout at a time. The recon team moves to the far side quickly and takes up covered and concealed positions that provide security on the opposite approach to the bridge. Once the entire dismounted element is secure on the opposite side, it continues beyond the immediate bank area to secure the far side.

Obstacle Recon. Once the area has been reconned and secured, a dismounted scout/engineer element moves to the bridge and performs a detailed examination focusing on information needed to accomplish the mission (see Figure 4-3, page 4-10). The element examines the bridge to—

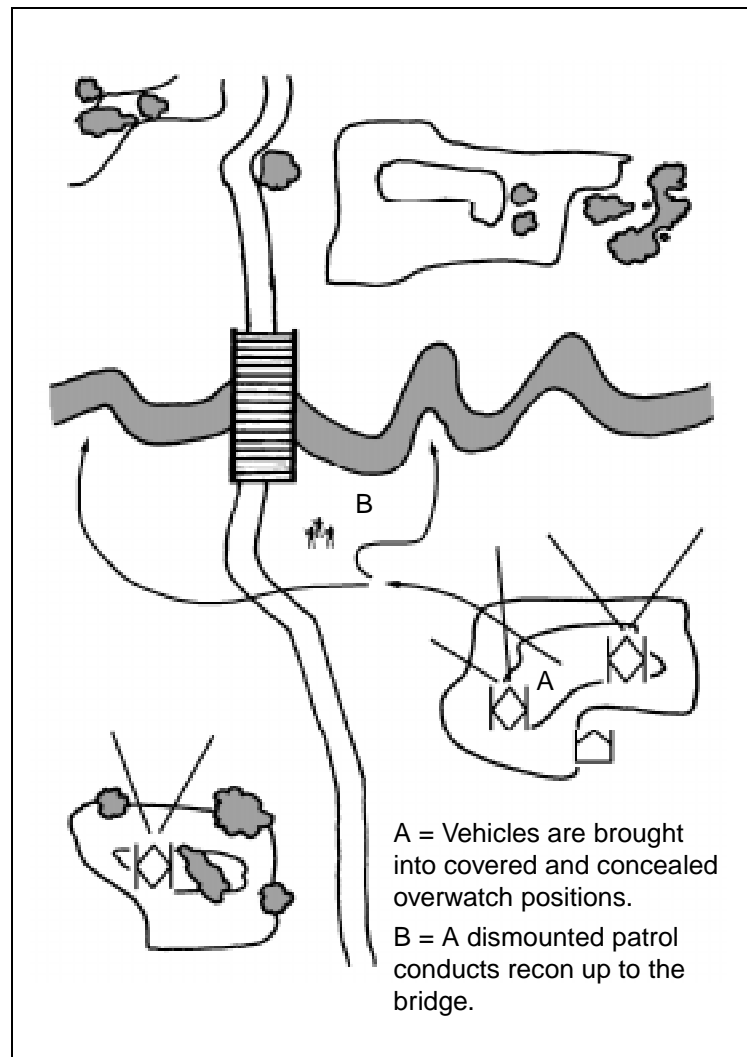

Figure 4-2. Area security and recon

- Ensure that it is clear and free of demolitions and booby traps. This requires examining underwater pilings and the underside of the bridge for hidden explosives, as well as the approaches for mines and booby traps. In addition, the element looks at the far side to find any electrical cables or wires connecting the bridge to the shore.
- Find structural damage. Scouts/engineers look for obvious signs of enemy destruction efforts as well as for less obvious signs of structural damage, including cracks or fractures in stringers or supports and twisted or untrue alignments of stringers or supports.
- Conduct a hasty bridge classification (see Appendix B) and a demolition recon when mission or orders dictate.

The recon team leader consolidates all appropriate and relevant reports (for example, the bridge, ford, and bypass reports) and relays them to higher headquarters in a timely fashion.

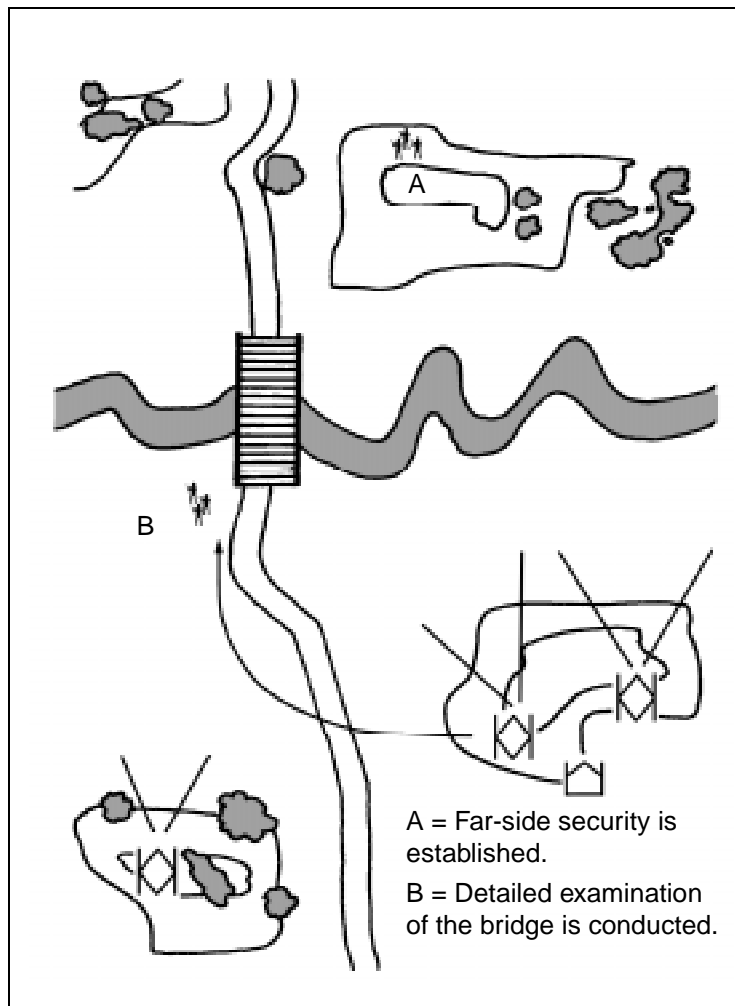

Figure 4-3. Bridge recon

COA Selection. Based on the results of the bridge recon, the team leader determines that the bridge is secure and that he can safely move the team across it and continue the mission.

COA Recommendation/Execution. In accordance with the team's SOP, the scout leader moves the remainder of his element across the bridge, overwatched by the other vehicles (see Figure 4-4). The vehicle crosses with only the driver on board. The leaders and the engineers who watch for any signs of damage or stress on the bridge observe the crossing.

Once the lead vehicle is across, it moves to link up with the dismantled element and assists in providing far-side security. At this point, the overwatch vehicles can cross the bridge, and the recon team continues its mission.

Example 2: Reconning an Obstacle (Covered by Fire)

Detection. Dismounted scouts detect an extensive wire obstacle from a covered and concealed position. From its vantage point, the team cannot determine any additional details.

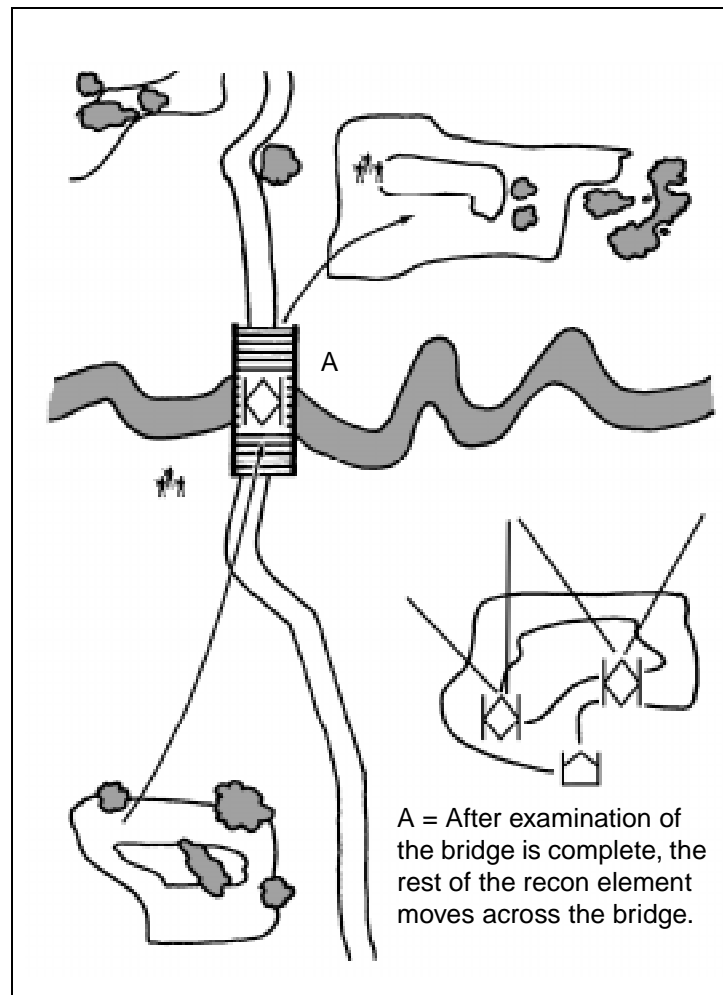

Figure 4-4. Movement of the recon element across the bridge

Area Security and Recon. The recon element (consisting of TF scouts and an engineer recon team) brings its vehicles up to covered and concealed positions to overwatch the obstacle. The team then organizes a dismounted element to locate a bypass and secure the far side. Because of the obstacle's size, the team informs the scout platoon leader that it will take considerable time to recon the obstacle. In the process of executing the patrol, the team discovers that the obstacle's left flank is tied into an impassable swamp (see Figure 4-5, page 4-12).

Based on this initial evaluation, the scout platoon leader attempts to increase the recon's speed by sending two additional scout teams and the engineer recon team to find a bypass around the obstacle's right flank and to conduct an obstacle recon. One team moves to a dismount point and sends a patrol around the right flank. The patrol is engaged by enemy machine guns and then are engaged by enemy vehicles in defensive positions. The team reports that it can maintain contact with the enemy but can no longer maneuver (see Figure 4-6). The other team finds a position where it can observe the enemy's rear; it reports a company-size element in defensive positions overwatching the obstacle. It also reports that there are no trafficable routes around the enemy's right flank (see Figure 4-7, page 4-14). The engineer recon team moves

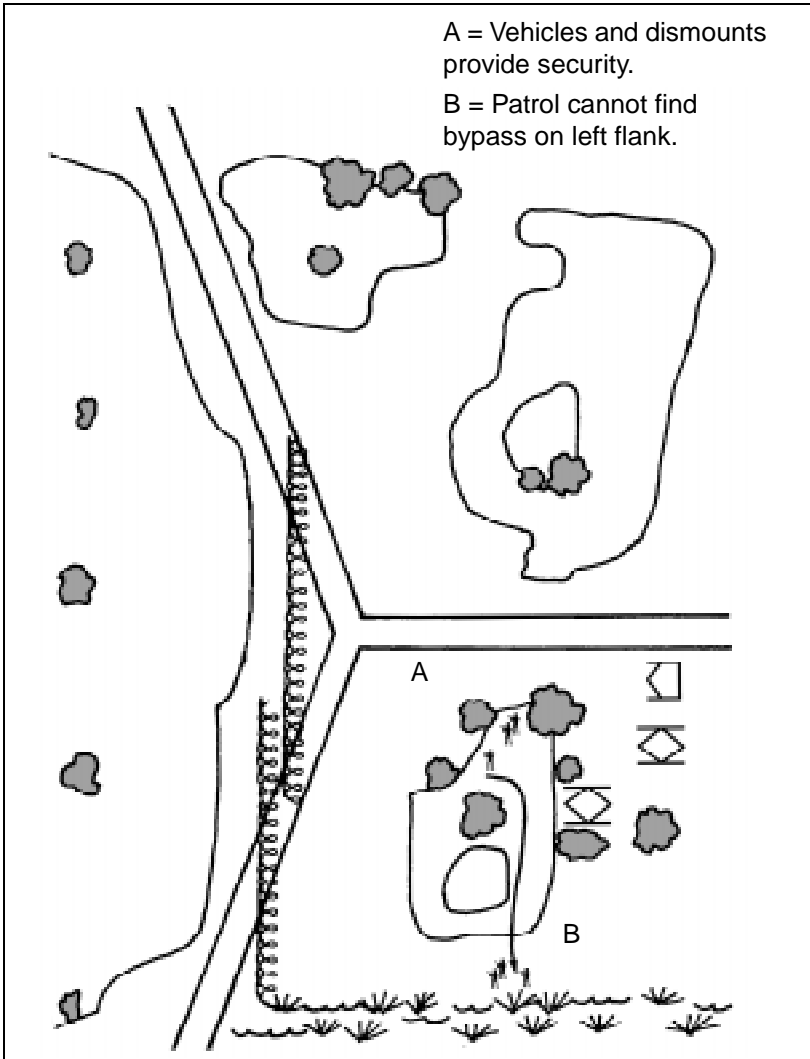

Figure 4-5. Area recon of obstacle

near the scout team that originally detected the obstacle. At this point, the platoon leader determines that he does not have the combat power to secure the objective's far side. He also determines that the only trafficable bypass is covered by enemy direct fires. He must conduct a detailed obstacle recon with the support of the engineer recon team before he can recommend a COA to his commander.

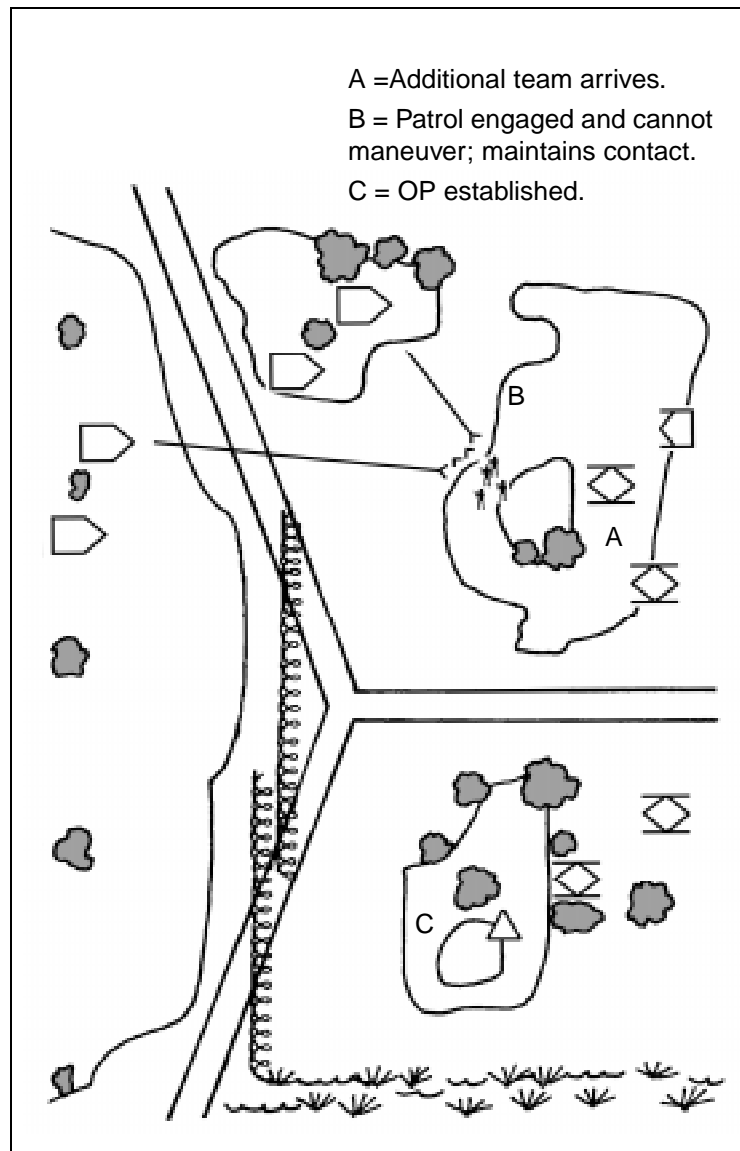

Figure 4-6. Recon of enemy obstacle

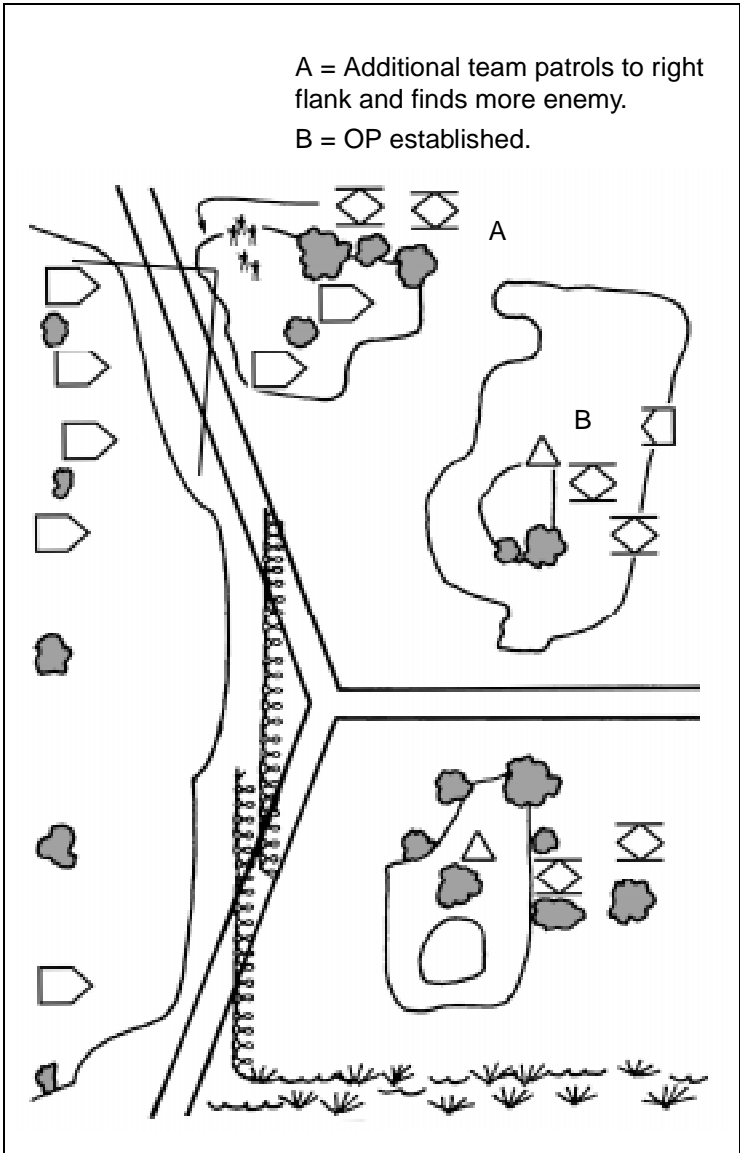

Figure 4-7. Recon to enemy's right flank

Obstacle Recon. The scout team that originally detected the obstacle is in the best position to perform the recon. This team links up with the engineers and moves dismounted to recon the obstacle. Because there is enough light for the enemy to cover the obstacle visually, the platoon leader coordinates indirect fire to support the patrol. As the patrol moves out, mortars lay suppressive fires on the known enemy positions, and artillery fires place smoke into the area between the enemy positions and the obstacle (see Figure 4-8).

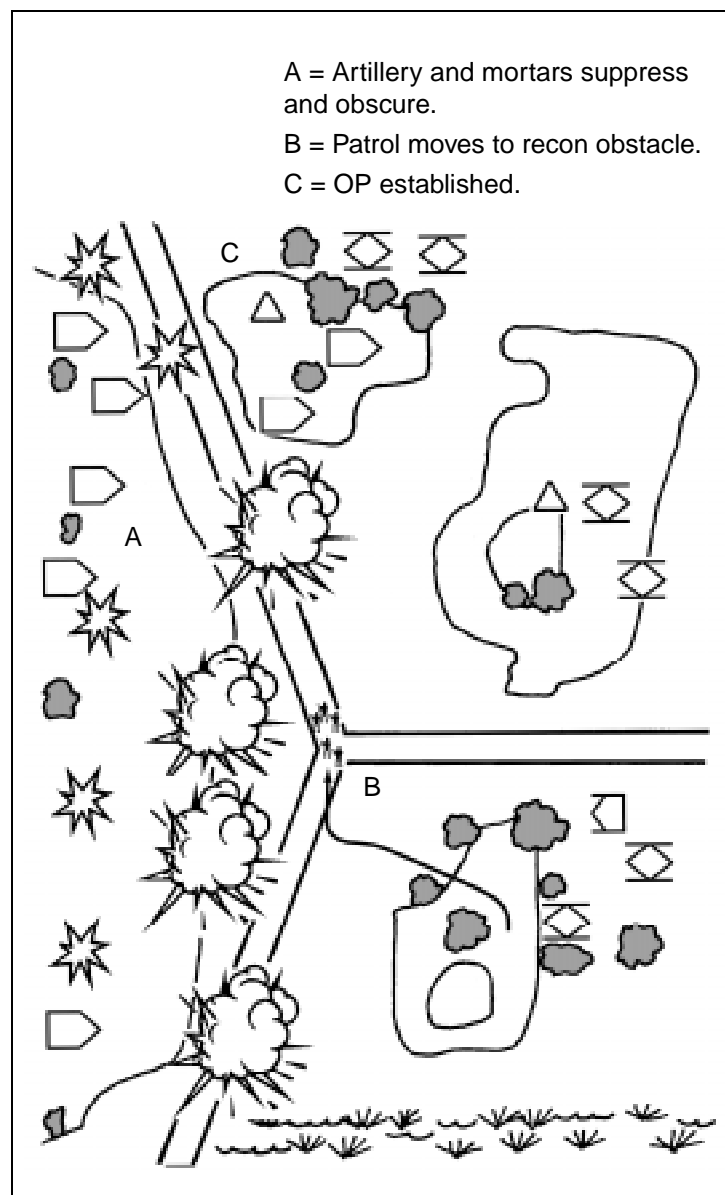

Figure 4-8. Mortar and artillery fires support obstacle recon

The scouts and engineers move by covered and concealed dismounted routes to the obstacle. Through probing, grapnel, and visual observation, they determine that the wire obstacle is oriented north to south and is reinforced with surface-laid mines. They

determine that the minefield consists of TM-62M AT mines. The mines are spaced 4.5 meters apart with two rows spaced 30 meters apart on the near side of the wire and another two rows on the far side. No AHDs are present. Once this information is acquired, the scouts/engineers move laterally along the obstacle for 200 meters to determine its length and confirm that the composition is uniform. They begin to look for the most favorable reduction site (see Figure 4-9).

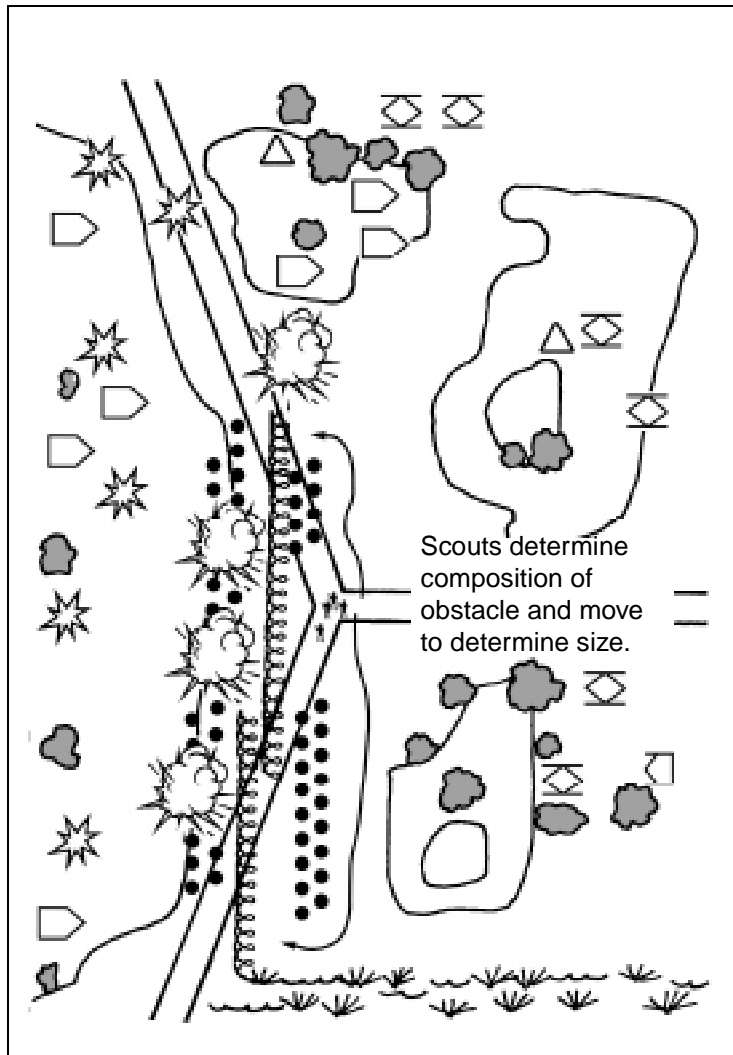

Figure 4-9. Recon of minefield/wire obstacle

COA Selection. The platoon leader evaluates the situation and determines that he cannot bypass the obstacle and does not have the internal capability to reduce it. He recommends a breaching operation.

COA Recommendation/Execution. The scout platoon leader recommends to higher headquarters that the platoon prepare to support a breaching operation. With higher headquarters' approval, he orders the platoon to recon the best location for the support force to suppress the enemy during the breaching operation. Further, he orders his scouts and the engineer recon team to recon an obscured route for the

breaching force's maneuver to the obstacle. The scout OP team continues to observe and report on enemy activity. The recon leader then begins coordination with the element responsible for conducting the breaching operation (see Figure 4-10).

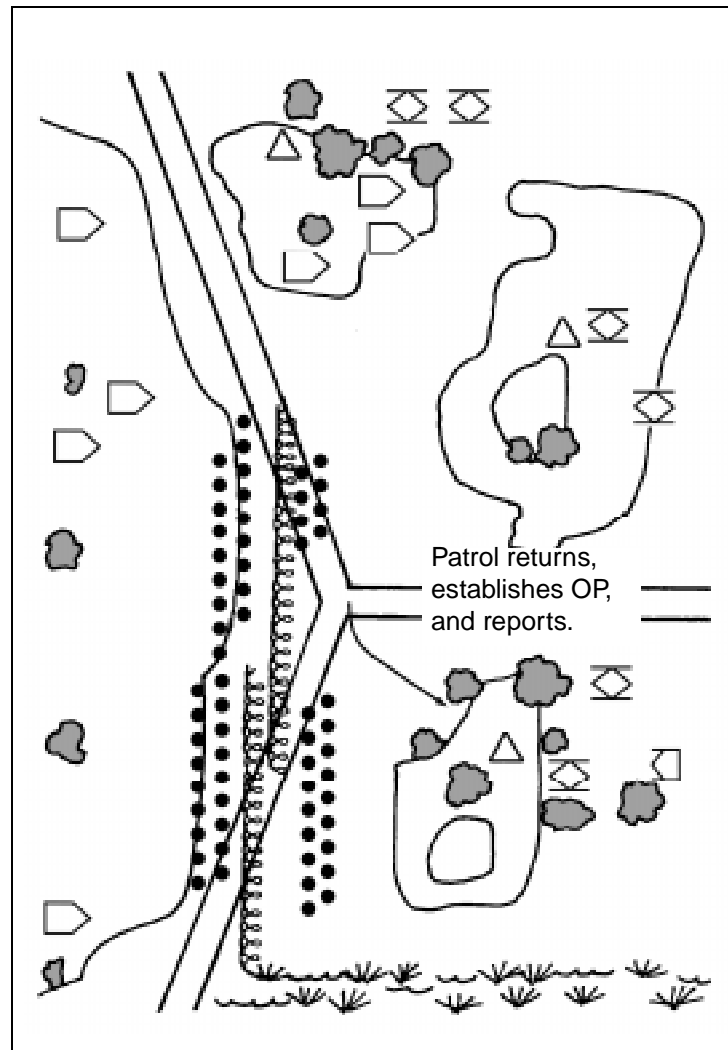

Figure 4-10. Patrol returns and establishes an OP

EMPLOYMENT CONCEPTS

An engineer recon team can be employed using several methods. Each method has advantages and disadvantages.

INTEGRATED AS PART OF THE BRIGADE INTELLIGENCE-COLLECTION EFFORT

In this method, an engineer recon team is integrated into a brigade's collection effort. This effort normally includes other assets (such as COLTs) and receives the same CS and CSS as the rest of the brigade's recon assets. It is imperative that the engineer battalion understands all aspects of the team's plan. As a minimum, the recon team leader should attend the brigade's R&S rehearsal. The battalion should track the recon team at all times. Resources (including

maintenance and personnel status, verification of the recon team's position, and activation of no-fire areas [NFAs]) must be closely monitored. The efficient dissemination of the intelligence collected by the recon team is also a critical task of the battalion staff. This employment concept may be used when—

- Engineer scouts are not expected to work close to the TF scouts.
- There are distinct advantages to moving the recon team across the LD before the TF scouts are ready to move (for example, to observe the enemy as he is emplacing his obstacles).

In the defense, the recon team may be—

- Employed to screen if the engineer battalion is required to occupy a battle position (BP) as an engineer TF.
- Positioned to overwatch a friendly emplaced scatterable minefield and to call fires as necessary.
- Positioned to overwatch NAIs where enemy scatterable minefields are templated.
- Positioned forward to identify and help target enemy engineer equipment.

ASSIGNED BRIGADE NAIs IN A TF'S AO

Under this method, a recon team receives its recon objectives from a brigade through an engineer battalion. The recon team leader should link up with the appropriate TF scout platoon leader upon receiving the mission from the engineer battalion. The engineer battalion must ensure that the necessary instructions to the appropriate TFs are included in the brigade's OPORD, especially if the TFs are expected to provide logistical support to the engineer recon team (including casualty evacuation and vehicle recovery support). The team leader should be present at the scout platoon leader's OPORD and rehearsals to ensure understanding of the scout platoon's plan. To reduce the risk of fratricide, the recon team leader must provide his plan to the scout platoon leader. The recon team should report all checkpoints/locations on the same net that the TF scouts are operating on (for example, the TF operations and intelligence [O/I] net). All intelligence reports should be sent to both the TF and the engineer battalion. The battalion should then pass the information to the brigade and its subordinate elements. This employment concept should be used anytime the recon team works close to the TF scouts.

WORKING UNDER A TF'S CONTROL

In this method, engineer recon teams are placed under the TF's control to look at NAIs that the brigade—

- Has tasked to the TF.
- Expects the TF to develop requiring engineer expertise (possibly a TF breaching operation).

This method involves the least amount of coordination and planning for the engineer battalion. However, the responsibility to plan and monitor the recon team's activities now falls to the TF engineer. Although the TF decides how to

use the engineer recon teams, the TF engineer must be involved in the planning details to ensure that the team is properly used, is integrated into a sound R&S plan, and receives all necessary support. The TF engineer must track the status of the recon team at all times, including—

- Reviewing maintenance and personnel statuses.
- Verifying that the recon team's position is plotted on the TF TOC's situation map (SITMAP).
- Ensuring that NFAs have been established around the recon team.
- Ensuring that any intelligence that the recon team collects is sent to the engineer TOC (in addition to the reporting requirements placed on them by the TF). The engineer TOC must forward all intelligence reports immediately to the engineer battalion.

SUPPORT CONSIDERATIONS

An engineer battalion can only provide a limited amount of logistical support to an engineer recon team, especially after it crosses the LD. For this reason it is essential that the engineer battalion understands the recon team's requirements. The engineer battalion must coordinate closely with the brigade or TF for support that the battalion cannot provide or that can be provided more timely by the maneuver units. Examples include casualty evacuation, vehicle recovery, and maintenance support (including vehicle, communications, and weapon repair). See Chapter 7 for a detailed discussion of CSS.

The following example of an engineer recon team assigned a brigade's NAI and operating in a TF's AO illustrates the use of an engineer recon team in a tactical situation.

Based on the division's SITEMP, the brigade S2 (with the assistance of the engineer battalion S2) has developed a SITEMP including templated obstacle locations. Based on this SITEMP, the brigade commander's guidance (he wants to penetrate the northern motorized rifle platoon [MRP] of the northern motorized rifle company [MRC]), and the commander's PIR, the brigade has developed one NAI (NAI 301) looking for OBSTINTEL (see Figure 4-11, page 4-20). In addition to the MRPs overwatching the obstacles, an additional threat to the engineer recon team templated on the SITEMP is an infantry platoon overwatching the obstacle on the north wall.

The engineer battalion S3 issues a five-paragraph OPORD to the recon team leader at the engineer battalion's TOC (see Appendix C). This OPORD includes a complete discussion of the enemy situation, all brigade assets that will be operating forward of the LD, specific instructions on the information that the battalion is expecting from the recon team, instructions on what nets the battalion expects the team to operate and report on, and complete information on the service-support plan for the team. For this mission, the engineer battalion has included in paragraph 3 of the brigade's OPORD (tasks to subordinate instructions) that the mechanized TF, in whose area the team will be operating, will provide security for the engineer recon team during the obstacle recon. It will also provide all logistical support to the engineer recon team (including maintenance support and casualty and vehicle evacuations). (Casualty evacuation by the TF is a backup to using aviation assets by the brigade.) Additionally, the engineer

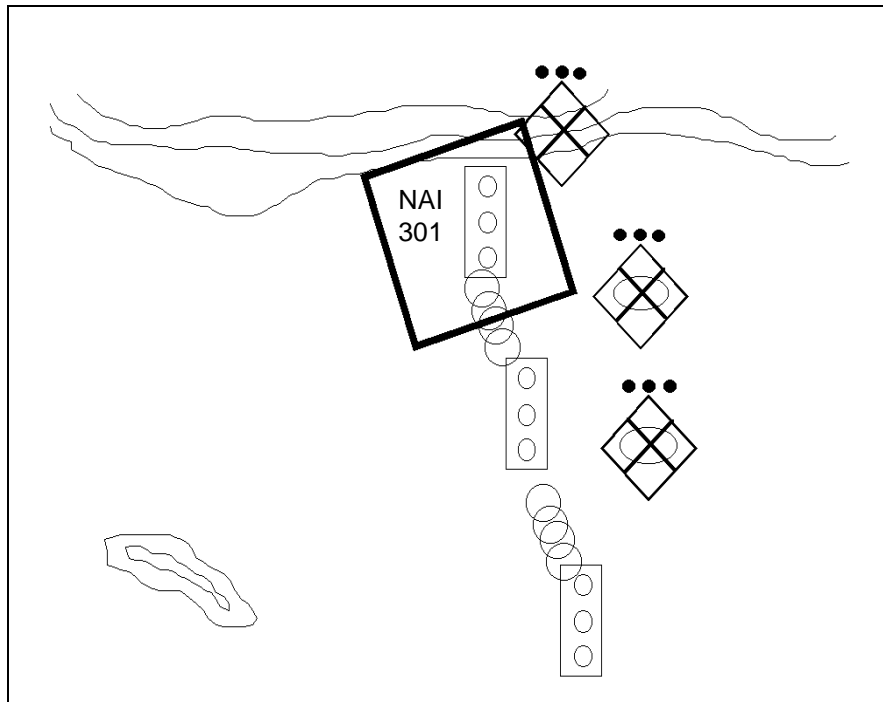

Figure 4-11. SITEMP with NAI 301

battalion XO and S4 have directly contacted their counterparts at the TF to reinforce and confirm this support requirement.

The recon team leader immediately begins moving his team to the TF's TOC where he has coordinated a link up with the TF scout platoon leader. At the TOC, the team leader ensures that the TF understands all the support elements on which the battalion briefed him and that the S3 further briefs him on exactly how that support has been planned. The team leader completes his OPORD as the assistant team leader conducts the team's precombat checks (PCCs). The leader's plan calls for the team to cross the LD (PL Pistons) at 082000 JAN 97 and travel along Route Blue to checkpoint 2, which he has designated as his dismount point. The recon team will observe the NAI throughout the day on 9 JAN 97 in an effort to observe the enemy during his obstacle emplacement. The team will link up with the TF scouts (who will provide security for the team during the obstacle recon) at checkpoint 2 after end evening nautical twilight (EENT) on 9 JAN 97. At that point, the leader plans to travel with the dismount element to the obstacle to conduct the recon. Two targets have been coordinated with the FSO in support of his mission—one in the vicinity of the dismount point and one in the vicinity of the templated obstacle. The team leader will establish rally points from the dismount point to the obstacle. In the event that the dismount element becomes separated during contact with the enemy, it will meet at the last established rally point (see Figure 4-12).

Before issuing his OPORD, the team leader will backbrief the engineer battalion commander via frequency-modulated (FM) radio and will brief the scout platoon leader on his plan. The engineer recon team will cross the LD about 24 hours before the TF scouts in an attempt to observe the enemy as he emplaces his obstacles, while the TF is still developing its R&S plan. The team leader provides the scout PSG with

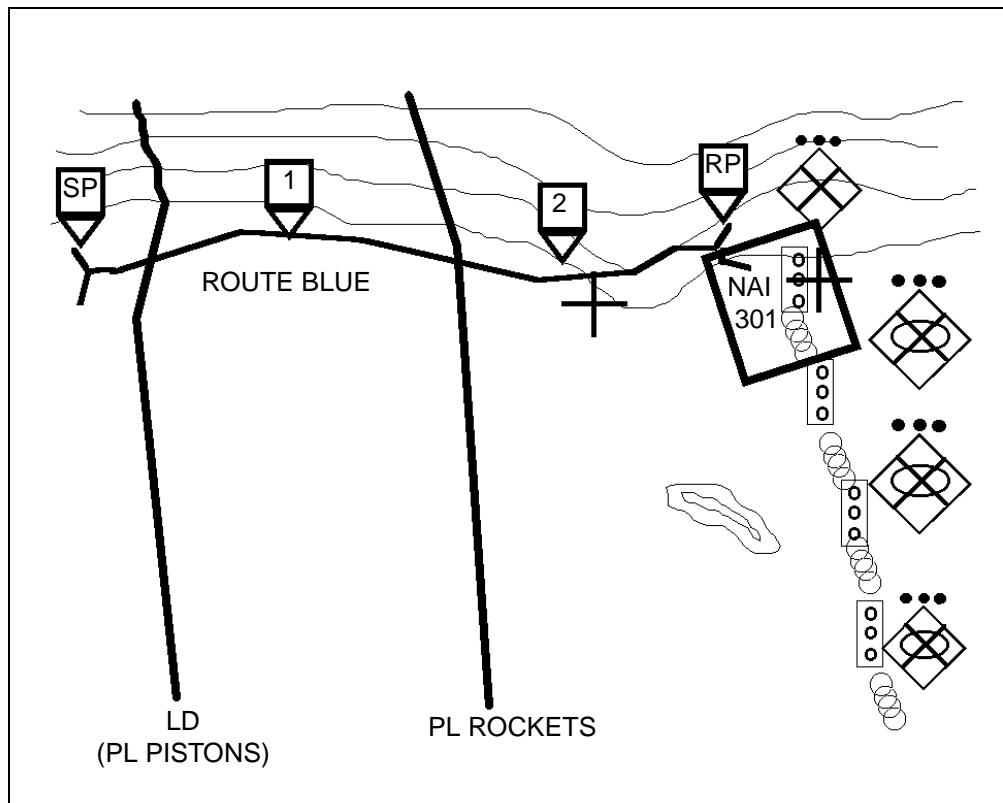

Figure 4-12. Team leader's addition to graphics

his personnel and vehicle information (because the TF plan calls for all support to the team to come through the scout platoon, including casualty evacuation). The team will use this method of evacuation if brigade aviation assets are not available.

At 082000 JAN 97, the team crosses the LD along Route Blue. This information is sent to the engineer battalion on the MSRT. The engineer battalion disseminates this information to the brigade (TF 1-23 in particular). At 0300, the team reaches its dismount point at checkpoint 2 and reports to the engineer battalion, ensuring that a NFA is established around the team's vehicle (see Figure 4-13, page 4-22). Additionally, the battalion's TOC ensures that the location of the recon team is plotted on both the engineer battalion and brigade map boards.

By 100500 JAN 97, the dismounted element has located the obstacle and, using the techniques discussed in Chapter 3, collects all of the required information about the northern minefield. The dismounted element reports all collected information on the TF scout net to the TF. The mounted element, who monitored the report to the TF, relays the same information to the engineer battalion over the MSRT. The engineer battalion passes the information to the brigade, ensures that the information is plotted on the brigade and battalion map boards, analyzes the information, and disseminates it to its subordinate elements.

Upon completion of its mission, the dismounted element returns to the team's vehicle and remains in the hide position until the attack. During the attack, the team links up with the breach force at a predetermined location and assists in guiding the breach force to the obstacle to begin its reduction effort.

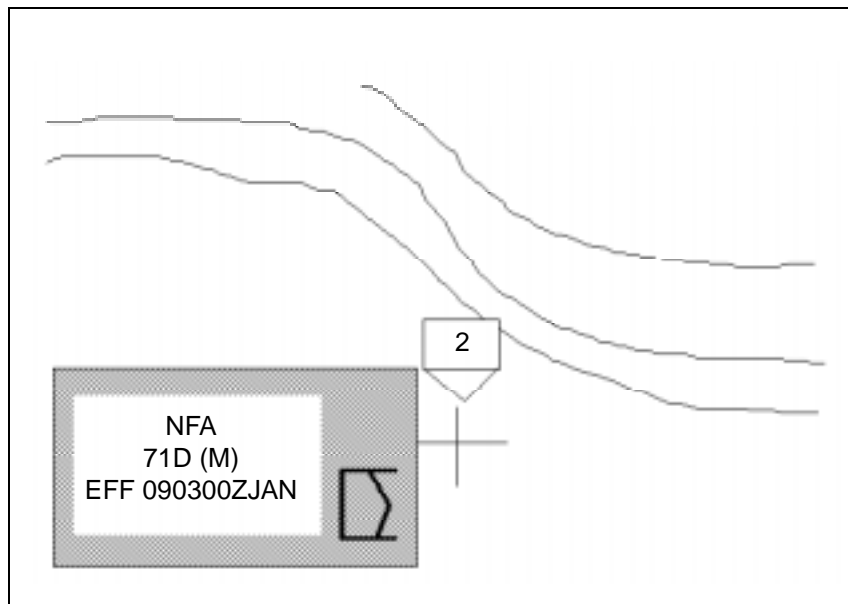

Figure 4-13. NFA established at dismount point

RESPONSIBILITIES

The following paragraphs outline the responsibilities of an engineer commander, an engineer staff, and a recon team leader:

An engineer commander—

- Ensures that the acquisition of information on enemy obstacles is one of the maneuver commander's PIR or IR.
- Understands exactly how an engineer recon team will be employed. This includes which vehicles the team will travel with or in, its routes, how its vehicles/casualties will be evacuated, the indirect-fire plan to support it, and how acquired OBSTINTEL will be reported and disseminated.
- Provides and fully supports well-trained and motivated soldiers and leaders as part of the engineer recon team.
- Develops a scheme of engineer operations (SOEO) that considers engineer recon integration into the supported unit's R&S effort.
- Recommends the appropriate command or support relationship for the recon team.

An engineer staff—

- Assists in developing NAIs to acquire OBSTINTEL for the appropriate areas of the battlefield (based on the SITEMP, current intelligence, and the commander's guidance) and provides this information to the brigade's/TF's S2.
- Ensures that the engineer recon team is tasked with the appropriate type and quantity of NAIs.

- Develops a feasible CSS plan for the team. It conducts staff coordination with the maneuver units, as required.
- Coordinates for fire support for the team.
- Issues a complete OPORD to the recon team leader. The OPORD should include instructions on what the recon team should do if communications are lost, actions if templated obstacles are not at the assigned NAI, and recon requirements for unexpected obstacles discovered en route.
- Tracks the location and activities of the recon team at all times.
- Ensures that NFAs are established around the recon team when they become stationary for an extended period of time (for example, in the team's hide position).
- Ensures that the team's location is plotted on the engineer and maneuver map board at all times.
- Tracks, analyzes, and disseminates all reported OBSTINTEL (see Figure 4-14, page 4-24).
- Refocuses the R&S plan when required.

A recon team leader—

- Accepts responsibility for all facets of the training and discipline of his men, the maintenance and operation of his equipment, and the integration of his team into the supported unit.
- Maintains communications throughout the mission and reports all information quickly and accurately.
- Ensures that the recon team conducts rehearsals and equipment preparations before each mission.

Obstacle No	Grid Coordinates	Type of Mines	How Obstacle is Marked	Unit to Clear Obstacle	DTG of Obstacle Clearance	Lane/Grid Marking	Remarks
ENA001MN01/	NK123456- NK125457	SB-MV	Single-strand concertina on all four sides	A/99 EN BN		NK124456-NK124457 Lane marked to full-lane pattern using traffic cones	Obstacle reported by A/1-23 IN (031500JAN97)
ENA001MN02+	NK450200- NK453202	SB-MV	Single-strand concertina on enemy side of minefield			NA	Reported by Engineer Recon Team 1 (NAI 301) (100200JAN97)
ENA001MN03X	NK189765- NK190768	SB-MV	NA	B/99 EN BN	011200JAN97	NA	
As of: <u>100600JAN97</u>							
<p>NOTE: Obstacle numbering system: ENXXXXXXXXXX.</p> <ul style="list-style-type: none"> • Characters 1-2: EN meaning enemy obstacle. • Characters 3-6: Alphanumeric description of the headquarters type and numerical designation that reported the obstacle. Character 3 designates the unit type: <ul style="list-style-type: none"> -A, armor division/brigade -I, infantry division/brigade -C, cavalry division -R, cavalry regiment -Z, corps • Characters 7-8: Letters indicating obstacle type (see FM 20-32). • Characters 9-10: Two numbers indicating obstacle number within the obstacle type. • Character 11: One of four characters indicating obstacle status: <ul style="list-style-type: none"> -+ obstacle reported, no clearance planned -/ clearance of obstacle planned -- clearance of obstacle in progress -X clearance of obstacle complete 							

Figure 4-14. Example of enemy obstacle-tracking chart

Chapter 5

Route Classification

This chapter describes how to perform the technical aspects of a route recon. Route classification is a tool that helps determine what can travel down a road network and how fast it may travel. Routes are reconned, and the results are displayed on map overlays. During war or military operations other than war (MOOTW), only the necessary and essential facts about a route are gathered as quickly and safely as possible. (This information is placed on a route-classification overlay and supplemented by additional reports.) During peacetime operations, detailed route-classification missions are performed to obtain in-depth information for future use.

Route classification may be conducted in a high-threat environment. The same tenets that guide tactical recons apply to technical recons. All recons must be coordinated with the supported unit. Combined-arms support should be planned and rehearsed to support the recon.

The first step in understanding the technical portions of a route recon is understanding what information is needed to complete a route-classification overlay.

ROUTE-CLASSIFICATION OVERLAY

A route-classification overlay graphically depicts a route's entire network of roads, bridge sites, and so forth. (These items are reconned, and the data recorded as support documentation for the complete route.) A route classification gives specific details on what obstructions will slow down a convoy or maneuver force along a route. Engineers are the experts on route classification.

As a minimum, the following information will be included on the route-classification overlay (see Figure 5-1, page 5-2):

- The route-classification formula.
- The name, rank, and social security number (SSN) of the person in charge of performing the classification.
- The unit conducting the classification.
- The date-time group (DTG) that the classification was conducted.
- The map name, edition, and scale.
- Any remarks necessary to ensure complete understanding of the information on the overlay.

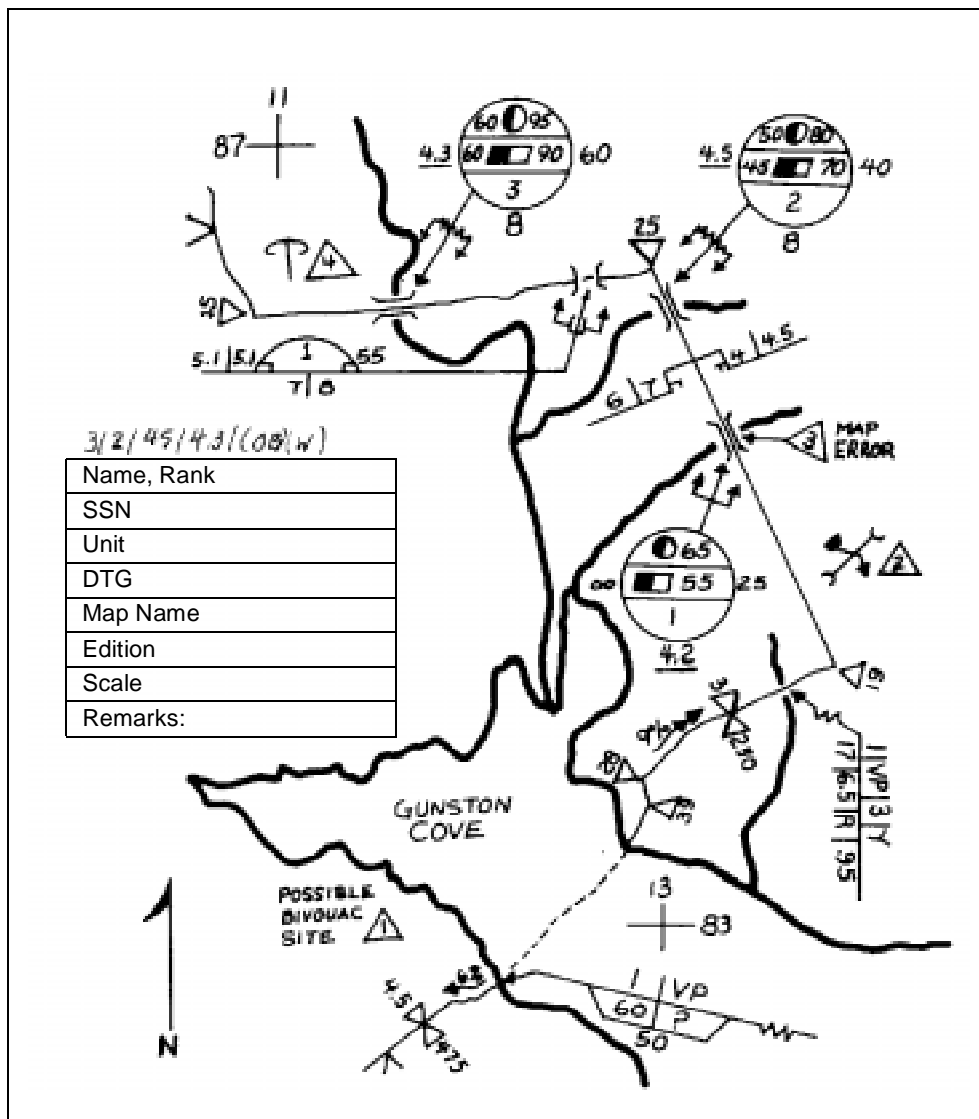

Figure 5-1. Route-classification overlay

ROUTE-CLASSIFICATION FORMULA

A route classification must include every alternate road on which movement can be made and what type of vehicle and traffic load that specific portion of the route can handle. Routes are classified by obtaining all pertinent information concerning trafficability and applying it to the route-classification formula. DA Forms 1248, 1249, 1250, 1251, and 1252 are designed to help organize recon data. These forms are covered in greater detail later in this chapter. The route-classification formula is derived from the information gathered during the route recon. The formula is recorded on the route-classification overlay (see Figure 5-1) and consists of the following:

- (1) Route width, in meters.
- (2) Route type (based on ability to withstand weather).

5-2 Route Classification

- (3) Lowest military load classification (MLC).
- (4) Lowest overhead clearance, in meters.
- (5) Obstructions to traffic flow (OB), if applicable.
- (6) Special conditions, such as snow blockage (T) or flooding (W).

Example: 5.5 / Y / 30 / 4.6 (OB) (T or W)

(1) (2) (3) (4) (5) (6)

Route Width

The route width is the narrowest width of traveled way on a route (see Figure 5-2). This narrow width may be the width of a bridge, a tunnel, a road, an underpass, or other constriction that limits the traveled-way width. The number of lanes is determined by the traveled-way width. The lane width normally required for wheeled vehicles is 3.5 meters; for tracked vehicles it is 4.0 meters.

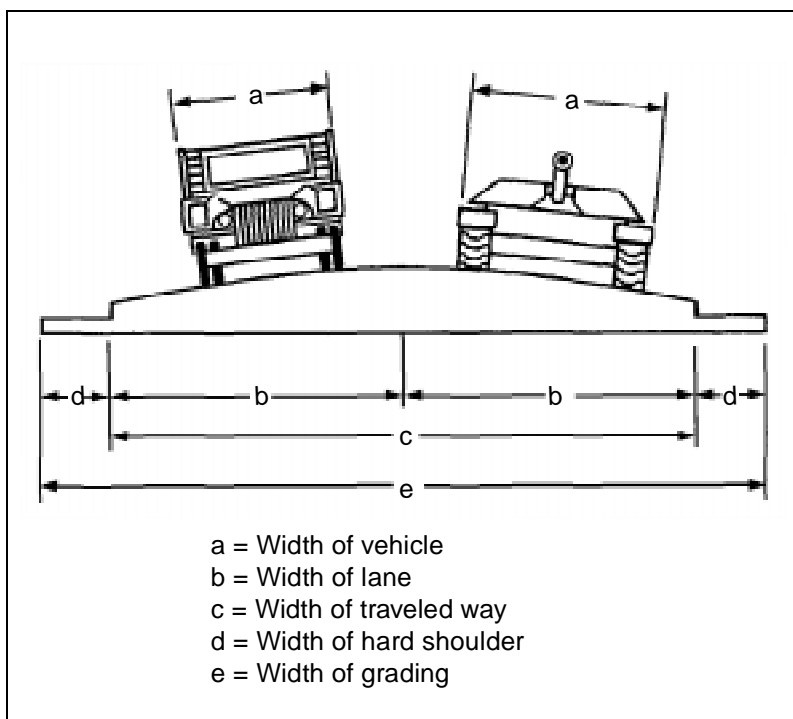

Figure 5-2. Route widths

According to the number of lanes, a road or route can be classified as follows:

- **Limited access**—Permits passage of isolated vehicles of appropriate width in one direction only.
- **Single lane**—Permits use in only one direction at any one time. Passing or movement in the opposite direction is impossible.
- **Single flow**—Permits the passage of a column of vehicles and allows isolated vehicles to pass or travel in the opposite direction at

predetermined points. It is preferable that such a route be at least 1.5 lanes wide.

- **Double flow**—Permits two columns of vehicles to proceed simultaneously. Such a route must be at least two lanes wide.

Route Type

The route type is determined by its ability to withstand weather. It is determined by the worst section of road on the entire route and is categorized as follows:

- **Type X**—An all-weather route that, with reasonable maintenance, is passable throughout the year to a volume of traffic never appreciably less than its maximum capacity. This type of route is normally formed of roads having waterproof surfaces and being only slightly affected by rain, frost, thaw, or heat. This type of route is never closed because of weather effects other than snow or flood blockage.
- **Type Y**—A limited, all-weather route that, with reasonable maintenance, is passable throughout the year but at times having a volume of traffic considerably less than maximum capacity. This type of route is normally formed of roads that do not have waterproof surfaces and are considerably affected by rain, frost, thaw, or heat. This type of route is closed for short periods (up to one day at a time) by adverse weather conditions during which heavy use of the road would probably lead to complete collapse.
- **Type Z**—A fair-weather route passable only in fair weather. This type of route is so seriously affected by adverse weather conditions that it may remain closed for long periods. Improvement of such a route can only be achieved by construction or realignment.

Military Load Classification

A route's MLC is a class number representing the safe load-carrying capacity and indicating the maximum vehicle class that can be accepted under normal conditions. Usually, the lowest bridge MLC (regardless of the vehicle type or conditions of traffic flow) determines the route's MLC. If there is not a bridge on the route, the worst section of road will determine the route's overall classification.

In cases where vehicles have a higher MLC than the route, an alternate route may be sought or an additional recon of the roads within the route may be necessary to determine whether a change in traffic flow (such as single-flow crossing of a weak point) will permit heavier vehicles on the route. When possible, ensure that the route network includes a number of heavy-traffic roads, as well as average-traffic roads. This helps staff planners manage heavy-traffic loads to decrease the bottleneck effect.

The entire network's class is determined by the minimum load classification of a road or a bridge within the network. These are the broad categories:

- Class 50—average-traffic route.
- Class 80—heavy-traffic route.

- Class 120—very heavy-traffic route.

Overhead Clearance

The lowest overhead clearance is the vertical distance between the road surface and any overhead obstacle (power lines, overpasses, tunnels, and so forth) that denies the use of the road to some vehicles. Use the infinity symbol (∞) for unlimited clearance in the route-classification formula. (Points along the route where the minimum overhead clearance is less than 4.3 meters are considered to be an obstruction.)

Route Obstructions

Route obstructions restrict the type, amount, or speed of traffic flow. They are indicated in the route-classification formula by the abbreviation “OB.” If an obstruction is encountered, its exact nature must be depicted on the route-classification overlay. Obstructions include—

- Overhead obstructions such as tunnels, underpasses, overhead wires, and overhanging buildings with a clearance of less than 4.3 meters.
- Reductions in traveled-way widths that are below the standard minimums prescribed for the type of traffic flow (see Table 5-1). This includes reductions caused by bridges, tunnels, craters, lanes through mined areas, projecting buildings, or rubble.
- Slopes (gradients) of 7 percent or greater.
- Curves with a radius of 25 meters and less. Curves with a radius of 25.1 to 45 meters are not considered to be an obstruction; however, they must be recorded on the route-recon overlay.
- Ferries.
- Fords.

Table 5-1. Traffic-flow capability based on route width

	Limited Access	Single Lane	Single Flow	Double Flow
Wheeled	At least 3.5 m	3.5 to 5.5 m	5.5 to 7.3 m	Over 7.3 m
Tracked and combination vehicles	At least 4.0 m	4.0 to 6.0 m	6.0 to 8.0 m	Over 8 m

Snow Blockage and Flooding

In cases where snow blockage is serious and is blocking traffic on a regular and recurrent basis, the symbol following the route-classification formula is “T.” In cases where flooding is serious and is blocking traffic on a regular and recurrent basis, the symbol following the route-classification formula is “W.”

EXAMPLES OF THE ROUTE-CLASSIFICATION FORMULA

The following are examples depicting the use of the route-classification formula:

- **6.1m/Z/40/ ∞** —A fair-weather route (Z) with a minimum traveled way of 6.1 meters, and an MLC of 40. Overhead clearance is unlimited (∞) and there are no obstructions to traffic flow. This route, based on its

minimum traveled-way width, accommodates both wheeled and tracked, single-flow traffic without obstruction.

- **6.1m/Z/40/∞ (OB)**—A fair-weather route (Z) similar to the previous example, except there is an obstruction. This obstruction could consist of overhead clearances of less than 4.3 meters, grades of 7 percent or greater, curves with a radius of 25 meters and less, or fords and ferries. A traveled way of 6.1 meters limits this route to one-way traffic without a width obstruction. If the route is used for double-flow traffic, then 6.1 meters of traveled way is considered an obstruction and is indicated in the formula as an obstruction.
- **7m/Y/50/4.6 (OB)**—A limited, all-weather route (Y) with a minimum traveled way of 7 meters, an MLC of 50, an overhead clearance of 4.6 meters, and an obstruction. This route width is not suitable for double-flow traffic (wheeled or tracked). This width constriction is indicated as OB in the route-classification formula if the route is used for double-flow traffic.
- **10.5m/X/120/∞ (OB) (W)**—An all-weather route (X) with a minimum traveled-way width of 10.5 meters, which is suitable for two-way traffic of both wheeled and tracked vehicles; an MLC of 120; unlimited overhead clearance; an obstruction; and regular, recurrent flooding.

CURVE CALCULATIONS

The speed at which vehicles move along a route is affected by sharp curves. Curves with a radius of 25 meters and less are obstructions to traffic and are indicated by the abbreviation “OB” in the route-classification formula and identified on DA Form 1248. Curves with a radius between 25.1 and 45 meters are recorded on the overlay but are not considered obstructions.

MEASURING METHODS

There are several ways to measure curves: the tape-measure, triangulation, and formula methods.

Tape-Measure Method

A quick way to estimate the radius of a sharp curve is by using a tape measure to find the radius (see Figure 5-3). Imagine the outer edge of the curve as the outer edge of a circle. Find (estimate) the center of this imaginary circle; then measure the radius using a tape measure. Start from the center of the circle and measure to the outside edge of the curve. The length of the tape measure from the center of the imaginary circle to its outer edge is the curve’s radius. This method is practical for curves located on relatively flat ground and having a radius up to 15 meters.

Triangulation Method

You can determine a curve’s approximate radius by “laying out” right triangles (3:4:5 proportion) at the point of curvature (PC) and point of tangency (PT) locations (see Figure 5-4). The intersection (o), which is formed by extending the legs of each triangle, represents the center of the circle. The distance (R) from point o to either point PC or PT represents the curve’s radius.

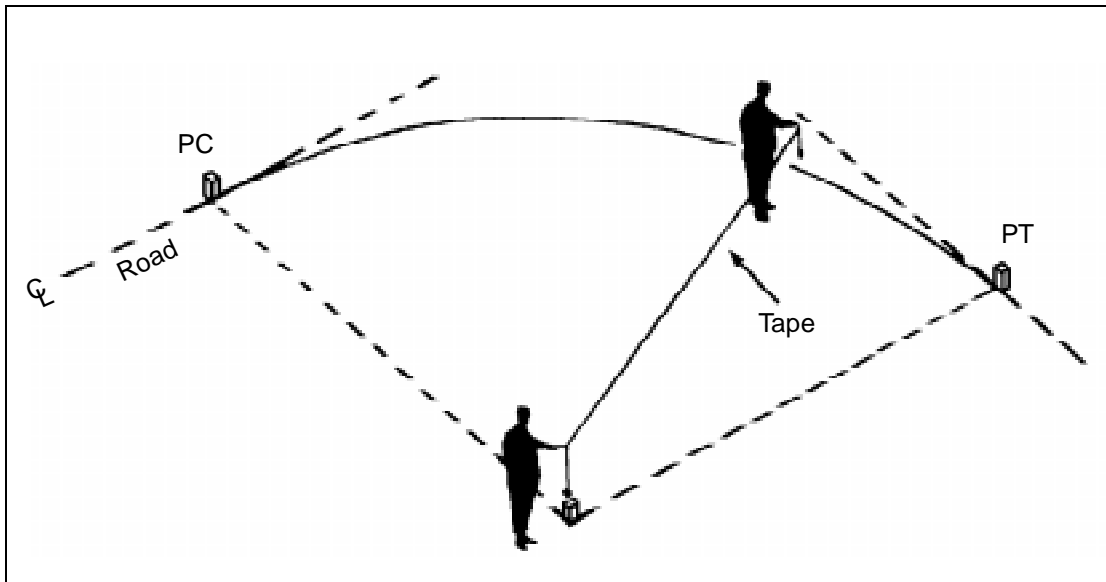

Figure 5-3. Tape-measure method

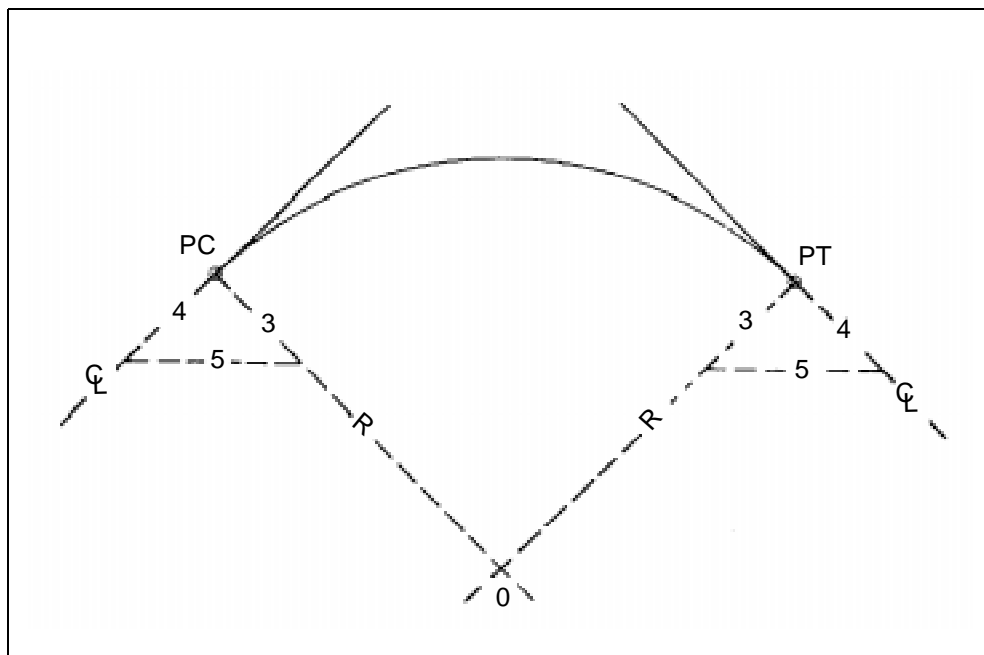

Figure 5-4. Triangulation method

Formula Method

Another method of determining the curve's radius (see Figure 5-5) is based on the formula (all measurements are in meters)—

$$R = (C^2/8M) + (M/2)$$

where—

R = radius of curve

C = distance from the centerline of the road to the centerline of the road at the outer extremities of the curve

M = perpendicular distance from the center of the tape to the centerline of the road

NOTE: When conditions warrant, set M at 2 meters from the centerline, then measure C 2 meters from the centerline. Use this method when there is a time limitation or because natural or man-made restrictions prevent proper measurements.

Example: If C is 15 meters and M is fixed at 2 meters, the formula becomes—

$$R = (15^2/16) + 2/2$$

The result of this calculation would be an obstruction to traffic flow, and "OB" would be placed in the route-classification formula.

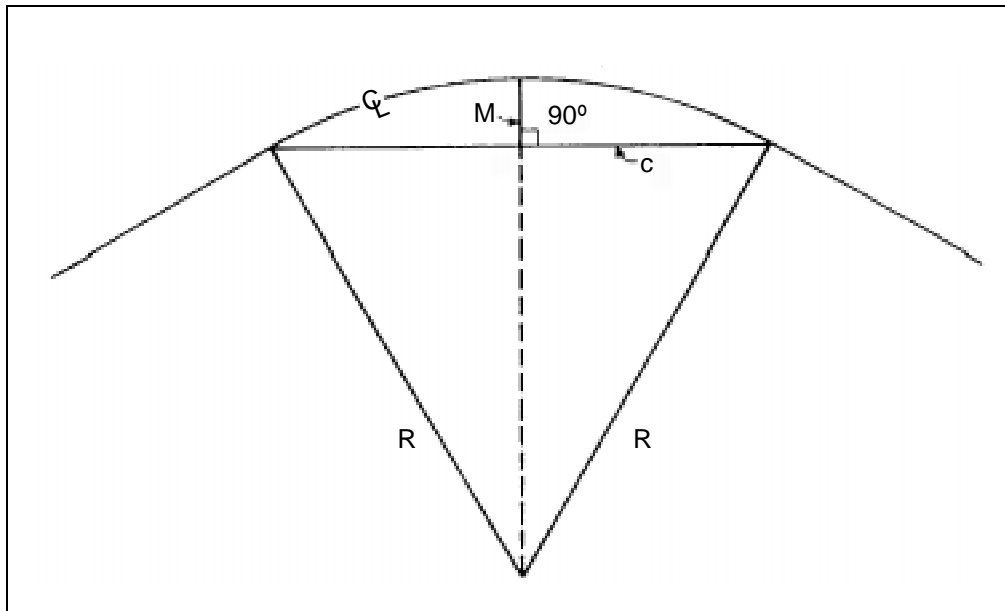

Figure 5-5. Formula method

CURVE SYMBOL

Sharp curves with a radius of 45 meters or less are symbolically represented on maps or overlays by a triangle that points to the curve's exact map location. In addition, the measured value (in meters) for the radius of curvature is written outside the triangle (see Figure 5-6). All curves with a radius of 45 meters are reportable and need to be noted on DA Form 1248.

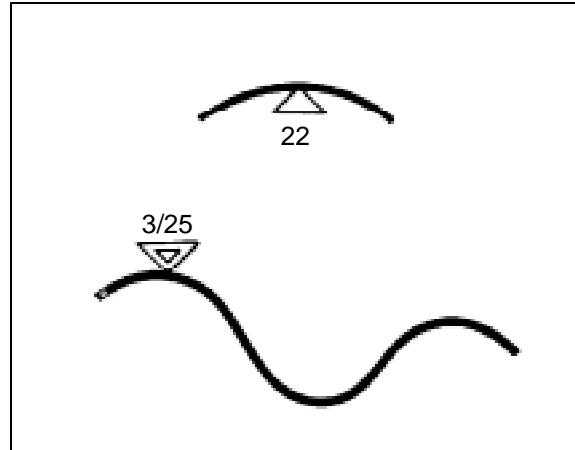

Figure 5-6. Curve symbols

SERIES OF SHARP CURVES

A series of sharp curves is represented by two triangles, one drawn inside the other. The outer triangle points to the location of the first curve. The number of curves and the radius of curvature for the sharpest curve of the series are written to the outside of the triangle (see Figure 5-6).

SLOPE ESTIMATION

The rise and fall of the ground is known as the slope or gradient (grade). Slopes of 7 percent or greater affect the movement speed along a route and are considered an obstruction. The percent of slope is used to describe the effect that inclines have on movement rates. It is the ratio of the change in elevation (the vertical distance to the horizontal ground distance) multiplied by 100 (see Figure 5-7, page 5-10). It is important to express the vertical distance and the horizontal in the same unit of measure. Report all slopes greater than 5 percent on the route-classification overlay.

PERCENT OF SLOPE

The following methods are used for determining the percent of slope:

Clinometer Method

A clinometer is an instrument that directly measures percent of slope. It can be found in engineer survey units, as part of an artillery compass, and as part of an engineer platoon sketch set. Follow the instructions included with the instrument.

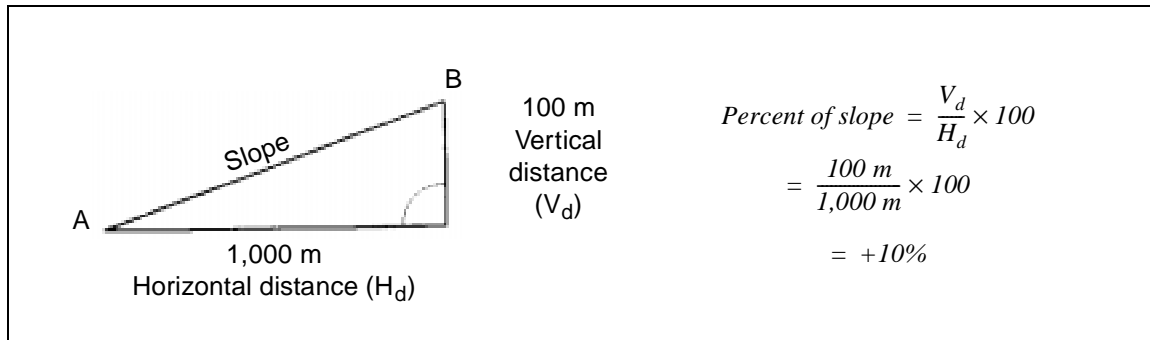

Figure 5-7. Percent-of-slope formula

Map Method

Use a large-scale map (such as 1:50,000) to estimate the percent of slope quickly. After identifying the slope on the map, find the difference in elevations between the top and bottom of the slope by reading the elevation contours or spot elevation. Then, measure and convert the horizontal distance (usually road distance) to the same unit of measurement as the elevation difference. Substitute the vertical and horizontal distances in the percent-of-slope formula and compute the percent of slope (see Figure 5-8).

Pace Method

The pace method is a quick way to estimate percent of slope. Determine, accurately, the height and pace of each soldier for each member of a recon team before using this method. As a rule of thumb, the eye level of the average soldier is 1.75 meters above the ground. The pace of the average soldier is 0.75 meter.

Perform the following procedures for the pace method:

- Stand at the bottom of the slope with head and eyes level.
- Sight a spot on the slope. This spot should be easily identifiable. If it is not, another member of the team should go forward to mark the location.
- Walk forward and stand on the marked spot. Record the number of paces. Repeat this procedure until you reach the top of the slope (estimate fractions of an eye level).
- Compute the vertical distance by multiplying the number of sightings by the eye-level height (1.75 meters). Compute the horizontal distance by totaling the number of paces and converting them to meters by multiplying by 0.75 (or the known pace-to-meter conversion factor).

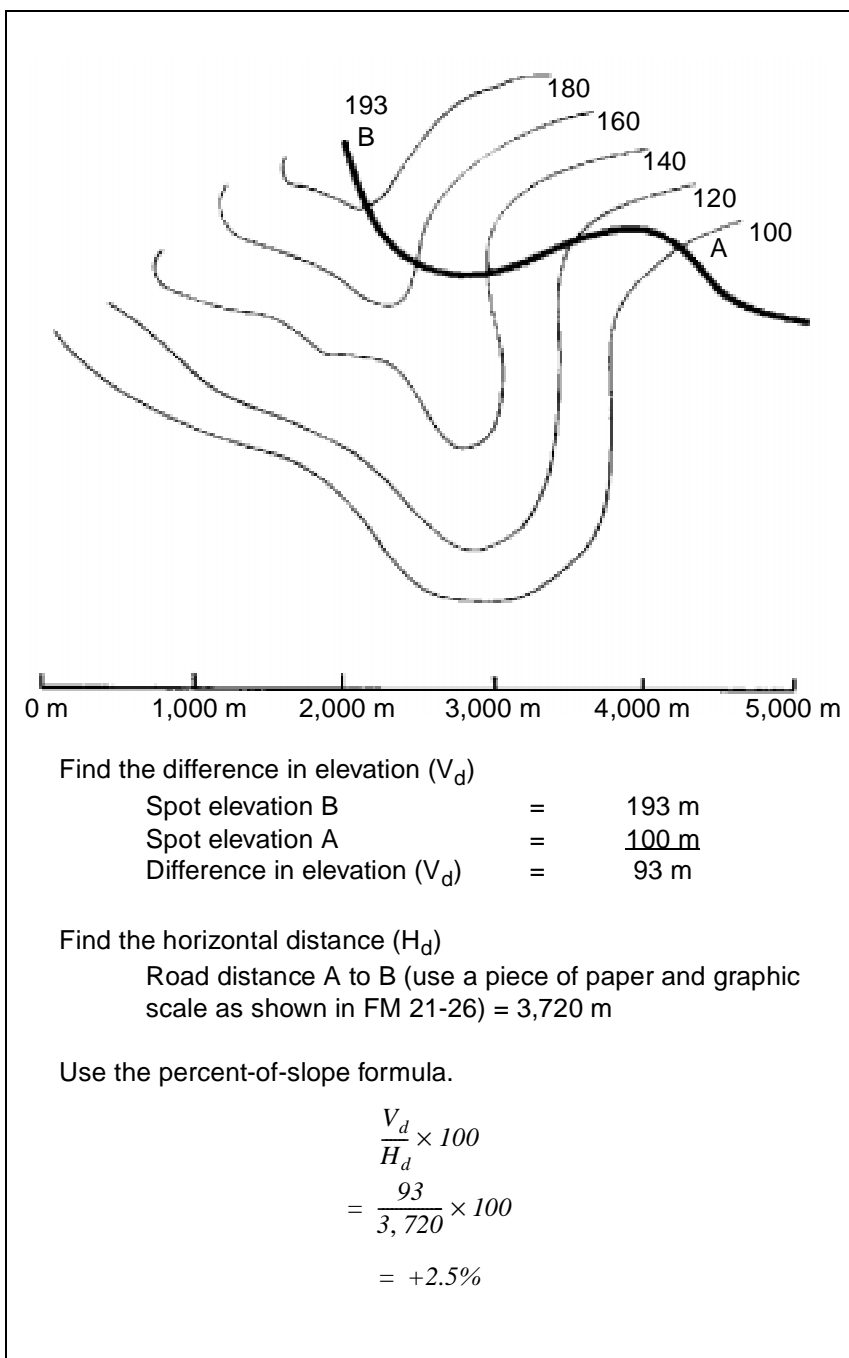

Figure 5-8. Map method to determine percent of slope

- Calculate the percent of slope by substituting the values into the percent-of-slope formula (see Figure 5-9). Because this method considers horizontal ground distance and incline distance as equal, you can obtain reasonable accuracy only for slopes less than 30 percent. This method requires practice to achieve acceptable accuracy. A line level and string can be used to train this method.

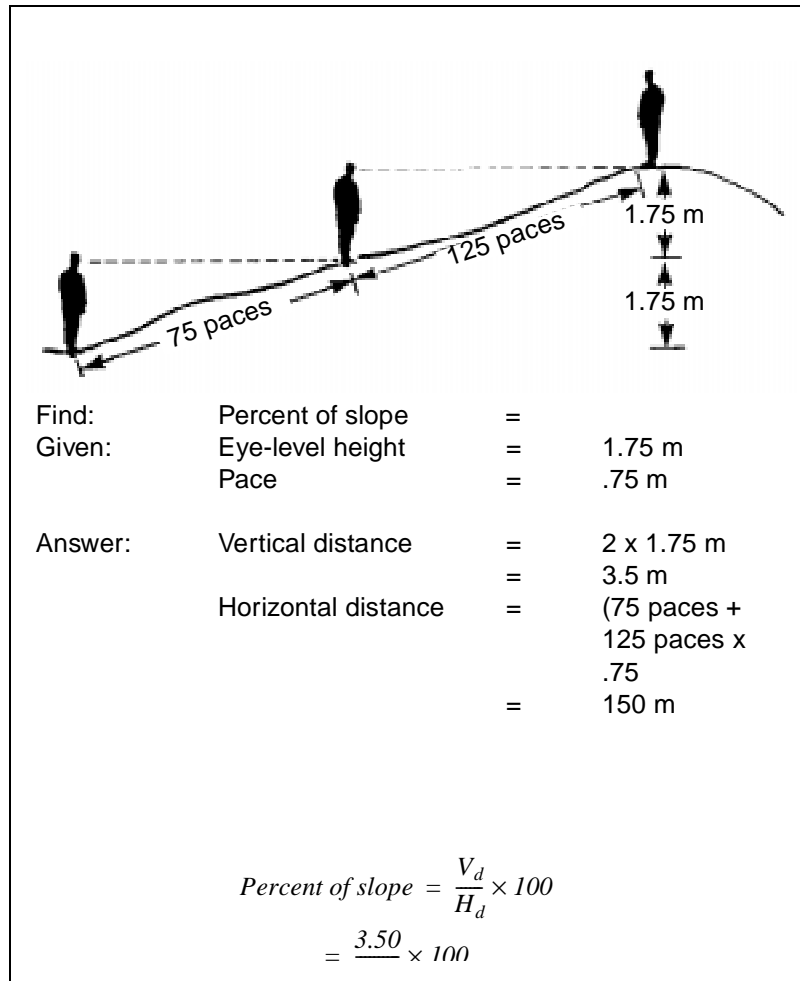

Figure 5-9. Pace method to determine percent of slope

Angle-of-Slope Method

The angle-of-slope method is a quick way to estimate the percent of slope. The angle of slope is first measured by using an elevation quadrant, an aiming circle, an M2 compass, or binoculars with a standard reticle. If the instrument used to take the angle of measurement is mounted above ground level, the height difference must be compensated for by sighting above the slope a corresponding, equal distance. (The corresponding distance is the distance the instrument is above the ground.) You must conduct the angle of measurement at the base of the slope. Once you obtain the angle of measurement, refer to

Table 5-2 and enter the column corresponding to the measured angle of slope. You can read the percent of slope directly from Table 5-2 (see Figure 5-10).

Table 5-2. Conversion of degrees and mils to percent of slope

Degrees of Slope	Mils of Slope	Percent of Slope
1	18	1.7
2	36	3.5
3	53	5.2
4	71	7.0
5	89	8.7
10	175	17.6
15	267	26.7
20	356	36.4
25	444	46.6
30	533	57.7
35	622	70.0
40	711	83.9
45	800	100.0
50	889	108.7
55	978	117.6
60	1,067	126.7

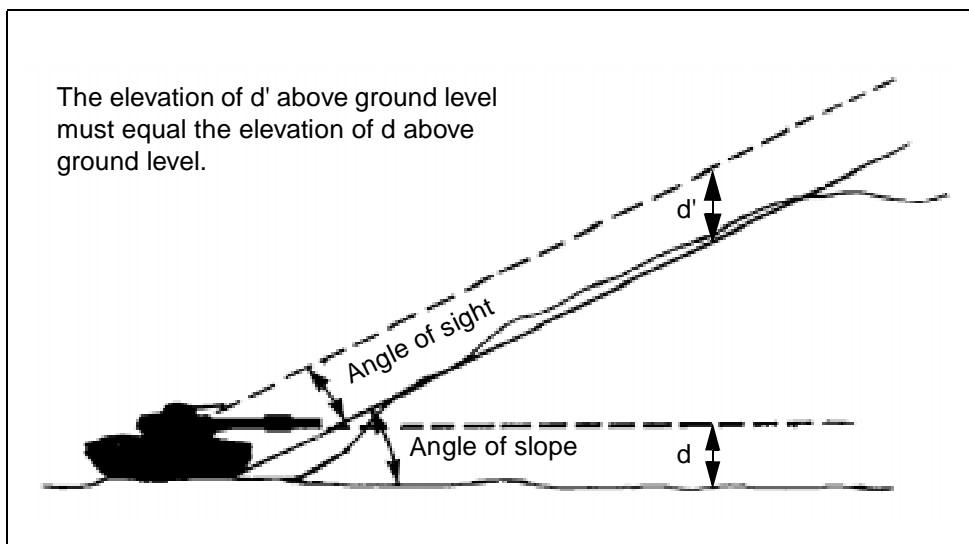

Figure 5-10. Angle-of-slope method to determine percent of slope

SLOPE SYMBOL

Most vehicles negotiating slopes of 7 percent or greater for a significant distance will be slowed. Such slope characteristics must be accurately reported. The symbols illustrated in Figure 5-11, page 5-14, are used to represent various slopes.

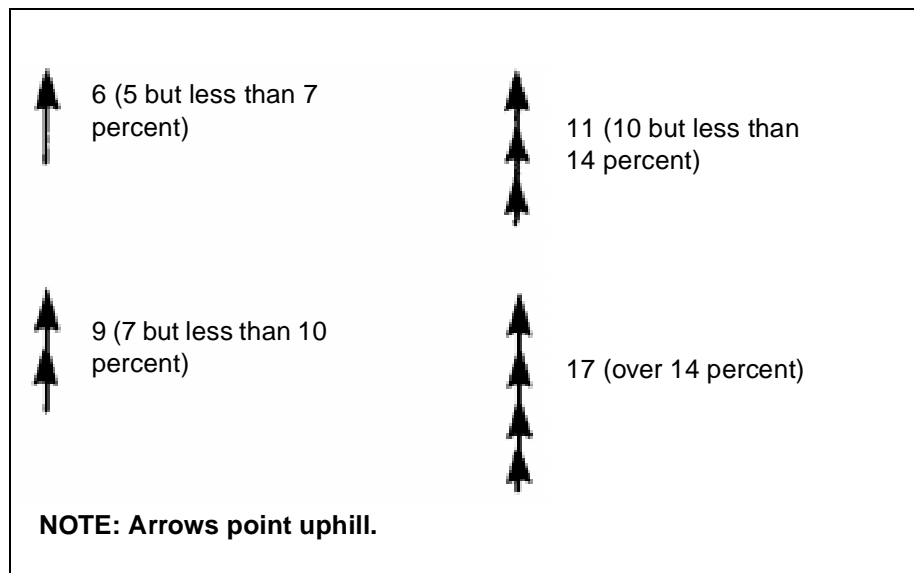

Figure 5-11. Percent-of-slope symbols

DESCRIPTION OF SLOPE SYMBOLS

A single arrowhead along the trace of a route pointing in the uphill direction indicates a grade of at least 5 but less than 7 percent. Two arrowheads represent a grade of at least 7 but less than 10 percent. Three arrowheads represent a grade of at least 10 but less than 14 percent. Four arrowheads represent a grade of 14 percent or more. A symbol is not required for slopes less than 5 percent.

The percent of slope is written to the right of the arrow. When the map scale permits, the length of the arrow shaft will be drawn to map scale to represent the approximate length of the grade.

NOTE: Slopes of 7 percent or greater are obstructions to traffic flow and are indicated by the abbreviation “OB” in the route-classification formula.

CONSTRICTIONS

Reductions in traveled-way widths (constrictions) include narrow streets in built-up areas, drainage ditches, embankments, and war damage. These constrictions may limit vehicle movement; therefore, the physical dimensions of the vehicles that will be using the route must be known and considered when conducting the route classification.

Constrictions in the traveled-way width below minimum requirements are depicted on maps and overlays by two opposing shaded triangles. The width of the usable traveled way (in meters) is written next to the left triangle. The length of the constriction (in meters) is written next to the right triangle (see Figure 5-12).

NOTE: Constrictions of traveled-way widths below the minimum standard for the type and flow of traffic are obstructions and are indicated by the symbol “OB” in the route-classification formula.

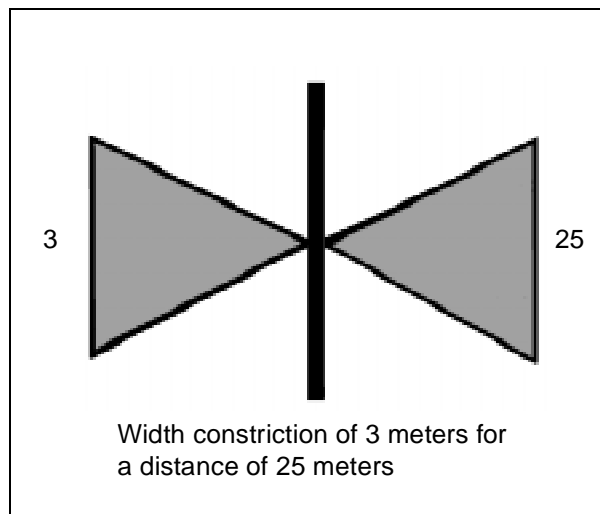

Figure 5-12. Route-constriction symbol

UNDERPASSES

An underpass is depicted on a map or overlay by a symbol that shows the structure's ceiling. It is drawn over the route at the map location. The width (in meters) is written to the left of the underpass symbol, and the overhead clearance (in meters) is written to the right of the underpass symbol (see Figure 5-13).

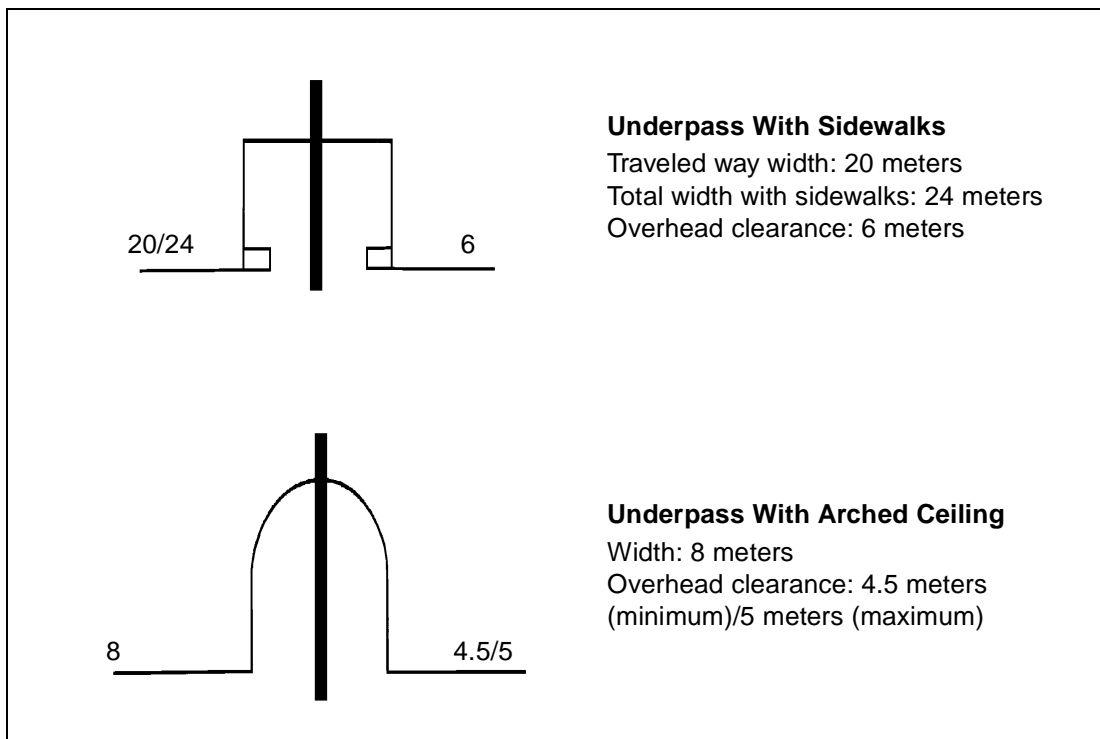

Figure 5-13. Underpass symbols

If sidewalks permit emergency passage of wider vehicles, the sidewalks are symbolically represented. This information should be noted on DA Form 1250. The traveled-way width is recorded first, followed by a slash, then the structure's total width, including sidewalks.

NOTE: Items such as arched ceilings or irregularities in ceilings that result in a decrease in overhead clearance must be noted. In such cases, an extension of width may not mean that the structure will accommodate wider vehicles.

Both minimum and maximum overhead clearances, if different, will be recorded. The minimum will be recorded first, followed by a slash, then the maximum overhead clearance.

TUNNELS

A tunnel is an artificially covered (such as a covered bridge or a snowshed) or underground section of road along a route. A tunnel recon determines essential information such as the serial number, location, type, length, width (including sidewalks), bypasses, alignment, gradient, and cross section. A tunnel consists of a bore, a tunnel liner, and a portal. Common shapes of tunnel bores (see Figure 5-14) are semicircular, elliptical, horseshoe, and square with an arched ceiling.

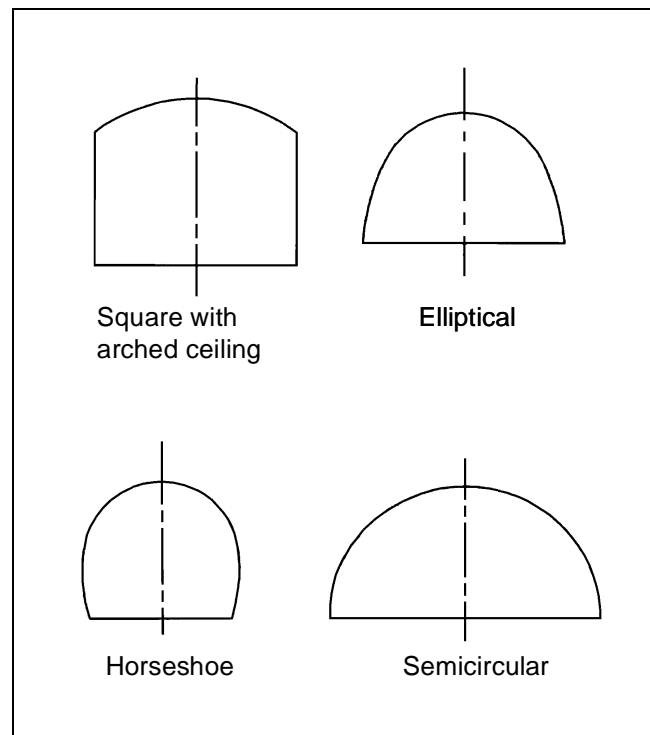

Figure 5-14. Types of tunnel boxes

TUNNEL SYMBOL

Basic tunnel information is recorded on maps or overlays using symbols (see Figure 5-15). The location of the tunnel entrance is shown on a map or overlay by an arrow from the symbol to the location of the entrance. For long tunnels (greater than 30.5 meters), both tunnel entrance locations are indicated.

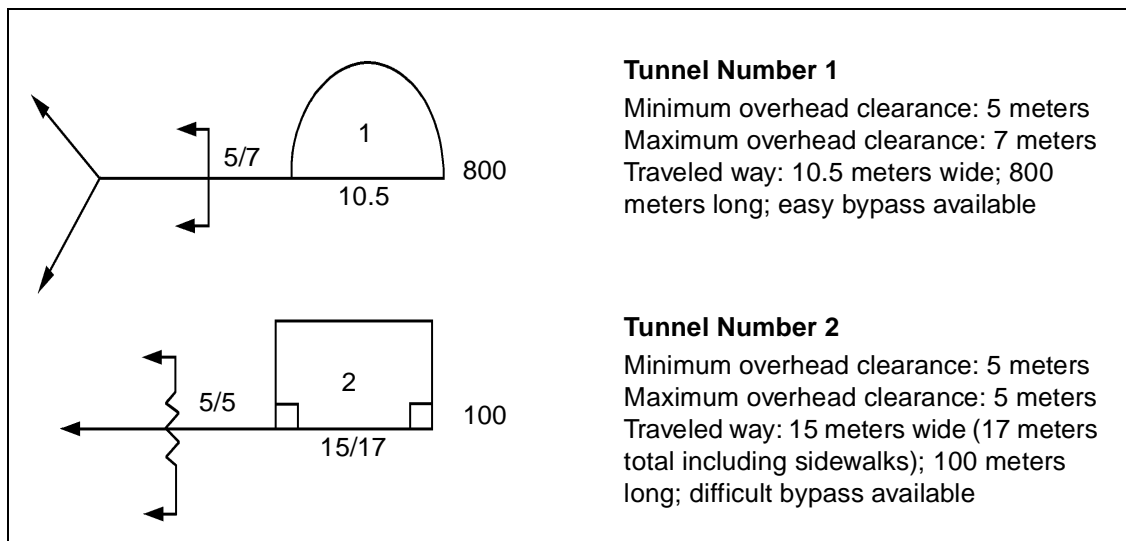

Figure 5-15. Tunnel symbols

For later reference, a serial number is assigned to each tunnel. (Check for an existing fixed serial number on the actual tunnel or map sheet; if there is not a serial number, assign a number based on the unit's SOP.) Serial numbers are not duplicated on any one map sheet, overlay, or document. The number is recorded inside the symbol. The traveled-way width is shown in meters and is placed below the symbol.

If sidewalks permit the emergency passage of wider vehicles, then the sidewalks are symbolically represented and the traveled-way width is written first, followed by a slash, then the total width including the sidewalks.

NOTE: Structures with arched or irregular ceilings will decrease overhead clearance. An extension of width does not always mean that the structure will accommodate wider vehicles.

OVERHEAD CLEARANCE

Overhead clearance is the shortest distance between the surface of a traveled way and any obstruction vertically above it. The measurement of overhead clearance must be accurate. Obtain the measurements shown in Figures 5-16 and 5-17 and record them on DA Form 1250.

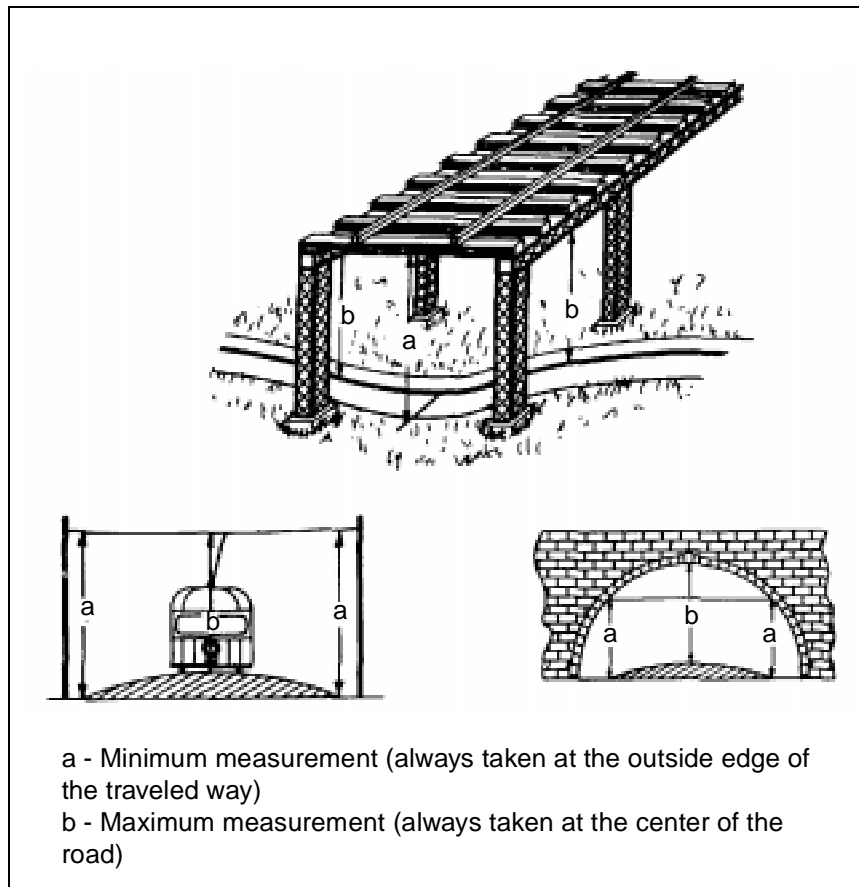

Figure 5-16. Overhead-clearance measurements

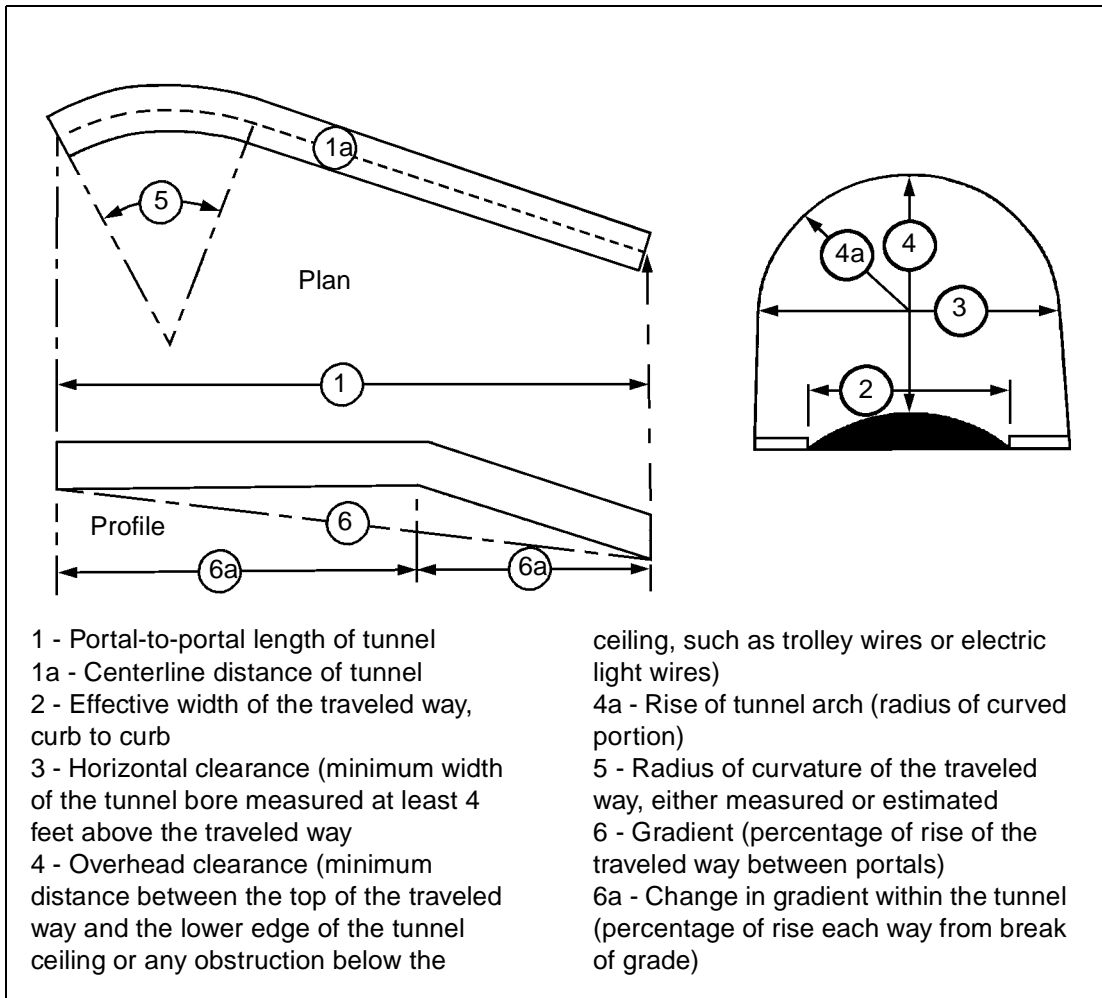

Figure 5-17. Dimensions required for tunnels

TUNNEL RECONNAISSANCE REPORT

The following are explanations for sections of DA Form 1250 that are not self-explanatory (see Figures 5-18 through 5-19a, pages 5-21 through 5-23):

- **Block 8.** Record the tunnel number found on the map sheet or on the head wall (or data plate) of the actual tunnel. If there is not a number on the map or tunnel, then assign an appropriate number based on the unit's SOP. If there is a different number on the map than on the tunnel, record both serial numbers.
- **Block 13.** Record the number of railroad tracks passing through the tunnel, if applicable.
- **Block 15.** Record the vertical clearance (the shortest clearance from the road surface in the tunnel to the lowest point on the ceiling above the traveled way). Also, record the distance from the sidewalk to the ceiling if traffic can travel on the sidewalks.
- **Block 15 (continued).** Record the horizontal clearance. It is the roadway width or the roadway width and sidewalks/emergency lanes (where vehicles can move through the tunnel without striking the top or sides).
- **Block 16.** Record the internal tunnel grade. Record the grade of the tunnel entrances in Block 27.
- **Block 17.** State whether the tunnel is straight or curved. Record curves that may restrict traffic flow.
- **Block 19.** Record a description of what the tunnel entrances (portals) look like and their composition.
- **Block 22.** Mark the applicable box. Some tunnels are chambered for demolition. This means that the tunnel has predesigned locations for placing demolitions to destroy the tunnel and deny use by the enemy.
- **Block 23.** Record the date the tunnel was constructed.
- **Block 29.** Inspect the rock or soil at the tunnel's entrances. If there is a chance of a rock or mud slide, record the location and possible solution to the problem.

TUNNEL RECONNAISSANCE REPORT				DATE	
For use of this form, see FM 5-20; the preparing agency is TRADOC.				29 Aug 84	
TO (Headquarters or other command/element)			FROM (Name, grade and unit of reconnaissance officer)		
Cdr, ATTN: S-2, 21st Eng. Bn			Charles Clark CHARLES CLARK, 2LT, Co A, 21st Eng. Bn		
1. ROUTE OR LINE		2. FROM (Quasi Point)		3. TO (Terminal Point)	
HIGHWAY VA 617		RAILROAD NA		UT 122 864 UT 097899	
4. MAP SERIES NR		5. SHEET NUMBER		6. DATE/TIME (of signature)	
V 734		5561 III		301700 Aug 84	
7. GRID REFERENCE			8. TUNNEL NUMBER		
TYPE 1:50,000			COORDINATES UT 098888		
9. LOCATION FROM NEAREST TOWN			10. TYPE (Subaqueous, Road, Soil)		
DISTANCE 10 Km		DIRECTION NW		NAME OF NEAREST TOWN Ft. Belvoir, VA	
11. NAME (Mountains or River features)		12. LENGTH		13. NUMBER OF TRACKS	
Accotink Mountains		100 m		NA	
14. ROADWAY WIDTH		15. GRADE (Percent)		16. ALIGNMENT (Straight or curve of curve)	
7.5 m		3%		Straight	
17. CLEARANCE		18. LIVING (Material)		19. PORTALS (Material)	
VERTICAL 6 m		HORIZONTAL 8 m		Concrete	
20. VENTILATION (Type)		21. DRAINAGE		22. CHAMBERED FOR DEMOLITION	
Natural		Excellent		<input type="checkbox"/> YES <input checked="" type="checkbox"/> NO	
23. BYPASSABILITY		24. CONDITION (Check appropriate box)		25. COMPL. (Year)	
Easy on East (Ft. Belvoir side) Difficult on West		<input type="checkbox"/> EXCELLENT <input checked="" type="checkbox"/> GOOD <input type="checkbox"/> FAIR <input type="checkbox"/> POOR			
26. ALTERNATE CROSSING					
Backlick Road to Shirley Highway					
27. APPROACHES					
Good, 3% Entrance, Exit is level					
28. IN-TUNNEL RESTRICTIONS					
Not to be used for double-flow, tracked because traveled way width not to standard. No lighting in tunnel.					
29. GEOLOGIC DATA					
Unknown - Possibility of slides at entrances.					

DA FORM 1250 1 JAN 78

Figure 5-18. Sample Tunnel Reconnaissance Report (front)

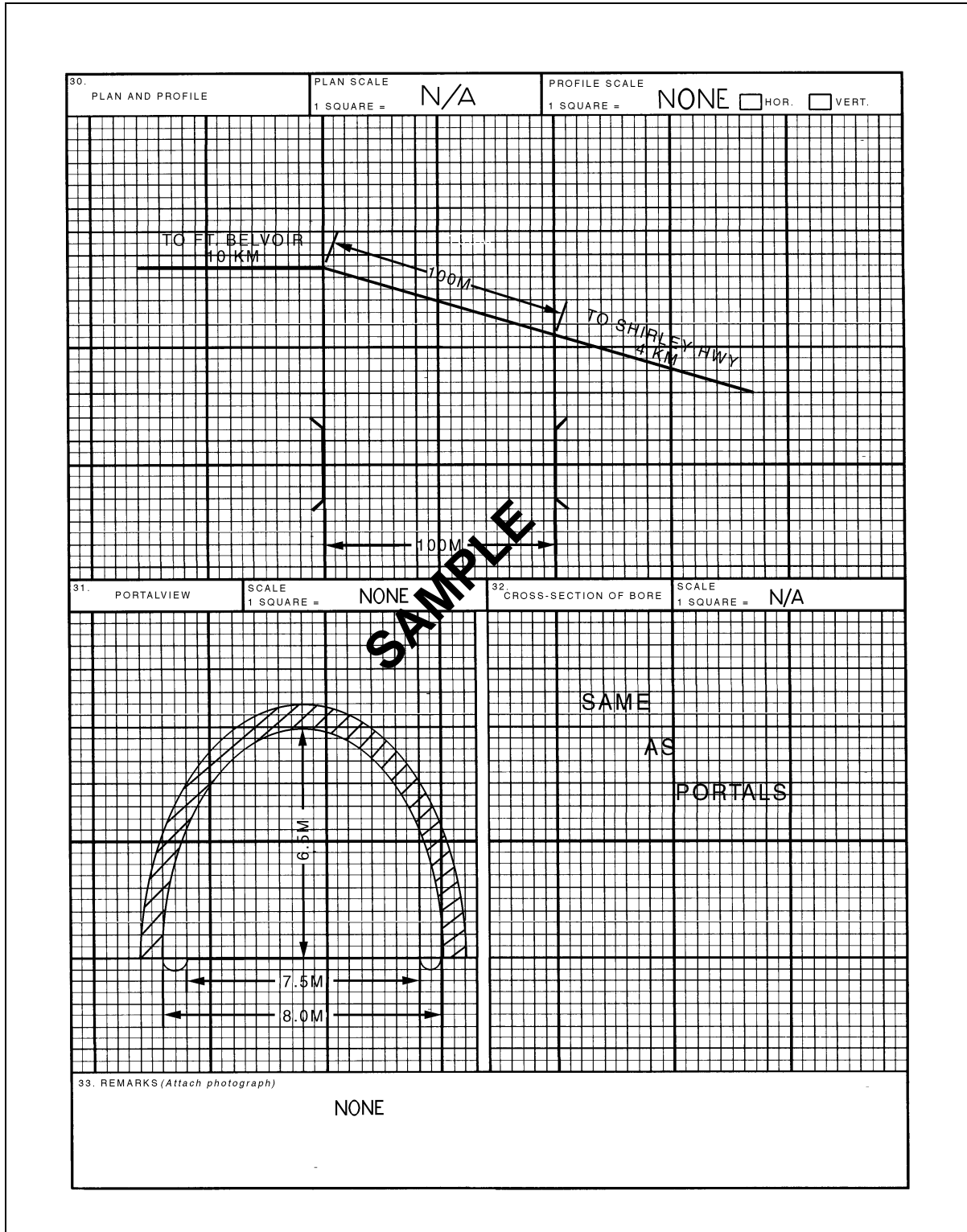

Figure 5-19. Sample Tunnel Reconnaissance Report (back)

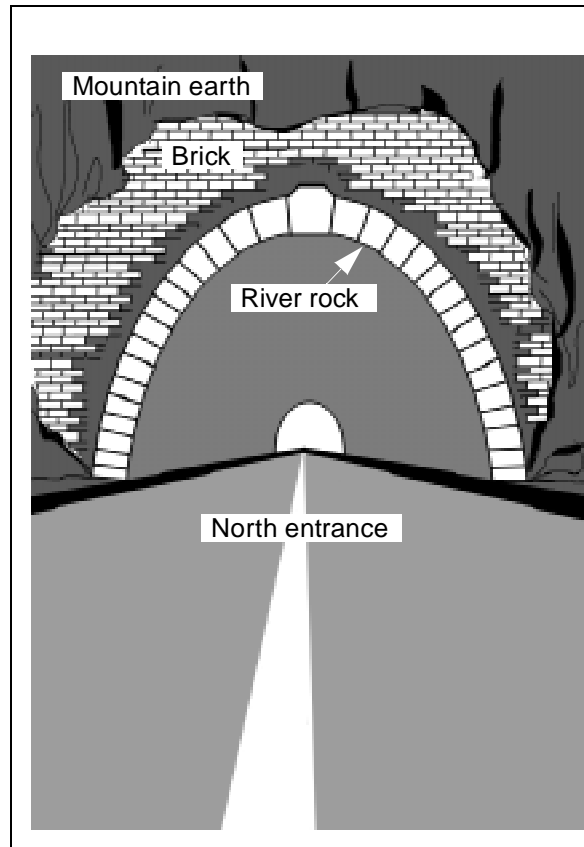

Figure 5-19a. Portal view of tunnel

STREAM RECON

A stream-crossing site is a location at a body of water where vehicles can “swim” across and not touch the bottom. Identify and report locations that permit smooth traffic flow and reduce route obstructions as much as possible. When conducting a recon of a stream-crossing area, record the stream’s depth, width, approaches, velocities, and natural and man-made obstacles (see Figure 5-20).

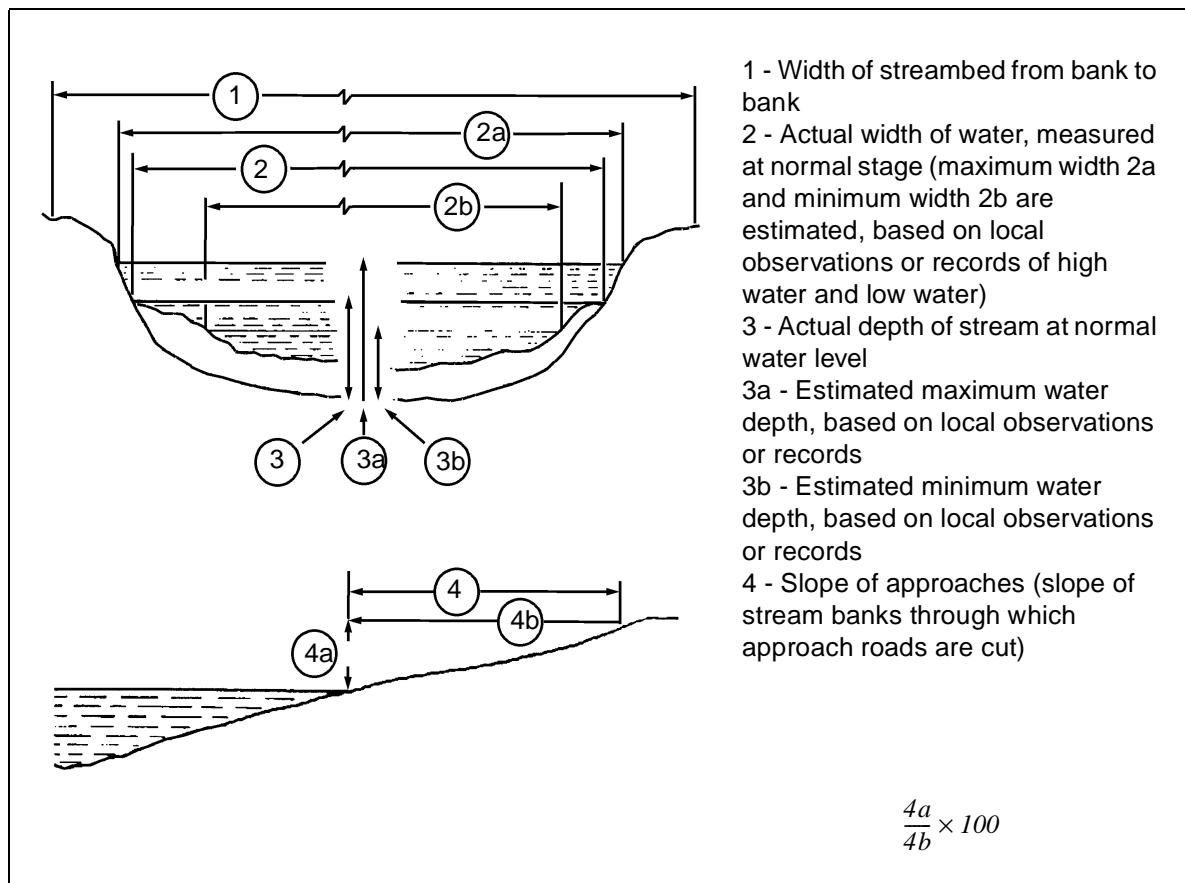

Figure 5-20. Dimensions required for streams

MEASUREMENTS

Stream depth is usually measured using field-expedient devices such as poles or weighted ropes. Measure the depth every 3 meters along the planned stream-crossing route. Recheck depths and currents frequently during inclement weather. As a result of sudden, heavy rainfall, a sluggish stream or river may become a torrent very quickly, particularly in tropical and arid regions. Monitor weather reports of the surrounding area. Storms occurring miles away can cause flash flooding. Always consider the importance of upstream dams and locks that may cause elevated levels or flooding when opened or destroyed. **NOTE: The actual depth you measure is recorded as normal depth when there is little time to recon.**

PREEXISTING DATA

In developed areas of the world, special water-navigation maps containing water-body data are available through government agencies. The S2 can obtain copies of such maps. However, always check the actual site when possible; there is no substitute for an actual recon.

STREAM WIDTH

Determine the stream width by using the compass method; an aiming circle, azimuth indicator, or alidade; or a GPS or by taking a direct measurement.

Compass Method

Determine stream width by using a compass to take an azimuth from a point on the near shore and close to the water's edge to a point on the opposite shore and close to the water's edge (see Figure 5-21). On the near shore, establish another point that is on a line and at a right angle to the azimuth selected. The azimuth to the same point on the far shore is + or - 45 degrees (800 mils) from the previous azimuth. Measure the distance between the two points on the near shore. This distance is equal to the distance across the stream.

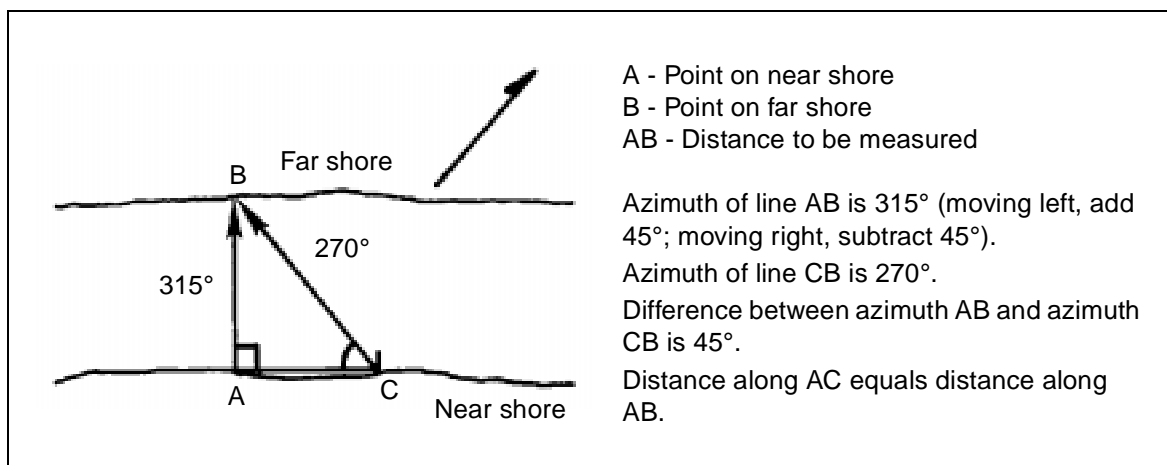

Figure 5-21. Measuring stream width with a compass

Aiming Circle, Azimuth Indicator, or Alidade

Use an aiming circle, azimuth indicator, or alidade to measure the angle between two points that are a known distance apart on the near shore and a third point directly across the river from one of these points (see Figure 5-22, page 5-26). Using trigonometric relationships, compute the distance across the stream.

Global Positioning System

Calculate the distance using two known grid points (from the GPS).

Direct Measurement

Measure short gaps with a tape measure or a dark rope that is marked and accurately measured.

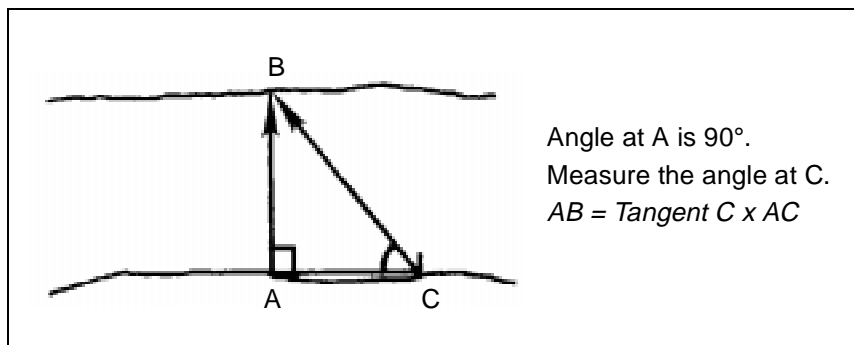

Figure 5-22. Measuring stream width with a surveying instrument

CURRENT VELOCITIES

Current velocities vary in different parts of a stream. Velocity is usually slower near the shore and faster in the main channel. Perform the following procedure to determine stream velocity:

- Measure a distance along a river bank.
- Throw a light floating object (not affected by the wind) into the stream.
- Record the time of travel it takes for the object to travel the measured distance. Repeat the procedure at least three times. Use the average time of the test in the following formula (see Figure 5-23) to determine the stream's velocity:

$$\text{Stream velocity, in meters per second} = \frac{\text{measured distance, in meters}}{\text{average time, in seconds}}$$

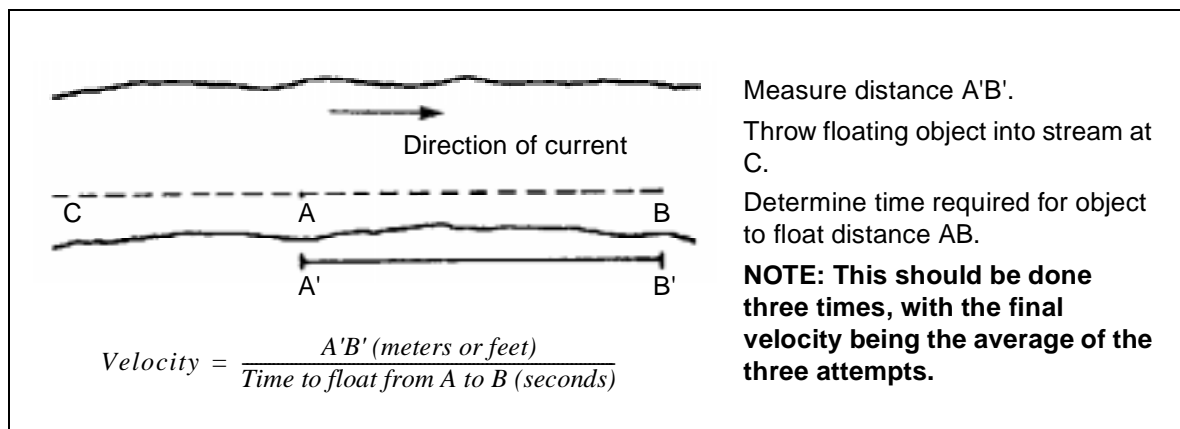

Figure 5-23. Finding stream velocity

STREAM APPROACHES

Gently sloping stream approaches are desirable for fording and swimming operations. Slope is expressed in percent. Ensure that the slope-climbing capability is considered for the vehicles that are expected to ford/swim the stream. This information is found on the vehicle's data plate or dash plate or

in the vehicle's technical manual (TM). When considering slope-climbing capability, consider the degrading effects of weather, the condition of the vehicle's tires or tracks, and the condition of the ground surface of both sides of the stream. When bank improvements are necessary, include the amount and type of work on DA Form 1711-R. See Appendix D for further details on engineer reconnaissance and DA Form 1711-R. A blank DA Form 1711-R is provided at the back of this publication; it can be locally reproduced on 8 1/2-by 11-inch paper.

Consider and avoid the following obstacles during stream-crossing operations:

- High, vertical banks.
- Mines and booby traps that are located at the entrance and exit or at likely approaches, submerged, or attached to poles and floating logs.
- Debris and floating objects such as logs and brush, poles, or floating logs with wire attached (which will foul propellers and suspension systems).
- Ice crusts.

FORDS

A ford is a location in a water barrier where the current, bottom, and approaches allow personnel and vehicles and other equipment to cross and remain in contact with the bottom during crossing. Fords are obstructions to traffic flow and are shown by the abbreviation "OB" in the route-classification formula (detailed information is recorded on DA Form 1251).

During high-water periods, low-water bridges are easily confused with paved fords because both are completely submerged. It is important to know the difference between this type of bridge and a paved ford because of corresponding military load limitations.

Fords are classified according to their crossing potential (or trafficability) for pedestrians or vehicles. Fordable depths for vehicular traffic can be increased by suitable waterproofing and adding deep-water fording kits. These kits permit fording depths up to an average of 4.3 meters. Check vehicle TMs for further fording information.

Record the composition of the approaches. They may be paved or covered with mat or trackway, but they are usually unimproved. The composition and the slope of the approaches to a ford should be carefully noted to determine the trafficability after fording vehicles saturate the surface material of the approaches. Identify the ford's left and right approaches when looking downstream.

Record the current velocity and the presence of debris to determine their effect, if any, on the ford's condition and passability. Estimate the current as—

- Swift (more than 1.5 meters per second).
- Moderate (1 to 1.5 meters per second).
- Slow (less than 1 meter per second).

The ford's stream-bottom composition largely determines its trafficability. It is important to determine whether the bottom is composed of sand, gravel, silt, clay, or rock and in what proportions. Record whether the ford's natural river bottom has been improved to increase the load-bearing capacity or to reduce the water depth. Improved fords may have gravel, macadam, or concrete surfacing; layers of sandbags; metal screening or matting; or timber (corduroy) planking. Note if there is material nearby that may be used to improve the ford. Record limited ford information (such as the following) on maps or overlays using a symbol as shown in Figure 5-24.

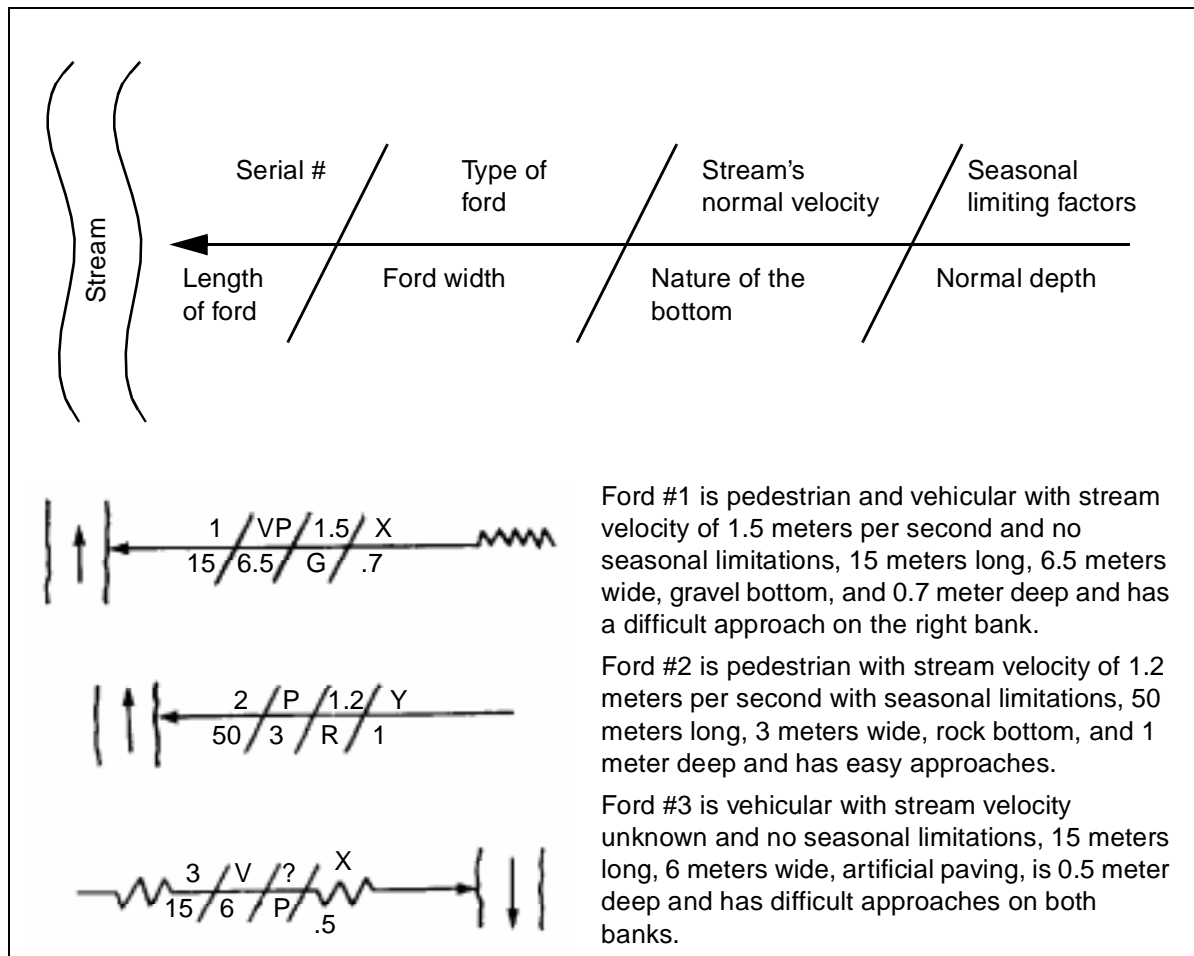

Figure 5-24. Ford symbols

- The ford's geographic location is shown by an arrow from the symbol to the ford location on a map or overlay. The symbol is drawn on either side of the stream.
- A serial number is assigned to each ford for reference (if the map sheet has a preassigned serial number, use it). Follow the unit's SOP in assigning serial numbers. They must not be duplicated within any one map sheet, overlay, or document.

- The type of ford is determined by bottom conditions, width, and water depth. Use the letters “V” for vehicular or “P” for pedestrian to show the ford type. Approaches are not considered in determining the ford type.
- The stream’s normal velocity is expressed in meters per second. Seasonal limiting factors follow the stream-velocity notation and are shown by the letters—
 - X = no seasonal limitations except for sudden flooding of limited duration (such as flash floods).
 - Y = serious, regular, or recurrent flooding or snow blockage.
NOTE: If the Y symbol is used, the route type in the route-classification formula automatically becomes type Z.
- The length of the ford, expressed in meters, is the distance from the near to far shores. The width of the ford is the traveled-way width of the ford’s bottom.
- The nature of the bottom is indicated by the most appropriate letter symbol:
 - M = mud.
 - C = clay.
 - S = sand.
 - G = gravel.
 - R = rock.
 - P = artificial paving.
- The normal depth is the depth of water at the deepest point, expressed in meters. During a hasty recon, the actual water depth is used.
- A stream’s left and right banks are found by looking downstream. Imagine yourself in the middle of the stream and looking downstream. Your left arm would indicate the left bank and the right arm the right bank. In drawing this portion of the symbol, pay attention to the direction of the stream flow. A difficult approach is shown by irregular lines placed on the corresponding side of the basic symbol.

All elements of the ford symbol are separated by slashes. If you do not know or cannot determine any item of the ford symbol, substitute a question mark for the required information. (Record ford information on DA Form 1251. See Figures 5-25 and 5-26, pages 5-30 and 5-31.)

UNDERWATER RECON

In deeper water, divers may have to determine bottom conditions. Diving teams trained and equipped for underwater recons select deep-water fording sites. When the divers cannot easily span the distance between banks, inflatable combat rubber recon craft or bridge-erection boats enter the water at a selected entrance and drop off teams at regular intervals. Unless the area is under enemy fire or observation, the craft remain in the water during the

FORD RECONNAISSANCE REPORT					DATE	
For use of this form, see FM 5-36, the predecessor agency's TRADOC					29 Aug 84	
TO: (Reconnaissance crossing reconnaissance)				FROM: (Name, grade and unit of reconnaissance officer)		
Cdr, ATTN: S-2, 21st Engr Bn				Ronald Perrin RONALD PERRIN, SFC, Co A, 21st Engr Bn		
1. ROUTE NUMBER	2. FROM (Initial Point)	3. TO (Terminal Point)	4. DATE/TIME (24 signature)			
Virg. 617	UT 122864	UT 097899	291800 Aug 84			
5. MAP SERIES NUMBER	6. SHEET NUMBER	7. GRID REFERENCE		8. FORD NUMBER		
V 734	5561 III	TYPE 1:50,000	COORDINATES UT 100886	1		
9. LOCATION FROM NEAREST TOWN						
DISTANCE	DIRECTION	NAME OF NEAREST TOWN		10. CROSSING (Name of stream or other body of water)		
14 Km	SE	Ft. Belvoir, VA		Accotink Creek		
11. CHARACTERISTICS OF CROSSING						
WATER LEVELS	WIDTH	DEPTH	VELOCITY	DATE	SEASON OR MONTH(S)	
TODAY	7.3 m	.5 m	1.5 m/sec	29 Aug 84		
LOP	6.1 m	.3 m	1.1 m/sec	14 Jun 80		
MEAN	7.3 m	.5 m	2.0 m/sec			
HIGH	8.4 m	1.8 m	2.2 m/sec			
12. BOTTOM			13. APPROACHES		14. SLOPE RATIO	
<input type="checkbox"/> SAND <input checked="" type="checkbox"/> GRAVEL <input type="checkbox"/> STONE <input type="checkbox"/> OTHER(S) _____			<input type="checkbox"/> FIRM <input type="checkbox"/> SOFT		3:1	
			<input checked="" type="checkbox"/> GRAVEL			
15. TYPE OF PAVEMENT		16. WIDTH	17. HAZARDS (Flesh Hooks, Culverts, etc.)			
Bituminous		9.3 m	Unknown			
18. REMARKS (Description of Approach Banks, Guide Markers, Depth Gauges, etc.)						
<p>The bottom is loose gravel, 9.2 m long, 7.3 m wide, .5 m deep, with a velocity of 1.5 m/sec. There appear to be no seasonal limitations. Approach conditions on both banks are easy. All measurements with a 100-meter tape measure. A yard stick was used to measure depth.</p>						

DA FORM 1251 JAN 84

Figure 5-25. Sample Ford Reconnaissance Report (front)

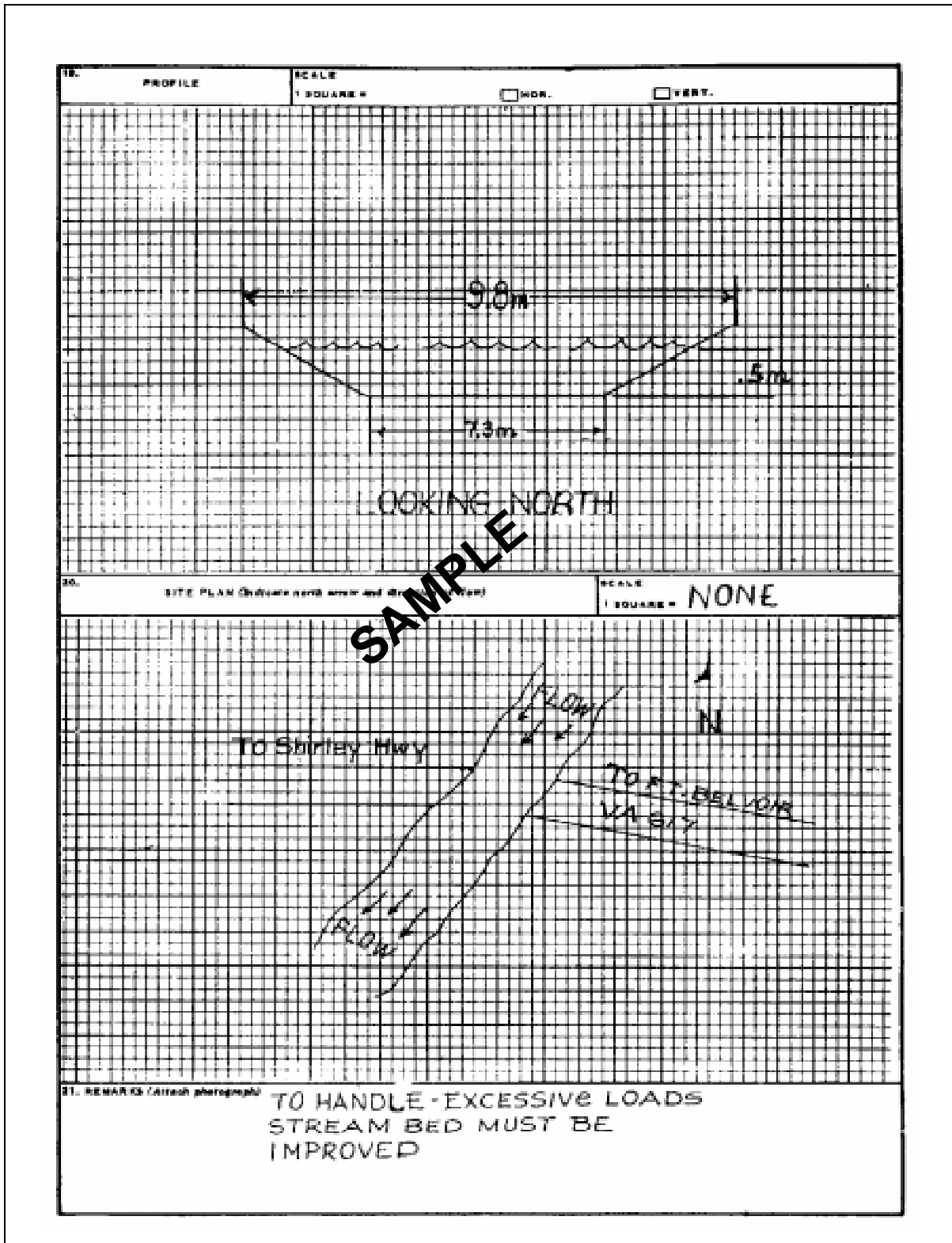

Figure 5-26. Sample Ford Reconnaissance Report (back)

recon and pick up divers when the operation is completed. Helicopters may be used to drop teams in the water or place teams on the far shore if the situation permits. Engineer light diving teams routinely conduct river recons at night.

To assist underwater recon teams in maintaining direction, weighted lines (transverse lines) may be placed across the bottom of the water obstacle. Buoys or other floating objects are attached to the lines to indicate the survey area for the underwater recon team(s). When the current is greater than 1.3 meters per second, underwater recon personnel will have difficulty maintaining a position along the line selected. To assist divers, another transverse line, parallel to the original line and with lateral lines connecting both lines, may be placed upstream.

Bottom conditions are easily determined during periods of good visibility and when the water is clear. However, under blackout conditions or when the water is murky, the recon is much slower because swimmers must feel their way across. If the tactical situation permits, diver's may use underwater lanterns.

Environmental conditions (such as depth, bottom type, tides and currents, visibility, and temperature) have an effect on divers, diving techniques, and equipment. The length of time that divers can remain underwater depends on water depth, time at depth, and equipment used. When conducting a recon in a current, swimmers expend more energy, tire more easily, and use their air supply more quickly. In water temperatures between 73° and 85°F, divers can work comfortably in their swimsuits, but will chill in one to two hours if not exercising. In water temperatures above 85°F, the divers overheat. The maximum water temperature that can be endured, even at rest, is 96°F. At temperatures below 73°F, unprotected divers will be affected by excessive heat loss and become chilled within a short period of time. In cold water, the sense of touch and the ability to work with the hands are affected. Air tanks vary in size and govern how long divers can operate. Extra tanks should be available for underwater recon teams, and the facilities to recharge equipment should be located close enough to respond to team requirements.

Units may develop a river-recon report to transmit important information about the river's location, near- and far-shore characteristics, and river characteristics. A sample report is shown in Figures 5-27 and 5-28, pages 5-33 and 5-34.

FERRY RECON

Ferries are considered obstructions to traffic flow and are indicated by the abbreviation "OB" in the route-classification formula. Ferryboat construction varies widely and ranges from expedient rafts to ocean-going vessels. Ferries differ in physical appearance and capacity depending upon the water's width, depth, and current and the characteristics of the traffic to be moved. Ferries may be propelled by oars; cable and pulleys; poles; the stream current; or steam, gasoline, or diesel engines.

CIVIL FERRIES AND FERRY SITES

Usually, the capacity of a civil ferryboat is expressed in tons and total number of passengers. In addition, it is often assigned an MLC number. Ensure that

RIVER RECONNAISSANCE REPORT						DATE
						24 Nov 97
TO: (Headquarters requesting recon)				FROM: (Name, grade and unit of recon officer)		
CDR, ATTN: SA, 536 th ENG BN				Mark G. Wilson WILSON, MARK A., SFC, A CO, 536 th ENG BN		
1. ROUTE NUMBER		2. FROM: (Initial point)		3. TO: (Terminal point)		4. DATE/TIME (of signature)
AP HILL 004		TT 945209		TT 938180		290800 NOV 97
5. MAP SERIES NUMBER		6. SHEET NUMBER		7. GRID REFERENCE		8. RECON NUMBER
V7345		5560 III		TYPE 1:50,000 COORDINATES TT 945185		1
9. LOCATION OF NEAREST TOWN					10. CROSSING (Name of river or other body of water)	
DISTANCE		DIRECTION	NAME OF NEAREST TOWN		CROSSING	
2 KM		SW	COLLINS CROSSING		CATTLET CREEK	
11. CHARACTERISTICS OF NEAR SHORE						
BANK HEIGHT		BANK SLOPE	BANK STABILITY	BANK SOIL TYPE	MINES	OBSTACLES (Type)
1.8 METERS		6%	FIRM	GRASS	NONE	NONE
SLOPE TO DEPTH OF 2 METERS		SOIL TYPE TO 2 METERS DEPTH		MINES TO DEPTH OF 2 METERS		OBSTACLES TO DEPTH OF 2 METERS
10%		SOFT MUD		NONE		NONE
12. CHARACTERISTICS OF RIVER						
GAP WIDTH		VELOCITY (m/sec)	FLOW DIRECTION	BOTTOM COMPOSITION (Mud, sand, gravel/hard packed or soft)		
143 METERS		1.5 MPS	SW	¼ GAP SOFT MUD ½ GAP SOFT MUD ¾ GAP SOFT MUD		
MAX DEPTH			ANCHORAGE SUITABILITY (Describe)		OBSTACLES	
¼ GAP 12' ½ GAP 18' ¾ GAP 10'			VERY GOOD / RECOMMEND USING KEDGE ANCHORS		NONE	
13. CHARACTERISTICS OF FAR SHORE						
BANK HEIGHT		BANK SLOPE	BANK STABILITY	BANK SOIL TYPE	MINES	OBSTACLES
.8 METERS		9%	FIRM	GRASS	NONE	NONE
SLOPE TO DEPTH OF 2 METERS		SOIL TYPE TO DEPTH OF 2 METERS		MINES TO DEPTH OF 2 METERS		OBSTACLES TO DEPTH OF 2 METERS
9%		SOFT MUD		NONE		STUMP LOCATED AT 3'
REMARKS: (Description of far- and near-shore approaches/assembly areas/ available cover and concealment/ overall assessment of crossing-site potential, potential for freezing over or flooding)						
- NEAR-SHORE APPROACH IS APPROX 150 METERS WIDE WITH FIRM SOIL AND GRASS BUT NO OVERHEAD COVER.						
- FAR-SHORE APPROACH IS APPROX 80 METERS WIDE WITH FIRM SOIL AND GRASS. NOTE: STUMP LOCATED AT 3' MEASURING 26 INCHES IN DIAMETER. STUMP NEEDS TO BE REMOVED BEFORE FAR SHORE CAN BE UTILIZED.						
- CROSSING SITE HAS NO HISTORY OF FLOODING, BUT HAS POTENTIAL FOR FREEZING OVER IN LATE JANUARY THRU MARCH.						

Figure 5-27. Sample River Reconnaissance Report (front)

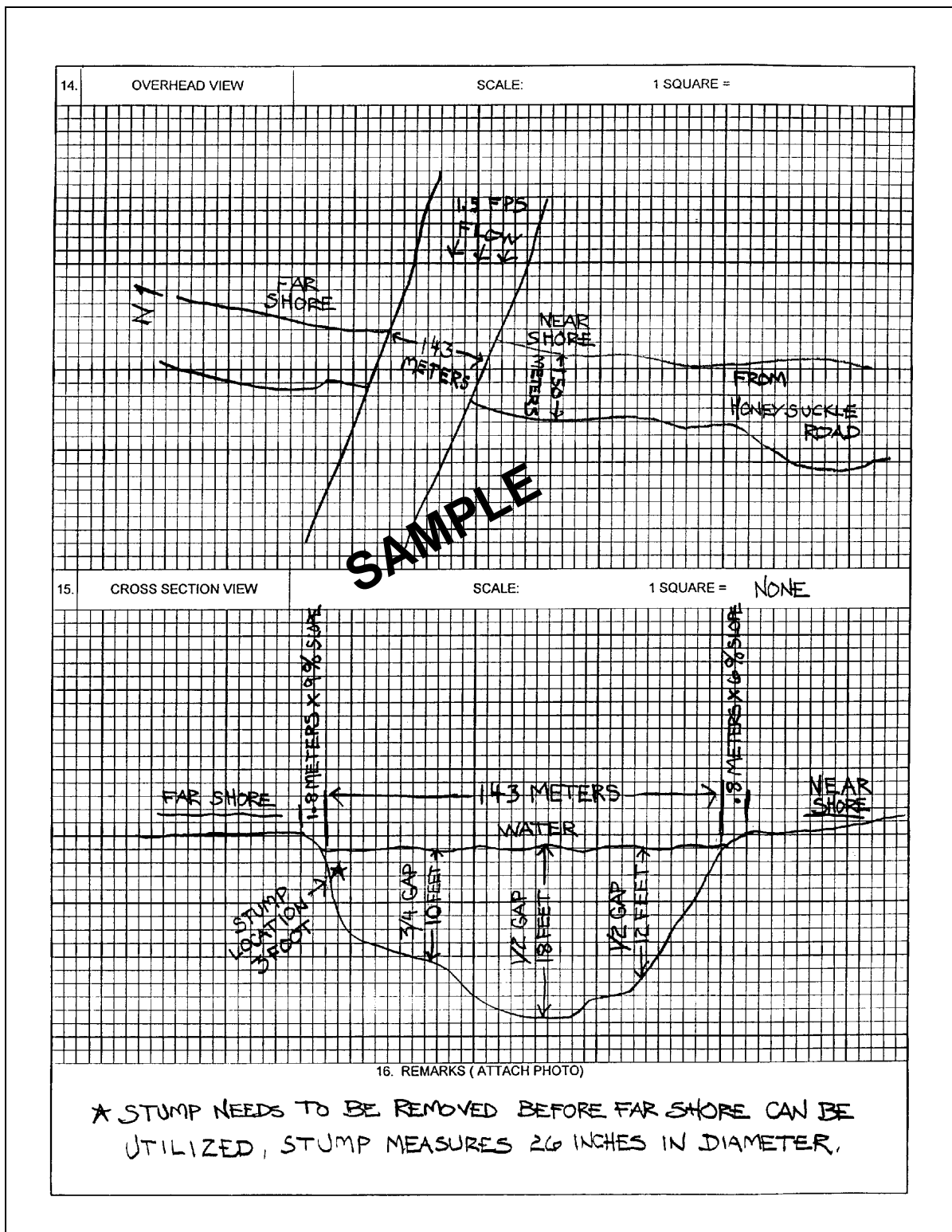

Figure 5-28. Sample River Reconnaissance Report (back)

you record the capacity of each ferry when more than one is used at a given site. The ferries may vary in capacity.

Ferry slips (or piers) are usually provided on each shore to permit easy loading of passengers, cargo, and vehicles. The slips may range from simple log piers to elaborate terminal buildings. A distinguishing characteristic of a ferry slip is often the floating pier that adjusts, with changes in the water depth, to the height of the ferryboat.

Approach routes to ferry installations have an important bearing on using the ferry. Reconning and recording the conditions of the approaches (including the load-carrying capacity of landing facilities) is very important.

Limiting characteristics of ferry sites that should be considered are the—

- Width of the water barrier from bank to bank.
- Distance and time required for the ferryboat to travel from one bank to the other.
- Depth of the water at each ferry slip.
- Ease in which each landing site can be defended.

Climatic conditions affect ferry operations. Fog and ice substantially reduce the total traffic-moving capacity and increase the hazard of the water route. Therefore, you must consider data on tide fluctuations, freezing periods, floods, excessive dry spells, and their effects on ferry operations.

FERRY INFORMATION

Record limited ferry information (such as the following) on maps or overlays by using the symbol shown in Figure 5-29. Figure 5-30, page 5-36, gives examples of completed ferry symbols.

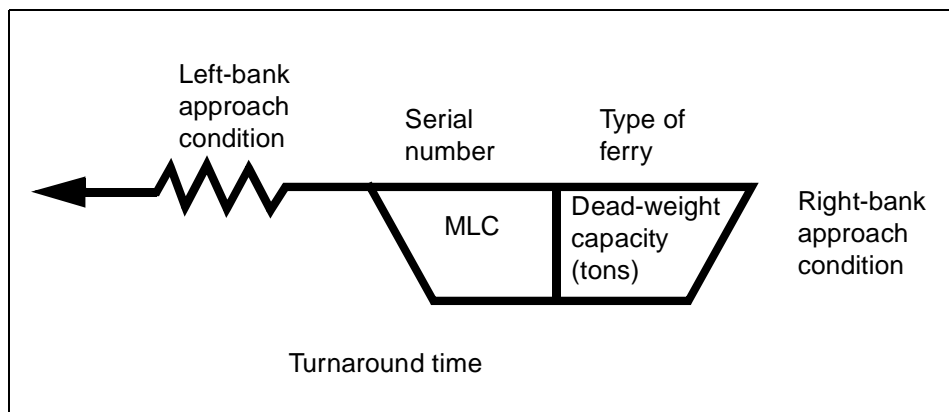

Figure 5-29. Ferry symbol

- The geographic location of the ferry is shown by an arrow from the symbol to the location of the ferry on a map or overlay. The symbol may be drawn on the map or overlay on either side of the stream.
- A serial number is assigned to each ferry, for later reference. Numbers must not be duplicated within any one map sheet, overlay, or

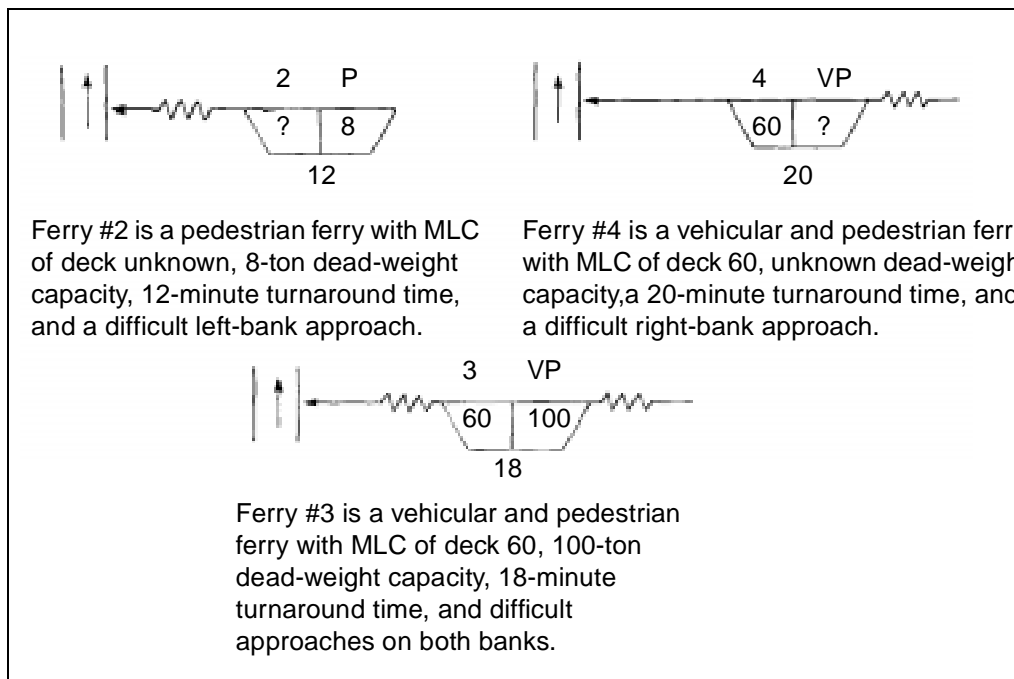

Figure 5-30. Sample ferry symbols

document. Some maps will already show a ferry serial number. Use this number for your recon. If you do not find a number, record a number according to the unit's SOP.

- The type of ferry (V for vehicular and P for pedestrian) is shown after the serial number. If the ferry can haul vehicles, it can also haul pedestrians.
- The deck's MLC is placed in the bottom left box of the symbol. Most ferries have this information on their data plate.
- The dead-weight capacity of the ferry is the MLC plus the actual weight of the ferry, in short tons.
- The turnaround time is shown by the number of minutes required to cross the water obstacle, unload, and return.

When drawing the approach-condition portion of the symbol, pay attention to the direction of stream flow. Left and right banks are determined by looking downstream. Approach conditions are determined in the same manner as for fords. A difficult approach is shown by irregular lines placed on the corresponding side of the basic symbol.

A question mark is substituted for unknown or undetermined information. Detailed ferry recon information is recorded on DA Form 1252 (see Figures 5-31 and 5-32, pages 5-37 and 5-38).

MILITARY FERRY AND RAFTING

Recon personnel will be required to locate and report suitable sites for military rafting or ferrying operations. Military floating bridges are presently available for such operations. Desirable site characteristics are—

FERRY RECONNAISSANCE REPORT										DATE 18 Aug 84	
To: (Headquarters ordering reconnaissance)										FROM: (Name, grade, and unit of reconnaissance officer)	
Cdr, ATTN: S-2, 21st Eng Bn										H. Z. Dugan M.L. DUGAN, SFC, CoA, 21st Eng Bn	
1. HIGHWAY		ROUTE OR LINE		2. FROM (Origin Point)		3. TO (Terminal Point)		4. DATE/TIME (Of signature)			
VA 617		NA		Lorton, VA		Hoby, MD		181900 Aug 84			
5. MAP SERIES NR		6. SHEET NUMBER		7. GRID REFERENCE		8. FERRY NR		9. CLASS			
V 734		5661 III		1:50,000 UT 134830		1		45			
10. LOCATION FROM NEAREST TOWN										11. CROSSING ORIGIN OR SOURCE OF BODY OF WATER	
DISTANCE		DIRECTION		NAME OF NEAREST TOWN		Potomac River					
8 km		East		Lorton, VA							
12. LIMITING FEATURE (Condition of season, tides, clouds, low water, freezing, tides etc.) (Seasons and Dates)											
River freezes in winter months											
13. WATER LEVELS (Depth)						14. CROSSING TIME		15. LENGTH			
LOW		MEAN		HIGH		20 minutes		1 Km			
3.2 m		4.7 m		7.6 m							
16. VESSEL FEATURES (Attach photographs)											
UNITS	CONSTRUCTION TYPE	PROPULSION METHOD			LENGTH	BEAM	DRAFT	TONNAGE		CAPACITY	
		TYPE	UNITS	HP				GROSS	NET	PASS	VEHICLE
2	Open	Diase	2	610	22.5m	1.6m	1.6m	85	85	200	Maximum NA
17. TERNAL FEATURES											
DIRECTION OF BANK	NAME	SLIP			DOCKING FACILITIES	APPROACHES					
		WIDTH	DEPTH	CAPACITY		HIGHWAY		RAILROAD			
N E S W	Little Reno	13.2m	3m	1	Good	Asphalt	2	45	NA	NA	
N E S W	Angels Point	4m	4m	1	Good	Concrete	2	55	NA	NA	
18. REMARKS (Amplify above details. Note obstructions, navigational and other pertinent data)											
Anchorage shows on back uses 30.5 cm piles, spaced approximately 10 meters, center to center											

DA FORM 1252 1 JAN 84

Figure 5-31. Sample Ferry Reconnaissance Report (front)

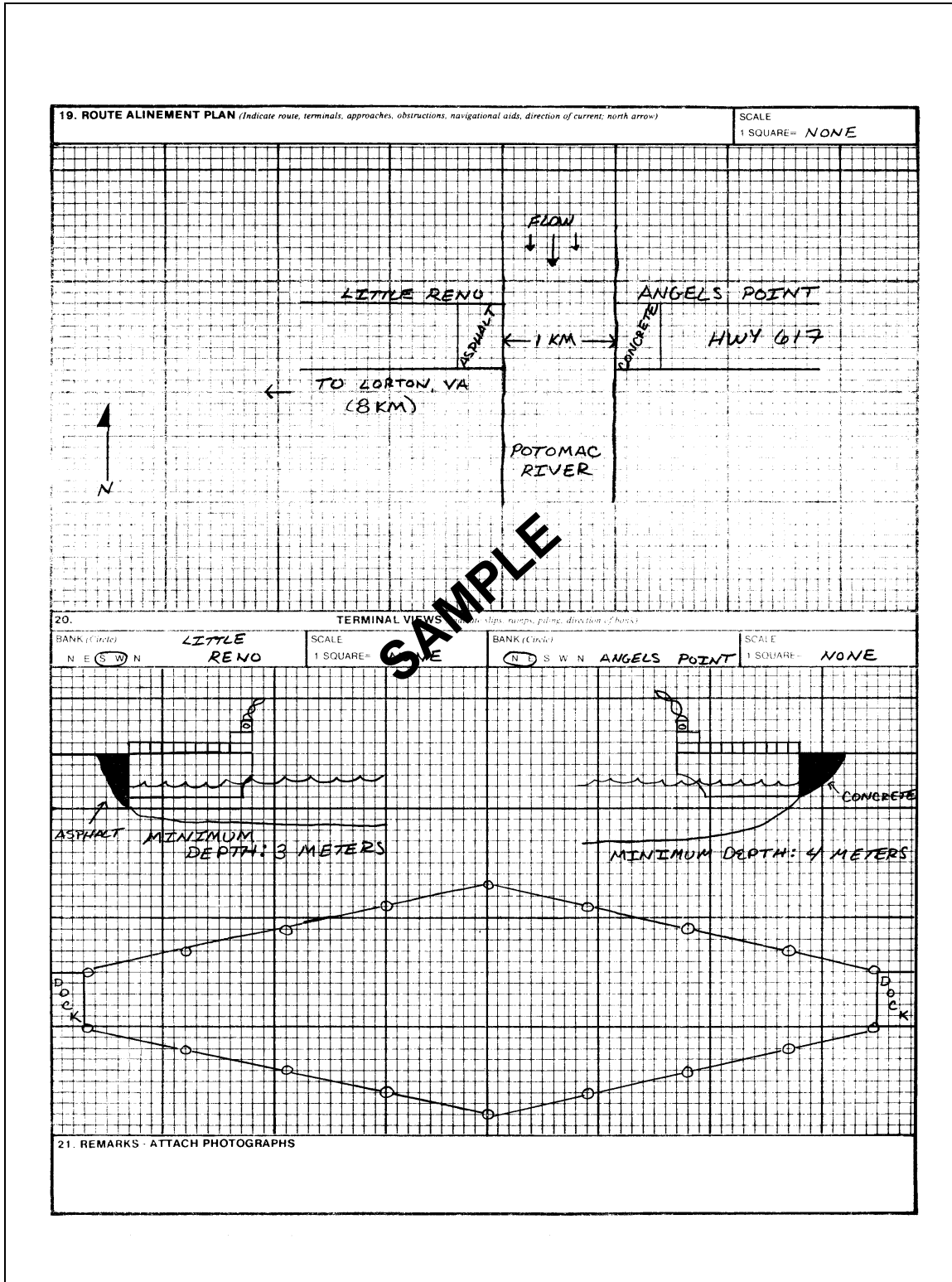

Figure 5-32. Sample Ferry Reconnaissance Report (back)

- Current velocity between 0 and 1.6 meters per second.
- Banks that permit loading without a great deal of preparation.
- Approaches that permit easy access and egress.
- Strong, natural holdfasts.
- Sites with no shoals, sandbars, or snags.
- Sites clear of obstacles immediately downstream.
- Sites clear of mines and booby traps.
- Sites with enough depth to prevent grounding the raft or ferry during loading and unloading operations or when crossing.
- Suitable raft-construction sites (dependent on type of raft).
- Holding areas for vehicles awaiting passage.
- A suitable road network to support crossing traffic.

NOTE: Refer to FM 90-13 for rafting operations.

ROAD RECON PROCEDURE

Perform a technical road recon to determine the traffic capabilities of a road within a route. In general, a road consists of a road surface, base course, and subgrade (see Figure 5-33).

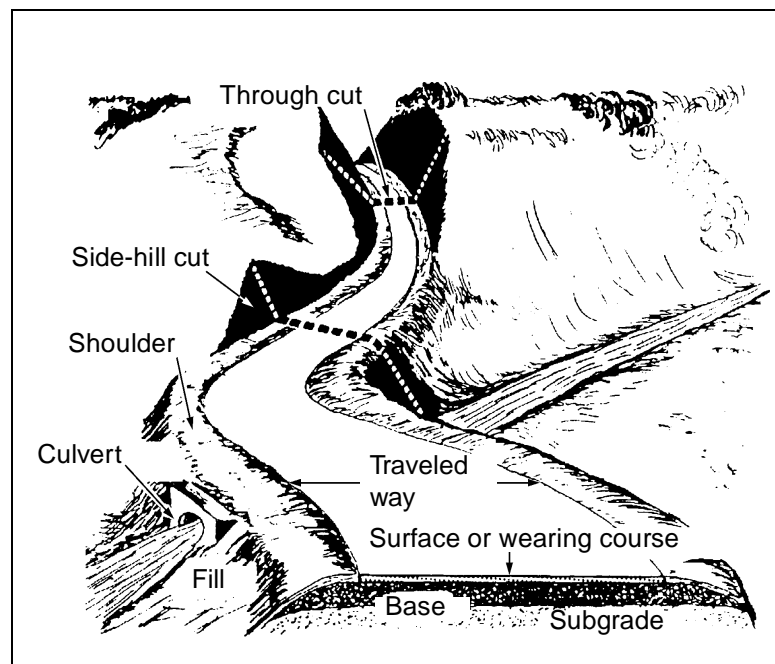

Figure 5-33. Parts of a road

BASE COURSE AND SUBGRADE

The base course and subgrade are the intermediate fill. They are usually composed of gravel or crushed rock. Soils may form the subgrade. See Tables 5-3 and 5-4, pages 5-40 through 5-42.

Table 5-3. Soil characteristics of roads and airfields

Major Divisions		Letter	Name	Field CBR	
Coarse-grained soils	Gravel and gravelly soils	GW	Well-graded gravels or gravel-sand mixtures, little or no fines	60-80	
		GP	Poorly graded gravels or gravel-sand mixtures, little or no fines	25-60	
		GM	d ¹	Silty gravels, gravel-sand-silt mixtures	40-80
			u ²		20-40
		GC	Clayey gravels, gravel-sand-clay mixtures	20-40	
	Sand and sandy soils	SW	Well-graded sands or gravelly sands, little or no fines	20-40	
		SP	Poorly graded sands or gravelly sands, little or no fines	10-25	
		SM	d ¹	Silty sands, sand-silt mixtures	20-40
			u ²		10-20
		SC	Clayey sands, sand-clay mixtures	10-20	
Fine-grained soils	Silts and clays (liquid limits <50)	ML	Inorganic silts and very fine sands, rock flour, silty or clayey fine sands, or clayey silts with slight plasticity	5-15	
		CL	Inorganic clays of low to medium plasticity, gravelly clays, sandy clays, silty clays, lean clays	5-15	
		OL	Organic silts and organic silt-clays of low plasticity	4-8	
	Silts and clays (liquid limits >50)	MH	Inorganic silts, micaceous or diatomaceous fine sandy or silty soils, elastic silts	4-8	
		CH	Inorganic clays of high plasticity, fat clays	3-5	
		OH	Organic clays of medium to high plasticity, organic silts	3-5	
	Highly organic soils	Pt	Peat and other highly organic soils		
¹ Indicates liquid limit is 28 or less, and plasticity index is 6 or less. ² Indicates liquid limit is 28 or greater.					

Table 5-3. Soil characteristics of roads and airfields (continued)

Letter		Value as Foundation When Not Subject to Frost Action ³	Value as Base Directly Under Bituminous Pavement	Potential Frost Action ⁴	Compressibility and Expansion	Drainage Characteristics
GW		Excellent	Good	None to very slight	Almost none	Excellent
GP		Good to excellent	Poor to fair	None to very slight	Almost none	Excellent
GM	d ¹	Good to excellent	Fair to good	Slight to medium	Very slight	Fair to poor
	u ²	Good	Poor	Slight to medium	Slight	Poor to practically impervious
GC		Good	Poor	Slight to medium	Slight	Poor to practically impervious
SW		Good	Poor	None to very slight	Almost none	Excellent
SP		Fair to good	Poor to not suitable	None to very slight	Almost none	Excellent
SM	d ¹	Good	Poor	Slight to high	Very slight	Fair to poor
	u ²	Fair to good	Not suitable	Slight to high	Slight to medium	Poor to practically impervious
SC		Fair to good	Not suitable	Slight to high	Slight to medium	Poor to practically impervious
ML		Fair to poor	Not suitable	Medium to very high	Slight to medium	Fair to poor
CL		Fair to poor	Not suitable	Medium to high	Medium	Practically impervious
OL		Poor	Not suitable	Medium to high	Medium to high	Poor
MH		Poor	Not suitable	Medium to high	High	Fair to poor
CH		Poor to very poor	Not suitable	Medium	High	Practically impervious
OH		Poor to very poor	Not suitable	Medium	High	Practically impervious
Pt		Not suitable	Not suitable	Slight	Very high	Fair to poor

³Values are for subgrades and base courses except for base courses under bituminous pavement.

⁴Indicates whether these soils are susceptible to frost.

Table 5-4. Principal soil types

Name	Description
Gravel	A mass of detached rock particles, generally waterworn, which passes a 3-inch sieve and is retained on a No. 4 sieve (0.187 inches).
Sand	Granular material composed of rock particles which pass a No. 4 sieve (0.187 inches) and are retained on a No. 200 sieve (0.0029 inches). It is difficult to distinguish sand from silt when the particles are uniformly small. Dried sand, however, differs from silt in that it has no cohesion and feels grittier.
Silt	A fine, granular material composed of particles which pass the No. 200 sieve (0.0029 inches). It lacks plasticity and has little dry strength. To identify, prepare a pat of wet soil and shake it horizontally in the palm of the hand. With typical inorganic silt, the shaking action causes water to come to the surface of the sample, making it appear glossy and soft. Repeat tests with varying moisture contents. Squeezing the sample between the fingers causes the water to disappear from the surface and the sample quickly stiffens and finally cracks or crumbles. Allow sample to dry, test its cohesion, and feel by crumbling with the fingers. Typical silt shows little or no dry strength and feels only slightly gritty in contrast to the rough grittiness of fine sand.
Clay	Extremely fine-grained material composed of particles which pass the No. 200 sieve (0.0029 inches). To identify, work a sample with the fingers, adding water when stiffness requires. Moist sample is plastic enough to be kneaded like dough. Test further by rolling ball of kneaded soil between palm of hand and a flat surface. Clay can be rolled to a slender thread, about 1/4 inch in diameter, without crumbling; silt crumbles, without forming a thread. Measure hardness of dry clay by finger pressure required to break a sample. It requires much greater force to break dry clay than dry silt. Clay feels smooth in contrast to the slight grittiness of silt.
Organic	Soil composed of decayed or decaying vegetation, sometimes mixed with fine-grained mineral sediments such as peat or muskeg. It is identified by coarse and fibrous appearance and odor. Odor may be intensified by heating. Plastic soils containing organic material can be rolled into soft, spongy threads.

ROAD-CAPACITY COMPUTATIONS

The charts that follow will help give you an accurate estimation of the load-bearing capacity of a road with flexible pavement. Tables 5-3 (pages 5-40 and 5-41), 5-4 (page 5-42), and 5-5 and Figure 5-34 (page 5-44) will help determine the road's load-bearing capacity. The load-bearing capacity of a road for wheeled vehicles is made by measuring the thickness of the surface and base course and by determining the type of subgrade material.

Table 5-5. Maximum axle and wheel loads for wheeled vehicles

Hypothetical Vehicle Class Number	Maximum Single-Axle Load (in tons)	Maximum Single-Wheel Load (in pounds x 1,000)
4	2.5	2.5
8	5.5	5.5
12	8.0	8.0
16	10.0	10.0
20	11.0	11.0
24	12.0	12.0
30	13.5	13.5
40	17.0	17.0
50	20.0	20.0
60	23.0	20.0
70	25.5	20.0
80	28.0	20.0
90	30.0	20.0
100	32.0	20.0
120	36.0	20.0
150	42.0	21.0

ROAD-CLASSIFICATION FORMULA

The road-classification formula is a systematic way of describing the worst section of a road. Do not confuse it with the route-classification formula. Recorded information from the road-classification formula is included in the route-classification formula. The following paragraphs describe each portion of the formula shown below:

$$B \ g \ s \ 4 / 5 \ r \ (8 \ km) \ (OB) \ (T)$$

(1) (2) (3) (4) (5) (6)

(1) Limiting characteristics. Prefix the formula with "A" if there are no limiting characteristics and "B" if there are one or more limiting characteristics. Represent an unknown or undetermined characteristic by a question mark, together with the feature to which it refers. In the example above, the letter *g* indicates steep gradients and the letter *s* indicates a rough surface (see Table 5-6, page 5-44).

(2) Minimum traveled-way width. Express this width in meters followed by a slash and the combined width of the traveled way and the shoulders. In the example above, the minimum traveled way is 4 meters and the combined width is 5 meters.

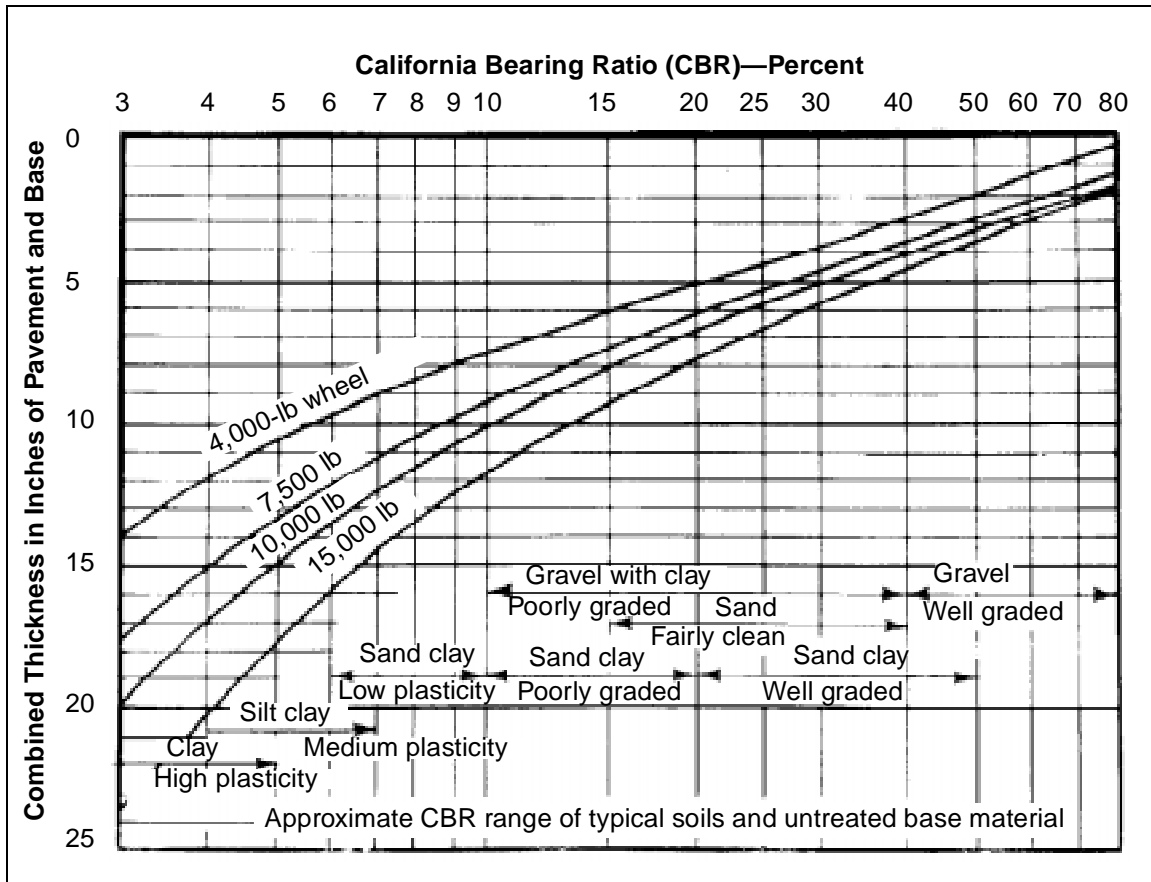

Figure 5-34. Load-bearing capacity of roads with a flexible surface

Table 5-6. Symbols for limiting characteristics

Limiting Characteristics	Criteria	Symbol
Sharp curves	Sharp curves with radius of 25 meters and less (82 ft); are also reported as obstructions	c
Steep gradients	Steep gradients, 7 percent or steeper; such gradients are also reported as obstructions	g
Poor drainage	Inadequate ditches, crown or camber, or culverts; culverts and ditches blocked or otherwise in poor condition	d
Weak foundation	Unstable, loose, or easily displaced material	f
Rough surface	Bumpy, rutted, or potholed to an extent likely to reduce convoy speeds	s
Excessive camber or superelevation	Falling away so sharply as to cause heavy vehicles to skid or drag toward shoulders	j

(3) Road-surface material. Express this with a letter symbol. The formula above describes the surface material as *r*; meaning water-bound macadam. Use the symbols listed in Table 5-7; they are further related to the X, Y, and Z route types of the route classification described earlier in route-recon procedures.

Table 5-7. Symbols for type of surface materials

Symbol	Material	Route Type
k	Concrete	Type X; generally heavy duty
kb	Bituminous (asphaltic) concrete (bituminous plant mix)	Type X; generally heavy duty
p	Paving brick or stone	Type X or Y; generally heavy duty
pb	Bituminous surface on paving brick or stone	Type X or Y; generally heavy duty
rb	Bitumen-penetrated macadam, water-bound macadam with superficial asphalt or tar cover	Type X or Y; generally medium duty
r	Water-bound macadam, crushed rock or coral or stabilized gravel	Type Y; generally light duty
l	Gravel or lightly metaled surface	Type Y; generally light duty
nb	Bituminous surface treatment on natural earth, stabilized soil, sand-clay, or other select material	Type Y or Z; generally light duty
b	Used when type of bituminous construction cannot be determined	Type Y or Z; generally light duty
n	Natural earth stabilized soil, sand-clay, shell, cinders, disintegrated granite, or other select material	Type Z; generally light duty
v	Various other types not mentioned above	Classify X, Y, or Z depending on the type of material used (indicate length when this symbol is used).

(4) Road length. Express the road length in kilometers and place in parentheses.

(5) Obstructions. Indicate any obstructions along a road by placing the symbol "OB" after the road length, as shown in the example above. Details of the obstructions are not shown in the formula; they are reported separately by appropriate symbols on accompanying maps or overlays or on DA Form 1248. Report the following obstructions:

- Overhead obstructions (less than 4.3 meters over the route).
- Constrictions in traveled-way widths less than 6 meters for single-flow traffic or less than 8 meters for double-flow traffic (tracked or combination vehicles [see Table 5-1, page 5-5]).
- Slopes of 7 percent or greater.
- Curves with a radius of less than 25 meters (report curves of 25.1 to 45 meters).

(6) Blockage. If blockage is regular, recurrent, and serious, then the effects of snow blockage and flooding are indicated in the road-classification

formula. The symbol for snow blockage is “T” and the symbol for frequent flooding is “W.”

EXAMPLES OF THE ROAD-CLASSIFICATION FORMULA

A sample Road Reconnaissance Report is shown in Figures 5-35 and 5-36, pages 5-47 and 5-48. The following are examples of the road-classification formula:

- **A 5.0/6.2k**—road with no limiting characteristics or obstructions, a minimum traveled way of 5.0 meters, a combined width of traveled way and shoulders of 6.2 meters, and a concrete surface.
- **B g s 4/5 1 (OB)**—road with limiting characteristics of steep gradients and a rough surface, a minimum traveled way of 4 meters, a combined width of 5 meters, gravel or lightly metaled surfaces, and obstructions.
- **B c (f?) 3.2/4.8 p (4.3km) (OB) (T)**—road with limiting characteristics of sharp curves and unknown foundation, a minimum traveled way of 3.2 meters, a combined width of 4.8 meters, paving brick or stone surface, obstructions and that is 4.3 kilometers long subject to snow blockage.

NOTES:

- 1. Where rock slides are a hazard or poor drainage is a problem, include information on a written enclosure or legend.**
- 2. DA Form 1248 is primarily self-explanatory. However, ensure that a new classification formula is entered each time the road changes significantly, as depicted in Figure 5-36.**

BRIDGE-CLASSIFICATION RECON

A bridge recon must take place to ensure that commanders know what bridge load-carrying capabilities are along a certain route or what material is needed to destroy a bridge. Engineers are responsible for reconning all bridges.

REQUIRED BRIDGE INFORMATION FOR CLASSIFICATION PROCEDURES

This manual reviews the basics of hasty bridge load-classification procedures and recon procedures for bridge destruction. Appendix B references hasty bridge classification. (Refer to FM 5-446 for a complete discussion of bridge-classification procedures.) The Sheffield Method for bridge destruction is discussed in FM 5-250.

The method of bridge load classification covered in Appendix B is adequate for most bridge recons. It allows vehicle operators to avoid bridge failure by determining what can cross the bridge without causing damage. Vehicle operators may cross without restrictions if their vehicle's load class (including the load) is less than or equal to the bridge's load class. The vehicle's load class can be found in the vehicle's TM.

ROAD RECONNAISSANCE REPORT		DATE: 29 Aug 84	
Purpose of this form: (See FM 5-26, paragraph 3 under 1. TRACOC.)			
TO: (Recipient's name and organization)		FROM: (Name, grade and unit of officer or 2LJ conducting reconnaissance)	
Cdr, ATTN: S-2, 21st Eng. Bn		D. Mooneyhan D. MOONEYHAN, SFC, CA, 21st Eng. Bn	
1. AREA	2. COUNTY	3. SCALE	4. SHEET NUMBER OF MAP
FT. Belvoir	Special	1:50,000	AMS 7733
5. RECONNAISSANCE DATE		6. DETECTED OBSCURE (All altitudes)	
29 Aug 84		Sheet 5561 II 291430 Aug 84	
SECTION I - GENERAL ROAD INFORMATION			
7. ROAD GRID REFERENCE		8. ROAD MARKING (Location of military number of road)	
FROM: UT 122864 TO: UT 097999		Virginia Route 617	
9. WIDTH OF ROADWAY (Foot or meters, include)		10. WEATHER DURING RECONNAISSANCE (Include barometer, if known)	
6.7m to 9.3m		Fair - Temp 79° Last Rain fall - 15 Aug 84	
11. RECONNAISSANCE DATE		12. TIME	
29 Aug 84		0615	
SECTION II - DETAILED ROAD INFORMATION (When reconnaissance permit more detailed information will be shown in an overlay or on the mileage sheet on the reverse side of this form. Standard symbols will be used.)			
13. ALIGNMENT (Check one ONLY)		14. DRAINAGE (Check one ONLY)	
<input type="checkbox"/> (1) FLAT GRADIENTS AND EASY CURVES <input type="checkbox"/> (2) STEEP GRADIENTS (Steepest of 7 to 10%) <input type="checkbox"/> (3) SHARP CURVES (Radius less than 100 m (300 ft)) <input checked="" type="checkbox"/> (4) STEEP GRADIENTS AND SHARP CURVES		<input type="checkbox"/> (1) ADEQUATE DITCHES (Mechanically with adequate culverts in 6000 cubic m) <input type="checkbox"/> (2) INADEQUATE DITCHES (Mechanically with inadequate culverts, its culverts or ditches are blocked or otherwise in poor condition)	
15. FOUNDATION		16. SURFACE (Check one ONLY)	
<input checked="" type="checkbox"/> (1) STABILIZED COMPACT MATERIAL OR ROAD GRADE		<input type="checkbox"/> (1) UNSTABLE, LOOSE OR SANDY DISPLACED MATERIAL	
SECTION III - OBSTRUCTIONS (List in the columns below particulars of the following observations which affect the travel capacity of a road. If information of any factor cannot be determined, insert "NOT KNOWN")			
(a) Obstructions to road width, less than 12 feet or 4.27 meters, such as buildings, bridges, overhead wires and overhanging buildings.			
(b) Reductions in road width which limit the traffic capacity, such as curves, narrow bridges, overhangs, and buildings.			
(c) Excessive gradients (steeper than 10%)			
(d) Curves (less than 100 feet (30 meters) in radius)			
(e) Other:			
17. SERIAL NUMBER	18. PARTICULARS	19. GRID REFERENCE	20. REMARKS
	Steep Grade - 8%	UT 119872	200m Long
	Sharp Curve	UT 112877	Radius 21m
	Constriction	UT 112878	6.7m wide, 300m long
	Constriction	UT 105896	7m wide, 100m long

DA FORM 1248

PREVIOUS EDITIONS
THIS FORM IS OBSOLETE

Figure 5-35. Sample Road Reconnaissance Report (front)

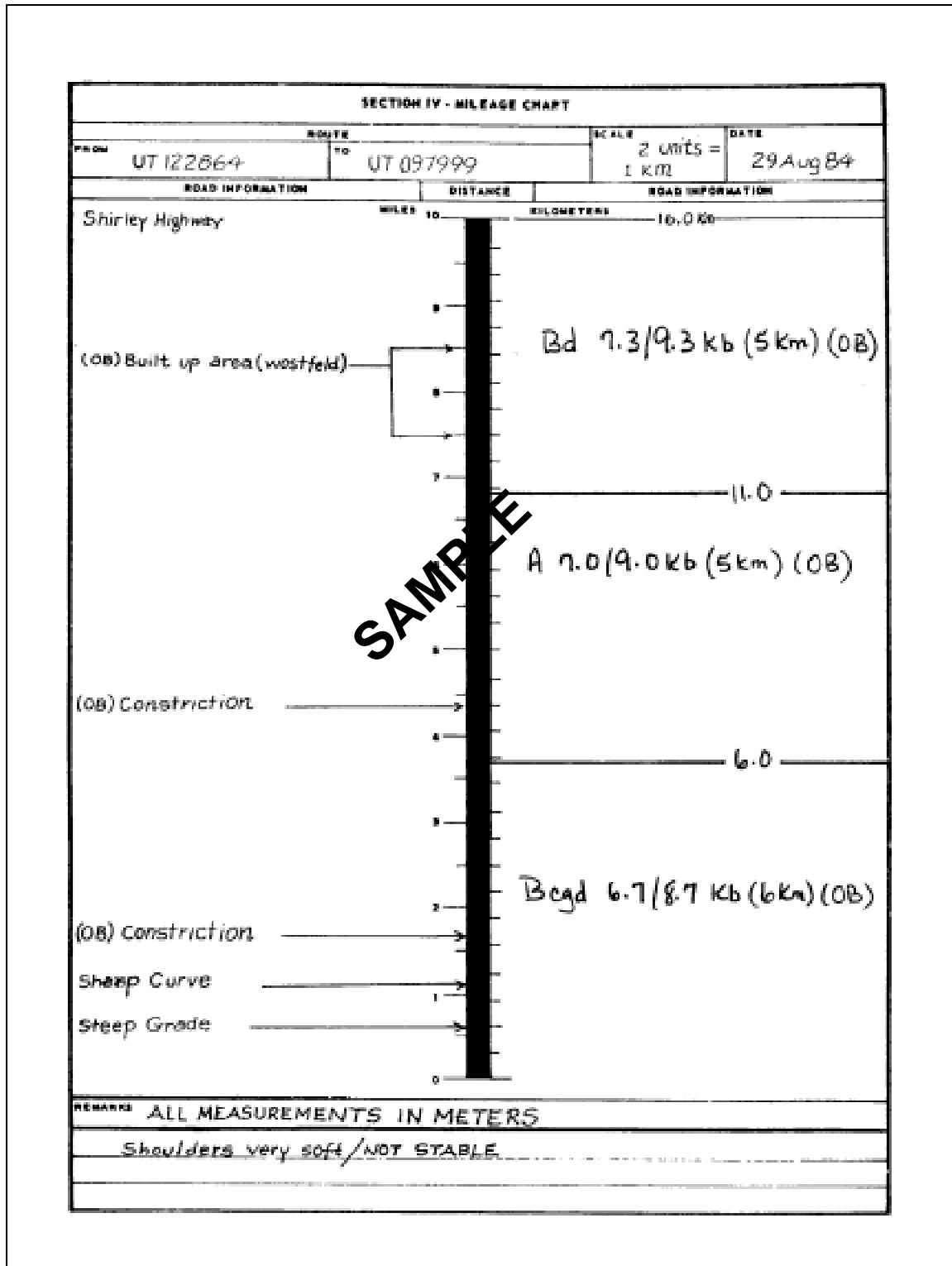

Figure 5-36. Sample Road Reconnaissance Report (back)

Appendix B covers the most common bridges in existence today, including a—

- Timber or steel trestle bridge with timber deck.
- Steel-stringer bridge with concrete deck.
- Concrete steel-stringer bridge.
- Concrete T-beam bridge with asphalt surface.
- Masonry arch bridge.

REQUIRED INFORMATION

To classify a bridge (see Appendix B), you must know the information concerning the bridge's basic components, including the following:

- **Approaches (the portions of a route leading to a bridge).** Approaches may be mined or booby trapped, requiring thorough investigation during a recon.
- **Substructure (lower part of a bridge).** The substructure consists of the abutments and intermediate supports that transfer the bridge's load to the ground. It is important to measure all aspects of an abutment, including its height, width, and length; the abutment wings; and the intermediate supports for bridge demolition missions. It may be more feasible to destroy the intermediate supports or abutments when compared to the rest of the bridge structure.
- **Superstructure (the upper part of a bridge).** The superstructure consists of the following components (see Figure 5-37, page 5-50):
 - Stringers rest on and span the distance between the intermediate supports or abutments. Stringers are the superstructure's main load-carrying members. They receive the load from the flooring and the vehicles and transfer it to the substructure.
 - The flooring system often consists of both decking and tread. The decking is laid directly over the stringers at right angles to the centerline of the bridge. The tread is laid parallel to the centerline of the bridge and between the curbs.
 - Curbs are placed at both edges of the flooring to guide the vehicles. A vehicle with an axle that is wider than the traveled-way width (between the curbs) cannot cross the bridge. Most bridges, however, allow for vehicular overhang beyond the normal traveled area. This allowance is called horizontal clearance above the curbs and is a safety factor. Commanders must perform a risk analysis before attempting such a crossing.
 - Railings along the bridge are built to guide drivers and to protect vehicular and foot traffic.
 - Trusses are used in some bridge superstructures, either above or below the traveled way, to increase the load-carrying capacity. A truss is a structural element made of several members joined together to form a series of triangles.

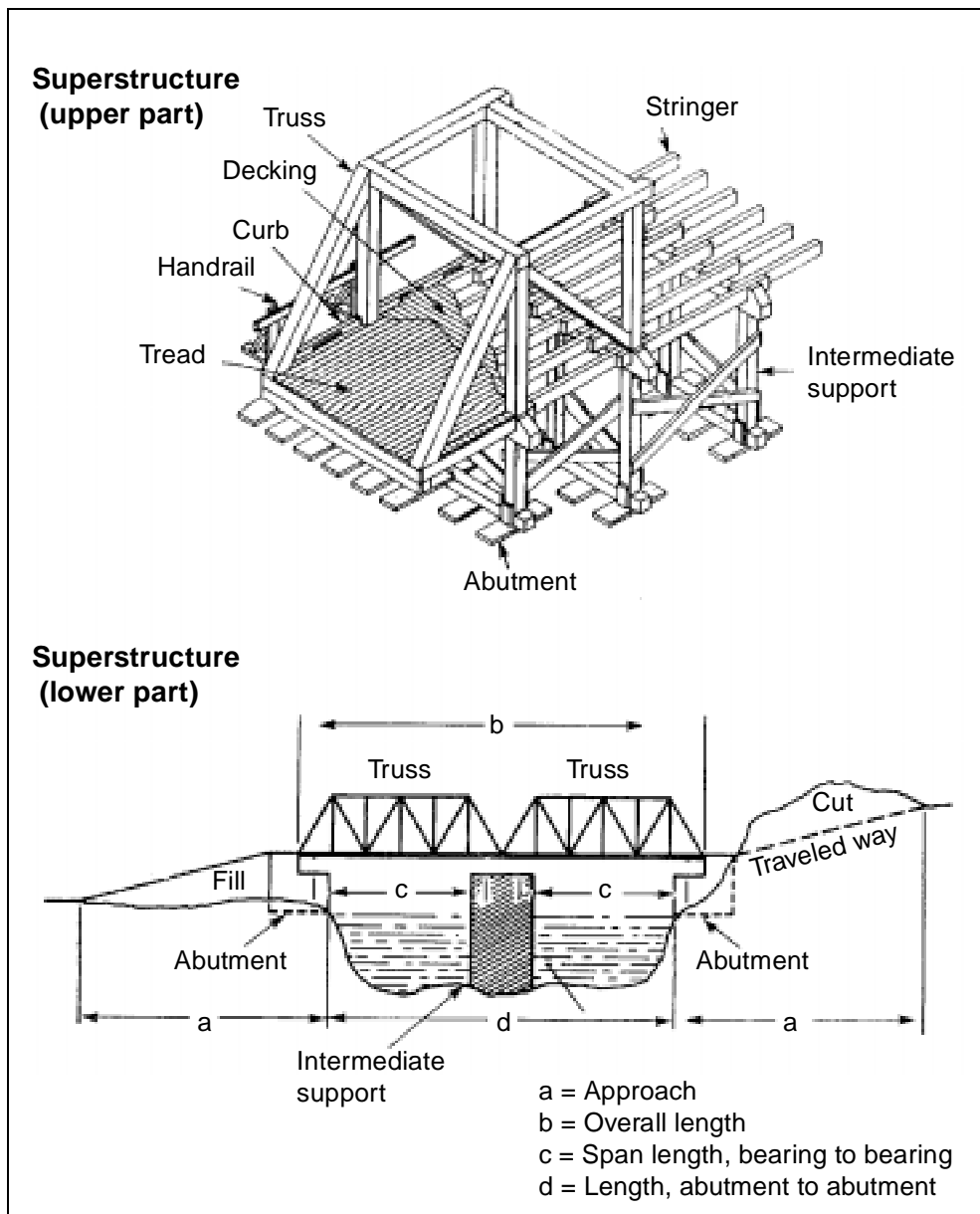

Figure 5-37. Bridge parts

- The number of members in each span is noted where applicable (for example, stringer bridges and concrete T-beam bridges). Exact dimensions of specific bridge members are taken as outlined later in this chapter.
- The span length is measured from center to center of the supports. The bridge's classification is usually based on the weakest span. If the weakest span is apparent, no other spans need to be reconned. However, if the weakest span is difficult or impossible to locate, all spans must be classified. Even if several spans look identical, actual measurements should be taken to prevent error.

- The traveled-way width is measured between the inside faces of the curbs. However, the horizontal clearance on a truss bridge is measured from a point 1.21 meters above the roadway.

BRIDGE CONDITION

It is essential to note the bridge’s general condition, paying particular attention to evidence of damage from natural causes (rot, rust, and deterioration) or combat action. Classification procedures presume that a bridge is in good condition. If the bridge is in poor condition, the class obtained from mathematical computations must be reduced according to the classifier’s judgment.

WIDTH AND HEIGHT RESTRICTIONS

Table 5-8 lists width restrictions for bridges. If a one-lane bridge does not meet width requirements, post a rectangular warning sign under the classification sign showing the actual clear width (see Figure 5-38, page 5-52). If this is a route restriction, annotate it in the route-classification formula. For a two-lane bridge, downgrade the two-way classification to the highest class for which it does qualify (one-way class is not affected). Post a limited-clearance sign if the overhead clearance is less than 4.3 meters. These signs must be a minimum of 40 centimeters in height or width, with a yellow background, and the appropriate description in black letters. Separate rectangular signs are used if necessary to denote width limitations, height limitations, or other technical information. The same signs are used for tunnels, if applicable.

Table 5-8. Minimum roadway widths

Roadway Width (meters)	Bridge Classification	
	One-Way	Two-Way
2.75 to 3.34	12	0
3.35 to 3.99	30	0
4 to 4.49	60	0
4.5 to 4.99	100	0
5 to 5.4	150	0
5.5 to 7.2	150	30
7.3 to 8.1	150	60
8.2 to 9.7	150	100
Over 9.8	150	150

NOTE: Minimum overhead clearance for all classes is 4.3 meters

BRIDGE TRAFFIC-CONTROL PROCEDURE

Posting standard bridge signs and other signs needed for proper and efficient traffic control across a bridge is an engineer’s responsibility. Additional signs are used when it is necessary to warn vehicles that require special controls while crossing. When necessary, holding areas, turnouts for parking and unloading vehicles, and checkpoints are installed near bridges to provide the necessary control during crossings.

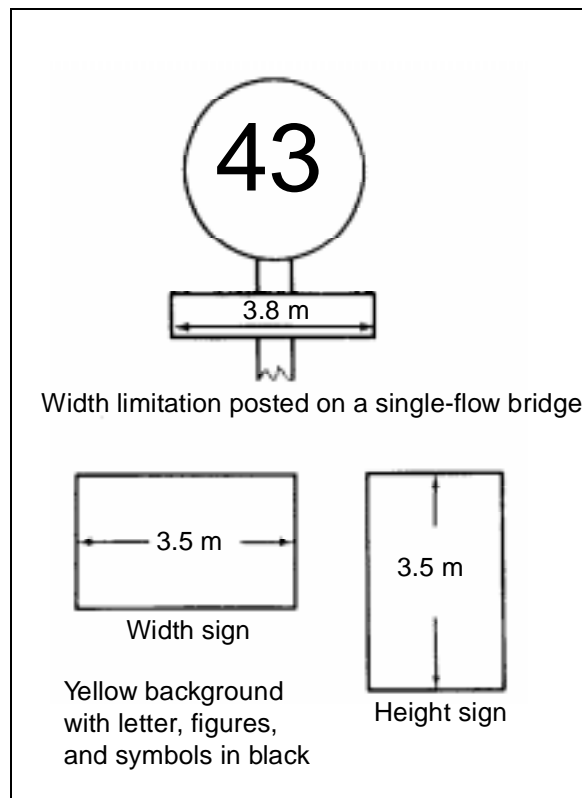

Figure 5-38. Width and height signs

FULL NORTH ATLANTIC TREATY ORGANIZATION (NATO) BRIDGE SYMBOL

Bridge information is recorded on a map or overlay by using the full NATO bridge symbol (see Figure 5-39). It is different from an on-site bridge-classification sign; do not confuse the two. The information necessary for the full bridge symbol includes the—

- Bridge's serial number.
- Geographic location.
- Bridge's MLC.
- Overall length.
- Traveled-way width.
- Overhead clearance.
- Available bypasses.

A bridge serial number is assigned for future reference and is recorded in the symbol's lower portion (assign a number according to the unit's SOP). For proper identification, do not duplicate serial numbers within any one map sheet, overlay, or document. The unit's S2 can obtain special maps containing bridge information for developed areas of the world.

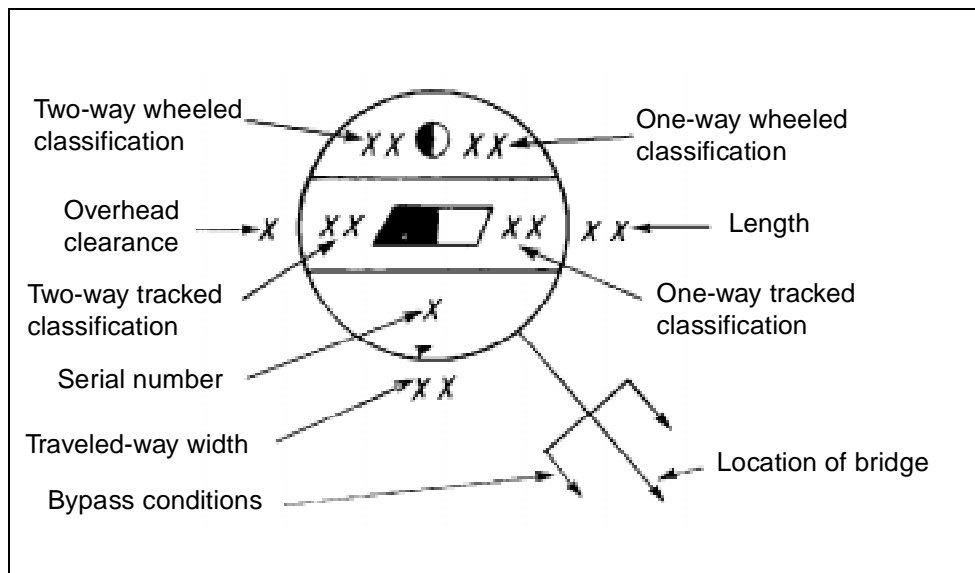

Figure 5-39. Full NATO bridge symbol

The bridge's geographic location is shown by an arrow extending from the symbol to the exact map location. The bridge's MLC number is shown in the symbol's top portion. This number indicates the bridge's carrying capacity; classifications for both single- and double-flow traffic are included. In those instances where dual classifications for wheeled and tracked vehicles exist, both classifications are shown.

The bridge's overall length is the distance between abutments, measured along the bridge's centerline. This figure is placed to the right of the circle and is expressed in meters.

The minimum lane width is the clear distance between curbs. Place this figure below the symbol and express it in meters. Bridges may be obstructions to traffic flow because the traveled-way width of the overall route may be reduced on the bridge to below the minimum standards prescribed in Table 5-1, page 5-5.

The overhead clearance is the minimum distance between the bridge's surface and any obstruction above it. This figure is shown (in meters) to the left of the symbol. Underline any overhead clearance less than the minimum required by the bridge class number (see Table 5-9, page 5-54). Unlimited overhead clearance is indicated by the symbol ∞ . Often a telltale (see Figure 5-40, page 5-54) or other warning device is placed before the bridge to indicate overhead-clearance limitations. Report any overhead clearance less than 4.3 meters as an obstruction in the route-classification formula. A question mark is used to indicate information that is unknown or undetermined and is included as part of the bridge recon symbol. See Appendix E for signs used to mark roads and bridges.

Railway bridges, which could be used by road vehicles in an emergency, are indicated as use easy or use difficult. Samples of the full NATO bridge symbol used to indicate a railway bridge can be found in the glossary.

Table 5-9. Minimum overhead clearance for bridges

Bridge Classification	Minimum Overhead Clearance
Up to 70	4.5 meters
Above 70	4.5 meters

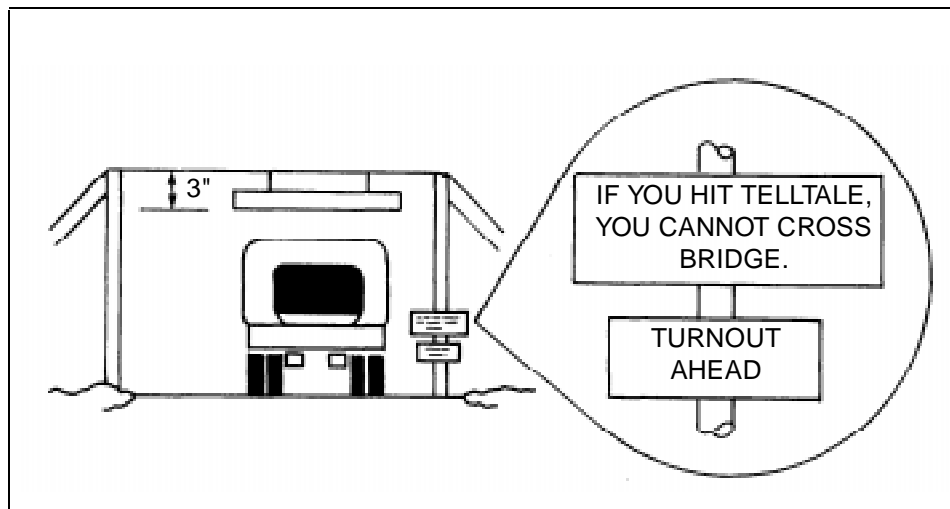

Figure 5-40. Telltale

NOTE: A railroad bridge is considered to be easy to adapt for use if it can be adapted in less than 4 hours with 35 soldiers and the appropriate resources.

THE BRIDGE RECONNAISSANCE REPORT

A systematic bridge recon obtains valuable data. However, this data will not benefit anyone unless it is recorded in an organized manner. Use DA Form 1249 to report information concerning any reconned bridge, as follows:

- **Column 1.** Record the assigned serial number. This number matches the serial number used in the bridge symbol of the route-classification overlay.
- **Column 2.** Record the grid coordinates, with the map identifier, of the actual bridge site.
- **Column 3.** Record horizontal clearance information, in meters. Horizontal clearance is the clear distance between the inside edges of the bridge structure, measured at a height of 0.3 meter above the surface of the traveled way and upwards. However, horizontal clearance for truss bridges is measured 1.21 meters above the traveled way. Any horizontal clearance less than the minimum required for the bridge's roadway width (as shown in Table 5-8, page 5-51) is underlined. Unlimited clearance is indicated by the symbol ∞ .
- **Column 4.** Record under-bridge clearance, in meters. It is the clear distance between the underside of each span and the surface of the water. The height above the streambed and the height above the

estimated normal water level (pertaining to the appropriate bridge type) are included in this column for each span.

- **Column 5.** Record the number of spans. Spans are listed in sequence starting from the west. If the bridge is oriented more north to south, start with the northern most span and work south. Place the letter N in column 5 before the span and list in sequence.
- **Column 6.** Record the type of span construction. Refer to the diagrams in Figure 5-41, page 5-56, and Table 5-9 for this information.
- **Column 7.** Record the type of construction material. Refer to Table 5-10 for this information.

Table 5-10. Construction material

Material of Span Construction	Letter Symbol
Steel or other metal	a
Concrete	k
Reinforced concrete	ak
Prestressed concrete	kk
Stone or brick	p
Wood	h
Other (to be specified by name)	o

- **Column 8.** Record span length, in meters. This is a center-to-center spacing between bearings. The sum of the span length may not equal the overall length. Spans that are not usable because of damage or destruction are indicated by the pound symbol (#), placed after the dimension of the span length. Spans that are over water are indicated by placing the letter W after the dimension of the span length (see Figure 5-42, page 5-57).

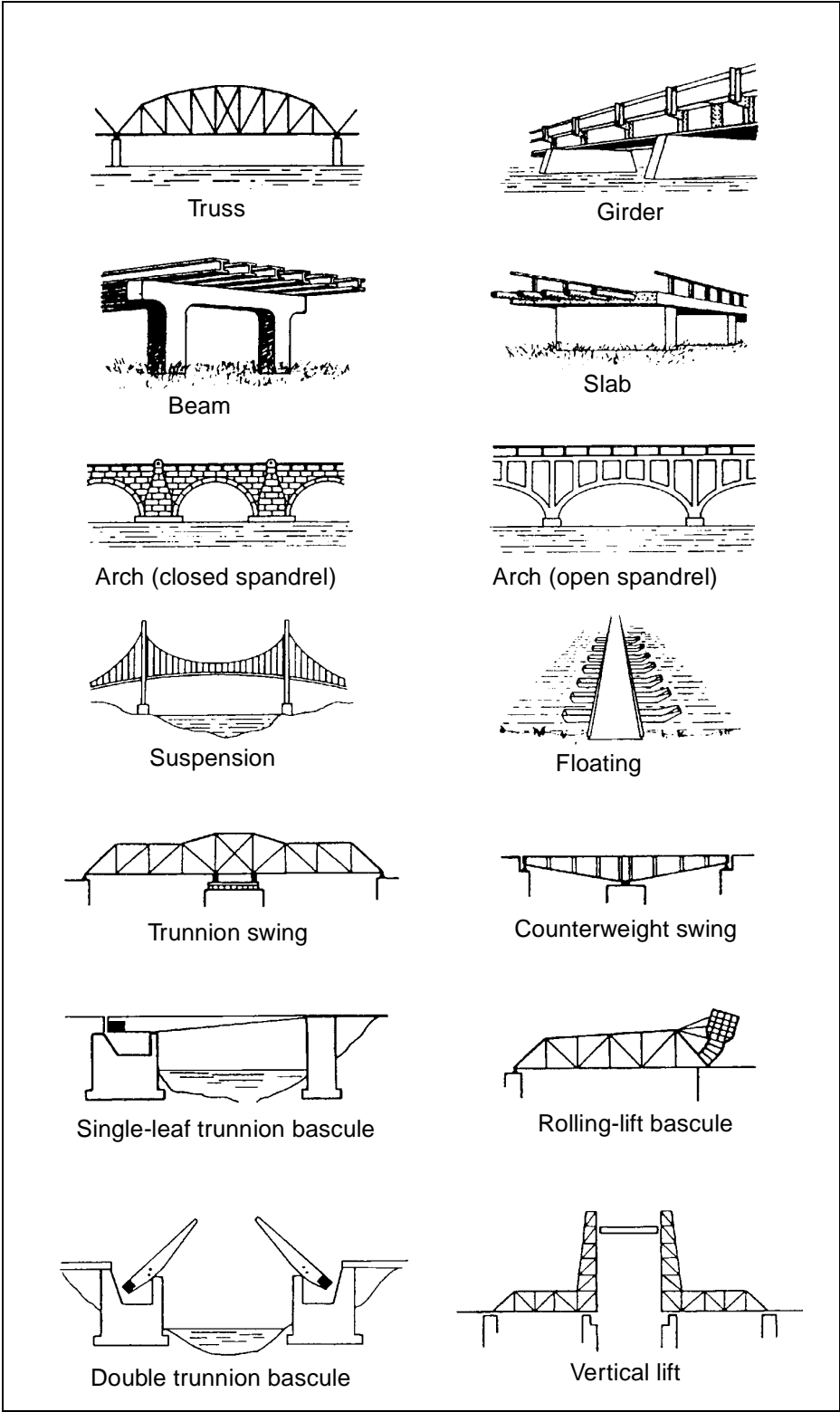

Figure 5-41. Typical bridge spans

BRIDGE RECONNAISSANCE REPORT										DATE		REPORT BY		
TO: (Headquarters, activity or individual)										27 Aug 84		Charles Clark		
FROM: (Headquarters, activity or individual)										27 Aug 84		Charles Clark		
ADDITIONAL TO: (Headquarters, activity or individual)										27 Aug 84		Charles Clark		
BRIDGE NUMBER										27 Aug 84		Charles Clark		
BRIDGE NAME										27 Aug 84		Charles Clark		
BRIDGE TYPE										27 Aug 84		Charles Clark		
BRIDGE LOCATION										27 Aug 84		Charles Clark		
BRIDGE STATUS										27 Aug 84		Charles Clark		
BRIDGE CONDITION										27 Aug 84		Charles Clark		
BRIDGE DIMENSIONS										27 Aug 84		Charles Clark		
BRIDGE MATERIALS										27 Aug 84		Charles Clark		
BRIDGE NOTES										27 Aug 84		Charles Clark		
BRIDGE DRAWINGS										27 Aug 84		Charles Clark		
BRIDGE REFERENCES										27 Aug 84		Charles Clark		
BRIDGE COMMENTS										27 Aug 84		Charles Clark		
1	UT	13 48734	NA	4	6	12 ft (W)	12 ft (W)	12 ft (W)	12 ft (W)	12 ft (W)	12 ft (W)	90 ft	24 ft	NO HANDRAILS NO CURBS

SAMPLE

DA FORM 1249

Figure 5-42. Sample Bridge Reconnaissance Report with full NATO symbol

OTHER INFORMATION

When an abbreviated bridge symbol is used or when a recon mission requires it, columns are added to give the MLC, overall length, roadway width, overhead clearance, and bypass possibilities (specify use easy, use difficult, or use impossible). Do not forget to indicate whether the bridge is simply supported or continuous (see Figure 5-43).

BRIDGE RECONNAISSANCE REPORT										DATE	ENGINEER		
For use after the use of FM 5-170 and associated agency is changed.										18 Aug 84	Gerald Smith		
FROM: Name, grade, unit of observer or reporting organization:										Gerald Smith, SFC, Co A, 2nd Engr BN			
TO: Name, grade, unit of recipient:										181620 HV 84			
BRIDGE SYMBOL (see Figure 5-43)										181620 HV 84			
ESSENTIAL BRIDGE INFORMATION										ADDITIONAL BRIDGE INFORMATION (add columns as needed)			BYPASS CONDITIONS
BRIDGE NO.	LOCATION	CLEARANCE			SPANS			MILITARY LOAD CLASS	OVERALL LENGTH	TRAVELLED WAY WIDTH	VERTICAL CLEARANCE		
		HEIGHT	UNDER ROADS	OVER RAILROADS	NUMBER	TYPE OF SPAN	SPAN LENGTH					SPAN MATERIAL	LENGTH AND SUPPORTS
21740	LA 0721674	00	0	0	1	3	h	9m W	16	73 m	00	EASY, FENCED SIDE AVAIL- ABLE NEXT TO BRIDGE	
					1	3	h	4.2m W					
					1	3	h	4.2m W					
					1	3	h	4.2m W					
					1	3	h	4.2m W					
					1	3	h	4.2m W					

DA FORM 1249

Figure 5-43. Sample Bridge Reconnaissance Report with abbreviated bridge symbol

BRIDGE SKETCHES

Show as much information as possible when sketching the bridge on the backside of DA Form 1249 (see Figure 5-44).

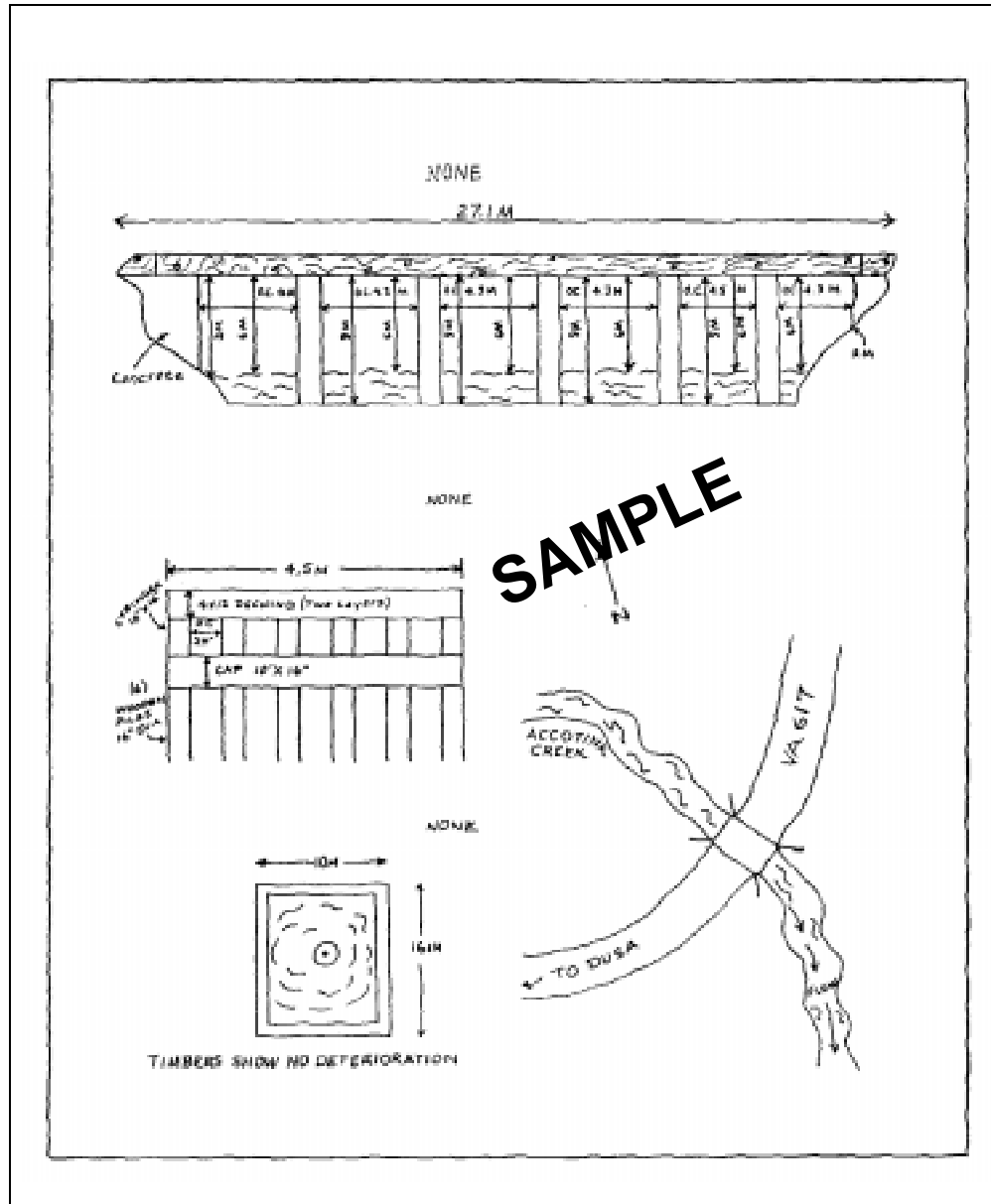

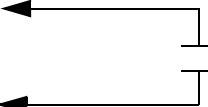

Figure 5-44. Sample bridge sketch on Bridge Reconnaissance Report

BYPASSES

Bypasses are detours along a route allowing traffic to avoid an obstruction. Bypasses limited to specific vehicle types, such as those capable of swimming or deep-water fording, are noted on the recon report. Bypasses are classified as easy, difficult, or impossible. Each type of bypass is represented symbolically on the arrow extending from the tunnel, ford, bridge, or overpass symbol to the map location (see Table 5-11).

Table 5-11. Bypass symbols

	<p>Bypass easy. Use when the obstacle can be crossed in the immediate vicinity by a US 5-ton truck without work to improve the bypass.</p>
	<p>Bypass difficult. Use when the obstacle can be crossed in the immediate vicinity, but some work to improve the bypass is necessary.</p>
	<p>Bypass impossible. Use when the obstacle can be crossed only by repairing or constructing a feature or by detouring around the obstacle.</p>

A bypass is considered easy when the obstacle can be crossed within the immediate vicinity by a 5-ton vehicle without work to improve the bypass. The bypass is considered difficult when the obstacle can be crossed within the immediate vicinity; however, some work is necessary to prepare the bypass (ensure that the estimation of time, troops, and equipment necessary to prepare the bypass is included on the recon report). The bypass is considered impossible when the obstacle can be crossed only by repairing the existing bridge or tunnel, building a new bridge or tunnel, or providing a detour.

Chapter 6

Combat Support

This chapter is applicable to all types of recon activities in which the recon team will be working with other CS elements.

An engineer recon team must take full advantage of available CS assets to accomplish its mission and reduce its vulnerability on the battlefield. CS may be provided by mortars, field artillery (FA), ADA, GSR, and aviation assets. None of these assets are organic to the engineer battalion but may be available through the brigade or TF. Engineer scouts must understand the capabilities and limitations of these CS assets.

INDIRECT-FIRE SUPPORT

Mortars and FA are the primary means of indirect-fire support available to recon teams on the battlefield. Engineer recon teams may request fires to—

- Assist in disengaging from the enemy.
- Provide harassing fire on enemy engineers emplacing obstacles.
- Cover movement.

The FSOs at TF and brigade levels plan and coordinate indirect fires. In addition to understanding the capabilities and limitations of these assets, engineer scouts must know what fire-request channels to use to request fires. FM 6-30 explains how to call for and adjust fires.

MORTAR SUPPORT

A 4.2-inch mortar platoon of six tubes is organic to armor and mechanized-infantry battalions. A 4.2-inch mortar section is organic to the armored cavalry troop (two tubes) and division cavalry troop (three tubes). The 4.2-inch mortar has a maximum effective range of 6,740 meters.

The 120-mm mortar is replacing the 4.2-inch mortar system in the mechanized infantry and armor battalions. The rates of fire per tube are a maximum of 15 rounds per minute (rpm) for 1 minute with a sustained rate of 4 rpm. The system weighs 320 pounds and the round weighs 33 pounds. The ranges of the various rounds for the M120 are shown in Table 6-1.

Table 6-1. M120 ranges

Ranges	Minimum	Maximum
HE M57	200 m	7,200 m
WP M68	200 m	7,200 m
ILLUM M91	200 m	7,100 m

Mortars provide indirect-fire support that is immediately responsive to the recon team's needs. They can provide a heavy volume of accurate, sustained fires. They are ideal weapons for attacking targets on reverse slopes; in narrow ravines or trenches; and in forests, towns, and other areas that are difficult to strike with low-angle fires.

Capabilities

In support of an engineer recon team, a mortar platoon can—

- Provide fast response times.
- Provide destructive target effects.

Limitations

Mortars are limited because—

- They have only short-range capability.
- There are limited types of ammunition available.
- Mortar elements can carry only limited amounts of ammunition.
- Their fire-direction center (FDC) and tubes are not directly linked to the supporting field artillery's FDC.

Available Munitions

A wide variety of munitions can be employed with mortars, including—

- **High-explosive (HE) rounds.** HE rounds can be used to force the enemy to button up or move to less advantageous positions. However, HE mortar rounds will not destroy armored vehicles unless a direct hit is achieved.
- **Smoke.** White-phosphorous (WP) rounds are used for obscuration and screening. Mortar smoke builds up faster than artillery smoke; however, it also dissipates much faster. Obscuration is achieved by placing smoke on or near enemy positions where the wind will cause it to obscure their vision. Screening is achieved by placing smoke between the enemy and the recon team's position to conceal movement. Mortar smoke is also used to mark enemy positions to orient direct fires. Scouts cannot allow smoke to work against them by marking their own positions for enemy gunners.
- **Illumination (illum).** Illumination rounds are used to light an area or enemy position during periods of limited visibility. Ground-burst illumination is used to mark enemy positions and to provide a thermal target reference point (TRP) for controlling fires. Scouts must take care not to illuminate friendly positions. Also, because US night-vision devices are superior to those of most potential adversaries, illuminating the battlefield may be unnecessary or even counterproductive.

FIELD ARTILLERY

Recon teams must fully understand how to use artillery support to their best advantage. It is often their primary means of impeding and disrupting enemy

formations and suppressing enemy positions. FA support can provide immediate, responsive, accurate fires with a wide variety of munitions.

FA support is normally provided by an artillery battalion in DS of a committed maneuver brigade or an armored cavalry regiment (ACR) or a squadron. The armored cavalry squadron also has its organic howitzer battery to provide dedicated indirect-fire support. Recon teams generally receive FA support through the FSO.

Capabilities

In support of the engineer recon team, FA elements can—

- Provide fire support in all weather conditions and types of terrain.
- Shift and mass fires rapidly.
- Support the battle in depth with long-range fires.
- Provide a variety of conventional shell and fuze combinations.
- Provide continuous fire support by careful positioning and timely displacement.
- Maintain the same mobility as the supported unit.

Limitations

FA support has the following limitations:

- Limited capability against moving targets.
- Limited capability to destroy point targets without considerable ammunition expenditure.
- Vulnerability to detection by enemy target-acquisition systems because of its firing signature.

Available Munitions

The FA employs a wide variety of munitions that can be tailored for the engagement of different types of targets. These ammunition types include—

- HE—for use against personnel, field fortifications, and vehicles.
- Smoke—for obscuration, screening, signaling, and marking.
- Illumination—for lighting an area or enemy position during periods of limited visibility.
- Cannon-launched guided projectiles (Copperhead rounds)—for use against armored vehicles.
- Improved conventional munitions (ICM) (for AP use) and DPICM (for use against personnel and light armored vehicles in the open). The danger to friendly troops in areas where AP munitions are fired must be considered.
- SCATMINES (including area-denial munitions)—for use against personnel and remote antiarmor mines for use against armored vehicles.

FIRE-SUPPORT TEAM (FIST)

A FIST is attached to companies or troops for combat operations. It may be task-organized to a TF scout platoon to support security operations when on-target designation is required for special munitions engagements. However, the FIST is a valuable resource because of its C² link with the artillery; it should not be exposed to direct fires except when absolutely necessary. A FIST is organized, equipped, and trained to provide—

- A fire-support advisor and coordinator.
- A communications link to all available fire support.
- On-the-spot support for infantry companies (10-man teams) or for armor companies and cavalry troops (4-man teams).

The armor/mechanized infantry FIST normally monitors the following radio nets:

- The attached unit's command net (battalion, company, or scout platoon).
- The battalion's mortar fire-direction net.
- The DS battalion's fire-direction net (digital).
- The battalion's fire-support net (voice).

The armored cavalry troop FIST normally monitors the following radio nets:

- The troop's command net.
- The troop's fire-support net.
- The supporting artillery's fire-direction net (voice and digital).
- The squadron's fire-support net.

The FIST serves as the net control station (NCS) for the troop's fire-support net. The FSE serves as the NCS on the maneuver battalion's fire-support net. The FIST relays the call for fire to supporting artillery on a digital net or sends the fire mission to the mortar platoon or section. The command net allows the FIST to monitor operations. It links the FIST to the commander and platoon leaders for planning and coordination.

FIRE-REQUEST CHANNELS

The following paragraphs describe possible fire-request channels the recon team may use under various command or support relationships. Given the numerous possible uses of engineer recon teams and command or support relationships, all possible situations are not discussed. The recon team leader must clearly understand the fire-request channel he will be using and who will clear his request for fires.

Engineer Recon Team Working Under Brigade Control

There are several ways that an engineer recon team can request indirect fire while under brigade control. The brigade's SOP or OPOD should specify which method it will use. The engineer recon team leader must coordinate with the brigade's FSO/FSE on which methods will be used.

The team can send requests for artillery fire to the recon leader (someone the brigade has put in control of all recon assets working under brigade control) or directly to the FA battalion on a fire-direction net. The FSE monitors the requests (see Figure 6-1).

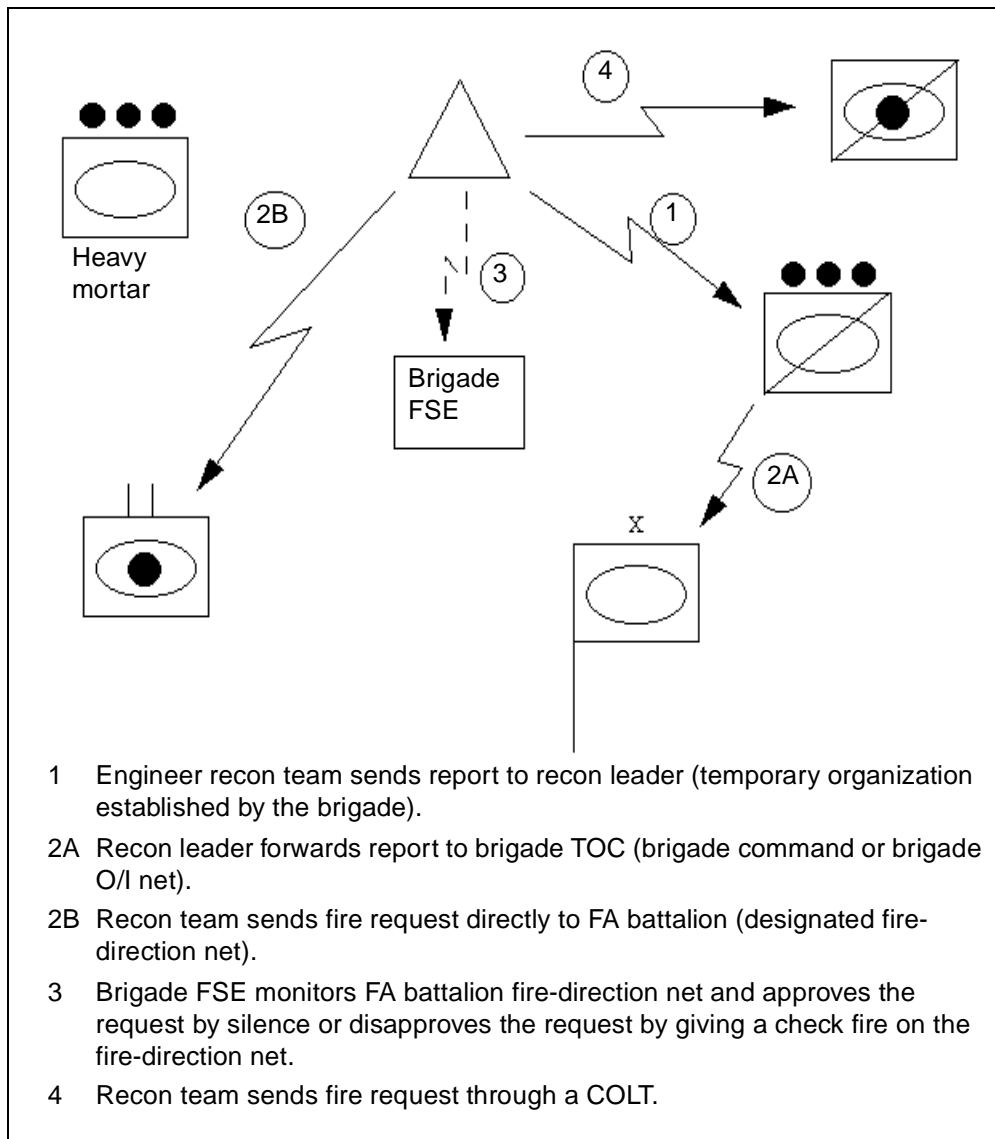

Figure 6-1. Possible methods to request fire while under brigade control

Requests for indirect fire can also be sent through the COLT, which has a secondary mission of processing these requests. The COLT monitors the net designated in the OPORD and handles the fire request and subsequent adjustments as a normal FIST. It has the primary mission of lazing targets for Copperhead rounds and close air support (CAS). A COLT can enter the lazing information directly into fire-support channels. A COLT is organic to each of the three DS 155-mm FA battalions of the armor and mechanized infantry and to the howitzer battery of the armored cavalry squadron. The cavalry

squadron has one organic COLT. From company/troop to brigade level, a COLT is placed under the control of a fire-support coordinator to augment the FIST's lazing capability and to function as a dedicated observation platform.

Engineer Recon Team Working in a TF's Area or Under a TF's Control

There are several ways that an engineer recon team can request indirect fire while working in a TF's area or under a TF's control. The TF's SOP or OPORD should specify which method it will use. The engineer recon team leader must coordinate with the TF FSO/FSE on which methods will be used.

The team can send requests for mortar fire to the scout platoon leader or directly to the mortar platoon on the battalion's heavy mortar net. The FSE monitors the requests (see Figure 6-2).

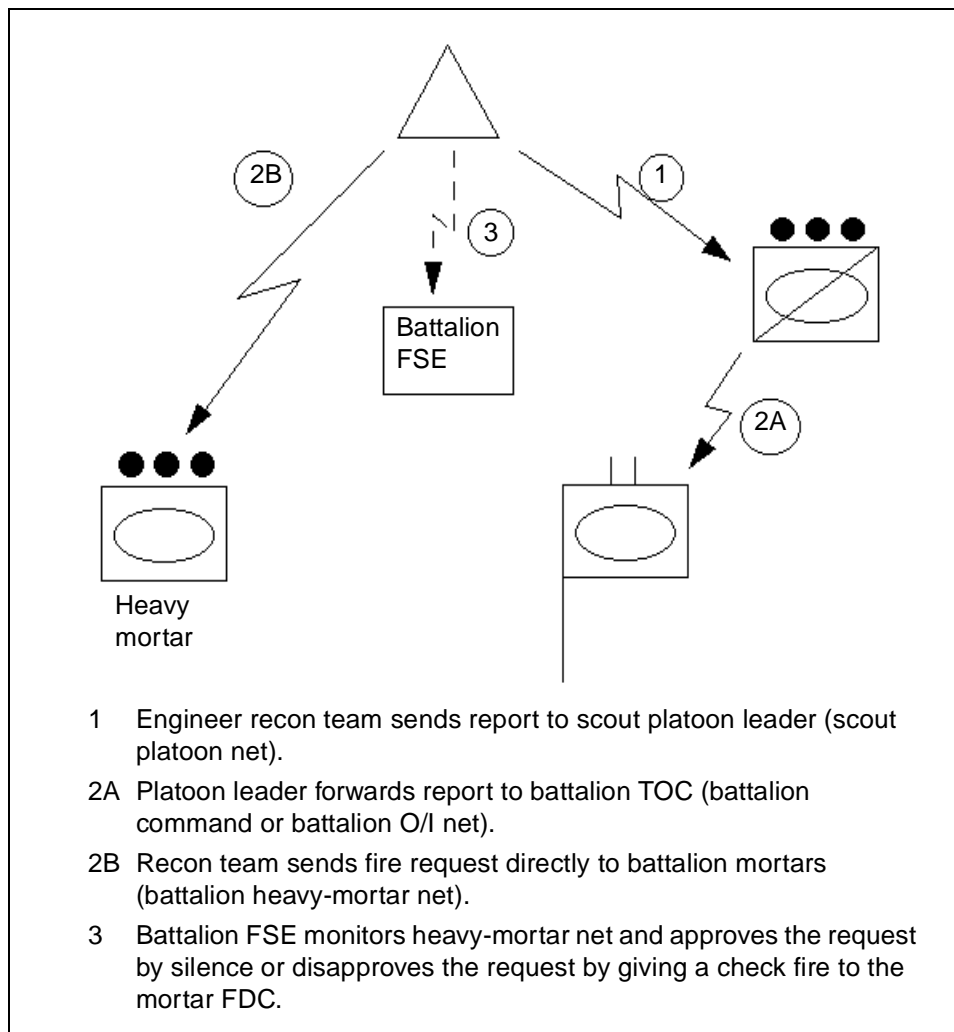

Figure 6-2. Possible methods to request fire from battalion mortars

The team can send requests for artillery fire to the TF scout platoon leader or directly to the FA battalion on a fire-direction net. The FSE monitors the requests (see Figure 6-3).

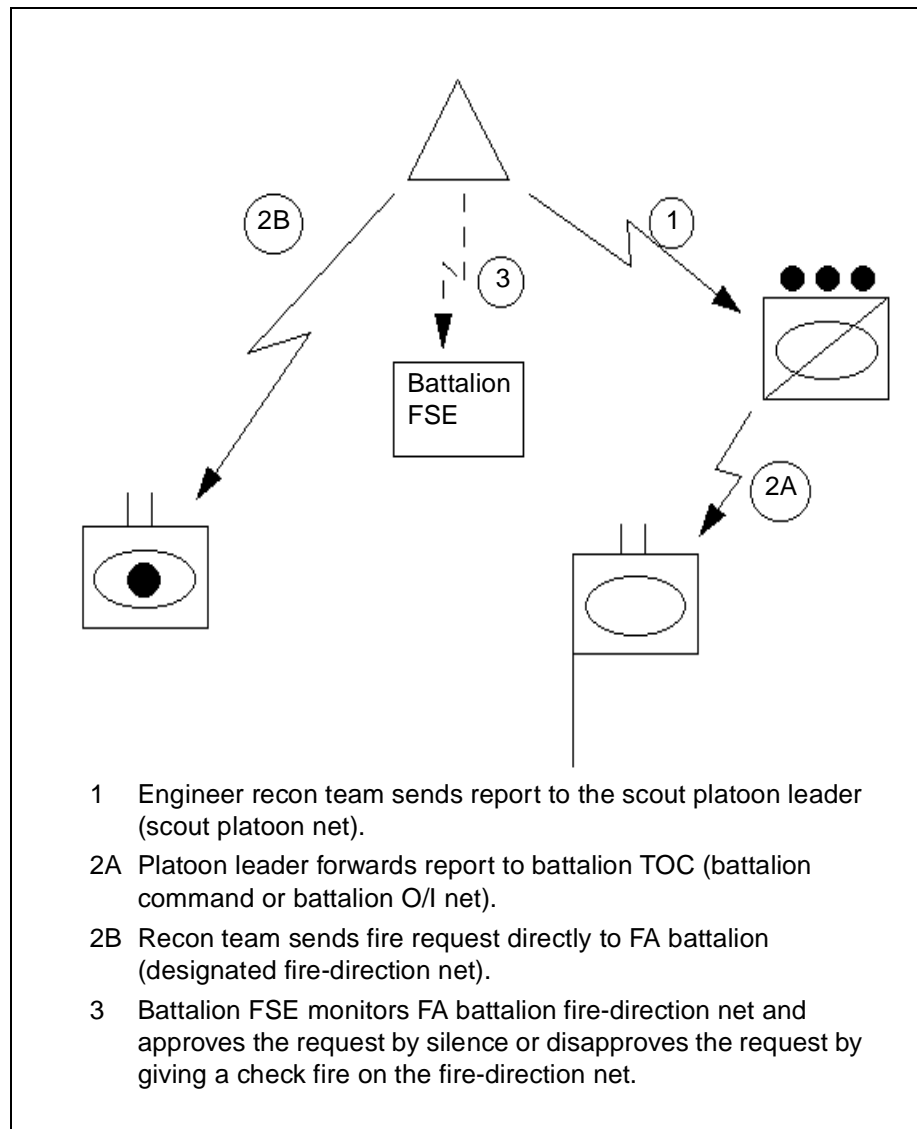

Figure 6-3. Possible methods to request fire from FA battalion

Engineer Recon Team Working with a Cavalry Squadron or Under Troop Control

A recon team working under squadron control would request fire the same way as if it were under brigade control (see Figure 6-1, page 6-5). However, if the recon team is placed under a troop's control, the call for fire changes slightly. When working for or with an armored cavalry troop, requests for all indirect-fire support normally goes through the troop FIST on the troop's fire-support net. The FIST selects the best available fire support to engage the target. If the FIST passes the fire mission to the troop mortar platoon, the recon team sends all adjustments of the fire mission directly to the mortar

platoon (see Figure 6-4). If the FIST passes the fire mission to a supporting artillery unit, the recon team sends all adjustments of the fire mission to the FIST, who relays the message to the artillery unit on a digital fire-direction net (see Figure 6-5).

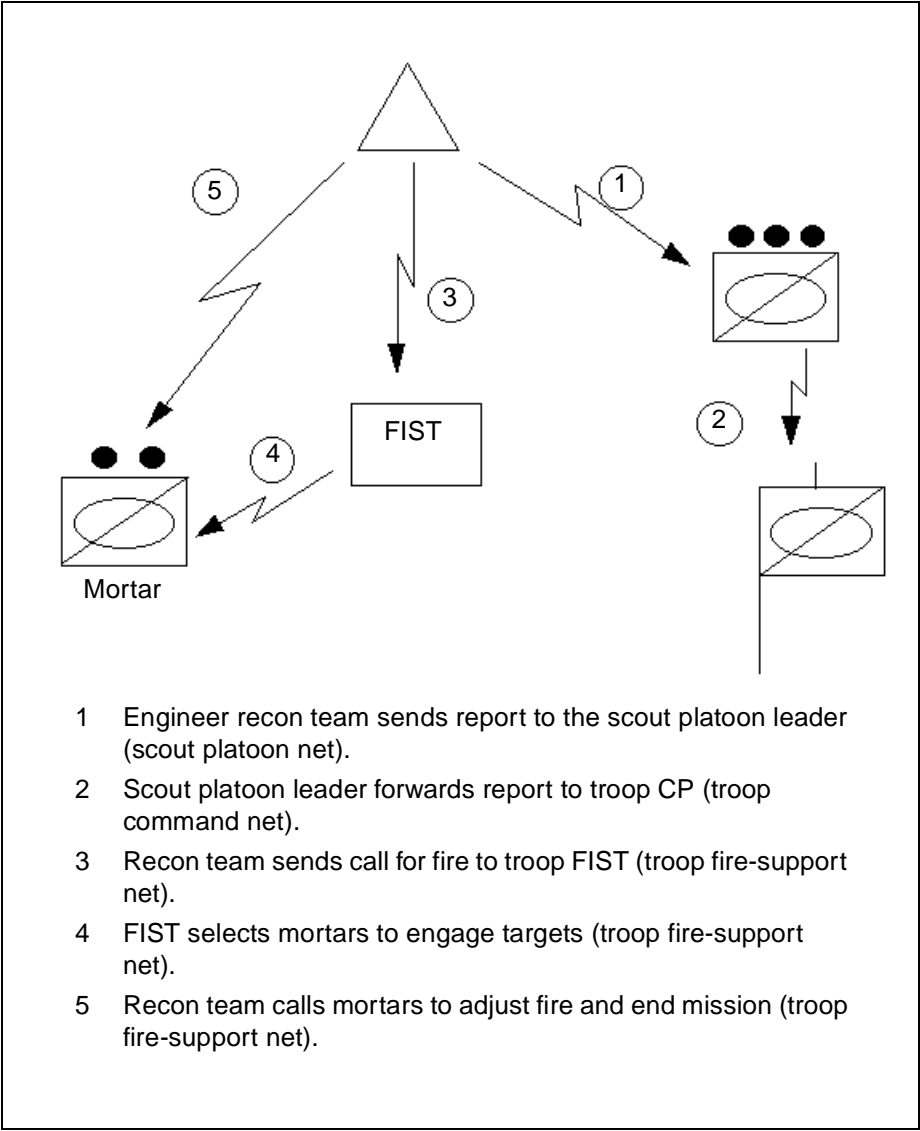

Figure 6-4. Possible methods to request fire from mortars

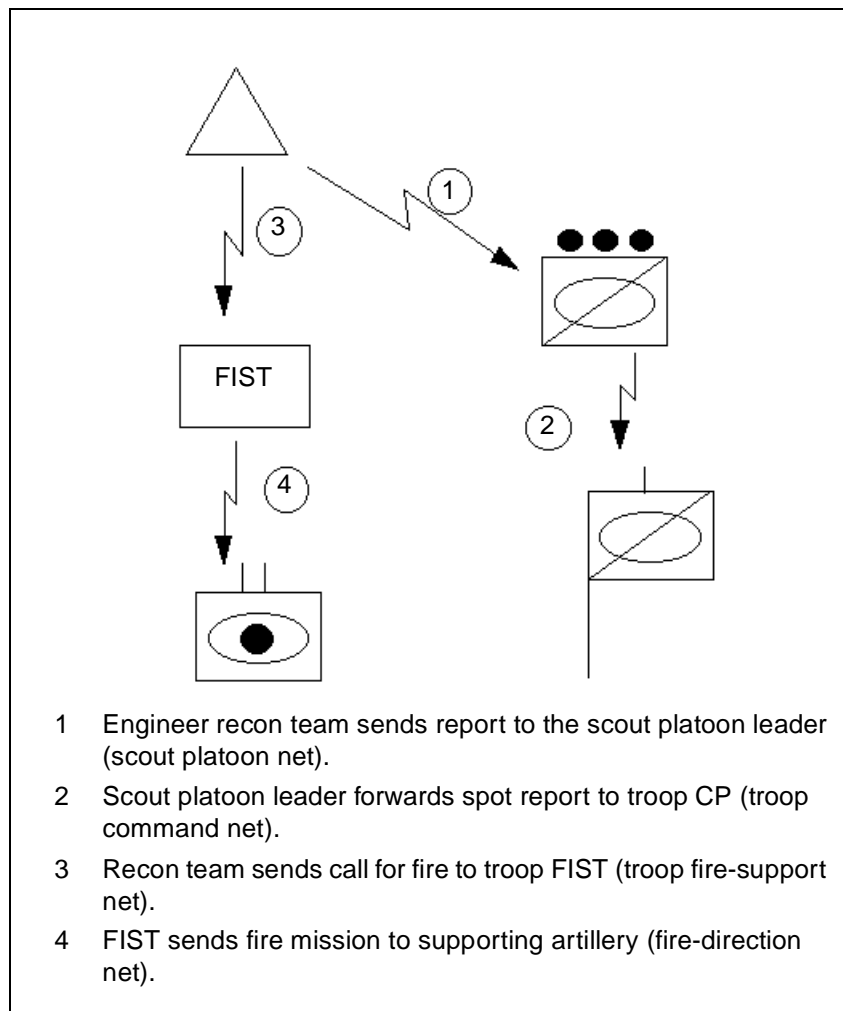

Figure 6-5. Possible methods to request fire from artillery

AIR DEFENSE

Air-defense assets are scarce; maneuver units cannot plan on always receiving dedicated air-defense protection. Consequently, recon teams must be able to protect themselves from enemy air attacks during all combat operations. Air-defense measures include taking actions to avoid enemy air attack or to limit the damage if attacked and, if necessary, fighting back.

PASSIVE AIR DEFENSE

Passive air defense is the team's first line of defense against enemy air attack. It includes all measures—other than active defense—taken to minimize the effects of hostile air action. There are two types of passive air defense: attack avoidance and damage-limiting measures.

Attack Avoidance

If an enemy pilot cannot find you, he cannot attack you. Recon teams use concealment, camouflage, deception, and any other necessary action to prevent the enemy from seeing them.

Team positions must provide effective concealment. When concealment is not available, vehicles must be camouflaged to blend into the natural surroundings. Track marks leading into the position must be obliterated. All shiny objects that reflect light and attract attention must be covered.

Damage-Limiting Measures

Dispersion is one of the most effective ways to reduce the effects of enemy air attack. When the team is on the move and air guards identify an enemy air attack, vehicles disperse quickly, move to a concealed position if possible, and stop (a stationary vehicle is more difficult to see than a moving one).

Another damage-limiting measure is using natural or man-made cover to reduce the effects of enemy munitions. Folds in the earth, depressions, buildings, and sandbagged positions can provide this protection.

ACTIVE AIR DEFENSE

Although passive measures are the first line of defense against an air attack, a recon team must be prepared to engage enemy aircraft. The decision to fight back against an air threat is based on the situation and the capabilities of the organic weapon systems. All team members must understand the weapon-control status. They can defend against direct attacks but cannot engage aircraft that are not attacking them unless the weapon-control status allows it.

Engineer scouts have several weapon systems (machine guns and small arms) that can be used against aircraft. Engaging aircraft with volume fire is the key to effectively using small-arms and machine-gun fires against an air attack. These fires must be coordinated to be effective. Delivered on the team leader's command, they are directed at an aim point in front of the target; gunners do not attempt to track the target. The rules for selecting the aim point are listed in Table 6-2. They are simple and logical; they must be learned and retained by everyone in the team.

Table 6-2. Selecting aim point

Type Aircraft	Course	Aim Point
Jet	Crossing	Two football fields in front of nose
Jet	Overhead	Two football fields in front of nose
Jet	Directly at you	Slightly above aircraft nose
Helicopter	Crossing	One-half football field in front of nose
Helicopter	Hovering	Slightly above helicopter body
Helicopter	Directly at you	Slightly above helicopter body

The three weapon-control statuses are—

- **Hold**—weapons are fired only in self-defense or in response to a formal order.
- **Tight**—weapons are fired only at aircraft positively identified as hostile.
- **Free**—weapons are fired at any aircraft not positively identified as friendly.

The three air-defense warning conditions are—

- **White**—an air attack is not probable.
- **Yellow**—an air attack is probable.
- **Red**—an air attack is imminent or in progress.

AIR SUPPORT

The Air Force provides CAS, which can be employed to destroy large enemy armor formations. CAS strikes are either preplanned (at TF or squadron level) or requested on an immediate-need basis through the TF's forward air controller (FAC). The FAC on the ground or in the air acts as a link between the ground element and the CAS aircraft.

Army air cavalry and/or attack helicopters are best equipped to coordinate with Air Force assets in joint air-attack team (JAAT) and attack-helicopter operations. The air cavalry can see the battlefield and the target better than ground forces can, and it has the radio equipment needed to talk to Air Force aircraft. The attack aircraft organic to the air cavalry can assist CAS aircraft in suppressing the enemy ADA threat. Reference FMs 1-114 and 17-95-10 for more information on using the Army air cavalry to assist in CAS operations.

Although planning normally begins at battalion/squadron level, a scout platoon may be called on to provide information for CAS employment. Engineer scouts should familiarize themselves with the procedures to call for CAS. If CAS assets are working for the same TF/brigade that the recon team is working for, the teams should provide suppressive fires on any known or suspected enemy ADA locations.

Friendly positions should always be marked during close air strikes. Marking is almost always necessary when friendly troops are within 300 meters of the target. Resources for marking positions include the following:

- **Smoke.** The smoke grenade is the most commonly used marker, but it has limitations. Wind may cause smoke to drift above trees, and some colors can blend with the background. Violet or white smoke shows up well with most backgrounds.
- **Flares.** Flares are good for attracting attention at night; they are sometimes effective during the day.
- **Mirrors.** Signal mirrors are probably the best ground-to-air devices for attracting attention. If the sun is shining and the operator is skillful, pilots can see a mirror flash miles away. VS-17 signal panels are also good visual references for pilots.
- **Lights.** Pocket-sized, battery-powered strobe lights produce brilliant white or blue flashes at about 1 1/2-second intervals. The flash is visible at night for 1 to 3 miles. Vehicle lights, such as an unshielded red taillight, are visible to a pilot for several miles at night. Chemical glow lights can be used to mark friendly positions. Another technique that can be used at night is to tie an infrared or green chemical light on a 10-foot string. When aircraft are in the area, a team member can swing the rope in a circular motion to mark the location.

Evolving technology provides a more accurate, secure, and effective means of supplementing or replacing traditional methods. Using a GPS will pinpoint a position to avoid fratricide during CAS operations.

GROUND SURVEILLANCE RADAR

A GSR team can augment a recon team's surveillance capability by detecting targets and providing accurate range and azimuth readings to enemy locations and obstacles during limited-visibility conditions. A team consists of three soldiers, one AN/PPS-5 radar unit, and an APC or a HMMWV.

For combat operations, GSR teams are usually attached to TFs and squadrons. The teams may be attached or under OPCON to companies/troops or recon elements for specific missions. When GSR is attached or under OPCON to a recon team, the team leader must plan its employment.

CAPABILITIES AND LIMITATIONS

GSR teams provide mobile, all-weather battlefield surveillance. When employed in pairs, they can provide observation from a given vantage point 24 hours a day.

The AN/PPS-5 has a line-of-sight range of 10,000 meters against vehicles and 6,000 meters against personnel. It can detect targets through light camouflage, smoke, haze, light snow and rain, and darkness. Foliage, heavy rain, and snow seriously restrict its radar-detection capability.

GSR is designed to detect targets moving against a background. It is generally ineffective against an air target unless the aircraft is flying close to the ground. It is vulnerable to enemy direction-finding and jamming equipment. The GSR team is normally equipped with a single radio. If forward with the recon team, the GSR team should send all reports to the recon team.

EMPLOYMENT

A GSR team should be assigned a specific sector of surveillance and frequency of coverage. However, GSR cannot be used for continuous surveillance because the enemy can detect radar signals. The tasks assigned to GSR teams in their surveillance mission may include the following:

- Searching avenues of approach or possible enemy positions on a scheduled or random basis to determine the location, size, and composition of enemy forces and the nature of their activity.
- Monitoring point targets such as bridges, defiles, or road junctions and reporting quantity, type, and direction of enemy vehicles and personnel moving through the target area.
- Extending the recon team's observation capabilities by enabling them to survey distant points and areas of special interest.

GSR must be positioned in an area that is free of ground clutter (such as trees, thick vegetation, and buildings) and that affords long-range observation and a wide field of view. Normally, the team will be assigned a general area, and the GSR team leader will select the specific position. To avoid enemy suppressive fires, the team should be prepared for rapid displacement by selecting several alternate positions ahead of time.

During a recon, GSR is best employed to the recon team's flanks or oriented on potential enemy locations. Since recon is a moving operation, the GSR teams will have to move as necessary to support the team.

CHEMICAL

When in a nuclear, biological, and chemical (NBC) environment, NBC recon elements can augment an engineer recon team's operational capability by providing NBC detection, warning, and sampling. The Fox (or its replacement) is a high-speed, high-mobility, wheeled, armored carrier capable of performing NBC recon on primary, secondary, or cross-country routes throughout the battlefield. The basic item or equipment to perform NBC recon is the M93-series NBC Reconnaissance System (NBCRS) or the Fox vehicle. A team consists of one Fox vehicle with its crew; two Fox vehicles and their crews compose a squad. NBC recon units are organic to the heavy division, the corps, the ACR, and the light ACR.

Depending on the other assigned priorities, an NBC recon team may be attached or under OPCON to an engineer battalion or a TF for specific missions. The NBC recon team can significantly enhance the engineer recon teams by being integrated into the overall R&S plan for monitoring NAIs.

CAPABILITIES AND LIMITATIONS

An NBC recon team assists an engineer recon team and in turn provides the maneuver force commander with information to maintain momentum and flexibility and avoid contamination.

The team has the capability to—

- Conduct an NBC recon and survey while on the move.

- Conduct an NBC recon mission without exiting the vehicle.
- Provide location data to better delineate contamination.
- Use a marking system that allows contamination to be marked without exposing the crew.
- Cover large areas due to its mobility.
- Communicate digitally.

The team is limited because it—

- Is not heavily armored.
- Cannot conduct standoff chemical surveillance with the M21 Rascal on the move.
- Does not have biological detection/identification capability.

The NBC recon team is equipped with the AN/VRC-89 and AN/VRC-90 radios and can communicate with both the engineer recon team and the engineer battalion or TF.

EMPLOYMENT

In an NBC environment, there are relatively sudden and drastic changes in the tactical situation, including—

- Dispersion.
- Mobility.
- Decentralization of control.
- Rapid exploitation.
- Reduction of reaction time.

In this type of environment, route recon assumes even greater importance than in conventional operations. Not only will more routes be required to support operations, but the engineer recon team must be alerted to widespread areas of contamination created by weapons of mass destruction. NBC recon elements/teams will provide an effective means of alerting engineer recon teams to these NBC hazards.

NBC recon performs five critical tasks on the battlefield: detect, identify, mark, report, and sample. Detecting NBC hazards early will permit timely warning of engineer recon teams preparing for or actually performing their critical missions. Knowing that NBC hazards are present in a planned AO will enable engineer recon personnel to avoid the area, take the appropriate protection level, or treat casualties that may result, if required.

The tasks assigned to the NBC recon team in its support role of performing route, zone, area, and point recon include the following:

- NBC route recon (a directed effort to obtain information on a specific route). The team—
 - Recons the assigned route and determines the location of any contamination.

-
- Locates and marks bypassed routes if contamination is encountered.
 - Reports and marks all NBC hazards along the route.
 - NBC zone recon (a directed effort to obtain detailed information about NBC hazards within a specified zone). The team—
 - Recons all terrain within the zone for contamination.
 - Locates all previously reported NBC attack areas and determines if a hazard is still present.
 - Locates all possible contamination within the zone.
 - Checks all water sources for contamination.
 - Marks contaminated areas.
 - NBC area recon (a directed effort to obtain detailed information concerning a specific area). The team—
 - Conducts a survey to define the extent of contamination.
 - Locates and marks clear bypass routes.
 - NBC point recon (a directed effort to obtain detailed information concerning a specific terrain feature). The team—
 - Conducts a survey to define the extent of contamination.
 - Collects samples.
 - Locates and marks clear bypass routes.

Chemical mechanized smoke platoons also have the capability to augment engineer recon-team operations when the latter team in the defense is employed to—

- Screen if the engineer battalion is required to occupy a battle position as an engineer TF.
- Overwatch a friendly emplaced scatterable minefield.
- Overwatch NAIs where enemy scatterable minefields are known.

The smoke platoon will probably be OPCON to the engineer battalion for specific missions.

Chapter 7

Combat Service Support

This chapter primarily deals with CSS to engineer recon teams conducting obstacle recon. Recon teams conducting more traditional missions such as zone, route, area, or technical recons will conduct CSS operations similar to those discussed in FMs 5-71-2 and 5-71-3.

CSS elements arm, fuel, fix, feed, clothe, and provide transportation and personnel for the recon team. The recon team leader is responsible for supervising CSS within the team. The assistant team leader is the team's CSS operator, as the first sergeant (1SG) is for a company. The assistant team leader advises the team leader of logistical requirements while preparing for combat operations. He also keeps the team leader informed of the team's logistical status.

ORGANIZATION

A recon team does not have organic CSS assets. The assistant team leader is primarily responsible for determining the team's maintenance, supply, and personnel statuses. He coordinates directly with the 1SG for all CSS.

An engineer recon team presents complex logistical problems for the battalion staff. As explained in Chapters 3 and 4, the team normally operates to the front of the brigade/battalion TF. The team will probably move earlier and stay away longer than any other battalion element. It can be resupplied in one of several ways.

A maintenance team and/or logistics package (LOGPAC) can be dedicated to the engineer recon team. The maintenance team responds to the needs of the recon team and is brought forward by the company's 1SG or another responsible individual. The support package is tailored specifically to the engineer recon team's requirements and is small and flexible. The LOGPAC links up with the team at a specifically designated logistics release point (LRP) as far forward as possible. The assistant team leader is then responsible for distributing supplies to the recon team. He may distribute supplies by himself or be assisted by the individual who brought the LOGPAC forward, which is significantly faster. This method is best for the recon team, but difficult for the battalion because of its limited CSS resources.

The engineer recon team can also use the nearest company team's CSS assets for its resupply and maintenance. If this technique is used, the headquarters and headquarters company (HHC) commander/S4 and the engineer recon team leader should coordinate with the company team 1SG for support. The HHC commander and the battalion S4 should ensure that the supplies dedicated for the resupply of the engineer recon team are forwarded with the company team's regular LOGPAC. If possible, engineer recon team supplies

pushed forward with the company team LOGPAC should be separated to ensure rapid resupply of the engineer scouts. In any case, the company team commander must realize the importance of refueling and rearming the engineer recon team.

Whatever support the engineer scout recon team receives must be keyed to a fast transfer of supplies. The recon team must be able to pull in, resupply, and leave as quickly as possible. The actual time that the recon team needs to resupply does not often coincide with standard LOGPAC times for the rest of the battalion. The S4, the support platoon leader, the engineer recon team leader, and any other key leaders must anticipate events to coordinate for the best resupply time.

SUPPLY OPERATIONS

Each team has a large amount of equipment and requires frequent resupply to accomplish its mission. Periodic checks are required by all leaders to make sure that the team's equipment (especially high-use items) is accounted for and ready to use. Leaders must anticipate expenditures and request supplies before an operation.

BASIC LOAD

For classes of supply other than ammunition, basic loads are supplies kept by units for use in combat. The quantity of each item of supply in a basic load is based on the number of days the team may have to sustain itself without resupply. For ammunition, the basic load is the quantity required to be on hand to meet combat needs until resupply can be accomplished. The basic ammunition load is specified by the commander. The basic load of a recon team will probably not be the same as the rest of the unit because of the amount of time the recon team may be expected to operate away from the engineer battalion. This basic load must be well planned.

CLASSES OF SUPPLY

The following paragraphs examine each class of supply and discuss important considerations as they apply to the recon team:

Class I

This class includes subsistence items and gratuitous-issue health and welfare items. Meal, ready-to-eat (MRE) rations are stocked on each vehicle (usually a 3- to 5-day supply). A-rations are brought forward when possible to supplement MREs.

Potable water should be replenished daily, either by refilling from the water trailer or by rotating 5-gallon cans during LOGPAC. Each combat vehicle should maintain a minimum of 5 gallons of potable water per soldier, more during operations in arid climates or in mission-oriented protective posture (MOPP) gear.

All meals should be eaten in shifts. The team leader must not only make sure that the team is fed, but also that the team eats nutritious meals to maintain the energy levels required in combat. During continuous or cold-weather operations, soldiers should eat more than three meals per day. The extra allowance must be planned for.

Class II

This class includes items of equipment (other than principal items) that are prescribed in authorization and allowance tables. Individual tools and tool sets, individual equipment and clothing items, chemical lights, batteries, engineer tape, tentage, and housekeeping supplies are requested through the supply sergeant.

Class III and Class V

Class III comprises all types of POL products. Class V is ammunition, to include small arms, mines, and demolitions. For optimum security, refueling and rearming should occur simultaneously under the cover of darkness. This resupply usually occurs daily or at the conclusion of major operations. The two techniques of refueling and rearming—tailgate and service station—are covered later in this section.

The team leader must control the redistribution of supplies when fuel and ammunition cannot be delivered or when only limited supplies are available. He continually monitors the section's supply status through logistical reports. He notifies the chain of command when a specific vehicle or the team as a whole is critically short of these major classes of supply. The team leader should ensure that ammunition is equally distributed throughout the team before any tactical operation and during consolidation on an objective.

When planning for refueling, the team leader should keep the range and capacity of his vehicles and the requirements of future operations in mind; the amount of fuel required determines how much time it will take to refuel. The team leader must realize that a vehicle's cruising range and estimated fuel consumption are only approximations, subject to the effects of weather, terrain, and other factors. The team must refuel vehicles whenever the tactical situation permits. When time is limited, the assistant team leader must choose between refueling vehicles that need the most fuel first or giving limited amounts to each. Each vehicle crew needs to maintain a stock of Class III-P materials (such as oil, grease, and hydraulic fluid), replenishing these POL products every time refueling takes place.

Class IV

This class includes construction and barrier materials. Barrier materials such as lumber, sandbags, concertina or barbed wire, and pickets are used by the team to construct OPs and obstacles and to improve fighting positions. These materials are requested through the company or directly from the S4.

Class VI

This class covers personal demand items. Tobacco products, candy, and toiletry articles are normally sold through the exchange system during peacetime or for units not in a combat environment. In a combat environment, these items are sent with Class I as sundry packs.

Class VII

This class includes major end items. These are major pieces of equipment, assembled and ready for intended use, such as combat vehicles, missile launchers, artillery pieces, and major weapon systems. Major end items that

are destroyed are reported immediately by means of logistical reports. They will be replaced by the parent unit as they are reported.

Class VIII

This class includes medical supplies that are provided through the battalion medical section and ordered through the battalion. These supplies include individual medical supplies such as first-aid dressings, refills for first-aid kits, water-purification tablets, and foot powder.

Class IX

This class comprises repair parts. These basic-load supplies are part of the combat prescribed load list (PLL). PLL items carried by the team usually include spare tires, assorted bolts, machine-gun parts, and light bulbs. Class IX supplies are requisitioned through the battalion's maintenance section.

TECHNIQUES OF RESUPPLY

The tactical situation and type/size of the engineer recon element will dictate which technique of resupply to use: tailgate, service station, a variation of one type, or a combination of both types. The situation will also dictate when to resupply. Generally, a recon team avoids resupply during recon operations; resupply should be done during mission transition.

In the tailgate technique, fuel and ammunition are brought to the engineer recon team by the assistant team leader or another responsible individual who is assisting him (see Figure 7-1). This method is used when routes leading to vehicle positions are available and the unit is not under direct enemy observation and fire. This technique is time-consuming, but useful in missions when the recon team is not moving and stealth is more easily maintained. If necessary, hand carry supplies to vehicle positions, further minimizing signatures.

In the service-station technique, vehicles move to a centrally located rearm and refuel point, either by vehicles or as an entire team (see Figure 7-2). Service-station resupply is inherently faster than the tailgate method; however, because vehicles must move and concentrate, it can create security problems.

The assistant team leader can vary the specifics of the two basic techniques, or he can use them in combination. For example, he may use the tailgate method for his most forward OPs and the service-station method for his OPs further to the rear (see Figure 7-3, page 7-6).

MAINTENANCE OPERATIONS

Proper maintenance keeps equipment and materiel in serviceable condition. It includes preventive maintenance checks and services (PMCS) as well as the functions of inspecting, testing, servicing, repairing, requisitioning, recovering, and evacuating equipment and materiel whenever necessary.

Maintenance tasks are divided into unit (operator and organizational), DS, GS, and depot levels. The team leader is concerned primarily with unit maintenance and repair of equipment in DS maintenance.

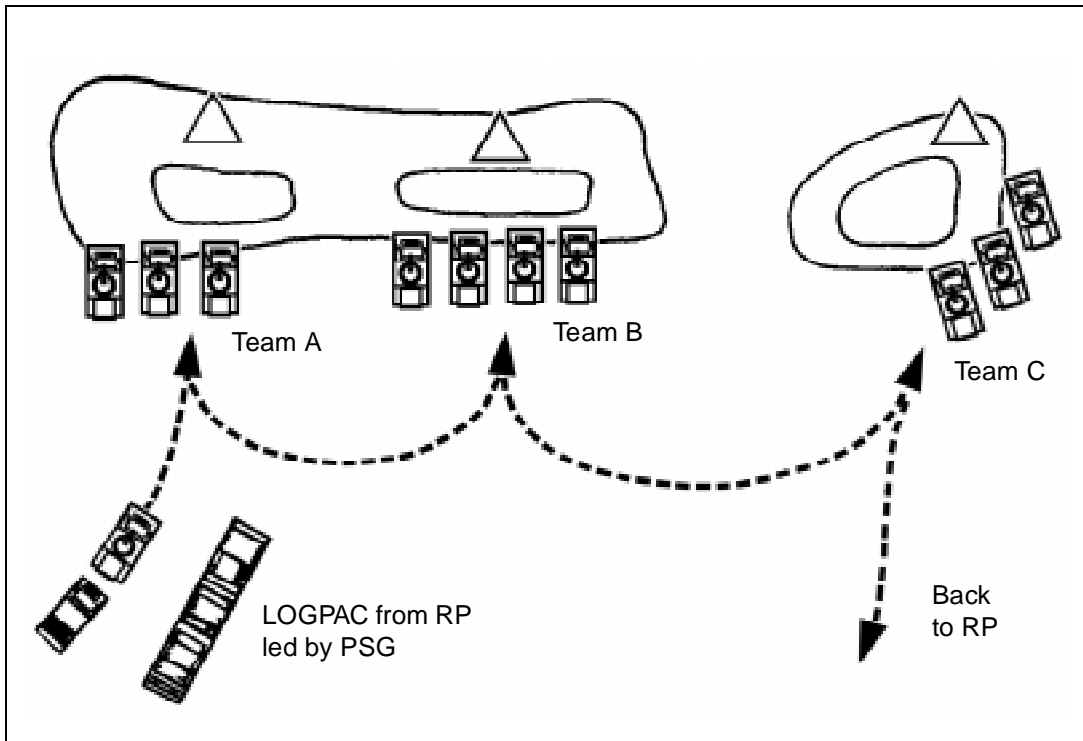

Figure 7-1. Tailgate method

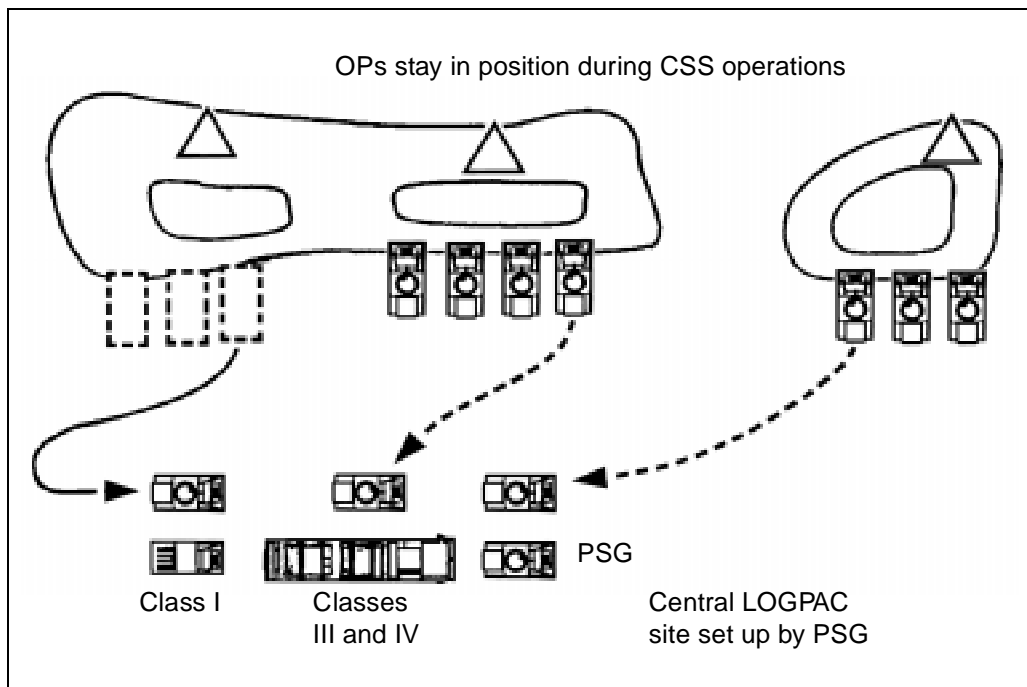

Figure 7-2. Service-station method

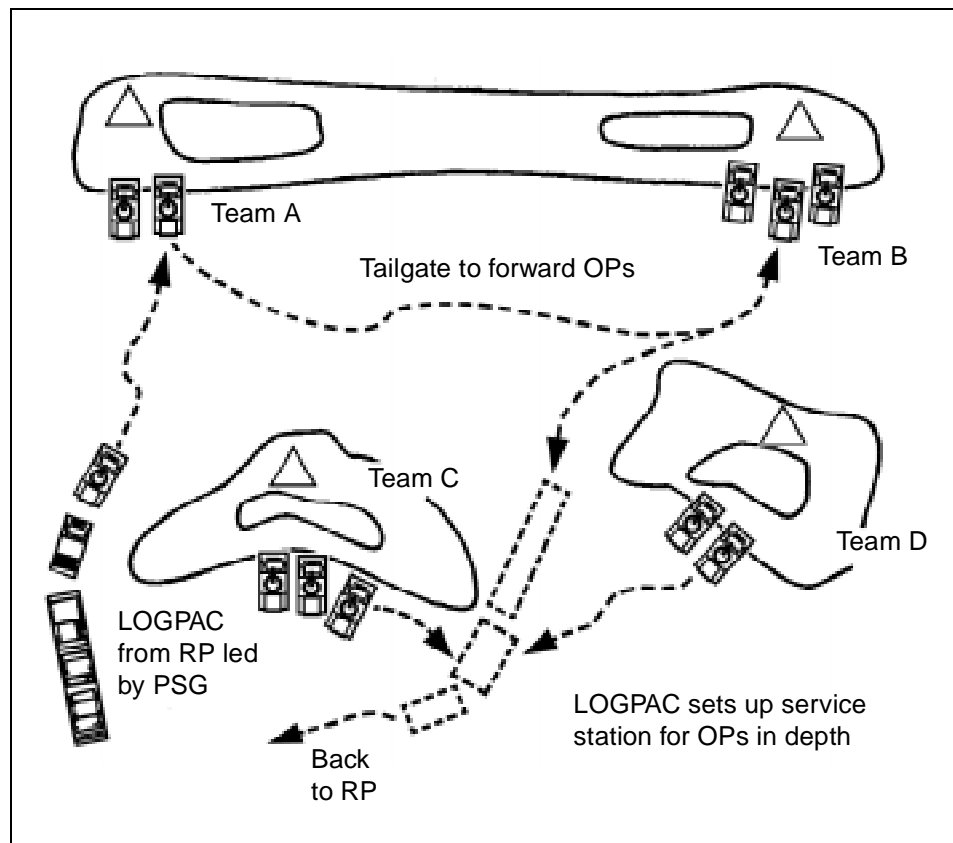

Figure 7-3. Combination of techniques

Repair and recovery are accomplished as far forward as possible. When equipment cannot be repaired on site, it is moved to the rear (but only as far as necessary for repair) to a unit maintenance collection point (UMCP).

RESPONSIBILITIES

The nature of a recon team's missions requires it to operate long distances from maintenance support. For this reason, proper maintenance procedures must exist within the team to ensure equipment readiness at all times. The following paragraphs outline the maintenance responsibilities within the team.

Team Leader

The team leader has the ultimate responsibility for the condition and performance of the team's equipment and materiel. In that role, his duties include the following:

- Ensuring that all team vehicles, weapon systems, and equipment (such as night-observation devices [NODs], mine detectors, and communications equipment) are combat ready at all times. The team leader also ensures that equipment that cannot be repaired at the team level is reported to the commander as soon as possible.

- Knowing the present status of equipment, to include document numbers, job order numbers, and the maintenance stage of his vehicles. The team leader keeps his company commander informed of the current maintenance status.
- Coordinating with the maintenance officer in planning, directing, and supervising the team's unit maintenance.
- Developing and supervising an ongoing maintenance training program.
- Ensuring that crews have the appropriate TMs and are trained and supervised to complete the required level of maintenance properly.
- Ensuring that unit-level PMCS are performed on all assigned equipment according to the appropriate operator's manuals.
- Ensuring that operators and assistant operators are trained and licensed to operate team vehicles and equipment in all weather conditions.
- Planning and rehearsing a maintenance evacuation plan for every mission.
- Supervising and accounting for section personnel during maintenance periods.
- Ensuring that repair parts are used or stored in a timely fashion as they are received.

Assistant Team Leader

The assistant team leader is the team's first-line maintenance supervisor. In large part, the team's maintenance status, and thus its combat readiness, depends on its commitment to proper maintenance procedures. The assistant team leader's duties in this area include the following:

- Ensuring that DA Forms 2404 and 2408-14 are filled out and updated according to DA Pamphlet (Pam) 738-750.
- Ensuring that the crew is properly trained in PMCS procedures and that PMCS are performed on the vehicle according to the appropriate TMs.
- Ensuring that, as a minimum, the assigned vehicle operator is properly trained and licensed. In preparing for continuous operations, the vehicle commander must ensure that all crew members are training and licensed as drivers.
- Collecting and consolidating the section's maintenance status in the field and sending the appropriate reports to maintenance personnel.
- Ensuring that vehicles are always topped off with fuel in garrison and that they receive fuel in the field.
- Ordering parts for the vehicle.
- Ensuring that repair parts are installed upon receipt or are stored in authorized locations.

- Ensuring that all tools and basic-issue items are properly marked, stored, maintained, and accounted for.
- Updating the vehicle's status constantly.

Unit Maintenance (Operator Level)

Operator maintenance includes proper care, use, and maintenance of assigned vehicles and crew equipment such as weapons, NBC equipment, and NVDs. The driver and other crew members perform daily services on the vehicles and equipment, to include inspecting, servicing, tightening, performing minor lubrication, cleaning, preserving, and adjusting. The crew is required to record the checks and services, as well as all equipment faults that they cannot immediately correct, on DA Form 2404. These reports are the primary means of reporting equipment faults through the assistant team leader to the team leader, and ultimately to organizational maintenance personnel.

Checks and services are prescribed for the automotive system and weapon systems. They are divided into three groups:

- Before-operation checks.
- During-operation checks.
- After-operation checks.

These services are explained in every operator's manual and should be conducted as stated in the manual. Although operators must learn to operate equipment without referring to the manual, maintenance must be performed using the appropriate TM, not from memory.

EVACUATION

Evacuation is necessary when a vehicle is damaged and cannot be repaired on-site within two hours or when it is the only means available to prevent capture or destruction by the enemy.

When a vehicle needs to be evacuated, the team leader reports its exact location, the vehicle type, and the extent of damage, if known, on the appropriate net to personnel designated in the unit's SOP or OPORD. Two soldiers should remain with the vehicle to assist in evacuation and repair, provide security, and deliver the repaired vehicle back to the team as soon as possible. A recovery vehicle from the company, battalion, or TF maintenance team will evacuate the damaged vehicle. It is vital that the damaged vehicle be placed in a covered position that allows the recovery vehicle to reach it without exposing the recovery crew to enemy fire.

If a recovery vehicle is not available or if time is critical, other team vehicles (if available) can evacuate the damaged vehicle for short distances. The decision to do this rests with the team leader. Procedures for towing are contained in the operator's manual. If the damaged vehicle will be lost for an extended period, the team can replace other vehicles' damaged equipment (such as weapons and radios) with properly functioning items from the damaged vehicle. The damaged equipment can then be repaired or replaced while the vehicle is being repaired. Self-evacuation by the team is a last resort that should be considered only to avoid losing the damaged vehicle to the enemy.

DESTRUCTION

When evacuation of damaged or inoperable equipment is impossible, it must be destroyed. Team leaders must make sure crews are trained to destroy the vehicle rather than allow it to fall into enemy hands. Instructions for destroying each item of equipment are included in the operator's manual.

The team leader should get the commander's authorization before destroying any equipment. However, when communications fail, the team leader must use his judgment to decide whether or not evacuation is possible. Every reasonable effort must be made to evacuate secure equipment, classified materials, and all weapons.

MEDICAL TREATMENT AND EVACUATION

Leaders must emphasize high standards of health and hygiene. Soldiers must shave daily (so that their protective masks will seal) and bathe and change clothes regularly to prevent disease. Each soldier should carry shaving equipment, soap, a towel, and a change of clothing in a waterproof bag inside his pack.

During cold weather, soldiers must check their hands and feet regularly to prevent frostbite, trench foot, or immersion foot. They must also learn that the effects of windchill on exposed skin are equal to those of temperatures much lower than the thermometer shows. A moving vehicle will cause a windchill effect even if the air is calm.

WOUNDED SOLDIERS

Battlefield positioning and dispersion make the treatment and evacuation of wounded personnel two of the most difficult tasks that an engineer recon team must execute. To ensure successful handling of wounded engineers, brigades, battalions, and TFs must specifically allocate CSS assets to the engineer recon team to assist in evacuation. In addition, operational planning or SOPs must cover evacuation procedures in detail.

In the engineer recon team, it is the team leader's responsibility to ensure that wounded team members receive immediate first aid and that the commander is notified of all casualties. Using engineer scouts who are trained as combat lifesavers is critical. As a minimum, one member of each engineer recon team must be trained as a combat lifesaver. If wounded team members require evacuation, the team leader can do one of the following:

- Coordinate evacuation with the closest troop, scout platoon, or company team for ground evacuation.
- Request that the brigade/battalion TF task-organize a dedicated ambulance to the team for operations forward of the larger element. In the case of the HMMWV section, the ambulance should be a HMMWV variant located (for security) with the nearest company team.
- Conduct self-evacuation with organic team assets.
- Coordinate for aerial evacuation through the battalion TF.

Aerial evacuation, if it is available, is preferred because of its speed. The engineer scouts coordinate with their higher command and then switch to the

designated frequency to coordinate directly with the medical-evacuation (MEDEVAC) aircraft. They must pick a relatively flat, open, and covered and concealed position for the aircraft's LZ. The location should be given to the aircraft by radio and marked with colored smoke as the aircraft approaches the area. The engineer recon team provides local security of the LZ until the evacuation is complete.

Regardless of the method of evacuation, the team leader and the assistant team leader must have the necessary CSS graphics available, to include casualty collection points. Evacuation procedures must be part of the section plan and should be rehearsed as part of mission preparation.

A wounded team member's individual weapon becomes the responsibility of the assistant team leader. Personal effects, weapons, and equipment are turned in to the company supply sergeant at the earliest opportunity. The team member's protective mask stays with him at all times. All sensitive items, such as maps, overlays, and SOPs, should also remain with the team.

SOLDIERS KILLED IN ACTION

The remains of personnel killed in action (KIA) will be placed in a body bag or sleeping bag or rolled in a poncho and evacuated by the team. The commander will designate a location for collection of KIA soldiers. If (as a last resort) the body must be left on the battlefield, the name, exact location, and circumstances are reported through channels with the appropriate SOP report. The lower dog tag is removed for turn-in to the team leader. The personal effects of a KIA soldier remain with the body. The KIA soldier's weapon, equipment, and issue items become the responsibility of the assistant team leader until they can be turned over to the supply sergeant or 1SG.

The bodies of KIA soldiers should not be placed on the same vehicle as wounded soldiers. If this rule cannot be adhered to, dead and wounded personnel may be carried on board a vehicle to its next stop. In an attack, the next stop may be the objective; in the defense, it may be the next BP. Teams must be prepared to give first aid and to continue the mission with a limited team without stopping.

PRISONERS

Enemy prisoners of war (EPWs) are excellent sources of combat intelligence information; they must be processed and evacuated to the rear quickly. If enemy soldiers want to surrender, it is a team's moral and legal responsibility to take them into custody and safeguard them until they can be evacuated.

The team leader directs team members to take the EPWs to a designated area. The prisoners are then evacuated to the rear for interrogation.

If an EPW is wounded and cannot be evacuated through medical channels, the nearest company XO or 1SG is notified. The EPW will be escorted to the company trains, or the 1SG will come forward with guards to evacuate him.

PRISONERS OF WAR

The basic principles for handling EPWs are covered by the five S and one T procedures: search, segregate, silence, speed, safeguard, and tag.

- **Search.** Remove all weapons and documents. Return to the EPW those personal items of no military value. The EPW keeps his helmet, protective mask, and gear to protect him from immediate dangers of the battle area.
- **Segregate.** Break the chain of command; separate EPWs by rank, sex, and other suitable categories. Keep the staunch fighters away from those who willingly surrender.
- **Silence.** Prevent EPWs from giving orders, planning escapes, and developing false cover stories.
- **Speed.** Speed EPWs to the rear to remove them from the battle area and to obtain and use their information.
- **Safeguard.** Prevent EPWs from escaping. Protect all EPWs from violence, insults, curiosity, and reprisals of any kind.
- **Tag.** Tag EPWs and documents or special equipment.

Never approach an enemy soldier. He may have a weapon hidden nearby, or he may be booby trapped. Gesture for him to come forward until it is clear that he is honestly surrendering and not trying to lure friendly troops into an ambush. Use a thermal sight to locate possible ambushes. When searching the EPW, always have another friendly soldier cover him with a weapon. Do not get between the EPW and the soldier covering him.

The rights of EPWs have been established by international law, and the US has agreed to obey these laws. Once an enemy soldier shows he wants to surrender, he must be treated humanely. It is a court-martial offense to physically or mentally harm or mistreat a EPW or needlessly expose him to fire. In addition, mistreated EPWs or those who receive special favors are not good interrogation subjects.

The senior officer or NCO on the scene is legally responsible for the care of EPWs. If the unit cannot evacuate an EPW within a reasonable time, he must be provided with food, water, and medical treatment.

Before evacuating an EPW, ensure that a tag is attached to him listing pertinent information and procedures. Tags may be obtained through supply channels or made from materials available on the battlefield. An example is illustrated in Figures 7-4 and 7-5, pages 7-12 and 7-13.

FRONT

ATTACH TO EPW A

DATE OF CAPTURE

NAME
SERIAL NUMBER
RANK
DATE OF BIRTH
UNIT
LOCATION OF CAPTURE
CAPTURING UNIT
SPECIAL CIRCUMSTANCES OF CAPTURE
WEAPONS/DOCUMENTS

FORWARD TO UNIT B

DATE OF CAPTURE
NAME
SERIAL NUMBER
RANK
DATE OF BIRTH
UNIT
LOCATION OF CAPTURE
CAPTURING UNIT
SPECIAL CIRCUMSTANCES OF CAPTURE
WEAPONS/DOCUMENTS

ATTACH TO ITEM C

DATE OF CAPTURE
NAME
SERIAL NUMBER
RANK
DATE OF BIRTH
UNIT
LOCATION OF CAPTURE
DESCRIPTION OF WEAPONS/DOCUMENTS

DOCUMENT AND **WEAPONS CARD**

Figure 7-4. Sample standardized EPW tag (front)

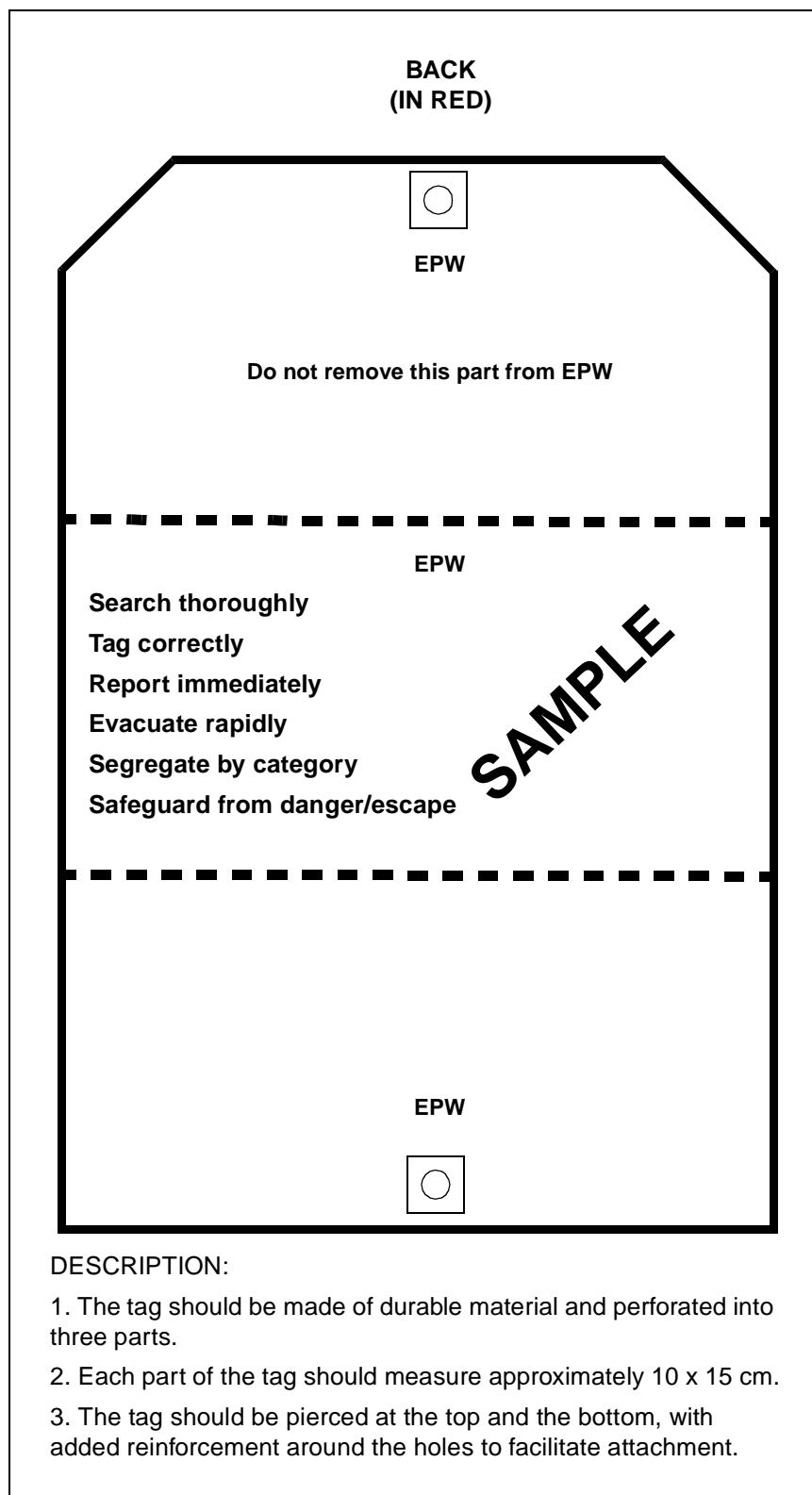

Figure 7-5. Sample standardized EPW tag (back)

CAPTURED ENEMY DOCUMENTS AND EQUIPMENT

Captured enemy documents (such as maps, orders, records, and photographs) and equipment are excellent sources of intelligence information. However, if captured items are not handled properly, the information in them may be lost or delayed until it is useless. These items must be evacuated to the next level of command as soon as possible.

The section should tag each captured item (see Figure 7-6). If the item is found in the EPW's possession, include his name on the tag and give the item to the guard. The guard delivers the item with the EPW to the next higher headquarters.

TYPE OF DOCUMENT
DATE/TIME OF CAPTURE
PLACE OF CAPTURE (GRID COORDINATES)
CAPTURING UNIT
CIRCUMSTANCES OF CAPTURE

SAMPLE

Figure 7-6. Sample tag for captured documents and equipment

CIVILIANS

When dealing with civilians or detained noncombatants, care must be taken. These personnel should be processed through the military police or the local police authority.

Appendix A
Metric Conversion Chart

This appendix complies with current Army directives which state that the metric system will be incorporated into all new publications. Table A-1 is a conversion chart.

Table A-1. Metric conversion chart

US Units	Multiplied By	Metric Units
Acres	0.4947	Hectares
Cubic feet	0.0283	Cubic meters
Cubic inches	16.3872	Cubic centimeters
Cubic inches	0.0164	Liters
Cubic yards	0.7646	Cubic meters
Feet	0.3048	Meters
Feet per second	18.288	Meters per minute
Gallons	3.7854	Liters
Inches	2.54	Centimeters
Inches	0.0254	Meters
Inches	25.4001	Millimeters
Miles	1.6093	Kilometers
Square feet	0.0929	Square meters
Square inches	6.4516	Square centimeters
Square miles	2.590	Square kilometers
Square yards	0.8361	Square meters
Yards	0.914	Meters
Metric Units	Multiplied By	US Units
Centimeters	0.3937	Inches
Cubic centimeters	0.0610	Cubic inches
Cubic meters	35.3144	Cubic feet
Cubic meters	1.3079	Cubic yards
Kilometers	0.62137	Miles
Meters	3.2808	Feet
Meters	39.37	Inches
Meters	1.0936	Yards
Millimeters	0.03937	Inches
Square centimeters	0.155	Square inches
Square kilometers	0.3861	Square miles
Square meters	1.1960	Square yards
Square meters	10.764	Square feet

Appendix B
Bridge Classification

Bridge and vehicle classification allows vehicle operators to avoid bridge failure due to overloading. Vehicle operators may drive across without restrictions if their vehicles' class numbers are less than or equal to the bridge class number. This appendix provides a quick method of estimating bridge capacity in the field.

BRIDGE SIGNS

All classified vehicles and bridges in the theater of operations require classification signs. Bridge signs are circular with a yellow background and black inscriptions. Sign diameters are a minimum of 16 inches for one-lane bridges and 20 inches for two-lane bridges. A two-lane bridge classification sign has two numbers, side by side, on its sign (see Figure B-1). The number on the left is the bridge classification when both lanes are in service simultaneously. The number on the right indicates the classification if the bridge is carrying one-way traffic and the vehicles proceed along the centerline of the bridge. For bridges with separate classifications for wheeled and tracked vehicles (dual classification), use a special circular sign that indicates both classifications (see Figure B-1, right side). Classify bridges greater than class 50 as dual-class bridges. Use a separate rectangular sign, if necessary, to show bridge width limitations.

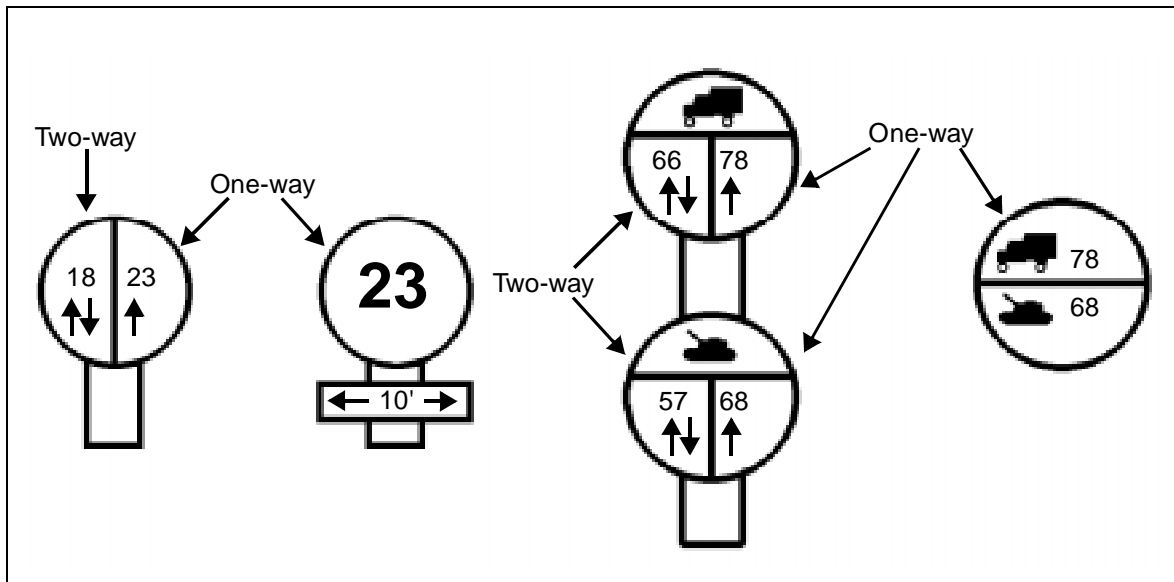

Figure B-1. Bridge classification signs

WIDTH AND HEIGHT RESTRICTIONS

Table B-1 lists width restrictions for bridges. If a one-lane bridge does not meet width requirements, post a rectangular warning sign under the classification sign showing the actual clear width. For a two-lane bridge, downgrade the two-way classification to the highest class for which it does qualify (one-way class is not affected). If the minimum overhead clearance is less than 4.3 meters, post a sign with the limited clearance.

Table B-1. Minimum roadway widths

Roadway Width (Meters)	Bridge Classification	
	One-Way	Two-Way
2.75 to 3.34	12	0
3.35 to 3.99	30	0
4 to 4.49	60	0
4.5 to 4.99	100	0
5 to 5.4	150	0
5.5 to 7.2	150	30
7.3 to 8.1	150	60
8.2 to 9.7	150	100
9.8+	150	150

NOTE: The minimum overhead clearance for all classes is 4.5 m.

CLASSIFICATION PROCEDURES

Tables B-2 through B-9 and Figures B-2 through B-16, pages B-2 through B-26, are used to determine the bridge classification of various bridges.

Table B-2. Notations

Variable	Definition
b	stringer width, in inches
b_d	concrete slab width, in feet
b_e	effective slab width, in feet
b_{e1}	effective slab width for one-lane traffic, in feet
b_{e2}	effective slab width for two-lane traffic, in feet
b_R	curb-to-curb roadway width, in feet
d	stringer depth, in inches
d_f	depth of fill, in inches
d_i	interior stringer depth ($d - 2t_f$), in inches
f_{bDL}	allowable bearing stress of the stringer, in ksi
L	span length, in feet
L_c	maximum brace spacing, in feet
L_m	maximum span length, in feet
m	moment capacity per stringer, in kip-feet

B-2 Bridge Classification

Table B-2. Notations (continued)

Variable	Definition
m_{DL}	dead-load moment per stringer, in kip-feet
M_{DL}	dead-load moment for entire span, in kip-feet
m_{LL}	live-load moment per stringer, in kip-feet
M_{LL}	live-load moment per lane, in kip-feet
M_{LL1}	live-load moment for one-lane traffic, in kip-feet
M_{LL2}	live-load moment for two-lane traffic, in kip-feet
N_b	number of braces
N_L	number of lanes
N_S	total number of stringers in the span
N_1	effective number of stringers for one-lane traffic
N_2	effective number of stringers for two-lane traffic
PLC	provisional load class
R	rise of arch, in feet
S	section modulus, in cubic inches
S_b	actual brace spacing, in feet
S_c	section modulus of the composite section, in cubic inches
S_s	center-to-center stringer spacing, in feet
t_c	crown thickness, in inches
t_d	average deck thickness, in inches
t_{eff}	effective deck thickness, in inches
t_f	flange thickness, in inches
t_{pl}	plate thickness, in inches
t_w	web thickness, in inches
t_x	thickness factor
T_1	one-lane, tracked-vehicle classification
T_2	two-lane, tracked-vehicle classification
v	shear capacity per stringer, in kips
v_{DL}	dead-load shear per stringer, in kips
V_{DL}	estimated dead-load shear of span, in kips
v_{LL}	live-load shear per stringer, in kips
V_{LL}	live-load shear per lane, in kips
W_s	stringer weight, in lbs/ft
W_1	one-lane, wheeled-vehicle classification
W_2	two-lane, wheeled-vehicle classification
X_{pl}	plate thickness factor
%lam	percent of lamination

Map Sheet Recon Officer/NCO	Grid Unit	Date
--------------------------------	--------------	------

<p>BRIDGE DIMENSIONS</p> L _____ ft b _R _____ ft N _L _____ (2 if b _R ≥ 18 ft) N _S _____ S _S _____ ft N _b _____ S _b _____ ft Deck: Single-layer, multilayer, or laminated t _d _____ in %lam _____		<p>STRINGER DIMENSIONS</p> Timber: b _____ in d _____ in Steel: Type _____ (Table B-4) d _____ in b _____ in t _w _____ in t _f _____ in
----------------------------------------------------------------------------------------------------------------------------------------------------------------------------------------------------------------------------------------------------------------------------------------------------------------------------	--	------------------------------------------------------------------------------------------------------------------------------------------------------------------------------------------

<p>PROCEDURE</p> <ol style="list-style-type: none"> 1. m _____ (Table B-3 or B-4) 2. M_{DL} _____ (Table B-5) 3. m_{DL} _____ (M_{DL} / N_S) 4. m_{LL} _____ <ol style="list-style-type: none"> a. Timber: m - m_{DL} b. Steel: (m - m_{DL}) / 1.15 5. L_m _____ (Table B-3 or B-4) 6. Adjust m_{LL} if L > L_m: m_{LL} (L_m / L) 7. N₁ _____ (5 / S_S) + 1 8. N₂ _____ 0.375N_S; calculate only if b_R ≥ 18 ft 9. M_{LL1} _____ (N₁) m_{LL} 10. M_{LL2} _____ (smaller of N₁ or N₂) m_{LL} 11. Moment classification (Figures B-13 and B-14) T₁ _____ T₂ _____ W₁ _____ W₂ _____ 12. v _____ (Table B-3 or B-4) 13. V_{DL} _____ (Table B-5) 21. Final classification 	<ol style="list-style-type: none"> 14. v_{DL} _____ (V_{DL} / N_S) 15. v_{LL} _____ (v - v_{DL}) 16. V_{LL} _____ <ol style="list-style-type: none"> a. Timber: (16/3) (v_{LL}) ([N₁ or N₂] / [N₁ or N₂] + 1) b. Steel: (2v_{LL} / 1.15) 17. Shear classification (Figures B-15 and B-16) T₁ _____ T₂ _____ W₁ _____ W₂ _____ 18. Width classification (Table B-2) T₁ _____ T₂ _____ W₁ _____ W₂ _____ 19. Deck classification (Figure B-8) T₁ _____ T₂ _____ W₁ _____ W₂ _____ <ol style="list-style-type: none"> a. Single-layer: t_{eff} = t_d b. Multilayer: t_{eff} = t_d - 2 in c. Laminated: t_{eff} = t_d (%lam) 20. N_{b(reqd)} _____ <ol style="list-style-type: none"> a. Timber: 3 required if d ≥ 2b b. Steel: (L / L_C) + 1 (L_C in Table B-4) Add braces if N_b < N_{b(reqd)}
------------------------------------------------------------------------------------------------------------------------------------------------------------------------------------------------------------------------------------------------------------------------------------------------------------------------------------------------------------------------------------------------------------------------------------------------------------------------------------------------------------------------------------------------------------------------------------------------------------------------------------------------------------------------------------------------------------------------------------------------------------------------------------------------------------------------------------------------------------------------------------------------------------------------------------------------------------------------------------------------------------------------------------------------------------------------------------------------------------------------------------------------------------------------------------------------------------------	------------------------------------------------------------------------------------------------------------------------------------------------------------------------------------------------------------------------------------------------------------------------------------------------------------------------------------------------------------------------------------------------------------------------------------------------------------------------------------------------------------------------------------------------------------------------------------------------------------------------------------------------------------------------------------------------------------------------------------------------------------------------------------------------------------------------------------------------------------------------------------------------------------------------------------------------------------------------------------------------------------------------------------------------------------------------------------------------------------------------------------------------------------------------------------------------------------------------------------------------------------------------------------------------------------------------------------------------------------------------------------------------------------------------------------------------------------------------------------------------------------------------------------------------

	T ₁	T ₂	W ₁	W ₂
Moment (Step 11)				
Shear (Step 17)				
Width (Step 18)				
Deck (Step 19)				
Final (lowest number)				

Figure B-2. Timber- or steel-trestle bridge with timber deck

B-4 Bridge Classification

Map Sheet Recon Officer/NCO	Grid Unit	Date
--------------------------------	--------------	------

<p>BRIDGE DIMENSIONS</p> L _____ ft b _R _____ ft N _L _____ (2 if b _R ≥ 18 ft) N _S _____ S _S _____ ft t _d _____ in (do not include wearing surface)		<p>STRINGER DIMENSIONS</p> Type _____ (Table B-4) b _____ in d _____ in t _w _____ in
--------------------------------------------------------------------------------------------------------------------------------------------------------------------------------------------------------------------------------------------	--	-----------------------------------------------------------------------------------------------------------------

<p>PROCEDURE</p> <ol style="list-style-type: none"> 1. m _____ (Table B-4) 2. W_s _____ (Table B-4) 3. m_{DL} _____ 0.00013L² (W_s + (t_d S_s)) 4. m_{LL} _____ (m - m_{DL}) / 1.15 5. L_m _____ (Table B-4) 6. Adjust m_{LL} if L > L_m: m_{LL} (L_m / L) 7. N₁ _____ (5 / S_s) + 1 8. N₂ _____ 0.375N_s; calculate only if b_R ≥ 18 ft 	<ol style="list-style-type: none"> 9. M_{LL1} _____ (N₁) m_{LL} 10. M_{LL2} _____ (smaller of N₁ or N₂) m_{LL} 11. Moment classification (Figures B-13 and B-14) T₁ _____ T₂ _____ W₁ _____ W₂ _____ 12. Width classification (Table B-2) T₁ _____ T₂ _____ W₁ _____ W₂ _____ 13. Deck classification (Figure B-8) T₁ _____ T₂ _____ W₁ _____ W₂ _____ a. t_d < 5 in: Class 40 b. t_d ≥ 5 in: Class 150
---------------------------------------------------------------------------------------------------------------------------------------------------------------------------------------------------------------------------------------------------------------------------------------------------------------------------------------------------------------------------------------------------------------------------------------------------------------------------------------------------------------------------------------------------------------------------------------------------------------	---------------------------------------------------------------------------------------------------------------------------------------------------------------------------------------------------------------------------------------------------------------------------------------------------------------------------------------------------------------------------------------------------------------------------------------------------------------------------------------------------------------------------------------------------------------------------------------------------------------------------------------------------------------------------------------------------------------------------------------------------------------------------------------------------------------------

14. Final classification

	T ₁	T ₂	W ₁	W ₂
Moment (Step 11)				
Width (Step 12)				
Deck (Step 13)				
Final (lowest number)				

Figure B-3. Steel-stringer bridge with concrete deck (noncomposite construction)

Map Sheet
Recon Officer/NCO

Grid
Unit

Date

BRIDGE DIMENSIONS

L _____ ft
 b_R _____ ft
 N_L _____ (2 if b_R ≥ 18 ft)
 N_S _____
 S_S _____ ft
 t_d _____ in (do not include wearing surface)
 S_c _____ (Table B-8)

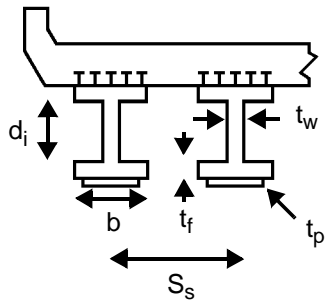

STRINGER DIMENSIONS

Type _____ (Table B-4)
 b _____ in
 d _____ in (d = d_i + 2t_f)
 t_w _____ in
 t_f _____ in
 S _____ in³
 t_{pl} _____ in
 W_s _____ (steel type)

PROCEDURE

1. $m_{DL} \text{ _____ } 0.00013L^2 (W_s + (t_d) S_s)$
2. $f_{bDL} \text{ _____ } 12m_{DL} / [(S) (x_{PL})]$
 - a. No plate: $x_{PL} = 1.00$
 - b. $t_{pl} = 0.5t_f$: $x_{PL} = 1.25$
 - c. $t_{pl} = t_f$: $x_{PL} = 1.50$
3. $m_{LL} \text{ _____ } [(29 - f_{bDL}) (S_c) (x_{PL}) (t_x)] / 13.8$
(t_x from Table B-9)
4. $N_1 \text{ _____ } (5 / S_s) + 1$
5. $N_2 \text{ _____ } 0.375N_s$; calculate only if b_R ≥ 18 ft
6. $M_{LL1} \text{ _____ } (N_1) m_{LL}$
7. $M_{LL2} \text{ _____ } (\text{smaller of } N_1 \text{ or } N_2) m_{LL}$
8. Moment classification (Figures B-13 and B-14)
T₁ _____ T₂ _____ W₁ _____ W₂ _____
9. Width classification (Table B-2)
T₁ _____ T₂ _____ W₁ _____ W₂ _____
10. Deck classification (Figure B-8)
T₁ _____ T₂ _____ W₁ _____ W₂ _____
 - a. t_d < 5 in: Class 40
 - b. t_d ≥ 5 in: Class 150
11. Final classification

	T ₁	T ₂	W ₁	W ₂
Moment (Step 8)				
Width (Step 9)				
Deck (Step 10)				
Final (lowest number)				

Figure B-4. Concrete steel-stringer bridge (composite construction)

Map Sheet Recon Officer/NCO	Grid Unit	Date																					
<p>BRIDGE DIMENSIONS</p> L _____ ft b _R _____ ft t _d _____ in S _S _____ ft N _S _____		<p>STRINGER DIMENSIONS</p> d _____ in b _____ in																					
<p>PROCEDURE</p> 1. m _____ 0.0116 (S _s) (d ²) 2. m _{DL} _____ 0.00013L ² (b _d + (t _d) S _s) 3. m _{LL} _____ (m - m _{DL}) / 1.15 4. N ₁ _____ (5 / S _s) + 1 5. N ₂ _____ 0.375N _s ; calculate only if b _R ≥ 18 ft	6. M _{LL1} _____ (N ₁) m _{LL} 7. M _{LL2} _____ (smaller of N ₁ or N ₂) m _{LL} 8. Moment classification (Figures B-13 and B-14) T ₁ _____ T ₂ _____ W ₁ _____ W ₂ _____ 9. Width classification (Table B-2) T ₁ _____ T ₂ _____ W ₁ _____ W ₂ _____																						
10. Final classification																							
	<table border="1" style="width: 100%; border-collapse: collapse;"> <thead> <tr> <th style="width: 30%;"></th> <th style="width: 15%; text-align: center;">T₁</th> <th style="width: 15%; text-align: center;">T₂</th> <th style="width: 15%; text-align: center;">W₁</th> <th style="width: 15%; text-align: center;">W₂</th> </tr> </thead> <tbody> <tr> <td>Moment (Step 8)</td> <td></td> <td></td> <td></td> <td></td> </tr> <tr> <td>Width (Step 9)</td> <td></td> <td></td> <td></td> <td></td> </tr> <tr> <td>Final (lowest number)</td> <td></td> <td></td> <td></td> <td></td> </tr> </tbody> </table>				T ₁	T ₂	W ₁	W ₂	Moment (Step 8)					Width (Step 9)					Final (lowest number)				
	T ₁	T ₂	W ₁	W ₂																			
Moment (Step 8)																							
Width (Step 9)																							
Final (lowest number)																							

Figure B-5. Concrete T-beam bridge with asphalt wearing surface

Map Sheet
Recon Officer/NCO

Grid
Unit

Date

BRIDGE DIMENSIONS

L _____ ft
 b_d _____ ft
 b_R _____ ft
 t_d _____ in (do not include wearing surface)

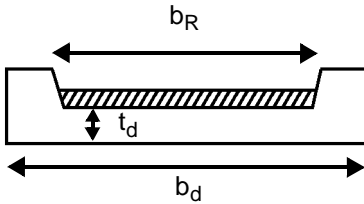

PROCEDURE

1. m_{LL} _____ (Figure B-10)
2. b_e _____
 - a. One-lane:
 $b_{e1} = L / [0.75 + (L / b_d)]$
 - b. Two-lane:
 $b_{e2} = L / [0.25 + (2L / b_d)]$
(Calculate b_{e2} only if $b_R \geq 18$ ft)

3. M_{LL1} _____ (b_{e1}) m_{LL}
4. M_{LL2} _____ (b_{e2}) m_{LL}
5. Moment classification (Figures B-13 and B-14)
 T_1 _____ T_2 _____ W_1 _____ W_2 _____
6. Width classification (Table B-2)
 T_1 _____ T_2 _____ W_1 _____ W_2 _____

7. Final classification

	T_1	T_2	W_1	W_2
Moment (Step 5)				
Width (Step 6)				
Final (lowest number)				

Figure B-6. Concrete-slab bridge with asphalt wearing surface

Map Sheet Recon Officer/NCO	Grid Unit	Date
--------------------------------	--------------	------

BRIDGE DIMENSIONS

L _____ ft
 t_c _____ ft
 d_f _____ ft
 b_R _____ ft
 R _____ ft

The diagram shows a cross-section of a masonry arch bridge. The span is labeled 'L' with a double-headed arrow below the arch. The rise of the arch is labeled 'R' with a vertical double-headed arrow from the spring line to the crown. The crown thickness is labeled 't_c' with a vertical double-headed arrow at the top of the arch. The depth of the foundation below the spring line is labeled 'd_f' with a vertical double-headed arrow.

PROCEDURE

1. PLC _____ (Figure B-11)
2. Arch factors:
 - a. Span-to-rise ratio (SR = L / R) _____
 - b. Profile factors (Table B-6) _____
 - c. Material factors (Table B-7) _____
 - d. Joint factors (Table B-7) _____
 - e. Deformations (Table B-7) _____
 - f. Crack factors (Table B-7) _____
 - g. Abutment size factors (Table B-7) _____
 - h. Abutment fault factors (Table B-7) _____
3. Classification of arch factors:

T₁ _____ (PLC x product of factors 2b through 2h)

T₂ _____ (0.9T₁)

W₁ _____ (Figure B-12)

W₂ _____ (Figure B-12)
4. Width classification (Table B-2)

T₁ _____ T₂ _____ W₁ _____ W₂ _____
5. Final classification

	T ₁	T ₂	W ₁	W ₂
Factors (Step 3)				
Width (Step 4)				
Final (lowest number)				

Figure B-7. Masonry-arch bridge

Table B-3. Properties of timber stringers

Rectangular Stringers				Rectangular Stringers			
Nominal Size (b x d, in) ¹	m (kip-ft) ²	v (kips) ³	L _m (ft) ⁴	Nominal Size (b x d, in) ¹	m (kip-ft) ²	v (kips) ³	L _m (ft) ⁴
4 x 6	4.80	2.40	7.14	16 x 16	136.50	25.60	19.10
4 x 8	8.53	3.20	9.50	16 x 18	172.80	28.80	21.50
4 x 10	13.33	4.00	11.90	16 x 20	213.00	32.00	23.80
4 x 12	19.20	4.80	14.30	16 x 22	258.00	35.20	26.20
6 x 8	12.80	4.80	9.50	16 x 24	307.00	38.40	28.60
6 x 10	20.00	6.00	11.90	18 x 18	194.40	32.40	21.50
6 x 12	28.80	7.20	14.30	18 x 20	240.00	36.00	23.80
6 x 14	39.20	8.40	16.70	18 x 22	290.00	39.60	26.20
6 x 16	51.20	9.60	19.10	18 x 24	346.00	43.20	28.60
6 x 18	64.80	10.80	21.50	Round Stringers (Nominal Size is Diameter)			
8 x 8	17.07	6.40	9.50				
8 x 10	26.70	8.00	11.90	8	10.05	5.70	9.50
8 x 12	38.40	9.60	14.30	9	14.31	7.20	10.70
8 x 14	52.30	11.20	16.70	10	19.63	8.80	11.90
8 x 16	68.30	12.80	19.10	11	26.10	10.60	13.10
8 x 18	86.40	14.40	21.50	12	33.90	12.70	14.30
8 x 20	106.70	16.40	23.80	13	43.10	15.00	15.50
8 x 22	129.10	17.60	26.20	14	53.90	17.40	16.70
8 x 24	153.60	19.20	28.60	15	67.50	20.20	17.80
10 x 10	33.30	10.00	11.90	16	80.40	22.60	19.10
10 x 12	48.00	12.00	14.30	17	98.20	26.00	20.20
10 x 14	65.30	14.00	16.70	18	114.50	28.60	21.50
10 x 16	85.30	16.00	19.10	19	137.10	32.40	22.60
10 x 18	108.00	18.00	21.50	20	157.10	35.40	23.80
10 x 20	133.30	20.00	23.80	21	185.20	39.60	24.90
10 x 22	161.30	22.00	26.20	22	209.00	42.70	26.20
10 x 24	192.00	24.00	28.60	23	243.00	47.60	27.30
12 x 12	57.60	14.40	14.30	24	271.00	50.80	28.60
12 x 14	78.40	16.80	16.70	25	312.00	56.20	29.70
12 x 16	102.40	19.20	19.10	26	351.00	60.80	30.90
12 x 18	129.60	21.60	21.50	27	393.00	65.60	32.10
12 x 20	160.00	24.00	23.80	28	439.00	70.50	33.30
12 x 22	193.60	26.40	26.20	29	487.00	75.60	34.50
12 x 24	230.00	28.80	28.60	30	540.00	81.00	35.70
14 x 14	91.50	19.60	16.70	31	595.00	86.40	36.80
14 x 16	119.50	22.40	19.10	32	655.00	92.10	38.00
14 x 18	151.20	25.20	21.50	33	718.00	98.00	39.20
14 x 20	186.70	28.00	23.80	34	786.00	104.00	40.40
14 x 22	226.00	30.80	26.20	35	857.00	110.20	41.60
14 x 24	269.00	33.60	28.60	36	933.00	116.60	42.80

¹ If $d > 2b$, bracing is required at the midspan and at both ends.

² Moment capacity for rectangular stringers not listed is $bd^2/30$. Moment capacity for round stringers not listed is $0.02d^3$.

³ Shear capacity for rectangular stringers not listed is $bd/10$. Shear capacity for round stringers not listed is $0.09d^2$.

⁴ Maximum span length for stringers not listed is $1.19d$.

Table B-4. Properties of steel stringers
($F_y = 36$ ksi, $f_b = 27$ ksi, $f_v = 16.5$ ksi)

Nominal Size	d (in)	b (in)	T_f (in)	t_w (in)	m (kip-ft)	v (kips)	L_m (ft)	L_c (ft)
W39x211	39.250	11.750	1.438	0.75	1,770	450	100	12.4
W37x206	36.750	11.750	1.438	0.75	1,656	425	95	12.4
W36x300	36.750	16.625	1.688	0.94	2,486	520	94	17.6
W36x194	36.500	12.125	1.250	0.81	1,492	431	93	12.8
W36x182	36.375	12.125	1.187	0.75	1,397	406	93	12.8
W36x170	36.125	12.000	1.125	1.06	1,302	381	92	12.7
W36x160	36.000	12.000	1.000	1.06	1,217	365	92	12.7
W36x230	35.875	16.500	1.250	0.75	1,879	421	91	17.4
W36x150	35.875	12.000	0.937	0.62	1,131	350	91	12.7
W36x201	35.375	11.750	1.438	0.75	1,545	402	90	12.4
W33x196	33.375	11.750	1.438	0.75	1,433	377	85	12.4
W33x220	33.250	15.750	1.250	0.81	1,661	392	85	16.6
W33x141	33.250	11.500	0.937	0.62	1,005	313	85	12.1
W33x130	33.125	11.500	0.875	0.56	911	300	85	12.1
W33x200	33.000	15.575	1.125	0.56	1,506	362	84	16.6
W31x180	31.500	11.750	1.312	0.75	1,327	327	80	12.4
W30x124	30.125	10.500	0.937	0.68	797	273	77	11.1
W30x116	30.000	10.500	0.875	0.62	738	263	76	11.1
W30x108	29.875	10.500	0.750	0.56	672	255	76	11.1
W30x175	29.500	11.750	1.312	0.56	1,156	304	75	12.4
W27x171	27.500	11.750	1.312	0.68	1,059	282	70	12.4
W27x102	27.125	10.000	0.812	0.68	599	217	69	10.6
W27x94	26.875	10.000	0.750	0.50	546	205	68	10.6
W26X157	25.500	11.750	1.250	0.50	915	237	65	12.4
W24x94	24.250	9.000	0.875	0.62	497	191	62	9.5
W24x84	24.125	9.000	0.750	0.50	442	174	61	9.5
W24x100	24.000	12.000	0.750	0.50	560	173	61	12.7
S24x120	24.000	8.000	1.125	0.50	564	286	61	8.4
S24x106	24.000	7.875	1.125	1.18	527	224	61	8.3
S24x80	24.000	7.000	0.875	0.62	391	183	61	7.4
W24x76	23.875	9.000	0.687	0.50	394	163	61	9.5
W24x153	23.625	11.750	0.250	0.43	828	217	60	12.4
S24x134	23.625	8.500	1.250	0.62	634	283	60	9.0
S22x75	22.000	7.000	0.812	0.81	308	168	56	7.4
W21x139	21.625	11.750	1.187	0.50	699	198	55	12.4
S21x112	21.625	7.875	1.187	0.62	495	238	55	8.3
W21x73	21.250	8.250	0.750	0.75	338	148	54	8.7
W21x68	21.125	8.250	0.687	0.50	315	140	54	8.7
W21x62	21.000	8.250	0.625	0.43	284	130	53	8.7

Table B-4. Properties of steel stringers (continued)
($F_y = 36$ ksi, $f_b = 27$ ksi, $f_v = 16.5$ ksi)

Nominal Size	d (in)	b (in)	T_f (in)	t_w (in)	m (kip-ft)	v (kips)	L_m (ft)	L_c (ft)
S20x85	20.000	7.125	0.937	0.37	337	195	51	7.5
S20x65	20.000	6.500	0.812	0.68	245	132	51	6.9
W20x134	19.625	11.750	1.187	0.43	621	177	50	12.4
W18x60	18.250	7.500	0.687	0.62	243	115	46	7.9
S18x86	18.250	7.000	1.000	0.43	326	184	46	7.4
W18x55	18.125	7.500	0.625	0.37	220	108	46	7.9
S18x80	18.000	8.000	0.937	0.50	292	133	46	8.4
W18x50	18.000	7.500	0.562	0.37	200	99	46	7.9
S18x55	18.000	6.000	0.687	0.50	199	126	46	6.3
S18x122	17.750	11.750	1.062	0.56	648	145	45	12.4
S18x62	17.750	6.875	0.750	0.37	238	100	45	7.3
S18x77	17.750	6.625	0.937	0.62	281	163	45	7.0
W16x112	16.750	11.750	1.000	0.56	450	136	42	12.4
S16x70	16.750	6.500	0.937	0.62	238	146	42	6.9
W16x50	16.250	7.125	0.625	0.37	181	94	41	7.5
W16x45	16.125	7.000	0.562	0.37	163	85	41	7.4
W16x64	16.000	8.500	0.687	0.43	234	106	40	9.0
W16x40	16.000	7.000	0.500	0.31	145	75	40	7.4
S16x50	16.000	6.000	0.687	0.43	155	105	40	6.3
W16x36	15.875	7.000	0.437	0.31	127	74	40	7.4
W16x110	15.750	11.750	1.000	0.56	345	127	40	12.4
S16x62	15.750	6.125	0.875	0.56	200	129	40	6.5
S16x45	15.750	5.375	0.625	0.43	150	104	40	5.7
W15x103	15.000	11.750	0.937	0.56	369	121	38	12.4
S15x56	15.000	5.875	0.812	0.50	173	110	38	6.2
S15x43	15.000	5.500	0.625	0.43	132	93	38	5.8
W14x101	14.250	11.750	0.937	0.56	344	114	36	12.4
S14x40	14.250	5.375	0.375	0.37	119	83	36	5.7
S14x51	14.125	5.625	0.750	0.50	150	104	36	5.9
S14x70	14.000	8.000	0.937	0.43	204	87	35	8.4
S14x57	14.000	6.000	0.875	0.50	153	101	35	6.3
W14x34	14.000	6.750	0.437	0.31	121	78	35	7.1
W14x30	13.875	6.750	0.375	0.25	109	61	35	7.1
W14x92	13.375	11.750	0.875	0.50	297	96	34	12.4
S14x46	13.375	5.375	0.687	0.50	126	99	34	5.7
S13x35	13.000	5.000	0.625	0.37	85	72	33	5.3
S13x41	12.625	5.125	0.687	0.37	108	104	32	5.4
W12x36	12.250	6.625	0.565	0.31	103	56	31	7.0
S12x65	12.000	8.000	0.937	0.43	182	73	30	8.4
W12x27	12.000	6.500	0.375	0.25	76	44	30	6.9

Table B-4. Properties of steel stringers (continued)
($F_y = 36$ ksi, $f_b = 27$ ksi, $f_v = 16.5$ ksi)

Nominal Size	d (in)	b (in)	T_f (in)	t_w (in)	m (kip-ft)	v (kips)	L_m (ft)	L_c (ft)
S12x50	12.000	5.500	0.687	0.68	113	120	30	5.8
S12x32	12.000	5.000	0.562	0.37	81	62	30	5.3
S12x34	11.250	4.750	0.625	0.43	81	72	28	5.0
W11x76	11.000	11.000	0.812	0.50	202	67	28	11.6
S10x29	10.625	4.750	0.562	0.31	67	48	27	5.0
W10x25	10.125	5.750	0.437	0.25	59	38	25	6.1
S10x40	10.000	6.000	0.687	0.37	92	53	25	6.3
S10x35	10.000	5.000	0.500	0.62	65	88	25	5.3
S10x25	10.000	4.625	0.500	0.31	55	46	25	4.9
W10x21	9.875	5.750	0.312	0.25	48	36	25	6.1
W10x59	9.250	9.500	0.687	0.43	132	56	25	10.0
S9x25	9.500	4.500	0.500	0.31	51	43	24	4.8
S9x50	9.000	7.000	0.812	0.37	103	45	23	7.4
S8x35	8.000	6.000	0.625	0.31	65	34	20	6.3
S8x28	8.000	5.000	0.562	0.31	49	35	20	5.3
W8x31	8.000	8.000	0.437	0.31	61	33	20	8.4
W8x44	7.875	7.875	0.625	0.75	81	40	20	8.3
W7x35	7.125	7.125	0.562	0.37	58	37	18	7.5
W6x31	6.250	6.250	0.562	0.37	45	31	16	6.6

Table B-5. Dead-load moment and shear

L (ft)	Timber Stringer/Timber Deck				Steel Stringer/Timber Deck			
	One-Lane		Two-Lane		One-Lane		Two-Lane	
	M _{DL} (kip-ft)	V _{DL} (kips)	M _{DL} (kip-ft)	V _{DL} (kips)	M _{DL} (kip-ft)	V _{DL} (kips)	M _{DL} (kip-ft)	V _{DL} (kips)
70					649.26	37.10	1,133.13	64.75
65					538.68	33.15	937.42	57.69
60					441.00	29.40	765.00	51.00
55					355.44	25.85	614.45	44.69
50					281.25	22.50	484.38	38.75
45					217.69	19.35	373.36	33.19
40					164.00	16.40	280.00	28.00
38					145.12	15.28	247.85	26.03
36					127.66	14.18	217.08	24.12
34					111.55	13.12	189.30	22.27
32					96.77	12.10	163.84	20.48
30	91.13	12.15	160.88	21.45	83.25	11.10	140.63	18.75
28	76.24	10.89	134.06	19.15	70.95	10.14	119.56	17.08
26	63.04	9.70	110.36	16.98	59.83	9.20	100.56	15.47
24	51.41	8.57	89.57	14.93	49.82	8.30	83.52	13.92
22	41.26	7.50	71.51	13.00	40.90	7.44	68.37	12.43
20	32.50	6.50	56.00	11.20	33.00	6.60	55.00	11.00
18	25.03	5.56	42.85	9.52	26.10	5.80	43.34	9.63
16	18.75	4.89	31.87	7.97	20.10	5.02	33.28	8.32
14	13.57	3.88	22.88	6.54	14.99	4.28	24.75	7.07
12	9.40	3.13	15.70	5.23	10.73	3.58	17.64	5.88
10	6.13	2.45	10.13	4.05	7.25	2.90	11.88	4.75
9	4.80	2.13	7.89	3.51				
8	3.66	1.83	5.98	2.99				

Table B-6. Profile factors

Serial No	Span-to-Rise Ratio	Factor	Remarks
1	Up to 4	1.0	For a given load, a flat arch of steeper profile (although it has a very large rise) may fail due to the crown's action as a smaller, flatter arch.
2	Over 4	See Figure B-9	

Table B-7. Arch factors

Material Factors			
Serial No.	Type of Material		Factor
1	Granite, white stone, or built-in course masonry		1.50
2	Concrete or blue engineering bricks		1.20
3	Good limestone masonry and building bricks		1.00
4	Poor masonry or any kind of brickwork		0.70 - 0.50
Joint Factors			
Serial No.	Type of Joint		Factor
1	Thin joints, 1/10 inch or less in width		1.25
2	Normal joints, width to 1/4 inch, pointed mortar		1.00
3	Normal joints, mortar unpointed		0.90
4	Joint over 1/4 inch, irregular good mortar		0.80
5	Joint over 1/4 inch, mortar with voids deeper than 1/10 of the ring thickness		0.70
6	Joints 1/2 inch or more, poor mortar		0.50
Deformations			
Serial No.	Condition	Adjustment	Note
1	The rise over the affected portion is always positive.	Discard profile factor already calculated and apply span-to-rise ratio of affected portion to whole arch.	Arch ring deformation may be due to partial failure of the ring (usually accompanied by a sag in the parapet) or movement at the abutment.
2	Distortion produces a flat section of profile.	Maximum MLC = 12.	
3	A portion of the ring is sagging.	Maximum MLC = 5 only if fill at crown > 18 inches.	
Abutment Size Factors			
Serial No.	Type of Abutment	Factor	Note
1	Both abutments satisfactory	1.00	An abutment may be regarded as inadequate to resist the full thrust of the arch if— <ul style="list-style-type: none"> • The bridge is on a narrow embankment, particularly if the approaches slope steeply up to the bridge. • The bridge is on an embanked curve. • The abutment walls are very short and suggest little solid fill behind the arch.
2	One abutment unsatisfactory	0.95	
3	Both abutments unsatisfactory	0.90	
4	Both abutments massive but a clay fill suspected	0.70	
5	Arch carried on one abutment and one pier	0.90	
6	Arch carried on two piers	0.80	

Table B-7. Arch factors (continued)

Abutment Fault Factors			
Serial No.	Type of Fault	Factor	
1	Inward movement of one abutment	0.75 - 0.50	
2	Outward spread of abutments	1.00 - 0.50	
3	Vertical settlement of one abutment	0.90 - 0.50	
Crack Factors			
Serial No.	Type of Crack	Factor	Note
1	<p>Longitudinal cracks within 2 feet of the edge of the arch; if wider than 1/4 inch and longer than 1/10 of the span, in bridges.</p> <ul style="list-style-type: none"> Wider than 20 feet between parapets. Narrower than 20 feet between parapets. 	<p>1.00</p> <p>0.90 - 0.70</p>	Due to an outward force on the spandrel walls caused by a lateral spread of the fill.
2	<p>Longitudinal cracks in middle third of the ridge with—</p> <ul style="list-style-type: none"> One small crack under 1/8 inch wide and shorter than 1/10 of the span. Three or more small cracks as above. One large crack wider than 1/4 inch and longer than 1/10 of the span. 	<p>1.00</p> <p>0.50</p> <p>0.50</p>	Due to varying amount of subsiding along the length of the abutment; large cracks are danger signs which indicate that the arch ring has broken up into narrower independent rings.
3	Lateral and diagonal cracks less than 1/8 inch wide and shorter than 1/10 of the arch width	1.00	Lateral cracks, usually found near the quarter points, are due to permanent deformation of the arch, which may be caused by partial collapse of the arch or by abutment movement. Diagonal cracks, usually starting near the sides of the arch at the springing and spreading toward the center of the arch at the crown, are probably due to subsiding at the sides of the abutment.
4	Lateral and diagonal cracks wider than 1/4 inch and longer than 1/10 of the arch width: Restrict load class to 12 or to the calculated class using all other applicable factors, whichever is less.		
5	Cracks between the arch ring and spandrel or parapet wall greater than 1/10 of the span due to fill spread	0.90	Cracks indicate that the bridge is in a dangerous condition due to spreading of the fill pushing the wall outward or movement of a flexible ring away from a stiff fill, so that the two act independently. The latter type of failure often produces cracks in the spandrel wall near the quarter points.
6	Cracks between the arch ring and spandrel or parapet wall due to a dropped ring: Reclassify from the nomograph, taking the crown thickness as that of the ring alone.		

Table B-8. Section moduli for composite steel stringers

Nominal Size	d (in)	b (in)	S _c (cu in) t _d = 3"	S _c (cu in) t _d = 4"	S _c (cu in) t _d = 5"	S _c (cu in) t _d = 6"	S _c (cu in) t _d = 8"
W36x300	36.750	16.625	1,105	1,264	1,323	1,380	1,489
W36x230	35.875	16.500	835	972	1,018	1,061	1,145
W36x194	36.500	12.125	663	805	847	887	961
W36x182	36.375	12.125	621	757	796	833	902
W36x170	36.125	12.000	579	709	745	779	844
W36x160	36.000	12.000	541	667	701	733	794
W36x150	35.875	12.000	502	624	656	686	744
W33x220	33.875	15.750	740	868	910	951	1,031
W33x200	33.625	15.750	669	789	828	865	938
W33x141	33.250	11.500	446	555	585	612	666
W33x130	33.125	11.500	404	509	536	561	612
W30x172	30.500	15.000	528	630	663	694	757
W30x124	30.125	10.500	354	449	474	497	546
W30x116	30.000	10.500	327	419	442	464	511
W30x108	29.875	10.500	299	387	409	429	473
W27x161	27.625	14.000	455	537	566	595	655
W27x102	27.125	10.000	267	342	362	381	423
W27x94	26.875	10.000	243	315	333	350	390
W27x84	26.750	10.000	213	279	295	311	347
W24x94	24.250	9.125	222	288	306	323	364
W24x84	24.125	9.000	196	258	274	290	326
W24x76	23.875	9.000	176	233	247	262	295
W21x73	21.250	8.250	151	203	216	231	263
W21x68	21.125	8.250	140	189	202	216	246
W21x62	21.000	8.250	127	172	184	197	224
W18x60	18.250	7.500	108	149	160	173	201
W18x55	18.125	7.500	98	137	147	159	184
W18x50	18.000	7.500	89	124	134	145	168

Table B-9. Deck thickness factors for allowable live-load moment

t _d (in)	t _x	t _d (in)	t _x
4	1.00	8	1.20
5	1.05	9	1.25
6	1.10	10	1.30
7	1.15		

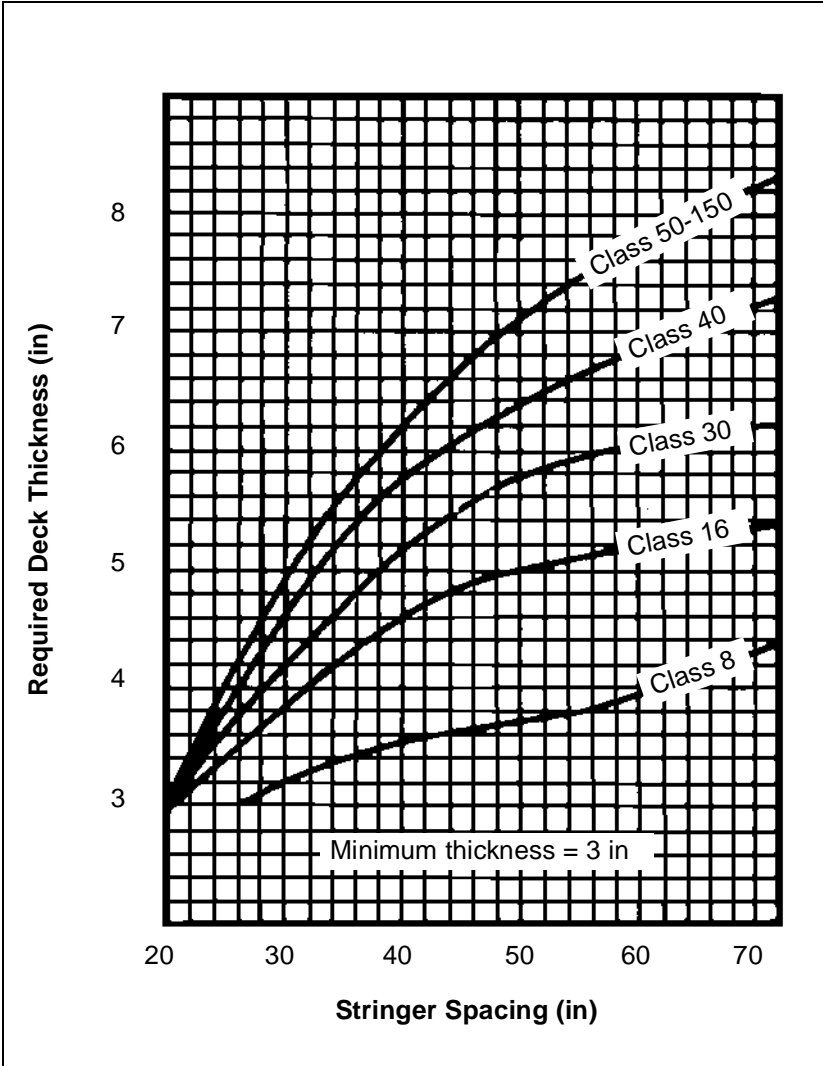

Figure B-8. Timber-deck classification

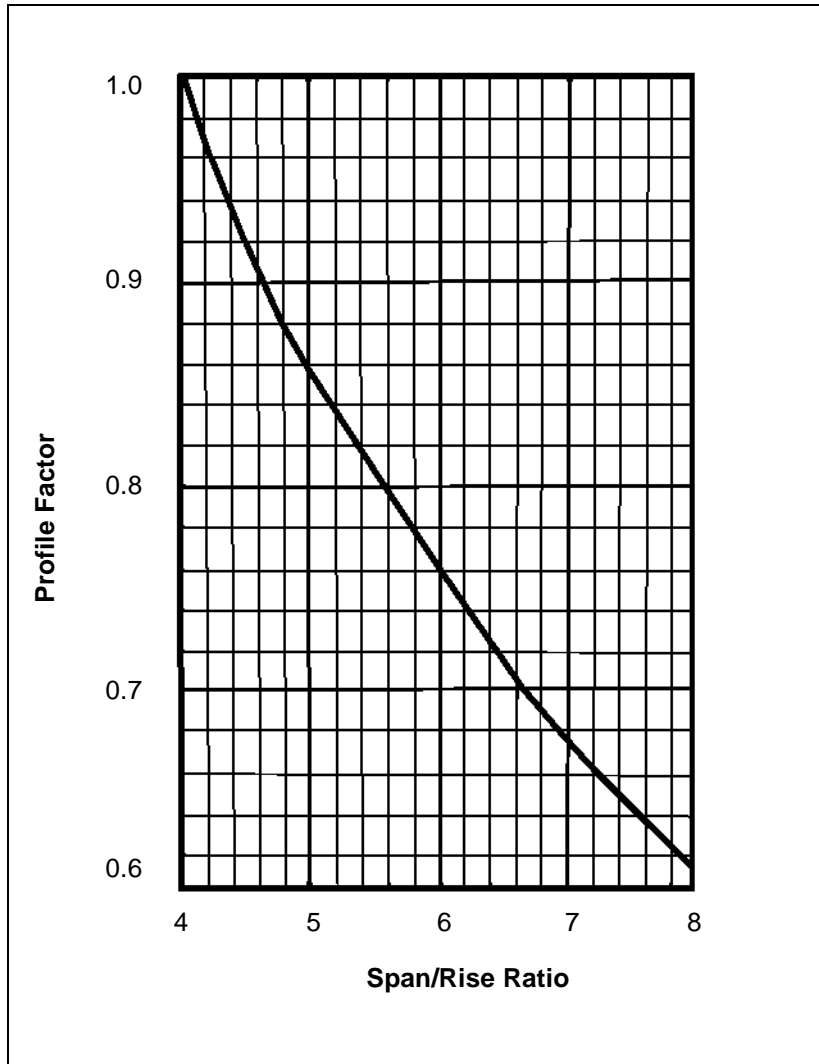

Figure B-9. Profile factors for arch bridges

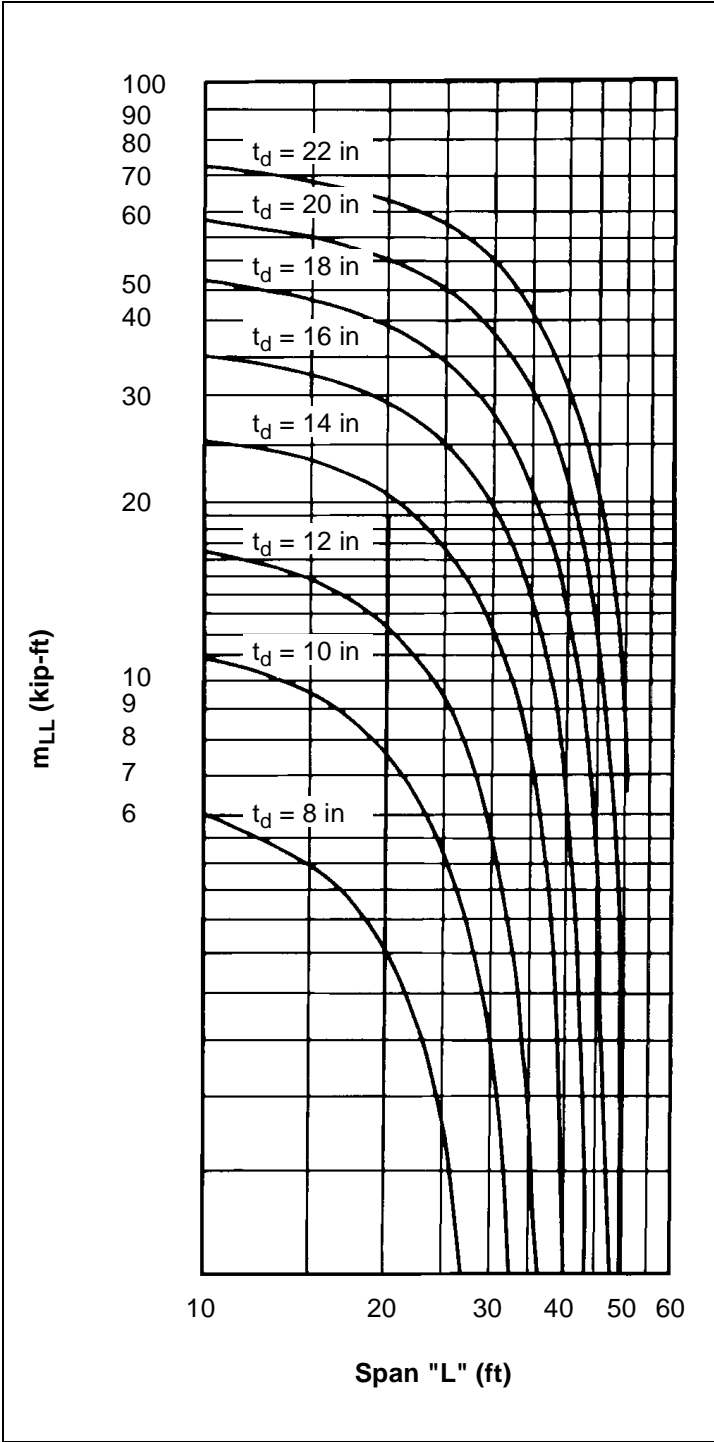

Figure B-10. Live-load moment for a 12-inch reinforced concrete strip

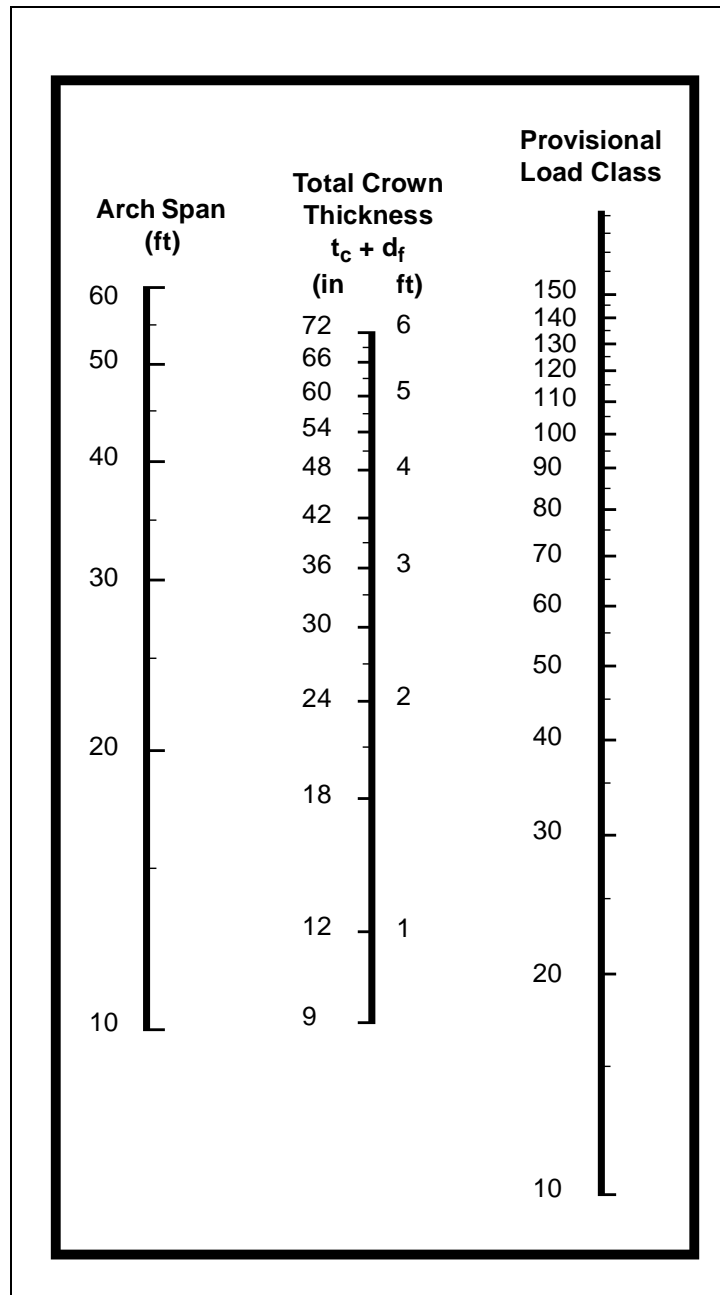

Figure B-11. Masonry arch PLC

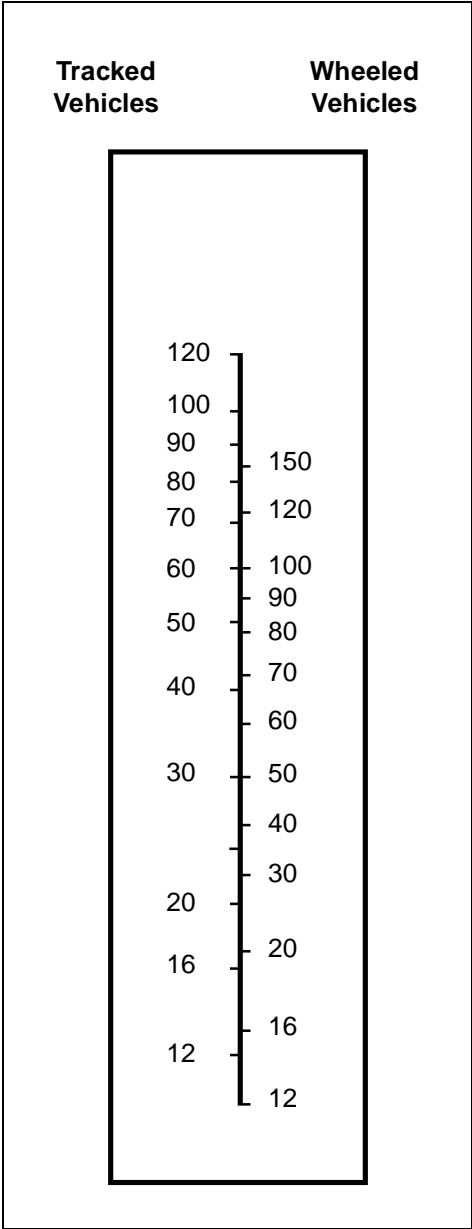

Figure B-12. Bridge class

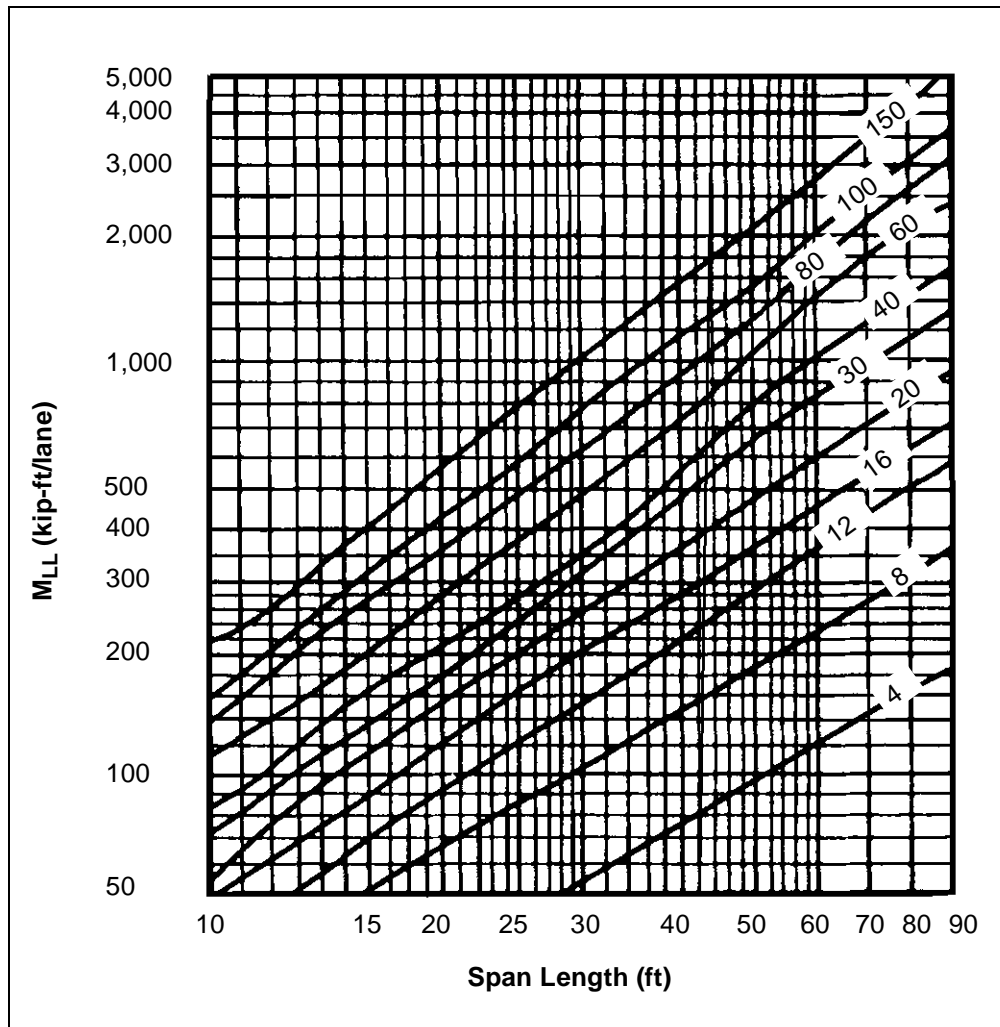

Figure B-13. Live-load moment for wheeled vehicles

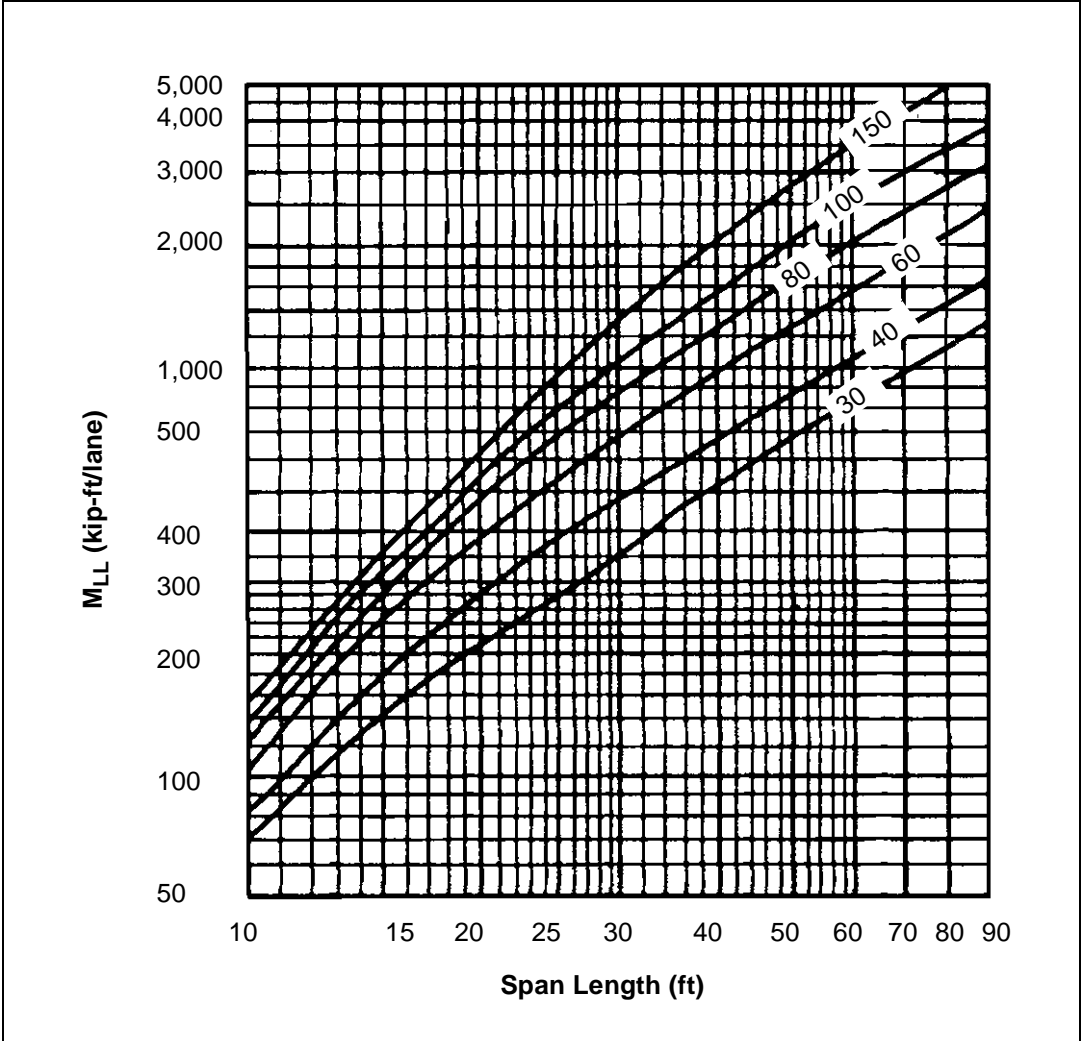

Figure B-14. Live-load moment for tracked vehicles

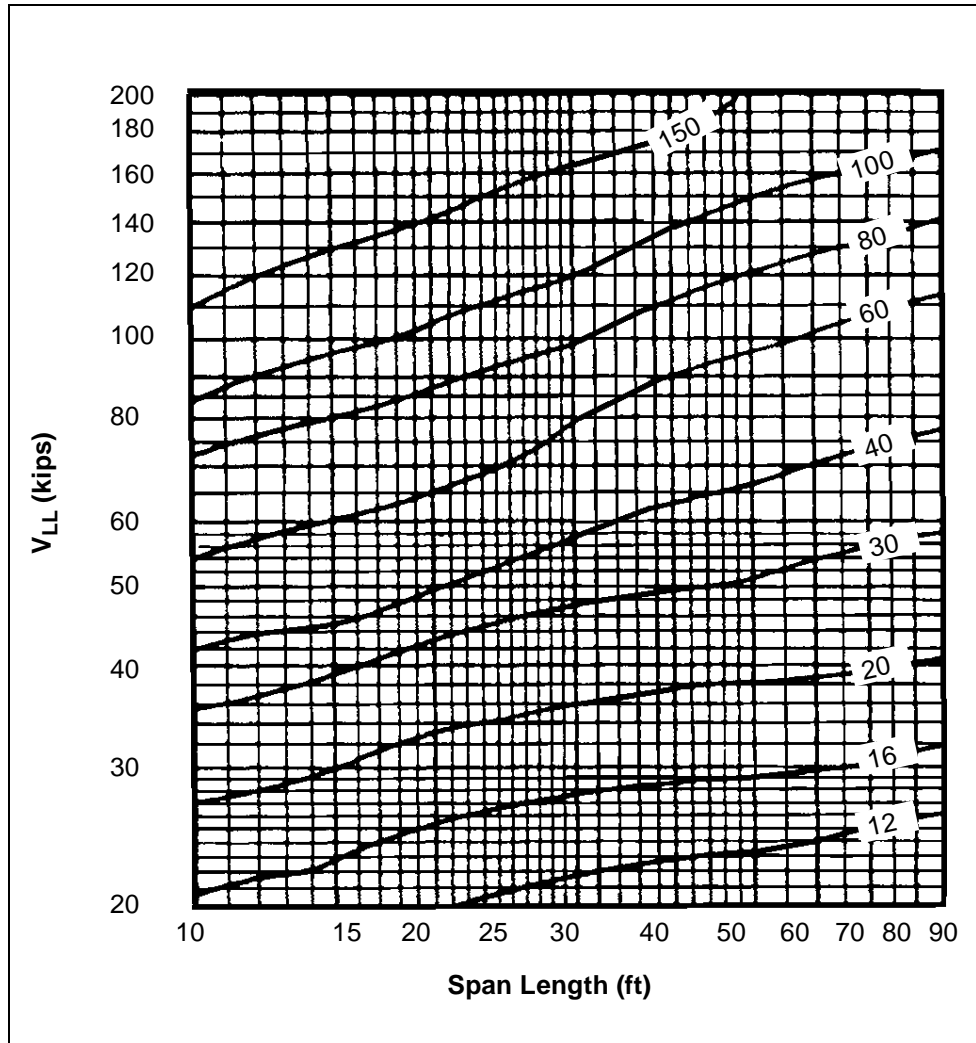

Figure B-15. Live-load shear for wheeled vehicles

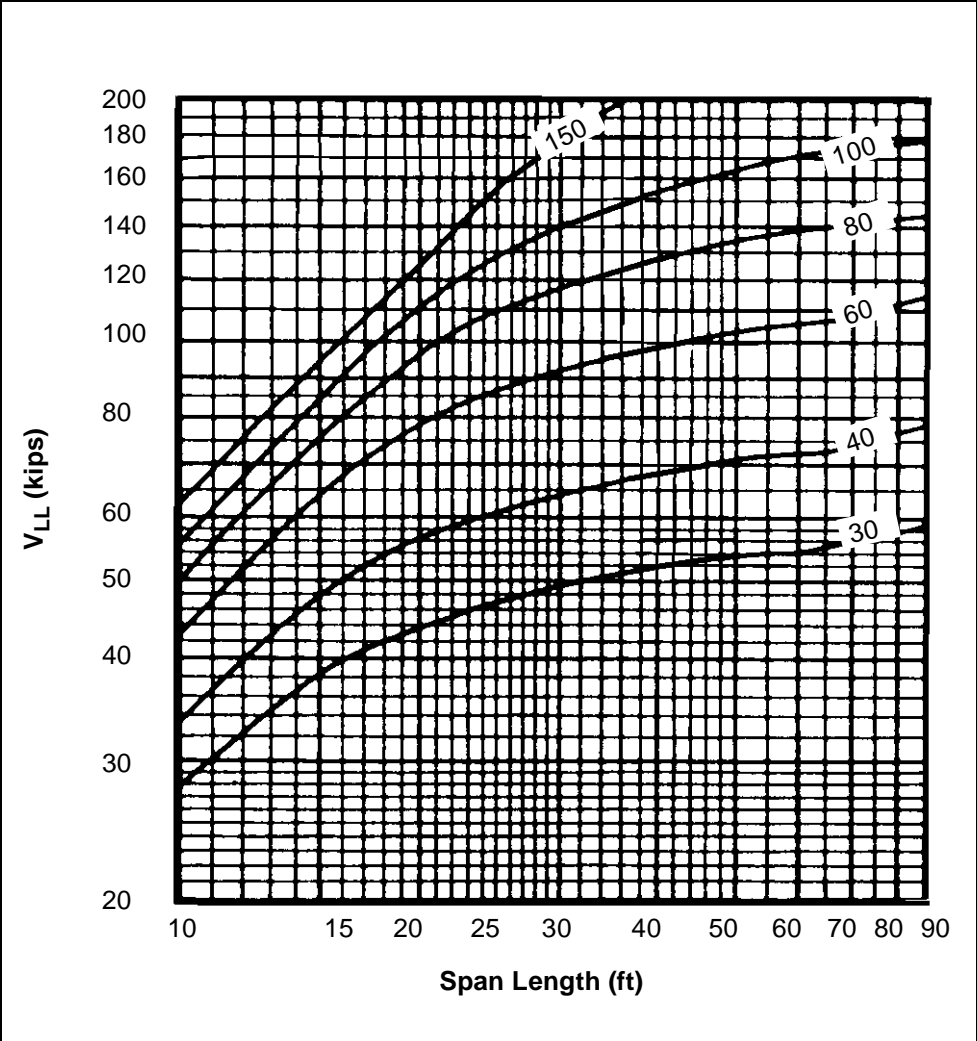

Figure B-16. Live-load shear for tracked vehicles

Appendix C

Sample Reconnaissance OPORD

A sample reconnaissance OPORD is shown in Figure C-1.

Classification		
Copy <u>1</u> of <u>10</u> copies HQ, 99th Engineer Battalion NK111111 080500 JAN 97		
OPERATION ORDER 97-11		
References:	1st Bde OPORD 97-23 Map sheet V107	
Time Zone Used Throughout The Order: Local		
Task Organization:		
<u>A/99 En Bn</u>	<u>B/99 En Bn</u>	<u>Bn control</u>
	1/C/99 En Bn	C/99 En Bn (-) Recon Team 1
1. SITUATION.		
a. Enemy Forces.		
(1) Terrain and Weather.		
(a) Observation is generally limited along the valley floor due to the terrain's undulating nature. Multiple intervisibility lines, generally running north to south and spaced between 500 to 1,000 meters, will hamper observation. Movement to the higher elevations along either the north or south wall will obviously improve observation. Winds (expected to exceed 20 knots until at least 111200 JAN 97) will lift sand from the desert floor and hamper observation. Observation at night will be extremely limited due to the light data for the next 72 hours. Note that on 8 JAN 97 the moon sets before the sun and on 9 through 11 JAN, the moon sets soon after the sun; therefore, night-vision goggles (NVGs) will provide limited capabilities for the next 72 hours and make observation, movement, and the acquisition of OBSTINTEL more difficult.		
Classification		

Figure C-1. Sample reconnaissance OPORD

Classification

Date	BMNT	SR	SS	EENT	MR	MS	Start NVG	Stop NVG	% Illum
8 JAN	0555	0654	1701	1800	0550	1633	*****	*****	0%
9 JAN	0555	0653	1702	1801	0643	1743	*****	*****	0%
10 JAN	0555	0653	1703	1802	0731	1853	*****	*****	4%
11 JAN	0554	0653	1704	1803	0813	2002	*****	*****	9%

(b) The only cover from both direct and indirect fires is provided by the undulating terrain previously mentioned. Concealment during movement can be enhanced by traveling parallel to the intervisibility lines when available. The dusty and windy conditions may make mounted movement less detectable by the enemy.

(c) The pipeline running parallel to the LD along the 30 easting is the only existing obstacle in the AO. Crossing points for this pipeline have been identified at NK 302215 and NK 295090.

(d) The terrain in the vicinity of the templated obstacle system is believed to be unsuitable for minefield reduction by MCBs because of the undulating terrain and the soil composition.

(2) Enemy Situation.

(a) The 133d motorized rifle battalion (MRB) is currently preparing defenses along the 47 easting. This unit's expected strength is estimated to be 12 T-80s, 32 BMP-1s, 3 AT-5s, and 1 dismounted infantry company. The 133d MRB began preparing its defenses 071500 JAN 97 and are not expected to complete its countermobility and survivability effort before 091600 JAN 97. The 133d MRB is expected to have a company-size combined-arms reserve at a strength of three T-80s and eight BMP-1s.

(b) As of 080100 JAN, three enemy MRCs have been located and are depicted on the SITEMP. The expected positioning of the subordinate MRPs is also templated as well as the anticipated combat security observation post (CSOP) and artillery positions. Expect to come within direct-fire range of the CSOPs when crossing the 42 easting and the main defenses when crossing the 44 easting. Enemy artillery is expected to be in position not later than (NLT) 081600 JAN; expect to come within indirect-fire range when crossing the 25 easting. However, the enemy will rarely use indirect fires against recon forces. Expect the enemy to use its rotary-wing assets in its attempt to try to locate and destroy recon forces. The enemy is not expected to be supported by fixed-wing aircraft. Although the enemy has the capability to employ chemical weapons, it has chosen not to do so thus far in the campaign. However, if the enemy does employ chemicals, we expect them to emplace a persistent chemical agent at center of mass NK 410280.

Classification

Figure C-2. Sample reconnaissance OPORD (continued)

 Classification

The enemy is not nuclear capable. Expect the enemy to use dismounted strong points to tie its obstacles into the restricted terrain at vicinities NK 450210 and NK 440100. These dismounted forces will be supplied with AT-5s to assist in their mission of preventing the obstacle system from being reduced along the walls of the valley. Additionally, the enemy will use dismounted patrols to protect all minefields.

(c) The templated obstacle system is included on the SITEMP. No confirmed obstacle locations have been obtained as of 080100 JAN. We expect the enemy to continue to lay its minefields similar to the method used throughout the campaign. We expect the enemy to mechanically lay its minefields and expect each minefield to be comprised of SB-MV mines and be 200 to 300 meters long and 60 to 120 meters deep. The mine spacing has consistently been 4.5 meters and the depth of the mines have been up to 9 inches. **NOTE: The SB-MV is magnetic-influence initiated and must be detected by probing. Operating hand-held mine detectors may detonate the mine.** If mines are surface laid, it is probably due to the soil conditions and indicates the probable success of using MCBs. The enemy has routinely used a single-strand of concertina fence on the enemy side of the minefield as a frat fence. The enemy is expected to emplace a total of 15 minefields in its defense.

b. Friendly Forces.

(1) Higher.

(a) 1st Brigade plans to conduct a brigade breaching operation and penetrate the northern MRP of the northern MRC as shown on the SITEMP. Other brigade recon assets include two COLTs and one chemical recon vehicle. The planned locations for each of these assets are shown on the maneuver graphics.

(b) Engineer recon team 1 is attempting to answer the brigade commander's PIR for location, composition, and orientation of the enemy's obstacles.

(c) If bypasses of the enemy obstacles can be located, the brigade commander would prefer to bypass the obstacles as close to the north wall as possible.

(2) Lower. Do not expect TF recon assets to cross the LD before EENT on 9 JAN 97.

2. MISSION. The 99th Engineer Battalion conducts an area recon of NAI 301 NLT 082000 JAN 97 to facilitate the brigade's attack at 110500 JAN 97.

3. EXECUTION.

Intent. The purpose of this mission is to identify enemy obstacles within NAI 301 to confirm or deny the enemy's COA and facilitate breaching operations. The end state is the identification of enemy obstacles in NAI 301 NLT 100500 JAN 97 and recon team 1 in position at checkpoint (CP) 15 ready to link up and guide the breach force to the obstacle location NLT 110001 JAN 97.

 Classification

Figure C-3. Sample reconnaissance OPORD (continued)

Classification

a. Concept of Operation. The battalion conducts an obstacle-oriented area recon. Recon team 1 will cross the LD NLT 082000 JAN. The brigade will have at least two batteries ready to provide indirect fires out to PL Celtics throughout the recon effort, and the attack helicopter battalion (AHB) will support casualty evacuation. Team 1 will cross the LD about 24 hours before the TF scouts in an attempt to observe the enemy emplacing obstacles while the TF is still planning its R&S effort. The recon team will link up with TF 1-23 scouts (who will provide security) before conducting obstacle recon. Recon team 1 will complete its area recon of NAI 301 NLT 100500 JAN to facilitate mounted rehearsals by the brigade during daylight hours on 11 JAN 97. Recon team 1 will continue to observe NAI 301 until 101700 JAN and report any further engineer activity. At 101800 JAN 97, recon team 1 will move to CP 15 and be in position NLT 110001 JAN 97, prepared to link up and guide the breach force to the obstacle location.

b. Tasks to Subordinate Units.

(1) Battalion's TOC. The battalion's TOC will—

(a) Provide liaison personnel to colocate with the recon team until they cross the LD and ensure that liaison personnel obtain a copy of the recon team's maneuver graphics.

(b) Coordinate the recon team's indirect fire plan with the FSO and confirm targets with the team leader once they are coordinated.

(2) Battalion S4. The battalion S4 will obtain the current logistical status of recon team 1. He will ensure that unit basic load (UBL) levels are reestablished NLT 081200 JAN 97 and report to the TOC upon completion.

(3) A/99 En Bn. A/99 En Bn will conduct liaison activities between recon team 1 and TF 1-23 according to the battalion's TACSOP.

(4) Recon team 1. Recon team 1 will—

(a) Report the current logistical status to the S4 NLT 080800 JAN 97.

(b) Backbrief the plan to the battalion commander via FM radio at 081300 JAN 97.

(c) Provide TF 1-23 the team's graphics, via the A/99 En Bn's TOC before crossing the LD.

(d) Forward requested indirect-fire targets to the battalion's TOC NLT 081600 JAN 97.

(e) Coordinate link up with the TF 1-23 scouts for security during obstacle recon.

(f) Conduct an area recon of NAI 301 NLT 082000 JAN 97 to verify the composition of obstacles within the NAI.

Classification

Figure C-4. Sample reconnaissance OPORD (continued)

<hr style="width: 20%; margin: 0 auto;"/> <p>Classification</p>
<p>c. Coordinating Instructions.</p> <p style="padding-left: 20px;">(1) Task organization is effective upon receipt of this order.</p> <p style="padding-left: 20px;">(2) All units will participate in the intelligence updates to occur at 0800 and 2000 each day.</p> <p style="padding-left: 20px;">(3) The LOA for recon assets is PL Celtics.</p> <p>4. SERVICE SUPPORT.</p> <p style="padding-left: 20px;">a. Support Concept.</p> <p style="padding-left: 40px;">(1) The recon team will cross the LD fully uploaded according to the battalion's TACSOP. These supplies will come from the engineer battalion. This basic load is expected to sustain the team throughout the mission.</p> <p style="padding-left: 40px;">(2) Emergency resupply will be coordinated through the engineer battalion's TOC and delivered by aviation assets. Backup resupply will be through TF 1-23.</p> <p style="padding-left: 20px;">b. Medical Evacuation and Hospitalization. The primary means of MEDEVAC is by air (requested through the battalion's TOC); backup is by ground evacuation (performed by TF 1-23).</p> <p style="padding-left: 20px;">c. Personnel Support. EPWs will be turned over to TF 1-23 for evacuation to the rear.</p> <p>5. COMMAND AND SIGNAL.</p> <p style="padding-left: 20px;">a. Command. The chain of command is the commander, the XO, the S3, and the commander of C Company.</p> <p style="padding-left: 20px;">b. Signal.</p> <p style="padding-left: 40px;">(1) All traffic from recon team 1 to the battalion's TOC will be over MSRT (primary) or the battalion's command net (alternate).</p> <p style="padding-left: 40px;">(2) The recon team's current location will be sent by the battalion's TOC to TF 1-23.</p> <p style="padding-left: 40px;">(3) OBSTINTEL will be reported according to the TACSOP.</p> <p>ACKNOWLEDGE:</p> <p style="text-align: center; padding: 20px 0 20px 100px;">PATTON LTC</p> <p>OFFICIAL: (Authentication) Overlays: SITEMP Maneuver graphics with artillery targets CSS graphics</p>
<hr style="width: 20%; margin: 0 auto;"/> <p>Classification</p>

Figure C-5. Sample reconnaissance OPORD (continued)

Appendix D

Engineer Recon

A general engineer recon gathers engineer information of a broad nature within an AO. It considers construction material, resources, and terrain features having engineer applications.

A general engineer recon may be conducted in conjunction with other recons. The Engineer Reconnaissance Report (see Figures D-1 and D-2, pages D-2 through D-6) will help ensure that all important information is captured.

The Engineer Reconnaissance Report is used to report items that are not adequately covered by other report forms previously discussed in this manual, but one of significance to engineer activities. The following information is included in the report:

- **Heading.** Self-explanatory.
- **Key.** The key references the item of the report and its corresponding location on the recon overlay. The object's serial number (or critical point number) is entered in this column.
- **Object.** Shown by a conventional symbol (see Figure D-3, pages D-7 and D-8) or a brief written description.
- **Work Estimate.** If a work estimate is included as part of the report, enter yes; if not, enter no.
- **Additional Remarks.** In this column, report the object's location by grid coordinates followed by remarks, calculations, and sketches. Make this information as detailed as possible to alleviate the necessity for an additional recon.
- **Authentication Block.** This is for the company commander's signature block and signature.
- **Work Estimate.** The work estimate is on the back of the DA Form 1711-R. Each work estimate is keyed by a serial or critical point number to the appropriate object on the reverse side of the form. Only those columns that are appropriate need be completed. Draw additional sketches when necessary (see Figure D-2).

ENGINEER RECONNAISSANCE REPORT <small>For use of the Engineer Reconnaissance Party, 1968</small>		PAGE 1 OF 4 PAGES		
TO Co, 21 ST ENGR BN		FROM CoA 21 ST ENGR BN		
FILE NO	PARTY LEADER (Name, Grade, Unit)	PLACE-HOUR-DATE		
REPORT NO 1	THOMAS P. TAYLOR 2LT CoA 21 ST ENGR BN	UT 586703 112000 MAR 80		
MAPS QUANTICO, VIRGINIA SHEET 5561 II		SCALE 1:50,000		
DELIVER TO (Organization, Place, Hour and Date)				
S2, 21 ST ENGR BN UT 556461 120100 MAR 80				
KEY	OBJECT	TIME OBSERVED	WORK ESTIMATE	ADDITIONAL REMARKS AND SKETCH
1		0900	YES	<p>UT 058674 - LOG POST OBSTACLE BLOCKING RT 132</p> <p>SKETCH</p> <p>(24) LOGS @ 0.5m DIAMETER, C-C 1.5m. ON ALL SIDES, 1.5m TO 2.5m ABOVE GROUND</p>
Engineer Work Estimate On Other Side				
TYPED NAME, GRADE, ORGANIZATION			SIGNATURE	
CHARLES ROSCOE, CPT Cdr, Co A, 21st Engr Bn				
DA Form 1711-R		Edition of 1 Jun 61 is obsolete		

Figure D-1. Sample Engineer Reconnaissance Report (front)

ENGINEER RECONNAISSANCE REPORT		PAGE 2 OF 4 PAGES		
TO <i>CO 21ST ENGR BN</i>		FROM <i>CO-CA 21ST ENGR BN</i>		
FILE NO	PARTY LEADER (Name, Grade, Unit) <i>THOMAS P. TAYLOR 2LT</i>		PLACE-HOUR-DATE <i>4T 586 708</i>	
REPORT NO <i>1</i>	<i>CA 21ST ENGR BN</i>		<i>112000 MAR 80</i>	
MAPS <i>QUANTICO, VIRGINIA SHEET 5561 III</i>		SCALE <i>1:50,000</i>		
DELIVER TO (Organization, Place, Hour and Date) <i>S2, 21ST ENGR BN UT 556461 120100 MAR 80</i>				
KEY	OBJECT	TIME OBSERVED	WORK ESTIMATE	ADDITIONAL REMARKS AND SKETCH
<i>1</i>		<i>0900</i>	<i>YES</i>	<i>CONT. OBSTACLE NOT DEFENDED BYPASS - DIFFICULT (fwd) DUE TO SWAMPY TERRAIN</i>
<i>2</i>		<i>0920</i>	<i>NO</i>	<i>UT 509676 - GRAVEL PIT IN OPERATION QUANTITY - APROX. 6000 YD³ STOCK PILES RANGING FROM 1in. to 3in. in DIAMETER TYPE - CRUSHED GRANITE COMMUNICATIONS - GOOD ACCESS ROADS WITH AMPLE SPACE FOR TURN AROUND AND LOADING.</i>
<i>3</i>		<i>0940</i>	<i>NO</i>	<i>UT 58978 - ABANDONED ENEMY EQPT. QUANTITY & TYPE - (2) "ZIPLO" MODEL 200 CRAWLER CRANES. (OPERATIONAL) CHECKED FOR BOOBY TRAPS - NONE</i>
SAMPLE				
Engineer Work Estimate On Other Side				
TYPED NAME, GRADE, ORGANIZATION <i>CHARLES ROSCOE, CPT Cdr, Co A, 21st Engr Bn</i>			SIGNATURE <i>Charles Roscoe</i>	

DA Form 1711-R, May 88

Edition of 1 Jun 81 is obsolete

Figure D-1. Sample Engineer Reconnaissance Report (front) (continued)



ENGINEER RECONNAISSANCE REPORT <small>Replaces the form used from 1955 to the 21st century edition of 1988</small>		PAGE <u>3</u> OF <u>4</u> PAGES		
TO <u>CO, 21ST ENGR BN</u>		FROM <u>CO, CoA 21ST ENGR BN</u>		
FILE NO	PARTY LEADER (Name, Grade, Unit) <u>THOMAS G TAYLOR 2LT</u> <u>CoA 21ST ENGR BN</u>		PLACE-HOUR-DATE <u>AT 556700</u> <u>11 2000 MAR 80</u>	
REPORT NO <u>1</u>	MAPS <u>QUANTICO, VIRGINIA SHEET 5561 III</u>		SCALE <u>1:50,000</u>	
DELIVER TO (Organization, Place, Hour and Date) <u>S2, 21ST ENGR BN UT 556461 120000 MAR 80</u>				
KEY	OBJECT	TIME OBSERVED	WORK ESTIMATE	ADDITIONAL REMARKS AND SKETCH
	<u>BIV AREA</u>	<u>1035</u>	<u>NO</u>	<u>UT 512692 - POSSIBLE BIVOUAC AREA</u> <u>SIZE - 700 m x 900 m</u> <u>COMMUNICATIONS - GOOD ACCESS</u> <u>ROAD W/GOOD DRAINAGE & HARD SURFACE</u> <u>SITE CONDITIONS - GOOD DRAINAGE WITH FIRM SOIL, GOOD CX, GOOD OBSERVATION & F/F</u>
		<u>1150</u>	<u>NO</u>	<u>UT 558610 - POSSIBLE WATER POINT</u> <u>QUANTITY - Q=AVG.V</u> <u>A=13.5 FT² V=35 FPM</u> <u>Q=(13.5)(35)(6.4)=3,012 GPM</u> <u>QUALITY - CLOUDY, NO ODOR, NO OBSERVED SOURCE OF POLLUTION, SPL WAS TAKEN FOR TESTS.</u> <u>COMMUNICATIONS - GOOD ACCESS RDS, FROM MSR, GOOD TURN AROUND & PARKING ON SITE.</u> <u>SITE CONDITIONS - GOOD, SLOPE OF BANKS 5%, BIVOUAC AREA ON SITE FOR W.P. TEAM, BRIDGE POSSIBLE ARTILLERY TARGET</u> 
Engineer Work Estimate On Other Side				
TYPED NAME, GRADE, ORGANIZATION <u>CHARLES ROSCOE, CPT</u> <u>Cdr, Co A, 21st Engr Bn</u>			SIGNATURE 	

Figure D-1. Sample Engineer Reconnaissance Report (front) (continued)

ENGINEER RECONNAISSANCE REPORT <small>For use of the Recon and Engr Bns in the preparation of maps.</small>		PAGE <u>4</u> OF <u>4</u> PAGES		
TO <u>CO, 21st ENGR BN</u>		FROM <u>CO, COA 21st ENGR BN</u>		
FILE NO	PARTY LEADER (Name, Grade, Unit) <u>THOMAS P. TAYLOR 2LT</u>		PLACE-HOUR-DATE <u>UT 586 701</u>	
REPORT NO <u>1</u>	<u>COA 21st ENGR BN</u>		<u>112000 MAR 80</u>	
MAPS <u>QUANTICO, VIRGINIA</u>		SHEETS <u>5562 III</u>	SCALE <u>1:50,000</u>	
DELIVER TO (Organization, Place, Hour and Date) <u>52, 21st ENGR BN UT 556 961 12 0100 MAR 80</u>				
KEY	OBJECT	TIME OR SERVED	WORK ESTIMATE	ADDITIONAL REMARKS AND SKETCH
	<u>MAP ERROR</u>	<u>1200</u>	<u>NO</u>	<u>UT 557 963 TO 558 003</u> <u>ROAD NOT SHOWN ON MAP</u> <u>R1 (1.5km)</u>
		<u>1230</u>	<u>NO</u>	<u>UT 761 932 EXISTING WATER PURIFICATION PLANT SUPPLYING WATER TO THE CITY OF YUCCA.</u> <u>OUTPUT 50,000 GAL PER DAY.</u>
Engineer Work Estimate On Other Side				
TYPED NAME, GRADE, ORGANIZATION <u>CHARLES ROSCOE, CPT</u> <u>Cdr, Co A, 21st Engr Bn</u>			SIGNATURE <u>Charles Roscoe</u>	

DA Form 1711-R, May 66

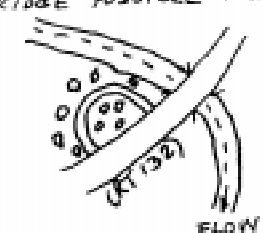
Edition of 1 Jun 61 is obsolete

Figure D-1. Sample Engineer Reconnaissance Report (front) (continued)

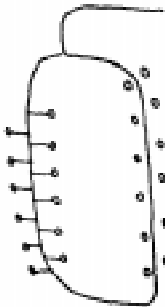
ENGINEER WORK ESTIMATE									
LOCATION KEY	DESCRIPTION OF WORK	UNIT RE-QUIRED	NO. HOURS	EQUIPMENT		MATERIALS		QUANTITY	
				TYPE	NO.	TYPE	UNIT		
 $P = \frac{0^4}{40} = \frac{(14.2)^4}{40}$ $= 9.5$ $\therefore 10^4 / \text{POST}$ $240 \# \text{ TOTAL}$	REMOVE LOG POST FROM ROUTE 132 BY DEMO 	1	2	DEMO SET #1	1	TNT	#	240	
				D-7 CAT	1	D-CORD	FT	140	
						NOAJ ELECT CAPS	EA	25	
						TIME FUSE	FT	4	
						M-2 FUSE LIGHTER	EA	1	

SAMPLE

Reconnaissance Report on Other Side

Figure D-2. Sample Engineer Reconnaissance Report (back)











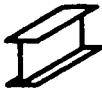

Sawmill		Iron and steel stock	
Lumber yard		Wire stock	
Stone		Paint	
Aggregate (including gravel and slag)		Glass stock	
Sand		Gypsum and lime products	
Cement concrete products		Asphalt and bituminous stock	
Stocks of bricks and other clay products		Stocks of roof covering	

Figure D-3. Engineer resource symbols

















Building hardware		Mobile, heavy-construction equipment	
Industrial gases		Forestry equipment	
Cordage, nets, yarns		Quarrying equipment	
Civil-engineering firms		Handling and transportation equipment storage	
Building contractors		Powered hand tools	
Factories		Water-purification equipment (civilian)	
Factory symbol plus plant product		Electrical supply equipment	
Steel-rolling mills and foundries		Established military water point	
Engineering workshops		Possible military water point	

Figure D-3. Engineer resource symbols (continued)

Appendix E

Signs

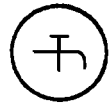
This appendix implements STANAGs 2027 and 2154.

Procedures for posting military routes are standardized for the US and Allied Nations (STANAG 2027). However, this system may be integrated into other road-sign systems in accordance with military requirements.

MILITARY ROUTE SIGNS

There are three general types of standard route signs—hazard, regulatory, and guide. Table E-1 lists the way each type may be used. The size of these signs is not prescribed; they must be large enough to be easily read under poor lighting conditions. Exceptions to this rule are bridge classification signs for which dimensions are specific. As a guide, signs for civil international road use are usually not less than 16 inches square.

Table E-1. Typical hazard, regulatory, and guide signs

	Type		
	Hazard	Regulatory	Guide
Application	Advance warning of stop signs and traffic signals	No entry	Detour
	Changes in road width	One way	Detour begins
	Crossroad	Parking restrictions	Detour ends
	Curves	Specific regulations for vehicles	Directions
	Danger or hazard	Speed limit	Distances
	Dangerous corner	Stop	Information to help driver
	Dips	Bridge classification	Locations
	Junction T		Route number
	Junction Y		
	Level railroad crossing, advance warning		
	Men working		
	Railroad crossing		
	Road construction repairs		
	Road narrows		
	Slippery road		
	Steep grades		
	Steep hill		
	Turns		

HAZARD SIGNS

Hazard signs indicate traffic hazards and require coordination with civil authorities. Hazard signs are square and are installed in a diamond position (see Figures E-1 and E-2). A military hazard sign has a yellow background with the legend or symbol inscribed in black. The wording on these signs is in the language or languages determined by the authority erecting the sign.

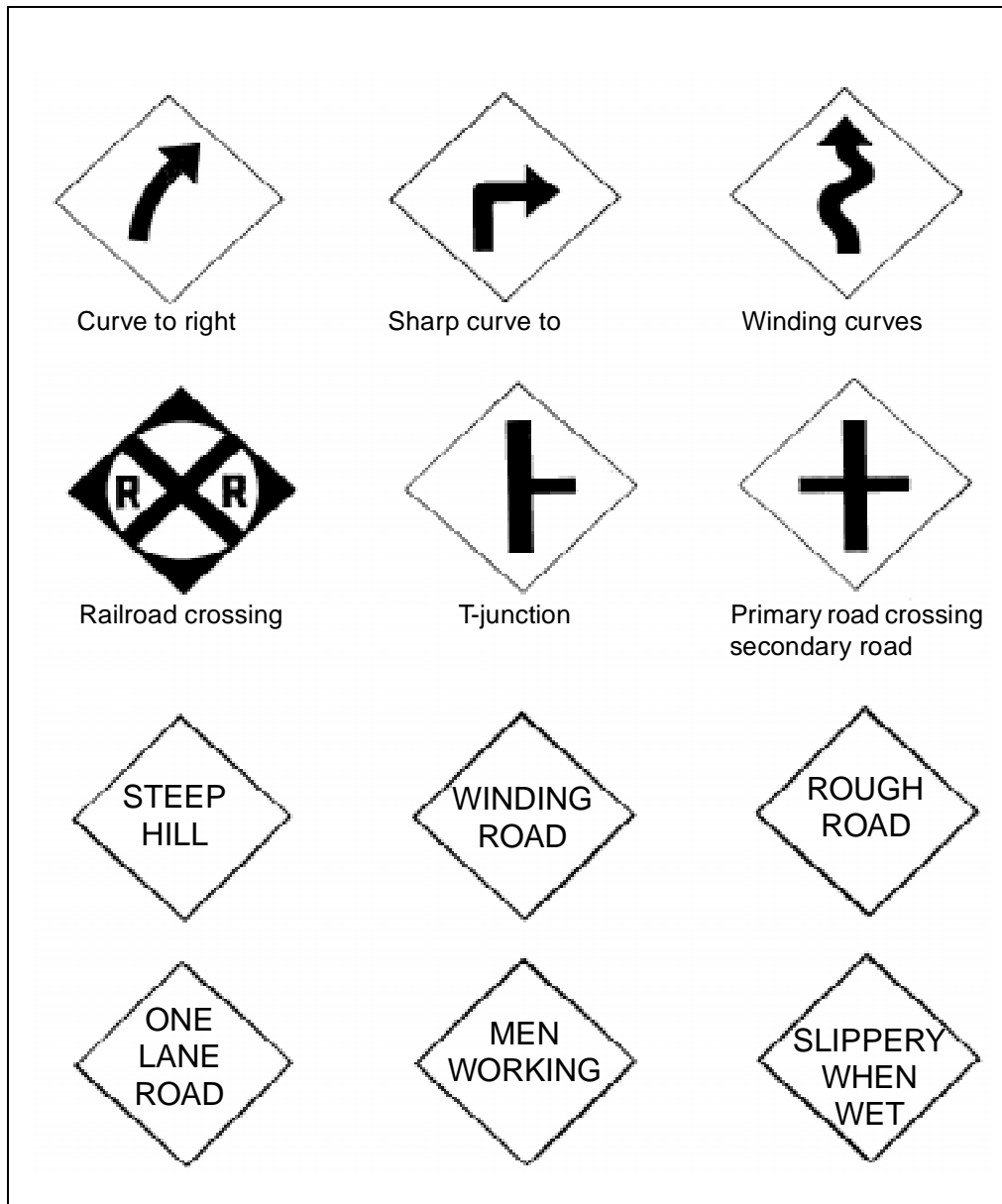

Figure E-1. Example of hazard signs not included in the Geneva Convention

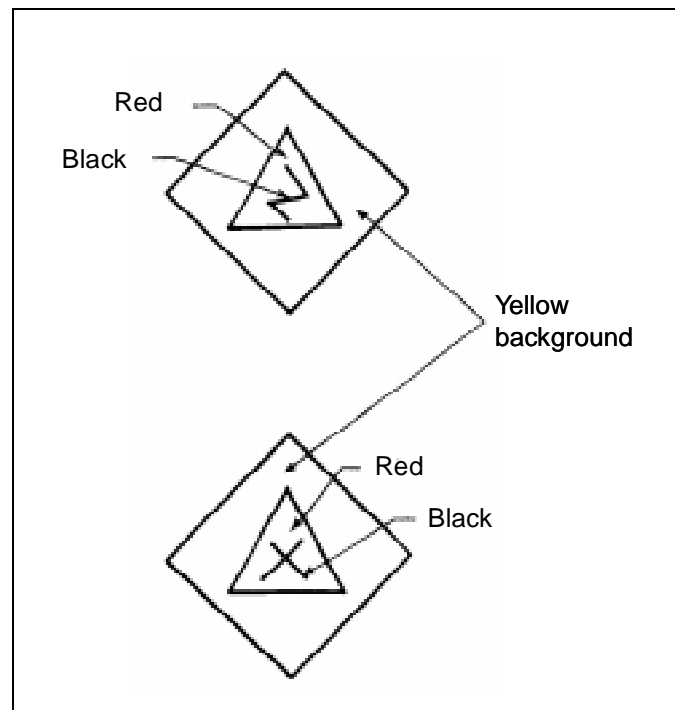

Figure E-2. Examples of hazard signs included in the Geneva Convention

REGULATORY SIGNS

Regulatory signs regulate and control traffic and define the light line. Regulatory signs have a black background on which the legend or symbol is superimposed in white. Exceptions to these rules are bridge classification signs, stop signs, no-entry signs, and signs that apply to civil as well as military traffic. Check with civilian authorities to ensure compliance when erecting signs in areas with civilian traffic.

Light Line

Indicate the light line (the line where vehicles must use blackout lights at night) with a rectangular sign preceded by two warning panels placed according to the situation and nature of the terrain (see Figure E-3, page E-4). Locate the first warning panel 200 to 500 meters before the light line.

Bridge/Raft Signs

All classified vehicles and bridges in the theater of operations require classification signs. Bridge signs are circular with yellow background and black inscriptions. Sign diameters are a minimum of 40 centimeters for one-lane bridges and 50 centimeters for two-lane bridges. A two-lane bridge has two numbers, side by side, on the sign. The number on the left is the bridge classification when both lanes are in use at the same time. The number on the right indicates the classification if the bridge is carrying one-way traffic and the vehicles proceed along the centerline of the bridge (see Figure E-4, page E-4).

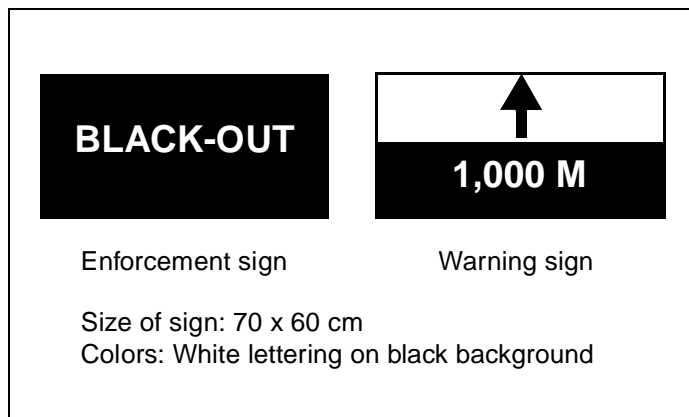

Figure E-3. Warning and enforcement signs

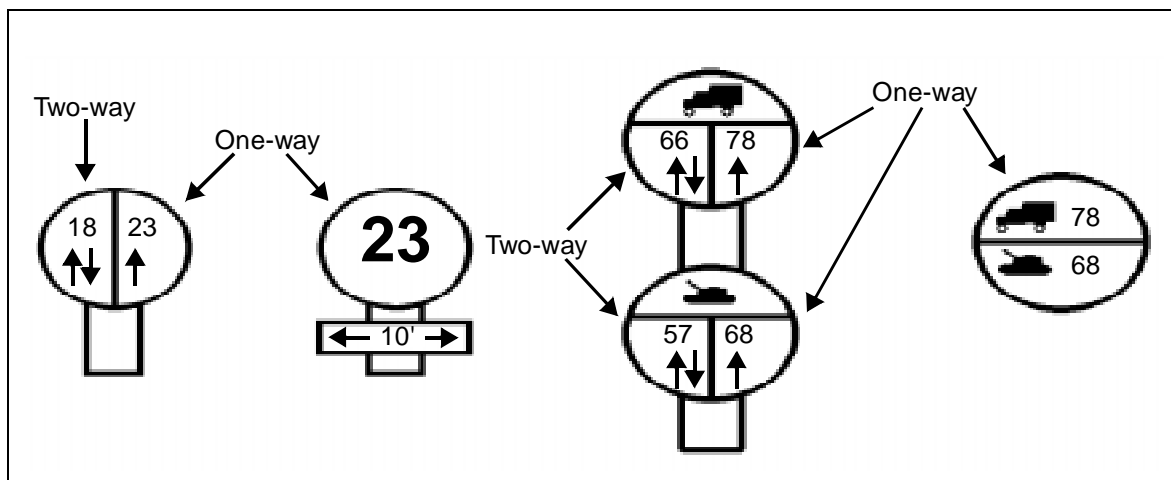

Figure E-4. Bridge signs

For bridges with separate classifications for wheeled and tracked vehicles (dual classification), use a special circular sign that indicates both classifications (only applicable if the classification is over 50) (see the right side of Figure E-4). Use a separate rectangular sign, if necessary, to show the bridge's width limitations. For one-way or two-way traffic bridges, the sign is to be a minimum of 50 centimeters.

Rectangular Bridge Signs

Additional instructions and technical information are posted on rectangular signs, which are a minimum of 41 centimeters in height or width and have a yellow background with the appropriate letters and symbols in black. Write the figures as large as the sign permits. Theater commanders may make special arrangements to indicate vehicles of exceptional width or to indicate low overhead obstructions. Use separate signs to show width or height limitations (see Figure 5-38, page 5-52) or technical information (see Figure E-5). Width and height signs are not required on bridges where existing civilian signs are in place and sufficiently clear.

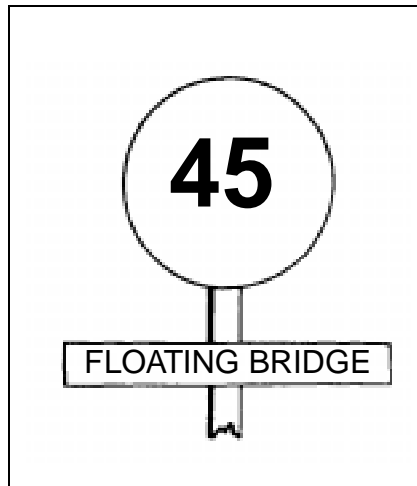

Figure E-5. Bridge sign containing technical information

Multilane Bridge Signs

Bridges of three or more lanes are special cases that require individual consideration; the minimum widths for respective load classifications (see Table 5-8, page 5-51) are used. In some cases, heavier loads can be carried on a restricted lane rather than on the other lanes (see Figures E-6 and E-7, page E-6). Under such circumstances, post standard bridge-classification signs for each lane and mark the restricted lanes with barricades, painted lines, or studs.

Bridge Sign Placement

Ensure that signs are placed properly (as listed below) to maintain uninterrupted traffic across a bridge.

- The bridge classification sign is placed at both ends of the bridge in a position that is clearly visible to all oncoming traffic.
- Rectangular signs, other than those indicating height restrictions, are placed immediately below the bridge classification (circular) signs.
- Signs that indicate height restrictions are placed centrally on the overhead obstruction.
- Special classification numbers are never posted on standard bridge-marking signs.
- Appropriate advance warning signals are placed on bridge approaches, as required.

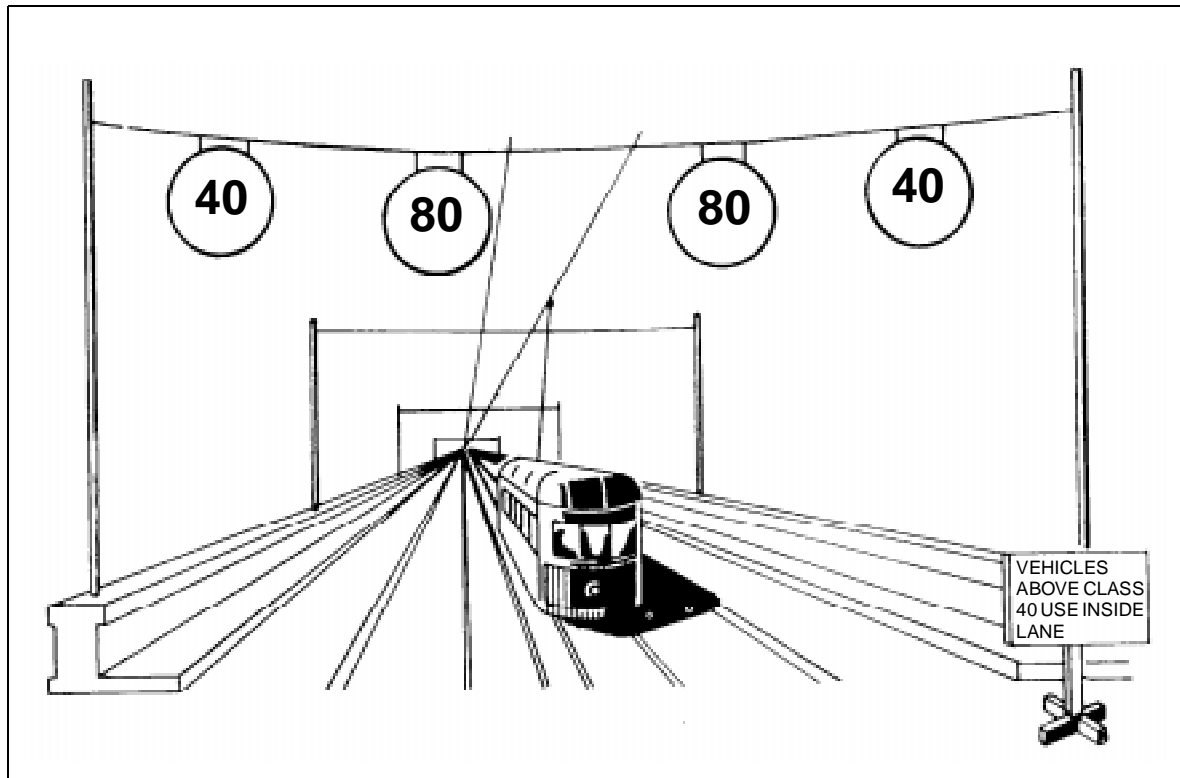

Figure E-6. Typical multilane bridge classification

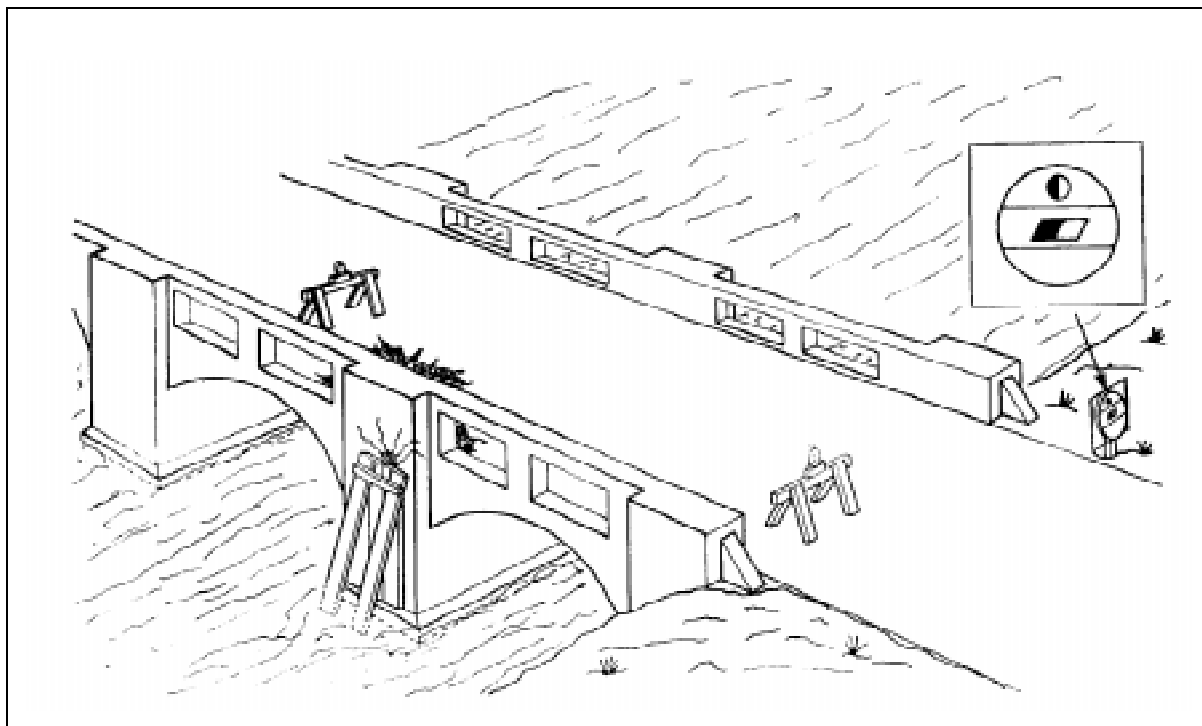

Figure E-7. Example of posting a damaged bridge

GUIDE SIGNS

Guide signs indicate direction or location. These signs consist of the military route number and the appropriate directional disk. If standard signs are not available, construct military route guide signs by placing a directional disk over a rectangular panel upon which the route number is inscribed (see Figure E-8).

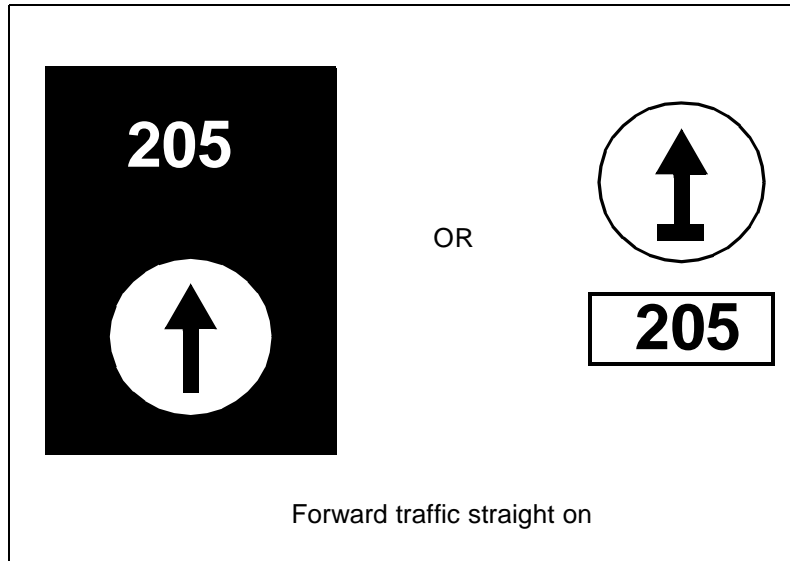

Figure E-8. Military route guide signs for axial routes

Directional Disks

A directional disk consists of a fixed black arrow, with or without a bar, on a white background. Eight equally spaced holes around the edges of the circumference allow the disk to be nailed with the arrow pointing in the desired direction. These disks are no larger than 16 inches in diameter (see Figure E-9, page E-8). They are used as standard guide signs to indicate military axial and lateral routes. Directional disks may be used together with unit signs to indicate direction to locations of major units (groups and above). Smaller units may not use directional disks. However, any arrow sign that provides a different shape and color from the standard direction disks can be used to indicate smaller units.

Headquarters and Logistical Signs

Use these signs to mark a headquarters and logistical installation. Use the appropriate military symbol (see FM 101-5-1). The inscription is black on a yellow background. This symbol may be supplemented by national distinguishing symbols or abbreviations. For division headquarters and above, nationality is always indicated. Colors other than black or yellow are prohibited except for national distinguishing symbols.

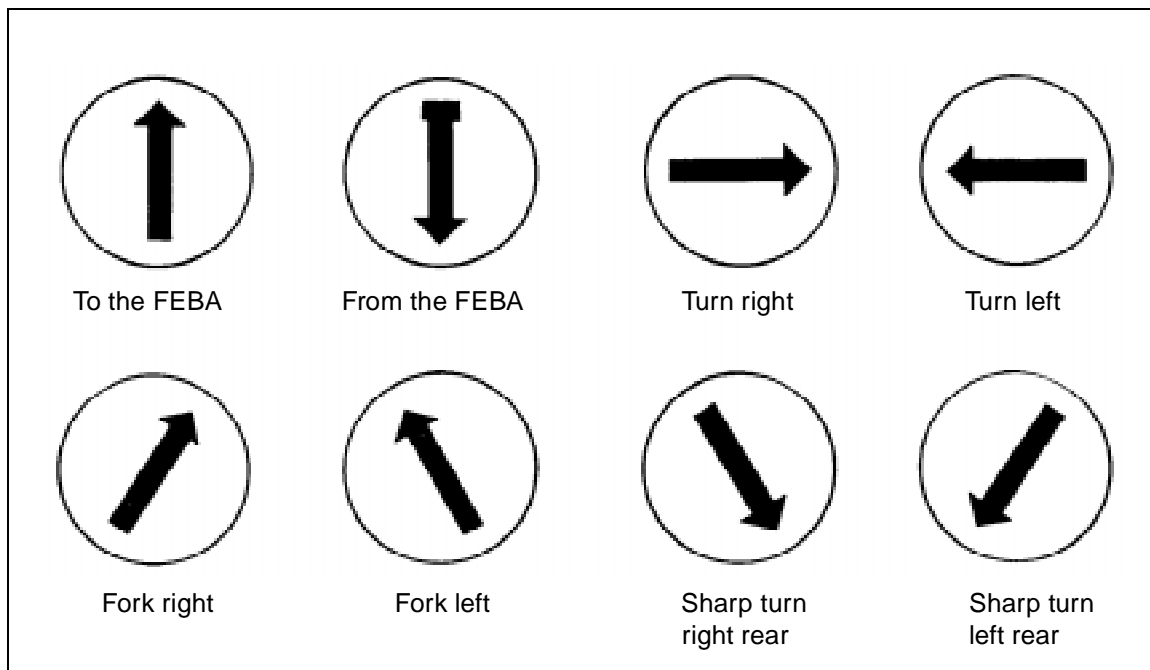

Figure E-9. Examples of directional arrows

Casualty Evacuation Route Signs

Indicate casualty evacuation routes on rectangular signs (see Figure E-10). The signs have a white background with red inscriptions of a directional arrow, a red cross (red crescent for Turkey), and a unit or subunit designation (if required). An alternate sign may be made from a white disk with four segments cut out to give an X shape. The inscriptions are shown in red.

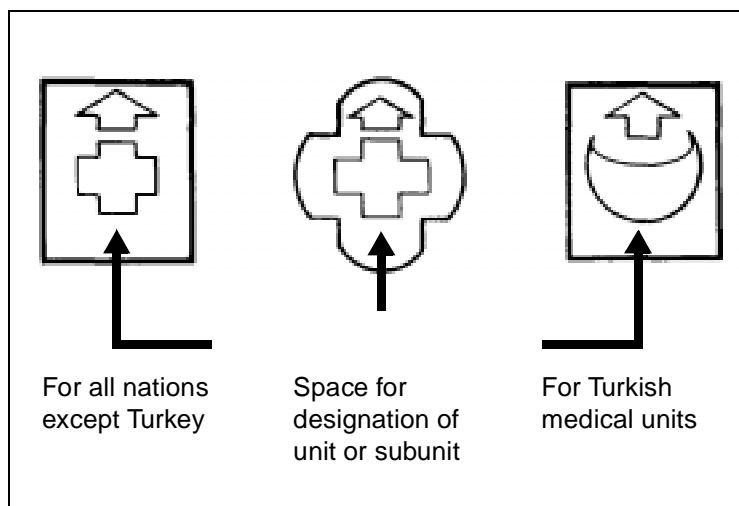

Figure E-10. Examples of guide signs for casualty evacuation routes

Unit Direction Arrow

Use temporary unit direction arrows to mark march routes (see STANAG 2154) (see Figure E-11). In addition to the direction arrow, include the unit identification symbol as part of the inscription. Unit route signs are placed in advance of the moving column and are picked up by a trail vehicle.

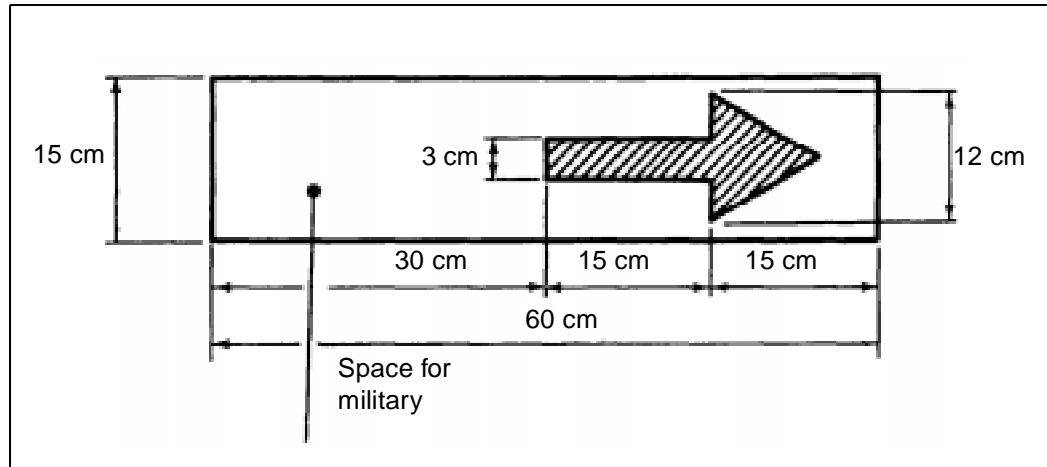

Figure E-11. Unit direction arrow

Military Detour Signs

Detour signs consist of a white arrow superimposed on a blue square. Place the sign in a diamond position (see Figure E-12, page E-10). Show the number of the diverted route by placing the number on the square over the arrow or placing the number on a small panel under the square.

ROAD MARKERS IN AREAS OF HEAVY SNOW

Posting road signs in areas of heavy snowfall requires special attention. Ensure that the markers are placed evenly on both sides of the traveled way. In open country, use poles of appropriate height with direction markers, snow markers, or flags. Erect markers at least one meter off the traveled way to avoid traffic damage. If you cannot completely mark a road, erect arrow signs at prominent points to indicate road direction. Road markers and signs used for long periods of time in areas of heavy snow should be checked frequently to ensure that their positions have not altered. In areas with prolonged conditions of snow, yellow (international orange) may be substituted for white on all standard military route signs.

VEHICLE SIGNS

There are two types of vehicle signs: front and side. Use front signs on all vehicles, except trailers, to show the classification of the laden vehicle. Use side signs on towing vehicles and trailers only to show the classification of the laden towing vehicles or trailers by themselves.

Both signs are circular and marked in contrasting colors consistent with camouflage requirements. Black figures on a yellow background may be used.

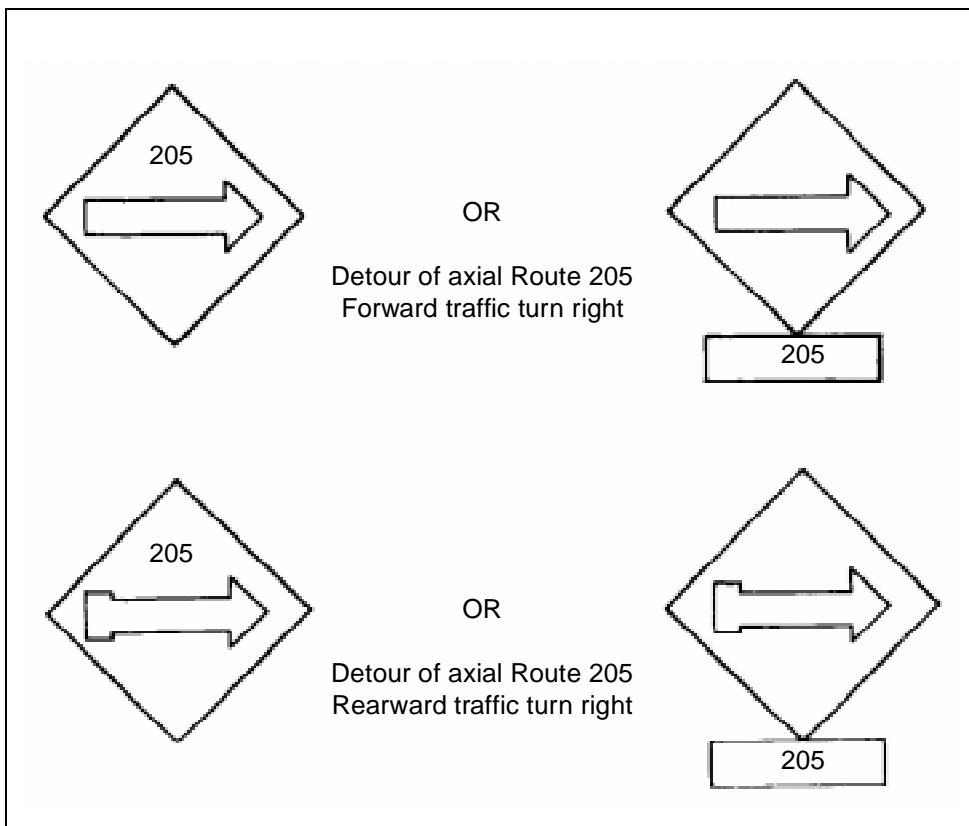

Figure E-12. Examples of detour signs

The front sign is 23 centimeters in diameter and the side sign is 15 centimeters in diameter.

Place or paint the front sign on the front of the vehicle, above or on the bumper, and below the driver's line of vision. When possible, place it on the right side, facing forward. Place or paint the side sign on the vehicle's right side facing outward.

Make the inscription on the sign as large as the sign allows. The front sign—except on towing vehicles and tank transporters—indicates the vehicle's laden solo class. On towing vehicles, the front sign indicates the train's combined load class. Above this number, write the letter C to distinguish the vehicle as a towing vehicle (see Figure E-13). On tank transporters and similar type vehicles, the fixed front sign shows the maximum classification of the laden vehicle. In addition, one alternative front sign may be carried. Place it so that it covers the fixed front sign, when necessary, to show the class of the vehicle when unladen. The side sign (used only by prime movers of combination vehicles and trailers) indicates the laden solo class of the prime mover or trailer.

Single vehicles (including tank transporters) carry the front sign only, towing vehicles carry both front and side signs, and trailers carry side signs only. Mark all vehicles as given above. See Appendix F for details on determining a vehicle's MLC. Marking the following vehicles is optional:

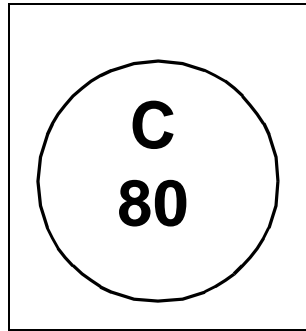

Figure E-13. Front sign

- Vehicles of a gross weight of 3.048 tons or less.
- Trailers with a rated capacity of 1.524 tons or less.

SIGN LIGHTING

The appropriate military authority in the area specifies which signs are to be illuminated. Primary considerations go to hazard and direction signs. The system of lighting must remain operational for a minimum of 15 hours without refueling or changing batteries. Consider the following:

- Under normal conditions, each armed force is responsible for ensuring that standard signs are visible at night and other periods of reduced visibility. Take necessary precautions in tactical situations.
- Under reduced lighting conditions, the positioning of the signs and the methods adopted to make them visible (illumination or reflection) must enable personnel to see them from vehicles fitted with reduced lighting or filtering devices.
- In a blackout zone, signs are equipped with upper shields that prevent light from being directly observed from the air. The light illuminating the sign is of such low intensity that it is not possible to locate the sign from the air at altitudes greater than 150 meters by its reflection off the road surface. Illumination devices are positioned so they can be recognized by oncoming vehicles at a road distance of 100 meters and read at a distance of 80 meters.

Appendix F

Military Load Classifications

The basis for MLC is the effect (load, vehicle speed, tire width, and so forth) a vehicle has on a bridge when crossing. Heavy loads, such as artillery and tanks, make vehicle classification a very important factor when determining what can travel down a route.

REQUIREMENT FOR CLASSIFICATION NUMBERS

Classification numbers are mandatory for all self-propelled vehicles having a total weight of 3 tons or more, as well as all trailers with a payload of 1 1/2 tons or greater (see STANAGs 2010 and 2021). Trailers with a rated capacity of less than 1 1/2 tons are usually combined with their towing vehicles for classification. During the classification process, vehicles are divided into two further groups—those with trailers (vehicle combination class number [CCN]) and those without (single vehicle classification number)—and calculated accordingly.

PROCEDURES FOR VEHICLE CLASSIFICATION

The actual mathematical computation of a vehicle's MLC is beyond the capability of route recon teams. However, temporary procedures are described below. MLC information is found in the vehicle's TM or on the dash's data plate.

TEMPORARY PROCEDURE FOR VEHICLE CLASSIFICATION

When a single vehicle tows another vehicle at a distance less than 30.5 meters and the vehicles are not designed to operate as one unit, the temporary vehicle MLC number may be assigned to this combination. The classification number assigned is nine-tenths the sum of the normal vehicle classification numbers if the total of both classifications is less than 60. If the sum of the two military classification numbers is 60 or over, then the total becomes the MLC number for the nonstandard combination.

$$CCN = 0.9 (A + B) \text{ if } A + B < 60$$

$$CCN = A + B \text{ if } A + B \geq 60$$

where—

A = class of first vehicle

B = class of second vehicle

EXPEDIENT PROCEDURE FOR WHEELED-VEHICLE CLASSIFICATION

It will be necessary, on occasion, to classify a vehicle in the field. Simply observe and compare the unclassified vehicle to a vehicle that is similar. Compare the axle loads, gross weight, and dimensions of the unclassified vehicle with those of a similar classification.

Example: The expedient classification for a wheeled vehicle is estimated to be 85 percent of its total weight. Therefore, you must determine the vehicle's gross weight. Multiply the air pressure in the tires (in pounds per square inch [psi]) by the total area (in square inches) of the tires in contact with the ground. If a gage is not available, use 75 psi as an average value. This yields an approximate weight of the vehicle in pounds. Convert this figure to tons and find 85 percent of the weight in tons. This resulting figure is the expedient classification.

EXPEDIENT PROCEDURE FOR TRACKED-VEHICLE CLASSIFICATION

Tracked vehicles weigh about one ton per square foot of track contact with the ground. By determining the area of track in contact with the ground, the vehicle's gross weight can be assigned. In the case of vehicles that weigh a fraction over whole tonnage, the next higher classification number is assigned.

Appendix G Symbols

Table G-1 identifies symbols used in recon missions.

Table G-1. Recon symbols

Symbol	Definition
	<p><i>Abbreviated bridge symbol.</i> Use this symbol only when the map scale does not permit the use of the full NATO bridge symbol. Submit DA Form 1249 if this symbol is used. Draw an arrow to the map location of the bridge. Show the bridge's serial number in the lower portion of the symbol and the MLC for single-flow traffic in the upper portion. If there are separate load classifications for tracked or wheeled vehicles, show the lesser classification. Underline the classification number if the width or overhead clearance is below minimum requirements.</p>
	<p><i>Concealment.</i> Show roads lined with trees by a single line of circles for deciduous trees and a single line of inverted Vs for evergreen trees. Show woods bordering a road by several rows of circles for deciduous trees and several rows of inverted Vs for evergreen trees.</p>
	<p><i>Critical points.</i> Number (in order) and describe critical points on DA Form 1711-R. Use critical points to show features not adequately covered by other symbols on the overlay.</p>
	<p><i>Ferry.</i> See Chapter 5 for a complete discussion.</p>

Table G-1. Recon symbols (continued)



Symbol	Definition
	<p><i>Ford.</i> See Chapter 5 for a complete discussion.</p>
	<p><i>Full NATO bridge symbol.</i> See Chapter 5 for a complete discussion.</p>
	<p><i>Grades.</i> See Chapter 5 for a complete discussion.</p>
	<p><i>Limits of sector.</i> Show the beginning and ending of a reconned section of a route with this symbol.</p>
	<p><i>Parking area.</i></p>

Table G-1. Recon symbols (continued)

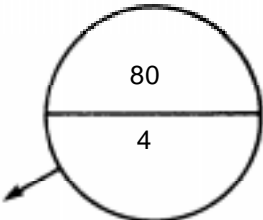
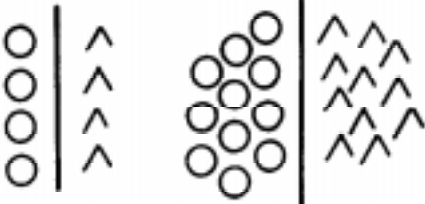
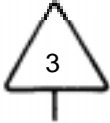
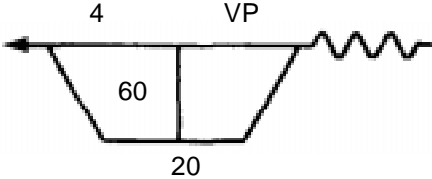

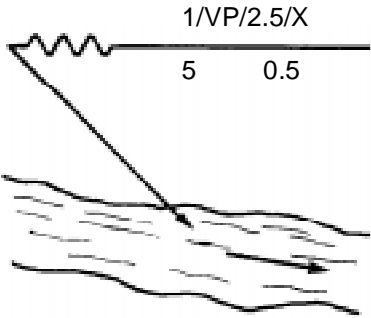
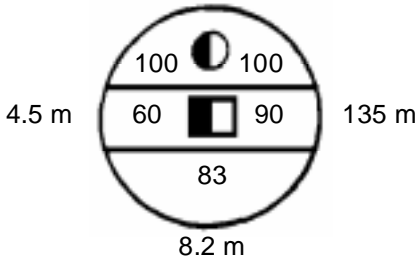
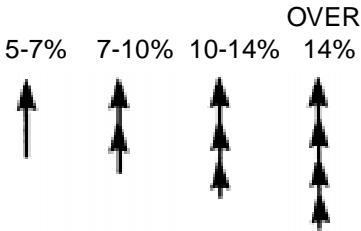

Symbol	Definition
 <p>The diagram shows a circular symbol divided into four quadrants. The top-left quadrant contains the number '45', the top-right contains '60', and the bottom-center contains '6'. To the left of the circle is the number '5', and to the right is '60'. Above the circle is the text 'RL'. Below the circle is the number '8', and below that is a smaller circle containing the number '6'. To the right of the circle is a zigzag arrow pointing downwards.</p>	<p><i>Railway bridge symbol.</i> Place RL above the symbol to indicate a railway bridge. At the left of the symbol, show the overhead clearance. Show the bridge's overall length at the right of the symbol. Indicate the traveled-way width below the symbol and underline it if it is below standard for the classification. Inside the symbol, show the bridge classification in the upper half. If the class is different for single- and double-flow traffic, show single flow on the left and double flow on the right. Place the railway bridge's serial number in the lower half of the symbol. Draw an arrow to the map location of the bridge. On the arrow shaft, indicate the ease of adapting the bridge for road-vehicle use. A zigzag line means it would be difficult to adapt; a straight line means it would be easy to adapt. Place the bypass symbol on the arrow shaft to indicate bypass conditions.</p>
 <p>The diagram shows a horizontal line representing a road crossing a diagonal line representing a railroad track. The railroad track has cross-ticks. To the left of the crossing is the number '4.2'.</p>	<p><i>Railroad grade crossing.</i> Use this symbol to show a level crossing where passing trains would interrupt traffic flow. If there is a power line present, show its height (in meters) from the ground. Underline the overhead clearance if it is less than 4.3 meters.</p>
<p>10.5 m/X/120/00 6 m/Z/30/4.1 m/(OB) 9 m/V/40/5 m/(OB) (W)</p>	<p><i>Route-classification formula.</i> See Chapter 5 for a complete discussion.</p>
 <p>The diagram shows a wavy line representing a series of sharp curves. To the left of the curve is a triangle containing the number '7/15'.</p>	<p><i>Series of sharp curves.</i> See Chapter 5 for a complete discussion.</p>
 <p>The diagram shows a single curved line representing a sharp curve. To the left of the curve is a triangle containing the number '26'.</p>	<p><i>Sharp curve.</i> See Chapter 5 for a complete discussion.</p>

Table G-1. Recon symbols (continued)

Symbol	Definition
	<p><i>Tunnel.</i> See Chapter 5 for a complete discussion.</p>
	<p><i>Turnout.</i> Use this symbol to show the possibility of driving off the road. Draw the arrow in the direction of the turnout (right or left of the road). For wheeled vehicles, draw a small circle on the arrow's shaft. For tracked vehicles, draw a small square on the arrow's shaft and place the length of the turnout, in meters, at the tip of the arrow. When a turnout is longer than 1 kilometer, use double arrows.</p>
	<p><i>Underpass constriction.</i> See Chapter 5 for a complete discussion.</p>
	<p><i>Width constriction.</i> The number on the left shows the narrowest width of the constriction; the number on the right is the total constricted length. Both dimensions are in meters.</p>

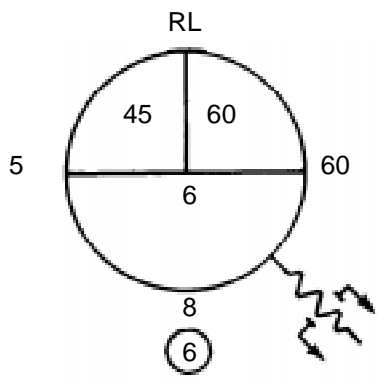
References

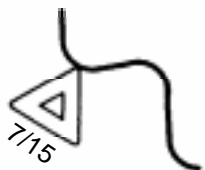
SOURCES USED

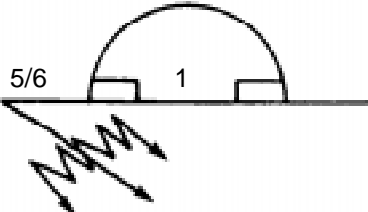
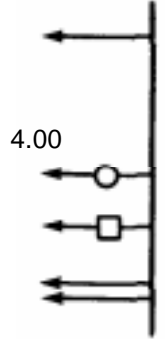
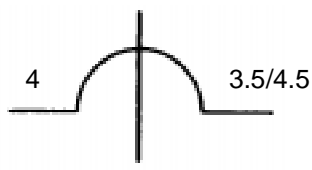
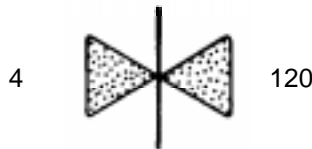
These are the sources quoted or paraphrased in this publication.

Army Publications

- DA Pam 738-750. *Functional Users Manual for the Army Maintenance Management System (TAMMS)*. 1 August 1994.
- FM 1-114. *Tactics, Techniques, and Procedures for the Regimental Aviation Squadron*. 20 February 1991.
- FM 5-71-2. *Armored Task-Force Engineer Combat Operations*. 28 June 1996.
- FM 5-71-3. *Brigade Engineer Combat Operations (Armored)*. 3 October 1995.
- FM 5-71-100. *Division Engineer Combat Operations*. 22 April 1993.
- FM 5-114. *Engineer Operations Short of War*. 13 July 1992.
- FM 5-250. *Explosives and Demolitions*. To be published within 6 months.
- FM 5-446. *Military Nonstandard Fixed Bridging*. 3 June 1991.
- FM 6-20-40. *Tactics, Techniques, and Procedures for Fire Support for Brigade Operations (Heavy)*. 5 January 1990.
- FM 6-30. *Tactics, Techniques, and Procedures for Observed Fire*. 16 July 1991.
- FM 17-95. *Cavalry Operations*. 24 December 1996.
- FM 17-95-10. *The Armored Cavalry Regiment and Squadron*. 22 September 1993.
- FM 17-98. *Scout Platoon*. 9 September 1994.
- FM 20-32. *Mine/Countermine Operations*. To be published within 6 months.
- FM 21-26. *Map Reading and Land Navigation*. 7 May 1993.
- FM 34-1. *Intelligence and Electronic Warfare Operations*. 27 September 1994.
- FM 34-2. *Collection Management and Synchronization Planning*. 8 March 1994.
- FM 34-2-1. *Tactics, Techniques, and Procedures for Reconnaissance and Surveillance and Intelligence Support to Counterreconnaissance*. 19 June 1991.
- FM 34-130. *Intelligence Preparation of the Battlefield*. 8 July 1994.
- FM 71-1. *Tank and Mechanized Infantry Company Team*. 22 November 1988.
- FM 71-2. *The Tank and Mechanized Infantry Battalion Task Force*. 27 September 1988.
- FM 71-3. *The Armored and Mechanized Infantry Brigade*. 8 January 1996.
- FM 90-13. *River Crossing Operations*. 30 September 1992.
- FM 90-13-1. *Combined Arms Breaching Operations*. 28 February 1991.
- FM 100-5. *Operations*. 14 June 1993.
- FM 100-7. *Decisive Force: The Army in Theater Operations*. 31 May 1995.
- FM 100-16. *Army Operational Support*. 31 May 1995.
- FM 101-5. *Staff Organization and Operations*. 31 May 1997.
- FM 101-5-1. *Operational Terms and Graphics*. 30 September 1997.

Standardization Agreements

- STANAG 2010. *Military Load Classification Markings*. 18 November 1980.
- STANAG 2021. *Military Computation of Bridge, Ferry, Raft and Vehicle Classifications*. 18 September 1990.
- STANAG 2027. *Marking of Military Vehicles*. 18 December 1975.
- STANAG 2154. *Regulations for Military Motor Vehicle Movement by Road*. 19 June 1992.
- STANAG 2174. *Military Routes and Route/Road Networks*. 25 February 1994.

STANAG 2253. *Roads and Road Structures*. 29 January 1982.
STANAG 2269. *Engineer Resources*. 14 May 1979.

DOCUMENTS NEEDED

These documents must be available to the intended users of this publication.

Department of the Army Forms

DA Form 1248. *Road Reconnaissance Report*. 1 July 1960.
DA Form 1249. *Bridge Reconnaissance Report*. 1 July 1960.
DA Form 1250. *Tunnel Reconnaissance Report*. 1 January 1955.
DA Form 1251. *Ford Reconnaissance Report*. 1 January 1955.
DA Form 1252. *Ferry Reconnaissance Report*. 1 January 1955.
DA Form 1711-R. *Engineer Reconnaissance Report*. May 1985.
DA Form 2028. *Recommended Changes to Publications and Blank Forms*. 1 February 1974.
DA Form 2404. *Equipment Inspection and Maintenance Worksheet*. 1 April 1979.
DA Form 2408-14. *Uncorrected Fault Record*. June 1994.

READINGS RECOMMENDED

These readings contain relevant supplemental information.

Army Publications

FM 3-4. *NBC Protection*. 29 May 1992.
FM 3-5. *NBC Decontamination*. 17 November 1993.
FM 3-19. *NBC Reconnaissance*. 19 November 1993.
FM 19-40. *Enemy Prisoners of War, Civilian Internees, and Detained Persons*.
27 February 1976.

Glossary

1SG	first sergeant
2LT	second lieutenant
ABE	assistant brigade engineer
ACE	armored combat earthmover, M9
ACR	armored cavalry regiment
ADA	air-defense artillery
AHB	attack helicopter battalion
AHD	antihandling device
AO	area of operations
AP	antipersonnel
APC	armored personnel carrier
approx	approximately
AT	antitank
attn	attention
Aug	August
bde	brigade
BMNT	before morning nautical twilight
bn	battalion
BOS	battlefield operating system
BP	battle position
C²	command and control
CAS	close air support
cbt	combat
CBR	California Bearing Ratio
CBU	cluster-bomb unit
CCN	combination class number
cdr	commander
cgo	cargo

CL	centerline
cm	centimeter(s)
co	company
COA	course of action
COLT	combat observation and lazing team
CP	checkpoint
CPT	captain
CS	combat support
CSOP	combat security outpost
CSS	combat service support
cy	cubic yard
DA	Department of the Army
DEUCE	Deployable Universal Combat Earthmover
DPICM	dual-purpose improved conventional munitions
DS	direct support
DST	decision-support template
DTG	date-time group
EA	engagement area
EENT	end evening nautical twilight
eff	effective
EN	engineer
eng	engineer
engr	engineer
EPLRS	Enhanced Position Location Reporting System
EPW	enemy prisoner of war
equip	equipment
FA	field artillery
FAC	forward air controller
FDC	fire-direction center
FEBA	forward edge of the battle area
FIST	fire-support team
FM	field manual
FM	frequency modulated
FRAGO	fragmentary order

FSE	fire-support element
FSO	fire-support officer
ft	foot, feet
GPS	global positioning system
GS	general support
GSR	ground surveillance radar
HE	high-explosive
HEMTT	heavy expanded mobility tactical truck
HHC	headquarters and headquarters company
HMMWV	high-mobility, multipurpose wheeled vehicle
hor	horizontal
hp	horsepower
HQ	headquarters
hr	hour(s)
HVT	high-value target
HYSTRU	Hydraulic System Test and Repair Unit
ICM	improved conventional munitions
illum	illumination
IN	infantry
in	inch(es)
intel	intelligence
IPB	intelligence preparation of the battlefield
IR	information requirements
IRV	recovery vehicle, full track
JAAT	joint air-attack team
Jan	January
Jun	June
KCLFF	kitchen, company-level, field feeding
KIA	killed in action
km	kilometer(s)
ksi	kips per square inch
LB	lowboy
lb	pound
LD	line of departure

LMTV	light medium tactical vehicle
LOA	limit of advance
LOGPAC	logistics package
LRP	logistics release point
LTC	lieutenant colonel
LZ	landing zone
m	meter(s)
maint	maintenance
Mar	March
MCB	mine-clearing blade
MCOO	modified combined obstacle overlay
MD	Maryland
MEDEVAC	medical evacuation
MET	medium equipment transporter
METT-T	mission, enemy, terrain, troops, and time available
MICLIC	mine-clearing line charge
MKT	kitchen, field, trailer mounted
MLC	military load classification
mm	millimeter(s)
MOOTW	military operations other than war
MOPP	mission-oriented protective posture
MR	moonrise
MRB	motorized rifle battalion
MRC	motorized rifle company
MRE	meal, ready-to-eat
MRP	motorized rifle platoon
MS	moonset
MSE	mobile subscriber equipment
MSRT	mobile subscriber radiotelephone
MTOE	modified table(s) of organization and equipment
MTV	medium tactical vehicle
N	north
NA	not applicable
NAI	named area of interest

NATO	North Atlantic Treaty Organization
NBC	nuclear, biological, and chemical
NBCRS	Nuclear, Biological, and Chemical Reconnaissance System
NCO	noncommissioned officer
NCS	net control station
NFA	no-fire area
NLT	not later than
no.	number
NOD	night observation device
Nov	November
NVD	night-vision device
NVG	night-vision goggle
NW	northwest
O/I	operations and intelligence
OBJ	objective
OBSTINTEL	obstacle intelligence
OCOKA	observation and fields of fire, cover and concealment, obstacles, key terrain, and avenues of approach
OP	observation post
OPCON	operational control
OPORD	operations order
org	organization
Pam	pamphlet
PC	point of curvature
PCC	precombat check
PIR	priority intelligence requirements
PL	phase line
PLC	provisional load classification
PLL	prescribed load list
PMCS	preventive maintenance checks and services
POL	petroleum, oils, and lubricant
PSG	platoon sergeant
psi	pound(s) per square inch
PT	point of tangency

R&S	reconnaissance and surveillance
RP	release point
rpm	rounds per minute
RR	railroad
S2	Intelligence Officer (US Army)
S3	Operations and Training Officer (US Army)
S4	Supply Officer (US Army)
SAW	squad automatic weapon
SCATMINE	scatterable mine
SE	southeast
sec	second
SEE	small emplacement excavator
SFC	sergeant first class
SINCGARS	single-channel, ground-to-air radio system
SITEMP	situational template
SITMAP	situation map
SOEO	scheme of engineer operations
SOI	signal operating instructions
SOP	standing operating procedure
SOSR	suppression, obscuration, security, and reduction
SP	start point
SR	sunrise
SS	sunset
SSN	social security number
STANAG	Standardization Agreement
surf	surface
t	ton
TACSOP	tactical SOP
TAMMS	The Army Maintenance Management System
temp	temperature
TF	task force
TIRS	terrain index reference system
TM	technical manual
TOC	tactical operations center

TOE	table(s) of organization and equipment
TOW	tube-launched, optically tracked, wire-guided missile
trk	truck
trl	trailer
TRP	target reference point
TTP	tactics, techniques, and procedures
TUL	tank, unit, liquid-dispensing, trailer mounting
UBL	unit basic load
UMCP	unit maintenance collection point
US	United States
USAES	United States Army Engineer School
UXO	unexploded ordnance
VA	Virginia
vert	vertical
w/	with
WP	white phosphorous
XO	executive officer

Index

A

aerial recon, 3-6
air defense, 6-10
air support
 flares, 6-12
 lights, 6-12
 mirrors, 6-12
 smoke, 6-2, 6-12
air-defense artillery, 6-1
area recon, 3-32, 6-15
area security, 4-4

B

basic load, 7-2
breaching, 4-6
bridge signs, B-1, E-3, E-4, E-5
bridge spans, 5-56
bridge-classification recon, 5-46
bypass symbols, 5-60
bypasses, 4-5, 5-60

C

cannon-launched guided projectiles, 6-3
chemical, 6-13
classes of supply, 7-2
close air support, 6-5, 6-11
combat observation and lazing team, 6-6
combat service support (CSS), 2-5, 4-17, 7-1
combat support (CS), 4-17
command and support, 1-5
 attached, 1-5
 direct support, 1-6
 general support, 1-6
 operational control, 1-6
communications, 1-3, 2-4, 4-2
constrictions, 5-14
course of action, 2-1, 4-5, 4-7
CS. *See* combat support.
CSS. *See* combat service support.
curve symbol, 5-9

D

decision-support template, 2-2
destruction, 7-9
dismounted element, 4-3
dismounted recon, 3-5

doctrinal templates, 2-2
double flow, 5-4

E

engineer recon, D-1
engineer recon team, 1-2, 2-1, 6-4, 6-6, 6-7,
 7-1
 capabilities, 1-2
 characteristics, 1-2
 limitations, 1-3
evacuation, 7-8, 7-9
event templating, 2-2

F

ferry recon, 5-32
ferry symbol, 5-35, 5-36
field artillery, 6-1, 6-3
fire-support element, 2-4
fire-support team, 6-4
ford symbols, 5-28
fords, 5-27
formula method, 5-8

G

ground surveillance radar, 6-1, 6-12
guide signs, E-1, E-7

H

hazard signs, E-1, E-2
high-explosive rounds, 6-2

I

illumination, 6-2
improved conventional munitions, 6-3
information requirements, 2-3
intelligence preparation of the battlefield, 2-1,
 4-4

L

lane width, 5-3
limited access, 5-3
logistical support, 4-19
logistics package, 7-1

M

maintenance operations, 7-4
 medical treatment, 7-9
 military load classification, 5-4, F-1
 military route signs, E-1
 minimum overhead clearance, 5-5
 modified table(s) of organization and equipment, 1-3
 mortars, 6-1
 mounted element, 4-3
 mounted recon, 3-4

N

named area of interest, 2-1, 2-2, 3-2, 4-2, 4-18
 nuclear, biological, chemical recon, 6-14

O

obstacle and restriction recon, 4-3
 obstacle intelligence, 1-4, 2-3, 2-6
 obstacle recon, 4-5
 obstacle reduction, 4-6
 operations order, 3-2, C-1
 overhead clearance, 5-18

P

passive air defense, 6-10
 point recon, 6-15
 prisoners, 7-10

R

recon
 elements, 1-1, 4-1
 fundamentals, 3-1
 objective, 3-1
 techniques, 3-3, 3-4
 recon by fire, 3-5
 reconnaissance and surveillance, 2-1, 2-4
 planning, 2-4
 regulatory signs, E-1, E-3
 responsibilities, 4-22, 4-23
 road markers, E-9
 road recon, 5-39
 road-classification formula, 5-43
 roads and airfields, 5-40
 route
 obstructions, 5-5
 recon, 3-7, 6-14
 Type X, 5-4
 Type Y, 5-4
 Type Z, 5-4
 width, 5-3
 route classification
 formula, 5-2
 overlay, 5-1

route-constriction symbol, 5-15

S

scatterable mines, 6-3
 service-station, 7-4
 single flow, 5-4
 single lane, 5-3
 situational template, 2-2, 3-6
 slope estimation, 5-9
 slope symbol, 5-13
 soil types, 5-42
 stream recon, 5-24
 symbols, G-1

T

table(s) of organization and equipment, 1-3
 tactical recon, 1-1, 3-1
 tailgate, 7-4
 tape-measure method, 5-6
 technical recon, 1-2, 3-1
 training, 4-1
 triangulation method, 5-6
 tunnel symbols, 5-17
 tunnels, 5-16

U

underpass symbols, 5-15
 underpasses, 5-15
 underwater recon, 5-29

V

vehicle signs, E-9
 vehicles, 1-4, 3-4, 4-2
 Fox, 6-13

Z

zone recon, 3-21, 6-15

ENGINEER RECONNAISSANCE REPORT For use of the form, see FM 5-170; the proponent agency is TRADOC.				PAGE _____ OF _____ PAGES	
TO			FROM		
FILE NO		PARTY LEADER (Name, Grade, Unit)		PLACE-HOUR-DATE	
REPORT NO					
MAPS				SCALE	
DELIVER TO (Organization, Place, Hour, and Date)					
KEY	OBJECT	TIME OBSERVED	WORK ESTIMATE	ADDITIONAL REMARKS AND SKETCH	
Engineer Work Estimate On Other Side					
TYPED NAME, GRADE, ORGANIZATION				SIGNATURE	

ENGINEER WORK ESTIMATE

LOCATION KEY	DESCRIPTION OF WORK	UNIT REQUIRED	NO HOURS	EQUIPMENT			MATERIALS		
				TYPE	NO	HOURS	TYPE	UNIT	QUANTITY

Reconnaissance Report On Other Side

