

**FM 34-3**  
**INTELLIGENCE ANALYSIS**

**MARCH 1990**

**HEADQUARTERS, DEPARTMENT OF THE ARMY**

**DISTRIBUTION RESTRICTION:** Approved for public release: distribution is unlimited

**INTELLIGENCE ANALYSIS**

**Table of Contents**

	<b>Page</b>
<b>Preface</b>	<b>iv</b>
<b>CHAPTER 1 - The Intelligence Mission</b>	<b>1-1</b>
<b>The AirLand Battle</b>	<b>1-1</b>
<b>The Battlefield Area</b>	<b>1-4</b>
<b>The Intelligence Analysis System</b>	<b>1-6</b>
<b>CHAPTER 2 - The Intelligence Cycle</b>	<b>2-1</b>
<b>Directing</b>	<b>2-1</b>
<b>Collecting</b>	<b>2-2</b>
<b>Processing</b>	<b>2-3</b>
<b>Dissemination</b>	<b>2-18</b>
<b>CHAPTER 3 - Order of Battle</b>	<b>3-1</b>
<b>Order of Battle Factors</b>	<b>3-1</b>
<b>Order of Battle References</b>	<b>3-6</b>
<b>Order of Battle Records</b>	<b>3-11</b>
<b>Enemy Combat Effectiveness</b>	<b>3-28</b>
<b>Arbitrary Unit Designators</b>	<b>3-28</b>
<b>CHAPTER 4 - Intelligence Preparation of the Battlefield</b>	<b>4-1</b>
<b>Purpose of Intelligence Preparation of the Battlefield</b>	<b>4-3</b>
<b>Development and Use of Intelligence Preparation of the Battlefield Products</b>	<b>4-5</b>
<b>Weather Analysis</b>	<b>4-21</b>
<b>Threat Evaluation</b>	<b>4-24</b>
<b>Threat Integration</b>	<b>4-26</b>
<b>Intelligence Preparation of the Battlefield During Peacetime</b>	<b>4-34</b>

**Distribution restriction: Approved for public release; distribution is unlimited.**

**\*This publication supersedes FM 34-3, 13 January 1986.**

	Page
<b>CHAPTER 5 - Analysis in Depth</b>	<b>5-1</b>
Meeting User Requirements	5-1
Determining the Risk Factor	5-3
The Threat Model	5-5
Biases	5-11
<b>CHAPTER 6 - Situation Development</b>	<b>6-1</b>
Enemy Capabilities	6-1
Enemy Courses of Action	6-3
Working Situation Map	6-4
Factors of Analysis	6-7
Techniques of Analysis	6-9
<b>CHAPTER 7 - Target Development</b>	<b>7-1</b>
Decide	7-4
Detect	7-8
Del iver	7-12
<b>CHAPTER 8 - Intelligence Support of Electronic Warfare Operations</b>	<b>8-1</b>
Intelligence Collection to Support Electronic Warfare	8-1
The Effects of Terrain and Weather on Electronic Warfare	8-2
Intelligence Required for Electronic Warfare Support Measures	8-2
Intelligence Required for Electronic Countermeasures	8-2
Intelligence Required for Electronic Counter-Countermeasures	8-3
<b>CHAPTER 9 - Counterintelligence Analysis</b>	<b>9-1</b>
Counter Human Intelligence Collection	9-2
Counter Signals Intelligence Collection	9-3
Counter Imagery Intelligence Collection	9-3
Other Intelligence Support to CI Analysis	9-3
Multidiscipline Counterintelligence	9-13
Intelligence Support to Combatting Terrorism	9-13
<b>CHAPTER 10 Intelligence Support to Counterinsurgency Support of Counterinsurgency Operations</b>	<b>10-1</b>
Intelligence Estimate	10-2
Processing Information	10-2
Dissemination	10-3
Dissemination	10-12
Order of Battle	10-12

	<b>Page</b>
<b>APPENDIX A - Report Formats</b>	<b>A-1</b>
<b>APPENDIX B - Automation Support to Intelligence Analysis</b>	<b>B-1</b>
<b>APPENDIX C - Indicators of Enemy Courses of Action</b>	<b>C-1</b>
<b>APPENDIX D - Enemy Strength Computations</b>	<b>D-1</b>
<b>APPENDIX E - Terrain Analysis in Intelligence Preparation of the Battlefield</b>	<b>E-1</b>
<b>GLOSSARY</b>	<b>Glossary -1</b>
<b>REFERENCES</b>	<b>References -1</b>
<b>INDEX</b>	<b>Index -1</b>

## PREFACE

This publication describes the processes, procedures, and techniques used to produce all-source intelligence. It focuses on intelligence production at echelons at corps and below and amplifies the doctrine contained in FM 34-1. It provides guidance for intelligence staff officers, warrant officers, NCOs, and intelligence analysts at all skill levels. It is designed for use by the active Army and reserve components (RC).

This publication implements international standardization agreement (STANAG) 2077 and quadripartite agreement 511. It is in compliance with STANAGS 1059, 2033, 2044, 2149, 6004, and 6010; quadripartite agreements 170, 295, 354, 492, 523, 528, and 593; and air agreement 101/3D. The proponent of this publication is Headquarters, United States Army Training and Doctrine Command (HQ TRADOC). Submit changes for improving this publication on DA Form 2028 (Recommended Changes to Publications and Blank Forms) and forward it to the Commander, US Army Intelligence Center and School (USAICS), ATTN: ATSI-TD-PAL, Fort Huachuca, Arizona 85613-7000.

## CHAPTER 1

### THE INTELLIGENCE MISSION

Intelligence is a key element of combined arms operations. It enables commanders to use their combat power effectively to win the decisive battles and it helps them identify and attack high payoff targets (HPTs). Intelligence is an important part of every combat decision.

The dramatic improvements in intelligence collection systems have greatly enhanced the availability of battlefield information from many different sources. Battlefield information, however, is of limited value until it has been analyzed. Through analysis, this information becomes intelligence. The intelligence analyst integrates the seemingly insignificant bits of information from multiple sources to produce an overall picture of the battlefield. This picture reduces the uncertainties about the battlefield and the situation. Analysis generates the intelligence the commander needs to successfully fight on the modern battlefield.

This chapter describes the commander's intelligence requirements. It describes how these requirements are generated and the factors that affect them. It addresses those elements within the intelligence and electronic warfare (IEW) system that plan, coordinate, and execute intelligence analysis operations.

### THE AIRLAND BATTLE

Intelligence is a vital part of the AirLand Battle. AirLand Battle is the current US Army doctrine for fighting in a mid- to high-intensity conflict. It is an extended, integrated battle involving the use of all available air and land forces. It is extended because the battle is fought from the forward edge of the area of operation (AO) to the rear boundary as a single, continuous battle (deep, close, and rear operations). It is integrated in that nuclear and chemical weapons, when released by the national command authority, are merged with electronic and conventional weapons in all operations.

AirLand Battle Doctrine is offensively oriented. Its success depends on the ability of friendly forces to take the initiative from the enemy and to carry the fight into the enemy's rear. The simultaneous attack of forward enemy forces and the deep attack of follow-on echelons is inherent in the battle. Its objectives include the diversion, delay, destruction, or attrition of enemy follow-on echelon forces before they can take part in the close operation. Figure 1-1 shows a sample deep attack.

The commander orchestrates a combination of offensive and defensive operations to defeat the enemy and gain the initiative. The commander uses defensive and offensive operations to destroy enemy first-echelon forces and deep-attack to simultaneously delay, disrupt, and manipulate enemy follow-on forces. The commander anticipates, creates, and exploits windows of opportunity, using flexible battle planning, to gain the initiative through offensive operations. By effectively employing maneuver and fire support assets, manipulating the enemy, and expertly

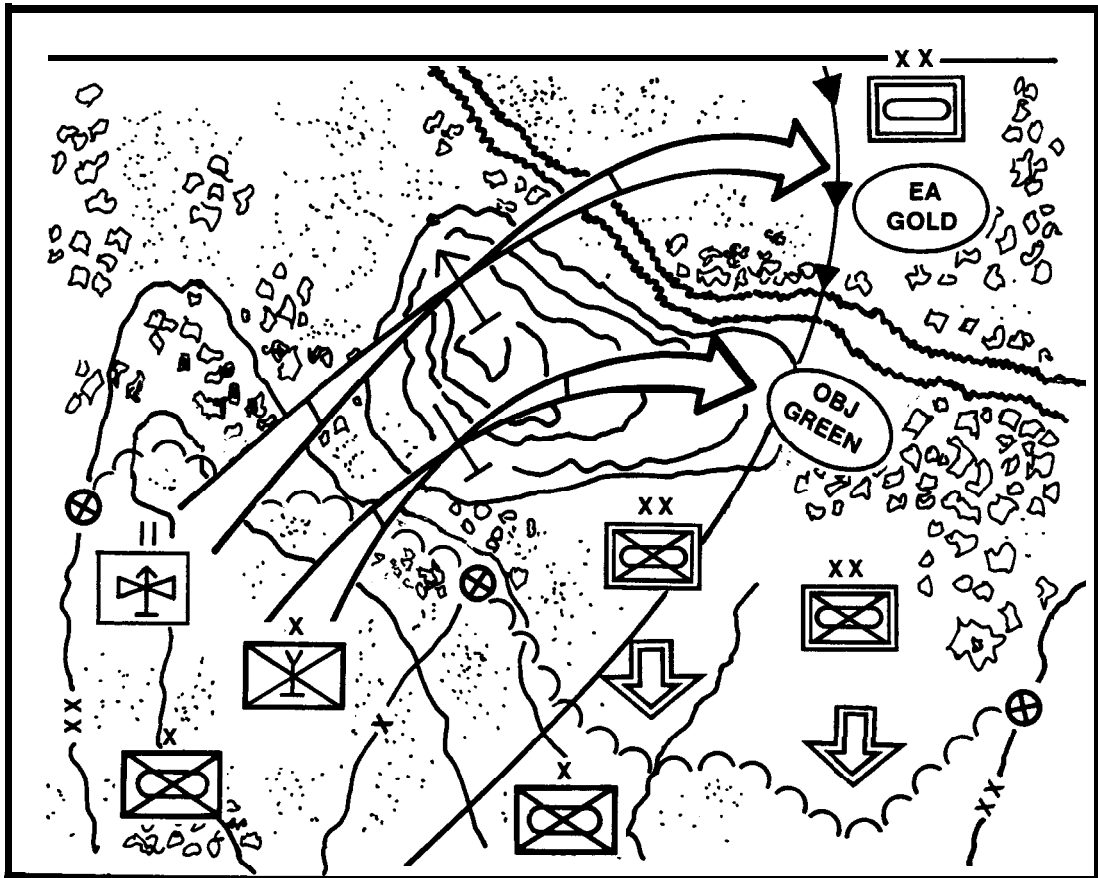

Figure 1-1. Deep attack.

using the weather and the terrain, the friendly commander can successfully defeat a superior enemy force.

To gain the initiative, the commander must--

- 0 See the enemy early and determine the capabilities and intentions of the enemy.
- 0 Find and track enemy follow-on echelons.
- 0 Identify enemy high-value targets (HVTs), targets which if successfully attacked, will contribute to the degradation of important enemy battlefield functions,
- 0 Identify, locate, and develop the required targeting data for the attack of HVTs, which if successfully attacked, will contribute to the success of friendly plans.
- 0 Detect enemy weaknesses and develop the necessary data to support the exploitation of these weaknesses.

- ° Effectively use electronic warfare (EW) to support the AirLand Battle while protecting friendly use of the electromagnetic spectrum.
- ° Determine the enemy's capability and guard against that capability.
- ° Protect friendly forces and operations from enemy intelligence collection operations.
- ° Use the weather and terrain to friendly advantage.

IEW support is vital to the successful planning and execution of the AirLand Battle at all echelons. Intelligence support at brigade and battalion levels focuses primarily on the close operation, while at division it focuses on both close and deep operations. Corps is the focal point for intelligence operations that support rear and deep operations.

Intelligence support of close operations supports the commander's risk analysis and consideration of mission, enemy, terrain, troops available, and time (METT-T). As such it must be the first step in planning. Intelligence operations reduce risk by identifying the enemy's most likely courses of action, and so allow the commander to concentrate or disperse forces as appropriate. Intelligence also provides administrative and logistic personnel, engineers, air defense artillery (ADA) staffs, and other planners with guidelines about the expected situations and enemy so they may make the best use of scarce assets.

To conduct deep operations the intelligence system supports the . . . commander's need to look deep, find and follow enemy follow-on forces, and determine their capabilities, vulnerabilities, and intentions. The commander must designate the HPTs and decide where and when to attack them to achieve the greatest benefit to the operation. The commander conducts deep attacks against designated HPTs to "shape" the battlefield by forcing the enemy commander to deviate from established plans and to create favorable conditions for friendly commanders conducting close operations. To facilitate deep operations, corps-level intelligence planning must focus its attention on analyzing and estimating enemy capabilities, intentions, and likely courses of action at least 72 hours in advance. At division-level, intelligence planners must perform this same function at least 24 hours in advance.

Intelligence support of rear operations supports the commander's need to identify enemy capabilities, intentions, and likely courses of action to interdict friendly combat support (CS) and combat service support (CSS) functions, and to inhibit the ability of the friendly commander to flexibly employ the reserves. The intelligence planner must consider all means and measures available to the enemy, to include sabotage, unconventional warfare, airmobile or airborne assaults, nuclear, chemical, and conventional long-range strikes, deception, and the employment of maneuver forces in deep exploitation or raiding operations.



## THE BATTLEFIELD AREA

Commanders consider the battlefield in terms of the time and space necessary to defeat an enemy force or complete an operation before the enemy can reinforce. They view the battlefield as having two distinct areas: the AO and the area of interest (AI).

The AO is that portion of an area of conflict necessary for military operations. The AO is assigned by the next higher commander and designated by lateral and rear boundaries. It carries with it the authority and responsibility to conduct operations therein. The commander must coordinate with adjacent commanders before conducting maneuver and fire support (FS) activities outside the designated AO.

The AI is that area of concern to the commander which includes the AO and areas adjacent thereto. It includes areas forward of, and to the flanks and rear of the AO. It encompasses areas either occupied by enemy forces that could jeopardize friendly mission accomplishment and/or which includes the objectives of friendly current or planned operations.

Each commander determines his own AI. The commander generally relies on higher headquarters and adjacent units to provide information and intelligence about enemy forces in that area. Figure 1-2 shows the battlefield areas of division.

Battlefield areas are important to the intelligence analyst because they help focus the information requirements of commanders concerning the weather, terrain, and enemy forces from battalion to echelons above corps (EAC). Specific information requirements are dependent on the mission and the tactical situation. Usually, in conventional operations, information requirements (IR) on enemy forces are based on the one-up and two-down formula. Commanders require detailed information about enemy forces at their equivalent levels of command as well as at one level above and two levels below their own. For example, brigade commanders need information about enemy regiments (equivalent level), enemy divisions (one-up), and enemy battalions and companies (two-down). Generally, the enemy forces of concern to each commander are found within the command's AO and AI.

The IEW mission includes four major tasks: situation development, target development, EW, and counterintelligence (CI).

Situation development (discussed in Chapter 6) provides commanders with the intelligence they need to make sound tactical decisions. It is a continuing estimate of the situation that projects enemy intentions and the effects of the weather and terrain. Situation development helps commanders--

- Find and follow enemy forces.
- Determine enemy capabilities, vulnerabilities, and intentions.
- Identify the enemy main effort.

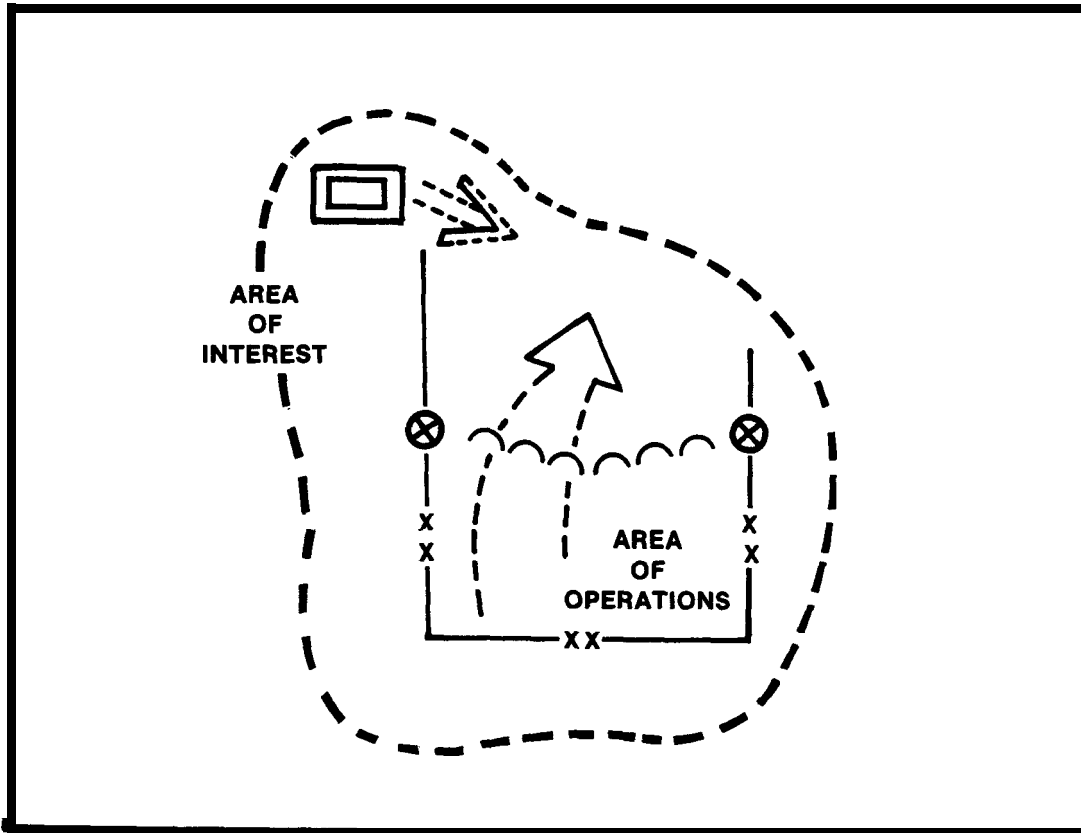

**Figure 1-2. Battlefield areas.**

- ° Determine how the weather and terrain will affect friendly and enemy operations.
- ° Detect opportunities to exploit enemy weaknesses and seize or retain the initiative.
- ° Assess the relative value of enemy combat systems, which serves as a basis for selecting HVTs.

Target development (discussed in Chapter 7) provides combat information, targeting data, and correlated target information which support the commander's tactical plans. It focuses on HPTs which have been selected, through the targeting efforts of the G2 or S2, the G3 or S3, and the fire support element (FSE), and approved by the commander. Target development identifies, locates, and tracks HPTs until they are neutralized. Target development operations must provide sufficiently accurate targeting data to attack by fire, maneuver, or electronic means.

Situation and target development provide the intelligence required to fight the AirLand Battle. Both are distinct tasks, but are interrelated and totally integrated to provide an accurate picture of the battlefield.

EW (discussed in Chapter 8) exploits, disrupts, and deceives the enemy command and control (C<sup>2</sup>) system while protecting friendly use of communications and non-communications systems. It is a significant force multiplier when integrated and employed with fire and maneuver. EW consists of the following functions:

- °EW support measures (ESM), which provide commanders the capability to intercept, identify, and locate enemy emitters.

- °Electronic countermeasures (ECM), which provide commanders the capability to disrupt enemy use of the electromagnetic spectrum.

- °Electronic counter-countermeasures (ECCM), which are used to protect friendly command, control, and communications (C<sup>3</sup>) systems against enemy radioelectronic combat (REC) activities.

CI (discussed in Chapter 9) includes specific actions which support the protection of the friendly force. Enemy commanders, to succeed against friendly forces, must employ all-source intelligence systems to collect information about friendly forces. Depriving enemy commanders of vital information about friendly forces is crucial to friendly success on the battlefield. CI enhances the operations security (OPSEC) of the command by supporting the following actions:

- °Countering the hostile intelligence threat.

- ° Safeguarding the command from surprise.

- °Deceiving the enemy commander.

- °Countering enemy sabotage, subversion, and terrorism.

- °Developing essential elements of friendly information (EEFI).

#### THE INTELLIGENCE ANALYSIS SYSTEM

The intelligence analysis system is a single, integrated system that extends from battalion level to national agencies. Figure 1-3 shows the all-source intelligence system.

The system includes the directors, coordinators, producers, and executors. All are linked together both laterally and vertically to ensure a coordinated and effective effort. Figure 1-4 shows the common IEW structure.

Analysis elements are the heart of the intelligence system. They include--

- ° Intelligence officers and their staff sections.

- ° Echelons above corps intelligence centers (EACICs).

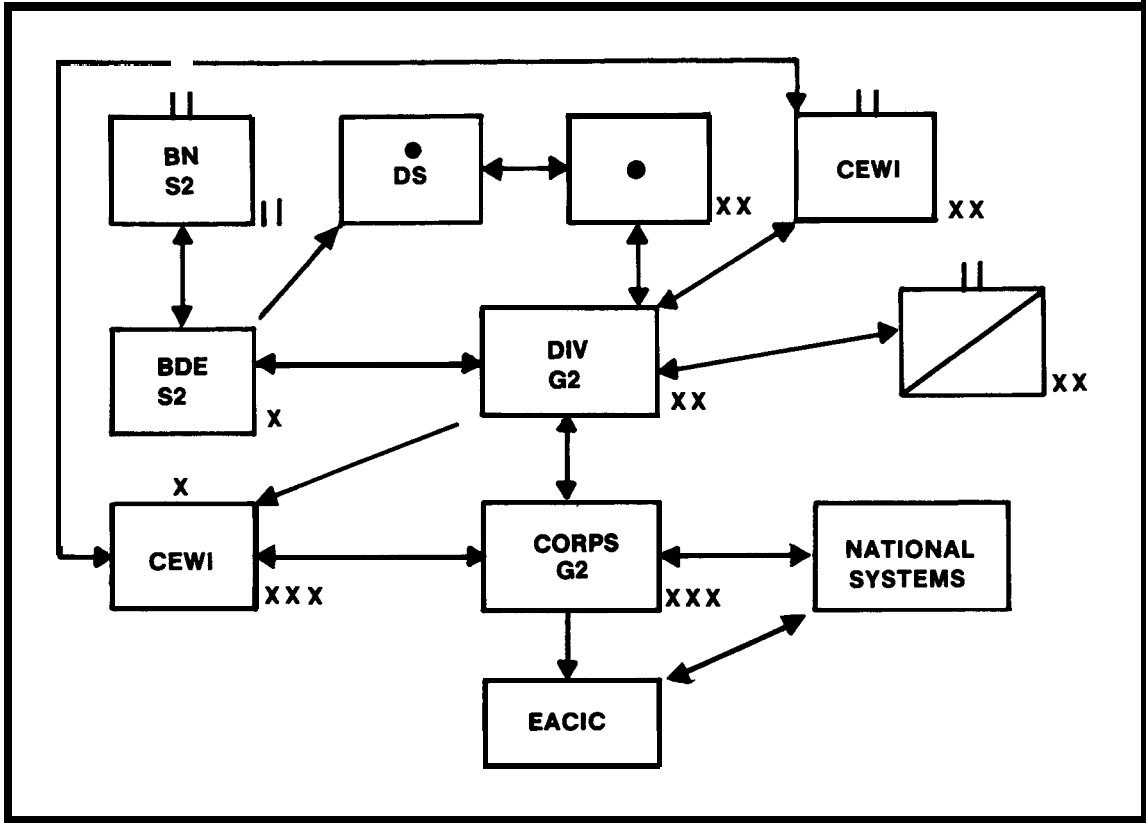

Figure 1-3. All-source Intelligence system.

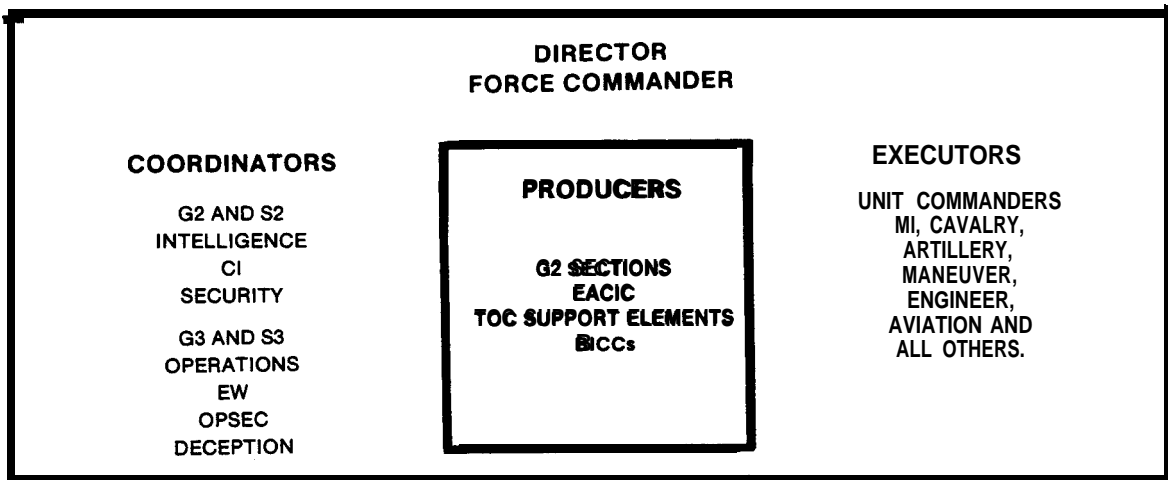

Figure 1-4. Common IEW structure.

°Tactical operations center (TOC) support elements at division and corps levels.

°Technical control and analysis elements (TCAEs) organic to military intelligence (MI) combat electronic warfare and intelligence (CEWI) battalions at division-level and MI CEWI brigades at corps-level.

°Battlefield information coordination centers (BICCs) at maneuver and artillery battalions and brigades.

#### INTELLIGENCE DIRECTOR, COORDINATORS, AND PRODUCERS

The intelligence director (commander), coordinators (staff), and producers (such as EACICS, TOC support elements, TCAEs, and BICCs) play the major roles in intelligence analysis.

##### Commander

The commander plays a critical role in intelligence analysis. The commander determines what intelligence is needed to plan and execute an operation. The commander provides guidance to the staff to ensure that the analysis effort is integrated with the other functional systems of the command and that it is focused on critical requirements and priorities. The commander, with the intelligence and operations staffs, accomplishes the planning, directing, guiding, and decision making that generate intelligence analysis and keep it going. The commander approves or modifies the priority intelligence requirements (PIRs) recommended by the G2.

##### Staffs

While the commander approves the PIR for the command, every staff officer in the command needs intelligence to support the functions under their staff responsibilities. However, the staff officers that are most involved with intelligence requirements are the G2 or S2, the G3 or S3, and the FS coordinator (FSCoord).

G2 or S2. The G2 or S2 manages intelligence operations. This officer is responsible for intelligence production and for determining the enemy's intentions. The G2 or S2 recommends PIR, based on the commander's guidance and concept of the operation. The officer manages the collection effort, supervises all i-source analysis, and ensures that combat information and intelligence are disseminated rapidly. The G2 or S2 develops the intelligence estimate. The officer ensures a team effort in planning, supervising, and executing iEW operations within the command.

G3 or S3. Second only to the commander, the G3 or S3 is the primary user of intelligence. As the principal planner and coordinator of unit operations, this officer relies heavily on intelligence support. The operations officer completes the estimate of the situation and recommends which friendly courses of action are feasible and which should be adopted. These estimates are based on the METT-T, of which a major part

is provided by intelligence. The G3 or S3 IRs are the same as, only more detailed than, those of the commander. The operations officer plays a key role, in conjunction with G2 or S2, in developing and recommending the PIR.

The G3 or S3 also has staff responsibility for EW, OPSEC, and battlefield deception (BAT-D). This officer relies on intelligence to plan and coordinate each of these functions.

**Fire Support Coordinator.** The FSCOORD plans and coordinates FS. This officer needs intelligence for FS targeting and target development. The FSCOORD, G2 or S2, and G3 or S3 coordinate very closely in selecting HPTs and developing targeting data for attacking HPTs.

#### **Tactical Operations Center Support Elements**

The TOC support elements provide dedicated intelligence support to the G2 or S2. TOC support elements, which are assigned to the headquarters and headquarters company (HHC) of the division, or the operations battalion of the corps MI brigade, perform intelligence collection management (CM), analysis, and dissemination functions. The all-source production section (ASPS) or equivalent element within the TOC support element performs intelligence analysis. Other TOC support element sections are collection management and dissemination (CM&D) and CI analysis, which support the G2; and the EW and OPSEC staff elements, which support the G3. There is also an informal targeting team formed in the DTOCSE and CTCOCSE to assist in the targeting effort.

The ASPS works under the staff supervision of the G2 or S2. It develops and maintains the intelligence data base. It develops intelligence from unprocessed information and other intelligence products. It performs IPB, assists the G2 or S2 in developing the intelligence estimate, and develops the analysis of the battlefield area. It also develops situation and targeting data to support maneuver, fire, and other battlefield functions. Each ASPS coordinates with other TOC support elements to ensure that all available data is evaluated and to exchange analysis approaches, techniques, and ideas for solving common intelligence problems.

#### **Technical Control and Analysis Element**

The TCAE, in addition to managing the signals intelligence (SIGINT) collection and EW assets, performs SIGINT analysis for the command. It maintains the enemy electronic order of battle (EEOB) and technical data bases. It analyzes and correlates ESM and SIGINT data from all sources to update the EEOB and technical data bases needed to produce SIGINT. It passes SIGINT data to the ASPS for correlation with information and intelligence from other sources.

#### **Battlefield Information Coordination Centers**

The BICCs are organic to maneuver brigades, battalions, and other support units. They consist of analysts who operate within their unit

TOCS as an integral part of the S2 section. They provide an organic intelligence management, production, and dissemination capability. BICCs vary in the size and type of support they provide, For example, maneuver unit BICCs concentrate on both situation and target development, while artillery unit BICCs are almost exclusively interested in target acquisition (1A) and development.

#### **INTERACTION OF ANALYSIS ELEMENTS**

Close coordination and interaction between analysis elements make the system function effectively. Analysis elements at all echelons exchange requirements, information, and intelligence both laterally and vertically throughout the system. At the same time they disseminate combat information and intelligence to maneuver, FS, and other units that need it.

## CHAPTER 2

### THE INTELLIGENCE CYCLE

Intelligence operations follow a four-phase process known as the intelligence cycle. The intelligence cycle is oriented to the commander's mission. Supervising and planning are inherent in all phases of the cycle. Figure 2-1 shows the intelligence cycle.

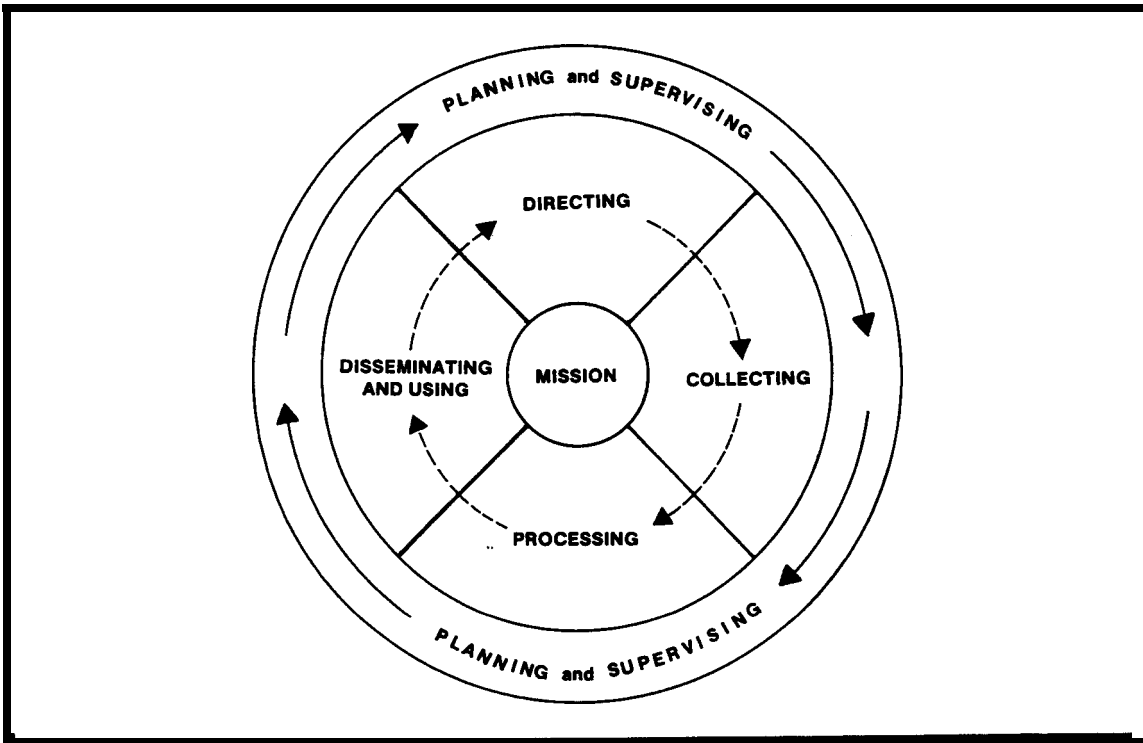

**Figure 2-1. The intelligence cycle.**

The intelligence cycle is continuous. Even though the four phases are conducted in sequence, all are conducted concurrently. While available information is processed, additional information is collected, and the intelligence staff is planning and directing the collection effort to meet new demands. Previously collected and processed information (intelligence) is disseminated as soon as it is available or needed.

This chapter describes the procedures outlined above and the processing phase of the intelligence cycle.

#### DIRECTING

The intelligence effort begins by determining requirements, establishing their priorities, and communicating information or intelligence collection orders (to subordinate elements) and requests (to



higher and adjacent units). This is accomplished by the commander and the intelligence and operations staff. Sources of information or intelligence requirements include the following:

- ° Commander's planning guidance, concept of the operation, and stated requirements.
- ° METT-T analysis by intelligence and operations staffs.
- ° Requests for intelligence information (RIIs) from higher, adjacent, allied, and subordinate units and elements, and from other staff elements within the command.

The highest or most important IRs are designated as PIRs. The commander chooses PIRs based in part on the recommendation of the G2 or S2. PIRs are those intelligence requirements for which a commander has an anticipated and stated priority in the task of planning and decision making. However, an excessive number of PIRs degrades efforts to focus relatively scarce intelligence collection resources on the most essential intelligence requirements.

IRs are those items of information regarding the enemy and the environment needing collection and processing to meet the intelligence requirements of the commander. IRs can either support PIRs or be stand-alone requirements of a lesser priority than PIRs. Both PIRs and IRs serve as the basis for collection and intelligence efforts.

Intelligence analysts in the ASPS advise the G2 regarding the PIRs and IRs. They analyze METT-T factors and the commander's guidance and concept of the operation to determine what intelligence and information is needed. The ASPS reviews the existing data base to identify information that is already available and that which must be acquired. They pass requirements for new information to the CM&D section as additional collection requirements. Figure 2-2 shows the directing phase from the commander's intent to the commander's requirements.

### COLLECTING

Based on requirements, the CM&D section manages the collection effort. The CM&D section develops a collection plan that is keyed to the PIRs and IRs. It continuously updates the collection plan as the situation changes.

The ASPS assists the CM&D section in planning and supervising the collection effort. The ASPS helps convert intelligence requirements into specific information requirements (SIR). SIR are keyed to indicators (see Appendix C) which when integrated with other indicators and factors present on the battlefield may provide clues to the enemy's most probable course of action. The ASPS monitors incoming reports, advises the CM&D section when PIR or IR are satisfied, identifies new requirements, and determines when previously requested information is no longer needed.

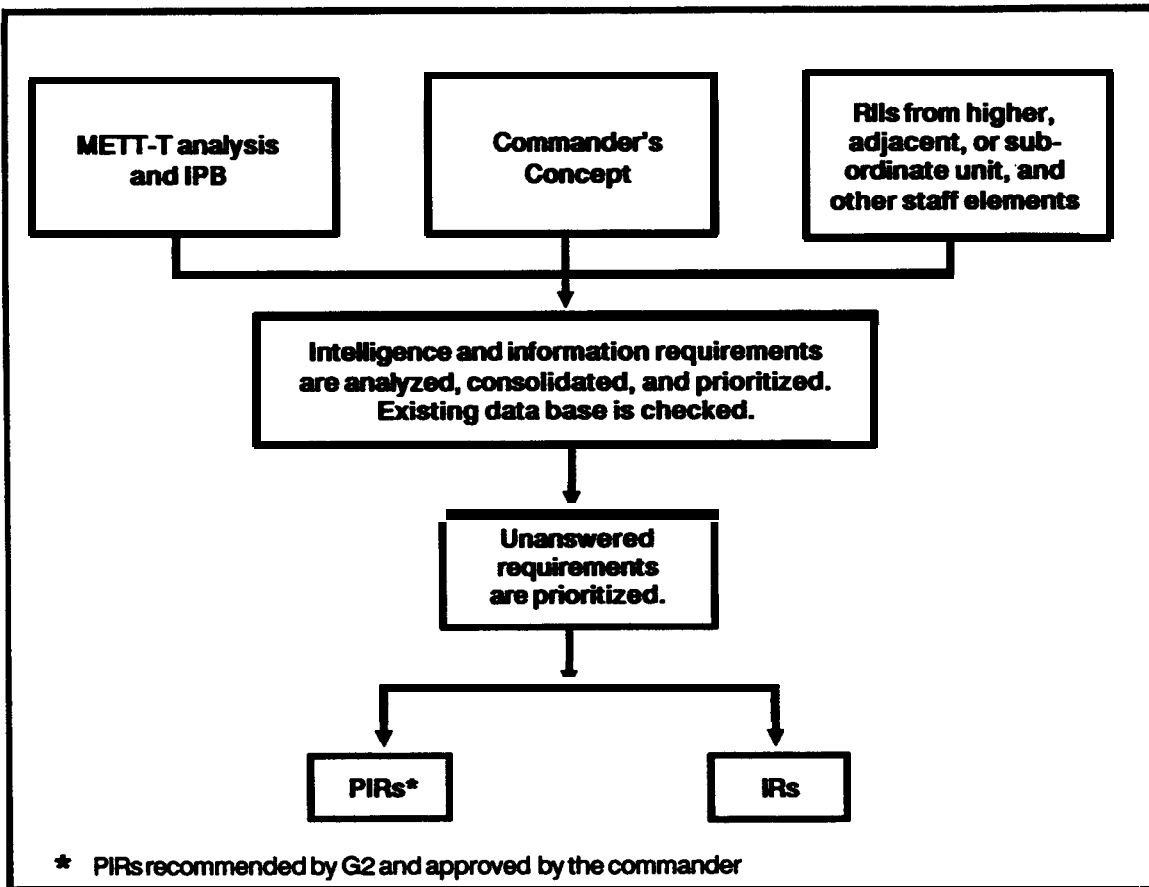

Figure 2-2. Commander's requirements and guidance.

Collection operations generate information from various sources. This information is fed into the ASPS. The ASPS--

°Reports combat information immediately.

°Processes information to develop the intelligence needed for tactical decisions and targeting.

#### PROCESSING

Processing is the phase in the intelligence cycle in which information becomes intelligence. It consists of three operations:

°Recording. Recording is the reduction of information to writing or some other form of graphical representation and the arranging of this information into groups of related items.

- Evaluation. Evaluation is the determination of the pertinence of information to the operation, reliability of the source or agency, and accuracy of the information.
- Analysis. Analysis is the determination of the significance of the information, relative to information and intelligence already known, and drawing deductions about the probable meaning of the evaluated information.

Processing is a continuous operation. The analyst processes new information as it is received without waiting for additional information. Intelligence derived from fragmentary information is essential, particularly during fast-moving operations or when the information concerns an HPT. Normally there is a time lag between the time an enemy target presents itself and the time the information becomes available to an element that can react to it. Complete information about a target or a situation is seldom available. The analyst continuously identifies information gaps and attempts to acquire information to complete, confirm, or refute fragmentary information. This information must assist the commander to generate and apply combat power. It helps the commander to strike critical units or areas, and to achieve and retain the initiative. Figure 2-3 shows information processing.

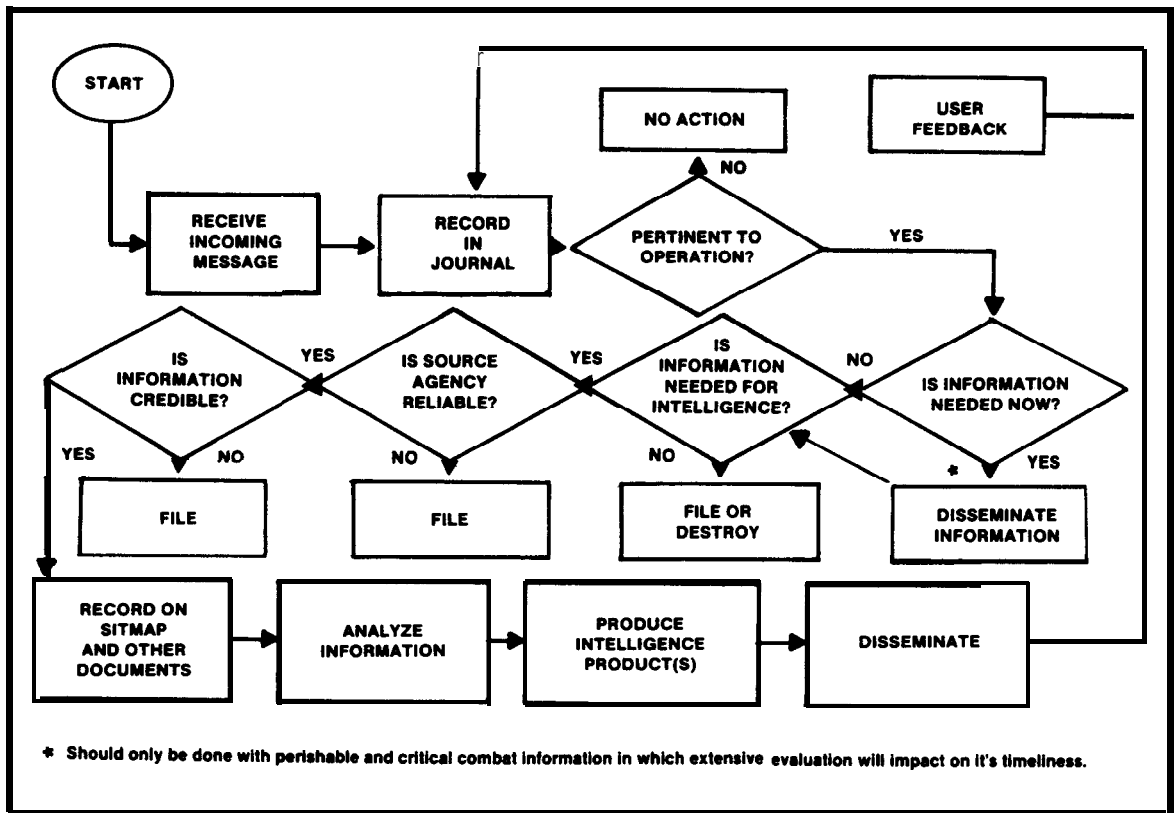

Figure 2-3. information processing.

The sequence for processing varies with the nature and urgency of the information. Information is normally recorded first; however, if it contributes to the development of urgent intelligence, it is recorded simultaneously with or after evaluation and analysis. Combat information or partially developed intelligence that is needed immediately is disseminated before it is completely processed. Information that is not of immediate value is processed before it is disseminated.

Evaluation and analysis may occur simultaneously followed by immediate dissemination. For example, information from a reliable source may indicate that the enemy is about to launch a major attack. In this case, recording is of secondary importance, and the intelligence report that an attack is imminent is disseminated as soon after receipt as possible.

Reporting of information to higher and lower echelons occurs concurrently with processing. For example, to speed target execution time of HPTs, a commander orders lower headquarters to report all information concerning specified enemy units, areas, or activities before the processing cycle is complete. Lower headquarters make similar requests of higher headquarters.

A sound collection program that effectively uses collection assets results in a heavy volume of information. Some information may be of no use to the collecting unit, but of great value to adjacent, higher, or lower units. This includes many reports which may appear insignificant and unrelated to other information. However, when these reports are analyzed along with other available information, definitive and predictable patterns of enemy activity often emerge.

Today, most information is processed manually. Emerging automatic data processing (ADP) systems help the analyst process greater volumes of information faster and more accurately. Appendix B describes ADP support to intelligence analysis. Developing and maintaining an intelligence data base is essential to processing. The data base is the basis for analyzing new information needed for situation and target development as well as CM, EW, and CI operations. When possible, intelligence data bases are created for contingency areas during peacetime. Initially, data base information and intelligence are collected by researching available literature published by various agencies and sources, including the following:

- ° Central Intelligence Agency (CIA).
- ° Defense Intelligence Agency (DIA).
- ° National Security Agency (NSA).
- ° US Army Intelligence Agency (USAIA),
- ° Unified and specified commands.
- ° Theater commands.

° Allies.

° Open sources.

The analyst identifies gaps in the data base and passes requirements to the collection manager. As information is received from the various collection agencies, it is correlated with existing information in the data base to assess its significance. Combat information, often highly perishable in nature, is disseminated immediately.

#### RECORDING

Recording information into the data base makes evaluation and analysis easier and more accurate and facilitates preparation of intelligence reports by conveniently drawing together all available information on a specific subject. The recording means used must be adequate to handle the volume of information and intelligence received and to serve the needs of those who must have access to it. Means and techniques of recording must permit timely dissemination of information and intelligence.

Recording is more complex at higher command echelons. At division level and above, ADP systems assist in the recording function. Some of the more common recording devices are listed below. Others are used when required.

° Intelligence journal.

° Intelligence files.

° Situation map (SITMAP).

° Intelligence workbook.

° Coordinate register.

° Order of battle (OB) records.

#### Intelligence Journal

The journal is an official, permanent, and chronological record of reports and messages that have been received and transmitted, important events that have occurred, and actions taken in response. Accuracy and completeness are essential, since various elements of the headquarters will refer to it later. It covers a specified time period, usually 24 hours. Journal entries should reflect--

° An accurate and concise statement of the message, report, or event.

° A notation about the sender or individual making the report, to include unit duty position and section: for example, S3 1/60 Infantry Battalion.

°The time of receipt or dispatch and method of transmission.

°Action taken as a result, to include dissemination given to reports, other information received, and other internal G2 recording (workbook, SITMAP),

Journal entries are concise and record the time and essential facts. As a minimum the journal entries include--

°Purpose, subject, and conclusions of conferences.

°Command decisions and summarizations of plans.

°Movements of enemy units, one echelon above and two echelons below your own level,

°Significant messages (radio, radio teletypewriter (RATT), hard-copy, overlays, photos, and any other verbal or written reports) transmitted and received.

°Incidents of enemy activity.

°Friendly patrol activity.

°Liaison activities.

°Changes in personnel within the staff section.

°Summaries of written messages and orders.

°Summaries of action based on enemy and friendly activity.

Figure 2-4 shows a partially completed intelligence journal (DA Form 1594).

### Intelligence Files

Intelligence files permit ready access to all available information. The files most commonly maintained are the journal file, reference file, and OB file.

**Journal File.** The journal file contains all previously recorded journal sheets and supporting materials. Supporting material referenced on the journal sheet is filed in chronological sequence. It includes copies of orders, periodic reports, messages, memoranda, conference notes, map overlays, and other material required to support the journal entries. The journal number is annotated on the supporting document. The unit SOP normally describes procedures for maintaining a journal. One good method is to begin the annotation with the letter "J," followed by the date and an entry number. The fifth entry on June 23d would read "J-23-05."

DAILY STAFF JOURNAL OR DUTY OFFICER'S LOG					PAGE NO.	NO. OF PAGES
For use of this form, see AR 220-15; the proponent agency is Office of The Deputy Chief of Staff for Operations & Plans.					1	1
ORGANIZATION OR INSTALLATION			LOCATION	PERIOD COVERED		
2 <sup>D</sup> BDE			BURGEW, GE	FROM		TO
52 <sup>D</sup> MECH DIV			(LA567275)	HOUR	DATE	HOUR DATE
				0001	07 DEC 80	2400 07 DEC 80
ITEM NO.	TIME		INCIDENTS, MESSAGES, ORDERS, ETC.	ACTION TAKEN	INL	
	IN	OUT				
1	0001		Journal opened 0001		BW	
2	0030		1st BTF: Company team A patrol reported enemy supply dump vicinity LA888912.	Map, S3, Cdr	BW	
3		0055	ALL UNITS: Execute alternate challenge password. Primary compromised at 0700045.	Cdr, Staff, Units	DT	
4	0200		1st BTF: Follow-up to item 2. Search results: 12XAT mines, 30,000 rounds 7.62 ammunition, 6 rolls barbed wire, all destroyed in place.	Cdr, S3	DT	
<b>SAMPLE</b>						
65	2400		Journal closed 2400			
<u>SUMMARY</u>						
No enemy contact during period, but one enemy ammunition dump destroyed.						
TYPED NAME AND GRADE OF OFFICER OR OFFICIAL ON DUTY				SIGNATURE		
SAMUEL A. MORRIS, CPT, MI				<i>SAM</i>		

DA FORM 1594 NOV 82

PREVIOUS EDITION OF THIS FORM IS OBSOLETE.

U.S. Government Printing Office: 1984-421-646/17155

Figure 2-4. Intelligence journal sample page.

**Reference File.** The reference file includes all information that is not of immediate interest but may be of future value. Information is cross-indexed to permit easy retrieval.

**OB File.** The OB file is discussed in Chapter 3.

### Working Situation Map

The working situation map (SITMAP) is the primary analytic tool at all echelons. It is a temporary graphic display of the current dispositions and major activities of the enemy. Information about friendly forces on this map usually is limited to boundaries; locations of command posts (CPs) of higher, lower, and adjacent units; reconnaissance units; the forward edge of the battle area (FEBA), and forward line of own troops (FLOT). The level of detail of the working SITMAP will be proportionate to the echelon at which it is maintained.

Generally, enemy maneuver units are posted which are two echelons below that of the friendly unit. Enemy units, regardless of size, in our rear area are always posted because of the amount of damage they can do to administrative and logistical nodes.

Enemy headquarters (especially regimental and higher levels) and CS and CSS asset locations are also posted. The SITMAP reflects enemy unit identification, disposition, and boundaries; major roads or trails for movement of personnel, weapons, and equipment; and locations of, for example--

- ° Automatic weapons (battalion SITMAP only).
- ° Supporting mortars (battalion SITMAP only).
- ° Antitank guns (battalion SITMAP only).
- ° Artillery,
- ° Air defense artillery.
- ° Minefields.
- ° Roadblocks.
- ° Entrenchments.
- ° Obstacles.
- ° Defensive positions.
- ° Logistics and command facilities.
- ° Aircraft and helicopter staging areas.
- ° Nuclear, biological, and chemical (NBC) contaminated areas.



° Ground surveillance devices.

° Smoke screens.

When plotting enemy activities and dispositions, indicate the latest time at which the activity was observed or the disposition confirmed. The S2 ensures that the working SITMAP and supporting overlays are maintained as simply as possible and that authorized conventional signs, military symbols and abbreviations are used. See FM 101-5-1 for authorized abbreviations and map symbols. Explain any deviations from these symbols in the marginal data on the map or overlay. Necessary classification markings also must appear in the margins of maps and overlays.

Rather than attempting to plot all entries on a map by means of conventional or improvised military symbols, the S2 uses a number or letter to plot the area where the activity was observed. A corresponding letter or number then is entered into a space alongside the map and a notation entered as to the activity observed. Use a number or letter that is easily cross-indexed to the journal or message file for a complete report. Ensure that the number or letter indicating an activity in the journal file matches that on the working SITMAP (see "action taken" column in Figure 2-4).

Care must be taken to prevent overcrowding the map. One method of doing this is to group entries by categories on a series of acetate overlays. Use separate overlays to display separate categories of information. A typical separate overlay might show fortifications or potential targets or details of OB. An enlarged sketch map also is prepared to cover overcrowded areas. This allows the presentation of additional details.

The working SITMAP (discussed in this chapter) and the OB SITMAP (discussed in Chapter 3) are two separate items. Although the same types of information are recorded on each, their functions differ. The G2 or S2 uses the working SITMAP for recording and analyzing. The OB SITMAP normally is less cluttered than the working SITMAP.

Maintenance of the OB SITMAP at brigade and battalion levels usually is a joint S2 and S3 action. At higher levels, each section maintains a separate SITMAP. Plotting the friendly situation is the responsibility of the S3, while the enemy situation is the responsibility of the S2. During operations, personnel from either section map or plot friendly or enemy entries on the SITMAP and perform other processing functions.

When the intelligence and operations staffs use separate maps, ensure that acetate overlays are readily interchangeable between these maps. This permits easy comparison of the current enemy situation (G2 or S2 map) with the disposition of friendly forces (G3 or S3 map), and easy comparison of enemy obstacles, barriers, and minefield with planned routes of march.

Examples of separate SITMAP overlays are--

- ° Enemy fortifications.
- ° High value targets.
- ° Obstacles.
- ° OB data.
- ° Friendly reconnaissance patrols.
- ° Surveillance activities (include the ground coverage of each system).

The maintenance of the working SITMAP takes precedence over all other recording means during combat operations. In a fast-moving situation, particularly at the maneuver battalion level, it is the only recording device used.

The working SITMAP is continually purged of information that is not current or otherwise no longer needed. Purging keeps it neat and uncluttered, making it more useful as an analysis tool. Map overlay tracings or periodic photographs of the SITMAP provide a permanent record of the situation. These records provide a reference to past enemy activity and help determine patterns of enemy movement and dispositions.

Use the working SITMAP to make sound tactical decisions; its primary intelligence uses are to--

- ° Display the enemy disposition and situation.
- ° Provide a basis for comparison to determine the significance of newly received data about enemy forces. IPB situation and event templates provide a basis for comparison.
- ° Provide a background and basis for briefings and other required intelligence reports.
- ° Provide the basis for overlays which graphically portray the enemy situation.
- ° Assist in the determination of movement patterns of guerrilla or insurgent forces.
- ° Show possible intelligence gaps which require redirection of the collection effort. For example, the need to locate and identify enemy units reported for the first time.

For secondary intelligence use, post the following information in the margin of the working SITMAP or on charts or cards nearby:

- ° Computations of enemy personnel and weapon strengths and weaknesses.

- ° Organization charts of specified enemy units.
- ° Summaries of weather and terrain data.
- ° A listing of PIR and IR.
- ° Notations about the current patrol plan.
- ° Movement computations.
- ° A listing of friendly attachments.
- ° A listing of unlocated enemy units believed to be in the AO.
- ° Probable courses of action.
- ° Battle damage assessment (BDA).

Chapter 6 describes how the SITMAP is used in situation development.

#### Intelligence Workbook

The intelligence workbook contains information arranged by subject heading. This arrangement helps to sort, evaluate, interpret information, and prepare intelligence reports. It is not a permanent record and it is not distributed to an outside agency. The workbook is kept current with obsolete entries deleted. At higher echelons, analysts maintain separate workbooks on various subjects.

There is no prescribed format for the workbook. At division and lower headquarters, use index tabs to label information in the intelligence summary (INTSUM). At corps and higher levels, use index tabs to label information in the periodic intelligence report (PERINTREP).

Record incoming messages and reports; for example, information concerning a newly identified armor unit could be recorded under index tab 3A, NEW UNITS, as well as index tab 2B, ARMOR. A message that furnishes information on different subjects results in several entries: each entry contains only that subject information. For example, a message containing information on the locations of a reserve armor unit and an artillery unit results in extracts under item 2B, ARMOR and under 2C, ARTILLERY. Base each entry in the workbook on an incoming message and include a reference to the journal serial number of that message. For example, J2, 091200 April, from 20th Engr Cbt Bn: "Bridge at LINDEN AB 910246 destroyed by bombing. Estimated out of action for 30 hours." The J2 refers to the journal serial number and the date-time group (DTG) entered refers to the time of occurrence of the event. The intelligence officer makes written comments on the evaluation of the information and its possible significance following the appropriate entry.

Figure 2-5 shows a sample intelligence workbook which might be used at corps and higher levels.

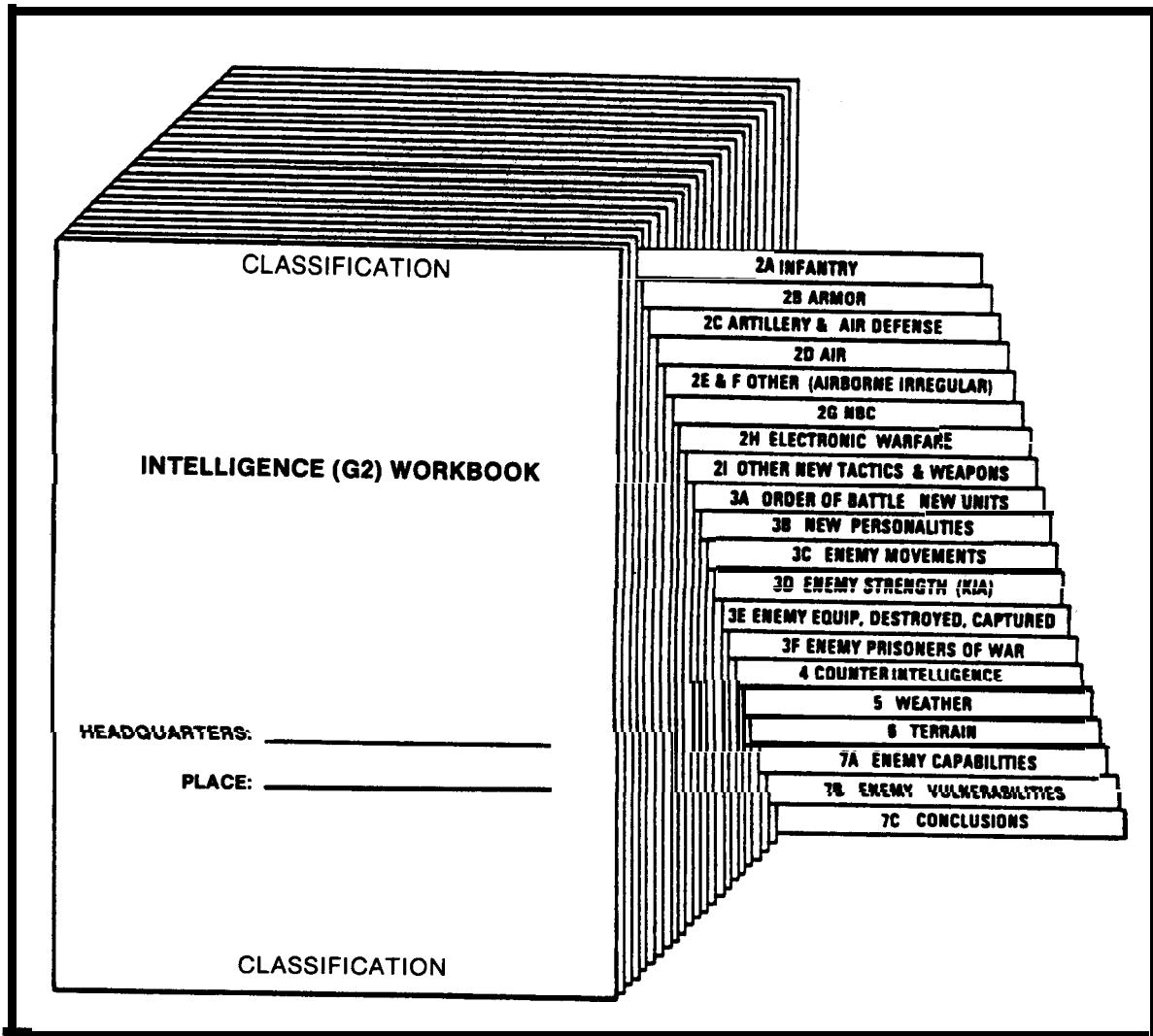

**Figure 2-5. Intelligence workbook.**

**EVALUAT 10N**

Evaluation includes determining the pertinence of information, the reliability of the source or agency through which the information was derived, and its credibility. Evaluation of information at the lower echelon is a simple step compared to the procedures employed at higher echelons. From the viewpoint of the brigade or battalion S2, information which relates to the unit's AO and AI is pertinent; information relating to areas outside the area of interest may or may not be pertinent. The brigade or battalion S2 may not be able to judge the reliability of a source because the S2 may not have repetitive contact with that source. This difference between higher and lower echelons is because information received from higher headquarters normally has been processed, evaluated, and interpreted and the information collected by organic agencies at lower

echelons generally is acquired by direct observation or actual contact with the enemy.

#### **Pertinence**

**pertinence is the examination of information to determine whether or not the information is-**

- ° Pertinent with regard to the enemy or to the battlefield area.  
Information that relates to a unit's AO or AI normally is pertinent.**
- ° Needed immediately, and if so, by whom? Of possible present or future value, and if so, to whom?**

#### **Reliability**

**The source of information and the agency by which it was collected are both evaluated for reliability. The principal basis for judging the reliability of a source or an agency, other than troop units, is previous experience with the source. Criteria for evaluating troop units include a knowledge of their training, experience, and past performance.**

**The headquarters closest to the source or agency is ordinarily the best judge of its reliability. Consequently, a higher headquarters normally accepts the reliability evaluation performed by a reporting headquarters. It does, however, consider the reliability of the reporting headquarters itself.**

#### **Credibility**

**Credibility means the probable truth of the information. Judgment of credibility is based on the answers to the following questions:**

- ° Is it possible for the reported fact or event to have taken place?**
- ° Is the report consistent within itself?**
- ° Is the report confirmed or corroborated by information from different sources or agencies?**
- ° Does the report agree or disagree in any way with other available information?**
- ° If the report does not agree with information from other sources or agencies, which one is more likely to be true?**

**The most reliable method of judging the accuracy of a report is by comparing it with similar information which already may be available in an intelligence file or workbook. When possible, the intelligence officer obtains confirming or refuting information through different agencies and from other sources.**

Marked differences in the evaluation of the accuracy of information may occur between higher and lower echelons. The reason for this difference is because higher echelons, which have more sources of information and intelligence than lower echelons, have a greater opportunity to confirm, corroborate, or refute the accuracy of reported data. Regardless of the source, reevaluate the accuracy of incoming information and intelligence at each echelon. Thus, the role of higher echelons in evaluating the credibility (or probable truth) of information differs somewhat from its role in evaluating the reliability of the source (again, usually done best by the echelon closest to the source),

The evaluation rating of each item of information is indicated by a standard system. Reliability is shown by a letter; accuracy by a numeral. The lowest headquarters possible assigns the evaluation ratings.

Indicate the reliability of the source and agency as follows:

- A - completely reliable.
- B - usually reliable.
- c - fairly reliable.
- D - not usually reliable.
- E - unreliable.
- F - reliability cannot be judged.

A rating of "A" indicates only the most unusual circumstances. For example, this evaluation is given when it is known that the source has long experience and extensive background with the type of information reported. A rating of "B" indicates a source of known integrity. A rating of "F" indicates there is no basis for estimating the reliability of the source.

Agencies ordinarily are rated A, B, or C. However, when the source and the collecting-reporting agency are evaluated differently, only the lower degree of reliability is indicated.

Indicate the credibility of information as follows:

- 1 - confirmed by other sources.
- 2 - probably true.
- 3 - possibly true.
- 4 - doubtfully true.
- 5 - improbable.
- 6 - truth cannot be judged.

If it can be stated with certainty that the reported information originates from a source other than that for already existing information on the same subject, it is classified as "confirmed by other sources" and is rated "1."

If no proof in the above paragraph can be established, and if no reason exists to suspect that the reported information comes from the same source as the information already available, it is classified as "probably true" and is rated "2."

If the report is confirmed in essential parts by information already available, it is classified as "probably true" and is rated "2."

If the investigation reveals that the reported facts, on which no further information is yet available, are compatible with the previously observed behavior of the target, or if the known background of a person leads to the deduction that the person might have acted as reported, the information received is classified as "possibly true" and is rated "3."

Reported but unconfirmed information, which contradicts the estimate of the development or the known behavior of the target, is classified as "doubtful" and is rated "4" if this information cannot be disproved by available facts.

Reported information which is not confirmed by available data and contradicts the experience hitherto assumed to be reliable with regard to the development of a target or issue is classified as "improbable" and is rated "5." The same classification is given to reported information that contradicts existing data on a subject originally given the rating "1" or "2."

If the investigation of a report reveals that a basis for rating 1 to 5 is not given, the reported information is classified as "truth cannot be judged" and is rated "6."

The statement "truth cannot be judged" is always preferred over the inaccurate use of ratings 1 to 5. If there is no sound basis for rating 1 to 5 because of the complete absence of other information on the same target, it must be rated 6.

The **scale** 1 to 6 does not represent progressive degrees of accuracy. Recognition must be given to the rating represented by the numeric symbol.

Although both letters and numerals are used to indicate the evaluation of an item of information, they are independent of each other. A completely reliable agency may report information obtained from a completely reliable source which, on the basis of other information, is judged to be improbable. In such a case, the evaluation of the information is A-5. A source known to be unreliable may provide raw information that is accepted as accurate information, when confirmed by reliable sources. In this case, a report is evaluated E-1. A report evaluated F-6 may be accurate and should not be arbitrarily discarded.

A report disseminated to higher, lower, and adjacent units should contain the evaluation for each item of information; for example, "The division artillery of the enemy 46th Tk Div can fire nuclear rounds of 0.5 kt yield (C-3)."

The evaluation and interpretation of information at the brigade and battalion is a simplified mental process: thus, the standard evaluation rating has little if any application. This system assists the G2 or S2 in processing information received from other headquarters and in evaluating information disseminated to other headquarters.

## ANALYSIS

The processing of information continues with analysis, which consists of three steps: assessment, integration, and deduction. It is during this phase of the intelligence cycle that information becomes intelligence.

### Assessment

Assessment is the sifting and sorting of evaluated information to update significant elements with respect to the mission and operations of the unit. The first and most important step towards proper assessment is a clear understanding of the unit's mission and the commander's intent. All information gathered is viewed in relation to what the commander wants to accomplish. Assessment also requires judgement and a thorough knowledge of military principles, the characteristics of the AO, and the enemy situation, to include enemy doctrine and past practices.

Assessment at headquarters above division level often involves detailed research with greater difficulty caused by the increased volume of information. Regardless of the level, individuals who assess information must relate their efforts to the unit's mission to avoid wasted time and effort.

### Integration

Integration is the combination of the elements isolated in assessment with other known information to form a logical picture or hypothesis of enemy activities or the influence of operational area characteristics on the mission of the command. In the process, more than one hypothesis may be formulated based upon existing intelligence.

Integration, particularly the development of hypotheses, requires the same good judgment and thorough background knowledge essential to making a good assessment. In formulating hypotheses, the intelligence officer avoids preconceived opinions and hypotheses based solely on personal experience or preference. The officer attempts to adopt the role of the enemy commander in the development of these hypotheses.

After they are formulated, all hypotheses are analyzed and tested. Analysis of an hypothesis includes determining the indications that should exist if the hypothesis is a valid one. Testing includes verifying the



existence or nonexistence of these indications within the limitations of available time and means.

Integration may be a mental process completed in a few moments or it may be a lengthy process involving the collection of a large volume of additional information.

#### **Deduction**

The last step in the analysis of information is deduction. Meaning is deduced from the hypotheses developed; these are then tested and considered valid as a result of integration. Deduction answers the question: "What does this information mean in relation to the area of operations, the enemy situation, and the friendly commander's intent?" The answer provides a useful conclusion which can serve as a basis for determining future enemy courses of action and for keeping the intelligence estimate current. Deduction should also answer the question: "What does this information mean in relation to the enemy's use of tactical deception or counterdeception?" The resulting answer reduces friendly vulnerability to being deceived and the false belief that battlefield deception operations are being believed by the enemy.

#### **DISSEMINATION**

The final step is to disseminate intelligence or information. Dissemination is not limited to regular reports. Critical Pieces of information are passed quickly to those who can use them. The G2 or S2 always is aware of this and prepares to use any form of communication, from RATT to courier, to pass vital reports. Intelligence is of no value on the battlefield when it becomes history.

## CHAPTER 3

### ORDER OF BATTLE

OB intelligence is an integral part of intelligence analysis at all levels. Intelligence analysts consider OB intelligence. They integrate it with other intelligence pertaining to weather, terrain, and other METT-T factors to determine Threat capabilities, vulnerabilities, and probable courses of action.

This chapter describes the OB analysis process and the tools used to develop and integrate OB.

OB is the identification, strength, command structure, and disposition of the personnel, units, and equipment of any foreign military force. During counterinsurgency operations, or whenever they become militarily significant, include guerilla and insurgent forces, associated agent nets, and the insurgent auxiliary and support structure in the Threat data base,

Data is developed in many fields outside the scope of OB, but all intelligence is related ultimately to it. For example, technical intelligence (TI) produces intelligence on the capabilities of weapons systems, but OB intelligence determines the effect of weapon capabilities and characteristics on enemy tactics, combat effectiveness, and organization.

#### ORDER OF BATTLE FACTORS

The OB consists of evaluated information on enemy, allied and neutral forces, including--

- 0 Composition.
- 0 Disposition.
- 0 Strength.
- 0 Tactics.
- 0 Training.
- 0 Logistics.
- 0 Combat effectiveness.
- 0 Electronic technical data.
- 0 Miscellaneous data.

#### COMPOSITION

Composition is the identification and organization of units. It applies to specific units or commands as opposed to type units. Unit

identification often is called the key to OB intelligence because it leads to the answers to many questions concerning the enemy. Unit identification consists of the complete designation of a specific unit by name or number, type, relative size or strength, and (usually) subordination. Through identification, the OB analyst develops a history of the composition, training, tactics, and combat effectiveness of an enemy unit. The identification of a specific unit within an organization alerts the analyst to the possible presence of other unidentified or unlocated units of the same organization.

Organization is the physical structure of a unit and the relationship of the various elements within the structure. Knowledge of the organization of a unit or military force aids in developing accurate intelligence on current strength, and combat efficiency. Further Threat capabilities as they relate to tactics, training, and logistics are difficult to assess accurately without knowledge of the current organization.

The basic self-sufficient tactical unit (normally a combat division) is considered when developing intelligence concerning composition. In some countries, the field army is considered the basic self-sufficient tactical unit. In others, it is the regiment. The importance of this concept lies in the term "self-sufficient." Units subordinate to self-sufficient tactical units, although capable of limited independent action, cannot sustain themselves over relatively long periods of time. Subordinate units seldom are employed independently or separately from the basic self-sufficient tactical unit. For example, a new Soviet motorized rifle regiment (MRR) is reported in the AO. Knowing that the division is the Soviets' basic self-sufficient tactical unit and the three MRRs of a motorized rifle division (MRD) seldom are employed independently, the presence not only of a new regiment but of a new MRD is given tentative acceptance. When one of these regiments is located, suspect that the remaining elements of the division also are in the area.

#### DISPOSITION

Disposition consists of the location of Threat units and the manner in which these units are deployed tactically (or administratively in times of peace). In addition, disposition includes the recent, current, and projected (or probable) movements of Threat units.

Location refers to a geographical area or position occupied by a unit or units. Knowledge of the strength and location of a Threat force assists the intelligence officer in determining the capabilities of the force and its effect upon the accomplishment of the friendly mission. Data of this type is collected during peacetime and form the basis for assessing capabilities during the initial period of hostilities.

Tactical deployment is the relative position of units with respect to one another or to the terrain. Tactical formations are designed for executing the various tactical maneuvers and usually are based upon doctrine. If this deployment is predetermined, it leads to an accurate appraisal of probable Threat courses of action. The knowledge of how

units are arranged in echelon indicates (if the Threat assumes the offensive) which units are used in the initial attack and which units are employed in supporting and reserve roles. Tactical deployment with respect to terrain also is important. A study of disposition with an analysis of the terrain leads to conclusions concerning Threat capabilities, vulnerabilities, and probable courses of action. Accomplish this through the IPB process detailed in FM 34-130.

Movement of units is part of disposition. Movement is the physical relocation of a unit from one geographical point to another. Patrol activity may be an indication of planned movement but, in itself, is not movement. Movement is significant because it automatically changes the tactical deployment of the opposing forces. When a Threat unit has moved, is moving, or possibly will move in the future, it becomes capable of executing a number of actions which affect the conduct of the battle (or the current political situation). Such a unit moves into an attack position, moves to reinforce or to replace a unit, or performs other missions. In view of these possibilities, movement of a unit becomes important. The O6 analyst must continually monitor unit movements in order to provide correct and detailed data on Threat dispositions.

#### **STRENGTH**

Strength describes a unit in terms of personnel, weapons, and equipment. Information concerning strength provides the commander with an indication of enemy capabilities and helps determine the probable courses of action or options open to Threat commanders. A lack of strength or a preponderance of strength has the effect of lowering or raising the estimate of the capabilities of an opposing force. Likewise, a marked concentration or buildup of units in an area gives the commander certain indications of enemy objectives and probable courses of action. During peacetime, changes in the strength of potential Threat forces are important factors which may indicate changes in the enemy's intention. Appendix D describes enemy strength computations.

#### **TACTICS**

Tactics in OB intelligence include tactical doctrine as well as tactics employed by specific units. Tactical doctrine refers to the Threat's accepted principles of organization and employment of forces for the conduct of operations. Tactics, on the other hand, describe the manner in which units conduct an operation. From a knowledge of tactical doctrine, the OB analyst knows how the Threat may employ forces under various conditions and in certain type situations or special operations. Units normally are expected to perform according to certain patterns within the framework of their tactical doctrine. All Armies establish basic principles and patterns for the employment of infantry, motorized rifle (MR), tank, and artillery units in the offense and defense. Of a more specific nature, specialized tactical doctrine a certain unit employs in given situations during combat or training activities is analyzed, because it indicates possible changes in Threat doctrine. Doctrinal templating, as detailed in FM 34-130, is one method of graphically portraying enemy tactics.

## TRAINING

Individual and unit training contribute significantly to the combat effectiveness of any military organization. The thoroughness, degree, and quality of individual training which the recruit, specialist, noncommissioned officer (NCO) , and officer receive are major factors in determining the overall efficiency of an armed force. Unit training, normally conducted in seasonal cycles from small unit exercises to large-scale maneuvers, is an essential part of the training necessary for a unit to operate at its full potential. Each type or phase of training a unit accomplishes adds to its capabilities and effectiveness.

Specialized training that a unit receives may point to its ability to undertake certain missions beyond its normal doctrinal capabilities or responsibilities. Therefore, it is easier to appraise the combat effectiveness of a unit when the degree and quality of its training are known, as well as any specialized training it undertakes.

## LOGISTICS

Logistics closely relates to combat effectiveness. The adoption of a course of action depends on the ability of the logistical system to support that action. With knowledge of the current capabilities of a unit's logistical support structure, make a more accurate evaluation of its capabilities, strengths, and combat effectiveness. Also, the locations of elements of a unit's logistical support structure indicate the disposition of maneuver formations and CS elements. Categories of logistical information include--

- All classes and types of supply.
- 0 Supply lines of communication.
- 0 Logistical requirements.
- 0 Procurement methods.
- 0 Distribution priorities and procedures.
- 0 Transportation networks and modes.
- 0 Installations and logistical control points.
- 0 Terminals.
- 0 Evacuation and salvage procedures.
- 0 Maintenance.

## COMBAT EFFECTIVENESS

Combat effectiveness describes the abilities and fighting quality of a unit. Numerous tangible and intangible factors affect it. Combat effectiveness affects the capabilities of a unit or army and is predicted by analyzing--

- ° Personnel strength.
- ° Amount and condition of weapons and equipment.
- ° Status of training.
- ° Efficiency of the officer and NCO corps.
- ° Quality of leadership.
- ° Length of time a unit has been committed in combat.
- ° Traditions and past performance.
- ° Personality traits of the unit commanders.
- ° Geographical area in which committed.
- ° Morale, esprit, health, discipline, and political reliability (or belief in the cause for which they fight).
- ° Status of technical and logistical support of the unit.
- ° Adequacy of military schooling at all levels.
- ° National characteristics of the people.

## ELECTRONIC ORDER OF BATTLE

Electronic OB information is required to conduct EW. This data includes communications and noncommunications equipment parameters, such as emitter type and nomenclature (including encoding equipment), modulation, multiplex capability, pulse duration, pulse repetition frequency, bandwidth, associated weapons systems, and other technical characteristics of electronic emissions. They also include critical communications nodes such as CPS and logistical control points. They support Threat electronic order of battle (EOB) templating. With electronic technical data, a more accurate evaluation of the enemy's vulnerability to electronic countermeasures (ECM) and deception is made; signals intercept and direction finding (DF) for the production of SIGINT is made easier; and support is given to electronic counter-countermeasures (ECCM) by assessing the threat EW capabilities.

## MISCELLANEOUS DATA

Miscellaneous data includes supporting information needed by an analyst to develop other OB elements. Miscellaneous data includes basic intelligence described as "know your enemy."

Personality files contain information on certain characteristics and attributes which describe individual members of a military force. A knowledge of personalities is important in identifying units and, in some cases, predicting the course of action the unit will take. Personality data, therefore, is valuable because the tactics and combat efficiency of particular units are often closely related to key individuals within its command structure.

Unit history includes information and intelligence on the elements of a specific unit; on present and past parent units; personalities who have commanded the unit; and other details like past performance and activities which describe, limit, or clarify the capabilities of the unit concerned. The development of unit history is important in determining the capabilities and limitations of a unit. Military or paramilitary units, like individuals, develop characteristics which distinguish them from other units. Just as they consider the various qualifications and traits of threat personalities, OB personnel also must consider a Threat unit as a personality in analyzing its capabilities and limitations. Information on uniforms and insignias is an important part of "know your enemy" intelligence. This information assists in establishing unit identification and organization and in determining morale and esprit de corps.

Some foreign armies use systems of code numbers, names or false tactical markings to conceal true designations (or affiliations) of units, field post numbers (FPNs) (unit mailing address), and vehicle identification or side numbers. These systems, when properly analyzed, are valuable sources of information that are related to unit composition and disposition.

The OB analyst is able to recognize and appreciate the capabilities and limitations of foreign weapons and equipment. Although technical intelligence agencies are primarily concerned with the determination of weapons and equipment characteristics and capabilities, the analyst uses this intelligence to analyze the effects of these items on the organization, disposition, tactics, and combat effectiveness of the military force.

## ORDER OF BATTLE REFERENCES

THIS SECTION IMPLEMENTS STANAG 2077
-------------------------------------

Standard OB references are published by higher echelons during peacetime. They form the basis for lower echelon OB efforts.

## ORDER OF BATTLE BOOK

An OB book is a summary of all basic intelligence concerning the composition, disposition, identification, subordination, and strength of a foreign nation's military forces. It includes all units from the various services that function in a ground or ground support role. It normally is published at EAC by the service departments and by the DIA. Allied nations, particularly the NATO nations, also publish OB books. The level or echelon of units shown depends on the level of command for the intended user. Generally, this is at least one echelon above and two echelons below that of the intended user. During peacetime, units which form only on mobilization are identified as such.

The OB book includes the following information for each unit:

° Identification, to include:

- Numerical designator and type of unit.
- Nationality (if more than one nation's forces are included in the OB).

° FPN.

° Subordination (parent unit) .

° Subordinate units.

° Location, to include:

- Place name (and country if deployed abroad).
- Installation number or name (if applicable).
- Military geographic region (if applicable).
- Universal transverse mercator (UTM) coordinates (supplement with geographic coordinates whenever possible).

° Category and effective strength.

The following data also is included:

° Code name or code number (enemy assigns official name or number).

° Nickname (unofficial popular name).

° Honors or honor titles.

° Unit insignia.

° Latitude and longitude of subject (in addition to UTM coordinates) .



° Commander's name, rank, initials and specialty, and those of other key personnel.

° Combat effectiveness (including any data on specialized training).

° Signature equipment.

° Turret numbers, vehicle registration numbers, or other tactical identification signs.

° Any other data at the discretion of the originator for example, basic encyclopedia (BE) or target data inventory (TDI) numbers.

The structure of an OB book varies, However, it normally contains three sections:

### **Section 1. General**

Section I contains the table of contents, explanatory notes and glossary of terms, acronyms, and abbreviations used in the document, summary list of major changes since the document was last issued, and summary chart of current dispositions.

### **Section II, Detailed Order of Battle**

Section II contains formations or units grouped according to their subordination and echelon. For example, military district, region, front level formations, and units follow immediately after the district, region, and front headquarters to which they are subordinate. While the same methodology is applied at all other levels of command within a district, region, or front formation, the inclusion of units subordinate to regiments is optional. Units of unknown subordination are included at the end of each district, region, or front and are identified clearly as such.

### **Section III. Summaries or Supporting Documentation**

Section III contains any additional summaries or supporting documentation, such as maps. The use of orientation maps of the nations dealt with in the OB book is an important visual aid, especially when the units being dealt with are superimposed. For a large country like the USSR, include an orientation map for each military district.

Annually issue or amend OB books. While the timing and degree of amendment are left to the discretion of the originators, an amendment normally is published when substantial changes to published OB holdings are detected. The date of information (DOI) for the contents of the OB book is taken to be the information cut-off date. Any amendments to the OB book should indicate their own 001.

### **ORDER OF BATTLE HANDBOOK**

The OB handbook, which is often referred to as a "handbook of military forces," is a summary of basic intelligence on a foreign nation's

political or governmental structure and military establishment, including its tactics and doctrine. It includes more technical data, such as the logistical system used and the characteristics of weapons and equipment. Like the OB book, higher US and allied commands publish the handbook.

The OB handbook normally deals with only one country. It deals with two or more countries in separate parts, especially when these countries are closely associated with each other by pact, geographically, or in some other way. As a minimum it contains--

- ° History, governmental, and political structure. A short history of the nation and a comprehensive description of its governmental and political structure.
- ° Armed forces organization. A description of the nation's military establishment (including paramilitary and an explanation of how C2 of the ground forces is affected).
- ° Ground forces organization. A complete explanation of the organization and composition of all the various types of ground force units and formations. The organization and composition of a nonground force unit also is included if that unit is likely to be placed under command or in support of the ground forces in time of war.
- ° Logistical support organization. An explanation of the logistical system the ground forces employs from ministerial level to the lowest echelon.
- ° Strategic and tactical doctrine. An explanation of the nation's strategic and tactical military doctrine, especially at combat levels of command.
- ° Reserve forces or mobilization. A description of reserve forces, the mobilization system and times required for mobilization.

In addition, the OB handbook includes--

- ° Military education and training. A description of the military education and training system and an explanation of the personnel recruitment and selection process.
- ° Uniforms and insignia. A full description of all armed forces uniforms, ranks, and insignia.
- ° Weapons and equipment. A listing and brief description including characteristics of the various types of weapons and equipment found in the ground forces. The list includes weapon and equipment's country of origin, availability of technical expertise, and likelihood of resupply of equipment and spares.

- ° Allies. A list of likely military and political allies, and type of support each may render.

The contents of the OB handbook are organized in the sequence shown above. When included, organizational and tabular data are presented as follows :

- ° Armed forces organization,, governmental and political structure. Organizational charts are to support the narrative description of these subjects where possible. There is no format for such charts.
- ° Organizational structure. Depict organizational structure for each type of unit, Within NATO, the-symbols depicted in STANAG 2019 rapresent the various units, formations, or installations. Arrange the organizational diagrams in the following sequence: headquarters, combat units, CS units, service support units.
- ° Tables of personnel , weapons, and equipment. Produce the tables according to STANAG 2077. Figure 3-1 shows a sample equipment list.

Amend OB handbooks periodically. The timing and degree of amendment are left to the discretion of the originator. They should, however, initiate amendment action whenever you detect a substantial change to intelligence contained in the handbook or whenever you have a number of minor amendments.

#### INSTALLATION HANDBOOKS

Ideally, installation handbooks contain complete information concerning every military installation in every city in the county or AI. They are useful, particularly during peacetime, for establishing which forces are already in place. During wartime, the usefulness of installation handbooks decreases somewhat. However, they still indicate likely reserve mobilization and training centers. Two particularly useful handbooks are the Automated Installation Intelligence File (AIIF) and the Contingency Planning Facilities List (CPFL).

#### MISCELLANEOUS REFERENCES

Other publications and periodicals prepared at departmentl and area command levels are of value to the OB analyst. These references may deal specifically with OB or with any or all phases of tactical, operational, and strategic intelligence. Specialized technical intelligence agencies provide detailed evaluations of equipment. The Soviet Battlefield Development Plan provides current and projected Soviet battlefield capabilities. The CIA produces studies on general mil itary capabilities, and economic factors which impact on military capabilities. Civilian organizations under contract to the Department of Defense (DOD) make special studies on various subjects concerning foreign and enemy military forces. These studies usually are detailed, technical in nature, and provide a wealth of special information not otherwise available.



- ° U n i t workbook.
- ° 0 B workbook.
- ° O B SITMAP.
- ° 0 B card file.
- ° Personal ity file.
- ° Military installation file.
- ° Organizational worksheet.
- ° Strength worksheet.

Other file systems or forms are developed locally for special situations.

#### UNIT WORKBOOK

The format of the unit workbook depends upon the structure of the foreign army being monitored. Typically, it consists of a collection of OB cards supplemented by supporting documentation and is arranged by type of unit or in numerical sequence. Minimally this documentation includes organization and strength worksheets with the workbook being updated as new information is received. The enemy parent unit listed on the unit worksheet should agree with the analyst's level of command.

The analyst normally maintains records for enemy units one level above and two levels below the command's. In some special purpose units, three levels or more down are followed as well. Review information from units three levels down to develop identities on units two levels down. List personalities on the worksheet as a ready reference to the personalities of the enemy unit. Note and use unit, postal, and vehicle numbers on the worksheet to determine OB changes or to confirm current data. Note details which may reveal any facet of the enemy unit's OB or indicate the source of information in the remarks column. Enter reports of branch insignia, number and type of weapons, and statements of local residents in this column in abbreviated form. Include the data and the source of information for each entry. The installation column of the worksheet shows the numerical designation assigned to a particular enemy installation when plotted on a sketch, map sheet, or town plan attached to the workbook. For consistency and to facilitate exchange of information between headquarters, use installation numbers previously assigned by theater or MACOM, Figure 3-2 shows a sample unit workbook. Figure 3-3 shows a sample page from the unit workbook.

#### ORDER OF BATTLE WORKBOOK

The OB workbook aids the analyst in sorting, evaluating, and interpreting information and in preparing intelligence reports.

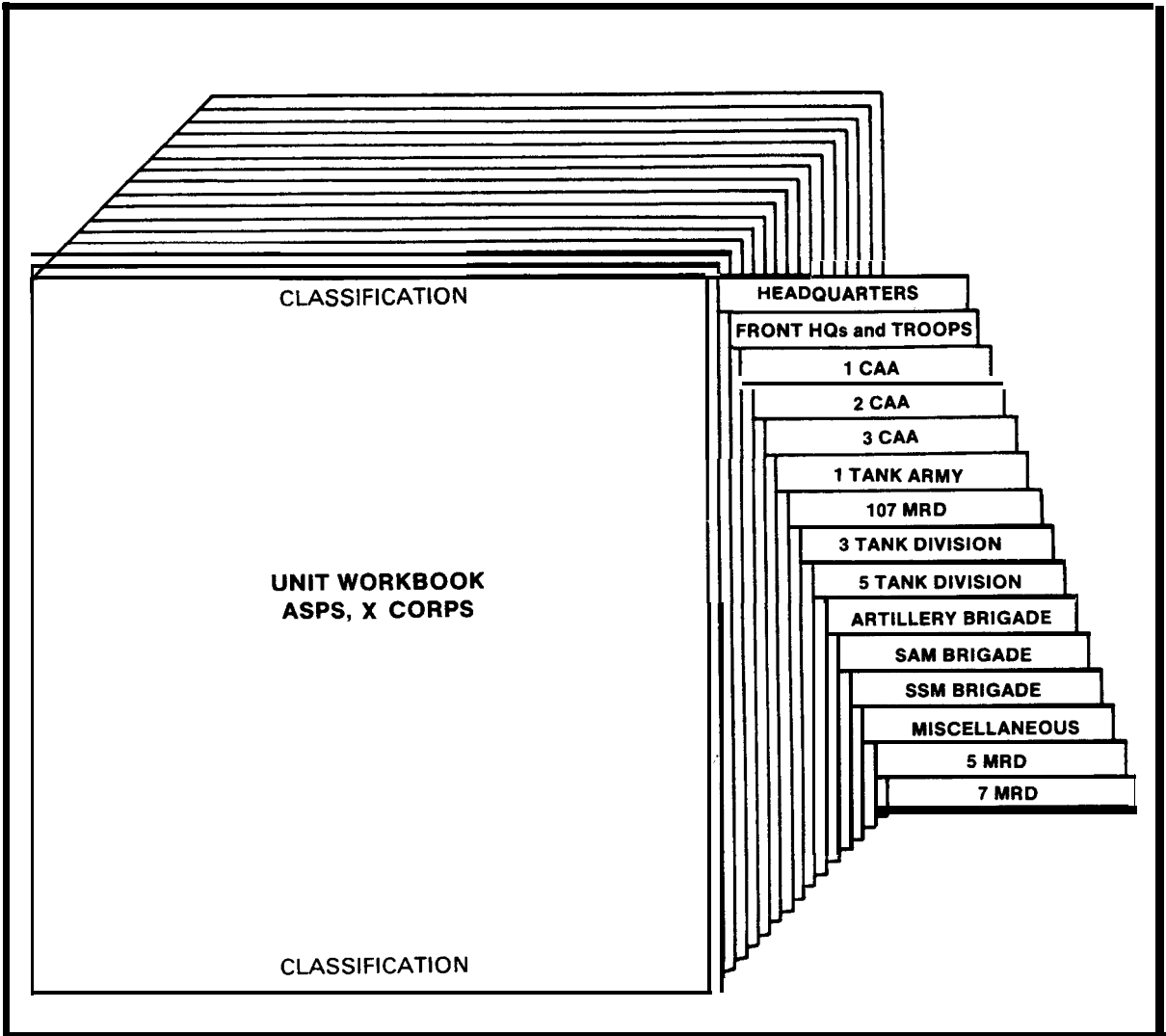

**Figure 3-2. Sample unit workbook.**

There is no prescribed format for the OB workbook. At corps level and higher, the OB workbook is tabbed to conform with paragraphs of the OB annex of the PERINTREP (see Appendix A). This makes it easier to extract needed information for the production of intelligence reports.

Information is entered under the appropriate heading or headings as either a complete report or a digest of the original report. All entries contain a journal date and number in addition to identification of the source. Comments added after each entry show the significance of the report when compared with the overall tactical situation. Figure 3-4 shows how information is organized in an OB workbook.

Parent Unit _____						
SUBORDINATE UNITS	CITY	COORDINATES	INSTL	PERSONALITIES	ID OR CODE NO	REMARKS
Div Hq	Stein	PV818147	1 and 3	Commander COL Crechin		EPW no 26, Captured 2 Feb 68
96 Mech Rifle Regt	Delltach	PU820934	4	Commander COL Kursheve	16181	Document Captured 19 Mar 68
145 Mech Rifle Regt	Ellenburg	PU852961	2	LTC Shrenko	16182	Deserter 21 Mar 68
3d Bn	Gladbach	PV891024	1			Gladbach residents rpt battalion subordinate to Hqs in Ellenburg, 3 Feb 68
43 Med Tk Regt	Linburg	PV863106	3	Commander COL Reshvic		Agent Report 26 May 68
358 Trans- Bn	Lehrt	PV825158	1		16195	OB Bank

**Figure 3-3. Sample page from unit workbook.**

#### ORDER OF BATTLE S I TUAT 10N MAP

The 06 SITMAP is a graphic portrayal of current threat OB, either confirmed or unconfirmed. It shows identification and disposition of the opposing units and any other information which will assist in developing the threat 06.

As a general rule, threat units one echelon above and two echelons below the analyst's own level of command are plotted by using the appropriate symbols in FM 101-5-1. For example, division plots maneuver regiments and battalions; corps plots maneuver divisions and regiments. Plot higher units to the extent practicable. The foregoing information is only a guide. Analysts at theater level who are responsible for publication of OB books may plot separate battalions. Peculiarities of unit organization, the tactical situation, and time and personnel available within the analysis section determines more precisely what is plotted and what is omitted on OB maps. Enter the time and date of the information to the left of each symbol or plot. During counterinsurgency operations, however, it may be necessary to plot guerilla or insurgent units down to the squad level, since, depending on the situation and the

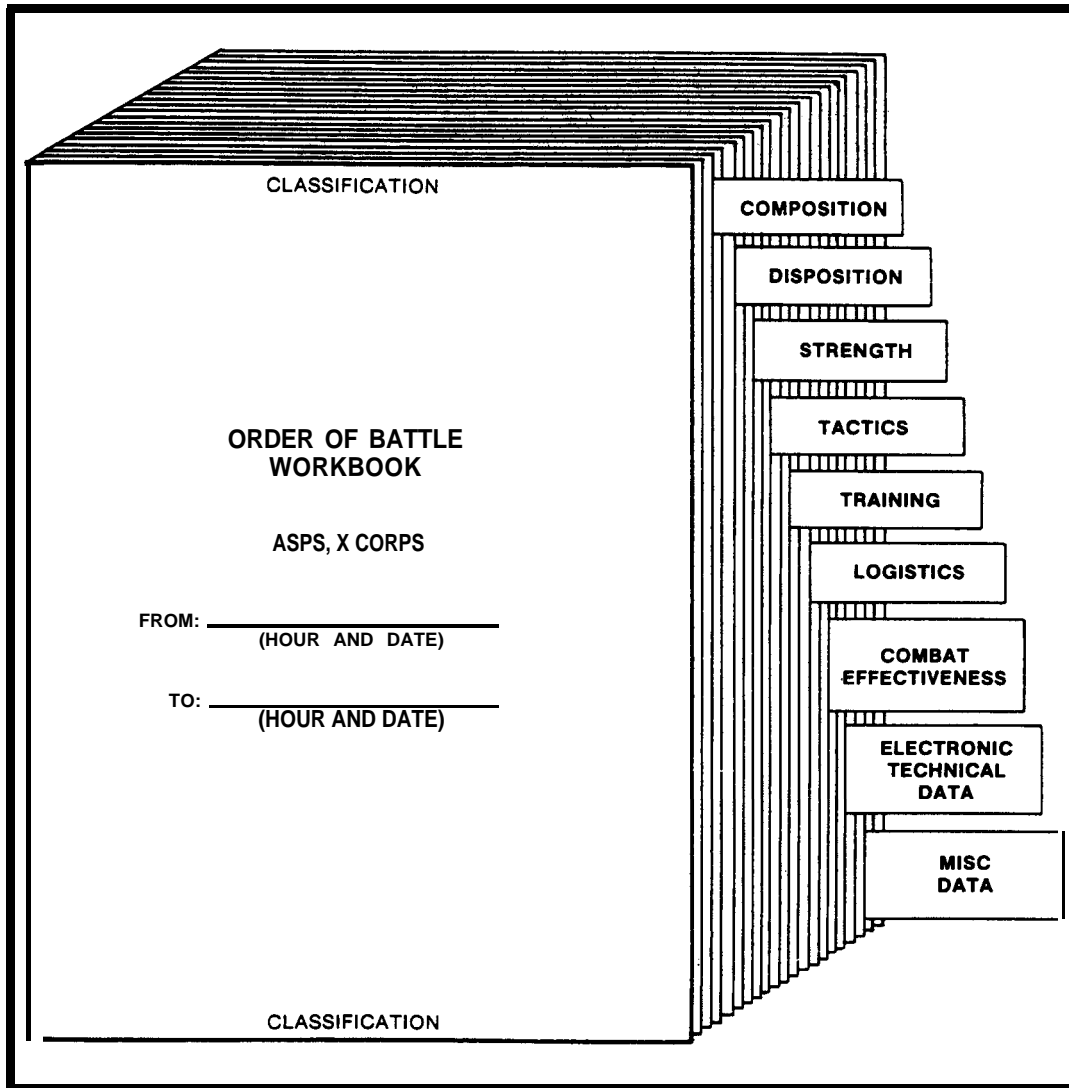

Figure 3-4. Order of battle workbook.

area, there may be no larger units operating against friendly forces. Figure 3-5 shows the OB SITMAP. The OB SITMAP contains the same types of information as the working SITMAP (described in Chapter 2), except it is kept in a less cluttered state so it is better integrated with G3 or S3 operational maps and for briefing purposes. At battalion and brigade levels, S2 and BICC officers often do not keep separate working and briefing OB SITMAPS.

Prepare the OB SITMAP as an overlay. Like other overlays, the OB SITMAP contains titling data. This data includes:

- ° Overlay title.



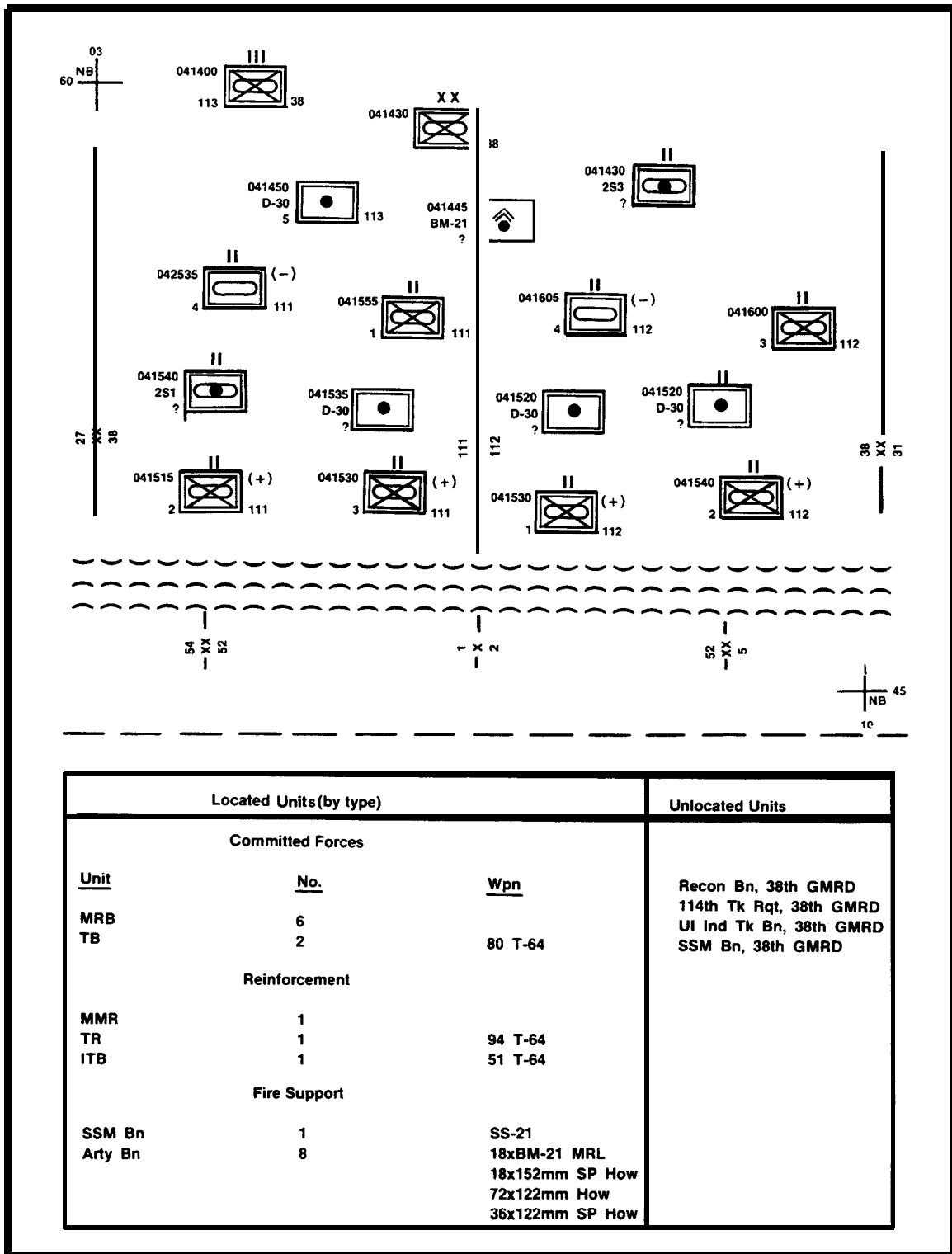

Figure 3-5. Order of battle situation map with caption box.

- ° Map sheet name.
- ° Map sheet number.
- ° Map series.
- ° Map scale.
- ° Prepared by \_\_\_\_\_.

A caption box on the OB SITMAP is an annotation containing information which helps to identify and explain the OB situation graphics. Although any number of caption boxes are used, normally three types are necessary: strength, unlocated units, and legend.

The entries in the strength caption box usually consist of strength computations in numbers of personnel, types of units, and weapons and equipment categorized as committed forces, FS, and available reinforcements. Reconnaissance elements which are part of an opposing maneuver unit are considered as reinforcements, if uncommitted. Assumptions like these are made to portray probable enemy capabilities.

The OB analyst must be aware of what is not known about the enemy. The unlocated units caption box lists existing unlocated units. These units pose a threat to the accomplishment of the friendly mission, and maximum effort must be directed toward establishing the disposition of unlocated units in the AO.

When it becomes necessary to improvise symbols for enemy units, include a legend caption box on the OB SITMAP. Within this caption box, explain the exact meaning of each, improvised symbol.

#### ORDER OF BATTLE CARD

The analyst uses OB cards to maintain complete and accurate data on enemy units. The format of the card is standardized within NATO to facilitate the exchange of information and intelligence among allied forces. The standard recording system (whether manual or automated) is based on a card entitled "Order of Battle Card." Such cards are maintained in wartime, at all levels including division and lower when directed by higher headquarters or when desired. Normally, keep one card for each enemy regiment and independent battalion within a friendly unit's AI.

Information on the OB card includes--

- ° Identification (numerics, designation, type of unit, and nationality).
- ° FPN.
- ° Subordination (parent unit).

- ° Subordinate formations or units.
- 0 Location (place name and UTM coordinates).
- 0 Table of major equipment (including war establishment and current effective strength).
- 0 Combat effectiveness and category (where applicable).

The OB card contains the following optional information:

- ° Code name (official name assigned by the enemy for convenience or as a cover) .
- ° Honoric title.
- ° Nickname (unofficial popular name).
- 0 Insignia.
- 0 Commander.
- 0 Unit history.
- 0 Signature equipment (including significant quantities).
- 0 Turret numbers, vehicle registration numbers or other tactical identification signs.
- ° Miscellaneous.

Record validity dates and source references on the back of the card. Also record information subject to frequent changes on the back of the card. This includes--

- ° Unit locations.
- ° Strength.
- ° Combat effectiveness.

Figure 3-6 shows the front and back sides of the OB card.

#### PERSONALITY FILE

A personality file records personality data on designated categories of individuals. The development of the personality file is probably one of the most difficult analytic functions, particularly for the personnel in Threat units at division level and below. However, much information is available through open-source literature and intelligence information reports (IIRs). This file provides reference material used in the development of other OB intelligence. Information on key military figures

(Front)

BASIC COMPOSITION OVERALL LIST

1. Tactical Symbol										2. Formation or Unit		3. Superior Formation or Unit		4. Nickname		5. Insignia or Personnel Equipment			
◇										125 GTR		369 MRD		URAL - KURSK DIVISION					
6. Initial Strength				7. Code Number			8. Code name		9. Location		10. FP Number								
85%											10169								
11. Coordinates (UTM)				12. Commander			13. Nationality, Formations or Unit		14. Effective Strength (%)		15. Combat Effectiveness								
32 U PB 123456				LTC VASILY YAKOV			UR		84 - 85%										
Consecutive Number	Subordinate Units	Location	Coordinates (UTM)	Installation	FP Number (Date)	Code Name or Code Number	Commander	Initial Strength	Effective Strength										
a.	b.	c.	d.	e.	f.	g.	h.	i.	j.										
01	1 GTB		PB 123456				UNK												
02	2 GTB		PB 125498				MAJ ROMANOV												
03	3 GTB		PB 118441				UNK												
History:						Miscellaneous:													

Figure 3-6. Order of battle cards.

cd  
10

Back)

UNIT PERSONNE AND EQUIPMEN TAB ES

1	2	3	4	5	6	7	8	9	10	11	12	13	14	15	16	17	18	19	20	21	22	23	24	25	26	27	28	29	30	31	32	33	34	
No	Unit	Tac- tical Sym	Off	NCO or Men	Tot																													
01	1TB		10	70	80	75																												
02	2TB		14	84	98	31																												
03	5TB		10	70	80	24																												
04	121 121Y		7	7	7	7																												

Figure 3-6. Order of baffle cards (continued).

is of significant value in the establishment of unit identification, tactics, and combat effectiveness. Keep the file in alphabetical order.

The card (or sheet) contains information concerning the individual's name, rank, current assignment, date and place of birth, civilian education, political affiliation, nicknames, and physical peculiarities. The file also contains the individual's schools, qualifications, awards, decorations, chronology of assignments, campaigns, engagements, demonstrated performance in leadership assignments, and important activities participated in, as well as character traits like morals, reputation, appearance, and mannerisms, published articles (which may identify areas of concentration and expertise), and cliques with which the individual is associated (may indicate influences and upward mobility prospects). Each entry records the source and date of the information.

The personality file also includes information which aids the friendly commander, G2, and G3 in deception planning and operations. This includes habits that make the opposing commander and staff vulnerable to deception, the most likely deception targets, the degree of freedom the commander allows subordinates, how the commander reacts to new situations, and how the fear of the unknown influences the commander's actions. Figure 3-7 shows a suggested format for biographies used in personality files required by STANAG 2077. Similar files may be maintained for key staff officers and other categories of key personnel.

- A. Name.**
- B. Date of Birth.**
- C. Place of Birth.**
- D. Civilian Education.**
- E. Military Education.**
- F. Foreign Languages.**
- G. Medical History.**
- H. Personality Traits.**
- I. Foreign Travel.**
- J. Other categories of information as deemed appropriate.**

**Figure 3-7. Biography.**

## MILITARY INSTALLATION FILE

During peace time, higher echelons maintain military installation files normally to facilitate publication of installation handbooks. A collation or explanatory sheet contains all information that has been collected on each installation to include the number and types of buildings and their capacities, personnel uniforms and insignia, and major items of unit equipment. Maps, town plans, or sketches showing the location of each installation within the city supplement this file. Figure 3-8 shows a sample military installation file.

## ORGANIZATIONAL WORKSHEET

The organizational worksheet provides a convenient method of showing types of units within an armed force. Organizational worksheets depict the complete breakdown of all units from the highest type headquarters to the lowest unit, including personnel and major weapon strengths. Since this is rarely possible on a single sheet of paper, prepare a chart showing the general organization of the major unit and individual charts for each of its subordinate units. Prepare principal weapons and equipment charts to supplement organizational charts. Figure 3-9 shows a sample MRR organizational worksheet.

## STRENGTH WORKSHEET

Use the strength worksheet to maintain a running numerical tabulation of the enemy's personnel and equipment strengths. This information is recorded on committed units, FS units, and reinforcements. Figure 3-10 shows a sample strength worksheet.

## COORDINATE REGISTER

When personnel and time are available, the brigade and battalion BICCs maintain a coordinate register. The coordinate register provides the lower echelon intelligence officer with a workable counterpart to the extensive intelligence files and workbooks that are maintained at higher echelons. It graphically illustrates the situation over a small geographical area. It is compact enough to be carried with ease for ready access.

The register is usually a looseleaf notebook. Each page represents a single grid square on the operational map which covers the geographical AO and AI. This geographical area should include the enemy area, friendly area, and areas of concern on both flanks.

The coordinate register contains two types of pages. One type is for written entries which describe enemy activities, locations, weapons, and similar items. The DTG and map coordinates precede these entries. The S2 adds personal comments or notations to any entry. Figure 3-11 shows a coordinate register page with written entries.

TOWN HEIMERZHEIM									
UUKU 33ULD 342U									
INSTL	LOCATION	DESCRIPTION	USE	CAPACITY	STRENGTH	UNIT	TIME LAST INFO	EVAL	REMARKS
	523208 (201-4th St)	5 Story, red brick bldg Flagpole extends from 5th story window	UI HQ	400	Unk	Unk	0758	B-2	Many high ranking officers and official sedans observed
2	522211 (Hwy 2 between K and L Sts)	4 x 2-story, wood barracks Surrounded by 8' board fence	Trps	500	350?	Engr?	0758	C-2	Sentry observed wearing engineer insignia.
3	531215	6 x 4-story, red brick bar- racks with 2-story bldg	Trps		850	Unidenti- fied Army	0458	B-2	Sentry observed wearing art insignia. Known to local residents as Kaiser Bks.
4	533218 (N of Instl 3)	8 x 1-story garage-type bldg	Gun park				0458	B-2	Probably belongs to unit in Instl 3. 9 x 100mm guns observed
5	514231	2 x 3-story, stucco bldg	Trps	Bn	Bn	1st Bn 19th MRR	1257	A-1	
6	535211	Local ing area, obstacle course in NW corner	... ...	... ...			0458	B-2	Believe used by trps from both Instl 2 and 3
7	554205	Several underground bunkers enclosed by 8' barbed wire fence. Guard towers. located on each corner.	Ammo dump	10 Tons (east)			1257	F-6	

Figure 3-8. Military installation file.



	PERSONNEL	TANKS	ARTILLERY		ADA			AT		SMALL ARMS	
			122mm SP How	120mm Mort	SA-9	SA-7	ZSU 23-4	ATGM	ATGL	AGS 17	LMG
Regt HQ	65					3					
3XMRB *	1290			18		27			99	18	108
Tk Bn	165	40							2		
SP How Bn	220		18						18		18
AA Missile Artillery Bn	60				4		4				
AT Missile Btry	40							9	9		
Recon Co	55								4		3
Engr Co	60								4		
Sig Co	50										
Cml Def Co	35										
Mtr Transport Co	70										
Maint Co	70								4		
Medical Co	25										
Supply and Service Plt	20										
<b>TOTAL</b>	<b>2225</b>	<b>40</b>	<b>18</b>	<b>18</b>	<b>4</b>	<b>30</b>	<b>4</b>	<b>9</b>	<b>140</b>	<b>18</b>	<b>129</b>
<b>* Strength and equipment figures are cumulative.</b>											

Figure 3-9. Organization worksheet motorized rifle regiment.

Figure 3-10. Strength worksheet (sample).

111th Guards Motorized Rifle Equipment

Category	Personnel		Tanks		Artillery						APC or IFVs		Remarks
	Type	Full Str	Losses	T-64	122mm How (2S1)	152mm How(2S1)	120mm Mort	BMP-1					
<b>1. Committed Forces</b>		Full Str	Losses	Full Str	Losses	Full Str	Losses	Full Str	Losses	Full Str	Losses		
1st MRB(-)		430	50	13						6			
2nd MRB(-)		430	35	13						6			
<b>2. Reinforcements</b>													
3rd MRB		430	10							6			
4th TB(-)		165	10	14									
<b>3. Fire Support</b>													
Arty Bn or 111 GMRR						18							
								18					
<b>Totals</b>			105	40	11	18	3	18	0	18	3		

Note: Additional columns and rows may be added to encompass additional unit or weapons systems.

GRID SQUARE 32U NA2815				
TEM	LOCAL TIME	COORD	STATEMENT	NOTES
1	092235	28381539	MG fires on recon plt from A Co.	Have next plt check this area.
2	092318	?	Veh noise - Tk? - Heard direct N of A Co OP 2 28321507.	Ask air OP to look
3	100600		Special OB report on wpns and fortifications.	Div wants more info on wpns strength.
		280215323 to 28141527  281415227 to 28221529  28611545 to 28781551  28811551 to 29001599	Trenches and bunkers.  Wire.  Platoon on line has 2 MG's.  Extensive trenches and firing PSNS.	Same MG as yesterday? Check this!
4	102335	28391530 to 28691541	B Co plt rpts wire and AP mines.	New since 081800.
5	110600	28431588	Res unit (co?) in general area.	(From Div PIR).
6	110630	28381557	Med tk spotted by L plane.	How many more?
7	111320	28731584 and 28151564	Active mortars.	
8	120010	28611564	Flash from small cal arty not over 75.	AT? AA? Gun? RR or bazooka? Ask higher HQ.

Figure 3-11. Coordinate register with written entries.

The second type schematically represents a single grid square. Entries are plotted on the square in the same manner used to plot the enemy SITMAP. This page shows graphically any data applicable to a single grid square. Figure 3-12 shows how an enlarged grid square is drawn and entries are made.

The coordinate register is used to--

- ° Determine enemy dispositions and routes of movement.
- ° Predict enemy intentions and main effort.
- ° Plan reconnaissance and surveillance (R&S) operations.
- ° Brief and debrief patrols.

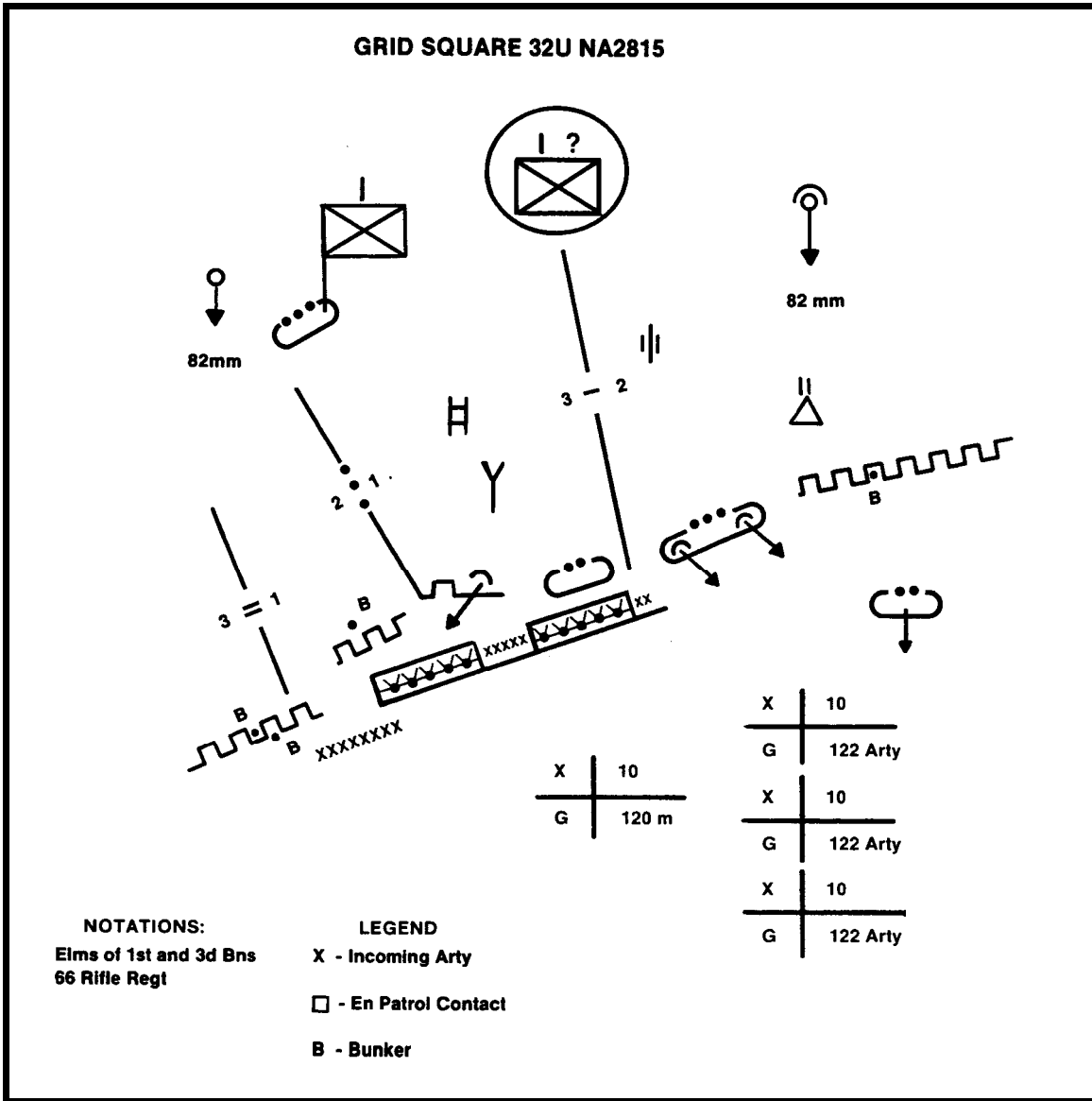

Figure 3-12. Coordinate register with schematic entry.

° Plans FS.

° Brief the commander and staff.

° Assist in IPB.

° Reveal enemy perceptions of how the terrain will support maneuver against them.

Data from the coordinate register is plotted on a vertical aerial photograph that has been annotated with grid lines. A scale of 1:25,000

or larger is desirable. By plotting selected OB information on the photo, an analysis of the terrain is conducted simultaneously with a correlation of information on the enemy. The photo provides an excellent means of briefing commanders down to platoon level on the AO and the enemy situation. Targeting is accomplished in a more precise manner by using a photo instead of the traditional 1:50,000 map. While not common in mid- to high-intensity conflict these photos are especially useful in LIC.

The coordinate register is reviewed when the unit moves to a new area, when new data is added, and when obsolete data is deleted. Timely maintenance of the coordinate register is not practical in fast-moving high-intensity situations like pursuit, delay, and exploitation. The coordinate register would, however, be very valuable in a relatively static situation or in a low-intensity conflict (LIC).

Whenever possible, maintain the register on strong semitransparent bond paper. The transparency of bond paper is sufficient to allow the use of a grid scale underneath the schematic page. This allows a more accurate and rapid plotting of, or reference to, the entries.

The scale of the schematic page normally is a matter of SOP. Such standardization assists in dissemination of intelligence data from higher to lower echelons. For security reasons, the friendly situation normally is not plotted in the coordinate register.

#### ENEMY COMBAT EFFECTIVENESS

A number of factors, some tangible, others not, determines the combat effectiveness of enemy units. Of these factors, only the personnel and equipment strength lend themselves to factual analysis, and only major items of equipment, like tanks, armored personnel carriers (APCs), and artillery weapons lend themselves to detailed quantifiable analysis. This is because personnel strength fluctuations are extremely difficult to assess accurately. Appendix D describes procedures for computing personnel and equipment strength. The following states the combat effectiveness of a unit:

“The 133 MRR is estimated to be at 80 percent effective strength. Evidence of low morale suggests that the unit is less combat effective than the estimated effective strength may indicate.”

#### ARBITRARY UNIT DESIGNATORS

The identification, by title, of a particular unit or formation on the battlefield is difficult during war. Although it is argued that such precise identification is not important and that one enemy division is as much of a threat as another, this ignores the problems of collation, dangers of double counting, and confusion. To deal with this problem, NATO and national formations apply a unique arbitrary unit designator (AUD) to unidentified enemy formations.

There are two types of unidentified enemy formations:

°Formations which are well known except for their actual title.

°Formations seen on the battlefield whose history, background, and title are unknown.

SHAPE allocates the AUDs. They appear in NATO and national OB summaries in peacetime in the columns normally filled by unit title. Use these AUDs in war also.

The AUDS consist of a prefix, a number, and a suffix.

The prefix consists of a three-digit alphanumeric distinguishing code that indicates the number and nationality of the corps that originates the AUD. The following are examples:

°The 1st British Corps uses IUK.

°The 2d German Corps uses 2GE.

°The 7th US Corps uses 7US.

A two-letter distinguishing code indicating the NATO formation and allocating the AUD is an optional method of establishing prefixes. Figure 3-13 shows these AUD prefixes.

Each national corps allocates blocks of numbers between 000 and 999 to their own headquarters and subordinate formations. Similarly, divisions may, if they wish, suballocate numbers to their subordinate formations. All formations of a corps and corps headquarters, however, use the same prefix.

After the prefix and number is a suffix indicating--

°The nationality of the enemy formation.

°The type of formation.

Do not change the actual numbers allocated by a particular national or NATO formation normally unless an unidentified enemy is recognized separately by two formations, each of which allocates its own AUD. Under such circumstances, the relevant superior headquarters, having agreed that an unidentified enemy formation is present, will either--

°Accept one of the already allotted AUDs, but replace the prefix with its own.

°Allocate a new AUD.

In either case, inform both of the originating formations.

As an example of an unidentified enemy with two allotted AUDs, a division of the 2d German Corps and a division of the 1st British Corps separately detect the presence of an unidentified Soviet MRD in the area

SHAPE .....	SH
AFNORTH .....	AN
COMMON .....	NN
COMSONOR .....	SN
COMBALTAP .....	BA
COMLANDJUT .....	JA
COMZEALAND .....	ZE
AFCENT .....	AC
NORTHAG .....	NG
CENTAG .....	CG
AFSOUTH .....	AS
LANDSOUTH .....	LS
LANDSOUTHEAST .....	SE
AMF(L) .....	AM

Figure 3-13. Arbitrary unit designator.

of the intercorps boundary and each gives it an AUD using the block of numbers allocated to them by their own corps (2GE369 UR MRD and 1UK473 UR MRD, respectively). Each corps adopts the AUD allocated by its division.

The corps HQ knows from which division the AUD originated by the number applied. HQ NORTHAG agrees that an UI UR MRD is present and decides to retain the German (GE) number but allocates it a NORTHAG prefix. From then on, until positively identified or changed by Allied Forces, Central Europe (AFCENT), or SHAPE, the unidentified formation is known as NG369 UR MRD. If for some reason it is changed by AFCENT or SHAPE, apply an AFCENT or SHAPE prefix.

## CHAPTER 4

### INTELLIGENCE PREPARATION OF THE BATTLEFIELD

IPB is a tool to aid the commander and staff in determining where and when to use limited resources to achieve decisive results. IPB applies to all phases of the AirLand Battlefield; close-in, deep, and rear operations synchronization are all supported by the IPB process.

For planning the close-in phase of the operations, IPB provides a guide for the initial allocation and employment of combat power. Through event templating, it is possible to identify where the enemy probably will thrust if attacking, or where the enemy will concentrate forces if defending. Through terrain and weather analysis and templating techniques, it is possible to determine where friendly forces can best move, shoot, and communicate, and where to place friendly strength against enemy weakness. During tactical operations, IPB supports the use of fire and maneuver to achieve a tactical advantage. Event templating facilitates following enemy forces and determining their probable course of action. Decision support templates (DSTs) enable the commander to apply combat power in a timely manner.

IPB is especially useful as a tool for planning and fighting the deep operations. Through threat evaluation, enemy critical nodes and HVTS are identified readily. Event templating determines the optimum time and place to interdict the enemy to achieve maximum delay, disruption, destruction, and when and where to achieve decisive exploitation of identified weakness. It facilitates the identification and location of deep targets in time to strike them at the optimum time and place in a manner which constrains and causes the collapse of close-in enemy actions. AirLand Battle concepts were introduced in Chapter 1 of this manual, and an application of IPB and collection in deep operations and maneuver plans is further explained in FM 34-130.

When planning rear operations, IPB allows the commander to efficiently focus friendly efforts. Capacity and trafficability of supply routes are identified. Avenues for the commitment of reserves become apparent, as do the choke points which the enemy will attempt to target. The analyst studies drop zones (DZs) and landing zones (LZs) and the air approaches to them, and provides the commander information about the rear area threat. The most advantageous locations for support areas can also be found. All of this permits the commander to use friendly forces in the most economical method possible, which frees assets for the close-in and deep operations.

IPB is an essential part of staff planning. Initially, the G2 uses it to develop intelligence about the enemy, weather, and terrain that the commander and staff need to complete their planning. The analysis of the AO and the intelligence estimate primarily embody this intelligence. While IPB does not replace these documents totally, use it as an aid to their development. It also converts much of the written material into



graphics which are understood easily, analyzed, and applied to the planning process.

The intelligence estimate is a key to the decisionmaking process. Through IPB, the estimate is presented in a graphic format. This enables the commander and staff to see, rather than visualize mentally, where both friendly and enemy forces can move, shoot, and communicate. It provides a graphic data base for comparing friendly and enemy courses of action. Weather and terrain overlays tell us not only where the enemy moves, shoots, and communicates but where friendly units accomplish these functions as well. Just as the G2 uses templating to determine enemy courses of action, the G3 uses templating techniques to compare friendly courses of action.

IPB helps the G2 determine--

- °Where to look.
- °When to look.
- °What to look for.
- °What to look with.
- °What to expect to see.

IPB helps the G3 determine--

- °Where to maneuver, shoot, jam, and communicate.
- °When to maneuver, shoot, jam, and communicate.
- °What friendly resources to maneuver, shoot, jam, and Communicate with.
- °What enemy assets to maneuver, shoot, and jam.
- °What results to expect.

IPB is vital to the commander's estimate and tactical decisions regarding the concept of the operation because it produces an accurate comparison of friendly and enemy capabilities and courses of action. It enables the commander to see friendly and enemy vulnerabilities and opportunities and to determine where, when, and how to support forces to ensure success.

Successful preparation and application of IPB products depend on the intelligence analyst's ability. The intelligence analyst must know both enemy and friendly maneuver doctrine; must understand what a mission statement involves; and must focus efforts to support the mission. To provide the commander with the intelligence required to make a high quality decision, the analyst must also coordinate extensively with other staff sections. These include the G3 or S3, the FSE, AD, engineers,

battlefield deception elements, and USAF weather teams. Other sections, such as the G5 and G4 or S4 become involved in rear area IPB. Each of these sections and others have data which are vital to IPB. Each of these sections also has requirements which are filled by IPB. Use of this manual and FM 34-130 helps the analyst succeed in supporting the commander effectively.

IPB influences every stage of an operation and is continuous. It begins with a staff estimate process, which involves interaction from all the staff sections.. Because battlefield conditions and tactical situations change, IPB must be dynamic. The products which result from IPB are often perishable, and must be updated to remain valid. Figure 4-1 shows how the staff sections interact during the IPB process. Chapter 4 of FM 101-5 describes in detail why IPB is conducted prior to an operation.

Conducting IPB and knowing how to apply its products, are two different processes. This chapter explains how the intelligence analyst utilizes IPB to assist the commander and staff in the successful planning and execution of AirLand Battle. A more detailed description of the IPB process is available in FM 34-130.

#### PURPOSE OF INTELLIGENCE PREPARATION OF THE BATTLEFIELD

The key to effective IPB application centers around the G2 or S2 staff understanding what can be accomplished with it. Much time and effort is expended without purpose if IPB is conducted in a vacuum.

The analyst's objective when applying the IPB process is to reduce battlefield uncertainties as they relate to terrain, weather, and enemy. During the IPB process, the graphics produced aid the commander and staff in planning and synchronizing more effective operations. IPB focuses the S2's intelligence collection effort where it is most effective. IPB also assists the commander in the decision-making process. For a detailed description of how IPB assists in decision making read Chapter 4, FM 101-5. IPB helps the commander control the battle by describing what the enemy's most likely course of action is, including when and where it will occur and how the enemy's follow-on forces affect the battle.

In situation and target development, the IPB product shows the commander when to most effectively attack enemy forces by fire and maneuver and when to seize the initiative. Using the IPB graphics, the intelligence analyst can identify and prepare the attack of HPTs as they move onto the battlefield. This reduces the effectiveness of the enemy's forces, causing them to be disrupted and delayed, and presenting further targets for maneuver or FS missions. In threat integration of IPB, the analyst uses analysis models to forecast events on the battlefield.

The IPB process, if applied properly and with purpose, contributes immeasurably to mission accomplishment. However, as with any predictive instrument, IPB will never achieve 100 percent accuracy.

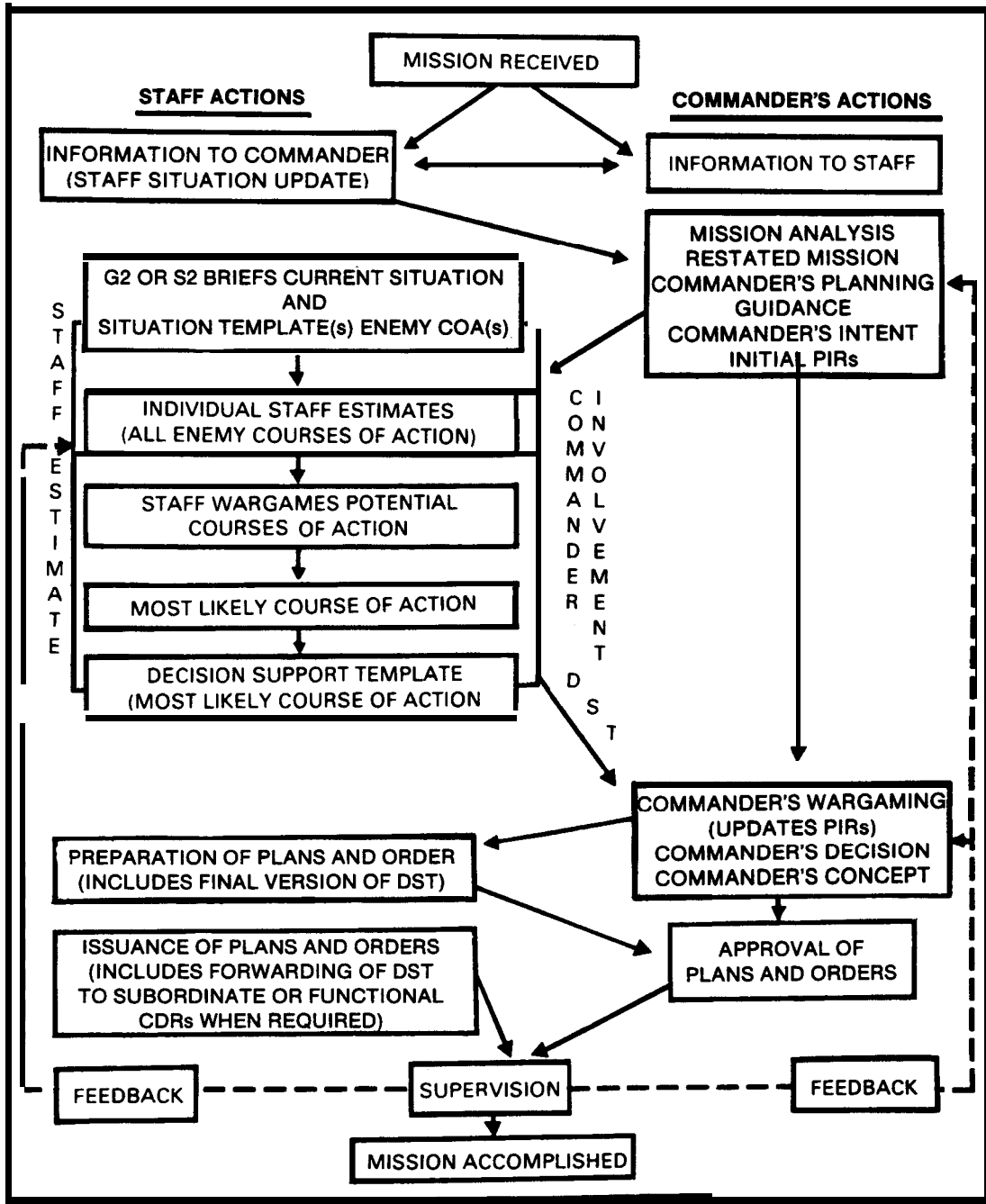

Figure 4-1. The planning process.

## DEVELOPMENT AND USE OF INTELLIGENCE PREPARATION OF THE BATTLEFIELD PRODUCTS

Graphics are basic to IPB analysis. Often intelligence is communicated best with pictures. The analysis of the battlefield and the intelligence estimate are not replaced, but merely assisted by graphics. These graphics become the basis for intelligence and operational planning. Currency is maintained through graphic renewal or update. Right now most aspects of IPB analysis are prepared manually. Preparing graphics by hand is slow and time-consuming. Properly prepared, graphics are relatively simple and inexpensive to maintain. The benefits of graphic analysis and display of intelligence are worth the initial investment of time and resources. It is therefore incumbent upon the G2 or S2 to make maximum use of available time and personnel to produce those graphics which are most beneficial to the commander. Particularly at brigade and battalion level, all personnel must be capable of conducting the IPB process. Additionally G2s or S2s at each echelon should provide subordinate unit S2s as many IPB products as possible. This saves time and permits the subordinate level S2 to expand on higher level IPB products or produce others unique to the unit mission.

The graphics produced during the IPB process have numerous purposes and functions. A good analyst knows what to accomplish from each. Terrain and weather factor overlays, for example, help depict the effects of terrain and weather on potential friendly and enemy courses of action.

Further on in the IPB process, analysts produce four templates--doctrinal, situation, event, and decision support. Figure 4-2 gives the description and purpose of each template. These templates help the analyst to deduce and analyze enemy capabilities, predict their most likely courses of action, identify information gaps, and determine TAIs. In other words, the graphics produced during the IPB process help in conducting analysis.

### APPLICATION OF INTELLIGENCE PREPARATION OF THE BATTLEFIELD

The IPB process begins with the mission. Upon receipt of a mission, the commander analyzes the situation and has the staff present a situation update. From this initial information, the commander conducts mission analysis and restates the mission. The commander then sets the staff planning process in motion by providing planning guidance and intent. The commander also determines initial PIRs.

Using the commander's guidance, the staff begins to prepare their estimates. The IPB process primarily takes place during the estimate process.

The intelligence analyst considers the amount of available time and the number of soldiers on staff who can conduct IPB. Giving due consideration to resources, the analyst initiates the IPB process with the intent to produce sufficient graphic products to assist the commander and staff in their planning.

As a minimum, the analyst prepares a modified combined obstacle overlay (MCOO), a situation template depicting how the enemy looks at the most critical moment on the battlefield, an event template from which to develop the R&S plan, and a DST.

The G2 or S2 applies IPB to assist the analytical process and accomplish as much of the process as possible to support the commander in what little time is available. Time is the analyst's greatest enemy as there is never enough of it. If there is time for only one situation template, the analyst prepares the one most critical to the commander's mission. This is why it is so important for the G2 or S2 staff to understand the commander's intent. Time spent initially providing guidance and establishing specific tasks for each member of the G2 or S2 staff who conducts IPB, goes a long way towards a more complete IPB product which contributes to the commander's successful mission accomplishment.

TEMPLATE	DESCRIPTION	PURPOSE	WHEN PREPARED
Doctrinal	Enemy doctrinal deployment for various types of operations without constraints imposed by the weather and terrain. Composition, formations, frontages, depths, equipment numbers and ratios, and HVTs are types of information displayed.	Provides the basis for integrating enemy doctrine with terrain and weather data.	Threat Evaluation.
Situation	Depicts how the enemy might deploy and operate within the constraints imposed by the weather and terrain.	Used to identify critical enemy activities and locations. Provides a basis for situation and target development and HVT analysis.	Threat Integration
Event	Depicts locations where critical events and activities are expected to occur and where critical targets will appear.	Used to predict time-related events within critical areas. Provides a basis for collection operations, predicting enemy intentions, and locating and tracking HVT.	Threat Integration
Decision Support	Depicts decision points and target areas of interest keyed to significant events and activities. The intelligence estimate in graphic form.	Used to provide a guide as to when tactical decisions are required relative to battlefield event.	Threat Integration

Figure 4-2. Intelligence preparation of the battlefield templates.

## BATTLEFIELD AREA EVALUATION

Battlefield area evaluation (BAE) as the first step in the IPB process sets the stage for the rest of the process.

During the conduct of BAE, the intelligence analyst studies the battlefield area to focus the IPB effort. The analyst studies the battlefield to obtain a general feel for how terrain and weather affect operations. The AO has been provided.

Delineation of the AI is done to direct a portion of the collection effort (with support from higher headquarters) against enemy forces which can directly influence the unit's mission. The G2 and G3 or S2 and S3 determine the AI based on how much time the commander needs to react to a threat. For example, if the enemy has the potential to enter the battalion AO via one of the flanks, and the battalion reserve needs two hours to move to most areas on the flanks, then based on an enemy doctrinal advance rate of 6 kilometers per hour (kph), the analyst would probably extend the AI on the flanks to at least 12 kilometers (kms). The analyst must understand the mission, the commander's intent, and both friendly and enemy capabilities.

METT-T and the commander's concept of the operation determine the AI. Once the AI is established, the analyst informs higher command of the area it covers so they can assist in collection.

During the BAE phase the analyst studies the battlefield to determine significant areas and considerations to be studied in more depth during the remaining IPB phases.

### Terrain Analysis

The intelligence analyst has one primary objective when conducting terrain analysis -- to reduce the commander's battlefield uncertainties as they relate to terrain. Terrain analysis emphasizes the use of graphics to portray the effects of terrain on operations.

The G2 or S2 depicts via graphic products--

- °Terrain which impedes or hinders maneuver and mobility.
- °Terrain which does not restrict maneuver and mobility.
- °Avenues of approach (AAs) and mobility corridors (MCs).

The lower the level at which the analyst works, the less time the analyst may have to prepare terrain factor overlays. The analyst must prepare those overlays which support the commander's mission and intent. This requires the G2 or S2 to prioritize and set time lines as to what the analyst should accomplish.

## Modified Combined Obstacle Overlays

The intelligence analyst prepares a MCOO. This overlay is a combination of various overlays or if done as one overlay, then simply is a graphic representation of what should be highlighted about the terrain. It is based on OCOKA (observation and fields of fire (FofF), concealment and cover, obstacles, key terrain, and AA and MCs).

Terrain analysis at division level and higher benefits from engineer terrain teams or detachments attached to G2 staffs assisting in terrain analysis. Time constraints may not permit receipt of engineer terrain products by brigade and battalion S2s. The intelligence staff must train in the conduct of terrain analysis to be capable of producing their own terrain graphics. Appendix E of this manual, Terrain Analysis in IPB, provides the analyst basic guidelines for conducting terrain analysis. For a detailed description of how to conduct terrain analysis refer to FM 34-130.

Terrain analysis focuses on the military aspects of terrain known as OCOKA. Chapter 4 of FM 34-130 provides a detailed description of OCOKA.

The following guidelines are important to the analyst when applying OCOKA.

**Observation and Fields of Fire.** Observation involves the type of units (both friendly and enemy) which are on the ground. The analyst asks questions such as:

°To what degree does vegetation or relief obscure the observation of friendly or enemy units?

°How will the ground unit be observed from the air?

The analyst focuses on the time of attack or expected time of enemy penetration into the main battle area (MBA). Also the analyst considers what night observation devices both forces possess. These factors impact on the conduct of the battle.

Another important factor is how the friendly force looks from the enemy's perspective. This principle applies to all other OCOKA factors as well. The distinction is made clear to the commander by providing details versus generalities.

Observation also influences the capability for R&S and TA. In the IPB context, this refers to optical and electronic line of sight (LOS). Many battlefield systems require LOS to function effectively. These include radios, radar, intercept and direction finders, jammers, direct fire weapons, human vision, and binoculars.

Air defense (AD) TA and weapons require LOS from their positions to air targets. The analyst considers the anticipated flight altitude relative to the elevation of adjacent terrain.

The effects of terrain and weather on these systems influence the commander's view of the battlefield. What is important for the analyst to consider when studying the terrain is to study it based on the battlefield systems available to the commander and the threat. Again, because time is limited, the analyst prioritizes those battlefield systems most critical to the mission.

LOS overlays graphically illustrate the effects of terrain on friendly and enemy observation and FofF. The horizontal visibility or FofF overlay combines the LOS effects of vegetation and elevation features. The relative capabilities of direct fire weapons, communications, and collection and TA systems become apparent. This overlay assists in identifying key terrain with greater precision. Figure 4-3 shows horizontal LOS FofFs. This is the type of overlay that the engineer terrain team prepares at division or higher. If assigned to brigade or battalion level, the analyst requests this overlay for the AI.

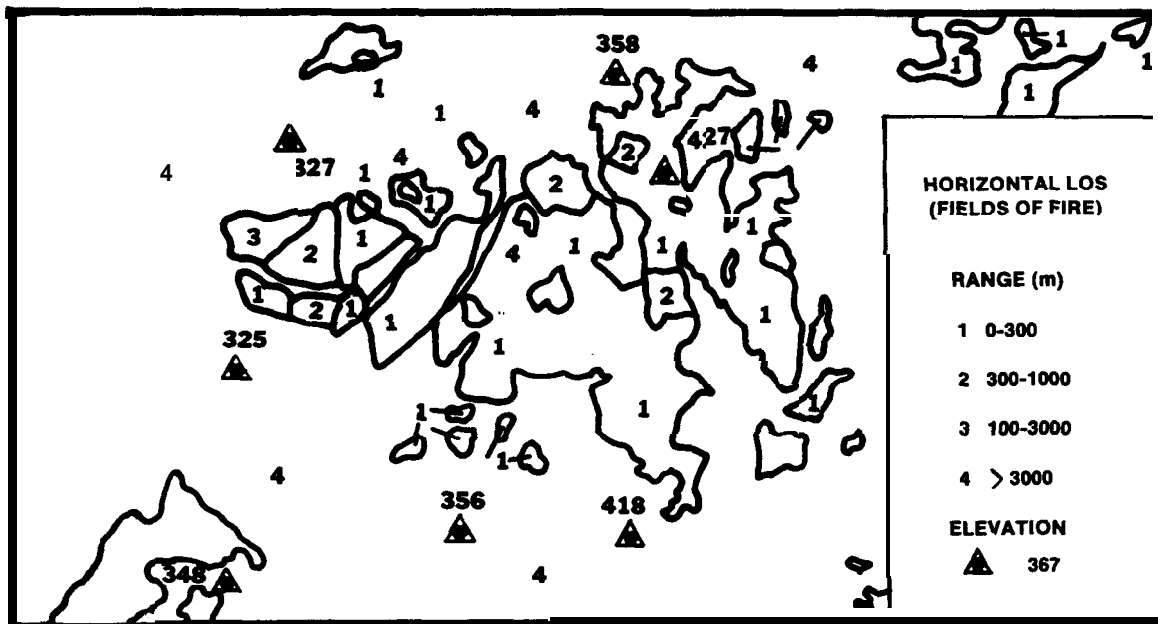

Figure 4-3. Horizontal LOS fields of fire.

Concealment and Cover. Concealment is protection from observation or surveillance. Cover is shelter or protection from fire either natural or artificial. The analyst discerns the difference between concealment and cover. The two are not combined when examining the terrain for their effects. The analyst examines concealment to distinguish it from ground and aerial observation.



The analyst decides the type forces which concealment may or may not impact; for example, concealment may be good for soldiers on foot, yet poor if riding in tracked vehicles.

The analyst addresses cover from direct and indirect fires. The analyst identifies (particularly important at battalion level) points within the AO where concealment and cover are critical to successful mission accomplishment.

**Obstacles.** Obstacles, whether artificial or natural, are very important considerations in the conduct of terrain analysis. Obstacles significantly impact on a force's ability to maneuver or move rapidly through an area. The analyst should not assume that an obstacle for friendly force units is an obstacle for threat units also. The wise analyst examines obstacles separately from the point of view of both enemy and friendly force units and acknowledges that obstacles are different and impact differently depending on the type of battlefield operating system that is used.

**Key Terrain.** Key terrain is any point or area on the ground whose control or seizure provides an important tactical advantage. Any terrain which increases a unit's ability to apply combat power or decreases the opponent's ability to apply theirs is considered key terrain.

Decisive terrain is that terrain which, if not controlled or if controlled by the opponent, significantly degrades the commander's ability to successfully accomplish the mission. For example: The Fulda River in West Germany, and in particular the crossing sites on it, is considered decisive terrain for US forces defending against Threat forces approaching from the east. On the other hand, the Harm River, 6 km east of the Fulda River, while it is considered key terrain for a unit in the defense, probably is not considered decisive terrain because--

°The Harm River hinders enemy movement across it (particularly if covered by fire); but it does not prevent movement because it is narrower and easier to cross than the Fulda.

°It is not an obstacle to movement because it is narrower and much easier to cross.

**Avenues of Approach and Mobility Corridors.** AAs are routes by which a force reaches key terrain or an objective. AAs are evaluated in the following terms:

- °Maneuver support potential .
- °Access to key terrain and adjacent AAs.
- °Degree of canalization.
- °Concealment and cover.
- °Observation and Foff.

#### ° Obstacles.

MCS are subsets of AAs. MCS are areas within the AA which permit movement and maneuver. They permit friendly and enemy forces to advance or withdraw in doctrinal configuration, and to capitalize on the principles of mass, momentum, shock, and speed.

The intelligence officer or analyst should not get caught up on whether a piece of terrain is an MC. It is important that the analyst identify, based on knowledge of friendly and enemy assets, routes which either force will most likely use. Later in IPB, the analyst focuses collection resources on them.

When determining AAs and MCs, the analyst uses the one-up, two-down rule. The analyst determines AAs for enemy forces one echelon above and MCS for forces two echelons below the level of command conducting the analysis.

In determining AAs and MCS, the analyst keeps in mind the type force for which they are developed, the unit mission, and the potential enemy force mission. If an air threat exists the analyst develops air AAs. If time is short, the analyst seeks assistance from higher commands. The analyst may even involve the unit air defense artillery (ADA) officer.

The analyst carries the AA through the enemy's immediate and subsequent objectives. When on the offense, the analyst identifies potential enemy counterattack AAs and if possible AAs within the AO for friendly force units. The analyst also identifies MCS for friendly units. In determining friendly AAs and MCS the one-down, two-down rule applies; that is, the analyst identifies potential AAs for subordinate elements one echelon below the command conducting the analysis and MCS for subordinate elements two levels below. The battalion S2, for example, identifies company size AAs and platoon size MCS.

#### TERRAIN DATA BASE DEVELOPMENT

The analyst compares terrain product requirements with the terrain data base to identify gaps. In addition to standard topographic maps covering the AI, the following sources are helpful:

- ° Current intelligence estimate and analysis of the AO from higher headquarters.
- ° Special terrain studies and products prepared by US or host-country agencies, special maps, charts, and geodetic studies.
- ° Current photography.
- ° Actual terrain reconnaissance.

#### TERRAIN FACTOR MATRIX DEVELOPMENT

The terrain factor matrix provides a guide for terrain analysis. The matrix develops from an analysis process whereby terrain factors are

identified and correlated with specific types of combat operations and battlefield functions. The terrain factor matrix assists the intelligence analyst in identifying the types of terrain products needed. Figure 4-4 shows the terrain factor matrix.

#### COMBINED OBSTACLE OVERLAY DEVELOPMENT

When the terrain factor overlays are stacked and registered, the uncolored portion represents areas in which a force moves unimpeded. Also highlighted are areas which facilitate a maneuver element's ability to shoot and communicate. The overlays show significant terrain features that are further developed in the analysis process. Through graphic terrain factor analysis, the terrain team and the S2 section focus on terrain areas that are significant for further analysis.

FACTORS								
FUNCTIONS	Surface Configuration (Slope)	Surface Materials (Soils)	Vegetation	Weather Effects On Terrain	Transportation	Obstacle (Linear)	Built-up Areas	Surface Drainage—(Hydrology)
Observation and Fields of Fire	X	X	X	X	X		X	
Concealment and Cover	X		X		X		X	
Assembly Areas	X	X	X	X	X		X	
Key Terrain	X		X	X	X		X	
Ground Avenues Of Approach	X	X	X	X	X	X	X	X
Air Avenues of Approach	X		X	X	X	X	X	X
Weapon Sites	X	X	X	X	X	X	X	X
DZ and LZ	X	X	X	X	X	X	X	X
Maneuver	X	X	X	X	X	X	X	X
LOC and MSR				X	X	X	X	
Barriers and Fortifications	X	X	X	X	X	X	X	X
Line of Sight	X		X		X	X	X	X
Communication Sites	X	X	X	X	X	X	X	
EW Sites	X	X	X	X	X	X	X	

Figure 4-4. Terrain factor matrix.

The combined obstacle overlay incorporates all pertinent terrain factors which assist the analyst in identifying mobility areas and deducing trafficability rates for AA analysis.

Figure 4-5 is an example of a combined obstacle overlay. The overlay is particularly important because it integrates all obstacles into one graphic display. This greatly simplifies further analysis of AAs and MCS. Crosshatching indicates the obstacles and the blank areas indicate freedom of movement.

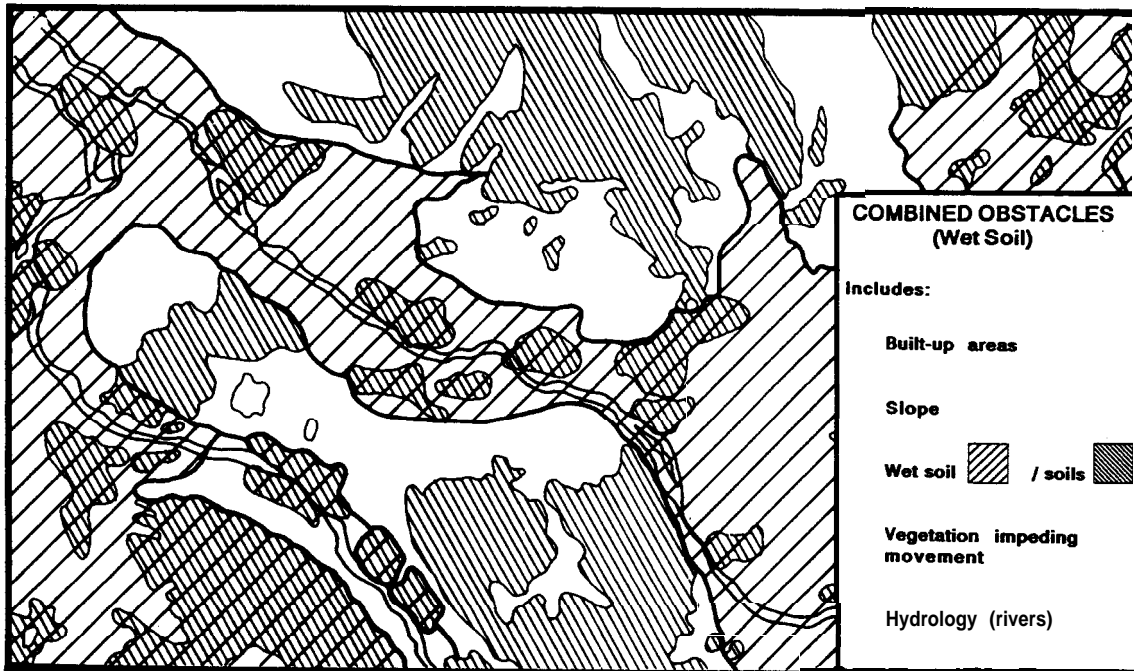

Figure 4-5. Combined obstacles overlay.

The effects of weather on mobility should not be ignored. Through the cooperative efforts of terrain and weather teams, weather effects are integrated with the terrain analysis. As a result, the combined obstacles overlay reflects average weather-induced terrain conditions. Excessive precipitation affects soil density, slope, river stage, and visibility.

Cloud cover (CC) prolongs the drying period. Normal SLOW-GO traffic conditions may convert to NO-GO conditions which impact on both friendly and enemy force movements. The intelligence analyst prepares combined obstacles overlays that reflect at least normal weather effects on mobility. Based on a review of historic weather patterns, the analyst associates specific weather factors with specific time periods.

Figures 4-6 through 4-8 show--

° Obstacles with dry soil.

° Obstacles created by wet soil.

° Combined obstacles with wet soil.

The combined obstacles overlay provides a basis for identifying AAs and MCS. Having determined where the enemy cannot move without difficulty, the analyst focuses attention on those areas where the opposing force can move. Figure 4-9 shows normal requirements for identifying AAs and MCS.

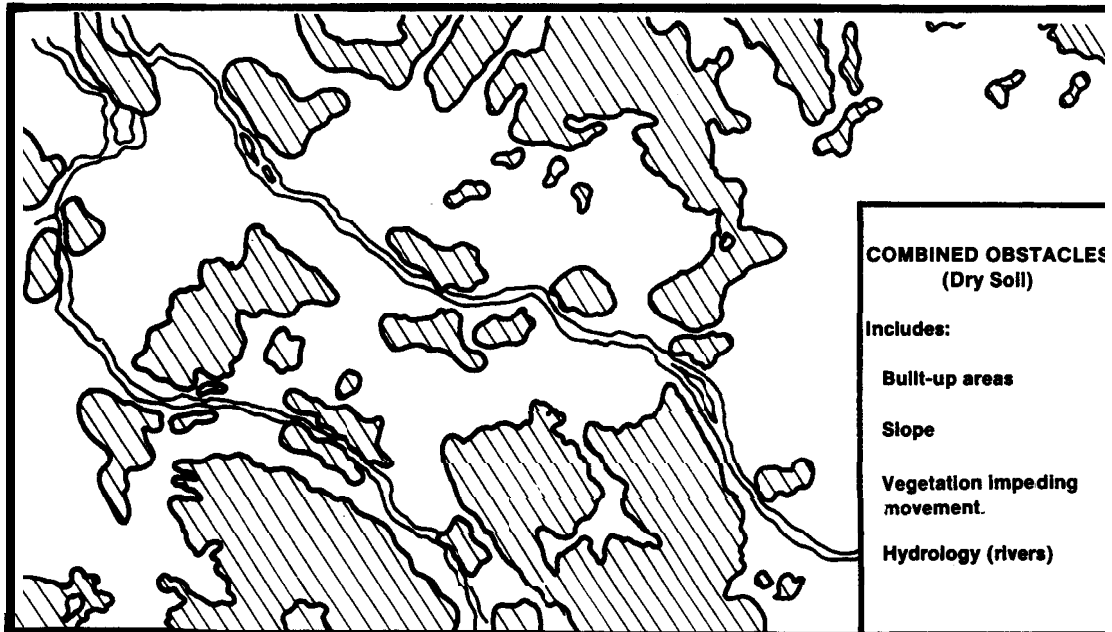
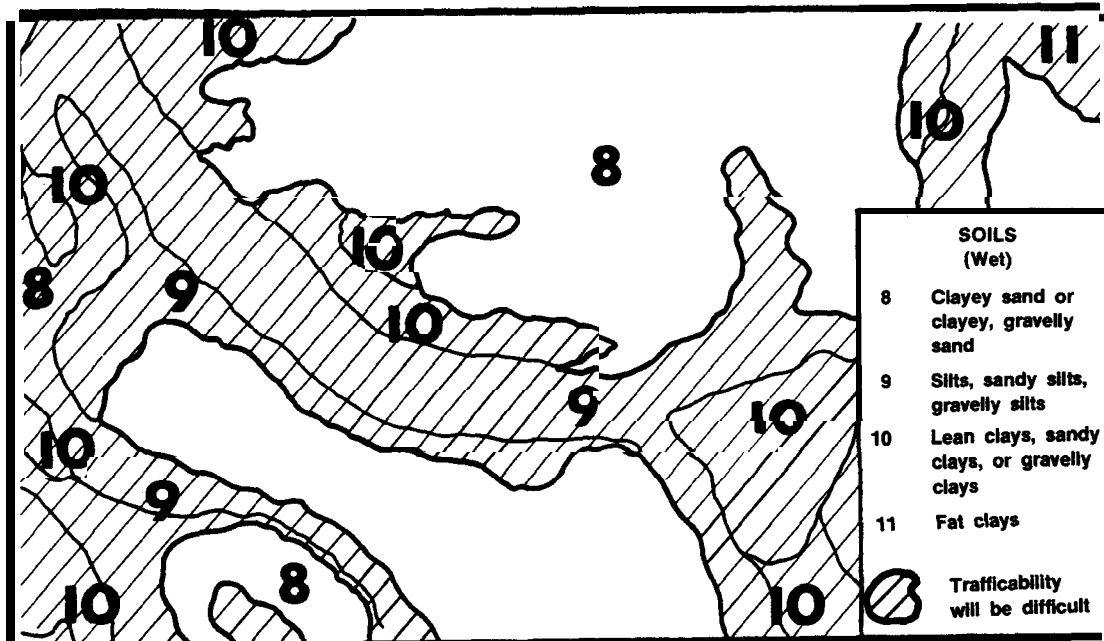

Figure 4-6. Obstacles with dry soil.

The combined obstacles overlay usually reveals one or more MC. Since regiments normally advance along separate MCS, each division AA should contain regimental MCS. The start point of an attack begins at enemy assembly areas and terminates at their objective.

A convenient technique for identifying AAs is to place a doctrinal template over a potential AA and visualize the enemy force moving through. Ask: Is there sufficient maneuver space? How does the enemy look while approaching critical points on the battlefield, such as the FEBA? How does the enemy look when considering attrition? An enemy force fighting through a covering force takes losses. To the attrition add the fact that the enemy has a narrower front when attempting a breakthrough. The analyst uses this information to depict a more realistic AA. When briefing on the AAs, the S2 or analyst must "talk" the commander through a visualization of the enemy force fighting along the AA. Figure 4-10 shows what the commander needs to see.



**Figure 4-7. Obstacles created by wet soil.**

The analyst moves the template along the avenue from projected enemy assembly areas to the objective. An AA is never completely free of obstacles, but it provides for relatively free movement. Obstacles generally parallel the direction of movement.

The analyst selects alternative AAs. If they partially overlap, the analyst should not be concerned. The most direct route to the objective normally is a viable option.

#### LINE OF SIGHT ANALYSIS

In terrain and weather analysis, the terrain team determines LOS for weapons, communications, TA, intelligence collection, and R&S systems. Direct fire weapon systems like the antitank guided missile (ATGM), the self-propelled anti-aircraft gun, and the tank need good FofF to successfully engage the enemy forces at maximum range. FM radio communications, forward observers, TA and surveillance radar systems, and SIGINT need optical or electronic LOS to the target. Terrain and weather factor overlays assist in analyzing LOS limitations. LOS analysis helps determine where ground forces can best shoot and communicate and the most likely low altitude air approaches into the AO. In LOS analysis, the analyst considers the following factors:

° Terrain elevation.

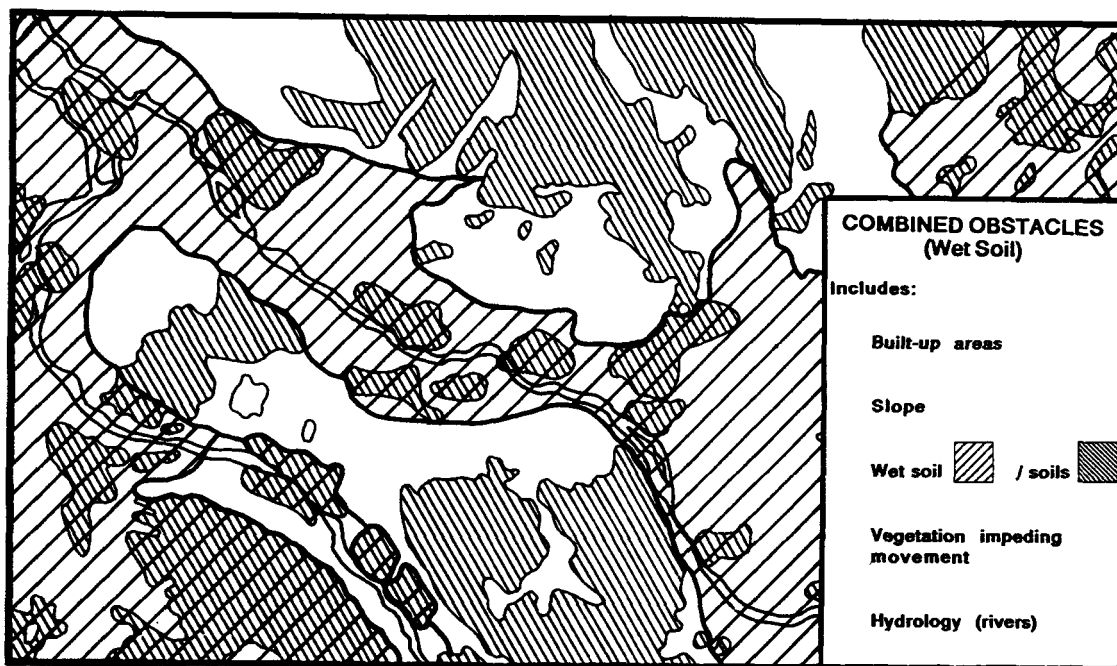

Figure 4-8. Combined obstacles with wet soil.

IF YOU ARE AT	AVENUES OF APPROACH	MOBILITY CORRIDORS
<b>DIVISION</b>	<b>RECEIVE ARMY AA FROM PARENT CORPS DEVELOP DIV AA FOR SUBORDINATE BDE</b>	<b>RECEIVE REGT MC FROM PARENT CORPS DEVELOP BN MC FOR SUBORDINATE BDE</b>
<b>BRIGADE</b>	<b>RECEIVE DIV AA FROM PARENT DIV DEVELOP REGT AA FOR SUBORDINATE BNS</b>	<b>RECEIVE BN MC FROM DIV DEVELOP CO MC FOR SUBORDINATE BN</b>
<b>BATTALION</b>	<b>RECEIVE REGT AA FROM PARENT BDE</b>	<b>RECEIVE CO MC FROM BDE DEVELOP PLT MC</b>

Figure 4-9. Avenues of approach and mobility corridors matrix.

- ° Tree and vegetation height above elevation.
- ° Height of built-up areas.
- ° Density of ground vegetation at full growth.
- ° Terrain factors, such as defiles, which are not apparent because of contour spacing.

° Effects of weather, such as fog or precipitation that obscure observation.

The effects of seasonal changes on LOS should be readily apparent. Winter vegetation compared to summer full growth alters LOS significantly. The limitations of the standard military map is overcome through imagery analysis (1A) and ground reconnaissance. Imagery analysts and terrain specialists are trained in LOS analysis.

Direct fire weapons systems require horizontal or ground LOS. As a rule, 4,000 meters (m) is considered the maximum range for unaided direct fire weapons. Horizontal LOS overlays also depict friendly LOS.

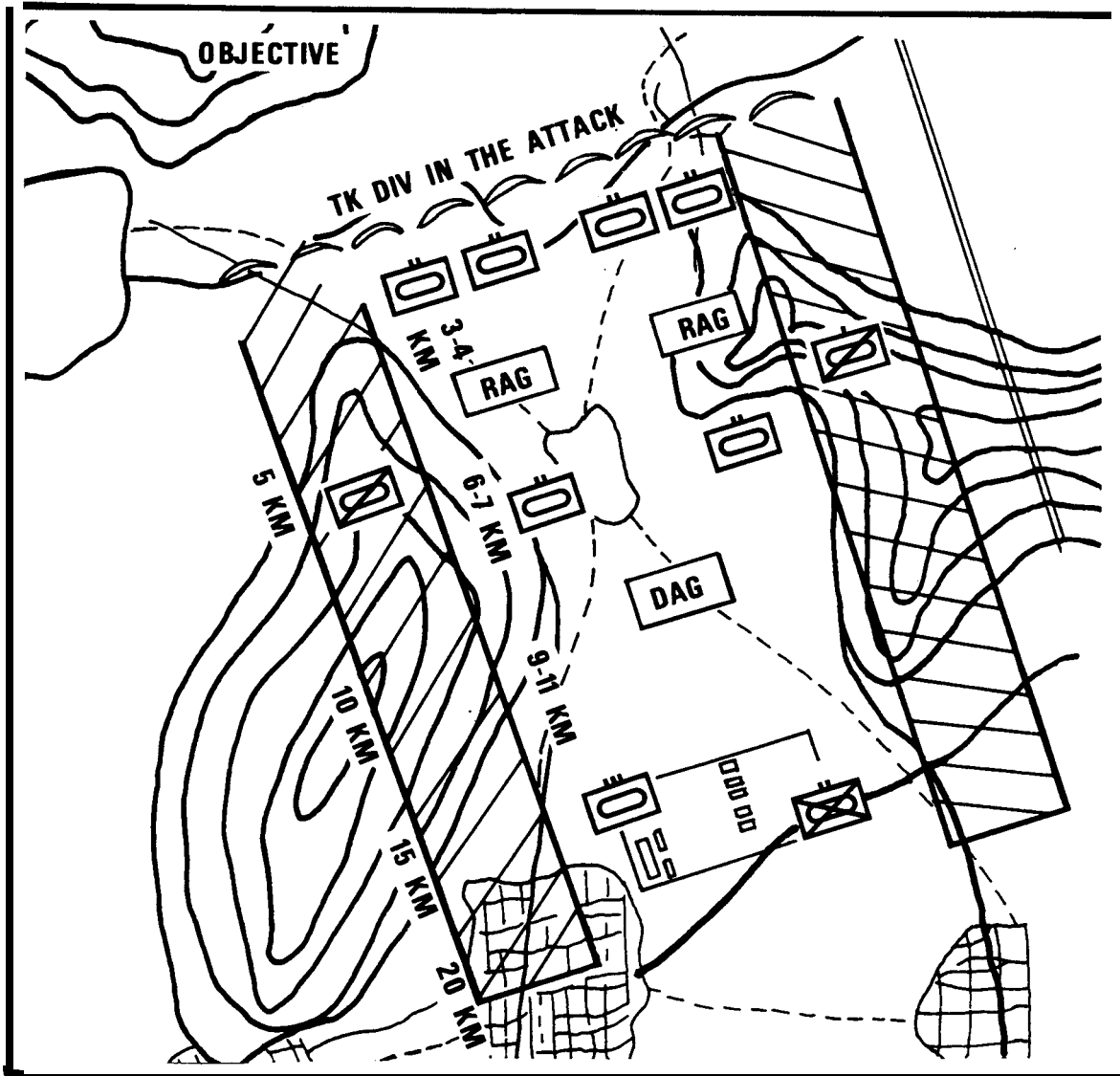

Figure 4-10. Selecting avenues of approach.



Figure 4-11 is a horizontal LOS overlay depicting Foff. Areas of maximum LOS are color-coded to aid analysis. Other range parameters are colored for easy identification. Heavily forested areas would not necessarily obscure LOS. Depending on the density of vegetation, LOS might penetrate 100 m or might penetrate 100 m or more of the forest. The height of ground vegetation and the seasonal density (taller than 1 m) might degrade LOS. This illustrates why an analyst must know the terrain of each battlefield system that is being analyzed.

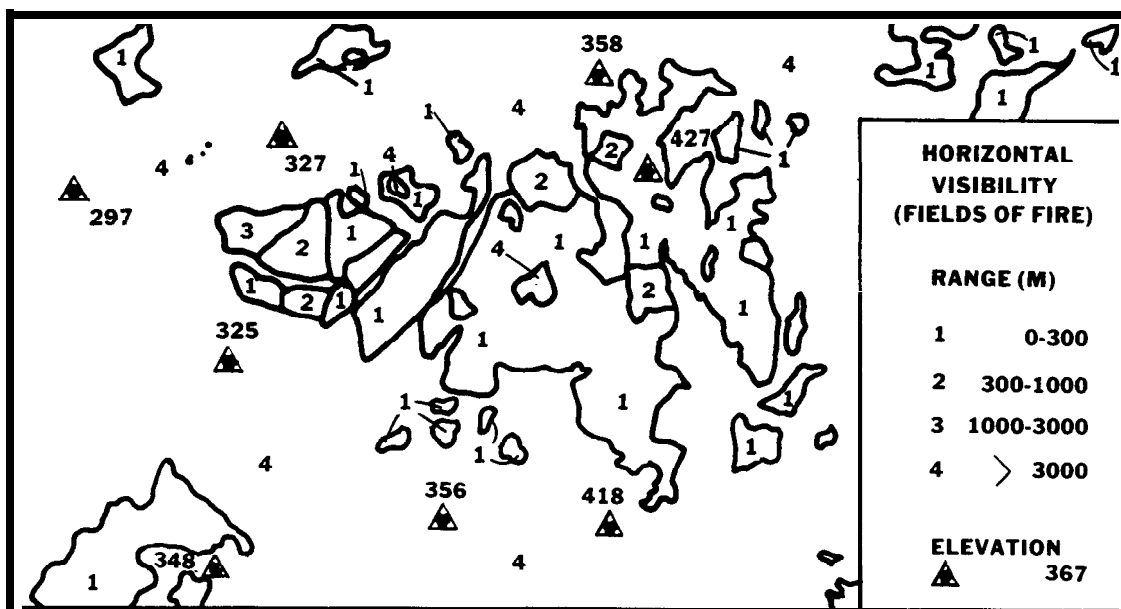

Figure 4-11. Horizontal visibility (fields of fire).

While ground-based systems need horizontal LOS, airborne systems use oblique or vertical LOS. An attack helicopter armed with machine guns and rockets relies on LOS from the aircraft to the target. Standoff weapon systems that pop up from behind masking terrain require accurate LOS and positioning data. Airborne R&S systems, such as the side-looking airborne radar (SLAR), have similar needs for LOS data. Analysis of vertical and oblique LOS from an enemy AD and target perspective helps identify the best air avenues of approach (AAAs) into enemy airspace.

Determining how terrain and weather conditions along each AA affects radio and other means of field communications is probably the area least considered by most analysts because of their general lack of knowledge of communications systems. The corps or division signal officer assists in determining the advantages and limitations of each AA to enemy communications systems. The SIGINT analyst also assists in this effort.

Most AAAs do not offer unlimited options for the employment of communications and noncommunications systems. The intelligence analyst prepares a communication-noncommunication overlay of potential sites for

each MC. Having done this, the analyst compares each and makes some initial determinations as to which is most favorable. LOS information also is essential to electronic deception since this operation requires knowledge of where friendly signatures are observed. Figure 4-12 shows terrain masking and horizontal LOS.

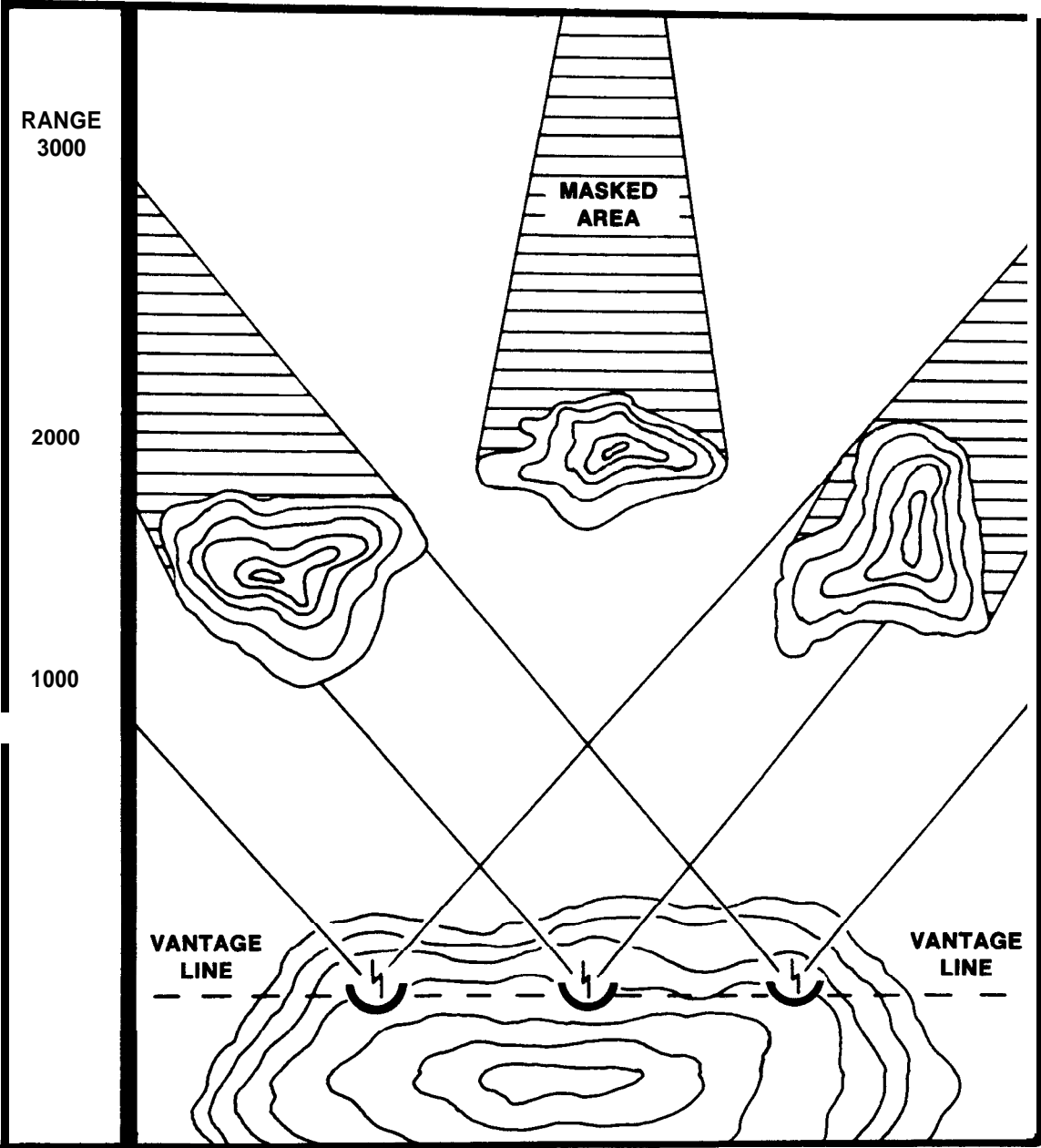

Figure 4-12. Horizontal line of sight.

## AVENUES OF APPROACH ANALYSIS

In AA analysis, the intelligence analyst selects the AAs and AAAs that best support the capabilities to move, shoot, and communicate. The analyst considers each avenue in relation to each friendly or enemy capability, and then lists and compares the advantages and disadvantages of each. This is not merely a matter of counting advantages and disadvantages, but requires detail led analysis and sound judgment.

This analysis is not to determine which AAs the enemy selects, but rather to determine which best supports the capability to move, shoot, and communicate. Figure 4-13 shows how an analyst depicts AAs on an overlay.

Once the most viable AAs are selected, the analyst prepares an overlay depicting each AA and MC. MCS are subsets of AAs and both are shown together. When weather is a consideration, the analyst prepares an overlay for each season.

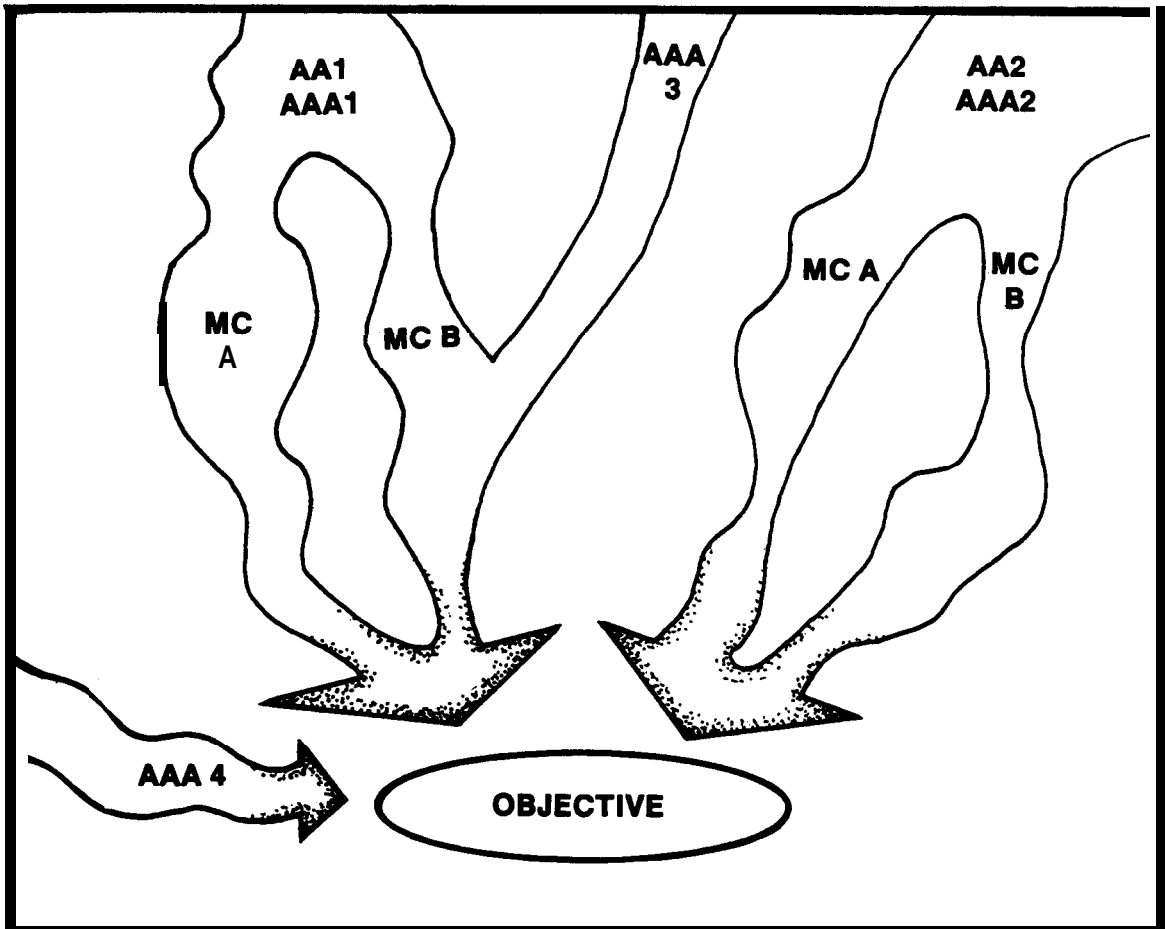

Figure 4-13. Avenues of approach.

## APPLICATION OF WEATHER FACTORS OVERLAYS TO ANALYSIS

Similar to terrain analysis, the G2 or S2 produces graphic weather overlays to help facilitate analysis of weather effects on friendly and enemy battlefield operations.

The analyst prioritizes which military effects of weather generally have the greatest impact on the unit and threat force. Time does not allow the analyst to cover all aspects nor to depend solely on the weather teams. Prioritizing becomes critical when operating at battalion or brigade level because there is little time available.

The analyst focuses on each weather factor, examining its effects separately for both friendly and enemy forces. Using weather factor analysis, the analyst identifies specific vulnerabilities and significant benefits which contribute to the command's successful accomplishment of the mission.

The analyst should not generalize weather effects. The analyst should seek details which are useful. The best way to be successful at this is to track weather effects on unit operations during training exercises, catalog these for future reference, and discuss with subordinate commanders what critical weather effects are needed to operate successfully. By doing this, the weather analysis supports operations and the analyst maximizes what little time exists for other IPB requirements.

### WEATHER ANALYSIS

Analyzing the climate and weather in the AO helps to determine their effects on friendly and enemy operations. Terrain and weather analysis are inseparable, because the tactical environment requires that climate, weather, and terrain information be considered concurrently. The products of weather analysis are applied in terrain and threat integration.

Weather has a significant impact on both friendly and enemy operations. The weather is analyzed in detail to determine how it affects both friendly and enemy capabilities to move, shoot, and communicate. A detailed discussion of weather analysis is found in Chapter 4, FM 34-130.

Weather factor overlays are integrated with the terrain overlays to predict the battlefield areas where friendly and enemy forces can maneuver.

The weather team analyzes climatic data to determine the characteristics of weather in the AO. The terrain team analyzes the effect of weather on tactical operations and, together, the teams integrate weather data and overlays with the terrain analysis and overlays.

The weather analysis team prepares a matrix to define the required analysis and specific weather requirements and determine which overlays are required to support the operation. The matrix isolates militarily significant weather factors and provides the capability to correlate

weather effects with specific combat operations. Examples of weather subfactor overlays produced by the weather analysis team include fog, cloud coverage (summer or winter), rain and snow, and weather effects on slopes. The overlays, along with the combined obstacle overlay, identify where forces maneuver on the battlefield.

At brigade and battalion level the S2 requests those IPB products which address weather effects for their AO from higher headquarters.

Commanders and staffs must understand and consider weather factors in tactical planning. They must recognize the tactical significance of weather effects and the risks or opportunities they present. While considering the effect of weather on all aspects of a mission, the S2 concentrates on weather impact on mobility and LOS. The effects of weather are integrated with the enemy and terrain through IPB; this integration is described in FM 34-81 and FM 34-130. A detailed description of weather effects is in the Weather Effects and Information Handbook (Draft) July 88, USAICS.

Low visibility is beneficial to offensive and retrograde operations and detrimental to defensive operations. In the offense, it conceals the concentration and maneuver of friendly forces, enhancing the possibility of achieving surprise. Low visibility hinders the defense because cohesion and control are difficult to achieve, R&S are impeded, and TA is less accurate. These disadvantages are offset partially by extensive use of illuminants, radar, sound detection, and IR devices. In some instances, using smoke and obscurant aerosols locally reduces visibility. When examining effects of visibility keep in mind friendly and enemy capabilities.

In all operations, restricted visibility prevents or limits the use of aerial systems. The analyst must explain how visibility affects aerial systems.

Wind speed and direction, both on the surface and aloft, usually favor the upwind force. Wind favors the use of either NBC or conventional weapons by the upwind force. Wind of sufficient speed reduces the combat effectiveness of the downwind force by blowing dust, smoke, sand, rain, or snow on personnel and equipment. The upwind force has better visibility and advances easier and faster. Strong winds limit airborne and aviation operations.

Strong surface winds and gusts cause injury to personnel (especially paratroopers in their descent), damage to materiel and structures, false radar returns, and restrictions on visibility by blowing sand, dust, and other materials. Generally, winds above 20 knots create such effects. Smoke operations generally are ineffective at wind speeds greater than 7 knots. As the surface wind increases at low temperatures, either naturally or enhanced by vehicle movement, windchill becomes a critical consideration. The windchill factor adversely affects improperly clothed personnel and impedes activity in unsheltered areas. Wind speed also affects the distance that sound travels. Winds are beneficial because

they improve trafficability by helping dry the soil. A windchill index is available in FM 34-81.

The primary significance of precipitation is its effect on the state of the ground, visibility, personnel effectiveness, and the functioning of some equipment. Ground status affects trafficability; heavy rain makes some unsurfaced roads and off-road areas impassible. Heavy rains make all roads in low-lying areas impassible. Both rain and snow drastically reduce personnel effectiveness by limiting visibility (causing discomfort, increasing fatigue, and creating other physical and psychological problems) and the persistence of chemical weapons thus creating NBC hot spots. Precipitation also adversely degrades the quality of some supplies in storage. Snow accumulation of one inch degrades trafficability and reduces the effectiveness of mines. Generally, more than one inch (2.54 centimeters (cm)) per hour or 2 inches (5.08 cm) in 12 hours of precipitation is considered critical for tactical operations. Snow fall exceeding 2 inches (5.08 cm) in 12 hours, 6 inches (about 15 cm) accumulated on the ground, or drifts of about 2 feet (.6 m) also have a significant effect on operations requiring mobility.

The type and amount of CC, as well as the height of cloud bases and tops, influence both friendly and enemy aviation operations. Extensive CC reduces the effectiveness of air support. This effect becomes more pronounced as CC increases, as cloud bases lower, and as conditions that are frequently associated with clouds, such as icing, turbulence, and poor visibility aloft increase. In relatively unstable air, clouds are associated with strong vertical currents, turbulence, and restricted visibility aloft. Generally, close air support (CAS) and aerial resupply operations require a ceiling of 1,000 feet (305 m) or more.

Clouds affect ground operations by limiting illumination and visibility. They also determine the types, intensities, and amounts of precipitation. Clouds, since they trap incoming heat from the sun and rising heat from the earth, tend to make temperatures near the earth more homogeneous. Temperature and humidity both affect air density. Air density decreases as the temperature or humidity increases; thus, efficiency of aircraft propulsion reduces in areas of high temperature or high humidity. Although temperature and humidity may not directly affect a particular tactical operation, extremes reduce personnel and equipment capabilities, and may necessitate a reduction of aircraft payloads.

Tactics that are effective in one climatic zone may be ineffective if used in another. The high temperatures and humidity found in the tropics are conducive to the growth of dense foliage, which drastically affects operations. In arctic climates, cold weather periods--

- Create an almost constant need for heated shelters.
- Cause difficulty in constructing fortifications.
- Increase the dependence on logistic support.
- Necessitate special clothing, equipment, and combat skills.

A combination of temperature and wind speed produces a windchill factor . A windchill factor of -26°F (-32°C) is considered the critical value for personnel and equipment operating in cold weather, The opposite extreme, 120°F (49°C), is considered the critical value for personnel and equipment operating in hot weather, Similar restrictions occur in the desert where temperature difference of over 50°F (10°C) occur between night and day in shelters without air conditioning or heaters.

At division and corps, updating the weather data base is continuous, particularly during periods of increased tension or combat. During these periods, the intelligence analyst compares current and forecasted weather with historic patterns to determine deviations. Updates are forwarded to subordinate commands.

The analyst uses the weather data base as the foundation for analyzing the effects of weather on combat operations. This analysis begins with an evaluation of the mission, threat, AI, and friendly capabilities. While the analyst considers the effects of the weather on personnel and equipment, the primary concern is with their impact on mobility and LOS.

#### WEATHER FACTOR ANALYSIS MATRIX DEVELOPMENT

The weather factor analysis matrix (see Chapter 4, FM 34-130) assists the analyst in organizing the analysis task, defining Specific weather requirements, and determining what weather factor overlays are required to support mission planning. The matrix isolates those weather factors that are militarily significant and correlates their effects with specific combat operations and supporting functions.

#### THREAT EVALUATION

During the threat evaluation phase, the intelligence analyst examines enemy forces utilizing the nine OB factors.

The objective for the intelligence analyst during this phase is to determine enemy capabilities, vulnerabilities, and strengths. Also the analyst determines how the enemy would operate doctrinally if not restricted by terrain and weather. The G2 or S2 analyzes the enemy based on known information maintained in the enemy OB file. Information gaps identified are translated into RILs and sent up the intelligence chain to be answered. Maintaining a detailed enemy OB file is a continuous process. The S2 section maintains one for each of the unit's contingency and normal operating areas. The intelligence analyst uses the enemy OB together with current information and the mission to develop an HVT list.

The S2 and staff develop an HVT list by imagining how the enemy would fight, relative to the friendly force mission. The S2's or analyst's goal is to identify enemy assets an enemy commander would consider valuable or critical for the accomplishment of the mission. In thinking through the enemy plan an analyst considers how the friendly element's mission and intent affects the enemy mission.

For example, if an analyst is thinking through an enemy attack and knows that the friendly force is in prepared positions with extensive obstacles and barriers throughout the perimeter, it is a logical assumption that the enemy commander will want substantial engineer support to breach friendly obstacles. The enemy commander may not be aware of the obstacles, yet engineer assets in fact are critical to the enemy battle plan. Enemy engineer units therefore become HVTS. The G2 or S2 provides this and other HVTS in the form of a HVT list to the G3 or S3 and the FSE so target priorities are established and planned for.

By analyzing probable enemy actions, the analyst enhances the probability of mission success by determining HVTS which can become enemy vulnerabilities if acted on by the G3 or S3 and the FSE.

The analyst develops doctrinal templates during the threat evaluation phase. Before creating doctrinal templates, the analyst determines which enemy echelon is the focal point for analysis. US commanders are interested in enemy echelons one level above their own because that is the enemy echelon that directs a battle against them. Enemy maneuver elements are templated for units two echelons below that of the US commander, because those are the ground force units in direct contact with the unit.

Knowledge of enemy doctrine provides a starting point for doctrinal templates. For example, doctrinal templates may be required to reflect the sequential order of an enemy unit in the attack from its assembly area to the ultimate objective. The sequence may be as follows:

- °Tactical march formations.
- °River crossing (hasty, deliberate) .
- °Breakthrough.
- °Envelopment.
- °Exploitation.
- °Pursuit.

One method of determining which operations and units should be templated is to develop a matrix. The matrix shows which types of operations and units that are expected to be encountered and provides a clear record of what has been determined. Figure 4-14 shows an operations or unit matrix,

It is also important to prepare doctrinal templates of battlefield functional systems. The functional system templates generally expand information that is reflected in the primary doctrinal templates. For example, a template depicting an enemy division in a river crossing is expanded by a subset depicting the deployment of engineer bridging and pontoon equipment.

Again, not every possible enemy action and subset is templated.



Types of Operations \ Types of Units	Movement to Contact	Meeting Engagement	River Crossing	Attack Against a Defending Enemy	Pursuit
Motorized Rifle Division	X	X	X	X	X
Motorized Rifle Regiment	X	X	X	X	
Motorized Rifle Battalion		X	X		X
Independent Tank Battalion			X	X	X
Tank Division	X	X	X	X	X
Tank Regiment	X	X	X	X	X
Tank Battalion		X	X		

Figure 4-14. Operations or unit matrix.

A matrix is an easy way to lay out the information to be analyzed and recorded. Using a matrix, the analyst looks for those battlefield functional systems in certain types of operations that tell the most about how the enemy operates in relation to the mission. Figure 4-15 shows the types of operations on a battlefield functional systems matrix.

#### THREAT INTEGRATION

The objective of threat integration is to integrate enemy doctrine with the terrain and weather analysis done in previous IPB phases. This further reduces uncertainty as to how the enemy fights. Members of the staff analyze potential courses of action during this phase to advise the commander of the best course of action to accomplish the mission.

To assist the staff, the G2 or S2 produces situation, event, and decision support templates. FM 34-130 provides a detailed description on how to prepare these templates. This chapter discusses how the analyst should apply these templates in order to support the staff planning process.

#### SITUATION TEMPLATE

The situation template depicts how the enemy adjusts doctrine to terrain and weather effects throughout the battlefield. Knowledge of enemy doctrine is critical to developing and using situation templates for analysis.

Types of Operations Types of Battlefield systems	Tactical March Formations	Meeting Engagement	River Crossing	Attack Against a Defending Enemy	Pursuit
Tactical Rockets and Artillery	X	X	X	X	X
AD	X	X	X	X	X
Communications	X	X	X	X	
REC		X	X	X	X
Missiles				X	X
Reconnaissance	X		X		X
Rear Services			X	X	X
C <sup>3</sup> of MRD	X	X	X	X	X
C <sup>2</sup> of MRR	X	X	X	X	X
Engineers	X		X	X	X

Figure 4-15. Battlefield functional systems matrix.

During this phase the analyst takes doctrinal templates and visualizes where the enemy force will place assets on a particular point on the ground. By doing this, MCS within each AA become apparent.

As enemy forces move along AAs and MCs, they do so sequentially. The analyst follows the enemy by sequentially and situationally templating their movement.

Because of time constraints, apply situation templating initially to critical areas on the battlefield. These are based on the friendly force mission and what the commander feels are critical battlefield points and areas. By applying situation templates the analyst usually depicts expected enemy movements along an AA for the commander and staff. This contributes to the planning process by allowing the commander to get a "visual feel" for the enemy's plan.

#### PRIORITY INTELLIGENCE REQUIREMENTS

PIRs are the expression of the commander's information needs. When recommending PIRs, the intelligence analyst keeps in mind the commander's intent. The analyst limits the PIR to a few questions. These PIRs must seek answers to questions critical to the successful accomplishment of the unit's mission.

While PIRs are general in nature, they must be specific enough to identify the critical information required. For example if the brigade is preparing defensive positions in anticipation of an attack, then a PIR could be: When will the enemy attack? A more specific PIR would be: When will the enemy attack and where is the main effort? This PIR, if answered, helps the commander prepare a more effective defense particularly if time is short. Knowing where the main effort is helps the commander prioritize defensive preparations.

#### EVENT TEMPLATE

Situation templating is the basis for event templating. Event templating is the identification and analysis of significant battlefield events which provide indicators of an enemy course of action. It is a projection of what most likely will occur if the enemy adopts a particular course of action. By knowing what the enemy can do and comparing it with what the enemy is doing, it is possible to predict what the enemy will do next. Because there are normally several courses of action which lead to the enemy's objective, each must be identified. Event templates are then developed for each course of action. This is because the enemy course of action which the analyst identifies as the most probable may not be selected for reasons of deception or other factors known only to the enemy. The analyst must be able to shift attention quickly between courses of action during the battle.

The event template is a critical analytical tool for determining the enemy's posture and movement. Knowledge of when and where enemy activity is likely to occur on the battlefield provides indicators of enemy intentions. Indicators may be negative (that is, things that do not happen may be just as critical as what does happen). The projection of battlefield events occurs through situation development during the prehostility or predeployment phase of the IPB process and is verified or refuted during combat operations.

While visualizing the enemy force moving along an AA or MC, critical areas become apparent. These areas are significant because they are where significant events and activities should occur. If the analyst's hypothesis is correct, it is within these areas that targets appear. The intelligence analyst designates these areas as named areas of interest (NAIs) .

An NAI is a point or area, often along an identified MC, where enemy activity (or inactivity) confirms or denies a particular enemy course of action. NAIs also fall outside of a MC. For example, there may be activity on key terrain, such as high ground, in support of movement on an adjacent MC.

The event template and its NAIs are the basis for intelligence collection, R&S, and analysis because they--

°Focus attention on areas where the enemy force must appear if it uses a particular MC.

- Frame militarily significant events by time and location within an NAI.
- Compare events in one NAI with events occurring in the NAI of other MCs to determine enemy intentions.

It is important to develop event templates as quickly as possible. Refine them further as time permits. Early preparation permits quick development of an R&S plan. R&S assets are focused on NAIs to obtain the greatest payoff in relation to limited assets. The primary goal of an analysis is to apply the event template to the collection of information which supports the mission planning effort.

#### EVENT ANALYSIS MATRIX

The event analysis matrix (EAM) supports the event template. It correlates the expected events and activities within each NAI and adds the dimension of time. Through analysis of enemy doctrinal movement rates and the effects of the terrain and weather on their mobility, estimate the time required for the enemy to move between NAIs.

The analyst prepares an EAM for the primary AA and each MC within it. Figure 4-16 shows a sample EAM. Due to time limitations and staff size, most EAMs are prepared at division level or higher.

Before combat, the EAM and event template illustrate possible enemy courses of action as a basis for comparing friendly courses of action. During combat operations, they focus on enemy probable courses of action.

Event templating enables the G2 to develop precise collection requirements, maximizing the effectiveness of limited resources over extended areas against a vast array of enemy targets. It assists the intelligence analyst in determining where to look, when to look, and what to look for. Situation and event templates enable the collection manager to establish collection priorities based on those courses of action the enemy is most likely to adopt. Framing movers and emitters, the primary indicators of events and activities, in time and location, allows the collection manager to determine the optimum mix of collection sensors.

Event templating also serves the G3 by telling--

◦ Where and when to shoot, jam, and maneuver.

◦ What to shoot, jam, and maneuver against.

Event templating is the vital link between the success of the commander's tactical concept and intelligence requirements and the collection, planning, and execution needed to fulfill those requirements.

#### DECISION SUPPORT TEMPLATE

The DST is a logical extension of event templating; it relates events of the event template to the commander's decision requirements. The DST

is not the sole responsibility of the G2 or S2. Production of the DST and synchronization matrix is a shared responsibility, involving the entire staff or their representatives. The G2 or S2 provides information about the enemy. The G3 or S3 guides the effort and ensures that it supports the commander's intent.

A properly prepared DST portrays the enemy's most likely course of action and possible target areas of interest (TAIs) along with time phase lines (TPLs). It also depicts decision points (DPs) which relate to the use of fire, maneuver, and CSS.

<p style="text-align: center;">AVENUE OF APPROACH II</p> <p style="text-align: right;">COORDINATES FM: NB 606330-NB 650333 TO: NB 462181-NB 494132</p>					
<p style="text-align: center;">MOBILITY CORRIDOR A</p> <p style="text-align: right;">FM: NB 670300 TO: NB 468158</p>					
NAMED AREA OF INTEREST	DISTANCE (kms)	RATE OF MOV (kph)	ESTIMATED TIME	EVENT OR ACTIVITY	OBSERVED TIME
<p style="text-align: center;">NAI NO. 1 NB 649288 RD JUNCTION</p>	<p style="text-align: center;">_____</p> <p style="text-align: center;">30 km</p>	<p style="text-align: center;">_____</p>	<p style="text-align: center;">_____</p> <p style="text-align: center;">1.5 hrs</p>	A. RECON ELM	
				B. ADV GUARD	
				C.	
<p style="text-align: center;">NAI NO. 4A NB 647264 CHOKE POINT</p>	<p style="text-align: center;">_____</p> <p style="text-align: center;">30 km</p>	<p style="text-align: center;">_____</p>	<p style="text-align: center;">_____</p> <p style="text-align: center;">1.5 hrs</p>	A. RECON ELM	
				B. ADV GUARD	
				C.	
<p style="text-align: center;">NAI NO. 4 NB 601222 RD JUNCTION</p>	<p style="text-align: center;">_____</p> <p style="text-align: center;">9 km</p>	<p style="text-align: center;">_____</p>	<p style="text-align: center;">_____</p> <p style="text-align: center;">30 min</p>	A. RECON ELM	
				B. ADV GUARD	
				C.	
<p style="text-align: center;">NAI NO. 3 NB 561220 BRIDGE</p>	<p style="text-align: center;">_____</p> <p style="text-align: center;">40 km</p>	<p style="text-align: center;">_____</p>	<p style="text-align: center;">_____</p> <p style="text-align: center;">2 hrs</p>	A. RECON ELM	
				B. ADV GUARD	
				C.	
<p style="text-align: center;">NAI NO. 7 NB 480180 RD JUNCTION</p>	<p style="text-align: center;">_____</p>	<p style="text-align: center;">_____</p>	<p style="text-align: center;">_____</p>	A.	
				B.	
				C.	

**Figure 4-16. Event analysis matrix.**

## Target Areas of Interest

Areas along each AA and MC where the commander influences the enemy through fire and maneuver are TAIs. The TAIs are normally areas which were earlier identified as NAI. They are areas where we delay, disrupt, destroy, or manipulate the enemy force. They are also areas suitable for attacking HVTS.

A TAI is an engagement area or point, usually along an MC, where the interdiction of enemy forces by maneuver, fires, or jamming deprives or reduces a particular enemy capability. It also may cause enemy forces to abandon or require the use of unusual support to continue operations. In the latter option, TAIs are terrain-dependent to inhibit or deny movement.

Sample TAIs include--

- °Key bridges.
- °Road junctions.
- °Choke points.
- °DZS and LZS.
- °Known fording sites.

The TAIs are significant because they constitute a basis for allocation of attack resources. The identification of TAIs is a joint effort of the intelligence, operations, and FSE staffs. The intelligence staff evaluates enemy forces and the effect of interdiction on their capabilities. The operations staff and FSE consider the availability of interdiction resources, the effects of interdiction on the accomplishment of friendly missions, and priorities for the use of available resources.

Part of determining TAIs involves target value analysis (TVA). TVA is a joint activity of intelligence, operations, and FSE personnel. Through analysis of enemy doctrine, TVA names and provides the basis for locating enemy elements which are key to the enemy's success. These enemy elements are known HVTS.

A second category of targets is the HPT. Destruction of an HPT is advantageous to friendly operations. The commander designates the HPTs. For example, suppose the enemy must cross a wide, deep river in a friendly sector as part of a probable attack. Enemy engineer assets are very important to the enemy commander's success. The engineer units and equipment are HVTs because without them the river crossing is impossible. The friendly commander, briefed on this HVT, designates the enemy engineer assets as HPTs because their destruction is of great value to the friendly defense plan. This particular HPT is prioritized among other HPTs for location by intelligence personnel and subsequent attack by lethal and nonlethal means.

An analyst must have an in-depth knowledge of enemy doctrine to determine potential HVTS, CPS, missile units, and logistics points on situation and event templates. This knowledge helps in cueing collection assets to possible HVT locations designated as TAI for the DST.

#### Decision Points

Following the selection of TAI, the analyst identifies DPs. The availability and capability of friendly fire and maneuver systems largely influence the location of DPs; therefore, their selection is primarily a G3 or S3 function. However, this task requires the efforts of both the G3 or S3, the G2 or S2, and their respective staffs.

DPs identify those battlefield events which may require tactical decisions and the no-later-than time when these decisions are made for the commander to retain available options. Decisions are made early enough to ensure implementation in time to achieve the desired effects; however, they cannot be made until there are indications that particular battlefield events will occur and their locations determined with a high degree of confidence.

DPs associate projected enemy locations with specific points on the battlefield. Comparing times required to implement decisions, enemy movement rates, and distances determine DPs. For example, if it requires two hours to implement a decision, it must be made while the enemy is at least two hours from the TAI where the event will occur. These decisions include more than fire and maneuver; they also include decisions such as donning mission oriented protective posture (MOPP) gear, and employing smoke. Enemy doctrinal movement rates that the analyst develops are adjusted to compensate for the effects of the terrain, weather, and friendly action on mobility. They provide the basis for computation.

The DST depicts the TAI and DPs. Figure 4-17 shows a sample offensive DST with synchronization matrix.

#### Decision Support Matrix

A decision support matrix supplements the DST. This matrix relates each DP to the event or associated TAI or NAI requiring a friendly reaction. Decisions are made by the time enemy forces pass DPs or a set of options which were available are negated. Other information from the IPB data base, like enemy composition and probable deployment, supports the DST.

Intelligence provides a basis for tactical planning and execution. Detailed planning is accomplished during the static period, as an 8- to 10-day battlefield scenario does not allow time for detailed planning. Event and decision support templates are the results of detailed intelligence planning that is accomplished during static conditions. They are the basis for all tactical planning. These templates are the filters through which all information and intelligence are directed to the commander. They are relevant to the commander's needs, as expressed in PIR and IR, because they are keyed to important battlefield events and

Figure 4-17. Offensive DST with synchronization matrix.

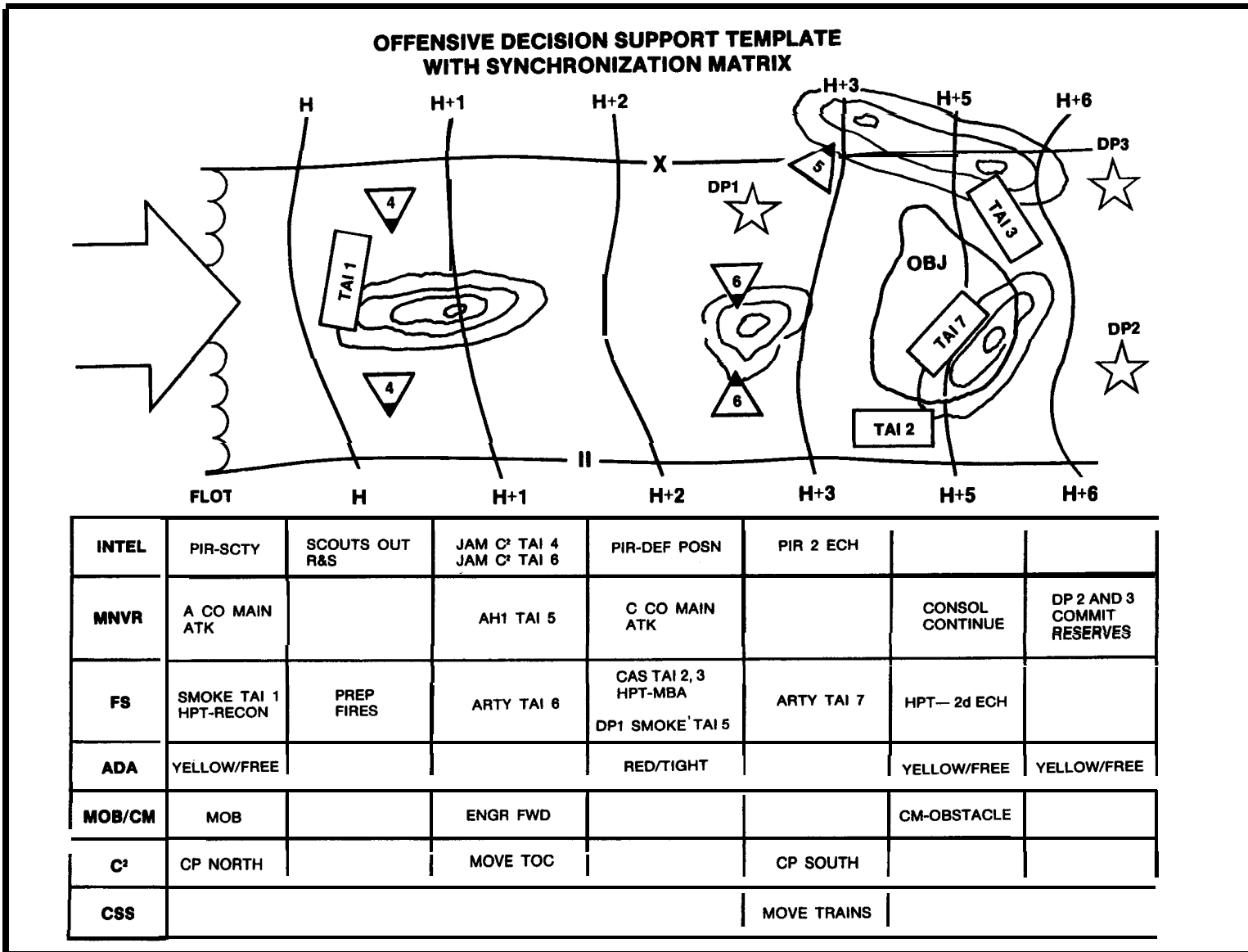



time and space factors known to be of interest to the commander. The DST is the vital link between the commander's intelligence needs and the resultant actions the commander and staff require.

The commander is vitally concerned with wresting the initiative from the enemy commander; that is, forcing the enemy commander to choose a less desirable course of action through design rather than chance. The DST frames the commander's opportunities and options and ensures timely and accurate decisions. This provides the means to influence enemy actions rather than just react to them.

#### INTELLIGENCE PREPARATION OF THE BATTLEFIELD DURING PEACETIME

This chapter has emphasized the vital role that IPB plays in preparing for the next battle. During peacetime, IPB builds an extensive data base for each potential area in which a unit is required to operate. It analyzes this intelligence data base in detail to determine the impact of the enemy, weather, and terrain on operations and presents this information graphically. IPB is initiated any time the commander faces a new enemy or receives a new mission. It is a continuous process which supports planning and execution for all operations.

## CHAPTER 5

### ANALYSIS IN DEPTH

Analysts do not find intelligence. Analysts develop intelligence through evaluating, assessing, integrating, and interpreting information. This intelligence focuses on the commander's needs. It must support the commander's decision to concentrate or disperse forces on the battlefield. It must provide information to assist the commander in targeting and defeating the enemy. This chapter addresses some of the techniques and tools which the intelligence analyst uses to manage intelligence production.

Analysts face daily problems. These challenges vary from the simple, such as finding information, to the complex, such as predicting specific enemy courses of action. The analyst makes decisions regarding what, how, and when the commander can use information to support the battle. This information often means the difference between winning and losing on the battlefield, so it is vital that analysis be both accurate and timely. This information and analysis influences decision making. Although the analyst does not make decisions for the commander, the commander cannot make quality decisions without the information that analysts provide.

#### MEETING USER REQUIREMENTS

The ultimate user of intelligence is the commander. The analyst produces intelligence that the user specifically needs. Through stated PIRs and IRs, the commander drives intelligence production and focuses efforts. The commander's IRs often pertain to varied areas on the battlefield. For example, intelligence required to support the rear battle is different from that required for the deep battle. Different staff sections require different information, yet all of this supports the commander's needs on the battlefield.

It follows then, that to satisfy user requirements, the analyst must understand what those needs are. Figure 5-1 lists some of the factors which an analyst should consider in developing an intelligence product. If the analyst and the user do not look at information or problems from the same perspective, the intelligence will not support requirements.

As a simple example, suppose the user asks for a list of locations where a river may be bridged. The analyst considers the enemy's tanks, which weigh about 40 tons, and provides such a list. If the user plans to cross these bridges with American tanks, which weigh about 60 tons, the list of locations is useless. Clearly, the analyst has failed to understand the user's needs.

In the tactical environment, the analyst and the user see the mission as fighting the same enemy in a specific geographic area. From the knowledge each has about the tactical situation, both develop conceptual models. The analyst and the user create some type of theoretical

<p><b>ABOUT THE USER:</b></p> <ul style="list-style-type: none"> <li>• What does the user want to know?</li> <li>• What does the user already know?</li> <li>• What are the user's areas of uncertainty?</li> <li>• What is the user's time frame for the requested information?</li> <li>• What does the user need to know to understand the product?</li> <li>• What is the user going to do with the product?</li> <li>• What is the last time a product was given to the user?</li> <li>• How did the user react to the product?</li> <li>• How should the user react or not react to this product?</li> <li>• How will uncertainties affect the user's reaction to this product?</li> </ul>	<p><b>ABOUT THE PRODUCT:</b></p> <ul style="list-style-type: none"> <li>• Is the product directly usable?</li> <li>• Is the most significant information up front?</li> <li>• Are the user's areas of uncertainty addressed?</li> <li>• Is the product understandable or is more information needed?</li> <li>• Are the user's requirements addressed directly?</li> <li>• Is there any nonessential information in the product?</li> <li>• Is the product adapted to the means of communication?</li> <li>• Is the product at the user's needed level of description?</li> <li>• Has the credibility of this product been established?</li> </ul>
--	--

**Figure 5-1. Developing an intelligence product.**

representation of the tactical situation. These conceptual models have common factors which both analyst and user share. These common factors are termed "a shared conceptual model."

Without a shared conceptual model, the user and analyst cannot communicate. Effective communication allows the analyst to understand the user's requirements and to tailor the product to them.

Communication allows analysts to interpret what the user wants and fill in any missing intelligence pieces. This is easily done through feedback.

Feedback greatly improves the quality of any intelligence product. If user and analyst communicate during the development of a product, the shared conceptual model is refined. This allows the analyst to orient on those areas important to the user and to eliminate nonessentials. Refinement of the "model" sensitizes the analyst to areas of uncertainty and the criticality of time in a given situation. The analyst, in turn, allows the user to understand the risk inherent in any estimate and the basis for assumptions made.

Face-to-face communication is the best form of feedback. It is also the best way to develop a shared conceptual model. Ambiguous words or ideas can be instantly clarified, pictures or sketches can be drawn, and maps consulted. When face-to-face communication is not possible, the analyst speaks with staff officers or other representatives of the user. If a standard of performance has been established or is described in SOP, the analyst uses this as a measure of current efforts.

### DETERMINING THE RISK FACTOR

Uncertainty is what the job of intelligence is all about. To succeed, the analyst handles uncertainty from a number of sources. While objective ground truth is found in the laboratory, it is not part of analysis of the battlefield. The analyst frequently deals with ambiguous or even misleading information.

The analyst's greatest concern is uncertainty, the commander's is risk. Good analysts translate uncertainty into risk. Figure 5-2 shows a graph of risk functions to consider. Risk increases as enemy lethality moves from low to high. When a range of uncertainty is added to the estimate of lethality, the potential danger becomes even greater. The degree of risk a commander will accept governs the amount of uncertainty the analyst reports.

For example, under a very high level of uncertainty, the commander faces between one and three enemy tank divisions. The analyst admits the level of uncertainty involved, while collecting and processing information to reduce the uncertainty. The level of uncertainty that the analyst

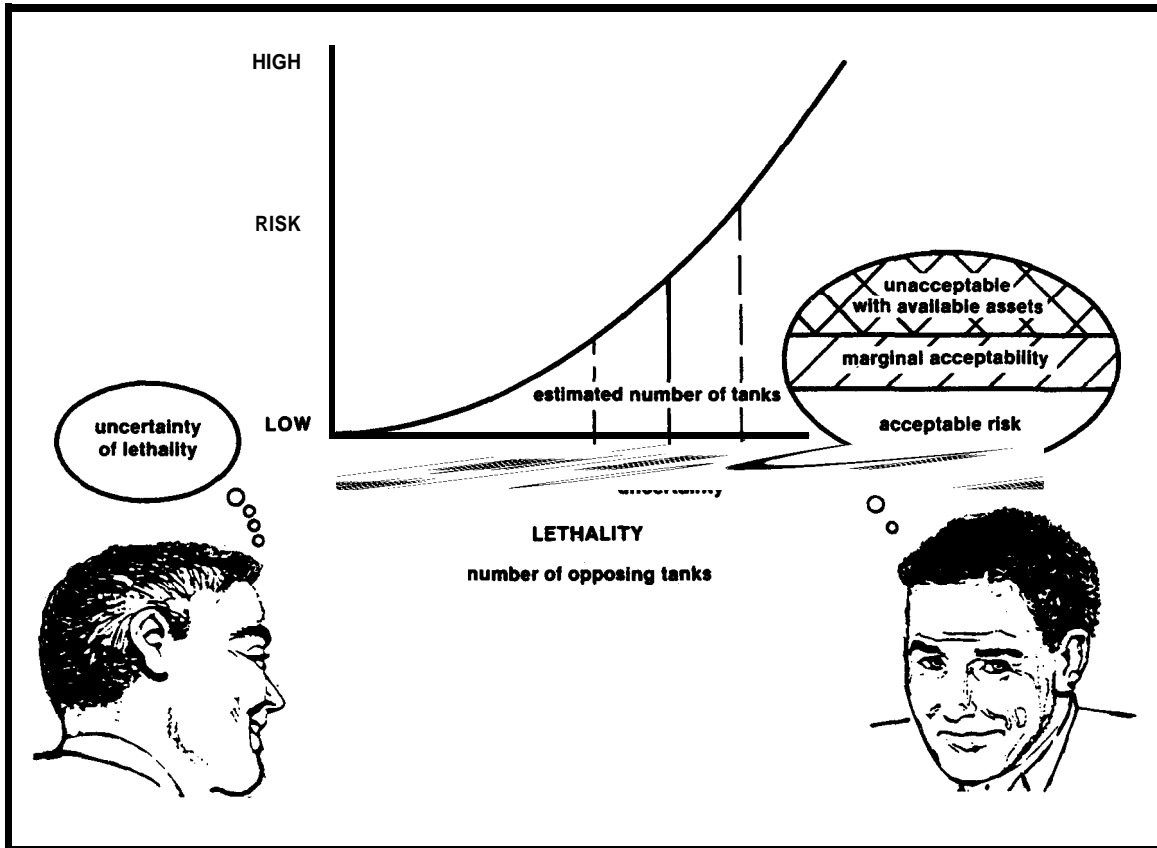

Figure 5-2. Translating uncertainty to risk.

accepts is driven by the degree of risk the commander accepts. The commander is unable to properly plan for battle knowing only that friendly forces face "between one and three enemy tank divisions". The same commander is not concerned about facing 10 or 12 enemy tank battal ions; the commander employs the same plan regardless, in facing 10, 11, or 12 battalions. The analyst does not waste time reducing the level of uncertainty beyond reporting "10 to 12 tank battalions" because the commander is satisfied with the given degree of risk.

Risk is a voluntary exposure to danger, however unavoidable it might be under the circumstances. In combat, there is always risk in not preparing response to a potential enemy action whether or not that action has a high possibility of execution. Risk increases in response to potential danger and decreases when the enemy threat credibility goes down.

Risk increases when--

- °Enemy force lethality increases.
- °Warning time decreases. (Crises occur when warning time is less than the required preparation time; the worst-case situation is when there is total surprise and no warning.)
- °The number of enemy options increases. (If the enemy's plans are ambiguous, then friendly forces might not plan effective responses to all of the enemy opt ions.)
- \* °The number of friendly options decreases. (If fewer options are available for countering the threat, there is a greater chance that the available options will not work.)
- °The enemy's knowledge of the battlefield environment, including friendly forces increases.

Risk decreases when--

- °The enemy force lethal ity decreases.
- °There is greater warning time.
- °The enemy has fewer options.
- °The number of friendly force options increases.
- °The friendly force knowledge of the battlefield environment, including enemy forces, increases. Knowing how the environment affects combat operations allows the commander to exclude unworkable courses of action and to gain maximum effectiveness from others.

The analyst's uncertainty plays a key role in the evaluation of the enemy and the amount of risk accepted. Uncertainty may arise for many

reasons. First, there is uncertainty about the enemy's intent: "What is the enemy's real objective? What are the various means of achieving this objective?" Second, there is uncertainty in evaluating the capabilities of the enemy force to achieve these objectives. Third, there is uncertainty in other factors (lethality, warning time, enemy and friendly options, and environmental conditions). Fourth, there is uncertainty that the method of response will produce the desired outcome.

### THE THREAT MODEL

The threat model is a portrayal of the enemy. It allows the analyst to piece together information, identify information gaps, speculate and predict, and do problem solving. Most importantly, the threat model allows some of the risk in a given situation to be quantified. There will always be inaccuracy in a model, and so there will always be uncertainty. Still, based on the model, an analyst can look for changes in a real-world situation to identify patterns, trends, and activity levels. Creating such a model requires a knowledge of--

- °Physical objects such as weapons, vehicles, and radar.
- °Organizational structures of enemy and friendly forces.
- °Battlefield environment, including terrain, hydrology, and weather.

Once developed the model is refined and maintained, or it will lose its validity.

Threat models incorporate white elements (battlefield geography and environment conditions), red elements (the enemy force (or threat)), and blue elements (the friendly force). The three elements of white, red, and blue form an organizational structure from which the analyst can mentally picture the battlefield. Figure 5-3 illustrates elements of the threat model.

Thinking white is understanding the elements of the environment as they affect the battle. In threat modeling, development of the white framework comes first. It is the white framework that anchors the threat model to the real world. The white framework is made up of space and time.

Developing the geographic framework of the battlefield is as simple as plotting the battlefield on a map. The dimensions of the battlefield encompass the unit's AO and AI.

The map is a model of the real world. The topographic map contains a wealth of information about the battlefield environment, including descriptions of terrain, roads, and population centers. The highly detailed military map contributes more information to the threat model.

Time in the threat model is a sequence of time-period snapshots (or windows) within which events occur. The analyst compresses threat model

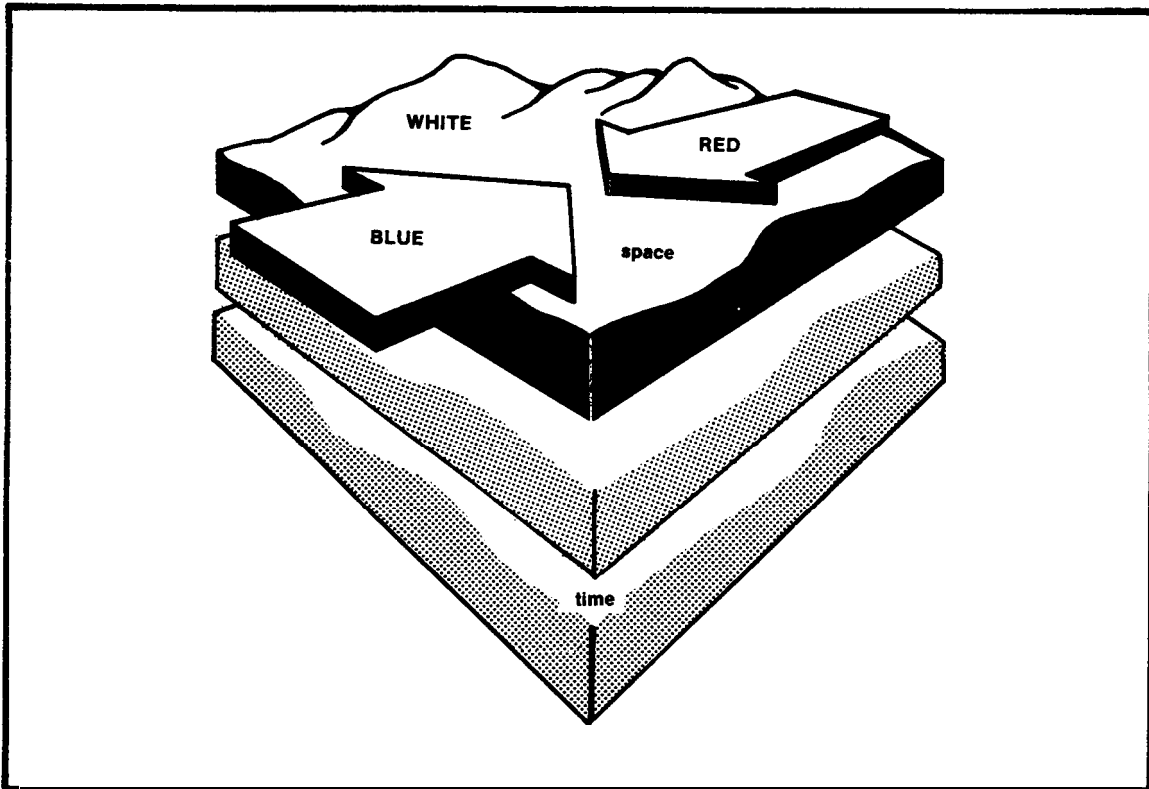

Figure 5-3. Elements of the threat model.

time to bring events closer together or expand it to make individual events more distinguishable. Overlaying time windows helps in seeing patterns of events or distinguishing changes. In the threat model snapshot sequence, one of the snapshots represents the current time frame. A sequence of snapshots allows the analyst to follow courses of action from the current time frame to the eventual outcome of the battle. Each snapshot represents an overlay of information on the battlefield geography. Figure 5-4 shows this.

Thinking red is seeing the battle from the enemy's viewpoint. The red element of the threat model is anchored in the real world. Enemy forces use the political and military policies of the foreign nations involved. The enemy combat force is an extension of political policies that are the source of the conflict that creates the battlefield situation.

Next, in threat modeling, plot the red element, including locations and linkages of the political, military, and combat organizations on the battlefield. The highest echelon of enemy organization plotted depends on the echelon of interest to the friendly force commander. For example, the strategic-level threat model has all aspects of the civilian and military

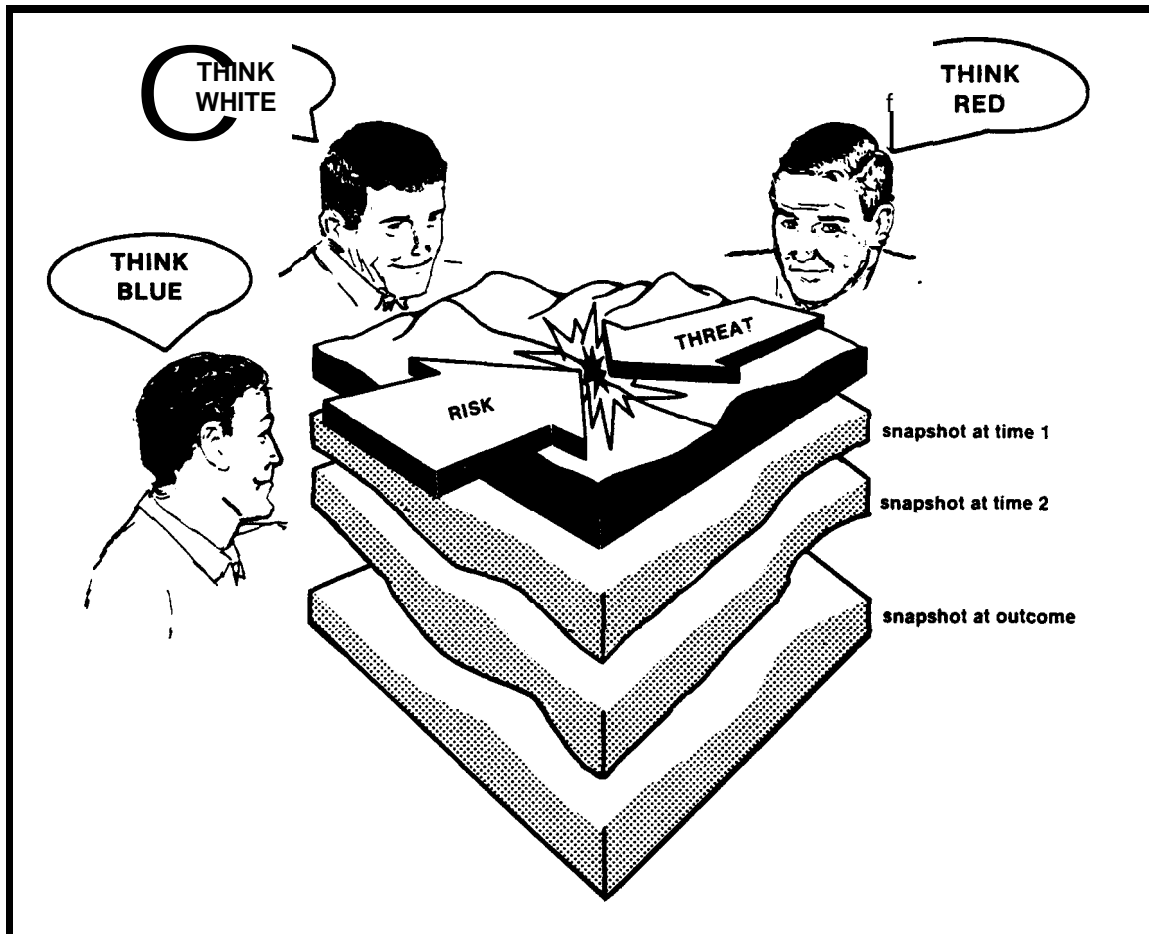

Figure 5-4. Seeing the battlefield.

force structure, whereas a division-level threat model shows only the locations of the red forces up to army level.

The organization of red elements follows some form of hierarchical structure, connected by lines of communication (LOC). The LOC shows the relationships between units for command, control, and coordination. The LOC is overlaid on the geographic structure and relates to physical communication paths like roads, transmission lines, or electromagnetic transmission paths. Figure 5-5 shows the three techniques.

Thinking blue refers to seeing the battle from the friendly commander's point of view. The threat model takes on its full meaning when the blue element is introduced along with white and red. The targets of red threat are blue elements; the components of the friendly force are blue elements.



**Fill out the RED War Plan with three techniques:**

1. **Start with enemy doctrine to structure the war plan.**
2. **Exploit intelligence sources to fill in details.**
3. **Use analogies to fill in missing information.**

**Figure 5-5. Red elements three techniques.**

The most common failing of analysts is their inability to “think blue”. Analysts become extremely knowledgeable about the enemy, knowing nearly exact numbers of equipment, biographies of commanders, and unit histories, but they cannot see how friendly forces operate. It does little good to understand enemy aviation without understanding some of the characteristics of friendly air defense. While there are staff officers who are experts in friendly systems and tactics, the analyst must still have a familiarity with blue doctrine and tactics. This returns to the need for a shared conceptual model.

In plotting the location of units in the white framework, the analyst is concerned with the location of those combat units that information from the threat model supports. Figure 5-6 lists some information sources for developing the blue element of the threat model.

- **Operations plan for the friendly force.**
- **Mission plans.**
- **Situation reports from operational elements.**
- **Friendly force doctrine.**
- **RED view of friendly forces.**
- **Mirror imaging.**

**Figure 5-5. Information sources for developing the blue element.**

Figures 5-7, 5-8, and 5-9 show checklists of white, red, and blue questions that are asked when creating the threat model.

- What is the geography of the battlefield?**
- What is the culture of the country area?**
- What is the history of conflicts in this region?**
- What is the attitude of the local population toward the enemy force? toward the friendly force?**
- What is the academic, economic, and technological level of the local population?**
- How is the local population armed?**
- How is the population distributed in the region?**
- What local cultural features (airfields, railways) can be exploited for military purposes?**
- How predictable is the weather in the area?**
- How does the weather affect operations, personnel, trafficability, equipment, and communications?**
- During what time frame will hostilities occur?**
- How much time is available for preparation?**

**Figure 5-7. Checklist of white questions.**

- |   |   |
|---|---|
| <b>What is the enemy's doctrine?</b>            | <b>What are the enemy's tactics?</b>      |
| <b>How does the enemy prepare war plans?</b>    | <b>How does the enemy train?</b>          |
| <b>What are the enemy's objectives?</b>         | <b>How is the enemy equipped?</b>         |
| <b>What is the enemy's strategy?</b>            | <b>How is the enemy force sustained?</b>  |
| <b>What are the enemy's operational plans?</b>  | <b>How is the enemy force structured?</b> |
| <b>What are the enemy's courses of actions?</b> |   |

**Figure 5-8. Checklist of red questions.**

<b>What are the BLUE principles of war?</b>	<b>What resources does the have at his disposal?</b>
<b>What are the friendly objectives?</b>	<b>What are the priority information needs of the commander?</b>
<b>What are the friendly force resources?</b>	<b>What are the information needs to execute the mission?</b>
<b>What is the commander's mission?</b>	

**Figure 5-9. Checklist of blue questions.**

Given a model of how the battlefield should appear in a certain situation, the analyst develops and tests hypotheses of how the enemy may act. An hypothesis is an explanation that accounts for a set of facts and that can be tested by further investigation. It is a set of logically related propositions and an outcome. An hypothesis can be proven false based on evidence, but it can never be proven correct in advance. The best that the analyst can do is rank order several hypotheses or assign rough probabilities to them, When seeking evidence to support or reject a hypothesis there are several considerations for the analyst:

- The enemy can be engaged in deception. The course of action selected by the enemy does not have to be the best, but only adequate. Deception efforts then can be mounted which support the most obvious course of action.
- Sensors can collect only in the areas where they look. If targeted at one specific area, they may not collect information in another. This information not collected may have confirmed or denied a particular course of action.
- Indicators may be redundant to several hypotheses,
- Several sensors may collect the same piece of information. This can give undue weight to a hypothesis.
- Some small indicator may be vital to a certain course of action. Large scale river crossings, for example, require engineer support. If that support is conclusively absent, a river crossing cannot occur, no matter what else supports that hypothesis.
- The evidence gathered in one area may not be representative of the whole battlefield. For example, the enemy has 15 battalions of artillery available. Sensors report 4 battalions in the north and 2 in the south. This does not conclusively indicate a total of 10 battalions in the north and 5 in the south. The true disposition may be 4 in the north and 11 well camouflaged battalions in the south .

When selecting an hypothesis as "most likely" or rejecting it out of hand, all of the above issues come into play. These errors in thinking may lead to false alarms or rejecting perfectly good ideas. Other errors also exist which affect analysis. They are called biases.

#### **BIASES**

If a single term best describes the factors that interfere with successful analytic thinking, it is bias. A bias is a subjective viewpoint. It indicates a preconceived notion about something or someone. Analysts must recognize biases and be aware of the potential influence they can have on judgment.

Biases can have a positive influence on analysis. With a lack of information, a preconceived notion gives a starting point for thinking about a situation. However, biases are generally bad because they obscure the true nature of the information. The analyst must recognize several categories of biases so as not to be misled or drawn into the wrong conclusions during the analysis process. Biases are cultural, organizational, personal, and cognitive (perception).

#### **CULTURAL BIASES**

Cultural biases begin forming at an early age and continue throughout a lifetime. They interfere with the ability to think in the same manner as the enemy (think red). Analysts need considerable background information on culture and social mores to perceive a situation in the same way the enemy perceives it. If analysts do not have this experience or information and decide to depend upon their own values when looking at a situation, the analysis is likely to be wrong. The reason for this is that different cultures tend to view similar situations differently.

#### **ORGANIZATIONAL BIASES**

Most organizations have specific policy goals. Any analysis done within these organizations may not be as objective as the same type of analysis done outside the organization. Some of the problems that occur from a subjective internal analysis range from an unconscious altering of judgment because of exposure to selective information and common viewpoints held among individuals, to deliberately altering a judgment to provide what the commander wants to hear. "Best case" analysis is a good example.

"Best case" is where an analyst presents the situation in the most optimistic light so as not to anger the commander. This frequently underestimates the enemy's capability while overestimating friendly capability.

#### **PERSONAL BIASES**

Personal biases come from past experiences. If a thought pattern previously led to success, analysts may continue to follow this pattern.

Even if the situations have nothing in common, the tendency to follow the methods that were successful in the past is very strong.

### COGNITIVE BIASES

The all-source analyst evaluates information from a variety of sources (including HUMINT, SIGINT, IMINT, and open sources). Each source has strengths and weaknesses. The degree of reliability, completeness, and consistency varies from source-to-source and even from message-to-message. This variance often creates doubt about the reliability of some sources.

The cognitive biases that cause analysts the most problems are vividness, absence of evidence, oversensitivity to consistency, persistence of impressions based on discredited evidence, and availability.

#### Vividness

Clear and concise information has a greater impact on thinking than abstract and vague information. Even if the vague piece of information has more value as evidence, the tendency is to disregard faster than you would eliminate a clear piece of information.

#### Absence of Evidence

Lack of information is by far the most common problem, especially in a tactical environment. This does not mean that analysts should be content with the information on hand; they always want more. Analysts shouldn't hold back information because it is not conclusive. It rarely is. Instead the analyst should--

- °Realize that information sometimes is missing.
- °Identify areas where information is lacking and consider alternative hypotheses.
- °Adapt and adjust judgments as more information comes in.
- °Consider whether a lack of information is normal in those areas or whether the absence of information is itself an indicator.

#### Oversensitivity to Consistency

Consistent evidence is a major factor for confidence in the analyst's judgment. On the one hand, consistent information is appropriate. On the other hand, information may be consistent because it's redundant, or it may come from a small or biased sample. The analyst considers if the evidence is representative of the total potentially available information. If it is not, or if it is not known, then the confidence level is low, regardless of the consistency. The analyst must be receptive to information that comes in from other sources regardless of whether it supports the hypothesis or not.

### **Persistence of Impressions Based on Discredited Evidence**

Whenever the analyst receives evidence, there is a tendency to think of things that explain the evidence. These connections create impressions. Although the analyst discredits the evidence, the connection remains, and so do the impressions. An example is a clandestine source under hostile control. If the source has a record of passing accurate information, the analyst tends to judge all information that is passed according to previous accuracy. The analyst may doubt the validity of the report claiming that the source is under hostile control or may rationalize the inaccuracy in some other way. Either way, the evidence is based on previous information and not on current indicators. This is one way an enemy could launch a deception operation. This is important. An analyst who "reasons away" information contrary to pet hypotheses does the commander a disservice. Analysts must be professional and capable of saying, "I was wrong," before the situation is lost.

### **Availability**

The ability to recall past events influences judgment concerning future events. Since memory is more readily available, and is more acceptable, it is easy to rely upon memory instead of seeking a proper sample to predict events.

Overcoming bias is a vital step to proper analysis. Any of the above biases reduces the quality of analysis performed.

## CHAPTER 6

### SITUATION DEVELOPMENT

Situation development enables commanders to see and understand the battlefield in sufficient time and detail to make sound tactical decisions. It helps locate and identify enemy forces; determine their strength, capabilities, and significant activities; and predict their probable courses of action. Situation development helps the commander to effectively employ available combat resources where and when the decisive battles will be fought. Also, it helps prevent the commander from being surprised.

This chapter describes the analysis phase of situation development. It also describes how information is converted to intelligence to satisfy the commander's PIR. Analysis in support of situation development continues the IPB process and portrays significant aspects of the enemy, weather, and terrain in support of the decision-making process. This portrayal is based on the analysis of information from all sources that previously has been recorded, cataloged, and evaluated in a manner to facilitate effective analysis. This intelligence data base is continuously updated to ensure the information in it is current and accurate.

Automation increases the capability to manipulate large volumes of information from many sources and assist in the analysis process. However, analysis continues to be a human function. Information is interpreted by an analyst who adds the element of judgment, which is essential "to effective intelligence analysis.

History provides many examples of intelligence failures that are directly attributable to faulty analysis by people. In some cases, the indicators were present, but were either not recognized or were misinterpreted due to the analyst's preconceptions of the situation. In others, the analysis was correct, but was not presented in such a way that decision makers would accept it.

The primary product of intelligence analysis is the intelligence estimate. The estimate provides the best possible answer to the commander's PIR that is available at the time. The estimate is dynamic, constantly changing with the situation. Thus, analysis is conducted continuously with the information available. The available information almost always is incomplete. The analyst uses what is known about the enemy, weather, and terrain from the IPB to estimate what is not known. In addition, the analyst determines the enemy's capabilities, which are the basis for predicting probable courses of action.

#### ENEMY CAPABILITIES

Enemy capabilities are courses of action which the enemy can take to influence the accomplishment of the friendly mission. They indicate--

°What the enemy can do.

- °When the enemy can do it.
- °Where the enemy can do it.
- °In what strength the enemy can do it.

The PIR normally are about enemy capabilities. Estimates of enemy capabilities and their probability of adoption impact significantly on the friendly commander's scheme of fire and maneuver for accomplishing the mission. By integrating the enemy's tactical doctrine, characteristics of the AO, and time and space factors as developed through IPB, the analyst estimates enemy capabilities with a reasonable degree of confidence. Enemy actions that would have little effect on friendly operations, would not benefit the enemy, or are not tactically feasible are not considered enemy capabilities. For example, an enemy force normally disengages its troops in an adjacent area to free these for commitment within our sector or zone. However, in some circumstances, this is not a viable enemy option. Therefore, in those circumstances this capability normally is not considered as an option.

Generally, there are four tactical courses of action open to the enemy in conventional operations: attack, defend, reinforce, or conduct a retrograde movement. These are divided into a variety of more specific courses of action. For example, an attack may be a penetration, an envelopment, or other variations of an attack. A retrograde movement may be a delaying action, a withdrawal, or a retirement.

Some enemy capabilities refer specifically to the support of combat forces rather than the capabilities of the combat forces themselves. Support capabilities include--

- °Use of NBC weapons.
- °EW.

Support capabilities always are considered, especially when enemy implementation of them will significantly affect the accomplishment of the friendly mission.

The analyst considers when the enemy can implement a capability. Time is a critical factor in the Air Land Battle; the friendly commander relies on time to defeat enemy first-echelon forces before follow-on echelon forces are committed to the battle. The friendly commander needs an accurate estimate of when enemy forces are employed to decide how to fight the battle. The analyst considers the following factors in estimating when an enemy force will be employed:

- °Mobility capabilities.
- °Disposition.
- °Doctrinal rates of movement.



° Characteristics of the terrain, LOC, trafficability, and obstacles.

° Time required for displacement, assembly, emplacement, and closing on the battle area.

Integrating information on the enemy and the battlefield environment determines where the enemy implements a capability. The enemy composition, disposition, and weapons and equipment dictate how well the enemy moves, shoots, and communicates--the activities vital to most enemy courses of action. Analysis of existing and forecasted weather conditions and military aspects of the terrain reveals how they affect enemy capabilities in various parts of the AO. AAs and MCS determine where the enemy moves on the ground. LZS and DZS determine where the enemy employs airmobile, air assault, or airborne forces. Suitable beaches determine where the enemy launches an amphibious assault. The location of suitable assembly areas, firing positions, and targets determines where the enemy launches NBC weapons. Also, the location of suitable defensive positions determines where the enemy defends. Terrain factor overlays, which are developed during IPB, identify specified aspects of the terrain. They help the analyst determine where the enemy implements various capabilities.

The strength in which an enemy implements a capability depends primarily on the composition, disposition, and strength of available forces. Chapter 3 describes the 06 files which provide the necessary data for computation. Appendix D describes how to compute enemy strength.

The IPB data base is the key in determining enemy capabilities. Doctrinal and situation templates assist the analyst in estimating enemy capabilities. The event template and EAM help the analyst determine when and where the enemy can implement a capability. Using the working SITMAP, the analyst continuously monitors the enemy situation. The analyst compares the working SITMAP with IPB templates and adjusts the capabilities accordingly. The analyst also follows the friendly operation to determine which enemy capabilities have the greatest effect on the friendly operation.

#### ENEMY COURSES OF ACTION

The ultimate objective of intelligence analysis is to answer the PIR with an acceptable degree of confidence. This normally involves a determination of the enemy's most likely courses of action and the probability the enemy adopts those courses of action. Like capabilities, the analyst determines the enemy's probable courses of action in terms of what, when, where, and in what strength. The probable courses of action provide the basis for predicting enemy intentions. By accurately estimating the enemy's intentions, the analyst provides the answers to critical uncertainties which impact on the commander's tactical decisions.

indicators are the basis for situation development. The analyst integrates information from all sources to confirm indicators of enemy

activities. As indicators are detected and confirmed, PIRs are answered. Appendix C lists common indicators.

#### WORKING SITUATION MAP

The working SITMAP is the basic analytical tool at all levels. It provides a graphic presentation of the battlefield for the analyst, commander, and staff. The working SITMAP integrates significant information from all sources in a graphic representation that is easy to comprehend. All intelligence records are used with the working SITMAP to develop the enemy situation and intelligence estimate. The analyst posts all practical information to the working SITMAP. Such information may include strength, activity, or last known location. An "as of" time must always accompany map information. This allows outdated intelligence to be removed and assists in monitoring enemy progress. The analyst maintains separate records of information that cannot be posted and uses them to back up and expand the information on the working SITMAP. Other records normally are more permanent than the working SITMAP. The significant information about the enemy and the terrain becomes apparent when posted. The analyst uses the working SITMAP to--

- o Identify critical relationships.
- o Evaluate, compare, and integrate information and intelligence from all sources.
- o Track enemy forces.
- o Identify indicators.
- o Wargame opposing courses of action.
- o Identify uncertainties.

Critical relationships help to determine the composition of enemy units, assess their capabilities and probable courses of action, and identify exploitable weaknesses. The analyst identifies critical relationships by comparing separate items of information on the working SITMAP and by comparing the working SITMAP with other intelligence records.

By comparing known information about an enemy unit (posted on the working SITMAP) with the appropriate doctrinal template and the OB book, the analyst identifies unknown elements of an enemy unit. For example, if two motorized rifle battalions (MRBs) of an MRR have been identified, located, and posted on the working SITMAP, the third MRB is most likely deployed nearby. The doctrinal template helps the analyst determine the most likely location of the third MRB. This comparison also helps the analyst identify and locate enemy HVTS like CPS and AD weapon sites. Figure 6-1 shows an example of a doctrinal template. Critical relationships become more apparent when the doctrinal templates are compared with known unit locations plotted on the working SITMAP. Further doctrinal templates of Soviet-style forces are available in GTA 30-1-24.

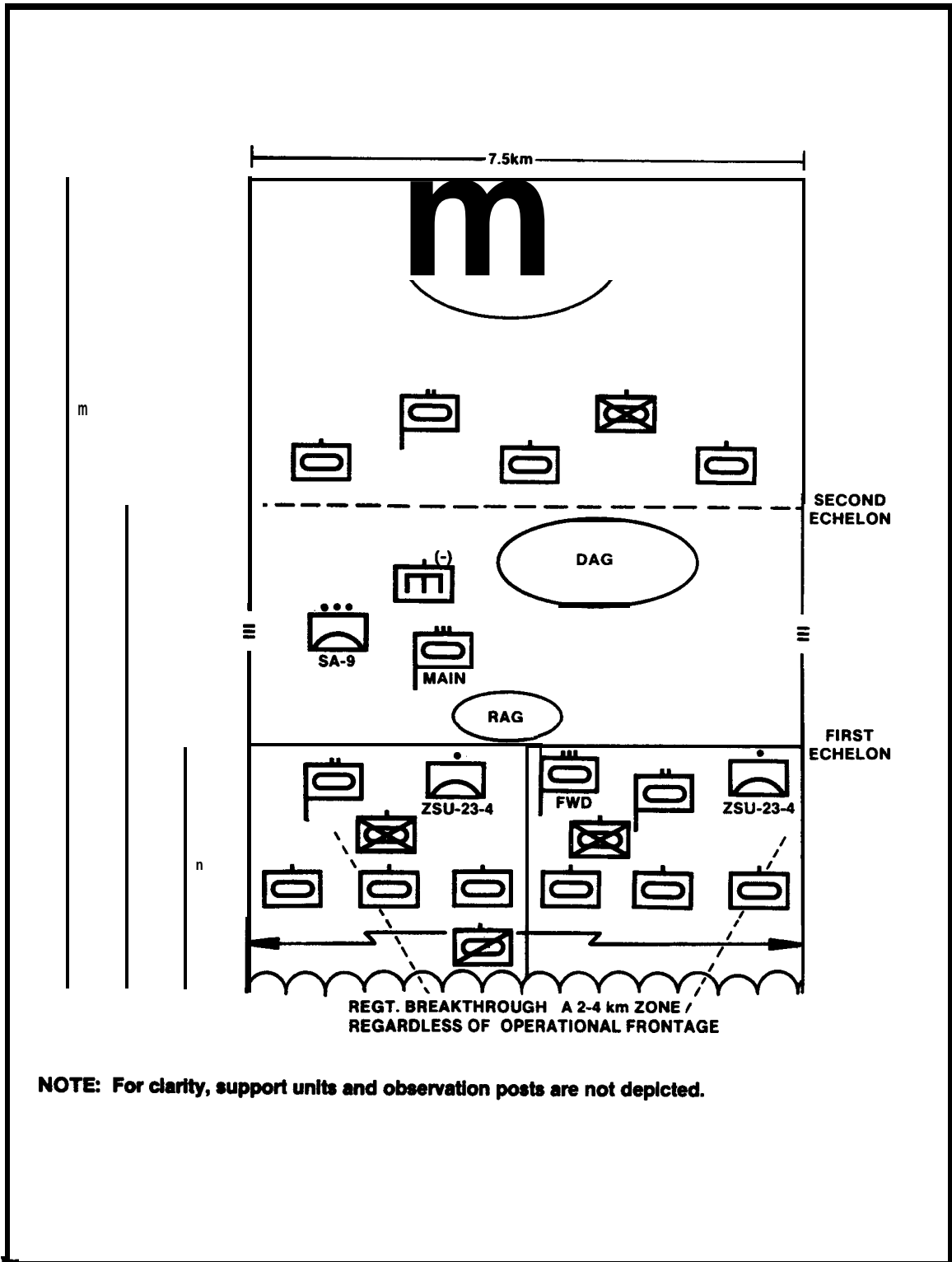

**NOTE: For clarity, support units and observation posts are not depicted.**

Figure 6-1. Doctrinal template tank regiment main attack (div slice).

The working SITMAP makes it easier to evaluate and compare information from different sources. The analyst compares incoming information with the information previously posted to the working SITMAP for compatibility with existing data. This comparison also helps to integrate new information with existing information and to determine its significance.

The working SITMAP provides a record of the latest location of enemy forces. As new information on enemy locations is received, the analyst compares it with information on the old location. This indicates the direction and rate of enemy movement. It also helps determine the accuracy of reports. For example, if the time a unit is observed in a new location (compared with the location and time the unit was last observed) indicates unusually rapid movement that significantly exceeds the doctrinal rates, the analyst is alerted to a problem. Either the old or the new report is inaccurate, or the two reports may not concern the same unit. It might alert the analyst to the possibility of an enemy deception operation. The analyst uses the IPB event template and EAM to project enemy movement. By comparing these with actual enemy movement as indicated on the working SITMAP, the analyst predicts the enemy's probable course of action and predicts when and where the enemy implements it.

The working SITMAP is vital in recognizing and evaluating indicators. Most indicators are associated with patterns of enemy activity, which become apparent on the working SITMAP. For example, an indicator of attack is the massing of artillery well forward. The working SITMAP reveals the location, density, and movement of enemy artillery. A careful analysis of the working SITMAP helps the analyst identify artillery groups, their composition, disposition, and location in relation to the FLOT. By comparing the working SITMAP with doctrinal and situation templates, the analyst better identifies significant patterns of enemy activity and associates them with specific indicators.

The working SITMAP is well-suited for wargaming opposing courses of action. Wargaming integrates friendly and enemy capabilities and possible courses of action with the weather and terrain. It helps both the operations and the intelligence staffs to analyze opposing courses of action. This is vital to preparing the estimate of the situation and the intelligence estimate. It also helps the analyst predict the enemy reaction to friendly courses of action.

The analyst uses the working SITMAP to clarify uncertainties. For example, if the analyst identifies two MRBs that are subordinate to a particular MRR, further knowledge of the enemy's organization tells the analyst that there is a third MRB that has not been located.

The IPB templates are important analytical tools when used with the working SITMAP. Comparison of templates and the working SITMAP systematizes analysis and increases the accuracy of the estimate. Situation and event templates depict projected enemy activities while the working SITMAP depicts the actual observed enemy activities. By comparing and integrating the two, the analyst predicts future enemy activities with greater accuracy.

## FACTORS OF ANALYSIS

The analyst must understand the dynamics of the AirLand Battle to accurately analyze the forces that occupy it and the impact of the environment on those forces.

The analyst understands the enemy's tactical doctrine and the other forces that impact on the execution of that doctrine. The following suggestions are some techniques for developing enemy capabilities and the relative probability of their adoption. These techniques help the analyst use available information effectively to find the right answers to critical uncertainties.

The analyst considers the enemy's use of mass and economy of force. The enemy commander, like the friendly commander, has limited combat resources. The enemy commander uses mass and economy of force at the optimum times and places to accomplish the mission. Rather than dissipate the forces across the entire battlefield, the enemy commander weights the main effort to ensure combat superiority at the decisive time and place. Once the analyst determines how the enemy commander uses mass and economy of force on the battlefield, the enemy's most probable course of action becomes more apparent. The enemy uses follow-on echelons to mass combat power at decisive times and places on the battlefield. In the AirLand Battle, the analyst locates and tracks these enemy follow-on echelons and predicts where and when they will be committed. Situation and event templates used with the working SITMAP help the analyst predict where the enemy will mass.

On a nuclear battlefield, massing presents new opportunities and dangers. Nuclear weapons are substituted for massing of other forms of combat power, yet some concentration of enemy forces is required to successfully exploit strikes.

Analysts identify the composition of enemy force at least one echelon above their own. The mass and economy of force problem is resolved at each enemy echelon. The higher echelon commander's decision on a maneuver scheme and the allocation of combat power and support impacts directly on enemy capabilities within the analyst's unit's zone or sector.

Identifying the enemy composition facilitates construction of a composite picture of the total enemy force structure, including information on identified and unidentified units, located and unlocated units, total reinforcements, types and amounts of CS or CSS, and the availability of special capabilities (river crossing, EW, intelligence collection). In addition, detailed analysis of enemy composition assists in quantifying the degree of uncertainty that still exists. This judgment affects the degree of confidence an analyst has in estimating. Most intelligence judgments are inductive generalizations based on fragmentary evidence. By comparing available information with the composition and organization of the enemy force, the analyst determines what percentage of the total picture of the enemy force is known, and what percentage remains uncertain. For example, agencies report that four enemy artillery batteries have displaced forward. The analyst generalizes that enemy

artillery is displacing forward, an indicator of attack. However, if the composition of the enemy force indicates a total of 40 available batteries, the analyst must recognize that the judgment is based on only 10 percent of the picture. Ninety percent is still uncertain. It is vital that analysts be conscious of the degree of uncertainty remaining in the situation.

Analyze the significance of enemy activity outside your zone or sector. Consider the big picture when assessing the meaning and significance of enemy activity in your AO. Enemy boundaries are not identical to friendly boundaries. Events outside your boundaries may be part of the enemy commander's scheme of maneuver. Analysis of events outside a unit's AO provides indicators or helps focus the collection and analysis efforts within that unit's AO. Events that occur within a friendly unit's AO require correlation with events outside the AO if they are to be correctly interpreted. This is related to and facilitated by the determined composition of the opposing enemy force.

Review enemy tactical doctrine. Enemy commanders are trained to follow their own tactical doctrine. Though some enemy commanders are more or less innovative, most consciously or unconsciously apply doctrine when confronted with a specific mission, threat, and AO.

Enemy tactical doctrine presents many of the indicators of enemy capabilities and probable courses of action. It relates directly to how the enemy uses mass and economy of force in operations.

The enemy's tactical doctrine is depicted on doctrinal templates when possible. Doctrinal templates depict unit formations; frontages and depths for attack, defense, and other operations; characteristic dispositions associated with particular courses of action; allocations of CS and CSS; and information on specialized military operations like river crossings and air assault operations. Event templates depict the doctrinal sequence in which the enemy conducts operations. The IPB templates and the working SITMAP are the basis for comparing the enemy's tactical doctrine with actual events.

Consider how the weather and terrain affect enemy capabilities and the enemy commander's choice of a course of action. Weather and terrain are physical constraints which facilitate or alleviate the adoption of specific courses of action. These constraints have a major impact on how the enemy commander allocates resources. Weather and terrain force enemy commanders to apply special methods of operations. They may require changes in weapons and equipment or in the way they are used. The weather and terrain may give rise to new force structures and organizations.

Paragraph two of the intelligence estimate addresses the effects of the weather and terrain on friendly and enemy operations (see Appendix A). Through continuous IPB and analysis, the analyst relates the enemy force structure and tactical doctrine to the constraints imposed by the weather and terrain, particularly on the AAs.

To relate enemy dispositions and physical constraints of the weather and terrain, there are four specific techniques used to determine how the enemy applies mass and economy of force.

The first technique is to determine the enemy unit boundaries and relate them to AAs. Boundaries frequently are identified through the location of enemy reconnaissance and cavalry units (which often have distinctive, easily identified equipment), terrain and doctrinal analysis of enemy prisoner of war (EPW) capture locations, and other techniques. This technique helps determine mass and economy of force and the enemy commander's perceptions of AAs.

The second technique is to compute enemy strength in terms of committed forces, reinforcements, and supporting weapons for the entire AO, then recompute for each AA. Determine whether enemy combat power and support are distributed evenly or whether one option is weighted. Appendix D describes how to compute enemy strength.

The third technique is to analyze enemy allocations of available LOC. Military forces usually allocate roads to tactical units for logistical support and tactical movement. If this allocation is determined through analysis of enemy boundaries and traffic patterns, it indicates the enemy's probable course of action and assists in identifying enemy support priorities.

The final technique is to identify potential enemy objectives and relate them to enemy dispositions and AAs. Determine which avenue is weighted by locating unit boundaries, computing unit strength, identifying allocation of LOC, and identifying the distribution of combat power.

#### TECHNIQUES OF ANALYSIS

The following techniques of analysis help the analyst identify the presence of indicators.

#### **PATTERN ANALYSIS**

Pattern analysis helps the analyst identify indicators of enemy activity. Pattern analysis is based on the premise that the enemy's course of action results in certain characteristic patterns that are identified and correctly interpreted. Ideally, paragraph 3d of the intelligence estimate (Appendix A) should identify the presence of these indicators. The analyst is faced with the problem of organizing and recording incoming information and adding it to existing information so that meaningful relationships are clarified. The working SITMAP and IPB templates are the primary tools used to organize information. Indicators can be ambiguous and incomplete. The analyst identifies the patterns of activity or tip-offs which characterize the operations of specific enemy units.

## WEIGHTING INDICATORS

Weighting indicators helps resolve ambiguity. In combat, intelligence analysts usually are confronted with conflicting indicators. Enemy forces may portray patterns associated with attack, defense, and delay simultaneously. Conflicting indicators result from--

- o Deliberate deception.
- o Bad execution.
- o Temporary indecision.
- o Transition between missions.
- o Random activity.
- o Incomplete or inaccurate information.
- o Ambiguity of the indicator itself.

When confronted with ambiguous or conflicting indicators, analysts weigh some indicators more heavily than others to determine the enemy's actual intent. This is not a problem of simple mathematics. The enemy's actual course of action may not have the most indicators. Analysts develop a methodology for identifying those indicators which are most highly characteristic of a course of action. There are several techniques which, individually or in combination, assist in this process.

### Origin of the Indicator

One technique of determining the enemy's intent is to consider the origin of the indicator; that is, the reason why the enemy force presents a particular pattern or tip-off. In brief, all indicators stem from either military logic, doctrinal training, organizational constraints, bureaucratic constraints, or the personality of the enemy commander.

**Military Logic.** Military logic implies, and military experts agree, that solutions to many military problems are obvious. For example, all modern armies employ artillery forward for attack and echeloned in-depth for defense. Violation of military logic usually implies the loss of combat power or support at some critical point during an operation.

**Doctrinal Training.** A nation's tactical doctrine includes military logic and much more. Most doctrine begins where military logic ends. Military experts sometimes disagree on the ideal solution to a specific military problem. For example, US and Soviet doctrine agree on deploying artillery forward in the attack, while they disagree on using artillery in a direct fire role. Just as terrain and weather are physical constraints on the enemy's adoption of a course of action, enemy doctrine and training are mental constraints. Soviet emphasis on detailed, repetitive training is designed to inbreed a sort of reflex action which enhances the value of doctrinal indicators. Though individual commanders display more or less



imagination and creativity in its application, indicators based on doctrine and training are generally reliable.

**Organizational Constraints.** Organizational structure represents a special case of doctrine. The ideal composition of a division (size, organization, weapons, and organic support) is debatable. The military experts have resolved this issue in radically different ways. Organization influences include a nation's strategic commitments, economic resources, geography, threat perceptions, historical experience, alliances, personnel and equipment resources, and a myriad of other factors. The tactical organization resulting from these factors causes identifiable patterns to develop when employed. A US division generally has three subordinate maneuver headquarters contrasted with four in a Soviet division, and differences in the composition and structure of the division base imposes distinct patterns concerning US and Soviet operations.

**Bureaucratic Constraints.** Identifying bureaucratic constraints as a source of indicators shows that military units are large organizations and must establish routines and SOPS to function efficiently. This imposes patterns in planning, execution, logistics support, and other activities, though there are general similarities in routines and procedures of comparable units, there are likely to be significant variations which can be identified and exploited locally.

**Personality of the Commander.** The enemy commander is the final source of indicators. Each commander has a unique history of personal training, experience, success, failure, and idiosyncrasies. Many are creatures of habit, prone to repeat what has worked in the past; others are creative and innovative. All are captives of their experience to some degree. It is the commander who must apply, and mix military logic, doctrine, and organization to accomplish the mission. The commander's personality is one major source of deviation from established doctrinal norms, The importance of personality is recognized in that biographic intelligence is a major component of strategic intelligence. US tactical OB doctrine classifies personality as a subcategory under miscellaneous factors.

In general, indicators are weighed, with the role of the commander being considered a variable. In the case of a strong, innovative, or eccentric commander (Patton or Rommel), personality is more important than doctrine or training; while the personality of a methodical, traditional commander ranks last.

#### Principle of Mass Indicators

Another technique is to weigh the indicators which reflect or are based on the principle of mass. Military units normally conduct deception operations with the same force constraints in which they accomplish their actual mission. The enemy commander often conducts deception with the least outlay of scarce resources. Indicators based on a major confirmed commitment of combat resources are more likely to reflect the true situation. In a nuclear environment, massing is not required to achieve a favorable combat power ratio; thus, mass is not a reliable indicator.

Analysts identify the enemy's capability to concentrate fires of potential nuclear delivery systems.

#### Other Indicators

The last technique is to weight those indicators which are most difficult to fake.

**Quantify Probable Relationship.** Quantify the probable relationship between the presence of specific indicators and the enemy's adoption of a particular course of action. If the enemy commander intends to adopt a particular course of action, what is the probability that a specific indicator is present? The answer is subjective, but it is based on the analyst's knowledge of and experience with the enemy, the analyst's professional judgment, and to some degree, the mathematical probability of specific indicators associated with enemy courses of action.

**Analyze the Time Sequence of Events.** It takes time for an enemy force to prepare, move, and execute an operation. Time, mass, and space relationships are a major tool in exposing deception. Since deception is often conducted with the least outlay of combat resources, close analysis of information from different sources which report on the same location, at the same time, or concerning the same enemy unit may reveal significant discrepancies.

**Assess the Enemy's Combat Effectiveness.** Such assessments are based on an analysis of both tangible and intangible factors. Tangible factors include personnel and equipment strength. Intangible factors include morale, training, political reliability, and other factors. While combat effectiveness bears directly on a unit's capabilities and probable courses of action, there is no scientific method of determining it. It requires the analyst's subjective judgment of the impact of both the tangible and intangible factors.

#### WARGAMING FRIENDLY AND ENEMY CAPABILITIES

Consider the enemy G2's perception of the friendly force. Though enemy capabilities exist independently of their assessment of friendly forces, the enemy's choice of alternative courses of action does not. Determine the enemy's perception of friendly capabilities through analysis of the collection capabilities, known collection activities, and inadvertent disclosures by friendly forces which might have been monitored by enemy intelligence. Detailed analysis of potential disclosure enables the analyst to partially reconstruct the enemy G2's working SITMAP.

Mentally wargame advantages and disadvantages of identified enemy capabilities from the enemy commander's point of view. This is a valuable analytical technique, but potentially dangerous if it becomes mirror-imaging.

Avoid preconceptions. The analyst must remember that the objective is not to prove a prior judgment. Experience suggests that preconceptions are the analyst's principal nemesis. Even if the techniques reconferred

above are creatively employed, there is a danger that the analyst who has reached and expressed a preliminary judgment unconsciously begins to seek and weigh evidence which confirms the initial estimate and dismisses or passes over inconsistent or conflicting information. The analyst should not be concerned about the answer, as long as it is the right answer. The analyst reserves judgment, maintains objectivity, remains aware of uncertainties, tolerates dissent, and constantly tests working theory against available evidence. Where practical, the analyst considers establishing a "devil's advocate" system to test, challenge, and think the unthinkable.

## CHAPTER 7

### TARGET DEVELOPMENT

Targeting is the process of selecting targets and matching the appropriate response to them taking into account operational requirements and capabilities. An efficient, organized targeting effort is critical to the success of AirLand Battle operations. A target is a geographical area, complex, or installation planned for capture or destruction by military forces. Attacking HPTs that are least affordable to lose, strips the enemy of the initiative and forces the enemy to conform to friendly battle plans.

Targeting has always been a complex effort. Large numbers of sensors under the control of different agencies are closely coordinated to be efficient and must rapidly report fleeting or dangerous targets. The wide variety of attack means and munitions are compared to the particular vulnerabilities of many different types of targets. Targeting is a multidisciplinary effort, requiring interaction between FS, intelligence, EW, operations, and plans cells.

The object of targeting is to disrupt, delay, or limit those enemy capabilities which could interfere with the achievement of friendly objectives. Do not confuse disrupt, delay, and limit with suppress, neutralize, and destroy. The latter relate to the amount of damage inflicted upon a target. Disrupt, delay, and limit apply to the effect that the damage has upon the target as it pursues a course of action. A further clarification of disrupt, delay, and limit is available in Annex A to FM 6-20-10. The staff recommends how a target is engaged.

Targeting is based on the friendly scheme of maneuver and tactical plans. It includes an assessment of the weather, terrain, and enemy to identify those enemy formations, equipment, facilities, and terrain which are attacked or controlled to ensure success. Targeting is an integral part of the planning process which begins with the receipt of a mission and continues through the development of the approved plan. The targeting process includes the development of a prioritized list specifying what targets are to be attacked, and what is required to defeat the target. Figure 7-1 shows the staff functions during the targeting process.

This process supports the commander's decision on which broad attack option to use to engage the targets: maneuver, EW, FS, or a combination thereof; and the determination of the echelons that engage the target. An assessment of the attack is then conducted to determine the effectiveness of the targeting process. Although the targeting process is more commonly associated with high and medium intensity conflicts, it also applies to LIC. While spread sheets and target sheets currently do not exist for LIC, the concept of key personnel meeting together to determine the most important targets to strike in support of the friendly maneuver commander HVTS and to detect and attack those targets still applies. The targeting methodology is characterized by three functions: decide, detect, and deliver. These three functions are inherently intertwined. Figure 7-2 shows the three functions of the targeting process.

**Receive guidance on:**

Commander's intent.  
HPT.  
Attack criteria.  
Lead time between decision points and TAIs.

**Develop:**

Future MCOO.  
Situation and event templates.

**Explain** enemy courses of action as part of wargaming. Based on friendly courses of action, refine event template. Assist in development of HPT matrix and target selection standards.

Based on commander's approval or changes of CoA, HPT, attack guidance:

**Publish** collection plans and SORs.  
**Brief** ASPS, CM&D, TCAE, as appropriate on CoA, HPT, TSS, attack guidance.  
**Ensure** all analysts and collectors understand commander's intent.

**Collect** information.

**Pass** HPT related information and intelligence immediately to FS.

**Pass** other intelligence and target damage assessments per SOP.

**Ensure** information collection and intelligence production supports any FRAGOs.

Figure 7-1. The targeting process checklist.

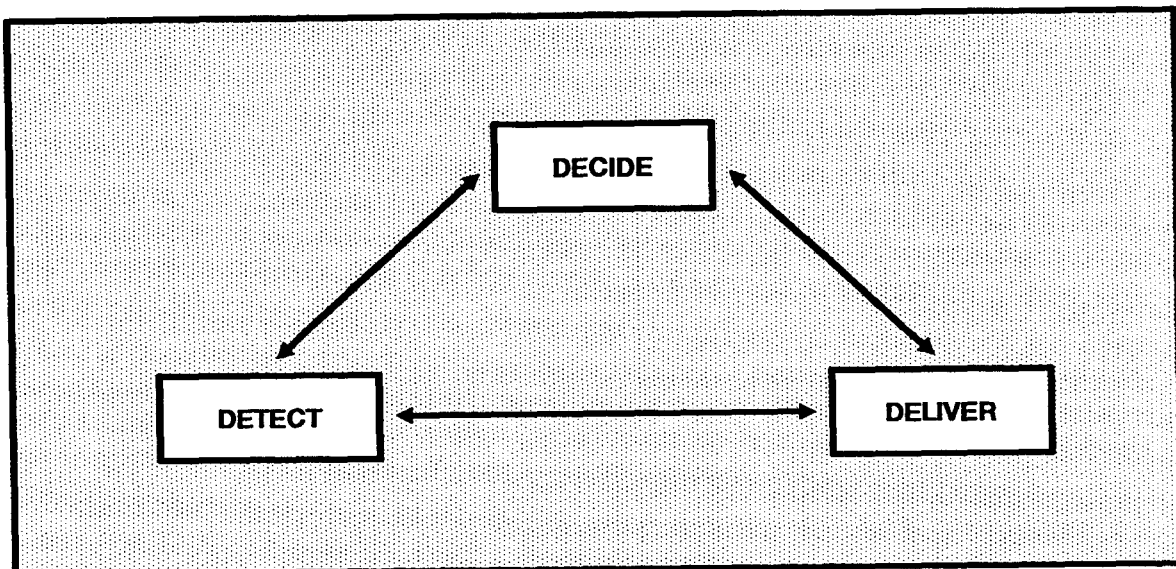

Figure 7-2. Targeting process.

The DECIDE function is the planning associated with a successful targeting effort. It requires close interaction between the commander, intelligence and operating staffs, FS personnel, and various other CS agencies. The staffs must have a clear understanding of the unit's mission, the commander's concept of the operation and intent, and the commander's initial planning guidance with respect to target priorities. With this information, the staff officers prepare their respective estimates. From the standpoint of targeting, the FS, intelligence, and maneuver estimates are interrelated and require close coordination between the respective elements. The DECIDE function provides a clear picture of the targeting priorities applicable to the tasking of TA assets, information processing, the selection of an attack means, and the requirement for post attack assessment. Specifically, the DECIDE function is designed to answer the questions:

- What is it we need to look for?
- Where and when can it be found?
- Who can locate and identify it?
- Which attack option should be used?
- Will target damage assessment (TDA) be required or possible?

In the DETECT function, the priorities developed in the DECIDE function are translated into the TA taskings found in the subordinate unit's portion of the OPORD and in intelligence and FS annexes. All TA assets available to the commander are fully utilized. As the TA assets gather information, they report their findings back to their controlling headquarters which in turn pass pertinent information to the tasking

agency. The information gathered is processed to produce valid targets. Not all the information reported benefits the targeting effort, but it may be valuable to the development of the overall situation. The target priorities developed in the DECIDE function help to expedite the processing of targets. As these targets are developed, appropriate attack systems are tasked in accordance with the commander's guidance and requirements of the attack system managers.

The DELIVER function is the execution portion of the targeting process. It consists of the selection of the appropriate attack means for a given target, the tasking of that attack system, and the execution of the attack by the specified means. If TDA reveals that the commander's guidance has not been met, then the entire targeting process continues focusing on this target.

The targeting effort is continuous. The intelligence, operations, and FS officers comprise the core of the effort at all echelons. Other staff officers that are involved with planning and controlling of firepower and TA also participate. The other staff officers that assist in the process include representatives of the Air Force (AF), the staff weather officer (SWO), the aviation officer, the chemical officer, the Army airspace control officer, the EW staff officers, and the engineer.

The rest of this chapter describes, in detail, the functions required to plan and engage targets successfully using the DECIDE-DETECT-DELIVER methodology.

### DECIDE

Decisions are critical to the targeting process. They create the guidelines for the acquisition and engagement of targets. Establishing these guidelines at the beginning of the DECIDE function allows for a unity of effort and efficiency that would otherwise not be achieved.

The decisions that are made are reflected in visual products. The decisions made are what targets should be acquired and attacked, where and when will the targets likely be found and who can locate them, how the targets should be attacked, and is TDA required. The products are the HPT matrix (what targets should be acquired and attacked), target selection standards (TSS) (what assets can produce targets), the collection plan (where and when should targets be found and who can find them), and the attack guidance matrix (how targets should be attacked). The collection plan is a G2 or S2 product that is important to the targeting process but is not discussed in detail in this chapter. See FM 34-2 for discussion of collection plans.

The commander and staff plan for future operations by projecting one or more alternative courses of action based upon a mission analysis, the current and projected battle situation, and anticipated opportunities. IPB is an important process that assists the commander and staff in developing courses of action.

The process begins with the receipt of a mission, which higher headquarters assigns or the commander deduces. The mission statement directs the focus toward a course of action, in a particular area, against a specific enemy. The commander then, either with or without input from the staff, performs mission analysis. This analysis considers tasks that are performed, the purpose behind the tasks, and the constraints on the unit, resulting in a restated mission.

The restated mission provides the basis from which to start the staff estimate process. The intelligence estimate provides key support to target development. Target development is one of the four IEW tasks: situation development, target development, EW, and CI.

#### **IPB AND TARGET DEVELOPMENT**

IPB provides most of the information for the intelligence estimate which impacts on the target development process. IPB is a continuous, systematic approach to analyzing the enemy, weather, and terrain in a specific geographical area. This approach evaluates enemy capabilities and predicts enemy courses of action with respect to specific battlefield conditions.

It is important for the analyst to understand the effects of battlefield conditions, especially obscurants, on targeting. Such conditions drive the need for remote sensors and redundant systems to ensure proper coverage. The analyst must "see" the battlefield as it is, and not just as it appears on a map.

The initial IPB effort produces doctrinal templates which convert enemy OB into graphics and aids in the initial identification of potential HVTS. HVTS are those assets that the enemy commander feels are critical to the successful accomplishment of the mission.

Situation templates assist the refinement of HVTS for specific battlefield and courses of action. Concurrent with situation template development is an examination of enemy decision and logic trees associated with each potential course of action. This identifies likely "fail paths" that provide indications of what might happen if the enemy commander's plan fails and what actions comprise the enemy commander's failure options. The "fail path" evaluation leads to an identification of critical enemy functions associated with each enemy course of action and general HVTS associated with each function. Through BAE, terrain evaluation, and weather analysis, the enemy course of action is associated with a specific battlefield. Situation, event, and decision support templates are developed to identify critical enemy activities and any NAIs where specific enemy activities or events or lack thereof will help to confirm or deny the enemy's adoption of a particular course of action. Additionally, DPs or decision phase lines, TAIs, and HPTs are identified. HPTs are those HVTS that are acquired and successfully attacked to ensure the success of the friendly commander's mission.



## TARGET VALUE ANALYSIS

IPB analysis considers terrain, weather, enemy doctrine, and current enemy actions to arrive at conclusions of what the enemy will do; the courses of action. Target value analysis (TVA) is a methodology which identifies potential HVT sets within a given tactical situation. If successfully countered, they provide a tactical opportunity. This methodology provides a relative ranking of worth of target sets. TVA begins when the analyst adopts the place of the enemy commander. The analyst, in coordination with the G3 or S3, FSO, and other staff members, wargames the operation. The purpose of wargaming is to finalize individual staff estimates and to develop a friendly and enemy DST. A by-product of this is the determination of the enemy assets that are critical to the success of the enemy mission--HVTS. Target spread sheets and target sheets are tools used in identifying HVTS. The information found on these documents is produced during the IPB and wargaming process. More information on the development and use of these targeting tools is available in Annex A of FM 6-20-10.

### HVTS and HPTs

An HVT is a target whose loss to the enemy can be expected to contribute to substantial degradation of an important battlefield function. HPTs are HVTs which, if successfully attacked, contribute substantially to the success of friendly plans. The G2 or S2 section, together with the FSO and other staff, nominate HVTS to be HPTs. The key to HPTs is that they are based on the friendly concept of the operation and support the friendly force commander's scheme of maneuver. The development of HPTs from HVTS is done during the wargaming process. As the different options are fought by the staff, the G2 or S2 identifies specific HVTS. The staff discusses or wargames different courses of action to develop the HPTs. The HPTs for a specific phase of a battle are recorded on the DST as are the means decided on to deliver the attack. HVTS include enemy C<sup>2</sup> points, air defense artillery (ADA) assets, and engineering equipment. If friendly forces were planning an air attack the enemy C<sup>2</sup> and ADA might be HPTs, while engineers probably would not. Discussion on templating and IPB is available in Chapter 4 and FM 34-130.

The process of designating an HVT as an HPT requires careful staff coordination. The G2 and collection manager evaluate HVTs at different points in the battle to determine if collection assets are capable of detecting them and providing the necessary target resolution, for example, time, location, and so forth, to permit effective action (DELIVER). HPTs, because of their importance, receive priority in the allocation of detection systems. This priority is weighed against the same systems for situation development.

The FSO uses target sheets and the knowledge of friendly weapons systems to determine if there exists a capability to attack the HVT with lethal assets. The EW officer and others assist the FSO with regard to non-lethal systems. Availability of a weapon system should not affect the attack since HPTs have precedence over other targets. Using the capabilities of the systems to attack the targets, the G2 or S2 analyzes

and predicts the enemy's response to each. This analysis determines if the attack of the HVT is necessary to ensure the success of friendly operations. The commander uses it in developing attack guidance. The HVTs that meet the criteria of being acquirable, attachable, and capable of ensuring friendly success are designated HPTs. In most instances, the analyst chooses to target enemy elements that have been designated "critical nodes." A critical node is an element, position, or communications entity whose disruption or destruction immediately degrades the ability of a force to command, control, or effectively conduct combat operations. HPTs are formatted for easy reference in an HPT matrix. The G3 or FSO prepares this matrix and gives it to the commander for approval. The selection of HPTs, which also are critical nodes, are facilitated by a number of already existing enemy studies. Selection of these critical nodes, coupled with other TVA efforts, allows friendly forces to best determine those enemy elements which are HVTS or HPTs.

#### TARGET SELECTION STANDARDS

TSS are criteria by which personnel determine which systems produce valid targets, and which require some form of confirmation before their targets are considered for attack. The development of TSS is a joint function of the G2 and G3 sections and requires that the capabilities and limitations of collection assets be known. The CM section of the G2 provides the majority of these capabilities and limitations.

TSS do not determine that the information that the sensor receives is, in fact, a target. The analyst determines that. TSS reflect the system's capabilities to produce targets. TSS are dynamic. The effects of weather and terrain on both the Collection assets and enemy equipment are taken into account. TSS are keyed to the tactical situation. Great care is taken to deal with potential enemy deception, and to ensure the reliability of the source or agency that is reporting. TSS are designed to allow targeting personnel in the TOC to readily distinguish between targets and suspect reports. TSS are developed for all TA systems available.

Target location errors (TLEs) are the accuracies to which the assets can locate various targets. The source's TLE and the timeliness of information are considered. It is an inherent responsibility for the FSE to decide which systems have acceptable TLEs for targeting purposes in a specific tactical situation.

#### ATTACK OPTIONS

Knowing target vulnerabilities and the effect an attack on them has on an enemy operation allows a staff to propose the most efficient available attack option. A primary decision here is whether to disrupt, delay, or limit the enemy.

The opportunity to disrupt, delay, or limit is annotated next to the target sets on the target spread sheet. It is emphasized that these are guidelines and each target is attacked based on its own merits.

Once the staff decides whether a target is best disrupted, delayed, or limited, they select attack options. Utilizing the situation template and MCOO, the risk to an asset versus its effectiveness is assessed. The decision on what attack option to use is made at the same time as the decision when to acquire and attack the target. Coordination is required when an attack with two different means, for example, EW and CAS, is decided upon. These decisions are recorded on the DST and are made during the wargaming process. This requires that the proper coordination be performed in a timely manner.

#### ATTACK GUIDANCE

The commander approves the attack guidance, as recommended by the staff. This guidance details the specific HPTs to attack, when and how they should be attacked, and any attack restrictions. The staff developed and defined all this information during wargaming. Figure 7-3, the attack guidance matrix, shows a format that this information is put in. The matrix consists of a column for target categories, specific HPTs, how targets should be attacked, when they should be attacked, any restrictions. For a detailed explanation on using the attack guidance matrix, refer to FM 6-20-10.

#### DETECT

DETECT is the next critical function in the targeting process. This function is perhaps the most important area for future planning. The G2 or S2 is the principal figure in directing the CM effort to detect the targets identified in the DECIDE phase. The G2 or S2 works closely with the FAIOs and FSOS to determine requirements for accuracy, identification, and timeliness for collection systems. The intelligence section is responsible for ensuring that the collection system asset managers understand these requirements.

#### TARGET DETECTION MEANS

The detection of targets is accomplished using all available assets. Key to the detect function is a focus on the HPTs designated during the DECIDE phase of the targeting process. This is accomplished by the CM section of the G2. Every targeting asset is aware of what the commander designates as HPTs.

#### Field Artillery Target Acquisition Means

Several detection assets are presently organic to the FA at both corps and division.

Field Artillery Battalions. FA battalions in DS of maneuver brigades provide each maneuver battalion headquarters with a FSE to help plan, direct, and coordinate FS operations. The FSE provides fire support teams (FIST) to each of the maneuver battalion companies. Forward observers (FOs) from each FIST are deployed at both company and platoon levels and may accompany reconnaissance patrols or help to man observation posts

CAT	HPT	WHEN	HOW	RESTRICTIONS
(C3) 1	46, 48	I	N EW	COORD ATK WITH EW DNE MRL OLDER THAN 10 MIN. SEAD PROGRAM 120800A COUNTERMOBILITY PROGRAM %  ACCY 0-200 M PER TDA REQ  NOT HIGH VALUE OR PAYOFF NOT HIGH VALUE OR PAYOFF NOT HIGH VALUE OR PAYOFF
(FS) 2	1, 2, 7	A	N	
(ADA) 3	58	P	SIG 2	
(ENGR) 4		P	N	
(RSTA) 5	85	P	EW	
(REC) 6	103, 105	P	N	
(POL) 7		A	D	
(AMMO) 8		A	D	
(MAINT) 9		P	25%	
(LIFT) 10		P	N	
(LOC) 11		P	N G3	
<b>CAT = Target Category (from TVA)</b> <b>HPT = Designated high payoff target; these targets have priority for engagement. Target numbers from TVA target sheets</b> <b>How = How target is attacked</b> —S: Suppress —N: Neutralize —D: Destroy —EW: Jamming or other offensive EW means —X%: Specified percentage of casualties or damage —G2: Coordinate attack with G2 (any other person or element could be indicated) <b>When = When the target should be attacked</b> —I: Immediately. Interrupt other nonimmediate attacks if necessary —A: As acquired. Attack as assets are available —P: Plan. Include target in a program of fires or file for later attack when the situation changes <b>Restrictions = Any constraint on the attack of targets. Such constraints could be accuracy, time since acquisition, required coordination, or munition restrictions by amount or type. Other notes such as "TDA requires" or "Missile target only" could be included.</b>  <b>DNE: Do not engage</b> — Other abbreviations could be used as required by unit mission or SOP.				

Figure 7-3. Sample attack guidance matrix.

(OPs). They are the grass roots of the FA's TA effort. They observe the battlefield to detect, identify, locate, and laser designate targets for suppression, neutralization, or destruction. They report both targeting data and combat information to the maneuver battalion FSO and S2 using either organic or supporting communications means. The capability of the F1ST to provide real time combat information cannot be emphasized enough. The battalion FSO receives information from and passes information to the F1ST. The FSO continually exchanges targeting data and combat information with the brigade FSO and elements from the DS FA battalion. The FSO coordinates with the battalion S2 and S3 to identify and verify targeting data and combat information derived from the overall collection effort. The FSO is both a producer and a consumer of combat information.

**Radar Assets.** FA TA assets are the principle means for locating active indirect fire weapons.

Moving target-locating radar (MTLR) detects, locates, and identifies wheeled vehicles (light or heavy), tracked vehicles, and dismounted personnel. MTLR is used for surveillance of critical areas such as AAs. Mortar locating radar detects and locates enemy mortars and artillery quickly and accurately enough for immediate engagement.

The DS FA battalion S2 has staff supervision responsibility for the radar. This officer coordinates with the division artillery (DIVARTY) targeting officer, the DS FA battalion S3, and the FSO at the maneuver brigade to ensure that both FS and maneuver coverage requirements are met. Cueing instructions are required. MI sources provide specific guidance to orient radar assets before the enemy fires.

**Combat Observation Laser Teams (COLTS).** COLTS organic to each heavy and light division provide a TA capability previously not available on the battlefield. They are equipped to direct the engagement of targets.

**Aerial Fire Support Officers.** Aerial FSOS and TA aircraft are organic to the division and the corps. These assets are highly mobile and cover a much larger area than ground observers. As such, they are particularly good target detection assets. Targeting data and combat information are reported to the FSO at the maneuver brigade or battalion, the DIVARTY TOC, or the fire direction center of the DS artillery battalion.

#### Air Defense Artillery TA Assets

The forward area alerting radar (FAAR) of the AD units provides a deep look capability that can detect the location and movement of enemy air assets. The integration of corps and theater AD efforts enable friendly forces to obtain an air picture that can potentially cover the entire area of interest for the echelon in question. Future concepts allow input directly from theater AD assets into division air situation updates. Collation of this AD information with other combat information enables us to locate major enemy air assets, airfields, and refueling and rearming points. Many of these become HPTs in support of the friendly scheme of maneuver.

#### DETECTION PROCEDURES

The collection of combat information is integral to the entire DETECT process. It is essential that all TA assets be used in the most effective and efficient manner possible. Avoid duplication of effort among the various assets unless such duplication is desired to confirm the location or nature of a target. At corps and division, the CM&D section develops and actively manages the collection plan to avoid such duplication. At the same time, the CM&D section ensures that no gaps in planning collection exist. This allows timely combat information to be collected to answer the commander's intelligence and TA requirements. This combat information enables analysts to develop the enemy situation as well as conduct target development.

To detect the desired HPTs in a timely, accurate manner, clear and concise taskings are given to those TA systems capable of detecting a given target. The FS personnel provide the G2 or S2 with the degree of accuracy that the targets must be located with to be eligible for attack. The G2 or S2 matches accuracy requirements to the TLEs of the collection systems. This matching allows the G2 or S2 to develop a more detailed set of TSS based not only on the acquisition system but also upon the HPTs' acceptable TLEs that the G2 or S2 gives. These acceptable TLEs cannot be placed in an SOP as they depend on the situation. Collection efforts focus on those NAI and TAI that the IPB process identifies during the DECIDE phase. Knowledge of the target type and its associated signatures (electronic, visual, thermal) enable friendly forces to direct the most capable collection asset to be tasked for collection against a given target. The asset is positioned in the most advantageous location based on friendly estimates of when and where the enemy target is located.

The decision to limit, disrupt, or delay a given HPT results in a requirement to detect that target. Information needs, to support the detection of the target, are expressed as PIR and IR. Their relative priority is dependent on the importance of the target to the friendly scheme of maneuver coupled with the commander's intent. The PIR and IR that support detection of a target are incorporated into the unit's overall collection plan. The collection manager translates the PIR and IR into SIRS. The collection manager considers the availability and capabilities of all collection assets within their echelon as well as those assets available to subordinate, higher, and adjacent units (to include joint or combined force assets).

As various assets collect the combat information to support target development, this information is forwarded through the IEW system to the intelligence analyst at the G2 or S2 staff. The analyst uses this combat information to perform both situation and target development. When the analyst detects a target, the target is passed immediately to the FS element to determine if the target is an HPT, its priority, and if it meets the TSS. Close coordination among the intelligence staff and the FSCoord is essential to ensure that these targets are passed to an attack system which engages the target. To ensure that this occurs in a timely manner the FAIO must have access to the ASPS. One technique is for the FAIO to be physically located in the ASPS or CM&D. Procedures are established for cueing the FAIO as the predesignated HPTs are identified. ASPS personnel are aware of HPT. When an HPT is discovered it is passed without delay to FSE personnel. Usually, a member of the ASPS hand-carries the intelligence. This allows for consultation at a map and for intelligence to be placed into context with the overall situation. The FAIOs coordinate with their respective G2s and FSES to pass the targets directly to the fire control element at the DIVARTY TOC or, if the commander approves, directly to a firing unit. This results in the most efficient and timely engagement of those targets which the FS has designated in advance for engagement.

The passing of targets and suspect targets to the staff is accomplished by a number of means. It is important that essential information that is passed for proper analysis and attack takes place. As a minimum, the target report includes:

- ° Date-time group (DTG) of acquisition by the sensor.
- ° Description of the target.
- ° Size of the target.
- ° Target location.
- ° TLE.

The specific forms and formats for passing target information are specified in the unit SOP.

The DTG is important as the target's perishability or vulnerability window is analyzed. This impacts on the urgency of the attack or the denial of attack based upon the likelihood of the target having moved.

The target description and target size are required to determine attack means, intensity of attack, number of assets to be committed, plus other technical considerations. They are used to compare with the attack guidance matrix. The target's location is given as accurately as possible within the confines of timeliness.

#### DELIVER

The DELIVER portion of the targeting process executes the target attack guidance and supports the commander's battle plan once the HPTs have been located and identified. This portion of the process has two key elements--the attack of targets and the TDA of those targets.

#### ATTACK OF THE TARGETS

The attack of the targets satisfies the attack guidance that was developed in the DECIDE portion of the targeting process. The attack of targets requires a number of decisions and actions. The decisions are described as a set of tactical and technical decisions. Determining the time for the attack, the attack system, and the required effects on the target are the tactical decisions to make. Based upon these tactical decisions, the technical decisions describe the precise attack means, the unit to conduct the attack, the time of the attack, and in the case of FS assets, the number and type of munition. The actions in the attack of the targets are the actual physical attack of the targets by lethal or non-lethal means. The time of attack of the target is planned or by opportunity.

#### Planned Targets

Planned targets are evaluated initially to determine if the DF has been reached or a trigger event has occurred. If either of these has

occurred and the resources that were identified to be used against the target are available, the target is attacked. If the decision is to attack now, a check is made to determine if the attack system, that was earlier allocated for the attack of that target, is available. If so, the attack is conducted with that system. If the allocated attack system is not available, a decision is made on which other attack asset to use. If the decision is made to defer the attack, the staff identifies the new DP to the intelligence or acquisition system.

#### **Targets of Opportunity**

Targets of opportunity are evaluated initially as to when they should be attacked. This decision is based on a number of factors such as the activity of the target, how long the target can be expected to stay in its current location (target perishability) and the target's payoff, relative to the payoff of the other targets currently being processed for engagement. If the decision is made to attack now, the target is processed further. If required, additional information is requested from the intelligence or acquisition systems. If the decision is made to defer the attack, then a DP is determined and described to intelligence or acquisitions systems. Additionally, an assessment of the availability and capabilities of attack systems to engage the target is made. If the target exceeds either availability or capability of the unit's attack systems, then the target should be nominated to a higher headquarters for attack.

#### **DESIRED EFFECTS**

The desired effects on the target are determined. As mentioned earlier, we either delay, disrupt, or limit the target, based either on time or terrain. This determination was made earlier in the case of planned targets. For targets of opportunity, the staff makes the determination. This decision is made based on the payoff of the target and the constraints on availability of attack systems and munitions. The determination of the desired effects is required before selecting an attack system.

#### **TARGET DAMAGE ASSESSMENT**

Assessment of the effects of an attack always is desirable and is required for certain important targets. The same assets that acquire targets often provide data on the effectiveness of the attack. The decision on which targets require assessment is made in the DECIDE function of the targeting process. Assessment may take many forms besides the determination of the number of casualties or equipment destroyed. Other information of use includes whether the targets are moving or hardening in response to the attack, changes in deception efforts and techniques, increased communications efforts as the result of jamming, and whether the damage achieved is having the expected effect on the enemy's combat effectiveness.

Assessments also are made passively through the compilation of information regarding a particular target or area. An example is the



cessation of fires from an area. If an assessment is to be made of an attack, the key personnel ensure that the intelligence or acquisition systems must receive adequate warning so the necessary sensors are directed at the target at the appropriate time. The assessment results cause battle plans and earlier decisions to be changed. If necessary, the decisions made during the DECIDE portion of the process are reexamined. IPB products, the HPT matrix, the TSS, the attack guidance matrix, and the entire battle plan are updated. Assessment allows friendly forces to tune our efforts to achieve the greatest result with the least amount of expenditure or risk.

## CHAPTER 8

### INTELLIGENCE SUPPORT OF ELECTRONIC WARFARE OPERATIONS

EW is an IEW function that plays a critical role in the AirLand Battle. Intelligence support is essential to maximize the effectiveness of EW operations. This chapter describes how intelligence supports EW operations.

There is a special relationship between EW operations and intelligence. EW, situation development, target development, and CI are the four major tasks of the IEW mission. ESM, one of the three EW functions, supports both situation and target development. EW operations are not unique, however, because they require intelligence to be successful and also result in the acquisition of additional intelligence. Both maneuver and FS operations share this characteristic. EW is most effective when integrated and employed with FS and maneuver. Planning this integrated employment requires information that permits a comparison of the courses of action open to the commander. Sources of intelligence that provide support to EW operations and describe the intelligence used for specific EW functions are outlined below.

EW requires careful staff coordination to be effective. This includes coordination within the staff as well as coordination with the MI unit executing the plan. The interactions involved are very similar to those seen in target development. The G3, in coordination with the G2 and the MI unit, is responsible for the integration of ECM into the fire and maneuver scheme. The synchronized use of ECM and lethal attack requires the electronic warfare section of the G3 to coordinate closely and constantly with the FSE. To do this, the EWS and the FSO will often be collocated. ESM are also carefully coordinated between the G2 and the MI battalion. The G2 ensures the ESM efforts are matched to the commander's PIR and targeting requirements. As these requirements change, the G2 coordinates with the MI unit to update collection efforts.

#### INTELLIGENCE COLLECTION TO SUPPORT ELECTRONIC WARFARE

The collection of intelligence to support EW is a multidiscipline effort. HUMINT, IMINT, and SIGINT all contribute to the support of EW operations. HUMINT provides invaluable information, such as captured enemy communications-electronics (C-E) operation instructions or an agent's photograph of an enemy code book contents.

IMINT provides location information important to jamming or intercept attempts and accurate data on the probable frequency ranges of enemy emitters. The size and shape of emitter antennas obtained from imagery provide indications concerning frequency data and other technical characteristics. A picture of an enemy CP or operational weapons site provides information about which types of emitter signals, both communications and noncommunications emissions, are associated with each other and with specific enemy deployments or weapon systems employment.

This information permits complex node analysis and parametric analysis of intercepted signals. This type analysis contributes to SIGINT support of EW.

Since SIGINT deals directly with information obtained from intercepted enemy signals, it provides the greatest volume of intelligence support to EW operations. SIGINT include the same functions as ESM. The <sup>Primary</sup> difference between ESM and SIGINT is how the information is used', Generally, ESM produces combat information that can be used for target development (jamming and FS), maneuver, or threat avoidance with little systematic analysis or processing. SIGINT requires more extensive processing to produce intelligence. ESM and SIGINT are mutually supporting. Information collected through ESM is processed to produce SIGINT, which is essential to support EW. See FM 34-40, Electronic Warfare Operations, for a complete discussion on conducting EW operations.

#### THE EFFECTS OF TERRAIN AND WEATHER ON ELECTRONIC WARFARE

Signal propagation is affected significantly by terrain and atmospheric conditions. An analysis of these effects is included in any successful EW planning. The IPB techniques described in Chapter 4 of this manual and further discussed in FM 34-130, Annex F, provide a useful tool for evaluating and graphically displaying the effects of the terrain on EW operations. The analyst creates templates to depict possible enemy deployment of electronic systems for C<sup>3</sup>, reconnaissance, TA, and REC. The analyst then compares the effects of the terrain on the employment of these assets based on a knowledge of signal propagation principles. Templates depicting locations of friendly ECM and ESM assets and knowledge of their capabilities also are used to help select friendly EW assets for employment against specific targets and indicate potential future deployment sites.

#### INTELLIGENCE REQUIRED FOR ELECTRONIC WARFARE SUPPORT MEASURES

The requirement to intercept, identify, and locate the sources of Threat electromagnetic emissions demands an extensive Threat electronic OB data base. Intercept operations require detailed intelligence on enemy frequency allocation and signal operating procedures. Identification is assisted by a knowledge of operating procedures; language recognition, to include special ized jargon, dialects, and code words; technical parameters of signals associated with specific functions or echelons; and the collocation of several types of emitters in a recognizable pattern which can be associated with a type of function or deployment. DF provides location data for ESM. As information is collected through ESM and used to support ECM, it also is compared with and integrated into data base information to be used for future ESM collection.

#### INTELLIGENCE REQUIRED FOR ELECTRONIC COUNTERMEASURES

Jamrning and electronic deception operations depend on current ESM data and all the intelligence required for successful ESM operations. Target receivers are jammed if LOS considerations permit it and the known frequency on which it is operating is capable of being jammed by friendly

ECM assets. However, indiscriminate jamming of target receivers is not the most efficient use of ECM assets. The most effective jamming requires information on the enemy's C<sup>3</sup> system so that the effects of disrupting a particular communications link is anticipated. This expected effect then is integrated into the commander's scheme of fire and maneuver.

Electronic deception operations depend heavily on intelligence. Both manipulative and simulative electronic deception require intelligence on the Threat SIGINT and ESM capabilities and a knowledge of friendly emission patterns and profiles. It would serve no purpose to simulate a friendly C<sup>2</sup>net or radar surveillance system if the opposing force cannot intercept or recognize these transmissions. Even the most simple imitative communications deception attempt, one designed to fool the operator of a clear voice net for only a few minutes, requires some knowledge of the target station's identity and the purpose of the net. A more sophisticated effort, one designed to confuse an enemy decision maker, requires not only detailed knowledge of the enemy communications system but also intelligence concerning the enemy decision-making process. If the deception effort involves intrusion into or imitation of an encrypted signal, the intelligence support may require an extensive multidiscipline effort. See FM 90-2A (C), Electronic Deception, for detailed discussion on electronic deception operations.

#### INTELLIGENCE REQUIRED ELECTRONIC COUNTER-COUNTERMEASURES

ECCM is divided into those measures designed to counter both ESM and ECM. The anti-ESM effort requires much of the same intelligence support required by manipulative and simulative electronic deception. The primary intelligence required concerns the enemy SIGINT and ESM capability evaluated in terms of the assessed vulnerabilities of friendly systems to such efforts. The counter-SIGINT effort requires technical information on the capabilities of enemy jammers and any intelligence on the capability of opposing forces to accomplish electronic deception. FM 34-60 provides detailed doctrine on counter-SIGINT operations. Threat doctrine on deception and information on the availability of the equipment necessary for Threat forces to implement deception activities is important. Multidiscipline intelligence efforts to obtain information on enemy ECM equipment before it is deployed is necessary if effective counter-countermeasures are to be established.

## CHAPTER 13

### COUNTERINTELLIGENCE ANALYSIS

Because the hostile intelligence collection threat arraved against US Forces and agencies is multidiscipline, Countering tnat threat also must be multidiscipline. Such an approach recognizes the need for a single program which counters all Foreign Intelligence Services collection as well as an analysis capability to bring it all together. The multidiscipline counter intelligence (MDCI) analytical effort is dependent upon information provided by the all-source intelligence system. It is found at various echelons of command. Specifically--

- °The CI analysis section (CIAS) at division and corps,
- °The CI analysts within EACIC at theater Army commands.
- °The intelligence and threat analysis center (ITAC) at DA.

MDCI analysis is by no means exclusive to Army agencies, but is a crucial activity of DOD. MDCI analysis operates through the DIA, and other federal agencies such as the CIA and the FBI. Highly trained, experienced, and skilled specialists perform MDCI analysis using the latest technology and modern methods of directing, processing, and disseminating.

The CI analyst uses the tools and skills identified in this chapter and Chapter 4, and as described in detail in FM 34-60. The intelligence analyst focuses on "how we see the enemy"; the CI analyst focuses on this and "how the enemy sees us." The CI analyst must also focus on how to counter the enemy's collection efforts. Where the intelligence analyst is a subject matter expert on the enemy, the CI analyst, in addition to having an in-depth understanding and expertise on foreign intelligence collection capabilities, must have a good working knowledge of the friendly force.

The CIAS must be collocated to integrate information fully with the ASPS. It must have access to all-source data that can be screened for CI use.

The CIAS is under the staff supervision of the Assistant Chief of Staff G2 and is found in the table of organization and equipment (TOE) of the EACIC at theater level; the corps tactical operations center support element (CTOCSE) at corps level; and the division tactical operations center support element (DTOCSE) at division level . An all-source mix of special ists is assigned to the CIAS to integrate their various skills and produce the MDCI analytical products required by the commander at each echelon. CIAS products are critical to the function of the G3 OPSEC and deception cells,

The CIAS mission is a diverse and all-encompassing MDCI analytical effort. The CIAS:

- ° Analyzes the multidiscipline intelligence collection threat targeted against friendly forces.
- ° Assesses enemy intelligence collection threat vulnerabilities and susceptibility to friendly deception efforts.
- ° Supports friendly vulnerability assessment.
- ° Along with the G3 OPSEC staff element, develops, evaluates, and recommends countermeasures to the commander. These countermeasures reduce, eliminate, or take advantage of friendly force vulnerabilities.
- ° Supports rear operations by identifying collection threats to rear area units and installations, to include low level agents responsible for sabotage and subversion.
- ° Nominates targets for exploitation, neutralization, or destruction.
- ° Develops and maintains a comprehensive and current MDCI data base.
- ° Tasks friendly intelligence collection resources through the CM&D section.

The CIAS focuses on hostile HUMINT, SIGINT, and IMINT collection.

#### COUNTER HUMAN INTELLIGENCE COLLECTION

Working in a concerted MDCI environment, counter human intelligence (C-HUMINT) analysts incorporate their efforts into the overall CIAS MDCI analysis product. C-HUMINT analysis includes:

- ° Analyzing and assessing the espionage, terrorism, subversion, treason, sedition, and sabotage threat.
- ° Analyzing enemy HUMINT collection capabilities and activities, and further analyzing how those collection capabilities can affect the friendly command.
- ° Analyzing level I (enemy controlled agents or partisan collection) and level II (diversionary and sabotage operations conducted by unconventional forces) threats.
- ° Recommending countermeasures and deception.
- ° Nominating targets for exploitation, neutralization, or elimination.

### COUNTER SIGNALS INTELLIGENCE COLLECTION

Working in a concerted MDCI environment, counter signals intelligence (C-SIGINT) analysts incorporate their efforts into the overall CIAS MDCI analysis product. C-SIGINT analysis includes:

- ° Analyzing and assessing enemy SIGINT collection capabilities and activities.
- ° Comparing enemy collection systems capabilities against friendly targets.
- ° Identifying, analyzing, and assessing friendly electronic patterns and signatures.
- ° Analyzing friendly vulnerabilities against enemy SIGINT collection efforts.
- ° Subsequently recommending countermeasures and deception.
- ° Nominating enemy SIGINT targets for exploitation, neutralization, or destruction.

### COUNTER IMAGERY INTELLIGENCE COLLECTION

Working in a concerted MDCI environment, counter imagery intelligence (C-IMINT) analysts incorporate their efforts into the overall CIAS MDCI product. C-IMINT analysis includes:

- ° Analyzing and assessing enemy imagery collection capabilities and activities, to include ground, and space threat systems. Threat systems include anything from hand-held cameras, to satellite platforms or fixed- or rotary-wing aircraft and unmanned aerial vehicles (UAV).
- ° Measuring enemy collection systems against friendly targets.
- ° Identifying, analyzing, and assessing friendly patterns, signatures, and vulnerabilities for subsequent development and recommendation of countermeasures and deception.
- ° Nominating enemy IMINT systems for exploitation, neutralization, or destruction.

### OTHER INTELLIGENCE SUPPORT TO CI ANALYSIS.

MDCI cannot be conducted without the support of all three intelligence disciplines--SIGINT, HUMINT, and IMINT. These disciplines are used to collect critical information on enemy collection, analysis, and dissemination systems. Analysts extract the information from the all-source data base within the CIAS to determine enemy collection capabilities and operations. These systems, coincidentally, collect a great deal of intelligence on friendly forces. This intelligence is vital

in evaluating friendly profiles and thereby determining their vulnerabilities. If the situation warrants, CI analysts can task friendly collection systems to specifically collect intelligence on friendly forces for the CIAS through the CM section.

The CI mission mandates a wide range of functions and tasks that are accomplished in peace and at all intensities of conflict. CI operational activities perform such functions as investigations, operations, and collection. Their products are of great value to the MDCI analyst. To get the CI operational reports, the CIAS closely interfaces with the CM&D section to identify those items of CI interest coming into the CM&D from operational CI personnel. The CIAS must task and receive answers to those taskings through the CM&D section.

#### ANALYTICAL PRODUCTS

Each of the specialties assigned to the CIAS has individual responsibilities and skills which enable the production of single-discipline analysis products. When these products are combined into a comprehensive product, an MDCI product emerges. The CIAS then uses the MDCI product to nominate targets for exploitation, neutralization, destruction, or elimination. The MDCI products also provide OPSEC or deception planners with critical information required for their operations. Various specialists within the CIAS create the products discussed in the following paragraphs.

#### Counter Human Intelligence Products

C-HUMINT analysts maintain the C-HUMINT data base. Using this data base, they produce:

- ° Association matrixes.
- ° Activities matrixes.
- ° Time event charting.
- ° HUMINT communication diagrams.
- ° Link diagrams.
- ° HUMINT situation overlays.
- ° HUMINT-related portions of the threat assessment.
- ° Black, gray, and white lists.

The analytical techniques used in HUMINT analysis enable the analyst to visualize large amounts of data in graphic form. These analytical techniques, however, are only tools used to arrive at a logical and correct solution to a complex problem; the techniques themselves are not the solution.



There are three basic techniques (tools.) used as aids in analyzing HUMINT-related problems. They are time event charting, matrix manipulation, and link diagraming. Used together, these techniques are critical to the process of transforming diverse and incomplete bits of seemingly unrelated data into an understandable overview of an exceedingly complex situation. See FM 34-60 for detailed discussion on these techniques.

#### Counter Signals Intelligence Products

C-SIGINT analysts maintain the C-SIGINT data base. Using this data base, they produce:

- °Threat fixed-base SIGINT matrixes. These are developed from the enemy collector characteristics data base and the threat fixed station data record.
- °Mobile SIGINT matrixes. These are developed from enemy collector characteristics data base and threat OB and location data records.
- °A system quick-reference matrix, providing a quick-reference of capabilities and limitations of those SIGINT systems which will most likely threaten that portion of the friendly command for which the analyst is responsible. This matrix is developed through manipulation of the data base to gain quick access to information concerning those systems which are the most likely threats to the command.
- °SIGINT direction charts, portraying areas or targets of threat SIGINT concentrations. This is accomplished through integrating the EEOB overlay with the friendly electromagnetic overlay to determine areas susceptible to collection.
- °SIGINT situation overlays. These are a continuous graphic update of the EEOB which depicts known or suspected threat SIGINT or REC positions. These overlays are continuously compared with the friendly electromagnetic overlay to identify susceptibility to collection.
- °SIGINT-related portions of the threat assessment.

#### Counter Imagery Intelligence Products

C-IMINT analysts maintain the C-IMINT data base. Using this data base they produce:

- °Threat SATRAN matrixes. (The definition for SATRAN is classified. See FM 34-60A for explanation.) These are designed to identify when and where a system is active and also show the collection characteristics of the system.

- ° Threat intelligence collection flight matrixes. These are similar to the SATRAN matrix, but are concerned “with other platforms used by the threat. Tracking these collection systems continuously allows the analyst to analyze threat IMINT collection patterns.
- ° System component quick-reference matrixes, including threat system’s capabilities and processing times. This file is a part of the data base which equates to an OB file on threat IMINT systems.
- ° IMINT situation overlays. These overlays are the paths from the SATRAN and threat intelligence collection flight matrixes depicted on the friendly operations graphics. This identifies areas susceptible to collection.
- ° IMINT-related portions of the threat assessment.

#### COLLECTIVE CIAS PRODUCTS

The CIAS collectively prepares MDCI analytical products, including:

- ° Rear operations IPB (ROIPB) products.
- ° MDCI graphic summaries (MDCISUM).
- ° MDCI threat assessments.
- ° MDCI situation overlays.
- ° MDCI estimate.

Chapter 3 of FM 34-60 includes a detailed description on how a CIAS functions and details how to prepare single discipline and MDCI products.

The individual products of C-HUMINT, C-SIGINT, and C-IMINT analysts become the analytical tools used to produce the MDCI collective products. A brief description of each collective product follows.

#### Rear Operations Intelligence Preparation of the Battlefield

IPB is an analytical tool used throughout the MI community. When a greater need for intelligence support to rear operations surfaced, the IPB process evolved into a new dimension and ROIPB surfaced. However, ROIPB is not confined to the geographical boundaries of the rear area alone. In addition to analyzing information of the enemy collection threat located above and beyond the FLOT, it looks at the total friendly AO from the FLOT back. It does not duplicate the IPB efforts of the ASPS, but rather complements their efforts. To avoid duplication, the CIAS must closely interface with the ASPS.

Like IPB, ROIPB is key in preparing for the next battle. During peacetime, ROIPB builds an extensive data base for each potential area in which threat intelligence collectors or battalion size or smaller units might operate. It analyzes this intelligence base in detail to determine

the impact of enemy, weather, and terrain on operations and presents it in graphic form. It has the added ingredient of assisting in the assessment of friendly courses of action from the enemy's perspective.

Like IPB, ROIPB graphics can assist the commander in identifying targets as they enter the battle area. ROIPB and IPB threat evaluation and integration use the same analytical technique: templating. ROIPB templates are similar to IPB templates in the MBA. ROIPB templates provide a comparative intelligence data base that enables the CI analyst to graphically portray enemy intelligence collection and small unit capabilities; depict probable courses of action before and during the battle; and confirm or refute predictions. Like IPB templates, ROIPB templates are dynamic and require continual review. For additional details concerning ROIPB see FMs 34-130 and 34-60.

#### **Multidiscipline Counterintelligence Summary**

The MDCISUM is a graphic portrayal of the current enemy situation from a CI point of view. It graphically displays known enemy collection units, as well as level I and II threats within the friendly area. The MDCISUM ordinarily covers events within a 12-hour period. It portrays friendly targets which have been identified as potential enemy objective during the specified time frame. A clear and concise legend appears on each MDCISUM which contains: time period covered by the MDCISUM, map reference information, and symbols clearly identifying friendly and enemy information. Figure 9-1 shows a sample MDCISUM.

The use of colors enhances an MDCISUM: but once reproduced, the disseminated product is black and white. Therefore, use dots, dashes, and slashes to ensure consumer understanding; explain these symbols in the legend. Subsequent MDCISUMs will not repeat information contained on previous MDCISUMs unless that information is critical to the current MDCISUM.

#### **Multidiscipline Counterintelligence Threat Assessment**

The MDCI threat assessment is a four-paragraph statement which is published as often as necessary and when significantly changed, depending on the situation and the needs of the commander. As a general rule, the MDCI threat assessment is disseminated through CM&D with every third or fourth MDCISUM. The MDCI threat assessment provides justification for MDCI target nominations, a primary goal of MDCI analysis. Figure 9-2 shows an example of the format and substance of an MDCI threat assessment.

#### **Multidiscipline Counterintelligence Situation Overlay**

The MDCI situation overlay is a composite of the functional area overlays prepared by the subject matter experts assigned to the CIAS. The MDCI situation overlay incorporates the most important information from each of the other overlays. The functional area overlays serve as "working" overlays, while the MDCI overlay is the master overlay and serves as the briefing overlay. It should be ready for briefings at all

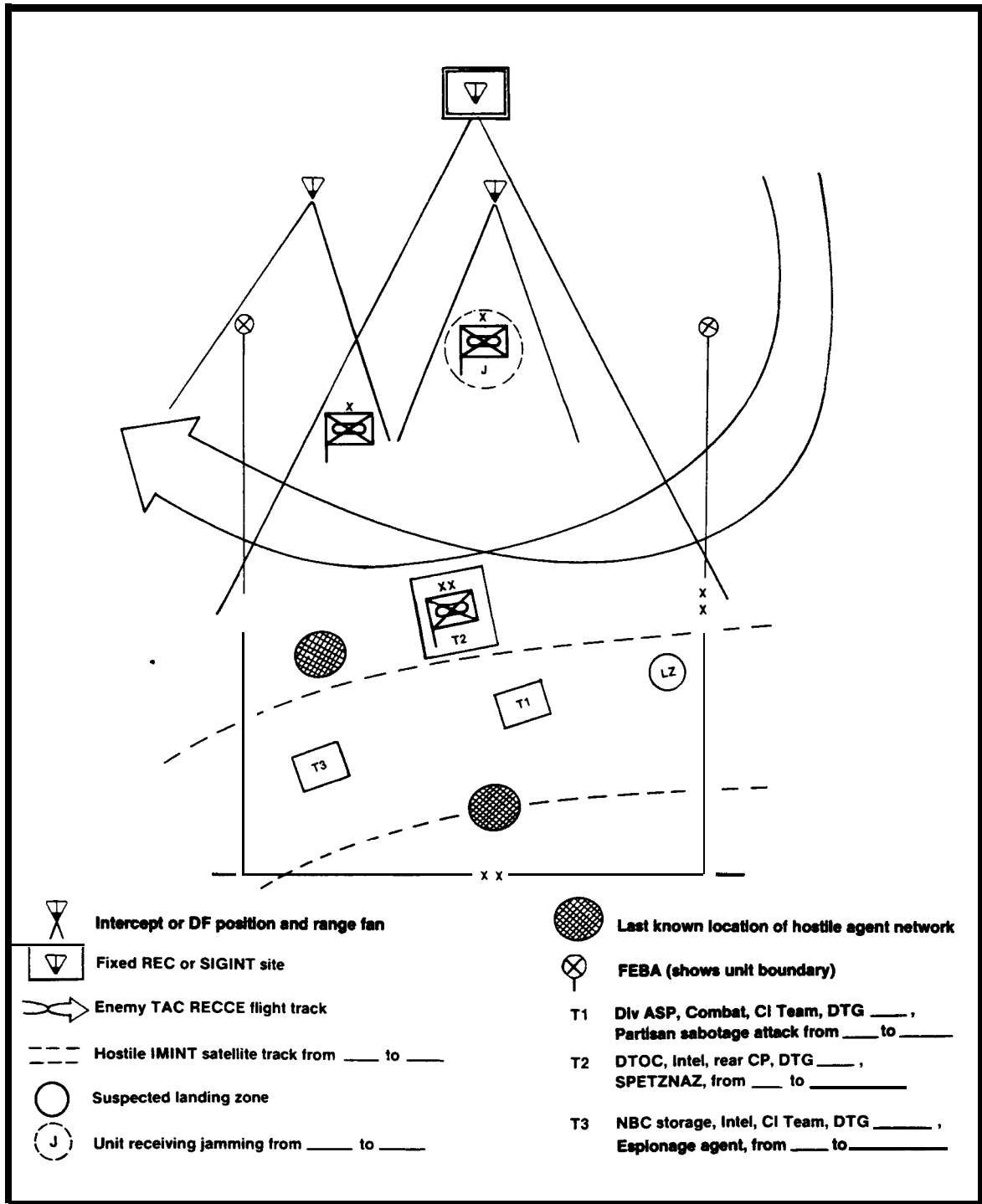

**Figure 9-1. Sample graphic MDCISUM.**

1. ENEMY ACTIVITY DURING PERIOD \_\_\_\_\_ TO \_\_\_\_\_ (LIST DTGs)

A. HUMINT: Summarize all known HUMINT activity during reporting period in one paragraph. Compile data from HUMINT situation overlay, matrixes, link diagrams, and MDCISUMs.

B. IMINT: Summarize all known IMINT activity during the reporting period in one paragraph. Compile data from IMINT situation overlay, matrixes, pattern and analysis charts, and MDCISUMs.

C. SIGINT: Summarize all known SIGINT activity during the reporting period in one paragraph. Compile data from SIGINT situation overlay, matrixes, direction charts, and MDCISUMs.

D. OTHER: Summarize all other enemy activity that is not already addressed using the same analytical tools.

2. INTELLIGENCE DAMAGE ASSESSMENT FOR THE PERIOD \_\_\_\_\_ TO \_\_\_\_\_ (LIST DTGs)

Briefly assess the intelligence damage to the friendly units for which the assessment is being prepared. Assessment is based on enemy collection activities that were traced, analyzed, and reported in MDCISUMs and were measured against the friendly force operations profile and countermeasures implemented by the friendly force. Coordination with G3 OPSEC staff element is essential in preparing this paragraph.

3. PROJECTED ENEMY ACTIVITY ASSESSMENT FOR THE PERIOD \_\_\_\_\_ TO \_\_\_\_\_ (LIST DTGs)

A. HUMINT: Using the same analytical tools identified in paragraph 1A, above, plus IPB, project or assess enemy HUMINT activity for the next reporting period.

B. IMINT: Using the same analytical tools identified in paragraph 1B, above, plus IPB, project or assess enemy IMINT activity for the next reporting period.

C. SIGINT: Using the same analytical tools identified in paragraph 1C, above, plus IPB, project or assess enemy SIGINT activity for the next reporting period.

D. OTHER: Using the same analytical tools identified in paragraph 1C, above, plus IPB, project or assess all other enemy activity for the next reporting period that is not otherwise addressed in the HUMINT, IMINT, or SIGINT assessments.

4. TARGET NOMINATIONS:

A. EXPLOITATION: Using aforementioned information and all other MDCI analytical tools, identify any targets worthy of exploitation. Provide

Figure 9-2. MDCI threat assessment.

recommended time frames, locations, methods of exploitation, justification, and any other pertinent data.

B. NEUTRALIZATION: Using aforementioned information and all other MDCI analytical tools, identify any targets worthy of neutralization. Provide recommended time frames, methods of neutralization, locations, justification, and any other pertinent data.

C. DESTRUCTION OR EXPLOITATION: Using aforementioned information and all other MDCI analytical tools, identify any targets worthy of destruction or elimination. Provide recommended methods for engagement, time frames, locations, justification, and any other pertinent data.

NOTE: All target nominations must have G2 or G3 approval before dissemination or presentation to the commander or designated representative for decision. Coordination with appropriate elements, consistent with type nomination, is essential.

**Figure 9-2. MDCI threat assessment (continued).**

CLASSIFICATION

Headquarters  
Place  
Date, Time, and Zone

MDCI Estimate Number \_\_\_\_\_.

References: Maps, charts, or other documents.

1. Mission: The restated mission determined by the commander.

2. The Area of operations: Summarizes the analysis of the AO.

a. Weather:

(1) Factors. Include light data and either a weather forecast or climatic information, as appropriate. Use appendixes for graphic representation or weather factors and other detailed information.

(2) Effect on enemy courses of action. Discuss the effects of weather on possible enemy courses of action (for example, sabotage, subversion, raids, air operations) in terms of mobility, concealment, and logistic sustainability. Discuss in terms of level I or II threat, and enemy all-source intelligence collection operations.

b. Terrain:

(1) Existing situation. Use graphic representatives where possible especially in regard to cover, concealment, and logistic

**Figure 9-3. MDCI estimate.**

sustainability. Use annexes for detailed information. Information covering observation, fields of fire, obstacles, key terrain, and approaches to the probable target aid in determining insurgent terrain. Also, consider graphics for critical facilities and buildings.

(2) Effect on enemy courses of action. Discuss in the same manner as for effects of weather in a(2) above. Discuss in detail those areas favorable and unfavorable to the levels of threat I or II enemy all-source intelligence collection opportunities.

(3) Effect on own courses of action. Discuss in the same manner as for effects of weather in a(2) above. Note the positive or detrimental effects on response forces and defensive measures.

c. Other characteristics. Include in subparagraphs any of the following factors or characteristics which are pertinent to friendly area activity (emphasis on rear area): population, ethnicity, religious makeup, literacy rate, medical considerations, economic stability, transportation, mass media, public services, and current political situation.

3. Enemy situation. Information on the enemy which will permit later development of enemy capabilities and vulnerabilities and refinement of these capabilities into specific course of action and their adoption.

a. Disposition. Reference may be made to overlays, enemy situation maps, or previously published documents. Location of potential threat forces may be difficult to pinpoint, but the greater the detail, the more thorough the analysis. Separate by level and type of threat (that is, combat (level I and II threats) or intelligence).

b. Composition. Summary of the OB of conventional level I and II threats, intelligence collection units and elements, and the structure or organization of paramilitary and/or terrorist groups. Separate by level and type of threat.

c. Strength. The purpose of this listing is to assist in developing enemy capabilities and vulnerabilities. Conventional and intelligence threats are discussed as in a regular intelligence estimate. Terrorist, paramilitary and other threats need to be assessed based on support from populace, monetary base, supplies, armament, personnel, and any other pertinent considerations. Subparagraphs should be used to address the different threats. Separate by level and type of threat.

d. Recent and present significant activities. Items of information are listed to provide bases for analysis to determine relative probability of adoption of specific courses of action and enemy vulnerabilities. Enemy failures to take expected actions are listed as well as positive information. Such a discussion should include recent all-source collection activities, terrorist actions, and other indications.

e. Peculiarities and weaknesses. For conventional and intelligence collection threats, discuss as in an intelligence estimate. For

Figure 9-3. MDCI estimate (continued).

terrorist, paramilitary, or other unconventional threats, discuss such pertinent information as leadership (key personalities), equipment, finances, and relations with the local populace.

4. Enemy capabilities. Based on all the previous information and analysis, develop and list enemy capabilities to conduct operations against the friendly area, with emphasis on the rear area. The listing provides a basis for analyzing the available information to arrive at those capabilities that the enemy can adopt as specific courses of action and their relative probability of adoption. Items should be separated by levels and type of threat.

a. Enumeration. State what, when, where, in what strength, and by what method for each enumerated threat.

b. Analysis and discussion. Each enumerated threat is discussed in terms of indicators of adoption or rejection. The intent is to assess the likelihood of a given threat taking a given action. This paragraph must consider all information previously recorded in the estimate. Some threats may not have any indicators of rejection listed due to insufficient data.

5. Potential enemy targets. Based on all previous information and analysis, develop, to the extent possible, a listing of potential enemy targets. Identify, at a minimum: target identity, capability, location or projected location, and projected intentions. Ascertain if targets can be exploited, neutralized, destroyed, or eliminated. Use subparagraphs and/or annexes as needed.

6. Conclusions.

a. Effects of AO on own courses of action. Indicate weaknesses in ability of response forces to react and in defensive measures.

b. HVT analysis based on the CARVE format (criticality, accessibility, recuperability, vulnerability, and effect). Such targets range from bridges to friendly units, public services, and key facilities. Complete for both friendly and enemy targets.

c. Probable enemy courses of action. Courses of action are listed in order of relative probability of action. However, insufficient data may only permit the probable level of threat for a given target.

d. Enemy vulnerabilities. List the effects of peculiarities and weaknesses that result in vulnerabilities that are exploitable.

Annexes (as required): Annexes may include graphic analysis products which support the estimate such as link diagrams, association matrixes, ROIPB products, or black, white, and gray lists distributed to units requiring them.

CLASSIFICATION

Figure 9-3. MDCI estimate (continued).



times. Ordinarily, the CIAS operations NCO is responsible for maintaining the overlay; however, its preparation is a collective effort of all members of the CIAS.

#### MULTIDISCIPLINE COUNTERINTELLIGENCE

The CIAS identifies the multitude of intelligence collection capabilities of adversaries on the battlefield. It then narrows the capabilities as accurately as possible to the actual collectors within an area, their targets, and the collectors technical characteristics. The CIAS also provides information to the battlefield deception (BAT-D) staff on the characteristics of friendly equipment so that an "as close as possible" replication of a friendly force is displayed to enemy collectors. This is done during the development of the deception story in the planning process.

On today's technical battlefield, the friendly force assumes that hostile collectors are analyzing friendly patterns of C<sup>3</sup> to find HVTs. In friendly communications, mostly secure, the enemy must locate the communications externals that identify specific units or nodes. In electronic deception, these communications externals are replicated down to and including specific anomalies in friendly transmissions. Currently, analysis of such signals parameters is extremely difficult. C-SIGINT analysts research technical bulletins, coordinate with C-E staff members and maintenance personnel to collect this information as accurately as possible for the deception staff. As friendly deception equipment evolves into the future and becomes more sophisticated, friendly capability to provide the needed detail of support also must expand.

BAT-D elements become one of the main consumers of the integrated MDCI products. They use the MDCI estimate and graphic summary to determine where best to execute deception based on the collection effort.

Specific needs and requirements for BAT-D are passed through G3 channels to the CM&D at each echelon. The CIAS researches its data base to satisfy these needs with existing intelligence information. If the CIAS cannot satisfy the requirement immediately, it is validated and returned to the CM&D for appropriate tasking and requirements management. When the information is finally collected, it is passed through the CM&D to the CIAS for analysis and product development. It is then passed to deception planners so they can develop deception plans or execute the deception mission.

Since adversaries change the focus of intelligence collection as often as necessary, the CIAS analyzes its efforts continuously and passes the changes to the deception cell rapidly. This enables deception personnel to change focus and evaluate their effectiveness.

#### INTELLIGENCE SUPPORT TO COMBATING TERRORISM

Terrorist activities are an ever-increasing threat to Army units, personnel, equipment, and operations, in peacetime and during conflict. CI personnel play a major role in supporting the force protection mission

through investigation, operation, and intelligence collection directed at terrorist groups and activities. The CIAS has an additional analytical role, using C-HUMINT techniques in this manual and fully explained in FM 34-60.

The MDCI threat assessment is an effective product for providing information to support the command force protection mission. The process includes educating the force on the threat, evaluating past activities of terrorists, maintaining a current data base, using pattern analysis, and predicting future activities and incidents. The CIAS also recommends offensive and defensive measures that may be effective in combatting terrorism.

Combatting terrorism is a shared mission among all members of the Army. The relationships between the operations staff, intelligence staff, and military police must be "locked in" completely to be effective. There are many other players who provide information to the process and to the intelligence analysis mission. Using the techniques of C-HUMINT analysis, the friendly goal is to track activities and associations, to predict the next terrorism act, to determine who is performing the act, when and where, and to get the information to decision makers who can do something about it.

## CHAPTER 10

### INTELLIGENCE SUPPORT TO COUNTERINSURGENCY

Recent history is characterized by the occurrence of numerous insurgencies in developing nations. The US government has taken the responsibility to assist, upon request, selected emerging nations in developing political stability, economic strength, and social progress. Thus, the US may become involved in a LIC, either in an advisory and assistance capacity or as a combatant. The analyst plays an important role in all LIC operations including foreign internal defense and peace keeping. The focus in operations such as these is different than in counterinsurgency. Here the analyst is concerned with political questions such as, "How can the people be made to support the government?" and "Who is the enemy?"

This chapter describes how information from all sources is analyzed to produce intelligence to support counterinsurgency. LIC includes counterinsurgency, but also foreign internal defense, peacetime contingencies, and terrorism counteraction. These last three areas are beyond the scope of this FM.

When the level of US participation with a host nation is sufficient to be considered a combined activity, a combined intelligence operation is carried out. Combined intelligence operations facilitate more effective collection and production capabilities. The host country provides detailed knowledge and access to the populace, while the US Army provides technical expertise, management, and advice. There are often varying degrees of US and host nation cooperation.

The primary responsibility of intelligence personnel engaged in LIC is to produce intelligence to support the prevention or defeat of an insurgency. To defeat an insurgency, information is collected and intelligence produced on virtually all aspects of the internal defense environment. When insurgents are known to be receiving aid from an external power, it is necessary to obtain information on the role of the external power in the insurgency.

The target of the intelligence collection cycle (described in Chapters 1 and 2) for LIC differs from mid- to high-intensity conflicts only in its application to the production of specific intelligence required for counterinsurgency operations. In planning, for example, information is not only needed on the armed insurgents but also on their underground organization and their relations with the populace as well. In collecting information, the local population represents one of the most lucrative sources of information. In processing information into intelligence, sociological, economical, and political requirements have equal or even higher priority than conventional military needs. In addition to military users, US, host nation, and allied governmental, law enforcement, and intelligence agencies are valid users of intelligence products.

## SUPPORT OF COUNTERINSURGENCY OPERATIONS

A sound collection program and proper use of the various collection agencies and information sources result in a very heavy volume of information which flows into the intelligence production element. The insurgent environment and its base area system and political and military tactics dictate that intelligence requirements can only be met by reporting minute details on a great variety of subject areas. Each one of these details appear unrelated to others and insignificant by itself; but when mapped and chronologically recorded over long periods of time and analyzed with other details reported, they lead to definitive and predictable patterns of insurgent activity.

For example, as in a conventional conflict, IPB is conducted before and continues throughout a LIC. IPB not only helps identify patterns of insurgent activity, but helps use these patterns to predict future actions. Appendix E, FM 34-130 fully addresses IPB in support of LIC.

Insurgents usually recognize their shortcomings in military posture. The insurgent makes maximum use of the weather, the terrain, and the population, employing secrecy, surprise, and simplicity. Combat plans and orders are usually simple, comprehensive, and repetitive in order to be executed by widely separated forces. Therefore, the insurgent's solution to a problem is composed of a system or systems which together are complex, but apart are independent, having simple, logical, and uniform characteristics. In developing a pattern analysis or IPB products, it is important to chart insurgent and friendly tactical actions. As actions of friendly forces disturb the environment and patterns of insurgent activities, it forces the insurgent into unanticipated and unrehearsed situations which can be exploited tactically. Communications intelligence (COMINT) is used to obtain direct insights into insurgent operations and plans. IPB helps the intelligence analyst answer two basic questions:

°Where can we expect to find the enemy?

°Where can we expect not to find the enemy?

The data to be developed and compiled by subject matter varies considerably with the intensity of the insurgent's operations. The types of overlays and categories of subjects plotted, therefore, vary extensively according to the needs. Using a graphic keying system and color schemes on large-scale maps greatly facilitate data analysis when superimposing transparent overlays.

## INTELLIGENCE ESTIMATE

IPB provides a basis for the intelligence estimate. As with mid- and high-intensity operations, IPB products are used extensively in the estimate. There are, however, some significant differences from these to estimates that support LIC in general and counterinsurgency specifically:

° Emphasis is placed on different parts of the estimate. The mission statement, for example, may be more difficult to compose because of the wide scope of low-intensity operations and their relationships with the internal defense program.

° Emphasis is accorded nontactical considerations, such as psychological, political, sociological, and economic factors.

° Factors are to be compared during the deliberative process. Advantages and disadvantages of various courses of action may be more complicated than when terrain, weather, and a visible, tangible enemy are the chief factors to be considered.

The intelligence estimate for a LIC operation, as in any situation, is based on all available intelligence and considers everything of operational significance. See Appendix A for an example of a LIC intelligence estimate.

The initial intelligence estimate helps to point out gaps in the intelligence data base. These gaps are a basis for determining requirements.

A basic requirement in low-intensity operations is a thorough understanding of the target area. Knowledge of the target society requires a complete understanding of the internal and external forces at work, those supporting the integrity of the society, and those engaged in subverting it. Only when these factors are thoroughly understood can actions be effected. All available assets are used to provide this intelligence.

Commanders, intelligence staffs, and analysts recognize the impact that political, economic, and sociological factors have on tactical operations of the insurgent and friendly forces. This applies even to a very narrow, confined, and localized situation. Therefore, an intense and continuing study of local history and developments, contemporary personalities, aspirations, and motivations is made. Because political, sociological, and economic factors are overlapping and interdependent, collation and interpretation of this data are extremely intricate and seldom are reduced to a formula similar to OB for mid- and high-intensity conflicts.

#### PROCESSING INFORMATION

Processing is the step in the intelligence cycle whereby information becomes intelligence. It consists of recording, evaluating, integrating, and interpreting. Chapter 2 describes information processing. Certain considerations are unique to the internal defense environment. To determine insurgent capabilities and courses of action and to provide the intelligence needed for all facets of LIC, the intelligence analyst is guided by an awareness of these considerations.

## RECORDING

As in mid- and high-intensity situations, LIC requires large amounts of information on a continuous basis which are promptly compared with existing information and intelligence to determine their significance. To a large-degree, the extent of the recording effort depends upon the insurgent activity in the area and the analysts available to maintain and analyze the recorded information. All of the recording aids mentioned below, however, serve a unique and useful purpose in the overall intelligence production effort. Chapter 2 provides a detailed description of the journal, journal file, intelligence files, and intelligence workbook. Variations in recording devices which are unique to LIC occur in the use of annotated overlays and working files.

### Annotated Maps

Depending on the echelon of responsibility, the state of insurgent activity in the area, and the degree of knowledge of the enemy, the intelligence analyst requires at least two annotated maps: the incident map and the insurgent SITMAP. Each of these recording devices normally is a transparent overlay covering a large-scale topographic map of the area. Unlike the workbook, which is maintained for individual use, the incident and insurgent SITMAPS provide a ready guide for briefing the commander, the civil authorities, or other interested parties. If activity in a particular area is limited, consideration is given to the combination of the two maps. Other annotated maps are valuable aids for recording information, depending on the needs in a particular headquarters' tactical area of responsibility. These special purpose overlays include records of--

- °Mining and booby trap incidents.
- °Insurgent names or codes for local terrain features, such as villages, areas, and trails.
- °Insurgent assassination or resource collection attempts.
- °Other significant activity.

It may be necessary to enlarge, with significant detail, certain AIs, either by drawing portions of the map to a larger scale, or by making a mosaic from aerial photos. Past, present, and potential insurgent activity must be visible with a detailed and thorough understanding of the environment. Comparison of the several annotated maps maintained often assist the intelligence officer in estimating the enemy's intentions and capabilities or to establish trends.

Incident Map. The incident map or overlay provides historical cumulative information on trends and patterns of insurgent activity. Properly maintained, the entries enable the intelligence officer to make judgments about the nature and location of insurgent targets, the relative intensity of insurgent interest in specific areas, insurgent control over or support from the population, and potential areas of insurgent operations.

Judgments concerning insurgent operations also require knowledge of terrain factors and insurgent limitations.

insurgent Situation MaQ. The SITMAP or overlay is prepared as part of the IPB process, and is modified as necessary by information from the incident map. It is difficult to pinpoint insurgent installations and dispositions with the same degree of confidence as in a conventional tactical situation. The insurgents can displace on short notice, making a report outdated before it is confirmed. While the SITMAP presents an uncertain and hypothetical picture, composed less of firm information than of reports of fleeting targets, estimates, and abstractions, it graphically substantiates the trends or patterns derived from the incident map. The analyst can then improve the economy and effectiveness of the R&S effort.

Trap Map. The trap map or overlay is used if the insurgent has a capability for sabotage or terrorist action. Data is directly annotated on the map on which the situation overlay is placed, or it can be kept separately. This map portrays particularly attractive target locations for insurgent sabotage or terrorism, such as road and railroad bridges, communications centers, theaters and assembly halls, and places where the terrain favors ambushes and raids. Such areas are identified and analyzed as part of the area study. They are plainly marked on this map with attention directed to possible insurgent access and escape routes. Photographs which are keyed to the map also supplement this effort.

Population Status Map. This consists simply of an overlay to the SITMAP. Essentially, this map portrays the attitudes of the population, whether disaffected, loyal, or doubtful. Colors are used effectively to designate these conditions.

Personalities and Contacts Map. What is known initially about the insurgent situation primarily is information concerning locations and activities of individual agents of espionage, agitation, organization, and liaison. The appearances, movements, meetings, and disappearances of these agents are recorded on a personalities and contacts map or overlay. A large-scale map is required (a city street map or town plan if an urban area is involved). Deviations from regular patterns of movement are detected in this manner. Depending upon the number of personalities under surveillance, the regularity of their habits, and the variety of reports received on them, it is necessary to maintain a separate overlay for each subject. Old overlays are filed for comparison. Each agent's route is portrayed in a different color, and regularly traveled routes distinguished from new routes. Observations are dated and incidents noted by symbol. Depending upon the amount of insurgent activity, this map is combined with the incident map.

#### Working Files

The intelligence worksheet and the annotated maps serve to isolate problem areas and formulate relationships between items of information and intelligence collected. Extensive research material is required, however, to analyze these problem areas. In the early phase of an insurgency, the insurgent leader is building an organization. The leader's organizational

procedures and tactics, therefore, are unique, and familiarization requires the intelligence officer to study personalities and incident analysis. Extensive working files, such as the insurgency analysis worksheet, hot files, current propaganda and psychological operations (PSYOP) file, personality and organization files, area study files, civil-military operations file, and resource reference files are established and maintained. Figure 10-1 shows an insurgency analysis worksheet.

<ol style="list-style-type: none"><li>1. US objective (Immediate, short-term, long-term).</li><li>2. Nature of society.<ol style="list-style-type: none"><li>a. Social, economic, political, and security conditions.</li><li>b. Causes of discontent.</li><li>c. Issues.</li><li>d. Groups (segments of the population) and forces (groups trying to influence the action of the others).</li><li>e. Variables likely to influence the level of violence (coercive potential, institutionalization, facilitation, legitimacy of the regime).</li></ol></li><li>3. Nature of insurgency.<ol style="list-style-type: none"><li>a. Leadership.</li><li>b. Objectives.</li><li>c. Organization.</li><li>d. Target groups.</li><li>e. External support.</li><li>f. Timing.</li><li>g. Mass support.</li><li>h. Relationship to legitimate political process.</li><li>i. Use of violence.</li><li>j. Urban or rural base.</li></ol></li><li>4. Nature of government.<ol style="list-style-type: none"><li>a. Objectives.</li><li>b. Description of counterinsurgency.</li><li>c. Evaluation of counterinsurgency.<ol style="list-style-type: none"><li>(1) Balanced development, neutralization, and mobilization programs.</li><li>(2) Preemptive and reinforcing aspects of counterinsurgency strategy.</li><li>(3) Adherence to operational guidelines.</li><li>(4) Evaluation of each counterinsurgency program in terms of likely impact on each segment of the population.</li></ol></li></ol></li><li>5. US response.<ol style="list-style-type: none"><li>a. Possible courses of action.</li><li>b. Evaluation of each course of action.</li><li>c. Recommendation.</li></ol></li></ol>
--

Figure 10-1. insurgency analysis worksheet.



**Insurgency Analysis Worksheet.** The insurgency analysis worksheet helps identify information and intelligence needed to satisfy the PIR and IR. It also provides a guide for analysis of a LIC environment.

**Hot File.** The hot file is the most important working file. It includes all available material pertaining to an incident or groups of possibly related incidents that are of current interest. This file contains material on persons or places likely to be involved in insurgent activity, together with material on agents or suspects who may be involved. A reported sabotage plot, for example, could initiate a hot file. The hot file remains active until the report is refuted, the incident occurs, the attention of the insurgent is diverted elsewhere, or friendly interest priorities change.

**Current Propaganda and PSYOP File.** If propaganda constitutes a major part of the insurgent effort in the area, a current propaganda and PSYOP file should contain all pertinent literature, background material, and analyses, to include copies of propaganda speeches and analyses of local grievances being exploited or subject to exploitation by the insurgents.

**Personality and Organization Files.** A local file is maintained on each insurgent personality. If surveillance is carried out by the local police, basic identifying and biographical information can be transferred from police dossiers to a card file. This card file helps train friendly surveillant to recognize key personalities on sight. The organization section of this file includes information on the history and activities of the insurgent organization's fronts, other subversive or suspected groups, and their officers, overlapping directorates, memberships, and liaison among these organizations. Figure 10-2 shows the format for a personality card file.

**Area Study Files.** Area study files contain up-to-date and pertinent data in the geographic, political, sociological, economic, and cultural fields. In low-intensity operations, even the lower echelon tactical commander, particularly when operating in the same general operational area over extended periods of time, has a definite requirement for such information. The intelligence staff officer should, therefore, have ready access to such data. The topical breakdown of such files concerns events and activities of continuing significance. Thus, for example, if rice is the basic staple in an economy, the topical breakdown includes files on rice production, distribution and marketing, price levels, and black marketeering and pilferage activities. Since this key economic indicator has continuing influence on friendly military operations as well as on the insurgent forces who depend on this staple for survival, careful analysis of this data over a period of time provides patterns based on which insurgent actions are anticipated and their capabilities predicted.

**Resource File.** A resource file includes all material which is of importance but are not of immediate value. It includes inactive incident files, inactive personality and organization files, and photography. The latter material is particularly useful. Air or ground photographs of places of interest are arranged chronologically by location and made readily available for use with hot files, incident maps, and trap maps.

PF NO.—					COLOR CODE
SURNAME:		FORENAME:		SEX:	
ALIAS(ES):		NATIONALITY, RACE OR TRIBE:		DOB:	
RELIGION:		NATIONAL IDENTITY REFERENCE:			
PERSONAL DETAILS		DESCRIPTION		ORGANIZATION	
ADDRESS(ES):		HEIGHT:		(USE PENCIL ONLY)	
		WEIGHT:		POLITICAL ORG:	
FAMILY:		HAIR:		MILITARY ORG:	
OCCUPATION:		EYES:		POSITION OR RANK:	
VEHICLE(S):		ACCENT:		SKILLS:	
WEAPONS:		DIST CHAR:		ASSOCIATES:	
		ADDITIONAL INFORMATION			
PHOTO		ADDITIONAL INFORMATION (CONT)		ASSOCIATES (CONT)	
DATE	FIELD OR PAGE NO	BRIEF DESCRIPTION	DATE	FIELD OR PAGE NO	BRIEF DESCRIPTION

**Figure 10-2. Personality card file format.**

**Reference Material.** A library is maintained of reference publications, such as manuals on doctrine, tactics, and methods; books on the area and on the insurgent threat; files of newspaper and magazine clippings; and any other material which is of use. This material is kept at a central library serving the entire staff or located at an area coordination center.

**Coordinate Register.** The coordinate register is a valuable analytical tool, and method to store information during LIC situations. It illustrates activity in a particular area over a period of time, and is compact enough to be carried with ease. Each page represents a specific geographic area or town that the S2 determined. The coordinate register has two types of pages. One has written entries to record insurgent activity with space for the S2 to add comments. Figure 10-3 shows a sample written-entry coordinate register, applicable to a LIC.

ITEM	TIME	COORDINATE	ACTIVITY	NOTES
1.	150930	XK345678	MG harasses site	position patrol south of site
2.	152230	XK348672	farmer reports 10 guerrillas moving south	
3.	200140	XK348678	individual with binoculars seen observing site	increase friendly surveillance vic. of site

**Figure 10-3. Written-entry coordinate register.**

The second type of coordinate register is visual. Entries are plotted on the overlay square as they appear on the incident map.

The coordinate register assists in trend and pattern analysis and is a good way to store data, in an easily retrievable manner, for long periods of time. The written register allows easy evaluation of enemy activity by type action while the visual one allows rapid comparisons of activity between several time periods.

**Civil-Military Operations File.** A civil-military operations file includes all material and information concerning civil-military operations, their results, effectiveness, and any countermeasures the insurgents take.

## EVALUATION

Evaluation is the determination of the pertinence of information to the operation, reliability of the source or agency, and accuracy of the information. In evaluating information, the knowledge and judgment of the intelligence analyst plays a major role. In determining the validity of a fact or whether a reported activity is at all possible, it must be realized that certain events are possible despite the fact that they did not previously occur and have been deemed by past analysis as unlikely to occur. Confirmation of information by other sources and agencies is always desirable, but it is not always possible to obtain. Initially, intelligence analysis commences with unconfirmed information which is subsequently supported, confirmed, or denied by the collection of additional and related information. As more information is obtained, the insurgent situation, capabilities, and probable courses of action become increasingly clear. As the body of intelligence expands, information that is not compatible with the current insurgent situation and is not consistent with the recent pattern of insurgent activity is suspect. Chapter 2 describes evaluation in detail. Procedures governing the assignment of evaluation ratings to sources and agencies have equal application in the internal defense environment.

## INTEGRATION

Evaluated information becomes intelligence only after it has been integrated with other information and interpreted to determine its significance. Integration involves the combining of selected data to form a pattern which will have meaning and establish a basis for interpretation. It is important that the intelligence analyst is sufficiently alert to recognize all the possible patterns that may be formed. The following example illustrates the mental process of integration: The intelligence section of the area coordination center receives information that a prominent labor leader has been murdered. In a search for related information, the intelligence analyst checks the incident file, the friendly and suspect personality files, and the organization file.

The incident file reveals a series of murders that have been linked with the insurgent, with the primary victims being government officials, prosperous merchants, and large landholders who opposed insurgent objectives.

The suspect personality file reveals the labor leader's controlling position within a union that has recently intensified its criticism of the government. The personality file also reveals the labor leader's close association with several government officials and recent extensive travel throughout the nation.

The organization file indicates that the union has recently begun to disseminate antigovernment leaflets and has threatened to call a strike if demands for representation in the current government are not met. The other primary contender for union leadership is a relatively unknown newcomer.

Once all related items of information from the intelligence files are obtained, the intelligence analyst begins to assemble the available information to form as many logical pictures or hypotheses as possible. Alternative methods of assembly are an essential prerequisite to any valid interpretation.

Assembly of information to develop logical hypotheses requires good judgment and considerable background knowledge. In formulating hypotheses, the intelligence analyst avoids the limitations which result from preconceived opinions. In the example of the murdered union leader, the new information is integrated with existing intelligence in several different ways. By combining the murder with one set of facts, the labor leader is pictured as a loyal supporter of the government who became the victim of a campaign of selective terror undertaken by the insurgents. On the other hand, by combining the murder with another set of acts, the labor leader is portrayed as a member of the insurgent organization who was murdered for reasons not connected with the insurgency. As a third possibility, the labor leader may have been a member of the insurgent organization who was eliminated by the insurgents. Finally, there is a fourth possibility that the labor leader and the murder are not connected with the insurgency.

#### INTERPRETATION

Interpretation is the result of making deductions as to the probable meaning of new information and determining its implications with respect to future insurgent activity. The meaning of the information is determined in relation to the insurgent situation and the insurgents' probable courses of action.

For example, in the case mentioned above, if the labor leader was loyal to the government and was murdered for opposing insurgent control of the union, it reasonably is expected that further consolidation of insurgent control over the union, increased antigovernment agitation by the union, and possibly, an extension of insurgent terrorist activities will take place.

However, if the labor leader was a member of the insurgent organization and was murdered by the insurgents, it is conjectured that the elimination was due to considerable unreliability or slow progression toward the achievement of insurgent objectives. In this case, the prompt emergence of another insurgent union leader who ensures more rapid progress toward insurgent objectives is expected. It also is inferred, however, that the labor leader was murdered as a result of a struggle for power within the insurgent organization. In this case, weaker insurgent control of the union is expected due to the dissension among the insurgents.

Finally, if the labor leader had no connection with the insurgent organization and was murdered for reasons unconnected with the insurgency, this event has no significance from an intelligence standpoint.

## DISSEMINATION

One of the more critical aspects of intelligence is the rapid dissemination of the information to personnel and units that need information. Each information report is looked at immediately to see if it is of immediate concern. If so, it needs to be disseminated to affected units or personnel without delay. Successful intelligence reporting communicates the results of analysis and combat information to the right people, at the right time, and in the right format. It provides the commander with the information and intelligence needed to reduce risk and uncertainty. The dissemination channel in a LIC varies little from the conventional environment but often there are more agencies and individuals to consider: police, potential terrorist targets, and other civilian agencies operating in the AO. Also, intelligence is disseminated to host nation military units.

Local SOP and guidance from higher headquarters dictate the amount and type of information that is given to civilian agencies and host national military forces. This question of releasability is resolved before effective dissemination can exist.

## ORDER OF BATTLE

Chapter 3 describes the production of OB intelligence. There are certain OB considerations, however, which are unique to the insurgent enemy. OB intelligence is equally as important in an insurgency as in conventional combat operations. However, some differences in nomenclature and approach must be recognized. The applicability of the various OB factors differs in an insurgency from conventional operations, and there also are differences in applicability between phase I and phase II insurgency situations,

The elements of OB intelligence (OB factors) are not independent of each other; they are closely related and are considered as a whole. Information on one of the elements often leads to a reevaluation or alteration of information previously received on another element. Furthermore, the general rule, whereby OB intelligence is developed and maintained down to and including two echelons below the analyst's own level of command, does not apply to low-intensity operations. Due to the nature of the insurgency and the phased development of the insurgent forces, OB intelligence is produced in much greater detail and pertains to much lower echelons (even down to squad) than in conventional combat operations.

During phase I of an insurgency, subversive activities range from being only a potential threat to frequently occurring activities along an organized pattern. No major outbreak of violence or uncontrolled insurgent activity exists. The insurgent is primarily concerned with organizing infrastructure during this phase, along with conducting PSYOP and terrorist attacks.

Phase II of an insurgency begins when the insurgent has gained sufficient local or external support to initiate organized guerrilla warfare against the government.

A phase III insurgency occurs when the insurgent has transitioned from a guerrilla-oriented force to a primarily conventional-oriented force. FM 100-20 describes, in detail, the goals and activities of insurgent forces during all three phases. An important point to remember is that the insurgent may be operating from areas outside the host country during all three phases. Therefore, geographic boundaries cannot limit intelligence collection and analysis.

A listing of the OB factors follows, together with a brief explanation of their applicability and means in the context of insurgency situations.

### COMPOSITION

In some insurgent movements, military force is only one of several instruments through which the insurgent movement seeks power. Development of a military force often has the lowest priority during the early stages of an insurgency. As long as the party core and civil organizations are established and move effectively toward the goal of the insurgency, the military arm either lies dormant or simply exists in cadre form until needed as a supporting force. Even after military organizations are fielded, the infrastructure never loses its importance. A counterinsurgency operation is never over until the infrastructure is neutralized.

#### Phase I Considerations

Rather than collecting information on the identification and organization of specific enemy units, we are concerned with the internal workings of insurgent activity groups. Knowledge of the composition of insurgent groups is a key to the entire planned course of the insurgency. Details of composition include the appearance of new organizations, the relative amount of enemy effort expended in rural and urban operations, the internal chain of C<sup>2</sup>, and the manner in which insurgent groups are organized for operations.

#### Phase II Considerations

The intelligence analyst is concerned here with determining the composition of insurgent combat units, including their organization and chain of command. The degree of sophistication encountered indicates other factors, such as training, logistics, and strength. Armed platoons or small terrorist cells indicate that the overt military portion of the insurgents' plan is just beginning, and armed battalions and large urban terrorist groups indicate that there is a serious menace to the current government.

## POLITICAL STRUCTURE

A tightly disciplined party organization, formally structured to parallel the existing government hierarchy in the country, is found at the center of some insurgent movements. In most instances, this organizational structure consists of committed organizations at the village, district, province, interprovincial, and national levels. Within major divisions and sections of an insurgent military headquarters, totally distinct, but parallel, command channels exist. These are the military chain of command and the political channels of control. Whether it is through a political division of an insurgent military headquarters, a party cell or group in an insurgent military unit, or a unit political officer, the party ensures complete domination over the military structure by use of its own parallel organization. These party organizations fuel military action. Should the military arm be eliminated, and the party left intact, only short-term security is achieved. The party begins construction of a new military organization. The population only is safe when the insurgent's political structure is rendered ineffective.

## COMBAT FORCES

The organization of insurgent combat forces is dependent upon the need, the tactics to be employed, and the availability of personnel and equipment. Frequently, subordinate elements of insurgent units are employed independently. The intelligence analyst who receives a confirmed report of a subordinate element of an insurgent unit operating in the area cannot, therefore, assume that the parent unit is also present.

Identification of insurgent units are by--

- °Number.
- °Commander's name.
- °Nickname.
- °Code designation.
- °Name of the area in which it operates.

Unit designations are frequently changed and multiple designations are often used to confuse friendly intelligence. It follows that the intelligence analyst is not able to determine the size and strength of an insurgent unit merely by obtaining a unit identification.

## DISPOSITION

Determination of the disposition of the insurgent involves the location of operational training and supply bases, LOC, and areas of political control. The intelligence analyst arrives at potential dispositions of the insurgent combat forces by developing patterns of activity based upon map study and knowledge of insurgent tactics. Insurgent base areas, for instance, normally are located near areas that



the insurgents politically control, thereby providing an early warning system. By plotting insurgent sightings and combining this information with weather conditions, time factors, detailed investigation of insurgent incidents, and after action reports, the analyst best selects possible enemy dispositions as well as possible areas of tactical deployment. Consideration should also be given to areas where no insurgent activity is reported. These areas, while appearing to be under the control of internal defense forces, may be under the political control of the insurgents.

#### Phase I Considerations

The location, deployment within this location, and any movements of insurgent organizations or personnel are of concern here. The enemy's strength and tactics are revealed, to some extent, by discovering whether this effort is concentrated in a few places or dispersed throughout the target country and neighboring nations. If the enemy's effort is initially concentrated in one city or in one rural area, then the extent and spread of the insurgent organizations are a key to how long the enemy has been operational and how successful the enemy has been, and is an indication of the enemy's appraisal of friendly strength. In a nation considered a relatively easy conquest, the enemy begins with many operations, rather than a few. By studying the other available elements of O6 intelligence, the intelligence analyst determines such things as whether the movement of an enemy cadre or group is an advance toward new goals or a retreat from an unprofitable operation.

#### Phase II Considerations

How the insurgent forces are deployed indicates whether the enemy is making a widespread show of strength, with units scattered about the country, or is concentrating forces around a few key targets. It also shows whether the enemy is going to concentrate on such activities as interdicting transportation or actively seeking battle with government forces.

#### STRENGTH

The strength of the insurgent forces is thought of in terms of the combat forces, political cadres, and popular support. Conventional methods of strength computation are applied in determining insurgent combat forces strength. The analyst should be aware, however, that the insurgent will attempt to have strengths overestimated by low-intensity operations forces. To give this false impression, the insurgent employs rapid unit movement and uses multiple designations for a single element. Reports from the populace concerning the strength of the insurgent forces should be viewed with caution and the importance of actual counts of enemy personnel stressed. Certain insurgent-initiated incidents provide useful indicators of the strength of the insurgents in a particular area. An example of these is an increase in raids with subsequent loss of weapons by friendly forces. The determination of popular support for the insurgents is a more difficult task and is stated best in terms of the

percentage of an area under government control, as opposed to the percentage under insurgent control, with both viewed together in terms of population density. A useful indicator of the extent of insurgent political control is the willingness of the populace to report information concerning the insurgents.

#### Phase I Considerations

The cadre who organize and activate the movement usually are highly trained, aggressive professionals who exercise an influence disproportionate to their actual numbers. The analyst also is concerned with the number of enemy units in existence, which in phase I means identifying and evaluating new groups and organizations which have either appeared in the host nation or in neighboring countries and any changes in the size of existent groups. Other types of equipment, besides weapons, are of paramount interest. A printing press in phase I is a deadlier weapon than a battalion of artillery in phase III.

#### Phase II Considerations

The actual number of personnel available to the insurgent now assumes the importance it lacked, to some degree, in phase 1. By knowing also the amount of weapons and equipment available, estimates of capabilities against friendly forces are formulated. The degree of popular support for the insurgent manifests itself in such areas as recruiting for forces, tax or resource collection, and degree of population support for friendly forces.

#### TACTICS

Tactics include both enemy doctrine and the conduct of operations according to that doctrine. Insurgent forces are more flexible in their application of doctrine than regular military organizations. The doctrine which guides the insurgent must be known and understood by friendly forces if they are to effectively counter insurgent efforts. The careful examination of the tactics, or actual operational techniques, reveals changes in doctrine as well as indications of the personality and competence of the insurgent leader. Again, the choice and application of tactics is a reflection of insurgent appraisal of friendly strength as well as of personnel strength. A continuing estimate of relative strengths is a very basic part of insurgent operational planning and has an immediate effect on tactics. Tactics of the insurgent involve political, military, psychological, and economic considerations, all closely integrated. They vary with the phase of the insurgency. The political goal of the insurgents is to undermine and discredit the established government.

#### Phase I Considerations

Phase I insurgency is characterized by a relative absence of strictly military operations and an emphasis on subversion and organizational development. Although instances of terrorism begin to occur in the later

stages of phase 1, military activity is usually limited to recruiting and establishment of military cadres.

#### Phase II Considerations

An increased emphasis on the study and evaluation of insurgent military tactics is required. Tactics during phase II are generally limited to ambushes, raids, sabotage, and terrorism. These activities provide the insurgent with supplies, experience, and self-confidence, while at the same time they erode friendly morale and reduce friendly economic and military capabilities.

#### TRAINING

Insurgent training is closely related to the tactics being employed and includes vigorous indoctrination in political affairs. Both the combat forces and the people within an area under the political domination of the insurgents receive training. Insurgents carefully plan and train for individual operations and phases of movement. A careful analysis of an area with respect to the type of training taking place provides a useful indicator of the probable courses of action that are employed against friendly forces.

#### Phase I Considerations

During phase I, the insurgent trains and indoctrinates existing cadre as well as newly accepted or recruited indigenous personnel. Training consists of a great deal of political indoctrination along with techniques of propaganda, communications, and intelligence collection. Training and effectiveness go hand in hand; the type, amount, and validity of training received by the insurgents is determined, to some degree, by any observed increase in the effectiveness or size of the insurgent movement. Some training normally is conducted in another country and is indicated by a change in number and type of personnel traveling to that country.

#### Phase II Considerations

Much attention now is devoted to locating training camps and areas, identifying training cadres, and interdicting the movement of insurgents to and from out-of-country training areas. Some insurgent units are identifiable as having been trained for special missions, such as reconnaissance, demolition, or even suicide attack missions.

#### LOGISTICS

In an insurgency, as in a conventional warfare situation, the effectiveness of the insurgent is very much dependent on the logistical support. In the early stages of an insurgency, the requirements for military equipment and supplies are less than in the later stages. Accurate intelligence on the insurgent's sources and availability of supplies and equipment is essential to determine the capability to maintain and expand the insurgency.

### Phase I Considerations

Two particular items always are essential to the phase I insurgent--money and a printing press. If highly successful in the establishment and motivation of the power base, the insurgent never really has a requirement for the usual items of military supply. Money is often supplied from abroad, but such occurrences as bank robberies, unusual or excessive fund drives, payroll deduction requests, or sudden affluence among suspect government officials are cause for suspicion. Equipment for the production and dissemination of propaganda, like printing presses and radio sets, is of a special nature, and its acquisition by insurgent forces indicates an increasing level of sophistication in propaganda efforts.

### Phase II Considerations

Logistics is now a larger and more elaborate requirement for the insurgent, who must now procure, store, transport, and maintain weapons, ammunition, explosives, signal equipment, and medical supplies. A much larger number of people are required to operate the logistical system. Insurgent supply caches or supply lines become items of critical concern to friendly forces. Borders and coastlines are controlled and aerial surveillance of remote areas or areas known to be used by the insurgents must be instituted to detect or deter the movement of supplies.

### EFFECTIVENESS

Effectiveness describes the qualitative ability of the insurgent to achieve political or military purposes.

### Phase I Considerations

In phase I, the term "combat effectiveness" is usually not applicable. While the insurgent uses words like "struggle" and "front," they do not connote the use of armed force. The overall effectiveness of the insurgent effort is sometimes made very obvious by spectacular successes (antigovernment victory in an important election) or failures (collapse of a new factory-worker organization known to have been backed by the insurgent). A continuing decline of governmental influence in a certain area or among a certain group of people may well indicate a corresponding increase in insurgent influence. The leaders forbid overt or easily detectable actions until they feel that their movement is in position to make a serious bid for power. In this case, the insurgent's real effectiveness remains unknown until it is too late for anything but a historical account of it. There usually is overt indication of the effectiveness of the insurgent operation, and information on it is gathered by careful observation of organizations, movements, and elections at all levels. Penetration of these activities by government agents is very desirable and makes a significant contribution to the OB picture.

## **Phase II Considerations**

The factor of effectiveness now expands to include combat efficiency of insurgent military forces. By carefully evaluating the other OB factors, and taking note of actual combat experience, we evaluate the insurgent's combat effectiveness or lack thereof. We determine the insurgent's strengths and weaknesses and, from this, calculate the capability to follow various courses of action.

## **PERSONALITIES**

Personalities are not listed as a separate OB factor in Chapter 3. In an insurgency, personalities often assume a greater importance than in mid- and high-intensity conflicts.

### **Phase I Considerations**

In phase I, personalities are an extremely important factor. During this phase, when the insurgency is just beginning to organize, function, and attempt to spread its influence, the loss of a comparatively small number of personnel practically destroys it or at least sets back its progress. Unfavorable publicity attached to the movement, as a result of exposure, renders its success less likely. The apprehension, compromise, or exposure of its leaders destroy the insurgency completely. Knowing who the insurgent leaders are also furnishes a valuable indication of how tactics and training are conducted and how effective the overall effort is.

### **Phase II Considerations**

As in phase I, personalities remain a critical concern. Many insurgent units are cat led by their commander's name, rather than having a conventional designation.

## **ELECTRONIC TECHNICAL DATA**

In the early stages, there is often a lack of uniform communications procedures, preventing the development of an extensive enemy electronic order of battle (EEOB) and electronic technical data base. There is very little use of noncommunications equipment, such as radar. The insurgents often use HF shortwave or ham radio sets to serve the initial "Committee of Correspondence" function. VHF citizen band sets play a role in early terrorist operations. Equipment available to the insurgent ranges from the most primitive to the most modern. Even equipment not generally available in the armed forces of major world powers, like spread spectrum and frequency hoppers, is easily obtained.

### **Phase I Considerations**

The propaganda requirements result in insurgent-sponsored medium frequency or commercial radio AM broadcasts. Transmitters are located outside the national boundaries or in remote, inaccessible areas. These broadcasts frequently use code words to control and coordinate insurgent

operations. Later, there is some increased use of VHF transmissions and more organized communications procedures. The standardization of communications practices reflects the level of communications training expertise.

#### Phase II Considerations

Much more extensive use of communications equipment characterizes this phase. Equipment is captured from government sources, purchased or stolen from commercial sources, provided by external sponsors, or locally manufactured. Communications procedures reflect doctrine and training practices of an external sponsor. Insurgents use repeater transmitters, set to receive and rebroadcast on the same frequency, to degrade VHF DF efforts against them.

#### MISCELLANEOUS

Any other items which contribute to knowledge of the insurgent, such as goals and methods, are considered here.

#### Phase I Considerations

This category includes such items as historical studies of people and parties involved in the insurgency, code names or numbers, and any other information which does not fit under the other eight categories. "This type of information should not be slighted, as seemingly superfluous items may well become useful and important.

#### Phase II Considerations

Several miscellaneous items now become vital adjuncts to the other factors. Weapons, insignia, code names and numbers, types and colors of uniforms and flags--all these things aid in the identification of insurgent units, the source of outside aid, the source of weapons and equipment smuggled into or purchased in the target nations, and the morale and effectiveness of the insurgent armed forces,

#### OB FACTORS SUMMARY

There are three points to remember in the application of OB factors to an insurgency:

- °The nine OB factors previously discussed are iclosely interrelated and cannot be analyzed separately.
- °When an insurgency escalates from a phase I to a phase II situation, the OB effort is expanded considerably. The enemy combat units must now be considered in addition to the various phase I organizations and activities, which still are active.
- °When ah insurgency escalates from a phase II to a phase III situation, the application of the OB factors to the insurgent's combat units is the same as for other conventional forces.

## APPENDIX A

### REPORT FORMATS

The report formats described are standard formats used to report intelligence or information to task assets, or to receive information, intelligence orders, or instructions. These formats are echelon-specific, like the patrol report usually prepared at battalion level, or are general reports used at all echelons, like spot reports.

This appendix provides a brief description of the most common intelligence-related formats, including those formats used to pass information of immediate potential intelligence value from one echelon to another. It also identifies the echelon or echelons where each format is most used and the element or individual responsible for preparing it. An example of each format is also provided. Additional information about report formats is in Chapter 8.

#### SPOT REPORT

The SALUTE mnemonic requires users to report enemy size, activity, location, unit (or uniform), time, and equipment. Figure A-1 shows a spot report using a SALUTE message format.

```
FROM: S2, 67TH INF, 3D BDE
TO: G2 20TH INF DIV

COMBAT OUTPOST NO 26:--A/a/67 PATROL REPORTS SIGHTING FOUR ENEMY
TANKS MOVING WEST ALONG SECONDARY ROAD AT GRID COORD NBB13397 AT
241730Z HR. TANKS TRAVELLING AT APPROX 5 KPH. HATCHES WERE
OPEN AND VISIBLE ENEMY PERSONNEL WERE WEARING PROTECTIVE MASKS.
UNIT MARKINGS WERE NOT VISIBLE BECAUSE THEY WERE COVERED WITH
MUD AND SANDBAGS.
```

Figure A-1. SALUTE messageformat.

#### INTELLIGENCE ESTIMATE

The intelligence estimate consists of five paragraphs. The first paragraph is a restatement of the mission. The remaining paragraphs outline an analysis of the battlefield area based on IPB; an estimate of enemy strengths, capabilities, and limitations; and the intelligence officer's conclusions about the total effects of the AO on friendly courses of action, the courses of action most likely to be adopted by the enemy, and the effects of exploitable enemy vulnerabilities. The five paragraphs are--

° Mission.

° Area of operations.

- ° Enemy situation.
- ° Enemy capabilities.
- ° Conclusions.

#### **MISSION**

Paragraph 1. Describe the mission in a short, clear, and concise restatement of the assigned or assumed mission of the command.

#### **AREA OF OPERATIONS**

Paragraph 2. Discuss what influence the AO has on probable enemy courses of action, based on facts and conclusions derived from IPB and an analysis of the AO if one has been prepared. A previously prepared analysis of the AO also is referenced. However, if previously prepared or other reference material is not contained in this paragraph, it must contain enough information to support the conclusions.

Weather and terrain analysis derived from IPB are always included in the characteristics of the AO. Other characteristics are included if they are important to either force in selecting courses of action to carry out their assigned or assumed mission. These other characteristics are of greater importance in AOs which have large civilian populations and to commands with extensive territorial or CSS responsibilities. Detailed or supporting terrain and weather information is included in an appendix to the intelligence estimate.

Weather or terrain effects on the use of nuclear weapons and chemical and biological agents are discussed when either combatant has the capability to use them. Each description of enemy courses of action includes the possible enemy or friendly use of these weapons, including the impact that weather or terrain conditions has on weapons systems and delivery means.

#### **Weather**

Weather conditions are those factors that impact on current and planned operations. This includes appropriate light data and either a weather forecast or climatic information. When operations cover a long period or are programmed for a future operation, climatic information replaces weather data forecasts. Light data, in tabular form, includes the beginning of morning nautical twilight (BMNT) and beginning of morning civil twilight (BMCT), ending of evening civil twilight (EECT), and the ending of evening nautical twilight (EENT), moonrise, moonset, phases of the moon, and other information as required.

#### **Terrain**

The existing terrain situation includes the tactical aspects of the area: observation and fire, concealment and cover, obstacles, key terrain features, and AAs. Each of these aspects is oriented based on its



influence on selected courses of action by either force. For example, in a CSS unit, the discussion of concealment and cover is oriented toward influence on CSS courses of action, including installation locations required to accomplish the CSS mission and on enemy forces which interfere with the accomplishment of the mission. In CSS unit intelligence estimates, key terrain features are omitted unless the enemy has the capability to seize or control terrain features which materially affect the accomplishment of the mission.

#### **Other Considerations**

Other characteristics which are considered pertinent are sociology, politics, economics, and psychology, science, materiel, transportation, manpower, and hydrography.

The effects of each characteristic of the AO on possible enemy courses of action normally include consideration of weather, terrain, and NBC capabilities, the effects of these on other possible enemy courses of action, and the possible use of particular weapons, methods, techniques, or forces.

The extent of consideration for the factors is limited by the mission. For example, when the mission is offensive, the discussion does not include defensive courses of action. It does, however, include security considerations.

#### **ENEMY SITUATION**

Paragraph 3. Provide information on the enemy which permits later development of enemy capabilities and vulnerabilities. Establish the basis for refining these capabilities into a specific course of action and for determining the probability that the enemy will adopt this course of action.

Paragraph 3 provides the following data on the enemy:

- ° Disposition,
- ° Composition.
- ° Strength.
- ° Recent and present significant activities.
- ° Peculiarities and weaknesses.

#### **Disposition**

Enemy dispositions are the known or estimated locations and sizes of enemy units. References are made to overlays, enemy SITMAPS, or previously published documents when discussing enemy dispositions. However, if these references are not readily available, they (or a copy of them) are attached as appendixes to the intelligence estimate.

## Composition

Composition is O6 data that is used to determine the strength the enemy uses to prevent the accomplishment of the mission. List all the units, including insurgent and guerrilla-type forces that contribute to this. Include such supporting units as air, nuclear delivery, and REC units that also affect the accomplishment of the mission. In determining which enemy units affect mission accomplishment, time and space factors are also considered.

## Strength

Strength is all opposing enemy forces which are logically employed against the command in time to affect the accomplishment of the mission. The total forces listed cannot exceed, but is equal to or less than the total forces listed under composition.

Enemy strength includes committed forces, reinforcements, air assets, and NBC operations. Air or NBC operations units are omitted when the enemy lacks such capabilities.

Committed Forces. Committed forces are those enemy ground maneuver units currently in contact and those ground maneuver units with which imminent contact is expected, regardless of the specific friendly course of action implemented. Designation of enemy forces as committed forces depends on disposition, location, controlling headquarters, and doctrine. For more information on computing enemy strength, see Appendix D.

Reinforcements. Reinforcements are those enemy maneuver units that are not committed in or out of the friendly sector, but react to the friendly course of action in time to influence the accomplishment of the mission. Contact with these units is not expected. Disposition, location, level of control, or other factors are considered in determining which enemy forces are reinforcements.

Enemy Air Capability. The enemy air capability is based upon numbers of enemy aircraft within operational radius, maintenance facilities, expected attrition, ground tactical situation, and other factors. The supporting tactical air force furnishes intelligence on the number of sorties, by type, which the enemy is expected to make within the field army or comparable areas. The estimate is not usually prorated below the field army level. Also, no attempt is made to calculate the number of sorties the enemy can or may make against a subordinate command of the field army or the communications zone (COMMZ). Corps, division, and COMMZ command intelligence officers usually quote the estimate furnished by the higher headquarters in stating enemy air capabilities. For example, a corps or division G2 might state: "30th Army estimates that the enemy can be expected to attack within the army area with as many as 150 fighter, 100 attack, and 75 bomber sorties daily. By massing all aircraft within operational radius, the enemy can make a maximum of 250 fighter, 300 attack, and 250 bomber sorties daily."

Nuclear Weapons and Chemical and Biological Agents. Estimates of enemy NBC capabilities usually are prepared at field army and higher headquarters. Units below field army level usually lack the means to gather the information to make such estimates. They use the estimates of the higher headquarters and modify them with available information.

The determination of enemy NBC operation capabilities is based primarily on estimates of numbers and types of weapons and amount and types of agents available, knowledge of enemy doctrine, past experience, and estimates of enemy capabilities involving the employment of ground troops. As with the enemy air capability, it is rarely feasible to estimate what portion of the available enemy NBC effort is used against a division or corps within a field army or a command in the COMMAZ. It is also rarely feasible to estimate the number of nuclear weapons the enemy is capable of using within a period as short as one day. The period selected is a month or other period depending on the available information and past experience.

The statement of the enemy's capability to use chemical and biological agents includes the amount, type, and delivery means of available chemical and biological agents.

#### Recent and Present Significant Activities

This is a summary of recent and current enemy activities which serve as indicators of future enemy actions. Significant enemy failures to take action also are listed. For example, if the enemy is apparently defending behind a river obstacle but has failed to destroy certain bridges, the omission is listed as a significant activity. Any basis for a belief that the enemy has specific knowledge of the friendly situation or intentions also is listed. For example, a capture by the enemy of an OPORD or a compromise of current signal operating instructions would be noted. For more information on enemy indicators, see Appendix C.

#### Peculiarities and Weaknesses

Briefly discuss each enemy peculiarity and weakness, indicating the extent to which it is a vulnerability and how it affects the selection of broad friendly courses of action. For example, if the enemy has an open flank, the fact is stated under operations. Discuss the extent to which the open flank constitutes an exploitable vulnerability. If enemy reserves are small and poorly positioned to extend the flank, the vulnerability may be great. If the enemy reserves are large and in position to extend the flank or counterattack an enveloping force, the vulnerability is probably insignificant. The G2 might state it as: "The enemy north flank is open. Available reserves are adequate to extend this flank a distance of only about 3,000 meters. Positions to extend the flank have not been prepared. The enemy is vulnerable to a flank attack," Conversely, it might be stated as: "The enemy north flank is open. However, available reserves are adequate either to extend this flank beyond our zone, or to counterattack an enveloping force. Positions suitable to block an attempted envelopment have been prepared as shown on the enemy situation map." In the first statement, the enemy's

vulnerability to a flank attack is carried forward to conclusions of the intelligence estimate. In the second statement, the open flank apparently is not a vulnerability and is not carried any further. Another example: If the guerrilla forces are poorly equipped with antitank means of all types, the fact is stated under logistics, and the extent 'to which this is an exploitable vulnerability is discussed briefly. The intelligence officer might state: "The guerrilla forces in our area are poorly equipped with antitank means. They cannot effectively defend against armored vehicles" The inability to defend against armored vehicles is carried forward as a vulnerability to conclusions of the intelligence estimate. Figure A-2 shows some examples of enemy peculiarities and weaknesses.

PERSONNEL

- Replacement situation (shortages or overages, particularly in specialists) .
- Morale less than excellent, or exceptionally high.
- Disproportionate number of very young or very old men.
- High rate of sickness.
- Percentage of authorized strength, if less than 80 percent.

INTELLIGENCE

- Susceptibility to deception or neutralization of certain enemy information collection agencies.
- Overdependence on one or more categories of information sources.
- Ineffectiveness of enemy intelligence.

OPERATIONS

- Habitual repetition of certain schemes of maneuver, or unconventional patterns of operations.
- Faulty organization of the terrain.
- Faulty disposition of reserves.
- Susceptibility to electronic countermeasures.
- Inadequate troop training, especially in defense against nuclear weapons or chemical agents.
- Lack of adequate mobility.

Figure A-2. Example of typical enemy peculiarities and weaknesses.

- Inadequate air or artillery support, or nuclear weapon delivery systems.
- Pronounced failure to disperse and dig in.
- Habitual failure to attack certain types of targets.

#### LOGISTICS

- Shortages or inadequacies of particular supplies and materiel, including nuclear weapons.
- Status of equipment, if less than 80 percent.
- Large concentrations of supplies.
- Location of vulnerable points and bottlenecks in the logistics system or lines of communications.
- Inability to resupply during action.
- Failure to equip troops with protective masks or protective clothing.

#### CIVIL-MILITARY OPERATIONS

- Hostile attitude toward the civil populace, or of the civil populace toward the enemy.
- Inadequacies in the control of civil communications, to include movement of civilians.

#### PERSONALITIES

- Peculiarities or weaknesses of the enemy commander, major subordinate commanders, or principal staff officers as disclosed by or deduced from their past performance, education, politics, experience, or other basis.

Figure A-2. Examples of typical enemy peculiarities and weaknesses (continued).

#### ENEMY CAPABILITIES

Paragraph 4. List the enemy courses of action which the enemy adopts and which influences the accomplishment of the friendly mission, either favorably or unfavorably. A properly stated enemy capability indicates what the enemy can do, when and where the enemy can do it, and in what strength. For example, "Attack (what) now (when) along our front (where) with five motorized battalions supported by all available nuclear weapons, artillery and air (strength)." Another example: "Conduct harassing operations (what) at any time (when) in our area (where) with about 200 guerrillas equipped only with small arms (strength)."

The evidence considered in the analysis and discussion of enemy capabilities includes characteristics of the AO and positive or negative evidence of enemy activity, listed under recent and present significant activities. A major obstacle across part of the friendly area is evidence that attack elsewhere is more likely. Low ceilings and low visibility are evidence that the enemy is not using all available aircraft. Open, flat areas without any appreciable cover are evidence that the enemy does not use guerrilla or infiltration forces.

In analyzing and discussing each enemy capability or appropriate combination, the intelligence officer judges from the enemy point of view the advantage or disadvantage of adopting the capability. In making this judgment, the G2 or S2 also considers enemy doctrine and practices and the ultimate results of adopting or rejecting the particular capability. For example: "Employment of the unidentified tank division at TNOMYEH deprives the enemy of the reserves needed to counterattack a penetration by either of the two friendly divisions to our south. Commitment of this tank division too early will result in the later defeat of the enemy."

If there is no evidence of the enemy's possible adoption of a particular capability and the capability does not represent a major threat to the accomplishment of the mission, the intelligence officer does not judge it. For example, the enemy usually withdraws beyond our objective. Ordinarily, such withdrawal is not a threat to the accomplishment of the mission. If there is no evidence that the enemy withdraws, a statement of conclusions is omitted. The intelligence officer states: "There is no indication of withdrawal. "

#### CONCLUSIONS

Paragraph 5. State the intelligence officer's estimate of the--

° Total effects of the AO on friendly courses of action.

° Courses of action most likely to be adopted by the enemy, including their relative probability of adoption.

° Effects of enemy vulnerabilities that can be exploited.

For a defensive mission, conclusions identify the best defense areas and the best AAs into the defense sector. For an offensive mission, the conclusion describes the best AA to the objectives.

Determine the enemy probable courses of action by the previous analysis and discussion of enemy capabilities. Consider how the enemy views the vulnerabilities as indicated by doctrine, past experiences, and the personality of the enemy commander. Consider previous enemy courses of action selected under similar circumstances. The determination is objective and not an unsubstantiated guess at what the enemy will do.

In determining the relative probability of adoption of enemy courses of action, the intelligence officer avoids conclusions based on friendly doctrine and practices. The officer considers the available evidence, to

include the enemy doctrine and practices, as well as positive or negative enemy activity, If enemy activity is not definitive enough to justify selection of the enemy's most probable course of action, the officer determines the most probable one based on the characteristics of the AO, enemy doctrine, practices, and previous experiences.

In the statement of the courses of action most likely to be adopted by the enemy, several capabilities are combined for brevity and clarity. However, all of the enemy capabilities combined in one statement are capable of being implemented at the same time. For example, the most probable enemy course of action is to: "Attack to envelop our northern flank, reinforced by corps reserve and using all available nuclear weapons, artillery, and air support; and conduct harassing operations in our rear areas with guerrillas and infiltrating forces. "

If more than one enemy course of action is stated, they are listed in the order of their probability of adoption.

An enemy vulnerability is any condition or circumstance of the enemy situation or the AO which makes the enemy especially liable to damage, deception, or defeat. Only those enemy weaknesses which are exploited are considered. In studying the enemy peculiarities and weaknesses to determine such vulnerabilities, the characteristics of the AO, all aspects of the enemy situation, and the enemy's doctrine and practices are considered. Only actual vulnerabilities are presented. An open northern flank which the enemy cannot, with available forces, extend or defend, is a vulnerability. If, however, the enemy has reserves which readily extend the flank to an impassable obstacle or counterattack to pin enveloping troops against that obstacle, the open flank is mentioned as a possible vulnerability, although the vulnerability may be eliminated by commitment of the enemy reserves. However, the commitment of reserves creates another vulnerability.

Each exploitable enemy vulnerability is listed as a brief statement of the effect of the vulnerability rather than a repetition of the peculiarity or weakness. For example: "Shortage of antitank means" is not stated. Instead, the effect of that weakness is given by stating: "Limited capability to oppose armored vehicles. " If the enemy's north flank is vulnerable, it could be stated as: "Enemy northern flank open to envelopment subject to destruction of enemy reserves at . . . ."

In determining enemy vulnerabilities, the G2 or S2 considers the feasibility of their exploitation and makes appropriate recommendations to the G3 or S3. All enemy vulnerabilities are not exploited at the same time. The exploitation of one vulnerability precludes the exploitation of another vulnerability.

For example, the enemy is vulnerable to both a night penetration and a daytime flank envelopment. The G3 or S3, in coordination with the G2 or S2, recommends to the commander the priority of vulnerabilities to be exploited. Based on the information in this appendix and in Chapter B, Figures A-3 through A-5 show the formats for the annotated intelligence estimate, sample intelligence estimate for a division, and an annotated intelligence estimate for stability operations.





(Classification)

(Short title identification)

(2) Effect on enemy courses of action. Describe in the same manner as for the effects of weather in a(2) above. For defensive courses of action, state the best defense area and the best AAs leading to it. For attack courses of action, state the best AAs.

(3) Effect on own courses of action. Describe in the same manner as for effects of weather in a(3) above.

c. Other Characteristics. The following additional characteristics considered pertinent are included in separate subparagraphs: sociology, politics, economics, psychology, and other factors. Other factors may include such items as science and technology, materiel, transportation, manpower, and hydrography. These factors are analyzed using the same subheadings as weather and terrain.

3. ENEMY SITUATION. This paragraph gives information on the enemy which will permit later development of enemy capabilities and vulnerabilities and refire ment of these capabilities into a specific c ourse of action and its relat ve probability of adoption.

a Disposition. Reference may be made to over ays, enemy situation maps, or previously publ ished documents.

b Composition. Summarize enemy OB that can influence accomplishment of the mission. Reference may be made to previously published documents. Special mention is made of units capable of EW, low-intensity operations, and other special operations, as appropriate.

c. Strength. Enemy strength is listed as committed forces, reinforcements, air assets, nuclear weapons, and chemical and biological agents. The purpose of this listing is to assist in developing enemy capabilities and vulnerabilities for use by the commander and staff in selecting courses of action. The unit mission, location of the enemy, enemy doctrine, and the level of command at which the estimate is being prepared are factors to be considered.

(Classification)

Figure A-3. Annotated intelligence estimate (continued).

(Classification)

(Short title identification)

(1) **Committed forces.** List those enemy ground maneuver units currently in contact and those ground maneuver units with which imminent contact can be expected, regardless of the specific friendly course of action implemented. Designation of enemy forces as committed forces depends on disposition, location, controlling headquarters and doctrine. The intelligence officer usually accounts for committed forces based on the size unit doctrinally used to oppose the friendly unit. Generally, enemy units are counted in terms of units two echelons below the friendly unit's size (for example, a brigade S2 normally considers committed forces in terms of companies; a division G2, in terms of battalions; and a corps G2, in terms of regiments). If there is doubt whether a unit is a committed force or a reinforcement, it is considered a reinforcement.

This attributes to the enemy the maximum capability to reinforce forces to oppose a given friendly course of action.

(2) **Reinforcements.** Include designation and location. Reinforcements are those enemy maneuver units that may or may not be employed against us, depending on our choice of a specific course of action and enemy plans. Reinforcements are enemy units not committed in or out of the friendly sector, but which can react to the friendly course of action, subject to time and distance considerations, in time to influence the accomplishment of the mission. Imminent contact is not expected. Disposition, location, level of control, or other factors at the time of the estimate are considered in determining which enemy forces are reinforcements.

(3) **Air.** List the number of enemy aircraft by type within operational radius. Include the number of possible sorties per day by type of aircraft, if known.

(4) **Nuclear weapons and chemical and biological agents.** Estimate, as appropriate, the number, type, yield, and delivery means of enemy nuclear weapons and chemical and biological munitions or agents available to the enemy.

d. **Recent and Present Significant Activities.** List selected items of information to provide bases for analyses to determine relative probability of adoption of specific courses of action and enemy vulnerabilities. Enemy failures to take expected actions are listed, as well as positive information.

(Classification)

Figure A-3. Annotated intelligence estimate (continued).

(Classification)

(Short title identification)

e. Peculiarities and Weaknesses. Based on knowledge of enemy tactical doctrine, practices, the principles of war, the AO, and the enemy situation previously described and discussed, list peculiarities and weaknesses, and briefly describe each, indicating the extent to which they may be vulnerable and how they influence possible friendly courses of action. The items listed are grouped under the headings indicated below. Only pertinent headings are used.

(1) Personnel. An estimate of strength usually is included if less than 80 percent of authorized strength. Status of morale is included, if known.

(2) Intelligence. An estimate of enemy intelligence success, ineffectiveness, and susceptibility to deception and detection is usually included.

(3) Operations. An estimate of combat effectiveness is usually included if less than excellent.

(4) Logistics. An estimate of the enemy's capability to support their forces logistically is included if there are apparent weaknesses.

(5) Civil-military operations. An estimate of the attitudes of the enemy and the civilian populace and the status of food supply, medical facilities, communications, and other critical resources is usually included.

(6) Personalities. An estimate of the capabilities and or weaknesses of the enemy commander and principal staff officers usually is included.

4. ENEMY CAPABILITIES. Based on all the previous information and analyses, develop and list enemy capabilities. The listing provides a basis for analyzing the available information to arrive at those capabilities the enemy can adopt as specific courses of action and their relative probability of adoption.

a. Enumeration. State what, when, where, and in what strength for each capability.

(Classification)

Figure A-3. Annotated intelligence estimate (continued).

(Classification)

(Short title identification)

b. **Analysis and Discussion.** To provide a basis for conclusions of enemy capabilities and their relative probability of adoption, each capability, or appropriate combination thereof, is discussed in a separate subparagraph. Consideration of enemy deception measures is included. All the pertinent previous information and conclusions are tabulated as either supporting or rejecting the adoption of the capability. After listing all the evidence, each capability is judged from the enemy point of view of whether the adoption of the capability is advantageous to the enemy. Such judgments need not be made if the conclusion is obvious or if there is no evidence that the enemy will adopt the capability, except when the capability is one that will make the accomplishment of the friendly mission highly doubtful or impossible. This exception is to focus attention on dangerous threats.

5. **CONCLUSIONS.** Based on all the previous information and analyses, conclusions are stated concerning the total effects of the AO on friendly courses of action; the courses of action most likely to be adopted by the enemy, including their relative probability of adoption; and the effects of enemy vulnerabilities that can be exploited. These conditions assist in the selection of a friendly course of action.

a. **Effects of Intelligence Consideration on Operations.** Indicate whether the mission set forth in paragraph 1, above, can be supported from the intelligence standpoint. Indicate which courses of action can best be supported.

b. **Effects of the AO on Own Courses of Action.** For attack courses of action, indicate the best AAs. For defensive courses of action, indicate the best defense areas and the best AAs leading to and into the defense areas. (This subparagraph is omitted if the discussion of the effects of the area on own courses of action in paragraph 2 has been omitted because of the availability of a current analysis of the AO.)

c. **Probable Enemy Courses of Action.** List courses of action in order of relative probability of adoption. A listed course of action may include several subordinate courses of action that can be executed concurrently. Usually, no more than two or three courses of action, in order of probability of adoption, can be justified by the available evidence.

(Classification)

Figure A-3. Annotated intelligence estimate (continued).

(Classification)

(Short title identification)

d. Enemy Vulnerabilities. List the effects of peculiarities and weaknesses that result in vulnerabilities that are exploitable at own, higher, or lower levels of command. The order in listing these vulnerabilities has no significance.

/s/ (Designation of staff officer)

OFFICIAL:

G2's Signature Block

Annexes (as required)

Distribution:

(Classification)

Figure A-3. Annotated intelligence estimate (continued).

(Classification)

Copy --- of --- Copies  
G2 Section, 52d Division (Mech)  
GLENVILLE (NF3277), EASTLAND  
2308302 June 19  
Msg Ref No. -

**INTELLIGENCE EST MATE NO 20**

Reference: Map, series East and, sheets Delta through Kilo, edition 2, 1:50,000 Time Zone Used Throughout the Estimate: Zulu.

1. **MISSION.** 52d Div defends along Dry Creek and prepares to attack on order.

2. **AREA OF OPERATIONS.**

a. **Weather.**

(1) Existing situation. Weather for the period 23 to 28 June will be rainy and cool, gradually warming and clearing as a high pressure system moves through the AO from the south. Temperatures from 40 to 65°F. Visibility will range from 16 to 25 kilometers, except during precipitation and in morning fog in low drainage areas. Surface winds from the south at 8 to 10 knots.

Date	BM- NT	BM- CT	EE- CT	EE- NT	Moon- rise	Moon- set
23 June	0331	0419	2029	2130	1746	0125
25 June	0339	0422	2025	2124	1907	0214
27 June	0344	0425	2022	2118	2001	0518
28 June	0349	0428	2018	2112	2022	0820

(2) Effects on enemy courses of action:

(a) Precipitation will not hinder cross country movement except in the low drainage areas of Minertown.

(b) Southerly winds will not affect enemy employment of NBC.

(c) Low visibility during precipitation and morning fog will favor enemy attack.

(3) Effects on friendly courses of action:

(Classification)

Figure A-4. Sample division intelligence estimate.

(Classification)

(a) Precipitation will not hinder cross country movement except in the low drainage areas of Minertown.

(b) Southerly wind direction will not affect friendly use of chemical or nuclear weapons.

(c) Low visibility during precipitation and morning fog will not favor friendly defense.

b. Terrain.

(1) Existing situation.

(a) Cover and concealment. Wooded areas around Midway offer good concealment. Numerous ravines in drainage areas of Minertown offer limited cover and concealment.

(b) Observation and fire. There are good observation points along bluffs above Gringo River. Fields of fire are excellent throughout plains areas north of Mud Creek but limited moderately in populated and vegetated areas near Glenville.

(c) Obstacles.

1 Swift River (fordable 1 km east of Glenville).

2 Bluffs above Gringo River.

3 City of Glenville. Routes around city are passable; routes through city impassable.

(d) Key terrain. Hill mass Jackson and Hill 333.

(e) AAs.

1 Available to the enemy into our sector:

a AA 1 is from Largo through gap around the northeast end of HILL 702, 34 km southwest to Minertown and south to Dry Creek.

b AA 2 is from Largo southeast through Midway to river crossing east of Glenville.

(Classification)

Figure A-4. Sample division intelligence estimate (continued).





(Classification)

**c. Strength.**

(1) Committed forces. 52d Div (Mech) is opposed immediately by four mechanized battalions and one tank battalion. These units are supported by normal divisional and regimental artillery groups.

(2) Reinforcements. Reinforcements available to the enemy for commitment in our zone are a total of five MRB and four tank battalions from the 27th MRR, 121st Tk Regt, and the second-echelon battalions of the 30th and 31st MRRs and the 37th Tk Regt. Also, the 23d MRR can totally reinforce within 8 hours from start of movement.

(3) Air. Enemy is supported by the 3d Air Army consisting of unidentified numbers of fighter-bomber aircraft, ground attack aircraft, and reconnaissance aircraft. Air parity currently exists with either force capable of obtaining air superiority for limited periods of time. Up to now enemy has used a maximum of 60 fighter-bomber sorties in a 12-hour period.

(4) Nuclear. No estimate of the enemy's nuclear support for the next 30 days is available. Enemy currently has 152mm Gun-Hows with nuclear rounds and SSMS which can deliver rounds of 10-50 kt yield within range of our division.

**d. Recent and Present Significant Activities.**

(1) Air reconnaissance and photo reports indicate increased enemy movement along axis Bravo to Limo. Movement indicates reinforcement of forward element of 4th CAA.

(2) Enemy's aerial recon and tactical air flights have increased in the last 36 hours, particularly along the line of contact.

(3) For the past 36 hours, volume of vehicular traffic has increased in southerly direction.

(4) Artillery fire from the enemy has become more intensive in the last 24 hours.

(5) Reliable source reports large tracked, amphibious vehicles moving into area vicinity Hill 805.

(Classification)

**Figure A-4. Sample division intelligence estimate (continued).**

(Classification)

(6) Enemy has begun to employ smoke along the forward slope of Hill 702.

e. Peculiarities and Weaknesses.

(1) Personnel. Enemy units are currently estimated to be at 85 to 90 percent authorized strength. Morale is high, although replacements may not be highly trained.

(2) Intelligence. Enemy stresses communications security and subordinate units of the 4th CAA have recently initiated intensive radio security and procedures training.

(3) Operations.

(a) Enemy is susceptible to mine warfare and antitank weapons.

(b) Enemy has trained heavily on attack formations and has been told offensive action is the only way to victory.

(c) Enemy is vulnerable to nuclear weapons due to massed forces and canalization by further advancement.

(4) Logistics. Supplies are adequate for the enemy's conduct of either the offense or defense. The enemy had previously stockpiled supplies well forward in division areas.

(5) Personalities. GD Masonski, CG of the 10th MRD, is an advocate of penetration type offense on a narrow front with subsequent widening of the gaps to split enemy forces.

4. ENEMY CAPABILITIES.

a. Enumeration:

(1) Attack at any time along AA 1 with four MRBs and one tank battalion supported by normal divisional and regimental artillery groups.

(2) Attack at any time along AA 2 with four MRBs and one tank battalion supported by normal divisional and regimental artillery groups.

(Classification)

Figure A-4. Sample division intelligence estimate (continued).

(Classification)

(3) Defend at any time with forces in contact supported by all available divisional and regimental artillery groups.

(4) Reinforce the attack or defense with all or part of the following units at the places and times indicated:

	<u>UNIT</u>	<u>PLACE</u>	<u>TIME</u>
(a)	30th MRR(-)	AA 2	immediately
(b)	31st MRR(-)	AA 1	immediately
(c)	37th Tk Regt (-)	AA 1	immediately
(d)	27th MRR	AA 1 or 2	2 hr after start of movement
(e)	23d MRR	vic Little	8 hr after start of movement
(f)	121st Tk Regt	Unlocated	Unknown
(g)	U/I MRR of 19th MRD	vic Bravo	9 hr after start of movement

(5) Delay in successive positions to the east of Little.

(6) Employ chemical agents within our sector at any time.

(7) Employ nuclear weapons of a 0.5-50 kt yield with delivery by artillery or SSM.

(8) Employ guerrilla forces in our rear area either alone or in communication with the capabilities enumerated below.

(9) The enemy can attack our area with an undetermined number of fighter, ground attack, and bomb sorties daily. The maximum number of daily sorties mounted in our area has been 60.

(Classification)

Figure A-4. Sample division intelligence estimate (continued).

(Classification)

b. Analysis and Discussion.

(1) Attack along AA 1.

(a) The following indicate adoption of this capability:

1 Uses a good AA.

2 The enemy is massing mechanized elements, tanks, artillery and logistic support along this avenue.

3 Forward elements disposed on a relatively narrow front.

4 Extensive artillery preparation along approach.

(b) The scant cover presented along this AA is a limiting factor but does not preclude adoption of this capability.

(2) Attack along AA 2.

(a) The following indicate adoption of this capability:

1 The enemy is massing mechanized elements, tanks, artillery and logistic support along this avenue.

2 Forward elements disposed on a relatively narrow front.

3 Extensive artillery preparation along this avenue.

(b) The following indicate rejection of this capability:

1 This AA accommodates only one deployed regiment and offers limited cover and concealment.

2 The limited obstacle presented by Glenville.

(3) Defend. The following indicate rejection of this capability:

(a) The enemy is massing forces along the line of contact.

(b) Enemy has followed known doctrine for attack.

(Classification)

Figure A-4. Sample division intelligence estimate (continued).

(Classification)

(c) Terrain favors attack.

(4) Reinforce. The following indicates adoption of this capability:

(a) Movement of additional troops toward the front.

(b) New units identified in the combat zone.

(c) Forward logistical buildup.

(5) Delay. There are no indications of the enemy's adoption of this capability.

(6) Employ chemical agents. There is no indication the enemy will employ chemical agents other than smoke.

(7) Employ nuclear weapons. There is no indication the enemy will employ nuclear weapons.

(8) Employ guerrilla forces. The following indicates adoption of this capability:

(a) Doctrine calls for use of guerrilla force.

(b) Use would enhance enemy advance by creating panic and confusion.

(9) Air attack. Indications are that enemy will continue to employ this capability as referenced in paragraph (9) above.

**5. CONCLUSIONS.**

a. Intelligence. Available intelligence indicates that the division can accomplish its mission. Intelligence supports adoption of the division course of action.

b. Weather and Terrain. The weather and terrain favors our defense. The best defensive area is the high ground east of Dry Creek. The best AA into our defensive sector is AA 1.

c. Probable Enemy Courses of Action.

(Classification)

Figure A-4. Sample division intelligence estimate (continued).

(Classification)

(1) Attack with forces in contact supported by air and artillery with the main attack of one mechanized regiment along AA 1. Will reinforce with elements as indicated in para 4a(4).

(2) Conduct secondary attack with forces in contact supported by air and artillery with one mechanized regiment along AA 2.

(3) Employ guerrilla or special forces in our rear areas in conjunction with the above courses of action.

d. Enemy Vulnerabilities.

(1) The enemy is vulnerable to counterattack due to slowness to exploit potential penetrations.

(2) Vulnerable to nuclear attack due to massing of troops and concentrated logistics depots.

(3) Mine warfare will be effective against mechanized elements.

KROOK

BG

OFFICIAL:

/s/ Bagger

BAGGER

GS

Annex: A--Situation Overlay (omitted)

Distribution: A

(Classification)

Figure A-4. Sample division intelligence estimate (continued).



(Classification)

d. Sociology (Includes minority groups and social programs.)

(1) Existing situation.

(2) Effect on insurgent courses of action.

(3) Effect on government courses of action.

e. Psychology. (Includes behavior patterns and motivating factors.)

(1) Existing situation.

(2) Effect on insurgent courses of action.

(3) Effect on government courses of action.

3. THE INSURGENT SITUATION. (This paragraph discusses the insurgent organization and its activities.)

a. Organization and Leadership. (Includes composition.)

(1) Nonmilitary. (Includes the underground.)

(2) Military. (Includes all insurgent armed elements.)

b. Strength and Disposition.

(1) Nonmilitary.

(2) Military.

c. Recent and Present Significant Activities.

(1) Nonviolent action. (Includes political, economic, sociological, and psychological action.)

(2) Terrorist action. (Includes murder, torture, extortion, kidnapping, and sabotage.)

(3) Guerrilla operations. (Includes harassment, destruction, interdiction, and dispersion.)

(Classification)

Figure A-5. Annotated Intelligence estimate for stability operations [continued].



(Classification)

(4) Conventional tactical operations. (Includes attack, defense, clay, and withdrawal.)

d. Strengths and Weaknesses.

(1) Recruitment and retention.

(2) Intelligence and security.

(3) Organization and training.

(4) Finance and logistics.

(5) Communications.

4. INSURGENT CAPABILITIES. (This paragraph lists current insurgent capabilities and discusses them in regard to probability of adoption.)

a. Enumeration. (Includes what, where, when, and how for each capability.)

(1) Basic capabilities.

(a) Nonviolent action.

(b) Terrorist action.

(c) Guerrilla operations.

(d) Conventional tactical operations.

(e) Employment of chemical, biological, or nuclear weapons.

(2) Supporting capabilities.

(a) Intelligence and security.

(b) Recruitment and retention.

(c) Organization and training.

(d) Finance and logistics.

(Classification)

Figure A-5. Annotated intelligence estimate for stability operations (continued).



INTELLIGENCE ANNEX TO THE OPORD OR OPLAN

The intelligence annex disseminates information about enemy forces which is essential to the conduct of the operation and to give any other necessary intelligence orders or guidance for the operation(s) in question. It also serves as a medium for instructing subordinate commanders to acquire information necessary for the conduct of the operation but which can only be obtained immediately before or when the operation itself has begun. The intelligence annex is not a substitute for an intelligence collection plan; rather it is a way to communicate the taskings and requests of the collection plan.

The intelligence annex is a formal intelligence tasking document that accompanies an OPLAN or OPORD. It should be as brief as possible consistent with clarity. Its first paragraph is a summary of the enemy situation required to understand the OPLAN or OPORD and refers to annotated maps, enemy situation overlays, or current intelligence reports. Subsequent paragraphs contain specific collection requirements and instructions. SOP information should not be repeated in the intelligence annex. Figures A-6 and A-7 show a general intelligence annex format and division intelligence annex example.

<hr/> <p>(Classification)</p>
<p>(Change from oral orders, if any)</p>
<p>Copy no — of —Copies Issuing headquarters Place of issue (may be in code) Date-time group of signature Message reference number</p>
<p>ANNEX (INTELLIGENCE) to OPERATION ORDER NO _.</p>
<p>References: Maps, charts, and other relevant documents.</p>
<p>Time Zone Used Throughout the Order: Zulu</p>
<p>1. SUMMARY OF ENEMY SITUATION. Information about enemy forces essential in implementing the operation plan. When the amount of detail makes it appropriate, a brief summary and reference to the appropriate intelligence document, or appendix to the annex, may be used. Reference to documents not included in the annex should not be made when they are not available to all recipients of the annex.</p>
<hr/> <p>(Classification)</p>

Figure A-6. Intelligence annex format.

(Classification)

2. **INTELLIGENCE REQUIREMENTS.** List each PIR in a separate subparagraph. If a priority has been assigned to the PIR list in order, so state. In a final subparagraph, list IRs, if any. If an intelligence annex is not prepared or is distributed separately from the basic order, PIR should be listed in the coordinating instructions subparagraph of the OPORD.

3. **INTELLIGENCE ACQUISITION TASKS.**

a. **Orders to Subordinate and Attached Units.** List, by unit, in separate numbered subparagraph, detailed instructions for reports required by the issuing headquarters. Units are listed in the same order as they are listed in the OPORD.

b. **Requests to Higher, Adjacent, and Cooperating Units.** List in a separate numbered subparagraph requests for information from units not organic or attached.

4. **MEASURES FOR HANDLING PERSONNEL, DOCUMENTS, AND MATERIEL.** This paragraph contains instructions about the operation that are not contained in SOP or that modify or amplify SOP for the current operation. Examples include--

a. **EPWs, Deserters, Repatriates, Inhabitants, and Other Persons,** Special handling and segregation instructions. Location of EPW collection point as provided by the provost marshal.

b. **Captured Documents.** Instructions for handling and processing of captured documents from time of capture to receipt by specified intelligence personnel .

c. **Captured Materiel.** Designation of items or categories of enemy materiel for examination, and specific instructions for their processing and disposition.

5. **DOCUMENTS OR EQUIPMENT REQUIRED.** This paragraph lists, in each category, the conditions under which certain documents or equipment required by or allocated to units can be obtained or requested. Items may include air photographs and maps.

6. **COUNTERINTELLIGENCE.**

a. This paragraph is covered largely by SOP. Many special operational instructions having CI aspects are listed in the OPORD or in other annexes.

(Classification)

**Figure A-6. Intelligence annex format (continued).**



(Classification)

(Change from oral orders, if any)

Copy 4 of 5 Copies  
20th Inf Div  
Zelle (4671), Buttano  
101900Z Sep 45  
BQ 13

Annex A (Intelligence) to Operations Order 24  
Reference: Map, Buttano, Edition 2, 1:50,000 sheets 204 (Zelle-Pagt).  
Zulu Time

1. SUMMARY OF ENEMY SITUATION. See INTSUM, this HQ, 101800Z  
September, and Appendix 1, Situation Overlay.

2. INTELLIGENCE REQUIREMENTS.

a. PIR.

(1) Will enemy reinforce the forces along the Flood River before the time of attack? If so, when, where, and with what forces? Special attention to the mechanized regiment and the medium tank regiment in vicinity of Burg.

(2) Will enemy employ nuclear weapons against us? If so, when, where, how many, of what yields, and by what delivery means?

b. IR.

(1) Will enemy continue to defend in the present position? if so, how will forces on the ground be organized, and with what troops? Special attention to locations and activities of reserves and vulnerability to nuclear attack.

(2) Will enemy attack prior to 110500Z September? If so, when, where, and in what strength? Special attention to the axis Hill 536--Hill 524--CR9841.

(3) Will enemy use CB agents? If so, what agents, when, how, and where?

(Classification)

Figure A-7. Sample of a division intelligence annex.

(CLASSIFICATION)

4. INTELLIGENCE ACQUISITION TASKS.

a. Orders to Attached and Subordinate Units.

(1) 1st Bale.

(2) 2d Bale.

(a) Report as obtained.

1 Status of construction of defensive positions and minefields on and to the east of the Flood River.

2 Location and size of ammunition storage sites and location, size, and content of engineer equipment parks.

3 Clearing of lanes through obstacles within enemy position in division zone.

4 Number, size, and composition of enemy patrols, and time they were observed.

5 Activity and size of units blocking our patrolling in forward areas.

6 The interception of enemy patrols equipped for CB activity.

7 The presence of enemy troops carrying protective masks or wearing protective clothing.

(b) Report as obtained. Negative reports by 110400Z September.

1 Activity in medium tank regiment (-) and tank battalion assembly area in vicinity of Burg.

2 Location and activity of mechanized regiment in vicinity of Burg.

(3) 3d Bale.

(a) Report as obtained--

(Classification)

Figure A-7. Sample of a division intelligence annex (continued)

(Classification)

1 Activity of mechanized battalion north and east of CR9847.

2 Activity of mechanized battalion on Hill 503.

3 Status of construction of defensive positions and minefields on and to the east of Flood River.

4 Location and size of ammunition storage sites and location, size, and content of engineer equipment parks.

5 Clearing of lanes through obstacles within enemy position in division zone.

6 Number, size, and composition of enemy patrols and time they were observed or contacted.

7 Activity and size of units blocking our patrolling in forward areas.

8 The interception of enemy patrols equipped for CB activity.

9 The presence of enemy troops carrying protective masks or wearing protective clothing.

(b) Report as obtained--Negative reports by 110400Z September.

1 Activity in medium tank regiment (-) and tank battalion assembly area in vicinity of Burg.

2 Location and activity of mechanized regiment in vicinity of Burg.

(4) 1/21 Cav report as obtained--

(a) Activity of mechanized battalion on Hill 503.

(b) Status of construction of defensive positions and minefield on and to the east of the Flood River.

(c) Location and size of ammunition storage sites and location, size, and content of engineer equipment parks.

(Classification)

Figure A-7. Sample of a division intelligence annex (continued).



(Classification)

(d) Clearing of lanes through obstacles within enemy position in division zone.

(e) Number, size, and composition of enemy patrols, and time they were observed.

(f) Activity and size of units blocking our patrolling in forward areas.

(g) The interception of enemy patrols equipped for CB activity.

(h) The presence of enemy troops carrying protective masks or wearing protective clothing.

(5) Div Arty.

(a) Report as obtained--

1 Status of construction of defensive positions and minefield on and to the east of Flood River.

2 Clearing of lanes through obstacles within enemy position in division zone.

3 Number, size, and composition of enemy patrols, and time they were observed or contacted.

4 Activity and size of units blocking our patrolling in forward areas.

5 The interception of enemy patrols equipped for CB activity.

(b) Report as obtained--Negative reports by 110400Z September. Locations of artillery positions, including number of weapons, caliber, and state of preparation of position.

(6) 20 Avn.

(a) Report as obtained--

1 Activity of mechanized battalion north and east of CR9847.

Classification

Figure A-7. Sample of a division Intelligence annex (continued).

(Classification)

2 Activity of mechanized battalion on Hill 503.

3 Location, size, and type of unit in vicinity of Hill 536 (north of Burg) .

4 Status of construction of defensive positions and minefields on and to the east of Flood River.

5 Location and size of ammunition sites, location, size, and content of engineer equipment parks.

6 Preparation of emplacements suitable for, and presence of equipment appropriate to, atomic demolition munitions (ADM).

7 The interception of enemy patrols equipped for CB activity.

(b) Report as obtained--Negative reports by 110400Z September.

1 Movement on the following roads:

a North on Highway 25.

b West on Highway 2.

c West on Highway 4.

2 Activity in medium tank regiment (-) and tank battalion assembly area in vicinity of Burg.

3 Location and activity of mechanized regiment in vicinity of Burg.

4 Location of artillery positions, including number of weapons, caliber, and state of preparation of positions.

(7) 20 Engr report as obtained--

(a) Status of construction of defensive positions and minefields on and to the east of Flood River.

(b) The interception of enemy patrols equipped for CB activity .

(Classification)

Figure A-7. Sample of a division intelligence annex (continued).

(Classification)

b. Requests to Higher, Adjacent, and Cooperating Units.

(1) 1st Corps is requested to provide:

(a) As obtained--

1 Location, size, and type of unit in vicinity of Hill 536 (north of Burg).

2 Number, types, direction of movement, and time of movement of air or surface vehicular traffic within the division zone, with special attention to Highway 2.

3 Troop concentrations, including types of vehicles, east of Highway 25 within the divisional area of interest.

4 Evidence of field fortifications and troop concentrations along the following lines:

a Hill 503--CR9847.

b Hill 518--Hill 536--Hill 499.

5 Location and size of ammunition storage sites and locations, size, and content of engineer equipment parks.

6 Instances of heavily guarded vehicular movement. Special attention to Highway 2 from Zilch to Burg.

7 Areas under unusual security restrictions in the divisional area of interest.

8 Presence of special security troop units in any area east of Highway 25.

9 Any location in the divisional area of interest from which civilians have been evacuated.

10 Launcher sites for guided missiles or rockets within divisional area of interest.

11 Preparation of emplacements suitable for, and presence of equipment appropriate to, ADM.

(Classification)

Figure A-7. Sample of a division intelligence annex (continued).

(Classification)

12 The interception of enemy patrols equipped for CB activity.

13 All CB supply movement and dumping in zone.

14 The presence of enemy troops carrying protective masks or wearing protective clothing.

(b) As obtained--Negative reports by 110400Z September.

1 Movement on the following roads:

a North on Highway 25.

b West on Highway 2.

c West on Highway 4.

2 Activity in medium tank regiment (-) and tank battalion assembly area in vicinity of Burg.

3 Location and activity of mechanized regiment in vicinity of Burg.

4 Location and activity of mechanized regiment southwest of CR9944.

5 Locations of artillery positions, including number of weapons, caliber and state of preparation of positions.

6 Command posts, supply points, and medical facilities east of Highway 25.

(2) 18 Inf Div is requested to provide--

(a) As obtained--

1 Troop concentrations, including types of vehicles, east of Highway 25 within the divisional area of interest.

2 Instances of heavily guarded vehicular movement; special attention to Highway 2 from Zilch to Burg.

(Classification)

Figure A-7. Sample of a division intelligence annex (continued).

(Classification)

3 Areas under unusual security restrictions in the divisional area of interest.

4 Presence of special security troop units in any area east of Highway 25.

5 Any location in the divisional area of interest from which civilians have been evacuated.

6 Launcher sites for guided missiles or rockets within divisional area of interest.

7 Locations of heavy artillery positions, including number of weapons, caliber, and state of preparation of positions.

8 Preparation of emplacements suitable for, and presence of equipment appropriate to, atomic demolition munitions (ADM).

9 The interception of enemy patrols equipped for chemical biological (CB) activity.

10 All CB supply movement and dumping in zone.

11 The presence of enemy troops carrying protective masks or wearing protective clothing.

(b) As obtained--Negative reports by 110400Z September.

1 Movement on the following roads:

a North on Highway 25.

b West on Highway 2.

c West on Highway 4.

2 Location and activity of mechanized regiment in vicinity of Burg.

(3) 52 Mech Inf Div is requested to provide as obtained--

(a) Troop concentrations, including types of vehicles, east of Highway 25 within the divisional area of interest.

(Classification)

Figure A-7. Sample of a division intelligence annex (continued).

(Classification)

(b) Instances of heavily guarded vehicular movement, special attention to Highway 2 from Zilch to Burg.

(c) Areas under unusual security restrictions in the divisional area of interest.

(d) Presence of special security troop units in any area east of Highway 25.

(e) Any location in the divisional area of interest from which civilians have been evacuated.

(f) Launcher sites for guided missiles or rockets within divisional area of interest.

(g) Locations of heavy artillery positions, including number of weapons, caliber, and state of preparation of positions.

(h) Preparation of emplacements suitable for, and presence of equipment appropriate to, ADM.

(i) The interception of enemy patrols equipped for CB activity.

(j) All CB supply movement and dumping in zone.

(k) The presence of enemy troops carrying protective masks or wearing protective clothing.

(4) Supporting MI units provide information obtainable from SIGINT and ESM and will respond to specific tasking as described in separate instructions.

4. MEASURES FOR HANDLING PERSONNEL, DOCUMENTS, AND MATERIEL (see division SOP).

5. DOCUMENTS AND EQUIPMENT REQUIRED.

a. Maps. SOP distribution of map, Buttano, 1:50,000, Zelle-Pagt.

b. Photographic. Following aerial photographs will be furnished:

(Classification)

Figure A-7. Sample of a division intelligence annex (continued).



## SITUATION REPORT

Preparation and submission of the SITREP is a staff responsibility of the S3; however, the S2 prepares paragraph 1, Enemy, of the SITREP and furnishes it to the S3 in usable form. Figure A-8 shows the prescribed format for preparing a SITREP.

### ENEMY .

Committed forces (overlay).

Forces committed against TF 2-80 are--

- (1) Four mechanized platoons.
- (2) Two medium tank platoons.
- (3) Normal regimental artillery.
- (4) Six 160mm mortars.
- (5) Ten 122mm howitzers.
- (6) Four 100mm artillery guns self-propelled (SP).
- (7) Two 122mm multiple rocket launchers.
- (8) One 152mm gun SP.
- (9) Air and nuclear weapons.

Reinforcements (overlay). Reinforcements currently capable of being employed in sector now total: U/I Medium tk plt vic BD4156, MRC of 281st MRR vic BD4867, MRC of 282d MRR vic BD4873, MRC of 281st MRR vic AB4673, MRB (-) of 281st MRR vic AB4650, MRB of 282d MRR vic CD5060, U/I tk co vic DE5265 .

Enemy Activity During Period IOO6OOZ-1018OOZ.

- (1) Occupation of previously unoccupied positions vic BG3531, NT3633, MT3734, DT4239 .
- (2) Movement of combat units fwd vic MN4036.
- (3) Dispersal of tanks to fwd units vic CG3136.
- (4) Movement of assault boats into vic GM3338.
- (5) Two 100mm AT guns (SP) vic MT3737, two 120mm AT guns (SP) vic ER3833 .
- (6) Six additional 122mm how vic DT3731.
- (7) Increased enemy counterbattery fire in bde sector.
- (8) Clearing lanes through minefield BC2937.
- (9) Mech regimental aid station vic CD3339.
- (10) Increased enemy air activity vic FN2836, RB2437.
- (11) Suspected jamming of VHF communications (intel net) at 100745Z and 013252.

Conclusions. Enemy's most probable courses of action--

- (1) Continue defense now.
- (2) Attack along our front within 8 hours.

Figure A-8. Sample situation report.



## INTELLIGENCE REPORT

The INTREP is a standardized report which, based on its importance, is disseminated without regard to a specific schedule. It is prepared at all echelons when facts influencing the enemy capabilities have been observed, or when a change in enemy capabilities has taken place. It is passed to higher, lower, and adjacent units at the discretion of the commander producing the report. It is sent as quickly as possible following receipt of the information. Whenever time permits, the INTREP includes the originating office's interpretation of the information or intelligence being reported. The first word of the report is INTREP. Otherwise, there is no prescribed format for this report. It is not used in lieu of the critical INTREP. Figure A-9 shows a message format for INTREPs that has been developed for joint operations.

**C110: Message Identification Number.**

**INTREP:** The first word of the report must be "INTREP."

**HEADING:** Addressee information and msg ctr data.

**TEXT:** Intelligence or information to be reported. Should answer Who, What, Where, When and How Questions.

**CONCLUSIONS:** Whenever possible the INTREP should include the originating office's interpretation of the information intelligence being reported.

**Figure A-9. Sample INTREP message format.**

Figure A-10 shows the Joint Chiefs of Staff (JCS) INTREP format.

MESSAGE HEADING  
ORIGINATING AGENCY  
ACTION ADDRESSEES  
INFORMATION ADDRESSEES  
SECURITY CLASSIFICATION AND CODE WORD OR NICKNAME  
INTREP (number) AS OF DATE-TIME GROUP (GMT)/MO/YR  
BODY Installation, Event, and Sighting Format  
Reference to previous message, if any.  
Source reliability evaluation.  
Concise narrative description.  
REMARKS: Any other information not covered in  
the body of the report.

**Figure A-10. Sample JCS INTREP message format.**

## INTELLIGENCE SUMMARY

The INTSUM provides a summary of the intelligence situation covering a specific period of time dictated by the commander. Figures A-11 and A-12 show INTSUM formats. There is no specified format for the INTSUM, except for joint service operations (see the format in Figure A-12).

<p>Format of an INTSUM</p> <p>NOTE: Omit items not applicable unless otherwise indicated.</p> <ol style="list-style-type: none"><li>1. Issuing unit (always included).</li><li>2. Time and date of issue (always included).</li><li>3. Summary of enemy activity for period.<ol style="list-style-type: none"><li>a. Ground activity.</li><li>b. Trace of forward elements.</li><li>c. Potential targets for clear weapons.</li><li>d. Nuclear activity.</li><li>e. CB activity.</li><li>f. Air activity.</li><li>g. Other (new tactics, counterintelligence).</li></ol></li><li>4. Enemy personnel and equipment losses.<ol style="list-style-type: none"><li>a. Personnel Killed in Action (KIA).</li><li>b. EPW.</li><li>c. Equipment destroyed or captured.</li></ol></li><li>5. New obstacles and barriers.</li><li>6. Administrative activities.</li><li>7. New identifications.<ol style="list-style-type: none"><li>a. Units.</li><li>b. Personalities.</li></ol></li><li>8. Enemy movements.</li><li>9. Estimates number and types of vehicles.</li><li>10. Weather and terrain conditions.</li><li>11. Brief discussion of capabilities and vulnerabilities (always included).</li></ol>	<p>IMMEDIATE</p> <p>TO CG 2D CORPS</p> <p>INTSUM NUMBER 144 ENDING 040600Z</p> <p>PARA 3 ALFA ENEMY CONTINUED DEFENSE IN ZONE EXCEPT FOR LOCAL ATTACK AT 0415 VICINITY RS376759 WITH ESTIMATED 90 MEN CMM 3 MEDIUM TANKS CMM AND LIGHT ARTILLERY SUPPORT PD ATTACK REPULSED PD PARA 3 DELTA ATTACK PRECEDED AT 0410 BY VERY HIGH AIR BURST NUCLEAR WEAPON CMM GROUND ZERO RS374761 CMM DELIVERY MEANS UNDETERMINED CMM YIELD ESTIMATED AT 0 PD 5 KT PD PARA 3 FOXROT ATTACK SUPPORTED BY 2 JET ATTACK AIRPLANES BOMBING AND STRAFING VICINITY RS396756 FOR 5 MINUTES STARTING AT 0425 PD PARA 4 ALFA CONFIRMED 20 KIA CMM ESTIMATED 5 KIA PD PARA 4 BRAVO 10 INCLUDING 2 WIA PD PARA 4 CHARLIE 2 MEDIUM TANKS DESTROYED CMM 1 DAMAGED CMM 1 JET</p> <p>ATTACK AIRCRAFT SHOT DOWN PD PARA 6 PRISONER STATES AMMUNITION SUPPLY IN FORWARD UNITS RUNNING LOW PAREN CHARLIE DASH 3 PAREN PD PARA 7 ALFA PATROL REPORTS BATTERY 152MM GUN HOWITZERS AT RS303292 PD PRISONERS CONFIRM LOCATION 2D BATTALION CMM 17F MRR VICINITY RS375758 PAREN BRAVO DASH 1 PAREN PARA 8 AIRBORNE RADAR RECONNAISSANCE DETECTED 10 TRUCKS MOVING SOUTH ON ROAD AT RS330280 AT 0345 PD PARA 9 PROBABLY ROUTINE SUPPLY VEHICLES PD PARA 10 SNOW STARTED AT 040545Z AND CONTINUING PD GROUND FROZEN HARD AND SUPPORTS ALL TYPES OF VEHICLES PD</p>
--	--

NOTE: In joint service operations, use the format in Figure A-12.

**Figure A-11. Format and sample of an intelligence summary.**

<p>12. Conclusions (always included).</p> <p>Examples of a Division INTSUM (full distribution not indicated) FM CG 520 Inf Div (Mech)</p>	<p>PARA 11 LOCAL ATTACK REPORTED PROBABLY WAS TO SEIZE HILL 405 PD ENEMY IS CAPABLE OF CONTINUING DEFENSE IN PRESENT POSITION CMM MAKING LOCAL ATTACKS TO IMPROVE HIS DEFENSIVE POSITION CMM DELAYING TO STRONGER POSITION ALONG LAURIEX RIVER PD PARA 12 CONTINUED DEFENSE IN PRESENT POSITION MOST PROBABLE.</p>
---	--

NOTE: In joint service operations, use the format in Figure A-12.

Figure A-II. Format and sample of an intelligence summary (continued).

HEADING

PRECEDENCE

ORIGINATING AGENCY

ACTION ADDRESSEES

INFORMATION ADDRESSEES

SECURITY CLASSIFICATION, CODE WORD, OR NICKNAME

INTSUM (Number) FOR PERIOD ENDING DATE-TIME GROUP-MONTH-YEAR

BODY

1. SUMMARY OF ENEMY ACTIVITY FOR THE PERIOD. Is a summary of those that occurred during the period of the report. It contains but not be limited to the following:

- a. GROUND ACTIVITY. Summarize major movements and activities of enemy ground forces. Indicate estimated strength, composition, disposition, and any other items of significance.
- b. TRACE OF FORWARD ELEMENTS. The most forward location or main location of the enemy force will be shown as a pinpoint position, area boundary, or a series of connected points, as applicable. The following methods for reporting locations is used and stated in the intelligence annex.

Figure A-12. Intelligence summary for joint service operations.

(1) **Operations Involving Ground Forces.** For unified or joint operations in which ground forces are directly participating, not specifically provided for in the subparagraph below, the UTM system prescribed for the area concerned is used to the maximum extent practicable in communications between ground forces and other forces jointly engaged. When the use of the UTM system is impractical, latitude and longitude is used.

(2) **Operations Not Involving Ground Forces, The World Geographic Reference System (GEOREF)** is used in joint operations which do not directly involve ground forces.

(3) **For Close Air Support of Ground Forces.** When air forces (including naval aviation) are acting in close air support of ground forces, the UTM system prescribed for use by ground forces in the area concerned is used.

(4) **For Joint Amphibious Operations.** The UTM system prescribed for use by landing forces within the amphibious objective area is used for support of landing force operations by all supporting forces.

(5) **For Joint Air Defense Operations.** GEOREF is used in joint air defense operations. When there is a possibility of confusing which system to use in reporting positions, the reference system should be indicated in the report. GEOREF is not used by air forces (including naval aviation) when reporting positions to ground forces, except in air defense operations. GEOREF is used by ground forces when reporting positions to air forces in air defense operations.

(6) in joint operations not using procedures specified in the above paragraphs, latitude and longitude is used.

c. **POTENTIAL TARGETS FOR NUCLEAR WEAPONS.** List all potential nuclear targets, such as concentrations of troops or equipment observed during period. Include location, date, and time (Zulu) of observation.

d. **NUCLEAR ACTIVITY.** Enemy nuclear capability observed during the period is reported. Include any changes to previously reported capabilities. Indicate location, date, and time (Zulu) of observation of artillery, missile, or air nuclear capability.

e. **NUCLEAR, BIOLOGICAL, AND CHEMICAL ACTIVITY.** Indicate NBC weapons (agents) employed or capability by type, location, date, and time (Zulu) of occurrence.

f. **AIR ACTIVITY.** All enemy air activity that has occurred during the period (CAS, air interdiction, AD, and reconnaissance affecting the

Figure A-12. Intelligence summary for joint service operations (continued).

operation is summarized, including location, date and time (Zulu), and type of aircraft involved.

g. NAVAL ACTIVITY. Summarize all enemy naval activity that has occurred during the period. include location, date and time (Zulu), and types of ships and craft.

h. OTHER. New tactics observed are summarized. CI measures of significance, including active and passive measures, are listed. Any item not properly reported in any other paragraph also may be included.

2. ENEMY PERSONNEL AND EQUIPMENT LOSSES.

a. PERSONNEL. List in separate categories confirmed KI A (body count) , estimated KIA, estimated wounded in act on (WIA), and captured.

b. EQUIPMENT AND MATERIEL. List by number and type the enemy equipment and materiel losses during the period. Include damaged enemy equipment separately.

3. NEW OBSTACLES AND BARRIERS. List those identified during the period by type and location.

4. ADMINISTRATIVE ACTIVITIES. Summarize enemy activities pertaining to personnel replacements, supply buildup, or other unusual logistic activity but not information or intelligence reported elsewhere in the INTSUM.

5. NEW IDENTIFICATIONS.

a. UNITS. List new units identified during the period. Include location, date and time (Zulu), and unit making the identification.

b. PERSONALITIES. List significant individuals identified during the period by name, rank or title, and organization.

6. ENEMY MOVEMENTS. Summarize significant enemy movements by type, activity, location, and unit designation, if known.

7. ESTIMATED NUMBER AND TYPES OF VEHICLES, SHIPS, AIRCRAFT. Summarize by type the estimated number of vehicles, ships, and aircraft available to the enemy.

8. WEATHER AND TERRAIN CONDITIONS. A summary of the weather and terrain conditions during the period that would have an effect on subsequent operations.

Figure A-12. Intelligence summary for joint service operations (continued).

9. BRIEF DESCRIPTION OF GAPABILITIES AND VULNERABILITIES. (Always included.) State courses of action which the enemy most probably will adopt.

NOTE: Paragraphs and subparagraphs for which no information has been obtained are omitted in the preparation of the INTSUM. Each topic reported upon retains the numerical (and letter) designation outlined above.

Figure A-12. Intelligence summary for joint service operations (continued).

#### PERIODIC INTELLIGENCE REPORT

The PERINTREP is a summary of the intelligence situation covering a longer period than the INTSUM. It is a means of disseminating detailed information and intelligence. Other intelligence documents like technical intelligence summaries, EPW interrogation reports, translations of captured documents, and weather and climate summaries are disseminated as appendixes to the PERINTREP. The PERINTREP is concise--but complete--and makes maximum use of sketches, overlays, marked maps, and annexes.

Although not normally prepared by intelligence officers at division and lower levels, PERINTREPs provide detailed information and intelligence. Therefore, intelligence officers at these levels should be familiar with the format and content of PERINTREPs.

The PERINTREP is normally published every 24 hours. The beginning and end of the period is selected to permit dissemination of the PERINTREP in time for its use in daily planning. It is disseminated by the most suitable means consistent with its volume and urgency. Figure A-13 shows the PERINTREP format.

The Supplementary Intelligence Report (SUPINTREP) is a comprehensive analysis of one or more specific subjects. This report is formatted like a PERINTREP and usually contains selected intelligence data collected over an extended period of time. It includes additional details on items contained in other reports. The report is disseminated based on the intelligence contained in the report and the desires of the commander. It is normally produced as the result of a request or in support of a particular operation.



g. Other. (Normally includes other than combat arms; includes appropriate comments not covered in other subparagraphs on reserves, reinforcements, new tactics, weapons and equipment, administrative installations, combat service support, and technical intelligence.)

3. ORDER OF BATTLE. Frequently, this paragraph will consist only of references to the enemy SITMAP (or overlay) and to the OB annex, which is developed using the format shown below. When desired by the commander, particularly significant O6 changes may be summarized in addition to being discussed in detail in the O6 annex.

- a. Composition and Disposition.
- b. Strength. (Personnel and major weapons and items of equipment.)
  - (1) Losses.
  - (2) Current strength.
- c. Tactics,
- d. Training.
- e. Css.
- f. Combat Effectiveness.
- g. Miscellaneous Data.

4. COUNTERINTELLIGENCE. This paragraph, or parts thereof, should be issued as an annex if a limited distribution is required.

- a. General. (A short summary of the CI situation during the period.)
- b. Espionage.
- c. Sabotage.
- d. Subversion.
- e. Communication and Noncommunication Security.
- f. Miscellaneous.

5. WEATHER. This paragraph gives a summary of the effect of weather on operations during the period.

---

(Classification)

Figure A-13. Sample format for a period intelligence report (continued).



(Classification)

6. **TERRAIN.** Use an annex, special maps, and overlays, when possible. Include impact on future operations, if appropriate.

7. **ANALYSIS AND DISCUSSION.** This paragraph lists and discusses briefly enemy capabilities and vulnerabilities. The conclusions present the commander's assessment of the most probable courses of action available to the enemy, probability of their adoption, and vulnerabilities that are exploitable by own, higher, or lower levels of command.

- a. **Enemy Capabilities.**
- b. **Enemy Vulnerabilities.**
- c. **Conclusions.**

**Authentication:**

**Annexes:** (Any intelligence document may be distributed as an annex to a PERINTREP. Although annexes are a means of distributing detailed intelligence and information, care is exercised to avoid unnecessary bulk and duplication.)

**DISTRIBUTION:**

(Classification)

Figure A-13. Sample format for a periodic intelligence report (continued).

PERIODIC INTELLIGENCE SUMMARY

The periodic intelligence summary (PERINTSUM) is a detailed hard copy summary of the intelligence situation covering a period of time specified by the force commander (normally 24 hours or more). The PERINTSUM is a means of disseminating concise and complete detailed information and intelligence and makes maximum use of sketches, overlays, annotated maps, and annexes. Normally, this report is prepared at corps level and higher. It is disseminated two echelons higher, two echelons lower, and to adjacent units; however, subordinate units also may be tasked to prepare a PERINTSUM. Figure A-14 shows a JCS message format for the PERINTSUM, structured to facilitate updating the intelligence estimate.

**HEADING**

**PRECEDENCE**

**ORIGINATING AGENCY**

**ACTION ADDRESSEES**

**INFORMATION ADDRESSEES**

**SECURITY CLASSIFICATION, CODE WORD, OR NICKNAME**

**PERINT SUM (Number) FOR PERIOD ENDING DATE-TIME GROUP-MONTH-YEAR**

**BODY**

1. **AREA OF OPERATIONS.** State conditions which exist and indicate the effect of these conditions on enemy capabilities and the assigned mission. The characteristics of the area are based on the facts and conclusions of an analysis of the AO, as follows:

a. **TOPOGRAPHY.** Include information available on observation and fields of fire, concealment and cover, obstacles, key terrain features, AAs, nuclear fires, biological and chemical agents, and so forth. Graphic representation may be included, if necessary.

b. **HYDROGRAPHY.** Include general relief of beaches and beach approaches, surf conditions, tides and currents, navigational aids, identifying features, channels, water depths, rocks and shoals, obstacles, anchorages, beach trafficability, coastline, contiguous islands, and compartmentation, as each affects operations.

c. **CLIMATE AND WEATHER.** Discuss weather during the period which will affect operations.

d. **TRANSPORTATION.** Include status of beaches, beach airways, pipelines, and inland waterways. The following should be included: capacities, surface conditions, bridges, amount and condition of rolling stock, motor and air transport, barges, freighters, and other inland waterways craft. Vulnerabilities are reported in as much detail as possible.

e. **ELECTRONICS AND TELECOMMUNICATIONS,** Report existing electronic telecommunications systems and equipment, both military and civil.

f. **POLITICS,** The extent of civil control of the region, the amenability of the civilian population to political control, the political organizations, and the key political figures.

**Figure A-14. Sample periodic intelligence summary.**

g. ECONOMICS. Include only that specific economic information which may be necessary for conduct of the current operation.

h. SOCIOLOGY. The sociological factors dealing with customs, characteristics, religions, the minority or dissident groups, and the allegiance of the population.

i. SCIENCE AND TECHNOLOGY. Scientific and technical information on enemy weapons, equipment, and techniques as well as the employment of new capabilities during the course of the operations.

2. ENEMY OPERATIONS DURING THE PERIOD.

a. GROUND FORCES.

(1) Strength and Dispositions. (By overlay, if possible.)  
Summary of enemy units and locations.

(2) Committed Forces. Report those enemy ground units, including guerrillas, together with their supporting ground fire units which are within the AO.

(3) Reinforcements. Include the designation and location of reinforcements which may or may not be employed.

(4) Activity. (Discuss by arm of service.) Include a description of all significant enemy movements which may affect the friendly mission.

(5) Other Order of Battle Factors. Reference may be made to overlays, enemy SITMAPS, or previously published documents.

(6) New Tactics, Weapons, and Equipment. List new tactics and equipment which may affect the mission and enemy capabilities.

(7) Nuclear-Capable Artillery and Launchers. Describe the operational capability to launch missiles by numbers and types of missiles; guidance systems; ranges; types of warheads; type of launching sites (if fixed, whether hardened or not); and for mobile launchers state mobility, rate of fire, and readiness.

(8) Nuclear, Biological, and Nuclear Activity. These weapons should be reported by type, yield, number, method of delivery or application, and enemy doctrine concerning their use.

b. AIR FORCES.

(1) Strength and Dispositions. Summary of enemy units and locations.

(2) Order of Battle. Summary of opposing forces and other enemy forces that can affect accomplishment of mission.

Figure A-14. Sample periodic intelligence summary (continued).

(3) New Tactics, Weapons, and Equipment. List new tactics, weapons, and equipment which may affect the mission and enemy capabilities.

c. NAVAL FORCES (Including amphibious forces).

(1) Strength and Dispositions. Summary of enemy units and locations.

(2) Order of Battle. Summary of opposing forces and other enemy forces that can affect accomplishment of mission.

(3) New Tactics, Weapons, and Equipment. List new tactics, weapons, and equipment which may affect the mission and enemy capabilities.

d. MISSILE FORCES (Excluding SAMs).

(1) Strength and Dispositions. Summary of enemy units and locations.

(2) Order of Battle. Summary of opposing forces and other enemy forces that can affect accomplishment of mission.

(3) New Tactics, Weapons, and Equipment. List new tactics, weapons, and equipment which may affect the mission and enemy capabilities.

e. ANTI-AIRCRAFT DEFENSES (including SAM).

(1) Strength and Dispositions. Summary of enemy units and locations.

(2) Order of Battle. Summary of opposing forces and other enemy forces that can affect accomplishment of mission.

(3) New Tactics, Weapons, and Equipment. List new tactics, weapons, and equipment which may affect the mission and enemy capabilities.

f. AIRBORNE UNITS.

(1) Strength and Dispositions. Summary of enemy units and locations.

(2) Order of Battle. Summary of opposing forces and other enemy forces that can affect accomplishment of mission.

Figure A-14. Sample periodic intelligence summary (continued).

(3) New Tactics Weapons, and Equipment. List new tactics, weapons, and equipment which may affect the mission and enemy capabilities.

3.. ENEMY MILITARY SITUATION.

a. IDENTIFICATION OF COMMITTED GROUND FORCES.

(1) Movement and Locations. Report disposition, location, and echelon of control of enemy ground forces.

(2) Reinforcements. Report disposition, location, and echelon of control of enemy ground force reinforcements.

(3) Logistics. Report the following elements of the enemy's logistic system: transportation, storage distribution, levels of supply, critical shortages.

(4) Equipment. Report weapons systems and equipment used by committed enemy ground forces.

(5) Personalities. Report significant individuals operating for the enemy ground forces.

(6) Morale. Report any significant breakdown or buildup of enemy morale.

(7) Personnel and Materiel Losses.

(a) KIA.

1 Body count.

2 Estimates.

(b) WIA (estimated).

(c) Captured.

(d) Materiel losses.

(8) Analysis of Capabilities. Analyze each capability of enemy-committed ground forces, considering all applicable factors in item 3a above.

Figure A-14. Sample periodic intelligence summary (continued).

b. IDENTIFICATION OF AIR FORCES.

(1) Operational Capability (aircraft and airfields). Report observed aircraft operational capability, including numbers of aircraft, fuel status, weapons, and status of the airfield.

(2) Movements and Locations. Report movements and locations of all observed aircraft and airfields,

(3) Materiel and Personnel Losses,

(a) Aircraft.

- 1 Confirmed destroyed in the air.
- 2 Confirmed destroyed on the ground,
- 3 Confirmed damaged in the air.
- 4 Confirmed damaged on the ground.
- 5 Probable destroyed.
- 6 Probable damaged.

(b) Ground equipment.

- 1 Destroyed.
- 2 Damaged.

(c) Personnel.

- 1 KIA.
  - a Confirmed.
  - b Estimated.
- 2 WIA (estimated).
- 3 Captured.

(4) Morale. Report any significant breakdown or buildup of enemy morale.

(5) Electronic Warfare Capability. Report enemy ECM, ECCM, and ESM capabilities and activities.

Figure A-14. Sample periodic intelligence summary (continued).

(6) Nuclear Capability. Report nuclear weapons observed, including type, yield, numbers, method of delivery, and enemy doctrine concerning their use.

(7) Analysis of Capabilities. Analyze each capability of enemy air forces, considering all applicable factors in item 3b above.

c. IDENTIFICATION OF NAVAL FORCES.

(1) Operational Capability. Report observed naval forces' operational capability, including numbers of ships, operational weapons, and problems which could affect their successful employment.

(2) Movements and Locations. Report movement and location of all observed naval forces.

(3) Ships, Materiel, and Personnel Losses.

(a) Ships (identification by name, class, type).

1 Confirmed sunk.

2 Probable sunk.

3 Damaged.

(b) Shore-based equipment and facilities.

1 Destroyed.

2 Damaged.

(c) Personnel .

1 KIA.

a Confirmed.

b Estimated.

2 WIA (estimated).

3 Captured.

(4) Morale. Report any significant breakdown or buildup of enemy morale.

(5) Electronic Warfare Capability. Report enemy ECM, ECCM, and ESM capabilities and activities.

Figure A-14. Sample periodic intelligence summary (continued).

(6) Analysis of Capabilities. Analyze each capability of enemy naval forces, considering all applicable factors in item 3c above,

4. ENEMY UNCONVENTIONAL AND PSYCHOLOGICAL WARFARE.

a. IDENTIFICATION OF GUERRILLA FORCES. Identify guerrilla forces being used in friendly areas or areas newly seized from the enemy.

b. PSYCHOLOGICAL WARFARE. Discuss psychological warfare, including enemy methods and facilities observed for the conduct of propaganda, the susceptibility of the population of the target area, and the major or main focus of the enemy's psychological warfare efforts.

5. COUNTERINTELLIGENCE.

a. SABOTAGE. Report enemy sabotage effects observed, including information concerning his methods, targets, sensitive targets in the AO, and successes or failures.

b. ESPIONAGE. Report enemy efforts to collect information by types of espionage: designation (trained agents) or saturation (mass use of citizenry) and include methods of pressure, coercion, and enforcing the saturation-type espionage.

6. CONCLUSIONS. State conclusions derived from item 3 above, and include, when possible, a concise statement of the effects of each enemy capability on the accomplishment of the assigned mission. Cite enemy vulnerabilities, where possible.

**Figure A-14. Sample periodic intelligence summary (continued).**

RECONNAISSANCE EXPLOITATION REPORT

The RECCEXREP disseminates results obtained from the first rapid interpretation of imagery and debriefing of the aircrew. The report addresses those targets requested in the original tasking with each target addressed separately. The RECCEXREP is submitted as rapidly as possible, but not later than 45 minutes after engine shutdown. If review of the imagery results in information contradictory to that in an earlier RECCEXREP, the new information is to be reported promptly in another RECCEXREP. Table A-1 shows an annotated format for the RECCEXREP.



**Table A-1. Sample reconnaissance exploitation report annotated format.**

---

Standard Message Heading RECCEXREP	Standard Message Heading RECCEXREP
Air Reconnaissance Mission Number:	2/R/501
A. Location identifier:	A. PB088195
B. Time on target; time of sighting.	B. 24161OZ
C. Results:	C. CAT 06 1. Type: Motor rifle and tank. 2. Status: Moving northwest on road from Rotterode to Asbach. 3. Activity: 24xT-62, 9xBMP. 4. Defenses: 2xZSU-23-4 moving with and defending target.
D. Other information	D. None.
1. TARWI:	1. TARWI 1234X
2. Imagery confirmed:	2. Yes
E. *Type sensor, exposures:	E. Good, large
F. *Percentage of coverage:	F. 100 percent.

\* To be completed if significant or requested.

---

NOTE: Target category codes are found in STANAG 3596. Standard message headings are noted in AR 105-31. The RECCEXREP replaces the hot (high priority) photographic report (HOTPHOTOREP) and mission report (MISREP) (except that the MISREP is used for negative mission results) in USAREUR. It may soon be accepted for use by US forces worldwide.

**INITIAL AND SUPPLEMENTAL PROGRAMMED INTERPRETATION REPORT**

The initial programmed interpretation report (IPIR) and the supplemental programmed interpretation report (SUPIR) are used to report intelligence obtained from imagery which has not been reported through previous reports. The format for both reports is the same and should be used to report data acquired from a systematic review of imagery or to report more detailed information than is provided in other reports. These reports are prepared in either manual or ADP formats.

The IPIR is not completed on all missions and must be requested. It is disseminated within four hours of engine shut-down. The IPIR reports on programmed mission objectives or other vital intelligence information which is readily identified in reasonable proximity to these objectives and which has not been reported in earlier reports.

The SUPIR reports on all significant targets covered by the mission and not included in other reports or when supplemental information is required. The SUPIR is completed at higher headquarters only if they decide it is necessary.

Table A-2 shows the format used for both the IPIR and the SUPIR. This format also is used for joint service operations.

**Table A-2. Initial and supplemental programmed interpretation reports.**

---

<p>Standard Message Heading IPIR (or SUPIR) Air Task or Mission Number: PART I: Mission highlights: PART II: Significant results: A. Perishable items:</p>	<p>Standard Message Heading IPIR 2/R/501 PART I: One new SA-2 site observed PART II: A. Target 1: CAT 06/PB088195/ 241610Z/LOOII-0113 1. Motorized rifle and tanks 2. Moving northwest on Road Rotterrode-Asbach. 3. 24xT-62, 9xn intelligence annex. 4. Two occupied air warning (AW) positions approx 200m west of site. 5. One FAN SONG E radar in center of site. 6. Six transporters; two van trucks, four cargo trucks. B. Air order of battle (AOB)</p>
<p>B. Change and OB items: Target 3: CAT 01/PB4056 241644Z/POO27. 3. Update: AOB: 6 Flagons 21 Fishbed 4 Hook</p>	<p>D. (Not used.) E. (Not used.) PART III: (Not used.) A. NTR (nothing to report.) B. NTR PART IV: A. NTR B. CAT 4/PB1437/241653Z/ camera malfunction.</p>
<p>C. Bonus items: D. Damage assessment: PART III: Other results: A. Additional items: B. Identification only items: PART IV: Mission collection results: A. Collector's objectives satisfied: B. Collector's objectives not satisfied:</p>	

---

(When issued separately from an OPORD)

## INTERROGATION AND TRANSLATION REPORTS

Interrogation reports summarize the results of interrogations of EPW, civil ian detainees, or refugees, and the translations of summaries of enemy documents. Information of immediate value is disseminated in spot reports.

The initial interrogation report serves as a written summary of the initial interrogation of each prisoner. Figure A-15 shows the format of this report. Emphasis is placed on completing as much of the tactical interrogation as possible at the lowest level and supplementing this with further interrogation at higher echelons. The primary purpose of this report is to preclude duplication of effort in subsequent interrogations.

The detailed interrogation report is used to record information obtained in the course of subsequent interrogations of selected interrogees. Figure A-16 shows its format. A more detailed interrogation and screening report format is available in FM 34-52.

During joint service operations, interrogation information of immediate tactical interest (obtained at the brigade or regimental level) is generally reported in the INTREP. Follow-on interrogation reports, the initial interrogation report, and the detailed interrogation report disseminate more complete and comprehensive information. It is essential that these follow-on reports reference the INTREP where the information first appeared to ensure that the information contained in these reports is not used to confirm the preliminary information contained in the INTREP.

Joint services use the document translation report to report information gained through the translation of documents which contain information of tactical value. Figures A-17 and A-18 show the format and sample of a translation report. Full or extract translations are accomplished as the intelligence officer directs. All translations are prepared in triplicate, unless otherwise directed, and each translation is conspicuously annotated with the word "Draft."

The original of the translation is appended to the document when it is forwarded to the next higher headquarters. Copies of the original document are provided to the intelligence officers at echelons which contain translation sections to support their journal entries. The document translation report format also is used for joint service operations. Figures A-19 and A-20 show sample screening reports. Figures A-21 and A-22 show sample tactical interrogation reports. These reports are used to record information on interrogees.

<u>(Classification)</u>			
	REPORT NO _____ C Y N O _ DATE-TIME(Zulu) (Numbered sequentially)		
SOURCE _____ (last name only)	INTG UNIT _____ (attached to interrogator)		
CATEGORY A B C D (see detailed report)	MAPS USED _____ (1 1st sheet name, number, and scale of maps)		
LANGUAGE USED _____			
<b>PART I INTELLIGENCE POTENTIAL OF ENEMY PRISONERS OF WAR</b>			
(rank)	(last name, first name)	(MI)	(service or serial number)
DOB _____ (day, mo, yr)	BIRTHPLACE _____ (city, county, or country)		
NATIONALITY _____	RACE _____		
LANGUAGES _____ (list and include proficiency)	UNIT _____ (interrogees' parent unit listed completely to highest headquarters)		
CIVILIAN CAREER _____ (summarize prisoner's premilitary career)			
MILITARY CAREER _____ (summarize)			
ASSESSMENT _____ (intelligence, experience, cooperation, and reliability of the interrogee, NOT the information)			
SPECIALIST KNOWLEDGE _____ (knowledge of technical subjects or equipment)			
DOCUMENTS _____ (carried at time of capture; include money or valuables)			
EQUIPMENT _____ (of intelligence interest) (personal equipment or weapons)			
PART II - INFORMATION OBTAINED _____ (sumrnarize)			
<u>(Classification)</u>			

Figure A-15. Initial interrogation report.





<u>(CLASSIFICATION)</u>	
b. Losses	_____
	(statement of personnel and equipment losses known to prisoner)
c. Replacements	_____
	(number and date received, sufficiency, and so forth)
6. PERSONALITIES	_____
	(list by name, rank, organization, duties, and characteristics)
7. MISCELLANEOUS.	
a. Morale	_____
b. Tactics	_____
	(new or unusual tactics)
c. Obstacles	_____
	(location, coordinates, type)
d. Other Information	_____
	(other information of intelligence value not covered above)
8. REMARKS	
	NAME _____
	(of Interrogator)
	GRADE _____
	TRANSLATOR _____
	(if used)
	_____

Figure A-16 Detailed interrogation report (continued).

(CLASSIFICATION)

DATE :

-0:

FROM :

REPORT NUMBER:

1. CONTROL DATA.

1. DOCUMENT NUMBER,

2. DOCUMENT DESCRIPTION: (type of document, originating headquarters, language, and number of pages),

3. DOCUMENTS ORIGINAL LANGUAGE.

4. DATE AND TIME RECEIVED.

5. DATE AND TIME OF CAPTURE: (date and time (Zulu) and place, including coordinates; if obtained from an individual, identify) .

6. PLACE OF CAPTURE.

7. CAPTURING UNIT: (unit initially obtaining document).

8. CIRCUMSTANCES OF CAPTURE.

9. TRANSLATOR.

10. TYPE OF TRANSLATION: (state whether extract or complete translation) .

11. TEXT OF TRANSLATION (Translation typed in here, using the format of the document. Use continuation sheets as needed).

(CLASSIFICATION)

Figure A-17. Document translation report.



(CLASSIFICATION)

DATE : 231500ZAug88  
TO: G2, X Corps

FROM: Team 1, IPW Section  
441st MI Bn, 23 Div (Armd)  
X Corps

REPORT NUMBER: 08-0356

PART 1: CONTROL DATA

1. DOCUMENT NUMBER: US-WAIBVC-03093
2. DOCUMENT DESCRIPTION: Personal letter, 1 page, handwritten, mentions a tank factory disguised as a sugar processing plant, and school teachers and elderly people working in factories.
3. DOCUMENT'S ORIGINAL LANGUAGE: Russian
4. DATE AND TIME RECEIVED: 240847ZAug88
5. DATE AND TIME OF CAPTURE: 230923ZAug88
6. PLACE OF CAPTURE: NB640320
7. CAPTURING UNIT: A/1-41/23 AD
8. CIRCUMSTANCES OF CAPTURE: Found in an abandoned enemy CP,
9. TRANSLATOR: SSG Bennett
10. TYPE OF TRANSLATION: Full

PART 2. TEXT OF TRANSLATION

My dear Serzhen'ka:

It has been a long time since I received a letter from you. How are and where are you? The last time you wrote that fighting was going on around you all the time, and this worries me a lot. Take care of yourself. There have been many changes at home. Your mother, despite her age, had to go to work in the factory. They make tanks there, but the sign over the entrance says this is a sugar plant. I don't know why they do this. At the school where I work, we were also told to go and work at the same plant. They are going to close the school. Everyone has either to go to the front or work in the war industry. This is necessary in order to speed up the victory over the enemy of our country. I would be more at ease if I knew that you are alive and well. Please write as soon as you can.

Your KATHY.

(CLASSIFICATION)

Figure A-18. Sample translation report.

(CLASSIFICATION)  
WORKING PAPERS

DEPARTMENT OF THE ARMY  
1st Brigade IPW Team, 123d MI  
APO New York, New York 09166

IPW TEAM REPORT NUMBER:

DATE-TIME:

SCREENING REPORT

PART I. INFORMATION CONCERNING CAPTIVE:

A. PREVIOUS SCREENING OR INTERROGATION REPORTS (Unit or Report No!)

---

B. CAPTURE INFORMATION:

1. CAPTIVE TAG NUMBER:

2. CAPTURING UNIT:

3. DATE-TIME OF CAPTURE:

4. PLACE OF CAPTURE:

5. Documents Captured (Disposition): \_\_\_\_\_  
\_\_\_\_\_

6. Equipment Captured (Disposition): \_\_\_\_\_  
\_\_\_\_\_

7. Circumstances of Capture: \_\_\_\_\_  
\_\_\_\_\_

c. BIOGRAPHICAL INFORMATION:

1. Full Name, Rank, Service Number: \_\_\_\_\_  
\_\_\_\_\_

2. Date, Place of Birth: \_\_\_\_\_

3. Sex, Marital Status, Religion: \_\_\_\_\_

4. Full Unit Designation or Unit Code: \_\_\_\_\_

(CLASSIFICATION)  
WORKING PAPERS

Figure A-19. Sample blank screening report.

(CLASSIFICATION;  
WORKING PAPERS

5. Duty Position: \_\_\_\_\_

6. Military Education and Experience: \_\_\_\_\_  
\_\_\_\_\_  
\_\_\_\_\_

7. Civilian Education and Experience: \_\_\_\_\_  
\_\_\_\_\_  
\_\_\_\_\_

8. Languages Spoken (Proficiency) : \_\_\_\_\_  
\_\_\_\_\_

D. OBSERVATIONS

1. Physical Condition of Captive: \_\_\_\_\_  
\_\_\_\_\_

2. Uniform, Insignia (type and condition): \_\_\_\_\_  
\_\_\_\_\_

3. Assessment of Attitude and Behavior: \_\_\_\_\_  
\_\_\_\_\_

4. Assessment of Knowledgeability: \_\_\_\_\_  
\_\_\_\_\_

PARTII. SCREENING RECOMMENDATIONS

A. SCREENER'S RECOMMENDATIONS:

1. Screener's and Interpreter's Names: \_\_\_\_\_  
\_\_\_\_\_

2. Place of Screening: \_\_\_\_\_

3. Screening Code: \_\_\_\_\_

9. SENIOR INTERROGATOR'S RECOMMENDATIONS:

1. Senior interrogator's Name: \_\_\_\_\_

2. Interrogate: \_\_\_\_\_

3. Action: \_\_\_\_\_

(CLASSIFICATION)  
WORKING PAPERS

Figure A-19. Sample blank screening report (continued).

(CLASSIFICATION)  
WORKING PAPERS

DEPARTMENT OF THE ARMY  
1st Brigade IPW Team, 123d MI  
APO New York, New York 09166

IPW TEAM REPORT NUMBER: 007                      DATE-TIME: 181530 AUG 99

SCREENING REPORT

PART I. INFORMATION CONCERNING CAPTIVE:

A. PREVIOUS SCREENING OR INTERROGATION REPORTS (Unit or Report No)

---

B. CAPTURE INFORMATION:

1. CAPTIVE TAG NUMBER: P-4A
2. CAPTURING UNIT: C Trp, 1st Sqdn, 8 ACR
3. DATE-TIME OF CAPTURE: 181300 AUG 99
4. PLACE OF CAPTURE: NB621108
5. Documents Captured (Disposition): 1x ID card no 1350412 (retained by EPW); 1x personal letter (evac with EPW); 1x map section (evac with EPW).
6. Equipment Captured (Disposition): 1x ShM protective mask (retained by EPW); 1x standard web gear, 1x individual first aid kit (both destroyed in place). 1x 5.45rnn AK-74 w/4x mag (129x rds) (evacuated through supply channels).
7. Circumstances of Capture: Surrendered to US Patrol

C. BIOGRAPHICAL INFORMATION:

1. Full Name, Rank, Service Number: Boris Petrovich BARONOV, JrSGT, No 0951046
2. Date, Place of Birth: 16 JAN 78, BRYANSK, BySSR, USSR
3. Sex, Marital Status, Religion: Male, Single, None

(CLASSIFICATION)  
WORKING PAPERS

Figure A-20. Sample completed screening report.

(CLASSIFICATION)  
WORKING PAPERS

4. Full Unit Designation or Unit Code: Would Not Answer (WNA);  
QKN-854
5. Duty Position: WNA
6. Military Education and Experience: WNA
7. Civilian Education and Experience: 10 yrs compulsory civil an  
education
8. Languages Spoken (Proficiency): Ukrainian (N) , Russian (FL

D. OBSERVATIONS

1. Physical Condition of Captive: Good
2. Uniform, Insignia (type and condition): Standard Soviet uniform,  
with JrSgt rank tabs and MR insignia, dirty and torn.
3. Assessment of Attitude and Behavior: Calm, cooperative.
4. Assessment of Knowledgeability: UNK

PART II. SCREENING RECOMMENDATIONS

A. SCREENER'S RECOMMENDATIONS:

1. Screener's and Interpreter's Names: SSG BROWN, None
2. Place of Screening: IPW See, 123d MI Bn MI, 23d Inf Div (Mech
3. Screening Code: A-2

B. SENIOR INTERROGATOR'S RECOMMENDATIONS:

1. Senior Interrogator's Name: MSG MOSCHETTI
2. Interrogate: YES
3. Action: None

(CLASSIFICATION)  
WORKING PAPERS

Figure A-20. Sample completed screening report (continued).

(CLASSIFICATION)  
Working Papers

Date \_\_\_\_\_

TACTICAL  
INTERROGATION REPORT

NAME OF PRISONER: LAST NAME SOURCE INTERROGATOR: RANK and LAST NAME

CATEGORY:        A     B     C     D        UNIT OR FORMATION TO WHICH INTG  
ATTACHED: \_\_\_\_\_

INTG SERIAL NO: \_\_\_\_\_ MAPS USED: \_\_\_\_\_

DTG OF INTG: \_\_\_\_\_ LANGUAGE USED: \_\_\_\_\_

INTG REPORT NO: \_\_\_\_\_ INTERPRETER: \_\_\_\_\_

PART I - INTELLIGENCE POTENTIAL OF ENEMY PRISONER OF WAR (EPW)

A. PERSONAL PARTICULARS:

1. Rank, full name, service number, and position:
2. Date and place of birth:
3. Nationality:                      Ethnic:                      Religion:
4. Knowledge of languages and proficiency:                      ..
5. Unit, formation or organization:
6. Date-time, place or grid references, capturing unit, and circumstances of capture:

B. CAREER:

1. Pre-military:  
    Paramilitary Tng:
2. Military:

C. ASSESSMENT OF INTELLIGENCE VALUE:

1. Intelligence, experience, cooperation, reliability:
2. Specialist knowledge:
3. Discussion of approach techniques:

(CLASSIFICATION)  
Working Papers

Figure A-21. Sample blank tactical interrogation report.

D. DOCUMENTS CARRIED AT TIME OF CAPTURE:

1. List of documents:

2. Details of money and valuables:

E. EQUIPMENT OF INTELLIGENCE INTEREST CARRIED AT TIME OF CAPTURE:

1. Personal Equipment:

2. Weapons:

PART II - INFORMATION OBTAINED

A. SUMMARY:

DOI is Time of Capture (TOC) unless otherwise indicated in the body of this report.

B. TEXT:

i. MISSIONS

a. EPW (or) EPW and \_\_\_\_\_

(1) TOC:

(2) Fut:

(3) Past:

b. Unit:

(1) Pres:

(2) Fut:

(3) Past:

Figure A-21. Sample blank tactical interrogation report (continued).

c. Unit:

(1) Pres:

(2) Fut:

(3) Past:

2. COMPOSITION:

a.

b.

c.

d.

e.

3. STRENGTH:

a. Personnel :

(1)

(2)

(3)

b. Weapons and Equipment:

(1) individual Weapons:

(a)

(b)

(2) Crew-served Weapons:

(a)

(b)

Figure A-21. Sample blank tactical interrogation report (continued).



(CLASSIFICATION)  
Working Papers

Date

- (3) Other Weapons:
  - (a)
  - (b)
- (4) Armored Vehicles:
  - (a)
  - (b)
- (5) Other Vehicles:
  - (a)
  - (b)
- (6) Communications Equipment:
  - (a)
  - (b)
- (7) NBC Equipment:
  - (a) Individual:
    - ((1))
    - ((2))
  - (b) Vehicular:
    - ((1))
    - ((2))
- (8) Specialized Equipment:
  - (a)
  - (b)

(CLASSIFICATION)  
Working Papers

Figure A-21. Sample blank tactical interrogation report (continued).

4. DISPOSITIONS

a. Activity, FUD, 6 digit grid coordinate, physical description,  
collocated units: \_\_\_\_\_, scty measures: \_\_\_\_\_: DOI.

b.

5. TACTICS:

a. Offensive:

b. Defensive:

c. Special Operations:

6 TRAINING:

a. Individual:

b. Unit:

c. Specialized:

7 COMBAT EFFECTIVENESS:

a. Losses:

(1) Personnel :

(2) Equipment:

b) Replacements:

(1) Personnel:

(2) Equipment:

c Reinforcements:

(1) Personnel:

(2) Equipment:

Figure A-21. Sample blank tactical interrogation report (continued).

(CLASSIFICATION)  
Working Papers

Date

- d. Combat Experience:
- e. Morale:
- 8. LOGISTICS:
  - a. Weapons and Ammunition:
    - (1) Weapons:
    - (2) Ammunition:
  - b. Vehicles and POL:
    - (1) Vehicles:
    - (2) POL:
  - c. Food and Water:
    - (1) Food:
    - (2) Water :
  - d. Communications Equipment:
  - e. Medical:
    - (1) Individual Equipment:
    - (2) Vehicular Equipment:
    - (3) Personnel:
    - (4) Facilities:
    - (5) Evacuation Procedures:
  - f. NBC Equipment:
    - (1) Individual:
    - (2) Vehicular:

(CLASSIFICATION)  
Working Papers

**Figure A-21. Sample blank tactical interrogation report (continued).**

(CLASSIFICATION)  
Working Papers

Date

g. Specialized Equipment: (NOTE: If para 3.b. (8) was Unk or None, DO NOT write this sub-para at all!)

3 MISCELLANEOUS :

a. Personal ities:

Last name	First name	MN/I	Rank	PSN	FUD
-----------	------------	------	------	-----	-----

b. Code Names and Numbers:

(1) Code Names:

(2) Code Numbers:

c. Radio Frequencies and Call Signs:

(1) Radio Frequencies:

Radio	Pr imary	Alternate
-------	----------	-----------

(2) Call Signs:

Unit	Primary	Alternate
------	---------	-----------

d. Passwords:

Challenge:	Countersign:
------------	--------------

(NOTE: If more than one password is known, use the following chart.!

Unit	Challenge	Countersign
------	-----------	-------------

e. Obstacles:

(1) Enemy:

(2) NATO:

f. PSYOPS :

(1) Enemy:

(2) NATO:

(CLASSIFICATION)  
Working Papers

Figure A-21. Sample blank tactical interrogation report (continued).

(CLASSIFICATION)  
WORKING PAPERS

TACTICAL  
INTERROGATION REPORT

NAME OF PRISONER: BARANOV

INTERROGATOR:

CATEGORY:        A        (B)        C        D

UNIT OR FORMATION TO WHICH INTG  
ATTACHED: IPW See, 123d MI Bn  
23d Inf Div (Mech)

INTG SERIAL NO: US-AR-2235-4A

MAPS USED: GERMANY, 1:50,000,  
EISENACH-HUNFELD, USACGSC 50-242

DTG OF INTG: 181500 AUG 99

LANGUAGE USED: RUSSIAN

INTG REPORT NO: 104

INTERPRETER: NONE

**PART I - INTELLIGENCE POTENTIAL OF ENEMY PRISONER OF WAR (EPW)**

**A. PERSONAL PARTICULARS:**

1. Rank, full name, service number, and position:  
JrSGT Boris Petrovich BARONOV, No, 0951046, driver
2. Date and place of birth: 16 JAN 78, BRYANSK, BySSR, USSR
3. Nationality: Soviet Ethnic: Ukrainian Religion: None
4. Knowledge of languages and proficiency: Ukrainian (N), Russian (FL) .
5. Unit, formation or organization: Regt HQ, 61MRR, 56MRD (HQ, 61MRR, 56MRD)
6. Date-time, place or grid references, capturing unit, and circumstances of capture: 181300 AUG 99; NB621108; C Trp, 1st Sqdn, 8 ACR; surrendered to US Border Patrol .

**B. CAREER :**

1. Pre-military: Civilian Education: 10 yrs compulsory. No vocational training. No civilian job. Paramilitary training: Standard preinduction training.

(CLASSIFICATION)  
WORKING PAPERS

Figure A-22. Sample completed tactical interrogation report.

(CLASSIFICATION)  
WORKING PAPERS

2. Military: 21 months conscripted service. Military schools: None. Previous job: None. Previous unit: None.

c. ASSESSMENT OF INTELLIGENCE VALUE:

1. Intelligence, experience, cooperation, reliability: Average, 3 years experience, cooperative, information checked against OB holdings.
2. Specialist knowledge: None.
3. Discussion of approach techniques: Direction approach failed but incentive approach was successful .

D. DOCUMENTS CARRIED AT TIME OF CAPTURE:

1. List of documents: 1x ID card no 0951046 (retained by EPW), 1x personal letter (returned to EPW), 1x map section (evac to G-2)
2. Details of money and valuables: None

E. EQUIPMENT OF INTELLIGENCE INTEREST CARRIED AT TIME OF CAPTURE:

1. Personal Equipment: 1x standard web gear, 1x indiv first aid kit (both destroyed in place), 1x SHM protective mask (retained by EPW)
2. Weapons: 1x 5.45rnn AK-74 assault rifle with 4x full mags (120xrds) (all evac thru supply channels)

PART II - INFORMATION OBTAINED

A. SUMMARY:

DOI is 181300 AUG 99 unless otherwise indicated in the body of this report.

B. TEXT:

1. MISSIONS
  - a. EPW

(CLASSIFICATION)  
WORKING PAPERS

Figure A-22. Sample completed tactical interrogation report (continued).

(CLASSIFICATION)  
WORKING PAPERS

- (1) TOC: Waiting outside of gasthaus S of Spahl (NB6412) for PO, 61MRR, 56MRD and PO, 1MRB, 61MRR, 56MRD (IMRB, 61MRR, 56MRD) for over an hour.
- (2) FUT: At 181330 AUG 99, was to drive PO, 61MRR, 56MRD and PO, 1MRB, 61MRR, 56MRD to a U/I unit 61MRR, 56MRD. (Hearsay: PO, 61MRR, 56MRD. DOI: 181130 AUG 99).
- (3) PAST: Left CDP, 61MRR, 56MRD, located SE of Geismar (NB6515) 180800) AUG 99 and drove PO, 61MRR, 56MRD to CP, 1MRB, 61MRR, 56MRD. Waited for PO, 61MRR, 56MRD about 3 hrs and at 181130 AUG 99 drove PO, 61MRR, 56MRD and PO, IMRB, 61, 56MRD to gasthaus S of Spahl (NB6412). At 172330 AUG 99, left assembly area, 61MRR, 56MRD and drove CO, 61MRR, 56MRD to CP, 61MRR, 56MRD arriving at 172345 AUG 99.

b. Unit: 61MRR, 56MRD

- (1) PRES: Preparing men and equipment to advance W to Nusttal (NB6010).
- (2) FUT: Cross international Border and attack Nusttal (NB6010) NLT 190530 AUG 99. (Hearsay: PO 61MRR to PO 1MRB, 61MRR; DOI: 181130 AUG 99).
- (3)- PAST: Moved into assembly area (exact location unk). 61MRR, 16 AUG 99.

c. Unit: 1MRB, 61MRR, 56MRD

- (1) ?RES: UNK
- (2) FUT: U/I element MRB to secure road junction somewhere N of Nusttal (NB6010) (exac loc unk). Road junction to be secured NLT 190430 AUG 99. (Hearsay: PO 1MRB to PO 61MRR; DOI 181130 AUG 99).
- (3) PAST: UNK

2. COMPOSITION: (61MRR, 56MRD)

- a. 61MRR had one HQ; three MRBs, dsg 1,2,3; one tk bn; one 122mm how bn; one engr co; one recon co; one supply and svc pit; one med co; one signal co

(Classification)  
WORKING PAPERS

Figure A-22. Sample completed tactical interrogation report (continued).

(CLASSIFICATION)  
WORKING PAPERS

b. Each MRB, 61MRR had one HQ; three MRC dsg 1,2,3; one mortar btry; one commo pit

3. STRENGTH: (HQ, 61MRR, 56MRD)

a. Personnel : (HQ, 61MRR) - HQ, 61MRR had approx 65 pers (UNK no off and EM)

b. Weapons and Equipment: (HQ, 61MRR)

(1) Individual Weapons: (HQ, 61MRR)

(a) UNK No x 9mm PM pistols (at least one ea off, HQ, 61MRR)

(b) UNK No X 5.45rrrn AK-74 assault rifles (at least one ea UAZ-469 driver, HQ, 61MRR)

(2) Crew-Served Weapons: LINK

(3) Other Weapons: UNK

(4) Armored Vehicles: (HQ, 61MRR) - 2xBTR-70, armament UNK (HQ, 61MRR)

(5) Other Vehicles: (HQ, 61MRR) - 3xUAZ-469 trk (one ea Regt driver, HQ, 61MRR)

(6) Communications Equipment: (HQ, 61MRR)

(a) 3xR-130 transceiver (trans) (one ea UAZ-469 , HQ, 61MRR)

(b) 2xR-123 VHF trans (one ea BTR-70, HQ, 61MRR')

(7) NBC Equipment: (HQ, 61MRR)

(a) Individual: (HQ, 61MRR)

((1)) UNK no.xShM prot masks (1x ea lower EM, HQ, 61MRR)

. ((2)) UNK no.xShMK prot masks (1x ea off, 1x ea NCO, HQ, 61MRR)

(cCLASSIFICATION)  
WORKING PAPERS

Figure A-22. Sample completed tactical interrogation report (continued).



(cLAsSIFICATION)  
WORKING PAPERS

((3)) UNK no.xOP-I prot clothing (one ea member, HQ, 61MRR)

((4)) UNK no.xIPP indiv decon kits (one ea member, HQ, 61MRR)

(b) Vehicular: (HQ, 61MRR) - 3xDK-4K portable decontamination sets (one ea UAZ-469 Trk, HQ, 61MRR)

(8) Specialized Equipment: UNK

4. DISPOSITIONS

- a. CP, 61MRR, 56MRD loc vic NB665139 at intersection of 2xfarm roads in forest SE of Geismar (NB6515). Collocated units: UNK. Security measures: UNK no.x perimeter guards (FUD UNK). DOI: 180800 AUG 99.
- b. Assembly area, 61MRR, 56MRD loc vic NB696163 (center of mass, and measures lkm N to S and E to W) SW of Kranlucken (NB7017). Collocated units: None. Scty measures: UNK No x perimeter guards (FUD UNK). DOI: 172330 AUG 99.
- c. CP, 1MRB, 61MRR, F6MRD loc vic NB666156 at intersection of 2x farm roads E of Geismar (NB6515). Collocated units: None. Security measures: UNK. DOI: 181130 AUG 99.
- d. DEPL, tk co (FUD UNK) loc vic from NB631104 to NB626104, along farm road S of Reinhardts (NB6210). Tanks engines were running and were facing S. Collocate units and security measures: UNK. cot: 181245 AUG 99

5. TACTICS: UNK

6. TRAINING: (61MRR, 56MRD)

- a. Individual: (HQ, 61MRR) - The 3x regt drivers have been practicing OPSEC (silence and no lights) while driving.
- b. Unit: (61 MRR) - Extensive political training in the 61MRR for the last month. (Hearsay: PO, 61MRR to PO, 1MRB, 61MRR. DOI: 181130 AUG 99.)
- c. Specialized: UNK

(CLASSIFICATION)  
WORKING PAPERS

Figure A-22 Sample completed tactical interrogation report (continued).

(CLASSIFICATION)  
WORKING PAPERS

7. COMBAT EFFECTIVENESS: (61MRR, 56MRD)
- a. Losses : (61MRR)
    - (1) Personnel: (61MRR) - Since arriving in the border area on 16 AUG 99, approx 20 training casualties have been evac to the rear, (Hearsay: PO, 61MRR to PO, 1MRB, 61MRR. Dot: 181130 AUG 99).
    - (2) Equipment: (61MRR) - None
  - b. Replacements: (61MRR) None, but there was a replacement center (FUD UNK) in "some large city". (Hearsay: PO, 61MRR to PO, 1MRB, 61MRR. DOI: 181130 AUG 99).
  - c. Reinforcements: UNK
  - d. Combat Experience: (HQ, 61MRR) - Most of the officers in HQ, 61MRR have had experience in Afghanistan, but it is always stressed that they were advisors and not fighters.
  - e. Morale: (HQ, 61MRR) - Officer morale is relatively high as they enjoy field duty and are anxious to show CO, 61MRR that they are proficient. Officers sometimes take their frustrations out on lower EM, causing them to become angry and despondent.
8. LOGISTICS: (HQ, 61MRR, 56MRD)
- a. Weapons and Ammunition: (HQ, 61MRR)
    - (1) Weapons: (HQ, 61MRR) - All weapons are in good condition due to reconditioning in JUL 99 by maint unit (FUD UNK). There are miscellaneous spare parts stored in each BTR-70. Hearsay: BTR-70 driver, HQ, 61MRR. DOI: 171400 AUG 99.)
    - (2) Ammunition: (HQ, 61MRR) - No problems with any ammo. 300xrds were issued for each AK-74 and 2 full mags (16xrds) for PM pistol on 171400 AUG 99 at assembly area, 61 MRR U/I officer, HQ, 61MRR.
  - b. Vehicles and POL: (HQ, 61MRR)

(CLASSIFICATION)  
WORKING PAPERS

Figure A-22. Sample completed tactical Interrogation report (continued).

(CLASSIFICATION)  
WORKING PAPERS

- (1) Vehicles: (HQ, 61MRR) - All vehicles are in good condition, Drivers are constantly working on vehicles. Spare parts are available from chief of Motor Transport, HQ, 61MRR on an as needed basis, but all drivers steal parts from each other occasionally. Tool kits are stored in each vehicle.
  - (2) POL: (HQ, 61MRR) - All vehicles were refueled at assembly area, 61MRR 17 AUG 99, Additional fuel will be obtained from U/I tanker trucks, 61MRR after reaching Nusttal (NB6010) (Hearsay: chief of Motor Transport, HQ, 61MRR. DOI: 171800 AUG 99.)
- c. Food and Water: (HQ, 61MRR)
- (1) Food: (HQ, 61MRR) - 9 canned rations were issued to each member, HQ, 61MRR at assembly area, 61MRR 171700 by chief of Food Supply, HQ, 61MRR. After reaching NUSTTAL (NB6010), members will be receiving more canned rations. CO and PO, 61MRR keep their canned rations and eat at gasthauses in Spahl (NB6412).
  - (2) Water: (HQ, 61MRR) - U/I Water trailer (FUD UNK) at HQ, 61MRR supplies water as needed.
- d. Communications Equipment: (HQ, 61MRR) - All commo equip was in good condition as it was inspected by technical officer, 61MRR 171600 AUG 99 at assembly area, 61MRR.
- e. Medical: (HQ, 61MRR)
- (1) Individual Equipment: (HQ, 61MRR) - Each member was issued 1x U/I indiv first aid kit around the first week of AUG (still sealed).
  - (2) Vehicular Equipment: (HQ, 61MRR) - Each vehicle had 1x U/I first aid kit.
  - (3) Personnel: UNK
  - (4) Facilities: UNK
  - (5) Evacuation Procedures: UNK
- f. NBC Equipment: (HQ, 61MRR) - All NBC equip was in good condition due to inspection by technical officer, 61MRR first week of Aug 99.

(CLASSIFICATION)  
WORKING PAPERS

Figure A-22. Sample completed tactical Interrogation report (continued).

3. MISCELLANEOUS : (61MRR, 56MRD)

a. Personalities: (61MRR)

<u>LAST NAME</u>	<u>FIRST NAME</u>	<u>MNI</u>	<u>RANK</u>	<u>PSN</u>	<u>FUD</u>
OREKHOV	Nikolai	MNU	COL	CO	61MRR
MILENOVICH	Svetoslav	MNU	LTC	PO	61 MRR
GABOVICH	Vladimir	MNU	MAJ	TO	61 MRR

b. Code Names and Numbers: (61MRR)

- (1) Code Name: (61MRR) - NOVY GOD
- (2) Code Number: (61MRR) - QKN-854

cm Radio Frequencies and Call Signs: (61MRR)

(1) Radio Frequencies: (61MRR)

<u>RAD 10</u>	<u>PRIMARY</u>	<u>ALTERNATE</u>
R-130	1.84 MHz	9.01 MHz

Radio frequencies are in effect 18 AUG 99 and are changed daily at 2400 hrs IAW 56MRD CEOI.

(2) Call Signs: (61MRR)

<u>UNIT</u>	<u>PRIMARY</u>	<u>ALTERNATE</u>
Regt HQ, 61MRR	ZHOLTAYA GORA	UNK
PO. 61MRR	ZHOLTAYA GORA-2	UNK

Call signs are in effect 18 AUG 99 and are changed daily at 2400 hrs AW 56MRD CEOI.

d. Passwords (61MRR) - Challenge: ZNAMYA Countersign: VPERYOD  
Passwords are in effect 18 AUG 99 and are changed daily at 2400 hrs AW 56MRD CEOI.

e. Obstacles UNK

f. PSYOPS: UNK

(CLASSIFICATION)  
WORKING PAPERS

Figure A-22. Sample completed tactical interrogation report (continued).

### BOMBING, SHELLING, AND MORTARING REPORTS

Bombing reports (BOMREPS), shell reports (SHELREPs), and mortar bombing reports (MORTREPs) supply information on enemy bombing, shelling, or mortaring activity. Submission is the responsibility of the affected unit. Reports are handled as normal messages and are transmitted by the fastest means available. Each transmission is preceded by the code word "SHELREP" in the case of enemy artillery, by the code word "MORTREP" in the case of enemy mortar or rocket fire, and by the code word "BOMREP" in the case of an enemy air attack. The text of the message is transmitted in the clear except for the unit identification and position of the observer. A call sign is used in place of unit identification. The observer's position is encoded if it discloses the location of a headquarters or an important OP. Figure A-23 shows the bombing, shelling, and mortaring report format.

(CLASSIFICATION)

- A. UNIT OF ORIGIN. (use current call sign, address group or code name) .
- B. POSITION OF OBSERVER (grid reference preferred--encode if this discloses the location of a headquarters or important OP, or if subparagraph F2, below, is used to give information on location).
- C. DIRECTION AND ANGLE OF FALL OR DESCENT. (direction and bearing of flash, sound, or groove of shell (state which) is measured clockwise from grid north in mils, unless otherwise specified, The angle of fall or descent may be determined by placing a stick or rod in the fuze tunnel and measuring in mils, Unless otherwise specified, the angle formed by the stick or rod in relation to the horizontal plane).
- D. TIME FROM.
- E. TIME TO.
- F. AREA BOMBED, SHELLED, ROCKETED, OR MORTARED. (may be sent either as--
1. Grid reference (clear reference is to be used).
  - OR
  2. Direction measures clockwise from grid north to impact points (degrees or mils--state which) and distance in yards or meters (state which) from observer. This information must be encoded. When this method is used, maximum possible accuracy is essential) .
- G. NUMBER AND NATURE OF GUNS, MORTARS, ROCKET LAUNCHERS, AIRCRAFT, OR OTHER METHODS OF DELIVERY.
- H. NATURE OF FIRE. (adjustment, bombardment, harassing) (may be omitted for aircraft) .
1. NUMBER, TYPE AND CALIBER. (state whether measured or assumed) of shells, rockets (or missiles) , and bombs.
- J. TIME FROM FLASH TO BANG. (omit for aircraft).
- F. DAMAGE . (encode if required).

NOTE: JCS Publication 12, page 14, requires an additional message indicator item. This item identifies the report being sent as a shell, bomb, or mortar report. It generally follows the unit of origin item in the message format.

(CLASSIFICATION)

Figure A-23. Format for BOMREP, SHELREP, or MORTREP reports.

## NBC ATTACK REPORTS

NBC attack report formats are used according to the provisions of STANAGS 2103 and 2104 and FM 3-3 to report NBC attacks and the resulting NBC hazardous areas. Chemical and radiological hazardous areas resulting from nuclear and chemical attack by friendly forces are also reported using these formats. These reports are--

- ° NBC-1. Report used by the observing unit to give initial and subsequent data of an enemy chemical, biological, or nuclear attack.
- ° NBC-2. Report used for passing evaluated data of a chemical, biological, or nuclear attack.
- ° NBC-3. Report used for immediate warning of expected NBC contamination or hazardous area.
- ° NBC-4. Report used for radiation dose-rate measurements and detection of chemical or biological contamination.
- ° NBC-5. Report used to locate the area of NBC contamination or hazard.
- ° NBC-6. Report used to detail information on chemical or biological attacks.

NBC-1 and -4 reports are prepared by the unit under attack or a unit observing an attack. These reports are submitted through command, intelligence, or FA communications channels to the designated headquarters TOC by the fastest means available. Initial enemy use of NBC weapons is always reported to the theater commander, through the chain of command, by the fastest means with a FLASH message precedence.

The information source for nuclear attack reports is normally the headquarters of an FA or AD unit (other units may also be designated as collection and reporting agencies). These units submit--

- ° An initial NBC-1 nuclear report to the unit's next higher headquarters with a FLASH message precedence.
- ° Subsequent NBC-1 nuclear reports, which are transmitted to the unit's next higher headquarters, with an IMMEDIATE message precedence, giving follow-up data.

The information source for chemical and biological attack reports is normally the headquarters of a company or independent platoon. It submits--

° An initial NBC-1 chemical or biological report, to its next higher headquarters, with a FLASH message precedence. The next higher headquarters forwards the initial NBC-1 chemical or biological report through command channels, to the NBC collection center, with the same message precedence.

° Subsequent NBC-1 chemical or biological reports, to the unit's next higher headquarters, with an IMMEDIATE message precedence, giving follow-up data. The next higher headquarters forwards subsequent NBC-1 chemical or biological reports through command channels, to the NBC collection center, with the same message precedence.

#### NBC COLLECTION CENTER

The NBC collection center is normally the nuclear, biological, and chemical element (NBCE) of the TOC at division. It consolidates NBC-1 nuclear, biological, or chemical reports of the same attack received from its various information sources and transmits an NBC-1 report to the NBC control center, normally the TOC at field army headquarters. It transmits appropriate NBC-2, -3, and -5 reports to subordinate, adjacent, and higher commands. If there is no NBCE, the G3 assumes these responsibilities.

#### NBC CONTROL CENTER

The NBC control center is normally the NBCE of the tactical operations center at field army. It consolidates and evaluates NBC reports received from subordinate commands and USAF, Marine Corps, and civilian installations and agencies. It directs reconnaissance and survey efforts; transmits evaluated NBC data to subordinate commands and adjacent area commands; and submits appropriate reports to higher headquarters, adjacent commands, and national agencies. If there is no NBCE, the G3 assumes these responsibilities.

#### NBC-1 REPORTS

NBC-1 reports follow the same format as SHELLREPs, MORTREPs, and BOMBREPs. The words "Type of Report," and the letters "B," "D," "H," or either "C" or "F" always are reported. Other items are optional. Table A-3 shows the letter explanation for NBC-1 reports. Table A-21 shows the master list of available letters.

**Table A-3. Letter explanation for NBC-1 report.**

LETTER	MEANING	EXAMPLE NUCLEAR	EXAMPLE CHEMICAL	EXAMPLE BIOLOGICAL
	Precedence date and time (local or Zulu time, state which) Security classification From To Type of Report	NBC 1 (NUCLEAR)	NBC 1 (CHEMICAL)	NBC (BIOLOGICAL)
A.	Strike serial number (if known—as assigned by the NBCE at the operations center responsible for the area in which the strike occurs).	A. 04	A. 02	
B.	Position of observer (UTM or place).	LB 196400	B. Marville	



**Table A-3. Letter explanation for NBC-1 report (continued).**

ETTER	MEANING	EXAMPLE NUCLEAR	EXAMPLE CHEMICAL	EXAMPLE BIOLOGICAL
C.	Direction measured clockwise from or magnetic north (state which) of the attack from observer (degrees or mils, state which).	C. Grid 060 Degrees		
D.	Date and time of denation or date and time attack started (local or Zulu time, state which).	D. 201405 Zulu	D. 201405 (local)	D. 201405 HOTEL
E.	Illumination time (seconds) or time attack ended (local or Zulu, state which).		E. 201412 (local)	
F.	Location of attack (UTM or place) or area attacked (actual or estimated, state which).		F. LB 25300 estimated	F. LB 2030 actual F. LB 2030 actual
G.	Means of delivery, if known.		G. Artillery	G. Aircraft, 100 meters
H.	Type of burst—air, surface or unknown (state which)—including height, if known; type of agent, if known (chemical or biological); or type of attack (chemical or biological).	H. Surface	H. Airburst, nerve	H. Aerial spray
I.	Type and number of munitions or aircraft (state which).			
J.	Flash-to-bang time (seconds).	J. 60		
K.	Crater present or absent and diameter if known (meters).			
L.	Nuclear burst angular cloud width measured at 5 minutes after the detonation (degrees or mils, state which). (Do not report if data is obtained more than 5 minutes after the detonation).	L. 280 mils		
M.	Stabilized cloud-top angle and cloud-bottom angle (state which) or cloud-up and cloud-bottom height (state which) measured at H+10 minutes (degrees, mils, meters, or feet—state which).			
S.	Date-time of reading or date-time contamination initially detected (chemical or biological). State whether local or Zulu time.	S. 201500 (local)		
X.	Located area of contamination (UTM).	X. LB 206303 LB 208306  LB 203303 LB 203306		
	NOTE: When the contaminated area is a complete circle, the first coordinate will be repeated as a last coordinate			

**Table A-4. Initial nuclear report example.**

---

(CLASSIFICATION)

FLASH 090910 ROMEO  
UNCLASSIFIED  
FROM REDDOG TO AMIGO  
NBC-1 NUCLEAR  
BRAVO SHACKLE DELTA HOTEL BRAVO  
UNSHACKLE  
CHARLIE GRID 182 MILS  
DELTA 090907 ROMEO  
HOTEL SURFACE  
JULIET 60  
END OF MESSAGE

(CLASSIFICATION)

---

**Table A-5. Initial chemical report example.**

---

(CLASSIFICATION)

FLASH  
201408 HOTEL  
FROM 07R06  
TO E4Z03  
NBC-1 CHEMICAL  
BRAVO MARVILLE  
DELTA 201405 HOTEL  
FOXTROT LIMA BRAVO 205305  
ESTIMATED  
GOLF ARTILLERY  
HOTEL AIR

(CLASSIFICATION)

---

Table A-6. Subsequent NBC-1 nuclear report example.

---

(CLASSIFICATION)

IMMEDIATE 090913 ROME0  
UNCLASSIFIED  
FROM REDDOG TO AMIGO  
NBC-1 NUCLEAR  
BRAVO SHACKLE DELTA HOTEL BRAVO  
UNSHACKLE  
CHARLIE GRID 182 MILS  
DELTA 090907 ROME0  
HOTEL SURFACE  
LIMA 280 MILS  
END OF MESSAGE

(CLASSIFICATION)

---

Table A-7. Subsequent NBC-1 chemical report example.

---

(CLASSIFICATION)

IMMEDIATE  
201438 HOTEL  
FROM Q7R06  
TO E4Z03  
NBC-1 CHEMICAL  
ALPHA 02  
ECHO 201405 HOTEL  
HOTEL NERVE

(CLASSIFICATION)

---

## NBC-2 REPORTS

NBC-2 reports are used for passing evaluated data of an NBC attack. They are normally based on two or more NBC-1 reports and include an attack location and in the case of a nuclear detonation, an evaluated yield. Tables A-8 and A-9 show examples of NBC-2 (nuclear) and NBC-2 (chemical) report messages.

**Table A-8. NBC-2 nuclear report example.**

---

(CLASSIFICATION)

E4Z03E4Z03  
IMMEDIATE NBC-2  
FROM Q7J04  
ALFA/N001  
201405 ZULU  
FOXTR0T LIMA BRAVO 187486  
HOTEL SURFACE  
NOVEMBER 50  
YANKEE/050/01Z KPH

(CLASSIFICATION)

---

**Table A-9. NBC-2 chemical report example.**

---

(CLASSIFICATION)

E4Z03E4Z03  
IMMEDIATE NBC-2  
FROM Q7J04  
200945Z  
FOXTR0T LIMA BRAVO 126456Z  
HOTEL NERVE

(CLASSIFICATION)

---

NBC-2 reports include the attack time, location, and, in the case of a nuclear detonation, an evaluated yield. Letters "A," "D," "F," "H," and "N" are repeated as often as necessary to produce a summary report. Other letters may be added; however, the letters mentioned must be included in the report. Table A-10 shows the letter explanation for NBC-2 reports.

**Table A-10. Letter explanation for NBC-2 report.**

LETTER	MEANING	EXAMPLE NUCLEAR	EXAMPLE CHEMICAL AND BIOLOGICAL
	Precedence Date-time (local or Zulu time, state which) Security Classification From To Type of Report	NBC-2 (NUCLEAR)	NBC-2 (CHEMICAL)
A.	Strike serial number	24	i
D.	Date-time of detonation or date-time attack started (local or Zulu time, state which).	201405 Zulu	200945 (local)
F.	Location of attack (UTM or place) or area attacked (actual or estimated, state which) .	LB 187486 actual	LB 126456 actual
G.	Means of delivery, if known.		
H.	Type of burst--air, surface, or unknown (state which)-- including height, if known; type of agent, if known; (chemical or biological); or type of attack (chemical or biological).	Surface	Nerve
N.	Estimated yield (kt).	50	

NBC-3 REPORTS

NBC-3 reports provide immediate warning of expected NBC contamination or hazardous areas. Tables A-11 and A-12 show examples of NBC-3 (chemical) and NBC-3 (nuclear) messages.

Table A-II. NBC-3 nuclear report example.

---

(CLASSIFICATION)

ASZ01E3Z02  
IMMEDIATE NBC-3  
FROM R4006  
DELTA 20140Z  
FOXTROT LIMA BRAVO 187486  
HOTEL SURFACE  
PAPA ALPHA-  
LIMA BRAVO 199420  
LIMA BRAVO 200440  
LIMA BRAVO 255410  
LIMA BRAVO 257457  
YANKEE 0272-0312 DEGREES  
ZULU 019-025-05

(CLASSIFICATION)

---

Table A-12. NBC-3 chemical report example.

---

(CLASSIFICATION)

ASZ01E2Z02  
IMMEDIATE NBC-3  
FROM R4006  
DELTA 201415Z  
FOXTROT LIMA BRAVO 206300Z  
HOTEL BC GB  
PAPA ALPHA LIMA BRAVO 208320, LIMA BRAVO  
210320, LIMA BRAVO 206130, LIMA  
BRAVO 204310

(CLASSIFICATION)

---

Table A-13 explains the letters in the NBC-3 nuclear and chemical report examples, Other letters from the master list, are added at the users' discretion.

NOTE: When the effective windspeed is less than 8 kph, the NBC-3 report consists of the letters "D," "F," and "Z." "Z" contains three digits only, (the radial distance of zone 1).

Table A-13. Letter explanation for NBC-3 reports.

LETTER	MEANING	EXAMPLE NUCLEAR	EXAMPLE CHEMICAL AND BIOLOGICAL
	Precedence Date-time (local or Zulu time, state which) Security Classification From To Type of Report	NBC 3 (NUCLEAR)	NBC (CHEMICAL AND BIOLOGICAL)
A.	Strike serial number.	A. 24	A. 3
D.	Date-time of detonation or date-time attack started (local or Zulu time, state which).	D. LB 201405 Zulu	D. 201405 (local)
F.	Location of attack (UTM or place) or area attacked (actual or estimated, state which).	F. LB 187486 actual	F. LB 206300 actual
P.	Areas of expected contamination (UTM).		P. LB 208320 LB 206310 LB 210320 LB 204310
Y.	Direction measured clockwise, from grid north, to the left and then to the right radial lines (degrees or mils, state which) (4 digits each).	Y. 0272-0312 degrees	
Z.	Effective windspeed (kph), 3 digits; downwind distance of zone 1 (km); 3 digits; cloud radius (km), 2 digits. (When effective windspeed is less than 8 kph, use 3 digits only for radial distance zone 1).	Z. 019-025-05	

NBC-4 REPORTS

NBC-4 reports are used to transmit radiation dose-rate measurements. Tables A-14 and A-15 show examples of NBC-4 radiation dose-rate messages.

Table A-14. NBC-4 report example 1.

---

(CLASSIFICATION)

E4Z03 E4Z03  
IMMEDIATE NBC-4  
FROM Q7R06  
201745 HOTEL  
QUEBEC LIMA BRAVO 123987  
ROMEO 35 INITIAL  
SIERRA 201735 HOTEL

(CLASSIFICATION)

---

Table A-15. NBC-4 report example 2.

---

(CLASSIFICATION)

REDDOG 3 REDDOG 3  
IMMEDIATE NBC-4  
FROM ALFA  
201745 HOTEL  
QUEBEC LIMA BRAVO 123987  
ROMEO 1 INITIAL  
SIERRA 201735 HOTEL

(CLASSIFICATION)

---



Table A-16 explains the items in the examples for NBC-4 nuclear and chemical report formats. The letters "Q," "R," and "S" are repeated as often as necessary. Users of NBC-4 reports are not confined solely to the use of the letters shown in the examples; other letters from the master list, (see table A-21), are added at the users' discretion.

NOTE: Radiation dose-rates are measured in the open, one meter above the ground. Other conditions are specified in the message as part of line ROMEO.

**Table A-16. Explanation of letters for NBC reports.**

LETTER	MEANING	EXAMPLE
	Precedence Date-time (local or Zulu time, state which) Security Classification From To Type of Report	NBC-4 (NUCLEAR)
Q.	Location of reading (UTM)	Q. LB 123987
R.	Dose-rate (cGy/hr) (this is NOT normalized to H + 1 hour). The words "initial," "increasing," "peak," or "decreasing," may be added (correlation factor information is included if shielded dose-rate readings are reported).	
s.	Date-time of reading (local or Zulu, state which)	S. 201735 (local) Q. LB 129965 R. 60 S. 201650 (local) Q. LB 146808 R. 27 INCREASING S. 201710 (local)

NBC-5 REPORTS

NBC-5 reports identify the area of contamination or hazard. Tables A-17 and A-18 show examples of an NBC-5 report messages.

Table A-17. NBC-5 nuclear report example.

---

(CLASSIFICATION)

A5Z01E3Z02	
IMMEDIATE NBC-5	
090913 GOLF	
FROM REDDOG	
TO AMIGO	
NBC-5 NUCLEAR	
TANGO 201505Z	
VICTOR NOVEMBER DELTA	651455
	810510
	821459
	651455
WHI SKEY NOVEMBER DELTA	604718
	991686
	114420
	595007

(CLASSIFICATION)

---

Table A-18. NBC-5 chemical report example.

---

(CLASSIFICATION)

A5Z01E2Z02	
IMMEDIATE NBC-5	
SIERRA 2008000Z	
TANGO 201045Z	
EXRAY CHEM NOVEMBER	
DELTA	206991
	201575
	200787
	206991

(CLASSIFICATION)

---

The NBC-5 report is most useful when sent as a map trace or overlay (if time and distance permit). When the contamination arises from a single threat or unidentified nuclear burst, the dose-rate always refers to H+1 hour, and the letter "T" is used. When there have been several nuclear detonations at different times or on different days and no single H+1 hour is possible, the dose rates are reported as a specified item using the letter "O." Letters "O" and "T" are, therefore, alternatives; both cannot be used in the same report. Table A-19 explains the letter designations used in NBC-5 reports.

NOTE: When requested decay rates are to be transmitted, use the letter "R."

**Table A-19. Letter explanation for NBC-5 reports.**

LETTER	EXAMPLE NUCLEAR	EXAMPLE CHEMICAL AND BIOLOGICAL
Precedence Date-time (local or Zulu time, state w h i c h ) Security Classification From To Type of Report	NBC-5 (NUCLEAR)	NBC-5 (CHEMICAL and BIOLOGICAL)
A. Strike serial numbers causing contamination (if known)	A. 24	A. 1
o. Reference date-time for estimated contours (see note (2) above) when not H+1 hour		
s. Date-time contamination initially detected (chemical or biological (local or Zulu time, state which)		S. 200800 (local)

**Table A-19. Letter explanation for NBC-5 reports (continued).**

<p>T. H+1 date-time or date-time of latest reconnaissance of contamination in the area (chemical or biological). State whether local or Zulu time.</p>	<p>T. 201505 ZULU</p>	<p>T. 201045 (local)</p>
<hr/> <p>u. 1,000 cGy/hr contour line coordinates</p> <hr/>		
<p>v. 300 cGy/hr contour line coordinates</p>	<p>V. ND 651455 ND 810510 ND 821459 ND 651455</p>	
<hr/> <p>w. 100 cGy/hr contour line coordinates</p>		
	<p>W. ND 604718 ND 991686 ND 114420 ND 595007</p>	
<hr/> <p>x. 20 cGy/hr contour line coordinates, or located area of contaminant ion (chemical or biological)</p>		
		<p>X. CHEMICAL ND 206991 ND 201575 ND 200787 ND 206991</p>

Figure A-24 shows a current example of the estimated radiological contamination trace (dose-rate type) format. It is not necessary, or even desirable, to report all four of the contours for different dose rates. Four are given to provide flexibility. (In the example, only two are reported.) When a contour closes to form a complete ring, the first coordinate is reported at the end. The following are colors used for plotting and sending the report as a trace:

- °Red for 1,000 cGy/hr.
- °Green for 300 cGy/hr.
- °Blue for 100 cGy/hr.
- °Black for 20 cGy/hr.

Yellow is used for chemical and biological contamination or hazardous areas. Additional letters, including those shown in the examples in Table A-19, are used. Letters from the master list in Table A-21 are added at the users' discretion.

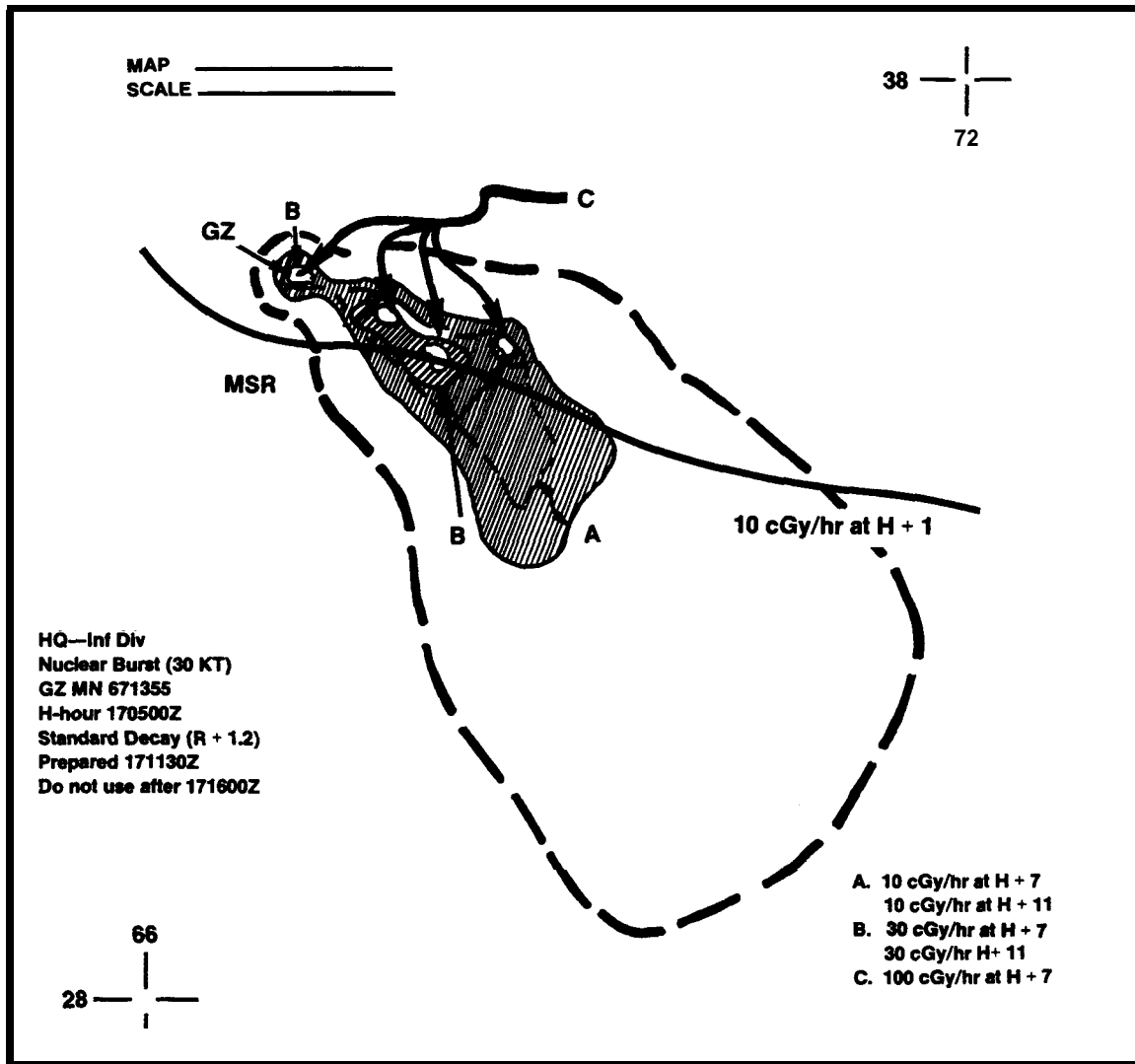

Figure A-24. Radiological contamination trace.

NBC-6 REPORT

NBC-6 reports are used to summarize information concerning a chemical or biological attack. Table A-20 shows an NBC-6 biological report.

**Table A-20. NBC-6 biological report.**

---

ALFA	cool
DELTA	200430Z
ECHO	200435Z
FOXTROT	LBZO0300 to LB208304 Actual
GOLF	Aerial spray
HOTEL	Toxin
INDIA	2 Aircraft
KILO	Rolling hills, mostly open
MIKE	Enemy broke contact just before the attack, then bypassed on right flank
QUEBEC	Soil sample taken at LB200300
YANKEE	Downwind direction 270 degrees, wind speed 015 kph
ZULU BRAVO	This is the only biological attack in our area

---

The NBC-6 report is a narrative description of chemical and biological attacks that have occurred in a unit's AO. It is designed to be developed at battalion level and above. It contains as much information as is known about the attacks. It is submitted only when requested and is usually sent in hard copy.

MASTER LIST

Table A-21 shows the master list of letters that is applicable to all types of NBC reports. Each letter is annotated. Care should be taken to ensure that letters mandatory for each NBC report are incorporated before adding letters to the reports, overlays, or traces.

Table A-21. Master list of letters.

LETTER	MEANING	MEANING
	NUCLEAR REPORTS	CHEMICAL OR BIOLOGICAL REPORTS
A.	Strike serial number(s).	Strike serial number(s).
B.	Position of observer (UTM or place) .	position of observer (UTM) or place) .
c.	Direction measured clockwise from grid or magnetic north (state which) of the attack from observer (degrees or roils, state which).	Direction measured clockwise from grid or magnetic north (state which) of the attack from observer (degrees or roils, state which) .
D.	Date-time of detonation (local or Zulu time, state which) . If local time is used, give the letter of the local time zone, if-known. See FM 101-10-1 for time-zone charts. If the local time is used and the time-zone letter is not known, the word "local" will be transmitted with this item.	Date-time attack started (local or Zulu time, state which). If local time is used, give the letter of the local time zone, if known. See FM 101-10-1 for time-zone charts. If the local time is used and the time-zone letter is not known, the word "local, " will be transmitted with this item.
E.	Illumination time. (Report only when other data are not available. Report in seconds.)	Time attack ended (local or Zulu, state which).
F.	Location of attack (UTM or place) (actual or estimated, state which).	Area attacked (actual or estimated, state which).
G.	Means of delivery, if known.	Means of delivery, if known.
H.	Type of burst--air, surface, or unknown, state which-- including height, if known.	Type of agent, if known (chemical or biological). Type of attack (chemical or biological).
1.	(This letter item is not used for nuclear report.)	Type and number of munitions or aircraft (state which).
J.	Flash-to-bang time (seconds).	
K.	Crater present or absent and diameter, if known (meters) .	

**Table A-21. Master list of letters (continued).**

LETTER	MEANING	MEANING
	<b>NUCLEAR REPORTS</b>	<b>CHEMICAL OR BIOLOGICAL REPORTS</b>
L.	Nuclear burst angular cloud width measured at 5 minutes after the detonation (degrees or roils, state which). (Do not report if data is obtained more than 5 minutes after the detonation.)	
M.	Stabilized cloud-top angle and cloud-bottom angle (state which) or cloud-top height and cloud-bottom height (state which) measured at H+10 minutes (degrees, roils, meters, or feet--state which).	
N.	Estimated yield (kt).	
O.	Reference date-time for estimated contours when not H+1 hour.	
P.	For radar purposes only:	Area of expected contamination (UTM).
	P.A. UTM coordinates of points to outline external contours of radioactive clouds.	
	P.B. Effective wind direction (direction from which the wind is blowing) in degrees or roils (state which) .	
Q.	Location of reading (UTM).	
R.	Dose-rate (cGy/hr). The words "initial, " " increasing," "peak." or "decreasing" may be added.	
s.	Date-time of reading (local or Zulu time, state which).	Date-time contamination initially detected (local or Zulu time, state which).
T.	H+1 date-time (local or Zulu time, state which).	Date-time of latest reconnaissance of contamination in the area (local or Zulu time, state which).
u.	1,000 cGy/hr contour line coordinates (UTM) (red).	
v.	300 cGy/hr contour line coordinates (UTM) (green).	



**Table A-21. Master list of letters (continued).**

LETTER	MEANING	MEANING
	<b>NUCLEAR REPORTS</b>	<b>CHEMICAL OR BIOLOGICAL REPORTS</b>
W.	100 cGy/hr contour line coordinates (UTM) (blue).	
x.	20 cGy/hr contour line coordinates (UTM) (black).	Located area of contamination (UTM) (yellow).
Y.	Direction measured clockwise from grid north to the left and then to the right radial lines (degrees or roils, state which--4 digits each).	
z.	Effective windspeed (kph), 3 digits; downwind distance of zone I (km), 3 digits; cloud radius (km), 2 digits. (When effective windspeed is less than 8 kph, the NBC-3 report will contain only three significant digits, that is, the radial distance of zone I.)	

## ANALYSIS OF AREA OF OPERATIONS

Figure A-25 shows a completed sample and explanation of analysis of the area of operations. The following paragraphs are keyed to paragraphs in the sample.

1. **PURPOSE AND LIMITING CONSIDERATIONS.** State the purpose of the analysis and define the area that is being analyzed. Include a statement of the mission of the command and other considerations that limit the applicability of the analysis. Include the commander's plan of action and enemy capabilities.

2. **GENERAL DESCRIPTION OF THE AREA.**

a. **Climatic or Weather Conditions.** This paragraph lists items of weather information that have military significance. Throughout the remainder of the analysis, weather information is interpreted as to its operational effects. For example, winds at low temperatures are interpreted in terms of the wind chill factor and the resulting effects on operations, such as attack or defense which must face the prevailing winds, or the use of open or closed storage facilities.

Light data is always reported to assist in selecting courses of action and the conduct of military activities.

The BMNT and the EENT are the beginning and end, respectively, of enough light for limited visibility. The BMCT and the EECT are the beginning and end, respectively, of adequate light for large-scale operations.

Moon phases and other phenomena, like atmospheric conditions and star brilliance, also influence night operations. During full moonlight, conditions of visibility sometimes approach those of daylight. Such conditions need to be anticipated as they influence friendly and enemy courses of action such as attacks, patrolling, and changes in dispositions.

b. **Terrain.**

(1) **Relief and Drainage System,** Drainage and ridge lines are basic elements in studying terrain, as they clearly indicate the general shape of the ground. A complete study of relief and drainage includes detailed information about slope, configuration, elevation of ground forms; and depth, width, tide data, and conditions of banks and bottoms of streams and rivers. These items are portrayed graphically on maps.

(2) **Vegetation.** Vegetation studies are best presented in the form of tinted, or otherwise marked, overlays. Considerations include locations of trees, diameters of trunks, density, ground cover or canopy, undergrowth, and types of natural and cultivated vegetation in nonwooded areas.

(3) **Surface Materials.** Surface materials are best presented on colored or marked overlays. Soil maps made by the agricultural services of various countries are particularly valuable. The information contained in soil maps frequently is translated into a trafficability map and a map of areas susceptible to high levels of induced radioactivity. A trafficability map based on weather forecasts are colored or marked to indicate degrees of trafficability effectively shows areas suitable for cross-country movement.

(4) **Artificial Features,** Artificial features of potential military significance include roads, railroads, bridges, tunnels, mines, towns, industrial areas, and fortifications. The features are best represented on maps or marked overlays.

c. **Additional Characteristics.** Only those characteristics--sociology, politics, economics, transportation, manpower--which influence the choice of a course of action by either force are included. Lengthy data is presented in an annex, preferably in tabular form.

3. **MILITARY ASPECTS OF THE AREA.** The facts listed in paragraph 2 are analyzed and their influence on tactical and CSS factors that are considered in the selection of a course of action by either force are determined. In the analysis of these factors, the effects of and on nuclear fires, chemical and biological agents, and important devices and equipment used in implementing courses of action are integrated, as appropriate. The tactical aspects of observation and fire, concealment and cover, obstacles, key terrain features, AAs, and the CSS aspects are discussed in the following paragraphs.

a. **Tactical Aspects.**

(1) **Observation and Fire.**

(a) Observation depends on conditions of terrain which permit a force to locate the enemy, either visually or through the use of surveillance devices. The highest terrain in an area usually provides the best observation. The increased use of equipment with LOS characteristics requires the availability of suitable terrain features for sighting purposes; while at same time, the capability of employing organic aerial platforms reduces the requirement to use such terrain. Dust clouds caused by nuclear blast reduce electronic LOS. Other limits to observation include darkness and tall vegetation (woods and jungle canopy). The effects of visibility on observation are analyzed along with weather conditions.

(b) Fire, as used in the analysis of the battlefield area, includes the FofFs of all weapons and characteristics of weapons delivery systems affected by weather and terrain. For example, gusty surface winds affect the use of projectiles. High, irregular terrain features or the absence of overhead mass clearance limit FofFs. A FofF is an area that weapons can cover effectively with fire from given positions. Although observation is essential to effective control of fire, the best observation does not always guarantee the best FofF. An ideal FofF for flat-trajectory weapons is an open area in which the enemy can both be seen and has no protection weapons fire.

(2) Concealment and Cover.

(a) Concealment is protection from observation. It is provided by woods, underbrush, snowdrifts, tall grass, cultivated vegetation, darkness, smoke, dust, fog, ground haze, rain, or falling snow.

(b) Cover is protection from the effects of direct and indirect fires. It is provided by ditches, quarries, caves, riverbanks, folds in the ground, shell craters, buildings, walls, railroad embankments and cuts, sunken roads, and highway fills. Defiladed areas which provide protection against some types of weapons do not necessarily protect against effects of nuclear fires. Unless the forward slopes of a terrain mass are very steep, nuclear blast will affect personnel and material on the reverse slope because the blast wave follows the configuration of all but the most rugged terrain. When a nuclear weapon is fired over a deep valley, or the valley axis points toward ground zero, the blast effects are canalized, increasing the damage. Irregular terrain provides some cover from thermal radiation of nuclear fires. Few buildings are sufficiently strong to withstand all effects of blast or, if not damaged or destroyed by blast, to be unaffected by thermal radiation. Foxholes, bunkers, and tunnel-type shelters offer the simplest forms of effective cover.

(c) Concealment and cover are desirable for both the attack and the defense. If troops move forward under the concealment of woods, fog, or a moonless night, the chances of achieving surprise are greater. If troops move protected from the enemy's fire by ditches, embankments, or walls, the attack is more effective. In a defensive situation, friendly forces seek to defend in an area which offers both concealment and cover but does not provide covered approaches for the enemy.

(d) The mobility of the command is considered in determining available concealment and cover. Concealment and cover are desirable during troop movements by any means. Routes which afford good concealment and cover reduce the vulnerability of a moving force to detection and to destruction by fire.

### **(3) Obstacles.**

(a) An obstacle is any natural or artificial terrain feature which stops, impedes, or diverts military movement. Natural obstacles include rivers, streams, canals, lakes, swamps, cliffs, steep slopes, dense woods, jungles, deserts, mountains, cities, and certain types of unstable soil. Artificial obstacles are works of construction and destruction executed to stop or impede military movement. They include minefield, craters, antitank ditches, trenches, abatises, roadblocks, deliberately flooded areas, areas contaminated with chemical and biological agents, extensive rubble, forest fires, trees blown down, and areas contaminated with residual nuclear radiation.

(b) To be fully effective, obstacles are covered by observation and fire. However, even undefended obstacles may canalize an attacker into concentrations which are easier to detect and which are suitable for nuclear attack. Obstacles perpendicular to a direction of attack favor the defender by slowing the enemy, forcing the enemy into concentrations that tend to occur while crossing obstacles, and holding the attacker for a longer time under the effective fires of the defense. Obstacles parallel to an axis of advance give the attacker flank protection. However, parallel obstacles interfere with lateral movement and coordination.

(c) The mission of the command influences consideration of obstacles. In the defense, the intelligence officer identifies as obstacles those features of the terrain which stop, impede, or divert military movement into, out of, or within the area encompassed by the FEBA, lateral boundaries, and the rear boundary (prescribed or assumed). In the attack, the intelligence officer considers the obstacles from the line of departure to the objective (both inclusive), bounded laterally by the assigned or assumed operational zone.

### **(4) Key Terrain Features.**

(a) A key terrain feature is any locality or area whose seizure or control affords a marked advantage to either opposing force. Key terrain features are selected to indicate areas and localities whose seizure or control are considered in formulating and selecting courses of action. The selection is based on the level of command, type of unit, and mission of the command. Key terrain which would give us a marked advantage in the accomplishment of our mission is selected. If it is seized or control led by the enemy, it would delay the accomplishment of our mission. For example, a bridge over an unfoldable river gives access to the opposite shore without requiring an assault crossing, Control of a road or rail center reduces the enemy's ability to resist our advance. A level clearing in rough terrain is the only accessible landing field for airmobile operations.

(b) Key terrain varies with the level of command. For example, to an army commander, a large city affords marked advantages as a communications center. To a division commander, the high ground which dominates the city is more important, and the city itself is an obstacle,

(c) Obstacles are rarely key terrain features. The high ground dominating a river, rather than the river itself, is usually the key terrain feature for the lower unit commander. An exception is an obstacle like a built-up area, which is assigned as an objective to a force; the obstacle then becomes key terrain to the force ordered to capture it.

(d) Key terrain, in addition to influencing mission accomplishment, is also highly significant in applying combat power. Control is not ensured only by seizure and occupation. Seizure and physical occupancy of key terrain features by relatively large forces may not be desirable. Destructive fires delivered by long-range means can destroy forces physically occupying key terrain. The commander controls key terrain to avoid destruction of force while keeping the enemy from gaining control. Control includes maneuver, surveillance, security, and use of fires. Terrain which permits or denies maneuver is key terrain. Tactical use of terrain often is directed at increasing the capability for applying combat power and, at the same time, forcing the enemy into areas which result in reduction of the enemy's ability to apply combat power. Terrain which permits this also is key terrain. The effects of terrain on maneuver, application of combat power, and preservation of force integrity are considerations in selecting and controlling key terrain and its tactical use.

(e) In the offense, key terrain features are usually forward of the friendly dispositions and are often assigned as objectives. However, terrain features in adjacent sectors are key terrain if their control is necessary for the continuation of the attack or the accomplishment of the mission. If the mission is to destroy enemy forces, terrain is selected whose seizure helps ensure the required destruction. Terrain which gives the enemy effective observation along an axis of advance to be used by the friendly forces is key terrain if the enemy must be denied its possession or control. Key terrain is within friendly territory when its control is essential to the success of an offensive operation. For example, if the enemy attacks before friendly forces attack, the control of this terrain is essential because it affords a marked advantage. Thus, it is a key terrain feature.

In the defense, key terrain is usually within the assigned sector and within or behind the selected defensive area. Some examples of key terrain are--

°Terrain which gives good observation over AAs to and into the defensive position.

°Terrain which permits the defender to cover an obstacle by fire.

°Important communication centers which affect command communications and the use of reserves.

Key terrain also is forward of the defensive area or in adjacent sectors. For example, a terrain feature along the FLOT or in an adjacent sector which gives the enemy good observation over defended localities, communication routes, or enemy AAs is key terrain when active measures are taken to reduce the enemy advantage. The defender moves positions forward to include the feature or take action to minimize the enemy advantage by the use of fire, chemicals, smoke, concealment, and cover.

(5) Avenues of Approach. An AA is a route for a force of a particular size to reach an objective or key terrain. To be considered an AA, a route provides some ease of movement and enough width for dispersion of a force of a sufficient size to significantly affect the outcome of the operation. The division G2 usually considers AAs adequate for the type brigade of the particular division. The corps and higher G2s usually consider AAs adequate for at least a division. In determining the width of dispersion, consideration is given to the deployment patterns, mobility means, and area required for maneuver to prevent presenting lucrative targets for nuclear fires.

(a) Ground Avenues of Approach. A valley approach gives the advancing force some cover from enemy direct fire and some concealment from enemy observation. A valley approach includes the floor of the valley, the slopes of the ridges, and the military crests. Control of the military crests on each side of the valley is essential. In a valley approach, the best AA is that which offers the best observation, cross-country trafficability, road net, FofF, concealment and cover, and dispersion. In evaluating the use of deep valley approach, the possible intensification of nuclear effects and resulting greater casualties on the valley floor are considered. At times, the best avenue is along the slopes of a ridge below the military crests, rather than along the valley floor.

The use of a ridge approach depends upon the width and shape of the ridge, the size and deployment of the units involved, and the distance to the elevation of adjacent ridges. A ridge approach usually has the advantage of good observation; however, there is little protection from enemy fire on the ridge. The best AA on a ridge is often slightly below the topographical crest, with sufficient force on the crest to control it.

(b) Air Avenues of Approach. An AAA is a route which provides a suitable path for a particular number of aircraft to reach a LZ. The aviation officer or the aviation mission commander assists in evaluating the effect of density altitude, wind, turbulence, and visibility on selected AAAs. In selecting AAAs, the following factors are considered:

°Sufficient air space.

°Concealment from ground observation.

° Easily recognized terrain features.

° Length of flight paths.

1 Sufficient air space is required for rapid movement of the aircraft to the LZS. FS requirements involving artillery and tactical air support may restrict the availability of air space. Consideration is given to gun-target lines and to restrictive fire plans that are in effect during the air movement phase. The size of the air assault force involved in the operation also is considered; however, no parameters are given as to width concerning AAA. Depending on the flight formation, a large number of helicopters are flown over a relatively narrow AAA. Another consideration in relation to adequate air space is the desirability of having multiple flight routes available. Generally, in situations with concentrated enemy forces along the LOC, multiple flight routes from the pickup zone to the objective area and back are desirable.

2 Heavily forested and swamp areas provide good routes and concealment from ground level because ground troops have little opportunity to see and fire on helicopters passing overhead at tree-top level. Low-altitude operations over heavy foliage distort the acoustic wave from aircraft and decrease the distance at which the sound is detected. They also hamper determination of the direction of the noise source by ground observers. AAAs are in defilade with respect to enemy AD radar and weapon locations. Ridge lines are crossed as infrequently as possible to reduce exposure time to radar detection. Steep defiles or canyons are avoided, especially when there is an appreciable amount of surface wind that can cause momentary loss of aircraft control because of downdrafts.

3 Navigation at low altitudes is extremely difficult. The presence of easily recognized terrain features, such as rivers or roads, significantly improves the pilot's ability to navigate by reference to ground features. Terrain corridors are usually desirable because they afford both ease of navigation and defilade. Linear features that parallel the direction of flight are the most valuable in assisting navigation.

4 In the interest of minimizing the exposure of aircraft enroute to the objective area, the shortest possible flight paths that afford sufficient air space, concealment from ground observation, and easily recognized terrain features are usually preferred. However, longer flight paths are selected for purposes of deception.

(6) **Combat Service Support Aspects.** The analyses of the facts and subconclusions developed in the preceding parts of the analysis are used as a basis for further studies of the effects of CSS activities on friendly and enemy units. This paragraph determines the effects of the characteristics of the battlefield area on CSS that influence the selection of a course of action by either force.



In studying the influence of the area, consideration is given to effects on matters such as availability of adequate routes for LOC, facilities for maintenance and storage, construction resources, public health situation, required shelter for administrative facilities, availability of labor, maintenance of discipline, law and order, and control of refugees.

4. EFFECTS OF CHARACTERISTICS OF THE AREA. This paragraph contains the conclusions reached on the basis of the facts and subconclusions previously developed. The effects of the characteristics of the AO on each significant course of action which the enemy is physically capable of adopting and which, if adopted, could adversely affect the accomplishment of our mission are discussed. Usually, the discussion includes effects on the enemy's ability to defend or attack. It also includes, as appropriate, the effects on the enemy's ability to delay; to use reserves, amphibious or airborne forces, nuclear fires, guerrilla forces, chemical and biological agents, cover and deception, sensor devices; or to conduct special operations and support the enemy's forces administratively. The discussion of the effects on our courses of action is limited to those required for the accomplishment of the mission.

(CLASSIFICATION)

copy no 2 of copies  
2d Mech Div  
ELLY (8831)  
21503S July 19  
582

ANALYSIS OF AREA OF OPERATIONS NO 6

reference: Map, series CSM 01, Westland, sheet 1 (Ebel), edition 1974, 1:50,000

I. PURPOSE AND LIMITING CONSIDERATIONS

a. Purpose. To analyze and evaluate the area east of Cartersberg (9297) from the general area of Verlook Ridge (9406) south to the Erie Canal within the division zone.

b. Mission. Division attacks 140900 July, secures high ground from Hill 322 (1394) to Hill 305 (0490) to deny the enemy a bridgehead, and prepares to cross the Erie Canal and continue the attack to the south.

II. GENERAL DESCRIPTION OF THE AREA

a. Climate or Weather Conditions.

- (1) Climate, Annex A (climatic summary).
- (2) Weather, Weather forecast, 12-16 July.
  - (a) Precipitation. None predicted.
  - (b) Fog. None predicted.
  - (c) Temperature. Range from 70° to 86°F.
  - (d) Wind. Surface winds from north, 9 to 17 knots per hour.
  - (e) Cloudiness. None predicted.
  - (f) Atmospheric pressure. Average about 980 millibars.
  - (g) Moon. New moon, 25 July.
  - (h) Light data.

Date	BMNT	BMCT	EECT	EENT	Moonrise	Moonset
13 July	0232	0440	1933	2138	2024	0608
14 July	0233	0442	1932	2138	2050	0714
15 July	0234	0444	1931	2137	2114	0806
16 July	0235	0446	1930	2137	2137	0901

b. Terrain.

(1) Relief and drainage systems. Annex B (Relief Overlay), Annex C (Drainage Overlay), and Annex D (Slope Overlay). Area is drained by the Maine River on the west and southwest and the South River on the northeast. The northwest to southeast ridge running from Hill 351 (9807) to Albany (3960) generally bisects the area. The major spurs of this ridge run generally east and west. The terrain is generally rolling with a series of sharply rising table lands. The Maine and South Rivers and the Erie Canal are unfordable. The Maine River south of Cartersberg averages about 30 meters in width and 2 meters in depth. The South River averages about 15 meters in width and about 2 meters in depth. The Erie Canal has steep banks and averages about 3 meters in depth and is about 17 to 21 meters in width at the top of the banks. All other rivers and streams are fordable, varying in width from about 1 to 7 meters, with an average depth of 40 centimeters.

(2) Vegetation. Annex E (Vegetation Overlay) and Annex F (Vegetation Impeding Movement Overlay). Vegetation consists of growing crops, vineyards, pasturelands, orchards, and wooded areas. Hay, wheat, and vegetables are the main crops. Most crops are completely cut by the end of September. Wheat is grown mostly on open-topped tablelands. Vineyards are generally terraced and on the slopes of hills. Most woods in the

(CLASSIFICATION)

Figure A-25. Example and explanation of analysis of the AO.

Classification is centered at the top and bottom of each page,

Copy number assigned by issuing headquarters. Official designation of unit. Physical location of command post by coordinates, state or county.

Date-time group when the analysis is signed followed by the message reference number (example: SB2) used when the analysis is distributed outside the headquarters for the purpose of acknowledgment in the clear. All appended material analysis having the same distribution bears the same reference number.

The title line identifies the analyses by number (consecutive throughout the calendar year).

Reference list maps, charts, or other documents required to understand the analysis. References to maps include the map series number (country or geographic area, if required), sheet number (and name, if required, edition and scale (if required)).

Paragraph 1a states the exact limits of the area being studied.

Paragraph 1b states the mission and any other limiting considerations such as time limitations, the commander's plan of action, and enemy capabilities.

Paragraph 2 is listing of pertinent facts for use as a basis for the succeeding paragraphs.

Paragraph 2a lists or refers to other documents containing (for the period under study) meteorological conditions to include precipitation, fog, cloud conditions, temperature, relative humidity, surface winds, effective winds (or winds aloft), atmospheric pressure, light data to include moon phases, moonrise and moonset, and other geodetic data as appropriate. When appropriate, include magnetic phenomena.

Paragraph 2a(2) lists data to be considered by aviation units. It is used in calculating aircraft performance and altimeter setting. Light data are always given, as they are necessary for the selection of courses of action. The BMNT and the EENT are the beginning and end, respectively, of enough light for limited visibility. The BMCT and the EECT are the beginning and end, respectively of adequate light for large scale operations.

Paragraph 2b(1) describes configuration of the ground, including slopes, for personnel and vehicles and critical relief for equipment dependent on configuration and conditions of streams, including depth, slope, and condition of banks and bottom, and location of crossing sites. Named localities are located by grid coordinates the first time they appear in the analysis. Grid coordinates are repeated only if required for ease of reference.

Paragraph 2b(1) also makes maximum use of special colored maps or overlays. Under each characteristic include facts to assist in subsequent determination of the effects of the characteristic on the use of nuclear weapons, chemical agents, and important devices and equipment used implementing courses of action (do not include here the interpretation of these effect on friendly or enemy possible courses of action).

Paragraph 2b(2) indicates wooded areas, including type, location, size, and shape of trees, diameter of trunks, density, crown cover, and undergrowth include types of natural and cultivated vegetation of nonwooded areas.

(CLASSIFICATION)

area are deciduous trees about 25 centimeters in diameter and approximately 10 to 12 meters apart. Underbrush has been cleared throughout the area. Logging operations throughout the forest in vicinity of 9306 have thinned the tree stand to an average density of 90 trees per hectare. Roads and streambanks are generally bordered with trees. Small, scattered patches of trees are found in the lowland plains. Wooded areas restrict, but do not preclude, the employment of armor.

(3) Surface materials. Annex G (Soils Overlay). Surface in most of the area consists of thick clay-like soil on a hard limestone or limey shale base. Above 200 meters elevation, with but few exceptions, the soil is firm and capable of supporting heavy wheeled and tracked vehicles even where under cultivation. The rains do not seriously affect trafficability at this time of year. The soil is generally wet in stream bottoms and in the lowlands below 200 meters elevation. While capable of supporting light tracked or wheeled vehicles, the soil becomes spongy and boggy where the turf has been destroyed.

(4) Artificial features. Annex H (Built-up Areas and LOC Overlay). A double-track, railroad crosses the area from Cartersberg to the east. A single-track railroad runs from Nome (9619) to Cartersberg, crossing the Macon saddle (9608). A double-track railroad from the west parallels the south bank of the Erie Canal as far as Dawson (0489). The area is covered with an extensive network of principal and secondary roads. Principal roads radiate from Cartersberg. Roads across Overlook Ridge (9406) from north to south have been improved. National highways are at least 6 meters wide. All bridges on regularly maintained roads are two-way class 50. Villages consist of closely grouped buildings of brick or stone. The enemy has constructed extensive field fortifications and artificial obstacles throughout the area north of Erie Canal. The artificial obstacles consist primarily of minefields and wire and are most extensive in the South River valley and in the general area of Athens (0194) and Auburn (0495).

c. Other Characteristics.

(1) Sociology. The area is generally rural. The farm villages have a present population of from 50 to 100 each. Current population of Cartersberg is estimated at 50,000 and population of Harlow is estimated at 15,000. The population is primarily Caucasian; farming is the principal occupation. Principal crops are wheat, corn, cotton, and grapes.

(2) Economics. Little food and few supplies are available because the enemy has taken food and materials to support the forces. However, some grain crops remain in fields and can be harvested at a later date if protected.

(3) Government. There are civil agencies that are prepared to take over functions of civil government as the country is recaptured.

(4) Psychology. The confiscation of food and supplies and the impressing of civilian labor have made the people extremely hostile toward the enemy. Acts of sabotage occur frequently in the Army's rear area.

3. MILITARY ASPECTS OF THE AREA.

a. Tactical Aspects.

(1) Observation and fire. Annex I (Horizontal Visibility Overlay).

(a) Weather conditions. Annex J (Fog Overlay). Weather permits good air and ground observation. Continued dry weather will increase dust clouds caused by nuclear weapons. Observation will be reduced for a longer period of time in nuclear target areas. Weather favors our, but not enemy's, use of smoke.

(b) Relief. The high ground now held by the enemy affords the enemy excellent observation over approaches into the position. The enemy-held hills west of the Maine River dominate the western part of the area. High ground vicinity Balda's Peak (0004) provides the enemy with excellent observation to the northeast, east, and south. The division objective, with the spur extending north from 1395 to 1004, provides the enemy with excellent observation over all approaches leading directly to it. FofFs within the area for flat-trajectory weapons are generally good but short, except in valley bottoms and from the military crests of open hilltops where they are generally excellent. FofFs on the northern slopes of Overlook Ridge and Hill 351 are excellent and favor enemy defense. FofFs from the northern slopes of the division objective are excellent. Long-range FofFs to the south from Overlook Ridge are good and favor our attack. FofFs for high-angle weapons are good throughout the area.

(CLASSIFICATION)

Figure A-25. Example and explanation of analysis of the AO (continued).

Paragraph 2b(3) indicates the type and distribution of soils and subsoils in the area and soil trafficability. Include soil content as it affects induced radiation, Use overlay if material is extensive.

Paragraph 2b(4) indicates roads, railroads, bridges, tunnels, mines, towns, industrial areas, fortifications, and other features of military significance; include type of construction.

Paragraph 2c(1), (2) consider as pertinent in separate subparagraphs sociology, politics, economics, psychology, and other characteristics. Other characteristics may include such items as science, material, transportation, manpower, hydrography, etc. Under each of these characteristics considered, list all facts as they pertain to the area of study and which may influence friendly and enemy courses of action. The degree of coverage required of these characteristics varied with the mission and other aspects of the operational environment. These characteristics influence, to some extent, the decisions of all commanders and become increasingly important as the area of interest of a command increases.

Paragraph 3 analyzes the facts in the previous paragraph to determine their influence on factors affecting tactical and activities that are considered in the development of specific courses of action. The extent of the analysis depends on the mission, the means available to accomplish the mission, and the possible means the enemy can use to prevent the accomplishment of the mission. In considering the factors under each aspect, include the effects, as appropriate, of and on nuclear fires, chemical and enemy biological agents, and important devices and equipment used in implementing courses of action.

Paragraph 3a considers the effect that the area will have on observation, fire, concealment and obstacles; and determines key terrain features and AAs.

Paragraph 3a(1) indicates graphically or describes the influence of weather, relief, vegetation, surface materials, artificial features, and other pertinent characteristics. Effects of and on nuclear fires, chemical agents, and so forth are included as are any marked effects on surveillance devices equipment based on LOS and fire delivery means. Effects on fire include effects on delivery means, Foffs and effectiveness of fires. Observation and fire are of concern to CSS units as they influence rear area security.

(CLASSIFICATION)

(c) Vegetation. The National Forest from 0306 to 0597 severely restricts observation and Foffs in the eastern part of the area. Within all wooded areas Foffs for flat-trajectory weapons are restricted in forest trails and roads. Fields and tree blowdown in woods, caused by nuclear weapons, may restrict Foffs within woods. Wheat fields severely restrict ground level observation at this time of the year. Forest fire smoke clouds may reduce observation throughout the area.

(d) Artificial features. Church steeples in the numerous villages afford excellent observation points. Villages and farm buildings will limit Foffs for flat-trajectory weapons.

(2) Concealment and cover.

(a) Relief. The rolling nature of the terrain affords some degree of concealment and cover from ground observation. Concealment and cover are poor on the northern slopes of Overlook Ridge and Hill 351. On the southern slopes of Overlook Ridge, concealment and cover are good. The rolling nature of the terrain and numerous folds in the ground will reduce thermal effects of nuclear bursts.

(b) Vegetation. Annex K (Canopy Closure Overlay). National Forest offers excellent concealment and cover for large units. Woods throughout the area afford excellent concealment and protection from thermal effects because of the thick deciduous trees being in full leaf. Wheatfields also afford some degree of concealment.

(c) Artificial features. Buildings in the area offer cover from small arms fire and shell fragments, but do not protect from blast by any significant degree.

(3) Obstacles. Annex L (Combined Obstacles Overlay).

(a) Relief. Terrain favors enemy use of persistent chemicals in the valley forward of the present position. Drainage system consists of the Maine and South Rivers.

(b) Vegetation. Woods, especially the National Forest, will restrict the cross-country mobility of all vehicles, including tracklaying vehicles. They will become severe obstacles in the event of blowdown by blast or if set afire. Cultivated areas will limit wheeled vehicles. Terraced vineyards on the south slopes of Overlook Ridge, Bard's Peak, and the plateau at 9400 northeast of Cartersberg will restrict the movements of tanks and heavy vehicles to road and trails in those areas.

(c) Surface materials. Annex M (Weather Effects on Cross Country Movement Overlay). The soil is generally wet in areas below 299 meters elevation. This will magnify the cratering effects of subsurface nuclear bursts in these locations. While capable of supporting light tracked or wheeled vehicles, the soil becomes spongy and boggy where the turf has been destroyed. Soil composition does not favor the production of high intensities or radio activity.

(d) Artificial features. The enemy has constructed extensive artificial obstacles consisting of minefields and wire, particularly on the east flank and north of Hill 305 (0490). This will hinder movements and limit use of certain AAs in these areas. Buildings and villages do not present significant obstacles even if destroyed by blast, except for the suburbs of Cartersberg on the east bank of the Maine River.

(4) Key Terrain Features.

(a) Hill 351 (9807) and Overlook Ridge west thereof. These terrain features control the AAs in the western and central parts of our zone. The mission will be seriously jeopardized if these areas are not secured.

(b) Hill 359 (0004). This hill mass dominates the central and eastern AAs. Its seizure is essential to the integrity and security of our forces, and will facilitate fire and maneuver to the south.

(c) Hill 334 (9400). This plateau controls the AAs in the western part of the division zone. It is key terrain if our tactical plans call for either a main attack or a supporting attack in the area.

(d) Hill 306 (9997). This hill provides dominant observation over a wide area in this part of the division zone. Its seizure and control will greatly enhance the security, fire, and maneuver of any our forces attacking in this area.

(CLASSIFICATION)

Figure A-25. Example and explanation of analysis of the AO (continued).

Paragraph 3a(2) on concealment and cover, indicates or describes the influence of weather, relief, vegetation, and artificial features. Effects of and on nuclear fires, surveillance devices, chemical and enemy biological agents, and so forth are included as appropriate. The discussion is oriented not only on protection of own and enemy forces, but also on other operations to include use of guerrillas, infiltration and counter infiltration, deception, CI, armor, and artillery. It is also oriented on site requirement for CSS and tactical installations. Include only marked effects that help in selection of friendly and enemy courses of action.

Paragraph 3a(3) on obstacles indicates graphically or describes all natural and artificial obstacles and the influence of relief, weather, vegetation, surface materials, and artificial features. Effects, as appropriate, of and on nuclear fires, chemical and enemy biological agents, and effects on trafficability and accessibility are included. If of significant influence, the effect of each obstacle on possible friendly and enemy courses of action is indicated. Obstacles and trafficability influence site locations for CSS units.

Paragraph 3a(4) describes key terrain features based on the analysis of observations and fire, concealment and cover, obstacles, and mission. Any locality or area the seizure, retention, or control of which affords a marked advantage of either force is considered. The influence of each key terrain feature listed is discussed briefly. The discussion is oriented toward subsequent development of friendly and enemy courses of action. Key terrain features selected are revised as required by the commander's decision and current situation. Key terrain features may be omitted when the enemy has no capability to secure or control terrain features that will materially affect the accomplishment of the mission.

(CLASSIFICATION)

(e) Hill 326 (1199), This hill dominates favorable terrain leading directly to the eastern part of the division objective.

(f) Hills 305 (0490) and 322 (1394). This terrain system constitutes the division objective. The mission cannot be accomplished without securing it. Control of this ridge is also necessary to continuation of the attack to the south,

(5) Avenues of Approach. Annex N (Avenues of Approach Overlay).

(a) Available to enemy into our position.

1. Axis Hill 351 (9607)-Hill 361 (9709),
2. Axis Hill 339 (9206)-Hill 356 (9310).
3. Axis Hill 230 (0010)-Paris (9811)-Hill 364 (9613).

(b) Available to us into the enemy's position.

1. Axis Hill 356 (9310)-Hill 339 (9206)-Hill 334 (9400)-Hill 306 (9997)-Hill 305 (0490)-ridges east thereof (Avenue A).
2. Axis Hill 361 (9709)-Hill 351 (9607)-Hill 359 (0004)-Auburn (0495)-ridge Hill 305 (0490) to Hill 322 (1394) (Avenue B).
3. Axis Hill 361 (9709)-Hill 351 (9807)-Hill 359 (0004)-Hill 271 (0702)-Hill 326 (1199)-Hill 322 (1394)-ridge west thereof (Avenue C).
4. Axis Hill 280 (0010)-Hill 262 (0803)-Hill 326 (1199)-Hill 322 (1394)-ridge west thereof (Avenue 9).

b. Combat services Support Aspects.

(1) Personnel. Characteristics of the society are such that only unskilled civilian labor will be available at any time. Employment of civilian labor to meet short-term objectives must be balanced carefully against the long-term needs of harvesting rams in ing crops.

(2) Logistics. Lack of civilian food and supplies may impose added logistic burdens on our forces. Some pilferage can be expected. Few resources beyond basic natural resources are available for military use.

(3) Civil-military operations. Displacement of civilians through the impressing of civilian labor by the enemy and lack of food and supplies will create problems which, if not controlled, can impact on military operations. The existence of civil agencies capable of assuming the functions of government will help alleviate the problem. However, these agencies will require guidance.

4. EFFECTS OF CHARACTERISTICS OF THE AREA.

a. Effects on Enemy Courses of Action.

(1) Effect on enemy defense.

(a) Terrain now held by the enemy favors defense in depth from present positions to the division objective. The enemy has excellent observation over all I Ms, and the enemy's flanks are protected by the rivers and canal on the west and artificial obstacles on the east. The enemy's best defense areas are the enemy-occupied forward positions.

(b) The excellent weather conditions favor enemy defense and permit the enemy to use supporting fire with maximum effectiveness.

(2) Effects on enemy attack.

(a) The enemy's best M is the axis Hill 260 (0100) -Paris (9811)-Hill 364 (9613),

(b) Weather conditions are such that the enemy will not be able to maneuver toward our positions without being observed except during the hours of darkness. The lack of precipitation favors cross-country mobility.

(CLASSIFICATION)

Figure A-25. Example and explanation of analysis of the AO (continued).



Paragraph 3a(5) describes the AAs that are developed from all the previous analyses of the tactical aspects. Such development does not consider the disposition of the enemy forces. An AA must afford some facility of movement and room for adequate dispersion for a force large enough to have significant effect on the outcome of the operation. When either opposing force has available and adequate number of aircraft that can be used to deploy troops and equipment forward to the battle area and significantly affect the accomplishment of the mission, AAAs are listed. If terrain and weather conditions do not significantly influence choice of flight paths, then AAAs are not listed. Enemy AAs are listed first, followed by a list of AAs into the enemy battle area. When the opposing forces are not in contact, or when only security forces are in contact, AAs to the battle area for both forces are listed. Each listing of an AA is accomplished by a brief discussion to provide a basis for subsequent development of possible courses of action by either force. For CSS units, the discussion of AAs is based on rear area security requirements.

Paragraph 3b analyzes the facts listed in paragraph 2, and the subconclusions developed under tactical aspects. Indicate those facts and subconclusions that significantly affect CSS activities influencing choices of possible courses of action by either force or by requiring special activities to ensure adequate support. Omit any activity that is not significantly influenced.

Paragraph 3b(1) addresses personnel. Personnel management is of particular importance when weather and terrain conditions are severe, when the AO has a significant population and potential labor forces, and when political and economic conditions are unsettled.

Paragraph 3b(2) covers logistics. Logistics is of particular importance when weather and terrain conditions are severe, when the AO imposes additional logistic requirements and has significant resources of military value, and when political and economic conditions are unsettled. Coverage is particularly detailed for those commands accomplishing their mission by logistic support of other units.

Paragraph 3b(3) discusses civil-military operations. Civil-military operations are of particular importance in cold war, limited war, occupation operations, and when extensive civil affairs responsibilities have been assigned to the command. It is particularly important to tactical units when the numbers of civilians in the area present control problems and restrict use of fire power. Coverage is detailed for those commands with extensive civil affairs responsibilities.

Paragraph 4 contains the conclusions developed in the previous paragraphs. The conclusions are stated in terms of effects on the general courses of action available to both forces.

Paragraph 4a(1)(a) lists in turn, each significant possible enemy course of action, such as attack; defense; withdrawal; use of air, armor, nuclear fires, chemical agents, guerrillas, etc. Each listed course of action (using separate subparagraphs) is accomplished by a discussion, to indicate the characteristics of the area favoring the courses of action. For attack courses of action, indicate the best AA. For defense courses of action, indicate the best defense areas and, if appropriate, the best AA leading to the defense areas.

(CLASSIFICATION)

(3) Effect on enemy air,

(a) Weather and terrain favor enemy employment of air in the division AO.

(b) Terrain favors enemy delivery of nuclear weapons by low-level air attack.

(4) Effect on enemy use of nuclear weapons. Weather conditions are favorable for enemy use of nuclear weapons. Effective winds do not favor use of fallout. Rolling terrain, numerous folds in the ground, and foliage will reduce thermal effects. Obstacles will be created by forest and tree blowdown.

(5) Effect on enemy chemical operations. Weather does not favor enemy use of chemicals. Terrain favors use of persistent chemicals in the valley forward of the enemy's present defensive positions.

b. Effect on Own Courses of Action.

(1) The best natural AA into the enemy area is axis Hill 280 (0010)-Hill 232 (0803)-Hill 326 (1199)-Hill 322 (1394)-ridge west thereof (Avenue D). It is blocked by extensive minefields.

(2) The second best AA is axis Hill 361 (97091)-Hill 351 (9607)-Hill 359 (0004)-Hill 271 (0702)-Hill 326 (1199)-Hill 322 (1394)-ridge west thereof (Avenue A).

(3) Weather and terrain do not favor our attack. We will not be able to maneuver toward enemy position without being observed except during the hours of darkness. The lack of precipitation will favor cross-country mobility except below 200 meters elevation. Forest fires and tree blowdown caused by use of nuclear weapons in National Forest will restrict mobility, observation, and FofFs.

(4) Effect on nuclear weapons. Weather conditions are favorable for the employment of nuclear weapon. The rolling nature of the terrain, numerous folds in the round, and foliage will reduce effects on nuclear bursts. The wooded areas are dry and subject to extensive burning. Soil composition does not favor the production of high intensities of radioactivity. Winds generally favor employment by our forces of radiation effects of fallout from nuclear weapons.

(5) Effect of chemical agents. Weather conditions are favorable for our use of chemicals.

Acknowledge.

MANN

OFFICIAL:

/s/ Foster  
FOSTER  
G2

Annex: A-Climatic Summary (omitted)  
B-Relief Overlay (omitted)  
C-Drainage Overlay (omitted)  
D-Slope Overlay (omitted)  
E-Vegetation Overlay (omitted)  
F-Vegetation Impeding Movement Overlay (omitted)  
G-Soils Overlay (omitted)  
H-Built-up Areas and LOC Overlay (omitted)  
I-Horizontal Visibility Overlay (omitted)  
J-Fog Overlay (omitted)  
K-Canopy Closure Overlay (omitted)  
L-Combined Obstacles Overlay (omitted)  
M-Weather Effects on Cross Country Movement Overlay (omitted)  
N-Avenues of Approach Overlay (omitted)

Distribution: A

(CLASSIFICATION)

Figure A-25. Example and explanation of analysis of the AO (continued).

Paragraph 4b lists, in turn, broad courses of action that will accomplish or facilitate the accomplishment of the mission, such as attack; defense; withdrawal; or use of air, armor, nuclear fires, chemical agents, and guerrillas. Each listed course of action is discussed in the same manner as enemy courses of action.

Acknowledgement instructions included if distributed outside the headquarters. Normally, the word "acknowledge" is sufficient.

The signature block contains the name and rank of the commander and appears on all copies of the analysis if distributed outside the headquarters. If not distributed outside the headquarters, it is signed by the intelligence officer.

Authentication is required only if the analysis has not been signed by the commander and is to be distributed outside the headquarters.

Annexes are listed by letter and title.

Distribution may refer to a standard distribution list.

PATROL REPORT

A patrol report is a written copy of verbal information reported following a reconnaissance or combat patrol mission. The battalion S2 generally prepares this report. Figure A-26 shows the patrol report format,

(DESIGNATION OF PATROL)

TO: \_\_\_\_\_

MAPS: \_\_\_\_\_

- A. Size and composition of patrol.
- B. Mission.
- C. Time of departure.
- D. Time of return.
- E. Routes out and back.
- F. Terrain. (description of the terrain--dry, swampy, jungle, thickly wooded, high brush, rocky, deepness of ravines and draws: condition of bridges as to type, size, and strength; effect on armor and wheeled vehicles).
- G. Enemy. (strength, disposition, condition of defense, equipment, weapons, attitude, morale, exact location, movements, and any shift in disposition; time activity was observed, coordinates where activity occurred) .
- H. Any map corrections.
  - 1. (Not used.)
- J. Miscellaneous information (include aspects of NBC warfare).
- K. Results of encounters with enemy (enemy prisoners and disposition; identifications, enemy casualties, captured documents and equipment).
- L. Condition of patrol (including disposition of any dead or wounded).
- M. Conclusions and recommendations (include to what extent the task was accomplished and recommendations as to patrol equipment and tactics).

Signature

Grade or Rank

Org Unit of Patrol Leader

Figure A-26. Patrol report format.

N. Additional remarks by interrogator.			
Signature	Grade <i>or</i> Rank	Org Unit of Patrol Leader	Time
o. Distribution.			

Figure A-26. Patrol report format (continued).

FRAGMENTARY ORDER

FRAGOs are extracts from more detailed orders or are issued to change previous orders. Like warning orders, these are usually brief oral or written messages. Mission orders are a form of FRAGOs which provide experienced commanders with the essentials of an order (such as a new mission or change to a previous mission).

FRAGOs do not have a specified format; however, to ensure understanding, the OPORD format is useful. A FRAGO is issued orally or in writing. Those elements found in a complete order are omitted when they have not changed, are not essential, or are incomplete at the time of issue. As a general rule, a FRAGO--

- o Is addressed to each commandar required to take action.
- o Is addressed to higher and adjacent headquarters for information.
- o Refers to a previous order. Indicates task organization changes.
- o When necessary for clarity, includes a brief outline of the situation that generated the requirement for a FRAGO, to include a statement of the mission, if changed.
- o Provides brief and specific instructions without loss of clarity.
- o Requests acknowledgment.
- o Contains proper classification.

With command approval, FRAGOs are prepared and issued by either coordinating or special staff officers with command approval. Figure A-27 shows an example of a FRAGO.

(CLASSIFICATION)

COPY NO OF COPIES  
52d Mech Div  
Xrayville (6271), Missouri  
141300 5 January 1980  
YZ55

Frag Order

Reference. OPORD 7

Map, Series V661, Sheet 7061,  
Edition 1, Scale 1:50,000

TASK ORGANIZATION. C/52 Avn OPCON 3d Bde  
Eff 141400 5 Jan

1. SITUATION. Estimated enemy tank regt delaying advance of 1st Ode
2. MISSION. No change.
3. EXECUTION:
  - a. Div continues attack, 3d Bde bypasses 1st Bde in north and attacks in zone to secure division objective. 1st Bde becomes reserve, follows 3d Bde. Priority of fires to 3d Bde.
  - b. 1-42 FA OS 3d Bde.
  - c. 1-40 FA GSR 1-42 FA.
4. SERVICE SUPPORT. No change.
5. COMMAND AND SIGNAL.  
Tac CP currently at 3067.

ACKNOWLEDGE.

VON STEUBEN  
MG

OFFICIAL:

YOUNG  
G3

DISTRIBUTION: C

(Classification)

DCOM7308D/FEB83

Figure A-27. Example of a fragmentary order.

## MISSION REPORT

The MISREP is used by all air units--strike or attack, reconnaissance or surveillance, airlift, observation, and helicopter--to report the results of all missions and significant sightings along the route of the flight. The MISREP amplifies the inflight report and is normally submitted within 30 minutes after aircraft landing to the tasking agency, the requesting unit or agency, and to other interested organizations. Upon completion of a tactical EW air task or mission, a debriefing is conducted by intelligence personnel, and a MISREP is submitted. Figure A-28 shows the MISREP format.

<p><u>HEADING</u></p> <p>PRECEDENCE</p> <p>ORIGINATING AGENCY</p> <p>ACTION ADDRESSEES</p> <p>INFORMATION ADDRESSEES</p> <p>SECURITY CLASSIFICATION, CODE WORD, OR NICKNAME</p> <p>MISREP (<u>Number</u>) DATE-TIME GROUP (GMT)-MONTH-YEAR</p> <p>BODY</p> <ol style="list-style-type: none"><li>1. <u>AIR TASK OR MISSION NUMBER OR NICKNAME</u>. Reference the request number, FRAGO number, or directive causing initiation of the mission.</li><li>2. <u>LOCATION IDENTIFIER</u>. Target number, line number, approved target designator or identifier, or coordinates of the target or sighting being reported.</li><li>3. <u>TIME ON TARGET OR TIME OF SIGHTING</u>. Report all times by date-time group, using Zulu time unless otherwise directed.</li><li>4. <u>RESULTS AND SIGHTING INFORMATION</u>. This item should contain the pilot or aircrew evaluation of expected results (for example, percent destroyed, number and type destroyed, or percent of coverage) and concise narrative information on significant sightings (for example, unusual or new enemy equipment or concentrations of enemy forces observed to include number, speed, and direction (if applicable)).</li><li>5. <u>REMARKS</u>. Includes information not specifically mentioned in above items (for example, enemy defenses encountered, weather data, hostile MIJI attempts, and so forth).</li></ol>
--

Figure A-28. Mission report format.





(CLASSIFICATION)

7. MISCELLANEOUS DATA. List personalities, unit history, FPO, code numbers and names, 06 changes, and any other item of 06 intelligence that cannot be properly inserted in preceding paragraphs.

Acknowledge.

(SIGNATURE)

Appendix:  
Distribution:  
OFFICIAL  
(NAME OF G2)

Figure A-29. OB annex to PERINTREP format (continued).

ORDER OF BATTLE

1. COMPOSITION AND DISPOSITION (see appendix 1 overlay).

a. All EPW captured during period are from the enemy 2d Combined Arms Army. Unit identification include--(C-I)

17 MRD	30 MRD	32 MRD
283 MRR	141 MRR	132d Med Tk Regt
290 MRR	142 MRR	
	130 Tk Regt	
	130 Recon Bn	

COMMENT. 32 MRD accepted as being organic to 2d CAA. 52 Tk Div previously accepted, completing organization of 2d CAA.

b. Two large missile-type weapons mounted on large amphibious armored carriers and several smaller vehicles identified in position vicinity MP 420513. (8-2) .

COMMENT. Probably elements of Free Rocket Regt, 2d CAA, previously unlocated.

c. Captured enemy field order reveals plan to attach 40 Tk Div to 2d CAA effective 22 Aug. (B-1).

COMMENT. EPW previously reported 40th Tk Div moving to reinforce 2d CAA. Enemy main effort probably planned for this area.

2. STRENGTH.

Enemy losses reported during period:

	EPW	KIA	ARTY	ARMOR	AIR	VEH
16 MRD	37	302	2	4	1	21
30 MRD	16	52	8	1	---	16
32 MRD	8	12	---	---	---	4
Total 111 US Corps Sector	61	366	10	5	1	41

COMMENT. The marked increase in personnel losses during the period have been sustained primarily by enemy combat patrols. Aircraft loss was HI, observation helicopter, equipped with aeronautics radar. Overall strength of 2d CAA is generally not affected.

(CLASSIFICATION)

Figure A-30. Sample OB annex.

(CLASSIFICATION)

3. TACTICS.

a. EPW from 16 MRD and 30 MRD state they have been instructed, in the event their units are cut off, to continue fighting as guerilla units or in small groups, live off the land, and destroy as much US Army property as possible before gradually infiltrating back to friendly lines. (C-6) .

COMMENT. Intensive guerrilla activity in our rear aress can be expected if elements of these units are cut off.

b. Enemy documents captured 07 Aug included a training pamphlet for battalion, company, and platoon commanders, written by GD Griboyedov entitled "Tanks Out Front," (appendix 3). It advocates tactics permitting US patrols and advancing forces to pass through aggressor lines. A coordinated tank-infantry attack is then made on open flanks and rear elements with tanks continuing momentum of attack to destroy remaining US forces. (B-2) .

COMMENT. Considering enemy doctrine that tanks are the decisive arm, the above tactic is possible, particular y in review of reports of probable employment of 40 Tk Div (para 1) .

4. TRAINING.

a. Reference paragraph 3b.

b. Indications of enemy concern for communications security (COMSEC) is noted in document captured from 2d CAA dated 10 Aug, directing all subordinate units to immediately initiate intensive training in radio security and communications procedures. (B-2) .

COMMENT. MI units confirm enemy lack of radio discipline and states that security violations increase during reinforcement and relief operations. Numerous enemy security violations have been noted since 17 Aug, further substantiating reinforcement or relief of 2d CAA units.

5. LOGISTICS.

a. EPW state enemy supply personnel have recently contacted local merchants, farmers, and fishermen for supplies of most class I items. (C-6) .

(CLASSIFICATION)

Figure A-30. Sample OB annex (continued).

(CLASSIFICATION)

COMMENT: Enemy either has critical shortage of class I items or has a bottleneck in the supply system requiring local procurement of these items.

b. Air and ground reconnaissance patrols have reported enemy stockpiling large quantities of supplies and equipment in rear areas of frontline divisions. (B-2) .

COMMENT. Not normal supply procedures. Significance as yet undetermined. Would indicate enemy may be planning major offensive soon.

6. COMBAT EFFECTIVENESS.

a. EPW from 16 MRD and 30 MRD state morale is high but senior officers are disgruntled because their units always receive difficult missions while the 32 MRD and 56 Tk Div have, until recently, been assigned less hazardous missions. (F-6) .

COMMENT. Analysis of unit history and recent operations of enemy 2d CAA indicates it has usually been highly successful in combat. This, and the fact that 2d CAA has always had fine commanders, would account for high morale in units. This is first indication of dissatisfaction among officer personnel. Report seems cogent, however, since 32 Mech Div has not been engaged in combat with US Forces in this campaign.

b. EPW reports 30 MRD to be redesignated 30 "Fusilier" Mech Div for superior combat record. (F-6) .

COMMENT. III US Corps rates combat effectiveness of 30 MRD from excellent to outstanding in comparison to other enemy divisions in same sector. 30 MRD casualties have been comparatively small; no deserters have been apprehended and its operations have been executed with determination.

7. MISCELLANEOUS DATA.

a. Personalities identified by EPW: (c-1).

CG, 40th Tk Div	GD GRIBOYEDOV, Semyon P. (Ref 3b)
CO, 282 MRR	Col CARDUCCI, Gherardo S.
CO, 283 MRR	Col UNSET, Bjornstjerna (Acting CO)
CO, 130 Med Tk Regt	Col STEENWYK, Martin J.
CO, 132 Med Tk Regt	Cot MATTEZ, Mario

(CLASSIFICATION)

Figure A-30. Sample OB annex (continued).

(CLASSIFICATION)

COMMENT. Confirms previously obtained information.

b. Unit history. Officer EPW stated that unit (32 MRR) trained extensively in special tactics for assault of river lines. (F-6) .

COMMENT. Special training received by 32 MRD should increase its overall effectiveness when employed in river-crossing operations. No evidence of other units so trained.

c. Field post numbers: Captured document reveals enemy FPN being used as identification symbols on documents and messages. First two and last three digits are transposed. FPN of 46 MRD will appear as 75031 instead of 31750. (B-1) .

COMMENT. Enemy has employed this system previously as a security measure. Expect this system of transposing digits will occur in different patterns during future operations.

Acknowledge.

LEE

LTG

Appendixes: 1--Enemy Disp Overlay  
2--Enemy Army Organization Chart  
3--Enemy Training Pamphlet

Distribution: Same as PERINTREP 29

OFFICIAL

GRANT  
G2

(CLASSIFICATION)

Figure A-30. Sample OB annex (continued).

### STANDARD COLLECTION ASSET REQUEST FORMAT

The standard collection asset request format (SCARF) is used for intelligence requirements tasking and for requesting information from higher or adjacent headquarters. At corps and division, intelligence requirements tasking is directed toward MI commanders and commanders of other elements of the combat force capable of collecting the information.

Intelligence requirements tasking provides the selected unit with a specific requirement, but not with specific instructions for carrying out the mission. The SCARF specifies--

°The information needed.

°Where to look for the movers, shooters, sitters, and emitters.

°When to look.

°When the information is needed.

°What to look with, in some cases.

Figure A-31 shows the SCARF format.

- A. Requester number.
- B. Originator priority.
- C. Activity or target type (area emitter and size (point, area, or unit)).
  - o. BE number, ELINT notation or case.
- E. Location (if known or last known).
- F. Ouration--
  - °Start date-time.
  - °Frequency.
  - °Stop date-time.
  - °Latest acceptable date-time for information utility.
- G. Location accuracy--
  - °Required.
  - °Acceptable.
- H. PIR and information desired.
- 1. Justification.
- J. Remarks (to include disciplines and collectors recommended).

Figure A-31. SCARF basic format.

### AERIAL RECONNAISSANCE AND SURVEILLANCE REQUEST

The aerial R&S request is used to request a tactical air reconnaissance or surveillance mission. The form states requirements, identifies needs, and, occasionally, specifies the actual air asset to perform the mission.

Any echelon initiates the request. It is used for both immediate and preplanned mission requirements. The requester completes section I of the request for each specific mission. Normally, these requests are transmitted by electrical means. The headquarters receiving the request adds information required to validate or complete the request. Figure A-32 shows the aerial R&S request form. This format is the same as the format used for joint service operations.



CLASSIFICATION <b>UNCLAS</b>		REQUESTOR	DTG <b>040800Z</b>		<b>2</b>
PRECEDENCE		Internal coordination			
ACTION:		INFO:			
FROM:		INFO:			
		SIC			
NOT FOR TRANSMISSION		H20C			
L ORIGINATOR SERIAL NO.		L-AIR RECON REQUEST/AIR RECON TASK NO: <b>381/82</b>			
M.1 TYPE OF SENSOR		M.1- <input checked="" type="checkbox"/> PHOTO <input type="checkbox"/> ELECTRONIC <input type="checkbox"/> SLAR <input type="checkbox"/> IR <input type="checkbox"/> BEST SUITABLE			
M.2 TECHNIQUE		M.2- <input checked="" type="checkbox"/> VERTICAL <input type="checkbox"/> OBLIQUE <input type="checkbox"/> PANORAMIC <input type="checkbox"/> BEST POSSIBLE			
N MAP SERIES SHEET NO. AND EDITION NO.		N. <b>M745 sheet 4102 Ed.2.</b>			
O.1 TARGET LOCATION		O.1- <b>32U ND 747866 (UTM)</b>			
O.2 TARGET DESCRIPTION		O.2- <b>TIARA AIRFLD</b>			
P OBJECT AND RESULTS DESIRED (TARGET CATEGORY)		P. <b>CAT OLD Items 2,3,6 &amp; 7</b>			
Q PHOTO SCALE		Q. <b>Best Possible</b>		<input type="checkbox"/> BEST POSSIBLE	
R NO. PRINTS, PLOTS, RPTS.		R. <b>IPIR/2 Sets Prints Stereo Cover of AirFld</b>			
S DELIVERY ADDRESS DATE TIME REQ		S. <b>IPIR to HQ OC, DePAIR INFO 27</b>			
T LATEST ACCEPTABLE DATE TIME FOR DELIVERY		T. <b>NLT 070800Z June 83 Prints 091200Z June 83.</b>			
U SPECIAL INSTRUCTIONS		U.1- <b>INFLT REP CAT 01</b>			
U.1 TOT		U.2- <input type="checkbox"/> PRI-1 <input type="checkbox"/> PRI-2 <input type="checkbox"/> PRI-3			
U.2 PRIORITY		U.3-			
U.3 TARGET SECURITY CLASS		U.4-			
U.4 REMARKS					
V. TASKING INSTRUCTIONS		V. <b>14 SON, 1x RHFC</b>			
COPIES TO		R DTG		INITIALS	DRAFTER TEL NO
COMM CTR <input type="checkbox"/>	ARMY <input type="checkbox"/>	C DTG			
CURRENT OPS <input type="checkbox"/>	ATTACK <input type="checkbox"/>	V DTG			
INT <input type="checkbox"/>	RECON <input type="checkbox"/>	O DTG			
OTHER <input type="checkbox"/>	EW <input type="checkbox"/>	A DTG			
		R DTG			
		A DTG			

Figure A-32. Aerial reconnaissance and surveillance request form.

Figure A-33 shows an air reconnaissance request and task format that is keyed to letter designators of message elements. An explanation of each of these letter designators follows in Figure A-34.

Air Reconnaissance Task (Format-not transmitted)	AIR RECON TASK (Example message)
L. Originators request and task number.	L. HQOC 468/82.
M. Type of recon.	M. PHOTOGRAPHIC, VERTICAL.
N. Map series, sheet no and edition.	N. M745 SHEET 4102 EDITION 2.
o. Location and description of target.	o. 32U ND 747866 (UTM) TIARA AIRFIELD
P. Purpose of request and reporting codes.	P. CAT OID ITEMS 2, 3, 6, 7.
Q. Photo scale or limits.	Q. BEST POSSIBLE.
R. Products required.	R. IPIR/2SETS PRINTS PROVIDING STEREO COVER OF TIARA AIRFIELD.
s. Delivery address.	s. IPIR TO HQOC, DEFAIR INFO 27 SO PRINTS HQOC/TGTS-1, DEFAIR/DAFIS.
T. Date-time limitation.	T. TOT NOT BEFORE 070600Z JUN 83 BUT NOT LATER THAN 070800Z JUN 83. PRINTS REQUIRED NOT LATER THAN 091200Z JUN 83.
u. Special instructions.	u. INFLIGHTREP CAT 01 ITEMS 3,
v. Tasking and mission data.	v. 14 SON, 1 X R4FC.

Figure A-33. Air reconnaissance request and task format.

Explanation of letter designators.

L. ORIGINATOR'S REQUEST NUMBER. The originator's request number usually consists of a unit identifier and a sequential numbering system. Commands may assign blocks of numbers to subordinate units to prevent confusion. if necessary to assist the tasking agency, commands also may establish a system of priorities for reconnaissance tasking and promulgate priority designators to be used in the originator's request number.

M. TYPE OF RECONNAISSANCE. Visual, electronic, weather, photographic, and so forth. Additionally, if the requester requires a specific type of sensor, system, or format to be used for some reason (such as a vertical photograph for briefing purposes), it is specified. Such detail generally should be omitted, however, to allow flexibility in planning and tasking.

N. MAP SERIES Z SHEET NUMBER. AND EDITION. Self-explanatory.

O. LOCATION AND DESCRIPTION OF TARGET. The target location or areas to be searched is indicated by the appropriate coordinate reference. The coordinate reference system used (for example, UTM grid, latitude or longitude) is identified clearly. Predetermined search areas or LOC segments can be nominated by relevant designators. A brief description of the target, its name and BE number (where known) should be included.

P. PURPOSE OF REQUEST AND REPORTING CODES. It is most important that tasking agencies and reconnaissance units understand the exact purpose of the request. Where possible, the code statements in appropriate reference books are used to identify the target category, reconnaissance purpose, and items to be reported. Otherwise, a plain language statement of purpose is provided.

Q. PHOTOGRAPHIC SCALE OR LIMITS. The photographic scale or limits should not be specified unless there is a specific reason for doing so; for example, survey photography or imagery is to be used for a particular task that requires it to be at a nominated scale or physical dimension. If the scale is nominated, care must be taken to differentiate whether the scale applies to the original film or to the end product requested (item R).

R. PRODUCTS REQUIRED. Specify the reports (RECCEXREP, IPIR, and any other end product) required. If photographs are required, specify quantities and the size or scale desired. Photographs should be requested only when essential and a report will not suffice. Quantities must be kept to an absolute minimum.

S. DELIVERY ADDRESS. State clearly where the report is to be delivered. For reports, nominate both action and information addressees.

Figure A-34. Explanation of letter designators.

T. DATE AND TIME LIMITATIONS. Specify any time constraints on the mission and follow-up actions. In particular, specify the date and time after which the information will no longer be of value. If the task cannot be accomplished by this date, it will be canceled automatically.

u. SPECIAL INSTRUCTIONS. Give instructions or information not provided elsewhere that will aid in the planning or accomplishing of the mission. This includes control arrangements, communications, security instructions, details of own forces, or other pertinent entries.

v. TASKING AND MISSION DATA. This is completed by the mission tasking agency. It generally details the unit and number and type of aircraft. The mission number for the task is the originator's request number, abbreviated if necessary.

Figure A-34. Explanation of letter designators (continued).

#### SIGNALS INTELLIGENCE TACTICAL REPORT

The purpose of the SIGINT TACREP is to transmit combat information to fire and maneuver elements. It also is used to transmit technical data to traffic and analysis teams or to the TCAE. It is normally sent by electrical message or by secure FM voice radio means. It is designed to present highly perishable information in a clear, concise, and easy-to-read format. Distribution is made according to local guidance or as directed by higher commands. An annotated format is available in the classified appendix to FM 34-80.

**MEACONING, INTRUSION, JAMMING, AND INTERFERENCE REPORT**

The MIJI report is used to pass information from operators to their units about actual or suspected enemy attempts to interfere with, jam, or deceive voice, teletypewriter, or MC signals. The report is submitted by the operator whose communications means is affected, through the net control station (in the case of FM voice), to the unit's C-E officer. The C-E officer coordinates this report with the EW officer, the intelligence officer and the supporting MI unit.

MIJI reports are transmitted; however, if they are transmitted over nonsecure equipment, reports are encrypted using the brevity list. See FM 34-40 for additional information about MIJI reports and brevity lists. Figure A-35 shows the MIJI report format.

LINE 1 - Type of report \_\_\_\_\_

LINE 2 - Affected station \_\_\_\_\_

LINE 3 - Station's location or. grid coordinates \_\_\_\_\_

LINE 4 - Frequency or channels affected \_\_\_\_\_

LINE 5 - Type of equipment affected \_\_\_\_\_

LINE 6 - Type emission or audio characteristics of interference \_\_\_\_\_

LINE 7 - Strength of interference \_\_\_\_\_

LINE 8 - Time interference started \_\_\_\_\_

LINE 9 - Interference effectiveness \_\_\_\_\_

LINE 10 - Operator's name and rank \_\_\_\_\_

LINE 11 - Remarks \_\_\_\_\_

Figure A-35. Meaconing, intrusion, jamming, and interference report.

## ORAL REPORTS

Briefings are oral reports that present information to commanders, staffs, or other designated audiences. The techniques employed are determined by the purpose of the briefing, the desired response, and the role of the briefer. There are four types of military briefings:

- ° Information briefing.
- ° Decision briefing.
- ° Staff briefing.
- ° Mission briefing.

The two most important briefing formats to intelligence officers and analysts at the tactical level are the information and decision briefings. An explanation of these two briefings follows.

### INFORMATION BRIEFING

The information briefing is intended to inform and gain the listener's understanding. The briefing does not include conclusions or recommendations, or require decisions. The briefing deals primarily with facts. The briefer states that the purpose of the briefing is to provide information and that no decision is required. The briefer provides a short introduction to define the subject and to orient the listener and then presents the information. Figure A-36 shows the information briefing format.

### DECISION BRIEFING

Decision briefings are intended to obtain an answer or a decision. They are used to present a staff officer's or intelligence analyst's recommended solution resulting from analysis or study of a problem or problem area. They vary as to formality and detail depending on the level of command and the decision maker's knowledge of the problem or problem area. In situations where the person receiving the briefing has prior knowledge of the problem and some information relating to it, the briefing normally is limited to a statement of the problem, essential background information, and a recommended solution. However, the briefer is prepared to present the assumptions, facts, alternative solutions, or reason(s) for choosing the recommended solution, and any coordination required. If the person who is being briefed is unfamiliar with the problem or the facts surrounding it, then a more detailed briefing is necessary. In this case, the briefing includes any assumptions used in analyzing the problem, facts bearing on the problem, discussion of the alternatives, conclusions, and the coordination involved.

1. **INTRODUCTION.**
  - a. **Greeting.** Use military courtesy, address the person(s) being briefed, and identify self.
  - b. **Classification.** Announce the classification of your briefing.
  - c. **Purpose.** Explain the purpose and scope.
  - d. **Procedure.** Explain any special procedures such as demonstrations, displays, or tours.
2. **BODY.**
  - a. Arrange main ideas in logical sequence.
  - b. Use visual aids correctly.
  - c. Plan for effective transitions.
  - d. Be prepared to answer questions at any time.
3. **CLOSE.**
  - a. Ask for questions.
  - b. Concluding statement.
  - c. Announce the next briefer, if any.

**Figure A-36. Information briefing format.**

In the introduction, it is stated that the briefer is seeking a decision. At the conclusion, if the briefer does not receive a decision, the briefer asks for it. The briefer should understand the decision thoroughly. If there is uncertainty, the briefer asks for clarification. In this regard, a precisely worded recommendation that is used as a decision statement, once approved by the commander, assists in eliminating possible ambiguities. Following the briefing, if the executive officer is not present, the briefer informs the next highest ranking officer or the staff secretary of the decision. Figure A-37 shows the decision briefing format.

1. INTRODUCTION,

a. Greeting. Use military courtesy, address persons being briefed, and identify self.

b. Classification. Announce the classification of the briefing,

c. Purpose. State that the purpose of the briefing is to obtain a decision and announce the problem statement.

d. Procedure. Explain any special procedures to be used, such as additional briefers. Omit if not required.

e. Coordination. Indicate what coordination has been accomplished,

2. BODY.

a. Assumptions. Must be valid, relevant, and essential to a solution to the problem. Omit if there are none.

b. Facts Bearing on the Problem. Must be supportable, relevant, and necessary.

c. Discussion. Analyze courses of action. Use smooth transitions between discussions of each course of action.

d. Conclusions. Degree of acceptance or order-of-merit for each course of action.

e. Recommendations. State actions recommended. Must be specific, not a solicitation of opinion.

3. CLOSE.

a. Ask for Questions.

b. Request a Decision.

Figure A-37. Decision briefing format.



## APPENDIX B

1

### AUTOMATION SUPPORT TO INTELLIGENCE ANALYSIS

During the past forty years, the battlefield has evolved from a relatively simple environment to one that is increasingly sophisticated in terms of collection systems and communications capabilities. Current collection systems incorporate state-of-the-art components and advanced technology. Deployed using Army-approved doctrine against known enemy capabilities, they exhibit the ability to collect vast amounts of information from a battlefield environment rich in enemy targets. Parallel advances in communications capabilities complement sensor system advances and provide the ability to transmit information faster and more efficiently than at any other time in history.

As the information flow increases, progressively more time is needed to identify, verify, and organize the information needed to produce intelligence. Yet, intelligence production methods and procedures have not kept pace with the advances made in collection systems and communications. Information collected by technologically advanced sensor systems and sent and received over high-speed communications equipment is still processed individually as it is received by manually sorting, recording, and filing it. Clearly, to produce the intelligence the commander needs, when it's needed, these manual processing functions must be updated and expanded.

This appendix describes how current and emerging automated systems support intelligence analysis. It will--

- ° Describe general computer system configuration and basic tactical military computer system capabilities and limitations.
- ° Discuss two current tactical semiautomated systems: MICROFIX and Intelligence Data Processing Set.

#### INTELLIGENCE ANALYSIS SUPPORT

ADP systems support efficient and timely intelligence production. This support upgrades the ability of analysts to deal with the vast amounts of information produced during the course of a battle. These systems are designed to supplement, not replace, existing manual analysis support systems. They provide expanded capabilities during the storage; access, retrieval, and manipulation; recording and record-keeping; and dissemination portions of the intelligence production process. These capabilities provide the analyst with substantially more time to devote to intelligence analysis.

Using ADP systems, the analyst not only stores more information in less space but the information is consolidated with other information and with previously produced intelligence. With this additional storage capacity, the analyst accesses data bases such as IPB or ground OB data from the same system. Consolidating this data onto one system lets the

analyst quickly and easily retrieve and manipulate the data and information needed to support the intelligence analysis process. With more information to work from, the analyst develops a better picture of the battlefield environment. This reduces risk and uncertainty.

ADP systems also provide the means to access this information quickly and easily. Data is accessed in seconds, rather than minutes or hours. By retrieving various types of information and using the computer capabilities to arrange this information in different patterns, information is manipulated to test previously established hypotheses or to create a new hypotheses based upon new or emerging patterns. Through this process of electronic comparison and contrast, the computer helps the analyst determine unit identifications, strengths, and enemy commanders' intent.

Computer system capabilities is used to facilitate and complement manual methods and procedures. For example, computers are programed to automatically record message header information into a separate file which subsequently is printed and placed in a three-ring binder. This provides a duplicate file that is easy to maintain and keep current and requires a minimum of time and effort. A record of all intelligence messages and products is printed. This establishes a record of all outgoing intel 1 elligence products and messages, including a list of all users receiving that message or product. When manual recording is kept to a minimum, it leaves more time for the analyst to develop intelligence.

Another example of a manual system being eased with ADP is recording and storing preprogrammed formats. The computer assists the analyst in preparing a variety of reports, summaries, and other intelligence documents and message formats electronically. Once correctly formatted, previously created lists of addresses and users are selected and automatically printed. If electronic message sending capabilities exist, messages are sent directly from the terminal. This capability significantly reduces the amount of time necessary to prepare, route, and transmit products to users, and the amount of time the intelligence analyst spends preparing and disseminating them.

These tasks are continuous and require time and the ability to assimilate large amounts of data quickly and accurately. The use of ADP enhances the analyst's ability to perform these tasks. It is a tool which provides the analyst with the ability to access and use more information and resources than manual processes provide.

#### COMPUTER SYSTEM CONFIGURATION

Every computer system is composed of hardware and software. Hardware is the actual physical equipment--or components--that make up the total ADP system. Software is a series of commands, recognized by the computer. It tells the computer how to perform a variety of functions.

## Hardware

Typical system hardware consists of a keyboard; central processing unit; storage device (disk drive); display or monitor; and printer. These basic hardware components access files, input new information, manipulate data and information, and display or print data of information which the analyst selects to perform analysis and produce intelligence. Figure B-1 shows the basic computer components.

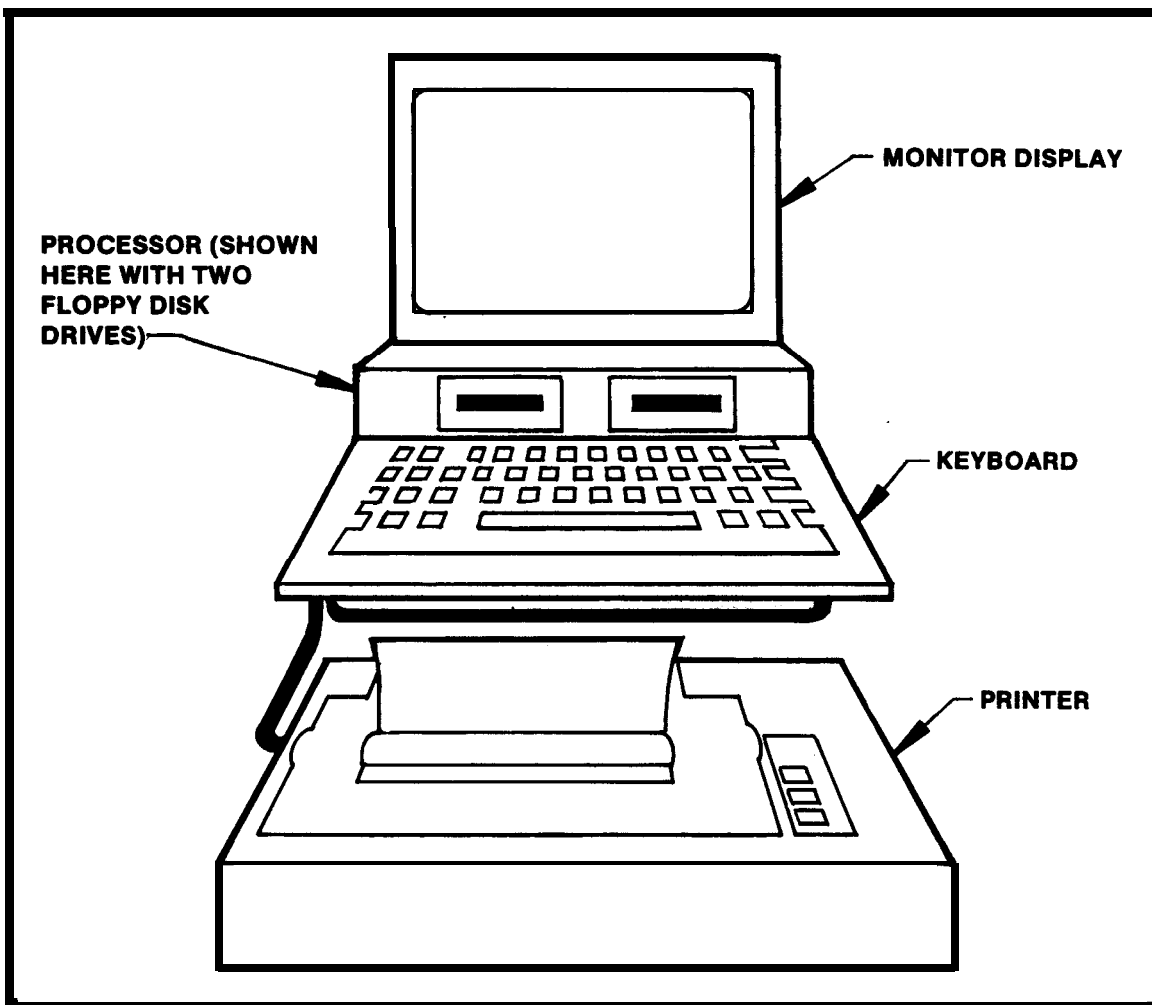

**Figure B-1 Basic computer components.**

Keyboard. The keyboard serves as the primary input device to the computer. Normally, the keyboard contains the same letters, numbers, and punctuation keys as a standard typewriter. The computer keyboard also contains special function keys which are used to initiate various computer functions.

**Processor.** The processor is the component that executes the commands from the programs. It controls the flow of information into, within, and out of the computer. It also contains a limited amount of the computer's memory.

**Storage Devices.** Information is stored inside the processor in special memory locations or in a separate storage device. Examples of storage devices are floppy or removable disks, magnetic tape, large capacity hard cartridge or fixed disks, and cassette tapes, or cartridges. The computer periodically reads these devices during each computing session in order to perform programs selected by the analyst. Conversely at the end of the computing session, data is saved to these devices if it is to be permanently retained. Information solely left displayed on the monitor or in the processor is lost when the system's power is shut off.

**Display,** The display is a cathode ray tube (CRT) (commonly referred to as a monitor). The monitor displays text, charts, graphs, or maps (depending upon system configuration and capabilities). It is similar to a television screen and is monochromatic or color.

**Printer.** Printers are similar to high-speed typewriters. Information from the processor is read and the output is printed on computer paper or bond paper. This provides the analyst with a permanent record (hard copy] of the information.

#### Peripherals

Other components are integrated into the basic ADP system to provide specialized or expanded capabilities. Whether or not components are added to a system depends upon several factors. First, the original system is designed so that it can be expanded. Second, expansion modules, add-on components, or peripherals are compatible with the existing system. Third, software limitations and design constraints are considered. Depending upon these factors, some of the following components are integrated into a tactical ADP system:

- °Video disk players (VDPs). VDPs allow map, text, photographs, or any information that can be stored on video disks to be displayed on a monitor.
- °Modems and communications networks. This equipment allows information to be passed directly from one computer to another. The modem connects directly to the telephone jack and transmits and receives data through telephone lines. Provides interface between data processing systems over communications lines. Paper tape reader/punch (PTR/P) devices provide the capability to generate and read tactical RATT messages via paper tape.
- °Video cassette recorders (VCRs). Identical to VCRs used for home entertainment, some systems have programs that allow a VCR to be connected to the processor for use as a back-up and restore device.

## Software

Software provides the instructions, tools, and basic programming required for computer system functions. There are many types of software; however, every system must have an operating system to be able to function.

Operating System Software. This software enables the computer to run applications. This operating system, which also is referred to as a control program, is thought of as a traffic cop. It regulates all actions within the processor and determines when any of the peripherals are activated. Another vital function performed by the operating system is to act as a translator between the users' language (English, German, Spanish) and the computer's language (binary).

Data Base Management Systems (DBMS) Software. DBMS software turns the computer into a high-powered, automated filing cabinet. This data base file is sorted on nearly any variable in the file's structure. The computer also extracts records in the file that match a very exacting criteria, or extract just selected bits of information (fields) about all the records in the file. This allows the analyst to manipulate data in varying ways to get a clearer picture of the battlefield and perhaps identify previously unrecognized patterns.

Word Processing Software. A word processing program turns the computer into a high-powered, automated typewriter. This software gives the analyst the ability to compose briefings, reports, and messages, and to perform editing functions for storage, printing, and display.

Applications Programs. These programs are the actual commands that perform the automated operations the analyst requires. These are written in a DBMS or computer language. Some common languages are BASIC, PASCAL, and FORTRAN.

### ADVANTAGES AND DISADVANTAGES

Advantages and disadvantages depend on the system, software, and training. The analyst uses the ADP system to store and manipulate facts or data that, when analyzed, produce intelligence.

#### Advantages

In general, for any system, the advantages of automated support to intelligence analysis lie primarily in the areas of information management and dissemination. ADP systems help the analyst disseminate information with speed and increased accuracy.

Speed. ADP support is particularly useful to the analyst because of the speed at which computers can perform calculations and assemble specific data from a large body of information. Given accurate data input, the computer produces a faster, more accurate output than is obtained through human calculation. Stress or pressure do not degrade ADP operations. They carry out prespecified tasks almost indefinitely. A caution about

computers being more accurate than humans working in a purely manual mode. Humans respond almost instantly to questions requiring a judgmental response: "What are the 10 most significant actions in the last 12 hours?" The computer cannot make such a response. To a computer, a report about the movement of the independent tank battalion carries the same weight as a report about three wheeled vehicles moving along an unidentified road.

**Report Generation.** When ADP systems are equipped with word processing capability, the analyst creates reports, messages, summaries, or other intelligence-related documents quickly and easily.

**Electronic Communication.** If ADP systems are netted, that is, linked together, data is transmitted directly from terminal to terminal. If they are not netted, a messenger sends correctly formatted diskettes, as well as hard copy reports. However, diskettes offer the advantage of being able to be loaded into the receiving person's computer. In any case, copies of the message are produced and then transmitted over established tactical communications channels. In either event, the ability to disseminate intelligence products is substantially improved over more traditional methods of dissemination.

#### Disadvantages

**Understanding the System.** Most of the disadvantages of ADP support to intelligence analysis result from a lack of computer literacy or an understanding of specific ADP system limitations and capabilities. Analysts and commanders tend to assign capabilities to the system that it does not possess. This results in an unrealistic view of the support ADP provides to the commander and creates a false reliance on the computer system by the analyst.

Computers perform only those functions they are explicitly told to do. They do not learn from mistakes, nor will they correct improper input. Therefore, the data stored in the computer is only as accurate as the data that is entered. Computers also have a finite capacity to store data. Design parameters establish this capacity. While additional storage capacity is provided by add-on component storage equipment, when maximum storage limits are reached, old data is deleted to make room for new input. Dual record-keeping procedures, both manual and automated, are established and kept in an updated status. If ADP capabilities are interrupted or lost, this ensures that intelligence production continues.

**Multi-Processing.** Another disadvantage is that some tactical systems cannot input, process, and output data simultaneously. Others only allow access to a shared data base on a one-by-one basis. Therefore, the analyst determines which data is most important and balances input, output, or access functions to best support the mission. This is critical to appropriate and maximum use of the ADP system.

**Environment.** Computers also are vulnerable to environmental conditions and influences like temperature extremes, weather conditions, power fluctuations, and power outages. Terrain constraints also may affect ADP access, system mobility, or system capabilities.

Temperature extremes, like alternating very hot and very cold weather cause condensation. Condensation inhibits the read and write ability of the system. Extreme temperatures also result in partial or complete loss of previously input data. For example, rain, fog, and high or low humidity cause partial or even complete system failure.

Static electricity also results in partial or complete loss of data. Planned power outages require shutdown of all computer functions immediately before and during the length of the outage. Unplanned power outages or power surges not only shut down computer functions, but also result in varying degrees of hardware or software damage or data loss.

Severe weather conditions, like lightning or dust storms, produce the same effects as unplanned power outages or power surges. Dust in the read and write heads of hard and floppy disk drives result in inaccurate input, output, data loss, or total destruction of disk capability.

Terrain also is a factor in ADP system survivability and use. Each time the system is moved, leveling is required before the system is operational. Crossing rough terrain under highly mobile conditions partially damages or completely destroys the ADP system. Also, while mobile, current systems are inoperative. Data accumulated while the computer system is down or inoperative must be saved and input when circumstances permit. This means that when the system initially returns to an operational status, it does not provide data for immediate analysis until the data base has been updated. If the accumulation of data is such that input requires a substantial amount of time, the analyst finds that manual systems and data bases support the commander's intelligence needs more efficiently.

Many of these disadvantages apply, in whole or in part, to all tactical battlefield electronic and automated systems. When the capabilities and limitations of ADP systems are thoroughly understood, measures are taken to protect the system while making maximum use of ADP support to intelligence analysis. By taking these factors into account, ADP support to intelligence analysis is a viable tool which the analyst uses to give the commander a more complete, accurate, and timely picture of the battlefield.

#### CURRENT AUTOMATED SUPPORT SYSTEMS

The US Army currently has two systems deployed specifically to support tactical SIGINT and all-source intelligence analysis functions: the MICROFIX and the TCAC. The MICROFIX assists the analyst in fulfilling the commander's need for information and intelligence on the AirLand Battlefield. The TCAC provides a variety of SIGINT and EW asset mission management functions, as well as to assist the analyst. Both of these systems are designed to enhance the analyst's ability to manipulate large quantities of unprocessed or partially processed data. Information is quickly and easily added, deleted, or moved. Historical enemy locations, enemy strengths, equipment, and unit designations, and specific enemy equipment capabilities and limitations are accessed from previously stored data base information. In fact, the analyst accesses data that is limited

only by storage capability, the data bases available for review, and the information or data the analyst elects to input into the system during the course of the battle.

Since the TCAC system is found only in USAREUR and XVIII Airborne Corps, (and is a non-TOE--table of organization and equipment--item) this manual does not address it in detail.

### MICROFIX

MICROFIX was introduced into the Army as a training device. The system exists to provide MI soldiers an opportunity to become familiar with computers before future automated systems, such as the all-source analysis system (ASAS), are introduced. The purpose of MICROFIX also is to support the tactical analyst, as OB analyst (96B), SIGINT analyst (98C), counter-SIGINT analyst (97G), CI agent (97B), or a terrain analyst (12 CMF). The MICROFIX gives the analyst the capability to input data into complex data bases. The analyst manipulates this data to provide a source of accurate and frequently updated knowledge about past and present enemy activities. This information assists the analyst in determining enemy courses of action and developing counter-strategy. The MICROFIX system also produces various reports and data files which are generated by the analyst. The system is menu-driven (all the user's options are on the screen at all times) and quite easy to use. Figure B-2 shows the MICROFIX system.

The system is based on the Apple II Pulse Microcomputer and incorporates other off-the-shelf components. TEMPEST engineering provides emission security between components of the system. Expansion cards provide the capability to control a large amount of peripheral equipment in the field environment. Figure B-3 outlines the hardware components of the MICROFIX system.

Figure B-4 shows further details regarding the eight basic components of the MICROFIX system. The MICROFIX is mounted in an AN/TYQ-5 data analysis center or in any shelter, tent, or building the G2 considers appropriate. Since both power boxes, the power conditioner, and the standby power supply, have surge protectors, the system is powered by either commercial power or a field generator. Both styles of VDP and power box are shown, but only one VDP and one power box comes with each system.

In addition to the eight basic components shown in Figure B-4, two special components are available. The VCR and PTR/P are issued on a 1:3 to 1:4 ratio; one component for every three or four MICROFIX systems. The VCR is used to backup and restore the entire 20 megabyte memory of the hard disk. The PTR/P is used to cut a five or seven band of paper tape. The message is generated in the system's word processor (Wordstar) and, once properly edited, the MICROFIX system cuts the tape. Figure B-5 provides details on these two components.



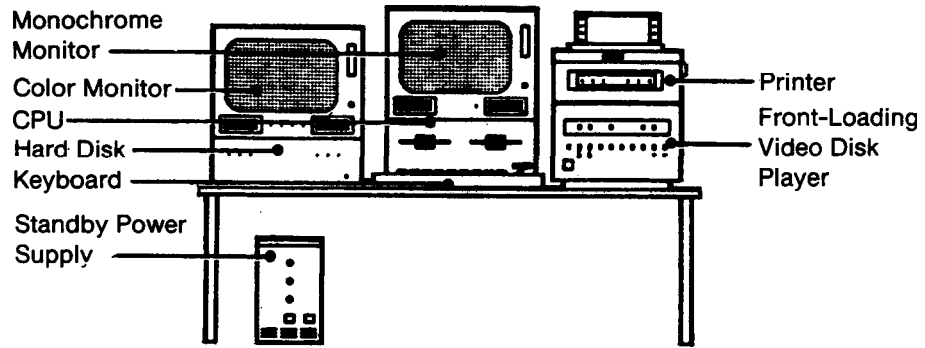

View with Front-Loading Video Disk Player and Standby Power Supply

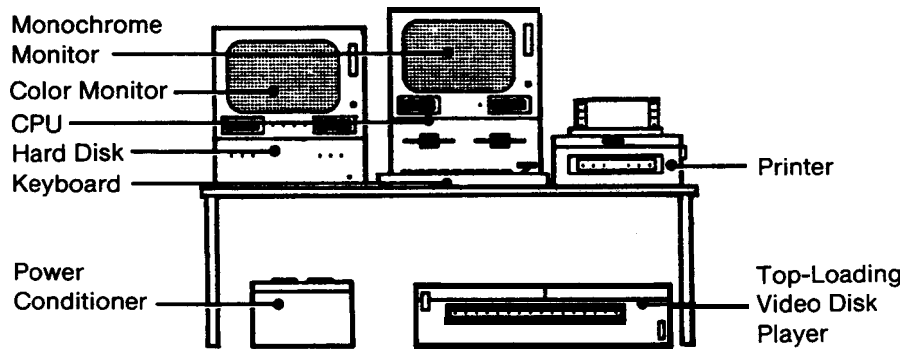

View with Top-Loading Video Disk Player and Power Conditioner

Figure B-2. MICROFIX system.

1. **HARD DISK SYSTEM.** The Corvus 20 megabyte hard disk drive assembly stores and maintains system software and the master data base.
2. **MONOCHROME MONITOR.** The monochrome monitor displays MICROFIX TEXT on a screen in green or black.
3. **COLOR MONITOR.** The amdck color monitor displays color graphic data. This includes video disk maps and military symbology.
4. **PRINTING.** The Apple Dot Matrix Printer operates at 120 characters per second (CPS) and has graphics capability.
5. **VIDEO DISK PLAYER.** The VDP reads photos or map sheets from a laser disk, using the same technology as used on a compact disk player. The photos of the map sheets are displayed on the color monitor.
6. **APPLE II PLUS MICROCOMPUTER.** The microcomputer is capable of controlling a large complement of peripheral equipment while operating in a field environment.
7. **KEYBOARD.** The keyboard assembly uses a full 128 ASCII character set, joystick and enhancer board. This equipment provides upper and lower case letter and number capability, in addition to auto-repeat keying.
8. **POWER BOX.** The older grey power conditioner has eight outlets on its top, assure protector and the capability to work with 110 or 220 volts. The newer green standby power supply has six outlets in the rear panel, a surge protector, a built-in battery pack capable of providing 20-25 minutes of uninterrupted power but works only with 110 volts.
9. **VIDEO CASSETTE RECORDER.** (Not shown in Figure B-2.) The VCR is used to initialize the system (hard disk) and acts as a backup or restore device for the hard disk drive assembly. This expands the potential data base capability of MICRO FIX. The VCR initiatea hard disks and backups which are quicker and easier to use than floppy disks. VCRs are issued with every three to four systems, or one per installation.
10. **PAPER TAPE READER/PUNCH.** (Not shown in Figure B-2.) The paper tape reader/punch (PTR/P) punches a paper tape coPy of messages prepared on the MICROFIX for transmission over tactical RATT systems. It also reads paper tape. PTR/P equipment is issued with every three to four systems, or one per installation.

**Figure B-3. MICROFIX hardware components.**

## EQUIPMENT SIZES AND WEIGHTS

TM, P. 1-2 thru 1-23 (Equipment Data)

**CENTRAL PROCESSING UNIT CPU**

HEIGHT 9.00 in. (22.86 cm)  
 WIDTH 16.62 in. (42.21 cm)  
 DEPTH 23.50 in. (59.69 cm)  
 WEIGHT 41 lbs. (18.6 kg)

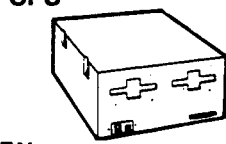

**INDICATOR, DIGITAL DISPLAY COLOR**

HEIGHT 14.12 in. (FRONT) (35.86 cm)  
 11.25 in. (BACK) (28.58 cm)  
 WIDTH 16.62 in. (42.21 cm)  
 DEPTH 18.00 in. (45.72 cm)  
 WEIGHT 53 lbs. (24.0 kg)

**COLOR MONITOR**

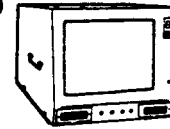

**RECORDER REPRODUCER DIGITAL**

HEIGHT 5.50 in. (13.97 cm)  
 WIDTH 16.62 in. (42.21 cm)  
 DEPTH 23.30 in. (59.69 cm)  
 WEIGHT 42 lbs. (19.1 kg)

**HARD DISK**

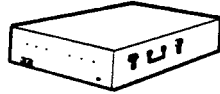

**INDICATOR, DIGITAL DISPLAY**

HEIGHT 14.12 in. (FRONT) (35.86 cm)  
 11.25 in. (BACK) (28.58 cm)  
 WIDTH 16.62 in. (42.21 cm)  
 DEPTH 18.00 in. (45.72 cm)  
 WEIGHT 36 lbs. (16.3 kg)

**MONOCHROME MONITOR**

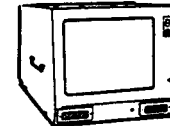

**KEYBOARD DATA ENTRY**

HEIGHT 1.75 in. (FRONT) (4.44 cm)  
 3.12 in. (BACK) (7.92 cm)  
 WIDTH 19.25 in. (48.90 cm)  
 DEPTH 7.25 in. (18.42 cm)  
 WEIGHT 6 lbs. (2.7 kg)

**KEYBOARD**



**REPRODUCER, VIDEO DISK**

HEIGHT 7.50 in. (19.05 cm)  
 WIDTH 19.87 in. (50.47 cm)  
 DEPTH 29.81 in. (75.72 cm)  
 WEIGHT 105 lbs. (47.6 kg)

**TOP-LOADING VIDEO DISK PLAYER**

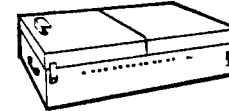

HEIGHT 7.50 in. (19.05 cm)  
 WIDTH 17.00 in. (43.18 cm)  
 DEPTH 16.00 in. (40.64 cm)  
 WEIGHT 39 lbs. (17.7 kg)

**PRINTER**



**FRONT-LOADING VIDEO DISK PLAYER**



**REPRODUCER, VIDEO DISK**

HEIGHT 11.00 in. (27.94 cm)  
 WIDTH 18.00 in. (45.72 cm)  
 DEPTH 25.50 in. (64.77 cm)  
 WEIGHT 67 lbs. (30.4 kg)

**POWER SUPPLY CONDITIONER**

HEIGHT 8.00 in. (20.32 cm)  
 WIDTH 13.00 in. (33.02 cm)  
 DEPTH 15.00 in. (38.10 cm)  
 WEIGHT 30 lbs. (13.6 kg)

**POWER PACK**

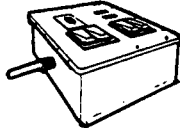

OR



**STANDBY POWER SUPPLY (SPS)**

HEIGHT 13.0 in. (33.02 cm)  
 WIDTH 8.5 in. (21.59 cm)  
 DEPTH 23.0 in. (58.42 cm)  
 WEIGHT 75 lbs. (34.0 kg)

Figure B-4. Eight components of MICROFIX.

**RECORDER-REPRODUCER VIDEO**

HEIGHT 4.50 in. (11.43 cm)  
 WIDTH 17.00 in. (43.18 cm)  
 DEPTH 16.93 in. (43.00 cm)  
 WEIGHT 22 lbs. (10.0 kg)

**VIDEO CASSETTE RECORDER (VCR)**

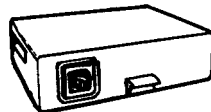

**RECORDER-REPRODUCER PAPER TAPE**

HEIGHT 11.25 in. (28.58 cm)  
 WIDTH 15.31 in. (38.89 cm)  
 DEPTH 19.37 in. (49.20 cm)  
 WEIGHT 50 lbs. (22.7 kg)

**PAPER TAPE READER/PUNCH (PTR/P)**

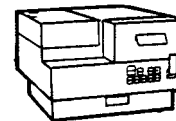

Figure B-5. Additional MICRO FIX components.

## MICROFIX SOFTWARE

MICROFIX software provides analysts with the ability to collect, consolidate, and retrieve information in the area of all-source production, SIGINT, counter-SIGINT, OPSEC, and topographic analysis. The analyst uses MICROFIX software to organize information into categories which facilitate rapid and meaningful analysis. The MICROFIX software provides the ability to manipulate records in various data bases, display tactical overlays on the color monitor, cross-correlate data from different data bases, and print reports. Figure B-6 shows the baseline software (those files which are found on all MICROFIX systems).

<b>DATABASEAPPLICATIONS</b>	
<b>Airfields</b>	<b>River Crossings</b>
<b>Attrition</b>	<b>Salute Spot Report</b>
<b>Bridges</b>	<b>TO&amp;E</b>
<b>Location History</b>	<b>Tunnels</b>
<b>Obstacles</b>	<b>Unit Hierarchy</b>
<b>Order of Battle</b>	<b>Water Supplies</b>
<b>SINGLE FUNCTION APPLICATIONS</b>	
<b>Collection Planning Aid</b>	<b>Help</b>
<b>Coordinate Conversion</b>	<b>New Map</b>
<b>CP/M</b>	<b>Paper Tape Interface</b>
<b>Format</b>	<b>Print Graphic Screen</b>
<b>Flex</b>	
<b>DEVELOP A NEW APPLICATION</b>	
<b>Define</b>	<b>Shape</b>
<b>New Symbol</b>	<b>Symbol Definition</b>
<b>Overlay Definition</b>	
<b>JOYSTICK CONTROL</b>	
<b>SITMAP</b>	
<b>COMMERCIAL SOFTWARE</b>	
<b>WordStar</b>	<b>PASCAL</b>
<b>Multiplan</b>	<b>BASIC</b>
<b>dBase II</b>	

**Figure B-6. Baseline software features.**

The primary advantage of the MICROFIX system is that it provides the tools to manipulate and retrieve data quickly and accurately. It gives the analyst the ability to access a much larger collection of data with more speed than manual systems provide. New information is added to existing data bases, new data bases are created, and old or inaccurate data are deleted. Graphic overlays allow the analyst to visually test theories and develop or discard hypotheses. Hard-copy printouts of text information, produced at each developmental stage of the analysis process, provide verification of the logic used to develop the final intelligence products and also serve as source documents for historical record-keeping purposes.

Figure B-6 shows all the applications that constitute the software package known as the all-source production system (ASPS). The baseline software package forms the foundation for all the other configurations. The additional software packages are explained in the order in which they were released.

### Topographic Workstation

Members of the terrain analysis team use the topographic workstation. The topographic software has all the applications of the baseline plus two topographic-specific applications: Topo and Topows. These applications allow the user to use digital terrain mapping features (tinted elevation, slope, or speed overlays; LOS profile; oblique view; perspective view and visible area plot); weather and environment features (sun rise and set, phases of the moon; NBC and smoke calculations; affect of weather on night vision devices, electro-optic sensors, and density altitude calculations); and a mobility calculator for friendly and enemy wheeled and tracked vehicles.

### Technical Control and Analysis Element Workstation

SIGINT analysts use the TCAE workstation. TCAE software has all the applications of baseline software plus five SIGINT-specific applications:

- ° Fix. Allows the user to input and plot lines of bearing and site locations. The program will calculate and plot the ellipse of the intercepts.
- ° Place. The automated gazetteer.
- ° COMINT working aid. A collection of four data bases (frequency, call sign, code word, and case notation) that allows correlation across each other.
- ° ELINT working aid. An automated ELINT parameters list (EPL).
- ° DATEXT. The data extract (DATEXT) program allows the user to create a subset from a file of messages. DATEXT allows the user to identify several key words, phrases, and numbers to cull the entire file down to a subset of messages which deal with the topic of interest.

### Counterintelligence Workstation

The counter-SIGINT analyst uses the CI workstation. The name of the workstation is a misnomer as the CI workstation is appropriate only for the 97G. CI workstation software has all the applications of the baseline software plus 11 counter-SIGINT-specific applications:

- ° Friendly and enemy antenna systems.
- ° Friendly and enemy SIGINT and REC unit OB.
- ° Friendly and enemy SIGINT and REC unit location.
- ° Friendly and enemy SIGINT and REC organization by doctrine.
- ° Friendly and enemy emitter and collector's characteristics.
- ° Enemy fixed station location.

### OPSEC Workstation

The OPSEC workstation is designed for use by the intelligence analyst and supporting the OPSEC staff element. Specific characteristics of the OPSEC workstation are uncertain.

### DISTRIBUTION OF MICROFIX CONFIGURATIONS

Tables B-1 and B-2 depict the number of systems at each echelon. Also shown is a recommended distribution of the various workstation configurations.

Table B-1. Workstation distribution (mid- to high-intensity conflict).

	TOTAL	ASPS	TCAE	CI	OPSEC	TOPO
<b>Theater</b>	1					1
<b>Corps</b>	13	6	4	1	1	1
<b>Division</b>	7	2	2	1	1	1
<b>SEP BDE or ACR</b>	2	1	1			

**Table B-2. Workstation distribution (low- to mid-intensity conflict).**

	TOTAL	ASPS	TCAE	cl	OPSEC	TOPO
Theater						
Corps						
Division	7	2	1	1 or 2	2 or 3	1
SEP BDE or ACR	2		0 or 1	0 or 1	1	

The G2 determines specific location of workstations for a given exercise or requirement.

#### UTILIZATION OF MICROFIX

Methods of using the MICROFIX system are limited only by the user's imagination. Several units are innovators in their use of the system. Some examples are--

- Printing the entire OB file (or selected enemy units) for use as an OB book. Updating the OB book is easier by doing the additions, deletions, or changes on the computer and then printing the updated or added records.
- Printing the unit hierarchy report for the enemy units your unit is facing. This report includes unit name, parent unit name, location, and DTG of last sighting. Gaps in your intelligence holdings become very evident since the computer prints a blank space for missing data. This report provides guidance to CM&D, provides a quick reference for RILs from adjacent and higher units and, by posting a copy beside the SITMAP, acts as a quick reference guide for locating enemy units.
- Using the location history function to plot the location histories of key enemy units (that is, independent tank battalions, RAGs, DAGs, BMP-equipped MRRs) on the color map screen. Plotting the movement history of these units provides an indication *or* confirmation of enemy commander's intent. Location history also indicates variances to doctrinal rates of march. This alone provides key indications to the enemy commander's intent or the terrain and weather influenced limitations not previously identified in the IPB.
- After doing your IPB in garrison, various options of enemy attack are conjectured. These various options are then templated over the terrain. Each option then is drawn on the color map using the sketch function and saved for immediate recall. When the exercise scenario (*or* real combat) confirms one of your templated options, considerable time is saved in analyzing the AAs.

## APPENDIX C

### INDICATORS OF ENEMY COURSES OF ACTION

Indicators are any positive or negative evidence of enemy activity or any characteristic of the AO that points toward enemy capabilities, vulnerabilities, or intentions. Individual indicators cannot stand alone. Each indicator is integrated with other factors and indicators before patterns are detected and enemy intentions established. Indicators are developed by the ASPS analysts who are assisted by other TOC elements in the G2 or S2 section. All indicators are developed to answer the commander's PIR and IR. The analyst uses indicators to correlate particular events or activities with probable enemy courses of action.

Indicators are also used to determine what events or activities occur for an enemy to follow a particular course of action. The ability to read indicators (including recognition of enemy deception indicators) contributes to the success of friendly operations.

Enemy deception operations provide indicators in an attempt to create false or misleading patterns of enemy intentions. Analysts detect these false indicators and then determine what actual courses of action the enemy is attempting to initiate. Enemy attempts at deception are discovered by comparing indicators, intelligence, and combat information from all sources to arrive at an accurate picture of the battlefield.

#### INTELLIGENCE INDICATORS

Tables C-1 through C-7 show different types of intelligence indicators. These lists of indicators are by no means complete, nor are they intended to apply to all situations or all types of enemy forces. They give some types of indicators which when incorporated with other indicators, creates patterns or suggests a series of activities which point to typical enemy activities or courses of action. Analysts are prepared to develop their own indicator lists for the specific situations which confront them.

**TableC-I. Enemy offensive indicators.**

<b>ACTIVITY</b>	<b>EXPLANATION</b>
Massing of motorized elements, tanks, artillery, and logistical support.	Areas of secondary importance are often denuded to mass maximum strength for the main effort.
Deployment of combat element (motorized rifle, armor, antitank (AT)) echelons on a relatively narrow frontage.	Normal attack formation provides for the second echelon of the regiment to be located 5-15 km in the rear of the first echelon, on-line; and the division second echelon 15-30 km in the rear of the first echelon.



**Table C-1. Enemy offensive Indicators (continued).**

ACTIVITY	EXPLANATION
Forward units disposed on relatively narrow fronts and depths.	A MRR breakthrough zone is from 2-4 km within an assigned attack frontage, which varies from 3-8 km. MRR headquarters located approximately 4 km from the FLOT during normal attack posture.
Concentration of mass toward either or both flanks within first echelon defensive area.	Single or double envelopment normally is attempted in the offense. Tanks and motorized units on either or both flanks may indicate single or double envelopment.
Demonstrations and feints.	Local, small-scale attacks or demonstrations involving motorized rifle units, tanks, and artillery frequently precede a general attack.
Establishment and strengthening counterreconnaissance screen.	Counterreconnaissance screens are used to cover possible assembly areas, routes of troop movement, or regrouping of forces to be used in the attack.
Forward movement of hostile units.	Before launching an attack, troops may be moved to assembly areas from which they can deploy.
Increased patrolling (ground reconnaissance) .	Patrolling by motorized rifle units usually is more active before an attack.
Forward CPS located close to the FLOT. Other CPS move forward.	Preceding an attack, an auxiliary CP is established, if needed, by Army or front. The division main CP is located 5-15 km from the FLOT; the division forward CP is located 5 km from the FLOT; the regiment main CP is located 2-3 km from the FLOT; and the battalion CP or OP is located 500-1,000 m from the FLOT.
Locating a division-sized operation maneuver group (OMG) at Army; Army-sized OMG at front.	OMGS are formed preceding an offensive operation. They are generally committed before the conclusion of the first echelon battle and operate independently of the main forces. OMGS use a separate axis of advance from the main body.

**Table C-1. Enemy offensive Indicators (continued).**

ACTIVITY	EXPLANAT 10N
Massing of artillery units.	Large RAGs, DAGs, and Army artillery groups (AAGs) indicate initiation of main attack. Enemy norms are 60-100 tubes per kilometer of frontage against well-prepared defenses for main attack; 60-80 tubes per kilometer of frontage against hasty defenses for main attack; and 40 tubes per kilometer frontage for secondary attack. The RAG is usually located 1-4 km from the FLOT; the DAG usually 3-6 km from the FLOT; and the AAG is usually more than 6 km from the FLOT. AAGs are formed only in the offense and only to support the main attack. TMS-65 are within 4 km of the FLOT for smoke operations.
Extensive artillery preparation of up to 50 minutes in duration.	The offense is built around the striking power and shock of massed artillery. Preparations of 1/2 to 1 hour normally precede an offensive.
Dispersal of tanks and self-propelled howitzers to units.	Tanks accompanying leading waves of assault motorized units--with motorized self-propelled howitzers following the tanks closely, by bounds.
Movement of fire and missile forward.	Enemy SAM control radars require time to be set up and oriented. The enemy prefers to establish SAM capability before moving other forces forward. In the event of the arrival of the second echelon, control radars are established to allow for an overlap of coverage as the first echelon moves their SAM radars forward in the offense.
FROG, SS-21, SS-23, and SCUD units located forward.	Enemy offensive operations also occur in-depth. Forward movement of SSMS puts friendly airfields and depots in jeopardy.
2 to 4 ZSU-23-4S located in forward areas.	Medium AD guns are displaced before attack to protect assault forces and to facilitate forward displacement during the attack. ZSU 23-4s protecting the leading battalions are approximately 1.25 km to the rear of the FLOT.

**Table C-1. Enemy offensive indicators (continued).**

ACTIVITY	EXPLANAT 10N
Increased air reconnaissance,	Air reconnaissance usually is more active before an attack.
Systematic air bombardment.	Before the attack, the enemy may engage in the systematic "softening up" of key positions by bombardment,
Establishment of auxiliary airfields or activation of inactive air fields.	Buildup of logistics and maintenance capability indicates increased capability to support offense.
Clearing lanes through obstacles within own position.	Lanes are cleared and marked through mined areas, and ramps and bridges prepared over ditches and trenches within enemy's own position. This is done before attack to facilitate forward movement and grouping, particularly at night.
Reconnaissance and destruction of obstacles that are part of our defenses.	Usually on the night preceding an attack, enemy patrols reconnoiter friendly obstacles to determine a plan for clearing lanes. The patrol destroys only such obstacles that will not disclose the direction of the main attack.
River assault crossing units located forward (providing there is a water obstacle) .	Amphibious, bridge, and other engineer units with water-crossing capabilities are located near the FLOT and also echeloned to the rear. They are also collocated with other tactical units of the attacking force.
Airborne, airmobile, and air assault attacks on our rear area.	The enemy conducts offensive operations throughout the depth of the defense. Heliborne attacks are also made to facilitate difficult operations, like river crossings.
Increased enemy agent activity in rear area.	The enemy attempts to prevent or disrupt the forward movement of friendly supplies, equipment, maintenance, and reinforcements.
Extensive efforts to destroy nuclear storage areas and delivery systems by air, artillery, and sabotage.	Enemy doctrine calls for the elimination of friendly nuclear weapons by any means. The enemy considers that we are more likely to use nuclear weapons when we are in the defense.

**Table C-1. Enemy offensive indicators (continua).**

<b>ACTIVITY</b>	<b>EXPLANAT 10N</b>
Movement of noncombatants out of the combat zone.	Noncombatants hinder rapid forward movement of follow-on forces.
Conducting drills and rehearsals in rear areas.	Major attacks may be preceded by drills or rehearsals. This is particularly true of attacks against fortified positions or strongly defended river lines.
Increased activity in rear areas.	Before an attack, supply and administrative activities increase in the rear areas.
Traffic control units marking routes to the FLOT.	Traffic control points are employed throughout the march routes to facilitate march formations. Allied border guards assist by controlling traffic through the barrier areas of the borders.
Forward placement of supply and evacuation installations.	Supply and evacuation installations usually are located well forward for an attack, Technical observation points are established close to the FLOT. Repair and evacuation groups are located at assembly points close to the FLOT to repair or evacuate damaged vehicles. The division supply point (ammunition, petroleum, oil, and lubricants (POL), rations) is located 25-30 km from FLOT. The regimental ammunition supply point is located 10-15 km from the FLOT; the regimental repair point is located 10-15 km from the FLOT; the regimental POL point is located 10-15 km from the FLOT, and the regimental rations point is located 10-15 km from the FLOT. Battalion ammunition and rations supply points are located 5 km from the FLOT. The division repair point for tanks and weapons is located 2-4 km from the FLOT. The division repair point for wheeled vehicles is located 10-14 km from the FLOT. Rear control points for the front are located 150-200 km from the FLOT; for the Army are 25-40 km from the FLOT; for the division is 20 km from the FLOT; and for the regiment are 20 km from the FLOT.

**Table C-1. Enemy offensive indicators (continued).**

ACTIVITY	EXPLANATION
Location of maintenance parties on lateral routes.	When the enemy conducts a march, the enemy establishes several maintenance parties on lateral routes to facilitate march operations.
Medical points and stations move forward.	Medical units move forward before an offensive operation to support anticipated medical and evacuation requirements. Division medical points and stations are located 10-14 km from the FLOT; the regimental medical points and station at 10-14 km from the FLOT; and the battalion medical points and station at 1.5-3 km from the FLOT.
Radio silence on nets organic to the division.	The enemy attempts to deny us information which can be developed from intercepting radio traffic.
Abnormal logistics traffic on command nets.	To expedite supplies to units about to conduct a main attack, commanders may get personally involved.
Dummy traffic in radio nets to cover unit moves.	The enemy will attempt to deceive us about the location of enemy forces.
Deception operations to cover unit movement.	Same as above.
Extensive smoke operations.	Smoke operations mask the movement of units during the period immediately preceding an attack.
SIGINT and jamming assets located forward.	SIGINT and jamming assets will move well forward to within 2-4 km of the FEBA before attack.
Extensive spot and barrage jamming of our front line units' communications nets, as well as communications systems associated with tactical air control systems.	Extensive jamming will precede an offense to cause the maximum disruption of our C <sup>2</sup> communications. However, jamming will cease when enemy forces reach our main defense area to prevent interference with their own communications systems.

**Table C-2. Enemy defensive indicators.**

<b>ACTIVITY</b>	<b>EXPLANATION</b>
<b>Preparation of battalion and company defense areas consisting of company and platoon strong points.</b>	Defense is based on holding prepared defensive areas and counterattacks by tank-heavy forces.
<b>Extensive preparation of field fortifications.</b>	The enemy makes extensive use of trenches, prepared positions, and overhead cover in defensive operations.
<b>Formation of AT strongpoints in depth along avenues of logical approach.</b>	AT strongpoints are formed in depth along logical avenues of approach for armor. These are made up of motorized rifle, engineer, and AT gun and missile units with positions strengthened by mines, ditches, and other obstacles.
<b>Attachment of additional AT units to frontline defensive positions.</b>	In areas where there is a serious armored threat, the enemy will concentrate as many as 25 AT guns for every 1,000 m of front.
<b>Preparation of alternate artillery positions.</b>	In normal defensive operations, three positions are prepared for each firing battery.
<b>Employment of roving artillery.</b>	Roving guns and batteries are part of normal defensive operations.
<b>Large tank heavy units located in assembly areas to the rear.</b>	Tank units are held in assembly areas for employment in counterattacks.
<b>Preparation and occupation of defensive positions.</b>	In the defense, a security zone and main defense area are prepared and occupied.
<b>Presence of demolitions, contaminated areas, obstacles, minefield.</b>	Demolitions, minefield, and other obstacles are placed to cover AA to the position.
<b>Deployment of motorized rifle units on good defensive positions. Preparation of company strongpoints on key terrain</b>	Dominating terrain that has good FofFs and is relatively inaccessible to tanks usually is selected for a defensive position.

**Table C-2. Enemy defensive indicators (continued).**

ACTIVITY	EXPLANATION
Prestocking ammunition and engineer supplies and equipment and fortification of buildings.	Prestocking ammunition reduces the load on logistics throughout the system once the battle begins, Engineer tools and equipment may be used to dig trenches and to erect obstacles.
Entrenching and erecting bands of wire.	Digging of trenches and the erection of wire indicate preparations to hold the position.
Presence of dummy artillery observation points.	Dummy artillery observation points preserve the effectiveness of the actual artillery positions by deceiving us as to their location.
Presence of dummy CPS.	Same as above.
Increased activity of SIGINT and ESM units but decreased activity of ECM units.	Increased activity is an attempt to gain information about us before the attack.
Early warning sites hardened.	When early warning sites are hardened, it indicates the intention of those forces to remain in place and to protect an important facility.
CPS placed in hardened facility.	Same as above.
Additional AT units attached to first echelon maneuver units.	The enemy puts great emphasis on killing tanks early. The enemy believes that if the tanks can be stopped, the attack will fail.
Establishment of a security zone.	A security zone is established to enable fortifications to be constructed away from immediate danger from our artillery and direct-fire weapons.
Forward units disposed on relatively wide fronts and depths compared to offensive posture.	The defense zone of an MRR varies from 10 to 15 km depending upon terrain and the combat availability of forces. MRR depth varies from 7 to 10 km.

**Table C-2. Enemy defensive indicators (continued).**

<b>ACTIVITY</b>	<b>EXPLANATION</b>
Displacement of logistics and units towards the rear.	Logistics and medical units are displaced to the rear to facilitate combat force defense and counterattack operations.
Displacement of artillery and SSM units towards the rear,	Artillery units are displaced toward the rear to reduce the chance that these units will be lost or destroyed during the preliminary stages of the battle. During the defense, deep fires are not as critical as during the offense.
Presence of large AT reserves with mobile obstacle detachments (MODS).	Large AT reserves are established (with MOD) to provide a quick reaction AT capability.
Decreased communications intercepts (due to increased use of wire).	The enemy places increased reliance on wire in the defense to increase security.
AD systems located in rear areas.	Destruction of logistics, command, and artillery units are high-priority missions for our deep attacks,

**Table C-3. Meeting engagement (movement to contact) indicators.**

<b>INDICATORS</b>	
<b>ACTIVITY</b>	<b>EXPLANATION</b>
Increased air and ground reconnaissance along MCS.	Accurate information about routes speeds the advance.
Road junctions, bridges, and other key features are occupied by either airborne forces or forward detachments.	The enemy wants to control high-speed armor AAs into our key areas.
Increased counterreconnaissance activity.	Counterreconnaissance is an attempt to prevent us from gaining information about enemy dispositions and movements.
Forward movement of columns dispersed laterally in two or more MCS.	The enemy prefers to use march formation when moving to contact.



**Table C-4. Reinforcement indicators.**

<b>ACTIVITY</b>	<b>EXPLANATION</b>
<b>Movement of additional troops toward the front.</b>	This action increases enemy's present strength.
<b>Increased traffic toward present position.</b>	Increased traffic brings up additional troops, equipment, and supplies.
<b>Identification of new units in the combat zone.</b>	The presence of new units--in addition to units already present--increases enemy's strength.
<b>Additional CPS and supply and evacuation installations.</b>	Presence of additional units causes an increase in the number of these installations.
<b>Logistical installations moved well forward.</b>	indicates preparation for the resumption of the offensive after reinforcement.

**Table C-5. Delaying action indicators.**

<b>ACTIVITY</b>	<b>EXPLANATION</b>
<b>Withdrawal from defensive position(s) before becoming heavily engaged.</b>	In delaying actions, units avoid becoming decisively engaged.
<b>Successive local counterattacks with limited objectives.</b>	Counterattacks are employed to assist in disengaging first echelon units, rather than to restore position.
<b>Counterattacks broken off before position is restored.</b>	Same as above.
<b>Maximum firepower positioned forward; firing initiated at long ranges.</b>	Long-range fires facilitate the delaying action.
<b>Frontages up to four times that normally assigned to units on the defensive.</b>	Forces conducting a delaying action are normally assigned frontages in excess of that normal for enemy units on the defense.
<b>Prepositioning of nuclear weapons.</b>	Prepositioning nuclear weapons facilitates the delaying action.
<b>Discovery of dummy minefield.</b>	Dummy minefield are easier and faster to prepare than active fields but cause approximately the same delay to advancing pursuers.

**Table C-6. Withdrawal indicators.**

---

Indications for withdrawal are generally the same as those for delaying action with the addition of the following indicators,

<b>ACTIVITY</b>	<b>EXPLANATION</b>
Systematic destruction of bridges, communication facilities and other assets in enemy-held territory.	Deliberate demolition and scorched earth tactics may be employed in military withdrawals.
Establishment of a covering force and rear guard.	Cover movement or withdrawal of main body. The rear guard fights delaying action, if required,
Increased use of night-driving devices in all areas.	The enemy will attempt to withdraw at night, if possible.
Minimum logistical and medical services.	Nonessential logistics and medical services are withdrawn first.
Marking withdrawal routes.	Movement and location of traffic control units or parties to the rear along the LOCS that are to be used by major units.
Use of contaminated areas to camouflage forces and cover withdrawal .	Contamination hinders reconnaissance and pursuit.
Presence of rear guard and covering force.	Minimizes losses and permits main body more freedom of movement.
Preparation of future defensive lines behind main defensive structure.	If the withdrawal is deliberate, the enemy will want new positions ready before withdrawing.
Jamming or destruction of friendly air and ground battlefield surveillance radars.	Battlefield surveillance radars are capable of detecting withdrawals at night or during conditions of poor visibility.
Engineer reconnaissance and MOD detected along LOCs, tunnels, built-up areas, dams, and dikes.	Withdrawing forces will begin to systematically destroy all crossings and implement obstacles as they withdraw.

---

**Table C-6. Withdrawal Indicators (continued).**

<b>ACTIVITY</b>	<b>EXPLANATION</b>
<b>Stockpiling of explosives at central points. Distribution of, and the establishment of, small dumps of explosives and landmines near bridges, possible abatis sites, and other demolition target sites.</b>	<b>Withdrawing forces will attempt to delay pursuit with obstacles,</b>
<b>Preparation of target for systematic or hasty destruction.</b>	<b>Same as above.</b>
<b>Deception operations, such as dummy radio traffic.</b>	<b>Withdrawing units will attempt to portray a normal defense.</b>
<b>Smoke operations to cover withdrawal operations.</b>	<b>Withdrawals must be unobserved to be effective.</b>
<b>Rearward movement of long-range artillery.</b>	<b>Long-range artillery will be moved back to new positions before the withdrawal takes place</b>
<b>Movement of small reconnaissance parties to the rear.</b>	<b>Withdrawing units need current reconnaissance along withdrawal routes.</b>
<b>Displacement to the rear of emitters associated with logistics units. Destruction or removal of logistic material from existing depot and dump locations to the rear.</b>	<b>Logistics are withdrawn first to avoid being overrun during a possible pursuit.</b>

**Table C-7. Nuclear weapons indicators.**

<b>ACTIVITY</b>	<b>EXPLANATION</b>
Heavily guarded movement of supplies, equipment, and material .	Movement of supplies, equipment, and material of nuclear nature requires special security measures.
Heavily guarded installations.	Sites for storage of nuclear supplies and the locations of delivery units are heavily guarded.
Preparation of heavy artillery positions.	Primary and alternate positions for nuclear delivery artillery are prepared before movement of the units.
Movement of small, heavily guarded convoys, including closed vans, with a high percentage of automatic weapons.	Nuclear warheads are moved under heavy security, usually in closed vans. Escort vehicles are equipped with machine guns.
Light aircraft circling over moving convoy.	Nuclear warhead convoys often use aerial radio relays to maintain communication.
Movement of small groups of heavily armed helicopters escorted by tactical fighters.	Nuclear warheads may be moved by helicopters, with guards and armed helicopters as escort, Tactical aircraft may provide air cover.
Movement of trailers with rockets or missile bodies.	Trailers are used to resupply missile and rocket units.
Identification of tall, slender objects, like towers, chimneys, or narrow trees, not previously in the area.	Ballistic missiles may be camouflaged as towers, chimneys, or narrow trees, such as poplars.
Large, well-guarded complexes, including tanks, trucks, radars, electronic equipment, generators, and maintenance tents, located well to the rear.	SSM units require extensive ground handling equipment.
Evacuation or exclusion of civilians from specific areas suitable for nuclear storage or delivery sites.	Civilians may be evacuated from areas selected for nuclear storage or delivery sites.

**Table C-7. Nuclear weapons indicators (continued).**

<b>ACTIVITY</b>	<b>EXPLANAT 10N</b>
<b>Presence of meteorological radars.</b>	<b>An END TRAY radar is part of the organic equipment of both the free rocket over ground (FROG) and SS-1c SCUD systems, as well as other nuclear-capable systems. (END TRAYS also are found with conventional artillery and AF units.)</b>
<b>Construction of FROG, SCUD, or SCALEBOARD, SS-21 or SS-23 launch positions.</b>	<b>All of these systems have confirmed nuclear capabilities. A survey-controlled launch position is constructed for each transporter-erector-launcher (TEL) before occupation.</b>
<b>Movement of SSM TELs to a launch site within 1/3 to 1/2 maximum range from the FLOT.</b>	<b>SSM TELs remain in camouflaged positions until movement to the launch area.</b>
<b>Passage of wind data from mid-range position to a command or technical element.</b>	<b>Enemy SSM accuracy is heavily dependent on wind data.</b>
<b>Passage of a nonsense word over command and selected fire control nets.</b>	<b>May be a code word relative to preparation for or execution of a nuclear fire mission.</b>
<b>Volume of traffic on command nets suddenly increasing then dropping to a low level or standdown.</b>	<b>May reflect passage of strike warnings followed by preparation for electromagnetic pulse protective measures.</b>
<b>Identification of SSM unit-peculiar equipment.</b>	<b>Presence of nuclear-capable systems.</b>
<b>Limited withdrawal of frontline units without apparent tactical reason.</b>	<b>Frontline units may withdraw for a limited distance to avoid casualties from close-in nuclear explosives.</b>
<b>Sudden and energetic digging in enemy areas.</b>	<b>Prior to use of nuclear weapons, frontline units may be ordered to dig deeper foxholes or take other individual protective measures.</b>

**Table C-7. Nuclear weapons indicators (continued).**

<b>ACTIVITY</b>	<b>EXPLANATION</b>
Large concentrations of radios, radars, and other electronic equipment located in the vicinity of suitable sites for guided missile launching.	Concentration of equipment is necessary to guide and control guided missiles, which must be located in close proximity of the launching site.
Sudden increase in communications and electronic activity.	Increase may be incident to delivery of nuclear weapons, for example, last minute orders and warnings, and use of electronic guidance and control.
Use of smoke cover on front-line troops.	Smoke may be used to protect troops against thermal effects of weapons used in close support.
Disappearance of known enemy agents from specific areas.	Prior to nuclear attack of an area, agents may be ordered to leave the area.
Increased or unusual air activity.	Delivery of nuclear weapons by air may require a temporary degree of total air superiority, special photo mission, or practice flight pattern runs by the delivery aircraft.
Additional AT elements with first echelon units.	Enemy will expect friendly forces to react to indications of a nuclear strike with an attack of tank-heavy forces. Also, tanks have greater survivability under nuclear conditions.
Movement of small convoys from the warhead storage areas.	Warheads being moved to be mated to missiles.
Removal of antennas and other equipment mounted on the exterior of vehicles.	To prevent blast damage.
Lowering of windshields on vehicles.	See above.
Removal of camouflage nets.	See above.
Movement of vehicles to reverse slopes.	See above.

**Table C-7. Nuclear weapons indicators (continued).**

ACTIVITY	EXPLANATION
Location of missile and free rocket units within striking distances.	Missile and free rocket units are located within one third of the maximum range from the line of contact on the offense, and one half of the maximum range on the defense.
Use of missiles or rockets with high-explosive warheads.	Missiles or free rockets may be used to deliver high-explosive warheads either in a normal support role or in a registration.
Location of very heavy artillery within supporting distance of front lines.	Nuclear delivery artillery is located within one third of its maximum range from the line of contact on the offense, and one half of the maximum range on the defense.
Registration of very heavy artillery.	Registration may be conducted using smoke and low charge or high explosive projectiles prior to firing a nuclear projectile.
Special or unusual activity by frontline troops.	Frontline troops may construct special positions, usually deep or covered foxholes, before enemy use of nuclear weapons.
AD weapons are deployed to cover possible warhead storage areas.	Enemy expects friendly air to attempt to destroy nuclear warheads in storage.
Use of high-explosive warheads from SSMs or heavy artillery in a normal support role.	Indicates presence of nuclear-capable systems.
Use of missile-associated terms on selected radio nets	See above.
Preparation of future launching positions.	See above.
Inability to locate previously identified missile units.	May be moving to firing positions.
Additional administrative, command, fire control, and logistics nets identified in the area of interest.	If these nets can be identified as nuclear-related, they indicate the presence of nuclear-capable units.

**Table C-7. Nuclear weapons Indicator (continued).**

<b>ACTIVITY</b>	<b>EXPLANATION</b>
Presence of heavy artillery,	203 mm SP gun, 240 mm SP mortar, and towed 203 and 240 have nuclear delivery capabilities, as do 152 mm SP guns.
Deployment of jamming assets.	Jammers are deployed to protect critical targets like nuclear units.



## INSURGENT ACTIVITY INDICATORS

Anything that insurgents do to influence and direct a society toward overthrowing its government is reflected by some action or indication, no matter how subtle. These occurrences are referred to as insurgent activity indicators. By recognizing these indicators, it is possible to obtain the first clues to insurgent existence and then evidence of the growth of the insurgent movement. Because there is a great deal of legitimate activity, there is a requirement to determine which of the various sociological, economical, political, and other activities represent insurgent activity.

It is not possible to provide an all-inclusive listing of insurgency indicators because there are too many possibilities existing in the many nations of the world. The following indicators, however, do provide a beginning framework for a detailed analysis of any particular country. The greater the perception of an insurgency situation within a particular country and the greater the knowledge of the insurgent involved, the easier it is to identify the insurgent activity indicators.

These indicators serve as a guide for intelligence officers and analysts in developing appropriate clues to insurgent activity in a particular area. Isolated actions of seemingly little significance in one area show a pattern of an emerging insurgency when coordinated with reports of indicators from other areas. In developing indicators, or using these suggested ones, it is important to remember that insurgent strategy suddenly changes. The insurgent threat unfolds along altogether different lines simultaneously or suddenly switches from use of military force, for example, to a political example, to a political offensive. Such a development is dangerous if it makes the general situation appear to be much less critical than it really is. The development of appropriate indicators not only indicates that an insurgency or potential insurgent situation exists, but also identifies any problems and dissatisfaction of the people. The elimination or effective control of insurgency is based on coordinated internal defense and development (IDAD) programs which address identified problems or potential problems. Before these programs are developed, the threat is defined. To define the threat, you first establish insurgent activity indicators.

### RURAL INSURGENT ACTIVITY

A rural area includes all farming areas, any town or village up to 5,000 people, and any town or village up to 20,000 people with a farm-based economy where the townspeople, if not engaged in farming, earn their livelihood in agricultural service industries. In such areas, where the interests are so interdependent, insurgency indicators would be similar in both the town and countryside. This is not to say that rural insurgency is not directed by urban insurgents and coordinated with urban insurgency; however, some theorists emphasize that the key to success is the countryside and the rural population. In such cases, early insurgency indicators are found in the rural areas where the subversive insurgents are concentrating their initial efforts.

During the development of a subversive insurgency, some of the first indicators of latent or incipient insurgency appear in the rural areas. While some of these indicators are rather obvious, some are not. For the sake of simplicity, these indicators of insurgency are placed into four categories: population, propaganda, commodity, and environmental.

### Population

Population indicators are broken down further into subcategories of general activity, insurgent-promoted activity, and activity directed against the government.

#### General Activity. This includes--

- ° Identification of insurgents, their supporters, and sympathizers who suddenly appear in, or move out of, an area.
- ° New faces in the community.
- ° Unusual gatherings among the population.
- ° Disruption of normal social patterns.

#### Insurgent-Promoted Activities. This includes--

- ° Refusal of peasants to pay rent, taxes, or loan payments or unusual difficulty in the collection of same.
- ° Trends of demonstrated hostility on the part of the local population toward government forces.
- ° Occurrence of actions previously considered taboo by the populace.
- ° Disappearance of the population from or avoidance by the people of certain areas.
- ° Unexplained disappearance or dislocation of young people.

#### Activity Directed Against the Government. This includes--

- ° Strangers attempting to join local security forces.
- ° Reports of the people being approached for purposes of intelligence recruitment.
- ° Unusual short absences of government employees.
- ° Failure of police and informant nets to report properly.
- ° Growth of general hostility toward the government.

- ° Unexplained destruction or loss of government identification papers or passports and increased forgeries thereof,
- ° Closing of rural schools.
- ° Murder and kidnapping of local government officials.

#### Propaganda

Propaganda indicators are broken down further into subcategories of general activity and activity directed against the established government, national military forces, and the educational system:

#### General Propaganda Indicators. This includes--

- ° Dissident propaganda from unidentified sources.
- ° Increase in the number of entertainers with a political message.
- ° Increasing religious unrest.
- ° Increased agitation on issues for which there is no identified movement or organization.
- ° Renewed activity by insurgent organizations thought to be dormant.
- ° Circulation of petitions advocating usual insurgent demands.
- ° Reports from other countries that the country is ready for revolution.

#### Directed Against the Established Government. This includes--

- ° Attempts to discredit and ridicule national or public officials.
- ° Attempts to discredit the judicial system and POI ice organizations.
- ° Characterization of government leaders as puppets and tools of a foreign government.
- ° Movement to remove strong anti insurgency leaders.
- ° Agitation against government projects and plans.
- ° Rumors designed to gain public acceptance of untruths about the government or governmental leaders.
- ° Advocacy of popular front government.

**Directed Against the National Military Forces. This includes--**

- ° Attacks which embarrass or ridicule military officials.
- ° Characterization of military leaders as puppets and tools of a foreign government.
- ° Movement to remove strong anti insurgency leaders from the military.
- ° Propaganda directed toward youth to refrain them from joining the military service or propaganda directed at soldiers to desert.
- ° Characterization of the armed forces as the enemy of the people.
- ° Civilian avoidance of and reluctance to cooperate with the military.

**Directed Against the Educational System. This includes--**

- ° Appearance of questionable doctrine in the educational system.
- ° Charges by students and others that the educational system is not adequate and is only training the youth of the nation to do the government's bidding.

**Commodity**

Commodity indicators are broken down further into crops, animals, arms and ammunition, clothing, drugs and medicine, and communication activity subcategories.

**Crops. This includes--**

- ° Diversion of crops from the market.
- ° Unexplained decrease in the marketing of a given crop.
- ° Increased reports of pilfering foodstuffs.
- ° Strangers attempting to purchase crops or produce.
- ° Farmers marketing a crop that is smaller than usual, yet showing no signs of subsequent financial difficulty.
- ° Discovery of caches of staple foodstuffs.
- ° Increase in crop prices indicating the existence of an insurgent taxing authority in the area.

**Animals. This includes--**

- ° Diversion of animals or meat from the market.

- ° Reports of loss of hides or diversion of hides from the market.
- ° Disappearance of wild game from an area in which it was previously plentiful.
- ° Disappearance of pack animals or the appearance of unusual numbers of pack animals in certain areas.

**Arms and Ammunition.** This includes--

- ° increased loss of weapons by military and police forces.
- ° Increased thefts of weapons.
- ° Discovery of arms caches.
- ° Attacks on patrols resulting in loss of weapons and ammunition.

The above factors could be applied not only to weapons but also to any similarly essential military goods.

**Clothing.** This includes--

- ° Unusual scarcity of any type of material that could be used for footwear. This could include such items as hides of animals and old tires, in addition to manufactured footwear.
- ° Discovery of caches of clothing or of materials which may be used in the manufacture of clothing or uniforms.

**Drugs and Medicine.** This includes--

- ° Scarcity of herbs and plants used in or for drugs and medicine.
- ° Large-scale purchasing or theft of drugs and medicine and of the herbs used in their manufacture.

**Communications.** This includes--

- ° increases in purchase and use of radios.
- ° Discovery of caches of communications equipment.
- ° Unusual increase in communications traffic in amateur radio operations.

**Environmental**

The environmental indicators include--

- ° Evidence of increased foot traffic in the area.
- ° Increased travel within and into remote or isolated areas.

- ° Unexplained trails and cold campsites.
- ° Establishment of new, unexplained agricultural areas, or recently cleared fields.
- ° Unusual smoke, possibly indicating the presence of a campsite or a form of communication.
- ° Concentration of dead foliage in an area, possibly indicating use of camouflage.
- ° Presence of foot traps, spikes, and the like.
- ° Presence of obstacles such as those used in roadblocks and canal blocks.

#### URBAN INSURGENT ACTIVITY

Indicators of urban insurgent activity also are placed in the four categories of population, propaganda, commodity, and environmental indicators. Many of the same or similar indicators appear for both rural and urban areas.

#### Population

Population indicators are broken down further into subcategories of general activity, insurgent-promoted activity, and activity directed against the government.

General Activity. This includes--

- ° Increase in size of embassy or consulate staffs from a country or countries which support insurgent groups.
- ° Increase in staff and activities in pro insurgency-oriented embassies or consulates in neighboring countries, including unusual patterns in nature and volume of external communications (both in-country and out-of-country).
- ° Increased travel by suspected subversives to pro insurgency-oriented countries or to countries notably under insurgent influence.
- ° Influx of insurgent leaders, both foreign and domestic, into the urban area.
- ° Reports of locals being trained in pro insurgency-oriented countries.
- ° Increase in visitors from pro insurgency-oriented countries (tourists, technicians, businessmen, and officials).

- ° Close connections between the diplomatic representatives of pro insurgency-oriented countries and the insurgents.
- ° Disappearance of known or suspected insurgents and dissident elements.
- ° Increase in insurgent youth gatherings.
- ° Hosting of trade fairs or similar activities by pro insurgency-oriented countries.
- ° Return of nationals from travel or study in pro insurgency-oriented countries.
- ° Increase in visits to urban centers by rural officials and leaders from areas of unrest.
- ° Establishment of organizations (even very small) of unexplained origin and of unclear or nebulous aims.
- ° Establishment of a new organization to replace an existing organizational structure with identical aims.
- ° Appearance of many new members in established organizations like labor unions,
- ° Attempts by new groups to obtain control of established organizations.
- ° Infiltration of student organizations and unions by known agitators.
- ° Appearance of new organizations with titles stressing patriotism, grievances, or interests of underprivileged or minority groups.
- ° Reports of large donations to new or revamped organizations.
- ° Reports of payments to locals for engaging in subversive activities.
- ° Reports of the formation of subversive paramilitary organizations.
- ° Use of grenades or other explosives in terrorist acts.
- ° Reports of insurgent lists of targets for planned terroristic acts.
- ° Appearance of professional agitators in demonstrations that result in violence.
- ° Evidence of the participation of paid and armed demonstrators in riots.

Insurgent-Promoted Activities. This includes--

- ° Reported incidents of attempted recruitment of people to join new movements or underground organizations.
- ° Unexplained unavailability or disappearance of doctors, printers, and other specialists who may be working with and for the insurgents.
- ° Habitual criminals and unruly youths who seem to be acting with and for the insurgents.
- ° Increased unrest and agitation among laborers.
- ° Inability or refusal of people to pay taxes.
- ° Reports of extortion and other coercion by the insurgents to obtain financial "donations" from the people.
- ° Disappearance of young men from the city.

Activity Directed Against the Government. This includes--

- ° Failure of police and informant nets to report properly, indicating *sources* are supporting the insurgents or are afraid of them.
- ° Decreasing success of government agents in infiltrating subversive organizations.
- ° Assassination or disappearance of government agents.
- ° Reports of increased attempts by insurgent representatives or suspected subversives to make contact with local leaders or government officials.
- ° Reports of attempts to bribe or blackmail government and law enforcement employees.
- ° Reports of attempts to get classified information from government officials or documents from government offices.
- ° Leakage of classified information to news media.
- ° Sudden improvement in financial status of certain government and law enforcement employees.
- ° Failure of government raids on suspected subversive meetings or headquarters apparently because of forewarning.
- ° Increased activity against the government and its police, minority groups, foreigners, or similar groups.



- ° **Demonstrations against government forces, scapegoat minority groups, or foreigners, designed to goad government forces into acting against crowds.**
- **More articles or advertisements in newspapers criticizing the government.**
- **Growth of general hostility toward the government and law enforcement agencies.**
- **Occurrence of strikes in critical areas casting doubt upon the ability of the government to maintain order and provide for the needs of the people.**
- **Unusual and unsatisfactorily explained absences of government employees from their offices.**
- **Sporadic, unexplained destruction, loss, or forgery of government identification cards and passports.**
- **Unexplained disruptions of public utilities.**
- **Reports of extortion attempts on local leaders and businessmen.**
- **Terrorist acts and threats against government and business leaders.**
- **Murder or kidnapping of government officials.**

#### **Propaganda**

**Propaganda categories are broken down further into categories of general activity, and activity directed against the established government, military and police, and educational systems.**

**General Activity. This includes--**

- ° **Worldwide propaganda by proinsurgency-oriented countries denouncing conditions and blaming the government of the targeted country.**
- ° **Appearance in-country of antigovernment slogans and pronouncements by word of mouth, wall scribbling, posters, and leaflets.**
- ° **Letter writing campaigns to newspapers and government officials deploring undesirable conditions and blaming individuals in power.**
- ° **Increased use of slogans pinpointing specific grievances.**
- ° **Increased use of petitions demanding government redress of grievances.**

- Circulation of petitions and pamphlets which appear to follow the beliefs and policies of a foreign power.
- More rumors, publications, or leaders from areas occupied by migrants which focus upon lack of official concern about poor conditions.
- More agitation and unrest within the urban population for which there is no logical explanation,
- Appearance of committees and organizations whose leaders do not seem to be from the urban area, yet who purport to speak for the citizens of that area.
- increased appeals directed at intensifying general religious unrest in countries where religious competition exists.
- Mass demonstrations where participants voice standard Communist demands.
- Announcements by foreign countries that the concerned country is ripe for "war of national liberation," or words to that effect,
- Propaganda linking local ethnic groups with those in neighboring countries.
- Clandestine in-country radio broadcasts worded to appeal to those with special grievances or to underprivileged ethnic groups.
- Use of bullhorns, truck-mounted loudspeakers, and other sophisticated equipment in "spontaneous" demonstrations.
- Presence of photographers other than newsmen among demonstrators.
- Widespread propaganda which appeals for sympathetic reception or participation in strikes or demonstrations.
- Rallies to honor "martyred" insurgents. Mass demonstrations honoring revolutionary heroes or dates significant to insurgency.
- Nationwide strikes tailored to demonstrate the strength of the insurgent movement.
- Sympathy strikes or demonstrations taking place outside the country concerned.

**Activity Directed Against the Established Government. This includes--**

- Radio propaganda from foreign countries, aimed at the target country, accusing its government of failure to meet the needs and desires of its people.

- ° Propaganda from foreign countries, aimed at the target country, denouncing imperialism.
- ° Demonstrations and violence in foreign countries against embassies, offices, and consulates of the target country or countries which support its government.
- ° Spreading accusations that the government is corrupt and completely out of touch with the people.
- ° Agitation against existing or proposed government projects and plans.
- ° Accusations that the government is a pawn of a foreign government.
- ° Calls for a popular front government, including new parties.
- ° Character assassinations of top government officials.
- ° Movement to remove strong anti insurgency leaders from office.
- ° Strikes or work stoppages called to protect government actions.

**Activity Directed Against the Military and Police.** This includes--

- ° Spreading accusations that the military and police are corrupt and completely out of touch with the people.
- ° Character assassinations of military and police officials.
- ° Movement to remove strong anti insurgency military and police leaders from the office.
- ° Calling on the people to stop cooperating with the military and police.
- ° Deliberate acts to provoke police reprisals during demonstrations or strikes.
- ° Accusations of police brutality or ineffectiveness or claims that government forces initiated violence when demonstrations end in riots.
- ° Publication of photographs purporting to show repressive police practices.

**Activity Directed Against the Educational System.** This includes--

- ° Student unrest manifested by new organizations, proclamations, demonstrations, and strikes against authority.
- ° Charges by students and others that the educational system is not adequate and is only training youth to do the government's bidding.

° Appearance of questionable doctrine in the educational system.

° Clamor for personnel changes in the educational system.

#### Commodity

Commodity indicators are broken down further into subcategories of foods, arms and ammunition, clothing, and drugs.

Foods. This includes--

° Scarce food supplies when there is no report of natural impediments to agriculture.

° Decline of foodstuffs in a country or province where there is a tolerated black market, which indicates that the food is being diverted.

° Sudden shortages of preserved foods or items of food requiring minimal storage facilities.

° Failure of farmers to transport their products to the city, indicating a fear of travel on the highways.

° Large-scale purchasing of foodstuffs which may be by purchasing agents for an insurgent movement.

Arms and Ammunition. This includes--

° Increase in assaults on police and military personnel which results in thefts of weapons.

° Increase in thefts and purchases of arms, ammunition, and explosives.

° Discovery of arms, ammunition, and explosives being clandestinely manufactured, transported, or cached.

° Increased purchase and theft from salvage yards of metal products like pipe, casings, wire, spikes, and nails.

° Increased purchase of surplus military goods.

° Increase in demand for small arms and ammunition on the open market.

° Reports of large-scale purchasing of weapons, ammunition, and material used in their manufacture.

° Increase in pilfering of arms and ammunition from the government.

° Increase in the number of armed robberies.

° Reports of theft or sudden shortages of chemicals which could be used in the clandestine manufacture of explosives.

° Appearance of arms manufactured in pro insurgency-oriented countries.

**Clothing.** This includes--

° Unusual systematic purchase of clothing materials which could be used for the manufacture of insurgent uniforms or footwear.

° Unusual scarcity of clothing or material used in the manufacture of clothing and footwear.

° Distribution of clothing to underprivileged classes by organizations of recent or suspect origin.

° Discovery of caches of uniform clothing.

**Drugs.** This includes--

° Scarcity of drugs and medical supplies on the market or black market.

° Large-scale purchase or theft of drugs and other medical supplies,

° Diversion of shipments of drugs.

**Environmental**

The environmental indicators include--

° Apartments and housing being rented, but not lived in as homes.

° Slogans written on walls, bridges, and streets.

° Defacement of government and police information signs.

° Disappearance of electrical lines. Pollution of the urban area's water supply.

° Terrorist acts against physical targets like bridges, dams, airports, or buildings.

° Changes in residence of suspected subversives.

° Discovery of message drops.

° Apartments and houses being used for purchases other than residences.

° Increased smuggling of currency, gold, gems, narcotics, medical supplies, and arms into urban centers.

- ° Reports that local currency is being bought up in world markets by pro insurgency-oriented countries.
- ° Appearance of abnormal amounts of counterfeit currency.
- ° Increase in bank robberies.
- ° Work stoppages or slowdowns in essential industries.
- ° Marked decline in product quality in essential industries.
- ° Marked increases in equipment failures in essential industries.
- ° Mass strikes and sympathy strikes in essential industries.
- ° Appearance of known agitators or suspected subversives in picket lines.
- ° Escalation of peaceful strikes to violence against property and nonstriking personnel.
- ° Explosions in essential utilities and industries,
- ° Roadblocks and mines on main lines of communication.
- ° Malicious damage to industrial products or factory machinery.

## APPENDIX D

### ENEMY STRENGTH COMPUTATIONS

Enemy strength undergoes a continuous fluctuation between TOE-type strengths and varying levels of force, unit, equipment, and personnel strengths during the course of a battle, campaign, or war. These fluctuations are a result of unit, personnel, and equipment losses and the enemy's ability or inability to provide suitable replacements quickly and consistently.

Enemy strength computations provide a method for estimating the level of combat effectiveness of enemy forces. It is computed in terms of committed forces, reinforcing and supporting units, and the number of nuclear weapons and chemical and biological delivery systems suspected or identified as being deployed within the friendly commandar's AOS or AIs.

Based on the analyst's knowledge of enemy doctrine, OB, and current information and intelligence on enemy dispositions, locations, and capabilities, the numbers of committed, reinforcing, and supporting forces is computed.

Once these enemy forces are determined, individual enemy units can be identified or located and enemy strength computed. Personnel and equipment strengths are described as percentages of known TOE-type strengths, based upon reported enemy personnel and equipment losses and known or estimated rates of replacement.

### COMMITTED FORCES AND REINFORCEMENTS

Committed forces are those enemy ground units, currently in contact or with which imminent contact is expected, whose area of employment is not expected to change to counter the specific course of action selected by the friendly commander. Committed forces may change disposition within their area of employment, but no significant delay is involved in their employment. Designation of enemy forces as committed forces depends primarily upon their disposition, location at the time of the estimate, the echelon at which the estimate is being prepared, and enemy doctrine. Committed forces are either located, unlocated, identified, or unidentified units.

Reinforcements are those enemy forces whose area of possible employment against the friendly force depends on the friendly selection of a specific course of action and on enemy capabilities. Reinforcements include all known enemy forces which are neither committed against a friendly force nor committed outside the friendly zone or sector, but which reasonably are considered capable of closing with the friendly force in time to affect the accomplishment of the mission.

Estimates of enemy NBC capabilities usually are prepared at field army and higher headquarters. Units below field army level usually lack the means to gather the information to make such estimates. They use the

estimates of the higher headquarters and modify them with available information.

The determination of enemy NBC operation capabilities is based primarily on estimates of numbers and types of weapons and amount and types of agents available, knowledge of enemy doctrine, past experience, and estimates of enemy capabilities involving the employment of ground troops. It is rarely possible to estimate what portion of the available enemy NBC effort may be used against a division or corps within a field army or a command in the COMMZ. It is also rarely possible to estimate the number of nuclear weapons the enemy is capable of using within a period as short as one day. The period selected is a month or longer, depending on the available information and past experience. The statement of the enemy's capability of using chemical and biological agents includes the amount, type, and delivery means of available agents.

#### COMPUTING COMMITTED ENEMY UNITS

The commander and the operations officer use the information the G2 or S2 provides on enemy committed forces and reinforcements for planning and conducting tactical operations. Accurate information is particularly important during the commander's analysis of opposing courses of action. For example, in planning for an attack, an overestimation of committed enemy forces and an underestimation of enemy reinforcements could cause the friendly commander to attack with a small reserve. The intelligence officer's error in computing committed and reinforcing forces could allow the enemy to counterattack with an unexpectedly strong force, inflicting unacceptable casualties upon the friendly force.

All uncommitted enemy forces are considered as reinforcements if they are committed in time to affect the accomplishment of the mission. If there is doubt as to whether an enemy unit is committed or reinforcing, it is considered as a reinforcement. This reduces the risk of surprise.

Expressing strength in number of units, by type, within an enemy force is stressed because it is a simple, reliable, and readily understood method of computing enemy strength. At the same time, the OB analyst cannot ignore individual unit strength computations. This is particularly important in arriving at a true picture of the enemy's strength.

Strength by type of unit includes the total number of enemy units listed by category and type. Normally, enemy units are counted down to and including two echelons below the friendly force's level of command. Some special purpose units three echelons below may also be counted.

Usually, an intelligence officer accounts for committed enemy forces by the size of the enemy unit which is opposing the friendly elements. At the most basic level, state the actual number of weapons systems. Against an enemy army, a division G2 usually counts committed forces in terms of battalions; a corps G2 in terms of regiments; and field army and higher headquarters, in terms of divisions. At headquarters above field army, a statement of the number of armies and army groups is included. For



example, "The committed forces facing this army group consist of one army group (3 combined arms armies with a total of 11 MRDs and 3 tank divisions). . . ." When committed forces, such as guerrillas, do not have a known organization, their strength is stated in total numbers. All FS weapons systems available to the guerrillas, including tanks, infantry fighting vehicles (IFVs), and artillery, also are listed and expressed in terms of total numbers.

The brigade S2 considers as committed forces the first and second echelon companies of enemy MR, tank, or reconnaissance battalions in contact with the brigade. Although the enemy company is the basic sized unit used by the brigade S2 in accounting for committed forces, the S2 also accounts for smaller units which have been located as separately employed.

The battalion S2 considers as committed forces the first and second echelon platoons of the enemy MR, tank, or reconnaissance companies in contact with the battalion. Although the enemy platoon is the basic unit used by the battalion S2 in accounting for committed forces, available intelligence frequently does not enable the individual platoons composing the enemy company to be located. Therefore, the battalion S2 considers that a located enemy company normally consists of three platoons; a company (-) consists of two platoons. Table D-1 shows the process of counting committed forces in the defense and in the offense.

The designation of enemy units as committed forces depends primarily on their disposition and location at the time the estimate is made. Enemy unit identification facilitates determining if a particular unit is the reserve of elements in contact with the brigade or battalion.

When an enemy unit of the size used in accounting for committed forces is in contact with two adjacent friendly units, the entire enemy unit is considered to be committed by the G2 or S2 of both friendly units. For example, if an enemy battalion is in contact with elements of two adjacent US divisions, both division G2s consider the entire battalion as committed against their respective divisions. This points up the need for correct identification and accurate strength computation at each echelon.

All ground FS weapons organic to the enemy MRB or MRR are usually referred to as normal regimental artillery and are always considered to be in support of committed forces. That is, each committed unit is assumed to have available to it its normal proportion of the available supporting weapons organic to the regiment. These weapons, therefore, need not be enumerated unless desired. FS weapons not organic to enemy motorized battalions or regiments which are identified as within supporting range are enumerated as if in support of committed forces. In the event that the forces committed against the brigade or battalion have no known TOE (that is, volunteer or irregular-type units), all FS weapons which are identified are enumerated.

**Table D-1. Counting committed forces in the defense and offense.**

When the US is in the defense,

THE	LOOKS AT	LOOKS FOR MR	TK	RECON
Battalion S2	1st Echelon Bns	Pits	Pits	Pits
Brigade S2	1st Echelon Regts	Cos	Cos	Cos
Division G2	1st Echelon Divs	Bns	Bns	Cos

When the US is in the offense,

THE	LOOKS	LOOKS FOR MR	TK	RECON
Battalion S2	Between LD, LC and the objective	Pits	Pits	Pits
Brigade S2	Between LD, LC and the objective	Cos	Cos	Cos
Division S2	Between LD, LC and the objective	Bns	Bns	Cos

\*Reinforcing units do not need to be expressed in the same units as committed forces; they should be expressed in the simplest possible terms.

\*supporting artillery may be expressed as "a RAG (or DAG)" of \_\_\_\_\_ battalions", battery or battalion equivalents (by type). However, if artillery has been located which is not a normal RAG or DAG asset, the type and size unit must be expressed. For example, "supported by a \_\_\_\_\_ battalions, RAG or DAG," artillery assets, augmented by one battery of 203 mm guns and one battery of 240 mm mortars.

When enumerating enemy forces in a defensive posture, enemy security elements forward of the combat outpost line are normally considered reinforcements of the main defensive position until contact with these security elements is made. The intelligence officer correctly identifies the enemy's main defensive positions and is not deceived by security forces. The security forces normally become reinforcements for the main defense after completing their security mission.

In addition to determining the enemy's ground combat unit strength in terms of committed forces and reinforcements, the G2 or S2 also considers the enemy's air and nuclear weapons strength. However, as estimates of enemy air NBC warfare strength are usually prepared only at field army level and higher, the G2 or S2 simply restates these capabilities in the estimate.

Reinforcements are stated conveniently and meaningfully. For example, if the opposing division has an MRR in reserve, this reinforcement is referred to as a motorized regiment rather than three motorized battalions. When enemy units--either committed forces or reinforcements--are very much understrength, the estimated remaining strength is expressed. Two divisions, each at half strength, are usually more formidable than a single division at full strength because of the added flexibility of employment and the additional CS probably available. A half-strength field artillery battalion is more than half as effective as a full strength battalion,

When only two elements of a unit are located, they are counted as they appear. By templating, it is possible to determine the approximate location of the third element. Although this unit should not be counted, the commander is advised as to its possible location. An exception to this rule occurs, however, in situations where enemy doctrine normally precludes elements of a unit operating independently of each other. For example, if a US brigade S2 detects the presence of one MR company of a Soviet MRB, then the remaining elements of the MRB are counted as committed, albeit unlocated, enemy forces. This is because Soviet doctrine normally precludes the MR companies of an MRB from operating independently of each other.

#### COMPUTING ENEMY REINFORCEMENTS

Factors derived from analysis of past similar enemy movements determine the time required for an enemy to move troops from one place to another and commit them. The considerations described below are applicable in training and as a point of departure for the development of experience factors in operations against an enemy force.

To determine the time when the enemy employ an uncommitted unit, the travel time from the unit location to a logical point where the unit can be committed is calculated. To the travel time, add the closing time (pass time of a column). Except when observation of enemy units is continuous, it is assumed that any unit could have started to move immediately after its last reported location. Therefore, to determine the earliest time at which the enemy can reinforce, add the travel plus closing time to the time last observed. For example, if an enemy reinforcement was last observed at 0800 hours, and it can deploy to envelop the northern flank in one hour, it is assumed that the attack can be launched as early as 0900 hours (0800 plus one hour). In the exceptional case involving piecemeal commitment of enemy reinforcements, consider only travel time. Forces which are committed piecemeal do not close into an assembly area or attack position.

Because observation of reinforcements is rarely continuous, statements of enemy reinforcing capabilities should include both the earliest time and that time after starting movement when the reinforcement is accomplished. For example, "the enemy reinforces the attack with the 45th MRR at 0900 hours, or one hour after starting movement." When the time since the last report is greater than the time after starting movement, only the time after starting movement is given. For example, "the enemy reinforces the attack with the 45th MRR now or one hour after starting movement." When the number of reinforcements is large or the enemy is capable of reinforcing in several areas, reinforcing capabilities are presented in tabular form. Table D-2 is an example of this. It shows the enemy reinforcing the attack or defense with all or part of the following units at the places and times indicated.

**Table D-2. Examples of estimating reinforcements.**

UNIT	PLACE	MOTOR	FOOT
45th MRR	RJ 6382	Now or 1 hr after starting.	091205 Jun or 4 hr 5 min starting movement.
	RJ 8884	090930 Jun or 1 hr 30 min after starting movement.	091605 Jun or 8 hr 5 min after starting movement.
37th MRR	RJ 6382	091000 Jun or 2 hr after starting movement.	100740 Jun or 23 hr 40 min after starting movement.
	RJ 8884	090920 Jun 1 hr 20 min after starting movement.	091430 Jun or 6 hr 30 min after starting movement.

In selecting a logical point for reinforcement, consider the effects of AO characteristics, such as AAs and logical enemy reactions to friendly courses of action. For reinforcement of an attack capability, select locations for commitment of second echelon and reserve forces for enemy battalions and regiments and forward assembly areas for enemy divisions and larger units. For enemy units moving to reinforce a defense, select defense or counterattack positions. For movements by aircraft, select logical LZS or DZS from which the enemy forces can materially affect the accomplishment of the mission.

The time required by the enemy to issue extra ammunition, make detailed reconnaissance, issue orders, and deploy to a line of departure is not normally considered because all these actions are completed before starting the operation or simultaneously with movement.

The following guidance is applicable until you develop experience factors against a particular enemy:

- Compute foot marching time for all appropriate reinforcements. Compute motor movement time only for distances greater than 10 kilometers (6 miles). If a unit is observed in trucks, compute only the motor movement time.
- Consider a foot march of more than 32 kilometers (20 miles) as a forced march. Consider a motor movement of more than 280 kilometers (175 miles) as a forced march for motorized units and a movement of more than 224 kilometers (140 miles) as a forced march for tank units.
- Compute closing time at the night rate of march if a column begins to close before the BMNT closing time; if a column begins to close at or shortly after BMNT, use the day rate of march. If a column begins to close before the EENT, use the day rate of march; if a column begins to close at or shortly after EENT, use the night rate of march.
- Move and close the entire unit to move an enemy infantry battalion. To move a unit of regimental or larger size, move and close two-thirds of the combat elements; that is, two battalions of an infantry regiment, two regiments of an infantry division.

#### COMPUTING COMBAT STRENGTH

The following three situations illustrate the method for computing combat strength, as discussed in the preceding paragraphs.

##### SITUATION 1

The 20th Infantry Division is advancing to the south. The advance of the division is stopped by elements of two MRRs (8th and 12th) of the enemy 16th MRD. Each of these MRRs has two MRBs in contact and one MRB in the second echelon. The third MRR (96th) is in contact with the 72d Infantry Division on the flank of the 20th Infantry Division. About 40 kilometers (25 miles) in rear of the 16th MRD and in the area of the 20th Infantry Division objective, two MRRs (43d and 75th) of the enemy 12th MRD are preparing field fortifications.

The four battalions of the 8th and 12th MRRs in contact with the 20th Infantry Division are considered as committed forces by the 20th Infantry Division G2. Regardless of the specific courses of action selected by the commander of the 20th Infantry Division to continue the advance, the area of employment of these four battalions in contact does not change appreciably. The second echelon battalions of the 8th and 12th MRRs are not considered committed since they are not in contact and are employed in other areas. The 96th MRR is considered committed and mentioned in the composition subparagraph of the OPORD, but only its second echelon battalion is listed as a reinforcement by the 20th Division. The other two battalions are committed against the 72d Division and are not available as reinforcements against the 20th Division. The 43d and 75th MRRs of the 12th MRD are considered as reinforcements because these units are not committed against the friendly force and are committed in

time to affect the mission of the 20th Infantry Division. Although the two MRRs of the 12th MRD are digging field fortifications in the vicinity of the division objective, the enemy commander employs these units against either the 20th Infantry Division or adjacent divisions. Figure D-1 shows this situation in a schematic sketch.



Figura D-1. Schematic sketch, situation 1.

#### SITUATION 2

The 20th Infantry Division is attacking to the east. Enemy committed forces are the 3d MRB, 3d GMRR, the 1st and 3d battalions of the 5th MRR, and the 1st Battalion, 7th MRR; the 2d Battalion, 33d GMRR, 2d Battalion, 3d GMRR, and the 3d Battalion, 7th MRR are committed against units on the 20th Infantry Division flanks. The 1st and 2d Battalion, 3d GMRR, 2d Battalion, 5th MRR, and the 2d Battalion, 7th MRR are not in contact and are second-echelon battalions which are employed against the 20th Infantry Division. They are considered as reinforcements. The two enemy regiments in the assembly area astride the 20th Infantry Division north boundary and the enemy MRR south of the south boundary are also possible

reinforcements. From their locations and dispositions, it is apparent that they are the 2d echelon regiments of the divisions committed against the 20th Infantry Division. Depending on the course of action selected by the commander of the 20th Infantry Division and plans of the enemy commander, all or part of these enemy elements are employed against the 20th Infantry Division, at various times and places, in time to affect the accomplishment of the division mission. Figure D-2 depicts this situation.

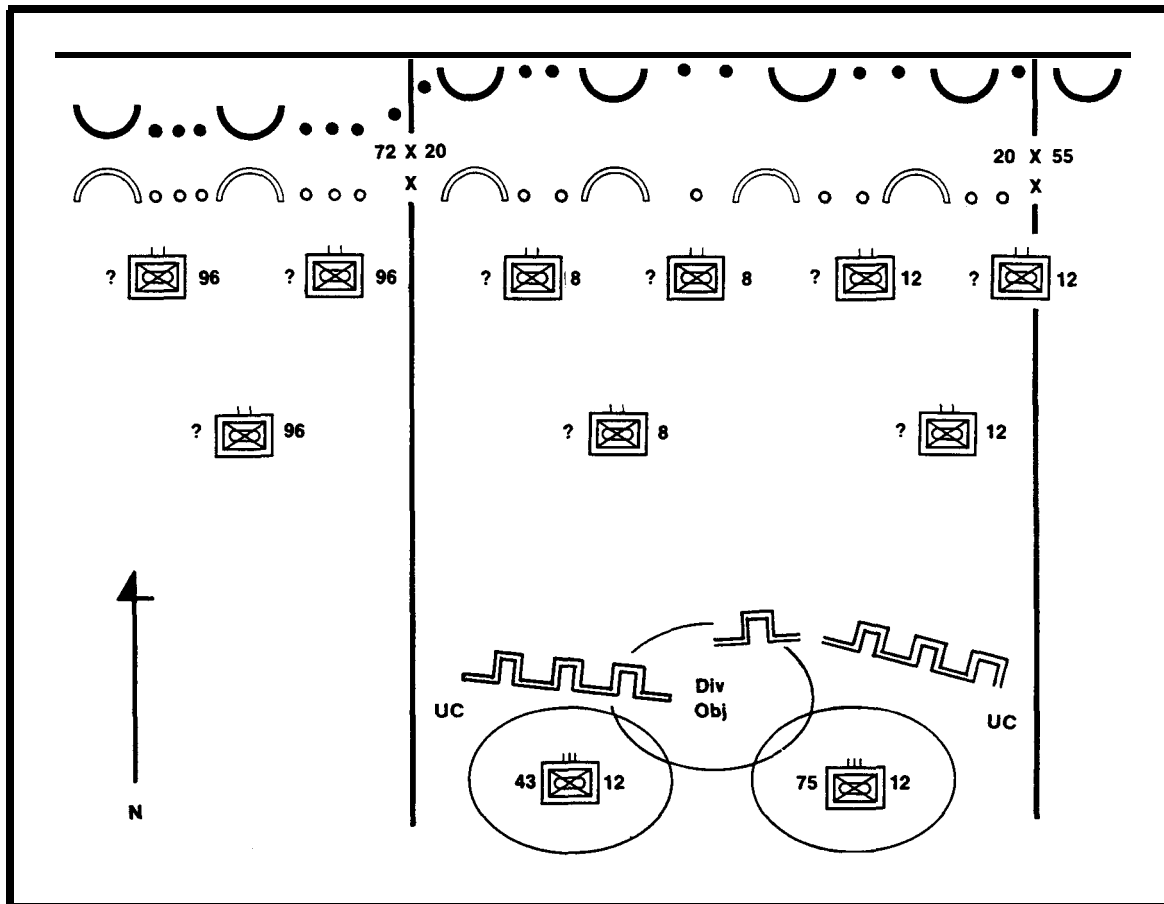
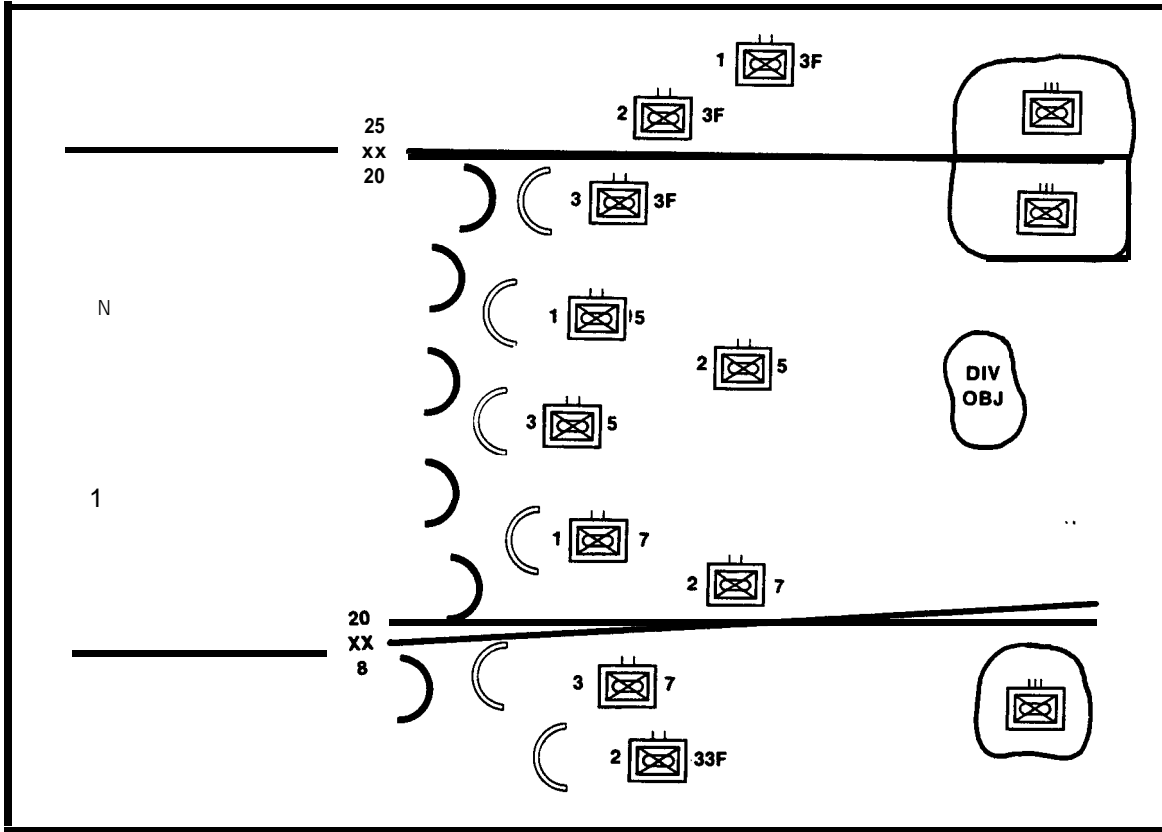

Figure D-2. Schematic sketch, situation 2.

### SITUATION 3

This example discusses the determination of enemy strength opposing the 1st Brigade, 21st Infantry Division, and each of its composite units: the 1st Battalion, 69th Infantry; and the 1st Battalion, 70th Infantry.

Figure D-3 shows the 1st Brigade, 21st Infantry Division, with the 1st Battalion, 69th Infantry, and the 1st Battalion, 70th Infantry forward defending positions as indicated in a schematic sketch. Reports from the





contact with, and committed against, the 1st Brigade and its respective battalions. All three platoons of the company northeast of the Highway 82 bridge are considered as one company committed against 1st Brigade, since brigades account for committed forces in terms of companies. The MR company south of Chigger Woods is located so that it is, logically, the reserve company of an enemy battalion in contact with 1st Brigade and is therefore considered committed. The MR companies of the 25th and 23d Regiments, located to the east and west of the 1st Brigade sector, are totally committed against adjacent brigades and are, therefore, neither committed nor available as reinforcements against 1st Brigade, 21st Infantry Division. Twelve medium tanks are located in the vicinity of the MR companies committed against 1st Brigade and are, therefore, also committed. The S2, 1st Brigade is equally correct to account for these committed medium tanks as three medium tank platoons or one medium tank company. In addition to the 120mm mortars (organic) and the 100mm AT guns and 122mm howitzer battery (both attached), the enemy MRB is supported by the artillery group of its parent regiment. The enemy also has an unknown number of air and nuclear weapons, which are employed in support of committed forces.

The S2, 1-69 Infantry, determines enemy strength now opposing the battalion as follows:

°Committed Forces: 1-69 Infantry is opposed by two MR platoons, one reconnaissance platoon, and one medium tank platoon, supported by normal regimental artillery, plus six 120mm mortars, six 122mm howitzers, six loom AT guns, and all available air and nuclear weapons.

°Reinforcements: Enemy reinforcements available for commitment in the sector of 1-69 Infantry are an unidentified MRB located in the vicinity of Hill 250 and an unidentified MR company and medium tank platoon located in the vicinity of Chigger Woods.

One MR platoon is in sole contact with, and therefore committed against, 1-69 Infantry. The MR platoon north of boundary 1-69 and 1-70 Infantry is counted as committed against both 1-69 Infantry and 1-70 Infantry. The medium tank platoon in the same vicinity is also in contact with and therefore committed against both 1-69 Infantry and 1-70 Infantry. The MR company and tank platoon located in the vicinity of Chigger Woods which are considered as committed by S2, 1st Brigade could logically be employed against 1-69 Infantry in time to affect the accomplishment of the battalion mission and are therefore considered as reinforcements. The discussion above concerning the battalion vicinity Hill 250, the normal regimental artillery and nonorganic weapons in support of committed forces, applies also to the determination by S2, 1-69 Infantry.

The S2, 1-70 Infantry, determines enemy strength now opposing the battalion as follows:

**°Committed Forces:** 1-70 Infantry is opposed by four MR platoons and two medium tank platoons supported by normal regimental artillery, plus six 120mm mortars, six 122mm howitzers, six 100mm AT guns and all available air and nuclear weapons.

**°Reinforcements:** Enemy reinforcements available for commitment in the sector of 1-70 Infantry are an unidentified MRB located in the vicinity of Hill 250 and an unidentified MR company and medium tank platoon located vicinity Chigger Woods.

The S2, 1-70 Infantry, considers the individually located MR platoons vicinity boundary 1-69 Infantry and 1-70 Infantry in the same manner as does S2, 1-69 Infantry. Two platoons of the motorized company northeast of Highway 82 bridge are considered committed against 1-70 Infantry. S2, 4-80 Mechanized, could also consider two platoons of this company committed against the battalion. The discussion concerning reinforcements and supporting fires applies also in the determination by S2, 1-70 Infantry. (See Figure D-3).

## APPENDIX E

### TERRAIN ANALYSIS IN INTELLIGENCE PREPARATION OF THE BATTLEFIELD

The function of terrain analysis is to reduce the uncertainties regarding the effects of terrain on combat operations. It allows the commander to "see the battlefield" and the effects of weather on the terrain in the AO. In order to accomplish terrain analysis, the intelligence staff receives support from the engineer terrain teams or detachments. To effectively use the terrain information developed by the terrain team, intelligence personnel must understand basic terrain analysis and its applications to the IPB process. In units where terrain analyst assets are not available, the intelligence staff collects, analyzes, and integrates terrain information into the commander's decision-making process.

#### TERRAIN ANALYSIS PROCESS

The terrain analysis process is paramount in prebattle support. Early in the IPB process planners determine the terrain information required to support the operations at all levels. Terrain analysis emphasizes the use of graphics to depict the effects of the terrain on ground and air operations. It considers the effects of weather on the terrain and how weather influences operations. The Defense Mapping Agency (DMA) prepares much of the data base that terrain analysts use. This DMA data is produced in two standard formats: a planning terrain analysis data base (PTADB) at 1:250,000 scale and a tactical terrain analysis data base (TTADB) at 1:50,000 scale. These scales coincide with the planning and tactical maps used by the US forces. DMA standard factor overlays produced include--

- ° Surface configuration (slope).
- ° Surface drainage.
- ° Vegetation.
- ° Surface materials (soils).

Overlays produced depicting factors related to military aspects of terrain (OCOKA) are--

- ° Concealment from aerial detection (summer and winter seasons) .
- ° Obstacles (microrelief).
- ° Built-up areas.
- ° Transportation.
- ° Key terrain.
- ° Cross-country movement (wet and dry conditions) .

These products have a wide dissemination, but are primarily intended for use by the terrain teams in support of the IPB process.

#### **TERRAIN FACTOR MATRIX AND TERRAIN ANALYSIS SUPPORT GUIDE**

The terrain factor matrix and terrain analysis support guide are tools for the analyst. They were developed through an analysis process whereby terrain factors that impact on combat operations are identified and correlated with specific types of combat operations and battlefield functions. Figure E-1 shows a terrain analysis support guide. The terrain factor matrix was introduced in Chapter 4 (see Figure 4-4).

#### **THE TERRAIN DATA BASE**

The focus of terrain analysis support in the prebattle is on providing the combat commander with detailed planning graphics of various terrain factors. These graphics are expedient, tailored to the mission, and updated with the changing combat and weather situations. Information concerning the types and sizes of units involved (both friendly and enemy), number and types of vehicles and equipment, and type of operation is needed in this developmental stage.

The process begins with the analyses of the basic terrain factors (surface configuration, surface drainage, vegetation and surface materials, built-up areas, and transportation nets). These products are used to assess the existing situation and further used in combination to develop the factors of OCOKA and other special purpose graphics. The analyst produces overlays depicting terrain factors not found on topographic maps. These factors include, but are not limited to, fording sites, tree height, stem spacing, stem diameter and canopy closure, micro-relief, and the effects of weather on soil. This information is necessary in the development of the OCOKA graphics. The information is gathered through on-site collection, aerial reconnaissance, photographic interpretation and analysis, and other collateral sources.

#### **Surface Configuration**

Surface configuration portrays and describes the landforms and the irregularities of the earth's surface. Maneuver commanders need accurate intelligence on the surface configuration of the terrain. The aspects of the various landforms and surface irregularities affect movement of troops, equipment, and materials from one point to another. Therefore, it is necessary that the analyst prepare an accurate surface configuration overlay.

There are three principal landform groups':

° Plains (less than 150 m difference in elevation between the high point and the low point and having more that 50 percent of the area with slope less than 4 percent).

° Hills (150 to 600 m--with low hills of 150 to 300 m and high hills of 300 to 600 m).

<b>MILITARY ASPECTS OF TERRAIN (OCOKA)</b>	<b>ELEMENTS OF TERRAIN INFORMATION</b>	<b>EXAMPLES OF TERRAIN ANALYSIS PRODUCTS</b>
<b>Observation and fields of fire</b>	<ul style="list-style-type: none"> <li>• Vegetation (summer and winter)</li> <li>• Surface configuration</li> <li>• Battlefield environmental Effects on the terrain</li> <li>• Urban areas</li> </ul>	<ul style="list-style-type: none"> <li>• Horizontal LOS for DF weapons and radar</li> <li>• Emplacement suitability and performance ratings for ground surveillance</li> </ul>
<b>Concealment and cover</b>	<ul style="list-style-type: none"> <li>• Vegetation (summer and winter)</li> <li>• Surface configuration</li> <li>• Obstacles (micro relief)</li> <li>• Battlefield environmental effects on the terrain</li> <li>• Urban areas</li> </ul>	<ul style="list-style-type: none"> <li>• Cover potential from Direct or indirect fire (good, fair, or poor)</li> <li>• Concealment, potential from horizontal observation (good, fair or poor)</li> </ul>
<b>Obstacles</b>	<ul style="list-style-type: none"> <li>• Vegetation (summer and winter)</li> <li>• Surface configuration</li> <li>• Drainage characteristics</li> <li>• Natural and manmade obstacles</li> <li>• Micro-relief</li> <li>• Surface material (wet and dry)</li> <li>• Urban areas</li> </ul>	<ul style="list-style-type: none"> <li>• Location of existing natural and manmade obstacles</li> <li>• Mobility potential on the battlefield expressed in GO, SLOW-GO and NO-GO for both tracked and wheeled vehicles</li> </ul>
<b>Key Terrain</b>	<ul style="list-style-type: none"> <li>• Urban areas</li> <li>• LOCs</li> <li>• Surface configuration</li> <li>• Drainage characteristics</li> </ul>	<ul style="list-style-type: none"> <li>• Location of key terrain features, both natural and manmade. Examples are: bridges, chokepoints, high ground, key military installations</li> </ul>
<b>Avenues of approach</b>	<ul style="list-style-type: none"> <li>• Vegetation (summer and winter)</li> <li>• Urban areas</li> <li>• Surface configuration</li> <li>• Surface materials (wet and dry)</li> <li>• Drainage characteristics</li> <li>• LOCs</li> </ul>	<ul style="list-style-type: none"> <li>• Identification of areas where movement of friendly and enemy forces may occur</li> <li>• Speed prediction</li> <li>• LZs</li> <li>• DZs</li> <li>• Landing beaches</li> <li>• NOE navigation</li> </ul>

**Figure E-1. Terrain analysis support.**

°Mountains (greater than 600 m with low mountains of 600 to 1500 m and high mountains greater than 1500 m) .

Major land forms, naturally and culturally dissected land areas, and micro-relief are depicted. Micro-relief includes escarpments, embankments, cuts and fills, and ditches less than 2 m in height.

Relief is the difference in elevations represented by contour lines, hypsometric tints, shading, or spot elevations. Slope is the inclined surface of a hill, mountain, or any other part of the earth's surface. Slope is shown in three basic categories:

- ° Map unit A equals 0-30 percent slope, where the distances between contour lines can be as narrow as the lines for 30 percent or wider. Movement and maneuverability are generally unrestricted except in local areas.
- ° Map unit B equals 30-45 percent slope, where the distances can be as narrow as 30 percent or narrower to 45 percent. Movement for vehicles in these areas is very slow. Maneuverability is difficult for tracks and large-wheeled vehicles.
- ° Map unit C equals greater than 45 percent slope, where the distances between contour lines are narrower than those for 45 percent. Movement is generally precluded and maneuverability is extremely limited. These areas are usually designated as NO-GO areas for most vehicles.

Figure E-2 shows the three basic categories of slope on a terrain and weather factor combined overlay. These categories may be further divided to obtain a more descriptive analysis.

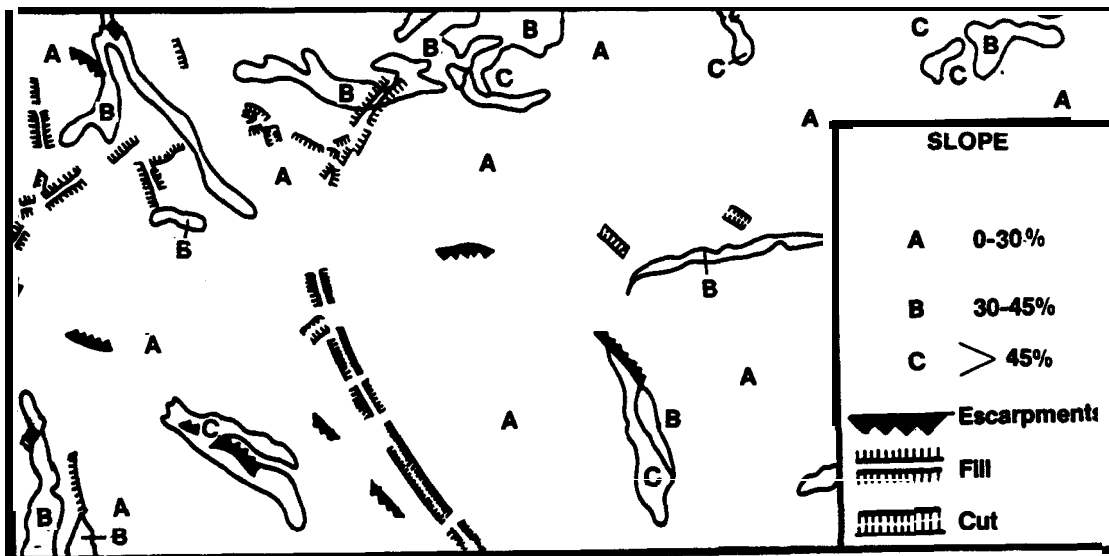
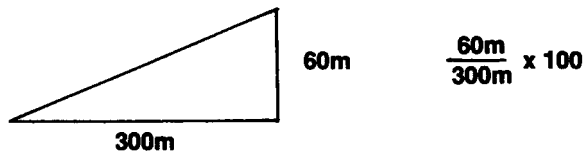
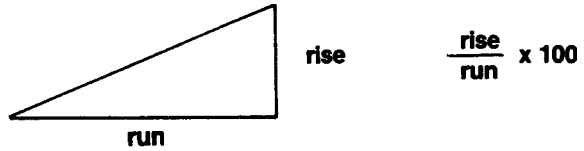

Figure E-2. Terrain and weather factor combined overlay: slope.

Slope can be expressed in three ways: first as a slope ratio (sometimes called gradient) represented as a fraction; second, as a degree of slope labeled in degrees; and third, as percent of slope. The best method of representation is the percent of slope. Figure E-3 shows how to calculate percent of slope.



$$.2m \times 100 = 20\% \text{ slope}$$

Construct a slope template of 30 and 45 percent for topographic map with a scale of 1:50,000 and a contour interval of 20m.

EXAMPLE -



1. Calculate horizontal ground distance (HD).

$$HD = \frac{\text{contour interval} \times 100}{\% \text{ slope}}$$

$$HD = \frac{20m \times 100}{30}$$

$$HD = 66.67m$$

$$HD = \frac{20m \times 100}{45}$$

$$HD = 44.44m$$

2. Calculate map distance (MD).

$$MD = \frac{HD}{\text{denominator of map scale}}$$

$$MD = \frac{66.67m}{50,000}$$

$$MD = .00133m \text{ or } 1.3mm$$

$$MD = \frac{44.44m}{50,000}$$

$$MD = .00088m \text{ or } .9mm$$

3. Draw 1.3mm and .9mm on a stable base transparent material. This is the slope template.

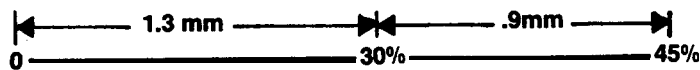

Figure E-3. Percent of slope.

Percent of slope is represented in the three categories described. Use a slope template or slope calculator to assist in determining slope categories.

A slope template or slope calculator is a device used for finding areas within a given class or slope on a topographic map. Many slope calculators have been made by various terrain detachments. These calculators show different contour densities to be used on maps at various scales with various contour intervals. They are usually reproduced by the photo lab on transparent plastic. Figure E-4 shows examples of six different slope calculators combined into one.

There are no significant weather effects on surface configuration. Most changes to surface configuration occur over long periods of time or as a result of a natural or artificial catastrophic event.

### Surface Drainage

With the concept of rapid mobility, it is vital for commanders to know what watercourses exist in their AO. Surface drainage is not just identifying rivers on a map. Military planners need to know types of watercourses, watercourse characteristics, conditions of the surrounding area, and artificial features along the watercourse. Figure E-5 shows a sample watercourse and water body data card. It is essential to military operations that analysts consider seasonal and short-term weather effects.

Watercourses are classified into four types: perennial, intermittent, ephemeral, and tidal. There are also 7 drainage patterns. These are dendritic, trellis, radial, annular, rectangular, parallel, and pinnate. Drainage patterns provide information on surface materials (soil types and geologic structure) and surface configuration. Figures E-6 through E-12 show the different drainage patterns.

Detailing is important in the preparation of the surface drainage overlay. Include a stream regime in the marginal information. This is a brief descriptive analysis of the prevalent drainage system(s) in the area. Rivers are identified as having a gap width greater than 2.84 mm and a length greater than 20 mm. Streams and canals are classified by type (perennial, intermittent, ephemeral or tidal) and by size. There are three sizes of streams:

- ° Less than .09 mm gap width.
- ° Greater than .09 mm-less than .36 mm gap width.
- ° Greater than .36 mm gap width.



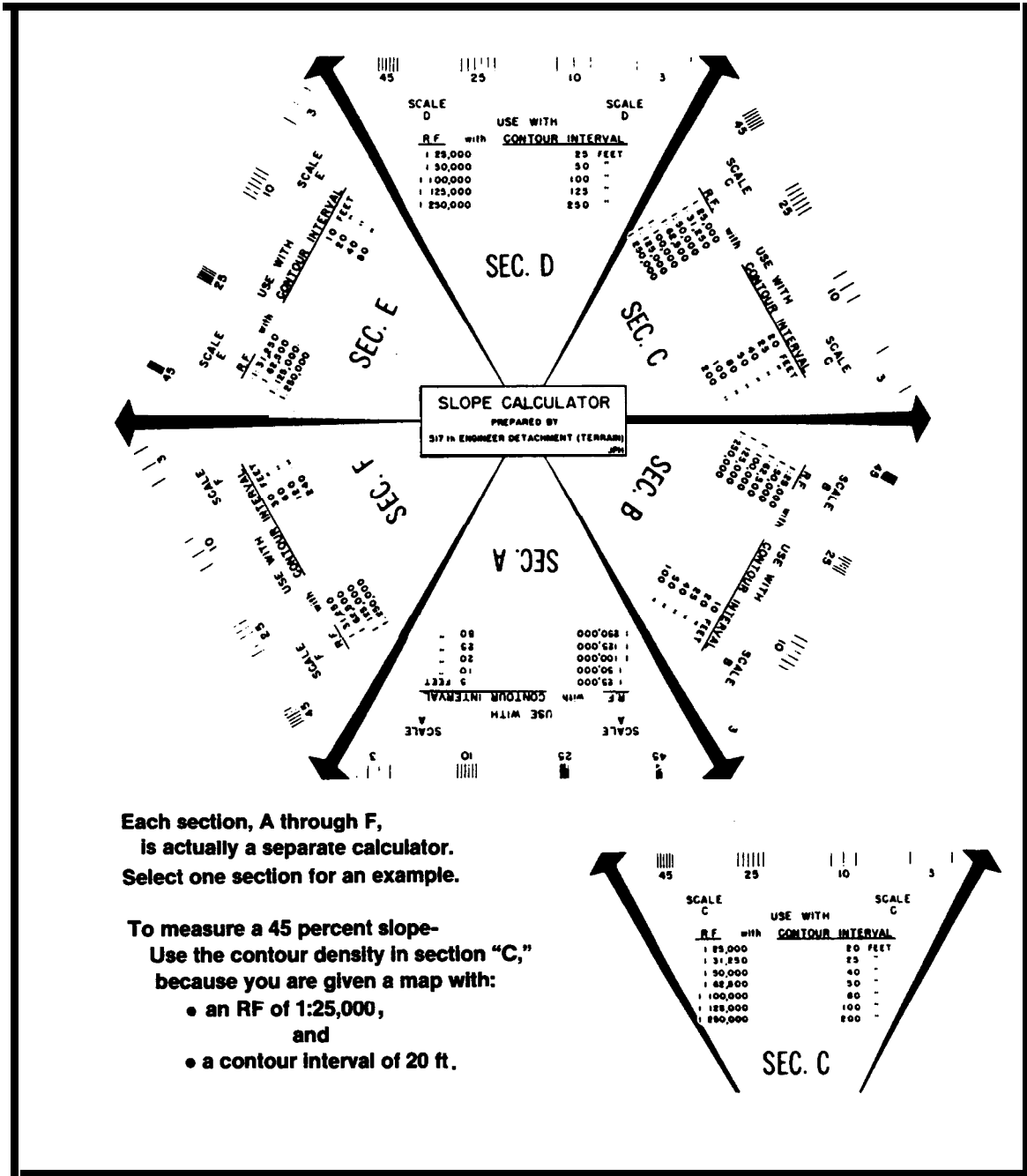
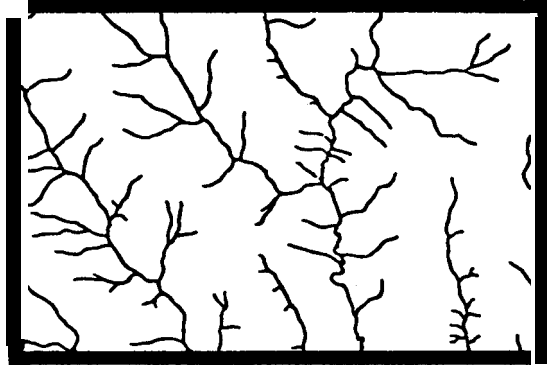

Figure E-4. Slope calculator examples.

Figure E-5. Watercourses and water bodies data.

Hydrographic Feature				Dry Gap Width In Meters	High Water Conditions				Low Water Conditions					
ID No	Local Name	Class	Segment Letter		Month	Depth (m)		Water Width In Meters	Vel M/S	Month	Depth (m)		Water Width In Meters	Vel M/S
						Min	Max				Min	Max		
1	WOODS CREEK	STREAM	a b	MAY 22	MAR	1.3	0.6	10	2.1	SEPT	0.0	0.2	3	0.5
					MAR	0.5	1.0	15	2.0	SEPT	0.2	0.5	10	0.7

Bank Conditions						Bottom Conditions		Ice Conditions												
Right Bank			Left Bank			Material	Slope In Deg	Number of Ice Days Per Month												Max Ice Thickness (cm)
Height (m)	Slope In Deg	Material	Height (m)	Slope In Deg	Material			1	2	3	4	5	6	7	8	9	10	11	12	
0.6	-	MH	1.2	7	MH	GP	3	5	8	1	0	0	0	0	0	0	0	2	10	
2.2	8	CH	2.0	10	CH	GP	2	5	8	1	0	0	0	0	0	0	0	2	10	



**A random developed, tree-like pattern composed of branching tributaries to a main stream. It is the most common pattern and is characteristic of essentially flat-lying and relatively homogeneous material.**

**Figure E-6. Dendritic drainage pattern.**

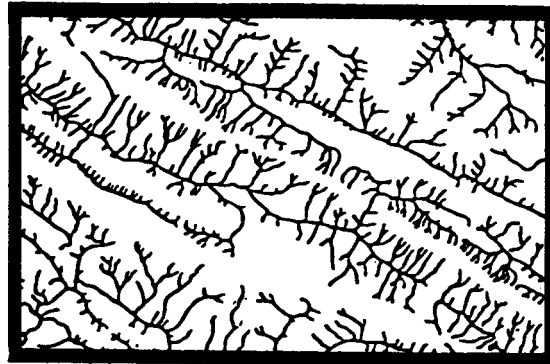

**A modified version of the dendritic pattern. Main streams generally flow parallel with the tributaries joining at right angles. This pattern is indicative of bedrock structure where rock strata have been folded and main streams now follow the strike of the rock units.**

**Figure E-7. Trellis drainage pattern.**



**This pattern is characterized by a network of channels, almost parallel, flowing away from a central high point. It is found on dome structures, isolated round hills, or volcanic cones.**

Figure E-8. Radial drainage pattern.

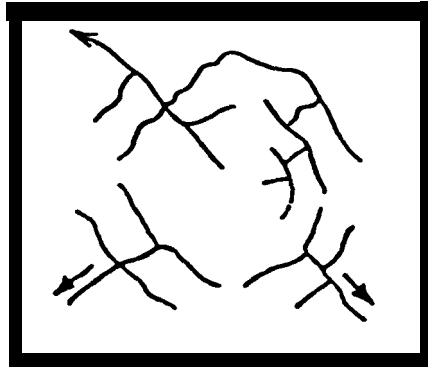

**Usually associated with radial drainage, as where sedimentary rocks are upturned by a dome structure. Joints or fractures may control the flow of the tributaries to provide a parallel aspect. Primary drainage will circle around a central high area.**

Figure E-9. Annular drainage pattern.

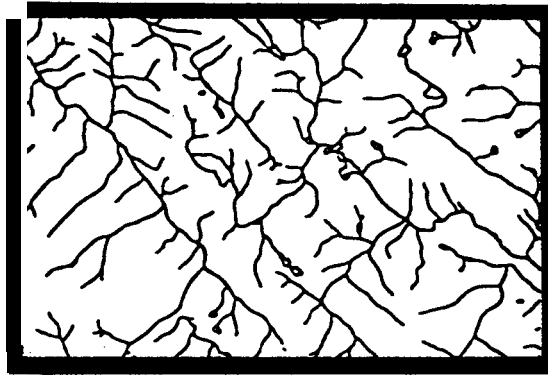

Sometimes called angulate, (rectangular dendritic or angular dendritic) this pattern is also a modified version of the dendritic pattern. It is characterized by abrupt, close to 90 degree, changes in stream directions and distinct obtuse or acute angles of stream juncture. This pattern is generally caused by faulting or jointing of the underlying bedrock. It is usually associated with massive igneous and metamorphic (intrusive) rocks, though it may be found in any rock type.

Figure E-10. Rectangular drainage pattern.

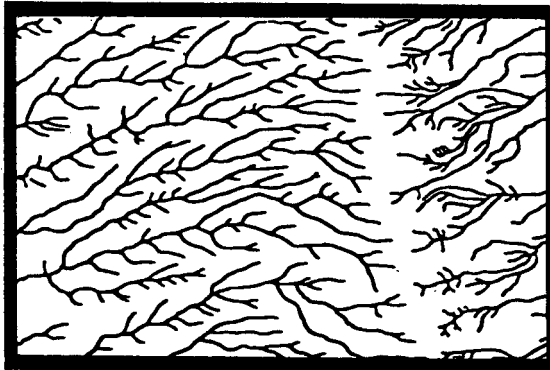

This drainage pattern is characterized by major streams that are trending in the same direction. Parallel streams are indicative of gently dipping beds of uniformly sloping topography. Tributaries characteristically join the mainstream at approximately the same angle. Extensive, uniformly sloping basalt flows and young coastal plains exhibit this drainage pattern. On a smaller scale the slopes of linear ridges may also reflect this pattern.

Figure E-11. Parallel drainage pattern.

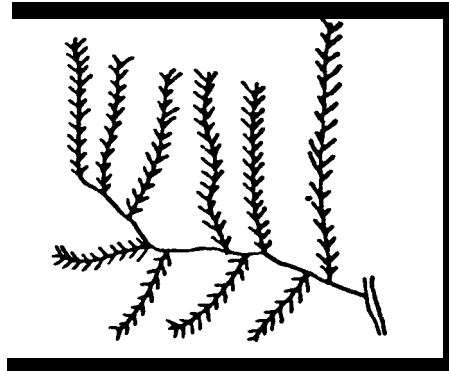

**This is a hybrid form of a fine dendritic pattern. It strongly resembles a feather structure in appearance. The gullies have steep, nearly vertical walls, profusely rilled with possible pinnacle development. The bottoms are generally flat and broad.**

**Figure E-12. Pinnate drainage pattern.**

An important consideration of streams and rivers are crossing sites for fording, swimming, and bridging, and bank conditions. Most trucks can ford depths up to three feet, most tanks up to four feet. Velocity should be less than five feet per second. Vertical banks greater than one foot stop trucks and greater than four feet stop tanks. Figure E-13 shows a sample surface drainage overlay. See terrain matrix (Figure 4-4) for surface drainage applicability.

Precipitation has a tremendous effect on hydrologic features and adjacent areas. It affects watercourse depths, velocities, and bank slope conditions. Evaluate flood plains and areas subject to inundation. The lack of precipitation also plays an important role in the evaluation of rivers and streams. The absence of water in various channels and flats provides concealed movement routes, however, use caution and give attention to weather forecasting when considering these routes. Wind affects velocity and surface turbulence on the larger watercourses.

#### Vegetation

Vegetation has a significant effect on many types of military activities and is considered carefully in planning operations. There are many ways vegetation affect military tactics, decisions, and operations. Perhaps the most important is concealment. Concealment is the ability to move troops, vehicles, and equipment without being detected from the ground or air.

Vegetation is defined as the natural plant cover characteristic of an area. There are four types of vegetation:

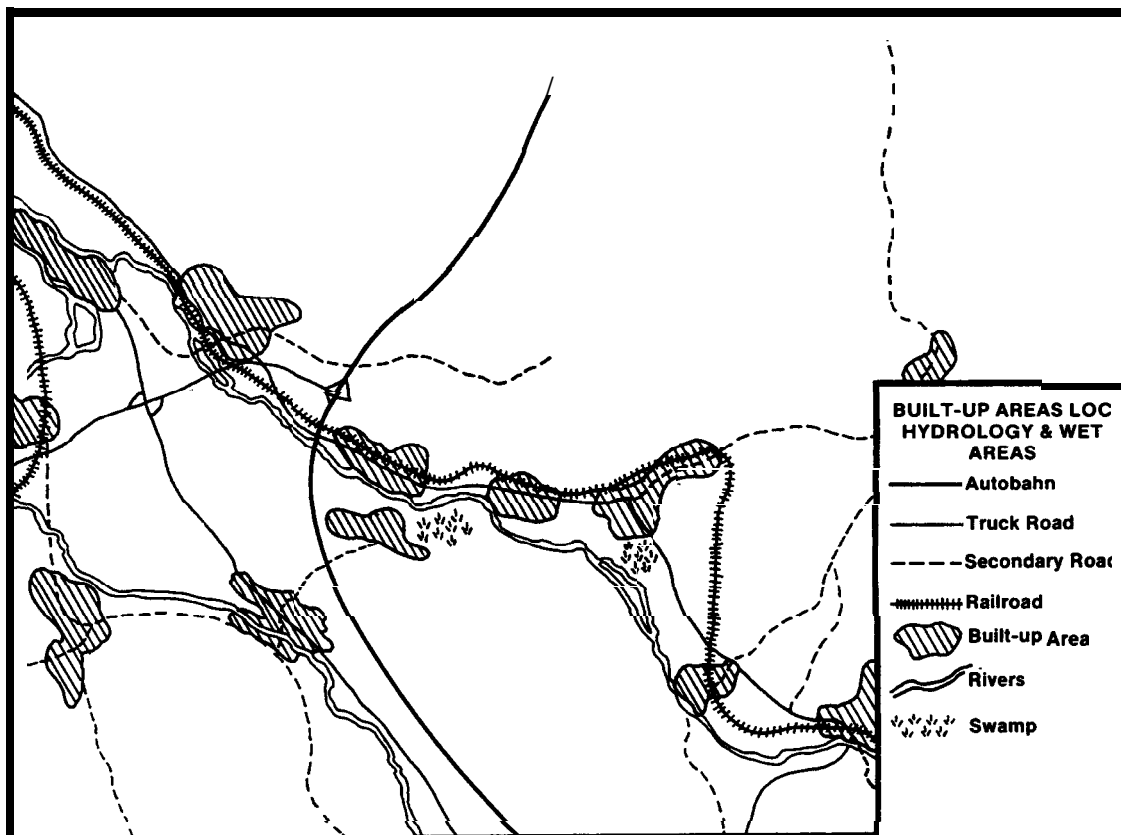

Figure E-13. Built-up areas, LOC and hydrology overlay.

°Trees are greater than 3.05 m tall, perennial wood plants, single stemmed, with a definite crown shape. They are either of the deciduous or coniferous variety.

°Scrub and shrub. Scrub is vegetation noted by its stunted growth due to poor soil or climatic conditions. Shrub is the undergrowth of the forested areas, normally the dominant vegetation. It is either deciduous or coniferous.

°Grasses are all non-woody plants (grasses and forbs) . They are classified as tall or short grasses depending on height (less than one meter is short, greater than one meter is tall).

°Crops are defined as cultivated vegetation (vineyards, farms, plantations, orchards, and fields).

Ground reconnaissance of vegetation provides the analyst with the necessary vegetation information to determine concealment possibilities. Reconnaissance allows the analyst to take precise measurements, thus producing a graphic of greater accuracy. Current aerial photography is

essential to accurate analysis of vegetation. The best altitude for photography for this analysis is less than 12,500 feet for accuracy within 10 percent. Altitude should not exceed 16,000 feet.

Areas are at least one square kilometer in size to be depicted on the overlay. It is important to check the surface drainage overlay to ensure the vegetation coincides on both overlays.

Vegetation annotated are those areas marked or those areas greater than 5 mm in size. Stands with more than 60 percent coniferous vegetation are designated as coniferous (C), with more than 60 percent deciduous vegetation are labeled as deciduous (D), and stands with mixed vegetation (C+D) in 40-60 percent combinations are marked with an E. Use standard symbology for other vegetation types (orchards, vineyards, and swamps). Indicate height and canopy closure for each vegetation type.

Figure E-14 shows mapping capabilities for vegetation data elements in the US, USSR, and Federal Republic of Germany. Figure E-15 shows a sample vegetation overlay. See terrain matrix (Figure 4-4) for vegetation applicability.

Concealment from aerial detection is determined from vegetation type, percent of canopy closure, stem spacing, and vegetation height. Canopy closure is normally computed for forested areas and is defined as the percentage of ground area covered by the tree crown area. Canopy closure has four categories:

- ° Category 1 - 0-25 percent closure (poorest concealment).
- ° Category 2 - 25-50 percent closure.
- ° Category 3 - 50-75 percent closure.
- ° Category 4 - 75-100 percent closure (best concealment) .

In categories two and three, concealment depends on the forest mixture of coniferous and deciduous trees. Tree height and canopy closure hinder visibility, while stem diameter and vegetation density (stem spacing) impede movement and maneuverability. Intervals less than 20 feet in spacing greatly restrict maneuverability. Forested areas with stem diameters greater than 2 inches stop wheeled vehicles (6-8 inches for tracks). The vehicles are able to knock down the trees; however, the brush pileup forms a significant obstacle.

Precipitation and wind affects vegetation by limiting or increasing visibility. Precipitation also impacts on the effects of vegetation on trafficability. Consider the fire potential of extremely high temperatures in conjunction with the lack of precipitation.

#### Surface Materials

The analysis of soils for military planners has two purposes: first for the engineering and construction uses and second, for military



DATA ELEMENT	UNITED STATES		FEDERAL REPUBLIC GERMANY		USSR	
	1:250,000	1:50,000	1:250,000	1:50,000	1:200,000	1:50,000
1. Map unit identification and vegetation boundaries	Limited to major vegetation boundaries	Limited to major vegetation boundaries	Limited to major vegetation boundaries	Limited to major vegetation boundaries	Limited to major vegetation boundaries	Limited to major vegetation boundaries
2. Mean height to top of canopy	Woodland 3m Scrub 3m	Woodland 3m Scrub 3m	No	No	Yes	Yes
3. Percent canopy closure by season	Limited estimate for major vegetation type	Limited estimate for major vegetation type	Limited	Limited	Limited	Limited
4. Number of stems per hectare	No	No	No	No	No	No
5. Crown diameter	No	No	No	No	No	No
6. Mean stem diameter	No	No	No	No	Yes	Yes
7. Number of trees in each stem diameter class per hectare	No	No	No	No	No	No
8. Stem Spacing	No	No	No	No	Yes	Yes
9. Species identification, seasonality, and distribution	No No No	No No No	Coniferous Deciduous Mixed only	Coniferous Deciduous Mixed only	Coniferous Deciduous Mixed only	Coniferous Deciduous Mixed only
10. Ground cover type, percent of cover, and height	No	No	No	No	No	No
11. Litter type and depth	No	No	Limited	Limited	Limited	Limited
12. Mean height to lowest branches	No	No	No	No	Limited	Limited
13. A representative transect	No	No	No	No	No	No

**Figure E-14. Map capabilities for vegetation data elements.**

operations, specifically, trafficability. Surface materials are important because of their influence on drainage, vegetation, field fortifications, and trafficability.

Surface materials are broken down into two groups, soils and rocks. Soils are of unconsolidated parent materials and are often called deposits or materials. Rocks are from consolidated parent material.

The Unified Soils Classification System is the system used in determining soil types and characteristics. There are several

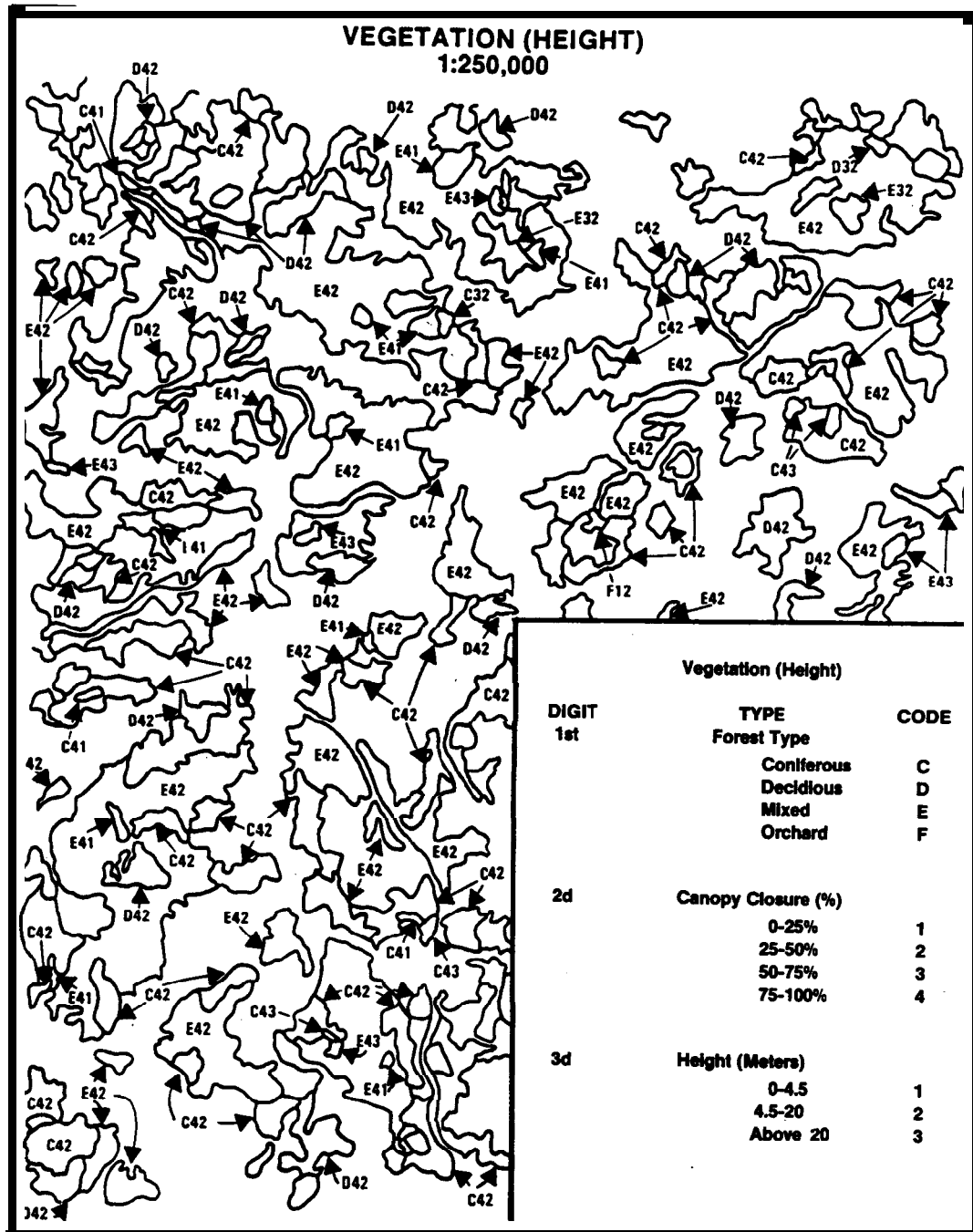

Figure E-15. Terrain factor overlay Vegetation Height.

characteristics needed to produce a surface materials (soils) overlay. The analyst identifies soil composition as either fine-grained, coarse-grained, or organic soils. Figure E-16 shows a sample soil classification chart. Figure E-17 shows a surface material overlay that further explains the classification designations. The first digit is the predominant soil, the second digit is a characteristic description. Surface roughness is depicted in the third digit. The following example further depicts the classification system.

GW1: Well-graded gravels, gravel-sand mixtures with little or no fines. Soil has no roughness effect. This soil is generally free of moisture. Soil depth is less than 5 meters.

Note: The subscript character indicates moisture and soil depth.

. . . indicates soil is normally moist.

— . . indicates soil is normally wet.

\_\_\_\_\_ indicates soil depth is less than 5 meters.

Other characteristics needed are an analysis of remoldability, soil depth in meters, moisture content, and soil horizonation. Remoldability is the tendency for a soil to change strength with traffic. Soil depth is measured in meters and is classified as--

° Class 1 - 0 - .5 meters deep,

° Class 2 - .5 - 1.5 meters deep.

‘ Class 3- 1.5- 3.0 meters deep.

° Class 4 - more than 3.0 meters deep.

Soil moisture content (the ability of the soil to retain moisture) must consider daily and seasonal changes. Soil horizonation (or layering) is the natural division of the unconsolidated material into three basic layers. The three layers are: layer A - surface materials; layer B - subsurface materials; and layer C - materials of the consolidated parent material . Other sublayers may be present.

A surface materials overlay breaks down the most probable soil types, characteristics, and distribution. Depicted on a soils overlay (surface configuration) are common soil types along with exposed rock outcrops (R), peat (PT), evaporates (E) and permanent snowfields (PS).

#### SOIL TRAFFICABILITY

The capability of a soil to withstand traffic is referred to as the soil strength or soil trafficability. Factors affecting soil trafficability are soil type, characteristics and conditions (wet or dry), vehicle type and vehicle cone index, and the soils rating cone index. A rating cone index is the product of the measured cone index and the remolding index. The vehicle cone index is the minimum soil strength that permits a given vehicle to complete 1 pass and 50 passes over a section of terrain. See TM 5-330 for the various vehicles and tables. The analysis

Major Divisions		Group Symbols	Typical Names	Field Identification Procedures (Excluding particles larger than 3 in and basing fractions on estimated weights)						
1	2	3	4	5						
More than half of material is larger than No. 200 sieve size. The No. 200 sieve size is about the smallest particle visible to the naked eye.	Gravels More than half of coarse fraction is larger than No. 4 sieve size. (For visual classification, the 1/4-in. size may be used as an equivalent to the No. 4 sieve size).	Clean Gravels (Little or no fines)	GW	Well-graded gravels, gravel-sand mixtures, little or no fines	Wide range in grain sizes and substantial amounts of all intermediate particle sizes					
		Gravel With Fines (Appreciable amount of fines)	GP	Poorly graded gravels or gravel-sand mixtures, little or no fines	Predominantly one size or a range of sizes with some intermediate sizes missing					
		Sands With Fines (Appreciable amount of fines)	GM	Silty gravels, gravel-sand-silt mixture	Nonplastic fines or fines with low plasticity (for identification procedures see ML below)					
			GC	Clayey gravels, gravel-sand silt mixtures	Plastic fines (for identification see CL below)					
	Sands More than half of coarse fraction is smaller than No. 4 sieve size. (For visual classification, the 1/4-in. size may be used as an equivalent to the No. 4 sieve size).	Clean Sands (Little or no fines)	SW	Well-graded sands, gravelly sands, little or no fines	Wide range in grain sizes and substantial amounts of all intermediate particle sizes					
		Sands With Fines (Appreciable amount of fines)	SP	Poorly graded sands or gravelly sands, little or no fines	Predominantly one size or a range of sizes with some intermediate sizes missing					
			SM	Silty sands, sand-silt mixtures	Nonplastic fines or fines with low plasticity (for identification procedures see ML below)					
		SC	Clayey sands, sand-clay mixtures	Plastic fines (for identification procedures see CL below)						
	More than half of material is smaller No. 200 sieve size. The No. 200 sieve size is about the smallest particle visible to the naked eye.	Silt and Clays Liquid limit is less than 50			Identification Procedures on Fraction Smaller than No. 40 Sieve Size					
						Dry Strength (Crushing characteristic)	Dilatancy (Reaction to shaking)	Toughness (Consistency near PL)		
ML					Inorganic silts and very fine sands, rock flour, silty or clayey fine sands or clayey silts with slight plasticity	None to slight	Quick to slow	None		
Silt and Clays Liquid limit is greater than 50					CL	Inorganic clays of low to medium plasticity, gravelly clays, sandy clays silty clays, clean clays	Medium to high	None to very slow	Medium	
					OL	Organic silts and organic silty clays of low plasticity	Slight to medium	Slow	Slight	
					MH	Inorganic silts, micaceous or diatomaceous	Slight to medium	Slow to none	Slight to medium	
CH		Inorganic clays of high plasticity, fat clays	High to very high	None						High
OH		Organic clays of medium to high plasticity, organic silts	Medium to high	None to very slow						Slight to medium
Highly Organic Soils			Pt	Peat and other highly organic soils	Readily identified by color, odor spongy feel and frequently by fibrous texture					

Figure E-16. Unified soil classification chart.

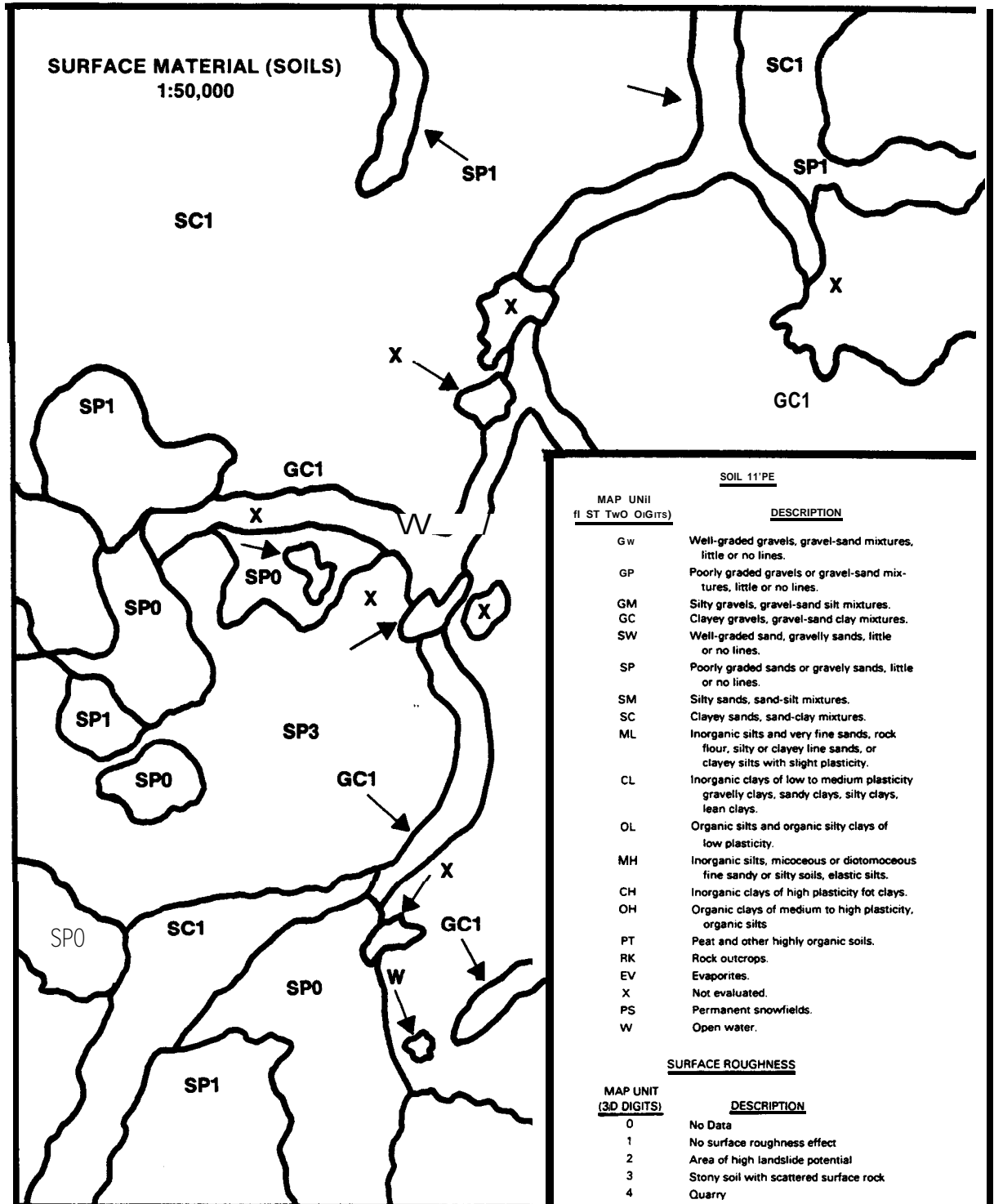

Figure E-17. Surface material (soils) overlay.

of soil trafficability is used in determining cross-country movement and vehicle maneuverability. (See Figures 4-5 and 4-6 for examples of over lays.)

Precipitation affects trafficability by changing the physical properties and characteristics of the soil and the consolidated parent material. Wind also is important because it decreases the drying time of inundated areas. Wind reduces visibility by creating dust plumes in exceptionally dry areas.

#### MILITARY ASPECTS OF TERRAIN - OCOKA

Terrain analysis focuses on the military aspects of the terrain known collectively as OCOKA. Military aspects of the terrain are observation and fields of fire, concealment and cover, obstacles, key terrain, and avenues of approach and mobility corridors.

##### Observation and Fields of Fire

Observation involves the influence of the terrain on reconnaissance, surveillance (optical and electronic LOS), and TA. Intervisibility is extremely important. Intervisibility is the unobstructed view from point A to point B. It is the ability to see from one station to another station. Vegetation is particularly effective in limiting observation on plains and plateaus. Prominences that could provide a commanding position are generally lacking. In areas bare of trees, long distance observation is good. The rugged topography of hills and mountains offers variable observation. Terrain masking is the concealment of areas from direct horizontal optical and electronic LOS by terrain features. Masking plays an important role in communications and surveillance techniques and systems emplacement. Consider LOS (intervisibility and masking effects) for various electronic and optical systems. (See Figure 4-12.)

FofF is the effect that the terrain has on weapons and weapons systems effectiveness. LOS is considered for LOS direct fire weapons. Indirect fire should consider surface configuration at the target site. It is important to indicate distance and direction of observation. For FofF indicate direction, trajectory angle for indirect fire to clear vegetation (or other obstructions) from a specific point, and the extent of the firing fan. (See Figure 4-11.)

##### Concealment and Cover

Concealment is protection from air and ground observation. Cover is protection from the effects of fire, both direct and indirect. Concealment and cover is derived from the surface configuration, vegetation, and built-up area overlays. Slopes greater than 30 percent, dense forested areas, and large built-up areas offer good cover. Fair cover is outlined by slopes 10-30 percent, medium forest density, and medium built-up areas. A medium built-up area is equal to nine square kilometers. It is important to accurately calculate percent of roof coverage of a built-up area when determining concealment. The best

concealment is described as 0-25 percent chance of detection. Concealment is evaluated for summer and winter seasons.

Cover, concealment, or defilade in the plains regions is generally poor. Those areas having low topographic features (micro-relief), such as escarpments, cuts and fills, and embankments afford some protection. The rugged terrain of the hills and mountainous regions provide abundant opportunity for concealment and cover. Above the timberline movement across most slopes or crests is exposed to view in many directions.

#### Obstacles

Obstacles are natural or artificial features that stop, impede, or divert military movement and maneuverability. Obstacles occur on the ground and in the air. The effects of removing, overcoming, or bypassing the obstacles must be considered in the planning of the overall operation. Hills and mountains usually are considered obstacles to movement and generally favor the defense. History records many cases in which forces inferior in numbers and equipment have held off superior attackers in mountainous areas. There have been many instances in which such obstacles have been effectively achieved by moving over the hilly and mountainous terrain instead of through adjacent corridors where the enemy was prepared. However, factors unfavorable to troop movement must be considered. These conditions include difficulty in movement, lack of maneuvering space, and the vulnerability of the LOC. Consider vegetation, built-up areas, and surface drainage, in addition to the surface configuration and micro-relief features in determining obstacles.

#### Key Terrain

Key terrain is any feature or area, natural or artificial, that the seizure or control of offers a marked tactical advantage to the occupant over the opposing force. Examples of natural key terrain features include DZs, high ground, route constrictions or choke points, and fording sites. Manmade key terrain features are a little harder to define. These include key bridges, communications and logistics sites, major built-up areas (urban, industrial, or commercial), major transportation centers (airports, rail facilities, ports and harbors, and roadway networks). Significant military, political, or governmental facilities and installations are considered key terrain.

It is important to be selective in determining what features are key. Selective criteria includes the following questions: Will control of this feature provide me with a tactical advantage over the enemy? Is control of this feature crucial to the success of the mission? Is this feature along a major LOC or in a major MC? How will weather affect this feature? What size force can this feature accommodate and are there ready access routes? Additional considerations in selecting key terrain includes concealment and cover and observation and Foffs. It is important to indicate why the selected features are considered key terrain and what effect control has on friendly and enemy forces.

## Avenues of Approach and Mobility Corridors

AAs and MCS are routes by which a force may reach key terrain or an objective. AAs and MCs address maneuver support potential, degree of canalization, concealment and cover, observation and FofFs, obstacles, and the access to key terrain and adjacent avenues or corridors. There are three types of AAs: ground, air, and rear area AAs.

Ground Avenues of Approach. A ground AA is broad enough and contains sufficient MCs to support rapid movement and maneuver of forces along its entire course. It should be free of obstacles. If obstacles are present they should be few in number and require reasonable engineer support to remove them. The avenue also affords good to excellent concealment and cover.

Air Avenues of Approach. These are much the same as ground avenues. They should be free of obstructions or have adjacent corridors to permit bypass of obstructions. It is important to consider avenues and corridors in layers as to reflect different altitudes of approach. This consideration would depend on the level and size of the operation.

Rear Area Avenues of Approach. These are avenues that provide the rapid movement of rear threat elements and the additional service support elements to the front lines.

Note: It is extremely important to indicate the width of the avenues and corridors and what size element can pass through. Note any major choke points that canalize movement along the AA into designated MCs as key terrain. (See Figure 4-13 for examples of AAs and MCs.)

### THE MODIFIED COMBINED OBSTACLES OVERLAY

The MCOO is the graphic terrain analysis on which all other IPB products are based. It is one of the two templates (the other being the DST) that is always prepared at all echelons. At echelons where the IPB process is more formal, the terrain analyst produces detailed combined obstacles overlays and AA overlays that may be combined or modified to form the basis of the MCOO. At lower echelons however, the MCOO is normally prepared by the intelligence staff as a single graphic.

A combined obstacles overlay is made up of built-up areas, LOCS, surface drainage, surface configuration (including micro-relief), surface materials, and vegetation. These component factors reflect average weather effects for wet and dry conditions. These features are outlined, highlighted, or marked to show their significance to movement and maneuverability. There are three movement categories: NO-GO, SLOW-GO, and GO.

A MCOO is produced for the IPB process when key terrain features, AAs and MCs for air and ground forces, and a friendly operations graphic are added to the combined obstacles overlay. Detail depends on the level and type of operation. The MCOO contains at a minimum registration marks, classification, titling data, and a legend. As a general rule the following information is depicted:



- NO-GO terrain.
- SLOW-GO terrain.
- Built-up areas.
- LOCs.
- Rivers and water obstacles.
- Obstacles.
- Key terrain.
- AAs and MCs.
- Objectives.

#### CONCLUSION

Weather and terrain have more impact on the battle than any other physical factor, including weapons, equipment, or supplies. The terrain on which battles are fought presents opportunities to both sides. Most battles are won by the forces that use the terrain and weather to their advantage in both offensive and defensive operations. The resurgence of terrain analysis in today's Army and the recognition of terrain as a potent multiplier of combat power makes each of us responsible for terrain information.

## GLOSSARY

### Acronyms and Abbreviations

AA	avenue of approach
AAA	air avenue of approach
AAG	Army artillery group
AD	air defense
ADA	air defense artillery
ADM	atomic demolition munitions
ADP	automatic data processing
ADPS	automated data processing system
adv	advance
AE	aerial exploitation
AF	Air Force
AFCENT	Allied Forces Central Europe
AFSCCOORD	assistant fire support coordinator
AI	area of interest
AIIF	Automated Installation Intelligence File
AKA	also known as
AMC	Army Materiel Command
ammo	ammunition
AO	area of operations
AOB	air order of battle
AP	antipersonnel
APC	armored personnel carrier
appl	application
approx	approximately
arty	artillery
AS	aerial surveillance
ASAS	all-source analysis system
ASL	authorized stockage list
ASPS	all-source production section
at	antitank
ATGL	antitank guided launcher
ATGM	antitank guided missile
AUD	arbitrary unit designator
Aug	August
AW	air warning
AWS	Air Weather Service
BAT-D	battlefield deception
BDA	battle damage assessment
bde	brigade
BE	basic encyclopedia
BICC	battlefield information coordination center
bks	barracks
bdg	building
BMCT	beginning of morning civil twilight
BMNT	beginning of morning nautical twilight

BMP	designation of a type of Soviet armored personnel carrier
bn	battalion
BOMREP	bombing report
BTF	battalion task force
btrv	battery
C	coniferous
C <sup>2</sup>	command and control
C <sup>3</sup>	command, control , and communications
C <sup>2</sup> CM	command, control , and communications countermeasures
CAA	combined arms army
cal	caliber
CARVE	criticality, accessibility, recuperability, vulnerability, and effect
CAS	close air support
cav	cavalry
CB	chemical biological
cc	cloud cover
CDP	company distributing point
cd r	commander
C-E	Communications-Electronic ics
CEWI	combat electronic warfare and intelligence
CFA	covering force area
CG	commanding general
cGy/hr	centiGray hour
C-HUMINT	counter human intelligence
ci	counter intelligence
CIA	Central Intelligence Agency
CIAS	counterintelligence analysis section
CID	Criminal Investigation Division
C-IMINT	counter imagery intelligence
cm	centimeter
cm	countermeasures
CM&D	collection management and dissemination
CML	chemical
COA	course of action
co	company
COL	colonel
COLT	combat observation and laser team
comd	command
COMINT	communications intelligence
COMMZ	communications zone
COMSEC	communications security
COMZEALAND	Commander, Allied Land Forces, Zealand
CONUS	Continental United States
coord	coordinate
COP	command observation post
COSCOM	corps support command
CP	command post
CPA	collection planning aid
CPFL	Contingency Planning Facilities List
CPS	characters per second

CPT	capta i n
CRT	cathode-ray tube
CRTA	commander rocket troop artillery
CS	combat support
CSA	corps support activity
CSG	corps support group
C-SIGINT	counter signals intelligence
Css	combat service support
CTL	critical task list
CTOC	corps tactical operations center
CTOCSE	corps tactical operations center support element
CTT	commander's tactical terminal
CUBIC	Common Users Baseline for the Intelligence Community
CUCV	commercial utility cargo vehicle
CW	continuous wave

D	deciduous
DA	Department of the Army
DAG	division artillery group
DATEXT	data extract
DBMS	data base management system
DCS	Defense Communications System
def	defense
deg	degrees
DF	direction finding
DIA	Defense Intelligence Agency
div	division
D1VARTY	division artillery
DMA	Defense Mapping Agency
DMz	demilitarized zone
DOD	Department of Defense
DOI	date of information
DP	decision points
DS	direct support
DST	decision support template
DTG	date-time group
DTOC	division tactical operations center
DTOCSE	division tactical operations center support element
DZ	drop zone

E	evaporates (soil type)
ea	each
EAC	echelons above corps
EACIC	echelons above corps intelligence center
EAM	event analysis matrix
ECB	echelons corps and below
ECCM	electronic counter-countermeasures
ECM	electronic countermeasures
EECT	end of evening civil twilight
EEFI	essential elements of friendly information
EEI	essential element of information

**EENT** end of evening nautical twilight  
**EEOB** enemy electronic order of battle  
**elm** element  
**EMCON** emission control orders  
**en** enemy  
**enr** engineer  
**EOB** electronic order of battle  
**EPL** ELINT parameters list  
**EPW** enemy prisoner of war  
**ESM** electronic warfare support measures  
**est** estimated  
**EW** electronic warfare

**F** Fahrenheit  
**FA** field artillery  
**FAC** forward air controller  
**FAIO** field artillery intelligence officer  
**FBI** Federal Bureau of Investigation  
**FEBA** forward edge of the battle area  
**FIST** fire support team  
**FLOT** forward line of own troops  
**FM** field manual  
**FO** forward observer  
**Fof F** field of fire  
**FP** field post  
**FPN** field post number  
**FRAGO** fragmentary order  
**FRG** Federal Republic of Germany  
**FROG** free rocket over ground  
**FS** fire support  
**FSCOORD** fire support coordinator  
**FSE** fire support element  
**FSO** fire support officer  
**ft** feet  
**FVD** full unit designation  
**fvdfwd** forward

**G1** Assistant Chief of Staff, G1 (Personnel)  
**G2** Assistant Chief of Staff, G2 (Intelligence)  
**G3** Assistant Chief of Staff, G3 (Operations and Plans)  
**G4** Assistant Chief of Staff, G4 (Logistics)  
**G5** Assistant Chief of Staff, G5 (Civil Affairs)  
**GE** Germany  
**GEOREF** Geographic Reference System  
**GMT** Greenwich Mean Time (Zulu)  
**GPS** grid producing source  
**GS** general support or general staff  
**GSR** ground surveillance radar  
**GTA** government training aid

HB	high burst
HD	horizontal ground distance
HF	high frequency
HHC	headquarters and headquarters company
HOTPHOTOREP	hot (high priority) photographic report
how	howitzer
HPT	high payoff target
HQ	headquarters
hr	hour
HUMINT	human intelligence
hv	heavy
HVT	high value target
hwy	highway
1A	imagery analysis
ID	identification
IDAD	internal defense and development
IED	imitative electronic deception
IEW	intelligence and electronic warfare
IFV	infantry fighting vehicles
IIR	intelligence information report
IMINT	imagery intelligence
inf	infantry
INSCOM	Intelligence and Security Command
inst I	installation
intg	interrogation
INTREP	intelligence report
INTSUM	intelligence summary
IPB	intelligence preparation of the battlefield
IPIR	initial programmad interpretation report
IR	information requirements
ITAC	Intelligence and Threat Analysis Center
JCS	Joint Chiefs of Staff
J2	Intelligence Directorate
J3	Operations Directorate
KIA	killed in action
km	kilometer
kph	kilometers per hour
LIC	low-intensity conflict
LOC	lines of communication
LOS	line of sight
LP	listening post
LTG	lieutenant general
LZ	landing zone

m	meter
maint	maintenance
MAJ	major
MAS[NT	measurement and signature intelligence
max	maximum
MBA	main battle area
MC	mobility corridor
MCOO	modified combined obstacles overlay
MD	map distance
MDCI	multidiscipline counterintelligence
MDCISUM	multidiscipline counterintelligence summary
mech	mechanized
MED	manipulative electronic deception
METT-T	mission, enemy, terrain, troops, and time available
MG	machinegun; major general
MI	military intelligence
MIJI	meaoning, intrusion, jamming, and interference
MIJFEEDER	meaoning, intrusion, jamming, and interference report feeder
min	minute or minimum
MISREP	mission report
mm	millimeter
MOD	mobile obstacle detachment
mort	mor tar
MOPP	mission oriented protective posture
MORTREP	mortar bombing report
MOV	military owned vehicle
MP	military police
MR	motorized rifle
MRB	motorized rifle battalion
MRC	motorized rifle company
MRD	motorized rifle division
MRR	motorized rifle regiment
m/s	meters per second
msg	message
msl	missile
MSR	main supply route
MTLR	moving target-locating radar
mtr	motor
mvr	maneuver
NAI	named areas of interest
NATO	North Atlantic Treaty Organization
NBC	nuclear, biological, and chemical
NBCE	nuclear, biological, and chemical element
NCO	noncommissioned officer
NLT	no later than
no	number
NSA	National Security Agency
NTR	nothing to report
NW	northwest

06	order of battle
obj	object
OCOKA	observation and fields of fire, concealment and cover, obstacles, key terrain, avenues of approach, and mobility corridors
off	officer
OIC	officer in charge
OMG	operational maneuver group
OP	observation post
OPLAN	operations plan
OPORD	operations order
OPSEC	operations security
org	organization
PERINTREP	periodic intelligence report
PERINTSUM	periodic intelligence summary
PIR	priority intelligence requirement
PL	phase line
PLL	prescribed load list
plt	platoon
PM	provost marshal
POL	petroleum, oils, and lubricants
pos	position
ps	permanent snowfields
Psns	positions
PSYOP	psychological operations
pt	peat
PTADB	planning terrain analysis data base
pt I	patrol
PTR/P	paper tape reader/punch
R	rock outcrops
R&D	research and development
R&S	reconnaissance and surveillance
RAG	regimental artillery group
RATT	radio teletypewriter
RC	reserve component
RD	road
REC	radioelectronic combat (not a US term)
RECCEXREP	reconnaissance exploitation report
recon	reconnaissance
regt	regiment
res	reserve
RF	representative fraction
RII	request for intelligence information
ROI/PB	rear operations intelligence preparation of the battlefield
rpt	report
RRII	response to request for intelligence information
RSTA	reconnaissance, surveillance, and target acquisition



<b>/s/</b>	<b>signature</b>
<b>S2</b>	<b>Intelligence Officer (US Army)</b>
<b>S3</b>	<b>Operations and Training Officer (US Army)</b>
<b>SA</b>	<b>special agent</b>
<b>SALUTE</b>	<b>size, activity, location, unit, time, equipment (spot report format)</b>
<b>SAM</b>	<b>surface-to-air-missile</b>
<b>SATRAN</b>	<b>definition is classified (see FM34-60A (S-NFD))</b>
<b>SCARF</b>	<b>standard collection asset request format</b>
<b>ScI</b>	<b>sensitive compartmented information</b>
<b>SCUD</b>	<b>nickname of a missile system</b>
<b>SEAD</b>	<b>suppression of enemy air defenses</b>
<b>SED</b>	<b>simulated electronic deception</b>
<b>SHAPE</b>	<b>Supreme Headquarters Allied Powers Europe</b>
<b>SHELREP</b>	<b>shell report</b>
<b>sig</b>	<b>signal</b>
<b>SIGINT</b>	<b>signals intelligence</b>
<b>SIGSEC</b>	<b>signal security</b>
<b>SIR</b>	<b>specific information requirements</b>
<b>SITDEV</b>	<b>situation development</b>
<b>SITMAP</b>	<b>situation map</b>
<b>SITREP</b>	<b>situation report</b>
<b>SLAR</b>	<b>side-looking airborne radar</b>
<b>SOP</b>	<b>standing operating procedures</b>
<b>SP</b>	<b>self-propel led</b>
<b>SSM</b>	<b>surface-to-surface missile</b>
<b>STANAG</b>	<b>standardization agreement</b>
<b>str</b>	<b>strength</b>
<b>SUPINTREP</b>	<b>supplementary intelligence report</b>
<b>SUPIR</b>	<b>supplemental programed interpretation report</b>
<b>Swo</b>	<b>Staff Weather Officer</b>
<b>TA</b>	<b>target acquisition</b>
<b>TAC-D</b>	<b>tactical deception</b>
<b>TACREP</b>	<b>tactical report</b>
<b>TAI</b>	<b>target areas of interest</b>
<b>TARDEV</b>	<b>target development</b>
<b>TCAC</b>	<b>technical control and analysis center</b>
<b>TCAE</b>	<b>technical control and analysis element</b>
<b>TDA</b>	<b>target damage assessment</b>
<b>TDI</b>	<b>target data inventory</b>
<b>TEL</b>	<b>transporter-erector- launcher</b>
<b>TEMPEST</b>	<b>an unclassified name for studies and investigations of compromising emanations</b>
<b>TF</b>	<b>task force</b>
<b>tgt</b>	<b>target</b>
<b>TI</b>	<b>technical intelligence</b>
<b>tk</b>	<b>tank</b>
<b>TLE</b>	<b>target location error</b>
<b>tng</b>	<b>training</b>
<b>TOC</b>	<b>tactical operations center</b>

TOE	table of organization and equipment
TPL	time phase line
trp	troops
TSS	target selection standards
TTADB	tactical terrain analysis data base
TTY	teletypewriter
TVA	target value analysis
UAV	unmanned air vehicle
UHF	Ultra-high frequency
UI	unidentified
UNCLAS	unclassified
Unk	Unknown
us	United States
USAF	United States Air Force
USAIA	United States Army Intelligence Agency
USAICS	United States Army Intelligence Center and School
USAREUR	United States Army Europe
Uses	Unified Soils Classification System
USSID	United States Signals Intelligence Directive
USSR	Union of Soviet Socialist Republics (Soviet Union)
UTM	universal transverse mercator (grid)
VCR	videocassette recorder
VDP	video disk player
veh	vehicle
VHF	very high frequency
vic	vicinity
WETM	weather team
WIA	wounded in action
WNA	would not answer
wpn	weapon
yr	year

## References

### REQUIRED PUBLICATIONS

Required publications are sources that users must read in order to understand or to comply with this publication.

#### Field Manuals (FMs)

- FM 34-1 Intelligence and Electronic Warfare Operations
- FM 100-5 Operations

### RELATED PUBLICATIONS

Related publications are sources of additional information. They are not required in order to understand this publication.

#### Army Regulation (AR)

- 105-31 Message Preparation and Processing

#### Field Manuals (FMs)

- 3-3 NBC Contamination Avoidance
- 3-12 Operational Aspects of Radiological Defense
- 3-22 Fallout Prediction
- 5-26 Employment of Atomic Demolition Munitions
- 21-26 Map Reading and Land Navigation
- 34-10 Division Intelligence and Electronic Warfare Operations
- 34-25 Corps Intelligence and Electronic Warfare Operations
- 34-37 Echelons Above Corps Intelligence and Electronic Warfare Operations
- 34-40 (U) Electronic Warfare, Secret
- 34-60 Counter intelligence
- 34-60A (U) Counterintelligence Operations, Secret
- 34-80 Brigade and Battalion Intelligence and Electronic Warfare Operations.

34-81 Weather Support for Army Tactical Operations

34-130 Intelligence Preparation of the Battlefield

90-2 Battlefield Deception

101-5 Staff Organization and Operations

101-5-1 Operational Terms and Graphics

101-10-1 Staff Officers Field Manual: Organizational ,  
Technical , and Logistical Data

101-31-1 Staff Officers' Field Manual: Nuclear Weapons  
Employment Doctrine and Procedures

**Joint Chiefs of Staff Publications (JCS Pubs)**

JCS - Pub 1 Department of Defense Dictionary of Military and  
Associated Terms

JCS - Pub 25 Title Unavailable, Top Secret.

**Training Circulars (TCs)**

34-41 Jamming Handbook

34-52 Intelligence interrogation

34-55 Imagery intelligence

**Field Circular (FC)**

100-15-1 Corps Deep Battle

**Standardization Agreements (STANAGs)**

1059 National Distinguishing Letters for Use by NATO Forces

2003 Patrol Reports

2008 Bombing, Shelling, and Mortaring Reports

2014 Operation Orders, Annexes to Operation Orders, and  
Administration and Logistic Orders

2020 Operational Situation Reports

2022 intelligence Reports

2019 Military Symbols

<b>2029</b>	<b>Method of Describing Ground Locations, Areas and Boundaries</b>
<b>2033</b>	<b>Interrogation of Prisoners of War (PW)</b>
<b>2073</b>	<b>NATO Intelligence Subject Code</b>
<b>2077</b>	<b>Order of Battle (Non-NATO Troops)</b>
<b>2084</b>	<b>Handling and Reporting of Captured Enemy Equipment and Documents</b>
<b>2097</b>	<b>Nomenclature for Soviet Bloc Army Weapons and Equipment</b>
<b>2103</b>	<b>Reporting Nuclear Detonations, Biological and Chemical Attacks, and Predicting and Warning of Associated Hazards and Hazard Areas</b>
<b>2104</b>	<b>Friendly Nuclear Strike Warning</b>
<b>2112</b>	<b>Radiological Survey</b>
<b>2118</b>	<b>Intelligence Estimate</b>
<b>2134</b>	<b>Offensive Air Support Operations</b>
<b>2149</b>	<b>Intelligence Request</b>
<b>3277</b>	<b>Air Reconnaissance Request and Task Form</b>
<b>3377</b>	<b>Air Reconnaissance Intelligence Report Forms</b>
<b>3596</b>	<b>Air Reconnaissance Target Reporting Guide</b>
<b>6004</b>	<b>Meaconing, Intrusion, Jamming, and Interference Report</b>

**STANAGs can be obtained from: Naval Publications and Forms Center,  
5801 Tabor Avenue, Philadelphia, Pennsylvania 19120.**

## INDEX

- AI. See area of interest
- ADP. See automatic data processing
- aerial fire support officers (FSO), 7-10
- AirLand Battle, 1-1
  - area of operation (AO), 1-1
  - deep attack, sample of, 1-2
  - HVT, 1-2
  - IPT, 1-2
  - intelligence support to
    - close operations, 1-3
    - daep operations, 1-3
    - rear operations, 1-3
- all-source production section (ASPS), 2-2
- analysis, 2-4, 2-17
  - area of operations, A-108
  - pattern, 6-9
- annotated jntelligence estimate, A-10
  - for stability operations, 1-4, A-26
- applications programs, B-6
- arbitrary unit designators, 3-28, 3-30
- area of jnterest (AI), 1-4, 4-7
- area of operations, 1-1, 1-4, A-108
- area study files, 10-7
- ASPS. See all-source production section
- assessment, 2-17
- attack options, 7-7
  - delay, 7-7
  - disrupt, 7-7
  - limit, 7-7
- automatic data processing (ADP), B-1
- automation support to intelligence analysis, B-1, B-4
  - current automated support systems, B-7
    - MICROFIX, B-7
    - TCAC, B-7
  - hardware, B-2
    - keyboard, B-3
    - modems, B-4
    - monitor, B-4
    - peripherals, B-4
    - printer, B-4
    - processor, B-4
    - storage device, B-4
    - video cassette recorders, B-4
    - video disk players, B-4
  - software, B-2
    - applications program, B-S
    - data base management system, B-6
    - operating system, B-5
    - word processing, B-S
- avenues of approach and mobility corridors, 4-10, 4-16, E-22

**BAE. See battlefield area evaluation**  
**battlefield area, 1-4**  
     AI, 1-4  
     AO, 1-4  
     CI, 1-4  
     EW, 1-4  
         ECCM, 1-6  
         ECM, 1-6  
         ESM, 1-6  
     IEW mission, 1-4  
     one-up and two-down formula, 1-4  
     situation development, 1-4  
         make sound tactical decisions, 1-4  
         target development, 1-4  
**battlefield area evaluation (BAE), 1-4, 4-7, 7-6**  
**battlefield information coordination center (BICC), 1-8, 1-9**  
**biases, S-11**  
**BICC. See battlefield information coordination center**  
**blue element, 5-7**  
**bombing, shelling, and mortaring report, A-87**

**canopy closure, E-14**  
**capabilities, 6-1**  
**cathode ray tube (CRT), B-4**  
**CC. See cloud cover**  
**checklists of white, red, and blue questions, 5-8**  
**CIAS. See counterintelligence analysis section**  
**civil-military operationa file, 10-9**  
**close operations, 1-3**  
**cloud cover (CC), 4-13, 4-22**  
**CM&D. See collection management and dissemination**  
**COA. See course of action**  
**collecting, 2-2**  
**collection management and dissemination (CM&D), 2-2**  
**COLT. See combat observation and laser team**  
**combat**  
     effectiveness, 3-1, 3-5, D-1  
     forces, 10-14  
     observation and laser team (COLT), 7-10  
**combined**  
     intelligence operation, 10-1  
     obstacle overlay, 4-6, 4-8, 4-12, 4-22, E-22  
**commander, 1-8**  
     intent of, 4-6, 4-27, 4-30  
**committed forces, D-1**  
**composition, 3-1, 10-13**  
**concealment and cover, 4-8, E-20**  
**conceptual model, 6-1**  
**contents of an OB book, 3-9**

- coordinate register, 3-22, 10-9
- counter-human intelligence (C-HUMINT), 9-2
- counter-imagery intelligence (C-IMINT), 9-3
- counterinsurgency, 10-1
- counterintelligence (CI), 1-4
  - analysis, 9-1
  - analysis section (CIAS), 9-1
    - C-HUMINT collection, 9-2
    - C-IMINT collection, 9-3
    - C-SIGINT collection, 9-2
    - EACIC, 9-1
    - ITAC, 9-1
    - rear operations, 9-2
- counter-signals intelligence (C-SIGINT), 9-2
  - workstation, B-14
- course of action (COA), 6-3
- credibility, 2-14
  - of information, 2-15
- critical nodes, 7-7
- CRT. See cathode ray tube
- current automated support systems, B-7
- current propaganda and PSYOP file, 10-7

- data base management system (DBMS) software, B-5
- DBMS. See data base management system
- decide. See targeting process
- decision
  - briefing, A-144
  - points (DP), 4-30, 4-32, 7-5
  - support
    - matrix, 4-32
    - templates (DST), 4-1, 4-5, 4-26, 4-29, 4-32
- decisive terrain, 4-10
- deduction, 2-17, 2-18
- deep attack, 1-1
  - sample of, 1-2
- delay. See targeting process
- deliver. See targeting process
  - planned target, 7-12
  - target damage assessment, 7-13
  - targets of opportunity, 7-13
- destroy, 7-1
- detect, 7-3, 7-8
  - aerial FSO, 7-10
  - COLT, 7-10
  - FIST, 7-8
  - forward area alerting radar, 7-10
  - moving target-locating radar, 7-10
  - target location errors (TLE), 7-11



- target selection standards (TSS), 7-11
- directing, 2-1
- disposition, 3-1, 3-2, 10-14
- dissemination, 2-18, 10-12
- disrupt, 1-1, 7-1, 7-7
- doctrinal, 4-7, 4-11, 4-24, 4-32
  - templates, 4-5, 4-14, 4-25, 4-27, 6-4
- OP. See decision point

- EACIC. See echelons above corps intelligence center
- echelons above corps intelligence center (EACIC), 1-6, 9-1
- effectiveness, 10-18
- effects of weather, E-1
  - on mobility, 4-13
- electronic
  - counter-countermeasures (ECCM), 1-6
  - countermeasures (ECM), 1-6
  - order of battle (EOB), 3-5
  - technical data, 3-1, 10-19
- electronic warfare (EW), 1-4, 6-1
  - intelligence required for ECCM, 8-3
  - intelligence required for ECM, 6-2
  - intelligence required for ESM, 8-2
- electronic warfare support measures (ESM), 1-6
- enemy
  - combat effectiveness, 3-28
  - strength computations, D-1
    - combat effectiveness, D-1
    - committed forces, D-1
    - reinforcements, D-1, D-5
- EOB. See electronic order of battle
- evaluation, 2-4, 2-13, 10-10
- event, 4-3, 4-29
  - analysis matrix, 4-14
  - template, 4-1, 4-5, 4-26, 4-28, 4-32
- EW. See electronic warfare

- factors analysts should consider, 5-1
- feedback, 5-2
- fire support team (FIST), 7-8
- FIST. See fire support team
- formats, A-1
  - analysis of area of operations, A-108
  - annotated intelligence estimate, A-10
    - for stability operations, A-25
  - bombing, shelling, and mortaring reports, A-87
  - fragmentary order, A-127
  - initial and supplemental programmed interpretation report, A-59

intelligence annex, A-29  
intelligence estimate, A-1  
intelligence report, A-43  
intelligence summary, A-44  
interrogation and translation report, A-61  
meaconing, intrusion, jamming, and interference report, A-143  
mission report, A-129  
NBC attack reports, A-09  
oral reports, A-144  
    decision briefing, A-144  
    information briefing, A-144  
patrol report, A-126  
periodic intelligence report, A-48  
periodic intelligence summary, A-51  
reconnaissance exploitation report, A-68  
SIGINT tactical report, A-142  
situation report, A-42  
spot report, A-1  
standard collection asset request format, A-136  
forward area alerting radar, 7-10  
fragmentary order, A-127  
FSO. See aerial fire support officer

G2/S2, 1-8

G3/S3, 1-8

handbook of military forces, 3-8  
hardware, B-2  
high payoff target (HPT), 1-2, 4-31, 7-4, 7-6  
high value target (HVT), 1-2, 4-24, 4-32, 7-6  
historical studies, 10-20  
hot file, 10-7  
HPT. See high payoff target  
WT. See high value target

identify enemy HVTs, 1-2  
IEW. See intelligence and electronic warfare  
incident map, 10-4  
indicators, 6-3  
information briefing, A-144  
information requirements (IR), 2-2  
initial and supplemental programmed interpretation report, A-59  
installation handbook, 3-10  
insurgency analysis worksheet, 10-7  
insurgent situation map (SITMAP), 10-4, 10-5  
integration, 2-17, 10-10  
intelligence and electronic warfare (IEW) mission, 1-4

- intelligence
  - analysis, B-1
    - ADP, B-1
    - automation support to, B-1
    - CRT, B-4
    - hardware, B-2
    - keyboard, B-3
    - modems, B-4
    - monitor, B-4
    - peripherals, B-4
    - printer, B-4
    - processor, B-4
    - software, B-2
      - applications program, B-5
      - DBMS, B-6
      - operating system, B-6
      - word processing, B-5
    - storage device, B-4
    - video cassette recorders, B-4
    - video disk players, B-4
  - annex, A-29
  - director, coordinators, and producers, 1-8
  - estimate, 10-2
    - dissemination, 10-12
    - evaluation, 10-10
    - integration, 10-10
    - interpretation, 10-11
  - recording, 10-4
    - area study files, 10-7
    - civil-military operations file, 10-9
    - coordinate register, 10-9
    - current propaganda and PSYOP file, 10-7
    - hot file, 10-7
    - incident map, 10-4
    - insurgency analysis worksheet, 10-7
    - insurgent SITMAP, 10-4
    - personalities and contracts map, 10-5
    - personality and organization file, 10-7
    - population status map, 10-5
    - resource file, 10-7
    - trap map, 10-6
  - file, 2-7
  - journal, 2-6
  - report, A-43
  - required for ECCM, 8-3
  - required for E(X), 8-2
  - required for ESM, 8-2
  - support to
    - combatting terrorism, 9-14
    - counterinsurgency, 10-1

- summary, A-44
- workbook, 2-12
- intelligence analysis system, I-6
  - BICC, 1-9
  - duties of, 1-8
    - commander, 1-8
    - coordinator, 1-8
    - director, 1-8
    - producers, 1-8
    - staffs, 1-8
      - G2/S2, 1-8
      - G3/S3, 1-8
  - TCAE, 1-9
  - TOC support element, 1-9
- Intelligence cycle, 2-1
  - collecting, 2-2
    - CM&D section, 2-2
  - directing, 2-1
    - ASPS, 2-2
    - IR, 2-2
    - PIR, 2-2
  - dissemination, 2-18
  - processing, 2-3
    - analysis, 2-4
      - assessment, 2-17
      - deduction, 2-18
      - integration, 2-17
    - evaluation, 2-4, 2-13
      - credibility, 2-14, 2-16
      - pertinence, 2-14
      - reliability, 2-14
        - of source and agency, 2-1S
  - recording, 2-3, 2-6
    - intelligence journal, 2-6, 2-8
    - intelligence file, 2-7
    - intelligence workbook, 2-12
    - OB SITMAP, 2-10
    - working SITMAP, 2-9
- intelligence preparation of the battlefield (IPB), 4-3, 4-34
  - application of, 4-5
    - commander's intent, 4-6, 4-27, 4-30
    - event template, 4-6, 4-28, 4-32
    - MCOO, 4-6, 4-8
    - template, 4-6
  - battlefield area evaluation (BAE), 4-7
    - AI, 4-7
    - METT-T, 4-7
    - MCOO, 4-6, 4-8
      - avenues of approach and mobility corridors, 4-16
      - one-down, two-down rule, 4-11

- one-up, two-down rule, 4-11
  - concealment and cover, 4-8
  - key terrain, 4-8, 4-28
    - decisive, 4-10
  - observation and fields of fire, 4-8
  - obstacle, 4-6, 4-8, 4-10, 4-22, 4-25
  - OCOKA, 4-8
- combined obstacle overlay, 4-6, 4-8, 4-12, 4-22
  - effects of weather on mobility, 4-13
- in support of LIC, 10-2
- line of sight analysis, 4-15
- process, 4-1, 4-11, 4-24, 4-26, 4-34
  - decision support, 4-1, 4-5, 4-26, 4-29
  - doctrinal template, 4-14, 4-25, 4-27
  - event, 4-3, 4-29, 4-32
  - situation, 4-3, 4-5, 4-26, 4-32
- products, 4-2, 4-5, 4-7, 4-11, 4-21
  - templates
    - decision support, 4-1, 4-26, 4-32
    - doctrinal, 4-14, 4-25, 4-27
    - event, 4-6, 4-28, 4-32
    - situation, 4-6, 4-26
- terrain factor matrix, 4-11
- threat evaluation, 4-1, 4-24
  - doctrinal template, 4-25
- threat integration, 4-3, 4-21, 4-26
  - decision support template, 4-1, 4-26, 4-29, 4-32
    - decision points, 4-30, 4-32
    - decision support matrix, 4-32
    - TAI, 4-31
    - time phase lines, 4-30
  - event analysis matrix, 4-29
  - event template, 4-6, 4-28, 4-32
  - PIR, 4-27, 4-32
  - situation templates, 4-26
- weather analysis, 4-1, 4-15, 4-21, 4-26
  - cloud cover (CC), 4-13, 4-22
  - precipitation, 4-13, 4-17, 4-23
  - visibility, 4-9, 4-13, 4-18
  - wind speed and direction, 4-22
- weather factor analysis matrix, 4-24
- intelligence support
  - of close operations, 1-3
  - of rear operations, 1-3
  - to combatting terrorism, 9-14
  - to deep operations, 1-3
- interpretation, 10-11
- interrogation and translation report, A-61
- ITAC. See intelligence and threat analysis center

keyboard, B-3  
 Key terrain, 4-8, 4-28, E-21

limit, 7-1, 7-7  
 line of sight analysis, 4-16  
 logistics, 3-1, 3-4, 10-17

make sound tactical decisions, 1-4  
 MCOO. See modified combined obstacle overlay  
 MOCI. See multidiscipline counterintelligence  
 MDCISUM. See multidiscipline counterintelligence summary  
 meaconing, intrusion, jamming, and interference report, A-143  
 METT-T. See mission, enemy, terrain, troops, and time available.  
   MICROFIX, B-7, B-8  
     CI workstation, B-14  
     OPSEC workstation, B-14  
     TCAE workstation, B-13  
     topographic workstation, B-13  
 military installation file, 3-22  
 miscellaneous data, 3-1, 3-6  
 mission, enemy, terrain, troops, and time available (METT-T), 4-7  
 mission report, A-129  
 modems, B-4  
 modified combined obstacle overlay (MCOO), 4-6, 4-8, E-22  
 monitor, B-4  
 moving target-locating radar, 7-10  
 multidiscipline counterintelligence (MDCI)  
   estimate, 9-10  
   situation overlay, 9-7  
   summary (MODCISUM), 9-7  
   threat assessment, 9-7, 9-14

named areas of Interest (NAI), 4-32  
 neutralize, 7-1  
 nuclear, biological, and chemical (NBC) attack reports, A-89

observation and fields of fire, 4-8, E-20  
 observation and fields of fire, concealment and cover, obstacles, key terrain, avenues of approach, and mobility corridors (OCOKA), 4-8, E-1  
 obstacles, 4-8, 4-10, 4-13, 4-25, E-21  
 one-down, two-down rule, 4-11  
 one-up and two-down formula, 1-4  
 one-up, two-down rule, 4-11  
 operating system software, B-5  
 operations security (OPSEC) workstation, B-14

- oral report, B-144
  - decision briefing, A-144
  - information briefing, A-144
- order of battle, 10-12
  - combat forces, 10-14
  - composition, 10-13
  - disposition, 10-14
  - effectiveness, 10-18
  - electronic technical data, 10-19
  - factors, 3-1
    - combat effectiveness, 3-1, 3-6
    - composition, 3-1, 3-2
    - disposition, 3-1, 3-2
    - electronic technical data, 3-1, 3-5
    - logistics, 3-1, 3-4
    - miscellaneous data, 3-1, 3-6
      - personality file, 3-6
      - unit history, 3-6
    - strength, 3-1, 3-3
    - tactics, 3-1, 3-3
    - training, 3-1, 3-4
  - historical studies, 10-20
  - logistics, 10-17
  - personalities, 10-19
  - Phase I of an insurgency, 10-12
  - Phase II of an insurgency, 10-13
  - Phase III of an insurgency, 10-13
  - political structure, 10-14
  - records, 3-11
    - card, 3-17
    - coordinate register, 3-22"
    - military installation file, 3-22
    - organizational worksheet, 3-22
    - personality file, 3-18
    - SITMAP, 2-10, 3-14
    - strength worksheet, 3-22
    - unit workbook, 3-12
    - workbook, 3-12
  - references, 3-6
    - book, structure of, 3-7, 3-8
    - handbook of military forces, 3-8, 3-9
    - Installation handbooks, 3-10
    - miscellaneous, 3-10
  - STANAG 2077, 3-6
  - strength, 10-15
  - tactics, 10-16
  - training, 10-17
- patrol report, A-126
- pattern analysis, 6-9
- patterns and signatures, 9-3

periodic  
    intelligence report, A-48  
    intelligence summary, A-51  
peripherals, B-4  
personalities, 10-19  
    and contacts map, 10-5  
    fries, 3-6, 3-18  
pertinence, 2-14  
Phase I of an insurgency, 10-12  
Phase II of an insurgency, 10-13  
Phase III of an insurgency, 10-13  
PIR. See priority intelligence requirements  
planned targets, 7-12  
planning terrain analysis data base, 7-12  
population status map, 10-5  
precipitation, 4-13, 4-17, 4-23, E-12  
printer, B-4  
priority intelligence requirements (PIR), 2-2, 4-27, 4-32  
processing, 2-3, 10-3  
processor, B-4

rear and deep operations, 1-3  
rear operations, 9-2  
reconnaissance exploitation report, A-58  
recording, 2-3, 2-6, 10-4  
    area study file, 10-7  
    civil-military operations file, 10-9  
    coordinate register, 10-9  
    current propaganda and PSYOP file, 10-7  
    hot file, 10-7  
    incident map, 10-4  
    insurgency analysis worksheet, 10-7  
    insurgent SITMAP, 10-4, 10-5  
    personalities and contacts map, 10-5  
    population status map, 10-5  
    resource file, 10-7  
    trap map, 10-5  
red element, 5-6  
reinforcements, D-1, D-5  
reliability, 2-14  
    of the source and agency, 2-15  
relief, E-4  
report formats, A-1  
    intelligence estimate, A-1  
    spot report, A-1  
resource file, 10-7  
risk, 5-3



- S2/G2, 1-8
- S3/G3, 1-8
- SIGINT. See signals intelligence
- signals intelligence (SIGINT) tactical report, A-142
- situation
  - development, 1-4, 6-1
    - capabilities, 6-1
    - courses of action, 6-3
    - indicators, 6-3
    - pattern analysis, 6-9
    - weighting indicators, 6-10
    - working SITMAP, 6-4
      - doctrinal templata, 6-4
  - report, A-42
  - template, 4-6, 4-26, 4-32, 7-5
- software, B-2
- spot report, A-1
- staffs, 1-8
- STANAG 2077, 3-6
- standard collection asset request format, A-136
- storage devices, B-4
- strength, 3-1, 3-3, 10-15
  - computations, D-1
  - worksheet, 3-22
- structure of an OB book, 3-8
- suppress, 7-1
- surface materials, E-14

#### tactical

- operations center (TOC) support elements, 1-8, 1-9
- terrain analysis data base, E-1

tactics, 3-1, 3-3, 10-16

#### target

- damage assessment, 7-13
- development, 1-4, 1-5, 7-1
  - attack options, 7-7
    - delay or limit, 7-7
    - disrupt, 7-7
- decide function, 7-3
  - HPT matrix, 7-4
  - target selection standards, 7-4
- detect function, 7-3, 7-8
  - aerial fire support officers, 7-10
  - combat observation laser teams (COLT), 7-10
  - first support teams (FIST), 7-8
  - forward area alerting radar (FAAR), 7-10
  - moving target locating radar (MTLR), 7-10
  - target location errors (TLE), 7-11
  - target selection standards (TSS), 7-11

- deliver function, 7-4
- IPB, 7-5
  - and BAE, 7-5
  - decision point, 7-5
  - situation template, 7-5
  - TAI, 7-5
  - terrain evaluation, 7-5
  - weather analysis, 7-5
- location errors (TLE), 7-7
- of opportunity, 7-12, 7-13
- planned, 7-12
- selection standards (TSS), 7-4, 7-7
- value analysis, 7-6
  - critical nodes, 7-7
  - HPT, 7-6
  - HVT, 7-6
- target areas of interest (TAI), 4-30, 7-5
- targeting process, 7-1
  - functions, 7-1
    - decide, 7-3
      - HPT matrix, 7-4
      - target selection standards (TSS), 7-4
    - deliver, 7-4
    - detect, 7-3
  - objective of, 7-1
    - delay, 7-1
    - disrupt, 7-1
    - limit, 7-1
      - destroy, 7-1
      - neutralize, 7-1
      - suppress, 7-1
- target location error (TLE), 7-11
- target selection standards (TSS), 7-7, 7-11
- TCAC. See technical control and analysis center
- TCAE. See technical control and analysis element
- technical
  - control and analysis center (TCAC), B-7
  - control and analysis element (TCAE), 1-8, 1-9
    - workstation, B-13
- templates, 4-5
  - decision support, 4-1, 4-26, 4-20, 4-32
  - doctrinal, 4-14, 4-25, 4-27, 6-4
  - event, 4-6, 4-28, 4-32
  - situation, 4-6, 4-26, 7-5
- terrain
  - analysis, E-1
    - avenues of approach and mobility corridors, E-22
    - combined obstacles overlay, E-22
    - concealment and cover, E-20
    - effects of weather, D-1

- key terrain, E-21
- modified combined obstacles overlay (MCOO), E-22
- observation and fields of fire, E-20
- observation and fields of fire, concealment and cover, obstacles, key terrain, avenues of approach, and mobility corridors (OCOKA), E-1
- obstacles, E-21
- planning terrain data base, E-1
- precipitation, E-12
- tactical terrain data base, E-1
- vegetation, E-12
- evaluation, 7-5
- factor matrix, 4-11
- masking, E-20
- military aspects of, E-20
  - avenues of approach and mobility corridors, E-22
  - concealment and cover, E-20
  - key terrain, E-21
  - observation and fields of fire, E-20
    - terrain masking, E-20
  - obstacles, E-21
- threat
  - evaluation, 4-1, 4-24
    - doctrinal templates, 4-25, 4-27
  - integration, 4-3, 4-21, 4-26
    - decision support matrix, 4-32
    - event analysis matrix, 4-29
    - PIR, 4-27, 4-32
  - templates
    - decision support, 4-1, 4-26, 4-29, 4-32
    - decision points, 4-30, 4-32
    - TAI, 4-31
      - HPT, 4-3, 4-31
      - HVT, 4-1, 4-24, 4-31
    - time phase lines, 4-30
    - event, 4-6, 4-28, 4-32
      - NAI, 4-28, 4-32
    - situation, 4-26
- model, 5-5
  - checklist of white, red, and blue questions, 5-8
  - blue element, 5-7
  - red element, 5-6
  - white elements, 5-5
- time phase lines, 4-30
- TLE. See target location error
- TOC. See tactical operations center
- topographic workstation, B-13
- training, 3-1, 3-4, 10-17
- trap map, 10-5
- TSS. See target selection standard

unit workbook, 3--12  
unit history, 3-6  
user of intelligence, 5-1

vegetation, E-12  
video cassette recorders, B-4  
video disk players, B-4  
visibility, 4-9, 4-13, 4-18, 4-22

weather analysis, 4-1, 4-15, 4-21, 4-26, 7-5  
    cloud cover, 4-13, 4-22  
    precipitation, 4-13, 4-17, 4-23  
    visibility, 4-9, 4-13, 4-18, 4-22  
    weather factor analysis matrix, 4-24  
    wind speed and direction, 4-22  
weighting indicators, 6-10  
white elements, 5-5  
word processing software, B-5  
working SITMAP, 2-9, 6-4

**FM 34-3**  
**15 MARCH 1990**

**BY Order of the Secretary of the Army:**

CARL E. VUONO  
General, United States Army  
Chief of Staff

**Official:**

WILLIAM J. MEEHAN II  
Brigadier General, United States Army  
The Adjutant General

**DISTRIBUTION:**

Active Army, USAR, and ARNG: To be distributed **in accordance with**  
**DA Form 12-II-E, requirements for FM 34-3, Intelligence Analysis**  
(Qty rqr block no. 1119).