



[RDL](#)

[Document](#)

[Download](#)

[Homepage](#) [Information](#) [Instructions](#)

Field Manual
No. 25-4

FM 25-4

**HEADQUARTERS
DEPARTMENT OF THE ARMY
Washington, DC, 10 September 1984**

FM 25-4

HOW TO CONDUCT TRAINING EXERCISES

Table of Contents

[Preface](#)

[Chapter 1 - Training Management and Training Exercises](#)

[Chapter 2 - Exercise Planning](#)

[Chapter 3 - Conduct of Training Exercises](#)

[Appendix A - Scenario Example](#)

[Appendix B - CS and CSS in Exercises](#)

[Appendix C - Opposing Forces](#)

[Appendix D - Exercise Control](#)

[Appendix E - Controllers, Umpires, and Evaluators](#)

[Appendix F - Assessment and Computation Tables](#)

[Appendix G - Postexercise Activities](#)

[Glossary](#)

[References](#)

[Authorization Letter](#)

DISTRIBUTION RESTRICTION: Approved for public release; distribution is unlimited.
--

***This publication supersedes FM 105-5, 31 December 1973.**



[RDL](#) [Table of](#) [Document](#) [Download](#)

[Homepage](#) [Contents](#) [Information](#) [Instructions](#)

Preface

The US Army must be prepared to fight and achieve victory in combat operations conducted anywhere in the world. Moreover, the Army must be prepared to conduct military operations in support of national policy objectives through tactical engagements and logistical support at any level of intensity within the spectrum of conflict. It must be ready for war in deserts, arctic regions, jungles, and mountains, as well as in urban areas. It must be ready to defeat modern and well-equipped armies, as well as small, lightly equipped irregular forces. Training exercises help achieve the high level of readiness needed to defeat the enemy.

Training exercises provide an excellent environment for the simultaneous performance of multiechelon responsibilities to evaluate and to sustain the skills of soldiers, leaders, teams, staffs, and units. Exercises simulate battle conditions to train leaders, staffs, and units in their wartime missions. They also train leaders for mission-unique conditions and for applying the best tactics to the unit mission, enemy, terrain, and troops available (METT). Some exercises employ minimal troop support in providing commanders and staffs realistic practice in executing wartime missions. Other exercises combine complete units, including those from other services and nations in order to train critical teamwork and coordination skills.

This manual provides commanders, staffs, and exercise planners with doctrine, guidance, and examples for planning, conducting, and controlling training exercises.

FM 25-4, which is one of the 25-series of training manuals, covers the conduct of training exercises. Beginning with fundamental training theory, this manual discusses how to determine training needs and how to plan for and conduct the appropriate exercises. It concludes with sample scenarios for exercises.

This manual is written for commanders, staffs, and exercise planners primarily at battalion level and above. It applies to both Active and Reserve Component units. The concepts described herein, however, are applicable at any level. It applies to combat arms, combat support, and combat service support units.

The proponent of this publication is the US Army Training Board. Submit changes for improving this publication on DA Form 2028 (Recommended

The proponent of this publication is the US Army Training Board. Submit changes for improving this publication on DA Form 2028 (Recommended Changes to Publications and Blank Forms) and forward it to the President, US Army Training Board, ATIC-TBT, Fort Eustis, VA 23604-5170.

Unless otherwise stated, whenever The masculine or feminine gender is used, both are intended.

[RDL](#)[Table of](#)[Document](#)[Download](#)[Homepage](#) [Contents](#) [Information](#) [Instructions](#)

CHAPTER 1

Training Management and Training Exercises

TRAINING MANAGEMENT

Commanders are responsible for all organizational training. They evaluate soldier and unit proficiency. They identify the training objectives and provide the necessary training guidance. They ensure that the training is supported with the needed resources and that it is properly planned and conducted. They then conduct and evaluate the training and obtain feedback.

Training management is the continuous process commanders use to develop unit training programs. The goal of training management is the best combination of resources, materials, guidance, and time to meet specific training requirements. The training management functions depicted in [Figure 1](#) apply equally to training exercises and to all training conducted in a unit. All management functions in the process take place at the same time. Training management and its applications are explained in detail in [FM 25-2](#).

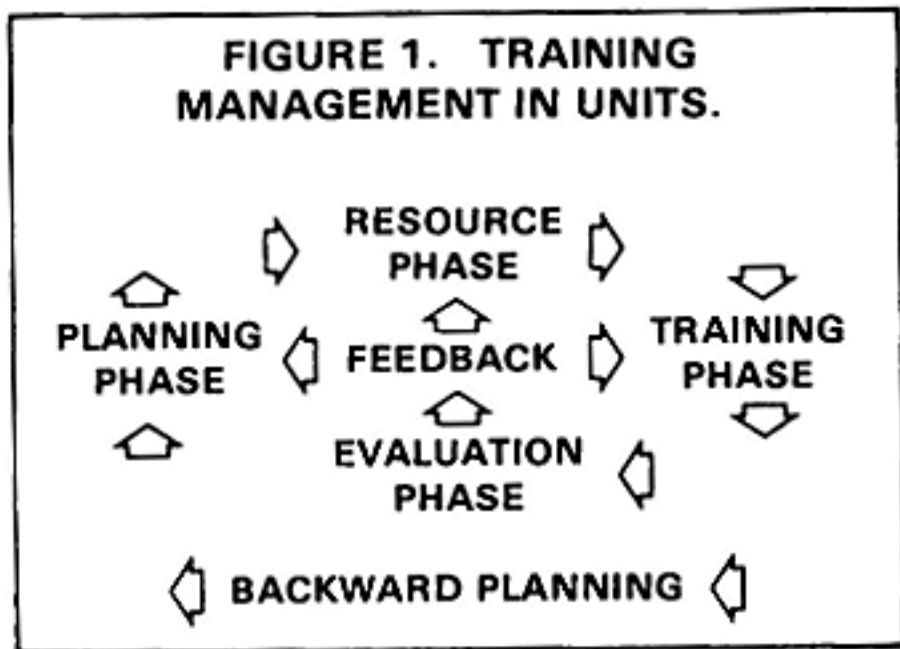

PLANNING

Planning for training requires input from several sources. Commanders and their planners must know the unit missions, goals, and objectives and the guidance from higher headquarters. They evaluate unit and soldier proficiency and obtain feedback from recent unit training activities. Commanders add their knowledge and experience to this basic information and develop training programs that specifically address unit and soldier training requirements.

RESOURCES

Training plans specify training events or activities that require resources and support. To implement those plans, resource actions--

- Identify.
- Program.
- Coordinate.
- Obtain.
- Provide the training support necessary.

Training events and activities identified during the planning phase provide input for the assessment of resources required to conduct effective training. Feedback on how well current and past training was supported with resources is also essential input in preparation of the resource assessment.

CONTENTS

TRAINING MANAGEMENT

Planning

Resources

Training

Evaluations

TRAINING EXERCISES

Purposes

Phases

During long-range planning, commanders and their staffs identify and request resources that require long lead times. During short-range planning, they identify and coordinate resources requiring shorter lead times. In the near-term planning period, they make final arrangements and provide resources to units.

TRAINING

Training can be as simple as performance-oriented training on a soldier's manual task. It can also be as complex as a field training exercise (FTX) using MILES and opposing forces (OPFORs). The training phase requires guidance with appropriate resources based on long-range, short-range, and near-term plans. [FM 25-3](#) provides directions and examples for the conduct of training.

EVALUATIONS

Evaluation is a continuous process. Commanders continually evaluate planning and resource actions to ensure that they meet unit needs and comply with guidance from higher headquarters. Higher headquarters evaluate their own planning and resource actions, as well as those of subordinate units to make sure that they are mutually supporting and focus on the unit mission. Commanders at all echelons evaluate how leaders and soldiers perform. Based upon their evaluations, commanders provide feedback to the chain of command, to the trainers, and to those being trained.

TRAINING EXERCISES

Training in units develops and sustains those individual and collective skills that soldiers and units (including squads, crews, and sections) need to accomplish their missions. To help soldiers' and leaders learn and sustain their skills, commanders develop training programs that implement the best mix of individual, leader, and collective training.

Training in units follows the hierarchy in [Figure 2](#), which [FM 25-1](#) and [FM 25-2](#) discuss in detail. [FM 25-3](#) assists leaders and trainers to conduct training at company level and below. Collective training involves the upper four levels of the hierarchy. The training exercises described in this manual also apply to these levels but concentrate on unit and combined arms and services proficiency.

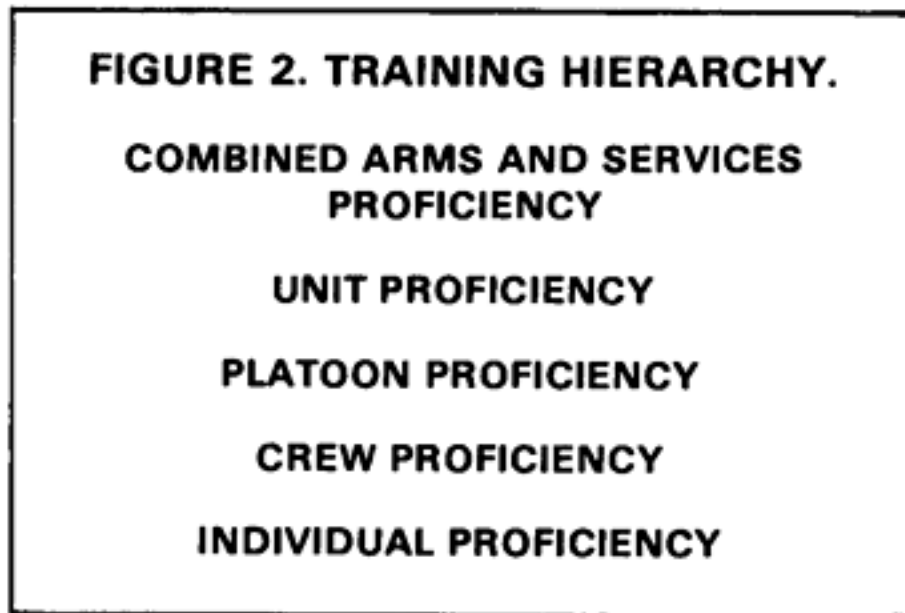

PURPOSES

The diversity of organizations, equipment, and environment inherent in air-land battles presents a major challenge to commanders. They must train soldiers and leaders who can effectively integrate the unit's weapon systems and doctrine to defeat an enemy that may be numerically superior. Training exercises are an effective way to build the team-work necessary to meet this challenge. All training exercises--

- Sustain and reinforce individual and collective skills.
- Develop and sustain command and control skills of commanders and their staffs.
- Support multiechelon training.

Individual and Collective Skills

Training exercises combine individual skills, leader skills, drills, and weapon systems proficiency. Training exercises reinforce and sustain proficiency in individual and collective skills in units. In addition, exercises provide training on collective tasks found in Army Training and Evaluation Programs (ARTEPs) and integrate all elements of the combined arms team. ARTEP tasks are modified as required to accommodate each unit's METT.

Command and Control Skills

Command and control training sustains skill proficiency for leaders, staffs, and individual soldiers. It reinforces common skills and those particular to duty positions. It trains each echelon to respond to the needs of higher, lower, adjacent, and attached combat, combat support (CS), and combat service support (CSS) units. Responding to subordinate units is particularly important. Inexperienced commanders and

staffs tend to orient themselves to respond upward and overlook the needs of subordinate units. One of the prime purposes of training exercises is to teach leaders to orient on the needs of subordinate units in a sequence of timely troop-leading steps that allow units to execute the mission properly.

Doctrine and training support materials for command and control training include such items as scenarios, simulation models, and recommended task lists. The unit can adapt these materials to address its unique METT assessment. Command and control training packages prepared by proponent service schools support MOS cross training and train-up and sustainment training. These packages are for each echelon of the command, including combat support and combat service support.

To win air-land battles, all elements of the combined arms and services team must be integrated and need to function effectively on the battlefield. Commanders must be competent in their command and control tasks. Battle staffs must be proficient in executing staff planning responsibilities to achieve full integration of supporting arms and services. Training that enhances these skills should receive emphasis at battalion level and above. The three categories of command and control training are battle staff training, survivability training, and combined arms and services training.

Battle Staff Training. Battle staff training allows commanders and their staffs to fight air-land battles in diverse command post configurations under realistic combat conditions as smoothly functioning teams. This training is vital to command and control of units. It develops the proficiency of individual staff members and molds them into trained teams that can effectively manage and coordinate all systems to support the command's mission. Such training requires that individual staff members know the unit's tactical SOPs (TSOPs) thoroughly. The TSOPs must be updated as appropriate to address changes in unit operations. Battle staff training relies heavily on simulations since they are often the only way to present many air-land battle situations and tasks to enable the commander to train his staff.

Survivability Training. Survivability training ensures proficiency during intense and continuous combat. It ensures that individual soldiers and teams can operate effectively in a variety of situations. It involves those routine tasks that units must perform well to ensure their survival. Examples include--

- Operations in nuclear, biological, or chemical (NBC) environments.
- Operations in hostile electronic warfare (EW) environments.
- Operations using various command post (CP) configurations.
- Operations required to feed, arm, fuel, and maintain the units' command and control elements.
- Procedures for succession of command.
- Limited visibility operations.

- Activation of alternate communication methods.
- Activation of alternate command posts.
- The hand-off between command posts (tactical CP to main CP).
- Passive air defense.
- Local security, to include calls for indirect fire and close air support.

Most survivability tasks are detailed in SOPs and provide standardization within a unit. Thus, they can be practiced prior to exercises. There is often no effective substitute, however, for full-scale exercises using all assigned equipment and personnel in a simulated combat environment to assess unit survivability proficiency in an environment that simultaneously employs all systems to full capacity.

Combined Arms and Services Training. Proficiency in combined arms and services training is required for units, staffs, and commanders to fight and win air-land battles. Examples of systems required to be integrated into training are--

- Fire support.
- Intelligence.
- Electronic warfare.
- Airspace management.
- Air defense artillery.
- Ground maneuver.
- Antiarmor.
- Combat support.
- Combat service support.

A single level of command and control first attains proficiency through battle staff training and survivability training. Battle simulations are an important means currently available for commanders and staffs to practice combined arms integration. Once technical proficiency by the battle staff has been achieved, it should be integrated with supporting, supported, and adjacent units in full-scale exercises

against a target array or OPFOR that realistically represents the enemy. Although the battlefield cannot be replicated completely, it should be represented accurately to include electronic warfare, sensor, and electronic intelligence targeting. Training aids such as emitters, transponders, jammers, and OPFOR vehicles to represent the enemy formations allow the commander to train the unit to operate under combat conditions.

PHASES

Training exercises contain three phases: preexercise, execution, and postexercise. The preexercise phase covers planning and preparation. It ends with the start of the execution phase (STARTEX). The execution phase begins at STARTEX and concludes with the end of the exercise (ENDEX). During the execution phase, player units participate in the exercise, which is controlled and evaluated according to plans developed during the preexercise. The postexercise phase, beginning at ENDEX, covers reviews and reports. All training events and exercises should conclude with after-action reviews (AARs). These reviews provide training as substantive as the activity itself. In AARs, commanders determine accomplishment of exercise objectives based on input from staffs, controllers, evaluators, umpires, and OPFORs, as appropriate. Participants should be encouraged to discuss what happened and why. They should be encouraged to suggest solutions and offer recommendations. To overcome short-comings, exercise participants can make a valuable contribution to training evaluation efforts by gathering information and analyzing the critical lessons learned. These lessons become essential elements of information (EEI) for commanders and trainers in the ongoing training management process. AARs must be conducted periodically during the exercise to gain maximum training benefit.

AARs should be used at every echelon, and they should occur as often as necessary to ensure that participants learn from the training conducted. If the exercise divides into deployment, attack, and defense, for example, an AAR should be conducted after each phase. If significant events, such as a movement to initial positions and a deliberate river crossing, occur in a phase, an AAR should likewise be held after each significant training event. [Appendix G](#) contains additional information on AARs.

As soon after ENDEX as possible and prior to leaving the exercise area, controllers, umpires, and evaluators conduct an exit briefing for those players with whom they were closely associated during the execution phase. As soon after ENDEX as possible, the exercise director prepares a formal after-action report for the unit commander. This report, which is distributed through the chain of command, is based on input from controllers, umpires, and evaluators. These reports and the AARs that precede them summarize the exercise. Commanders use them both to observe and evaluate staffs, leaders, and soldiers and to plan future training. The best use of these evaluations is to apply lessons learned to training within the near term (two through six weeks), rather than to file for review prior to the execution of the next major exercise.

[RDL](#)[Table of](#)[Document](#)[Download](#)[Homepage](#) [Contents](#) [Information](#) [Instructions](#)

CHAPTER 2

Exercise Planning

ANALYSIS

During the planning phase of training management, commanders at each echelon determine the need for training exercises and identify the types they will use. The need for an exercise is based upon--

- Higher headquarters' analysis of subordinate unit proficiency.
- Higher headquarters' issuance of the missions, goals, objectives, and guidance.
- Commanders' evaluations of unit and soldier proficiency.

Higher headquarters employ the exercise planning steps explained in this chapter when directing subordinate units to participate in training exercises. Subordinate units also employ applicable planning steps based on information and orders received from higher headquarters. When commanders direct internal exercises, they must ensure that the exercises meet unit training needs and objectives.

Commanders must first analyze soldier, leader, and unit training proficiency. Then they select a particular type of training exercise. A training analysis must first establish the training requirements and the priorities for unit training programs, as described in [FM 25-2](#). This analysis also determines the training objectives, which are based on the individual and collective skills that need initial or sustainment training. In so doing, the analysis must consider the three categories of command and control training:

- Battle staff training.
- Survivability training.
- Combined arms training.

One or more of these categories must be included in the unit training objectives and integrated in the exercise. The exercise objectives should be specific, relevant, realistically obtainable, measurable, and supportive of exercise goals. Exercise objectives should be organized into functional areas to highlight

activities that need improvement. Properly stated objectives provide players, controllers, umpires, and evaluators with a solid basis for conducting their evaluation and AARs. When the exercise objectives are established, the type of exercise to be conducted can be selected.

CONTENTS

ANALYSIS

SELECTION

CONSIDERATIONS

Flexibility

Resources

Participants

Battle Simulations

Situational Training Exercises

PREEXERCISE PLANS

Preparing an Exercise Directive

Assigning Responsibilities

Planning Milestones

Conducting Research

Preparing a Supporting Plan Schedule

Preparing an Outline Plan

Conducting a Reconnaissance

Completing the Exercise Support Plans

[Preparing the Scenario](#)

[Preparing an Operation Plan](#)

[Publishing the Letter of Instruction](#)

[Preparing a Contingency Plan](#)

[Preparing the Terrain](#)

[Conducting a Rehearsal](#)

An exercise must never be conducted simply for its own sake. It must always help to attain training objectives, which are tied to the unit mission.

SELECTION

Once the initial analysis is completed, commanders determine the type of exercises to be conducted. Comparing the objectives with the kind of training that each exercise provides, they identify the proper exercise, within resource constraints, that can best meet the objectives. [Table 1](#) shows the exercises that best fit the command and control training categories for each echelon of command.

TABLE 1. EXERCISE SELECTION MATRIX.

EXERCISES	PLATOON OR COMPANY				ECHELONS ABOVE CORPS	
	TEAM	BATTALION	BRIGADE	DIVISION	CORPS	
MAPEX		A,C	A,C	A,C	A,C	A,C
TEWT	C	C	C	C	C	
CPX		A,B,C	A,B,C	A,B,C	A,B,C	A,B,C
FTX	B,C	B,C	B,C			
LFX	B,C	B,C				
FCX	A,C	A,C				
CFX	B,C	B,C	B,C	A,B,C	A,B,C	

Legend:**A - battle staff training****CFX - command field exercise****LFX - live-fire exercise****B - survivability training****CPX - command post exercise****MAPEX - map exercise****C - systems training****FCX - fire coordination exercise****TEWT - tactical exercise without troops**

Map exercises (MAPEXs) are employed to teach staff planning and coordination, as well as preparation of estimates and operations orders. They are not conducted below battalion level. Commanders employ tactical exercises without troops (TEWTs) to teach the effective use of terrain to subordinate leaders. TEWTs involve specific tactical problems, employing unite and weapon systems. Command post exercises (CPXs) are effective in training members of staffs, command posts, and communications systems above company level. FTXs provide realistic survivability and combined arms training for the total force. Battle staff sustainment training does occur in FTXs. However, to preclude the delays and inefficient use of troop-leading time that normally occur in the preliminary training of the staff, they should not be selected solely for this purpose. Battle staff skills should be sharpened through CPXs, TEWTs, and MAPEXs prior to an FTX.

[Table 2](#) aids in selecting the appropriate exercise. It shows training exercises and some of the systems and objectives that can be trained effectively. The "X" indicates the exercise which best affords realistic training in the employment of the system or attainment of the objective indicated. For example, the training objective "Staff procedures" is shown only for the MAPEX, CPX, and command field exercise (CFX) since they are the most effective ways to train those objectives.

TABLE 2. EXERCISE EFFECTIVENESS.

SYSTEMS OR OBJECTIVES	MAPEX	TEWT	CPX	CFX	FCX	LFX	FTX
Use of terrain		X		X		X	X
Actual maneuver of units				X	X	X	X
Staff procedures	X		X	X			X
Weapons employment		X		X	X	X	X
Fire support planning and coordination			X	X	X	X	X
Combat support				X		X	X
NBC operations			X	X			X
Systems integration	X		X	X	X		X
Survivability			X	X			X
Contingency operations	X		X				
Communications/ electronics			X	X			X
Intelligence/EW			X	X			X
Direct and indirect fire control and distribution				X	X	X	X
Air defense	X		X	X			X
Airspace management			X	X	X		X
Sensor/CEWI/target cell interface	X		X	X			X
Engineer systems*	X	X	X	X			X

*Mobility, countermobility, and survivability operations

LEGEND: CEWI - combat-electronic warfare intelligence EW - electronic warfare

CONSIDERATIONS

FLEXIBILITY

The planning phase must recognize the value of flexibility and the necessity for being thorough. Planners must plan for alternate types of exercises in case weather or other constraints prohibit the originally scheduled exercise. For example, if a brigade needs an FTX but there is a chance of funds being reduced or the possibility of excessive maneuver damage, contingency plans for a CFX or CPX should be prepared concurrently.

Exercises must be flexible. They should allow subordinate commanders the freedom to innovate within the framework of new or existing doctrine, tactics, techniques, and operating procedures. They should not follow rigid timetables that inhibit training and learning. Instead, they should establish schedules that provide sufficient time to correct mistakes and ensure learning and AARs at all levels.

RESOURCES

Once a headquarters decides to conduct a training exercise, the needed resources must be identified and procedures begun to obtain them, in accordance with the training management procedures described in [FM 25-2](#). The general steps below must be taken before beginning detailed work. They indicate whether the exercise can meet the training objectives. If any area appears inadequate, the commander must decide whether to proceed or consider an alternate training activity.

Facilities and Land

Planners must consider the environment for the exercise and the impact of weather. If inadequate land or facilities will seriously degrade training, planners may have to alter the exercises. For example, if an FTX has been selected but the available training areas are not large enough to allow unit tactics to be realistically played, the planners may--

- Reduce the number of units in the exercise.
- Use a MAPEX or a CPX in place of an FTX.
- Conduct the exercise at a lower echelon.

Range facilities in the continental United States (CONUS) usually limit LFXs to company team level. The exception is the National Training Center (NTC) at Fort Irwin, California. At the NTC, resources and distances permit LFXs at battalion task force level. Except for scaled range training, range limitations also restrict fire coordination exercises (FCXs) to small units. Battle staff training during FCXs is generally limited to--

- Fire support coordination.
- Fire control.
- Preparation and issuance of plans and orders.

When exercises use privately owned land, planners must also consider maneuver damage control.

Support

Training exercises require support. Some exercises consume large quantities of allocated resources such as fuel, spare parts, flying hours, and maneuver area time. The planners must ensure that the exercises can be conducted within the resource levels and that the training received justifies the resources expended.

Commanders and staffs ensure that internal and external support equipment is sufficient. For example, communications and transportation for players, controllers, umpires, and evaluators must be adequate. Player units, including HQs, should use only organic transportation, communications, and TOE equipment. Doing so teaches them to employ the full capabilities of the unit. They should not rely on outside assistance to replace systems that are not mission capable or to beef up the authorized strength of the staff. Controller, umpire, and evaluator equipment must not come from player units.

Time

The time allocated for each exercise must permit appropriate troop-leading steps to be exercised, as well as develop tactical situations that lead to logical and sound tactical employment of player units. The time should also be allocated for conducting complete logistical support of tactical operations, as well as for an appropriate AAR.

PARTICIPANTS

Planners must consider whether or not units or groups of individuals to be trained are of the proper size or strength to benefit from the type of exercise selected. For example, the soldiers of a tank platoon consisting of two-man tank crews can be expected to gain very little from an LFX. Personnel shortages might also cause commanders to conduct CFXs rather than FTXs.

BATTLE SIMULATIONS

Battle simulations, both manual and computer-supported or computer-assisted, provide effective training in many battle staff skills. Battle simulations can be used with virtually any scenario. They are readily adapted to specific local conditions and unit missions.

Simulations will not correct all command and control training problems or substitute for field training. If properly used, they can provide a readily acceptable means for exercising significant elements of the command and control system.

Battle simulations have the following characteristics:

- They are relatively inexpensive.
- They do not require large training areas.
- They save training time.
- They reduce preexercise and postexercise requirements.
- They are flexible and easily tailored to unique training objectives.

- They can present situations (nuclear, chemical, tactical air) that cannot be reproduced in other training environments because of safety or expense.

Battle simulations encourage multiechelon training. Higher and lower echelons can be exercised simultaneously with a minimum expenditure of valuable training resources. Simulations can portray joint service operations involving the Air Force, Navy, and Marines, as well as the combined elements of other nations. Battle simulations can also portray various equipment mixes or degraded operations, allowing commanders and staffs to exercise back-up systems and procedures.

Battle simulations provide realistic cues and feedback to the command as a result of decisions made by higher, lower, and adjacent units. Each command group executes and subsequently modifies its plans, based on the situation. Simulations force command groups to adjust plans, organizations, assets, and firepower to cope with changing battlefield situations. They may also force adjustments in command post configurations and procedures to deal effectively with unforeseen situations.

Battle simulations can create unique mixtures of organizations, equipment, missions, and operational situations. They do this while realistically portraying the unit METT. Questions and comments about battle simulations may be addressed to Deputy Commandant, Command and General Staff College, ATTN: ATSL-SWN, Fort Leaven-worth, KS 66027; AUTOVON 552-4612/2442, Commercial (913) 684-4612/2442.

Tactical engagement simulations such as MILES add significant realism to field exercises. They do so by confronting leaders and soldiers with realistic simulations of direct fire weapon systems in a training environment. Only units that have demonstrated high levels of proficiency during battle drill and situational training exercises should use MILES for training. Because MILES is the most realistic training short of actual combat, it should be approached with detailed planning that keeps the training objectives clearly in mind. For details on the planning and use of MILES, see [TC 25-6](#).

TABLE 3. CURRENT AND PROJECTED BATTLE TRAINING SIMULATIONS.

ECHELON	MANUAL SIMULATIONS	COMPUTER-SUPPORTED, OR COMPUTER-ASSISTED SIMULATIONS
CORPS	War Eagle First Battle-BC*	TACSIM
DIVISION	First Battle First Battle-BC*	CAMMS II*
BRIGADE	Pegasus First Battle-BC*	CAMMS CAMMS II*
BATTALION	Pegasus First Battle-BC* Transwar I/II/III*	CATTS CAMMS CAMMS II* ARTBASS* MACE* ATLAS I/II* MEDMOD*

*Under development.

LEGEND:

ARTBASS - Army Training Battle Simulation System

ATLAS - A Tactical Logistical and Air Simulation

BC - battalion through corps

CAMMS - Computer-Assisted Map Maneuver Simulation

MEDMOD - Medical Module

TACSIM - Tactical Simulation

SITUATIONAL TRAINING EXERCISES

The use of situational training exercises (STXs) should be considered in the development of an exercise. They teach the "best" or preferred way to accomplish a task and are a standard way in which a task should be executed. They are developed by the service schools to teach the doctrinally preferred way to perform a specific mission. [FM 25-3](#) explains the STX concept. STXs can facilitate training through the application of standardized tactical formations and employment. Thus, they should be considered in planning and preparing for an exercise, whenever appropriate.

PREEXERCISE PLANS

The preexercise is usually the longest of the three exercise phases. For large exercises, such as the FTX

portion of Redeployment of Forces to Germany (REFORGER), this phase can take longer than a year. The preexercise phase develops all the support plans that govern the execution and postexercise phases.

Planning begins immediately after the decision has been made to conduct an exercise. The planning steps listed below are used to prepare for an exercise. Specific exercises may omit some. These steps are generally sequential; however, some may be performed simultaneously.

- Preparing an exercise directive.
- Assigning responsibilities for planning.
- Conducting research.
- Preparing a supporting plan schedule.
- Preparing an outline plan.
- Conducting a reconnaissance.
- Completing the exercise support plans.
- Preparing the scenario.
- Preparing and issuing the operations plan (OPLAN).
- Publishing the letter of instruction (LOI).
- Preparing the terrain.
- Conducting a rehearsal.

The training objectives and the echelon at which the exercise is to be conducted determine how complex these steps will become. For example, at battalion level there may be little or no need to conduct detailed research or to write a planning schedule. Much of the planning can take place during training meetings. However, at division level, research and written planning schedules are necessary. They can be the key to a successful exercise.

PREPARING AN EXERCISE DIRECTIVE

The headquarters requesting or conducting the exercise issues an exercise directive. It starts the development process.

Before preparing the exercise directive, the exercise planner carefully considers the purpose of the exercise, the objectives stated or implied by the commander, and guidance from higher headquarters. The objectives are the basis for planning and developing the exercise directive. An exercise directive will--

- Name the exercise director and provide for a staff. These personnel will plan the exercise.
- Specify what type of exercise to conduct and state its specific training objectives.
- Indicate the time frame for the exercise, its physical location, and the duration of its execution phase. The location, time, and duration must be consistent with the type of exercise selected, the participating units, and the training objectives.
- Prescribe the type and number of participating units.
- Identify the type and quantity of special equipment required.
- Provide additional information such as funding, environment, and any pertinent assumptions. Funding data should specify both fund citations and fund limitations. Environmental information should describe the strategic setting to be played during the exercise. It should describe the type of exercise envisaged such as general or limited warfare or internal defense operations. It should also include area and background studies pertinent to the exercise site.

ASSIGNING RESPONSIBILITIES

Planning and conducting a large exercise requires the same attention to detail as an actual combat operation. The exercise director and designated staff are responsible for planning and conducting the exercise to meet the training objectives stated in the exercise directive. See [Figure 3](#) for a summary of planning staff duties and coordination. Normally, the planning staff G3/S3 acts as the principal coordinator for the exercise director.

FIGURE 3. PLANNING STAFF DUTIES.

G3/S3 Prepares the unit troop list, which identifies the units participating in the exercise and those in the support structure.

Prepares the manning table for the control organization.

Note: If simulated units are to be portrayed, they are shown in the unit troop list for player planning purposes. The organization and manning of the exercise planning staff and the control staff are all included in the unit troop list. The final unit troop list should be established early in the planning sequence, and alterations should be avoided.

G1/S1 Identifies controller requirements based on the input provided by the planning staff G3 and the chief controller.

Has responsibility for the personnel portions of the exercise plan.

Provides the planning staff G3 with the name, rank, and organization of personnel who have a part in conducting the exercise.

FIGURE 3. PLANNING STAFF DUTIES (continued)

G2/S2 Studies the exercise order, appropriate references, and the scenario. In coordination with the planning staff G3, prepares a series of OPFOR situations to guide the conduct of the exercise. The planning staff G2 should refer to Appendix D of this manual, FM 30-102, and FM 34-71 to plan the OPFOR scenario.

Prepares the information concerning the enemy situation and the plan for disseminating it to the players. Use of preexercise intelligence buildup allows the staff to become familiar with the OPFOR order of battle and to prepare appropriate intelligence estimates needed during the initial phase of the exercise.

Prepares the intelligence plan and the intelligence annex to the OPLAN.

G4/S4 Studies the exercise directive, appropriate references, and the scenario; consults with senior logistic controllers and agencies that will support the exercise.

Plans the logistic play of combat service support units.

Plans for the actual support of the exercise, to include the maneuver damage plan prepared in coordination with the planning staff G5.

Drafts the administrative and logistics plan and reconnoiters the terrain to make sure that the OPLAN is supportable within the framework of available logistics resources.

G5/S5 Studies the exercise directive, appropriate references, and the scenario; prepares the civil-military operations (CMO) plan.

Coordinates with the planning staff G3 to ensure that the CMO plan conforms to the exercise OPLAN.

Coordinates with the planning staff G4 to ensure an adequate administrative and logistics plan, including provisions for maneuver damage payments.

Consults with the G1, G2, and G3 regarding civil affairs and psychological operations (PSYOP) requirements for controller personnel.

Note: If the exercise is conducted on privately owned land, the G5/S5 conducts a preexercise positive publicity campaign, to include briefings for local authorities. This normally begins three to six months in advance. It explains the purpose of the exercise, the reason why privately owned land must be used, and the steps taken by the military authorities to minimize maneuver damage.

PLANNING MILESTONES

Developed early in the process, milestones will ensure full and timely completion of the planning effort. Typical milestones for a brigade-size FTX are shown in [Table 4](#). The planning milestones to support a large division exercise would be more extensive and include such actions as establishing budget requirements and acquiring maneuver land permits. Exercises that involve Reserve Component units also

require extra planning and preparation time.

TABLE 4. EXERCISE PLANNING MILESTONES.

DATE	MILESTONE
E-13 to 14 months	Exercise inserted in the long-range planning calendar.
E-120 days	Training objectives determined and planning responsibilities assigned.
E-115	Exercise selected.
E-110	Exercise area selected (may be required sooner based upon local maneuver area allocation requirements).
E-100	Exercise directive published.
E-90	Research completed.
E-90	Supporting plan schedule prepared.
E-75	Outline plan developed.
E-70	Reconnaissance conducted.
E-60	LOI prepared.
E-60	Scenario prepared.
E-30	OPLAN and supporting plans and documents prepared and issued.
E-15	Terrain prepared.
E-15	Controllers, evaluators, and umpires trained.
E-15	Players briefed.
E-7 to E-13	OPFOR, controllers, umpires, evaluators, and communications rehearsed.
E-2	Unit movement conducted.
E to E+5	Exercise (STARTEX to ENDEX) conducted.
E+7	After-action review completed.
E+12	After-action report completed.

LEGEND: E - Exercise (the first date of maneuver, or STARTEX)

CONDUCTING RESEARCH

New missions spawn new tactical doctrine. In turn, the new doctrine generates requirements for improved weapon systems, equipment, and organizations. Thus, exercise planners must be thoroughly familiar with doctrine, TOES, and equipment requirements prior to development of training exercises. Exercise planners must conduct appropriate research to update controllers and participants prior to STARTEX. The intelligence staff provides the information for making the OPFOR and the combat environment realistic. Realism maintains the participants' interest and enthusiasm.

Such research identifies appropriate and available training support or training support materials. Up-to-

date training support may come from Reserve Component activities such as maneuver area commands (MACs) or maneuver training commands (MTCs). These organizations develop and conduct exercises for Reserve Component units. Planners may request model training exercises developed by proponent service schools. Use of the models may save considerable planning time by providing examples and format guides. Planners should consider battle simulation kits, available through training and audiovisual support centers (TASCs) or training resource assistance centers (TRACs). They should consult after-action reports and lessons learned from previous exercises. Planners should also consult administrative references. These ensure that the exercise planning is consistent with policy governing the safety and welfare of the participants. Post and garrison regulations, range regulations, and unit SOPs are always pertinent and should be reviewed prior to the publication of exercise plans.

PREPARING A SUPPORTING PLAN SCHEDULE

Training exercises must have complete, workable supporting plans. Exercises may fail to accomplish all intended training objectives if planners overlook guidance essential for conducting them. The supporting plan schedule lists all the major plans required for the exercise. It also designates the staff officer responsible for each plan and the time when it must be submitted for the commander's approval. The amount of time required to produce the plan will vary with the experience of the planning staff.

FIGURE 4. SAMPLE EXERCISE SUPPORT PLAN SCHEDULE.

Exercise Name _____
 Received Commander's Exercise Concept _____
 Period Available for Support Plan Preparation _____ Days _____

	EXERCISE SUPPORT PLAN	START DATE	COMPLETION/ APPROVAL DATE	STAFF RESPONSIBILITY
1.	Maneuver Damage Plan	E-50	E-30	G5
2.	Information Plan	E-50	E-31	G5
3.	Civil-Military Operations Plan	E-50	E-32	G5
4.	Administrative/Logistics Plan	E-50	E-32	G1/G4
5.	Communications Plan	E-49	E-34	Division Communications Officer
6.	Control Plans	E-45	E-35	G3/G1
7.	OPFOR Maneuver Plans	E-60	E-50	G2/G3
8.	Intelligence Plans	E-60	E-50	G2/G3

For a battalion-level exercise, the S3 prepares a planning schedule. It may be nothing more than a brief written set of milestones which identifies the tasks to be trained. At corps and division levels, the planning staff G3 prepares a planning schedule that calls for detailed supporting plans. The first step in preparing this schedule is to determine the data that will be used as a basis for the exercise. Using backward planning as described in [FM 25-2](#), the G3 sets completion dates for each supporting plan based on its required publication date. The schedule allows for timely planning and detailed coordination between

appropriate staff agencies.

PREPARING AN OUTLINE PLAN

The outline plan is the framework used to build the scenario--the story of the exercise. The procedures for developing the outline plan depend on the size of the unit involved. In small-unit exercises at company and battalion levels, the reconnaissance phase and the outline planning considerations are normally combined. For large-unit exercises, these two phases are separated. Nonetheless, exercise directors and staffs take the same actions in preparing outline plans for large-unit and small-unit exercises.

FIGURE 5. SEQUENCE FOR THE OUTLINE PLAN.

1. Determine what must be done by analyzing the exercise directive to ensure that the commander's intended purpose is understood and that the proposed training objectives will achieve it.
2. Select the general area (facilities or land) for the exercise.
3. Consider the general sequence of events.
4. Examine the training objectives to identify those factors that have a bearing on the course of action.
5. Determine how the terrain will affect each sequence.
6. Select a feasible sequence of events that may be used to accomplish the training objectives.
7. Retain and compare all feasible combinations with one another.
8. Choose the best sequence. This becomes the recommended course of action.
9. Select actual locations and visualize combat situations at these locations. In doing so, either of two methods can be employed: Selecting a final objective and scheduling other events by using the backward planning, or selecting a final objective and scheduling other events starting from the initial assembly area.
10. Develop schedules as guides for completing objectives and keeping the combat situation realistic.
11. Develop control measures to guide the exercise. Control measures, such as boundaries and phase lines, are essentially the same as those for actual operation. Additionally, the activities and status of notional units can be used to assist in the control of player units.
12. Anticipate problems that may prevent the exercise from progressing as outlined: the effects of adverse weather on aviation activity, for example, or the unavailability of special personnel or equipment. Develop alternate courses of action for such contingencies.

CONDUCTING A RECONNAISSANCE

Planners should make the most efficient use of land allocated for exercises. They should first study updated maps of the areas with updated aerial photographs, if available. They should analyze the land to determine its military features, including observation and fields of fire, cover and concealment, obstacles, key terrain, and avenues of approach. For example, if an exercise starts with the mission "deliberate attack," the planners should first select the final objective. They then plan backward, choosing a possible assault position, a line of departure, an assembly area, and other control features normally used in the

attack.

Planners must select locations for OPFOR activities or positions where specific actions are to take place. They conduct intelligence preparation of the battlefield (IPB) for each phase of the exercise, using US and potential adversary doctrinal templates. Next, they select locations for roadblocks, road guards, and control points. Then they determine the overall scheme of the operation by visualizing the employment of the parent unit two command levels higher than the participating unit. For battalion exercises, they must visualize the employment of the entire division.

In selecting the locations, planners must remember that they are limited to the areas designated for the exercise. In special cases where the exercise may use land not owned by the military, they must get approval to use such land and consider environmental impact during initial planning.

Plans must be developed that fully use the terrain but do not abuse it. The use of legs, as illustrated in [Figure 6](#), is one method of ensuring that terrain does not suffer from excessive maneuver damage.

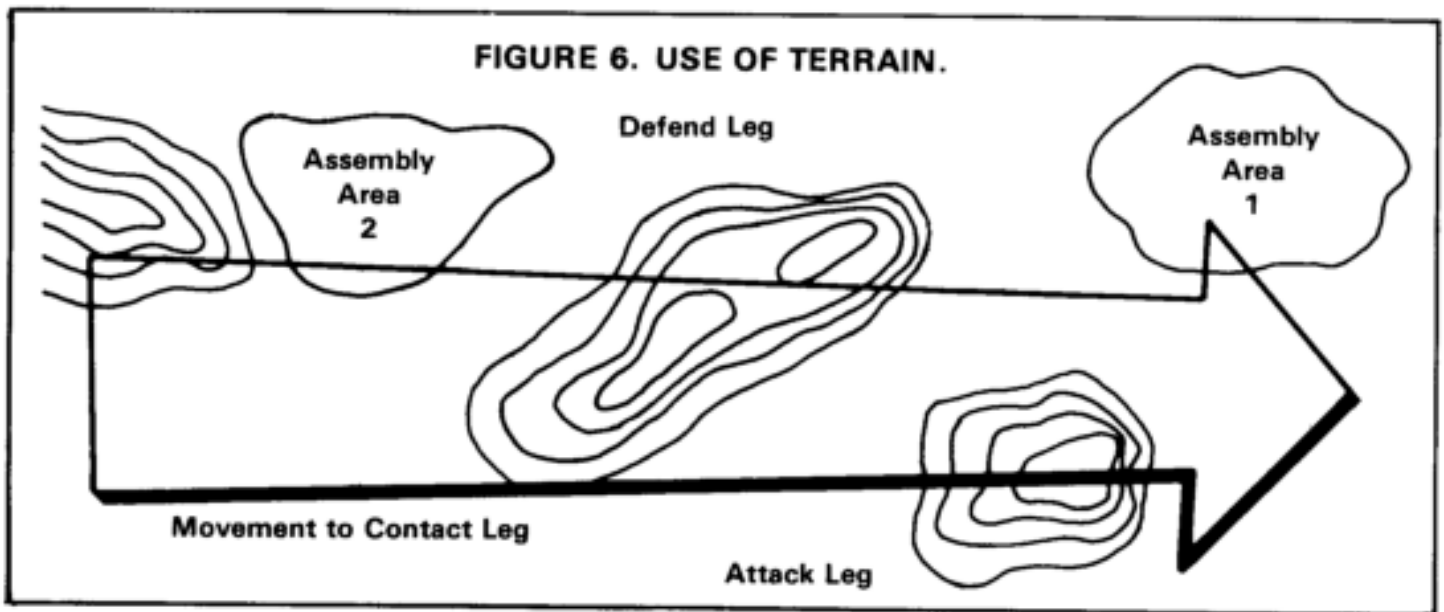

Second, planners reconnoiter the ground to verify the tentative plan prepared from maps and aerial photographs. Ground reconnaissance should consider such points as--

- The use of chemical agents and decontamination requirements.
- The impact of tactical engagement simulations.
- The effect of low visibility operations.
- Maneuver damage and safety.

- The impact of the equipment such as the M1 tank as compared to wheeled vehicles.

A ground reconnaissance validates the plan backward from the objective. It verifies that the plan is appropriate for the participating units. At the objective, the planners critically examine the terrain, as would an enemy commander, to determine the most realistic locations for scheduled activities. The planners then move through the remaining portion of the area and determine the most realistic locations for other planned events. The planners should change the original plan as necessary. Then they submit it to the directing authority for approval before making any further plans. If the map and aerial photographic reconnaissance has been thorough, the original plan may require only minor changes.

COMPLETING THE EXERCISE SUPPORT PLANS

For the training exercise to run smoothly and accomplish its objectives, written support plans must contain practical guidance for the exercise participants. The plans discussed in this section are distributed to the appropriate controllers, umpires, evaluators; OPFORS, and players.

TABLE 5. EXERCISE SUPPORT PLANS.

SUPPORT PLAN	RESPONSIBLE STAFF
Intelligence Plans	G2/G3
Control Plans	Chief Controller
Administrative and Logistics Plan	G1/G4
Movement Plan	G4
Maneuver Damage Plan	G5
Civil-Military Operations Plan	G5
Emergency or Readiness Measures Plan	G3
Orientation and After-Action Review Plan	G3
Information Plan	G5/PAO
Claims Plan	G5/SJA
Comptroller Plan	Comptroller
Records and Reports Plan	G3/Exercise Director
Operations Plan	G3
Evaluation Plan	G3
Contingency Plan	G3
LEGEND: PAO - public affairs officer SJA - staff judge advocate	

Intelligence Plans

The planning staff G2 prepares the intelligence plan in coordination with the planning staff G3 and the chief controller. The plan should provide for--

- OPFOR units to portray OPFOR tactics.

- Realistic input of combat information.
- Timely introduction of information into the exercise intelligence.

Before writing an intelligence plan, the G2 studies the directive and the scenario. In coordination with the G3 and designated OPFOR commander, the G2 prepares a series of OPFOR situations. These will guide the exercise in a scenario that reflects the tactical doctrine, capability, and vulnerability of the selected adversary. The G2 then reconnoiters the terrain to ensure that the OPFOR situations are feasible. The intelligence plan and its support documents must be carefully coordinated with the control plan and the operations plan.

OPFOR Situation. This portion of the plan covers the various enemy situations that must be portrayed by the OPFOR. To clarify it, planners prepare a situation overlay for each phase. Given the OPFOR situations and overlays, the OPFOR commander makes a detailed plan of operations for the required tasks. This plan includes simulating OPFOR units that are not physically portrayed.

The play of intelligence sources and agencies is described. These include--

- Aerial surveillance and reconnaissance.
- Surveillance devices.
- Patrols.
- Signal intelligence.
- Electronic intelligence.
- Prisoners of war.
- Technical intelligence.

Counterintelligence, guerrilla activities, enemy propaganda, counterpropaganda, and intelligence activities in rear areas are also portrayed. Planners first determine what systems the player units have for collecting this information. The types of intelligence portrayed by the OPFOR must be varied enough to exercise all the intelligence collecting agencies of the player unit.

The NBC attack capabilities of the OPFOR are developed in enough detail to require the player units to interpret the information gathered. Plans should be made for early dissemination of--

- Meteorological data.

- Recent OPFOR NBC activities.
- Intelligence bulletins on OPFOR equipment.
- Unusual diseases.
- Other pertinent information.

Whenever possible, OPFOR capabilities should be represented by replicating actual intelligence targets for friendly units to detect. This not only refers to combat-electronic warfare intelligence (CEWI) activities, but applies across the board for all systems. It is essential that exercises duplicate the tasks, conditions, and standards that must be mastered to fight air-land battles in a realistic environment.

Situations are developed for disseminating electronic warfare support measures (ESM) information, current OPFOR electronic warfare order of battle (OB), and recent OPFOR electronic warfare activities. OPFOR tactical deception (TD) and counter-deception activities are standard parts of exercise scenarios. They are necessary for realism. The TD story must be plausible, complete, and consistent with previous, current, and anticipated OPFOR activity.

Intelligence information released to friendly forces must depict both the TD and the true exercise activities of the OPFOR, though not necessarily at the same time. There should be enough information in both categories so that friendly forces will have difficulty in reaching a quick decision about the OPFOR. Information for bringing the play back to the intended path must also be ready in the event that friendly forces accept the initial OPFOR TD activity as the true picture. OPFOR counterdeception activities should be realistic and inhibit friendly development of TD activities. Planners always distinguish between exercise and actual security and intelligence measures.

Directive to OPFOR Commander. The planning staff G2 prepares a directive outlining the OPFOR commander's responsibilities. It cites the training objectives, announces the exercise dates, and specifies the suspense date for the OPFOR commander's operation plan. The directive also defines the command relationship between the OPFOR commander and the exercise director or chief controller.

Special Instructions to the OPFOR. These instructions are an enclosure to the OPFOR commander's directive and outline matters of interest to the entire OPFOR unit. At a minimum, these instructions cover--

- The composition and identity of the OPFOR.
- OPFOR uniforms and equipment.
- Provisions for an orientation of OPFOR key personnel.
- Guidance for conducting OPFOR training.

- Preexercise training area allocation.
- A rehearsal schedule for OPFORs. Rehearsals may be MAPEXs, terrain walks, CPXs, FTXs, or a combination of these.
- OPFOR conduct during the exercise. This includes actions taken with prisoners of war (PWs) and as PWs.

[Appendix C](#) is a detailed discussion of the OPFOR, its use, and the training it requires.

Intelligence Information Distribution. This plan provides the scheme of intelligence play before and during the tactical play of the exercise. It includes the information to be released, guidelines on how to release it, and a schedule for its distribution. The intelligence information released falls into two categories:

- What the unit receives automatically through command channels.
- What the unit receives only when it takes the proper action to obtain it.

The most realistic method of starting intelligence play in large-unit exercises is for the next higher tactical headquarters to disseminate intelligence to the participating unit early in the exercise. Disseminating area analysis and intelligence summaries and reports provides the necessary background to initiate intelligence play. The OPFOR plan and situation and the intelligence information distribution scheme are carefully coordinated to ensure synchronization. They also introduce events designed to see how the friendly force will react to air-land battles. The reactions of friendly units become key points of discussion for the AAR.

Control Plans

Control plans provide instructions for controlling and evaluating the exercise and organizing the control group. To build a control group, the planning staff G3 prepares the control plan based on the exercise scenario and appropriate references. Instructions for the control group must conform to the scenario and the intelligence plan. The success of the exercise depends largely on how thorough these plans are and how well they are executed.

Safety Instructions. The effort to attain maximum realism may cause hazardous conditions and situations to arise. These hazards could have an adverse effect on the progress of the exercise, as well as on the individual participants and the local civilian communities. To minimize accidents and injuries, planners must prepare and issue specific safety instructions to all units well in advance of the exercise. The control personnel in the exercise area are responsible for implementing these instructions. This in no way, however, lessens the command responsibility within the player units for issuing, clarifying, and enforcing safety rules. Safety instructions include--

- Objectives and responsibilities.
- Accident causes and preventive measures.
- Accident reporting. Spot reports, as well as formal accident reporting and investigative procedures, are prescribed.

Because current equipment is very mobile, command instructions must emphasize its safe operation during training exercises and under administrative conditions during day, night, and reduced visibility.

Uniform Markings, Color Control, and Exercise Rules. This portion of the control plan prescribes--

- Uniform markings for OPFOR, controller, evaluator, umpire, and observer personnel.
- Markings for vehicles, aircraft, and equipment.
- Pyrotechnics, munitions, and lasers permitted in the exercise and instructions for their use.
- Flag-signaling devices allowed and instructions for their use.
- Funding authorization and source of supply.
- Controller rules.
- Guidance concerning the use of civilians (or military personnel disguised as civilians) in exercise play, their identification, and treatment.
- Guidance for civil-military relationships. The plan must be closely coordinated with the exercise G5 and the public and unit information programs and activities. Additionally, it will include procedures for identifying and treating civilians who reside in or near the exercise area but who do not participate.

Umpires, personnel, vehicles, and installations participating in combined land exercises with other nations must be marked in accordance with NATO Standardization Agreement (STANAG) 2100, Edition 5.

Controller, Umpire, and Evaluator Assignments. Controllers, umpires, and evaluators are essential for the effective and efficient operation of training exercises. Controllers ensure that events occur at the appropriate times and places according to the exercise scenario and schedule of events. Controllers represent all headquarters and units not physically present as players. Evaluators observe the activities of players and player units to determine whether they perform tasks to predetermined standards. Evaluators

provide input to the AARs. Umpires determine the outcome of battle engagements and the effects of fires, obstacles, and support activities. They report the results both to player units and the control organization. The planning staff G1 coordinates with appropriate staff members to recommend sources of personnel and selection criteria to the exercise director. Members of the control group should be taken from nonplaying units because playing units should be at full strength. During any one exercise, controller, evaluator, and umpire duties are normally assigned to separate individuals. However, the exercise director may have to assign two or more of these functions to the same person due to shortages of qualified personnel.

Each controller, evaluator, and umpire is assigned to a specific section for the duration of the exercise. The chief controller determines these specific assignments based on the scope of the exercise and the available personnel and required equipment. If possible, personnel assigned as evaluators should have experience in the position being evaluated. Whenever feasible, commanders should evaluate commanders. For a description of the duties of umpires, controllers, and evaluators, refer to specific exercises in [Chapter 3](#) and to [Appendix E](#).

Controller, Umpire, and Evaluator Communication and Transportation. To control and coordinate exercises, good communications are essential. A large-unit FTX may operate over extended distances and require highly mobile controllers, umpires, and evaluators. In such a case, obstacles to continuous and efficient communication are numerous. The G4, the special security officer (SSO), and the signal officer assist the planning staff G3 to coordinate communication and transportation needs. Since the player units require their organic communication equipment and vehicles during the exercise, the G3, G4, and signal officer should acquire this equipment from other sources.

Schedule of Controller, Umpire, and Evaluator Training. Controllers, umpires, and evaluators must be trained to execute their assignments. The amount of training depends on the backgrounds and experience of these individuals as well as the scale of the exercise. The schedule provides for--

- A detailed orientation to the exercise, including the training objectives, the methods for attaining the objectives, the scenario, and the supporting plans.
- A detailed reconnaissance of the exercise area.
- Schooling that emphasizes duties, use of control equipment, map reading, and tactics.
- Rehearsals or MAPEXs to ensure complete understanding of the exercise.
- Orientation on the conduct of the AAR.

[Appendix E](#) describes controller, evaluator, and umpire training.

Controller Reports. The chief controller prepares a guide for reports. It lists required reports, provides the format for those reports, and designates special areas of interest for evaluation during each part of the

exercise.

Administrative and Logistics Plans

The administrative and logistics plan provides for actual combat service support of the exercises. The planning staff G4 coordinates with the G1, G5, and appropriate special staff officers regarding CSS. The G4 determines the availability of essential supplies and maintenance support and plans for medical evacuation and traffic control.

The administrative and logistics plan must match the scenario and operation plan. It contains instructions for the realistic play of CSS for both OPFOR and friendly units. It also provides for the concurrent training of the CSS elements involved. Logistic support must conform to the logistic policies of the exercise. The planning staff G4 coordinates closely with the G1 and G5 to prepare the plan, which covers all phases of the exercise.

Appendixes to the administrative and logistics plan pertaining to CSS must--

- Establish a list of mandatory supply items to be brought to the exercise area by supporting troops.
- Describe the procedures for obtaining and maintaining training supplies.
- Establish available supply rates for all types of munitions.
- Determine logistics requirements for special items such as decontamination materials, fog oil, and NBC simulators.

Planners estimate the required types and quantities of these various supply items early in the planning phase to ensure that the appendixes will contain all this information.

Movement Plan

The number of player units, OPFOR, and control personnel involved in a large-unit field exercise requires the planning staff G4 to prepare a detailed movement plan. This plan coordinates transportation assets and controls traffic. When the exercise is conducted off military controlled land, this plan must be coordinated with appropriate civil authorities. Failure to do so may result in military and civilian traffic problems that could interfere with the exercise time schedule.

Maneuver Damage Control Plan

The maneuver damage control plan is closely related to the claims plan described later in this chapter. The maneuver damage control plan prescribes--

- General policies.
- Responsibilities of commanders and units.
- Areas of responsibility.
- Training and orientation of troops, claims personnel, and repair teams.
- Restrictions, limitations, and precautions to be observed. These include rules governing vehicle travel, use of airstrips and railroads, communications, command post sites, and wire and cable laying.
- The organization and duties of maneuver damage control teams.
- Participation of umpire and control personnel.
- Preexercise reports, spot damage reports, player and support unit location reports, and postexercise repair reports.

If possible, aerial and other photographs of the exercise area should be made prior to and immediately after the exercise. They will assist with cleanup and resolution of maneuver damage claims.

Civil-Military Operations Plan

The CMO plan, prepared by the planning staff G5, establishes the scope and objectives of CMO play in the exercise. It may cover the employment of civil affairs units and staffs during the exercise, as well as those portions of the PSYOP plan consolidating PSYOP activities in support of the civil affairs plan.

Emergency or Readiness Measures Plan

Since forces involved in an exercise may be required for actual operations, an emergency deployment plan is prepared. Multiple and secure notification means are provided for this purpose. The planning staff G3 prepares this plan.

A situation may require implementation of operation or alert plans and warrant the immediate termination of the exercise. If so, the exercise director transmits in the clear a duly authenticated, preselected code word. In turn, the code word is transmitted by each player and control echelon taking part in the exercise, and the exercise is terminated. All communication circuits are cleared for emergency traffic. Circuits out of action due to exercise play are restored immediately.

Planners make careful distinctions between exercise instructions and the actual instructions for an operation or alert plan. Before leaving their garrisons, all units are told the locations and availability of

live ammunition in case play is terminated and execution of a contingency plan is ordered. Live ammunition to be carried during the exercise is loaded according to local SOP. Coordinating and arranging for convoy routes from the exercise location to deployment positions must occur during the planning phase. If the exercise area is an unreasonable distance from the planned deployment position, contingency plans must be developed prior to the exercise.

Orientation and After-Action Review Plan

The planning staff G3 prepares this plan. It contains detailed instructions for orientation before the exercise and for the AAR.

The preexercise orientation is essential to ensure that all personnel start with the same information and carry out their duties with interest and enthusiasm. The orientation develops an understanding of the training objectives and how to attain them. Key personnel are designated to attend the orientation to ensure that player units receive the necessary information. A briefing schedule is published and a rehearsal conducted.

AARs occur as soon as practicable following major events, exercise phases, or ENDEX. Effective AARs are as brief and concise as possible considering the amount of information to be covered. At a minimum, AARs include commanders and staff. If possible, they include participating soldiers. Players discuss their reasons for taking actions. Controllers, umpires, and evaluators make their observations. The OPFOR should give its view of the exercise. In scheduling AARs, planners should consider the physical condition of the soldiers and the locations of units. They also need to consider the time needed to collect, collate, and evaluate reports from controllers, evaluators, umpires, and OPFORs. For larger scale exercises, the G3 should schedule multiechelon AARs, as described in [Appendix G](#).

Information Plan

The planning staff information officer coordinates with all staff sections to prepare a public information plan that will develop public support of the Army's mission. The scope and objectives of the exercise determine the extent of this plan. In the interest of sound public relations, the exercise director should prepare the local population for any unusual or inconvenient situations that may arise.

All exercises have certain security, political, and public relations implications. Planners weigh these implications carefully and formulate a basic concept for publicity for each exercise. They determine a suitable press release date in advance. It takes into consideration the requirements for security, public relations, and items of international and political interest. They weigh the release of detailed information concerning the nature and location of the exercise and the participating forces in relation to security and political implications. Invitations to the press are prepared by information officers and cleared by SSOs. The invitations may request that the exercise be given no publicity until a predetermined date.

When publicity is not desired, planners establish policies for handling press inquiries. The information

plan also provides for--

- Initial releases announcing the exercise.
- The extent of hometown press releases.
- Radio, television, and other news media coverage.
- The extent of press coverage and the invitations to be issued.
- Support of news media representatives.
- Briefings to be given and courtesies to be extended.
- Unit orientation.
- Exercise news publications or other news features.

Claims Plan

When a large-unit field exercise uses privately owned land, buildings, or equipment, the planning staff G4 must prepare a claims plan. This plan is prepared in coordination with the G1, staff judge advocate, engineer officer, G5, and G3. The plan designates--

- A claims officer, who is appointed early to execute the leases for the property required. The same officer is responsible for settling any claims arising from the exercise.
- The amount of land, equipment, or building space required.
- A rental procedure, to include the length of time that facilities or land will be required.
- The limitations imposed on the use of all leased property.
- The means for issuing these instructions to all units.
- A means of processing claims.
- The procedure for obtaining claims releases.
- Off-limits areas.

Comptroller Plan

For funding purposes, large field exercises normally require the assignment of a comptroller to the planning staff. Comptroller activities in support of the exercise include--

- Preparing the comptroller plan.
- Monitoring the exercise expenditures.
- Advising the planning staff on financial matters.

Records and Reports Plan

The planning staff G3 formulates a plan for required records and reports based on the exercise director's guidance. At a minimum, it requires an AAR upon completion of the exercise. The plan designates the commanders who must conduct AARs and prescribes the format, number of copies, and suspense date for after-action reports. All reports are tabulated to show the--

- Proper title.
- Basic references.
- Submitting unit.
- Time interval covered.
- Suspense date.
- Format.
- Number of copies required.
- Method of transmission.

PREPARING THE SCENARIO

Once the exercise director has approved the outline plan, the planning staff G3 and G2, with other staff participation, complete the scenario. Scenarios are stories for training exercises. They list the events that lead up to the points requiring player units to execute their operation orders (OPORDs) and thus begin the exercises. These lists include the facts necessary to place player units in the desired tactical settings prior to STARTEX. Scenarios guide umpire, controller, and evaluator personnel so that the exercise will

progress according to predetermined plans. Although scenarios are normally in narrative form, overlay scenarios may be used for small exercises with limited objectives. Scenarios portray a series of tactical situations. They are supported by OPLANs to include the annexes and overlays necessary to meet the command objectives.

Each free-play scenario presents an initial situation and provides sufficient detail and guidance so the player can prepare an OPLAN, annexes, and overlays. After STARTEX, higher headquarters and the player commander control the activities, based on METT and a realistic enemy. Using this type of scenario, a player is free, within doctrine and the higher unit OPORD, to initiate activity. Each controlled-play scenario presents detailed situations and events created to accomplish a specific exercise objective. It is normally keyed to a rigid schedule of events with a predetermined message release list.

The two scenarios differ in purpose. Free-play scenarios allow commanders maximum latitude in executing missions. Conversely, controlled-play scenarios cause commanders to take specific actions in response to pre-determined events.

Controlled-play scenarios are best used when exercise objectives are to train on specific battle staff, survivability, or combined arms and services tasks under specific conditions. Examples include operations in a chemical environment, deliberate river-crossing operations, and military operations on urbanized terrain (MOUT). Controlled-play scenarios are best supported by schedules of events that ensure the timely insertion of incidents.

Free-play scenarios are best used when the exercise objective is to integrate systems, survivability, and battle staff training in the most realistic, full-threat environment possible. Free-play scenarios can use battle simulations such as Pegasus, First Battle, or CAMMS.

Scenarios contain the following elements:

- A general situation that provides the participants with the background information normally available in a combat situation.
- An initial situation that starts the action by the player unit and causes the commander to issue orders committing units.
- A subsequent situation that continues the exercise and causes controllers, umpires, and evaluators to maintain control. It includes all major events necessary to accomplish the exercise objectives within the allotted time.

Considerable guidance is required from player unit commanders regarding the pace of the exercise. The scenario developers must plan thoroughly to balance the number and types of requirements placed on the players and the time allocated to complete them. The planners must not attempt to do too much in too little time. It is better to conduct a few events to standard and have time for conducting good AARs and

for repeating any events as necessary, rather than to attempt more events than can be executed using the appropriate troop-leading procedures.

General Situation

At a minimum, the general situation includes--

- A general statement describing the events that precipitated the current situation causing the commitment of US forces.
- The strategic and tactical situation, to include friendly forces two echelons higher.
- A description of the OPFOR situation, to include the disposition of their forces two echelons higher.
- An analysis of the area of operations.

In developing the general situation, planners should establish the troop list of the next higher echelon and the time frame for the execution phase of the exercise. Adjustments can be made as the training and support situations change; however, major revisions should be avoided.

Initial Situation

The initial situation places the player unit in a tactical situation before STARTEX. If a preexercise phase is used to prepare an OPLAN, the prepared OPLAN is converted to an OPORD at, or prior to, STARTEX by a fragmentary order (FRAGO). However, if a preexercise phase is not used, an OPLAN is developed during the initial phase. It provides the basis for subsequent operations. The requirements for the initial situation will depend on when the player OPLAN is developed. In any case, the controllers should review the OPLAN for format and content, since the preparation, dissemination, and supervision of plans, orders, and estimates are normally prime objectives of any exercise. The annotated OPORD shown as an annex in [FM 101-5](#) should be used as a model format.

The OPORD causes the player to execute the mission assigned by higher head-quarters. The OPORD clearly expresses the way the player unit commander visualizes the flow of the battle. If the player's OPORD does not comply with higher headquarters' directives or if execution of the order would create a serious safety hazard, the order should be returned for correction.

The initial situation should cause the G2/S2 to begin IPB. Through careful analysis of the terrain, avenues of approach, and adversary doctrinal templating, the player unit can determine the most dangerous avenue of approach and the most likely enemy configuration. At STARTEX, the player unit should have sufficient enemy intelligence information as would realistically be available in wartime. This information should be provided through player channels to the lowest level to ensure a consistent portrayal of the

enemy situation. Failure to disseminate intelligence to subordinate units should be addressed in the AAR.

Subsequent Situations

Exercise planners develop the subsequent situations by creating a list of events that--

- Ensures a logical flow for the exercise.
- Obtains a realistic time estimate for the entire exercise.
- Ensures all training objectives are achieved.

Events are concise written statements of tactical activities. Planners list them in chronological order and estimate when they will occur. They may cross reference events and their scheduled times by arranging both in column format. Such a list will help the exercise flow to a logical conclusion. Once they prepare the list of events, planners develop corresponding incidents with execution times, if appropriate, that provide controllers, umpires, evaluators, and OPFORs with a way of realistically presenting each event to the player. The list should indicate--

- Where each event or incident takes place.
- Who is involved in each.
- How each is initiated.

The events, incidents, and additional information become a schedule of events and an enclosure to the scenario. The enclosure is an abbreviated publication arranged chronologically in column format. It provides a ready index to the time, place, soldiers or units involved, and the activity planned for a given situation. It also estimates the time required to conduct the exercise, including the time for troop orientation before STARTEX and for an AAR after each exercise phase or at ENDEX. Planners should adjust this time estimate after the exercise is rehearsed. For free-play scenarios, the schedule of events will be much less detailed than for a controlled-play scenario. Items on the schedule of events cause specific actions or reactions by the players within or among various systems. The schedule of events should provide sufficient information to allow follow-up and observations by controller and umpire personnel. These events, actions, and reactions become topics of discussion in the AAR.

PREPARING AN OPERATION PLAN

The exercise scenario is the basis for the OPLAN. The OPLAN is the responsibility of the planning staff G3. However, all members of the planning staff must share in developing the OPLAN to produce the various supporting annexes and overlays that it requires.

The complexity of the OPLAN may vary with the scope of the exercise. For example, the OPLAN for a battalion-level exercise may be issued as a verbal order. Warning orders and FRAGOs to initiate, continue, change, or halt operations are often prepared in advance in support of exercises conducted for the purpose of evaluating or testing multiple units under like conditions.

PUBLISHING THE LETTER OF INSTRUCTION

The LOI provides exercise information to all participants. It may include references to information such as the maneuver damage plan or the safety SOP, already published in other sources.

The LOI is prepared in a format that is easy to use and provides all the necessary information. If the exercise is very large or complex, annexes to the LOI may address specific subjects.

The first draft of the LOI is published far enough in advance of STARTEX to allow all concerned agencies, major subordinate commands, and special staff members to respond and submit comments. The final version of the LOI is published only when these comments have been considered and incorporated. At division level, planning should start at least 60 days prior to STARTEX. For exercises above division, a minimum of 30 additional days should be allowed for each echelon.

Those who plan and participate in exercises must be kept well informed throughout the planning process. The LOI should not be used as the sole method of providing information. Briefings, updates, fact sheets, or in-process reviews (IPRs) may also be used, as appropriate or whenever important changes occur that will influence the exercise development.

PREPARING A CONTINGENCY PLAN

The planning staff G3 is responsible for preparing the contingency plan. It stipulates what actions are to be taken in the event of adverse weather, actual war, or other factors limiting exercise. If the plan calls for an alternate exercise, then the planning process for it must be given the same consideration as the original exercise, including the appropriate support plan.

PREPARING THE TERRAIN

Preparation of the terrain may be necessary to provide a realistic environment, to protect the terrain from excessive maneuver damage, and to ensure troop safety while employing high-mobility systems. For example, in a live-fire exercise, electronically or mechanically controlled targets may be in-stalled in foxholes or bunkers to represent the OPFOR. Dug-in, remotely controlled machine gun simulators may represent OPFOR fire from the objective. Barbed wire obstacles on the objective, demolition pits along the routes of approach, enemy fighting positions, and simulated gun emplacements can all add realism. Safety devices to facilitate control and safe operation should be installed when-ever demolitions or live-fire exercises are incorporated in the training exercise.

FIGURE 7. SAMPLE LETTER OF INSTRUCTION.

SUBJECT: Letter of Instruction for Division FTX_____

SEE DISTRIBUTION

1. **PURPOSE.** This paragraph states what the LOI is designed to do; for example, "To provide direction for planning, conducting, and controlling FTX"
2. **GENERAL.** This paragraph provides general background information on why the exercise is being conducted, who is involved, and what will be accomplished.
3. **OBJECTIVES.** Each objective of the exercise should be specific and keyed to ARTEP task/unit mission and individual and collective tasks. The objectives should be listed in subparagraphs.
4. **CONCEPT OF OPERATION.** This paragraph is either a narrative description or a general listing of major events that will occur. Overlay annexes are included.
5. **RESPONSIBILITIES.** Specific responsibilities of the staff and major subordinate commands are listed in subparagraphs.
6. **COORDINATING/ADMINISTRATIVE INSTRUCTIONS.** This paragraph lists instructions that apply to two or more units or staff sections.

FOR THE COMMANDER

APPENDIXES AS REQUIRED

APPROPRIATE EXERCISE SUPPORT PLANS

CONDUCTING A REHEARSAL

As a final check on planning, the exercise is rehearsed. This rehearsal does not include players. It occurs far enough in advance of the exercise for planners to correct errors and adjust the schedule. Controllers, umpires, evaluators, and OPFORs should rehearse so that they are all thoroughly familiar with their duties. For large exercises, it is critical to rehearse communications. The agency or individual who originally directed the exercise should be represented at the rehearsal in order to make necessary changes and to approve the exercise.

[RDL](#)[Table of](#)[Document](#)[Download](#)[Homepage](#) [Contents](#) [Information](#) [Instructions](#)

CHAPTER 3

Conduct of Training Exercises

INITIAL CONSIDERATIONS

The training exercises described in this chapter provide the preferred methods to teach, sustain, and reinforce individual and collective skills. They provide training methods to develop, sustain, and evaluate command and control skills. They are essential team-building tools, inasmuch as they teach the employment of the internal and external systems necessary to coordinate and integrate combined arms and services teamwork in order to fight and win air-land battles.

Training exercises are a vital part of the spectrum of training. Commanders use them to train individual, leader, and collective skills in battle staff, survivability, and combined arms and services training. Commanders select a particular training exercise or combination of exercises based on specific training objectives and on available resources. They select the specific training exercise that will best attain their objectives and expend the fewest resources.

COMMAND AND CONTROL PROFICIENCY

In order to conduct successful maneuvers or FTXs at battalion level and above, commanders and their staffs must already be proficient in fundamental command and control skills. The exercises described in this chapter train staffs to issue orders in a timely sequence so that the available combat power can be committed at the right place and time. Exercises allow commanders to train their staffs--

- To prepare orders to maneuver or move units.
- To plan and coordinate fire support.
- To integrate all supporting systems.

CONTENTS

INITIAL CONSIDERATIONS

Command and Control Proficiency

Active Involvement

Autonomy

MAP EXERCISES

Description

Phases

TACTICAL EXERCISES WITHOUT TROOPS

Description

Phases

COMMAND POST EXERCISES

Description

Phases

FIELD TRAINING EXERCISES

Description

Phases

COMMAND FIELD EXERCISES

Description

Phases**LIVE-FIRE EXERCISES**DescriptionPhases**FIRE COORDINATION EXERCISE****DEPLOYMENT EXERCISES****JOINT TRAINING EXERCISES****COMBINED TRAINING EXERCISES**

Engineer barrier plans, for example, must be coordinated with final protecting fires. Battalion battle positions and natural obstacles must be tied to engineer tank obstacles. Where appropriate, exercises should use automated data information and automated data processing (ADP) systems to teach operators to support staff requirements. Moreover, scenarios should be intense enough to stretch ADP systems in providing timely information.

ACTIVE INVOLVEMENT

Commanders must caution their staffs to recognize that reality is the basis for decision making. Operations centers, current situation maps, and ADP printouts are not reality. They are no more accurate than the fragmentary information fed into the tactical operations center (TOC). Decision making must ultimately rely upon the commander's judgment based upon his personal observation of the battlefield. The purpose of the staff training through simulations, TEWTs, and ultimately major exercises is to teach unit teamwork and the proper preparation of estimates and orders in support of the commander.

The well-trained staff assists the commander in recognizing the critical actions unfolding on the battlefield. The commander positions himself behind the main effort to encourage his soldiers, to see the battle develop, and to be in position to make the critical decisions that will determine the outcome of the battle. The staff members take the commander's decisions and use their communications and their teamwork to make maximum combat power available to implement his decisions. Exercises teach the unit to achieve this vital teamwork that enables the commander to translate his decisions into actions that produce a decisive advantage at the critical period of the battle.

AUTONOMY

The commander teaches his staff to operate without him. Inasmuch as he can seldom be at the TOC except to receive a periodic update during periods of reduced activity, the commander uses a series of exercises to train the staff. He ensures they are capable of continuous operations by insisting upon designation and observance of working shifts. The next war is unlikely to be a short war. Consequently, the commander must teach the staff to make operations routine, allowing personnel to be rested and alert for their tour of duty. To avoid a break in duty personnel thoroughly abreast of the tactical situation, officer and NCO shifts should not coincide.

The commander should receive an update briefing from the staff upon his return to the TOC. This practice requires the staff to maintain an estimate of the situation, which is continually updated during the course of their duties. TOC operators brief their replacements when relieved at the end of their tour of duty. The update briefing for the commander normally takes one of two forms: a formal briefing attended by the senior shift personnel or individual updates for the commander at each staff section.

The commander uses the update to ensure his estimate of the situation is current, to evaluate the staff estimate, and to train the staff. Normally the commander, who has observed the major actions of the unit and visited his subordinate commanders, will have more current information than does his staff. The staff update will often show that subordinate units have failed to report essential information that SOP requires them to report. This experience teaches the staff to insist upon prompt and continuous reporting. During the update briefing, the commander coaches the staff on the proper formulation of estimates, a disciplined thought process developed over time.

Through the conduct of austere exercises, the commander trains his commanders and the staff so that they are prepared to perform their duties during maneuvers or the conduct of combat operations. During a MAPEX or CPX, the commander can observe individual staff sections and critique specific actions, such as--

- Posting situation maps.
- Using radio telephone procedures.
- Preparing estimates and orders.
- Exchanging information within the staff.
- Arranging the TOC to facilitate coordination.

The commander must emphasize coordination and information flow since they are essential to an efficient operation. He must insist that information be disseminated down the chain, as well as to higher and adjacent units. Each echelon can become a filter of essential information unless the staff continually works at information sharing. Recognition that the staff serves the lower units, as well as the commander, is a profound concept--a mark of professional staff organization.

Mastery of troop-leading procedures allows subordinates adequate time to issue warning orders, to conduct reconnaissance, and to prepare and issue timely orders. Such mastery is a key training objective of the commander. This objective can be achieved only through practice. The time for mistakes and omissions is during training exercises that do not involve troops. The AAR should highlight this important dimension of command and control, upon which successful operations are predicated. Once the commander's concept of operations is provided to his commanders and detailed orders are published, a shared understanding of operations is established. It can become the basis for verbal FRAGOs to adjust to the changing tactical situation. The compression of time in the troop-leading steps for the use of a FRAGO is made possible by the previous employment of full troop-leading steps. These ensure a common understanding of the enemy, mission and friendly situation, current control measures, and detailed reconnaissance (map or ground) of the operational area. The teamwork of a trained staff facilitates this process. Staff proficiency and teamwork are developed over time through the exercises discussed in this chapter.

FIGURE 8. KEY QUESTIONS IN SELECTING EXERCISES.

Who will be trained (leaders, soldiers, teams, or units)?

What are the training objectives?

Which, if any, of the training exercises are most suitable to accomplish each objective?

What are the available resources (time, training areas, or equipment)?

Which of the training exercises or combination of them will help meet the training objectives within the available training resources?

MAP EXERCISES

DESCRIPTION

MAPEXs are low-cost, low-overhead training exercises that portray military situations on maps and overlays that may be supplemented with, or replaced by, terrain models and sand tables. MAPEXs allow commanders to train their staffs to perform essential integrating and control functions to support their decisions under simulated wartime conditions. MAPEXs may be employed by commanders to train the staffs at any echelon--

- To function as effective teams.
- To exchange information.

- To prepare estimates.
- To give appraisals.
- To make recommendations and decisions.
- To prepare plans.
- To issue orders.
- To be proficient in integration of all branch elements of the teams.

MAPEXs are suitable for command and control training from battalion through corps levels. They are especially useful for multi-echelon staff training when commanders want to involve the minimum number of soldiers while fully exercising staff procedures and techniques at multiple echelons. MAPEXs are relatively inexpensive. Their scenarios derive from event schedules or from battle simulations, depending upon the resources available.

MAPEXs can provide survivability training through the practice of continuous operations, operations in a mission-oriented protection posture (MOPP) 4 environment passing control to alternate operations centers and jump CPs, as well as practice in operation in a dispersed posture.

Characteristics

MAPEXs should attempt to portray the battlefield as realistically as possible. They should include NBC play, both defensive and offensive, to demonstrate and prepare participants for the physical and psychological effects of continuous NBC operations. They portray exercise administrative and logistical situations realistically to integrate all aspects of the battle. They portray EW realistically to allow participants to achieve proficiency in working through jamming and in exercising appropriate countermeasures.

Controllers must consider how the information they input affects player staff sections under actual battle conditions. These inputs should make players aware of the tactical and logistical situations, both friendly and enemy, as well as of the impact of the civilian situation upon tactical operations. The control group must render prompt and logical rulings for all tactical and logistical situations that arise. When player and enemy forces make contact, controllers allow the situation to develop until a tactical ruling is indicated or required. The control group assesses casualties and damage and announces engagement results. The company players use this information to paint the battlefield picture to battalion headquarters. Since MAPEXs are training vehicles, players, and controllers must not reveal information unavailable in a real situation.

MAPEXs require the controllers to avoid influencing exercise play artificially since doing so creates

other artificial situations later. Controllers should not interfere with player personnel even though they may be allowed free access to player facilities so they can perform their assigned duties. Controllers should provide their insights and suggestions during periodic AARs to assist players in maximizing lessons learned through the exercise.

Personnel

The player personnel for MAPEXs should include representatives from all elements of the combat team or task force. MAPEXs require control teams to regulate the exercise and cause play to flow to a logical conclusion. The chief controller supervises the entire controller facility and acts as the director of controller personnel. The assistant chief controller acts as the chief battle map (terrain model) controller. He is responsible for the battle portrayal on the map, to include battle damage assessment. The assistant battle map controllers ensure that players report to higher headquarters only what they could observe in an actual tactical situation. They ensure that maneuver, fire support, CS, and CSS functions are realistically portrayed by both friendly personnel and threat controllers. They also arbitrate all points of disagreement concerning battle map play.

The threat controllers ensure that enemy actions are portrayed according to threat doctrine and the exercise order of battle. They begin the exercise by displaying the initial threat situation prepared by the exercise planning group. They continue exercise play by interacting with the player commanders and by continually presenting realistic situations using threat tactics. The damage assessment controllers assess personnel and equipment loss and determine when damaged equipment and wounded personnel can be returned to action. Controllers must not usurp player functions. For example, medical personnel of the player unit should be required to determine when or if wounded personnel can return to the battle.

The number of control personnel required depends upon the size of the player organization and the scope of the exercise scenario. If a simulation drives the MAPEX, the instructions contained in the simulation package will provide guidance for developing controller manning tables.

Both controller and player personnel must understand the specific job positions and command echelons represented by members of the control group. The control group represents all persons and units except those specifically represented by the player units.

Equipment and Facilities

MAPEXs require only minimal equipment. It may consist of the following:

- Exercise maps sufficient in number to meet the demands of the exercise objectives. Terrain models or sand tables that are exact replicas of the maps may be used in conjunction with the maps or alone. If they are used, they should be large enough to allow all player and controller personnel to observe and to perform as assigned.

- General purpose items such as office supplies, overlay production material, message and journal logs, report forms, unit SOPs, and appropriate reference materials.
- Simple point-to-point wire communications to permit simulation of communication links to be practiced during the exercise. If radio or wire links are employed in an operational environment, players should not be permitted to make face-to-face communication with other players.

Requiring little communications equipment and a minimum number of support personnel, MAPEXs may be conducted in permanent or temporary locations. Planners must provide buildings or tents large enough to house both player and control functions. The work area should be relatively uncrowded. Planners must make provisions for security, visitor reception and briefing, food service, and vehicle parking, as appropriate. If the MAPEX is conducted away from the unit's cantonment area, planners must arrange transportation and medical support. If the MAPEX is to last longer than one day, they must arrange for billeting.

PHASES

Preexercise

Prior to selecting the MAPEX training mode, commanders must ensure that staff members and leaders are familiar with the individual skills of their duty positions and the collective skills of their staff section or command group. Full proficiency is not required for participation, inasmuch as the purpose of the MAPEX is to build proficiency.

Planners must consider the planning steps discussed in [Chapter 2](#). Commanders and staffs at battalion level plan and conduct MAPEXs for their own units. At higher echelons, planning staffs and controller teams plan, prepare, conduct, and review the exercise. Once the objectives, scope, troop list, exercise area, and outline are approved, the player unit commander and selected unit personnel should be briefed on the exercise. The commander of the player unit uses the MAPEX LOI as the basis for providing exercise information to subordinates. The planning staff also uses the LOI to brief controllers, umpires, and evaluators.

Normally 24 to 48 hours before STARTEX, the controllers train the players in the conduct of the MAPEX. Players who receive battlefield information directly from controllers must have additional training on how to translate it into usable and recognizable formats. These formats include spot reports, situation reports, NBC reports, shell reports, and others.

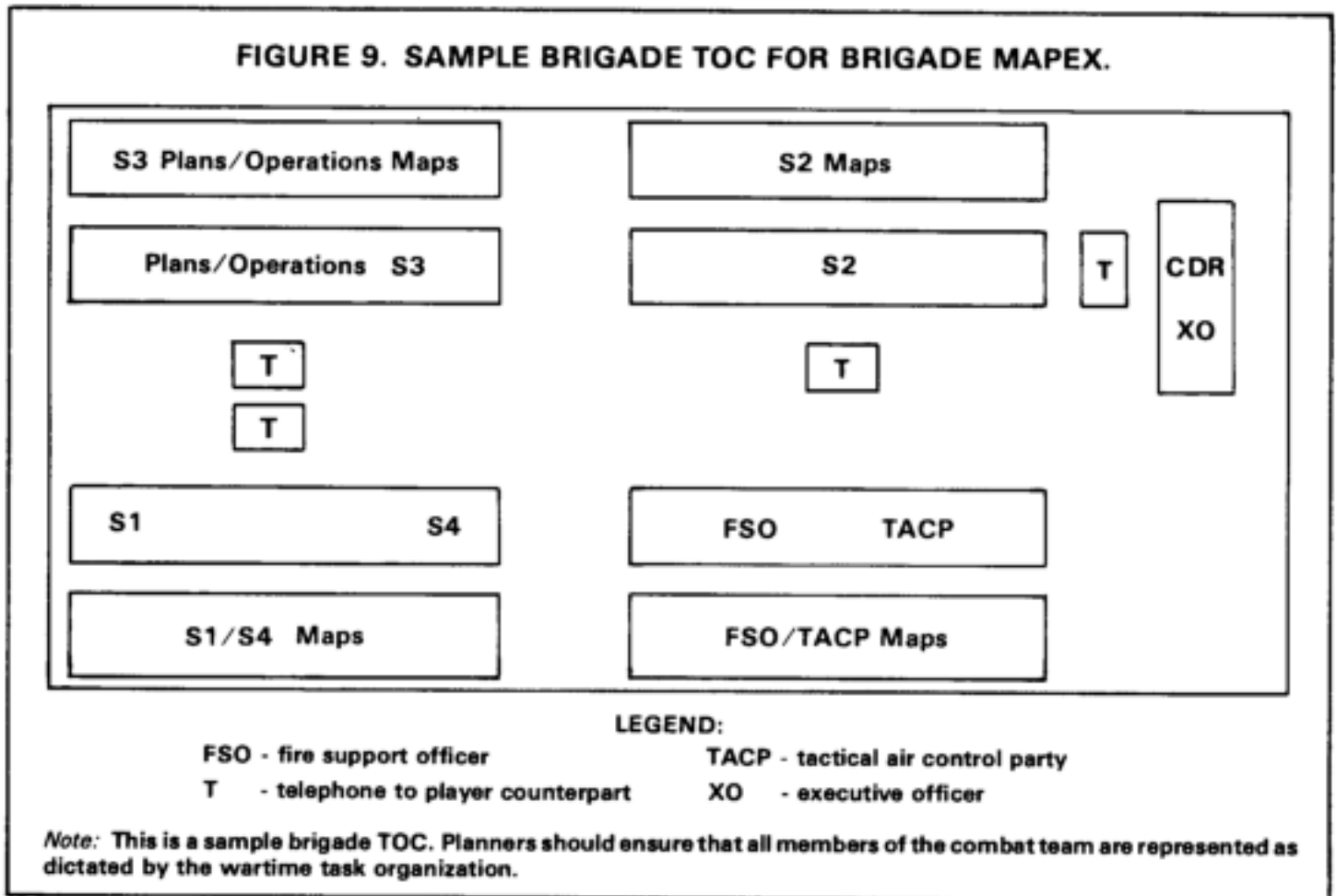
FIGURE 9. SAMPLE BRIGADE TOC FOR BRIGADE MAPEX.

Controller and player training prior to a MAPEX involves the following:

- Purpose and scope.
- Training objectives.
- Participating units.
- Enemy situation.
- Control organization.
- Communications plan.
- Casualty and damage assessment.
- Time delays in message transmission.
- Controller records and reports.

- Intelligence play.
- War-game procedures.
- Information flow.
- In-progress and after-action reviews.
- Controller duties.

Execution

The LOI for the MAPEX will include instructions for moving to the exercise site, if appropriate. Time must be set aside and personnel assigned prior to STARTEX to install any necessary point-to-point wire communications, to set up the player and controller TOC, and to prepare maps, sand tables, or terrain models.

Prior to STARTEX, the chief controller gives the player commander a commander's update briefing. This briefing includes any changes to the LOI not already announced or any items requiring reiteration. The chief controller may assume the role of the player unit's higher commander, unless the commander elects to play this role himself in the training of his subordinates. At this point, the chief controller is briefed by controllers representing staff members. This briefing sets the stage for the remainder of the exercise and imparts realism. The chief controller, acting as the higher commander, converts the exercise OPLAN to an OPOD and announces that staff members are available for coordination with their player counterparts. This normally constitutes STARTEX.

FIGURE 10. SAMPLE BATTALION TOC FOR BATTALION MAPEX.

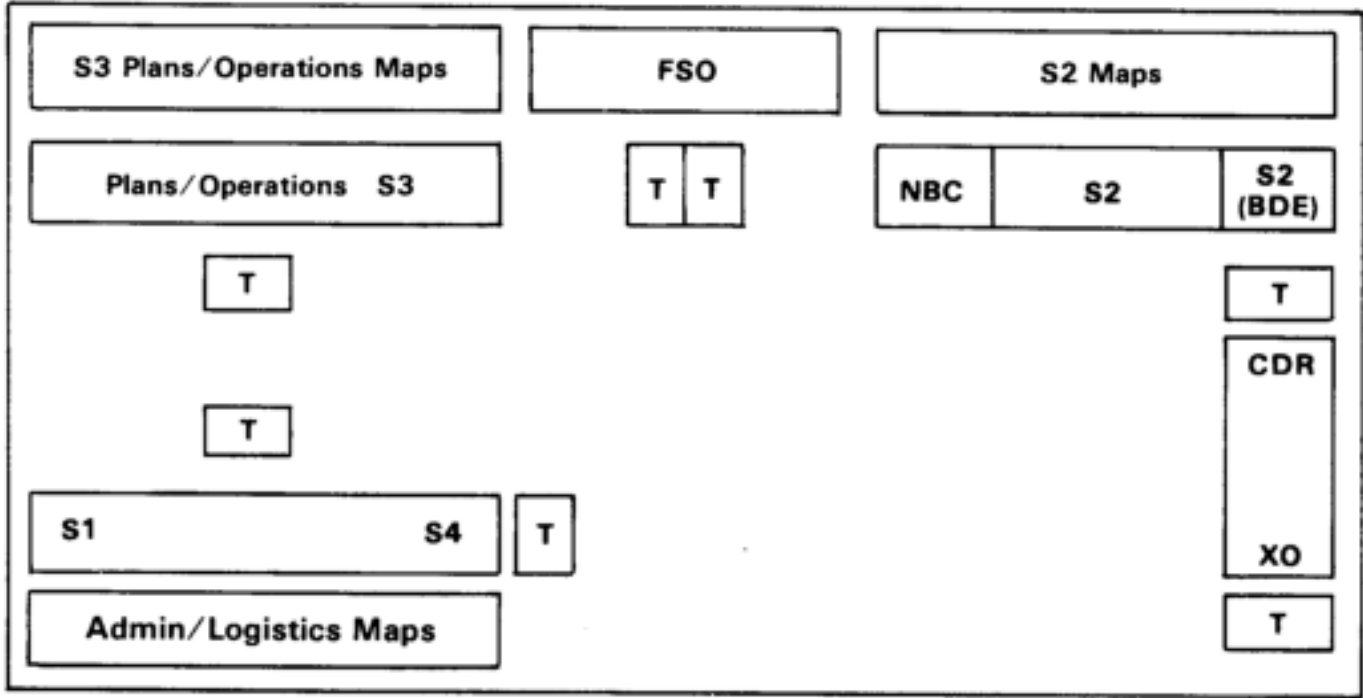

Note: This is a sample battalion TOC. Planners should ensure that all members of the combat team are represented as dictated by the wartime task organization.

FIGURE 11. BRIGADE MAPEX CONTROL FACILITY.

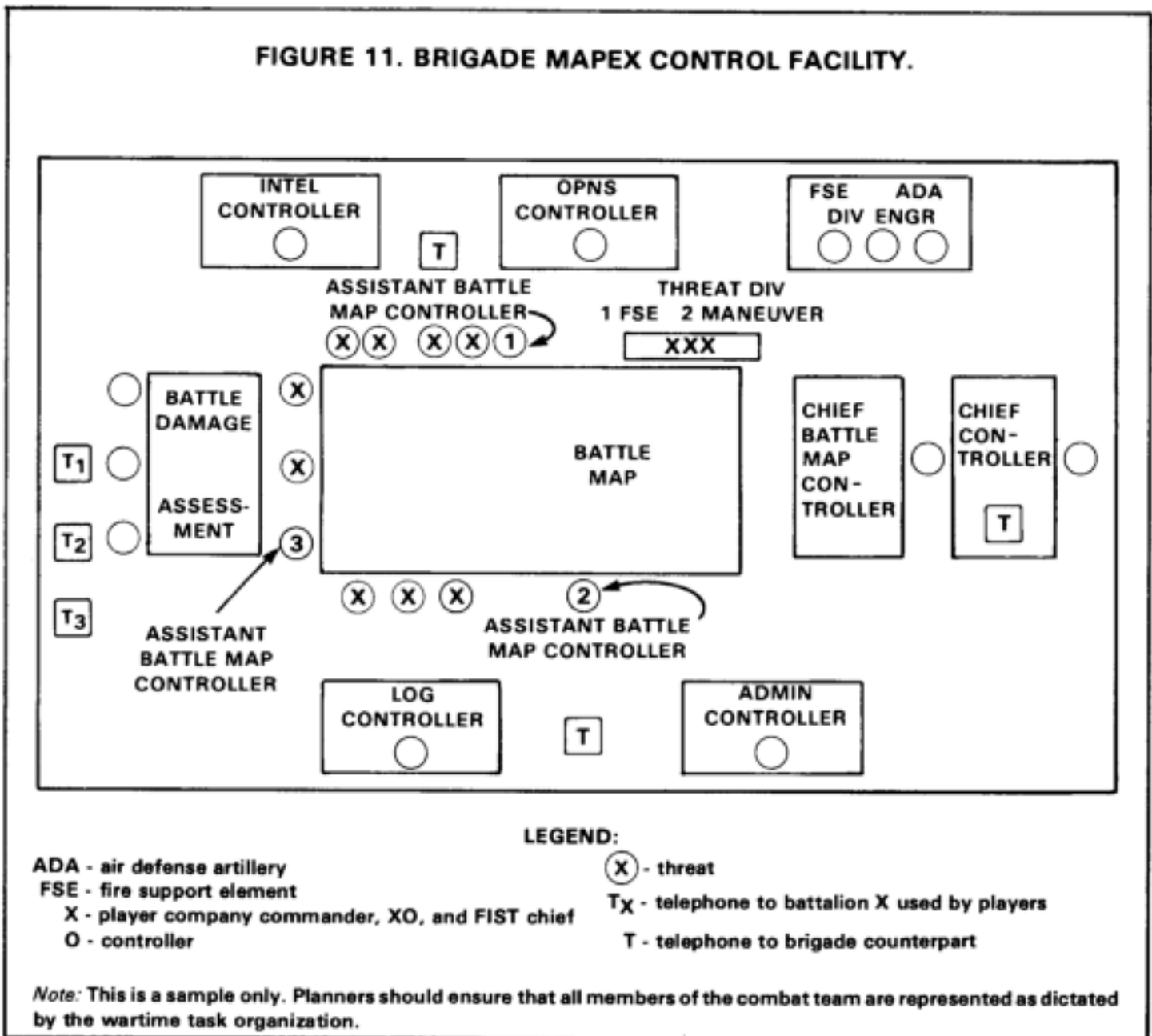

The brigade-level MAPEX functions as follows:

- The players are presented with a general and a special situation.
- The players react to the situation and provide information and reports to higher, lower, and adjacent units, as appropriate.
- The control group, in its role as higher headquarters, evaluates the player orders for mission accomplishment, fights its portion of the air-land battles, and responds to player requests for support, as appropriate. At the same time, company commanders gather around the battle map and fight the battle according to battalion orders.

- The results of battle board actions are relayed to the player battalion headquarters in the form of reports and requests. These portray the battle and create new situations requiring additional player actions or reactions. Battalion TOCs, in turn, feed information, reports, and requests to the brigade.
- The players react to the new situations as they normally would in combat. This forces the brigade and battalions to alter battle plans, issue FRAGOs, and place demands on CS and CSS units.
- This process continues until the MAPEX ends.

Postexercise

At ENDEX, the chief controller holds an immediate AAR so that all players and controllers gain the maximum training benefit from the exercise. At a minimum, the AAR should--

- Provide an opportunity for the players and controllers to exchange information, ideas, and lessons learned.
- Allow the threat controllers to explain their battle plans, battle outcomes, and strength at ENDEX. An assessment of future threat capabilities should also be presented.

[Appendix G](#) contains a complete discussion of the AAR and after-action reports.

TACTICAL EXERCISES WITHOUT TROOPS

DESCRIPTION

TEWTs are low-cost, low-overhead exercises conducted in the field on actual terrain suitable for training units for specific missions. Using few support troops, TEWTs are used by commanders to train subordinate leaders and battle staffs at any echelon--

- To analyze terrain.
- To employ units according to terrain analysis.
- To emplace weapon systems to best support the unit's mission.
- To plan conduct of the unit mission.
- To coach subordinates on the best use of terrain and proper employment of all combat arms (CA), CS, and CSS assets.

Unit personnel participate in a TEWT as members of small groups. The commander or his S3 orients them on the terrain, pointing out prominent features and their importance to the exercise. The commander then presents the special situation--an extension of the general situation that was issued in advance of the TEWT--followed by the initial requirement. Group members then solve each requirement individually and prepare to present their solutions. Next, the group discusses individual solutions and develops a group solution. The commander critiques the group and presents his solution. Discussion of individual solutions generates interest and understanding of tactics and optimum use of the terrain. By allowing group leaders to explain unit dispositions for a given operation, TEWTs create a favorable environment for a professionally challenging and informative class on subjects that impact directly upon the unit mission.

Characteristics

For a successful TEWT, the commander must select the proper terrain and reconnoiter it. This process is vital since the TEWT teaches tactics by using actual terrain. The general area is selected from a map reconnaissance and then followed up with an on-the-ground reconnaissance. Sites preselected should be appropriate for the training objectives and flexible enough to portray more than one practical solution. The various locations selected for specific events during the reconnaissance become training sites for specific situations. The time schedule identifies these locations by six-digit grid coordinates.

Personnel

The personnel participating in a TEWT are subordinate commanders, leaders, and staffs selected by the unit commander. Commanders or S3s from direct support organizations may supply advice on situations concerning their own specialties. Based on their participation, the TEWT can provide combat team training. The participants from supporting organizations should be consulted during the preparation of the exercise and be available during its execution.

The procedures involved in the TEWT can also be applied to achieve battle staff and combined arms training in--

- MOUT.
- Deployment planning.
- Mobilization planning.
- Amphibious operations.
- Combat and field trains establishment and operations.
- Intelligence-gathering techniques.

Equipment and Facilities

Equipment required for a TEWT depends on the amount of time to be spent on the exercise and the objectives of the exercise. TEWTs are always conducted in the field on terrain suitable for training the units to perform in specific missions.

PHASES

Preexercise

Prior to selecting the TEWT training mode, commanders determine whether subordinate leaders and staff members are proficient in the individual and leader skills their duty positions require. Although a TEWT may be the best way to teach tactical principles on the ground, it does not emphasize time and distance factors and their significance for effective troop-leading procedures. Before conducting other exercises with soldiers, commanders should recognize these limitations and provide appropriate emphasis to ensure that participants recognize how important time, distance, and light conditions are to actual operations. Planners must consider the planning steps discussed in [Chapter 2](#).

The exercise directive for a TEWT can be as simple as a warning order from the commander that states--

- Why the TEWT is being conducted.
- Who will participate.
- What equipment is required.
- When and where the TEWT will be conducted.
- What the special instructions are.

Plans for a TEWT are normally formatted by the unit staff and should include the tasking of assistant trainers, if required.

Research for a TEWT consists of--

- Reviewing missions, weapons capabilities, and tactics.
- Reviewing appropriate laws, regulations, and SOPs pertinent to the use of a particular piece of land.

During the preliminary reconnaissance of the terrain, the planners--

- Walk the terrain, making a careful inspection of the entire area to ensure that the military aspects of the terrain are fully appreciated. The commander normally makes this reconnaissance and selects teaching points that support his mission, as well as his training objectives.
- Take notes at each training site concerning the problem to be presented and its solution.
- Select the initial rendezvous point for all personnel.
- Choose vehicle parking areas, if required.
- Confirm routes and movement times from vehicle parking areas to each training site and between training sites.
- Select an area for meals, if necessary.

If the TEWT is to be conducted off a military reservation, planners must contact landowners to get permission to use the land.

After the first reconnaissance, planners prepare a draft of the exercise with situation narratives for each requirement and solution. They may have to visit each training site several times to finalize details of the situation and to check the proposed solutions. Doing so is particularly important if the solutions will become the bases for subsequent situations and requirements.

Once the commander approves the tactical problems and solutions, a scenario is developed. The scenario includes a general situation, initial situation and requirement, subsequent situations and requirements, and a time schedule. The general situation describes the friendly and enemy units involved, their locations on the ground, and the significant activities for the previous 24 hours. Subsequent situations and requirements are derived from the training objectives.

The time schedule should indicate the estimated time needed for presenting each situation and requirement at each training site. The schedule helps ensure that no one spends too much time on any one requirement or at any one location. Figure 3-5 shows a time schedule for a single training objective covered at two different locations.

Once the time schedule is developed, the scenario is checked to ensure that it fits the terrain selected. During this check all likely responses to situations and requirements should be war-gamed.

Narratives covering the subsequent situations should create a realistic battlefield picture. They should be as short as possible, be compatible with the exercise, and contain only the information players need to weigh relevant factors and produce an acceptable solution. Narratives should cover the composition of

forces and the air situation. Participants are expected to know the TOE and weapon capabilities; consequently, the problem is normally in the form of orders and appropriate graphics. Short verbal orders to introduce new situations will not only save time, but also give subordinate commanders and staffs practice in working from verbal orders.

FIGURE 12. SAMPLE TIME SCHEDULE.

EVENT	TIME
Introduction	5 minutes
General Situation	2 minutes
Situation and Requirement (XT 532486)	120 minutes
Travel	15 minutes
Situation and Requirement (WT 416483)	120 minutes
Summary	15 minutes
	<hr/>
	4 hours, 37 minutes

The LOI includes--

- Administrative instructions (mess, transportation, medical).
- Maneuver damage procedures.
- Actual time and duration of the TEWT.
- Training objectives.
- Personnel to be trained.
- Preexercise training requirements.

The OPORD for the TEWT should be issued at least 24 hours prior to STARTEX. It is written in the five-paragraph field order format with annexes, as appropriate. It contains information developed from the general and initial situations and the first requirement.

Execution

For a battalion-level TEWT, the battalion commander begins at the first training site by explaining the purpose of the exercise and the tasks to be covered. The commander then presents the general situation, the initial situation, and the first requirement.

FIGURE 13. SAMPLE SITUATIONS.

General Situation: Task Force 1-66 has recently been conducting offensive operations against the 318th Motorized Rifle Regiment. Due to heavy casualties, the task force has been temporarily forced into a defense. Your team, Team A, is the task force left flank with Task Force 1-67 on its left and B Team on its right. During this exercise, you will be the Team A commander.

Initial Situation: The task force is temporarily going into a defense to await replacements. The mission is to defend by 1100 today. The team defensive sector is indicated on the overlay.

Requirement: Conduct a reconnaissance to select platoon positions and prepare a five-paragraph field order for the conduct of defense. Be prepared to present your order in one hour.

After giving the first requirement, the commander--

- Allows time for players to develop solutions.
- Selects one leader to present a solution.
- Selects other leaders to present their solutions.
- Guides a discussion of the various solutions.
- Presents a solution and the reasons for it.
- Guides a discussion of all solutions for the requirement and explains the preferred solution.
- Gives instructions and time limits for proceeding to the next training site.

This procedure occurs at all subsequent training sites until the TEWT is completed.

FIGURE 14. SAMPLE SUBSEQUENT SITUATION.

Subsequent Situation: The enemy situation remains unchanged. The company is deployed as indicated on the map in front of you. Bravo Company has received the attachment of an infantry platoon and an engineer platoon.

Requirement: The company will conduct an attack commencing at BMNT to seize high ground dominating the approaches to river-crossing sites required for TF 1-66 to continue the attack in the sector. B Company will initiate the attack to secure objective Zulu from coordinates XT 153462 to coordinates XT 154475. Conduct your reconnaissance and prepare a five-paragraph field order. Be prepared to present your order in two hours. I will meet you at grid coordinates XT 123456 at 1400 to discuss your order.

Postexercise

Inasmuch as the TEWT is a formal part of the officer development program of the unit, the lessons learned should provide a foundation for subsequent instruction. Materials compiled during preparation and conduct of the TEWT may be retained for reference on future TEWTs. Some service schools offer additional information and examples of TEWTs through their catalogs of instructional materials. Planners should consult these catalogs to determine the suitability and availability of appropriate supporting materials.

COMMAND POST EXERCISES

DESCRIPTION

CPXs are medium-cost, medium-overhead training exercises that may be conducted at garrison locations or in the field. In garrison, CPXs are expanded MAPEXs using tactical communications systems and personnel in a command post environment. Normal battle-field distances between the CPs are usually reduced, and CPs do not need to exercise all tactical communications.

The most effective CPXs are conducted in the field. In field operations, time and distance should realistically reflect AirLand Battle doctrine. Operations should be continuous and use all organic and supporting communications equipment. Commanders practice combined arms integration and tactical emplacement and displacement of CPs. Each headquarters should practice survivability operations such as dispersion, camouflage, and security.

Commanders use CPXs to train subordinate leaders and staffs at all echelons--

- To function as effective teams and build cohesion.

- To exchange information.
- To prepare estimates.
- To give appraisals.
- To prepare plans.
- To issue orders.
- To reconnoiter, select, and tactically occupy CP locations.
- To establish and employ communications.
- To displace headquarters and command posts.

CPXs also provide commanders with valuable training experiences in planning and executing CS and CSS activities. Troops other than headquarters and communications personnel are normally represented by controllers. CPXs may be driven either by master schedules of events or battle simulations.

Characteristics

Successful CPXs are conducted under battlefield conditions. To validate staff and unit procedures, tactical exercises integrate nuclear and chemical weapons employment; NBC warning and reporting; reconnaissance; and MOPP, logistical, decontamination, and smoke operations. Administrative and logistical situations are portrayed and played realistically so that player commanders and staffs realize their effects on all aspects of the battle. EW should be portrayed to show how important it is to all elements and how it hinders commanders and staff officers who are not prepared for it.

Controllers should avoid influencing exercise play artificially since doing so creates other artificial situations later. When inputting information, controllers consider which player staff section would be most affected under actual battle conditions. Inputs should make the player personnel aware of the tactical and logistical situations and cause player action. Field CPXs should force the player units at all echelons to emplace and displace their TOC. TOC displacement teaches the units to use tactical and main CPs, to perform continuous operations and reconnaissance, and to set up organic and supporting communications systems. It also provides realistic time and distance experience.

The control group renders prompt and logical rulings for all tactical and logistical situations that arise during exercise play. When player and threat forces make contact, controllers allow the situation to develop until a tactical ruling is indicated or required. Rulings are based on results obtained from war-gaming, based on player-directed actions. The control group assesses casualties and damage and

announces engagement rulings. The company players use this information to paint the battlefield picture to the battalion headquarters. Controllers are allowed free access to player facilities to perform their assigned duties, but they do not interfere with player personnel.

Personnel

In addition to the commander, staff, and subordinate commanders and staffs of the player units, CPXs require controllers and evaluators. The controllers, directed by the chief controller, manage the exercise and cause play to flow to a logical conclusion. The evaluators observe player activities to determine if tasks are performed to preestablished standards at each echelon. The number of evaluators and their qualifications depend on the scope of the exercise and the tasks or procedures to be evaluated. If an external evaluation has been directed, the chief evaluator will form evaluator teams.

It is essential that both controller and player personnel understand the specific job positions and command echelons represented by the control group. The control group represents all persons and units except the job positions and functions specifically represented by the player units.

The exercise control center (ECC) functions as the player unit higher headquarters. One of the functions of the ECC is to monitor the player actions, situations, and plans. ECC personnel also--

- Maintain controllers' battle maps.
- Portray the threat force.
- Insert incidents and messages.
- Assess equipment and personnel losses.

The chief controller is in charge of the ECC and all subordinate controllers, umpires, and evaluators. Additionally, the chief controller acts as the higher commander. Staff controllers act as the higher HQ staff. In support of the chief controller, they fight the air-land battles. They prepare orders, request information, and receive and act on reports and requests from the players. The assistant chief controller acts as the chief controller when necessary and performs as the higher HQ chief of staff for the player units.

The service support controller supervises the activities of the service support staff controllers. They prepare orders, request information, and act on requests and messages from players.

OPFOR controllers are responsible for enemy actions according to threat doctrine and order of battle. They show the initial threat situation prepared by the exercise planning group. They also interact with the player company commanders and continually present them with realistic situations using threat tactics.

Damage assessment controllers assess personnel and equipment losses and determine when damaged equipment and wounded personnel can be returned to the player for use in the CPX. They do not circumvent actions taken by the players. For example, medical personnel in the exercise determine when wounded personnel can be returned to action.

Player personnel include the company commanders, XOs, and FIST chiefs from the battalions. They execute the battalion OPORD and fight the battle according to orders received. Since the exercise is a training vehicle for the battalion, they do not reveal information unavailable in a real situation.

Equipment and Facilities

The equipment required for a CPX consists of--

- Communications equipment to replicate the higher headquarters of the player unit.
- General purpose items such as office supplies, overlay production material, message and journal logs, report forms, unit SOPs, and appropriate reference material.
- Equipment required to replicate the TOC of the player units' higher headquarters if the CPX is to be conducted in a field environment.
- Appropriate military references (field manuals, training circulars).
- Equipment necessary to identify participants and provide security for the TOC (ID badges, signs).

CPXs conducted in garrison require separate buildings or tents large enough to house the control team and player units. The available space should be adequate for the unit's TOC. Provisions should be made for security, visitor reception and briefing, feeding, and vehicle parking. If the exercises are conducted away from the unit's immediate cantonment area, transportation and medical support must also be arranged. Exercises lasting longer than one day require billeting arrangements.

For CPXs conducted in the field, maneuver areas must be large enough for player headquarters to disperse realistically. The control headquarters will ensure good radio and/or wire communications with player units and subordinate control elements. The control headquarters should be located to obtain the best possible communications and to facilitate travel to and from player headquarters. Facilities to support the control headquarters must also be planned. They provide--

- Security.
- Visitor reception and briefing.
- Food service.

- Medical aid.
- Maintenance.
- Hygiene.

The amount of outside support required for the control organization depends on the scope and duration of the exercise. Assistance from outside agencies may be required in the following areas:

- Prepackaged battle simulations.
- Additional communications.
- Additional map coverage.
- Maneuver area clearances.
- Billeting.
- Medical support.
- Food service.

Sample division CPX controller facility configurations and relationships are shown in the following [diagrams](#). These can be tailored or augmented for use in CPXs conducted at other echelons. These diagrams do not portray specific vehicles or buildings. They are presented to show the personnel, elements, and equipment required and their physical relationships. Controller and player relationships are as shown. The division command structure extending through the brigade, division artillery (DIVARTY), and division support command (DISCOM) to the battalions should function as it would in a tactical situation. These echelons inject realism by forcing units to respond to higher and lower unit needs.

FIGURE 15. CONTROLLER-PLAYER RELATIONSHIPS.

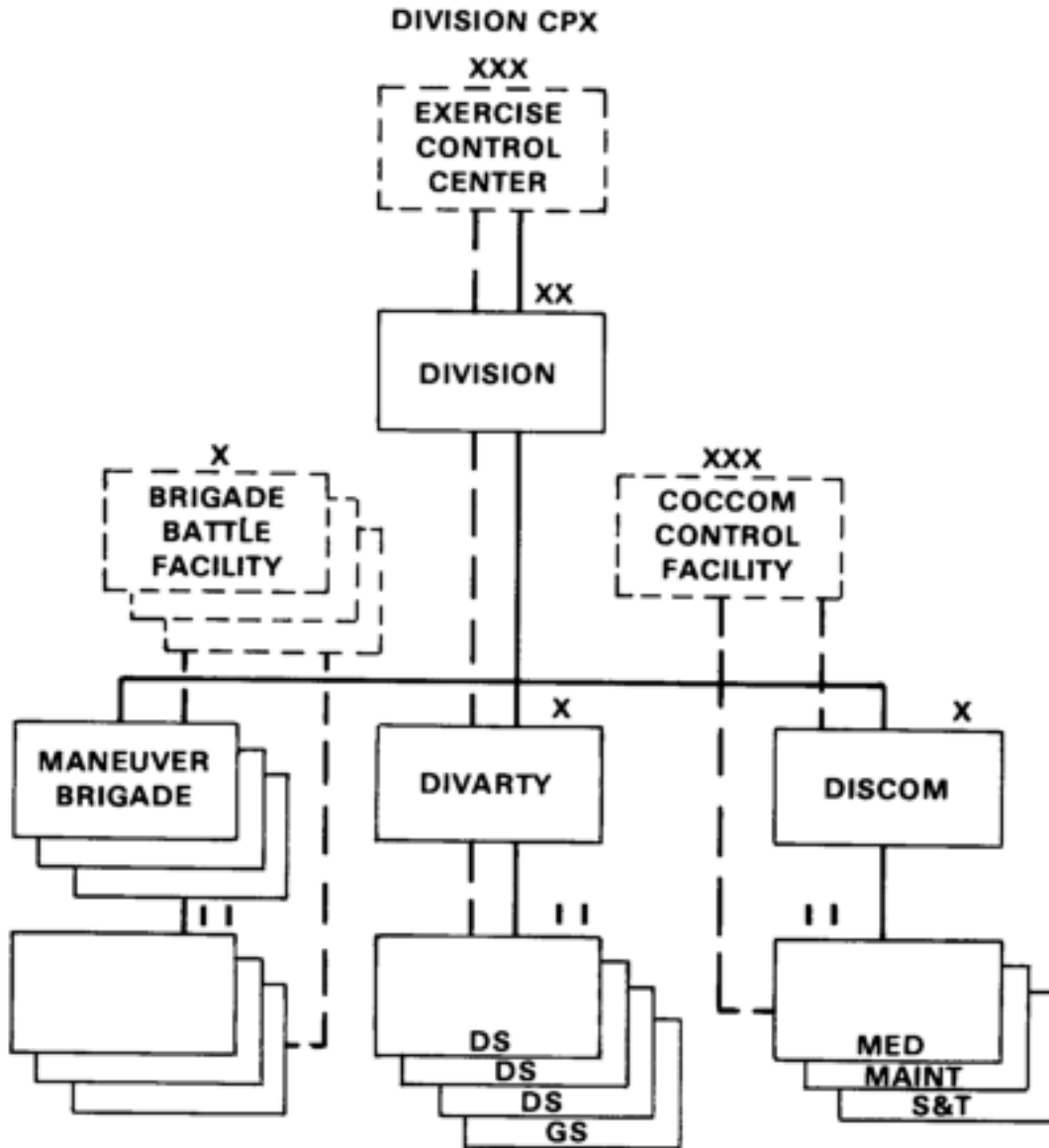

LEGEND:

DS - direct support
 GS - general support
 S&T - supply and transport

————— COMMAND (PLAYER)
 - - - - - CONTROL
 - - - - - MONITOR

FIGURE 16. SAMPLE CORPS TOC/EXERCISE CONTROL CENTER.

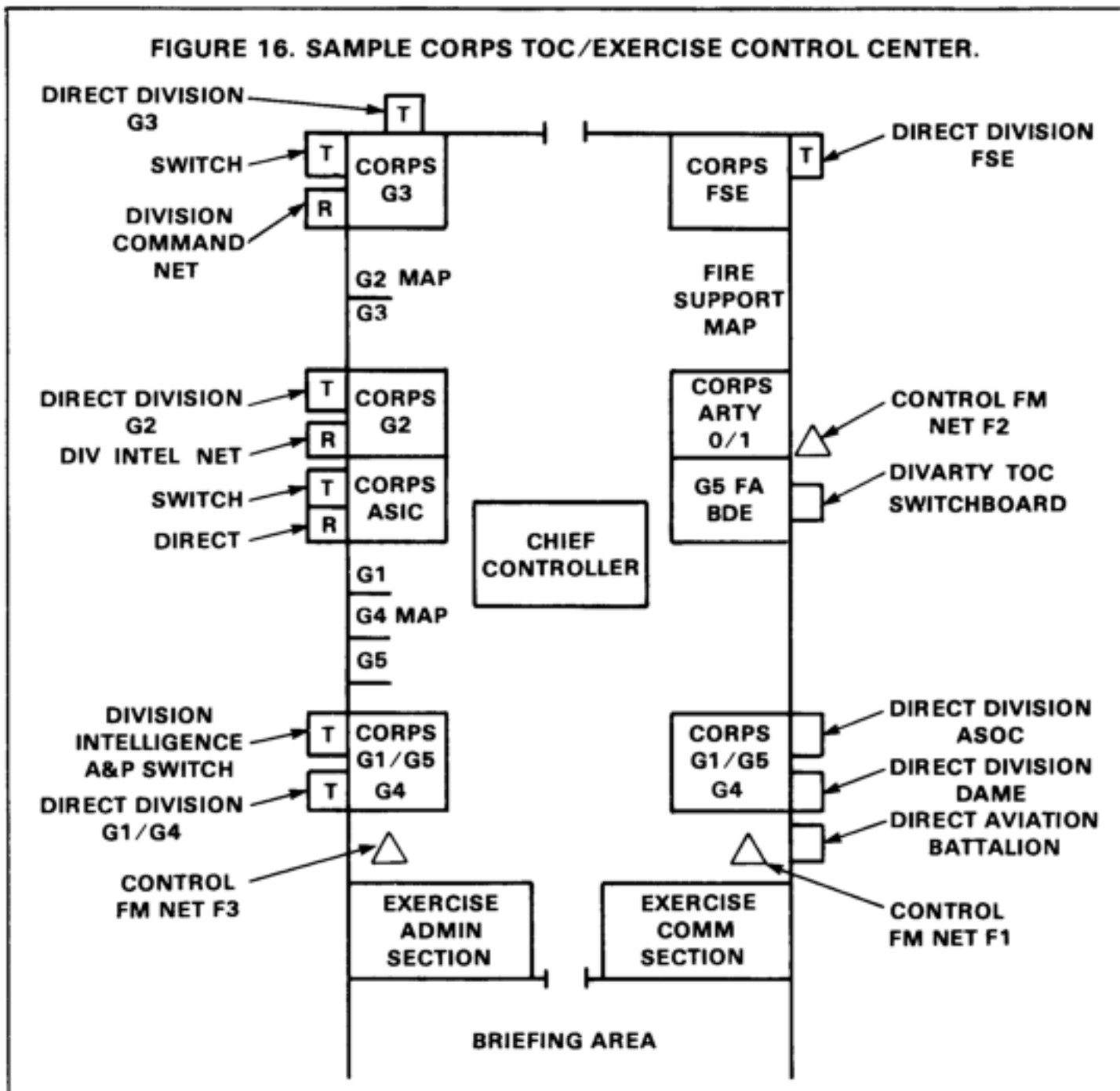

LEGEND:

A&P - administration and personnel
 ASIC - all-source intelligence center
 ASOC - air support operations center

DAME - division airspace management element
 FA - field artillery
 O/I - operations/intelligence

FIGURE 17. SAMPLE COSCOM TOC.

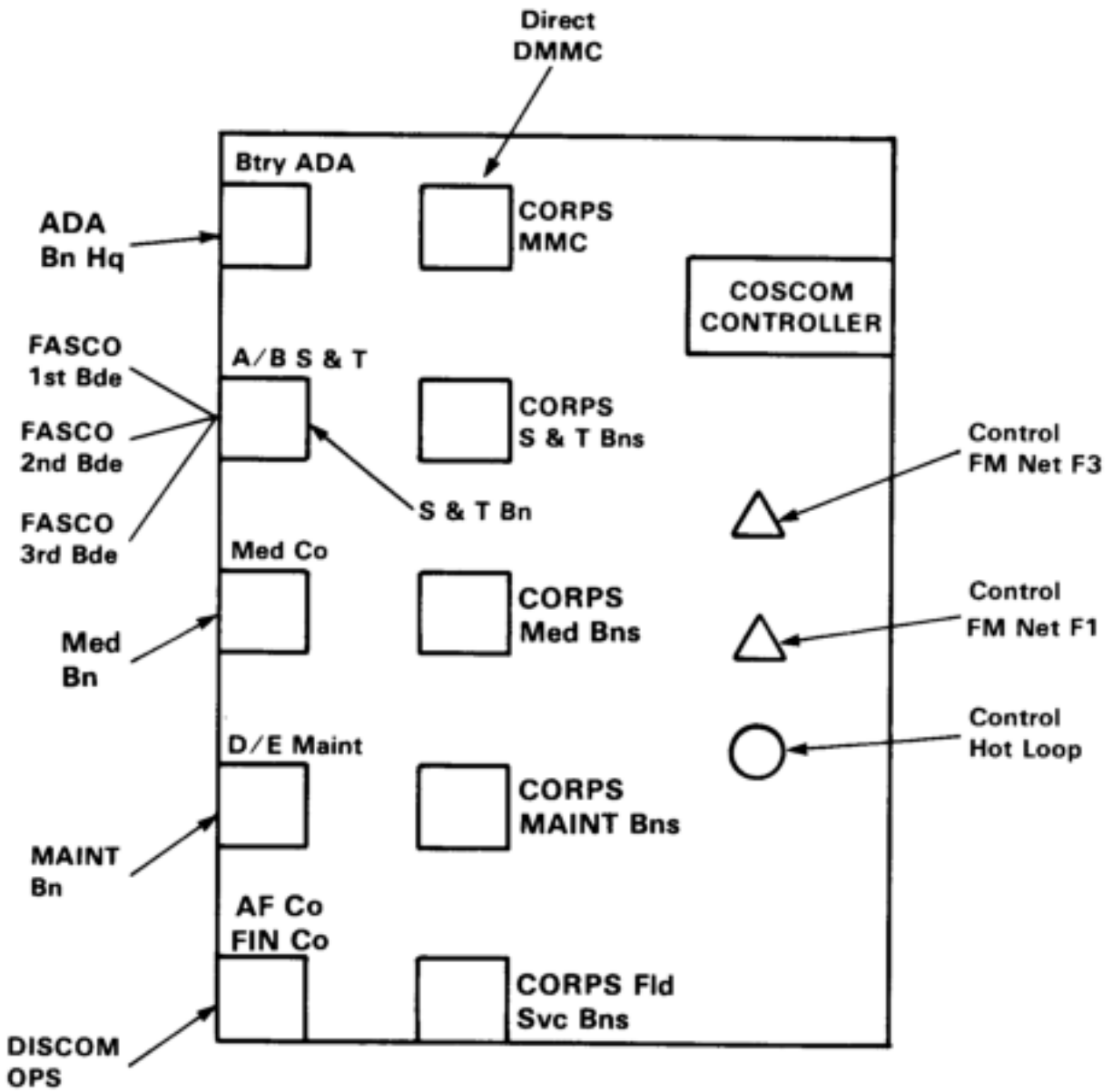

LEGEND:

- | | |
|--|--|
| AG - adjutant general | FASCO - forward area support coordinator |
| DMMC - division materiel management center | MMC - materiel management center |

FIGURE 18. BRIGADE BATTLE FACILITY.

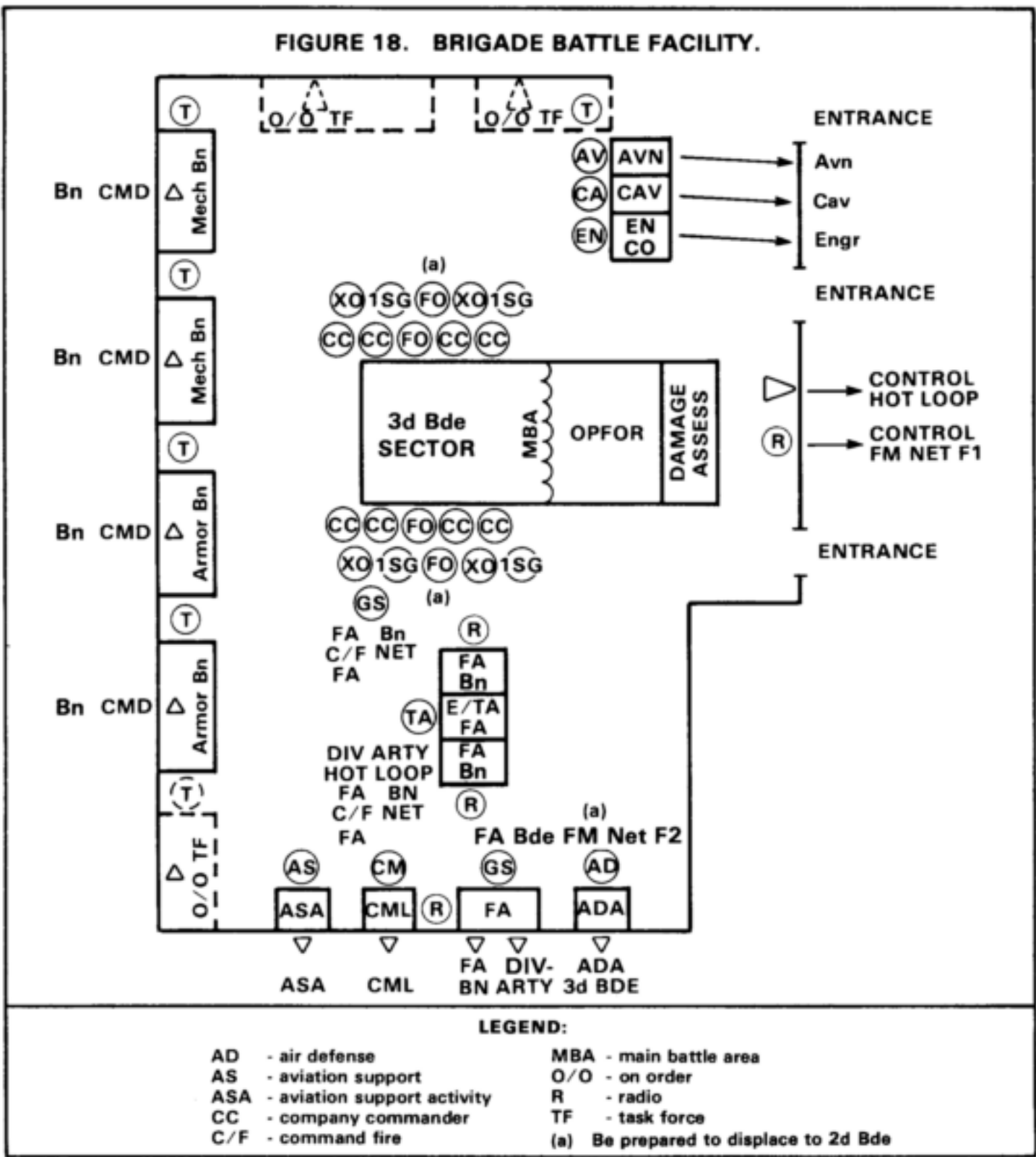

PHASES

Preexercise

Prior to selecting the CPX training mode, the commander should determine whether the personnel chosen

to participate are proficient in the individual and collective skills required by their duty positions and assigned units. Planners must consider the steps listed in [Chapter 2](#).

Sufficient time must be allocated to allow for thorough planning and preparation. The size and length of the exercise impacts on the time required for these functions.

Normally 24 to 48 hours before STARTEX, the controllers train the players in the conduct of the CPX. Players who receive battlefield information directly from controllers must be given additional training on how to convert that information into usable and recognizable formats. These formats include spot reports, situation reports, NBC reports, shell reports, and others.

For controller and player training prior to a CPX, planners should consider the following subjects, as appropriate:

- Purpose and scope of the exercise.
- Training objectives.
- Maneuver area rights and restrictions.
- Participating units.
- Enemy situation.
- Control organization.
- Communications plan for the exercise.
- Controller duties.
- Casualty and damage assessment.
- Use of time delays in message transmission.
- Controller records and reports.
- Intelligence play.
- War-game procedures.
- Information flow.

- Controller communications check.
- Controller reconnaissance of exercise area.
- After-action reviews.

A CPX at the battalion level is normally conceived, planned, and conducted by the commander and his staff. At higher echelons, planning staffs and controller teams are normally formed to plan, prepare, conduct, and review the exercise. The commander directing the CPX first approves the objectives, scope, troop list, exercise area, and outline plan of the CPX. Then the player unit commander and selected personnel should be briefed by the controllers.

The planning staff completes the exercise LOI and sends it to the player unit for use in planning for the exercise. The planning staff also uses the LOI to brief controllers, umpires, and evaluators. The LOI for the CPX includes instructions for movement to the exercise site, if appropriate. Time must be set aside and personnel assigned prior STARTEX to install necessary communications equipment, set up the controller TOC, and prepare maps.

Execution

Immediately prior to STARTEX, the chief controller and staff give the player commander and staff a commander's update briefing. Included in this briefing are any changes to the LOI which have not already been announced or any items requiring reiteration. When this portion of the briefing is completed, the chief controller assumes the role of the players' higher commander and is briefed by controllers, who represent the staff. This briefing sets the stage for the exercise and imparts realism to it. At this point the chief controller, in the role of higher commander, first converts the exercise OPLAN to an OPORD. Then he announces that the staff is available for coordination with player counterparts. This is normally STARTEX.

The division-level CPX functions as follows:

- The players are presented with a general and a special situation.
- The players react to the situation and provide information and reports, as appropriate, to higher, lower, and adjacent units.
- The control group, in its role as the corps, evaluates the player orders for mission accomplishment, fights its own portion of the air-land battle, and responds to player requests for support, as appropriate. At the same time, company commanders gathered around the battle map in each brigade battle facility fight the battle according to battalion orders. The results of engagements are relayed to the player headquarters as reports and requests that combine to create new situations

and continue to portray the battle.

- The players react to the new situations as they would in combat. This forces battalions to alter battle plans, issue FRAGOs, and place demands on CS and CSS units.
- The process continues until the CPX is terminated.

Postexercise

At ENDEX, the chief controller holds an immediate AAR for all players and controllers, in order to gain the maximum training benefit from the exercise. At a minimum, the AAR--

- Provides an opportunity for the players and controllers to exchange information, ideas, and lessons learned.
- Allows the threat controllers to explain their battle plans, battle outcomes, and strength at ENDEX. An assessment of future threat capabilities is also presented.

Exercises conducted at brigade level and above offer an excellent opportunity to conduct a multiechelon AAR. For example, a division CPX AAR could involve the following:

- A battalion-level AAR conducted by battalion controllers for the battalion commander, staff, company commanders, and threat controllers from the brigade battle facility.
- A brigade-level AAR conducted by the battle facility controller for the brigade commander and staff, battalion commanders, and controllers from the brigade battle facility.
- A division-level AAR conducted by the exercise director for the division commander, staff, major subordinate commanders, and selected staff members. Controllers from the ECC and selected controllers from the brigade battle facilities participate in the AAR according to the agenda.

Following the division-level AAR, individual sessions may be held for functional areas: intelligence, maneuver, fire support, logistics, and communications. These discuss the action and interaction of each staff function in detail. [Appendix G](#) contains a complete description of the AAR and after-action report.

FIELD TRAINING EXERCISES

DESCRIPTION

FTXs are high-cost, high-overhead exercises conducted under simulated combat conditions in the field. They exercise command and control of all echelons in battle functions--intelligence, combat support,

combat service support, maneuver, communications--against an actual or simulated OPFOR. They are conducted in a realistic environment using the full combined arms teams. They provide both intersystems and intrasystems training to fight air-land battles, using all unit personnel and equipment. FTXs must include all attached units.

FTXs provide the most realistic environment of all training exercises. FTXs allow participants to appreciate real time and distance factors. FTXs involve several tactical situations in which one or more units participate. They may require movement and communications over long distances. FTXs do not use live fire. However, they may use a TES such as MILES to assess losses realistically. [TC 25-6](#) provides details regarding MILES employment.

FTXs are used to train the commander, staff, and subordinate units--

- To move and/or maneuver units realistically.
- To employ organic weapon systems effectively.
- To build teamwork and cohesion.
- To plan and coordinate supporting fires.
- To plan and coordinate logistical activities to support tactical operations.

FTXs are the only exercises that fully integrate the total force in a realistic combat environment. They involve combat, CS, and CSS units to include battle staff, survivability, and combined arms training. FTXs encompass battle drills, crew drills, situational training exercises, and other types of training to reinforce individual and collective task integration.

Characteristics

FTXs are executed under battlefield conditions. They provide opportunities to practice both offensive and defensive operations. Thus, they enhance the ability of soldiers and leaders to fight and survive on an integrated battlefield. Such training builds teamwork under conditions likely to prevail in time of war and impresses players, commanders, and staffs with the magnitude and scope of planning and operations.

FTXs portray administrative and logistical situations realistically so that player commanders and staffs experience their impact on all aspects of the battle. FTXs should also integrate E W and NBC warfare into exercise play. Doing so familiarizes commanders and staffs with the capabilities, availability, and employment doctrine of EW and NBC assets. When properly employed, EW assets become a combat multiplier that extends a unit's tactical capability. They provide commanders with nonlethal means, which can accomplish desired results and conserve combat capability. PW play should be realistic. Trained personnel should act as PWs so that interrogators and capturing units get realistic training.

FTX controllers, umpires, or evaluators must consider how players will be affected by the information they input. These inputs should make the players aware of the tactical and logistical situations. The inputs present situations and requirements that will cause players to act.

Controllers must not influence play artificially. The control group must render prompt and logical rulings in all tactical and logistical situations that arise. When the players and OPFOR controllers make contact, the control group allows the situation to develop until a tactical ruling is indicated or required. The control group assesses casualties and damage. It announces rulings in a manner that provides as much realism as possible. These rulings are based on observation of the player units, as well as on results from war-gaming, player-directed actions. Controllers have free access to player facilities so they can perform their assigned duties. However, they do not interfere with the players.

Personnel

Player unit personnel perform their assigned functions and duties. Controllers guide the exercise through OPFOR actions. To do so they create tactical situations which achieve exercise objectives and cause the play to flow to a logical conclusion. Evaluators observe player and OPFOR unit activities and determine whether tasks are performed to predetermined standards. Umpires determine the results of battle engagements, fires and obstacles, and support activities. They report the results to players, evaluators, and controllers. OPFORs replicate enemy forces in the appropriate size and strength to portray the threat activities realistically at specific times and places on the battlefield. The number of controller, umpire, evaluator, and OPFOR personnel that will be required depends upon the size of the player organization and the objectives of the exercise.

Equipment and Facilities

The equipment required for an FTX consists of--

- Communications equipment that will portray the higher headquarters of the player unit.
- General purpose items such as office supplies, overlay production materials, message and journal logs, report forms, unit SOPs, and appropriate reference materials.
- Equipment that player units at all echelons need to operate in the field for a sustained period.
- Appropriate military reference materials.

The exercise area should be large enough to allow realistic dispersion of all player units according to AirLand Battle doctrine. See [TC 25-1](#) for guidance in determining space requirements. The site for the control headquarters should ensure good communications. The control headquarters should be located where it will support the exercise and allow for easy travel to and from player headquarters. Facilities in

support of the control headquarters include--

- Security.
- Visitor reception and briefing.
- Food service.
- Medical service.
- Maintenance.
- Hygiene facilities.

The amount of outside support required will also depend on the scope and duration of the exercise. Assistance from outside agencies may be required in the following areas:

- Additional communications capability.
- Additional map coverage.
- Maneuver area clearances.
- Billeting.
- Medical service.
- Food service.

PHASES

Preexercise

Prior to selecting the FTX training mode, commanders must determine that subordinate commanders, leaders, and soldiers are proficient in the individual, leader, and collective skills required by their duty positions. Commanders will also ensure that all squads, platoons, and companies have attained basic proficiency in appropriate ARTEP tasks and missions. This must be done to obtain the appropriate training benefit from maneuvering tactical units while conducting a battalion-or brigade-level FTX. Planners must consider the steps discussed in [Chapter 2](#).

Normally within 72 hours before STARTEX, the planners of the exercise train the controllers and

umpires. Controller, evaluator, OPFOR, and umpire training for an FTX involves some or all of the following:

- Purpose and scope.
- Training objectives.
- Maneuver area rights and restrictions.
- Participating units.
- Enemy situation.
- OPFOR organization.
- Rules of engagement.
- Communications plan.
- Controller duties.
- Casualty and damage assessment.
- Controller records and reports.
- Intelligence play.
- Information flow.
- Controller communications checks.
- Controller reconnaissance of exercise.
- After-action review.

The chief controller first trains his staff in supporting umpires/controllers. Then the controllers brief the player unit commanders and selected personnel on the exercise.

Execution

The LOI should include instructions for moving to the exercise site. Time should be set aside and

personnel assigned prior to STARTEX to install the necessary controller communications equipment, to set up the controller TOC, and to prepare maps and overlays.

The controller manning tables for a division FTX in [Appendix D](#) can be used as guidelines for manning the ECC. Manning tables should be modified to fit the echelon at which the FTX is being conducted. For example, battalion ECCs need fewer personnel than division ECCs, and their functions are narrower.

Immediately prior to STARTEX, the chief controller and controller staff give the player commander and staff a commander's update briefing. This briefing includes any changes to the LOI not already announced or items that require reiteration. Then the chief controller assumes the role of the players' higher commander. He is briefed by the controllers, who represent the staff. This briefing sets the stage for the exercise and imparts realism. At this time, the chief controller, as the higher commander, converts the exercise OPLAN to an OPORD. He then announces that the command staff is available for coordination with their player counterparts. This normally constitutes STARTEX.

The battalion FTX functions as follows:

- Player units with their respective evaluators and umpires, controller elements, and OPFOR personnel with their controllers and umpires move to initial field positions for STARTEX. They receive an orientation on administrative requirements and exercise objectives. The general and initial situations are issued to players.
- OPFOR personnel are briefed separately and in a different location. They execute their role in the FTX, using predesignated incidents from the schedule of events to trigger player actions.
- Players fight the battle according to the initial OPORD. OPFOR actions are used to build intelligence estimates, which require players' staffs to make estimates and commanders to issue guidance and make decisions. FRAGOs are issued as needed in order to continue the battle.
- Players provide reports to higher headquarters, request support, and allocate or apply combat power, as appropriate.
- Umpires determine the results of maneuver engagements and the effects of fire support. They assess losses accordingly.
- Controllers guide battle play in order to accomplish the exercise objectives and to keep the exercise within the limits prescribed by the scenario.
- Evaluators judge units and soldiers according to established standards in ARTEPs and soldiers manuals.
- This process continues until the FTX ends. The player commander in coordination with the chief

controller should monitor the attainment of the exercise objectives. If necessary, the exercise may be halted to reorient either the OPFOR or the player units in order to accomplish the exercise objectives.

All unit leaders and controllers must stress safety. They ensure that all participants follow the established procedures for preventing injuries and keeping incidents caused by carelessness or overly aggressive personnel from interrupting the exercise. These include--

- Stand-off distances between troops and vehicles to prevent physical contact.
- Safety procedures for firing blanks and using pyrotechnics.
- Search procedures for captured personnel.
- Procedures for returning captured personnel to their own units as quickly as possible so the soldiers can continue FTX training.
- Safety procedures to halt all exercise activity.
- Safety requirements for vehicle movement at night or in limited visibility.

FTXs must be thoroughly planned and executed, or extensive maneuver damage can result. Great care must be taken to prevent water pollution or damage to roads, fields, crops, trees, animals, or man-made structures.

Postexercise

At ENDEX, the chief controller holds an immediate AAR for all players and controllers in order to obtain the maximum training benefit from the exercise. This AAR will--

- Provide an opportunity for the players and controllers to exchange information, ideas, and lessons learned.
- Allow the OPFOR controllers to explain their battle plans, the battle results, and their strength at ENDEX. They should also present an assessment of future OPFOR capabilities. [Appendix G](#) contains a full description of the AAR and after-action reports.

COMMAND FIELD EXERCISES

DESCRIPTION

CFXs lie on a scale between CPXs and FTXs. Available resources-- money, time, personnel, equipment-- determine where CFXs fall on the scale. CFXs can also be used as backups for FTXs in the event that maneuver damage or other factors such as changes in the weather prohibit the planned FTX.

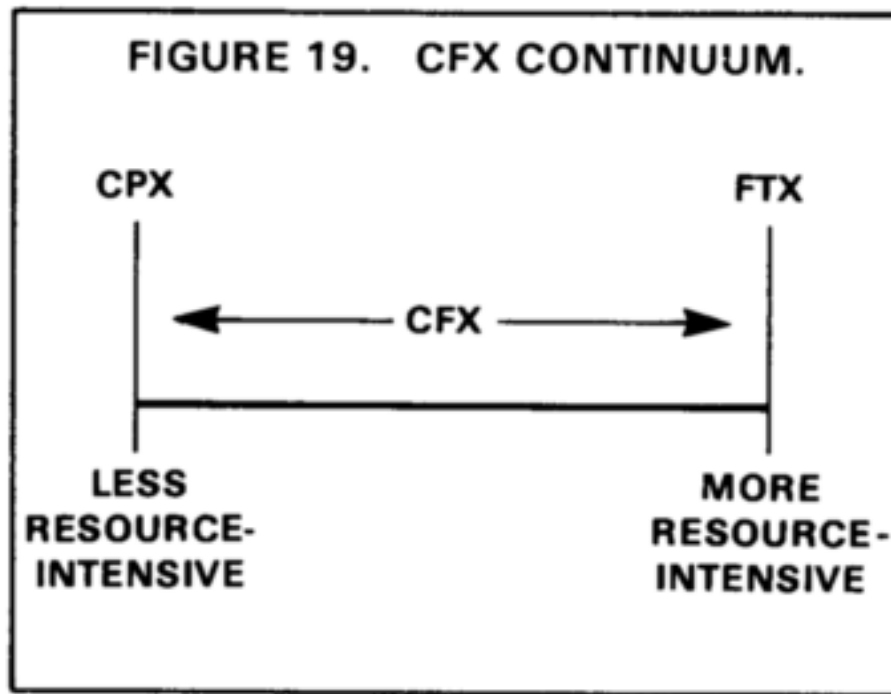

The CFX is an FTX with reduced combat unit and vehicle density, but with full command and control, CS, and CSS elements. For example, the platoon leader in his combat vehicle represents the entire platoon. The battery headquarters, the fire direction center (FDC), and the base piece represent the artillery firing battery. The CFX allows the full-up employment of certain assets such as the signal battalion, the CEWI battalion, and the target acquisition battery (TAB). CFXs are not simply scaled-down FTXs. They are, in fact, excellent vehicles for training commanders and staffs with certain full-up systems to gather information, to provide communication links, and to develop intelligence. CFXs provide real-time operations over actual distances with appropriate logistical support. They are driven by schedules of events or by controlled OPFORs operating under the exercise director.

Characteristics

CFXs are less expensive than FTXs. Yet they provide equal training value for training of the staff. They may be the single best way to train intersystems linkages for full-up integration of all brigade and above assets. Commanders should use CFXs to sharpen unit skills in such areas as--

- Fire support.
- Resupply procedures.
- Rear area combat operations (RACO).

- COSCOM interface.
- CEWI collection interpretation. and dissemination procedures.

Personnel

Personnel requirements are similar to those in the FTX with fewer controllers/umpires needed at lower levels.

Equipment and Facilities

Because CFXs use fewer soldiers than FTXs, they need less logistical support. The support should be sufficient for the personnel and equipment actually employed. The maneuver area required for a CFX is the same as for an FTX at the same echelon. However, because the CFX uses fewer vehicles, maneuver damage is considerably less.

PHASES

Preexercise

CFXs follow the same planning steps as FTXs. Prior to selecting the CFX training mode, commanders should determine if subordinate commanders, leaders, and soldiers are proficient in the individual, leader, and collective skills required by their duty positions. Preliminary training through TEWTs, MAPEXs, and CPXs can ensure that participants are sufficiently trained to justify the use of the CFX. Planners must consider the steps discussed in [Chapter 2](#). The complexity of each step depends upon the desires of the commander directing the exercise and the echelon at which the exercise is conducted. Planning and preparation must be thorough. The size and length of the exercise impacts on the time required for preparation.

Normally within 72 hours before STARTEX, the controllers train the players in the conduct of the CFX. Controller, evaluator, OPFOR, and umpire training is similar to the training requirements in preparation for an FTX. The chief controller trains his umpires and controllers. Then they brief the player unit commanders and selected personnel on the exercise. The planning staff completes the LOI and sends it to the players for preparing for the exercise. The planning staff also uses the LOI to brief controllers, umpires, OPFORs, and evaluators.

Execution

Control requirements are approximately the same as for an FTX. Additional control input is required when more realism is added and more systems integrated. Moreover, additional controller input will be required to simulate enemy activity, EW, or fire support as troop participation decreases.

Basic umpire functions in a CFX are the same as those required in an FTX, as described in [Appendix D](#). Umpires base their decisions on the orders and actions of player unit commanders, as understood and executed by the lowest echelon player head-quarters. Umpires visualize how the units would actually be employed based on the detailed plans and orders of the participating units.

Umpires are even more critical to successful CFXs than to FTXs. They must see the concept of the exercise through the eyes of unit commanders. They must make decisions critical to exercise control and unit evaluation. They must be present when company OPLANs, OPOrDs, and FRAGOs are issued. They must observe each platoon leader brief a simulated platoon to ensure that they have detailed pictures of unit deployment when they meet with OPFOR umpires to determine the results of unit engagements.

Once platoon leaders have had sufficient time to simulate deployment, they should walk over the terrain with the umpires or evaluators and explain the deployment. In turn, umpires must be able to explain the disposition and maneuver of their player units to the OPFOR umpires, so that they can work together to resolve the outcome of each engagement accurately and professionally. This coordination takes place before the OPFOR and friendly units make contact. To do so, player and OPFOR umpires, who know unit disposition and activities in detail, should meet at a vantage point to umpire the ensuing action.

Platoon umpires stay with their units and maintain radio contact with their company umpires. The company umpires assess damage and casualties and consider reports from platoon umpires as fire and maneuver take place on the battlefield. Platoon umpires relay the decisions of the company umpires to the unit commanders. When platoons or companies do not physically participate, the umpires and their player counterparts exchange plans, developments, and directed actions to war-game engagements and assess the outcome of the action.

Postexercise

A face-to-face exchange between company umpires and their player counterparts is required at the conclusion of each engagement. The CFX is executed and an AAR is conducted, as previously described for the FTX.

LIVE-FIRE EXERCISES

DESCRIPTION

LFXs are high-cost, resource-intensive exercises in which player units move or maneuver and employ organic and supporting weapon systems using full-service ammunition with attendant integration of all CA, CS, and CSS.

The extensive range and ammunition requirements for LFXs usually limit them to platoon and company team levels. Consequently, unit and weapon systems integration at the company team level is the

principal focus of the exercise.

LFXs can provide maximum training benefits through multiple iterations. These iterations, each including an AAR, normally occur in the following sequence:

1. A dry run conducted to review the unit SOP and battle drills.
2. An AAR to discuss actions on this dry run.
3. A second run with a reduced amount of ammunition to show the complexities of fire and maneuver coordination.
4. An AAR to discuss actions on this second run.
5. A third run with full ammunition to reinforce previous training and to build confidence.
6. An AAR to discuss actions on the third run.
7. A fourth iteration, preferably with ammunition, conducted at night or during limited visibility.
8. Other iterations using ammunition saved by crews/units to sustain and attain proficiency for new or unqualified crews/units.

Characteristics

LFXs are executed under simulated battlefield conditions. They are employed by commanders to train integration of fire and maneuver or movement against a realistic target array. They train squads, crews, and sections to employ their weapons in a tactical environment. They permit evaluation of tactical employment and precise measurement of the effectiveness of fire employed against target arrays.

Personnel

LFXs require commanders, leaders, and soldiers from the participating units. They also require controllers, evaluators, umpires, and range support personnel. The control team, developed by the chief controller, manages the exercise and causes exercise play to flow to a logical conclusion.

Evaluators and umpires observe the activities of the players and player units to assess the results of fires and determine whether tasks are performed to standard. Range support personnel include an officer in charge (OIC) and a chief safety officer. An ammunition detail is necessary to handle, secure, and account for ammunition. A guard detail controls traffic adjacent to and entering the range. If targets are left in place overnight, additional guards are required. A target detail checks targets after each unit run.

Demolition personnel emplace and detonate the explosives in demolition pits. Moving target operators, if applicable, activate the appropriate targets at the appropriate time in the scenario. Administrative personnel assist the range OIC and chief safety officer in operating radios and telephones and in tabulating scores. Medical personnel and a litter-carrying vehicle stand by.

Equipment and Facilities

Player units are expected to have assigned TOE equipment on hand. LFXs are conducted according to local range regulations and SOPs. Target arrays should adequately display the appearance and characteristics of the threat force targets. Communications equipment must be available for range operations (according to the range SOP) and for controller/evaluator personnel.

Transportation, food service, ammunition, and administrative support for the LFXs are dictated by the level and scope of the exercise. LFXs for maneuver elements also require the following materials:

- [Target engagement chart.](#)
- [Target description chart.](#)
- [Target maps.](#)
- [Demolition pit map.](#)
- Fire support plan.
- Ammunition amounts, by type.

TABLE 6. SAMPLE TARGET ENGAGEMENT CHART.

ENGAGEMENT	TARGET	RECEIVER
1	1	A1
2	2, 3	A2, A3
3	Moving target	
4	4, 5	A4, A5
5	6, 7, 8	A6, A7, A8
6	9, 10, 11	B1, B2, B3
7	12, 13, 14, 15, 16, 17 18, 19, 20, 21, 22, 23 24, 25, 26, 27, 28 29 30	B4, B5, B6 B7, B8, C1 C2 C4 C5 C6
8	46, 45, 44	D1, C8, C7
9	Moving target	
10	Moving target	
11	43, 42, 41	D4, D3, D2
12	40, 39 38, 37, 36, 35, 34 33, 32, 31	D6, D5 E8, E7, E6, E5, E4 E3, E2, E1

Note: Targets will appear for a maximum of 60 seconds. As soon as that time is up, they will be pulled down whether or not they have been engaged. Vehicular targets should be equipped with smoke to indicate when the target has been destroyed.

TABLE 7. TARGET DESCRIPTION CHART.

TARGET NUMBER	TARGET PANEL	TARGET NUMBER	TARGET PANEL
1	F	33	59
2	E	34	59
3	Hind	35	F
4	E	36	F
5	44	37	59
6	E	38	E
7	44	39	E
8	E	40	E
9	44	41	44
10	E	42	44
11	E	43	44
12	F	44	Hind
13	F	45	Hind
14	F	46	Hind
15	F	M-1	59
16	F	M-2	59
17	F	M-3	59
18	F		
19	F		
20	F		
21	F		
22	F		
23	F		
24	F		
25	F		
26	F		
27	F		
28	59		
29	59		
30	59		
31	F		
32	F		

Note: The target description chart links the type of target to be portrayed with the target number on the target engagement chart.

FIGURE 20. TARGET MAP.

**Mechanized Infantry
Platoon Qualification
Course**

LEGEND:



-  E
-  59
-  HIND
Helicopter



FIGURE 21. DEMOLITION PIT MAP.

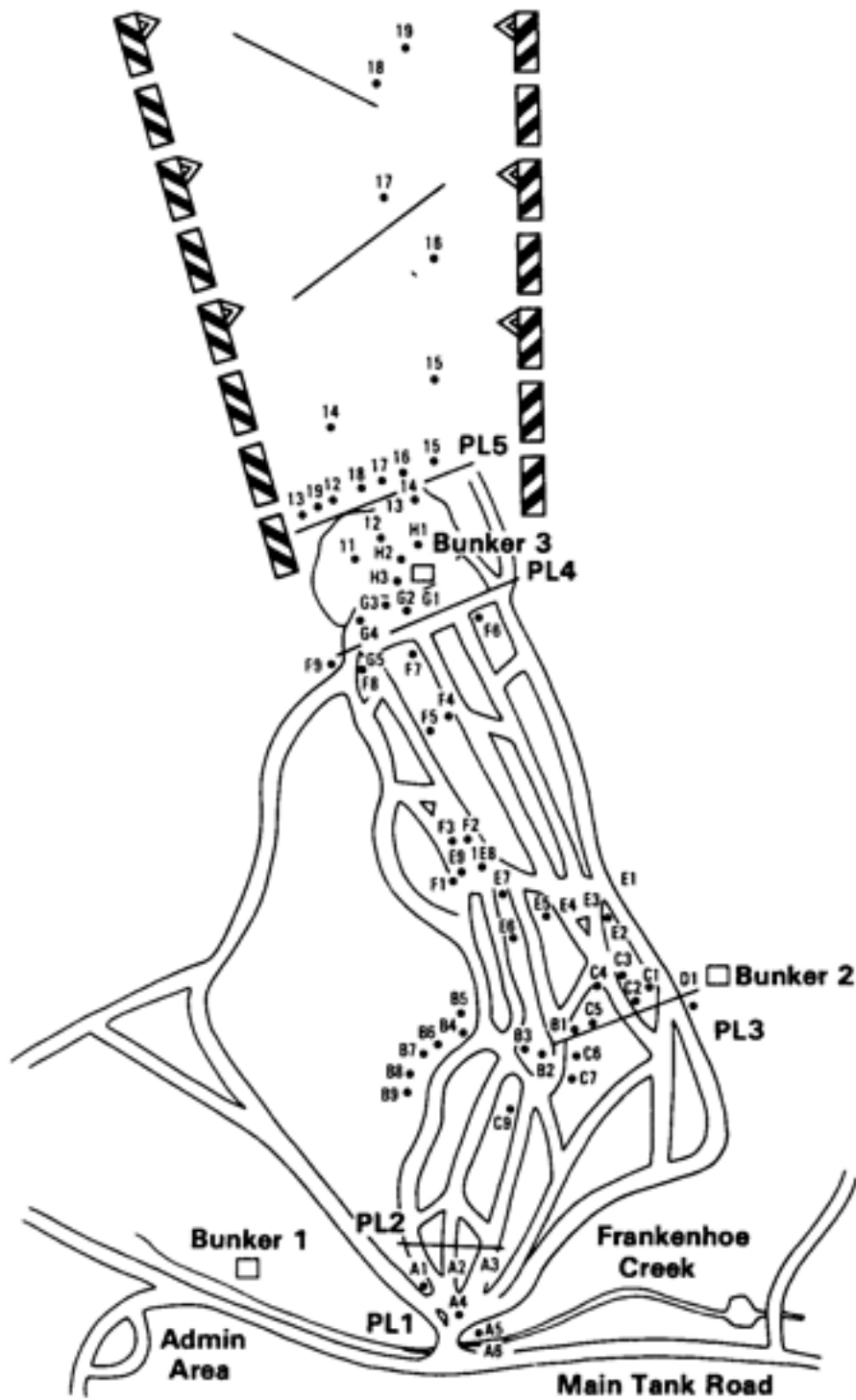

The [target engagement chart](#) describes the manner and sequence in which targets will be displayed. It keys the target display to events from the scenario. Before the LFX starts, controller personnel must receive instructions from range personnel on using the scenario, chart, and target system.

The [target map](#) is normally in strip map format and shows where each target, by number, is located on the

range. The demolition pit map shows the location of each demolition pit on the range, displaying its number.

Fire support information details the weapons and ammunition that can be fired and specifies when they can be fired. It provides special instructions to the players and controllers. Approved overlays of all firing points and the to weapons and ammunition from them must be developed and approved by range control. Information concerning ammunition requirements must be provided.

TABLE 8. AMMUNITION REQUIREMENTS FOR PLATOON LFX.

TYPE	AMOUNT
M113A1 SQUAD APC	
Ctg ball 5.56	1,800
Ctg ball 5.56 tracer	180
Ctg ball 7.62 4/1 tracer MLB	700
Ctg ball .50 cal 4/1 tracer MLB	500
Rocket practice 35-mm LAW subcaliber	6
Ctg TPT 40-mm	18
Ctg smoke 40-mm	6
Rocket practice Dragon	1
M113A1 PLATOON LEADER APC	
Ctg ball 5.56	360
Ctg ball 5.56 tracer	180
Ctg ball 7.62 4/1 tracer MLB	1,400
Ctg ball .50 cal 4/1 tracer MLB	500
Ctg TPT 40-mm	6
SUPPORT ITEMS PER PLATOON	
Ctg 81-mm HE with PDF	277
Ctg 81-mm WP with PDF	3
Charge demolition block TNT (1/4 lb)	75
Cap blasting electrical special	85
Grenade hand smoke HC	7
Grenade hand smoke green	3
Grenade hand smoke red	3
Grenade hand smoke yellow	3
Signal ground star cluster white	1
Signal ground star cluster green	1
Signal ground star cluster red	1
Booby trap simulator	1
Hoffman charges	11

Legend:	HE - high explosive	PDF - point detonating fuze
APC - armored personnel carrier	LAW - light antitank weapon	TNT - trinitrololuene (dynamite)
cal - caliber	lb - pound	TPT - target practice tracer
ctg - cartridge	MLB - metallic link belt	WP - white phosphorus
HC - high concentrate	mm - millimeter	

PHASES

Preexercise

Before selecting the LFX training mode, commanders must ensure that subordinate commanders, leaders, and soldiers are proficient in the individual and collective skills required for maneuvering or moving and for employing weapons and weapon systems in tactical environments. Planners must consider the steps discussed in [Chapter 2](#).

Scenarios for LFXs differ from those described in [Chapter 2](#), because of the specific control measures dictated by safety requirements. Scenarios are normally modified to fit the range on which the LFX is conducted. Scenarios should precisely define the sequence of events in terms of the types of targets and the time that specific target arrays are displayed.

Scenarios must be flexible enough to allow the commander and other leaders to decide how to use the terrain. They must also be extensive enough to facilitate training and evaluation of unit tasks executed in accordance with the commander's concept for the operation, which is formulated through a METT assessment. They must be varied enough to allow leaders to engage the proper targets with the right weapons at the appropriate times. Sample scenarios for defense and offense in a platoon LFX are shown in [Figures 22](#) and [23](#). More detailed scenarios are available from the commanders of local live-fire complexes. The battalion commander and company commanders normally plan LFXs, and battle simulations are not used.

FIGURE 22. SAMPLE OFFENSIVE SCENARIO.

EVENT	ACTION
1	Platoon moves into assembly area, vicinity grid PA 943072.
2	Orders are issued, ammunition uploaded, and all troop loading procedures conducted.
3	Platoon leader reconnoiters primary and alternate positions.
4	Platoon moves tactically to first defensive position, vicinity grid PA 999077.
5	Platoon has time to establish the position tactically, and then it receives enemy pressure.
6	Platoon fires Engagement 8.
7	Platoon fires Engagement 9 with Dragons.
8	Platoon fires Engagement 10 with Dragons.
9	Platoon fires Engagement 11.
10	Platoon fires Engagement 12.
11	Platoon receives order to occupy alternate position, vicinity grid PA 995085.
12	Platoon withdraws from defensive position and establishes hasty defense at alternate position.
13	Platoon receives enemy pressure.
14	Platoon fires Engagement 4.
15	Platoon fires Engagement 5.
16	Platoon fires Engagement 6.
17	Platoon fires Engagement 7.
18	Platoon receives order to move to alternate position, vicinity grid PA 984074.
19	Platoon withdraws from defensive position and establishes hasty defense at alternate position.
20	Platoon fires Engagement 2 with Dragons.
21	Platoon fires Engagement 3.
22	Platoon withdraws from position and moves to control center for an AAR.

Note: The platoon's initial defensive position is on the objective. Engagements 8 through 11 are on the target arrays normally forward of the position. The alternate position is directly north on the target map. Ranges and target types for target numbers 4 through 30 will be staked forward of this position. The second alternate position is the vicinity of phase line (PL) 2, and from this location targets 2 and 3 will be engaged.

FIGURE 23. SAMPLE OFFENSIVE SCENARIO.

EVENT	ACTION
1	Platoon moves into assembly area, vicinity grid PA 955075 and uploads all ammunition.
2	Platoon leader reconnoiters area.
3	Platoon moves east on tank trail until it encounters NBC obstacle, vicinity coordinates PA 963075.
4	Platoon moves tactically across country to PL 1.
5	Platoon encounters bridge that must be crossed and establishes an overwatch element. A dismounted element is sent to secure the choke point. The dismounted element has all its weapons loaded and fires Engagement 1.
6	Platoon (-) crosses PL 1 and secures a position on the far side of the choke point (PL 2).
7	The bounding element is ordered forward. The overwatch element fires Engagements 2 and 3.
8	The bounding element reaches PL 3 and fires Engagements 4, 5, or 6. (The bounding element will fire only 1 of the 3 engagements depending on the course road that the bounding element chooses.)
9	Platoon (-) (overwatch element) moves forward to PL 3.
10	Platoon moves forward to vicinity of the defensive position.
11	Platoon dismounts and fires Engagement 7 as it assaults the defensive position.
12	Platoon secures objective and is directed to establish a defensive position on the reverse slope of the objective.
13	Platoon receives pressure from enemy counterattack and calls for indirect fires.
14	Platoon fires Engagement 8.
15	Platoon fires Engagement 9 with antitank weapons only.
16	Platoon fires Engagement 10 with Dragons.
17	Platoon fires Engagement 11.
18	Platoon fires Engagement 12.
19	Platoon withdraws from defensive position.

The OPOD issued to the player unit for an LFX is in the form of a standard five-paragraph field order. It contains enough detail to ensure that the player unit deploys properly to begin the exercise and to allow the LFX to flow smoothly.

The commander directing the LFX approves its objectives, scope, troop list, exercise area, and outline

plan. Then the player unit commander and selected personnel, such as controllers, umpires, and evaluators, must be briefed on the exercise. The company commander uses the exercise LOI as a basis for providing instructions to subordinates.

Before the unit occupies the range, each OIC, controller, umpire, and evaluator must be briefed by range control personnel. Briefings are scheduled with range control operations and conducted at least 24 hours before STARTEX. These briefings include a terrain walk of the entire range area. It familiarizes evaluators and safety personnel with all the safety requirements.

Controller, evaluator, and umpire training for an LFX include the following:

- Purpose and scope.
- Training objectives.
- Range regulations and restrictions.
- Participating units.
- Enemy situation and its relationship to the target array.
- Control measures.
- Communications plan.
- Controller duties.
- Casualty and damage assessment.
- Controller, evaluator, and umpire records and reports.
- Intelligence play.
- Safety during live fire.
- Medical treatment and evacuation procedures.

Execution

The unit moves to and tactically occupies an assembly area. The assembly area may be task force size with other teams depicted as notional units. At this time, live ammunition is issued but not loaded in

weapons. MILES should be integrated into the exercise when range or resource limitations prevent live fire for certain weapon systems such as the Dragon, TOW, or HELLFIRE.

Final briefings occur at the task force command post in the vicinity. The task force commander and staff brief the team commander and selected key personnel on the immediate enemy situation. They also give any last minute administrative and safety instructions. Leaders conduct a reconnaissance under the supervision of the range OIC. The team commander prepares plans and gives a briefing to the task force commander and staff. The team commander then briefs his subordinates.

The team conducts a tactical move to the attack position, which is close to the line of departure/line of contact (LD/LC). Here the live ammunition is loaded in the weapons, and the safeties are locked. The controller gives the order to begin the attack. Once the team is across the LD/LC, it may begin live firing. The exercise then continues until the scenario is completed.

After the exercise, participants clear all weapons, and controllers immediately collect all the live ammunition. Safety personnel check and clear all weapons before the unit moves off the range. The company returns tactically to the assembly area where it receives an AAR.

Postexercise

The chief controller and commander conduct the AAR. It should include range control personnel and evaluators who lead a discussion of the unit's performance in relation to--

- Troop-leading procedures.
- Maneuver.
- Close support.
- Weapons employment.
- Communication of orders and directives.
- Combined arms integration.

FIRE COORDINATION EXERCISES

FCXs are medium-cost, reduced-scale exercises that can be conducted at platoon, company/team, and battalion/task force levels. The purpose of FCXs is to exercise the command and control skills of the leadership of the unit through the integration of all organic weapon systems, as well as indirect and supporting fires. Subcaliber devices are substituted for service ammunition to permit fire planning and

simulated employment of all weapon systems available to support the commander in the execution of his assigned mission. FCXs should stress target acquisition. FCXs present target arrays and target information to player units, placing commanders and leaders in realistic battle-field situations. Targets controlled mechanically and electronically appear at the appropriate places and times according to the scenario. Commanders employ FCXs to train subordinate leaders to integrate and distribute direct and indirect fire systems so that the optimum weapons engage the targets at optimum ranges as they become vulnerable to engagement.

FCXs should be fast moving, with several weapon systems engaging multiple targets simultaneously as targets enter optimum engagement ranges. FCXs should challenge the skills of commanders, subordinate leaders, crews of direct fire weapons, FDC personnel and forward observers. They facilitate training in the effective use of organic weapon systems, employment of supporting weapon systems, and target acquisition systems. FCXs require players to react to fluid battlefield situations by promptly applying supporting and organic fires against changing target arrays.

Note: **TC 25-4-1 should be used as a study guide prior to participation in FCXs.**

DEPLOYMENT EXERCISES

Deployment exercises (DEPEXs) provide training for individual soldiers, units, and support agencies in the tasks and procedures for deploying from home stations or installations to areas of hostilities. Practicing these tasks and procedures ensures that--

- Soldiers have properly secured and accounted for military equipment and personal property in case of actual deployment.
- Soldiers have their personal and family affairs in order.
- Soldiers are qualified in the minimum essential combat skills such as weapon qualification and NBC proficiency.
- Unit alert and recall plans are current and adequate.
- Unit equipment disposition plans and loading plans are current and accurate.
- Unit SOPs for movement to the embarkation point and from the debarkation point to the mission site are current and adequate.
- Units, higher headquarters, installation, and supporting agencies such as maintenance, logistics, and transportation have current and adequate staff and support functions for deployment.

DEPEXs are conducted under simulated emergency conditions. They use immediate deployment such as the emergency deployment readiness exercise (EDRE); or if time is available, they use time-phased deployment with AARs built in. Deployment involves a complex matrix of SOPs that are very time-critical and sequential, both hour-by-hour and day-by-day. They may be conducted as stand-alone exercises or as parts of CPXs or FTXs.

Commanders vary the scope and complexity of DEPEXs based on resources, time, and training objectives. One option is a full-scale exercise. In it, units actually move deployable equipment to staging areas and load equipment and personnel aboard air, rail, or sea transport. At the other extreme, no equipment is moved. Personnel report to designated locations for coordination and for any necessary activities short of moving equipment. Deployment procedures are also exercised with facilities that simulate deployment processing agencies. For example, medical personnel and transportation stations as required by the scenario may set up in a large gymnasium. Designated personnel representing the deploying unit and participating agencies report to the proper station to coordinate activities. In such environments, DEPEXs are conducted like MAPEXs, using scenarios, maps, and appropriate sketches.

JOINT TRAINING EXERCISES

Joint training exercises (JTXs) involve two or more services of the US armed forces. A JTX at brigade level and higher may be a--

- MAPEX.
- CPX.
- CFX.
- FTX.
- DEPEX.

The planning steps for JTXs are similar to those employed in preparation for the conduct of other types of exercises. The planning staff includes representatives from all the services involved. Each service must have adequate time to plan, staff, and approve its exercise support plans. Special accountability arrangements may be required for logistics support to accommodate the elements of each service. For example, if the Army provides all the fuel, it must establish an accounting system for the fuel consumed by other services.

In preexercise training, participants review each service's tactical SOP and joint training regulations. Umpires study the capabilities of the various weapon systems used by each service. They prepare appropriate effects tables to assess weapon effects and battle casualties.

The following considerations are essential to the success of JTXs. They must receive detailed attention during the planning, execution, and evaluation phases:

- Command and control relationships.
- Interoperability of weapon and support systems.
- Communication and electronics compatibility and procedures.
- Map compatibility.
- Administrative and logistics arrangements.

During the planning phase, services must be advised of AAR procedures and the necessity for their participation. Representatives from each service must actively participate in the AAR.

COMBINED TRAINING EXERCISES

Combined training exercises (CTXs) involve armed forces from two or more nations. CTXs may be in the form of any of the training exercises previously described. The planning steps for CTXs are the same as those discussed in [Chapter 2](#).

Language differences among participants must be addressed and practical steps taken to ensure effective two-way communication. CTX planners must also consider differences in doctrine, organization, logistics, and customs. The unified commander of the multinational armed forces involved in a CTX must establish an exercise planning group to ensure these matters are considered. This group must include planning staff representatives from all the armed forces elements involved. The group's primary goal throughout the planning, execution, and evaluation phases is interoperability of both equipment and methods of operations. Interoperability allows multinational armed forces to work smoothly and effectively together.

The following considerations are vital to successful CTXs and must receive detailed attention during the planning process:

- Common objectives. Multinational armed forces participating in a CTX must agree upon training objectives.
- Command and control relationships. CTXs should exercise the wartime operational command structure as established by international agreement.
- Standing operating procedures. For effective operations, the nations involved will exchange SOPs

and translations of commonly used terms.

- **Coordination.** Because boundaries between multinational armed forces are particularly vulnerable, areas adjacent to them require detailed coordination. Operational procedures must be established to ensure mutually supporting and responsive employment of all direct and indirect fire to include close air support (CAS).
- **Communications.** Communications equipment and language training must permit interoperability in the nets of the armed forces elements involved.
- **Language.** Interpreter-translators will be required in key positions to allow commanders to communicate effectively with adjacent, supporting, and supported units.
- **Liaison.** Liaison teams must be bilingual and know the organization, procedures, and equipment of the armed forces with which they will be operating.
- **Plans and orders.** Commanders must take differences in tactics, terminology, graphics, and language into consideration when issuing orders. Personal contact among commanders and liaison teams is necessary to ensure mutually agreed upon and supporting actions during the exercise.

During the planning phase, all national armed forces must be advised of AAR procedures and the necessity for their participation. Representatives from each-national force should participate actively in the AAR.

[RDL](#)[Table of](#)[Document](#)[Download](#)[Homepage](#) [Contents](#) [Information](#) [Instructions](#)

APPENDIX A

Scenario Example

OUTLINE

The defense of Western Europe is a fundamental US national security objective. This sample exercise scenario for a notional corps in the Central Army Group (CENTAG) in Europe portrays corps actions during the early days of a general war in Central Europe. To provide the foundation for both the exercise scenario and the schedule of events, exercise planners develop a scenario outline.

SCENARIO

NATO COMMAND STRUCTURE

During general alerts or wartime, national forces in NATO are placed under operational command (OPCOM) of the Allied Command, Europe (ACE). Each nation is responsible for its own combat service support; therefore, the US theater army (TA) commander will retain command and control of US CSS forces in the communications zone (COMMZ). The resulting [NATO command structure](#) is shown below.

FIGURE 25. NATO COMMAND STRUCTURE.

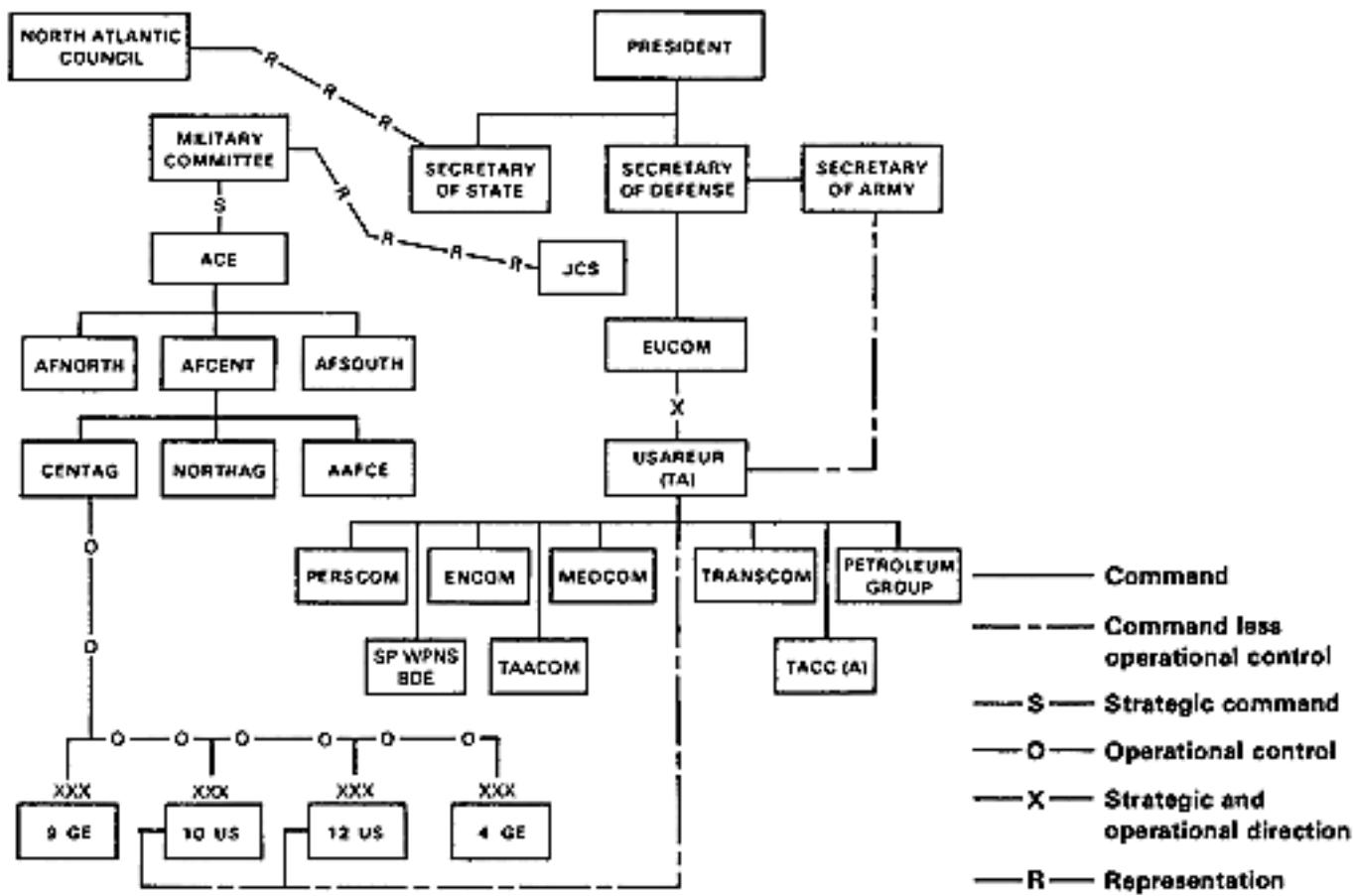

- Legend:**
- AAFCE - Allied Air Forces, Central Europe
 - AFCENT - Allied Forces, Central Europe
 - AFNORTH - Allied Forces, Northern Europe
 - AFSOUTH - Allied Forces, Southern Europe
 - ENCOM - Engineer Command
 - EUCOM - European Command
 - GE - Germany, Federal Republic of (West Germany)
 - JCS - Joint Chiefs of Staff
 - MEDCOM - Medical Command
 - NORTHAG - Northern Army Group, Central Europe
 - PERSCOM - Personnel Command
 - TAAACOM - Theater Army Area Command
 - TACC - Tactical Air Control Center (attached)
 - TRANSCOM - Transportation Command
 - USAREUR - United States Army, Europe

GENERAL SITUATION

The nations of Europe are generally divided into two camps: the western-aligned nations that comprise NATO; the Soviet Union and its satellite regimes that make up the Warsaw Pact. Germany is similarly divided, with the Federal Republic of Germany aligned with NATO, and the German Democratic Republic (GDR) aligned with the Warsaw Pact. Germany is vital to the interests of both NATO and Soviet efforts to expand their spheres of influence.

Three months ago, relations between NATO and the USSR deteriorated to the point of a complete diplomatic breakdown. Charges of an unprecedented Soviet arms buildup and charges of Soviet

violations of arms control agreements by NATO were answered by strident propaganda attacks by communist controlled news media. This propaganda further deteriorated confidence and increased tensions.

Both the Warsaw Pact and NATO forces have fully mobilized. The general disposition of forces and threat attack plans are shown in [Figures 24](#) and [25](#). Initial enemy air superiority is assumed.

FIGURE 24. SCENARIO OUTLINE.

PERIOD	ACTIVITY
E-60 to E-7	<p>Enemy doubles force structure.</p> <p>Units deploy to Germany.</p>
E-7 to E-Day	<p>Allied units prepare to defend.</p> <p>All pre-positioning of material configured to unit sets (POMCUS) and pre-positioned war reserve materials (PWRMs) are issued.</p> <p>Enemy prepares to attack.</p>
E to E+1	<p>Enemy forces attack across international border, capture towns of Schweinfurt and Bamberg.</p> <p>Divisions of the 10th (US) Corps conducts covering force operations.</p> <p>Covering force elements begin rearward passage of lines.</p> <p>Intelligence picture develops main and secondary attack objectives of combined arms army (CAA).</p> <p>Enemy uses chemical strikes to maintain attack momentum.</p>
E+2 to E+3	<p>MBA units from the 10th (US) Corps conduct defensive operations in sector.</p> <p>Intelligence reports indicate CAA second-echelon unit located within 36 hours of the forward edge of the battle area (FEBA).</p> <p>Corps engages CAA's second echelon with battlefield air interdiction (BAI) and reports bomb damage assessment (BDA), disposition, and movement to MBA units.</p>

FIGURE 24. SCENARIO OUTLINE (Continued)

PERIOD	ACTIVITY
E+4 to E+5	<p>Continued enemy pressures cause penetrations in the sectors of the 20th Infantry Division, the 54th Mechanized Division, and the 25th Armored Division.</p> <p>Enemy uses chemical strikes to maintain attack momentum.</p> <p>Enemy aircraft attack logistical support facilities.</p> <p>Enemy launches airborne/air assault attacks in corps rear.</p> <p>Corps directs MBA units to update nuclear subpackages.</p> <p>MBA battle continues as US forces are pushed back toward Phase Line Black.</p> <p>MBA units conduct counterattacks within sectors.</p> <p>Corps reserve is committed in the 25th Armored Division sector against the enemy's main attack.</p> <p>Corps nuclear release authority is requested.</p> <p>Corps package is updated.</p> <p>Intelligence locates enemy front's second echelon moving toward the 10th (US) Corps sector.</p> <p>Corps logistical effort becomes strained.</p> <p>Corps logistics support facilities move west of Rhine River.</p>
E+6 to E+10	<p>Corps experiences extreme shortages of critical items.</p> <p>Corps conducts rearward crossing (five days) of Rhine River.</p> <p>Nuclear release authority granted.</p> <p>Corps logistical base comes under attack.</p> <p>Pressure continues in the 25th and the 54th division sectors.</p>

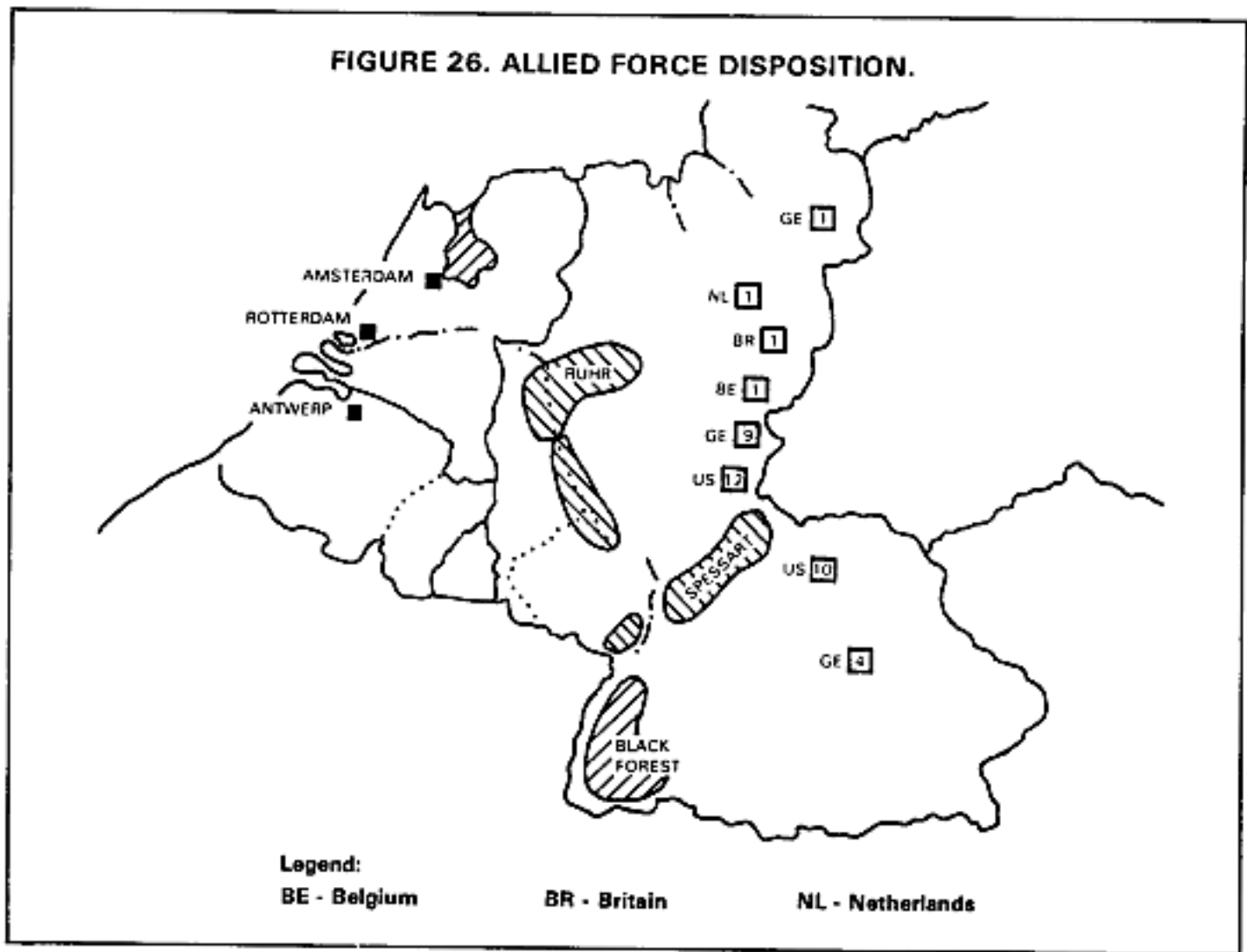

INITIAL SITUATION

In the past several years, relations between NATO nations and the enemy in Central Europe steadily deteriorated over the issue of the reunification of Germany. In early 19__, most negotiations and diplomatic relations between the Western Allies and the enemy were suspended. By E-73, provocative Soviet maneuver exercises along the eastern border of the Federal Republic of Germany had increased. Intelligence reports indicated a massive buildup, especially in the central region of Germany. By E-60, the NATO secretary general authorized the European allied commander to declare a low-level alert. All national units permanently assigned under Allied Command Europe were reinforced, and all nonessential US dependents were ordered to CONUS. The commander in chief, United States Army, Europe (CINCUSAREUR), requested early shipment of replacement combat vehicles, as well as buildup of ammunition, spare parts, and high priority Class IX assemblies from CONUS.

FIGURE 27. THREAT ATTACK PLAN.

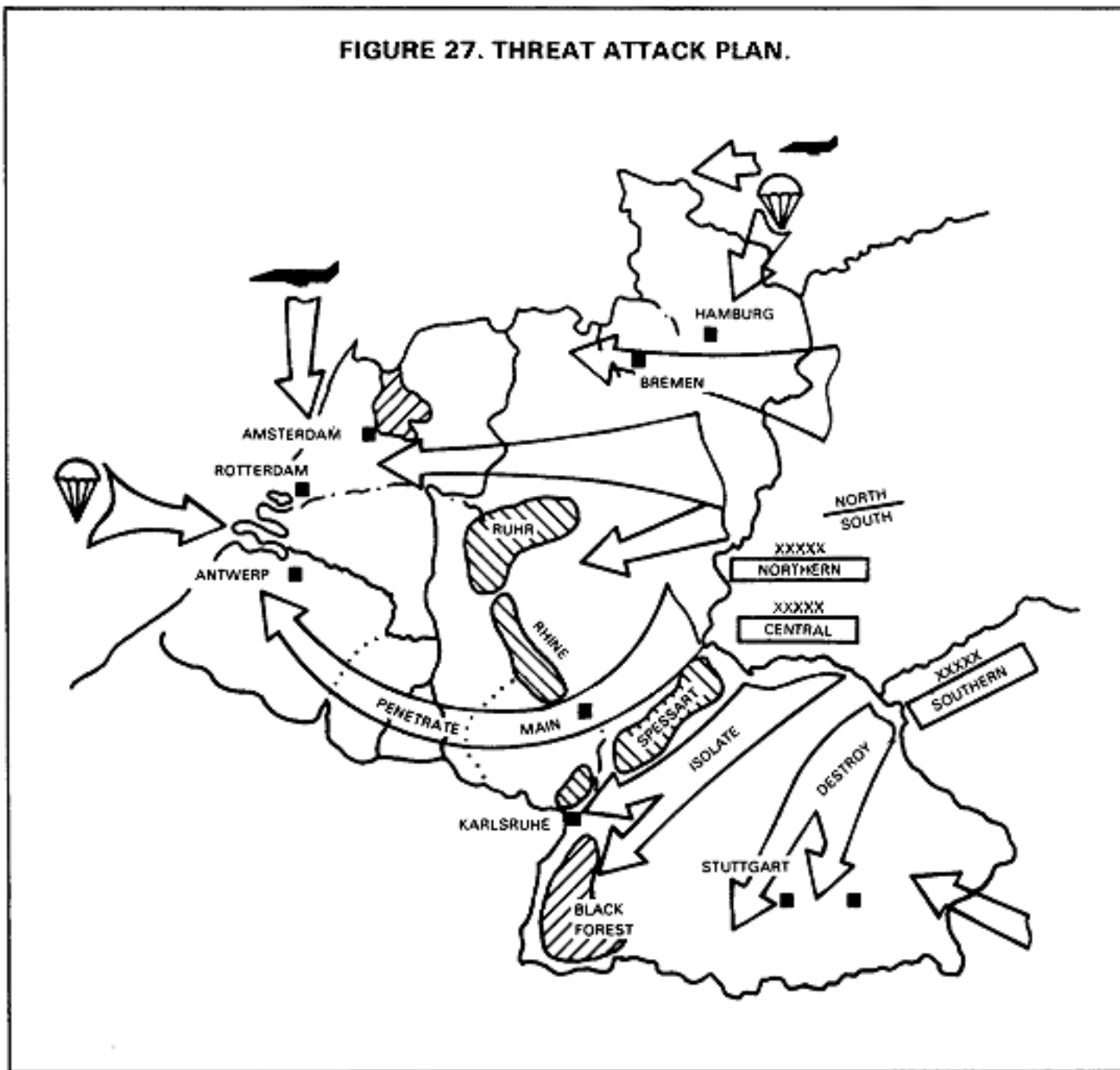

In response to a continued enemy buildup, NATO declared a mid-level alert on E-37 and a high-level alert one week later (E-30), when all NATO nations began mobilization. On the same day, the US declared a state of national emergency and ordered selected units of the Ready and Standby Reserves to active duty. The president ordered the deployment of forces to Germany. During the mobilization period, a limited number of active personnel and combat and combat support units began deploying to Europe by air. Merchant ships were engaged to transport equipment and other supplies to Europe to reinforce deployed US units.

The Soviet Union ignored repeated attempts to negotiate; therefore, NATO nations continued to strengthen their defenses in Central Europe. As NATO's defense posture improved rapidly, the chances of an enemy daring raid diminished until it was no longer considered a realistic threat. The primary threat

appeared to be a major offensive operation against NATO forces, as indicated by continued enemy air buildup and ground force deployment. On E-25, several US Air Force fighter, fighter bomber, and reconnaissance squadrons began deploying to Germany.

On E-14, the 10th (US) and 12th (US) Corps units were deployed to positions along the international border. From north to south, CENTAG forces consisted of the 9th (GE), 12th (US), 10th (US), and 4th (GE) Corps.

The enemy continued to build up combat units and began to pre-position ammunition and fuel at supply points along the inter-national border. Upgraded active duty CS and CSS units were deployed from CONUS. A COMMZ was established under a TA commander to support the 10th (US) and 12th (US) Corps. Recently activated Reserve Component units were deployed from CONUS by air and surface transportation and began arriving in the theater at E-10.

Allied forces continued making defensive preparations in sectors, and at E-7 all CENTAG corps implemented their OPLANS. In the 10th (US) Corps sector, OPLAN 1-82 became OPORD 1-82. It placed the 201st Armored Cavalry Regiment and the 313th Separate Mechanized Brigade in a covering force mission under the deputy corps commander. The 20th Infantry Division, the 54th Mechanized Division, the 124th Separate Infantry Brigade, the 25th Armored Division, and the 230th Separate Armored Brigade were ordered to defend the MBA in the corps sector. The 312th Separate Mechanized Division was given a primary RACO mission in the corps rear. The 171st Air Cavalry Combat Brigade was placed in reserve.

POMCUS was issued, and residual was placed in the supply system. All PWRMs were issued by E-Day. PWRMs remaining at E-Day were treated as GS supply items reported accordingly.

Intelligence reports indicated enemy force concentrations were nearing final preparation for a major offensive operation. Three combined arms armies and one tank army were identified massing near the international border.

FIGURE 28. INITIAL SITUATION.

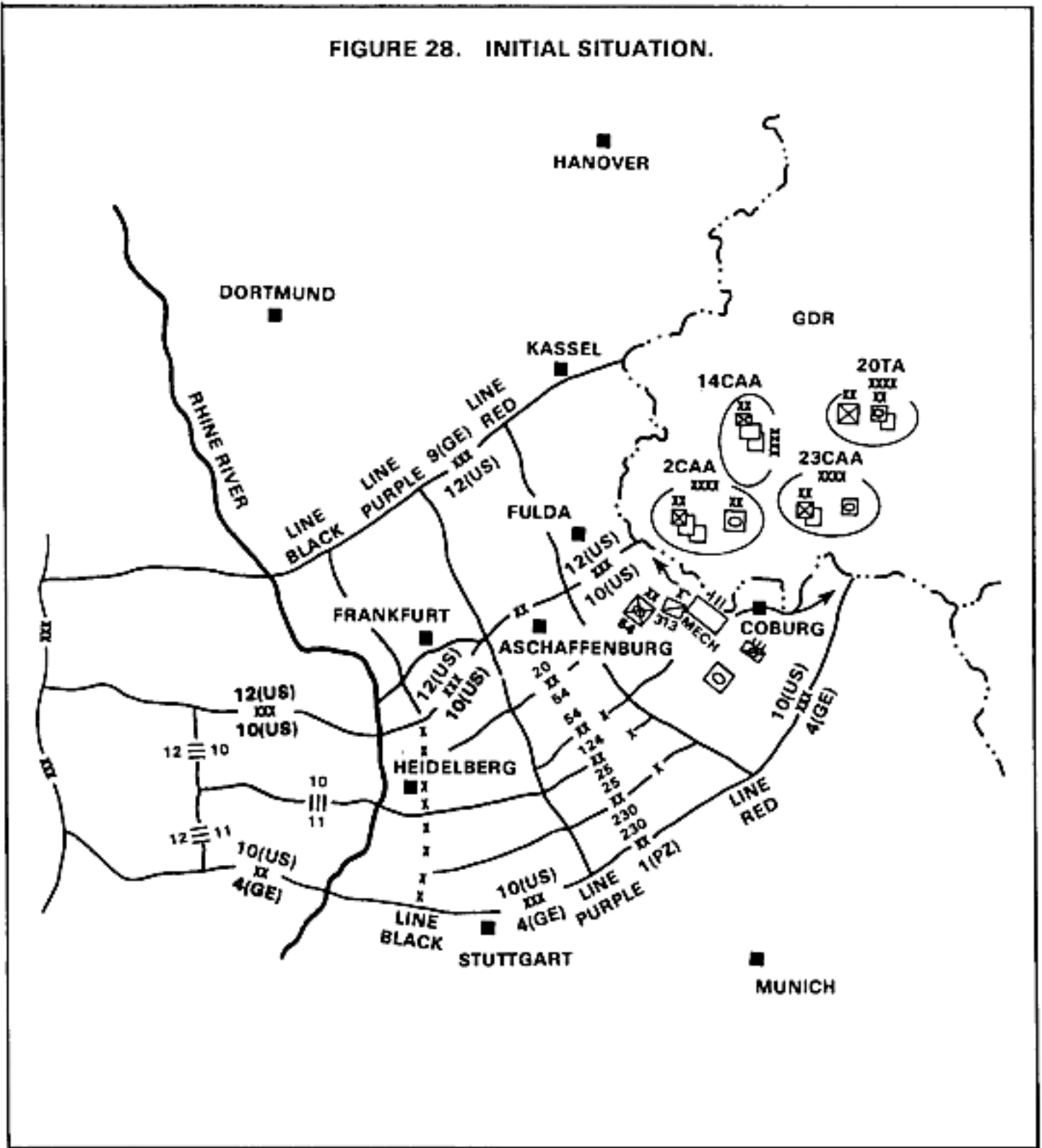

FIGURE 29. SAMPLE SCHEDULE OF EVENTS.

EVENT	DTG	FROM	TO	METHOD TO INITIATE EVENT	EVENT	ANTICIPATED PLAYER ACTION	CONTROLLER OPFOR ACTION	REMARKS
1	Chief controller	19 Aug 0700	OPFOR commander	Radio	STARTEX	Corps to conduct covering force operations	Enemy to attack across inter-national border capture Schweinfurt and Bamberg	Initiates the start of the exercise
2	Chief controller	19 Aug 1400	Controller with TF Saber	Radio	Rearward passage of lines	TF Saber, corps covering forces to begin rearward passage of lines	Lead elements of OPFOR CAA to advance slowly	
3	Controller with division G2	19 Aug 1400	Division G2	Verbal	Division G2 to develop locations of CAA main and secondary attacks Combat	Division G2 to brief division commander on locations of CAA main and secondary attacks	Controller to attend briefing	

[RDL](#)[Table of](#)[Document](#)[Download](#)[Homepage](#) [Contents](#) [Information](#) [Instructions](#)

APPENDIX B

CS and CSS in Exercises

PRINCIPLES

Support functions respond to the needs of the supported units. [Figure 30](#) depicts the system within which CS and CSS units operate.

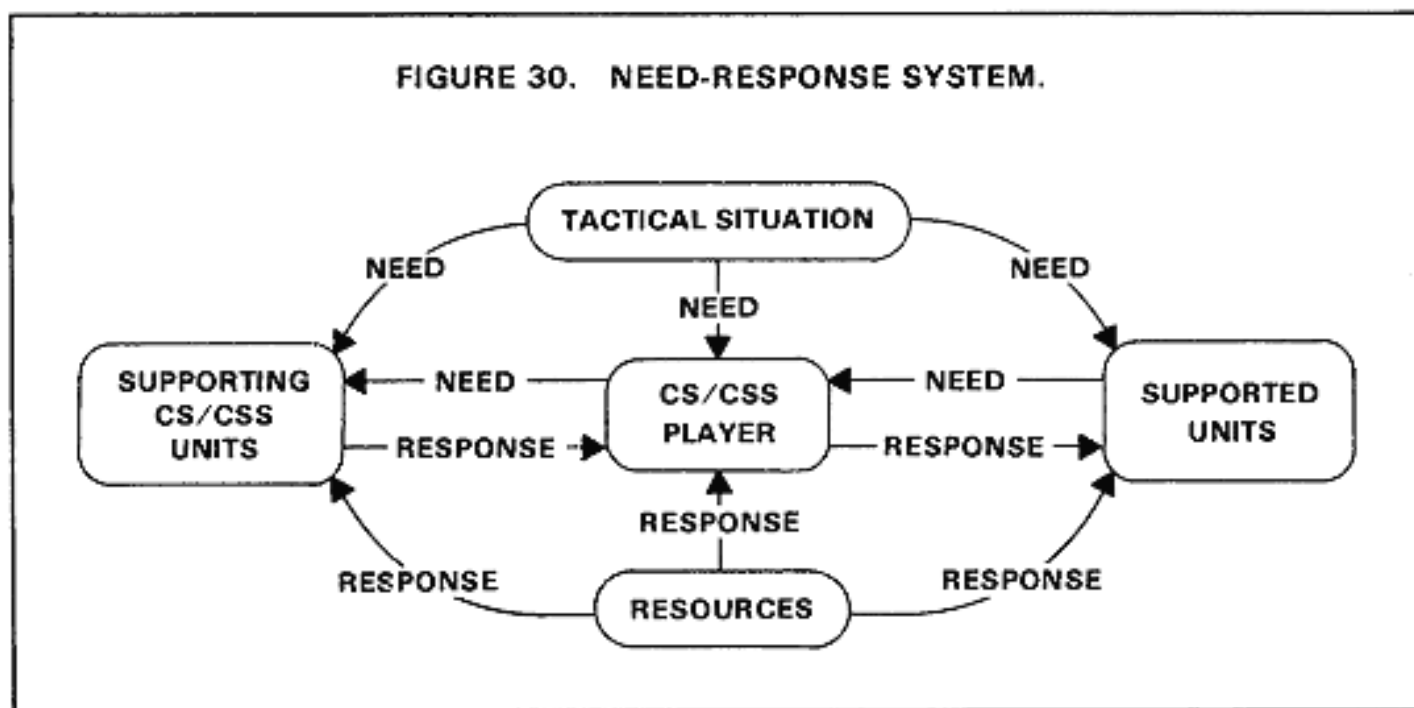

The tactical situation creates the needs to which the system responds. Consequently, the tactical situation drives the support system. The response is the way in which CS and CSS fill the needs. It is determined by the resources available. In wartime, the needs are created by what happens on the battlefield: equipment may be lost or damaged, personnel may be killed or wounded. However, in peacetime exercises, planners determine the tactical situation and the resources available in order to meet the objectives.

In training exercises, CS and CSS units support actual units or notional units. Actual units generate their own needs. However, to meet the exercise objectives, planners control the resources available for responding to these needs. For notional units, planners control both the needs and the resources. In

preparing for training, planners should employ the principles in this manual to conduct CS and CSS training exercises.

This appendix discusses specific considerations for planning, controlling, umpiring, and evaluating the following functions:

- Health services.
- Military police.
- Personnel and administration.
- Transportation.
- Maintenance.

HEALTH SERVICES OPERATIONS

Exercise play should include health services support operations, involving both nonmedical units and supporting Army Medical Department (AMEDD) organizations. As far as possible, AMEDD units and personnel should provide realistic support in exercises. They use moulaged casualties to train medical units in the transport, triage, and care of the wounded.

The terms *patient* and *casualty* are precise designations that ensure proper care of actual patients and proper use of actual resources. Patients are sick, injured, or wounded personnel receiving medical care or treatment. Actual patients are those who are really sick, injured, or wounded. They need actual medical care. Simulated patients are not really sick, injured, or wounded. They are tagged or otherwise identified (with or without cosmetic makeup) to simulate actual patients for training or evaluation purposes. They must be physically moved or cared for to meet training or evaluation requirements. Constructive patients represent sick, injured, or wounded patients in reports, messages, or other written or oral communications to assist in CPX play. It is not necessary to move these patients. Casualties are those lost to their organizations because of death, wounds, injuries, or disease. The differences among actual, simulated, and constructive casualties are similar to those described for patients. In exercises, all patients and casualties should have one of these designations.

Actual health services support must integrate with simulated and constructive exercise play. However, actual support should not replace simulated or constructive play unless it is furnished under the combat conditions. For example, a combat support hospital (CSH) providing only area sick call support for an exercise is not accomplishing its major CSS mission. See [Table 9](#) for the types of health services support operations that should be performed by different levels of AMEDD and non-AMEDD units in field exercises.

TABLE 9. TYPES OF OPERATIONS.

	<i>Non-AMEDD company/section</i>	<i>Combat/combat support battalion</i>	<i>Brigade division surgeon's section</i>	<i>Division medical battalion/brigade/ regiment medical company</i>	<i>Non-AMEDD corps/COMMZ units</i>	<i>AMEDD corps/ COMMZ units</i>
Self/buddy first aid	X	X	X	X	X	X
Personal hygiene and field unit sanitation functions	X	X	X	X	X	X
AMEDD staff functions			X	X		X**
Health services missions/tasks in nonmedical ARTEP	X	X*	X		X	
Missions/tasks in AMEDD ARTEP			X	X		X

*Appropriate AMEDD organizations only.

**Unit authorized a medical platoon/section.

PLANS

Exercise directors must ensure that AMEDD planners include actual, simulated, and constructive health services support requirements early in preexercise planning. AMEDD training objectives should integrate with other exercise objectives. Detailed guidance is contained in the 8-series AMEDD ARTEPs.

Planners must identify all the necessary resources such as--

- Funds.
- Personnel.
- Equipment.
- Supplies.
- Transportation.

Some of the required health services personnel for exercises may be temporarily assigned to fixed installation medical facilities. Agreements between AMEDD TOE units and the local medical activity/medical center (MEDDAC/MEDCEN) should specify the release procedures for TOE unit personnel in on-the-job training or directed support programs. Agreements should specify procedures for obtaining controller, umpire, and evaluator personnel. Local agreements should also provide adequate time to request and obtain release of personnel from their parent units. When local assets cannot provide actual, simulated, and constructive health services assistance, requests should go through appropriate command

channels.

To support the training objectives of most AMEDD treatment and evacuation units, realistic simulated casualty or patient play is necessary. Exercise planners must determine the source of casualties and patients, for example, by assessing player units or by using casualty or patient pools. In exercises that involve only medical or other support units, pools are usually necessary to provide the required volume of patients or casualties. In large exercises, assessments during exercise play should generate casualties. This procedure ensures that AMEDD training objectives are met. It also ensures that player units operate with realistic combat losses. Detailed instructions issued to controllers, umpires, and player units specify how to release simulated casualties into the treatment and evacuation system. Procedures must also provide for the timely return of personnel to units upon their release from medical channels. Normally, exercised to accomplish this. AMEDD units are not responsible for returning patients to their units.

Casualties should simulate only those injuries or diseases that could be found in the area of operations under the conditions established for the exercise. To determine the battle and nonbattle casualties for each exercise, planners consider--

- Units involved.
- Troop population and density.
- Enemy forces.
- Type of combat.
- Weather.
- Terrain.

The available resources may limit the simulated casualties. To meet the training objectives, varying numbers of casualties are necessary.

Medical planning should provide realistic situations and events for AMEDD units. It should provide enough information so that participating units can respond realistically. Medical units practice survivability operations and operate 24 hours a day.

For FTXs, units attached to the medical headquarters in peacetime or scheduled for attachment in contingency operations may comprise only a portion of the organization. Other units must be added, as needed. ARTEP 8-112 contains guidance.

PERSONNEL AND EQUIPMENT

Detailed requirements to support specific AMEDD units are contained in appropriate 8-series ARTEPs. To determine the personnel and equipment for large-unit exercises, planners analyze--

- The objectives of the exercise.
- The quantity, types, and locations of player units.
- The timing of exercise events.

Control and evaluation functions may be combined or separated, depending on the exercise. Sufficient qualified personnel must be available to play all nonparticipating agencies with which the unit would normally coordinate and communicate. Many professional specialties in AMEDD units cannot be adequately evaluated. Controllers must be experienced and knowledgeable enough to initiate actions for, and respond to, player units. Control personnel have to moulage simulated patients and instruct them in their roles. Simulated casualty pools that generate patient play must have sufficient personnel. The appropriate 8-series ARTEPs recommend numbers of personnel for specific units. Driver/radio telephone operator (RATELO) personnel with vehicles are required to support the AMEDD controllers, umpires, evaluators, and patients.

When simulated patients and casualties are in treatment facilities during meal hours, the facilities will feed them. Class X clothing is required for simulated patients, particularly those who will be moulaged.

CONTROL

Exercise plans must specify detailed control procedures for actual casualties and patients. Actual medical support is normally the responsibility of the participating units. Provisions are made for--

- Sick call and outpatient care.
- Emergency care.
- Ground and air evacuation, as appropriate.
- Hospitalization.
- Care for personnel unable to return to their units but not requiring hospitalization.
- Medical supply and maintenance support.
- Communications to support the above functions.

FIGURE 31. CASUALTY TAG (FRONT).

CASUALTY TAG — PART A		NUMBER:					CASUALTY TAG — PART B NO.	
	NAME	EVENT SEQUENCE RECORD					NAME	
	SSN	EVENT	PGM TIME	D/G INITIATED	D/G COMPLETED	INITIALS	SSN	
GRADE	MOE/SS						GRADE	MOE/SS
UNIT							UNIT	
<input type="checkbox"/> SIMULATED <input type="checkbox"/> CONSTRUCTIVE							D/G TAGGED	
<input type="checkbox"/> LITTER <input type="checkbox"/> WALKING							LOCATION TAGGED	
<input type="checkbox"/> INJURY <input type="checkbox"/> DISEASE							CASUALTY EVACUATED TO:	
DIAGNOSIS								
INSTRUCTIONS ON REVERSE		CASUALTY EVACUATED TO:					INSTRUCTIONS ON REVERSE	

Casualty tags identify simulated casualties, place them into training exercises, and trace their movement through the medical treatment and evacuation system. If simulated casualties result from assessments, controllers must be briefed and issued the simulated casualty tags with Part A completed. Often the assessors are not AMEDD personnel. They may be controllers for other participating units. When players are tagged, Part B of the tag should be completed, separated, and turned in to AMEDD controllers on a prearranged schedule, normally at least once a day. Part A should remain affixed to the simulated casualty until released from medical channels. The last medical treatment or evacuation unit seeing the casualty should keep Part A and turn it in to AMEDD controllers on a prearranged schedule. Controllers should compare the collected Parts A and B at least once daily. Doing so ensures that assessed casualties are being released into, and properly moved through, the medical system. Controllers should bring major problem areas to the attention of player units for corrective action.

Standard moulage aids are relatively simple and increase visual impact. Patients must be briefed on behavior, signs, and symptoms. Then they can add realism to the exercise play.

Exercises with MILES should use the casualty procedures in TC 25-8. Controllers for such exercises will be issued packages of MILES casualty tags (GTA 8-11-5). The tags are issued concurrently with MILES devices. Unlike the casualty tags described above, the MILES casualty tags have predetermined wound diagnoses by percentage of various types of casualties. The controller will randomly issue one tag to each player prior to STARTEX. Players will place the tags in their pockets without reading them. If a player's MILES equipment is activated, the controllers read the card to assess the casualty.

FIGURE 32. CASUALTY TAG (BACK).

SEE FM 8-23 FOR DETAILED GUIDANCE ON THE USE OF THIS FORM.					INSTRUCTIONS — PART A	INSTRUCTIONS — PART B
1. THIS TAG WILL ACCOMPANY SIMULATED CASUALTIES TO THE MEDICAL TREATMENT FACILITY RELEASING HIM TO DUTY. TAGS WILL BE RETAINED AT THAT FACILITY AND BE PICKED UP BY A MEDICAL CONTROLLER.					LEGEND (PARA 7-3, AR 40-400) CW - CONFUSED WOUND LW - LACERATED WOUND PEN W - PENETRATING WOUND MW - MULTIPLE WOUND PERF W - PERFORATING WOUND FS - FRACTURE, SIMPLE FC - FRACTURE, COMPOUND FCC - FRACTURE COMPOUND COMMUNICATED SV - SEVERE SL - SLIGHT	REMOVE THIS PART OF TAG AFTER FILLING OUT REVERSE SIDE AND TAGGING CASUALTY. FORWARD THIS PART TO CHIEF MEDICAL EVALUATOR.
2. THIS TAG MAY BE USED AS A CONSTRUCTIVE CASUALTY AND MAY BE MOVED THROUGH THE TREATMENT/EVACUATION SYSTEM AS THOUGH IT WERE A CASUALTY.						
3. THIS TAG IS NOT INTENDED TO REPLACE DD FORM 1380.						
4. IF SECTION ON "EVACUATE CASUALTY TO" IS LEFT BLANK, CASUALTY WILL BE EVACUATED TO FACILITIES APPROPRIATE TO DIAGNOSIS.						
5. COMPLETE EVENT SEQUENCE RECORD SAW FM 8-23 AND THE ADMINISTRATIVE INSTRUCTIONS PREPARED FOR THIS EXERCISE.						
EXAMPLES: EVENT - BRIEF DESCRIPTION OF ACTION, PROGRAMMED TIME - SEE FM 8-23, DTG INITIATED/COMPLETED - ACTUAL DTG ; INITIALS - (1) CONTROLLER (2) COMPANY AIDMAN (3) AMBULANCE DRIVER (4) AID STATION PA (5) INDVY RELEASING TO DUTY.						
EVENT	PGM. TIME	DTG INITIATED	DTG COMPLETED	INITIALS		
TAGGED		170817	170815	TC (1)		
TREATED		170817	170825	ADD (2)		
EVAC TO AID STA		170835	170845	BTM (3)		
TREAT AT AID STA		170900	170920	JCH (4)		
RTD			171100	DRJ (5)		
					AHS 3871071	
					9 Jul 79	

If a casualty pool is used, medical controller personnel should moulage and brief the patients, attach a casualty tag and/or DD Form 1380 (Field Medical Card), and coordinate their insertion in exercise play. Simulated casualties can be introduced into play by--

- Being transported to the treatment facility by ground or air ambulances or other vehicles.
- Being picked up at simulated aid stations or other field sites by evacuation units.
- Walking into a facility.

If the scenarios require that casualties be evacuated after receiving initial treatment, each must have a DD Form 1380 to reflect treatment received.

Non-AMEDD controllers must ensure that released patients return to their units according to established exercise procedures. If they do not receive casualty information through normal communications, controllers portraying a unit's higher headquarters or a subordinate unit should request it from player units. These controllers should also respond realistically to requests from participating units.

FIGURE 33. SAMPLE CASUALTY TAGS FOR MILES-SUPPORTED EXERCISES.

CASUALTY TAG NO. 405	
NAME	
SSN	
GRADE	MOS/ISSI
UNIT	
<input type="checkbox"/> SIMULATED	<input type="checkbox"/> CONSTRUCTIVE
<input type="checkbox"/> LITTER	<input type="checkbox"/> WALKING
<input type="checkbox"/> INJURY	<input type="checkbox"/> DISEASE
DIAGNOSIS	
KIA	
Headquarters, Department of the Army, GTA 8-11-5	

CASUALTY TAG NO. 494	
NAME	
SSN	
GRADE	MOS/ISSI
UNIT	
<input checked="" type="checkbox"/> SIMULATED	<input type="checkbox"/> CONSTRUCTIVE
<input type="checkbox"/> LITTER	<input checked="" type="checkbox"/> WALKING
<input checked="" type="checkbox"/> INJURY	<input type="checkbox"/> DISEASE
DIAGNOSIS	
Lacerations, shoulders and upper arm, left.	
RTD	
INSTRUCTIONS ON REVERSE	
Headquarters, Department of the Army, GTA 8-11-5	

Detailed procedures for evaluating and maintaining records of medical exercise activities are found in appropriate 8-series ARTEPs and FM 8-23. Also, see [TC 25-6](#) for instructions on MILES-supported exercises.

DA Pamphlet 310-12 describes a wide range of available simulation training aids. Planners should also consider other locally constructed aids. Some applicable nonstandard aids may be available through the MEDDAC/MEDCEN. They may be justified for purchase and use within a command. Improvised medical training aids are as varied as imagination and resources allow.

MILITARY POLICE OPERATIONS

Military police (MP) units participate in exercises to provide realism. These units provide combat, CS, and CSS to the commander. [Table 10](#) summarizes MP missions and operations and identifies the military police TOE units responsible for each.

TABLE 10. MP MISSIONS AND RESPONSIBILITIES.

	<i>DIVISION MP COMPANY (TOE 19-17)</i>	<i>CORPS OR TAACOM MP BRIGADE (TOE 19-262)</i>	<i>BATTALION (TOE 19-76) COMPANY (TOE 19-77)</i>	<i>MP PRISONER OF WAR BRIGADE (TOE 19-282)</i>	<i>MP CONFINEMENT BATTALION (TOE 316-H600)</i>	<i>MP SECURITY COMPANY (TOE 19-97)</i>
Battlefield Circulation Control						
Route reconnaissance and surveillance	X	X				X**
Main supply route (MSR) regulation enforcement	X					
Straggler and refugee control	X					
Information dissemination						
Area Security Mission						
Area reconnaissance	X	X				X
Rear area combat operations	X	X				X
Area damage control operations	X	X				X
Intelligence collecting and reporting	X	X				X
NBC detecting and reporting	X	X				X
Enemy Prisoner of War (EPW) Mission						
EPW collection and evacuation operations	X	X	X			
EPW internment operation	X	X	X			
Law and Order Mission						
Law enforcement	X	X				
Criminal investigation	X	X				
US military prisoner confinement	X*	X*			X	

*Battlefield temporary detention of US military prisoners.

**As needed by the security mission.

PLANS

Military police planning considerations are applicable to actual tactical situations, as well as to the planning and conduct of training exercises. Wherever feasible, military police participate in the planning so that their training needs can be incorporated in the exercise. Tasks in the MP ARTEP should be included in the exercise scenario. Additional military police tasks dictated by local missions or

circumstances may also be included. Planners should keep in mind the size and actual capabilities of the military police unit being employed. The wide spectrum of possible military police missions requires that the military police be given every opportunity to experience situations as close to actual combat conditions as possible. For example, military police play a vital role in RACO. Planning of military police missions for RACO should be exercised in accordance with current doctrine. The conditions needed to employ military police realistically are best met by including them in exercises conducted by major head-quarters. Military police can receive excellent training in planning for, and assisting with, the movement of units to and from the training areas.

PERSONNEL AND EQUIPMENT

Military police planners develop their plans to best support the concept of the exercise. Planning factors that affect military police employment include--

- Number, types, and missions of units in the MP element's area of operation.
- Specific missions and the type of support required of the MP element.
- Quantity, quality, and types of vehicles and equipment available to the MP element.
- Environmental conditions within the area of operations.
- Width, depth, size, and location of built-up areas.
- Attitudes and needs of the inhabitants.
- Requirements for augmentation by MP elements.
- Enemy capabilities in the rear area.
- Political or psychological activities directed against US forces.

The military police controller, umpire, or evaluator checks to ensure that MP unit commanders establish mission priorities in the light of available troops and provide for 24-hour area coverage. Once these determinations have been made, the formula below, as well as the directions found in [ARs 310-31](#), [310-49](#), and [570-2](#), may be used.

Military police planners will consider special equipment, facilities, and transportation. MP units can provide the majority of their equipment needs. Special missions require augmentation. Such missions may involve--

- Support of river-crossing forces.

- Security of ports and harbors.
- Security of permanent stations.
- Handling unusual numbers of PWs or military prisoners.
- Riot or civil disorder control.
- Security for extended lines of communication (LOC) under enemy observation and fire.

Military police planners consider aviation employment and support in the following missions:

- Command and control, especially for extending communications capabilities.
- Security.
- Overwatch of extended LOC, including convoy cover, location of congestion, interruption of the MSR, and in-transit security.
- Movement of MP elements to unblock a threat obstruction and to relieve congestion on road networks.
- Timely coordination with supported head-quarters and subordinate military police elements.
- Evacuation of selected PWs for special protection or interrogation.

FIGURE 34. COMPUTING REQUIRED MP STRENGTH.

Man hours required per day times requirement	X	Operational days for mission to be in effect	
Productive man hours per person for the length of the mission		=	Number of military police required to man post or accomplish mission

EXAMPLE:

$$\frac{51.7 \times 365}{2700} = 7 \text{ military police required}$$

Contingency planning must include implementing instructions to undertake all types of operational support, including--

- Rear area protection.
- Security of critical installations.
- Security of LOC.
- Reaction to major disaster situations (area damage control).
- Reaction to installation security plans.
- Reaction to civil disturbance and riot control missions.
- Implementation of nuclear accident/incident control plans.
- Conduct of joint operations.

PERSONNEL AND ADMINISTRATION OPERATIONS

Personnel and administration (P&A) functions are heavily loaded with peacetime requirements. During wartime, only a few of these functions become more important or create a heavier work load than during

peace-time. Training exercises must focus on these critical wartime functions at each echelon. Critical functions include--

- Personnel strength accounting.
- Personnel information system (automated/manual) operations.
- Replacement requirements and requisitions.
- Replacement processing/operations.
- Casualty reporting.
- Military awards.
- Postal operations.
- Tactical administration service operations.
- Promotions/reductions.

Other P&A functions may be performed in combat. However, these are the critical ones that must be performed by each echelon. They differ from echelon to echelon. For example, at battalion level, personnel information will be detailed. At corps level, it will be summarized. Tactical SOPs and plans should include procedures and requirements to ensure that the system supports each echelon.

PLANS

For successful exercises, P&A planning must occur early. It must--

- Establish objectives.
- Determine which functions will be played and plan to exercise them thoroughly.
- Coordinate with scenario developers to ensure that the play will exercise the selected objectives.

In multiechelon exercises, P&A elements at all levels must coordinate to ensure that current SOPs and plans are sufficient. In exercises without higher and lower echelons, controllers must be provided proper information to create exercise realism. A number of functions require support from other organizations. If a player element does not provide this support, a controller must provide it to ensure that the units are fully exercised. For example, the division AG company (replacement detachment) needs transportation support from the supply and transportation (S&T) battalion to move replacements. If the replacement system is not

being exercised, movement requirements must still be submitted so that the transportation element can exercise.

Exercises should involve both P&A functional and tactical responsibilities. For example, the division AG company should also perform rear area security and rear area damage control in the division support area. The maneuver battalion's personnel administration center (PAC) should perform the same function in the brigade trains area.

PERSONNEL AND EQUIPMENT

The personnel selected for the exercise must be those who would normally perform during combat operations. The exercise objectives and the P&A functions to be played determine the actual number of participants. Only equipment authorized by the TOE should be used. Blank forms and appropriate references required by field SOPs should be available.

CONTROL

Exercise play drives P&A activities. For example, as personnel losses are declared, these losses are translated into MOSs and reported in accordance with established procedures. The personnel controller is the key to this function. He should have the TOE and Standard Installation/Division Personnel System (SIDPERS) rosters to verify losses by MOS and grade. The personnel controller ensures that personnel and other staff elements coordinate properly especially when exercise action increases. ARTEPs and 12-series field manuals cover P&A elements.

TRANSPORTATION OPERATIONS

Exercise play should include realistic transportation requirements for participating units. Transportation planners consider--

- The types of transportation operations and the modes of transportation to be exercised. See [Table 11](#) for an example.
- The levels of transportation to be exercised.
- The integration of transportation play into exercises.

TABLE 11. FTX TRANSPORTATION OPERATIONS.

COMMAND LEVEL	STAFF PLANNING	MOVEMENTS MANAGEMENT	AIRCRAFT MAINTENANCE	MOTOR TRANSPORTATION	AIR TRANSPORTATION	WATER TRANSPORTATION	RAIL TRANSPORTATION	TERMINAL SERVICE
COMPANY AND BELOW			X	X	X		X	
BATTALION		X	X	X	X		X	
BRIGADE AND DIVISION	X	X	X	X	X		X	
ABOVE DIVISION	X	X	X	X	X	X	X	X

PLANS

Planning steps identify basic transportation levels--strategic, coordinative, and operative. The steps then relate these to the transportation command structure. The strategic level involves high-level, long-range planning. It is done by the assistant chief of staff for transportation at theater army HQ or by the senior transportation command in a theater. The coordinative level integrates movement. Normally, the movement control center or the senior transportation command does this planning. The operative level involves unit missions. Each unit performs its function:

- Discharging containers from ships.
- Clearing terminals by truck, water, rail, and air.
- Performing intermediate aviation maintenance.
- Providing training for troops.

TABLE 12. PLANNING LEVEL RESPONSIBILITIES.**STRATEGIC**

- Assess the theaterwide transportation situation.
- Determine transportation requirements.
- Allocate resupply.
- Study the theater operations area and select main supply routes and alternates.
- Advise the theater commander on theater transportation operations.
- Select ports, terminals, and transfer points to use or avoid.
- Set the theater transportation policy.

COORDINATIVE

- Match transportation requirements with capabilities.
- Allocate and use transportation modes.
- Control activities, transportation groups, and other assigned units required in the movement of cargo and personnel.
- Report the daily capabilities of highways, inland waterways, air routes, and rail lines.
- Maintain liaison with local and national commercial transporters.
- Collect, evaluate, interpret, analyze, and integrate transportation intelligence.
- Prepare traffic circulation plan.
- Advise all concerned of the plan.
- Recommend substitution of one mode for another.

TABLE 12. PLANNING LEVEL RESPONSIBILITIES (continued).**OPERATIVE**

- Perform the unit mission as directed.
- Prepare reports on requirements versus capabilities.
- Recommend rerouting or diversion.
- Recommend substitution of one mode for another.
- Report daily readiness status.
- Maintain readiness.
- Apply and implement command policies and directives.

PERSONNEL AND EQUIPMENT

Exercise planners assign tasks at the correct transportation level--strategic, coordinative, or operative. Planners use the applicable ARTEP to suggest support requirements for various transportation exercises, as well as the framework for the desired standards and control.

MAINTENANCE OPERATIONS

By virtue of their missions, maintenance units perform daily many of the functions they can expect to perform under field conditions. At the DS level, these include--

- Inspecting.
- Testing.
- Classifying.
- Supplying repair parts.
- Cannibalizing.
- Controlling exchange.
- Repairing.
- Modifying materiel.

These are prime candidates for exercise play. Some functions, notably reclamation, overhaul, and rebuilding, are performed at maintenance levels higher than DS. Nonetheless, exercise planners should consider giving all functions some play.

The exercise scenario should include the applicable tasks shown in the appropriate ARTEP. It should also include tasks that are not part of the daily maintenance mission.

Exercises should be as close as possible to actual combat. For example, the supply function should train in conjunction with maintenance. Doing so is important because most maintenance supply actions will have an effect on Class IV supply. Similarly, the materiel management center (MMC) should train to find additional sources of repair parts, such as adjacent maintenance units and equipment that can be cannibalized. Accurate and timely readiness reporting is absolutely essential. Effective communications nets are also vital. If radio silence is imposed, couriers must be used. Likewise, as maintenance support teams (MSTs) are sent forward, they should train to satisfy both the supported and supporting units. Response times may be critical, both for equipment repair and MST survivability. MSTs may be transported by airlift to the equipment or provided armored maintenance vehicles.

[RDL](#)[Table of](#)[Document](#)[Download](#)[Homepage](#) [Contents](#) [Information](#) [Instructions](#)

APPENDIX C

Opposing Forces

PURPOSE

OPFOR units are trained and equipped to confront US units with realistic opponents that look like and fight like potential adversaries. Such realism enhances training exercises. Well-equipped OPFOR units are skilled in the tactics and techniques of a potential adversary. They not only add realism to training exercises, but generate player enthusiasm. Soldiers learn the potential adversary's tactics, doctrine, and weapon systems that they could successfully exploit in air-land battles. OPFOR units encourage--

- Effective intelligence-gathering procedures.
- Electronic warfare techniques.
- Operations security measures.
- Deception measures.
- Unconventional warfare techniques.

Presently, the collective sustainment training in units further refines the tactical skills taught in service schools. However, such training usually derives from friendly-on-friendly force engagements. Given such training, US forces would have to develop innovative ways to fight an actual enemy during the initial stages of a war. However, under current operational concepts, a period of adaptation is no longer acceptable. All units should train for future battles by exercising as much as possible against realistic, uncooperative, and competitive OPFORs that use threat doctrine, tactics, weapon systems, and fortifications. Knowing how a potential adversary is likely to perform on the battlefield, US soldiers and units can take advantage of enemy characteristics and weaknesses from the very start.

ORGANIZATION

Successful OPFOR employment relies on support from unit commanders and staffs. Except for the NTC, the Army has no authorized manpower allocations for OPFOR maneuver units. Therefore, corps and

division training programs must use unit assets to depict OPFOR tactics and operational principles. The G3 manages the OPFOR program. The G3 staff section uses the available expertise within the G2 section to help manage the program. This staff relationship fosters intelligence support to the overall unit training goal of combat readiness. The G3 also monitors unit scenarios. He ensures that they are properly designed and controlled and that they allow the OPFOR to create a realistic environment.

Units in the division or corps should be trained, on a rotating basis, to perform as an OPFOR element for training exercises and ARTEP evaluations.

SIZE

Full-scale employment of OPFORs demands extensive resources. Thus, OPFOR participation may be scaled down to reduce costs. The size of the OPFOR usually depends on the unit's ability to provide supporting personnel. For reporting purposes, one OPFOR soldier normally represents three enemy soldiers. One tank normally represents a tank platoon. The ratio between the OPFOR and the notional enemy it represents is flexible. The chief controller of the exercise must establish the ratio, based on available OPFOR training time, equipment, and personnel. However, the ratio must always be realistic. When using MILES with an OPFOR, refer to [TC 25-6](#). Some additional considerations when using OPFOR units in a training exercise include--

- Free play or controlled play scenarios.
- The exercise training objectives.
- The personnel, equipment, and facilities available.
- The scheme of maneuver.
- The fire support plan.
- The type, strength, composition, and training status of the OPFOR unit.
- The available maneuver space within the area of operations.
- The weapon systems to be employed.

EQUIPMENT

Modified US vehicles can suggest the appearances and silhouettes of threat combat equipment. Vehicle and equipment modification kits and soldier uniforms can be obtained from TASCs. Likewise, foreign material and equipment for training can and should be an important part of the total OPFOR program.

Foreign equipment in displays and in typical strongpoints can enhance realism in individual, leader, and collective training. AR 350-2 outlines the training objectives and explains how to obtain and maintain foreign equipment.

The OPFOR emblem identifies OPFOR equipment and personnel. It is also used on OPFOR training literature and materials. When the emblem is superimposed on OPFOR-designed equipment, the star is black and the circle red. The background remains the original color of the equipment. When a colored version is for uniforms, flags, and staff papers, the star and circle will be gold and the background red. These emblems can be obtained from TASCs.

TRAINING

Ideally, each division should have a small, permanent cadre to assist in OPFOR training. This cadre should train the OPFOR maneuver unit to execute the OPFOR portion of exercises quickly and professionally. It should provide divisionwide classroom instruction pertaining to Soviet and North Korean military forces. See [FM 30-102](#) and [FM 34-71](#).

The US Army Forces Command (FORSCOM) Red Thrust element, located at Fort Hood, Texas, has prepared training packages to teach tank and motorized rifle companies and battalions throughout the Army how to portray authentic Soviet and North Korean tactics. Both Soviet and North Korean formations are relatively easy to learn. To save fuel, OPFOR units can practice them with 1/4-ton trucks instead of tracked vehicles. Considerations to keep in mind when using OPFORs are--

- The general tendency of an OPFOR to revert to US tactics once it begins to maneuver against an actual US force.
- The tendency of OPFOR commanders to use the best of both Soviet and US tactics. Doing so should be avoided because any-thing less than authentic Soviet and North Korean tactics degrades the training of both the player unit and the OPFOR element.

PLANNING

The exercise directive provides initial planning guidance such as--

- The size of the OPFOR element required.
- The player units that will participate.
- The equipment available.
- The constraints (physical, financial) or other limitations.

- The tactical doctrine or techniques to be emphasized.
- The procurement of special supply items.
- The OPFOR training objectives and equipment.
- The source of OPFOR equipment and personnel.

The OPFOR scenario is developed in the same manner as the player unit scenario to facilitate player intelligence training. The OPFOR scenario emphasizes the following:

- Propaganda to enable all personnel to develop positive attitudes toward the exercise. Appropriate means may include posters and leaflets, agent activities, and loudspeaker broadcasts.
- Simulated nuclear-chemical operations.
- Tactical deception designed to strengthen procedures for developing counter-deception activities.
- Partisan, guerrilla, and counterintelligence agency operations to train all player units in survivability operations.

The preexercise phase must provide sufficient time to allow for--

- Training and converting a unit to OPFOR status, to include rehearsing the tactical plan.
- Developing plans and orders, to include preparation of communication, air support, and fire support plans.
- Developing plans for OPFOR intelligence activities.

Once the OPFOR has been designated by the directive, the OPFOR commander and staff begin planning and training--

- To establish operational headquarters.
- To reorganize units for OPFOR employment.
- To designate OPFOR identities for personnel and to issue weapons, clothing, markings, and documents, as needed.

- To construct necessary defensive positions according to threat tactics.
- To prepare the OPFOR OPLAN based on the exercise scenario.
- To plan and conduct appropriate rehearsals in coordination with controller personnel.
- To schedule briefings for all OPFOR personnel on the nature of the exercise and their particular roles in the exercise.

CONTROL

The exercise control plan details provisions for controlling OPFOR play. The type of scenario dictates the measures used for OPFOR control. Threat doctrinal control measures and graphics control OPFOR elements during the exercise. Controllers and umpires are designed to OPFOR units--

- To evaluate actions.
- To ensure realism.
- To assess loss and damage.
- To control activities.

Detailed training for umpires and controllers in OPFOR organization, doctrine, and tactics is the key to realistic control of exercise play. The corps or division OPFOR program manager or other personnel trained in OPFOR tactics and organization can provide this training.

The OPFOR commander has tactical and administrative control of the OPFOR and its attached units during the exercise. The OPFOR should rehearse planned tactical operations with the umpires and controllers. This enables all concerned to become familiar with the terrain and control measures to be used and allows correction of faulty tactical procedures.

[RDL](#)[Table of](#)[Document](#)[Download](#)[Homepage](#) [Contents](#) [Information](#) [Instructions](#)

APPENDIX D

Exercise Control

PURPOSE

All training exercises require control. Some such as TEWTs need only commanders. Others such as division-or corps-level CPXs or FTXs may require formal controller organizations responsible for conducting entire exercises. The control system for any exercise should ensure that it follows its scenario and attains its objectives. The control system makes sure that each exercise develops smoothly and provides meaningful, realistic training.

ORGANIZATION

To control exercises, chief controllers must organize the staffs to use the available personnel most effectively and beneficially. To do so, they prepare controller manning tables.

The composition of the control team depends upon--

- The type of exercise and the echelon at which it is conducted.
- The method, sometimes called the exercise driver, that sustains the exercise and causes it to flow to a logical conclusion. A sequence of events, a battle simulation, an OPFOR element, or a combination of these may drive an exercise.
- Troop lists from the notional higher and adjacent headquarters.

Controllers should represent all higher, subordinate, adjacent, and supporting units and staffs except those physically represented. If First Battle drives a CPX, the chief controller can use the organizer's guide from First Battle and the OPLAN troop list to assign controllers properly. For an FTX with an OPFOR element and no higher headquarters, OPLAN, or troop list available, the chief controller must decide not only where to place controllers, but whom they must represent.

Each battle simulation includes a recommended controller manning table along with the instructions. In many instances, manpower restrictions will dictate modifications to it. However, control organizations

that are not familiar with the particular simulation being used should follow the recommended control organization as closely as possible. A control staff, a headquarters together with umpires, and evaluators may all be necessary.

Controllers ensure that events take place at the right time and place per scenario and schedule. They perform as all HQs and units not present as players. Umpires determine outcomes of--

- Engagements.
- Fires.
- Obstacles.
- Support activities.

TABLE 13. SAMPLE MANNING TABLE.

CONTROL TEAM

Duty Position	Rank	Quantity	Specialty	Clearance	Equipment
Chief umpire	COL	1	11A	S	
Driver/RATELO	SP4	1	NA	S	M151 with trailer; VRC 47 secure

They report outcomes to players and controllers. Evaluators observe activities to determine whether tasks are performed to standard. Ideally, one person should not serve as controller, evaluator, and umpire during the same exercise. However, exercise directors may have to make dual assignments if there is a shortage of qualified personnel.

EXERCISE CONTROL CENTER

As the focal point for controlling each exercise, the ECC will portray the higher headquarters of the player unit. It will also be responsible for the administration and logistics necessary to support the exercise. Subordinate control centers, if used, and umpire teams report to, and coordinate their activities through, the ECC. ECC personnel must also know control and umpire procedures thoroughly and interact as required with subordinate control centers. The chief controllers or their designated representatives will coordinate all activities of the control organization according to the guidance from the exercise director. All training exercises have ECCs. Higher echelons require formal organizations.

A sample controller manning table for the ECC of a division-level FTX appears in [Table 14](#). The

suggested task organizations are austere. Actual controller requirements must be based on a mission analysis of the exercise being conducted and permit sustained operations. Manning and equipment tables vary depending on the type of exercise. They are based on the mission, the terrain, and the troops available to support the operation. The ECC must be organized to permit sustained operations.

TABLE 14. EXERCISE CONTROL CENTER MANNING.

DUTY POSITION	RANK	QUANTITY
Exercise director	COL	1
Deputy exercise director/chief controller	LTC	1
Clerk/driver	SGT	1
Pilot	CPT/WO	1
Crew chief	SGT	1
NCOIC	MSG	1
Draftsman	SP4	1
Operations/intelligence officer	MAJ	2
Assistant operations/intelligence officer	CPT/WO	2
Operations/intelligence NCO	SFC	2
Operations/intelligence specialist	SP4	4
RATELO	SP4	3
Clerk/driver	SP4	3
FSE officer	MAJ/CPT	2
FSE NCO	SFC	2
FSE specialist	SP4	2
RATELO	SP4	2

TABLE 14. EXERCISE CONTROL CENTER MANNING (continued)

NBC officer	LTC/MAJ/CPT	2
NBC NCO	SFC	2
Clerk/driver	SP4	2
Engineer officer	CPT	1
Engineer NCO	SFC/SSG	1
Clerk/RATELO	SP4	2
ADA officer	CPT/LT	1
ADA NCO	SFC	1
Clerk/RATELO	SP4	1
Aviation officer	CPT	1
Aviation NCO	SFC	1
Clerk/RATELO	SP4	1
ALO officer	LTC/MAJ	2
ALO NCO	SFC	2
Personnel officer	MAJ	1
Personnel NCO	SFC	1
Clerk/driver	SP4	1
Logistics officer	MAJ	1
Logistics NCO	SFC	1
Clerk/driver	SP4	1
G5 officer	LTC	1
Assistant G5 officer	CPT	1
Clerk/driver	SP4	1
Provost marshal	LTC	1
Deputy provost marshal	CPT	1
Operations NCO	SFC	1
Clerk/driver	SP4	1
Surgeon	LTC	1
Medical NCO	SFC	1
Joint visitor's bureau OIC	MAJ	1
Operations officer	CPT	1
NCO	SGT	1
Clerk	SP4	1

Note: The scope of the exercise will dictate what equipment and facilities are necessary. Equipment for this and all subsequent tables in this appendix is intentionally omitted.

Chief Controller

The chief controller commands all exercise controller personnel. He is responsible for informing the exercise director of player unit locations, plans, and intentions. He advises the exercise director about taking possible actions through controller channels to influence the tactical situations. ECC staff

members aid the chief controller in these duties. In the absence of a chief controller, a senior member of each shift of the operations section acts as ECC officer in charge.

Operations Officer

The operations officers are the primary advisors to the chief controller for exercise planning and operations. The operations section controls all notional units. It is aggressive in seeking updated information from the area coordination centers (ACCs) and the player unit's highest headquarters. It is responsible for--

- Fighting its portions of air-land battles.
- Disseminating changes to the highest player unit's OPORD.
- Issuing orders and directives.
- Planning on behalf of the player unit's higher headquarters.

Intelligence Officer

The intelligence officers are the primary advisors to the chief controller on all OPFOR matters. The ECC intelligence section controls all OPFOR units. It makes sure they adhere to the OPFOR commander's orders. It ensures that all necessary intelligence reports are issued and received per SOP requirements.

FSE Officer

The FSE officers represent the chief artillery umpires at the ECC. They--

- Brief the exercise director, chief controller, and staff.
- Recommend actions to control the exercise.
- Direct actions based on guidance from the exercise director and chief controller.

The FSE officers receive reports from the fire support sections of the ACCs and maintain current status reports on all field artillery player elements. The FSE officers ensure that map and status charts for ECC operations are properly posted. They pass guidance and information to the subordinate fire support controllers as required, and they maintain artillery unit status logs and staff journals.

NBC Officer

The ECC NBC officers are responsible for general supervision of the NBC control and umpire system. The NBC element coordinates chemical release procedures and chemical fire support plans. It maintains liaison with area control center NBC personnel and brigade NBC umpire personnel. Through reports submitted by ACC personnel, the NBC element monitors the effects of chemical or nuclear weapon systems in tactical play. It recommends chemical or nuclear courses of action to the chief controller.

Engineer Officer

The ECC engineer officer is responsible for briefing the exercise director and chief controller concerning engineer activities. The engineer officer also posts information about current engineer operations on the map and maintains all necessary logs. He directs engineers to comply with guidance received from the exercise director and chief controller, and he coordinates with other ECC staff sections, as required.

ADA Officer

Using information from ACCs, the ECC ADA officer maintains status maps showing all units and their engagement zones. He reports all ADA position changes to the ECC operations section, and he reports all changes in ADA position and operational status to the ALO. In addition, the ADA officer maintains the current and planned air defense situation based on situation reports received from the air defense umpires.

Air Liaison Officer

The ECC air liaison officer assesses the bomb damage from sorties not controlled by the forward air controller (FAC) and passes the BDA to the ACC, which in turn passes it on to the maneuver unit umpires for assessment. The chief ECC ALO exercises operational control over airborne umpires, ECC ALO umpires, and other controllers of Air Force activities, as required.

Aviation Officer

The ECC aviation officer compiles and maintains all Army aviation-related data during the exercise. He briefs aviation-related activities to the exercise director and chief controller.

Logistics and Civil Affairs Officers

The ECC G4 aids in the coordination of US and local national agencies or citizens, as required, concerning conflicts or maneuver damage, linguistic support, and other civil affairs activities related to the control mission. The G5 assists in handling foreign nationals who visit control facilities or activities. The G5 may collocate with the provost marshal section to assist in resolving incidents involving foreign nationals.

Provost Marshal

The provost marshal advises the chief controller on the status of all control personnel during the exercise. He advises the ECC personnel officers on matters involving policy violations. He maintains liaison with safety officers and provides the required reports on accidents involving umpire personnel and equipment. The provost marshal maintains the umpire's serious incident reporting system and is the ECC point of contact with appropriate public agencies.

Surgeon

The surgeon advises the chief controllers on the health status of all personnel during the exercise. He is responsible for operations of the casualty evacuation system.

Visitor's Bureau Officer

The ECC visitor's bureau (VB) is responsible for hosting visitors to the ECC, in accordance with established itineraries. The OIC of the VB establishes and maintains liaison/coordination with the secretary of the general staff. He keeps the chief controller and staff advised of visitors and their status, reporting their times of arrival and departure to the VB. He meets and escorts visitors in the ECC area, as the headquarters commandant directs, and he provides ground transportation for visitors in the ECC area, as necessary. The OIC also coordinates visits with umpires or ACCs.

AREA COORDINATION CENTER

ACCs, when established, are subordinate to the ECC. ACCs remain in fixed locations. They coordinate the administrative and logistical support that is not part of exercise play. In addition, ACCs monitor and record maneuver damage. ACCs are normally established for division and higher echelon exercises or when the geographic area is too large for an ECC's control radius. ACCs are normally composed of three elements:

- A maneuver section.
- A fire support section.
- An obstacle section.

For exercises above division or for special contingencies, they might add other sections such as air liaison or maneuver damage control.

ACCs must know--

- The locations of all player and OPFOR units.

- The locations of all emplaced obstacles.
- The general tactical situation.

ACCs use this information--

- To coordinate the support, such as maintenance, refueling, feeding, and administrative information, for umpire teams and controller/evaluator personnel.
- To coordinate emergency support that is not part of exercise play for all participants.
- To brief visitors to the exercise area.

Wire and/or radio communication connects each ACC with the ECC and with each other. ACCs are administrative elements and do not control, umpire, or evaluate. ACCs depend upon effective communication and timely reports from the umpire teams operating within their areas of responsibility. When the need for ACCs has been established, it is normal to field two or more of them.

The number of communications nets established by each ACC will depend on the type and echelon of the exercise. Sufficient nets must be established to enable the ACC to function effectively. Some nets that can be used are the--

- Umpire command net.
- Administrative/logistical net.
- Maneuver net.
- Fire support net.
- Obstacle net.
- Fire marker net.

Whenever possible, each ACC spans a geographical area that corresponds to the player unit boundaries. Thus, each ACC should work with only one player, OPFOR, and umpire/controller organization. However, if terrain and communication limitations make this ideal impossible, each ACC must be prepared to act as a relay point for other umpire/control elements. For division-level exercises, ACC limits usually correspond to brigade boundaries. ACCs then perform both their own functions and those of brigade umpire teams. All ACC sections assist area umpires and controllers in resolving administrative and logistical problems.

Maneuver Section

The maneuver section maintains the locations and status of all player and OPFOR units on the operations map. It places opposing maneuver umpires and controllers in direct communication with each other to institute and/or evaluate planned activities. This section consolidates umpire team reports and keeps the ECC informed of the intentions of subordinate units. It coordinates with adjacent ACCs and reports to the ECC on the status of flank units and on any boundary problems.

Fire Support Section

The fire support section monitors all fire support activities and communications, serving as the control element for all support fires within the ACC radius. All fire support umpires are required to process their reports through this section to the ECC. During LFXs, this section may have to halt play for safety reasons.

Obstacle Section

The obstacle section provides current information on obstacles to area umpires and controllers. It monitors conventional obstacles and damage to the MSR and to LOC for its assigned area. It should be staffed by experienced engineer personnel. Collateral damage from conventional, chemical, or nuclear strikes that create obstacles must be reported to this section. It assigns sequential target numbers to obstacles, and it reports their status, target numbers, and locations to the ECC. It reports current obstacle information to maneuver unit umpires by means of updated obstacle overlays. This section assists in controlling tactical obstacles and coordinates the placement of obstacle guards within the ACC area. It may divide its area into subareas to simplify the dissemination of information to tenant units. Breached obstacles are logged on the obstacle status log and removed from the obstacle map. Repairing unit umpires report MSR and LOC repairs, and ACC personnel post them in proper logs, remove them from the correct obstacle overlay, and report them to the ECC G4. The obstacle section also ensures that all obstacles in the ACC area are properly marked throughout the exercise. The obstacle should be marked by either the emplacing unit umpire, the requesting unit umpire, or a nearby resident umpire.

A sample ACC organization for a brigade area of operations during a division FTX is shown in [Table 15](#). The table is provided for guidance. Exact manning will depend on the type of exercise, the echelon at which it is conducted, and the geographic area.

TABLE 15. ACC MANNING.

DUTY POSITION	RANK	QUANTITY	SPECIALTY
Area chief controller	COL/LTC	1	11/12/13
Assistant area controller	LTC	1	11/12/13
Driver/RATELO	SP4	1	
Maneuver controller	MAJ/CPT	2	11/12
Assistant maneuver controller	MSG/SFC	2	11B/19
Driver/RATELO	SP4	2	
Fire support controller	MAJ/CPT	2	13
Assistant FS controller	MSG/SFC	2	13E/13C
Driver/RATELO	SP4	2	
Obstacle controller	MAJ/CPT	2	21A
Assistant obstacle controller	SFC/SSG	2	
Driver/RATELO	SP4	2	

UMPIRE TEAMS

The umpire teams evaluate engagements, fires, obstacles, encounters, and support activities, based on weapons effect tables, professional judgment, and a thorough knowledge of the player unit's disposition and scheme of maneuver. The teams interface with ACCs. They are especially active at the battalion and lower levels of command where they may perform simultaneously as controllers and evaluators.

The [organizational tables](#) that follow depict umpire teams supporting a division (brigade-slice) FTX. These tables depict the most commonly required teams. Any unit in an exercise may require a corresponding umpire team.

TABLE 16. BRIGADE UMPIRE TEAM.

DUTY POSITION	RANK	QUANTITY	SPECIALTY	CLEARANCE
Brigade chief umpire	COL/LTC	1	11B/12A	S
Driver/RATELO	SP4	1	NA	C
Pilot	WO	1	Rated pilot	S
Assistant chief umpire	MAJ	1	11B/12A	S
Driver/RATELO	SP4/PFC	1	NA	C
Administrative umpire	CPT	1	41, 42	C
Assistant administrative umpire	SFC	1	71L, 75B	C
Intelligence umpire	MAJ/CPT	2	35A	S
Intelligence NCO*	SFC	1	Intelligence experience	S
Driver/RATELO	SP4/PFC	1	NA	C
PW umpire	SSG	1	30A	S
Assistant PW umpire	SP4	1	NA	S
Operations umpire*	MAJ/CPT	2	11B/12A	S
Operations NCO*	SSG	1	Intelligence experience	S
Assistant operations NCO*	SSG	1	Operations experience	S
Track Driver/RATELO*	SP4	2	NA	C
Logistics umpire	CPT	1	92, 94	C
Assistant logistics umpire	SFC	1	76Y, 76D	C
Driver/RATELO	SP4/PFC	1	NA	C
NBC umpire	CPT/LT	1	74	S
NBC NCO	SFC/SSG	1	54E	S
Driver/RATELO	SP4/PFC	1	NA	C
Medical umpire	CPT/WO	1	60A/011A	C
Assistant medical umpire	SFC	1	91B	C
Driver/RATELO	SP4	1	NA	C
Maintenance umpire	CPT/WO	1	92	C
Assistant maintenance umpire	MSG/SFC	1	76	C
Driver/RATELO	SP4	1	NA	C

*Personnel and equipment that will not move.

TABLE 17. MANEUVER BATTALION CONTROL TEAM.

DUTY POSITION	RANK	QUANTITY	SPECIALTY	CLEARANCE
Chief umpire	LTC	1	11B/12A	S
Driver/RATELO	SP4	1	NA	C
Assistant chief umpire	MAJ	1	11B/12A	S
Driver/RATELO	SP4	1	NA	C
Operations/intelligence	CPT	2	11A/12A	
Operations NCO	SFC	1	Operations experience	S
Driver/RATELO	SP4	1	NA	C
Battalion fire support umpire	MAJ/CPT	1	13A	S
Assistant fire support umpire	LT	1	13A	S
Battalion fire support NCO	SFC/SSG	1	13E/F	S
Assistant fire support NCO	SSG/SGT	1	13E/F	S
Driver	SP4	2	NA	C
Redeye/Stinger section umpire	SSG/SGT	1	16S	C
Driver/RATELO	PFC	1	NA	C
Redeye/Stinger team umpire	SSG/SGT	1	16S	C
Driver/RATELO	SP4	1	NA	C
Scout platoon umpire	SFC	1	11D	C
Driver/RATELO	SP4	1	NA	C
NBC/operations umpire	SFC/SSG	1	54E	C
Driver/RATELO	SP4	1	NA	C
Company chief umpire	CPT	3	11C/12A	C
Driver/RATELO	SP4	3	NA	C
Company FIST/FO umpire	SFC/SSG	3	13A	C
Driver	SP4	3	NA	C
Assistant company umpire	SFC	3	11B/E	C
Driver/RATELO	SP4	3	NA	C
Administrative umpire	CPT/SFC	1	41, 42 71L, 75B	C
Logistical umpire	CPT/SFC	1	92, 94 76Y, 76D	C
Driver/RATELO	SP4	1	NA	C
Mortar platoon umpire	LT/SFC	1	11,12/11C	C
Driver/RATELO	PFC	1	NA	C
Antitank platoon umpire*	LT/SFC	1	11/11H	C
Driver/RATELO	PFC	1	NA	C

*For infantry battalions only.

TABLE 18. DIVISION ARTILLERY UMPIRE TEAM.

DUTY POSITION	RANK	QUANTITY	SPECIALTY	CLEARANCE
FA control/chief umpire				
Chief umpire	LTC	1	13A	S
Assistant chief umpire	MAJ	1	13A	S
Driver/RATELO	SP4	2	NA	S
Counterfire team/ DIVARTY or FA brigade umpire				
Counterfire chief	CPT/LT	2	13A	S
Operations NCO	SSG/SGT	2	13E	S
Driver/RATELO	SP4	2	NA	S
FA battalion team				
Chief umpire	MAJ/CPT	1	13A	S
Operations NCO	SFC	1	13Z	S
Driver/RATELO	SP4	1	NA	S
Lance battalion team				
Chief umpire	MAJ/CPT	1	13A	S
NCOIC	SFC/SSG	1	13	S
Driver/RATELO	SP4	1	NA	S

TABLE 19. CAVALRY SQUADRON UMPIRE TEAMS.

DUTY POSITION	RANK	QUANTITY	SPECIALTY	CLEARANCE
Chief umpire	LTC/MAJ	1	12A/11B	S
Assistant squadron umpire	MAJ/CPT	1	12A/11B	S
Driver/RATELO	SP4	2	NA	C
NBC umpire	SFC/SSG	1	54E	S
Assistant NBC umpire	SFC/SSG	1	54E	S
Driver/RATELO	SP4	1	NA	C

TABLE 19. CAVALRY SQUADRON UMPIRE TEAMS (continued).

Fire support umpire	CPT	1	13A	S
Assistant fire support umpire	LT	1	13A	S
Fire support NCO	SFC	1	13E/F	S
Assistant fire support NCO	SSG	1	13E/F	S
Driver/RATELO	SP4	2	NA	C
Troop FIST umpire	SFC	3	13F	S
Driver/RATELO	SP4	3	NA	C
Troop umpire	CPT	3	12A	S
Assistant troop umpire	SFC	3	19/11	S
Driver/RATELO	SP4	3	NA	C
Tank company umpire*	CPT	1	12A/11B	S
Assistant tank company umpire*	LT	1	12A/11B	S
Driver/RATELO	SP4	3	NA	C
Howitzer battery umpire*	CPT	1	13A	S
Assistant battery umpire*	SFC	1	13B	S
Driver/RATELO*	SP4	1	NA	C

*Regimental squadron only.

TABLE 20. AIR DEFENSE BATTALION UMPIRE TEAMS.

DUTY POSITION	RANK	QUANTITY	SPECIALTY	CLEARANCE
Chaparral/Vulcan battalion				
Chief umpire	LTC	1	14B	S
Assistant chief umpire	CPT	2	14B	S
Driver/RATELO	SP4	2	NA	S
Battery umpire	CPT	4	14B	S
Assistant battery umpire	SFC	4	16H	C
Driver/RATELO	SP4	8	NA	C
Platoon umpire	LTC/SFC	12	14B/16H	C
Driver/RATELO	SP4	12	NA	C
HAWK battalion				
Chief umpire	LTC	1	14D	S
Assistant chief umpire	CPT	2	14D	S
Driver/RATELO	SP4	2	NA	S
Battery umpire	CPT	3	14D	S
Assistant battery umpire	SFC	3	16D	S
Driver/RATELO	SP4	6	NA	S
Platoon umpire	LT/SFC	9	14D/16D	S
Driver/RATELO	SP4	9	NA	C

TABLE 21. DIVISION ENGINEER BATTALION UMPIRE TEAM.

DUTY POSITION	RANK	QUANTITY	SPECIALTY	CLEARANCE
Per division:				
Division engineer umpire	LTC	1	21A	S
Driver/RATELO	SP4	1	NA	C
Assistant division engineer umpire	MAJ	1	21A	S
Driver/RATELO	SP4	1	NA	C
Operations/intelligence umpire	CPT	1	21A	S
Administration/logistics umpire	CPT	1	21A	S
Driver/RATELO	SP4	1	NA	C
Per line company:				
Company umpire	CPT	1	21A	S
Platoon umpire	LT/SFC	4	21A	S
Driver/RATELO	SP4	5	NA	C
Per bridge company:				
Company umpire	CPT	1	21A	S
Driver/RATELO	SP4	1	NA	C
Per headquarters and headquarters company:				
Company umpire	CPT	1	21A	S
Driver/RATELO	SP4	1	NA	C

TABLE 22. AVIATION CONTROL AND UMPIRE TEAMS.

DUTY POSITION	RANK	QUANTITY	SPECIALTY	CLEARANCE
Chief company umpire	MAJ	1	Rated aviator	S
Pilot	WO	1	Rated aviator	S
Operations officer	CPT/LT	1	Rated aviator	S
Driver/RATELO	SP4/PFC	1	NA	C
Platoon umpire	CPT/LT	3	Rated aviator	S
Pilot	WO	3	Rated aviator	S

TABLE 23. MEDICAL CONTROL AND CASUALTY TEAMS.

DUTY POSITION	RANK	QUANTITY	SPECIALTY	CLEARANCE
Medical control team				
Medical umpire	CPT/WO	1	60A/011A	C
Assistant medical umpire	SFC	1	91B	C
Driver/RATELO	SP4	1	NA	C
Casualty control team				
NCOIC	SSG	1	91B	C
Mouflage technician	SP4/SGT	2	91B	C
Driver	SP4	1	91B	C

Brigade Team

Brigade Chief Umpire. The brigade chief umpires are in charge of all brigade umpire teams in their sphere of control. They are the primary link between the ECC, ACC, and the player units. They provide liaison with player units and ensure that ACCs and the ECC receive frequent updates on unit locations, plans, and intentions. They coordinate with OPFOR brigade umpires and assist in positioning opposing battalion umpires. They ensure that timely situation reports (SITREPs) are received and forwarded.

The brigade chief umpires maintain current locations of player units and monitor player unit plans and intentions. They resolve conflicts among player umpires and report them to the division chief umpires, when appropriate. The brigade chief umpires also conduct AARs at the ends of exercises.

Assistant Brigade Chief Umpire. The assistant brigade chief umpires represent the chief umpires in their absence and perform other duties that the chief umpires specify.

Administrative Umpire. The administrative umpires monitor the personnel replacement and casualty reporting system.

Intelligence Umpire. The intelligence umpires monitor the performance of the brigade S2 section, to include the brigade intelligence net traffic and actions generated by that traffic.

PW Umpire. The PW umpires control trained PWs, coordinate their insertion in player channels, and monitor the handling, processing, and evacuation of PWs in player channels. They accompany PWs from insertion to evacuation to the division PW collection point. They ensure that captured OPFORs are repatriated and not processed as PWs.

Operations umpire. The operations umpires monitor the brigade S3 section, maintain communications with the ECC or ACC, and gather and transmit SITREPs from battalion umpires.

Logistical Umpire and Assistant. The logistical umpires and assistants monitor all supply expenditures and resupply activities. They also monitor equipment loss reports and weapon systems replacement operations in the brigade.

Medical Umpire. The medical umpires coordinate the insertion of medical casualties and monitor the casualty evacuation system of player units.

NBC Umpire. The NBC umpires at brigade level ensure that NBC umpires in maneuver units are informed of brigade NBC player operations. They assist the maneuver unit NBC umpires in effecting umpire linkup between firing units and targeted units. They also inform the ECC and ACC of brigade NBC player operations.

Maintenance Umpire and Assistant. The maintenance umpires and assistants monitor all maintenance activities in the brigade. They ensure that recovery, repair, and replacement follow established procedures. They may accompany equipment through the maintenance system to observe player actions.

Maneuver Battalion Team

Battalion Chief Umpire. The battalion chief umpires are in charge of all battalion umpires. They are the primary communications link between the brigade team and the player units, and they ensure that the brigade team and the ACC maneuver section are notified prior to entering or departing ACC areas. The chief umpires make sure that the brigade team and the appropriate ACC maneuver section get updates whenever the battalion or a subordinate company moves 2 to 3 kilometers or more, changes the direction of attack, or withdraws. They make sure that timely SITREPs are transmitted to the ACC. They update the ACC frequently on player plans and intentions. They place subordinate company umpires in direct contact with their counterparts in the OPFOR. They resolve player-umpire conflicts and report them to the brigade chief umpire, as necessary. They conduct informal briefings at the ends of the exercises and provide input for the AARs.

Battalion Assistant Chief Umpire. The battalion assistant umpires take the place of the chief umpires, in their absence. They perform any other functions that the chief umpires direct.

Operations/Intelligence Umpire. The operations/intelligence umpires are the primary contact between player unit umpires and the umpire chain of command. As assistants to the battalion assistant umpires/evaluators, they establish the umpire maneuver operations center. They maintain the operations map with the current locations of battalion and subordinate units. They maintain communication and coordination with ACCs and subordinate company/scout platoon/attached unit umpires such as the engineer platoon umpire. They consolidate and transmit SITREPs from subordinate unit umpires to the ACC, and they transmit required reports to the appropriate ACCs. They provide target information, when requested, through the ACC maneuver section to the fire support section, and they receive and relay information on opposing forces and obstacles from ACCs to concerned company/scout platoon umpires.

NBC Umpire. The NBC umpires are the primary contact for NBC actions and information. They coordinate to ensure that ACC and higher and subordinate unit umpires are informed of any NBC hazards. The NBC umpires monitor and evaluate NBC protective measures and defensive actions. They ensure that the battalion and subordinate and attached units respond to NBC attacks. They assist and advise the operations/intelligence umpire on NBC matters, and they assess NBC casualties.

Logistics Umpire. The logistics umpires monitor the battalion logistics activities. They also monitor the equipment loss reports and weapon system replacement operations.

Company Umpire. Normally, company umpires go with the company commanders. They ensure that team members are properly positioned to observe player activities. They communicate or meet directly with the opposing force unit umpires to exchange information, adjust engagements, assess all battle losses, and determine the outcome of engagements. They report the plans and intentions of player unit commanders, as well as changes in unit location of more than 2 to 3 kilometers, to the battalion umpire teams. They also report all obstacles that player units emplace, execute, or breach to the battalion umpire team. The company umpires emphasize safety and report any violations directly to the unit or through umpire channels. They conduct informal briefings at the end of the exercise and report maneuver damage that exceeds the allowable maximum.

Scout Platoon Umpire. The scout platoon umpires monitor the activities of the scout platoon. They ensure that information regarding opposing force sightings and imminent contact is relayed to the company umpire. They must clear with the battalion chief umpire/operations officer before directing the platoon's withdrawal when it is reduced to one-third TOE strength.

Battalion Fire Support Umpire. The battalion fire support umpires assess the effects of hostile weapons. They monitor the FSO's fire planning and coordination.

Company Fire Support Umpire. The company fire support umpires assess the effects of incoming hostile fire. They monitor FIST/FO fire planning and coordination, positioning, and calls for fire. They forward fire planning and other appropriate information through umpire channels to the battalion umpires. They mark indirect fires within their sectors.

Mortar Platoon Umpire. The mortar platoon umpires monitor platoon planning, coordination, calls for fire, positioning, and interface with the scheme of maneuver.

Administrative Umpire. The administrative umpires have the same duties as the administrative umpires for the brigade team.

Redeye/Stinger Umpire. The Redeye/Stinger umpires monitor the tactical employment of Redeyes and Stingers.

Antitank Platoon Umpire. For infantry battalions only, these umpires function like the company

maneuver umpires but have specific responsibility for the antitank platoon.

Division Artillery Team

Chief Artillery Umpire. The chief artillery umpire is in charge of all field artillery umpires in the exercise sector. He is responsible for the training, supervision, placement, and welfare of umpires. The chief umpire arbitrates conflicts; serves as contact between players and umpires, as required; and ensures that all umpires adhere to established procedures in performing their duties.

Division Artillery Umpire. The division artillery umpire team locates near the division artillery TOC. The division artillery umpires monitor all counterfire missions, serve as umpires for the division artillery, and evaluate the operations of the division artillery units.

FA Battalion Team. The FA battalion team collocates with the player FDC operations center. The team monitors all counterfire and indirect fire missions, as required.

Lance Battalion Team. The Lance battalion team collocates with the player unit and monitors all missions.

Calvary Squadron Team

The squadron umpire team has the same responsibilities as the maneuver battalion team. The howitzer battery team has the same responsibilities as the field artillery team. Intelligence and administrative/logistics umpires may be added as appropriate.

Air Defense Battalion Team

Battalion Umpire. The battalion umpires activities, keep abreast of unit intentions, maintain the status and location of all units assess battle losses and casualties, and report and report to the ACC, as appropriate. The battalion umpires are the relay points for information provided the player unit by the ACC, especially obstacle information. They monitor both tactical play and movement of the battalion headquarters and headquarters battery. They assess battle loss and engagements, as required.

Battery Umpire. The battery umpires receive and act upon messages from the battalion and platoon umpires. They monitor unit current status to the battalion, umpires, as required. The battery umpires also submit obstacle reports to battalion umpires.

Platoon Umpire. The platoon umpires monitor player movement, tactics and engagements; and they report to the battery umpires, as required. They assess battle losses and casualties and report obstacles to battery umpires. The platoon umpires provide aviation umpires with air defense locations and operational status, as required.

Division Engineer Battalion Umpire Team

Division Engineer Umpire. The division engineer umpires monitor operations of the division engineer battalion headquarters and the division engineer section. They monitor all engineer obstacle information and ensure that reports on engineer obstacles are transmitted to the ACC.

Engineer Company Umpire. The engineer company umpires validate operations of the engineer company to include obstacle emplacement, execution, breaching, and bridging operations. They monitor Class V obstacle materiel management. They ensure that obstacles are marked and reported and that obstacle guards are properly placed.

Engineer Bridge Company Umpire. The engineer bridge company umpires validate the operations of an engineer company equipped with mobile assault bridge (MAB), ribbon, and panel bridging. They ensure that river-crossing operations are conducted in a realistic manner and verify bridge construction estimates during bridging operations with the ACC.

Aviation Control Team

Attack Helicopter Company Controller. The attack helicopter company controllers are in charge of the company umpire teams. They keep the ACC informed of company and forward arming and refueling point (FARP) locations, receive engagement reports from platoon umpires, and monitor current company strength. They ensure that assessed aircraft are removed from operation for the prescribed time period, and they monitor selected ammunition expenditures and resupply, to include FARP interdiction. The company controllers mark and assess incoming fire missions upon receipt of reports or retransmit reports to subordinate umpires in the vicinity of the impact grid for their assessment.

Platoon Umpire. The platoon umpires fly with and observe the deployment of the player-accompanied platoon. They assess losses from ground fire and ADA weapons, contact ground unit umpires through the ACC, provide a subjective loss evaluation of both air and ground elements, and submit engagement reports to the company umpire.

Medical Control and Casualty Teams

Medical control and casualty teams record and tag simulated casualties that medical umpires have designated for evacuation through medical channels. They will collocate with the specific evacuation companies that provide a simulated combat support hospital in the division support area.

[RDL](#)[Table of](#)[Document](#)[Download](#)[Homepage](#) [Contents](#) [Information](#) [Instructions](#)

APPENDIX E

Controllers, Umpires, and Evaluators

BASIC FUNCTIONS

Through the controllers, exercise directors monitor the play to ensure that the training objectives are accomplished. Controllers keep the play within the limits prescribed by the scenario. By arbitrating engagements and assessing losses, umpires help player units get the maximum training benefits. Evaluating is separate and distinct from both controlling and umpiring. Evaluators determine proficiency, based on the training objectives in soldiers manuals and ARTEPs, by observing player activities.

PREPARATION

At all echelons of command the controllers, umpires, and evaluators who monitor exercise play must be knowledgeable in the performance of assigned duties. They must know the schedule of events that support the training objectives. Controllers, umpires, and evaluators receive formal training after the LOI is published and prior to STARTEX. The chief umpire, chief controller, chief evaluator, and their respective staffs conduct training sessions together or separately.

Generally, preparation begins with team leaders' conferences. The chief controllers, umpires, and evaluators conduct conferences with their player counterparts at each echelon to acquaint them with the exercise scenario and background information; the missions, concepts, policies, and procedures for controllers, umpires, and evaluators; the organization, duties, and responsibilities for controllers, umpires, and evaluators; and the schedules for controllers and umpires. Preparation includes further schooling for controllers, umpires, and evaluators. Conducted either concurrently or separately, these schools familiarize personnel with--

- Duties, responsibilities, and procedures.
- The exercise scenario and background information.
- Administrative and logistics procedures.
- The exercise area, rules, and safety requirements.

- Medical procedures.
- Environmental protection.
- Procedures during player tactical movement.
- Procedures for umpiring obstacle encounters.
- Direct and indirect fire assessment.
- Procedures for controlling ADA, tactical air, and Army aviation.
- NBC operations.
- Preparation of reports.
- Procedures for multiechelon AARs.

Preparation also includes reconnaissance, coordination, and communications. Prior to STARTEX, controller, umpire, and evaluator teams and supporting personnel should reconnoiter the exercise area and test the communications equipment.

Evaluators should be selected with care and must be thoroughly knowledgeable in the specific tasks to be evaluated. The senior evaluator will instruct evaluator personnel on evaluation objectives and be responsible for their training. The senior evaluator will also develop the evaluator manning table in conjunction with the chief controller, taking care to ensure that evaluators are properly selected and assigned to positions they are qualified to evaluate. Evaluators must also be knowledgeable concerning--

- Player units' TOE and TDAs.
- The personnel status of the player units.
- The training of the player units to date.
- The equipment status of the player units.
- Player units' SOPs.

Evaluators are responsible for positioning themselves where they can observe as many activities as possible. However, because it is physically impossible to observe all activities during an exercise, they

must make sound judgments to determine which ones are more important. This does not relieve the evaluator of the responsibility to evaluate the other activities. To do that, evaluators must rely on the reports received from other means, including--

- Radio traffic.
- Pointed questions of other evaluators.
- Message traffic.
- Directed discussions with commanders and staff.

Evaluators may also assist unit commanders who desire help in meeting training objectives. Acting as trainers during the exercise, they can show soldiers and leaders better ways to perform tasks or correct poor performance, if required.

PARTICULAR FUNCTIONS

Control personnel must be able to monitor and assess various kinds of exercise play: direct fire, indirect fire, ADA, Army aviation, tactical air support, and engineer.

DIRECT FIRE PLAY

If the exercises use MILES, umpires must be familiar with assessment procedures from [TC 25-6](#). If simulation is used, umpires will assess casualties using the tables in [Appendix F](#) for evaluating small arms engagements.

INDIRECT FIRE PLAY

Control

Indirect fire control procedures require effective radio communications among opposing unit umpires and fire direction centers. Fire support controllers must be aggressive in establishing and maintaining communications. They must be accurate and prompt in informing each other of changes in locations, maneuver control measures, fire support coordination measures, and frontline traces.

Dedicated fire support umpires are assigned to each echelon from maneuver company headquarters to brigade head-quarters, including FA units. The composition of umpire teams for FA units depends upon unit missions and exercise objectives. Terrain and local situations may dictate modifications to any manning table. Only the planners at local levels can determine modifications. [Appendix D](#) of this manual provides guidance and sample manning tables for control organizations. Umpires accompanying other

forces must mark and assess indirect fires on their units' installations, as required.

Because no OPFOR live fire occurs during field exercises, targets that would normally be located by counterfire radar, sound and flash ranging, and crater analysis cannot be developed. The targeting assistance provided by CEWI units is also difficult to portray in exercises. Controllers or umpires can provide necessary information for exercising target intelligence systems to provide battle staff, survivability, and systems training. For example, the umpire of the targeted unit can receive the gun-target (GT) direction in each indirect fire mission report from the FDC umpire. If the targeted unit players can, in a practical manner, demonstrate to the controller that they know how to perform crater analysis correctly and have the equipment to do it, the controller will provide the hostile GT direction to the player unit. The player unit must then get this information through correct channels to the counterfire center at player division artillery. The fire support section of each ACC where indirect fire systems are positioned will notify the ECC fire support section of the identity and grid locations of OPFOR targets according to the schedule in [Table 24](#).

TABLE 24. OPFOR INDIRECT FIRE TARGET ACQUISITION RATES.

UNIT	NUMBER REPORTED TO EACH FORCE
Mortar platoon	1 each hour
Multiple rocket launcher battery	1 each hour
FA howitzer battery	1 each 2 hours
FA gun battery	1 each 3 hours
FA battalion command post	1 each 4 hours
Missile/rocket battery	1 each 6 hours

Another way to create target intelligence is to have the ECC for the support section consolidate opposing force locations and, according to percentages specified in [Table 34](#), relay a portion of them via telephone to division G2/G3 controllers. The G2/G3 controllers place the locations in the player division all-source intelligence center (ASIC). The ECC fire support element relays the remaining firing unit locations to each OPFOR DIVARTY controller by the fastest and most secure means available. In order to simulate radar acquisitions, the DIVARTY controller sends relay locations to the FA battalion umpire, who will provide them to the player radar section located in the area. The player division artillery is responsible for providing the communications link from the FA battalion umpire to the radar section. To simulate radar detection error, the ECC alters FA unit locations by no more than a 300-meter radial error.

As constraints permit, umpires can use pyrotechnics, munitions, or other aids to add realism. Upon notification of the mission, the umpire with the targeted unit can use an artillery simulator. A smoke grenade can simulate chemical or smoke munitions.

Assessment

For exercises such as CPXs that have no actual OPFOR, umpires assess field artillery and mortar effects, damage, and casualties using the appropriate tables from [Appendix F](#). For exercises such as FTXs that use an actual OPFOR, umpires with player and OPFOR units should determine the effects of fires and assess damage and losses using the appropriate tables from [Appendix F](#). For example, when an observer locates a target and calls for fire, the unit umpire gets the fire request information. The FDC umpire informs the company umpire of the impact location, shell, fuze, number of volleys, and observer target direction, rounded to the nearest 10 mils. This information passes from the friendly to the OPFOR umpire, who assesses casualties and damage based on damage tables, accuracy of fire, and subjective judgment, as appropriate. The OPFOR controller provides damage and casualty assessment to, the friendly controller, who then provides it to the FO. The FO uses the assessment in submitting a surveillance report if, in the controller's judgment, the terrain and weather allow observation. If the OPFOR unit correctly conducts a crater analysis, the OPFOR controller will provide the unit with a back azimuth upon which to base a shell report. If the exercise is so large that it is difficult to identify opponents, the umpire should get the call sign for the opposing umpires from the ACC.

Using [Table 33](#), umpires assess personnel losses and equipment damage caused by artillery and mortar fires. Simulated battle losses of cargo carrying vehicles include the loss of the cargo. The controller reduces or stops maneuver and/or delivery of fires, as circumstances require, until the player unit simulates resupply of destroyed cargo. In those firing units where weapon systems are assessed, the umpire adjusts the total rounds fired per mission based on the number of volleys fired, multiplied by the total number of operational tubes remaining.

In order to place realistic restrictions on the number of fire missions that an indirect fire unit can deliver, umpires assigned to mortar and field artillery units must maintain strict and proper ammunition accountability, including simulated losses to counterfire as described above. Maximum daily expenditures by type of firing unit and ammunition are shown in [Table 35](#). Unless OPFORs are designated and configured as threat units, the maximum authorized expenditures listed for US forces will apply to both. When a unit has fired its maximum daily expenditure or lost it through damage assessment, the umpire denies the unit permission to fire additional missions until it is resupplied. [Table 35](#) approximates the ammunition available daily, based on the unit's on-board basic load plus 2 1/2 turn-arounds of its organic resupply vehicles.

AIR DEFENSE ARTILLERY PLAY

Control

Control of ADA play occurs at respective fire units and at ADA tactical headquarters. The chief ADA controller manages play through control channels. Operating elements of the ADA control organization maintain continuous communications and keep records of all key events and observations.

Each OPFOR maneuver battalion is credited with the ADA array in [Table 43](#). It is not necessary to simulate that array since all air defense play is based on tables. Threat capabilities to our rear areas are also simulated regardless of the actual mix of US or allied weapons on the ground.

Aircraft are so fast and air defense tracking systems so sophisticated that a fully automated system is necessary for system-to-system engagements. In order to generate useful air defense play without ADP, control procedures define the flight route, the engagement technique of the aircraft, and the air defense array that they fly over. These become the basis for assessments against the aircraft.

Lacking the capability for system-to-system engagements, ADA training uses simulations. Such simulations include actual tracking (radar and manual), simulated firing, and ammunition resupply. Reports go through command channels to battalion level where the commanders informed of the number of aircraft engaged, the number estimated to be hit, and the volume of ammunition expended. Although such reports are not used for assessments against aircraft, they exercise air defense systems and reporting channels. An ADA umpire team is assigned to each ADA battalion operations center. The teams monitor and report ADA firing unit locations and are notified of suppression fires delivered against the unit.

Assessment

When determining losses from ground fire, umpires consider all types of weapons that engage the target, including surface-to-air missiles (SAMs), short-range air defense (SHORAD) artillery, and small arms. To assess losses from simulated engagements by operational ADA units, umpires determine the validity of the engagement. For HAWK units, this occurs in the battery control center (BCC); for Nike Hercules units, it occurs in the director station trailer (DST); for SHORAD units and small arms/automatic weapons, it occurs at the individual fire unit. Additional details on engagement procedures are found in [FM 44-4](#).

Umpires determine the volume of fire during the engagement. SAM units record the number of simulated missile launches by a single fire unit. Vulcan and 40-millimeter units record the length of time the weapons simulate fire.

ADA and USAF controllers operate in the ECC or the TOC. They maintain a situation map indicating current locations and status of air defense assets. They receive aircraft flight data from the air support operations center (ASOC) and determine aircraft attrition.

ADA controllers plot the anticipated aircraft flight route over the opposing ADA array. Based on the number and type of opposing ADA units, they use [Tables 37](#), [38](#), and [39](#) to determine attrition. They enter the figures on the line corresponding to the opposing ADA array and the column corresponding to the number of aircraft flown. The intersection of that row and column indicates the number of aircraft destroyed.

USAF controllers receive the ADA losses and determine additional losses caused by opposing interceptors. They then assess these losses based upon guidance from the USAF controller at the ECC. The overall attrition agreed upon by the ADA and USAF controllers will be given to the ASOC.

ADA unit umpires operate at each ADA battalion and battery and at HAWK platoons. ADA unit umpires determine the success of individual aircraft engagements based on the system kill probabilities shown in [Table 30](#) and the random number table at [Table 45](#). Chaparral/Vulcan (C/V), 40-millimeter, and Rapier engagements will be assessed at the battery operations center when the report is received from the platoon. HAWK engagements will be assessed at battery level. ADA unit umpires pass air defense locations and HAWK operational status reports to the ACC. Company or battery umpires assess Redeye engagements using [Table 41](#). They assess small arms engagements using [Table 42](#).

When ADA units are targeted by FA units, the HAWK battalion controller or the C/V or Rapier battery controller will be contacted by the ACC. The ACC fire support section relays FA mission reports from the suppressing FA unit umpires. HAWK battalion umpires or C/V or Rapier battery umpires determine if any player elements were at the specified grids when the missions were fired. If no element was at the grid, no further action is required. For successful suppression missions, ADA umpires refer to [Table 32](#) to determine personnel and vehicle casualties. They pass casualty figures to their player counterparts by face-to-face contact.

When ADA units are targeted by air assets, aerial umpires contact HAWK battalion umpires over the player battalion operations net and the C/V or Rapier battery umpires over the battalion controller net. The aerial umpires determine vehicle and personnel casualties. They pass the casualty figures to ADA umpires using the procedures outlined below. The ADA umpires pass casualty figures to their player counterparts face-to-face.

To use a random number table (see [Table 44](#)), controllers enter it at any starting point--for example, row 12, column 2. The number encountered is 15. They take additional random numbers in order from this starting point in any direction. When they reach the end of a row or column without having the required amount of random numbers, they proceed to the next row or column until they get the desired quantity of random numbers. The number 00 in the table means 100, not zero. Thus, if a system or event has 0.64 probability of success, it will succeed 64 times out of 100. When umpires use the random number table to assess the system, the event occurs for any number between 01 and 64 and fails for any number between 65 and 00.

To assess an engagement with a flight of four high-performance threat aircraft attacking at 2,000 feet and using electronic counter-measures (ECM), an umpire considers the flight route. En route to the target, the aircraft fly through three overlapping HAWK defenses and a Vulcan platoon that surrounds the target. The umpire enters the aircraft attrition table for high-performance aircraft with ECM ([Table 37](#)) for an array of three HAWK platoons and one Vulcan platoon. In a flight of four aircraft, three are destroyed. The one surviving aircraft flies through two HAWK defenses exiting the target. The umpire reenters the table for an array of two HAWK platoons. For a flight of one aircraft, none was destroyed. The umpire

reports that three aircraft were destroyed before reaching the target.

To assess an engagement of a Chaparral platoon firing three missiles at a flight of high-performance aircraft, an umpire uses the appropriate table. [Table 40](#) shows the kill probability of Chaparral against high-performance aircraft as 0.16. The umpire enters the random number table ([Table 44](#)) at row 15, column 16, and reads down. The first three numbers encountered are 54, 08, and 64. The umpire determines that one missile was successful (08 versus 16) and reports that fact to the player battery TOC.

TABLE 25. ASSUMED AIR DEFENSE CAPABILITIES.

	HORIZONTAL RANGE (KM)	EFFECTIVE ALTITUDE (KM)
Nike Hercules	130.0	30.0
HAWK	40.0	15.0
Vulcan	1.2	1.0
Chaparral	5.0	4.0
Redeye	3.0	4.0
Small Arms	.3	—

Detailed classified information appears in FM 44-1A and FM 44-1B.

For additional details on air defense operations, exercise planners and umpires should consult [FM 44-1](#), [FM 44-3](#), [FM 44-23](#), [FM 44-90](#), and [FM 44-95](#).

ARMY AVIATION PLAY

Control

Army aviation control computes losses for both aviation and OPFOR units during engagements and insertions. Engagements are confrontations between an attack helicopter (AH) section, platoon, or company and an OPFOR unit for a 5-minute period. Insertions are troops or equipment delivered into landing zones by assault or combat support aviation companies. Engagement outcomes are based on attack positions, exposure times, and OPFOR air defense assets.

Assessment

For engagements between AH-1 attack helicopters with TOWs against an OPFOR ADA array, an umpire is assigned to each AH platoon. A rated pilot rides in the front seat of the OH-58 or in the back seat of the player platoon OH-58 which accompanies the AH platoon. The pilot must have access to FM communications.

To assess engagements with AHs, OPFOR umpires monitor the number of engagements their ADA units accumulate against helicopter elements, keeping cumulative figures throughout the exercise. OPFOR company umpires coordinate with the OPFOR battalion umpire to determine what ADA assets, in addition to organic or attached systems, are available to the company. With these cumulative figures and knowledge of available ADA assets, OPFOR umpires consult the helicopter-ADA assessment card (Table 26). They determine the line number by indexing available ADA assets on the left of the card. They determine column number by adding 1 to the total number of prior engagements that have accumulated against the unit. They then transmit the line and column number to the airborne umpire.

TABLE 26. ADA-HELICOPTER ASSESSMENT CARD.

Line	ADA Assets	HELICOPTER CUMULATIVE ENGAGEMENTS (INSERTIONS)									
		1	2	3	4	5	6	7	8	9	10
1	Redeye (Blowpipe)	0	0	0	0	1	0	0	0	0	0
2	Vulcan (allied gun platoon)	0	0	0	0	1	0	0	0	0	0
3	Chaparral/Rapier	0	0	1	0	0	0	0	1	0	0
4	Gephardt	0	1	0	0	1	0	0	0	1	0
5	Line 4 and 1, 2, or 3	0	1	0	1	0	0	1	0	1	0
6	Line 3 and 1 or 2	0	1	0	0	1	0	0	0	1	0
7	Line 1 and 2	0	0	1	0	0	0	0	1	0	0
8	OPFOR ADA	1	0	1	0	1	1	0	1	0	1

Helicopter losses are the total losses for an engagement (5-minute period). OPFOR controllers use line 8 for any ADA assets when OPFOR tactics and organizations are used. Controllers use this card when the OPFOR ground unit is attacked by helicopters or when an OPFOR ground unit occupies the landing zone used for an insertion. OPFOR ground unit controllers keep track of the cumulative number of insertions and engagements that have been conducted against their units. For example, four engagements (20 minutes total time) have been conducted against an OPFOR ground unit since the start of the exercise. When the helicopter controller again makes contact with the OPFOR controller, the OPFOR controller sends the helicopter controller line 8, column 5, because this engagement is the fifth conducted against the unit. The helicopter controller consults the ADA-helicopter assessment card and follows line 8 across to column 5 and finds the number 1 under column 5. This means that one helicopter is lost during the first 5 minutes. If the engagement lasts longer than 5 minutes, the helicopter controller uses line 8, column 6. The number 1 under column 6 means that another helicopter is assessed during the second 5-minute period. The helicopter controller keeps going across the line for each additional 5-minute period. After reaching column 10, he returns to column 1.

When air assault, air cavalry, or attack helicopter missions overfly OPFOR territory, the inbound and

outbound flights are subject to casualty assessments. Helicopter unit umpires should establish communications with OPFOR umpires along the intended flight routes. Doing so determines losses inflicted on the way in and out of the mission objective areas before the missions are actually flown. Once the assessment process has been coordinated and computed by aviation and OPFOR umpires, helicopter units are allowed to perform the mission. Helicopter unit umpires will direct their units to divert the losses back to their home bases, to a FARP site, or in the case of an air assault, to the predesignated casualty holding area.

Aviation umpires should consider air-to-air engagements both in planning and controlling field exercises. Because Army aviation performs a wide range of missions with a wide variety of helicopters, standardized assessments are very difficult. Range, weapons, and targets control air-to-air and antihelicopter engagements. For example, rapid fire Gatling weapons are extremely effective at ranges less than 1,000 meters, but their effectiveness decreases significantly as the range increases. At 1,000 meters or less, machine guns or Gatling guns are effective. At 1,000 to 1,800 meters, folding fin aerial rockets or air-to-air missiles are effective. At distances greater than 1,000 meters, antitank guided missiles (ATGMs) or air-to-air missiles are effective.

In addition to the weapon systems and how they relate to range, planners must consider other factors. Gatling guns have a high volume of fire and create devastating effects on point targets at ranges under 1,000 meters. They require little time to lay on targets but must hit targets directly to be effective. Rockets require relatively little time to lay on targets. However, firing aircraft must aim at the targets, which requires maneuvering time. The greatest advantage of rockets is their effectiveness without making a direct hit. Although ATGMs are long-range and accurate weapons, they require targets that are stationary or moving very slowly. They are relatively ineffective against air-to-air targets including other helicopters. Air-to-air missiles are effective from 500 meters to their individual maximum effective ranges. Aircraft must be maneuvered to aim the weapon.

Target presentation is the third factor to be considered in an anti-helicopter confrontation. Does the target helicopter present its flank or front? Is it hovering, flying nap-of-the-earth (NOE), masked, flying contour, or attacking? Optimum hit and kill probability may occur when the target helicopter presents its flank and is engaged as a point target at a range of less than 1,000 meters. As the presentation becomes frontal and the range increases, the hit/kill probability decreases proportionally. Given all the possible factors, the professional judgment of qualified control personnel must still remain primary in assessing results.

TACTICAL AIR SUPPORT PLAY

Control

For tactical air support during exercises, the ECC should be manned by sufficient Air Force TACP personnel and equipment to maintain 24-hour duty and the Air Force control net. Normally, Air Force controller functions are performed by the ALO attached to the Army HQ that is given the mission to

establish control for the exercise. Each active ACC should be manned by sufficient TACP personnel to maintain and operate the Air Force control net as directed by the chief controller, and to receive/record BDA reports for airstrikes conducted within the ACC's area of responsibility. On joint training exercises, the appropriate Air Force headquarters will designate a chief controller for the exercise.

The Army controller organization should man the ASOC with sufficient ADA controller personnel and equipment to maintain 24-hour duty and communications with the ECC. If the ASOC is not deployed to the exercise area, ADA controllers must establish communications to the ASOC or to the Air Force organization fulfilling the ASOC mission for the exercise.

Assessment

For all Air Force tactical air support sorties entering the exercise area airspace (close air support, battlefield air interdiction, reconnaissance), the ADA controller computes attrition from ground-based ADA. The ASOC advises the ADA controller of missions, times over targets (TOTs), target coordinates or initial contact points based on NATO procedures, and numbers of aircraft involved. Using the attrition reports, the ASOC advises the ADA controller of the number of sorties remaining.

Close Air Support. Forward air controllers are also players. They control specific missions and supply BDA for them using mutually agreed upon tables provided for the exercise. They also introduce BDAs into controller channels and transmit them via controller communications to targeted unit umpires.

The ASOC notifies FACs of the number of aircraft for which BDA will be made. For example, the message *Four aircraft; score three* shows that ADA killed one aircraft. BDA reports only three aircraft are scored. All other ASOC transmissions to and from the FACs are standardized.

After each mission, the FACs make the BDAs using mutually agreed upon tables and deliver the standard reports. In addition, the FACs contact the ACC responsible for the area of the target coordinates and pass on messages indicating the mission number, TOT, target coordinates, BDA, and number of aircraft in the area. The ACCs log these mission reports.

Battlefield Air Interdiction. The ASOC notifies the Air Force controller in the ECC of all ground attack missions that will not be observed or for which a BDA by a FAC will not be made. The ASOC will provide mission number, actual TOT, target coordinates, type of attack (visual, radar, air support radar team), target description, type/number of aircraft to score, and ordnance. The Air Force controller will determine what unit may have been at the coordinates at the time of the strike and initiate assessment procedures.

Reconnaissance. The ADA controller at the ASOC will notify the ECC if a reconnaissance mission was unsuccessful due to OPFOR action. The G2/S2 air controller will prevent the appropriate reconnaissance mission reports from being used by player units.

For tactical air reconnaissance missions, the ASOC notifies the supported unit TACP of how many aircraft were lost before they reconnoitered the approved targets. The TACP then notifies the designated or supported unit umpire, as well as the appropriate staff member of the supported unit. Unit umpires should provide an appropriate intelligence readout given the flight path of the reconnaissance flight.

Air Transport. For tactical air transport missions, the ASOC notifies the supported unit TACP of how many aircraft were lost before they got to the drop or landing zones. The TACP then notifies the designated supported unit controller, as well as the appropriate staff member of the supported unit.

ENGINEER PLAY

Control

The planning sequence for engineer play in training exercises and for actual combat are identical. Exercise objectives determine the scope of engineer operations. The OPLAN published by the higher headquarters conducting the exercise provides subordinate commanders with EEI necessary to carry out the mission.

The engineer staff officer assigned to the exercise planning staff writes the engineer annex to the OPLAN. During planning, major engineer elements participating in the exercise work with the engineer planner to ensure that operations are adequate.

Umpires validate all simulated obstacles with obstacle certificates. Upon partial or full completion of a simulated obstacle, the umpire assigned to the emplacing unit fills in and signs the certificate and gives it to the obstacle guard. Obstacles should be so constructed that encountering units have difficulty in breaching or bypassing them. Attrition will be enhanced if an obstacle is covered by fire or if it coincides with a direct fire kill zone. The emplacing engineer unit umpire or, in the case of reserve targets, the umpire with the maneuver company guarding the obstacle reports completed obstacles to the ACC. Demolition obstacles are not effective until execution, including detonation, is reported to the ACC.

Umpires of units capable of delivering scatterable mines are informed of the mine-field mission by the delivering unit. After the emplacement, the maneuver unit umpire submits a report to the ACC, completes the obstacle certificate, and marks the obstacle.

Atomic demolition munitions are used only as obstacles and should be controlled as such. Once an ADM squad has deployed, the team umpire should ensure the proper delay for transporting the munitions from the special ammunition supply point (SASP) to the target site. The team umpire should also ensure that the squad is proficient in ADM procedures before validating the emplacement and detonation. After the simulated detonation, the team controller reports the resulting obstacle to the ACC and marks the obstacle with appropriate marking material. [Appendix F](#) contains information concerning ADM target analysis. See [Figures 34](#) and [35](#) for an obstacle certificate. Residual radiation casualties from ADM obstacles are not normally assessed during combined arms exercises.

FIGURE 34. OBSTACLE CERTIFICATE (FRONT).

OBSTACLE CERTIFICATE

(To be completed by unit officer)

1. **TYPE AND NATURE OF OBSTACLE** (Example: Bridge demolition, bridge damaged by bombs, road crater, pre-positioned weapons.)
2. **METHOD USED** (Brief description of work done. Example: ADM placed at center of abutment; for conventional explosives, attach a sketch, indicate location, type and amount of explosives in each charge and include the wiring diagram.)
3. **MATERIAL OR EXPLOSIVE USED** (Example: ADM _____KT; 6 charges, TNT, 200 pounds each with electric or nonelectric blasting caps.)
4. **STARTED** (Date and hour)
EXECUTED (Date and hour) or DATE AND HOUR BOMBED
5. **COMMENT:**

FIGURE 35. OBSTACLE CERTIFICATE (BACK).**CONTROLLER CERTIFICATE**

1. I HAVE INSPECTED THE OBSTACLE DESCRIBED ABOVE AND FIND THAT IT (WILL/ WILL NOT) CREATE AN EFFECTIVE MILITARY OBSTACLE.
2. DATE AND HOUR EXECUTED:

_____ UNIT

.....
 OBSTACLE REDUCED AT _____ HR

DATE _____

BY _____
 (Unit) (Signature of controller) (Rank)

LEGEND:

ADM - atomic demolition munition

KT - kiloton

Assessment

Upon entering an exercise area, the maneuver battalion umpire receives obstacle information from the ACC. The maneuver unit empire is responsible for ensuring that the unit takes appropriate action when encountering an obstacle. Units encountering obstacles should actually perform all steps of the breach possible. For example, when a unit encounters a minefield, the leader must choose the breaching method. If mine detectors are used, operators with detectors should actually attempt to locate and neutralize the mines. The nature of an obstacle determines the time required to reduce or breach it. This time obtained from the breaching requirements specified on the obstacle certificate. [Appendix F](#) provides the time required for breaching and the casualty assessment criteria for simulated minfields.

When an obstacle is covered by fire, the encountering unit must suppress or eliminate the source of fire and proceed with the breaching requirements specified in the obstacle certificate. Casualties from direct or indirect fire will be determined by casualty assessment instructions.

The exercise control organization provides obstacle guards who have the same authority as other exercise controllers. Obstacle guards enforce and ensure active compliance by all participating troops encountering the obstacle.

[RDL](#)[Table of](#)[Document](#)[Download](#)[Homepage](#) [Contents](#) [Information](#) [Instructions](#)

APPENDIX F

Assessment and Computation Tables

PRINCIPLES

The tables that follow were developed by the Command and General Staff College for assessing such exercise effects as personnel losses and equipment damage and for computing emplacement or deployment times. When battle simulations support an exercise, the tables from the simulations should be used. Other field manuals and training circulars, such as [FM 101-10-1](#), contain data and tables that should be used, as appropriate, in the assessment procedures. Locally produced tables and procedures should be used judiciously. Within any exercise, all participating elements must use the same tables.

To determine armored vehicle kill probability (AVKP), umpires follow the procedure [below](#).

STEP 1

First, opposing umpires determine task organization based only on the part of the unit that is in contact. For instance, one armored platoon, two mechanized infantry platoons, and two TOW sections may be opposing each other. Each of these elements has a kill potential in the following ranges: 1,000 meters, 1,000-2,000 meters, and 2,000 meters and beyond. At 500 meters or less, each can also inflict casualties. Umpires total the kill potential of all elements for each range, using [Table 27](#).

	RANGE IN METERS			
	1,000	1,000-2,000	2,000	500 (Casualties)
US				
1 Tank platoon (105-mm)	4	2	1	12
1 Mechanized platoon	3	0	0	20
1 TOW section	1	2	1	3
Totals	8	4	2	35
OPFOR				
1 Tank platoon (105-mm)	4	2	1	12
2 Mechanized platoons	6	0	0	40
2 TOW sections	2	4	2	6
Totals	12	6	3	58

TABLE 27. DIRECT FIRE ADJUSTMENT TABLE.

TARGET POSTURE					VISIBILITY				SUPPRESSION		
Moving or Open	Hasty (In Position Less Than 2 Hours)	Improved (In Position 2-8 Hours)	Prepared (In Position 8-24 Hours) or in Towns	Canalized Crossing, Obstacle Covered by Fire	Day-light	Fog, Snow, Heavy Rain, Sleet, Smoke	Night (Illumination)	Night (No Illumination)	Hot Suppression	Light Suppression*	Heavy Suppression**
1	1	1	0	2	1	1	1	0	1	1	1
2	2	1	1	3	2	2	1	1	2	2	1
3	2	2	1	4	3	2	2	1	3	2	2
4	3	2	1	5	4	3	2	1	4	3	2
5	4	3	1	6	5	4	3	1	5	4	3
6	5	3	2	8	6	5	3	2	6	5	3
7	5	4	2	9	7	5	4	2	7	5	4
8	6	4	2	10	8	6	4	2	8	6	4
9	7	5	2	12	9	7	5	2	9	7	5
10	8	5	3	13	10	8	5	3	10	8	5
11	8	6	3	15	11	8	6	3	11	8	6
12	9	6	3	16	12	9	6	3	12	9	6
13	10	7	3	17	13	10	7	3	13	10	7
14	11	7	4	19	14	11	7	4	14	11	7
15	11	8	4	20	15	11	8	4	15	11	8
16	12	8	4	21	16	12	8	4	16	12	8
17	13	9	4	23	17	13	9	4	17	13	9
18	14	9	5	24	18	14	9	5	18	14	9
19	14	10	5	25	19	14	10	5	19	14	10
20	15	10	5	27	20	15	10	5	20	15	10
21	16	11	5	28	21	16	11	5	21	16	11
22	17	11	6	29	22	17	11	6	22	17	11
23	17	12	6	30	23	17	12	6	23	17	12
24	18	12	6	31	24	18	12	6	24	18	12
25	19	13	6	34	25	19	13	6	25	19	13
26	20	13	7	36	26	20	13	7	26	20	13
27	20	14	7	37	27	20	14	7	27	20	14
28	21	14	7	37	28	21	14	7	28	21	14

27	20	14	7	37	27	20	14	7	27	20	14
28	21	14	7	37	28	21	14	7	28	21	14
29	22	15	7	38	29	22	15	7	29	22	15
30	23	15	8	39	30	23	15	8	30	23	15

LEGEND

*Light Suppression - 2 or fewer batteries. **Heavy Suppression - more than 2 batteries.

STEP 2

Opposing umpires then exchange their accompanied unit AVKP. The totals [above](#), for instance, would be exchanged as follows:

US to OPFOR 8/4/2/35

OPFOR to US 12/6/3/58

STEP 3

The umpires then adjust the AVKP they received for posture, visibility conditions, and the amount of indirect fire being used to suppress the opposing forces. They adjust the US to OPFOR 8/4/2/35 AVKP for these factors by referring to the OPFOR to US 12/6/3/68 direct fire adjustment [table \(27\)](#).

Example 1

US forces are in defensive/prepared positions (2 to 8 hours). Heavy rain reduces visibility. The US is firing light suppression on OPFORs located 1,500 meters from US positions. The AVKP US received from OPFOR is 12/6/3/58. By entering the adjustment table at 6 (1,500 meters) and reading across, the umpire determines that the posture adjustment is 3. The umpire then enters the visibility table at 3 and adjusts for rain. The AVKP is reduced to 2. Finally, the umpire enters the suppression table at 2 and, reading across to light suppression, determines an AVKP of 2. Thus, at a range of 1,500 meters, the OPFOR has the potential to kill 2 US armored vehicles in each five minutes of contact.

Example 2

The OPFOR is attacking 900 meters from US defensive positions. There is no night illumination, and heavy suppression is being fired on US positions. The AVKP that OPFOR received from US is 8/4/2/35. Entering the table at 8 and reading across, the umpire would determine that there is no target posture adjustment. The OPFOR is moving or in open positions; the night illumination adjustment is 4; the heavy suppression adjustment is 2. Thus, at a range of 900 meters, the US has the potential to kill 2 OPFOR armored vehicles in each five minutes of contact.

Example 3

The US is attacking and has breached a minefield 900 meters from the OPFOR. The US umpire takes the AVKP previously received from the OPFOR controller--8/4/2/35--and makes a special AVKP adjustment. Using the AVKP for 900 meters, which is 8, the umpire enters the direct fire adjustment [table \(27\)](#) in the Moving or Open column and reads directly across to the Canalized Crossing Obstacle column where the AVKP increases to 10. This number reflects the increased vulnerability for crossing an obstacle through a narrow breach. Other adjustments are made for visibility and suppression. The adjusted AVKP is assessed for each 55-minute period the US is moving through the breached obstacle.

STEP 4

From the above calculations, the umpires determine that the OPFOR now has the capability to inflict 2 armored vehicle losses per 5 minutes of engagement on the US forces and that the US can inflict 2 armored vehicle losses per 5 minutes of engagement on the OPFOR.

When more than one unit opposes a single unit, umpires use the cumulative AVKP in assessing losses. For example, an umpire may receive AVKPs from two opposing controllers:

	10/7/3/20
	6/5/1/30
	16/12/4/50
Total	

The umpire then adjusts the cumulative AVKP for target posture, illumination, and suppression. When a company is attacked by two opposing companies, the AVKP is divided and forwarded to each opposing controller. For example, a company in such a posture has an AVKP of 10/6/4/18. The umpire forwards an AVKP of 5/3/2/9 to each opposing controller.

DIRECT FIRE TABLES

To determine the effects of direct fires, umpires use the [tables](#) below, as appropriate.

TABLE 28. DIRECT FIRE ENGAGEMENT (AVKP).

UNIT	POTENTIAL ARMORED VEHICLE KILLS PER 5 MINUTES			
	50-1,000	1,000-2,000	2,000-3,000	PERSONNEL
RANGE IN METERS				
US				
Tank platoon (3 tanks, 105-mm)	3	1	1	8
Tank platoon (4 tanks, 105-mm)	3	2	1	10
Tank platoon (5 tanks, 105-mm)	4	2	1	12
Tank platoon (3 tanks, 152-mm)	1	3	1	5
Tank platoon (4 tanks, 152-mm)	1	3	2	6
Tank platoon (5 tanks, 152-mm)	1	4	2	8
Armored cavalry platoon	3	4	2	13
Scout platoon	2	3	1	10
Rifle platoon (mechanized)	3	-	-	20
Rifle platoon (foot)	2	-	-	15
Combat engineer platoon	1	-	-	10
Combat engineer platoon (CEV)	2	-	-	10
TOW section (2 TOWs)	1	2	1	3
AH platoon	3	4	4	10
Air cavalry section (2 AH, 2 OH)	1	2	2	4
FA battery (155-mm/8-inch)	2	1	1	36
FA battery (105-mm)	2	2	1	24
Vulcan ADA platoon	-	-	-	12
OPFOR				
Tank company	7	5	2	18
Motorized rifle company	8	9	2	23
Reconnaissance company	2	2	1	11
Antitank company (100-mm)	2	1	-	6
Antitank company (missile)	1	2	1	3
AH company (Hind)	5	6	5	18
FA battery	2	1	1	25
LEGEND: CEV - combat engineer vehicle OH - observation helicopter				
<i>Notes:</i> The data above is a guide. Controllers must adjust for target posture, visibility, and suppression. They must apply judgment to account for reduced effectiveness because of combat losses.				
Crew loss per armored vehicle kill is 3 personnel.				
Against wheeled or unarmored vehicles, the above losses double.				
Personnel casualties are the total casualties against a dismounted element, regardless of total elapsed time of engagement.				
Potential armor vehicle kills for a 105-mm FA battery are not valid against tanks.				
To determine personnel casualties in a pure infantry versus infantry combat situation, refer to Tables 30, 31, and 32.				

TABLE 29. INFANTRY FIRES VERSUS INFANTRY PERSONNEL.

ATTACKING UNIT	TARGET UNIT	
(Infantry, Stationary)	(Infantry, Open or Moving) Casualties/Probabilities	
	PLATOON	COMPANY
Mounted platoon	2/1-85 4/86-100	2/1-50 4/51-67 6/68-83 8/84-100
Mounted company	2/1-34 4/35-50 8/51-100	3/1-34 8/35-68 12/69-85 20/86-100
Dismounted platoon	2/1-50 4/51-68 6/69-85 8/86-100	2/1-34 4/35-50 6/51-68 8/69-100
Dismounted company	2/1-50 6/51-68 10/69-85 12/86-100	10/1-34 12/34-50 14/51-68 20/69-85 24/86-100
	TARGET	ADDED CASUALTIES
	Dismounted platoon (attack)	11
	Dismounted company (attack)	18
	Defending platoon	4
	Defending company	9

Note: To obtain probabilities, umpires use Table 44 and then enter the target unit column for casualties. The table assumes light or moderate indirect fires. For heavy fires (Battery 4, Battalion 1, or above), umpires add casualties, as shown above.

TABLE 30. INFANTRY AMBUSH.

ATTACKING UNIT (Infantry, Stationary)	TARGET UNIT (Infantry, Open or Moving) Casualties/Probabilities	
	PLATOON	COMPANY
Mounted platoon	2/1-50	2/1-17
	6/51-85	4/18-50
	8/86-100	8/51-68
		10/69-85 12/86-100
Mounted company	2/1-17	12/1-17
	6/18-34	14/18-34
	8/35-50	18/35-50
	10/51-68	21/51-67
	12/69-85	26/68-85
	18/86-100	32/86-100
Dismounted platoon	2/1-17	4/1-17
	4/17-50	6/17-34
	6/51-67	10/51-67
	10/68-100	12/68-85
		14/86-100
Dismounted company	4/1-17	22/1-17
	8/18-50	26/18-34
	10/51-67	40/34-50
	14/68-85	48/51-67
	24/86-100	66/86-100
	TARGET	ADDED CASUALTIES
	Dismounted platoon (attack)	11
	Dismounted company (attack)	18
	Defending platoon	4
	Defending company	9

Notes. This table is for use during an ambush or the initial assault phase of airborne operations. It should be used until the landing zone is secured.

To obtain probabilities, umpires use Table 44 and then enter the target unit column for casualties. The table assumes light or moderate indirect fires. For heavy fires (Battery 4, Battalion 1, or above), umpires add casualties, as shown above.

TABLE 31. CLOSE ASSAULT (ATTACKER/DEFENDER FRACTIONAL LOSSES).

ATTACK TO DEFENSE RATIO

RANDOM NUMBER	ATTACK TO DEFENSE RATIO								
	1:3	1:2	1:1	2:1	3:1	4:1	5:1	6:1	7+:1
1-17	A .50/0	A .45/.05	A .40/.10	A .35/.15	A .30/.20	A .25/.25	B .20/.30	C 0/0	D .10/.40
18-34	A .45/.05	A .40/.10	A .35/.15	A .30/.20	A .25/.25	B .20/.30	C 0/0	D .10/.40	D .05/.45
35-50	A .40/.10	A .35/.15	A .30/.20	A .25/.25	B .20/.30	C 0/0	D .10/.40	D .05/.45	E 0/1.0
50-67	A .35/.15	A .30/.20	A .25/.25	B .20/.30	B .15/.30	C 0/0	D .05/.45	E 0/1.0	E 0/1.0
68-85	A .30/.20	A .25/.25	B .20/.30	B .15/.35	C 0/0	D .05/.45	E 0/1.0	E 0/1.0	E 0/1.0
86-100	A .25/.25	B .20/.30	B .15/.35	C 0/0	D .05/.45	E .10/1.0	E 0/1.0	E 0/1.0	E 0/1.0

LEGEND:

- A Attacker retreats 200 meters.
- B Attacker and defender retreat 200 meters.
- C Attacker and defender are pinned. Recalculate after 20 minutes.
- D Defender retreats 400 meters.
- E Defender is eliminated.

Notes. To calculate the attacker-to-defender ratio, umpires use the column to the left of the computed ratio if the defender is occupying prepared positions. Umpires assume light to moderate indirect fire and use opposing unit sizes for a rough force ratio.

If either side uses heavy or intense indirect fires (CAS, Battery 4, Battalion 1, or higher), umpires increase the unit factor by 1. For example, if a company attacks a platoon position, the rough ratio is 3:1. If the platoon calls for and receives the allocated 105-mm FPF (final protective fire), the corrected initial ratio is 3:2 or 1.5:1 or, rounded to the nearest whole number, 2:1.

For surprise, flank, or rear attack, umpires add 1 to 4 to the attacker ratio.

INDIRECT FIRE TABLES

To determine the effects of indirect fires, umpires apply the [tables](#) below, as appropriate.

TABLE 32. CONVENTIONAL INDIRECT FIRE DAMAGE ASSESSMENT.**SECTION A**

Munitions effects radii for various indirect fire weapon systems using HE ammunition.

4.2-in mortar platoon - 100 meters	8-in howitzer battery - 175 meters
120-mm mortar platoon - 100 meters	Single Lance (HE) - 250 meters
105-mm howitzer battery - 100 meters	36-tube 110-mm MRL - 300 meters
155-mm howitzer battery - 150 meters	

SECTION B

Standardized target arrays in normal battlefield configurations.

Tanks	- 5 vehicles
APCs	- 4 vehicles
FA	- 7 SP (155)/6 towed weapons (105-mm)/5 SP vehicles (8-in/175-mm)
Mortars	- 5 vehicles
Troops	- 25 individuals
Missile/rocket	- 1 target element
Antitank/ADA	- 4 SP/towed/ground-mounted weapons
Trucks	- 5 vehicles
Radar	- 3 targeted elements
Helicopters	- 5 aircraft
Towed/ground-mounted artillery crew	- 4 individuals

SECTION C

Number of HE rounds, by caliber, necessary to destroy one target element of the type indicated:

Target	Mortars		Field Artillery			Rocket/ Missile	
	4.2-in	120-mm	105-mm	155-mm	8-in	MLRs	Lance
Armor/mechanized							
Tank	-	-	-	120	40	To be	
APC	24	24	24	18	12	published	-
M551	36	36	36	24	16	-	

TABLE 32. CONVENTIONAL INDIRECT FIRE DAMAGE ASSESSMENT.
(Section C Continued)

Target	Mortars		Field Artillery			Rocket/ Missile	
	4.2-in	120-mm	105-mm	155-mm	8-in	MLRs	Lance
Antitank/ADA							
Ground-mounted weapon	12	12	12	6	4	-	-
SP weapon	24	24	24	18	12	-	-
Ground-mounted weapon crewman	1	1	1	.75	.5	-	-
Mortar/FA							
Towed weapon	12	12	12	6	4	-	-
Towed weapon crewman	1	1	1	.75	.5	-	-
SP weapon (mortar)	24	24	24	18	12	-	-
SP weapon (FA)	36	36	36	24	16	-	-
Other armored vehicle	24	24	24	18	12	-	-
Radar (including ADA)	16	16	16	12	8	-	1
Rocket/missile	50	40	50	36	20	-	1
CP/Trains/FARP*							
Trucks	8	8	8	6	4	-	.25
Armored vehicles	24	24	24	18	12	-	-
Helicopters	8	8	8	6	4	-	.25
Troops	1	1	1	.75	.5	-	.06
Dismounted Troops							
In open	1	1	1	.75	.5	-	.06
Dug-in	4	4	4	3	2	-	.33

*For helicopters.

LEGEND: FARP - forward arming and refueling point MRL - multiple rocket launcher SP - self-propelled

Note: The artillery round-off rule applies. Fractions 0.5 and greater are rounded to the next higher number; those below 0.5 are rounded to the next lower number.

TABLE 33. INDIRECT FIRE ENGAGEMENT.

TARGET	POTENTIAL LOSSES INFLICTED PER BATTERY VOLLEY*
Armor	1 crewman per 11 battery volleys 1 vehicle per 27 battery volleys (stationary targets) 1 vehicle per 35 battery volleys (moving targets)
Mortars/artillery	1 crewman per volley 1 truck per 2 volleys 1 tube (towed) per 16 volleys 1 tube (SP) per 27 volleys
ADA/antitank weapons	1 crewman per 3 volleys 1 weapon (ground-mounted) per 6 volleys 1 weapon (SP) per 27 volleys
CPs, trains, FARP	1 soldier per volley 1 truck per 2 volleys 1 armored vehicle per 27 volleys
Dismounted Troops	
In open	3 soldiers per volley
In hasty positions	1 soldier per volley
In improved positions	1 soldier per 4 volleys
In prepared positions	1 soldier per 10 volleys

*Mortar platoon volleys count as 1/2 FA battery volley.

TABLE 34. COUNTERBATTERY TARGETING.

Target	Average Percentage Acquired per Hour
Mortar platoon	60
MRL batteries	40
Howitzer batteries	30
Gun batteries	20
Missile/rocket batteries	10

TABLE 35. MAXIMUM DAILY INDIRECT FIRE EXPENDITURES.

Caliber and Unit	Ammunition Type			
	HE	Smoke	WP	Illumination
US				
81-mm mortar platoon (light infantry battalion)	600	-	150	80
81-mm mortar platoon (mechanized infantry battalion)	600	-	200	100
4.2-in mortar platoon (light infantry battalion)	450	-	100	50
4.2-in mortar platoon (mechanized infantry battalion)	550	-	100	50
105-mm howitzer battalion (towed)	9,500	1,000	1,500	300
110-mm MRL battalion (towed)	7,500	3,000	4,500	-
120-mm mortar platoon (mechanized infantry battalion)	600	-	150	75
155-mm howitzer battalion (towed)	4,000	300	700	-
155-mm howitzer battalion (SP)	5,000	400	1,100	200
8-in howitzer battalion (SP)	2,800	-	-	-
OPFOR				
120-mm mortar battery	1,400	-	300	60
122-mm MRL battalion	7,500	-	-	-
122-mm howitzer battalion	8,500	400	800	300
152-mm howitzer battalion	4,000	200	400	150

152-mm howitzer battalion	4,000	200	400	150
130-mm gun battalion	7,500	-	-	-

AIR DEFENSE ARTILLERY TABLES

To determine the effects of ADA, umpires apply the [tables](#) below, as appropriate.

TABLE 36. ADA ENGAGEMENT.

ADA FIRE UNIT	POTENTIAL AIRCRAFT KILLS PER ENGAGEMENT		
	Rotary Wing	High Performance	High Performance with ECM
Combat Arms Companies			
Redeye (US)	.10	.10	.07
Blowpipe (UK)	.10	.10	.07
Stinger (US)	.32	.40	.40
SHORAD Platoons			
20-mm Vulcan (US)	.10	.04	.04
20-mm S-530 (FR)	.08	.03	.03
30-mm HSS-83I (FR)	.12	.05	.05
40-mm L/70 Sergeant York gun (US)	.45	.27	not available
40-mm gun (UK)	.12	.05	.05
Gephardt (GE)	.28	.12	.09
Rapier (UK)*	.20	.20	.15
Roland (GE/FR)*	.30	.72	.52
Chaparral (US)*	.70	.92	.55
Medium Altitude Missile Fire Units			
Bloodhound (UK)	.85	.55	.30
HAWK (US)	.85	.84	.60
Patriot (US)	-	.92	.70

*Potential kills are per missile fired.

LEGEND:

ECM - electronic countermeasures
FR - France

SHORAD - short-range air defense
UK - United Kingdom

Notes. To use this table, umpires add all kill potentials and round off to the nearest whole number to determine aircraft losses.

Umpires should add all kill potentials for overflight at low altitude (below 3,000 feet). For higher altitudes, they add kill potentials only for medium altitude missile batteries during entry and egress and for combat arms companies and SHORAD platoons only in the target area. For example, four SU-7 aircraft without ECM enter Blue airspace at an altitude above 3,000 feet. They drop down below that level to attack the target. En route, they enter the fan of two 2 HAWK batteries (2 X .60 = 1.2) and strike a target protected by one Roland platoon (1 X .30 = .3). During exit, the surviving aircraft fly at medium altitude, entering the fan of one HAWK battery (1 X .60 = .6). Total losses incurred are two aircraft (1.2 + .3 + .6 =

attack the target. En route, they enter the fan of two HAWK batteries (2 X .60 = 1.2) and strike a target protected by one Roland platoon (1 X .30 = .3). During exit, the surviving aircraft fly at medium altitude, entering the fan of one HAWK battery (1 X .60 = .6). Total losses incurred are two aircraft (1.2 + .3 + .6 = 2.1). One is lost before delivering its ordnance; the other is lost en route home.

TABLE 37. ATTRITION OF HIGH-PERFORMANCE AIRCRAFT WITH ECM.

CHAPARRAL/ RAPIER			AIRCRAFT				CHAPARRAL/ RAPIER			AIRCRAFT			
HAWK	Array	Vulcan	1	2	3	4	HAWK	Array	Vulcan	1	2	3	4
0	0	0	0	0	0	0	2	0	0	0	1	1	2
0	0	1	0	0	0	0	2	0	1	0	1	2	2
0	0	2	0	0	0	0	2	0	2	0	1	2	2
0	0	3	0	0	0	0	2	0	3	0	1	2	2
0	1	0	0	0	0	0	2	1	0	0	1	2	2
0	1	1	0	0	0	0	2	1	1	0	1	2	2
0	1	2	0	0	0	1	2	1	2	0	1	2	2
0	1	3	0	0	0	1	2	1	3	0	1	2	2
0	2	0	0	0	1	1	2	2	0	0	1	2	3
0	2	1	0	0	1	1	2	2	1	0	1	2	3
0	2	2	0	0	1	1	2	2	2	0	1	2	3
0	2	3	0	0	1	1	2	2	3	0	1	2	3
0	3	0	0	1	1	1	2	3	0	0	1	2	3
0	3	1	0	1	1	1	2	3	1	1	1	2	3
0	3	2	0	1	1	1	2	3	2	1	1	2	3
0	3	3	0	1	1	2	2	3	3	1	1	2	3
1	0	0	0	0	1	1	3	0	0	0	1	2	3
1	0	1	0	1	1	1	3	0	1	0	1	2	3
1	0	2	0	1	1	1	3	0	2	0	1	2	3
1	0	3	0	1	1	1	3	0	3	1	1	2	3
1	1	0	0	1	1	2	3	1	0	1	1	2	3
1	1	1	0	1	1	2	3	1	1	1	1	2	3
1	1	2	0	1	1	2	3	1	2	1	1	2	3
1	1	3	0	1	1	2	3	1	3	1	1	2	3
1	2	0	0	1	1	2	3	2	0	1	1	2	3
1	2	1	0	1	1	2	3	2	1	1	1	2	3
1	2	2	0	1	1	2	3	2	2	1	1	2	3
1	2	3	0	1	2	2	3	2	3	1	1	2	3
1	3	0	0	1	2	2	3	3	0	1	1	2	3
1	3	1	0	1	2	2	3	3	1	1	1	2	3
1	3	2	0	1	2	2	3	3	2	1	1	2	3
1	3	3	0	1	2	2	3	3	3	1	1	2	3

TABLE 38. ATTRITION OF HIGH-PERFORMANCE AIRCRAFT WITHOUT ECM.

CHAPARRAL/ RAPIER			AIRCRAFT				CHAPARRAL/ RAPIER			AIRCRAFT			
HAWK	Array	Vulcan	1	2	3	4	HAWK	Array	Vulcan	1	2	3	4
0	0	0	0	0	0	0	2	0	0	1	1	2	3
0	0	1	0	0	0	0	2	0	1	1	1	2	3
0	0	2	0	0	0	0	2	0	2	1	1	2	3
0	0	3	0	0	0	0	2	0	3	1	1	2	3
0	1	0	0	0	0	1	2	1	0	1	1	2	3
0	1	1	0	0	0	1	2	1	1	1	2	2	3
0	1	2	0	0	1	1	2	1	2	1	2	2	3
0	1	3	0	0	1	1	2	1	3	1	2	2	3
0	2	0	0	0	1	1	2	2	0	1	2	2	3
0	2	1	0	1	1	1	2	2	1	1	2	2	3
0	2	2	0	1	1	1	2	2	2	1	2	2	3
0	2	3	0	1	1	1	2	2	3	1	2	2	3
0	3	0	0	1	1	2	2	3	0	1	2	3	3
0	3	1	0	1	1	2	2	3	1	1	2	3	3
0	3	2	0	1	1	2	2	3	2	1	2	3	3
0	3	3	0	1	1	2	2	3	3	1	2	3	3
1	0	0	0	1	2	2	3	0	0	1	2	3	3
1	0	1	0	1	2	2	3	0	1	1	2	3	3
1	0	2	0	1	2	2	3	0	2	1	2	3	4
1	0	3	0	1	2	2	3	0	3	1	2	3	4
1	1	0	0	1	2	2	3	1	0	1	2	3	4
1	1	1	0	1	2	3	3	1	1	1	2	3	4
1	1	2	0	1	2	3	3	1	2	1	2	3	4
1	1	3	0	1	2	3	3	1	3	1	2	3	4
1	2	0	0	1	2	3	3	2	0	1	2	3	4
1	2	1	0	1	2	3	3	2	1	1	2	3	4
1	2	2	1	1	2	3	3	2	2	1	2	3	4
1	2	3	1	1	2	3	3	2	3	1	2	3	4
1	3	0	1	1	2	3	3	3	0	1	2	3	4
1	3	1	1	1	2	3	3	3	1	1	2	3	4
1	3	2	1	1	2	3	3	3	2	1	2	3	4
1	3	3	1	1	2	3	3	3	3	1	2	3	4

TABLE 39. POTENTIAL KILL PROBABILITY (AIR DEFENSE ARRAY).

SYSTEM	HIGH PERFORMANCE	
	WITHOUT ECM	WITH ECM
Blowpipe (UK)	.10	.07
Redeye (US)	.10	.07
Stinger (US)	.15	.10
20-mm Vulcan (US)	.04	.04
20-mm S-530 (FR)	.03	.03
30-mm HSS-831 (FR)	.05	.05
40-mm gun (UK)	.05	.05
Gephardt (GE)	.12	.09
Rapier (UK)	.20	.15
Roland (GE/FR)	.30	.22
Chaparral (US)	.20	.15
Bloodhound (UK)	.55	.30
HAWK (US)	.60	.35

TABLE 40. POTENTIAL KILL PROBABILITY (AIR DEFENSE ENGAGEMENT).

SYSTEM	LOW PERFORMANCE		HIGH PERFORMANCE	
	ROTARY WING	FIXED WING	WITHOUT ECM	WITH ECM
Redeye (US)	.10	.10	.05	.05
20-mm Vulcan (US)	.60	.60	.04	.04
Rapier (UK)	.60	.60	.60	.50
Chaparral (US)	.40	.40	.16	.16
HAWK (US)	.80	.60	.40	.35
Small arms	.06*	.01	.01	.01

*Small arms against hovering rotary wing aircraft have a .24 kill probability.

TABLE 41. REDEYE VERSUS AIRCRAFT.

ROTARY AND FIXED WING					HIGH PERFORMANCE				
N	N	N	N	N	N	N	N	N	N
N	KILL	N	N	N	N	N	N	N	N
N	N	N	KILL	N	N	N	KILL	N	N
N	N	N	N	N	N	N	N	N	N

Note: Based on the type of aircraft engaged, umpires enter the corresponding table and read one square per engagement reported. For each engagement, they read one successive entry in the table. After using the last entry, they return to the first entry and begin again. They report the results of each engagement to the player element.

TABLE 42. SMALL ARMS VERSUS AIRCRAFT.

N	N	N	N	N	N	N	N	N	N
N	N	N	N	N	N	KILL	N	N	N
N	N	N	N	N	N	N	N	N	N
N	N	N	N	N	N	N	N	N	KILL
N	N	N	N	N	N	N	N	N	N
N	N	KILL	N	N	N	N	N	N	N
N	KILL	N	N	N	N	N	N	N	N
N	N	N	N	N	N	N	N	KILL	N
N	N	N	N	N	N	N	N	N	N
N	N	N	N	KILL	N	N	N	N	N

Note: Umpires enter the table and read one square per engagement reported. For hovering rotary wing aircraft, they must read four squares per engagement. For each engagement, they read successive entries in the table, returning to the first entry and beginning again after using the last entry. They report the results of each engagement to the player element.

TABLE 43. ADA ENGAGEMENT (OPFOR).

ADA FIRE UNIT	POTENTIAL AIRCRAFT KILLS PER ENGAGEMENT		
	Rotary Wing	High-Performance	High-Performance with ECM
Maneuver Battalions			
SA-7	-	-	-
SA-9	-	-	-
ZSU 23-4	.60	.50	.30
ZSU 57-2	-	-	-
Division Rear			
57-mm S-60	.12	.07	.05
Medium Altitude Missile Fire Units			
SA-4	-	.40	.25
SA-6	-	.45	.30

TABLE 44. RANDOM NUMBERS.

1	22	17	68	65	84	68	95	23	92	35	87	02	22	57	51	61	09	43	95	06	58	24	82	03	47
2	19	36	27	59	46	13	79	93	37	55	39	77	32	77	09	85	52	05	30	62	47	83	51	62	74
3	16	77	23	02	77	08	51	87	25	21	28	06	24	25	93	16	71	13	59	78	23	05	30	16	25
4	78	43	76	71	61	20	44	90	32	64	97	67	63	99	61	46	38	03	93	22	69	81	21	99	21
5	03	28	28	26	08	73	37	32	04	05	69	30	16	09	05	88	69	58	23	99	35	07	44	75	47
6	93	22	53	64	39	07	10	63	76	35	87	03	04	79	88	08	13	13	85	51	55	34	57	72	69
7	78	76	58	54	74	92	38	70	96	92	52	06	79	79	45	82	63	18	27	44	69	66	92	19	09
8	23	68	35	26	00	99	53	93	61	28	62	70	05	48	34	56	65	05	61	86	90	92	10	70	80
9	15	39	25	70	99	93	86	52	77	65	15	33	59	05	28	22	87	26	07	47	86	96	98	29	06
10	58	71	96	30	24	18	46	23	34	27	85	13	99	24	44	49	18	09	79	49	74	16	32	23	02
11	57	35	27	33	72	24	53	63	94	09	41	10	76	47	91	44	04	95	49	66	39	60	04	59	81
12	48	50	86	54	48	22	06	34	72	52	82	21	15	65	20	33	29	94	71	11	15	91	29	12	03
13	61	96	48	95	03	07	16	39	33	66	98	56	10	56	79	77	21	30	27	12	90	49	22	23	62
14	36	93	89	41	26	29	70	83	63	51	99	74	20	52	36	87	09	41	15	09	98	60	16	03	03
15	18	87	00	42	31	57	90	12	02	07	23	47	37	17	31	54	08	01	88	63	39	41	88	92	10
16	88	56	53	27	59	33	35	72	67	47	77	34	55	45	70	08	18	27	38	90	16	95	86	70	75
17	09	72	95	84	29	49	41	31	06	70	42	38	06	45	18	64	84	84	31	65	52	53	37	97	15
18	12	96	88	17	31	65	19	69	02	83	60	75	86	80	68	24	64	64	35	51	56	61	87	39	12
19	85	94	57	24	16	92	09	84	38	76	22	00	27	69	85	29	81	81	78	70	21	94	47	90	12
20	38	64	43	59	98	98	77	87	68	07	91	51	67	62	44	40	98	98	93	78	23	32	65	41	18
21	53	44	09	42	72	00	41	86	79	79	68	47	22	00	28	35	55	31	51	51	00	83	63	22	55
22	40	76	66	26	84	57	99	99	90	37	36	63	32	08	58	37	40	13	68	97	87	64	81	07	83
23	02	17	79	18	05	12	59	52	57	02	22	07	90	47	03	28	14	11	30	79	20	69	22	40	98
24	95	18	82	06	53	31	51	10	96	46	92	06	88	07	77	56	11	50	81	69	40	23	72	51	39
25	35	76	22	42	92	96	11	83	44	84	34	68	35	48	77	33	42	40	90	60	73	96	53	97	86

TABLE 45. BOMB DAMAGE ASSESSMENT.

SECTION A Aircraft and Ordnance	PERSONNEL		VEHICLES			
	Pro- tected	Unpro- tected	Armored Tanks	APC	Soft	Bridges
G91/F104/ Buccaneer/Jaguar						
GP bombs	.10	.30	.05	.10	.30	.10
Napalm	.20	.20	0	0	.40	0
Strafing	.10	.20	0	0	.35	0
CBU	.05	.35	.10	.15	.40	0
Rockets	.05	.10	.10	.15	.30	0
BLU-755	.10	.40	.25	.30	.45	0
A-10						
GP bombs	.20	.65	0	0	0	.10
GBU	.10	.45	0	0	0	.60
Strafing	.10	.20	0	0	0	0
Rockeye	.50	.70	1.50	1.50	2.00	0
Maverick	0	0	1.00	1.00	1.50	.30
GAU-8	0	0	1.00	1.00	1.50	0
F4/A7/F-111						
GP bombs	.10	.65	.15	.20	.40	.10
GBU	.10	.45	.40	.50	.60	.60
Strafing	.05	.20	.10	.15	.40	0
CBU	.10	.45	.25	.30	.45	0
Maverick	0	0	.45	.50	.50	.30
Redeye	.40	.50	.45	.50	.70	0
F-111 Beacon/F-4/ ASRT/LORAN						
GP bombs	.15	.30	.15	.20	.40	.10
CBU	.40	.10	.20	.25	.30	0
Rockeye	.50	.80	.30	.35	.40	0
OPFOR Air						
GP bombs	.03	.45	.04	.14	.36	.05
Rockets	.10	.10	.24	.48	.87	0
Strafing	.05	.10	0	0	.40	0
CBU	.33	.33	.32	.64	.64	0

LEGEND: CBU - cluster bomb unit GBU - guided bomb unit GP - general purpose

TABLE 45. BOMB DAMAGE ASSESSMENT (continued).

SECTION B PROBABILITY	TARGETS AT RISK											
	1	2	3	4	5	10	15	20	25	30	40	50
.05	.1	0	0	0	0	1	1	1	1	2	2	3
.10	.1	0	0	0	1	1	2	2	3	3	4	5
.15	.2	0	0	1	1	2	2	3	4	5	6	8
.20	.2	0	1	1	1	2	3	4	5	6	8	10
.25	.3	1	1	1	1	3	4	5	6	8	10	13
.30	.3	1	1	1	2	3	5	6	8	9	12	15
.35	.4	1	1	1	2	4	5	7	9	11	14	18
.40	.4	1	1	2	2	4	6	8	10	12	16	20
.45	.5	1	1	2	2	5	7	9	11	14	18	23
.50	.5	1	2	2	3	5	8	10	13	15	20	25
.55	.6	1	2	2	3	6	8	11	14	17	22	28
.60	.6	1	2	2	3	6	9	12	15	18	24	30
.65	.7	1	2	3	3	7	10	13	16	20	26	33
.70	.7	1	2	3	4	7	11	14	18	21	28	35
.75	.8	2	2	3	4	8	11	15	19	23	30	38
.80	.8	2	2	3	4	8	12	16	20	24	32	40
.85	.9	2	3	3	4	9	13	17	21	26	34	43
.90	.9	2	3	4	5	9	14	18	23	27	36	45
.95	1.0	2	3	4	5	10	14	19	24	29	38	48

Notes: Umpires enter Section A at proper aircraft and ordnance. They read across, entering the column with the proper target category, and determine probability.

They then find the probability in Section B. Umpires read across to determine number of target kills under the columns indicating the type and number of targets at risk for each sortie. They interpolate, if required. To use this table for vehicle kills, umpires assume a maximum of 5 targets at risk per sortie.

Umpires multiply the target kills by the number of sorties for the total bomb damage assessment (BDA). For bridge destruction, target kills must equal 1.0 or more.

Umpires assume a single pass on the target (no reattack) for all except A-10. To determine the A-10 BDA against vehicles, umpires use the actual number of passes made and the ordnance used. They assume the first pass will be made with Rockeye, if Rockeye is loaded. All subsequent passes will be made with either Maverick or GAU-8.

Any fraction of a vehicle appearing in the final calculation will be reported as damage.

ENGINEER TABLES

To determine the effects of obstacle emplacement and breaching operations, umpires apply the [table](#) below, as appropriate.

TABLE 46. OBSTACLE EMPLACEMENT.

OBSTACLE TYPE	DENSITY/ AREA COVERAGE	MANPOWER/ TIME REQUIRED
Standard pattern minefield	1-1-1 (100m x 50m)	3 platoon hours
Standard pattern minefield	1-4-8 (100m x 50m)	8 platoon hours
Row minefield	1.5-0-0 (100m x 35m)	1/2 platoon hour
Hasty crater	(20 foot roadbed)	2 squad hours
M180 crater	1m x 10m x 3m	1/2 squad hour
		5M180 kits
Abatis	(20m x 75m)	1 1/2 platoon hours
Tank ditch (100m long)		2 dozer hours

TRANSPORTATION REQUIRED	LOSSES PRODUCED
5T or two 2 1/2T	Two armored vehicles Two dismounted troops
Two 5T or three 2 1/2T	Two armored vehicles Six dismounted troops
5T or 2 1/2T	Two armored vehicles
5T or 2 1/2T	15 minutes and first vehicle in column if crater is covered by fire
N/A	Consideration of losses by covered fire
N/A	10 minutes delay and two armored vehicles if ditch is covered by fire

Note. Row minefields can be laid in 1/3 hour with a mechanical mineplanter or emplaced by one sortie when air delivered.

TABLE 47. OBSTACLE-BREACHING REQUIREMENTS.

OBSTACLE	BREACHING OPTION	EQUIPMENT	EFFORT	REMARKS
Minefield (1-0-0 density) Initial loss of 2 armored vehicles	Deliberate breach "Bull through"	Miscellaneous demolitions, rope, or mine detectors Line charge	1 squad hour (engineer) 2 squad hour (maneuver) 1/2 squad hour 15 minutes	All minefield breaching requirements listed are for clearance of one vehicle lane through 100m of minefield.
Standard pattern minefield (1-2-2 density) Initial loss of 2 armored vehicles	Deliberate breach "Bull through"	Mine detectors, probes, and rope or miscellaneous demolitions Line charge	2 platoon hour (engineer) 3 platoon hour (maneuver) 1/2 squad hour 15 minutes	Figures must be adjusted for increased minefield depth, density, or lane width.
Tank Ditch Triangular Trapezoidal	Tactical bridge Excavate/fill lane Cross in tactical formation	AVLB with launcher* Dozer/tank-dozer/CEV Adjust opposing unit AVKP	10 minutes 30 minutes 15 minutes	Add one platoon hour to effort required if nuisance mines are present.
Road Crater Abatis (75m long)	Tactical bridge Excavate/fill lane Clear trees from route	AVLB with launcher* Dozer/front-end loader/CEV Dozer/front-end loader and chain saws	15 minutes 15 minutes 1 hour	*AVLB used only for gaps less than 60m. For larger gaps, refer to TOC or consult engineer.
Bridge demolition Wire obstacles Double apron fence concertina bands	Tactical bridge Bangalore	AVLB with launcher* 5 Bangalore sections (one box)	15 minutes 1/4 squad-hour	

LEGEND: AVLB - armored vehicle launched bridge CEV - combat engineer vehicle

Notes: For breaching standard pattern minefields, umpires assess initial loss of two armored vehicles.

For bull through operations, umpires assess a 30 percent loss of all vehicles entering.

To assess losses for a unit breaching an obstacle covered by opposing direct fire antitank weapons, umpires use the target posture Canalized, Crossing Obstacle Covered by Fire in Table 28. Umpires must use subjective judgment when only part of a unit covers an obstacle.

When a unit crosses a tank ditch while deployed in a tactical formation, umpires use the target posture Moving or Open from Table 29. Umpires adjust the AVKP to account for the increased vulnerability of the tanks crossing the ditch. Breaching times apply only after the equipment is on site and ready to work.

**TABLE 48. DEMOLITION REQUIREMENTS FOR
CONVENTIONAL TACTICAL OBSTACLES.**

TARGET	TNT	40-LB CRATERING CHARGE	40-LB SHAPED CHARGE	AMMONIUM NITRATE	COMPOUND C-4
Gap in Average Reinforced Concrete Bridge					
Up to 100 feet	500				
Up to 200 feet	600				
Up to 300 feet	700				
Up to 400 feet	800				
Road Craters					
2-lane road (6 meters)					
		7	4		
4-lane road (21 meters)					
		19	12		
Timber Cutting					
18-inch timber	7				5
24-inch timber	12				8
30-inch timber	18				12
40-inch timber	30				21
Tank Ditch					
100 meters	720			1,500	
100 meters	1,440			3,000	

Note. All weights are expressed in pounds.

TABLE 49. PRECHAMBER ROAD CRATER EMPLACEMENT GUIDELINES.

Number of Shafts	Engineer Squad Hours Required	DM 41 Charges Required (in pounds)
3	1	3,600
4	1.3	4,800
5	1.6	6,000
6	2.0	7,200
7	2.3	8,400
8	2.6	9,600

Notes: One DM 41 charge weighs 50 pounds and displaces 1.2 cubic feet.

The one-way vehicle haul time to 5-ton bunker is 45 minutes.

The upload time is 1 hour per vehicle.

TABLE 50. ADM CRATER BREACH WORK RATES.

Size	Equipment	Dry Soil (Hours)	Wet Soil (Hours)	Dry Rock (Hours)	Wet Rock (Hours)
1.0 KT	One dozer	4	9	1.9	2.3
	Two dozers	2	4.5	1	1.1
	Scraper team (three scrapers, one dozer)	5.5	12.7	2.8	3.3
5.0 KT	One dozer	18.7	40.8	10	15.4
	Two dozers	9.3	20.4	5	7.7
	Scraper team (three scrapers, one dozer)	26.7	12.7	14.3	22

LEGEND: KT - kiloton

TABLE 51. CRATER DIMENSIONS.

YIELD: 1.0 KT											
DEPTH OF BURST	CRATER RADIUS DRY SOIL	CRATER DEPTH DRY SOIL	CRATER RADIUS DRY ROCK	CRATER DEPTH DRY ROCK	CRATER RADIUS WET SOIL	CRATER DEPTH WET SOIL	CRATER RADIUS WET ROCK	CRATER DEPTH WET ROCK	CRATER RADIUS WET ROCK	CRATER DEPTH WET ROCK	CRATER DEPTH WET ROCK
-5	4	2	0	0	8	3	2	1			
-4	5	3	1	0	9	4	4	2			
-3	7	4	3	1	11	5	6	4			
-2	10	4	6	3	14	6	9	5			
-1	13	5	9	4	18	8	12	6			
0	19	9	15	7	25	9	18	9			
1	26	12	22	9	30	12	26	11			
2	31	14	25	11	33	14	29	13			
3	34	14	27	12	35	16	31	14			
4	35	15	28	13	37	17	33	15			
5	36	16	29	14	38	18	34	16			
10	40	20	35	18	45	22	40	20			
YIELD: 5.0 KT											
-5	13	6	6	2	19	9	11	6			
-4	15	7	8	4	22	10	13	8			
-3	18	7	11	5	25	11	16	9			
-2	22	8	14	7	29	13	20	10			
-1	26	11	18	9	35	14	24	12			
0	32	15	26	11	43	16	30	15			
1	38	18	32	13	46	18	38	16			
2	44	21	37	16	50	31	43	18			
3	49	22	40	17	53	23	46	20			
4	52	23	41	18	55	24	49	21			
5	54	23	43	19	57	26	51	22			
10	60	27	50	24	64	31	57	27			

Notes: All dimensions are in meters.
 Minus signs preceding figures indicate distances above ground.

TABLE 52. CLASS IV BARRIER HAUL GUIDELINES.

VEHICLE	ROLLS OF BARBED WIRE	ROLLS OF CONCERTINA	LONG U-SHAPED PICKETS #
5-ton dump	100	50	800
2 1/2-ton cargo	100	50	800
1 1/2-ton trailer	35	25	350

NBC ASSESSMENT TABLES

To determine the effects of NBC warfare, umpires apply the [tables](#) below, as appropriate.

TABLE 53. CHEMICAL STRIKE COMPUTATION CHARTS.

NONPERSISTENT CHEMICAL CASUALTIES (GB)

	Masked Before Attack	Masked Within 15 Seconds	Not Masked Within 15 Seconds
Direct Hit:	0	10%	25%
Close:	0	5%	10%

PERSISTENT CHEMICAL CASUALTIES

MOPP 4	MOPP 3	MOPP 2	MOPP 1	No MOPP
	2%	10%	12%	30%

Notes: Persistent chemical contamination lasts for 24 hours unless units perform decontamination. Units in contaminated areas suffer 10 percent additional casualties per hour unless they are in full mission-oriented protection posture (MOPP) or have withdrawn to a safe area. Contaminated units in MOPP 4 will suffer 10 percent casualties per hour, starting six hours after persistent attack, unless they exchanged chemical protective ensembles before their overgarments lose effectiveness.

A chemical strike is considered a direct hit when 50 percent or more of the targeted company-size unit is located within the radius of damage around ground zero.

A close hit results when 50 percent or more of a unit is located in the downwind chemical zone from ground zero.

TABLE 54. NUCLEAR TARGET CATEGORY CODES.

CATEGORY CODE	TYPE	MEANING OF NUMBER TRANSMITTED
V	Towed artillery, mortars, ADA, small arms, machine guns, masonry or concrete bridges, dismounted antitank weapons, wheeled vehicles, and rockets.	Radius within which 30 percent are moderately damaged. Within 1/2 of this radius, the equipment will be severely damaged.
T	Supply dump, barbed wire; highway, railroad, and float supplies.	Radius within which 30 percent of the supplies are severely damaged.
P	Personnel in tanks, foxholes, APCs, SP artillery, or buildings.	Radius within which 30 percent are immediate casualties; twenty percent will be casualties within 1 hour.
X	Personnel in the open.	Radius within which 30 percent are immediate casualties; twenty percent will be casualties within 1 hour.
DP	Delayed casualties among personnel in tanks, foxholes, and APCs.	Of the personnel in the zone between ring P and ring DP, 30 percent will be casualties within 1 hour; 20 percent will casualties within 4 hours.
DX	Delayed casualties to exposed personnel.	Of the personnel in the zone between ring X and ring DX, 30 percent will be casualties within 1 hour; 20 percent will be casualties within 4 hours.
TB	Tree blowdown.	Radius within which 60 percent of trees are blown down.
AC	Aircraft.	Radius within which all aircraft are severely damaged; those within 1/2 of this radius are destroyed.

TABLE 55. DAMAGE CIRCLE RADII.

DELIVERY SYSTEM	V	T	P	X	DP	DX	TB	AC
A (0.5 KT)	2	4	7	10	10	14	4	22
B (1 KT)	3	6	9	12	12	16	5	28
C (5 KT)	5	10	12	16	16	20	10	56
D (2 KT)	4	7	10	13	14	18	6	34
E (5 KT)	5	10	12	16	16	20	10	56
F (10 KT)	8	14	14	20	18	24	14	72

TABLE 56. SAMPLE NUCLEAR ASSESSMENT REPORTS.**1. Nuclear Assessment Report.**

- a. Date-time group (DTG) of assessment: _____
- b. Grid coordinates of strike: _____
- c. Damage/casualties assessed: _____
 - (1) WIA: _____
 - (2) KIA: _____
 - (3) Vehicles damaged: _____
 - (4) Vehicles destroyed: _____

2. Brigade Nuclear Damage Report.

- a. From: (Bde designation) controller.
 - b. Thru: (OPFOR/US) FSE controller.
 - c. To: Arty Section, controller TOC.
 - d. From: (DTG) to (DTG)
- (12-hour report as of 0800 and 2000, due 1200 and 2400 to the controller group HQ).
- e. Total damages/casualties assessed as a result of nuclear fires during the period indicated above.
 - (1) WIA: _____
 - (2) KIA: _____
 - (3) Vehicles damaged: _____
 - (4) Vehicles destroyed: _____

[RDL](#)[Table of](#)[Document](#)[Download](#)[Homepage](#) [Contents](#) [Information](#) [Instructions](#)

APPENDIX G

Postexercise Activities

AFTER-ACTION REVIEWS

Whether externally or internally evaluated, all training exercises have AARs. Normally, the formality and scope of the AARs increase as the level and scope of the training expand. For example, because events occur so frequently and over such distances in a company-level field exercise, no single person can observe all the events, especially someone preoccupied with the overall unit mission. AARs pull together the separate events. They integrate the experiences and observations of everyone involved in an atmosphere that promotes effective learning. To be most effective, AARs should be conducted during the exercise at logical break points, as well as at the conclusion.

AARs are not critiques in the traditional sense. They do not merely judge success or failure. Instead, they are professional discussions of training events. Trainers or controllers should not lecture participants on what went wrong. Rather they guide discussions to ensure that important lessons are openly discussed, preferably by the participants themselves. Soldiers who identify what went right and wrong learn much more than when lessons are dictated. For effective AARs--

- All controllers, umpires, and evaluators must be trained in AAR techniques and prepared to conduct AARs with subgroups. The chief controller should debrief all controllers and assistants prior to the AARs.
- Commanders and controllers should not critique or lecture. They guide the discussions by asking leading questions. They enter the discussion only to sustain the AAR, to get the discussion back on the right track, or to bring out new points.
- Discussions do not embarrass leaders or soldiers but emphasize the positive.
- Participants describe what happened in their own terms.
- The discussions are outlined, prepared, and rehearsed.
- Thought-provoking questions are prepared to stimulate discussion.

- Analyses relate tactical events to subsequent results and training objectives.
- Alternate courses of action are discussed.
- Discussions avoid minor events that do not directly relate to the major training objectives.
- Participants do not excuse inappropriate actions. Instead, they examine why actions were taken and what alternatives were available.
- Terrain models and training aids illustrate events. Participants relate their comments to the model and move the markers for units, vehicles, and personnel to show the events. TV tape playbacks of key events generate interest and discussions.
- Every element that participated in the exercise is present at the AAR.
- Training deficiencies surfaced during the AAR are incorporated into the unit training schedule within two to six weeks of the exercise.

AARs encourage discovery learning. Soldiers learn best when they learn from each other and from their leaders. Controllers, umpires, and evaluators are there to guide that learning. In this way, soldiers and junior leaders get involved in their own professional development and learn more in the process.

Controllers, umpires, and evaluators must provide comments to the units with which they work. AARs occur during the exercises or as soon after them as practical. During lengthy exercises, they occur at predetermined times following significant activities. Controllers, umpires, and evaluators coordinate with respective OPFOR and player commanders to determine who will attend. The chief controllers schedule AARs in convenient locations, preferably quiet places protected from adverse weather, where the soldiers can feel relatively comfortable. Coffee and soup help create the proper atmosphere. Regardless of the echelon conducting the exercise, the maximum number of player personnel should attend an AAR, down to and including the first-line NCO leaders and soldiers. Exercises at battalion and above normally conduct separate AARs at each echelon.

AARs cover both the strengths and the weaknesses associated with--

- Tactics.
- Combined arms employment.
- Command and control.
- Communications.

- Survivability.
- Personnel and logistics support.

They encourage dialogue among controllers, evaluators, umpires, and player unit personnel so that everyone will have the opportunity to discuss the conduct of the exercise. AARs highlight lessons learned and alternative solutions. The chief controllers provide agendas for the reviews. The agendas then become outlines for the formal after-action reports, which are written concurrently with or immediately after the exercise.

PREPARATION

In order to conduct AARs, chief controllers must have a complete picture of what happened in the exercises. They base the AARs on comments provided by controllers, umpires, evaluators, and OPFORs. They must debrief the controllers immediately after ENDEX to determine what happened. They must also debrief the OPFORs, which as control elements, are in advantageous positions to observe player units.

If the controllers know something occurred that they could not observe, they should ask a player unit member who was involved exactly *what* happened, but not why or how. The why and how will be presented by the player during the AAR. [Figure 36](#) provides a possible format they could use for making detailed observations during exercises. By collecting and recording the data from these working papers, chief controllers get the information needed to conduct AARs. After gathering all the information, the chief controllers review the exercises to determine the sequence of events and the cause and effect relationships for all significant activities. The chief controllers then coordinate the AARs and outline an agenda. [Table 57](#) shows a possible agenda for the AAR of a platoon-or company-size maneuver unit in an offensive role using TES.

FIGURE 36. SAMPLE FORMAT FOR OBSERVATIONS.

DETAILED OBSERVATIONS

Event number (from schedule of events)/OPFOR action:

Description:

Observation (player action):

Comments/conclusions:

Recommendations:

Comments from the AAR:

TABLE 57. SAMPLE AAR AGENDA.

EVENT	WHO
State training objective	Chief controller
State defensive plan	OPFOR leader
Offensive plan	Unit leader
Events before detection/contact	Unit leaders
First detection/contact	Unit umpire
Report of detection/contact	Unit umpire
Reactions to detection/contact	Unit leader/OPFOR leader
Fragmentary order	Unit leader/OPFOR leader
Events during engagement	All
Results	All
Summary	Chief controller

CONDUCT

Each AAR contains three major steps:

- A restatement of training objectives.
- A discussion of all events and how they are related, in order to bring out teaching points.
- A summary of the AAR and a recommendation for subsequent training to correct weaknesses and sustain strengths.

The chief controller briefly restates the specific training objectives. The AAR normally covers only the training objectives that the commander identified prior to the exercise. The chief controller then guides a discussion of events and their relationships by--

- Asking leading questions that emphasize the training objectives.
- Having the unit members describe what happened in their own words and from their own points of view. Key elements of the AAR are the unit commander's visualization of the battle, the commander's concept, the actual events, and the reasons why they happened.
- Bringing out important lessons learned.
- Relating tactical events to subsequent results.
- Exploring alternative courses of action that might have been more effective.

- Avoiding detailed examination of events not directly related to major training objectives.

Diagrams or overlays help players visualize what happened during the exercise. For example, the assembly area and the objective could be shown first. As the AAR proceeds, routes of advance and engagement locations can be shown later as the exercise events are covered.

The chief controller concludes the AAR with a quick summary. After the summary, the chief controller privately discusses individual and unit performance with unit leaders. They discuss weaknesses honestly and candidly in order to improve performance. But like the whole AAR, this portion should be positive and encourage proud, confident units. Training objectives for subsequent exercises can derive from such an analysis.

ECHELONS

Most training exercises integrate several systems such as maneuver, fire support, intelligence, engineer, and maintenance support. They are intersystem exercises. Others train only one system, regardless of its complexity. They are intrasystem exercises. AARs are conducted either consecutively or concurrently at each echelon that took part in the exercise.

For a division FTX, each echelon's AAR discusses items and events relating to the exercise objectives, unit OPORD, and TSOP as they affected the unit's mission. CS units also conduct multiechelon AARs following exercises or after major phases or events during an exercise. FA, ADA, and combat engineer units have special considerations that affect their AARs. CS units normally provide elements, such as FIST and fire support sections, that associate and collocate with maneuver units. These personnel should attend both the maneuver unit AAR and the parent unit AAR. If one person cannot attend both AARs, a representative should attend each one. Commanders of DS units (FA, engineer) should attend the maneuver brigade (third-echelon) AAR and may wish to schedule the DS unit AAR later.

First Echelon

As soon after ENDEX as possible, the company umpire holds an AAR for the company commander, leaders, and soldiers. A maneuver company AAR will discuss--

- Engagements.
- Use of terrain.
- Suppression of enemy weapons.
- Coordination of fire and maneuver.

- Employment of antitank weapons.
- Employment of other organic and supporting weapon systems.

For example, during the FTX, antitank weapons engaged OPFOR units from defensive positions at the maximum range of 3,000 meters. The OPFOR dispersed instead of entering a kill zone where Dragons could have been employed. The AAR discusses the pros and cons of this event and the tactical procedures. It explores what should have happened and what the results might have been.

During an FTX, elements of CSS units are normally assigned to support maneuver units or areas. After ENDEX, members of CSS units attend the first-echelon AAR of the supported maneuver unit. Those in forward areas should remain in position and attend the AAR of the maneuver unit being supported. Those in rear areas such as field trains should attend the AAR conducted there.

A first-echelon AAR should also be held at company level for CSS units. For example, the maintenance company umpire should conduct an AAR for the commander, leaders, and soldiers. This AAR must be delayed until all members attending maneuver unit or other AARs can arrive and until evaluator observations are compiled. A maintenance company AAR will discuss--

- The capability to repair equipment as far forward as possible.
- Provision of spare parts.
- Optimum use of available spare parts.
- Communications.
- Availability of proper tools.
- Response time to requests for repair.
- Coordination procedures with supported units.
- Tactical operations (rear area security) and survival operations.

It will also discuss how the contact team can get enough information from the unit requesting support so that supervisors send the right personnel equipped with the right tools forward to make repairs.

Second Echelon

Second-echelon AARs are conducted only after the first-echelon AARs are held and the necessary

observations are recorded. Battalion umpires conduct second-echelon AARs. Battalion commanders, staffs, company commanders, and officers and non-commissioned officers down to platoon sergeants or the equivalent attend. At this echelon, AARs are professional discussions led by commanders and battalion umpires to examine what happened, why it happened, and what alternatives should be used in different tactical situations. A maneuver battalion AAR might discuss--

- Organization for combat.
- Concept of operation and scheme of maneuver.
- Fire support coordination.
- Combat engineer support.
- Employment of antitank weapon systems.
- Communication support.
- Target acquisition systems.
- Staff coordination.
- Administrative and logistical support.
- Integration and orchestration of all CA, CS, and CSS elements.
- Probable results for alternate courses of action.

For example, the AAR might discuss why the battalion did not use combat engineer support properly as a combat multiplier and how ineffective planning resulted in inadequate preparation of the battlefield. The lessons learned can apply to the next exercise. The engineer officer who supported the battalion should be present to discuss the proper use of combat engineers.

A maintenance battalion AAR will cover--

- Systematic procedures for requesting spare parts.
- Procedures for dispatching contact teams to support maneuver units.
- Training shortcomings in specific maintenance areas.

- Communication procedures.
- Maintenance system operations with units above and below battalion level.
- The effect of terrain, weather, and intensity of combat on the demand for various types of spare parts.
- The effect of new weapon systems on maintenance procedures.
- Recovery and evacuation.
- Controlled substitution.
- Maintenance collection points.
- Operational safety.
- Operational readiness plan.
- Mission essential maintenance only (MEMO).
- Calibration.
- Repair facility sites.

For example, the AAR might discuss the procedures for dispatching contact teams to perform forward area maintenance and how a lack of organic transportation degraded responsiveness. The AAR addresses alternate means of transportation available to the battalion and procedures to obtain and use them. If the unit SOP seems to be in error, the discussion should focus on correcting and validating it in the next similar exercise.

Third Echelon

Third-echelon AARs are conducted after the second-echelon AARs are completed, allowing enough time for compiling necessary observations and examining lessons learned at the battalion level. Brigade umpires conduct third-echelon AARs for the commanders, staffs, and appropriate non-commissioned officers. Battalion commanders, their staffs, and company commanders attend. AARs at this echelon are professional discussions of what happened and why. However, third-echelon AARs include--

- Operations under limited visibility.

- Tactical operations in an NBC environment.
- The impact of new systems and doctrine on operations.
- Intelligence preparation of the battlefield.
- Tactical operations against different enemy actions.
- Effects of enemy EW activity on friendly operations.
- Integration and use of all CA, CS, and CSS assets.

If the exercise were conducted in summer under ideal conditions, the AAR could discuss how the same operation would be conducted in winter on frozen ground and with limited visibility. Under such conditions, operation planning would have to consider--

- Increased control measures.
- Degraded air support.
- Limitations on target acquisition.
- Effects of cold weather on troops and equipment.
- The impact on logistical systems.

Third-echelon AARs conducted for the DISCOM should be attended by the commander, staff, subordinate battalion commanders and staff, and company commanders. Representatives from maneuver and combat support units (FA, engineer, ADA) should also attend. These AARs should cover all aspects of CSS during the exercise and their impact on the tactical operation. Topics for discussion include--

- Medical support and casualty evacuation.
- Personnel and administrative support.
- Supply system operations.
- Maintenance procedures.
- Transportation.

- Ammunition hauling and stockpiling.

The AAR discusses the time units actually spent supporting exercise requirements as opposed to the time they spent on scenario events. The AAR compares the training benefits received from responding to actual situations caused by the exercise to the benefits from simulated situations. The lessons learned from this comparison allow planners to schedule events for CSS units during future exercises. They also provide indicators of what will actually be required in combat and allow commanders to fine tune support systems and procedures.

Fourth Echelon

Fourth-echelon AARs bring together comments from all previous AARs and the exercise in general. The exercise director and control staff conduct these AARs. Those attending are division commanders and staffs, along with the commanders and staffs of the DISCOM, the maneuver brigades, and their battalion commanders. Fourth-echelon AARs focus on the exercise objectives and the degree to which they were accomplished. They are professional discussions of the effects of decisions made in response to changes in the battlefield environment. They discuss battle staff training, survivability operations, and the CA, CS, and CSS integration necessary to fight and win air-land battles. They discuss how new systems impact on operations.

AFTER-ACTION REPORTS

Formal after-action reports should be submitted as soon after training exercises as practical. Normally, this is no longer than one to two weeks. Exercise directors are responsible for producing this report.

The written after-action reports inform all units about combat, CS, and CSS problems encountered during the exercise. They document strengths and weaknesses of operations. They also include test results on new tactics, techniques, and equipment. Commanders and staffs should use them as input for long-and short-range planning for training. The format and content of after-action reports vary from one command to another. Exercise LOIs should provide guidance for the format. See [Figure 37](#) for a sample after-action report.

FIGURE 37. SAMPLE AFTER-ACTION REPORT.

DATE _____

SUBJECT: After-Action Report, FTX_____

- A. Executive summary (informs senior leaders about exercises at brigade and above. Contains significant lessons learned, discussion of unit readiness, and recommendations for future training)**
- B. Letter of transmittal**
- C. Exercise objective (restated from the exercise LOI)**
- D. General discussion (detailed discussion of significant events, lessons learned, and exercise support requirements. Findings and conclusions associated with each lesson learned, and exercise support deficiencies. Specific recommendations for future training and conduct of exercises)**

ANNEXES, as required

- Annex A Personnel**
- Annex B Intelligence**
- Annex C Aviation**
- Annex D Electronic Warfare**
- Annex E Funding Procedure**
- Annex F After-Action Reports**
- Annex G Logistics**
- Annex H Public Affairs**
- Annex I Civil/Military Operations**
- Annex J Range Instructions**
- Annex K Communications**
- Annex L Operations Security**
- Annex M Protocol**
- Annex N Maneuver Damage and Environmental Considerations**
- Annex O Control Cell Organization**
- Annex P Provost Marshal**
- Annex Q Engineer**
- Annex R Distribution**



[RDL](#)



[Table of](#)



[Document](#)



[Download](#)

[Homepage](#) [Contents](#) [Information](#) [Instructions](#)

Glossary

A

AAFCE Allied Air Forces, Central Europe

AAR after-action review

AC Active Component

ACC area coordination center

ACCB air cavalry combat brigade

ACE Allied Command, Europe

ACR armored cavalry regiment

ADA air defense artillery

ADM atomic demolition munition

ADP automatic data processing

AFCENT Allied Forces, Central Europe

AFNORTH Allied Forces, Northern Europe

AFSOUTH Allied Forces, Southern Europe

AG adjutant general

AH attack helicopter

ALO air liaison officer

AMEDD Army Medical Department

APC armored personnel carrier

AR Army regulation

ARTBASS Army Training Battle Simulation System

ARTEP Army Training and Evaluation Program

ASA aviation support activity

ASIC all-source intelligence center

ASOC air support operations center

ATGM antitank guided missile

ATLAS A Tactical, Logistical, and Air Simulation

AVKP armored vehicle kill probability

AVLB armored vehicle launched bridge

B

BAI battlefield air interdiction

BC battalion through corps

BCC battery control center

BDA bomb damage assessment

bde brigade

BE Belgium

BMNT before morning nautical twilight

bn battalion

BR Britain

C

C confidential

CA combat arms

CAA combined arms army

cal caliber

CAMMS Computer-Assisted Map Maneuver Simulation

CAS close air support

CATTS Combined Arms Tactical Training Simulator

CBR chemical, biological, and radiological

CBU cluster bomb unit

CC company commander

CENTAG Central Army Group, Central Europe

CEV combat engineer vehicle

CEWI combat electronic warfare intelligence

CFX combined field exercise

cal caliber

C/F command/fire

CI counterintelligence

CINCUSAREUR commander in chief, United States Army Europe

cml chemical

CMO civil-military operations

co company

COL colonel

COMMZ communications zone

CONUS continental United States

COSCOM corps support command

CP command post

CPT captain

CPX command post exercise

CS combat support

CSH combat support hospital

ctg cartridge

CSS combat service support

CTX combined training exercise

C/V Chaparral/Vulcan

D

DA Department of the Army

DACCS Department of the Army Command and Control System

DAME division airspace management element

DD Department of Defense

DEPEX deployment exercise

DISCO division support command

div division

DIVARTY division artillery

DMMC division materiel management center

DS direct support

DST director station trailer

DTG date-time group

E

E exercise (STARTEX)

EAC echelons above corps

ECC exercise control center

ECM electronic countermeasures

EDRE emergency deployment readiness exercise

EEI essential elements of information

ENCOM Engineer Command

ENDEX end of the exercise

EPW enemy prisoner of war

E/TA electronic target acquisition

ESM electronic warfare support measures

EUCOM European Command

EW electronic warfare

F

FA field artillery

FAAR forward area altering area

FAC forward air controller

FARP forward arming and refueling point

FASCO forward area support coordinator

FCX fire coordination exercise

FDC fire direction center

FEBA forward edge of the battle area

1SG first sergeant

FIST fire support team

FM frequency modulated

FO forward observer

FORSCOM US Army Forces Command

FPF final protective fire

FR France

FRAGO fragmentary order

FS fire support

FSC fire support coordinator

FSE fire support element

FSO fire support officer

FSS fire support section

FTX field training exercise

G

G1 assistant chief of staff, G1 personnel

G2 assistant chief of staff, G2 intelligence

G3 assistant chief of staff, G3 operations and plans

G4 assistant chief of staff, G4 logistics

G5 assistant chief of staff, G5 civil affairs

GBU guided bomb unit

GDR German Democratic Republic (East Germany)

GE Germany, Federal Republic of (West Germany)

GLLD ground laser locator dectector

GP general purpose

GS general support

GT gun-target

GTA graphic training aid

H

HAWK homing-all-the-way killer

HC high concentrate

HE high explosive

HELLFIRE Heliborne Laser Fire-and-Forget Missile System

HQ headquarters

HTF how-to-fight

I

ID identification

IPB intelligence preparation of the battlefield

IPR in-process review

J

JCS Joint Chiefs of Staff

JTX joint training exercise

JVB joint visitor's bureau

K

KIA killed in action

KT kiloton

L

LAW light antitank weapon

lb pound

LC line of contact

LD line of departure

LFX live-fire exercise

LOC lines of communication

LOI letter of instruction

LT lieutenant

LTC lieutenant colonel

M

m meter

MAB mobile assault bridge

MAC maneuver area command

MACE Military Air Cargo Export System

MAJ major

MAPEX map exercise

MBA main battle area

MCC movement control center

MEDCEN medical center

MEDCOM Medical Command

MEDDAC medical activity

MEMO mission essential maintenance only

MEDMOD Medical Module

METT mission, enemy, terrain, and troops available

MI military intelligence

MILES Multiple Integrated Laser Engagement System

MLB metallic link belt

mm millimeter

MMC materiel management center

MOPP mission-oriented protection posture

MOS military occupational specialty

MOUT military operations on urbanized terrain

MP military police

MRL multiple rocket launcher

MSG master sergeant

MSR main supply route

MST maintenance support team

MTC maneuver training command

MTOE modification table of organization and equipment

N

NA not applicable

NATO North Atlantic Treaty Organization

NBC nuclear, biological, chemical

NCO noncommissioned officer

NCOIC noncommissioned officer in charge

NL Netherlands

NOE nap-of-the-earth

NORTHAG Northern Army Group, Central Europe

NTC National Training Center

O

OB order of battle

O/O on order

OH observation helicopter

O/I operations/intelligence

OIC officer in charge

OP observation post

OPCOM operational command

OPFOR opposing force

OPLAN operation plan

OPORD operation order

OPSEC operations security

P

P&A personnel and administration

pam pamphlet

PL phase line

PAC personnel and administration center

PAO public affairs officer

PDF point detonating fuze

PERSCOM Personnel Command

PFC private first class

POMCUS pre-positioning of materiel configured to unit sets

PSYOP psychological operations

PW prisoner of war

PWRM pre-positioned war reserve materiel

R

RACO rear area combat operations

RATELO radio telephone operator

RC Reserve Component

REALTRAIN realistic training

REFORGER redeployment of forces to Germany

RG Reserve Guard

S

S secret

S&T supply and transportation

S1 adjutant

S2 intelligence officer

S3 operations and training officer

S4 logistics officer

S5 civil affairs officer

SACEUR supreme allied commander, Europe

SAM surface-to-air missile

SFC sergeant first class

SGT sergeant

SASP special ammunition supply point

SHORAD short-range air defense

SIDPERS Standard Installation Division Personnel System

SITREP situation report

SJA staff judge advocate

SOP standing operating procedure

SP self-propelled

SP4 specialist 4

SQT skill qualification test

SSG staff sergeant

SSI specialty skill identifier

SSN social security number

SSO special security officer

STANAG standarization agreement

STARTEX start of the exercise

STRAC Standards in Training Commission

STX situational training exercise

T

t ton

T&E training and evaluation

T&EO training and evaluation outline

TA theater army

TAACOM theater army area command

TAB target acquisition battery

TACC tactical air control center

TACP tactical air control party

TACSIM tactical simulation

TADS Target Alerting Data Display Set

TASC training and audiovisual support center

TC training circular

TD tactical deception

TDA tables of distribution and allowance

TES tactical engagement simulation

TEWT tactical exercise without troops

TF task force

TNT trinitrotoluene (dynamite)

TOC tactical operations center

TOE table(s) of organization and equipment

TOT time over target

TOW tube-launched, optically-tracked, wire-guided missile

TPT target practice tracer

TRAC training resource assistance center

TRANSCOM Transportation Command

TSOP tactical standing operating procedure

U

U unclassified

US United States

UK United Kingdom

USACAC US Army Combined Arms Center

USAF US Air Force

USAREUR US Army, Europe

USATSC US Army Training Support Command

USSR Union of Soviet Socialist Republics

V

VA Virginia

VB visitor's bureau

vs versus

W

WIA wounded in action

WO warrant officer

WP white phosphorus

X

XO executive officer



[RDL](#)

[Table of](#)

[Document](#)

[Download](#)

[Homepage](#)

[Contents](#)

[Information](#)

[Instructions](#)

References

AR 310-31 *Management Systems for Tables of Organization and Equipment*

AR 310-49 *The Army Authorization Document System (TAADS)*

AR 570-2 *Organization and Equipment Authorization Tables: Personnel*

FM 25-1 *Training*

FM 25-2 *How to Manage Training in Units*

FM 25-3 *How to Conduct Training in Units*

FM 30-102 *Opposing Forces: Europe*

FM 34-71 *Opposing Forces Training Module: North Korean Military Forces*

FM 41-5 *Joint Manual for Civil Affairs*

[FM 41-10](#) *Civil Affairs Operations*

FM 44-1 (HTF) *US Army Air Defense Artillery Employment*

FM 44-3 (HTF) *Air Defense Artillery Employment, Chaparral/Vulcan*

FM 44-4 *Operation and Training, Chaparral*

FM 44-23 *US Army Air Defense Artillery Employment, Redeye*

FM 44-90 *US Army Air Defense Artillery Employment, Hawk*

FM 44-95 *Air Defense Artillery Employment, Nike Hercules*

[FM 101-5](#) *Staff Officer Field Manual: Staff Organization and Procedures*

FM 101-10-1 *Staff Officer Field Manual: Organizational, Technical and Logistic Data*

[TC 25-1](#) *Training Land: Unit Training Land Requirement*

TC 25-3 *Training Ammunition*

TC 25-6 *Tactical Engagement Simulation Training with MILES*

USATSC Bulletin 82-1 *Battle Simulations*

USACGSC 101-1 *Organizational Data for the Army in the Field*



[RDL](#) [Table of Contents](#) [Document](#) [Download](#)

[Homepage](#) [Contents](#) [Information](#) [Instructions](#)

FM 25-4

10 SEPTEMBER 1984

By Order of the Secretary of the Army:

JOHN A. WICKHAM, JR.
General, United States Army
Chief of Staff

Official:

ROBERT M. JOYCE
Major General, United States Army
The Adjutant General

DISTRIBUTION:

Active Army, ARNG, and USAR: To be distributed in accordance with DA Form 12-11B, Requirements for Operations of Army Forces in the Field (Qty rqr block no. 405) and Maneuver Control (Qty rqr block no. 422).

Additional copies may be requisitioned from the US Army Adjutant General Publications Center, 2800 Eastern Boulevard, Baltimore, MD 21220.

◆ U.S. GOVERNMENT PRINTING OFFICE:1992-281-496/43581