

FM 21-11

FIELD MANUAL

**FIRST AID
FOR
SOLDIERS**

HEADQUARTERS, DEPARTMENT OF THE ARMY

JUNE 1976

FIRST AID FOR SOLDIERS

	Paragraph	Page
PART ONE INTRODUCTION		
CHAPTER 1. GENERAL	1-1-1-5	3-7
2. VITAL BODY FUNCTIONS	2-1, 2-2	8-10
PART TWO BASIC LIFESAVING FIRST AID MEASURES		
CHAPTER 3. OPEN THE AIRWAY AND RESTORE BREATHING AND HEARTBEAT (MEASURE A)		
Section I. Open the Airway—Immediately ..	3-1, 3-2	11-14
II. Artificial Respiration—If Needed Administer Immediately	3-3-3-7	14-20
III. Closed-Chest Heart Massage—If needed Administer Immediately	3-8-3-14	21-28
CHAPTER 4. STOP THE BLEEDING (MEASURE B)		
Section I. General	4-1, 4-2	29
II. Application of Pressure Dressing, Elevation of Limb, and Digital Pressure	4-3-4-8	29-31
III. Application of Tourniquet	4-9-4-14	31-35
CHAPTER 5. PREVENT SHOCK (MEASURE C)	5-1-5-8	36-39
6. DRESS AND BANDAGE THE WOUND TO AVOID INFECTION (MEASURE D)		
Section I. General	6-1-6-3	40
II. Dressings	6-4, 6-5	41-43
III. Basic Types of Bandages	6-6-6-8	43
IV. Bandaging of Various Body Parts	6-9-6-18	44-55
PART THREE SPECIAL FIRST AID MEASURES		
CHAPTER 7. FIRST AID FOR SEVERE WOUNDS AND BURNS		
Section I. Introduction	7-1, 7-2	56
II. Head Injuries	7-3-7-5	56-57
III. Face and Neck Wounds	7-6, 7-7	57
IV. Sucking Wounds of the Chest	7-8, 7-9	58-60
V. Abdominal Wounds	7-10, 7-11	60
VI. Severe Burns	7-12, 7-13	61-63
CHAPTER 8. IMMOBILIZATION OF FRACTURES		
Section I. Introduction	8-1-8-6	64-67
II. Immobilization Methods	8-7-8-11	67-83

*This manual supersedes FM 21-11, 28 May 1970.

	Paragraph	Page
CHAPTER 9. FIRST AID FOR COMMON EMERGENCIES	9-1—9-14	84—96
10. TRANSPORTING THE WOUNDED SOLDIER		
Section I. Introduction	10-1, 10-2	97—98
II. Manual Carries	10-3—10-6	98—123
CHAPTER 11. FIRST AID IN A TOXIC ENVIRONMENT		
Section I. Introduction	11-1, 11-2	124—125
II. Chemical-Biological Agents	11-3—11-5	125—127
III. Nerve Agents	11-6—11-8	127—133
IV. Other Agents	11-9—11-16	134—139
CHAPTER 12. PSYCHOLOGICAL FIRST AID		
Section I. General	12-1—12-5	140—141
II. Principles of Psychological First Aid	12-6—12-10	142—144
III. Common Types of Reaction to Disaster	12-11—12-13	144—146
IV. Psychological First Aid	12-14—12-17	146—149
APPENDIX A. REFERENCES		150
B. CONTENTS OF FIRST AID CASE AND KITS		151—152
INDEX		153—158

PART ONE

INTRODUCTION

CHAPTER 1

GENERAL

1-1. Purpose and Scope

a. The purpose of this manual is to describe first aid measures, to explain how and when to apply them, and to emphasize the significance of prompt, effective first aid. The measures described can be applied as self-help as well as help to others. Since first aid is the emergency care given to the sick, injured, or wounded before medical treatment can be administered by medical personnel, this manual is directed to nonmedical personnel. Even though the manual uses the terms "soldier" and "he/his," the procedures discussed apply to all types of casualties/victims; and the measures described are for use by male and female soldiers alike.

b. Part One is an introductory discussion of first aid. Part Two explains the four basic lifesaving first aid measures: A—OPEN THE AIRWAY AND RESTORE BREATHING AND HEART-BEAT, B—STOP THE BLEEDING, C—PREVENT SHOCK, and D—DRESS AND BANDAGE THE WOUND TO AVOID INFECTION. Part Three describes special first aid measures and modifications of the basic lifesaving measures.

c. The material in this manual is applicable to both nuclear and nonnuclear warfare.

1-2. Standardization Agreements

Provisions of this publication are the subject of the following international agreements:

<i>Title</i>	<i>NATO STANAG's</i>	<i>CENTO STANAG's</i>	<i>SEATO STANAG's</i>
Medical Training in First Aid, Basic Hygiene and Emergency Care	2122	2122	2122
Medical First Aid Equipment and Supplies	2126	2126	
First Aid and Hygiene Training in NBC Operations	2358	2358	

When amendment, revision, or cancellation of this publication is proposed and such action would affect or violate the international agreements concerned, the preparing activity will take appropriate reconciliation action through international standardization channels.

1-3. Users' Comments or Queries

Users of this manual are encouraged to recommend changes for its improvement. Comments should be recorded on DA Form 2028 (Recommended Changes to Publications and Blank Forms) and keyed to the specific page, paragraph, and line of the text in which change is recommended. Reasons must be provided for each change to insure understanding and complete evaluation. The recommended changes are to be forwarded directly to the Superintendent, Academy of Health Sciences, US Army, ATTN: HSA-CDL, Fort Sam Houston, Texas 78234.

1-4. Importance of First Aid and First Aid Items

a. The Army Medical Department has the finest equipment available and personnel who have been trained in the most modern methods of saving life and easing pain. Medical personnel, however, cannot be everywhere at once.

b. The soldier may have to depend upon his first aid knowledge and skill to save his own life or the life of another soldier. He may be able to save lives, prevent permanent disabilities, and reduce long periods of hospitalization by knowing what to do and not to do and seeking medical assistance as soon as possible.

c. Anything the soldier can do to keep himself and others in fighting condition is part of his primary mission, that of fighting. Most wounded soldiers are able to return to their units to fight again primarily because they are given appropriate and timely first aid followed by excellent medical care.

d. Every soldier is issued a field first aid case which he carries with him at all times for his personal use (fig 1-1). It contains one or two combat dressings with attached bandages for use on a

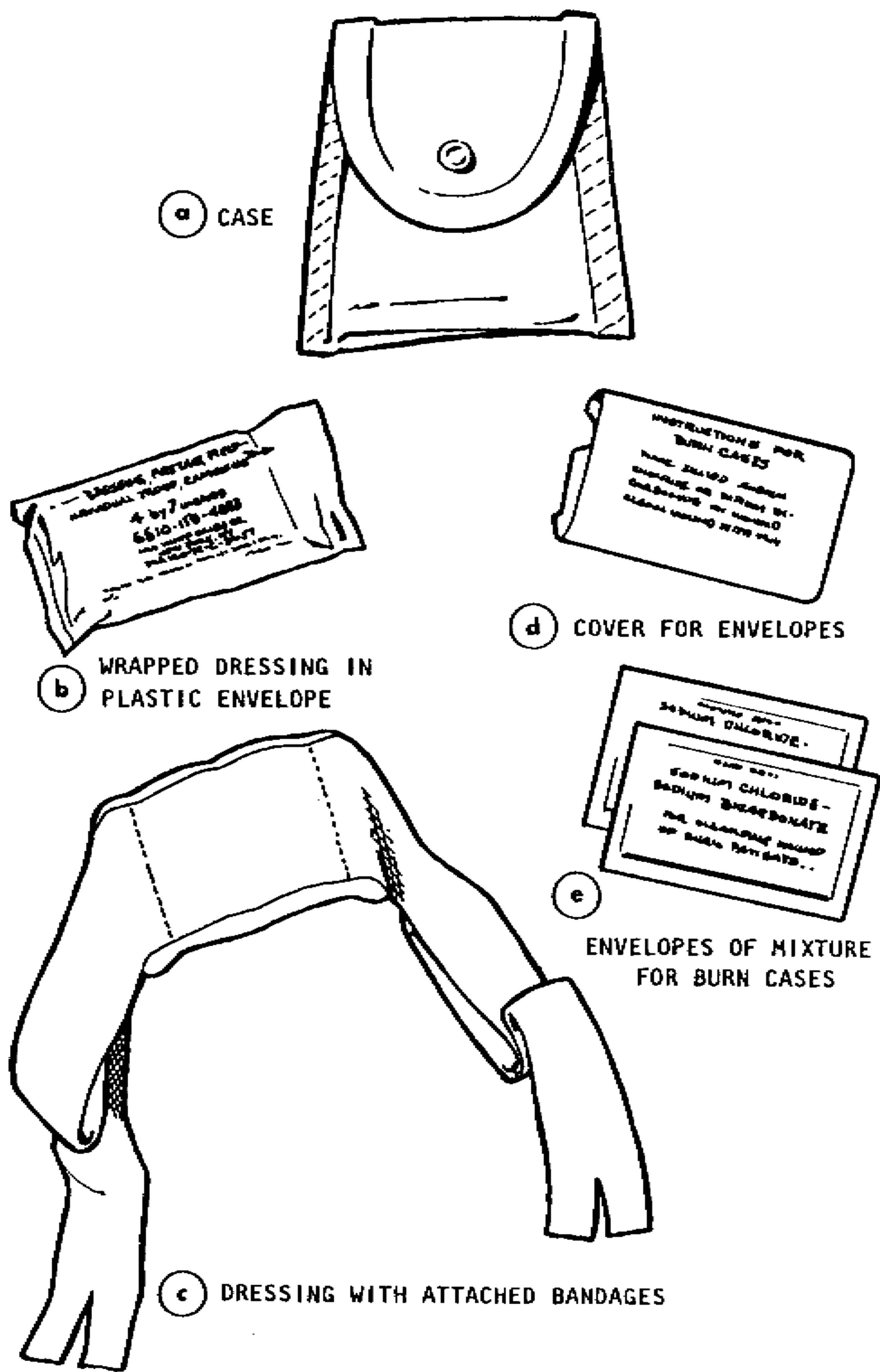

Figure 1-1. Field first aid case (individual) and contents.

wound and two envelopes of sodium chloride-sodium bicarbonate mixture for consumption in the event of a burn. When the soldier administers first aid to another person, he must remember to use the wounded person's first aid items first; he may need his own later. The soldier must check his first aid case regularly and replenish any items used from it. The items may be obtained from unit supply. (A general purpose first aid kit is carried in all vehicles (app B).

1-5. Basic Guides for Administering First Aid

After the soldier learns thoroughly how to administer each of the lifesaving and other first aid measures discussed in this manual, the time will come when he must apply his knowledge instantly. A special awareness of the basic DO's and DO NOT's in administering first aid will help to guide him in making quick and correct decisions. To act incorrectly can be just as serious or fatal to a wounded soldier as the failure to administer a lifesaving measure.

a. The DO's.

(1) *Act promptly but calmly.* (A person who "loses his head" is of little or no value to a wounded soldier.)

(2) *Reassure* the wounded soldier and at the same time quickly and gently *examine* him to determine the need for administering lifesaving measures **A—OPEN THE AIRWAY AND RESTORE BREATHING AND HEARTBEAT** and **B—STOP THE BLEEDING**. If *required*, administer these measures instantly. (Lack of oxygen intake leads to death in a very few minutes. Human life cannot continue without an adequate volume of blood to carry oxygen to the tissues.)

(3) *Reexamine* the wounded soldier immediately in a careful, gentle, organized (head-to-toe, front and back) manner to determine the extent and type of injuries; then, as required, *administer* promptly lifesaving measures **C—PREVENT SHOCK** and **D—DRESS AND BANDAGE THE WOUND TO AVOID INFECTION**. (If shock is not prevented or corrected, the soldier may die even though the injury causing the shock would not otherwise be fatal. Healing of a wound and recovery of the soldier depend to a great extent upon how well the wound was protected from contamination initially.)

b. The DO NOT's.

(1) Do not position a soldier on his back if he is unconscious or has a face or neck wound (para 5-7b and 7-7b).

(2) Do not remove clothing from an injured soldier by pulling or tearing it off (para 4-5, 7-13a(1), and 8-1).

(3) Do not touch or try to clean a dirty wound, including burns (para 6-1 and 7-13a(1)).

(4) Do not remove dressings and bandages once they have been placed over a wound (para 4-6b).

(5) Do not loosen a tourniquet once it has been applied (para 4-14).

(6) Do not move a soldier who has a fracture until it has been properly splinted (para 4-7, 5-7a, and 8-4) unless it is absolutely necessary, such as moving him from close enemy action, a toxic (carbon monoxide) environment, or a burning building.

(7) Do not give fluids by mouth to a soldier who is unconscious, nauseated, or vomiting or who has an abdominal or neck wound (para 7-11b, 7-13b, and 9-13a).

(8) Do not permit the head of a soldier with a head injury to be lower than his body (para 7-5b).

(9) Do not try to push protruding intestines or brain tissue back into a wound (para 7-5a and 7-11a).

(10) Do not put any medication on a burn (para 7-13a(1)).

(11) Do not administer first aid measures which are unnecessary or beyond your capabilities.

(12) Do not fail to replenish your first aid case with items which you have used from it.

CHAPTER 2

VITAL BODY FUNCTIONS

2-1. Respiration and Blood Circulation

Respiration (inhalation and exhalation) and blood circulation are vital body functions. Interruption of either of these two functions need not be fatal IF timely and appropriate first aid measures are correctly applied.

a. Respiration. Respiration is the means through which oxygen is taken into the body and carbon dioxide is expelled from the body.

(1) Respiration is accomplished by means of the *airway* (nose, mouth, throat, voicebox, windpipe, and bronchial tree), a canal through which air passes to and from the lungs; the *lungs* (two elastic organs made up of thousands of tiny air spaces and covered by airtight membrane); and the *chest cage* (formed by the muscle-connected ribs which join the spine in the back and the breastbone in the front). The top part of the chest cage is closed by the structure of the neck, and the bottom part is separated from the abdominal cavity by a large dome-shaped muscle called the diaphragm (fig 2-1).

(2) The diaphragm and the rib muscles, which are under the control of the respiratory center in the brain, automatically contract and relax. *Contraction* causes an increase, and *relaxation* a decrease, in the size of the chest cage. When the chest cage increases and then decreases, the air pressure in the lungs is first less and then more than the atmospheric pressure, thus causing the air to rush in and out of the lungs to equalize the pressure. This cycle of inhaling and exhaling is repeated about 12 to 18 times per minute.

b. Blood Circulation. Blood is circulated through the body tissues by means of the heart and the blood vessels (arteries, veins, and capillaries). The heart is divided into two separate halves, each

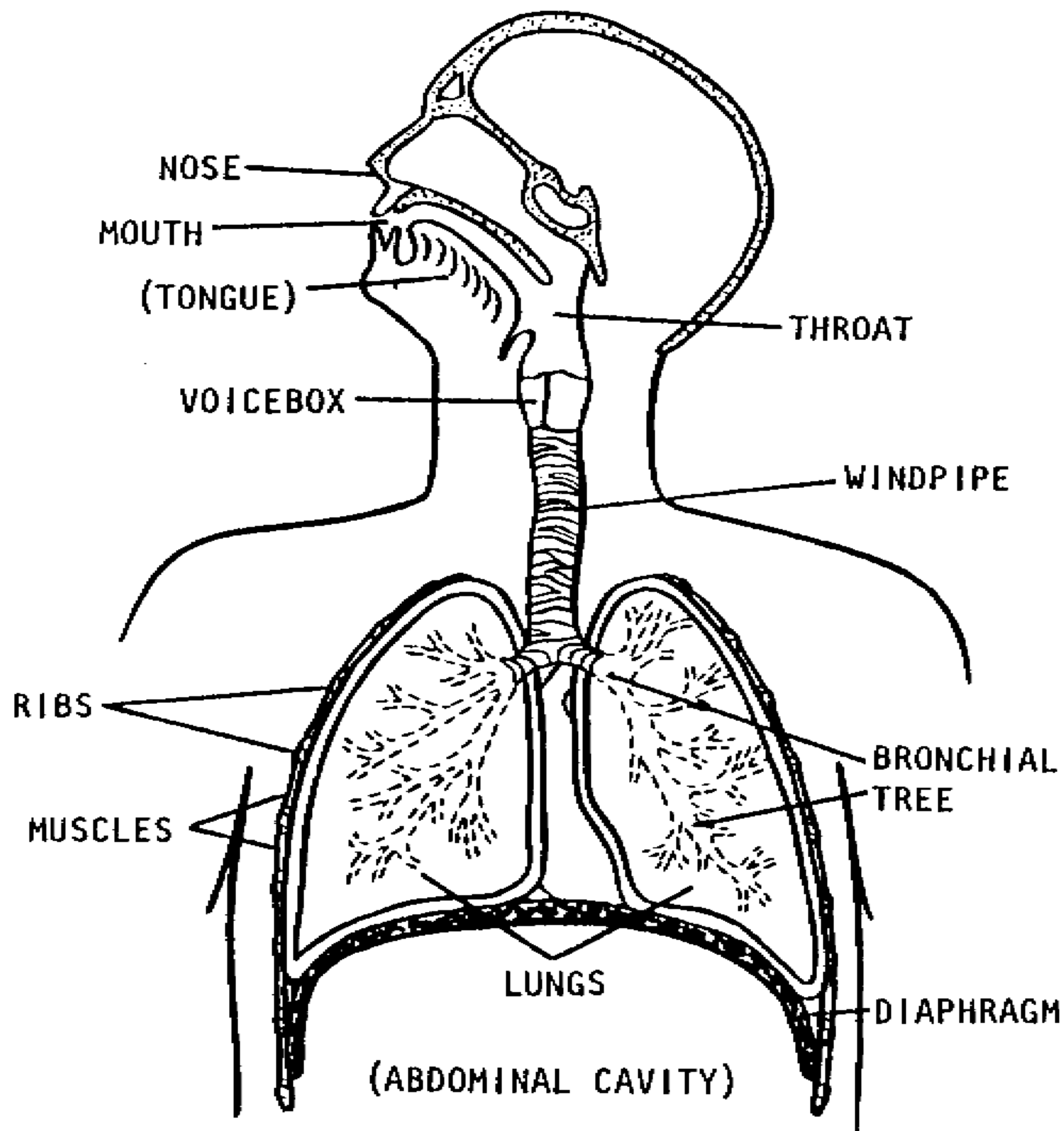

Figure 2-1. Airway, lungs, and chest cage.

acting as a pump. The left side pumps oxygenated blood (bright red) through the arteries into the capillaries; nutrients and oxygen pass from the blood through the walls of the capillaries into the cells. At the same time waste products and carbon dioxide enter the capillaries. From the capillaries the deoxygenated blood is carried through the veins to the right side of the heart and then into the lungs where carbon dioxide is expelled and oxygen is picked up. Blood in the veins is dark red because of its low oxygen content. Blood does not flow through the veins in spurts as it does through the arteries ((2) below).

(1) *Heartbeat.* The heart functions as a pump to circulate the blood continuously through the blood vessels to all parts of the body. It contracts, forcing the blood from its chambers; then it

relaxes, permitting its chambers to refill with blood. This cycle of *contraction* and *relaxation*, which is repeated continuously at a regular rhythmical rate, is called the *heartbeat*.

(2) *Pulse*. The systemic arteries carry richly oxygenated blood from the left side of the heart into all parts of the body. Blood flows through the arteries in spurts. The arteries expand each time the heart forces blood into them and contract as the blood moves farther along the circulatory system. This cycle of *expansion* and *contraction* of the arteries is called the *pulse*. The normal average rate of the pulse is considered to be 60 to 80 beats per minute.

2-2. Conditions Which Adversely Affect the Vital Body Functions

a. *Lack of Oxygen*. Human life cannot exist without a continuous intake of oxygen. Lack of oxygen rapidly leads to death. First aid, therefore, involves knowing how to **OPEN THE AIRWAY AND RESTORE BREATHING AND HEARTBEAT** (chap 3).

b. *Bleeding*. Human life cannot continue without an adequate volume of blood to carry oxygen to the tissues. An important first aid measure, then, is to **STOP THE BLEEDING** to prevent unnecessary loss of blood (chap 4).

c. *Shock*. Shock is a condition in which there is inadequate blood flow to the vital tissues and organs. Shock which remains uncorrected may result in death even though the injury or condition causing the shock would not otherwise be fatal. Shock can result from many causes, such as loss of blood, loss of fluid from deep burns, expansion of the blood vessels, pain, and reaction to the sight of a wound or blood. First aid includes knowledge of how to **PREVENT SHOCK**, since the soldier's chances of survival are much greater if he does not develop shock (chap 5).

d. *Infection*. Recovery from a severe injury or healing of a wound depends to a great extent upon how well the wound was protected from contamination initially. Infection results from the multiplication and growth of germs which invade a wound or a break in the skin by contamination. Since germs are in the air and on the skin and clothing, some of them will get into every wound immediately. The objective is to keep additional germs out of the wound. A knowledge of first aid includes how to **DRESS THE WOUND TO AVOID INFECTION** (chap 6).

PART TWO
BASIC LIFESAVING FIRST AID MEASURES

CHAPTER 3
**OPEN THE AIRWAY AND RESTORE BREATHING AND
HEARTBEAT (MEASURE A)**

Section I. OPEN THE AIRWAY—IMMEDIATELY

3-1. General

In order for air to flow to and from the lungs, the upper airway must be unobstructed.

3-2. Adjusting Position to Enlarge Airway Passage

a. Head-Tilt Method. Immediately place the soldier on his back with his neck extended and his head in a chin-up position (fig 3-1). If a rolled blanket, poncho, or similar object is available, place it under his shoulders to help maintain this position, but do not waste time obtaining such materials. **SECONDS COUNT!** The head-tilt method is effective in many cases.

b. Jaw-Lift Method. If the head-tilt method is unsuccessful, adjust the jaw to a jutting out position (fig 3-2). This positioning moves the base of the tongue farther away from the back of the throat, thus enlarging the airway passage to the lungs. It may be accomplished by either the thumb jaw-life method or the two-hand jaw-lift method.

(1) *Thumb jaw-lift.* This is ordinarily the method of choice for adjusting the jaw unless the nature of the injury prevents its use. Place your thumb in the soldier's mouth, grasp the lower jaw firmly, and lift it forward (a, fig 3-2). Do not attempt to hold or depress the tongue.

AIRWAY
CLOSED
BY TONGUE



a

AIRWAY OPENED
BY EXTENDING
NECK

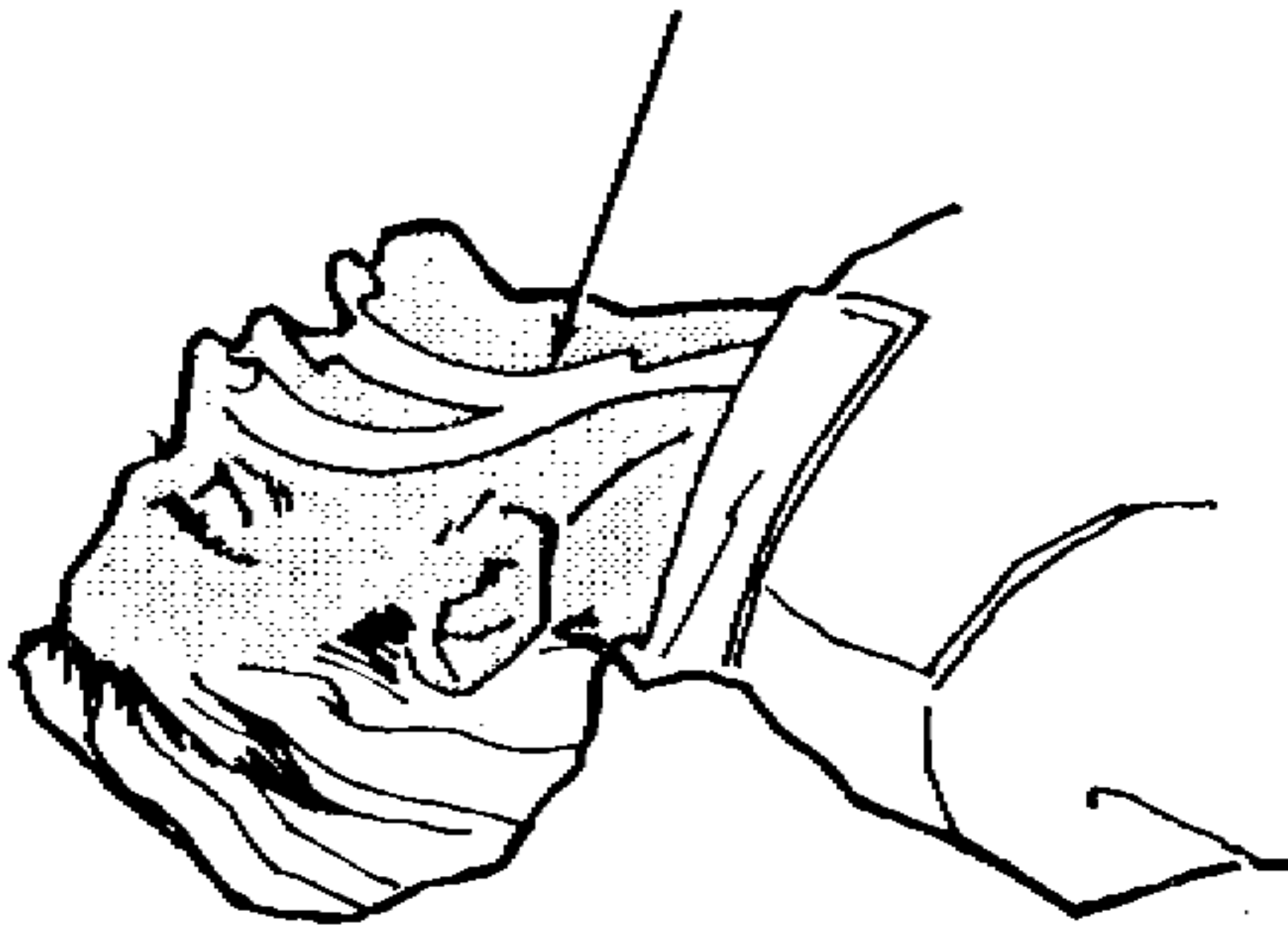

b

Figure 3-1. Neck extended and head in chin-up position.

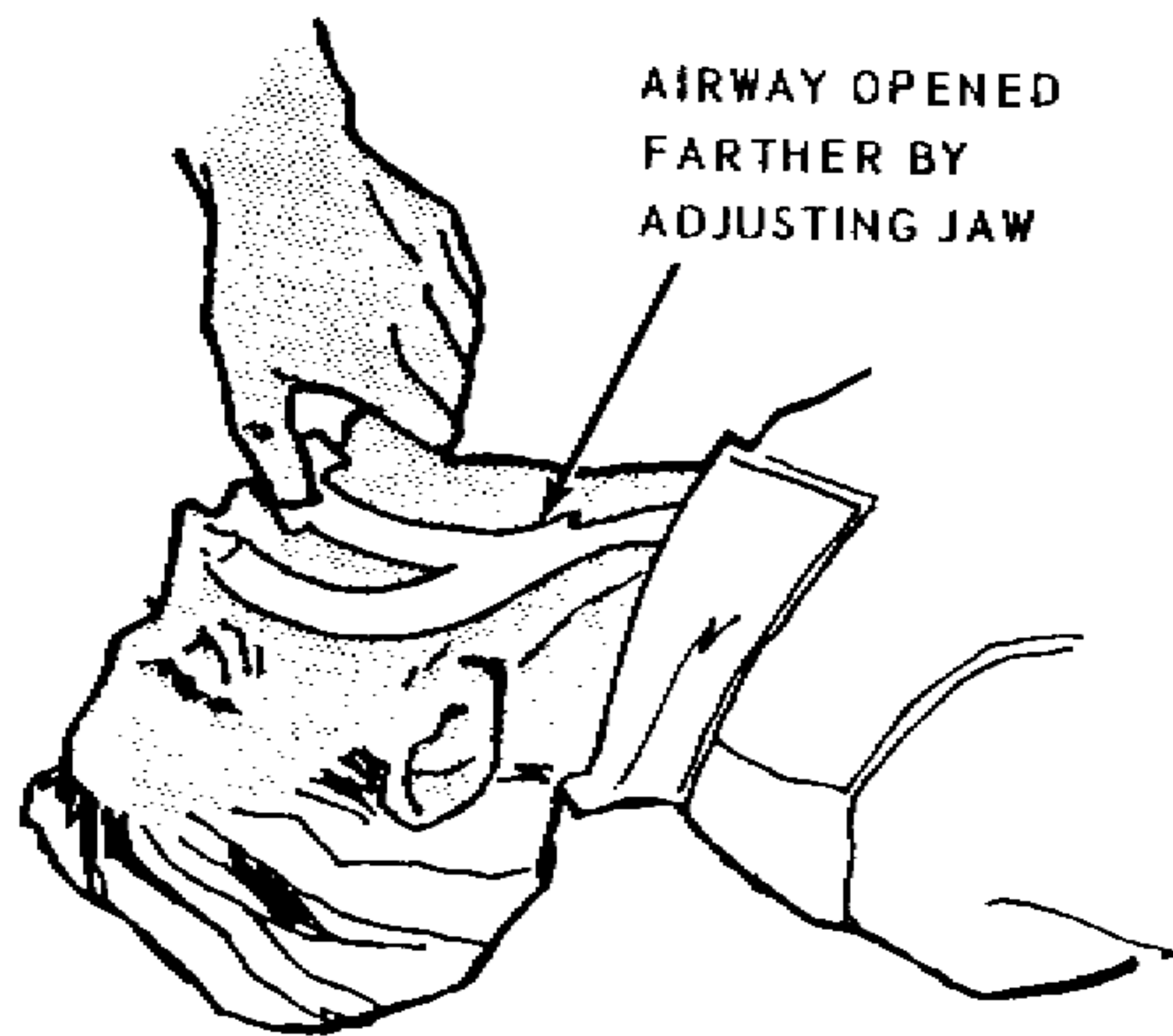

a THUMB JAW-LIFT



b TWO-HAND JAW-LIFT

Figure 3-2. Methods for adjusting lower jaw to jutting out position.

(2) *Two-hand jaw-lift.* If the soldier's jaws are so tightly closed that the thumb cannot be inserted into the mouth, the two-hand jaw-lift is used. Using both hands, grasp the angles of the lower jaw just below the ear lobes. Lift the jaw forcibly forward; then open the lips by pushing the lower lip toward the chin with the thumbs (b, fig 3-2).

Section II. ARTIFICIAL RESPIRATION—IF NEEDED, ADMINISTER IMMEDIATELY

3-3. General

a. If the injured soldier does not promptly resume adequate spontaneous breathing after the airway is open, artificial respiration must be started. Be calm! Think and act quickly! The sooner you begin artificial respiration, the more likely you are to succeed in restoring his breathing. If you are in doubt as to whether or not he is breathing, do not waste valuable seconds; give him artificial respiration, since it can do no harm to a person who is breathing. If the soldier is breathing, you can ordinarily feel and see his chest moving or feel and hear air being expelled by putting your hand or ear close to his mouth and nose.

b. If the soldier has no heartbeat, you must also give him closed-chest heart massage immediately (sec III). If two persons are available, one can give artificial respiration while the other gives closed-chest heart massage. If you are the only person available, you must perform both measures, alternating them as described in paragraph 3-13.

c. There are two primary methods of administering artificial respiration: the mouth-to-mouth and the chest-pressure arm-lift. The mouth-to-mouth method is the preferred one; however, it cannot be used if the soldier has a crushed face or is in a toxic environment. If he has a crushed face, the chest pressure arm-lift method must be used. In a chemically contaminated atmosphere, the back-pressure arm-lift method may be used as a substitute for the mask-to-mouth method.

3-4. Mouth-to-Mouth Resuscitation Method

In this method of artificial respiration, you inflate the soldier's lungs with air from your lungs. This can be accomplished by blowing air into his mouth. The mouth-to-mouth resuscitation method is performed as follows:

a. With the wounded soldier lying on his back, position yourself at the side of his head. Place one hand behind the neck to maintain the head in a face-up position with the head tilted back as far as possible.

b. Pinch the nostrils together with the thumb and index finger of your other hand and let this same hand exert pressure on the forehead to maintain the backward head tilt (fig 3-3). (The nose can also be sealed by pressing your cheek firmly against it.)

c. Take a deep breath and place your mouth (in an airtight seal) around the soldier's mouth. (If the injured person is an infant or small child, cover both his nose and mouth with your mouth, sealing your lips against the skin of his face.)

d. Blow into the mouth forcefully to cause the soldier's chest to rise. (In infants and small children you should need to blow only small puffs of air from your cheeks rather than deep breaths from your lungs.) If the chest rises, this indicates that sufficient air is getting into the soldier's lungs. Then proceed as in *e* and *f* below.

(1) If the chest does not rise, take corrective action immediately by adjusting the jaw (para 3-2b) and blowing harder making sure that air is not leaking from around your mouth or out of the soldier's pinched nose.

(2) If the chest still does not rise, move the soldier's head to one side and clear his airway with your fingers. To do this, open his mouth and run your fingers down the inside of the lower cheeks, over the base of the tongue, and into the throat. Move your fingers across the back of the throat with a sweeping motion to remove any vomitus, mucus, or foreign bodies.

(3) If the airway is still not clear, roll the soldier onto his side; then using the heel of your hand, deliver sharp blows between the soldier's shoulder blades to dislodge the foreign body from the airway. Immediately inflate his lungs, using mouth-to-mouth resuscitation.

e. When the soldier's chest rises, remove your mouth from the soldier's mouth and listen for the return of air from his lungs (exhalation). If his exhalation is noisy, elevate his jaw more.

f. After each exhalation of air from the soldier's lungs, pinch his nose again and blow another deep breath into his airway. Adequate ventilation should be insured on every breath by seeing the soldier's chest rise and fall and by hearing and feeling the air escape during exhalation. The first four breaths should be full

quick breaths (except in infants and small children), without allowing time for full lung deflation between breaths. Thereafter, repeat the mouth-to-mouth resuscitation procedure at the rate of approximately once every 5 seconds. Continue mouth-to-mouth resuscitation until the soldier regains consciousness, until you are relieved by a medically trained person, or for at least 45 minutes in the absence of all life signs. As the soldier starts to breathe, adjust the timing of your efforts to assist him. A smooth rhythm is desired but split second timing is not essential.

(1) After a period of resuscitation, the soldier's abdomen may bulge. This indicates that some of the air is going into his stomach. Since inflation of the stomach makes it more difficult to inflate the lungs, apply gentle pressure to the abdomen with your hand at frequent intervals between inflations.

(2) If your breathing has been very deep and rapid for too long a period, you may become faint, tingle, or even lose consciousness if you persist. However, if you administer only four full quick breaths then adjust your breathing to the rate of approximately once every 5 seconds with only moderate increase in normal volume, you will be able to continue to give artificial respiration for a long period without experiencing temporary ill effects. (If you



Figure 3-3. Mouth-to-mouth artificial respiration.

become distressed from giving shallow breaths to an infant or a small child, interrupt your rhythm occasionally to take a deep breath.)

3-5. Mouth-to-Nose Method

This method should be used if you cannot perform mouth-to-mouth breathing because the soldier has a severe jaw fracture or mouth wound or his jaws are tightly closed by spasms. The mouth-to-nose method is performed in the same way as the mouth-to-mouth method except that you blow into the nose while you pinch the lips closed with one hand. It may be necessary to separate the soldier's lips to allow the air to escape during exhalation.

3-6. Chest-Pressure Arm-Lift Method

This method is to be used when the mouth-to-mouth method cannot be used because the soldier has a crushed face.

a. Preliminary Steps.

- (1) Clear the soldier's airway (para 3-4d(2)).
- (2) Position him on his back.
- (3) Position the soldier's head with his face up and place a rolled blanket or some other similar object under his shoulders so that his head will drop back in a chin-up position.
- (4) Stand at his head and face his feet. Kneel on one knee and place your other foot at the other side of his head and against his shoulder to steady it (a, fig 3-4). If you become uncomfortable after a period of time, quickly switch to the other knee.

b. Procedure.

- (1) Grasping the soldier's hands and holding them over his lower ribs, rock forward and exert steady, uniform pressure almost directly downward (b, fig 3-4) until you meet firm resistance. This pressure forces air out of the lungs.
- (2) Lift his arms vertically upward (c, fig 3-4). Stretch them backward as far as possible (d, fig 3-4). This process of lifting and stretching the arms increases the size of the chest and draws air into the lungs.
- (3) Replace his hands on his chest and repeat the cycle: PRESS, LIFT, STRETCH, REPLACE. Give 10 to 12 cycles per minute at a steady uniform rate. Give counts of equal length to the first three steps. The fourth or REPLACE step should be performed as quickly as possible.

(4) As he attempts to breathe, adjust the timing of your efforts to assist him. Continue artificial respiration until the soldier regains consciousness, until you are relieved by a medically trained person, or for at least 45 minutes in the absence of all life signs.

c. Releasing Position to Replacement. When you become tired, release your position to another person, if available, with no break in rhythm. Continuing to administer artificial respiration, move to one side while the replacement takes his position from the other side. During the STRETCH step, the replacement grasps the soldier's wrists and continues artificial respiration in the same rhythm, shifting his grip to the soldier's hands during the REPLACE step.

3-7. Back-Pressure Arm-Lift Method

This is an alternate method used in a chemically contaminated atmosphere as a substitute for the mask-to-mouth method. It is the third best choice of artificial respiration.

a. If the soldier is wearing a protective mask, lift the mask, quickly clear the upper airway and the mask with your fingers, and replace the mask. Maintain a clear airway by repeating this procedure later, if necessary. If the soldier should be masked but is not, put his mask on him.

b. Place the soldier on his stomach with face to one side, neck extended, and hands under the head. Kneel at the soldier's head and place your hands on his back so that the heels of your hands lie just below a line between the armpits with thumbs touching and fingers extended downward and outward (a, fig 3-5).

(1) Rock forward, keeping your arms straight, and exert pressure almost directly downward on the soldier's back, forcing air out of his lungs (b, fig 3-5).

(2) Then rock backward, releasing the pressure, and grasp his arms just above the elbows (c, fig 3-5).

(3) Continue to rock backward, pulling the arms upward and inward (toward the head) until resistance and tension in his shoulders are noted. This expands the chest, causing air to enter the lungs (d, fig 3-5).

(4) Rock forward and release the soldier's arms. This causes passive expiration.

(5) Repeat the cycle of PRESS, RELEASE, LIFT, and RELEASE for 10 to 12 times per minute.

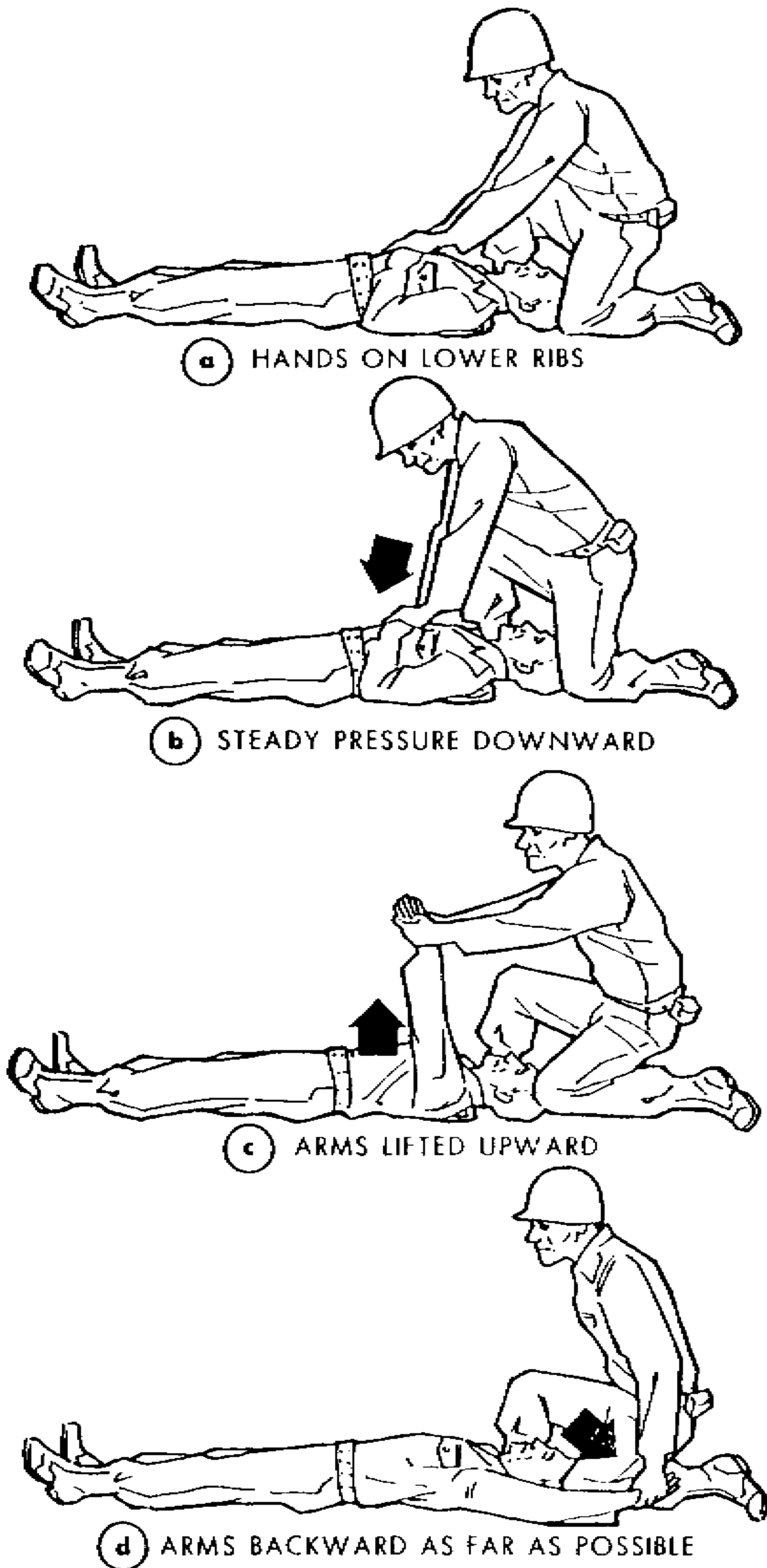
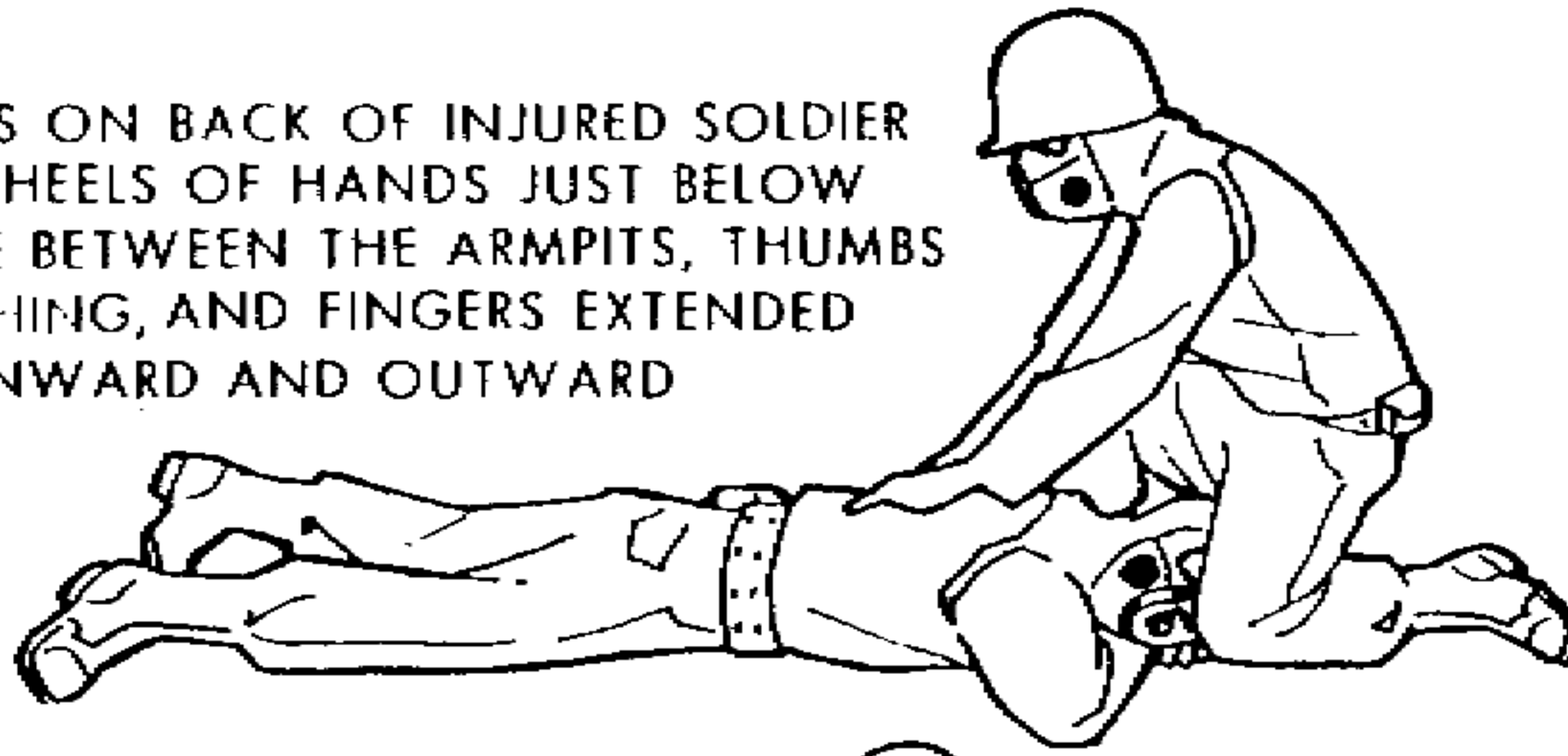

Figure 3-4. Chest-pressure arm-lift method of artificial respiration.

(a)

HANDS ON BACK OF INJURED SOLDIER WITH HEELS OF HANDS JUST BELOW A LINE BETWEEN THE ARMPITS, THUMBS TOUCHING, AND FINGERS EXTENDED DOWNWARD AND OUTWARD



(b)

ROCKING FORWARD WITH ARMS STRAIGHT, PRESSING ALMOST DIRECTLY DOWNWARD

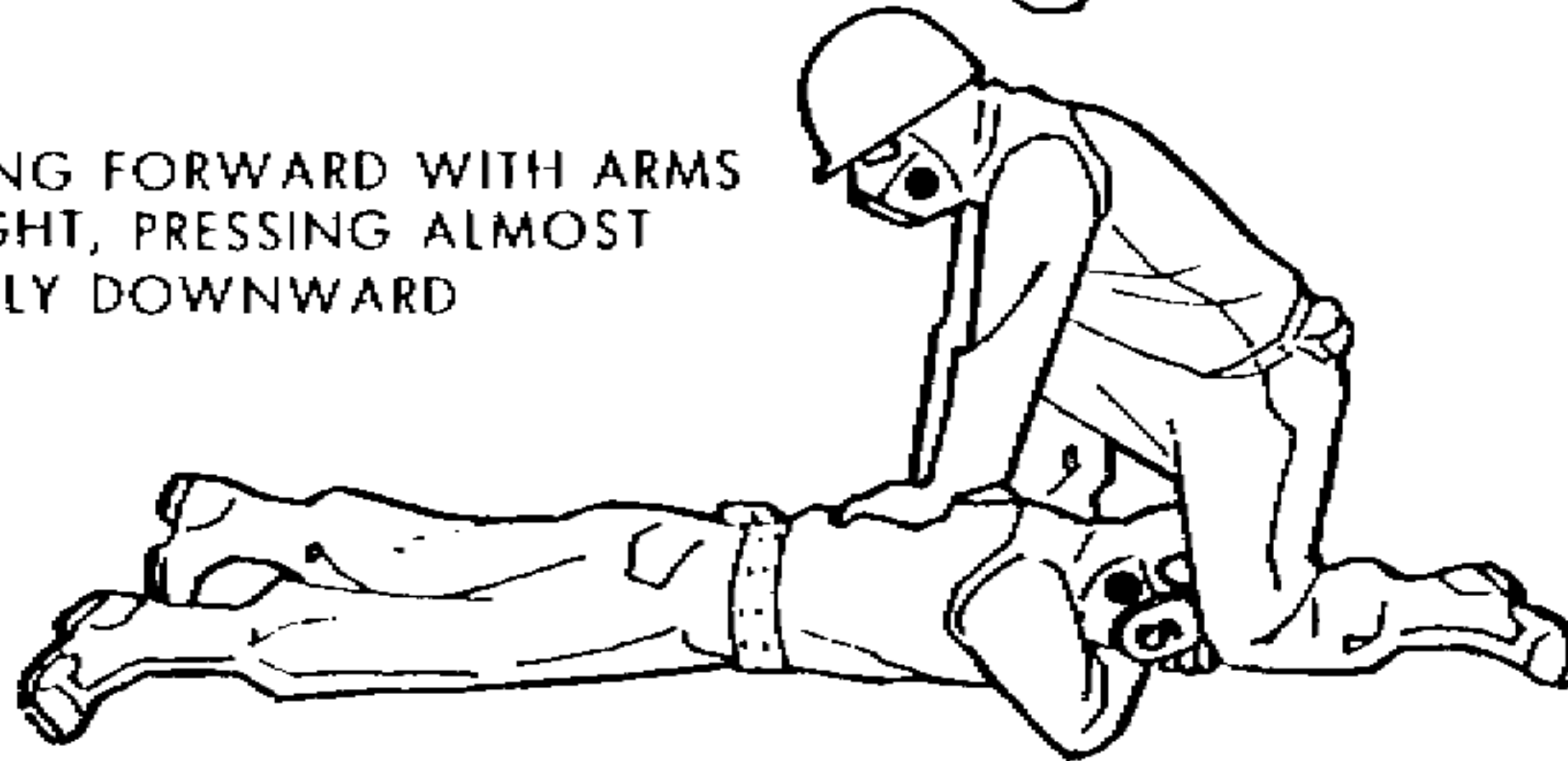

(c)

ROCKING BACKWARD, RELEASING THE PRESSURE, AND GRASPING THE ARMS JUST ABOVE THE ELBOWS

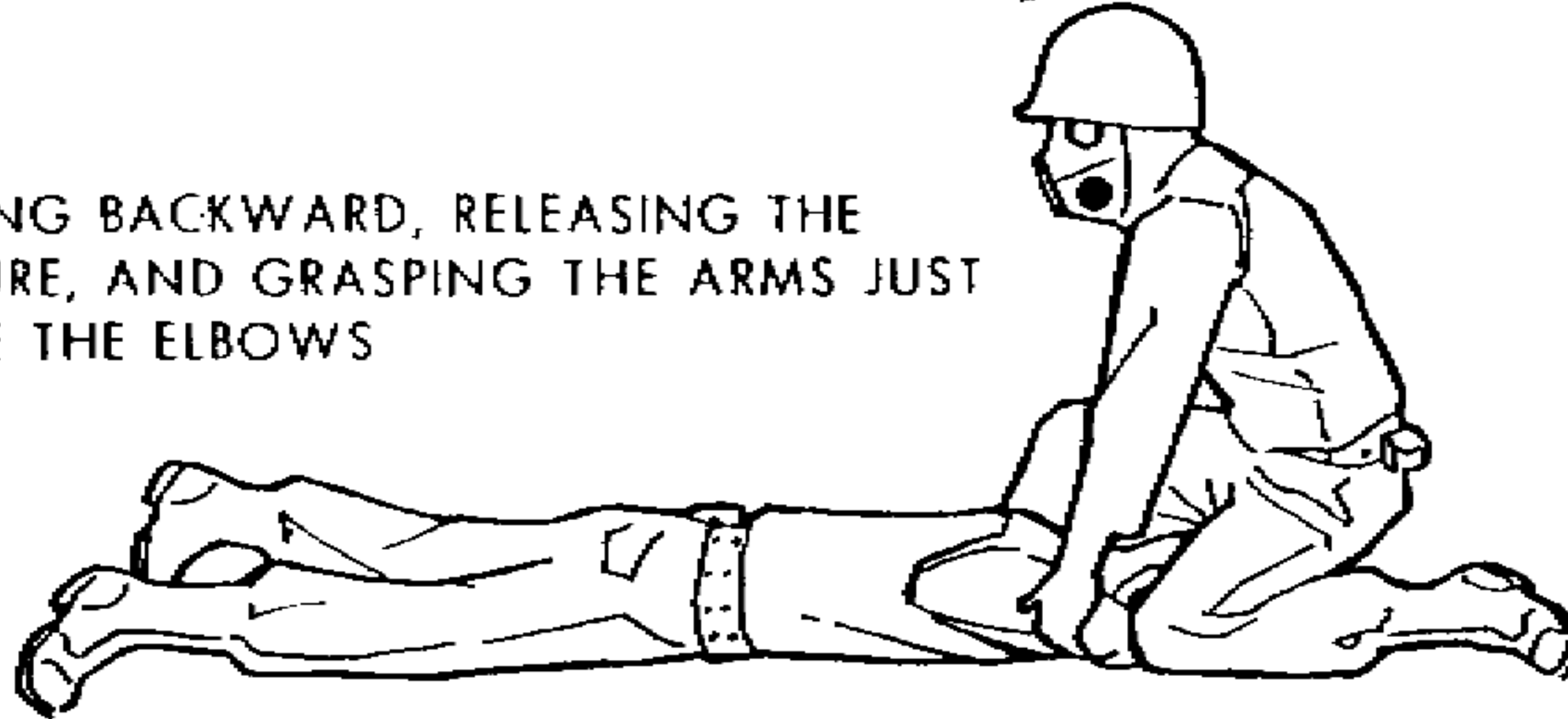

(d)

CONTINUING TO ROCK BACKWARD, PULLING THE ARMS UPWARD AND INWARD (TOWARD THE HEAD)

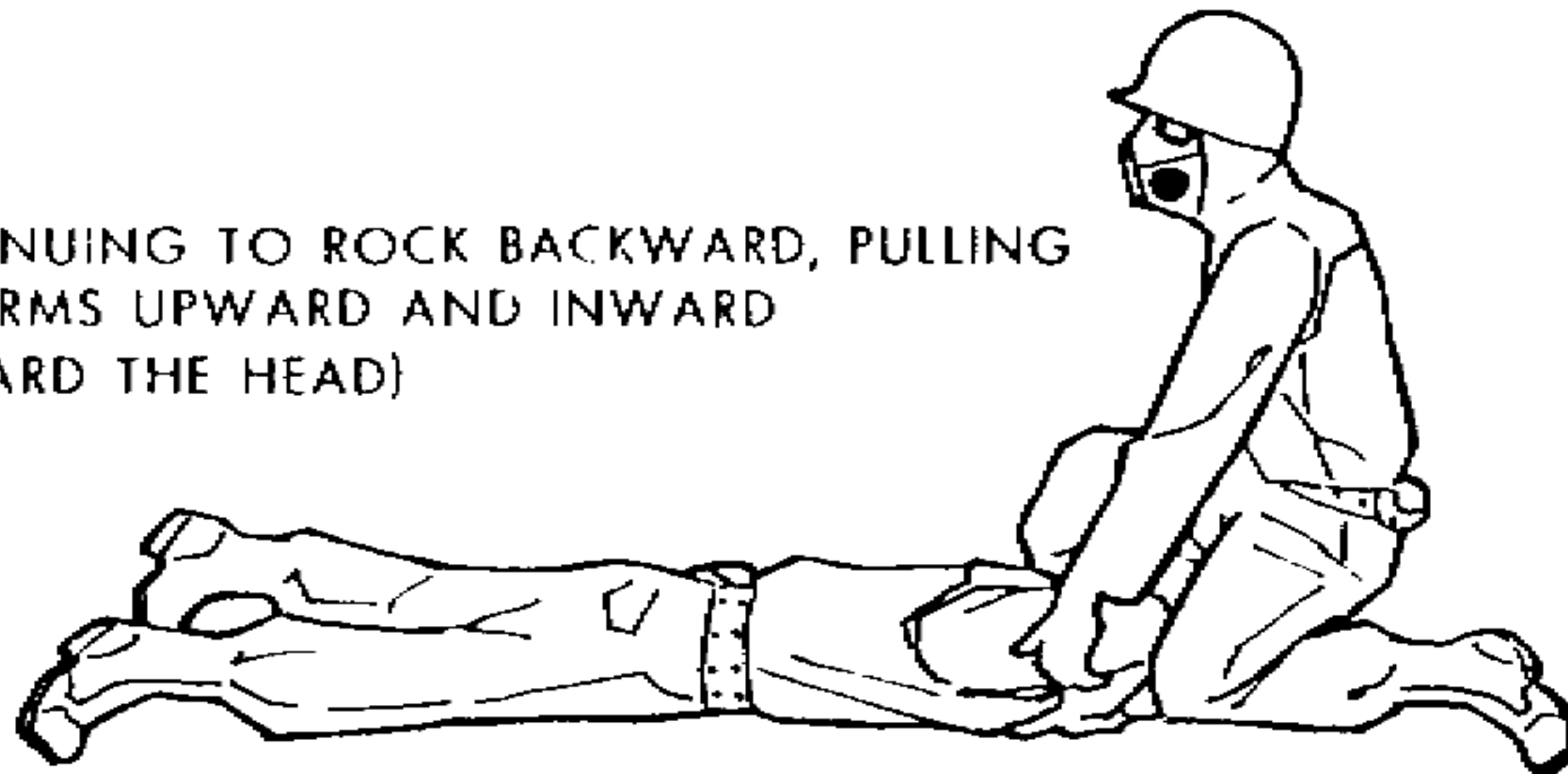

Figure 3-5. Back-pressure arm-lift method of artificial respiration.

Section III. CLOSED-CHEST HEART MASSAGE—IF NEEDED, ADMINISTER IMMEDIATELY

3-8. General

If a soldier's heart stops beating, you must give him closed-chest heart massage as well as artificial respiration immediately. **SECONDS COUNT!** Stoppage of the heart is soon followed by cessation of respiration unless cessation of respiration has occurred first. Be calm! Think and act! When a soldier's heart has stopped, he has no pulse at all (para 2-1b(2)); he is unconscious and limp, and the pupils of his eyes are open wide. To determine the presence or absence of a soldier's pulse, place the tips of your fingers on his neck at the side of his windpipe as illustrated in figure 3-6. If you do not detect a pulse immediately, do not waste time checking further; start heart massage and artificial respiration at once! Furthermore, if you find the soldier's pulse to be very weak and irregular, you must give him closed-chest heart massage and artificial respiration, since these signs indicate ineffective beats of the heart and precede heart stoppage.

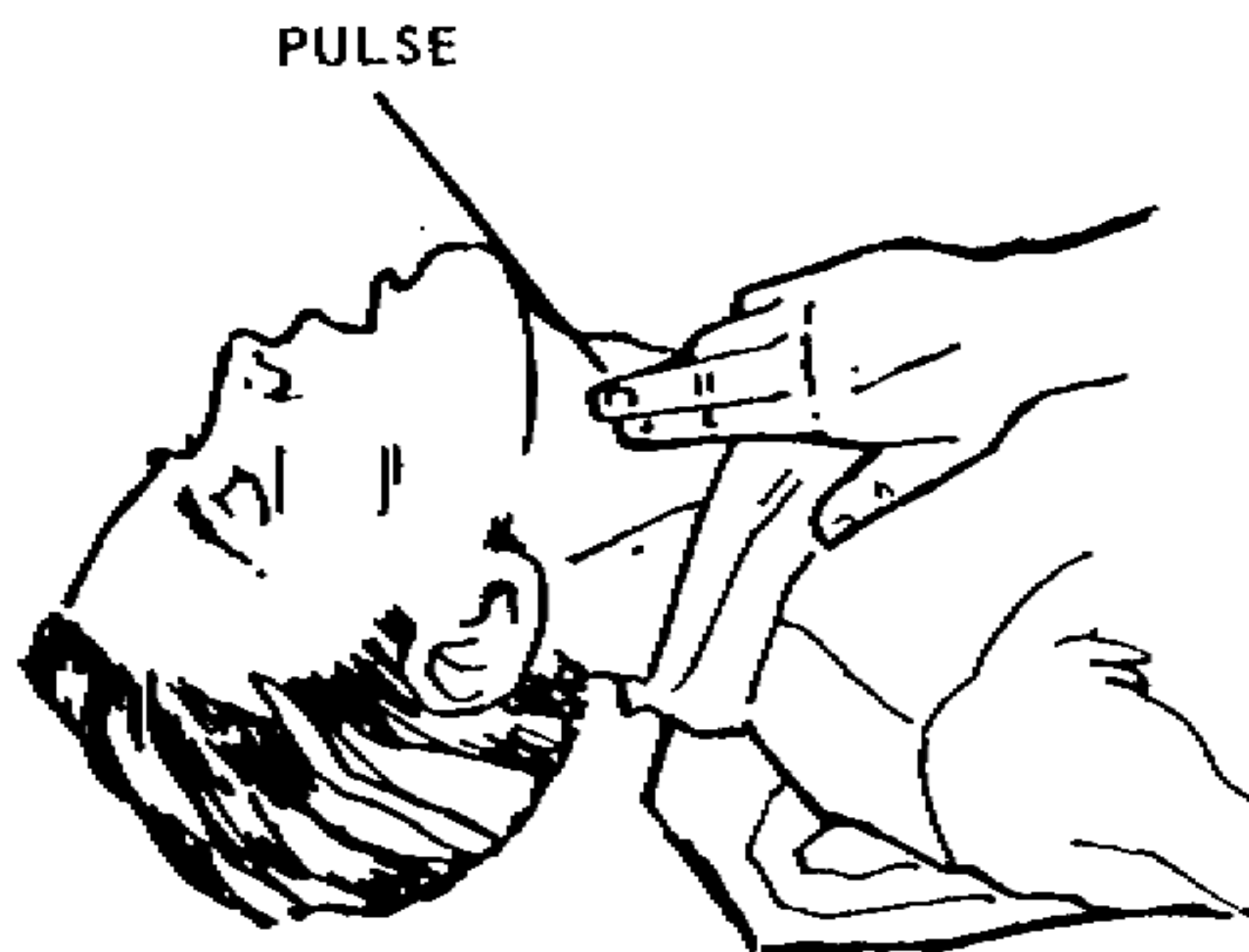

Figure 3-6. Placement of fingers to detect pulse.

3-9. General Principles of Closed-Chest Heart Massage

a. Closed-chest heart massage is the rhythmical compression of the heart without surgically opening the chest. It is designed to provide artificial circulation in order to keep blood flowing to the

brain and other organs until the heart begins to beat normally again. It is not the same as open-chest heart massage, in which the chest wall is cut open and the heart itself is compressed directly by hand.

b. The heart is located between the breastbone and the spine (fig 3-7). Pressure on the breastbone pushes the heart against the spine, thus forcing the blood out of the heart into the arteries. Release of pressure allows the heart to refill with blood.

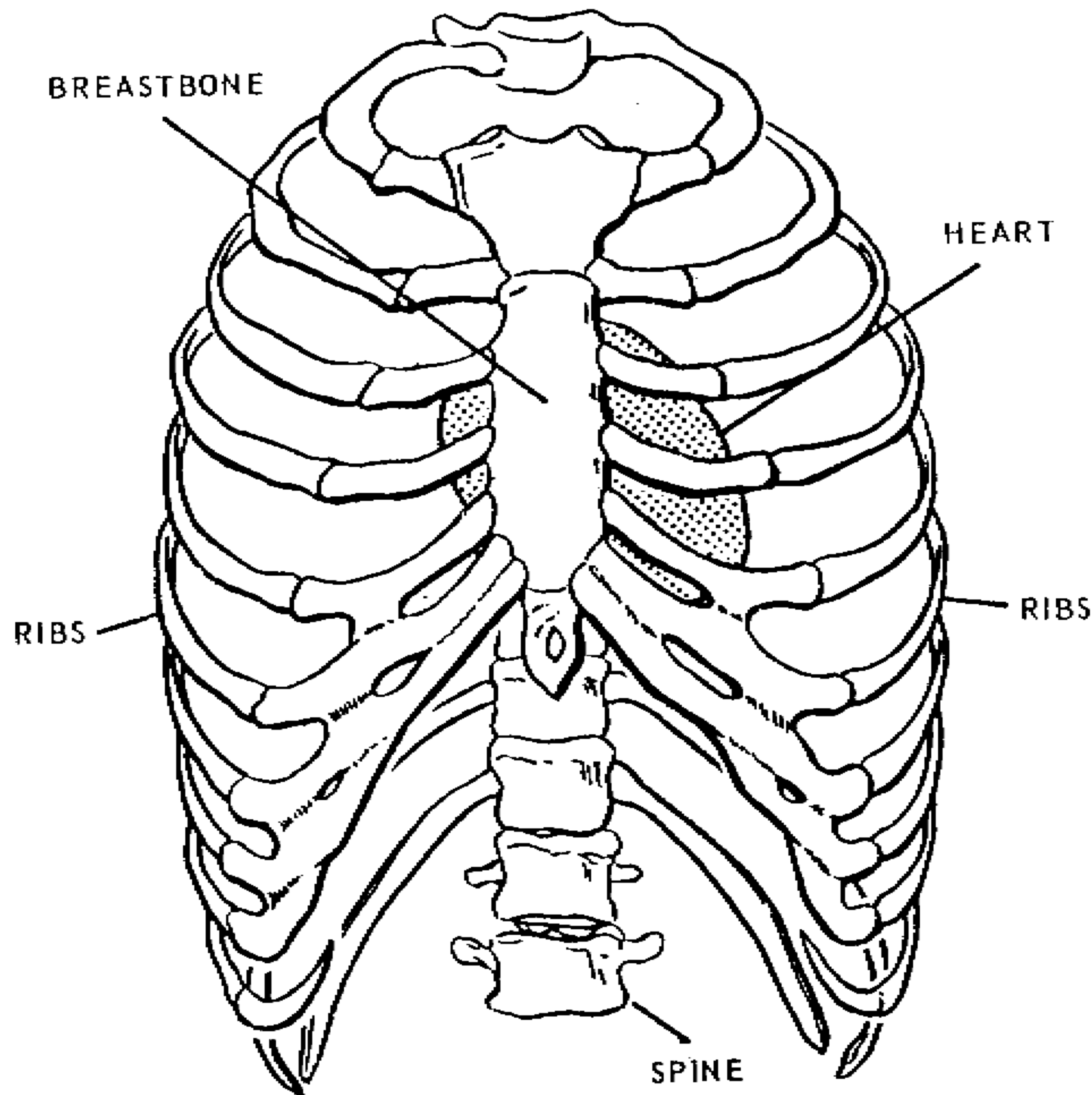

Figure 3-7. Chest cage and heart.

3-10. Preliminary Steps for Administering Closed-Chest Heart Massage

Since closed-chest heart massage always must be combined with artificial respiration, it is preferable to have two rescuers. One person positions himself at the soldier's side and performs closed-

chest heart massage while the other person positions himself on the opposite side of the soldier at his head, keeps the soldier's head tilted back, and administers artificial respiration. If you must administer these steps alone, alternate these methods as described in paragraph 3-13.

a. Prepare the soldier for the mouth-to-mouth method of artificial respiration (para 3-4). The soldier always must be in the horizontal position when closed-chest heart massage is performed, as there is no blood flow to the brain when the body is in a vertical position, even during properly performed closed-chest heart massage. The surface on which the soldier is placed **MUST BE SOLID**. The floor or the ground is adequate. A bed or couch is too flexible. Elevate the legs about 6 inches while keeping the rest of the body horizontal. This will help the return of blood to the heart.

b. Position yourself close to the soldier's side and place the heel of one hand on the lower half of the breastbone. Be careful **NOT** to place your hand on the soft tissue of the abdomen below the breastbone and rib cage. Spread and raise the fingers of your hand so that you can apply pressure to the breastbone without pressing on the ribs. Place your other hand on top of the first. (If the injured person is a child, omit placing the second hand over the first. If he is an infant, place only the fingertips of one hand on the breastbone.)

3-11. Basic Procedure

a. With your hands in the correct position, bring your shoulders directly over the soldier's breastbone, keep your arms straight, and press downward. Apply enough pressure to push the breastbone down 1½ to 2 inches (fig 3-8). Too much pressure may fracture the soldier's ribs; therefore, do **NOT** push the breastbone down more than 2 inches. (If the injured person is a child, press the breastbone lightly with only one hand. If he is an infant, press the breastbone lightly with your fingers.)

b. Release the pressure immediately (fig 3-9). The heel of the rescuer's hand should not be removed from the chest during relaxation, but pressure on the breastbone should be completely released so that it returns to its normal resting position between compressions.

3-12. Measures Applied With Two Rescuers

a. If there are two rescuers (fig 3-10), one performing artificial respiration and the other administering closed-chest heart mas-

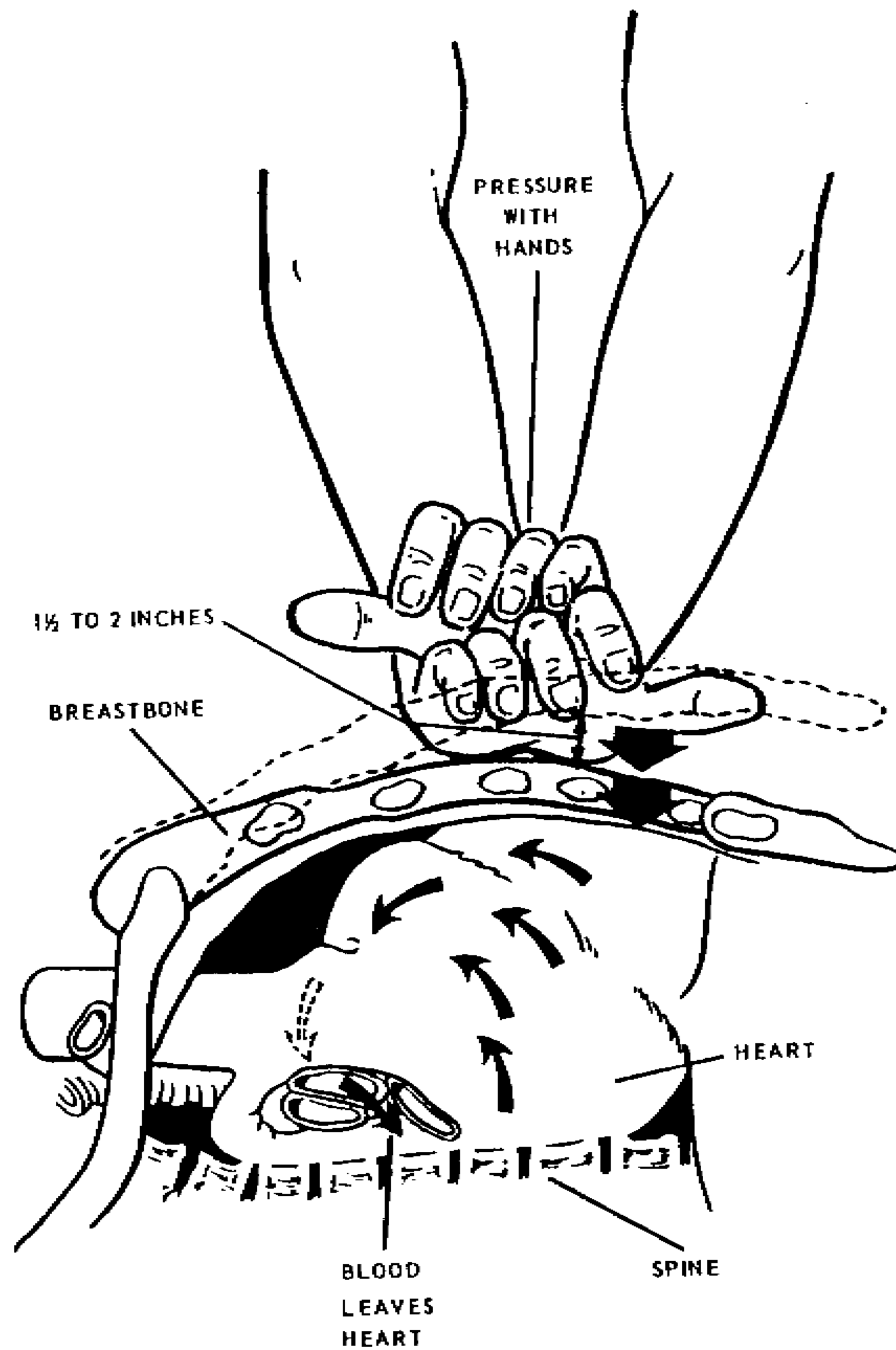

Figure 3-8. Blood forced out of the heart into the arteries by application of pressure on the breastbone.

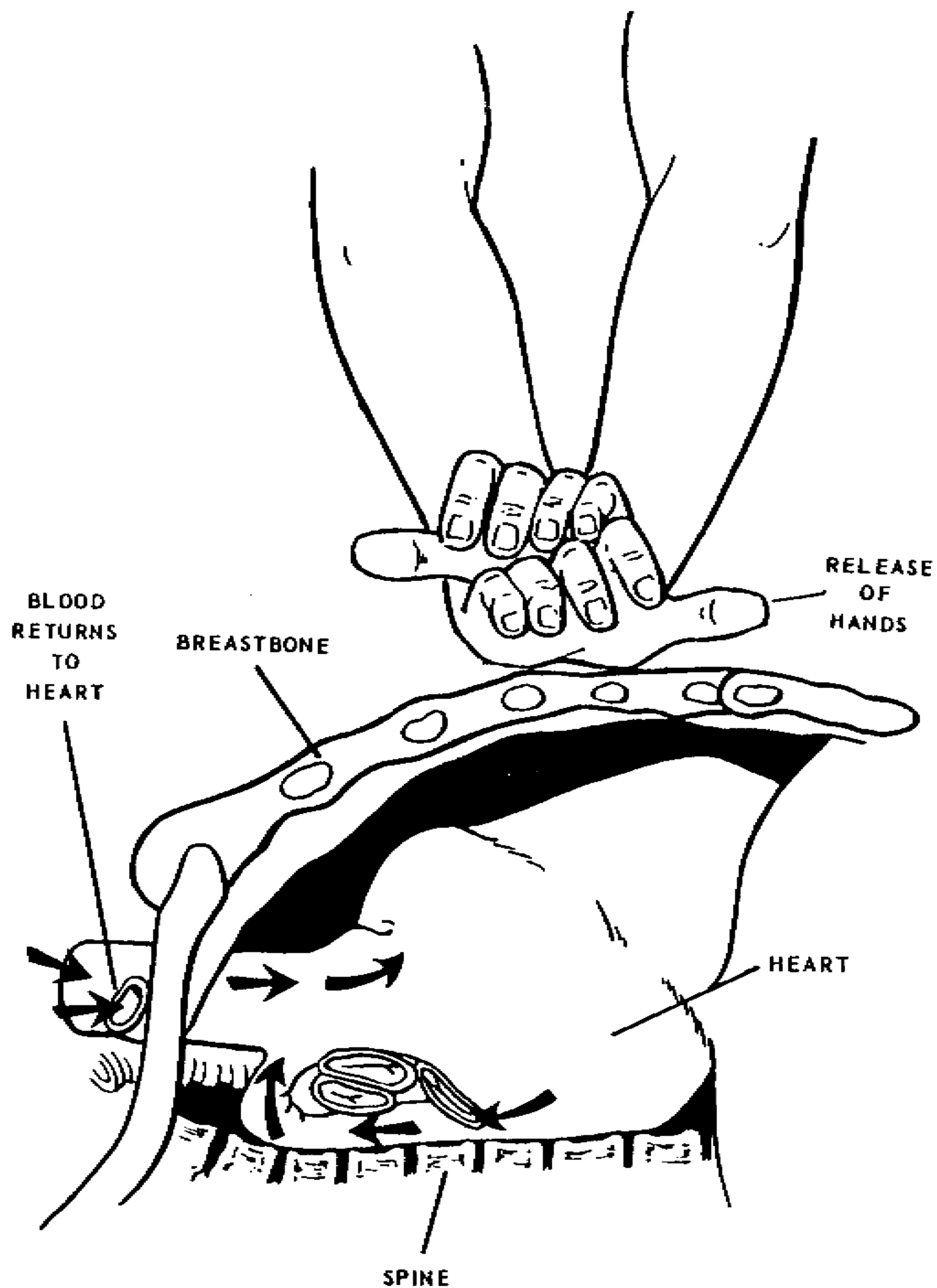

Figure 3-9. Release of pressure to allow the heart to refill with blood.

sage, the person who is administering closed-chest heart massage should compress the heart *once every second* (60 compressions per minute). At this rate he does not pause for breaths to be blown into the airway. The compressions must be uninterrupted, regular, and smooth. Relaxation must immediately follow compression and should be of equal duration. Proper timing for 60 compressions per

minute with a natural rhythm is achieved by counting aloud as follows: one 1000, one 2000, one 3000, one 4000, one 5000. Each time the rescuer says, "one," he compresses the heart; and as he says the thousand number, he releases the pressure. He repeats the same count to 5000 throughout the entire period he is administering closed-chest heart massage.

b. The member of the rescue team who is performing artificial respiration quickly blows into the soldier's lungs after each five compressions (5:1 ratio). When the other rescuer says, "5000," this is his signal to blow a deep breath into the soldier's airway. The breaths are interjected without any pauses in compression. This is **IMPORTANT**, as any interruption in heart compression results in a drop in blood flow and blood pressure to zero.

c. Two rescuers can perform closed-chest heart massage and artificial respiration best when they are on opposite sides of the soldier. They can then switch positions when one becomes fatigued without any significant interruption in the 5:1 rhythm. This is

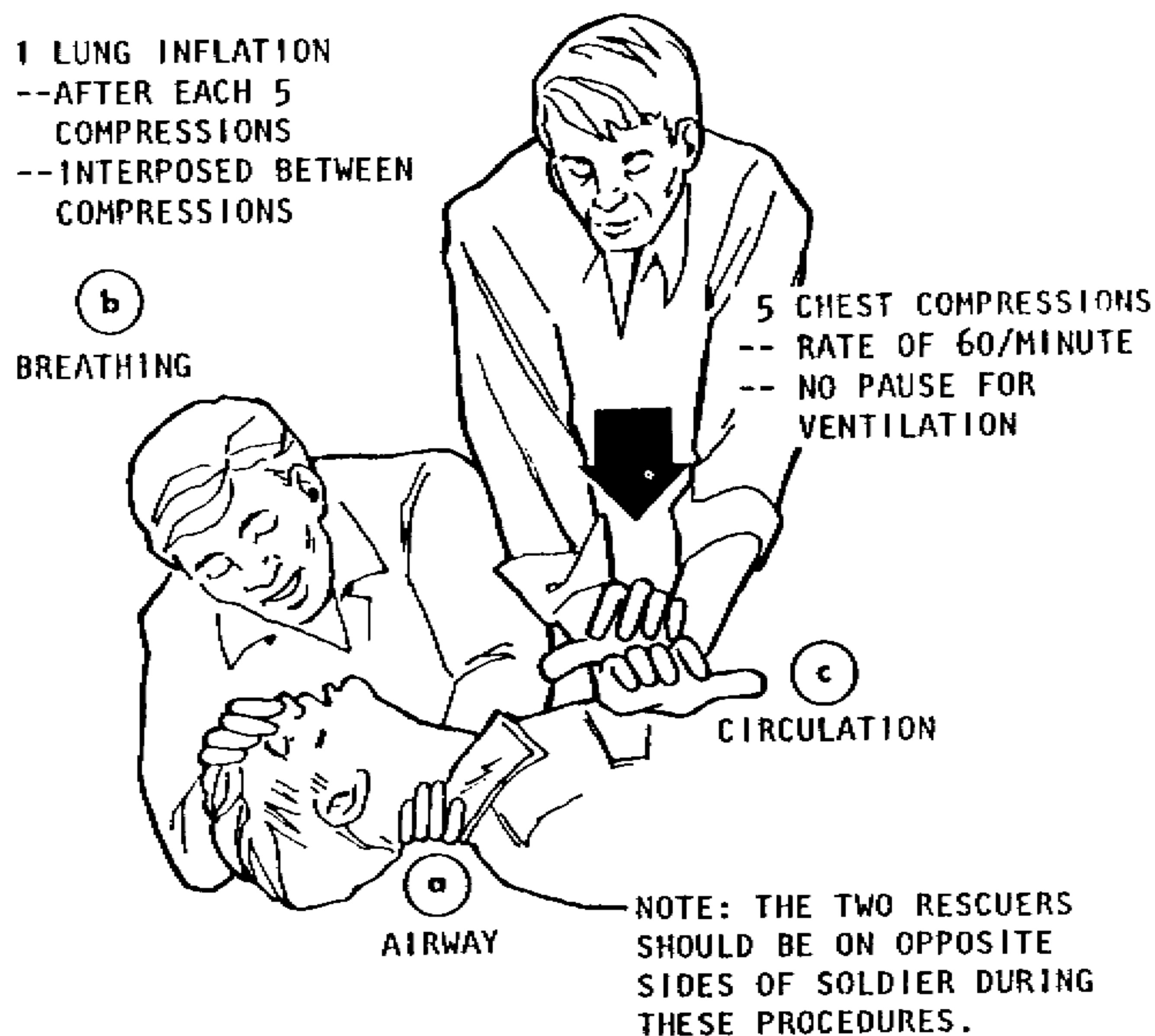

Figure 3-10. Two rescuers administering closed-chest heart massage and mouth-to-mouth artificial respiration.

accomplished by the rescuer who is performing artificial respiration moving to the side of the soldier's chest immediately after he has inflated the lungs. He places his hands in the air next to those of the other rescuer who continues to perform heart compression. As soon as the other rescuer's hands are properly placed, the rescuer initially performing heart compression removes his hands (usually after the count of 2000 or 3000 in the series of compressions), and the other rescuer then continues with the series of compressions. The rescuer who has been compressing then moves to the soldier's head and interposes the next breath on the count of 5000.

3-13. Measures Applied With One Rescuer

When there is only one rescuer (fig 3-11), he must perform both closed-chest heart massage and artificial respiration using a 15:2 ratio. This ratio consists of 15 heart compressions followed by *two very quick but full lung inflations*. To make up the time used for inflating the lungs, the rescuer must perform each series of 15 heart compressions at the faster rate of *80 compressions per minute*. This timing is achieved by counting aloud as follows: 1 and 2 and 3 and 4 and 5 and, 1 and 2 and 3 and 4 and 10 and, 1 and 2 and 3 and 4 and 15. After the count of "15," the rescuer blows two deep breaths into the soldier's airway in rapid succession (within a period of 5 to 6 seconds) without allowing full exhalation between the breaths. He repeats the same count as he continues resuscitation.

3-14. Cessation of Resuscitative Measures

Cessation of resuscitative measures must not be based upon the discomfort of the rescuer. It may be necessary to perform these lifesaving measures for a long time after the heavy effects of body discomfort and fatigue are felt. They should be continued until the victim regains consciousness, until the rescuer is relieved by a medically trained person, or for at least 45 minutes in the absence of all life signs.

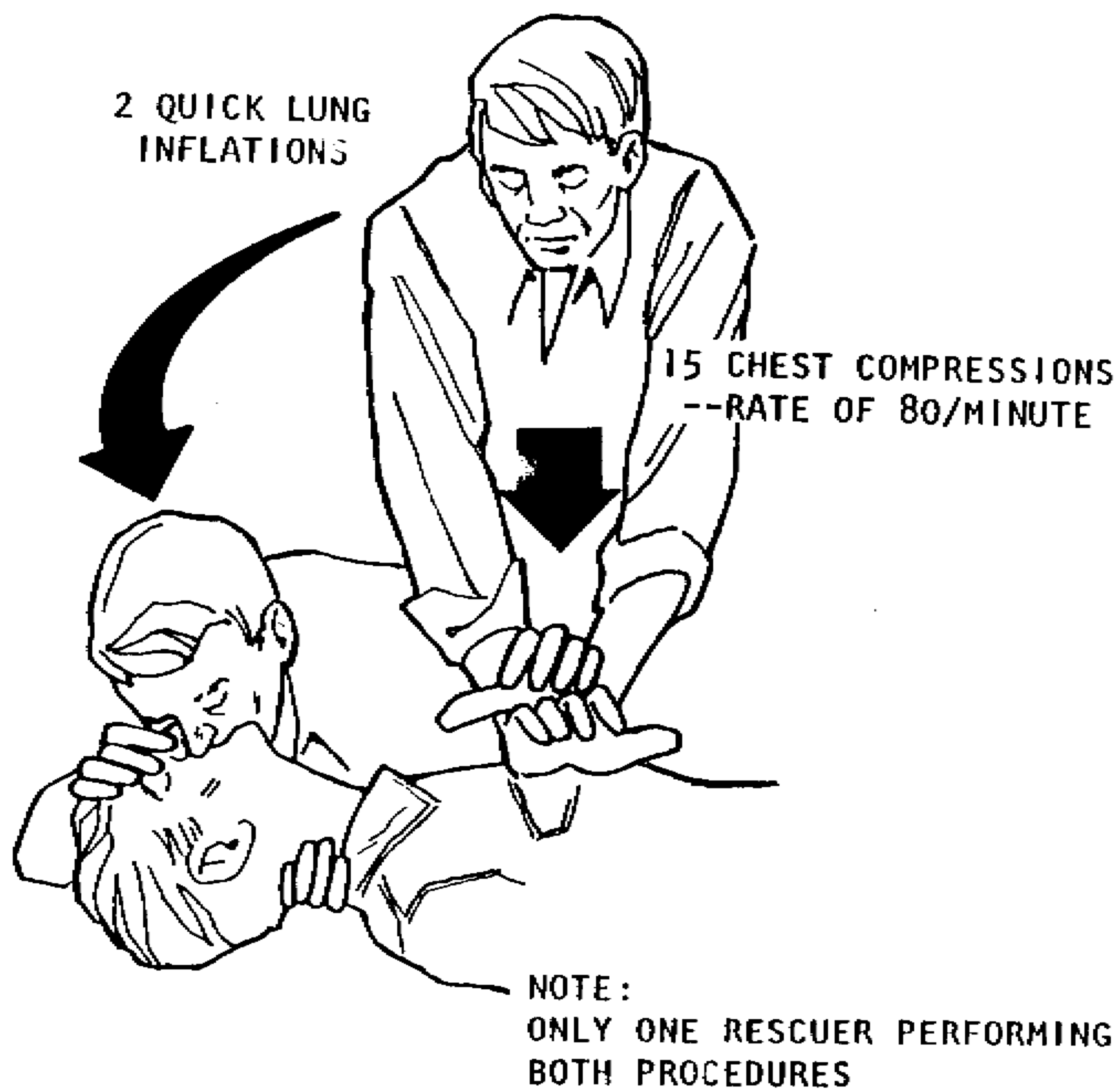

Figure 3-11. One rescuer administering closed chest heart massage and mouth-to-mouth artificial respiration.

CHAPTER 4

STOP THE BLEEDING (MEASURE B)

Section I. GENERAL

4-1. Important of Preventing Loss of Blood

The open wound is the most common condition which requires your first aid assistance. Acute loss of blood may lead to shock, and shock may lead to death; therefore, you must act immediately to prevent loss of blood.

4-2. Methods to Control Bleeding

The use of the pressure dressing is the preferred method for controlling severe bleeding. Elevation of the wounded limb and application of digital pressure should also be used, as appropriate, in conjunction with the pressure dressing. The tourniquet can be used to control bleeding from a limb. It should not be used, however, unless a pressure dressing has failed to stop the bleeding.

Section II. APPLICATION OF PRESSURE DRESSING, ELEVATION OF LIMB, AND DIGITAL PRESSURE

4-3. General

The application of a sterile dressing with pressure to a bleeding wound helps clot formation, compresses the open blood vessels, and protects the wound from further invasion of germs.

4-4. Searching for Entrance and Exit Wounds

Before applying the pressure dressing, examine the soldier to determine whether there is more than one wound. For example, a missile may have entered at one point and come out at another point. The exit wound is usually larger than the entrance wound.

4-5. Removing the Clothing

Cut the clothing and lift it away from the wound to avoid further contamination. Tearing the clothing might result in rough handling of the injured part. Do not touch the wound; keep it as clean as possible. If it is already dirty, leave it that way. Do not try to clean it in any way.

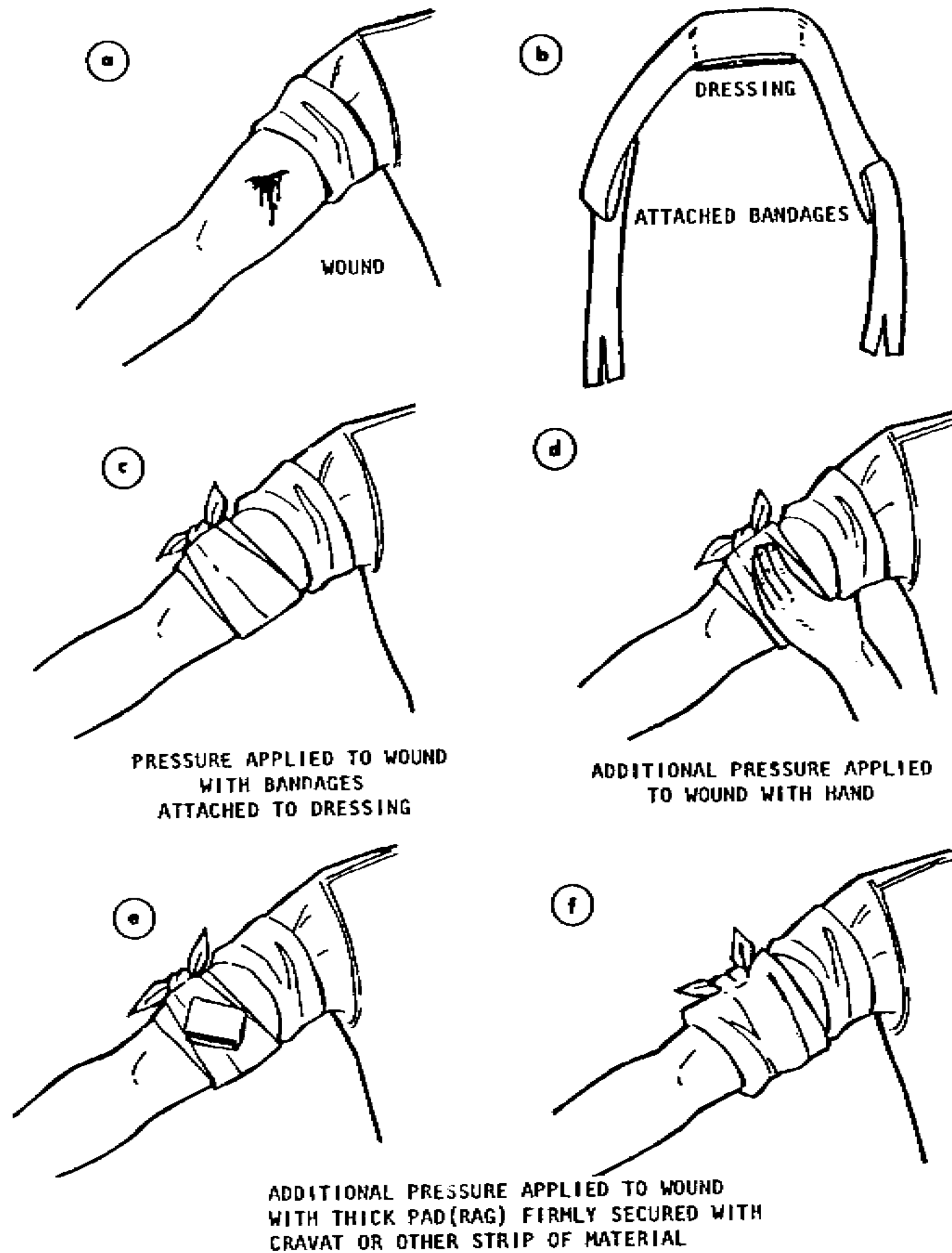

Figure 4-1. Application of Pressure dressing.

4-6. Covering the Wound and Applying Pressure

a. Cover the wound with a field first aid dressing (individual) and apply pressure to the wound by using the bandage strips attached to the dressing (a, b, c, fig 4-1).

b. If additional pressure is required to stop the bleeding, place your hand over the dressing and press hard (d, fig 4-1). Pressure from your hand may be required for 5 to 10 minutes to allow the clot to form. The clot must be strong enough to hold with the help of only the dressing and bandage strips when your hand is removed. Additional pressure can also be applied by placing a thick pad on top of the original dressing at the site of the wound and firmly securing this pad with a cravat or strip of material (e and f, fig 4-1). Do not remove any dressings or bandages once they are placed over the wound. Apply any additional dressings over the ones in place. Removing a dressing may dislodge clots which are partially formed.

4-7. Elevating the Limb

Frequently, bleeding can be lessened by raising the injured part above the level of the heart; however, direct pressure must be continued. Elevation must not be used if there is a broken bone in the injured part. Moving an unsplinted fracture causes pain, can increase shock, and may further damage nerves, muscles, and blood vessels.

4-8. Applying Digital Pressure

If blood is spurting from the wound (arterial bleeding), digital pressure can be used to control the bleeding until a pressure dressing can be unwrapped and applied. Digital pressure is applied to a pressure point with the fingers, the thumbs, or the hands. A pressure point is the site at which a main artery supplying the wounded area lies near the skin surface or over a bone. By passing at this point, the flow of blood from the heart to the wound is shut off or at least slowed down (fig 4-2). You will have properly located a pressure point when you can feel the pulse at this point. You must feel the pulse before applying the digital pressure.

Section III. APPLICATION OF TOURNIQUET

4-9. General

A tourniquet is a constricting band placed around an arm or leg to stop severe bleeding.

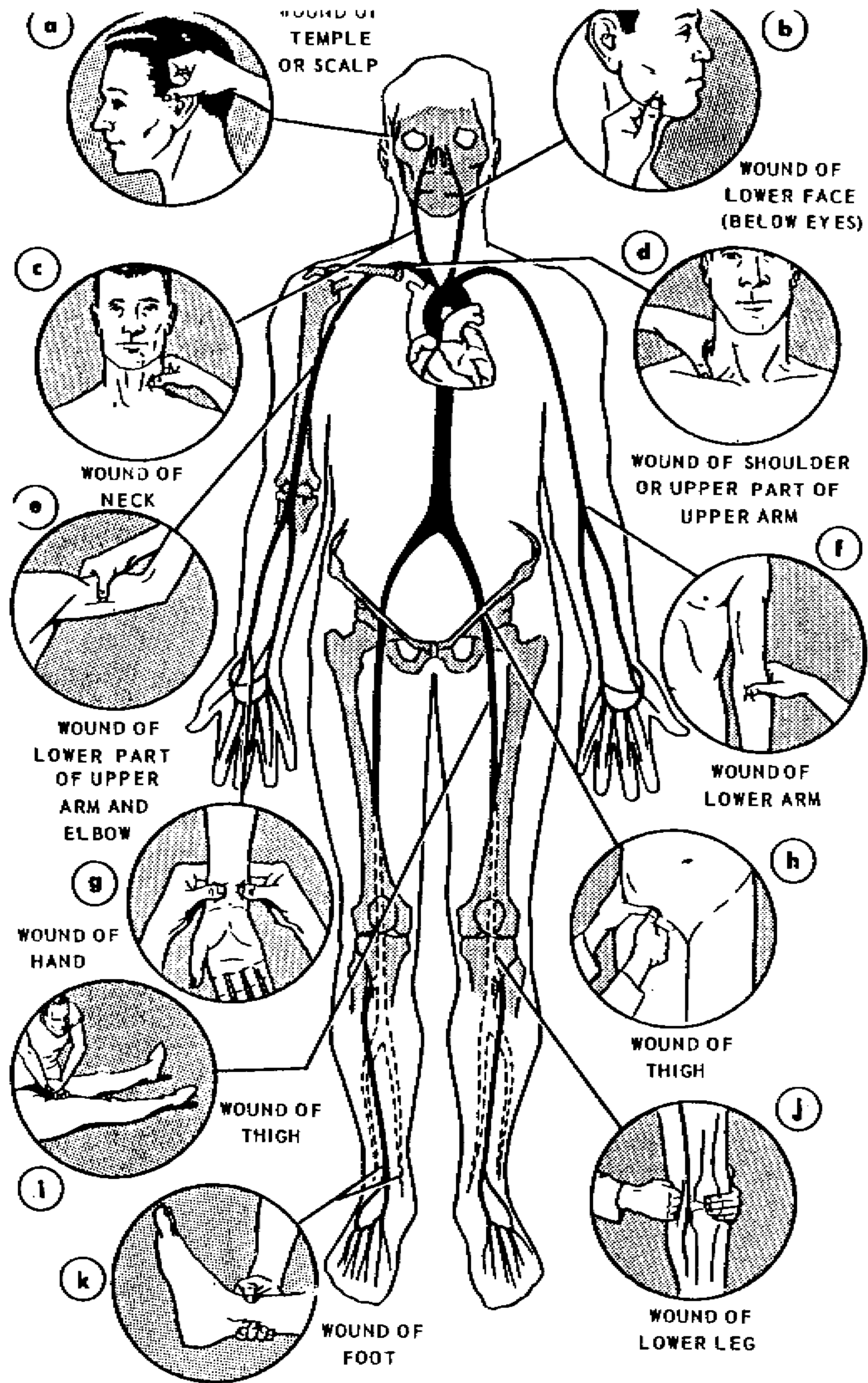

Figure 4-2. Pressure points in the circulatory system for temporary control of arterial bleeding.

a. The tourniquet should be used *only* when pressure over the wound area, pressure over the appropriate pressure point, and elevation of the wounded part (if it is possible) fail to control the bleeding. Its use will rarely be necessary and should be avoided if possible. Use of a tourniquet has on occasion been associated with injury to blood vessels and nerves. If it is left on too long, it can cause loss of an arm or leg.

b. Bleeding from a major artery of the thigh, lower leg, or upper arm or bleeding from multiple arteries, which occurs in a traumatic amputation, may prove to be beyond control by pressure. If the first aid dressing under hard hand pressure becomes soaked with blood and the wound continues to bleed, you should apply a tourniquet.

c. Once a tourniquet has been applied, it must stay in place; and the soldier must be taken to the nearest medical treatment facility as soon as possible.

d. Do not loosen a tourniquet after it has been applied and has stopped the bleeding. Shock and blood loss can result in death.

4-10. The Improvised Tourniquet

In the absence of a specially designed tourniquet, a tourniquet may be made from strong, soft, pliable material such as gauze or muslin bandage, clothing, or kerchiefs. An improvised tourniquet is used with a rigid stick-like object (fig 4-3). To minimize skin damage, insure that the improvised tourniquet is sufficiently wide to remain at least 1 inch in width after tightening.

4-11. Placing the Improvised Tourniquet

a. Place the tourniquet around the limb and between the wound and the body trunk (or between the wound and the heart) (fig 4-3). Place the tourniquet 2 to 4 inches above the injury. Never place it directly over a wound or fracture.

b. When possible, place the tourniquet over the smoothed sleeve or trouser leg to prevent the skin from being pinched or twisted (fig 4-3). Damaging the skin may deprive the surgeon of skin required to cover the amputation, thus forcing amputation of more of the limb than might otherwise be necessary. Protection of the skin reduces the pain.

4-12. Tightening the Tourniquet

a. Tighten the tourniquet as illustrated in figure 4-3. Tighten it only enough to stop blood from passing under it. If a pulse can be

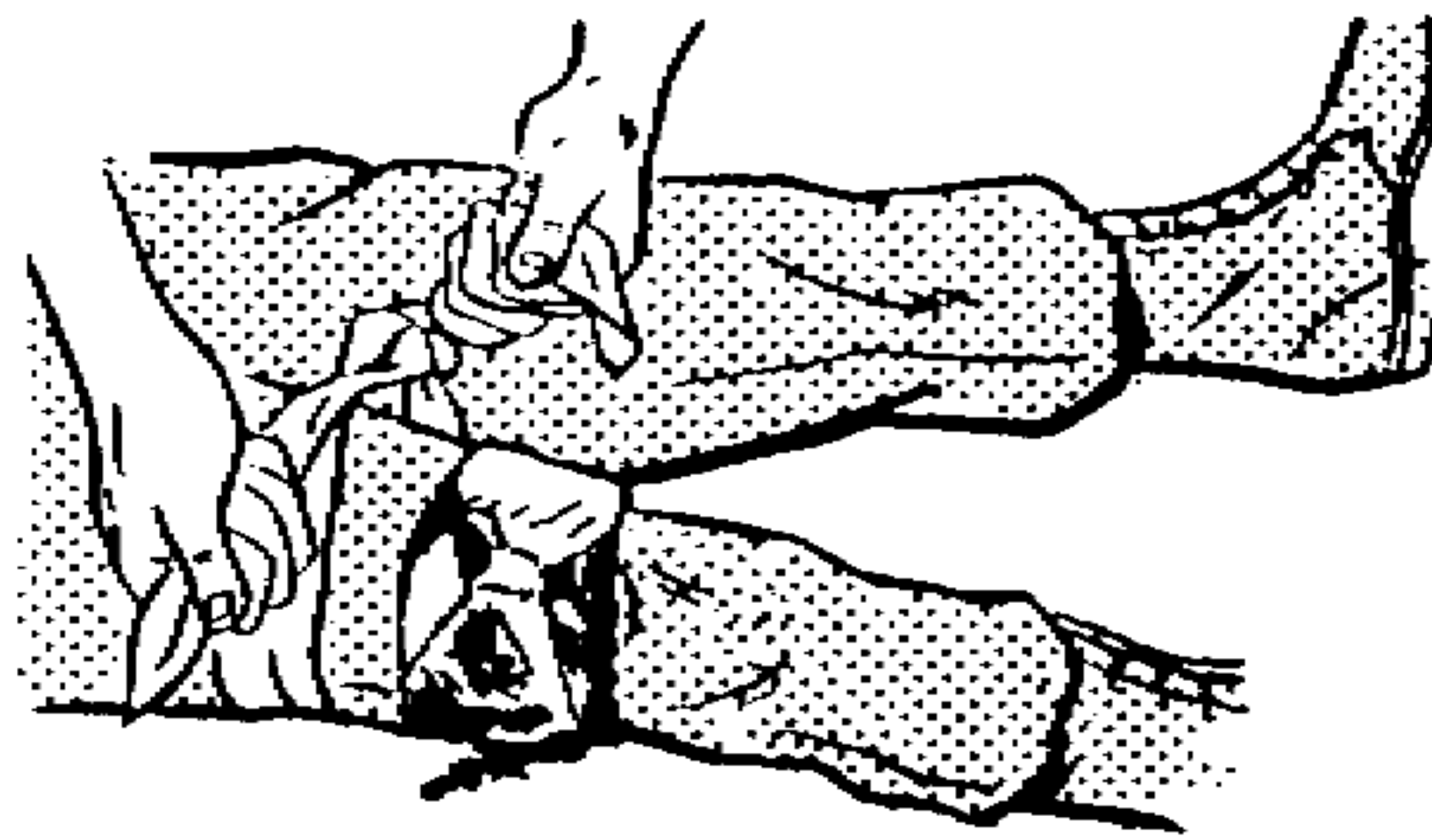

a

MAKE A LOOP
AROUND THE LIMB;
TIE WITH SQUARE
KNOT.



SQUARE KNOT

b

PASS A STICK,
SCABBARD, OR
BAYONET UNDER
THE LOOP.

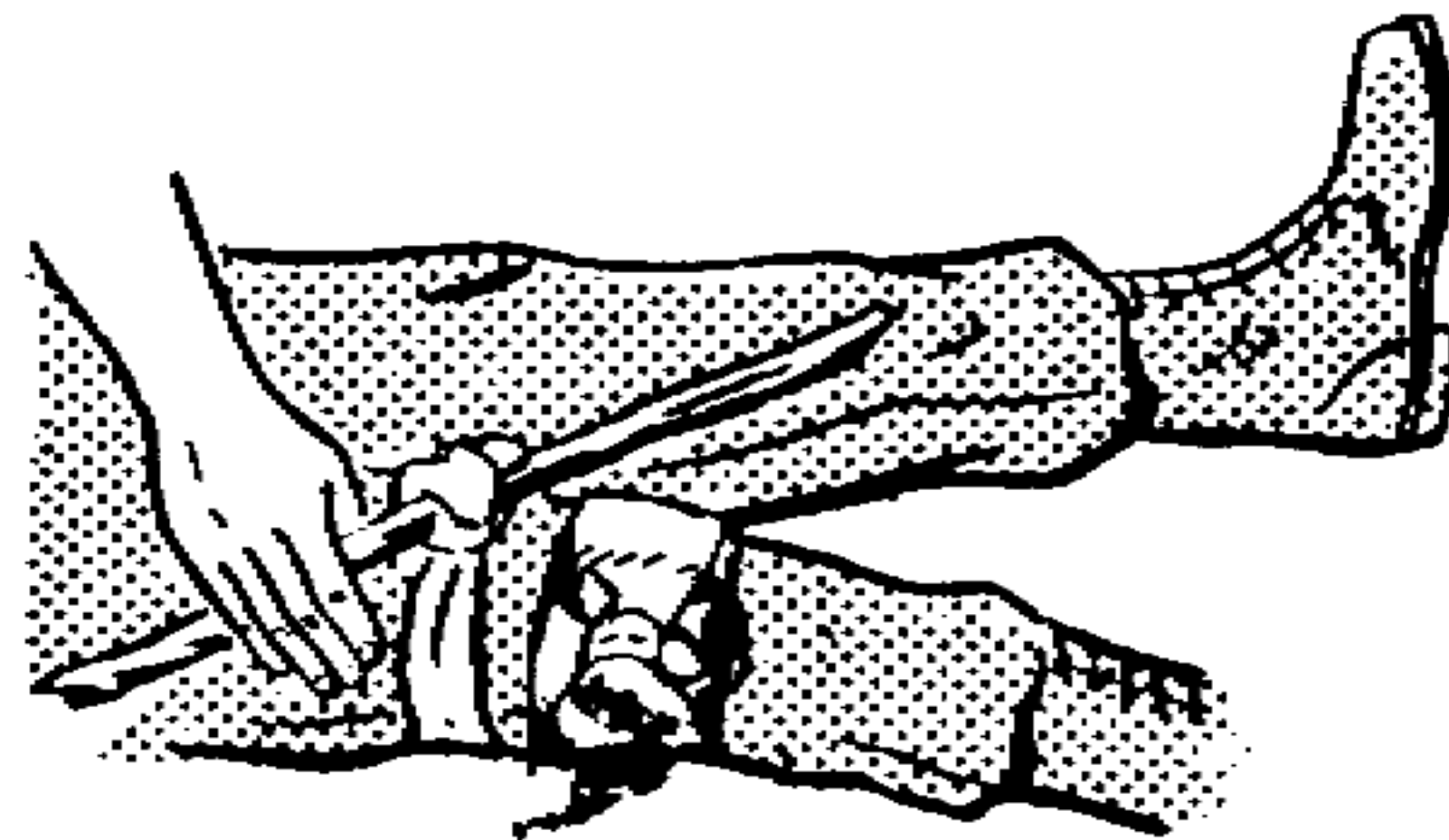
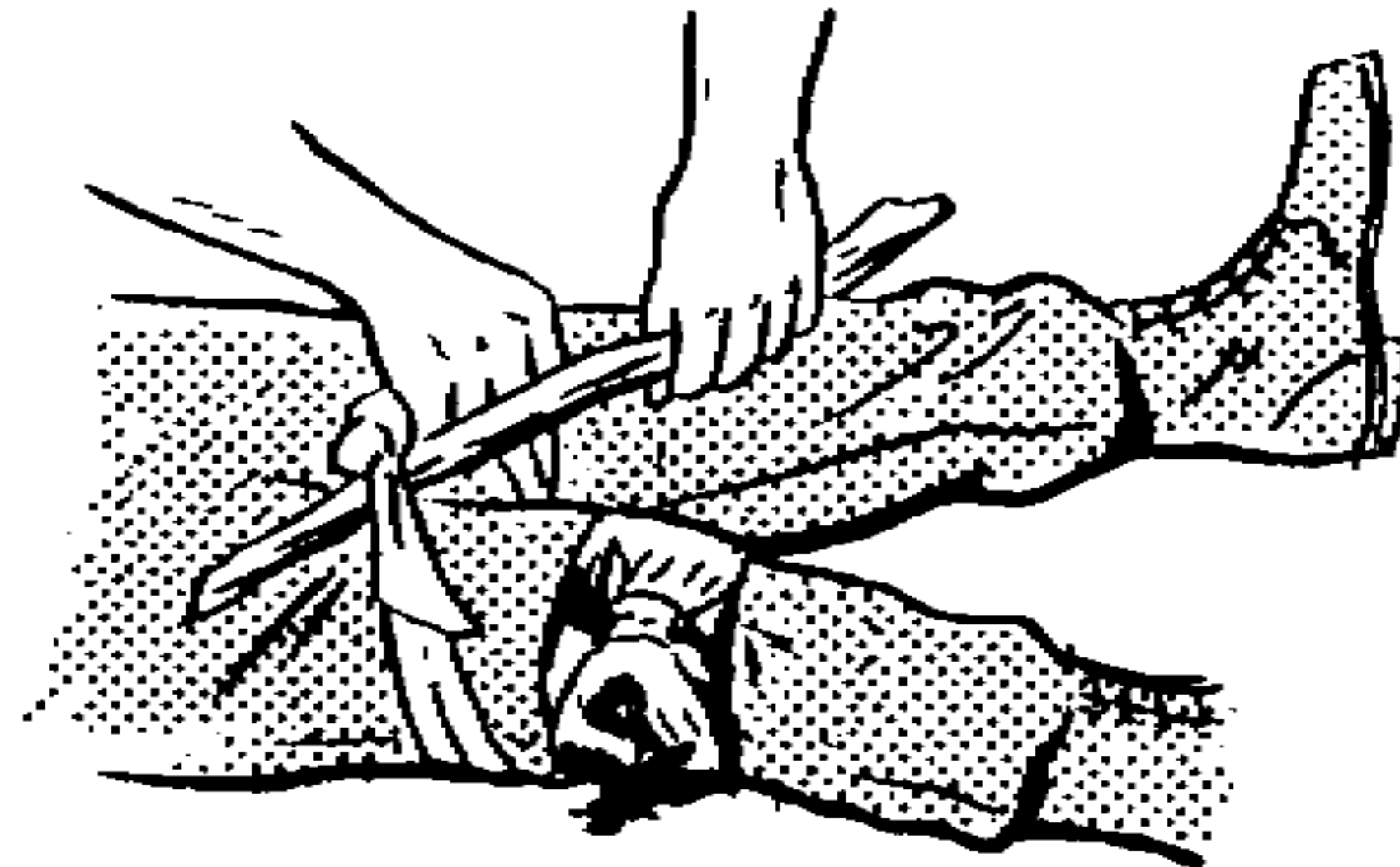

c

TIGHTEN TOURNIQUET
JUST ENOUGH TO
STOP ARTERIAL
BLEEDING.

d

BIND FREE END
OF STICK TO
LIMB TO KEEP
TOURNIQUET
FROM UNWINDING.

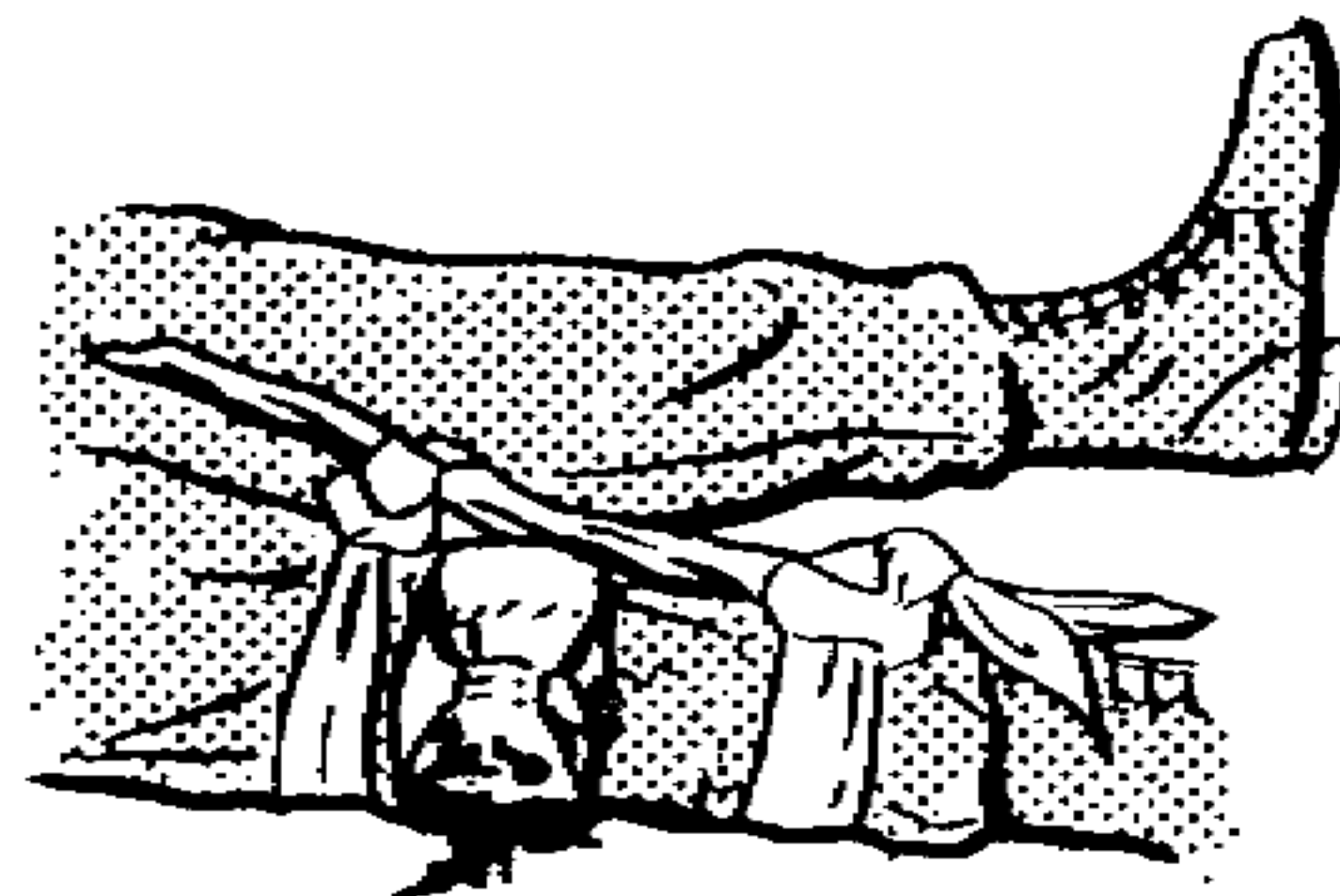

Figure 4-3. Application of an improvised tourniquet to stop bleeding.

felt in the intact wrist or foot of the affected limb before the tourniquet is applied, stoppage of this pulse can be used as the indicator that tourniquet pressure is sufficient.

b. To detect a pulse, place two fingers (not the thumb) over the pressure point in the wrist or ankle (fig 4-2). Do not use your thumb because the small arteries in your thumb may cause a false pulse reading. If such a pulse cannot be used as an indicator, you must rely upon your judgment of reduction of blood flow from the wound. In this case, uncover the wound temporarily to observe the blood flow.

c. After a tourniquet is properly tightened, arterial (spurting) bleeding will immediately cease; but bleeding from veins (para 2-1b) in the lower part of the limb will continue until the vessels are drained of the blood already in them. *Do not* continue to tighten the tourniquet in an attempt to stop this drainage.

4-13. Dressing the Wound

After the tourniquet has been secured in place, dress and bandage the wound (para 6-5).

4-14. Marking the Soldier

If the condition of the soldier or the weather makes it necessary to cover the soldier, leave the tourniquet exposed so that it can be readily seen. If possible, mark him with a T on his forehead and indicate the time that the tourniquet was applied. Once a tourniquet has been applied, it must *not* be loosened by anyone except medical personnel.

CHAPTER 5

PREVENT SHOCK (MEASURE C)

5-1. General

a. Shock may result from any type of injury. The more severe the injury, the more likely shock is to develop.

b. The early signs of shock are restlessness, thirst, pale skin, and a rapid heartbeat. A soldier in shock may be excited or he may be calm and appear very tired. He may be sweating even though his skin feels cool and clammy. As shock becomes worse, he breathes in small fast breaths or gasps even when his airway is clear. He may stare vacantly into space. His skin may have a blotchy or bluish appearance, especially around the lips and mouth.

c. Your objective is to administer first aid measures which will prevent shock from developing or getting worse, such as elevating the soldier's feet, loosening his clothing, and placing covers over and under him to prevent chilling (fig 5-1). All of the shock control measures described in the following paragraphs help to prevent or control shock.

5-2. Maintain Adequate Respiration and Heartbeat

To maintain adequate respiration and heartbeat, you may need to do nothing more than clear the upper airway (para 3-4d(2)), position the soldier to insure adequate drainage of any fluid obstructing his airway, and observe him to insure that his airway remains unobstructed. You may need to administer artificial respiration and closed-chest heart massage (chap 3).

5-3. Stop the Bleeding

Control bleeding by application of pressure dressing, by elevation of the part, and by use of pressure points as appropriate (para 4-3-4-8). Apply tourniquet if necessary (para 4-9-4-14).

5-4. Loosen Constrictive Clothing

Loosen clothing at the neck and waist and at other areas in which the clothing tends to bind the soldier (b, fig 5-1). Loosen but do not remove boots or footgear.

5-5. Reassure the Soldier

Take charge. Show by your calm self-confidence and gentle yet firm actions that you know what you are doing and that you expect him to feel better because you are helping him. Be attentive; initiate conversation only to give instructions or warnings or to obtain necessary information. If the soldier asks questions regarding the seriousness of his injury, explain that a physician will have to examine him in order to determine the extent of injury. Remember, ill-timed or erroneous information can increase the soldier's anxiety.

5-6. Splint Fractures

If the soldier has a fracture, splint the part (chap 8).

5-7. Position the Soldier

The position in which a soldier should be placed varies, depending upon the type of wound or injury and whether he is conscious or unconscious. Unless he has an injury for which a special position is prescribed (chap 7 and 8), gently place him on a blanket or a other suitable protective item (para 5-8) in one of the following positions:

a. If he is conscious, place him on his back on a level surface with his lower extremities elevated 6 to 8 inches to increase the flow of blood to his heart (a, fig 5-1). This may be accomplished by placing his pack or another suitable object under his feet. If he is placed on a litter, elevate the foot of the litter. Remember however, do not move a soldier who has a fracture until it has been properly splinted.

b. If the soldier is unconscious, place him on his side or on his abdomen with his head turned to one side to prevent his choking on vomitus, blood, or other fluid (c, fig 5-1).

c. The soldier with a head injury should be lying so that his head is in a position higher than his body.

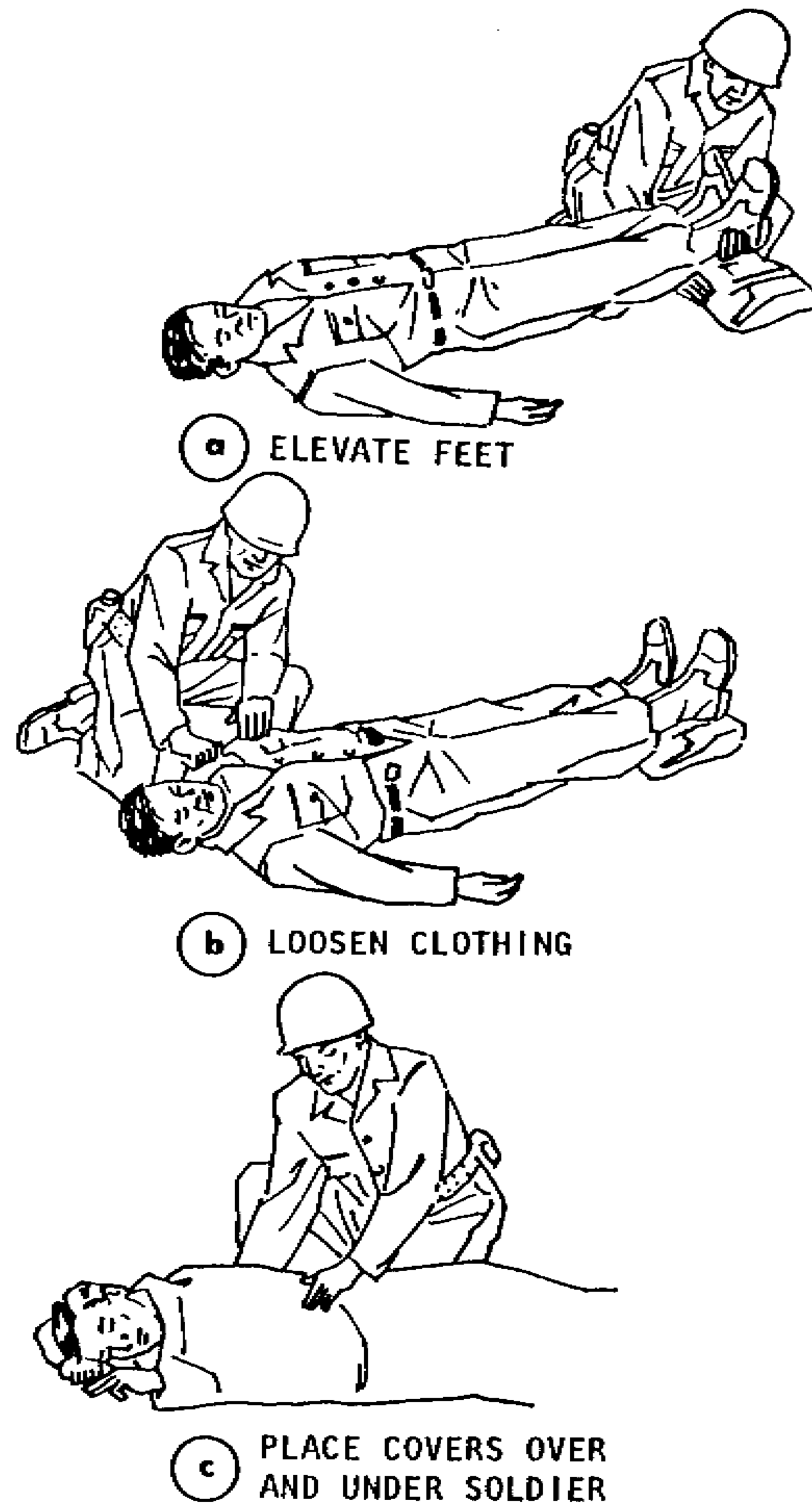

Figure 5-1. Administering first aid to conscious or unconscious soldier to prevent shock.

5-8. Keep the Soldier Comfortably Warm

Do not overheat the soldier. If possible place a blanket, a poncho, a shelter half, or other suitable material under him. He may or may not need a blanket over him, depending upon the weather. If the weather permits, remove any wet clothing except boots or footgear before covering him.

CHAPTER 6

DRESS AND BANDAGE THE WOUND TO AVOID INFECTION (MEASURE D)

Section I. GENERAL

6-1. Importance of Protecting the Wound from Further Infection

All wounds are considered to be contaminated, since infection producing germs are always present on the skin, on the clothing, and in the air. Furthermore, any missile or instrument causing the wound pushes or carries germs into it. Infection results from the multiplication and growth of the germs which invade the wound or a break in the skin. The fact that a wound is contaminated, however, does not lessen the importance of protecting it from further contamination. The fewer the germs which invade a wound, the less possibility there is of infection and the greater are the soldier's chances for recovery. You must, therefore, dress and bandage a wound as soon as possible to protect it from further contamination, as well as to stop the bleeding.

6-2. Dressings

Dressings are sterile pads or sterile compresses used to cover wounds. They are usually made of gauze or cotton wrapped in gauze.

6-3. Bandages

A bandage may be made of gauze or muslin. It is used over a dressing to secure it in place, to close off its edges from dirt and germs, and to create pressure on the wound for control of bleeding. It is also used to support an injured part or to secure a splint to an injured part.

Section II. DRESSINGS

6-4. Types of Dressings

In the field the most widely used dressing is the field first aid dressing with attached bandages (fig 1-1). Other dressings available under certain conditions are gauze compresses of various sizes and small sterile compresses on adhesive strips (fig 6-1). For availability of these compresses, see appendix B.

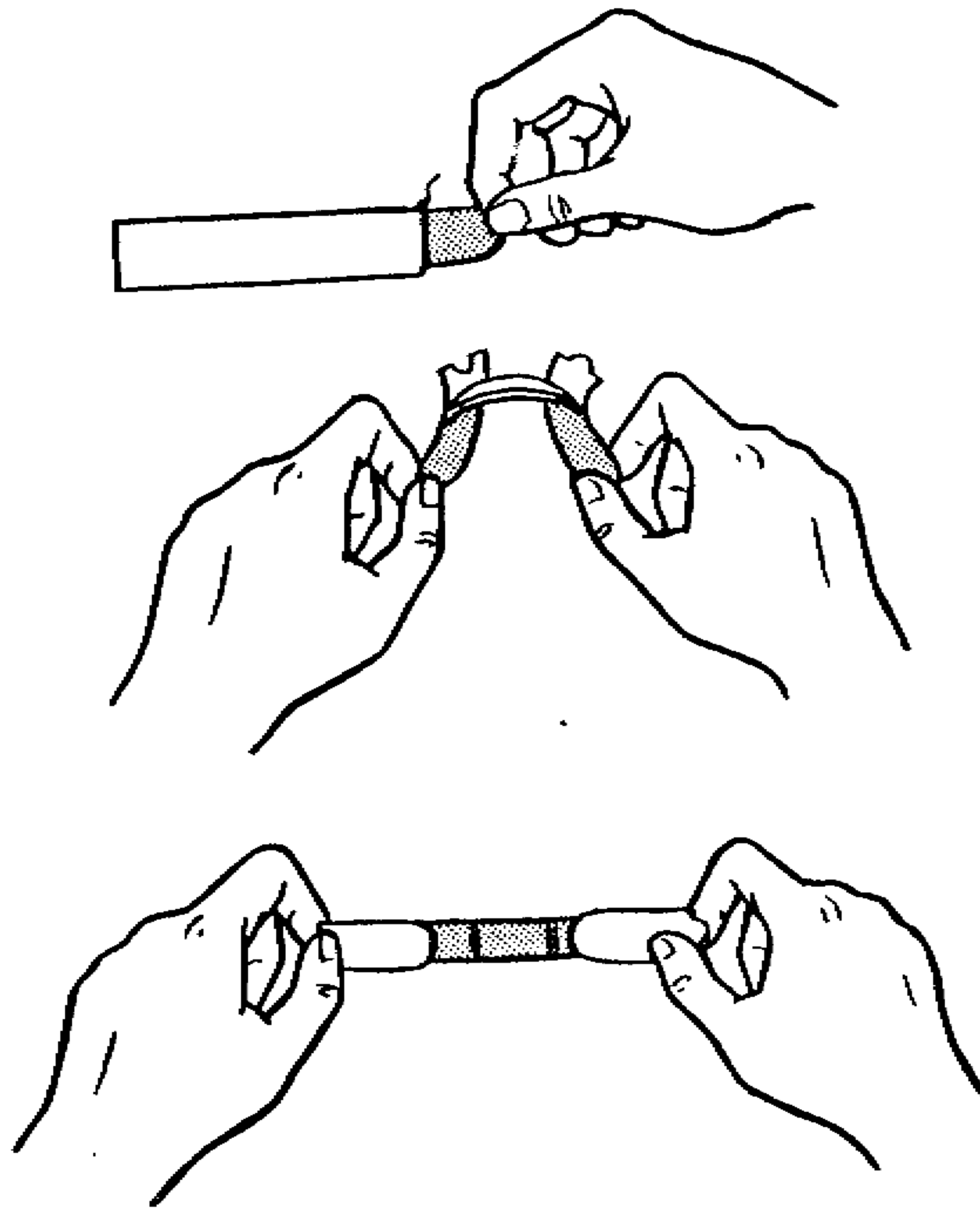
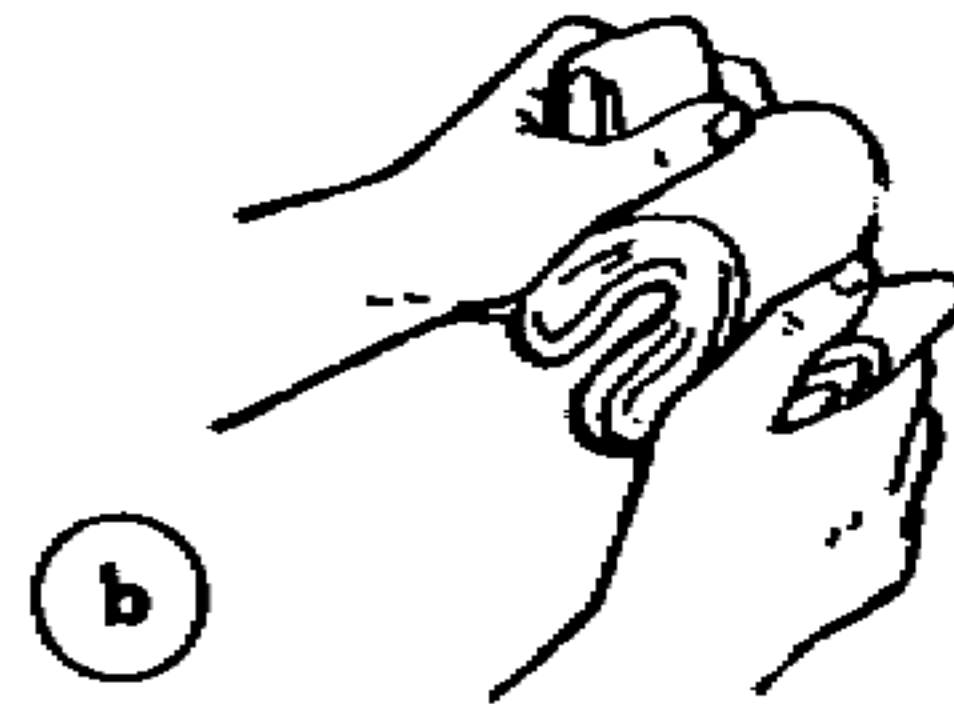

Figure 6-1. Method of removing sterile compress (adhesive strip) from wrapper to avoid touching compress.



a REMOVE WRAPPED DRESSING (WITH ATTACHED BANDAGES) FROM PLASTIC ENVELOPE; THEN TWIST TO BREAK PAPER WRAPPER.



b GRASP FOLDED BANDAGES WITH HANDS, BEING CAREFUL NOT TO TOUCH SIDE OF DRESSING WHICH GOES NEXT TO WOUND.

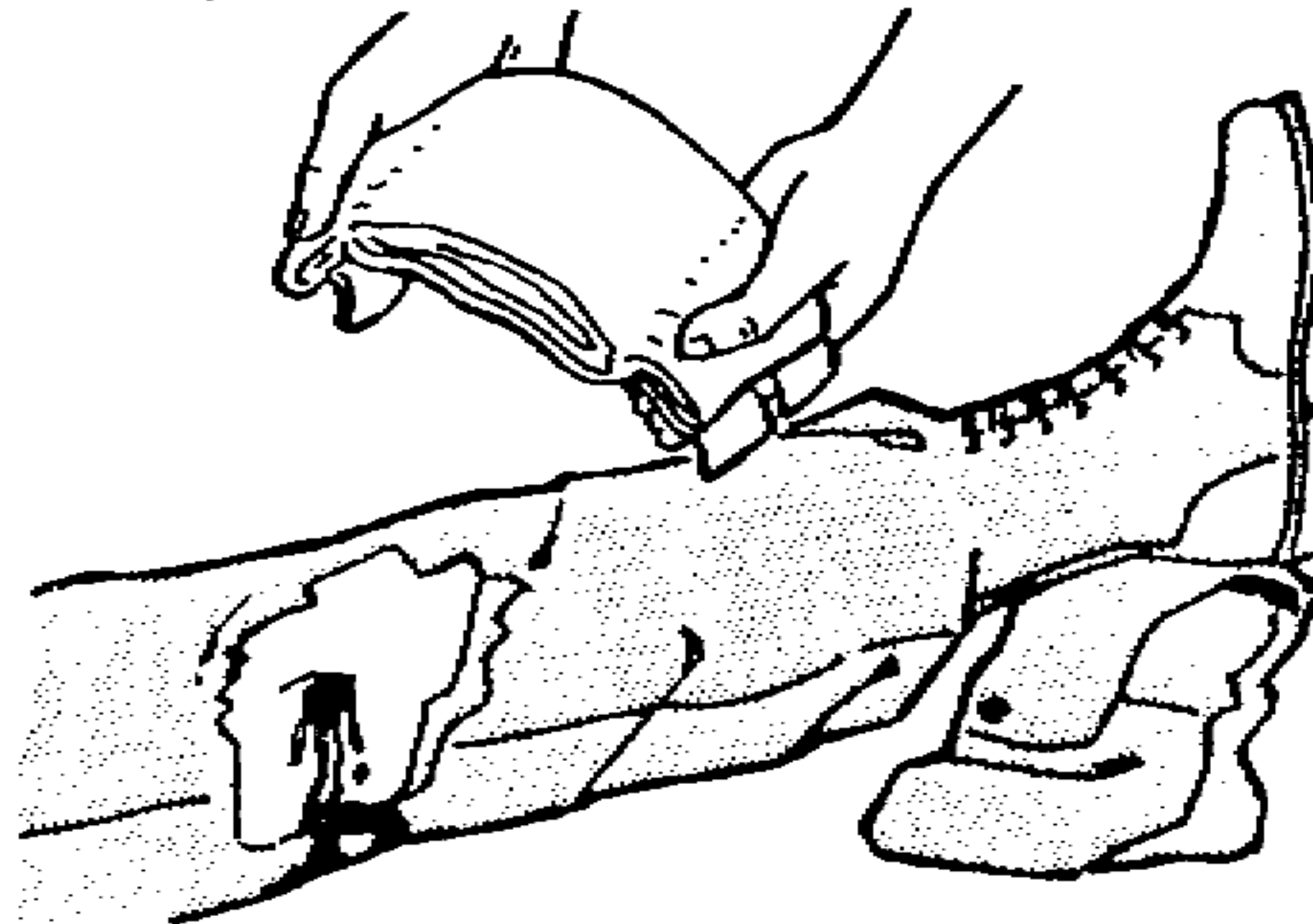

c CONTINUING TO HOLD FOLDED BANDAGES, PULL DRESSING OPEN.

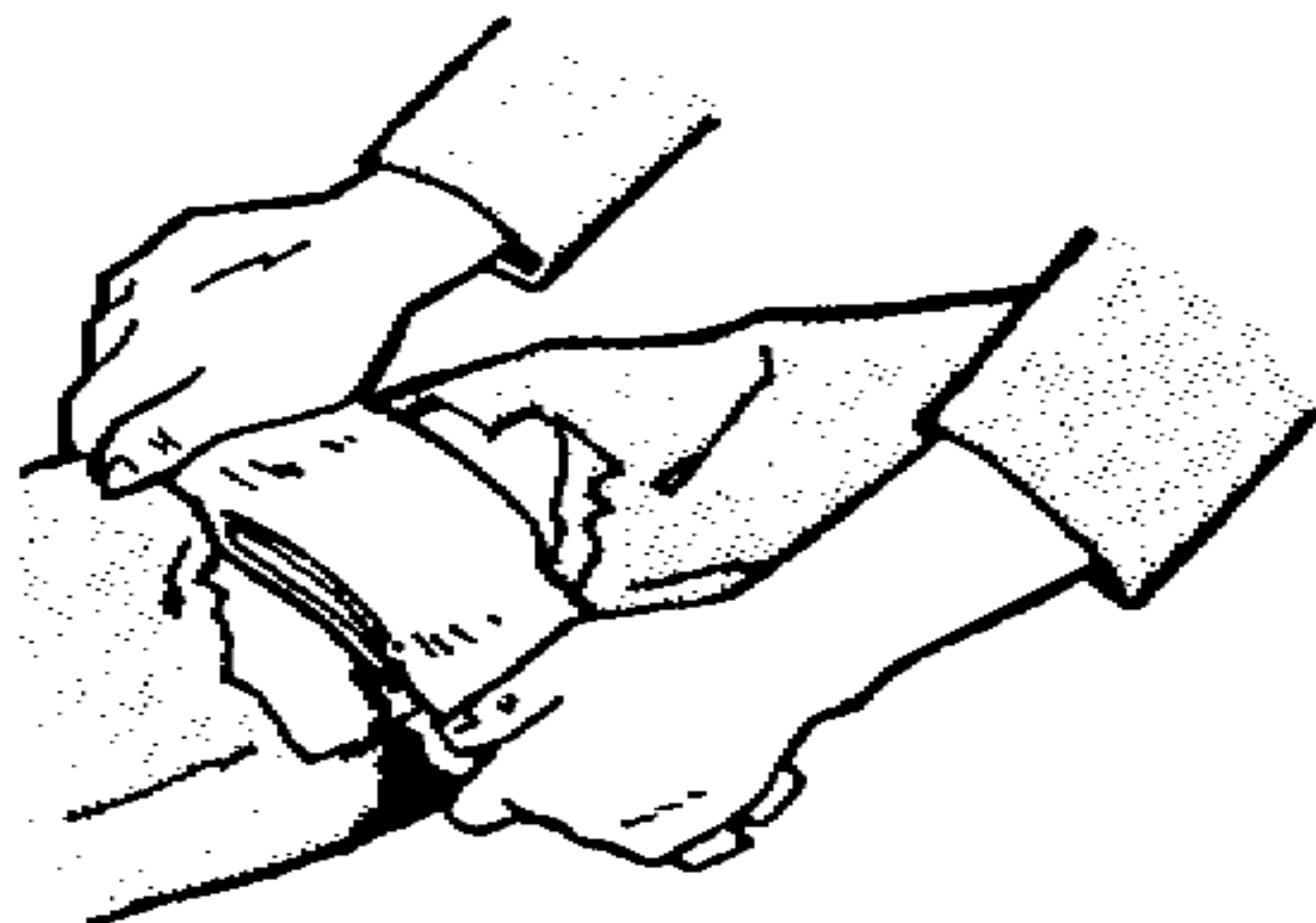

d PLACE DRESSING ON WOUND WITHOUT ALLOWING IT TO TOUCH ANYTHING ELSE.



e WRAP BANDAGES AROUND THE PART AND TIE THE ENDS SECURELY.

Figure 6-2. Application of field first aid dressing.

6-5. Application of Dressings

- a.* Cut the clothing and lift it away from the wound to avoid further contamination.
- b.* Remove the dressing from its wrapper and place it directly over the wound without letting it touch anything else (fig 6-2).

Section III. BASIC TYPES OF BANDAGES

6-6. General

A bandage must be applied firmly with the ends secured in place to prevent the bandage and dressing from slipping. It must not be applied so tightly that it stops circulation. If a knot is necessary for securing a bandage, the square knot (fig 4-3) must be used, since it will not slip.

6-7. Tailed Bandages

Tailed bandages may be attached to the dressing as they are in the field first aid dressing (fig 6-2). The two tails are split 4 to 6 inches from the loose ends; they may be split farther as required to bandage a particular part of the body. Tail bandages may also be made by splitting a strip of gauze (4 by 36 inches) from each end, leaving the center part intact to cover the dressing, which has been placed over the injured part.

6-8. Triangular and Cravat Bandages

a. Triangular and cravat bandages (fig 6-3) are made from the triangular piece of muslin (37 by 37 by 52 inches) provided in the general purpose first aid kit (app B). If this bandage is applied without folding it, it is called a triangular bandage. If it is folded into a strip, it is called a cravat bandage. Two safety pins are packed with each bandage.

b. These bandages are valuable in an emergency, since they are easily applied. They can also be improvised from a piece of shirt, sheet, kerchief, or any other pliable material of a suitable size. To improvise a triangle, cut a square of material somewhat larger than 3 by 3 feet and fold it diagonally. If two bandages are needed, cut the material along the fold.

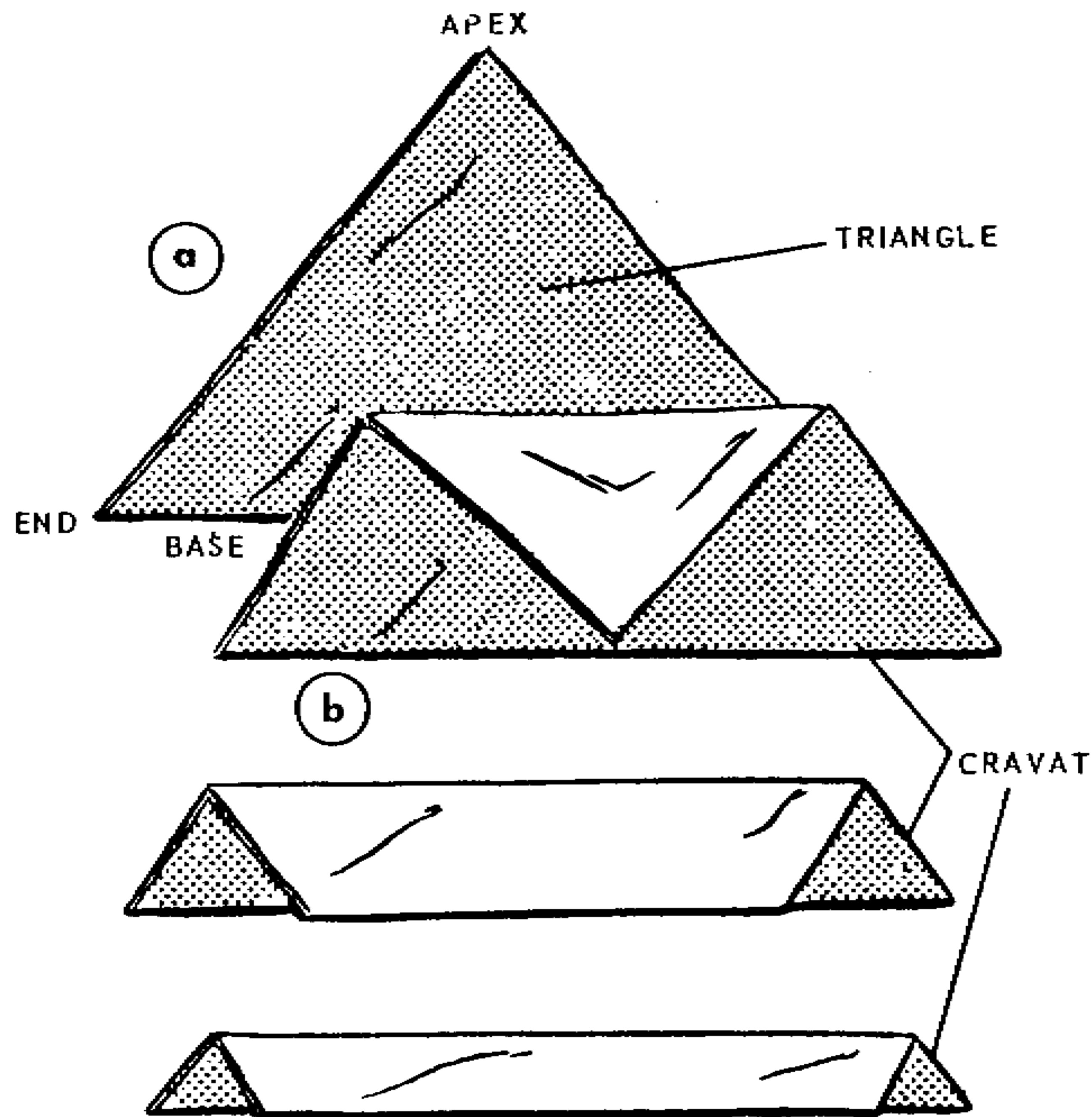

Figure 6-3. Triangular and cravat bandages.

Section IV. BANDAGING OF VARIOUS BODY PARTS

6-9. Head

a. *Application of Bandages Attached to Field First Aid Dressing (fig 6-2).*

- (1) Place bandage on head as shown in a, figure 6-4.
- (2) Cross the two front bandages under chin and tie them on top of head (b, fig 6-4).
- (3) Bring the right rear bandage under chin to meet left rear bandage at a point above ear and secure to other bandages (c, fig 6-4). Do not cover ear.

(4) Take rear bandages in opposite directions to other side of head and tie them above ear to other bandages with square knot (d, fig 6-4). Do not cover ear.

b. Triangular Bandage Applied to Head.

(1) Turn base of bandage up and place center of base on center of forehead, letting apex fall on back of neck; then take ends backward (a, fig 6-5).

(2) Cross ends over apex; then take them over forehead and tie with square knot (b, fig 6-5).

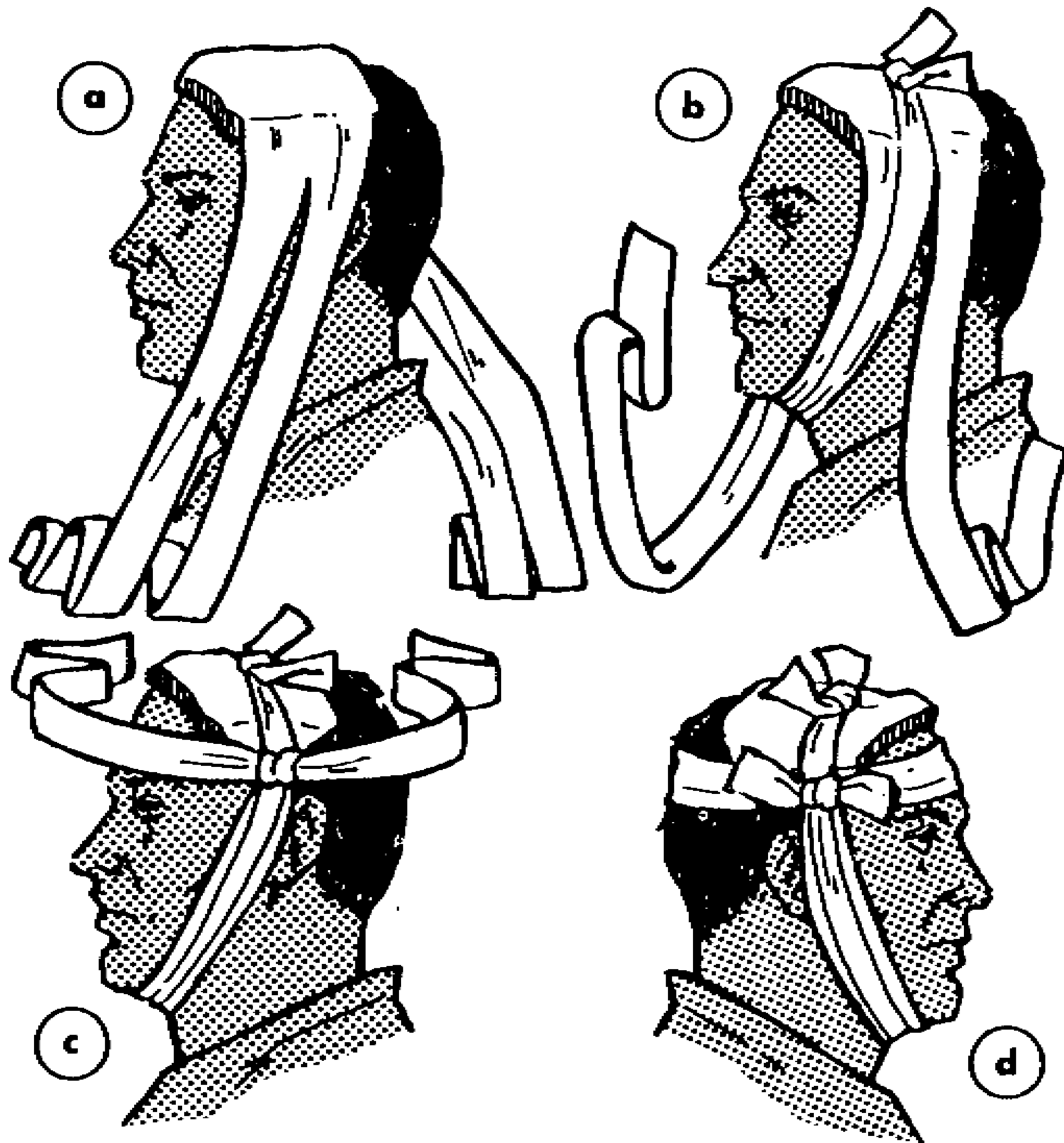

Figure 6-4. Securing field first aid dressing to head with attached bandages.

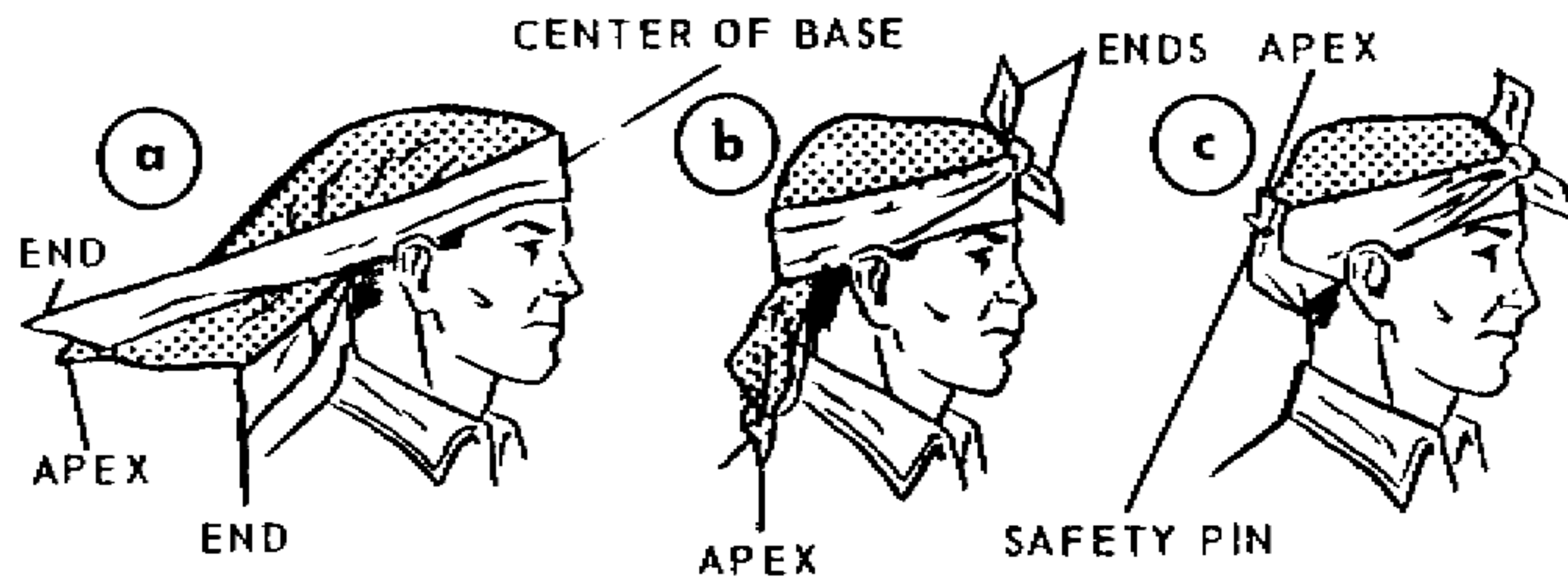

Figure 6-5. Applying triangular bandage to head.

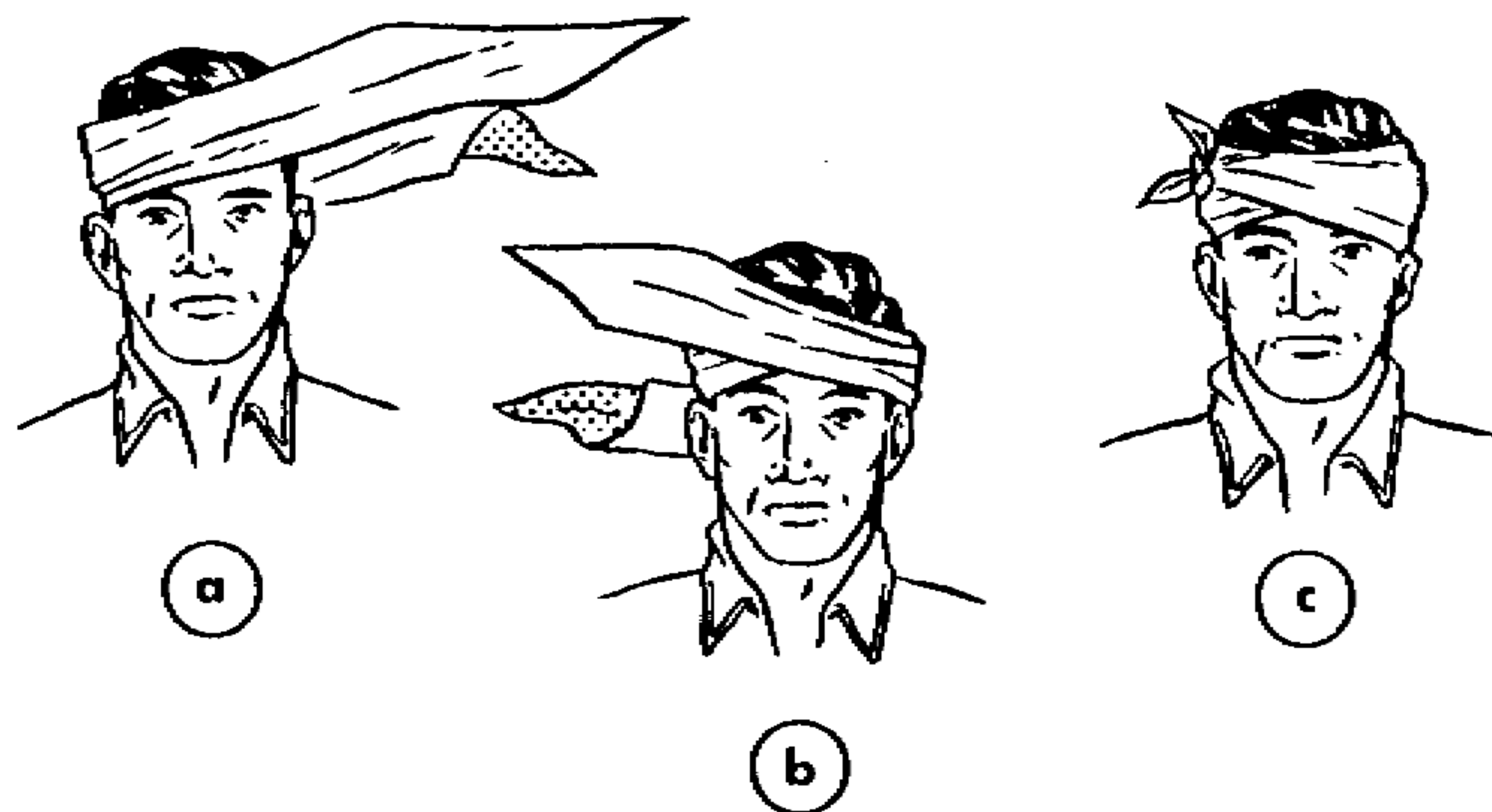

Figure 6-6. Applying cravat bandage to head.

(3) Tuck apex behind crossed part of bandage and further secure it with safety pin, if available (c, fig 6-5).

c. Cravat Bandage (fig 6-3) Applied to Head.

(1) Place middle of bandage over dressing (a, fig 6-6).

(2) Pass the two ends of the bandage in opposite directions completely around the head and tie them with a square knot over the dressing (b and c, fig 6-6).

6-10. Ear

The cravat bandage (fig 6-3) is applied to the ear as follows:

- a. Place middle of bandage over ear (a, fig 6-7).
- b. Cross ends, take them in opposite directions around head, and tie them with square knot (b and c, fig 6-7).
- c. If possible place some dressings between the ear and the side of the head to avoid crushing the ear against the head when the bandage is applied.

6-11. Eyes

Even though only one eye is injured, both eyes must be bandaged. Since both eyes move together, any movement of the uninjured eye would cause the same movement and further damage to the injured eye. The bandages attached to the field first aid dressing (c, fig 1-1) are applied to the eyes as follows:

- a. Take upper bandages on each side (a, fig 6-8) to back of head and cross them. Bring bandages around head and tie them with square knot on side of head (b, fig 6-8).
- b. Cross lower bandages on top of head and bring longest bandage under chin. Secure bandages to other bandages and tie them with square knot (c, fig 6-8).

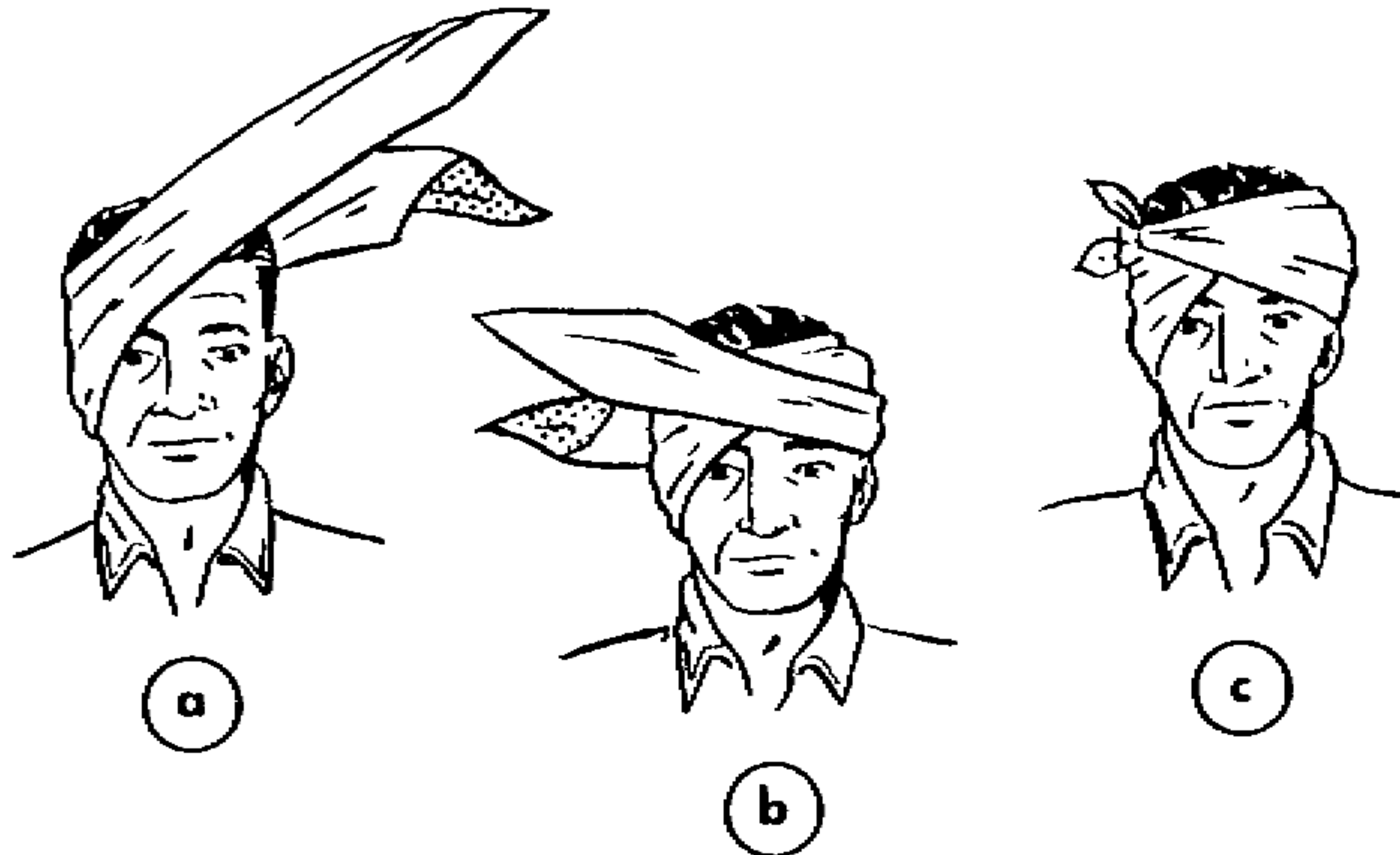

Figure 6-7. Applying cravat bandage to ear or eye area.

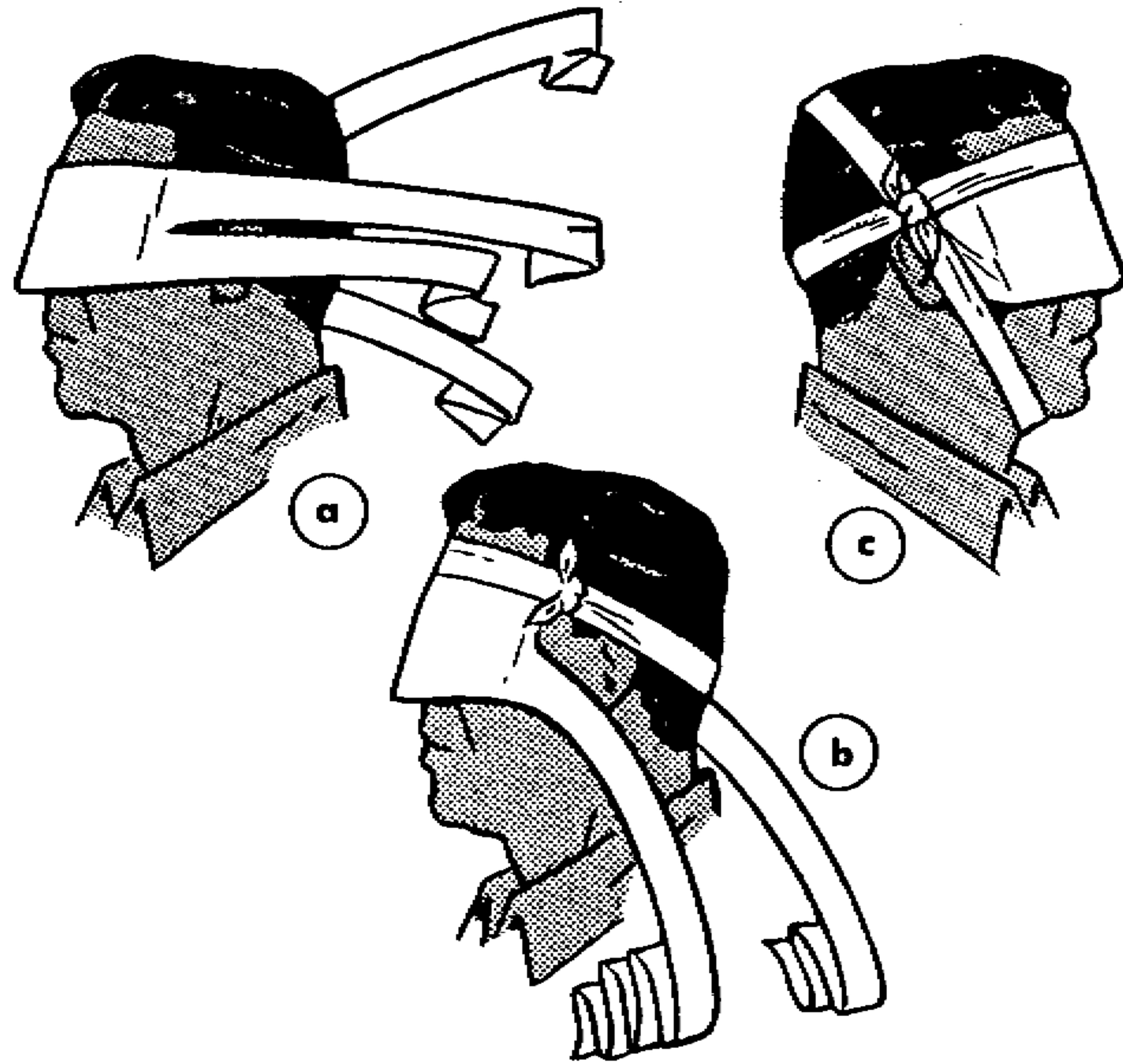

Figure 6-8. Securing field first aid dressing to eyes with attached bandages.

6-12. Jaw

Before applying bandage to a soldier's jaw, take any removable dentures (full or partial) from his mouth and put them in his pocket. In applying the bandage, allow the jaw enough freedom to permit passage of air and drainage from the mouth. To avoid bandaging the mouth completely closed, place a wad of material with a thickness of approximately one-eighth inch between the upper and lower teeth and gums. To insure that this wad of material does not fall into the mouth and block the airway, leave streamers of the material attached to the wad and tie them to the bandage.

a. Application of Bandages Attached to Field First Aid Dressing (fig 6-2). After placing the dressing over the wound, apply the bandages, using the same technique illustrated in figure 6-4.

b. Cravat Bandage (fig 6-8) Applied to Jaw.

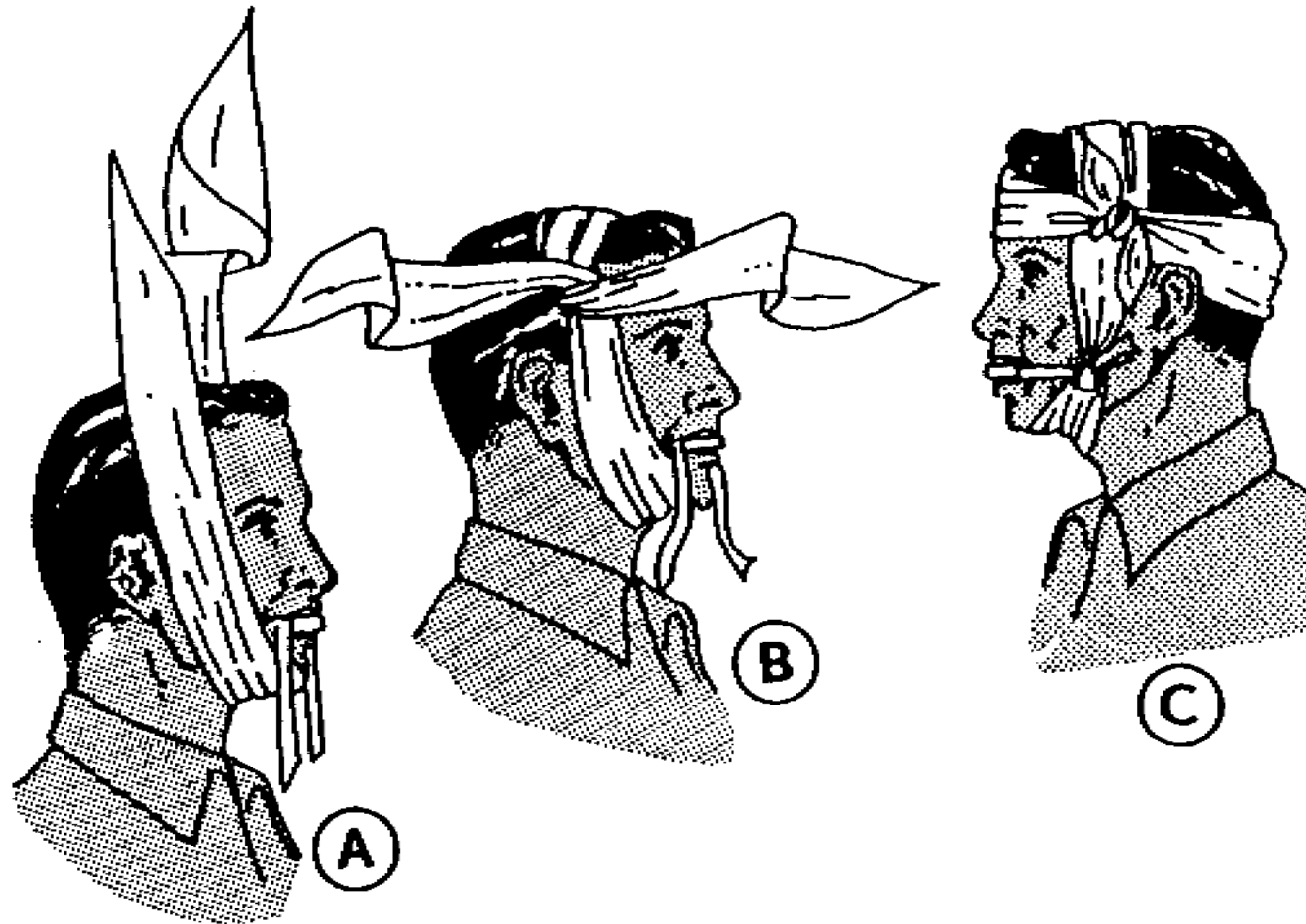

Figure 6-9. Applying cravat bandage to jaw.

(1) Place bandage under chin and carry ends upward. Adjust bandage to make one end longer than the other (a, fig 6-9).

(2) Take longer end over top of head to meet short end at temple. Cross ends (b, fig 6-9).

(3) Take ends in opposite directions to other side of head and tie them with square knot over part of bandage applied first (c, fig 6-9).

(4) Tie mouth wad streamers to bandage.

6-13. Shoulder

a. Application of Bandages Attached to Field First Aid Dressing (fig 6-10).

(1) Take one bandage across chest and the other across back and under arm opposite to injured shoulder.

(2) Tie ends with square knot.

b. Cravat Bandage (fig 6-8) Applied to Shoulder or Armpit.

(1) Extend length of cravat bandage by placing end of one triangular bandage along middle of another one, folding the two bandages into a single cravat, and securing the thicker part with one or more safety pins.



Figure 6-10. Securing field first aid dressing to shoulder with attached bandages.

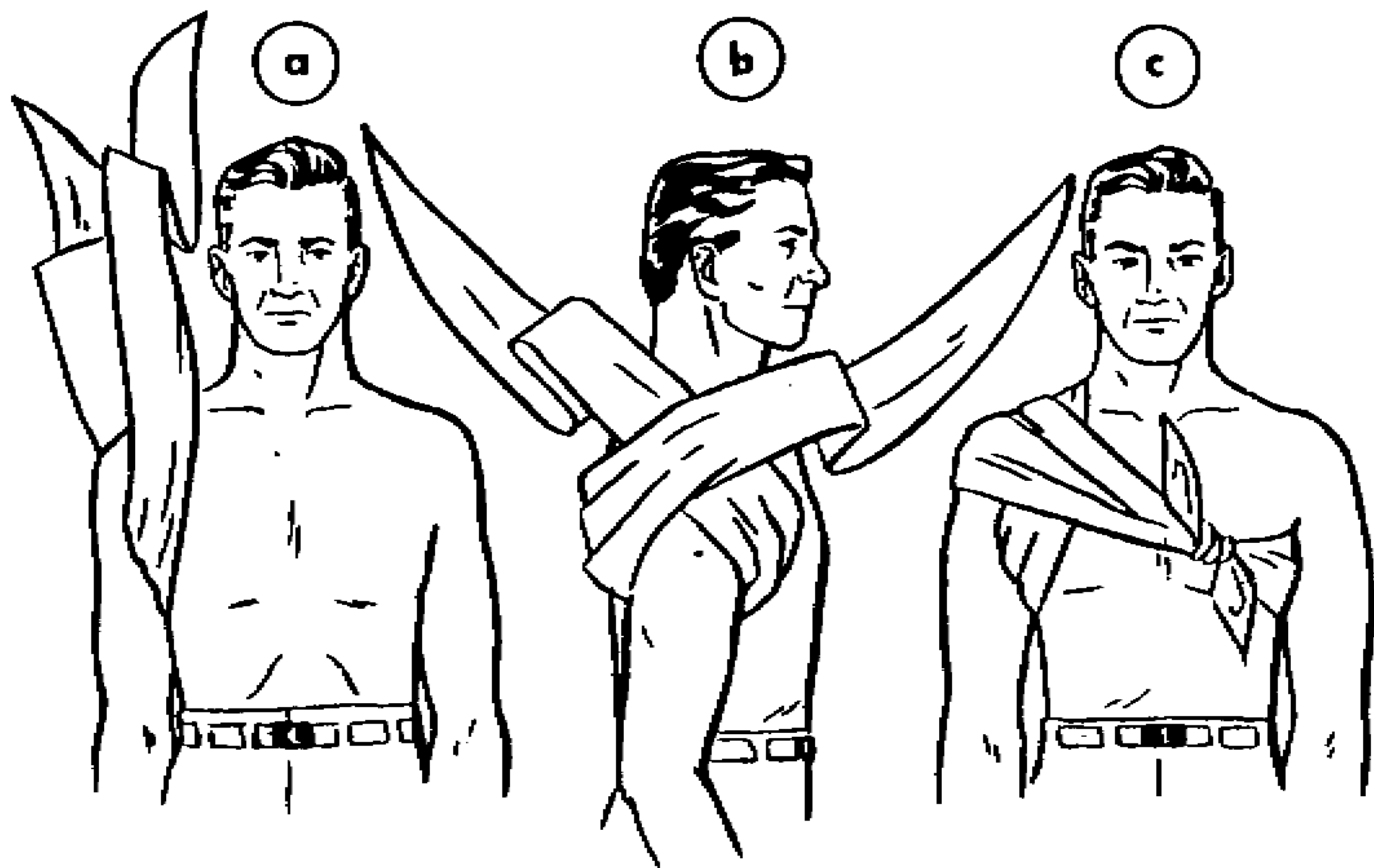

Figure 6-11. Applying cravat bandage to shoulder or armpit.

(2) Place middle of cravat bandage under armpit so that front end is longer than back end and safety pins are on the outside (a, fig 6-11).

(3) Cross ends on top of shoulder (b, fig 6-11).

(4) Take one end across back and under arm on opposite side and other end across chest. Tie ends with square knot (c, fig 6-11).

(5) Be sure and place sufficient wadding in the armpit and do not tie the cravat bandage too tightly so as to avoid compressing the major blood vessels in the armpit.

6-14. Elbow

The cravat bandage (fig 6-3) is applied to the elbow as follows:

a. Bend arm at elbow and place middle of cravat at point of elbow (a, fig 6-12).

b. Bring ends up and across, extending one downward and one upward (b, fig 6-12).

c. Take each end around arm and tie with square knot at front of elbow (c, fig 6-12).

6-15. Hand

a. *Triangular Bandage (fig 6-3) Applied to the Hand.*

(1) Place hand in middle of triangular bandage with wrist at base of bandage (a, fig 6-13). Insure that fingers are separated with absorbent material to prevent chafing and irritation of skin.

(2) Place apex over fingers and tuck excess fullness into pleats on each side of hand (b, fig 6-13).

(3) Cross ends on top of hand, take them around wrist, and tie them in square knot (c, d, and e, fig 6-13).

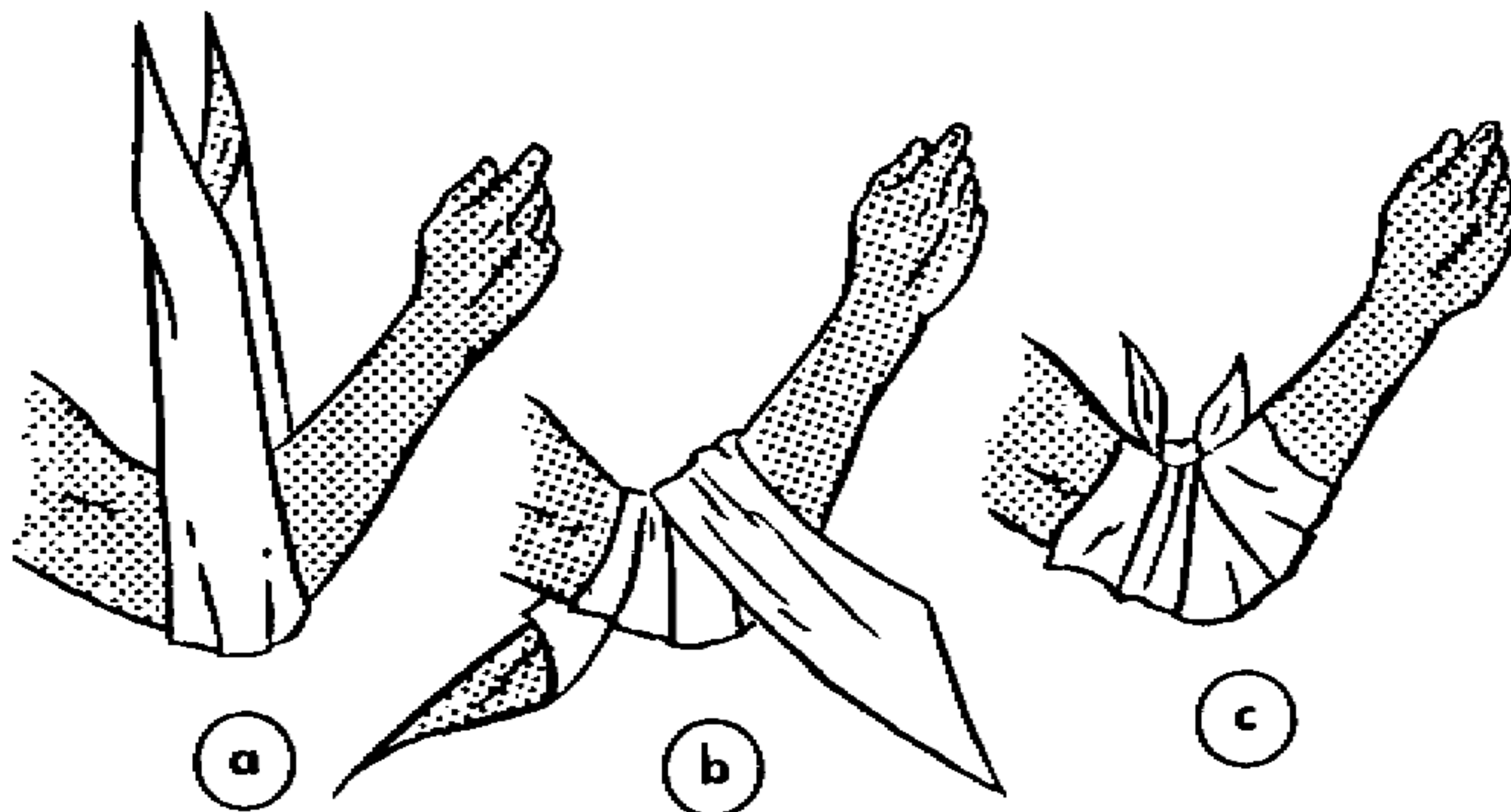

Figure 6-12. Applying cravat bandage to elbow.

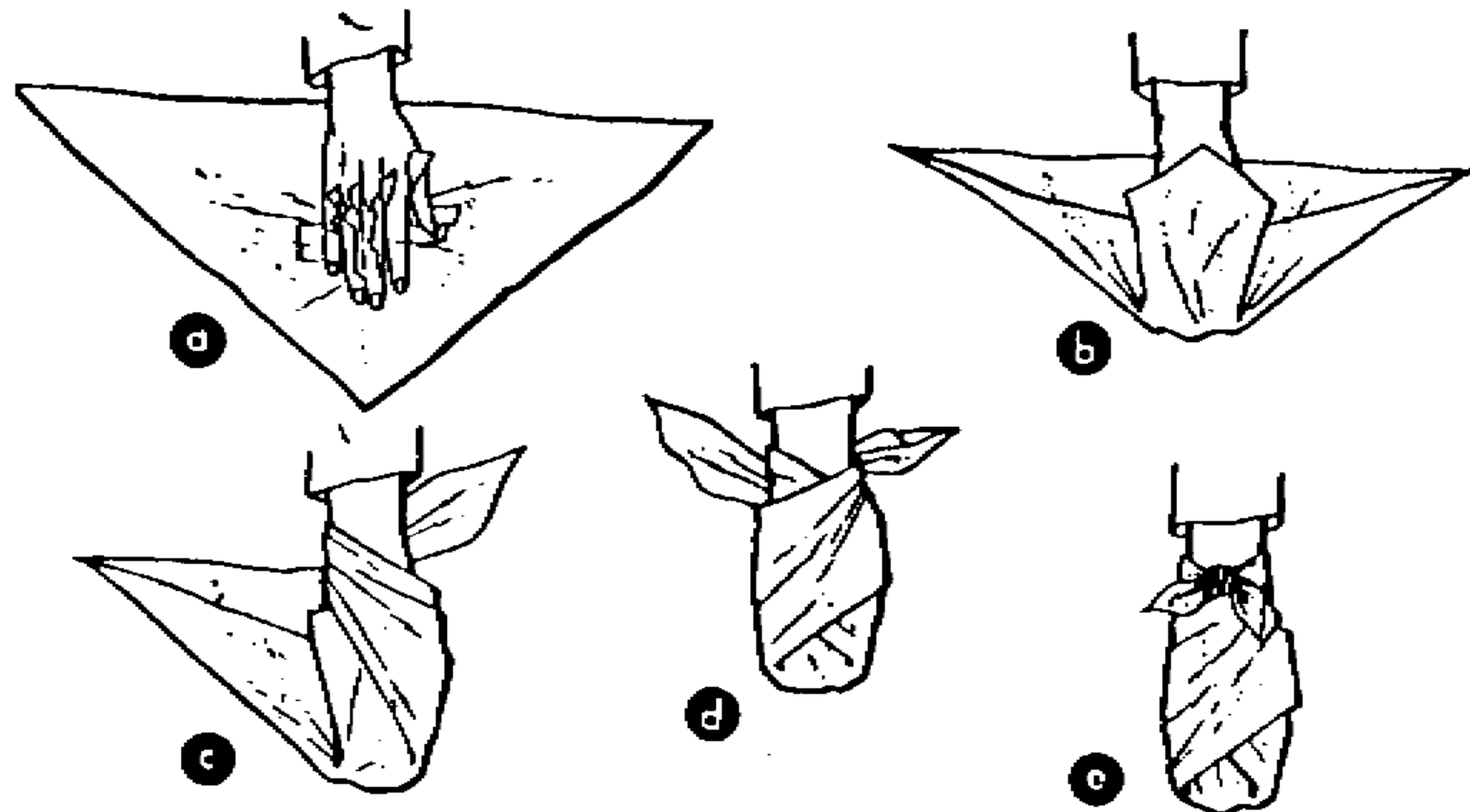

Figure 6-13. Applying triangular bandage to hand.

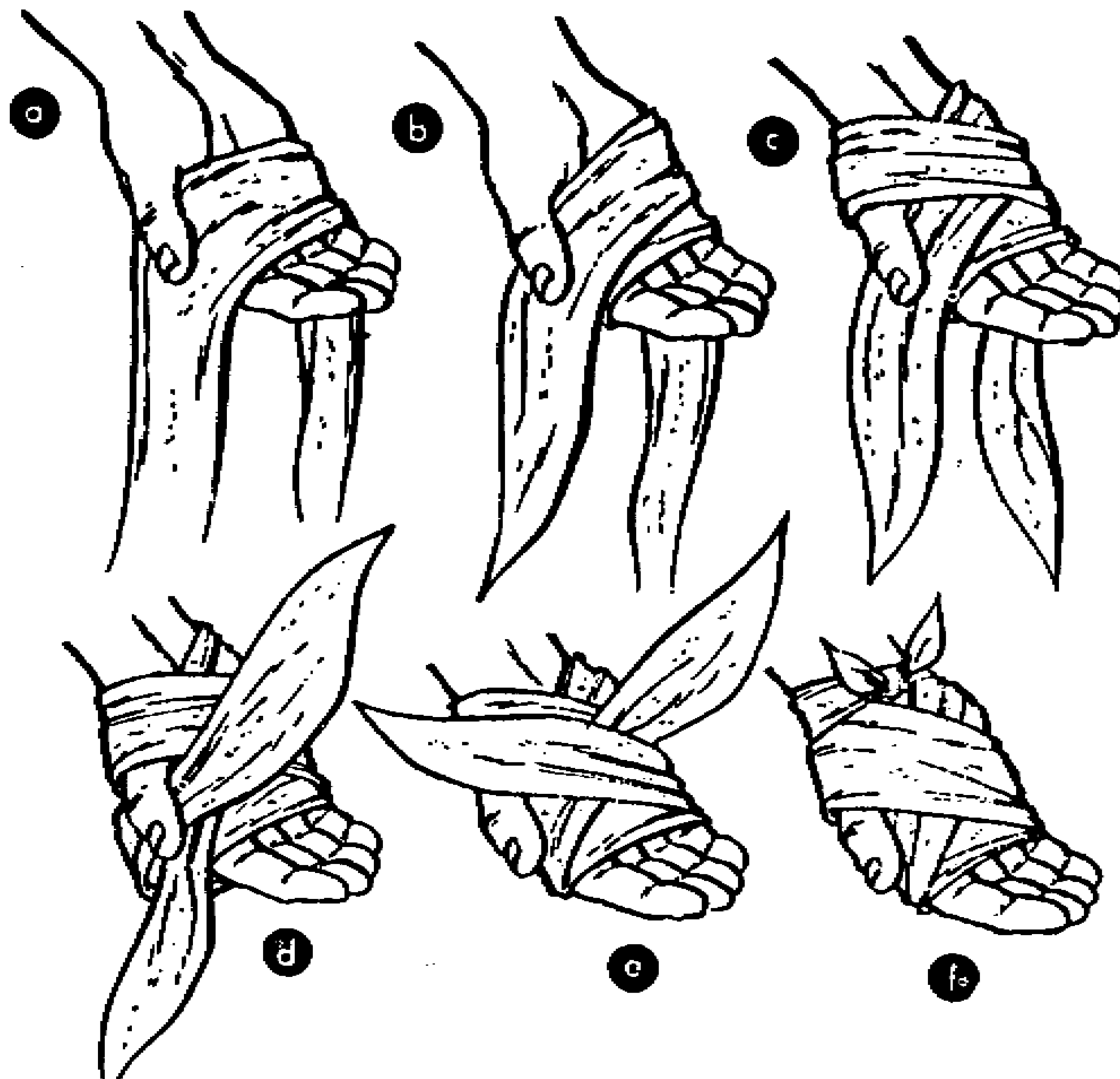

Figure 6-14. Applying cravat bandage to palm of hand.

b. Cravat Bandage (fig 6-3) Applied to Palm of Hand.

(1) Lay middle of cravat over palm of hand with ends hanging down each side (a, fig 6-14).

(2) Take thumb end across back of hand, over palm, and through hollow between thumb and palm (b, fig 6-14).

(3) Take other end across back of hand, extending it upward over base of thumb; then bring it downward across palm (c, fig 6-14).

(4) Take ends to back of hand and cross; then bring them to front of hand and cross again (d and e, fig 6-14).

(5) Tie ends with a square knot at wrist (f, fig 6-14).

6-16. Knee

Apply cravat bandage to knee as illustrated in figure 6-15, using the same technique described in paragraph 6-14.

6-17. Leg

The cravat bandage (fig 6-3) is applied to the leg as follows:

a. Place center of cravat over dressing (a, fig 6-16).

b. Take one end around and up the leg in a spiral motion and the other end around and down the leg in a spiral motion, overlapping part of each preceding turn (b, fig 6-16).

c. Bring both ends together and tie with square knot (c, fig 6-16).

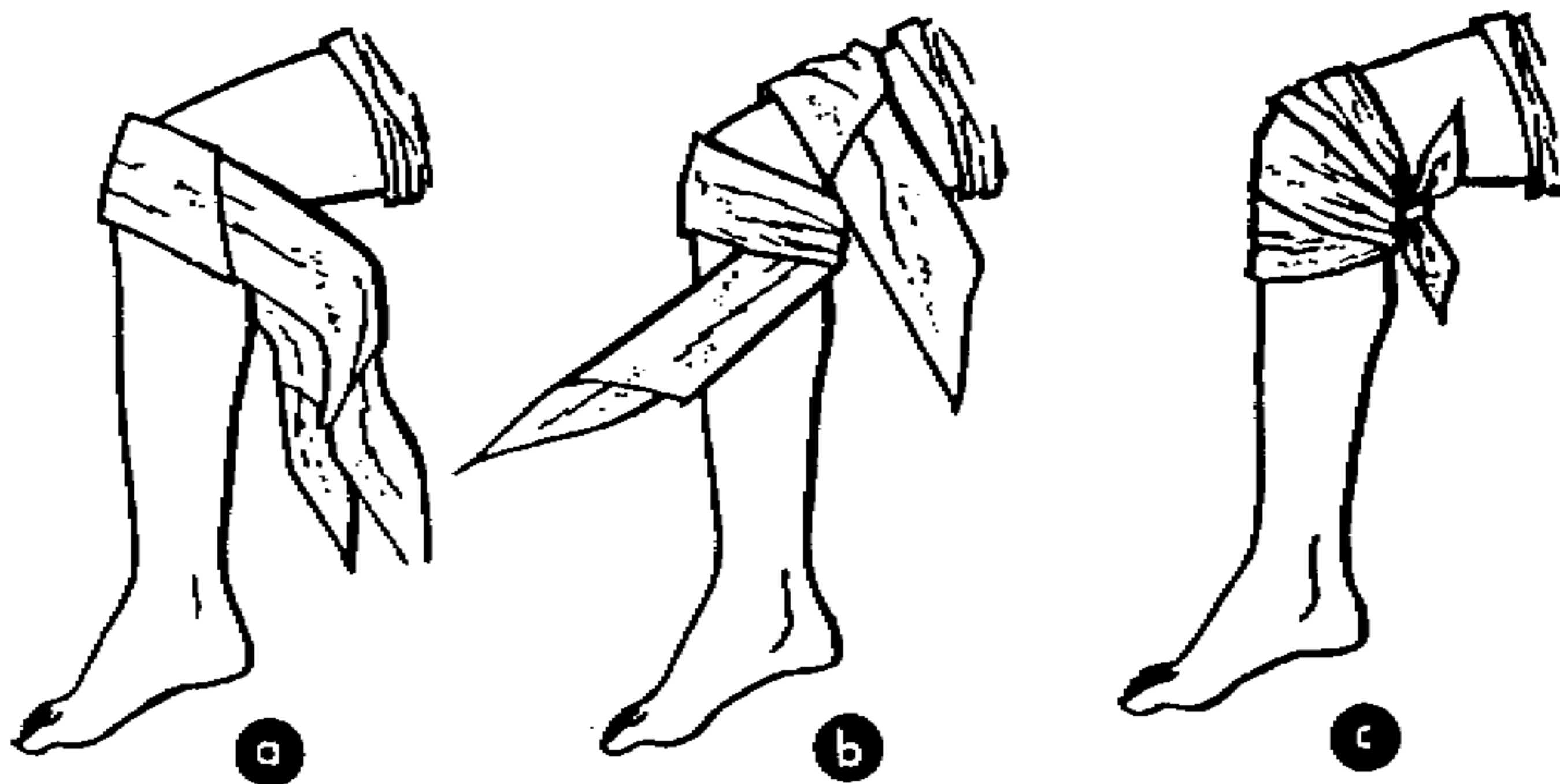

Figure 6-15. Applying cravat bandage to knee.

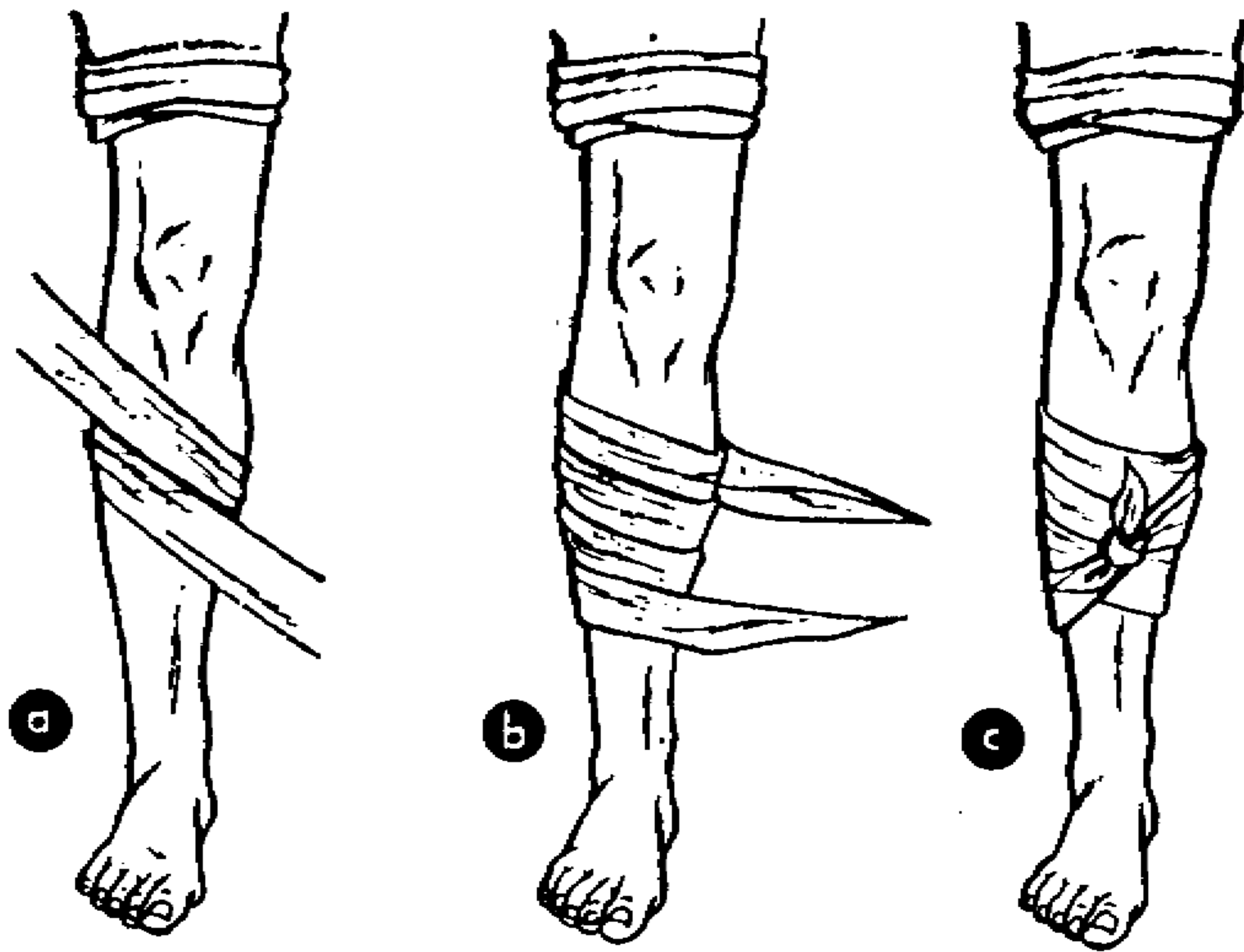

Figure 6-16. Applying cravat bandage to leg.

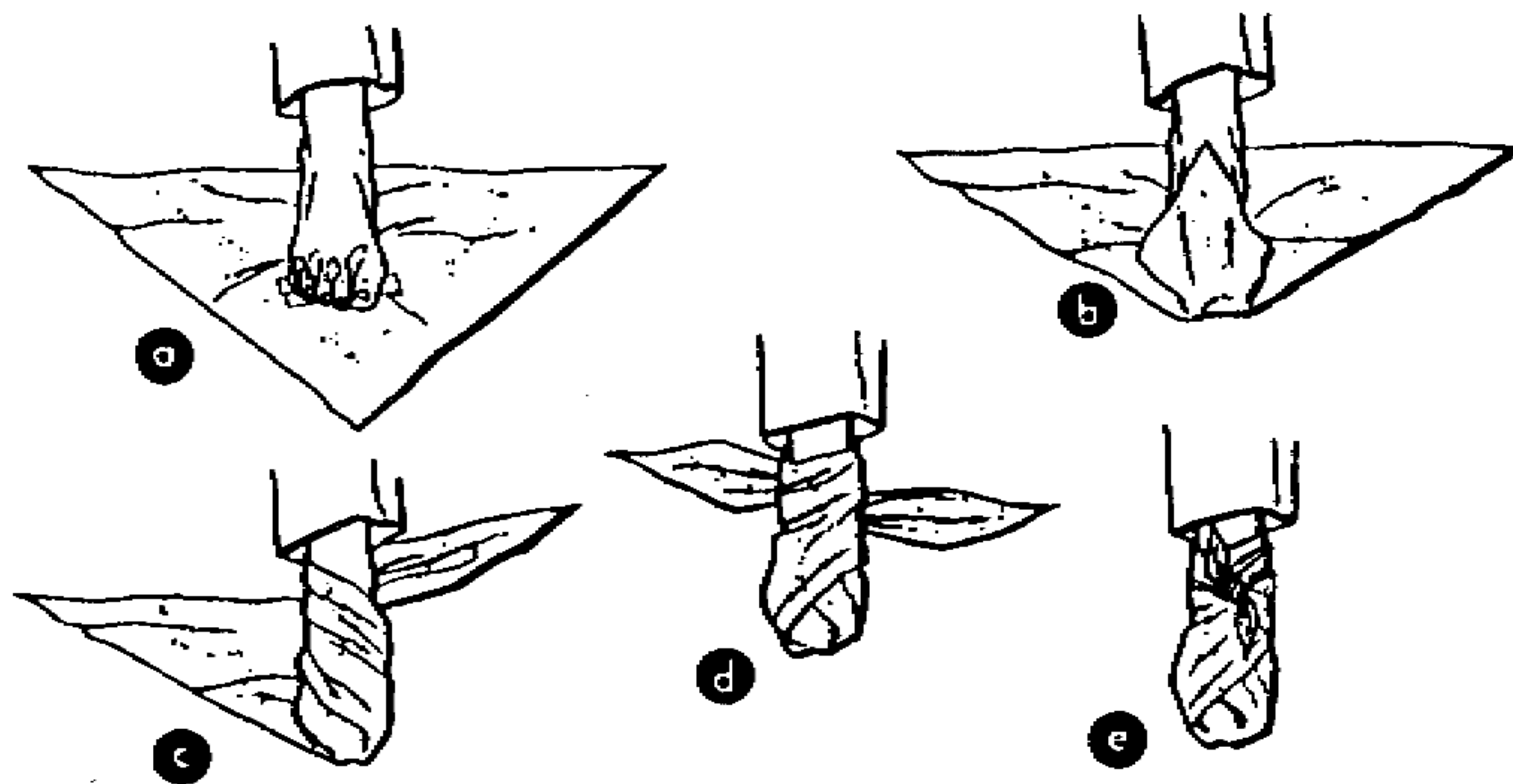

Figure 6-17. Applying triangular bandage to foot.

6-18. Foot

The triangular bandage (fig 6-3) is applied to foot as follows:

a. Place foot in middle of triangular bandage with heel well forward of base (a, fig 6-17). Insure that toes are separated with absorbent material to prevent chafing and irritation of the skin.

b. Place apex over top of foot and tuck excess fullness into pleats on each side of foot (b, fig 6-17).

c. Cross ends on top of foot, take them around ankle, and tie them in square knot at front of ankle (c, d, and e, fig 6-17).

PART THREE
SPECIAL FIRST AID MEASURES

CHAPTER 7
FIRST AID FOR SEVERE WOUNDS AND BURNS

Section I. INTRODUCTION

7-1. General

The lifesaving measures A, B, C, and D, discussed in chapters 3 through 6, apply to first aid measures for all injuries. Certain types of wounds and burns, however, require special precautions and procedures or modifications in the four basic measures.

7-2. Types of Wounds and Burns Requiring Special First Aid Measures

These injuries include head injuries, face and neck wounds, sucking wounds of the chest, abdominal wounds, and burns, as well as fractures. Fractures will be discussed in chapter 8.

Section II. HEAD INJURIES

7-3. General

A head injury may consist of one of the following conditions or of a combination of them: a cut or bruise of the scalp; a fracture of the skull with injury to the brain and/or to the blood vessels of the scalp, skull, and brain. Usually, serious skull fractures and brain injuries occur together; however, it is possible to receive a serious brain injury without a skull fracture.

7-4. Signs and Symptoms

A head injury with scalp wound is easily recognized. Injury of the head *without* a scalp wound is more difficult to recognize. You should, therefore, suspect a head injury and act accordingly if the soldier—

- a. Is or has recently been unconscious.
- b. Has blood or other fluid escaping from his nose or ears.
- c. Has a slow pulse (para 2-1b(2)).
- d. Has a headache.
- e. Is nauseated or is vomiting.
- f. Has had a convulsion.
- g. Is breathing very slowly.

7-5. Special Precautions in A, B, C, and D Lifesaving Measures

(chaps 3 through 6).

a. Leave any protruding brain tissue as it is, and apply a sterile dressing over this tissue. Furthermore, do not remove or disturb any foreign matter which may be in the wound.

b. The soldier should be lying so that his head is in a position higher than his body.

c. For proper application of bandages to the head, see paragraph 6-9.

Section III. FACE AND NECK WOUNDS

7-6. General

Wounds of the face and neck bleed profusely because of the many blood vessels in these parts. Furthermore, the bleeding is difficult to control.

7-7. Special Precautions and Modifications to A, B, C, and D Lifesaving Measures

(chaps 3 through 6).

a. First, stop any bleeding which may be causing obstruction of the soldier's upper airway. Then clear his airway (para 3-4d(2)).

There may be pieces of broken teeth or bone and loose bits of flesh, as well as dentures, in his mouth.

b. If the soldier is conscious and chooses to sit up, have him lean forward with his head down to permit free drainage from his mouth; otherwise, place him in the shock position for an unconscious person (c, fig 5-1), even though he may be conscious, to permit drainage from his mouth.

Section IV. SUCKING WOUNDS OF THE CHEST

7-8. General

A chest wound which results in air being sucked into the chest cavity is particularly dangerous. This will cause the lung on the injured side to collapse (fig 7-1). The soldier's life may, therefore, depend upon how quickly you make the wound airtight. Be sure to examine the soldier carefully so that you do not miss a second or exit wound (para 4-4).

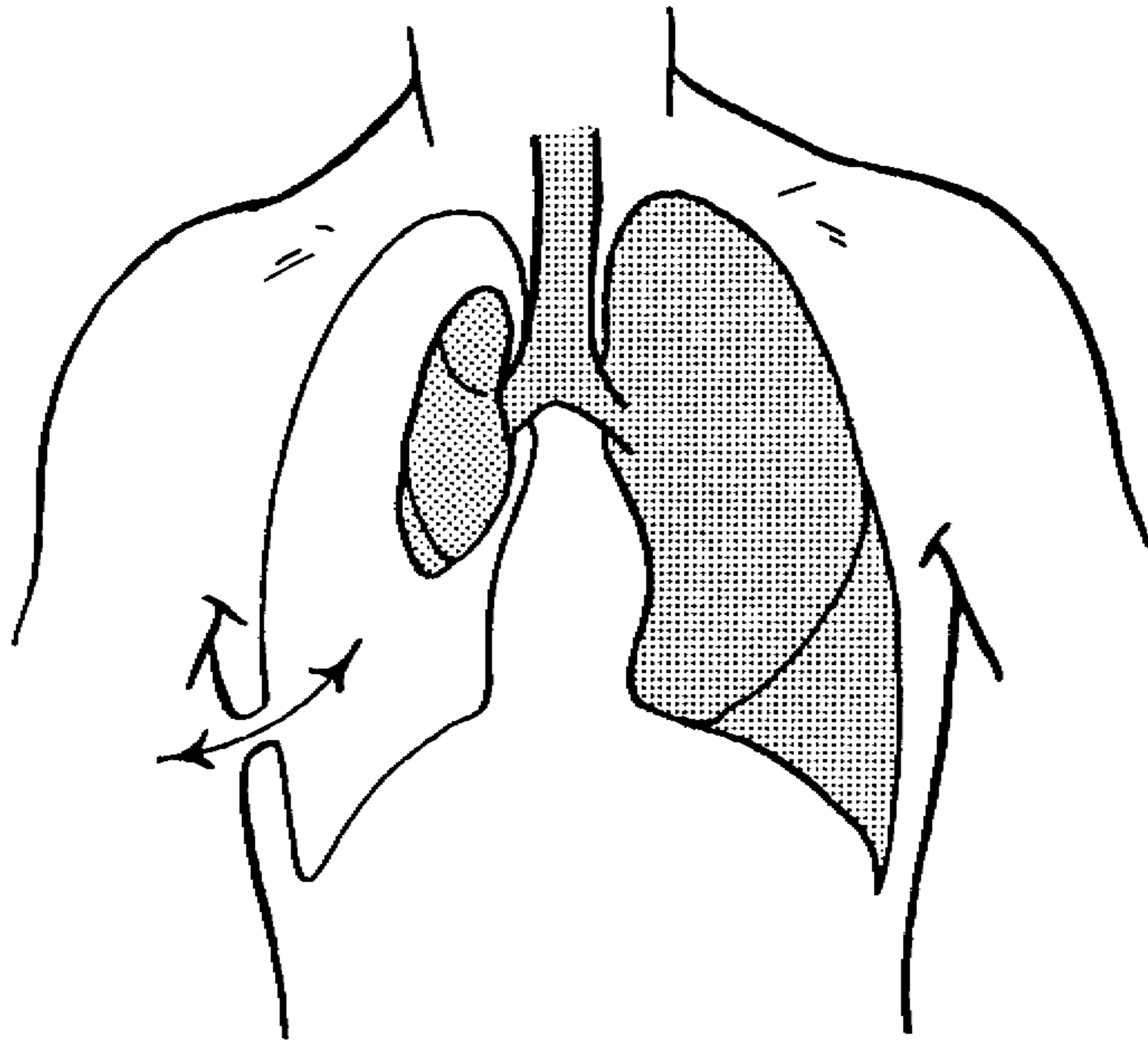

Figure 7-1. Sucking wound of the chest.

7-9. Special Precautions, Procedures, and Modifications to A, B, C, and D Lifesaving Measures

(chap 3 through 6).

a. Have the soldier forcibly exhale (breathe out), if possible, and hold his breath while you seal the wound.

(1) Seal the wound airtight by applying a piece of plastic or foil, such as the dressing wrapper or the foil-lined envelope which contains the burn salt solution, directly over the wound. Apply the first aid dressing over the plastic and have an assistant or the soldier exert pressure on the dressing with his open hand while you secure the bandages attached to the dressing around his body (a and b, fig 7-2).

Note: If petrolatum gauze is available (app B), it should be applied directly over the wound.

(2) Apply a strip of bandaging material torn from clothing, a shelter half, or a blanket, et cetera, or apply a folded poncho over the dressing and around the soldier's body to create further pressure, thus making the wound airtight. Each turn of this

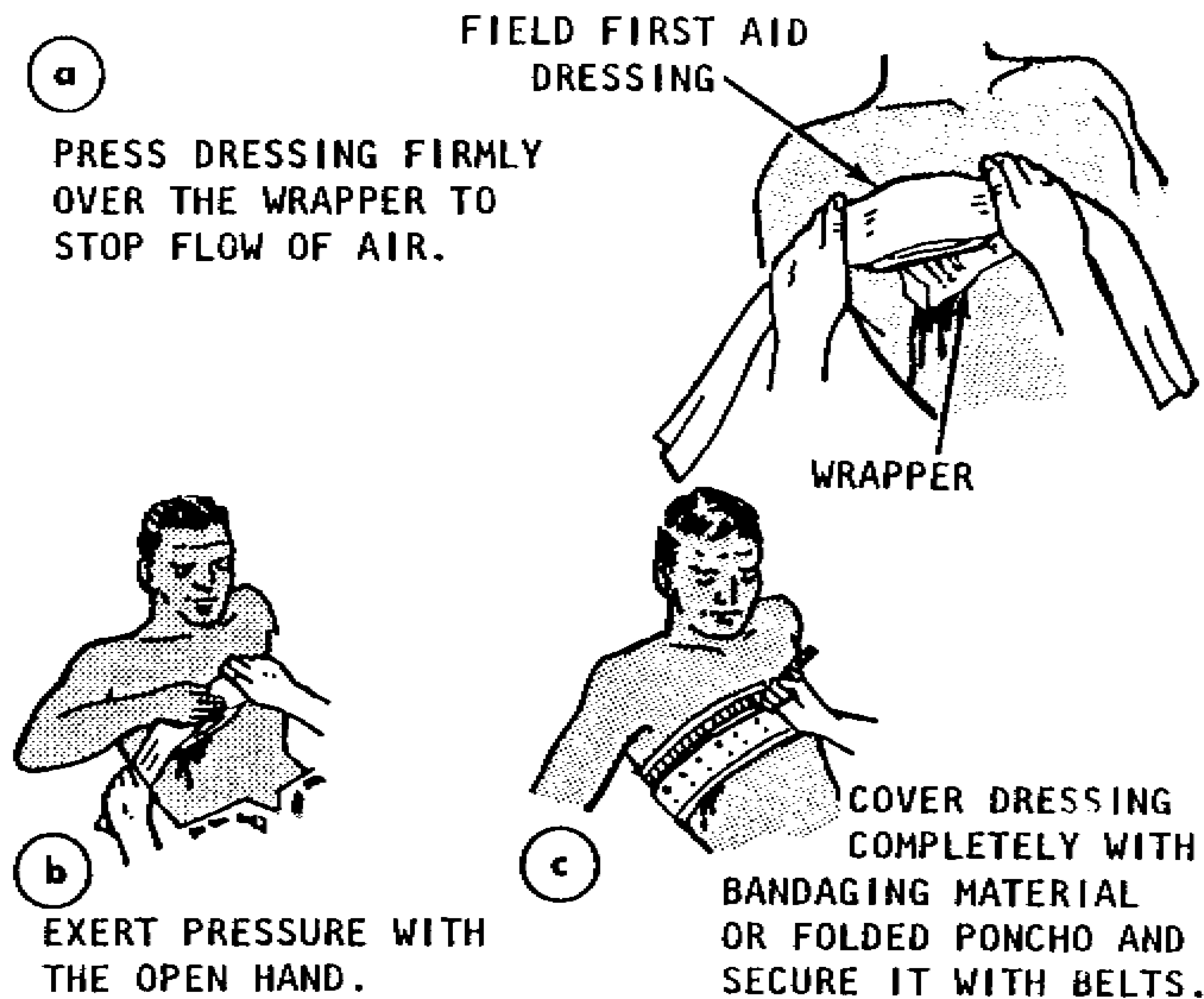

Figure 7-2. Sealing a sucking wound of the chest.

bandaging material must overlap the preceding one in order to provide firm, evenly distributed pressure over the entire dressing.

(3) Secure the bandages with the soldier's belts.

b. If the soldier finds it more comfortable to sit up, allow him to do so. Sitting up makes breathing less difficult, as abdominal pressure is relieved and the diaphragm muscle functions easier. If he chooses to lie down, encourage him to lie on his injured side so that the lung on his uninjured side can receive more air. Also, the surface on which he is lying serves somewhat as a splint to the injured side and thus decreases pain.

Section V. ABDOMINAL WOUNDS

7-10. General

The most serious abdominal wound is one in which an object penetrates the abdominal wall and pierces internal organs or large blood vessels.

7-11. Special Precautions and Modifications to A, B, C, and D Lifesaving Measures

(chap 3 through 6).

a. Do not touch or try to push protruding organs such as intestines back into the wound; apply one or more sterile dressings over them (a and b, fig 7-3). If it is necessary to move an exposed intestine onto the abdomen in order to cover the wound adequately, then do so. Secure the dressings in place with bandages (c, fig 7-3); but *do not* apply them tightly, as internal bleeding cannot be controlled by pressure and excessive pressure can cause additional injury.

b. Do not give or allow the soldier to take anything by mouth, since it will eventually pass through the injured intestines and spread contamination in the abdomen. The soldier's lips may be moistened to help lessen his thirst.

c. Leave him on his back, but turn his head to one side (c, fig 7-3). Since he will likely vomit, watch him closely to prevent him from choking.

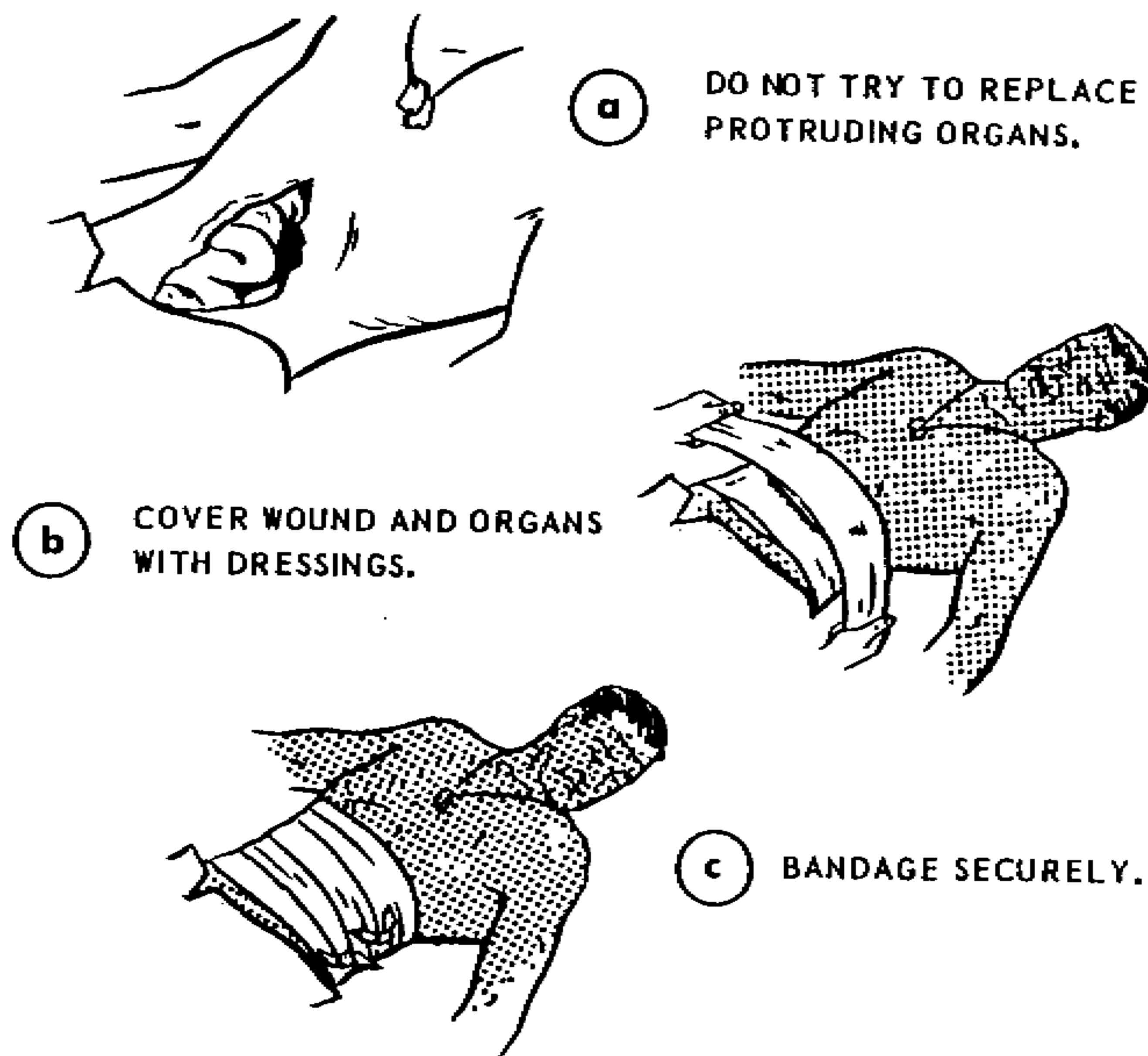

Figure 7-3. First aid for an abdominal wound.

Section VI. SEVERE BURNS

7-12. General

If a soldier has a burn which is blistered or charred, special first aid measures are required. The primary objective is to prevent or lessen shock and infection.

7-13. Special Precautions, Procedures, and Modifications to A, B, C, and D Lifesaving Measures

(chap 3 through 6).

a. Protect the burn against further contamination, thus lessening the possibilities of infection:

(1) If clothing covers the burn, cut and lift it gently away without touching the burn.

(a) *Do not* try to remove pieces of cloth which have stuck to the burn or to clean the burn in any way.

(b) *Do not* pull clothes over the burned area.

(c) *Do not* break blisters.

(d) *Do not* put ointment or any medication whatsoever on the burn.

(2) Place a sterile dressing over the burned area and secure it in place with bandages. In a mass casualty situation, a clean sheet may be used in the absence of sufficient dressings.

b. Prevent shock by applying the measures discussed in chapter 5 and outlined as follows:

(1) If the soldier is conscious, is not vomiting, and has no abdominal or neck wound, give him the sodium chloride-sodium bicarbonate mixture included in the first aid case. Dissolve one envelope (4.5 grams) of the mixture in one canteenful or quart of cool or cold water. Never use warm water, since warm salt water often causes vomiting.

Note: If the sodium chloride-sodium bicarbonate mixture is not available, dissolve four Army issue salt tablets and two sodium bicarbonate tablets or one-half teaspoonful of loose salt and one-fourth teaspoonful of baking soda in one canteenful or quart of cool or cold water. If only salt is available, use it without the soda.

(2) Give the solution to the soldier slowly, having him consume the entire amount over a 1-hour period. Should he become nauseated, stop giving him the solution to prevent vomiting and further loss of fluids; but keep the solution available for him to drink later. This solution helps restore body fluids and salts.

(3) If the soldier is wearing a protective mask (fig 7-4), turn the valve handle to the right, thus moving the drinking tube on the inside of his mask into his mouth; then insert the tube on the outside of his mask into the M1 Protective Canteen Cap on his canteen, making sure that a tight seal is effected. Tilt the canteen upward and then downward in the appropriate positions for the soldier to drink the solution described above.



Figure 7-4. Administration of oral fluids in a toxic environment.

CHAPTER 8

IMMOBILIZATION OF FRACTURES

Section I. INTRODUCTION

8-1. General

Fractures (broken bones) can cause total disability or death of a soldier. On the other hand, they can more often be treated so there is complete recovery. A great deal depends upon the first aid the soldier receives before he is moved. First aid includes immobilization of the fractured part in addition to the application of lifesaving measures A, B, C, and D as required. A basic splinting principle is to immobilize the joints above and below any fracture.

8-2. Kinds of Fractures (fig 8-1)

a. Closed Fracture. A closed fracture is a break in the bone without a break in the overlying skin. In a closed fracture there may be tissue damage beneath the skin. Even though an injury may be a dislocation or sprain, it should be considered as a closed fracture for purposes of applying first aid.

b. Open Fracture. An open fracture is a break in the bone as well as in the overlying skin. The broken bone may have come through the skin, or a missile such as a bullet or shell fragment may have gone through the flesh to the bone. An open fracture is contaminated and is subject to infection.

8-3. Signs and Symptoms of a Fracture

A fracture is easily recognized when the bone is protruding through the skin, the part is in an unnatural position, or the chest wall is caved in. Other indications of a fracture are tenderness or pain when slight pressure is applied to the injured part and

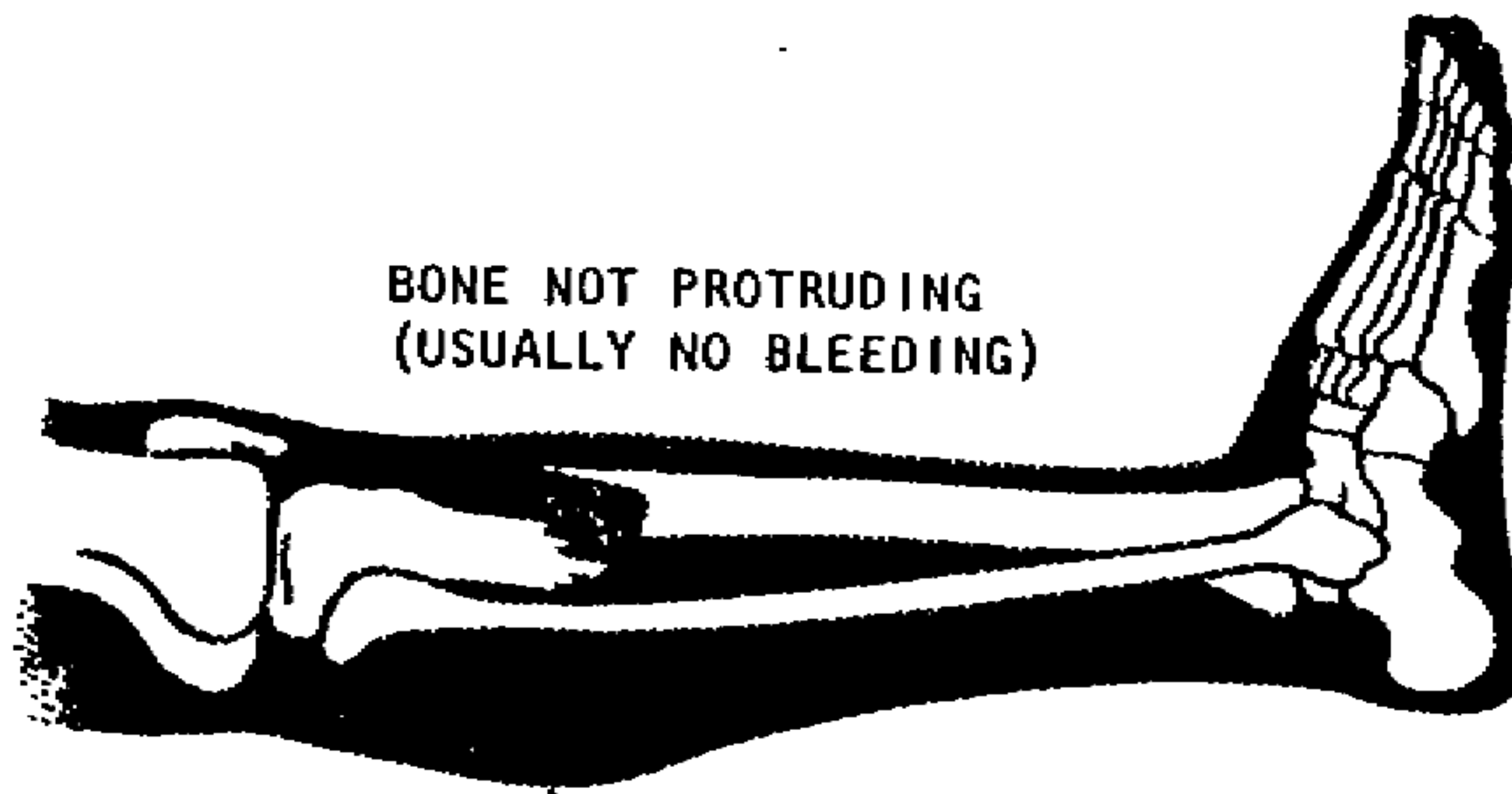

BONE NOT PROTRUDING
(USUALLY NO BLEEDING)

a CLOSED FRACTURE

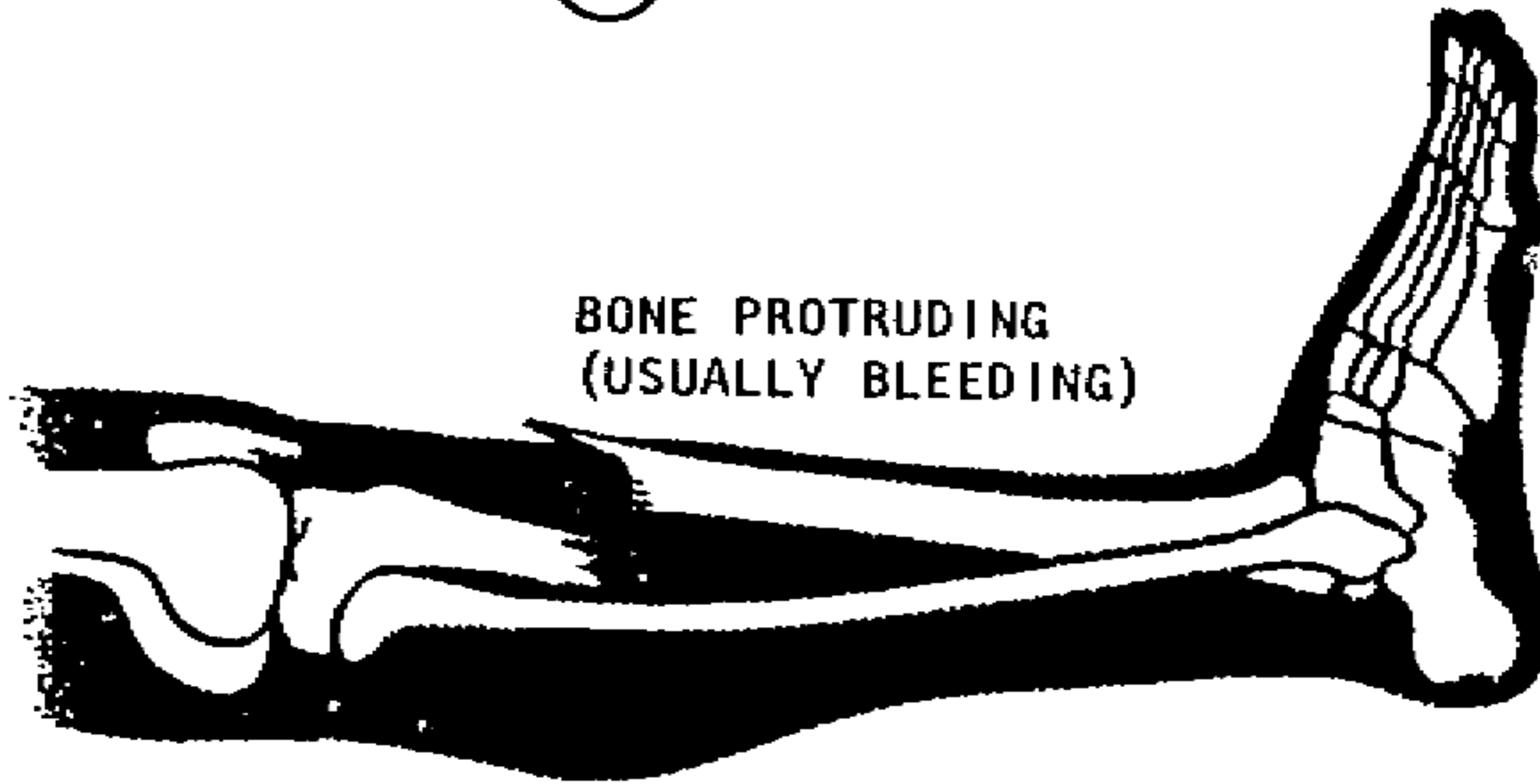

BONE PROTRUDING
(USUALLY BLEEDING)

b OPEN FRACTURE

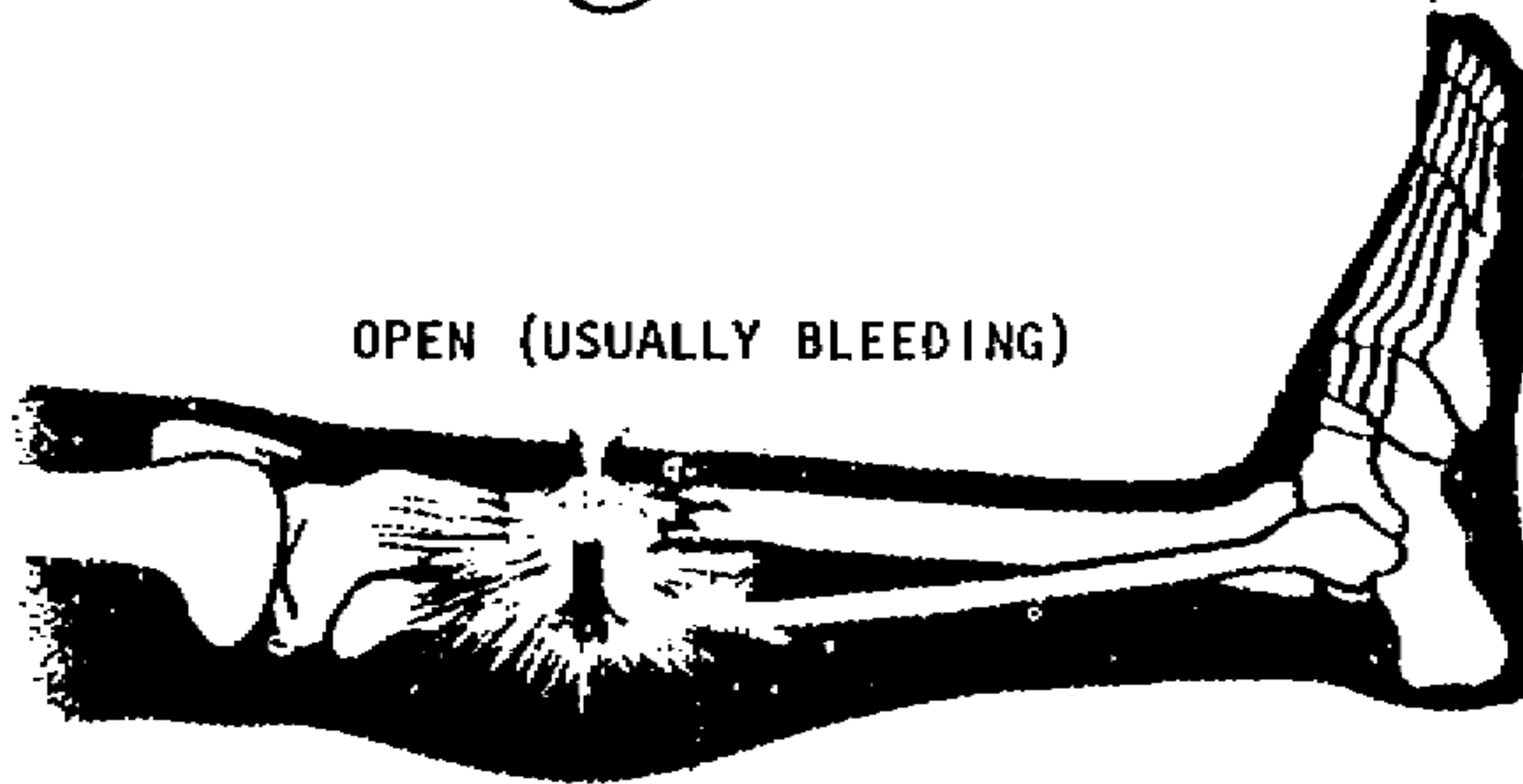

OPEN (USUALLY BLEEDING)

c OPEN FRACTURE PRODUCED BY MISSILE

Figure 8-1. Kinds of lower extremity fractures.

swelling as well as discoloration of the skin at the site of the injury. Deep, sharp pain when the soldier attempts to move the part is also a sign of a fracture. Do not, however, encourage the soldier to move a part in order to identify a fracture, since movement of the part would cause further damage to surrounding tissues and promote shock. If you are not sure whether or not a bone is fractured, treat the injury as a fracture.

8-4. Purpose of Immobilizing a Fracture

A body part which contains a fracture must be immobilized to prevent the razor-sharp edges of the bone from moving and cutting tissue, muscle, blood vessels, and nerves. Furthermore, immobilization greatly reduces pain and helps to prevent or control shock. In a closed fracture, immobilization keeps bone fragments from causing an open wound (fig 8-1) and thus prevents contamination and possibly infection (para 6-1). Immobilization is accomplished by splinting.

8-5. Rules for Splinting

If the fracture is an open one, first stop the bleeding; then apply a dressing and bandage (chap 6) as you would for any other wound.

a. Apply the proven principle "*Splint them where they lie.*" This means to splint the fractured part before any movement of the soldier is attempted and without any change in the position of the fractured part. If a bone is in an unnatural position or a joint is bent, *do not try to straighten it.* If a joint is not bent, *do not try to bend it.* If circumstances make it essential to move a soldier with a fracture of a lower extremity before a splint can be applied, use the uninjured leg as a splint by tying the fractured one to it; then grasp the soldier beneath the armpits and pull him in a straight line only. *Do not roll him or move him sideways.*

b. Apply a splint so that the joint above the fracture and the joint below the fracture are immobilized.

c. Use padding between the injured part and the splint to prevent undue pressure and further injury to tissue, blood vessels, and nerves. This is especially important at the crotch, in the armpit, and on places where the splint comes in contact with bony parts such as the elbow, wrist, knee, and ankle joint.

d. Bind the splint with bandages at several points above and below the fracture, but do not bind so tightly that it interferes with the flow of blood. No bandage should be applied across the

fracture. Tie bandages so that the knot is against the splint, and tie them with a square knot.

e. Use a sling to support a splinted arm which is bent at the elbow, a fractured elbow which is bent, a sprained arm, and an arm with a painful wound.

8-6. Splints, Padding, Bandages, and Slings

a. *Splints.* Splints may be improvised from such items as boards, poles, sticks, tree limbs, carbines, rifles, rolled magazines or newspapers, and cardboard. If nothing is available for a splint, the chest wall can be used to immobilize a fractured arm; and the uninjured leg can be used to immobilize, to some extent, a fractured leg.

Caution: If weapons are used as splints, be absolutely sure they are unloaded.

b. *Padding.* Padding may be improvised from such items as a jacket, blanket, poncho, shelter half, or leafy vegetation.

c. *Bandages.* Bandages may be improvised from belts, rifle slings, bandoleers, handkerchiefs, or strips torn from such items as clothing and blankets. Narrow materials such as wire or cord should not be used to secure a splint in place.

d. *Slings.* Slings may be improvised by using the tail of a coat or shirt, belts, and pieces torn from such items as clothing and blankets. The triangular bandage is ideal for this purpose.

Section II. IMMOBILIZATION METHODS

8-7. Upper Extremities

Figures 8-2 through 8-8 illustrate the application of splints, slings, and cravats for immobilizing and supporting fractures of the upper extremities. Although the padding is not visible in some of the figures, it is applied along the injured part for the length of the splint.

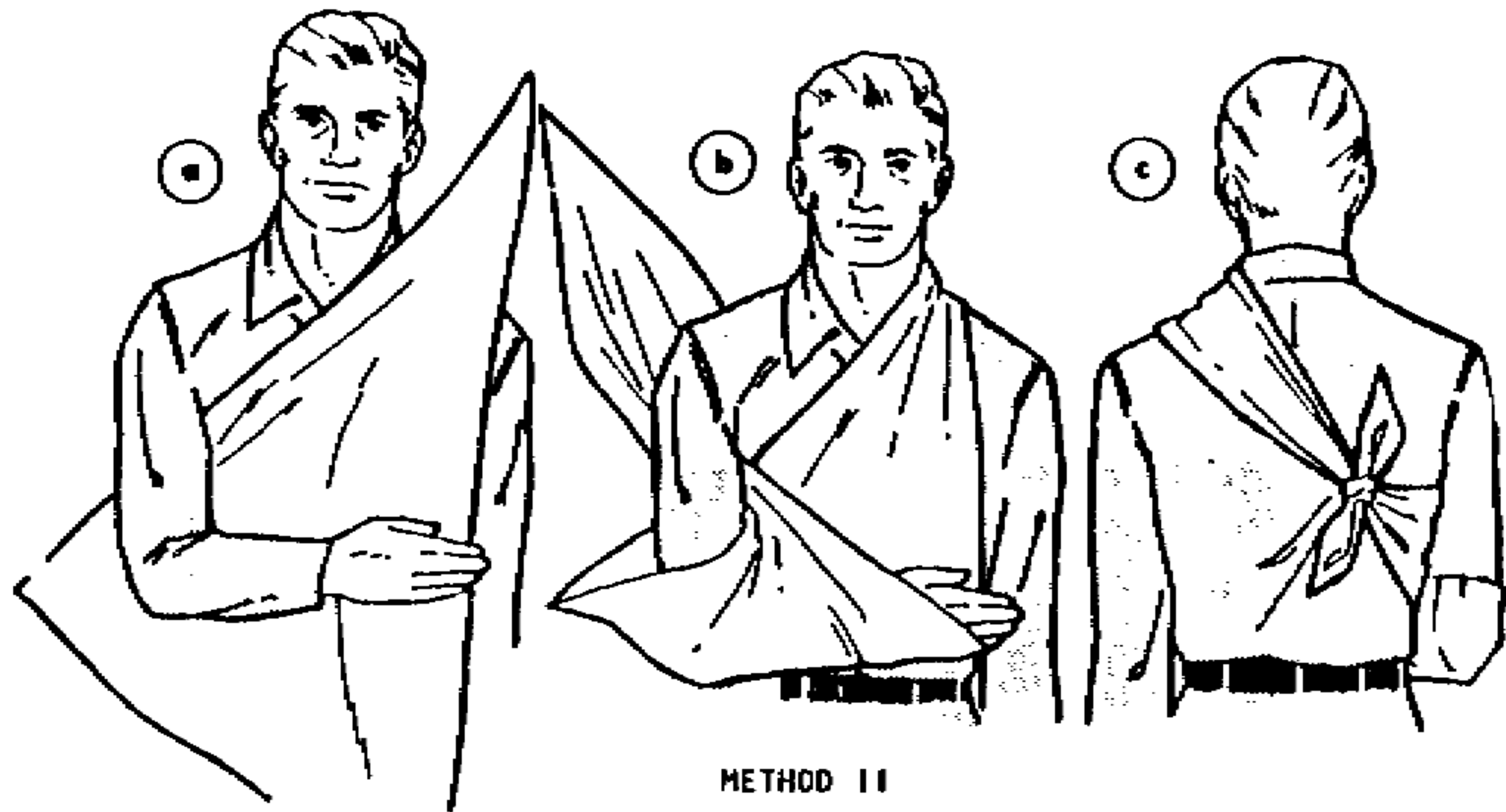
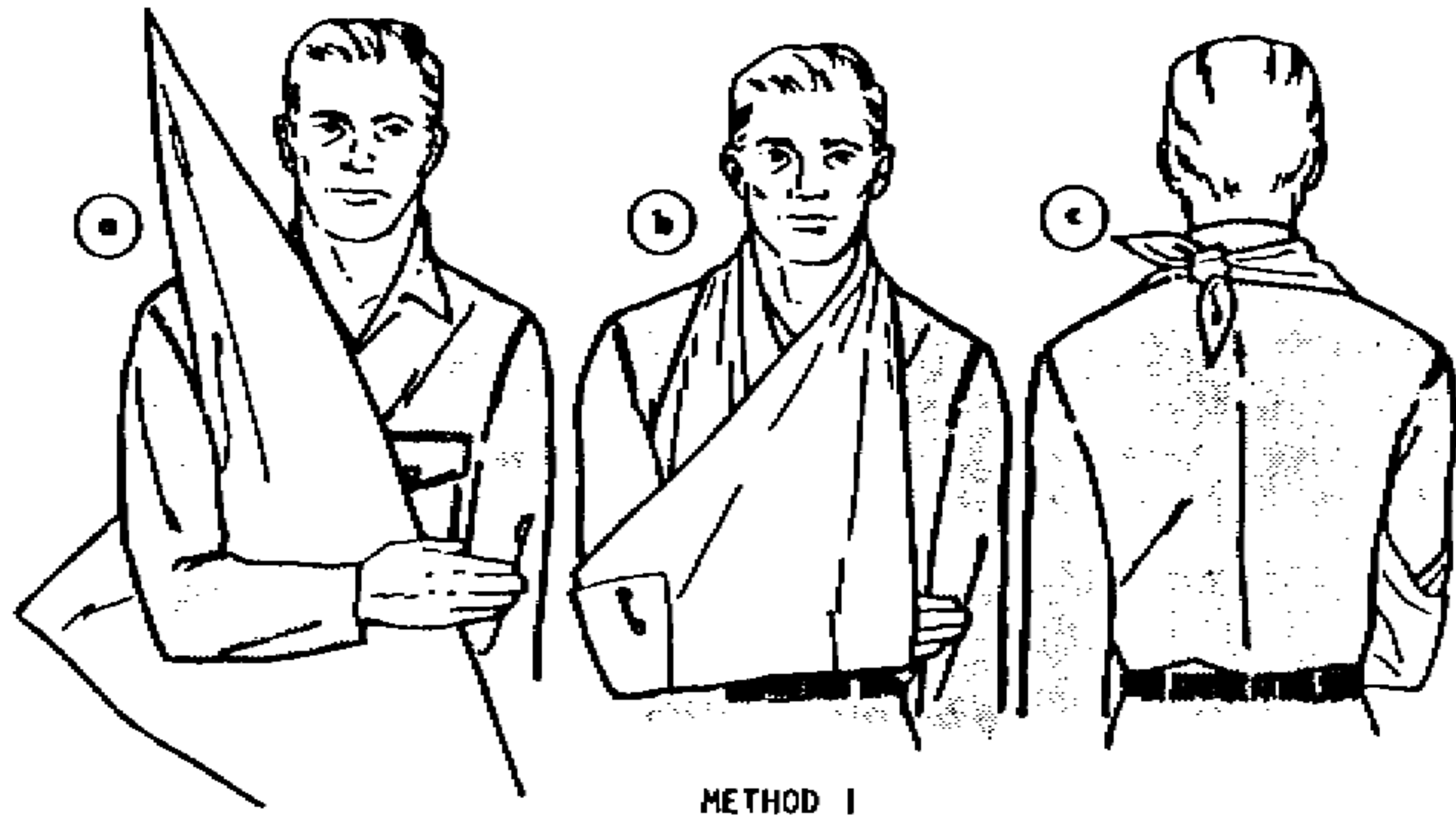

Figure 8-2. Application of a triangular bandage to form a sling (two methods).

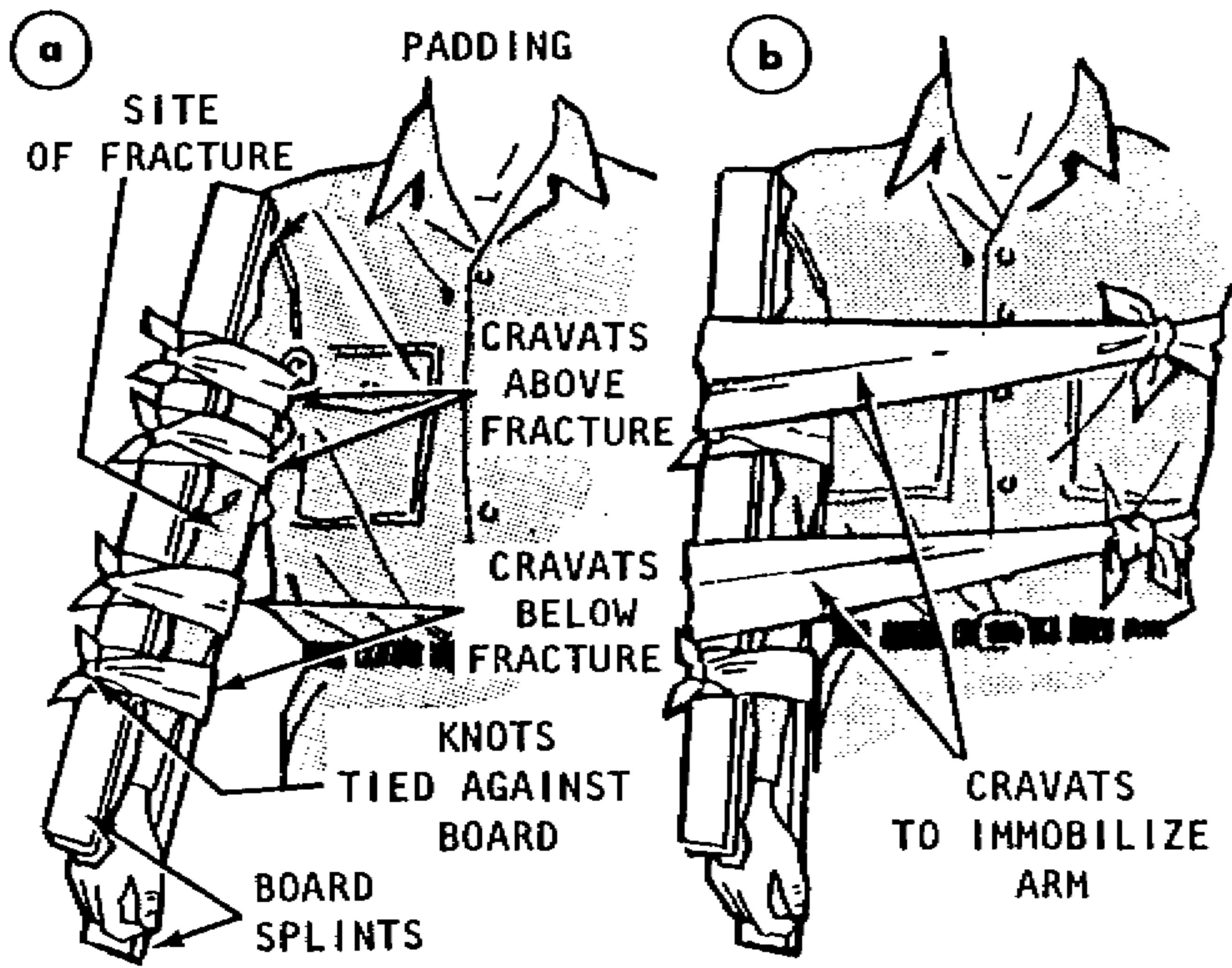

Figure 8-3. Board splints applied to fractured arm or elbow when elbow is not bent.

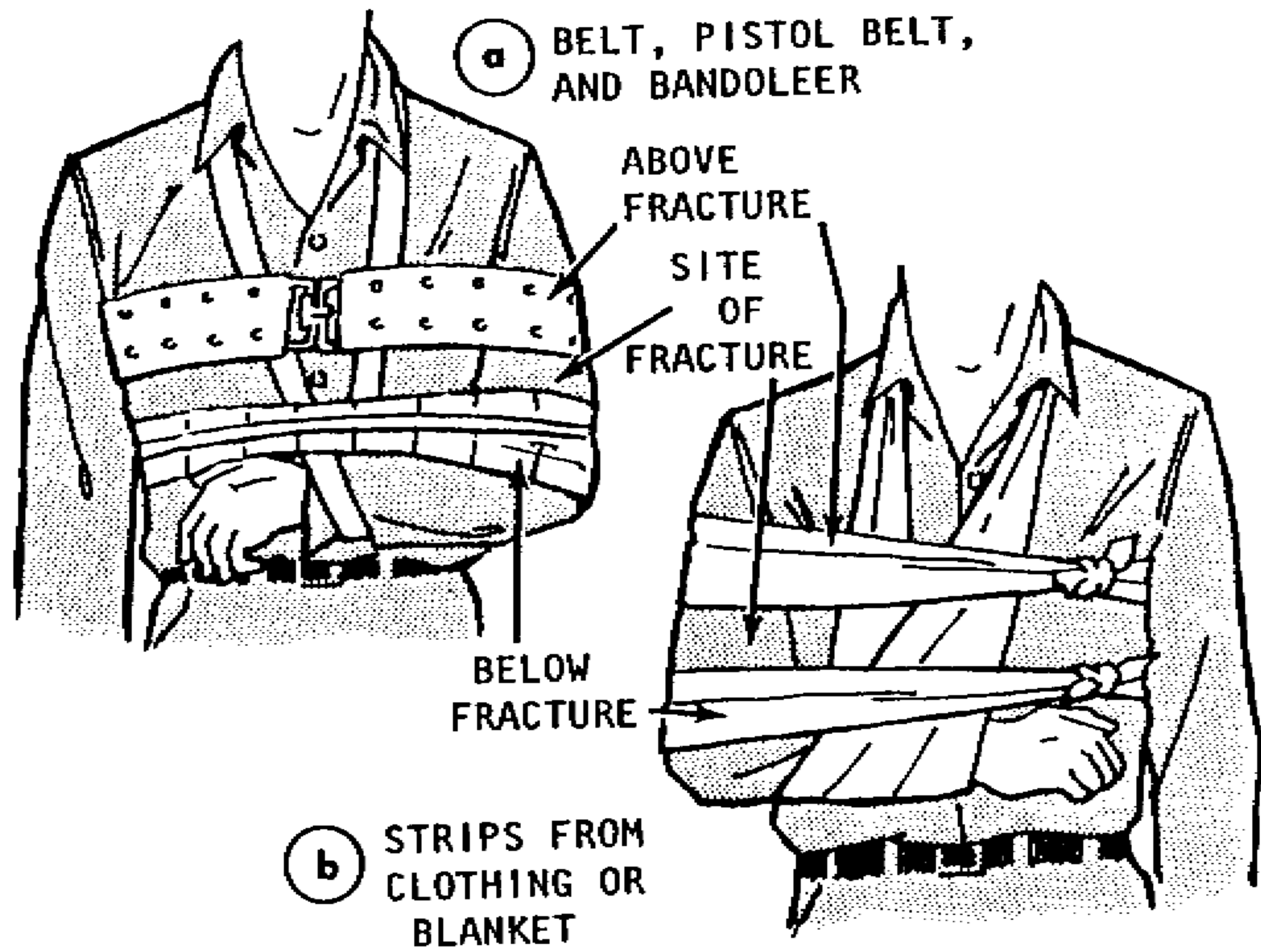

Figure 8-4. Chest wall used as splint for upper arm fracture when no splint is available.

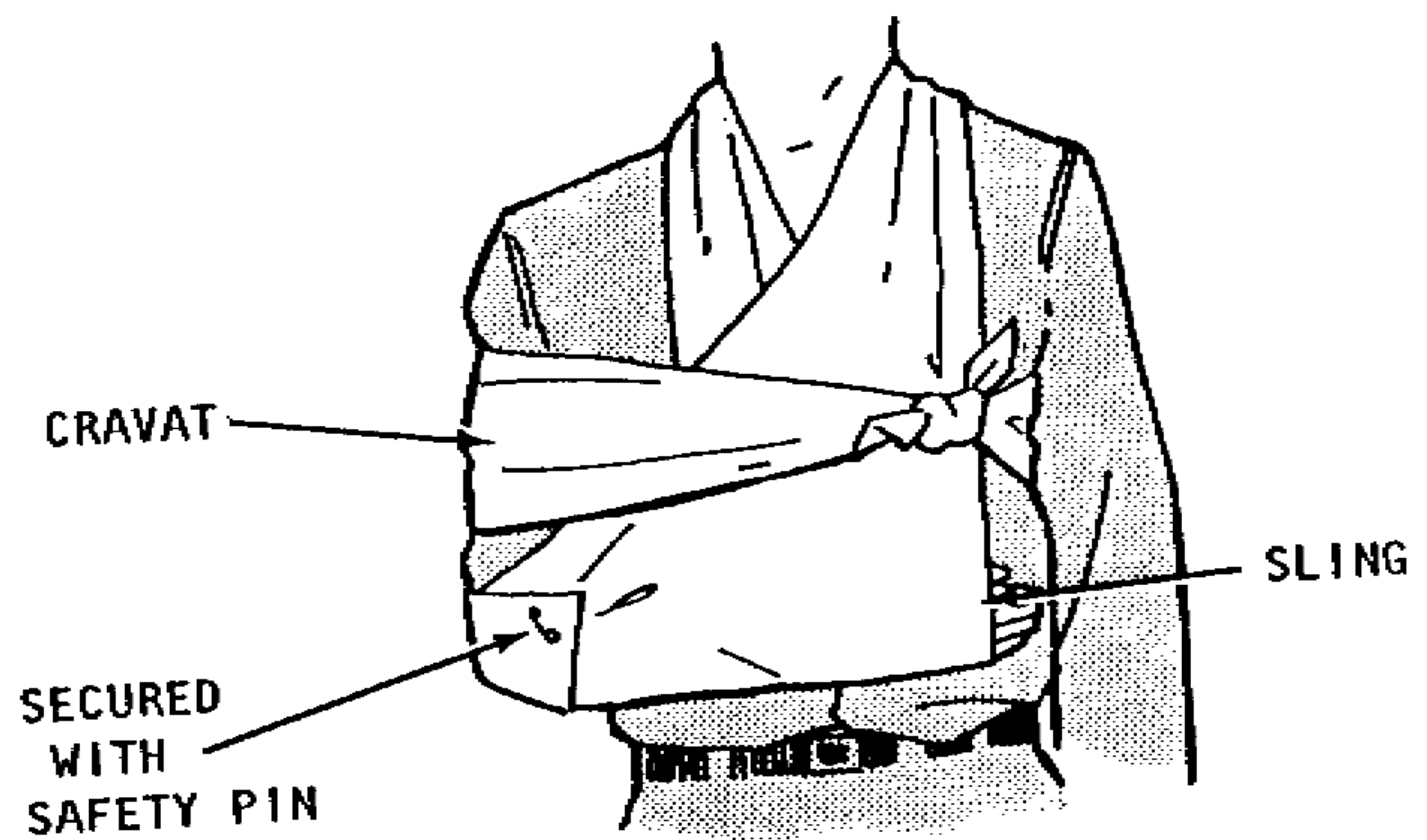

Figure 8-5. Chest wall, sling, and cravat used to immobilize a fractured elbow when elbow is bent.

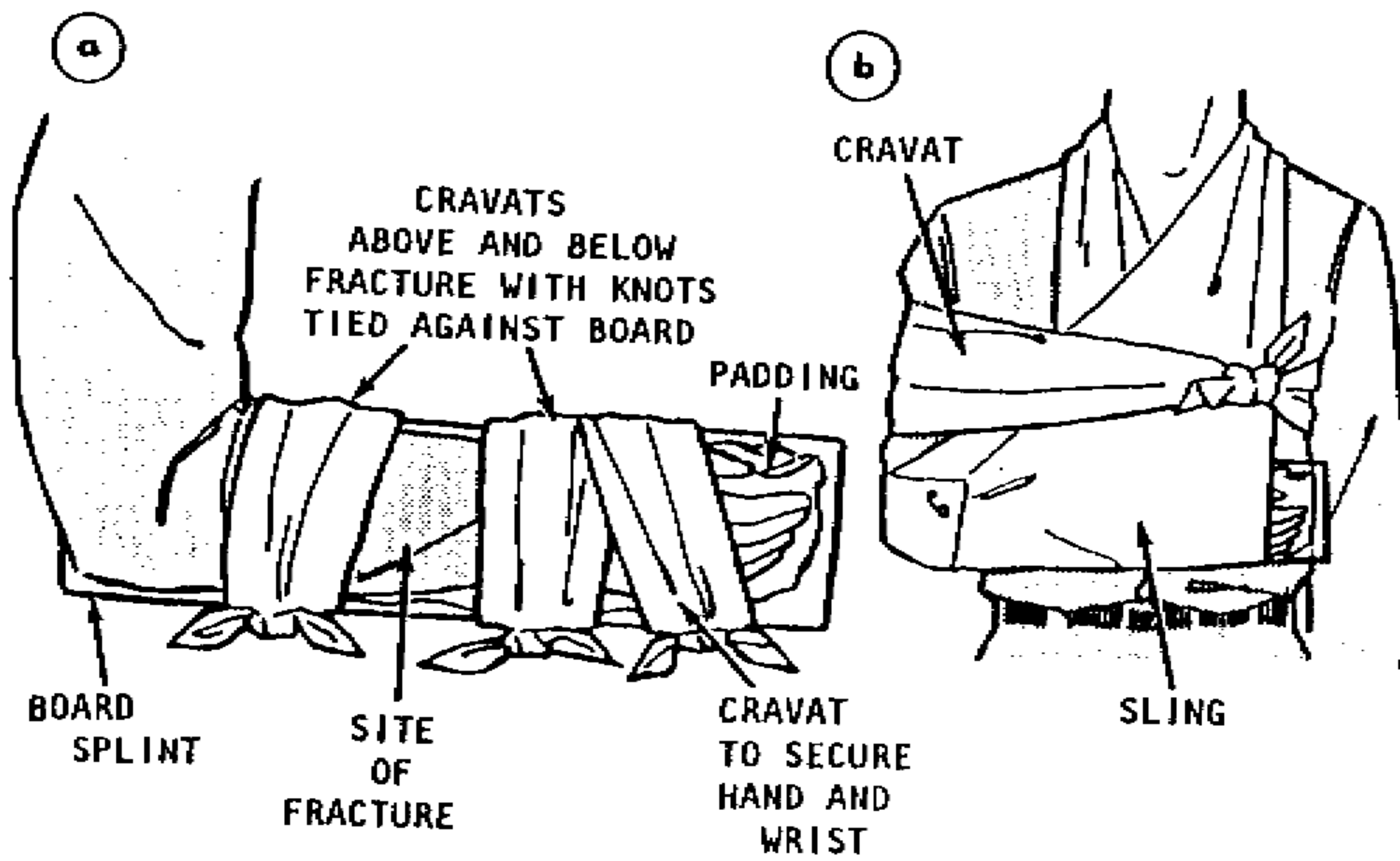

Figure 8-6. Board splint applied to fractured forearm.

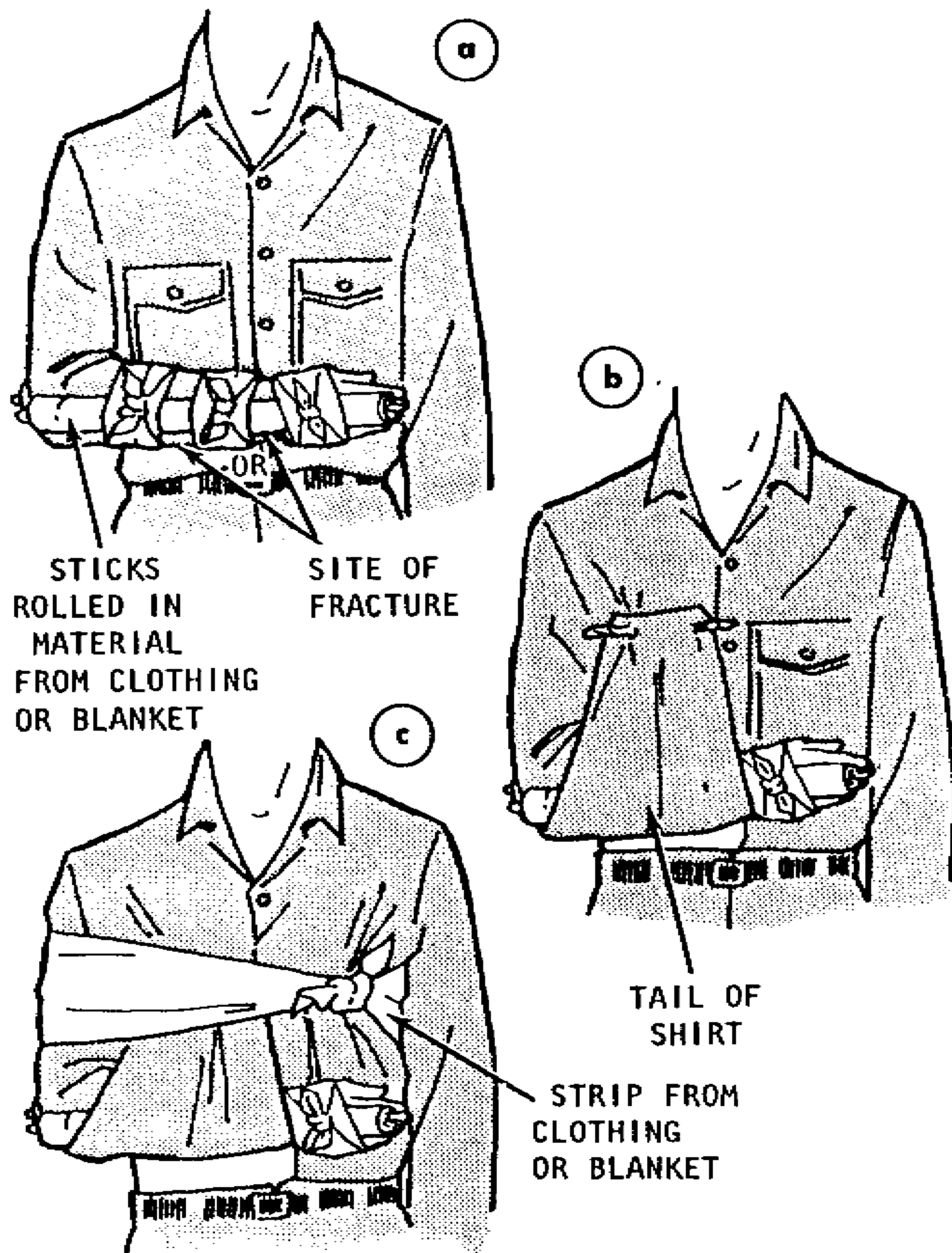

Figure 8-7. Fractured forearm or wrist splinted with sticks and supported with tail of shirt and strips of material.

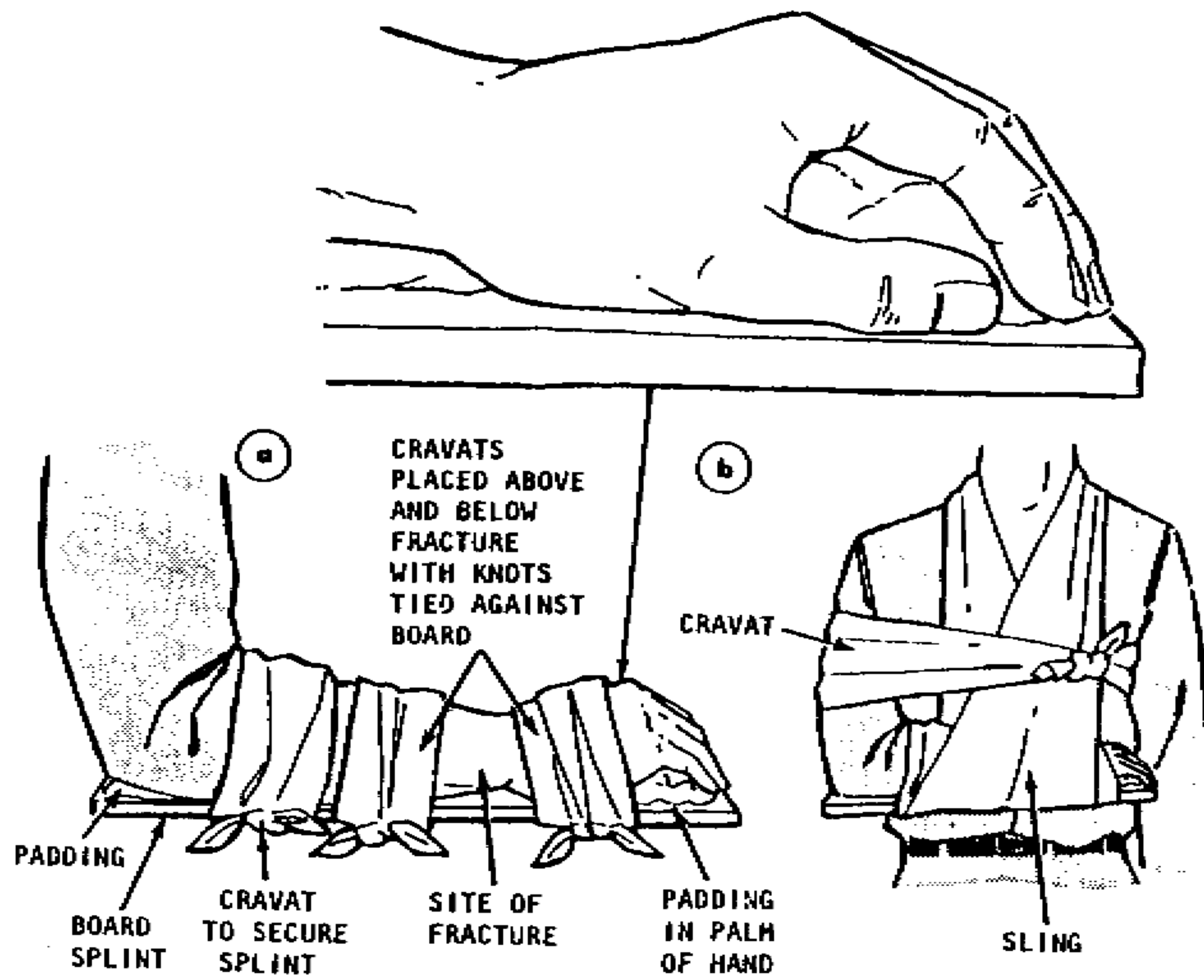

Figure 8-8. Board splint applied to fractured wrist and hand.

8-8. Lower Extremities

Figures 8-9 through 8-13 illustrate the application of splints for immobilizing fractures of the lower extremities. Although the padding is not visible in some of the figures, it is applied along the injured part for the length of the splint.

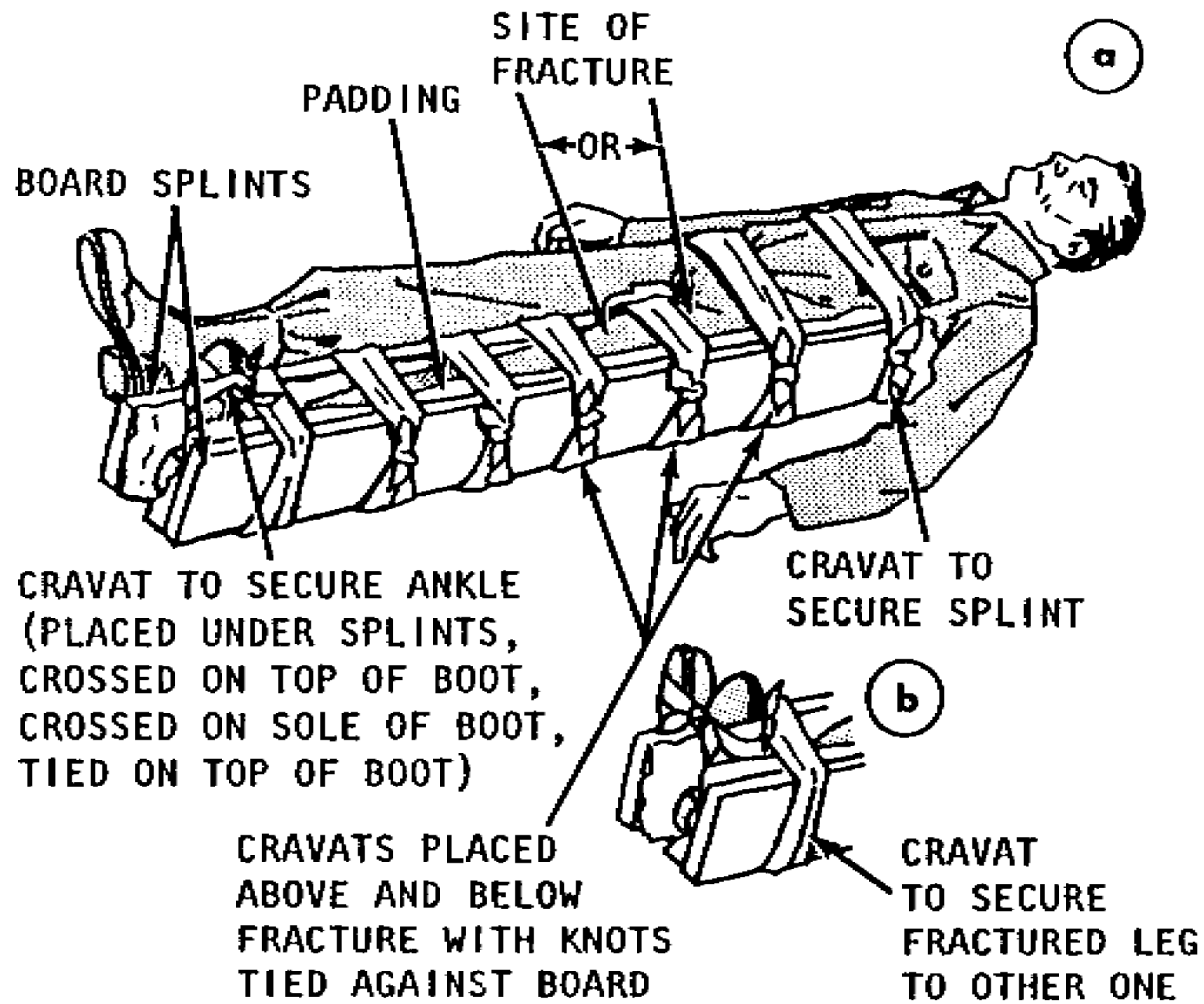

Figure 8-9. Board splints applied to fractured hip or thigh.

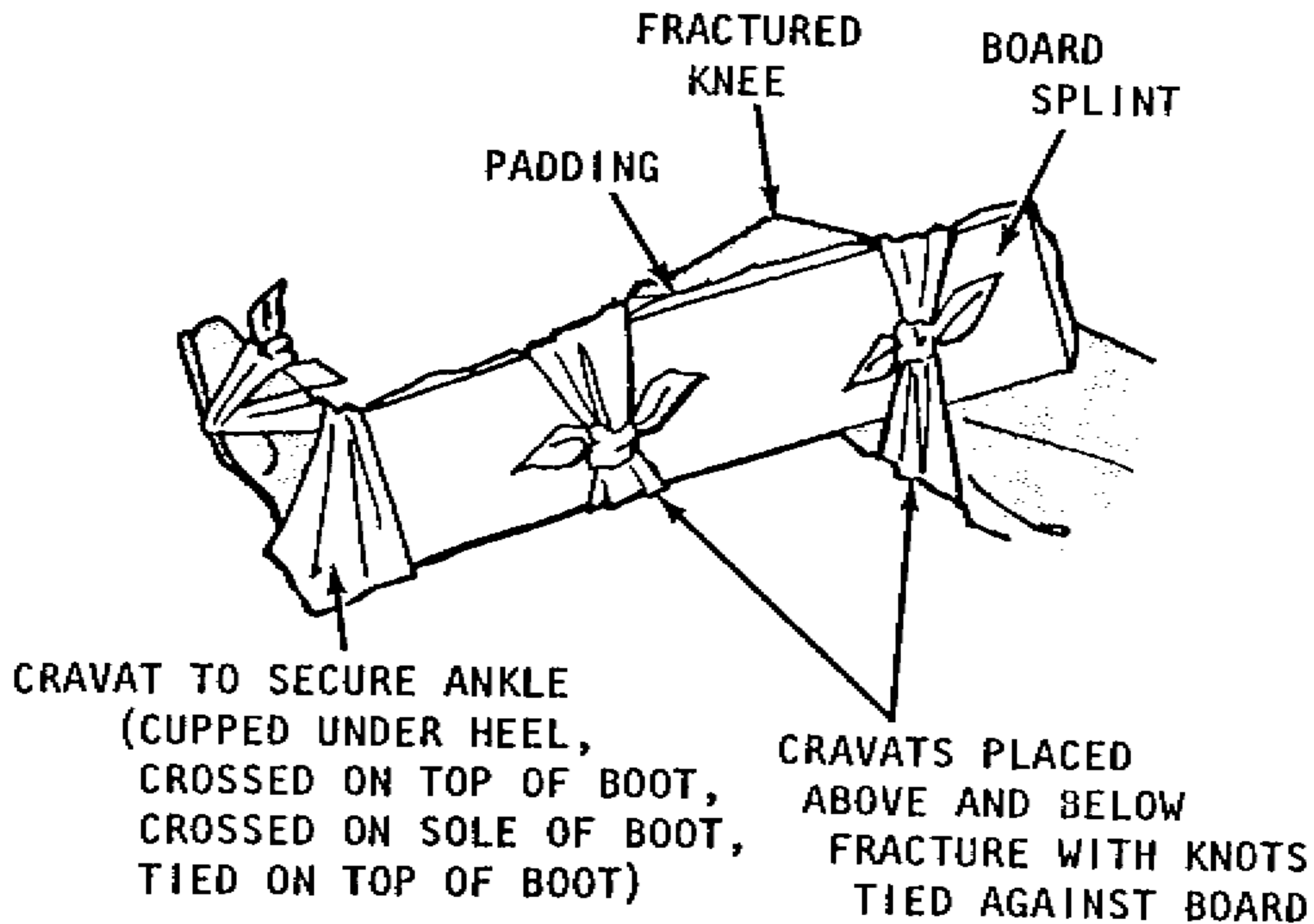

Figure 8-10. Board splint applied to fractured or dislocated knee.

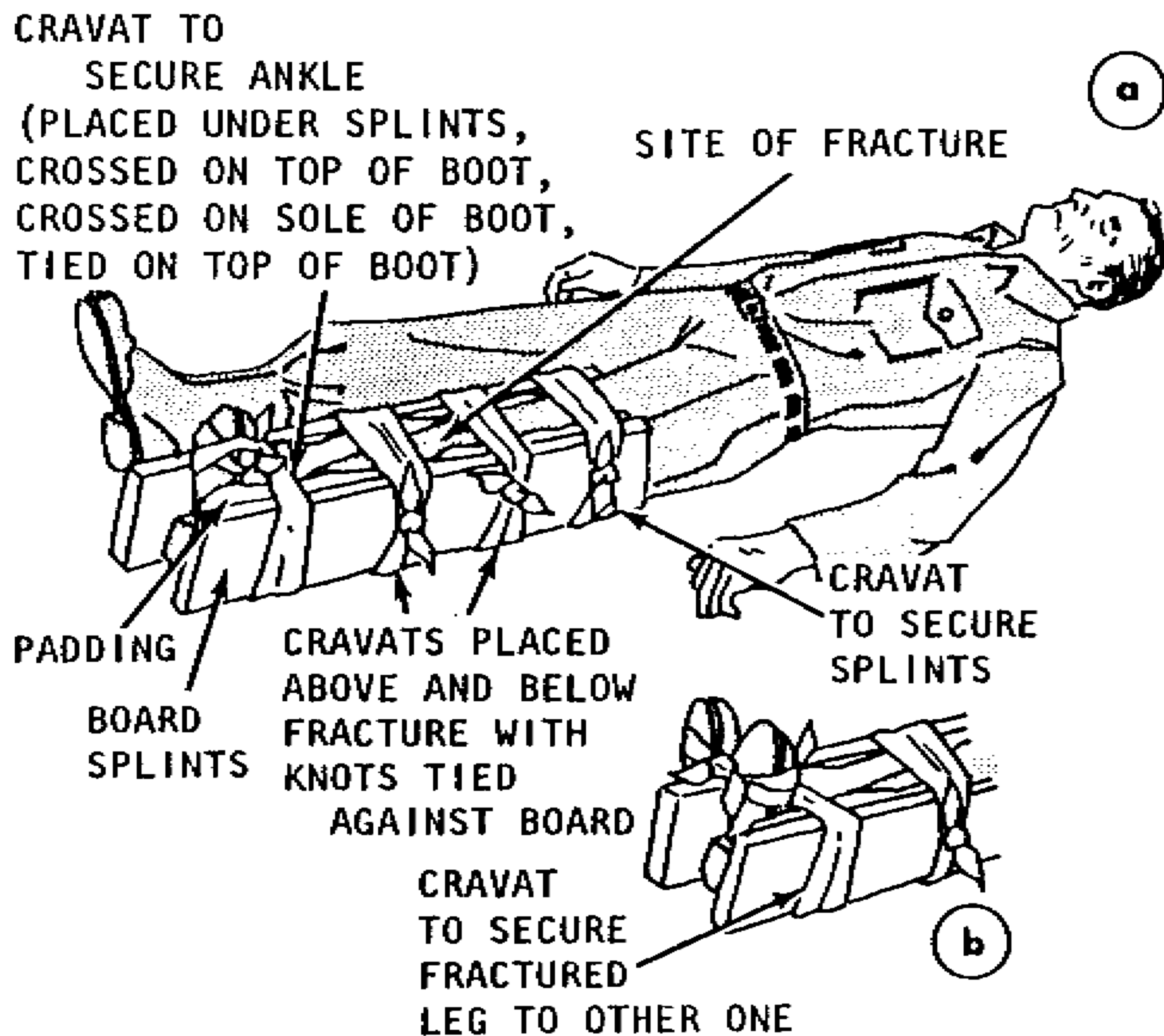

Figure 8-11. Board splints applied to fractured lower leg or ankle.

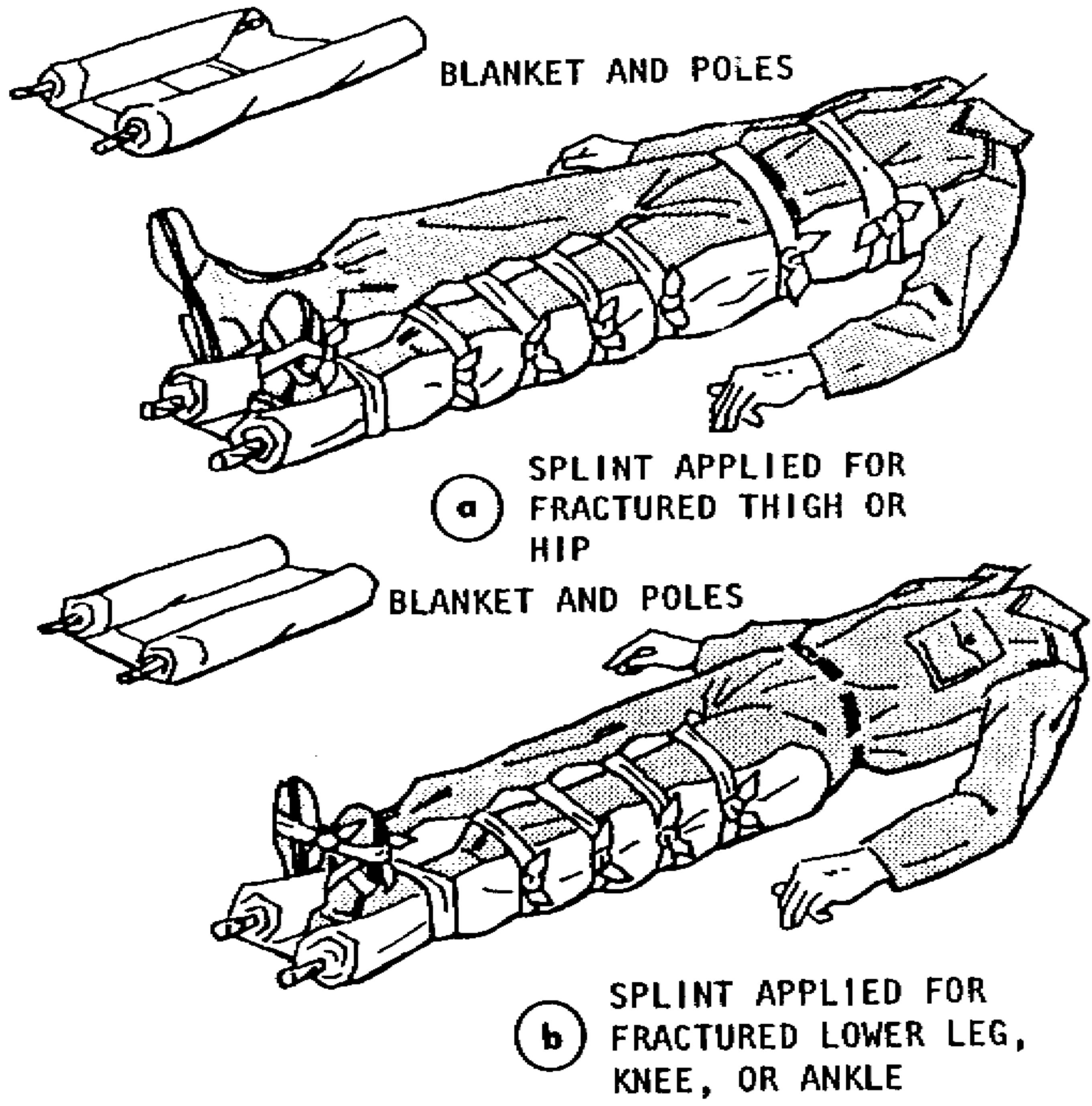

Figure 8-12. Application of splints to lower extremity fractures, using poles rolled in a blanket.

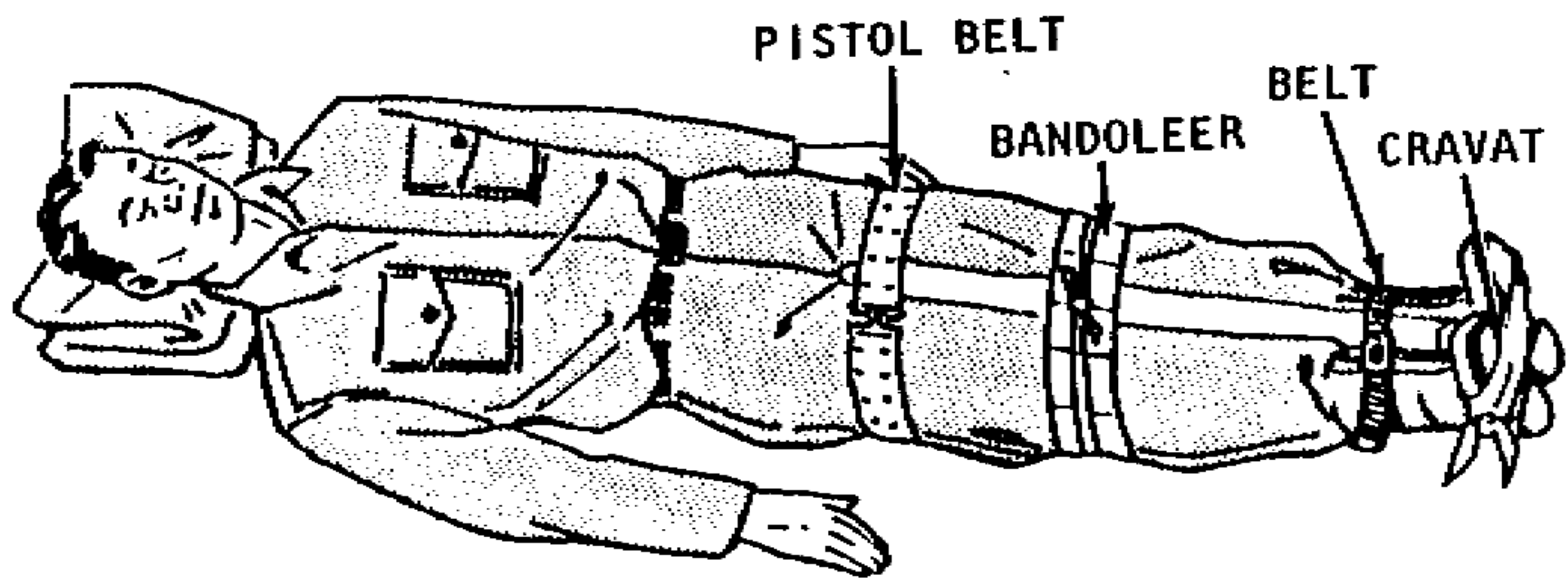

Figure 8-13. Uninjured leg used as splint for fractured one.

8-9. Jaw, Collarbone, and Shoulder

a. Apply a cravat to immobilize a fractured jaw as illustrated in figure 6-9. Direct all bandaging support to the top of the soldier's head and not to the back of his neck, since the latter pulls the jaw back, thus interfering with his breathing.

b. Apply two belts, a sling, and cravat to immobilize a fractured collarbone, as illustrated in figure 8-14.

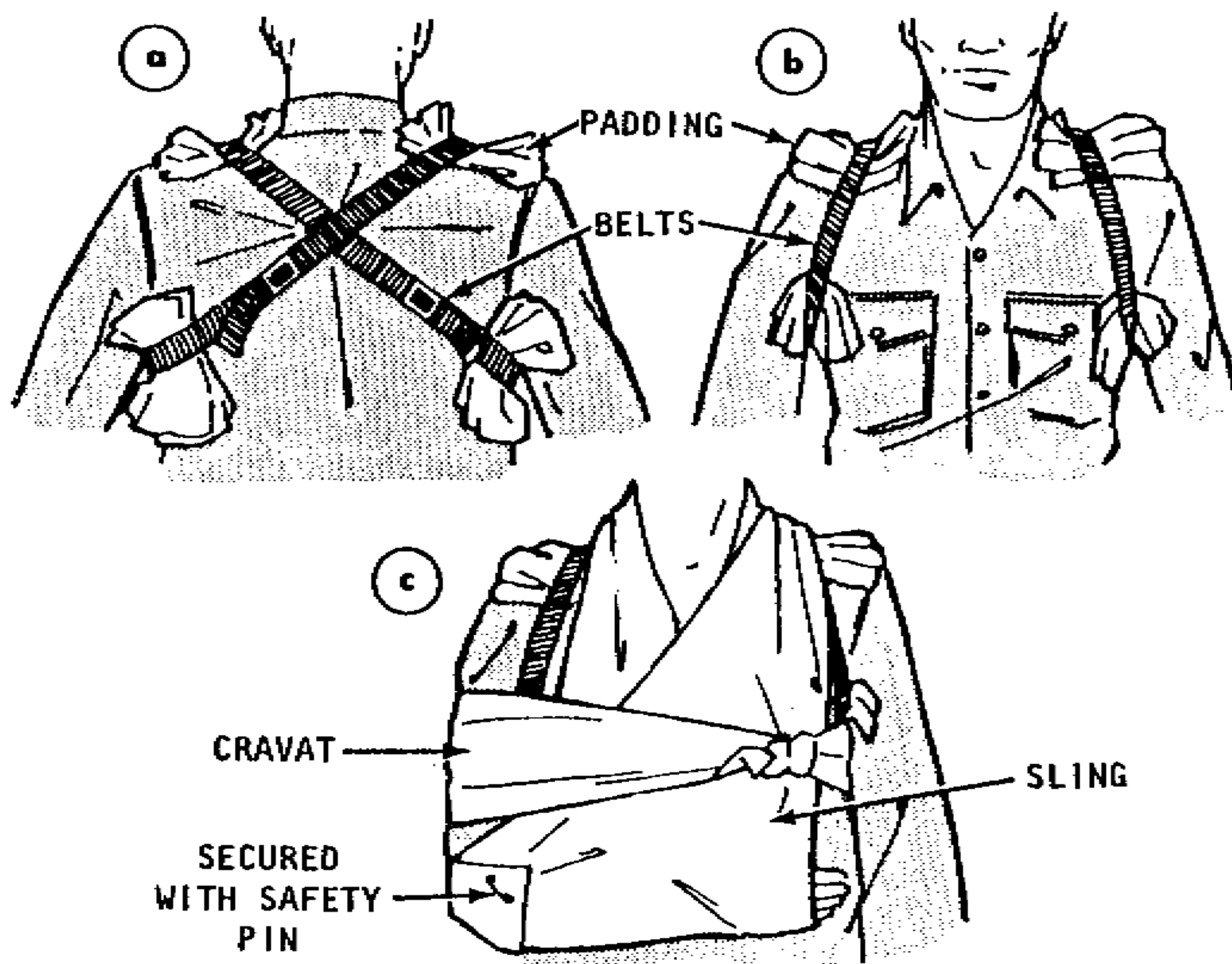

Figure 8-14. Application of belts, sling, and cravat to immobilize a collarbone.

c. Apply a sling and a cravat to immobilize a fractured or dislocated shoulder, using the technique illustrated in figure 8-15.

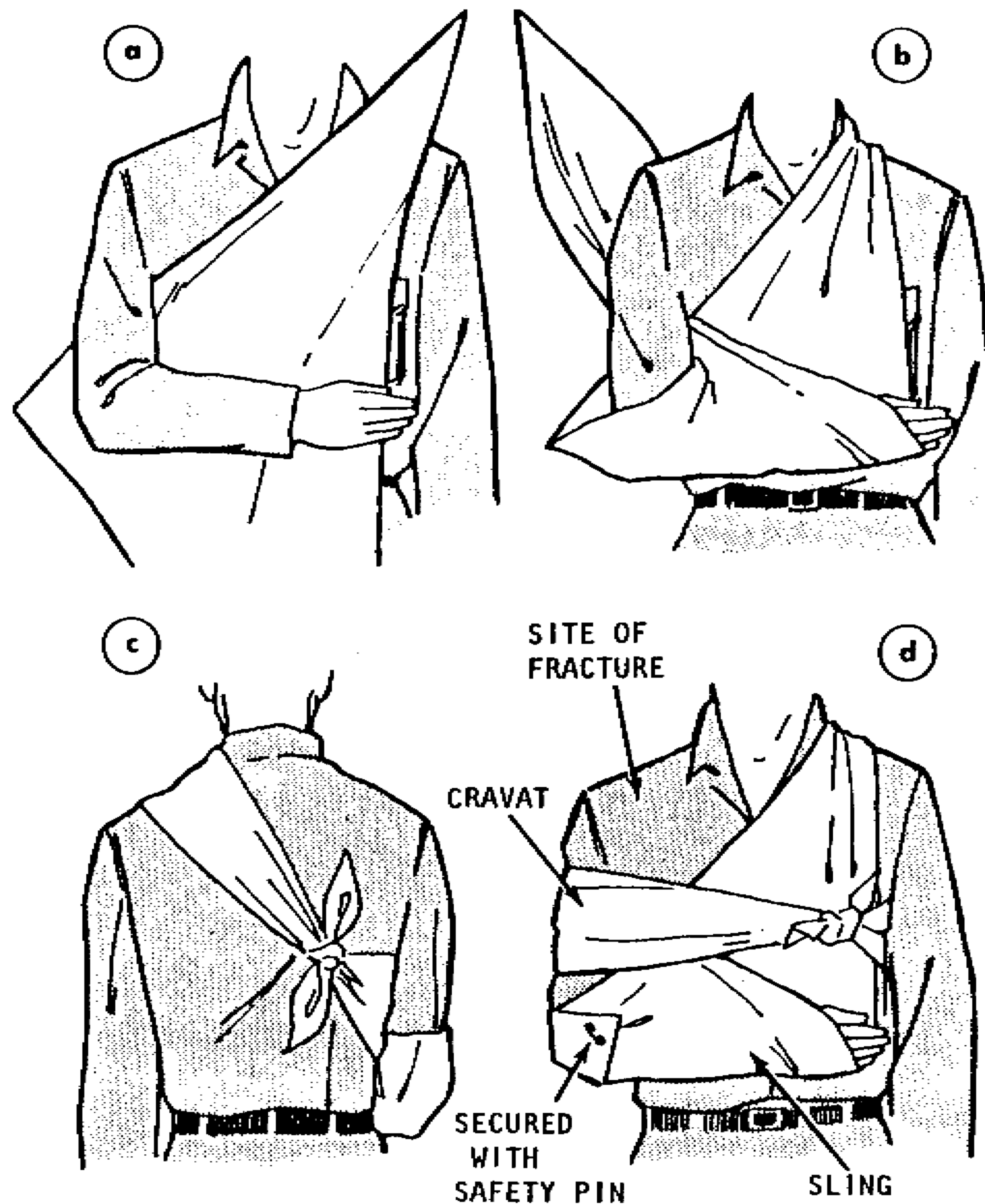

Figure 8-15. Application of sling and cravat to immobilize a fractured or dislocated shoulder.

8-10. Spinal Column

It is often impossible to be sure whether or not a soldier has a fractured spinal column. Be suspicious of any back injury, especially if the soldier has fallen or his back has been sharply struck or bent. If a soldier has received such an injury and he lacks feeling in his legs or lacks the ability to move them, you can be

reasonably sure that he has a severe back injury which should be treated as a fracture. You must remember that, if there is a fracture, bending the spinal column can cause the sharp bone fragments to bruise or cut the spinal cord and result in permanent paralysis. The spinal column must maintain a swayback position to remove pressure from the spinal cord (fig 8-16).

a. Steps To Follow If the Soldier Is Not To Be Transported Until Medical Personnel Arrive.

- (1) If the soldier is conscious, caution him not to move.
- (2) Leave him in the position in which he is found. Do not move any body part.

(3) If he is lying with his face up, slip a blanket or material of similar size under the arch of his back to support the spinal column in a swayback position (b, fig 8-16). If he is lying with his face down, do not put anything under any part of his body.

b. Steps To Follow If the Soldier Must Be Transported to Safe Location Before Medical Personnel Arrive.

(1) *Face-up position.* If the soldier is lying with his face up, transportation must be by litter or a firm substitute such as a

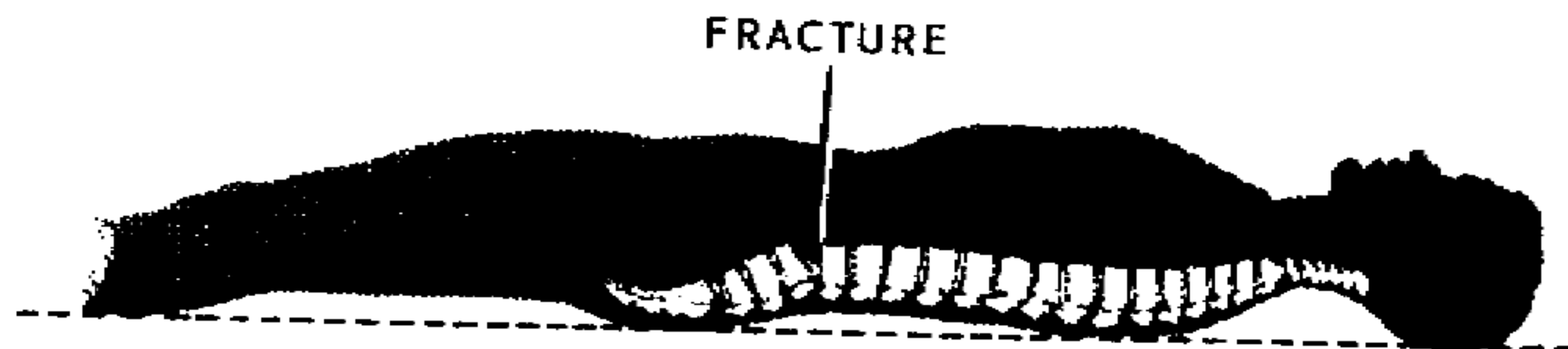

a IN THIS POSITION, BONE FRAGMENTS MAY BRUISE OR CUT THE SPINAL CORD.

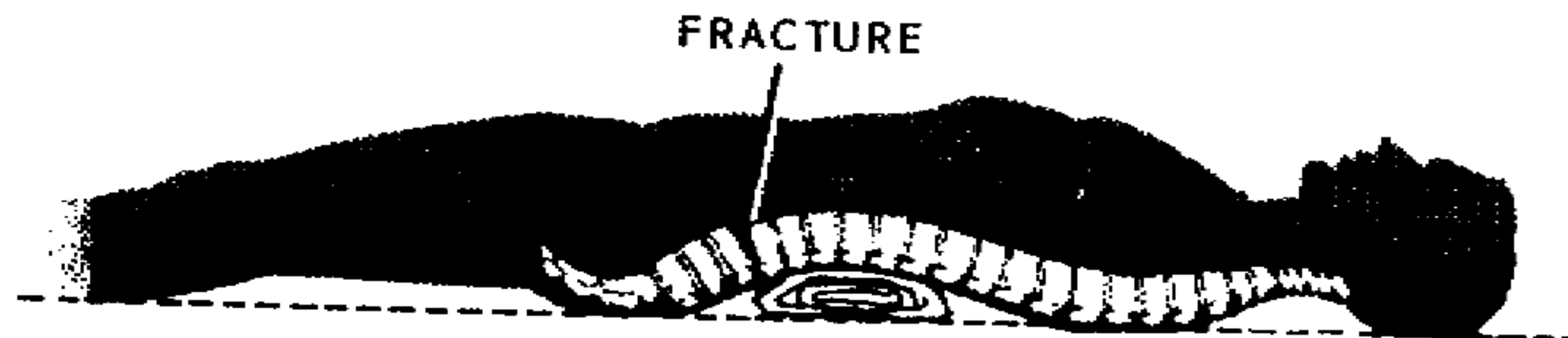

b IN THIS POSITION, BONE FRAGMENTS ARE IN PROPER PLACE AND WILL NOT BRUISE OR CUT THE SPINAL CORD.

Figure 8-16. Fracture of spinal column.

wide board or a flat door longer than the soldier is tall. Tie his wrists together loosely over his waistline with a cravat or strip of cloth. Lay a folded blanket across the litter where the arch of his back is to be placed. Using a four-man team (fig 8-17), place the soldier on the litter without bending his spinal column:

(a) Kneeling on the knee nearer the soldier's feet, No. 2, 3, and 4 men position themselves on one side of the soldier. No. 1 man positions himself on the opposite side. No. 2, 3, and 4 place their hands as illustrated in figure 8-17. No. 1 assists in lifting at the site of the fracture.

(b) All men in close coordination gently lift the soldier about 8 inches; then No. 1 slides the litter under the soldier, insures that the blanket is in proper position, and returns to his original position.

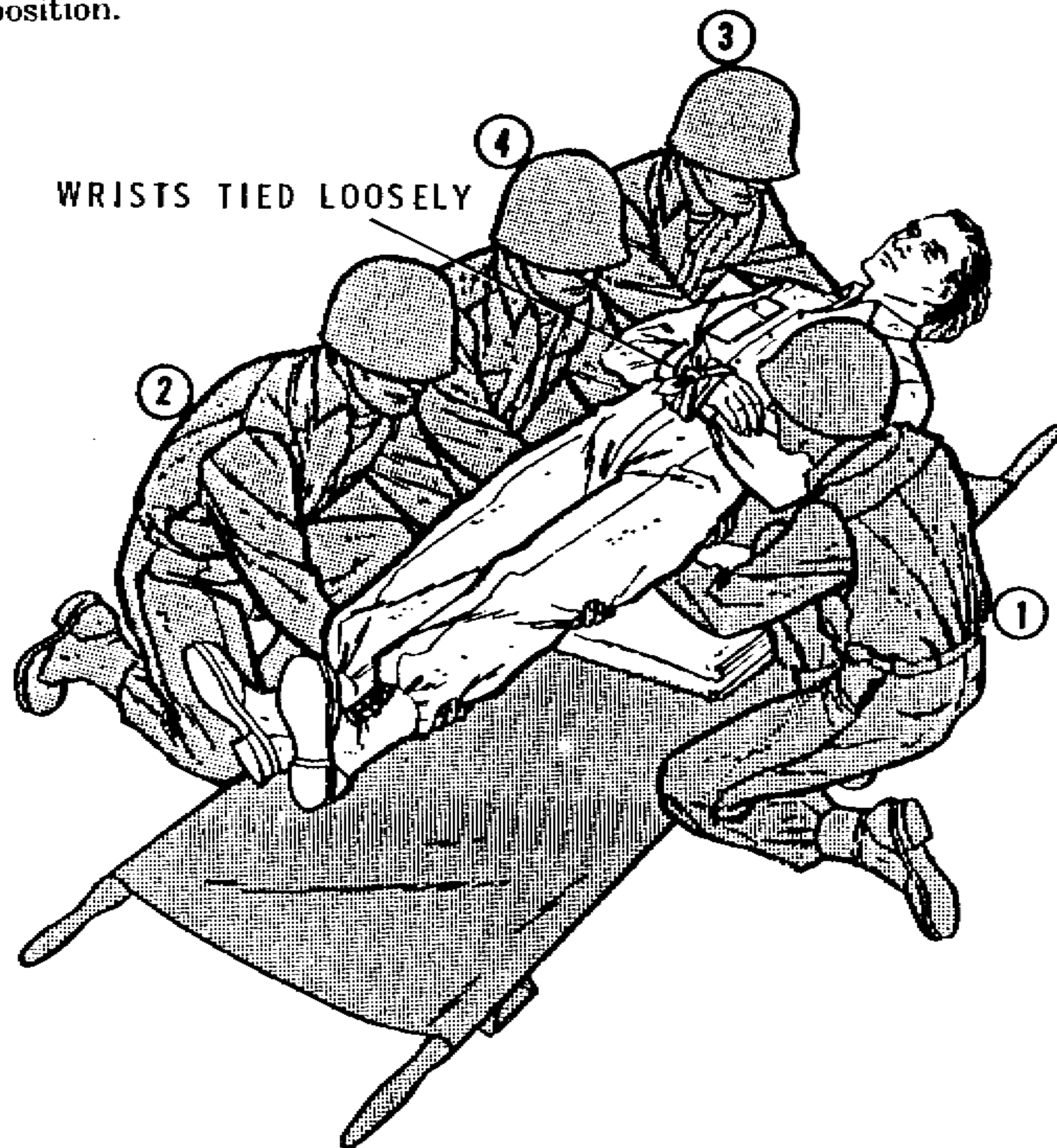

Figure 8-17. Placing a soldier with a fractured back onto a litter.

(c) All men in close coordination gently lower the soldier onto the litter.

(2) *Face-down position.* If the soldier is lying with his face down, he must be transported in this same position. Using the four-man team, lift him onto a regular litter or a blanket roll litter (para 10-5), keeping the spinal column in a swayback position. If a regular litter is to be used, first place a folded blanket on the litter at the point where the chest will be placed.

8-11. Neck

A fractured neck is extremely dangerous. Bone fragments may bruise or cut the spinal cord just as in the case of a fractured back.

a. Steps To Follow If the Soldier Is Not To Be Transported Until Medical Personnel Arrive.

(1) If the soldier is conscious, caution him not to move. Moving may cause death.

(2) Leave the soldier in the position in which he is found. If the neck is in an abnormal position, immobilize it in this position ((4) below).

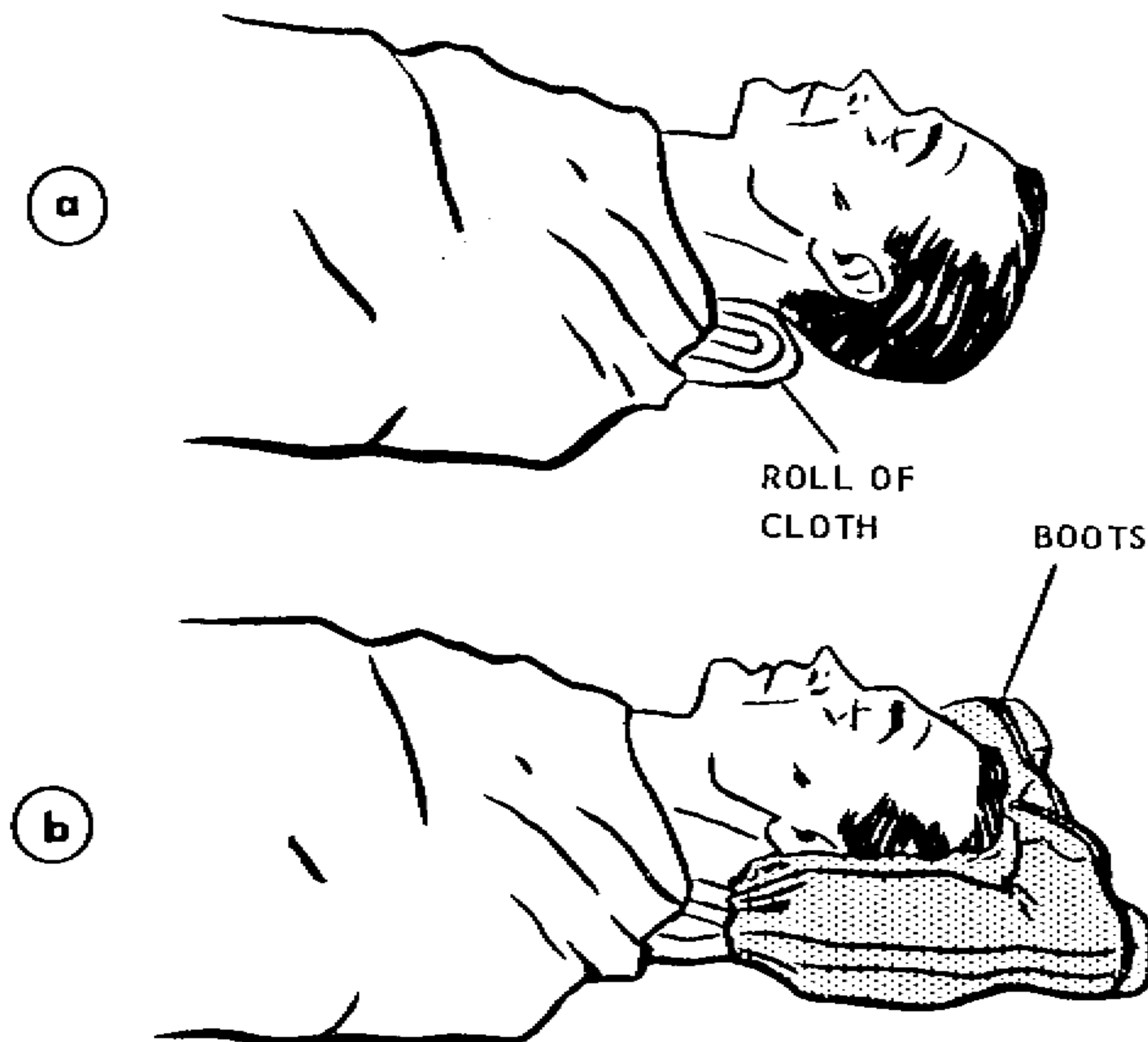

Figure 8-18. Immobilization of a fractured neck.

(3) If he is lying with his face up, keep his head still, raise his shoulders *slightly*, and slip a roll of cloth which has the bulk of a bath towel under his neck (a, fig 8-18). The roll should be thick enough to arch the neck only slightly, leaving the back of his head on the ground. Do not bend the neck or head forward. Do not raise or twist the head.

(4) Immobilize the soldier's head (b, fig 8-18). This may be accomplished by padding heavy objects such as rocks or his boots and placing them on each side of his head. If it is necessary to use his boots, they should first be filled with stones, gravel, sand, or dirt and tied tightly at the top. It may be necessary to stuff pieces of material in the tops of the boots to secure the contents.

b. Steps To Follow If the Soldier Must Be Prepared for Transportation Before Medical Personnel Arrive. The services of at least two persons are necessary to prepare a soldier with a fractured neck for transportation because the head and trunk must be moved in unison. The two persons must work in close coordination to avoid bending the neck in any way. The proper procedure is described as follows:

(1) Place a wide board lengthwise beside the soldier. It should extend at least 4 inches beyond his head and feet (a, fig 8-19).

(2) If the soldier is lying with his face up, No. 1 man steadies his head and neck between his hands while No. 2 man with one foot and one knee placed against the board to prevent it from slipping grasps the soldier at his shoulder and hip and gently slides him onto the board (b, fig 8-19).

(3) If the soldier is lying with his face down, No. 1 man steadies the soldier's head and neck between his hands while No. 2 man gently rolls him over onto the board (c, fig 8-19).

(4) No. 1 man continues to steady the soldier's head and neck while No. 2 man raises his shoulders *slightly*, places padding under his neck (a(3) above), and immobilizes his head. The head may be immobilized with his boots, with stones rolled in pieces of blanket, or with other material (d, fig 8-19).

(5) Secure any improvised supports ((4) above) in position with a cravat or strip of cloth extended across the soldier's forehead and under the board (d, fig 8-19).

(6) Lift the board onto a litter or blanket, as available, to transport him (e, fig 8-19).

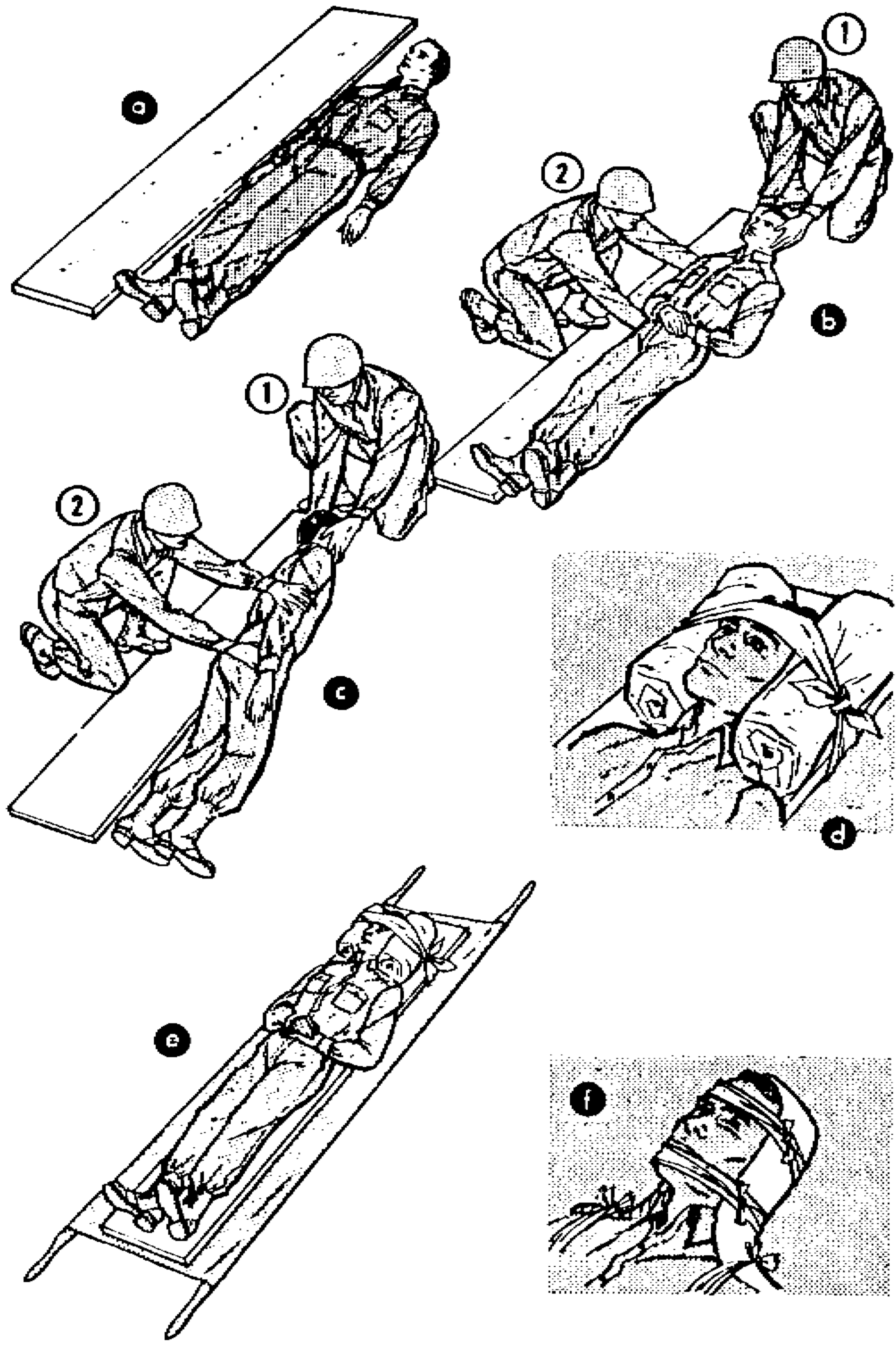

Figure 8-19. Preparing a soldier with a fractured neck for transportation.

CHAPTER 9

FIRST AID FOR COMMON EMERGENCIES

9-1. Minor Wounds

Most small wounds, such as cuts, do not usually bleed very much. Infection from contamination (para 6-1) is the principal danger. If you receive a minor wound, take the following first aid measures:

a. Do not allow anything to touch the wound, except as described in *b* and *c* below.

b. Wash the surrounding skin thoroughly with soap and water. Gently clean the wound. If a disinfectant solution (tincture of benzalkonium or another acceptable solution) is available, apply it to the wound. (In no instance should solutions stronger than 1:750 be used.)

c. Place a sterile compress over the wound without allowing it to touch anything else and secure it in place with a bandage.

9-2. Minor Burns

Minor burns may be caused by exposure to dry heat, hot liquids, chemicals, electricity, or rays of the sun. If you receive a minor burn, you should immerse it or flush it with the coldest water available until the pain subsides (usually about 5 minutes). Minor burns are of two types:

a. *Small Burns Which Include Blistering or Charring.* Since the skin is most likely to break when it is blistered or charred, cover it with a sterile compress to protect it from contamination and possible infection. Do not attempt to break the blisters. Secure the compress in place with a bandage.

b. *Burns With No Blistering or Charring.* If the burn does not cause the skin to blister, char, or break, it is a minor burn even

though it may cover a large area of the body, as in mild sunburn. It is not necessary to cover such a burn with sterile compress.

9-3. Foreign Body in the Eye

a. If a foreign particle gets into the eye, do not rub the eye. If the particle is beneath the upper eyelid, grasp the eyelashes of the upper lid and pull the lid up and away from contact with the surface of the eyeball. Hold the eyelid in this manner until tears flow freely. The tears will frequently flush out the particle. If this technique fails, attempt to remove it as shown in figure 9-1.

b. If the foreign particle is glass or metal or it cannot be removed by the techniques described in *a* above and illustrated in figure 9-1, bandage both of the soldier's eyes (fig 6-8) and get him to a medical treatment facility.

Note: If only one eye is bandaged, the soldier will use his unaffected eye. Since eye movements are synchronized, use of the unaffected eye may result in movement of the affected one, thereby subjecting it to further injury.

c. If caustic or irritating material, such as battery acid, ammonia, et cetera, gets into the eye, immediately flush it with a large volume of water. To flush the right eye, turn the head to the right side; to flush the left eye, turn the head to the left side. This prevents the caustic or irritating material from being washed into the other eye. The soldier should be immediately evacuated to the nearest medical treatment facility for care to prevent further damage.

9-4. Foreign Body in the Ear, Nose, or Throat

a. Never probe in an attempt to remove a foreign body from the ear. An insect in the ear may be removed simply by attracting it with a flashlight held to the ear. If this fails, it may be drowned or immobilized by pouring water into the ear. Foreign objects in the ear can sometimes be flushed out with water. However, if the object is something which will swell when wet, such as a seed or particle of wood, do not pour water into the ear.

b. Probing into the nose will generally jam a foreign object tighter. Damage to the nasal passages can also result. Try to remove the object by gently blowing the nose. If this fails, seek medical aid.

c. Coughing will frequently dislodge a foreign object from the throat. If this fails and the object can be reached, try to remove it with the fingers; but be careful to avoid pushing it farther down



a

INSPECT EYEBALL AND LOWER LID. GENTLY REMOVE OBJECT WITH MOIST CLEAN CORNER OF HANDKERCHIEF.

b

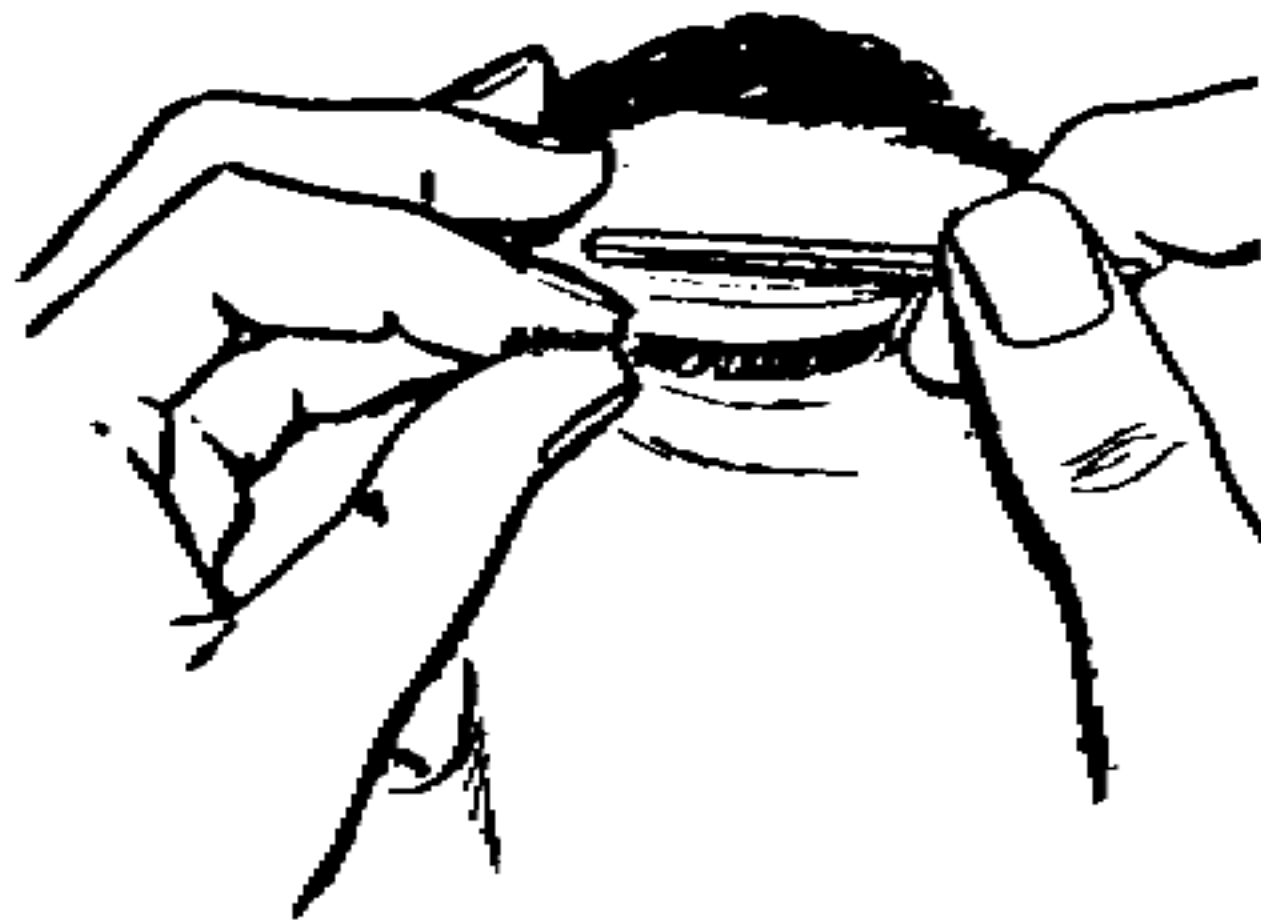

IF THE OBJECT IS NOT IN LOWER LID, INSPECT UPPER LID. GRASP EYELASHES WITH THUMB AND INDEX FINGER AND PLACE MATCH STICK OR SMALL TWIG OVER LID.

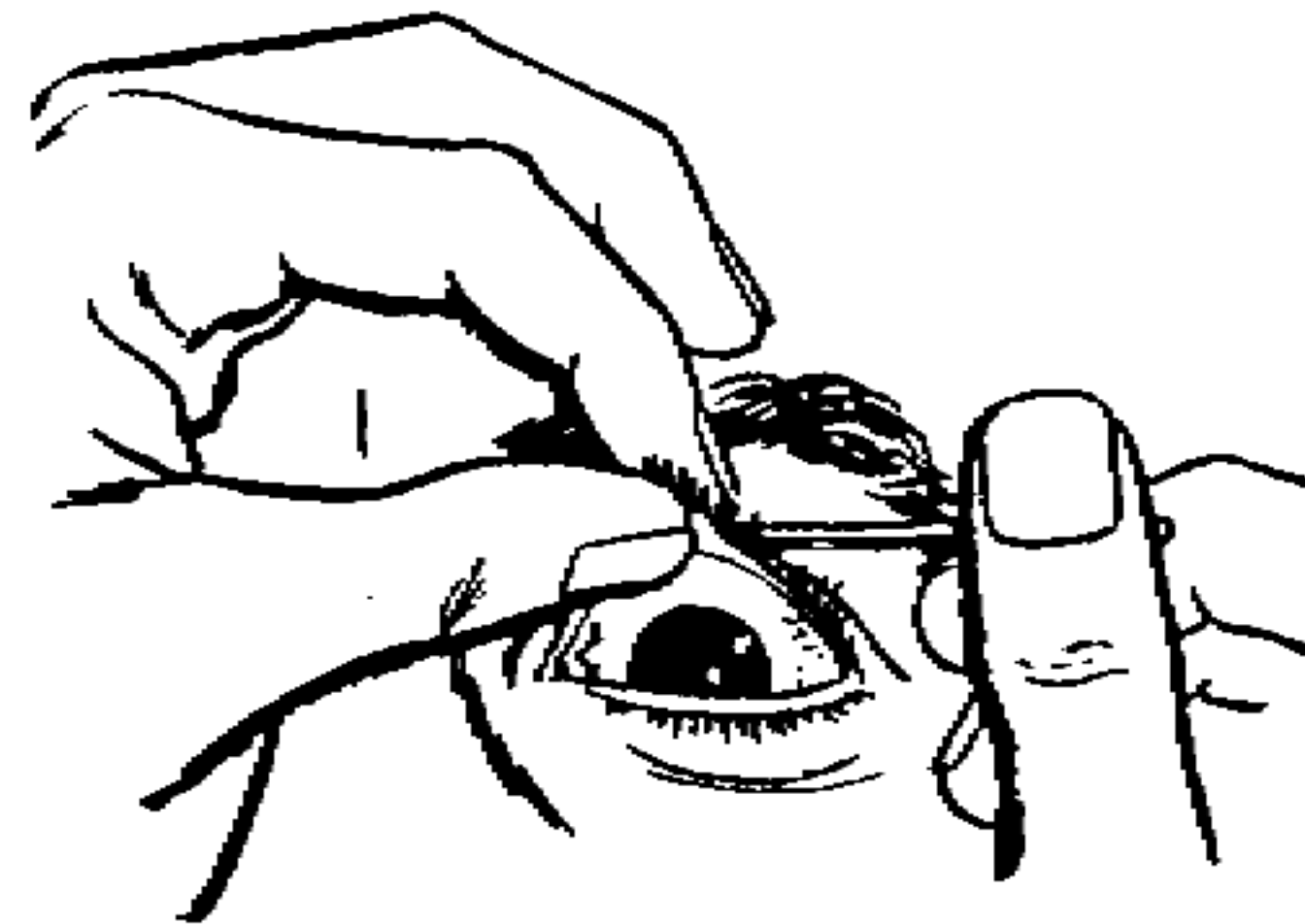

PULL LID UP AND OVER STICK. EXAMINE INSIDE OF LID WHILE THE CASUALTY LOOKS DOWN. GENTLY REMOVE PARTICLE WITH CLEAN CORNER OF HANDKERCHIEF.

Figure 9-1. Removing a foreign particle from the eye.

the throat. There is great danger of respiratory obstruction if the object cannot be removed, so get medical aid as quickly as possible. An alternate method, the Heimlich hug, is described in paragraph 9-14.

9-5. Foot Trouble

Foot trouble can be avoided by taking proper care of the feet as discussed in FM 21-10. Should you develop foot trouble such as a callus or corn, a blister, or athlete's foot, get medical aid. Do not

cut a callus or corn, as this can cause a serious infection. If the blister develops, seek medical aid. Meanwhile, thoroughly wash the blister with soap and water and apply a first aid dressing.

9-6. Snake and Spider Bites and Scorpion Stings

Bites from snakes, black widow spiders, and brown recluse spiders and stings from scorpions can be prevented by following the measures discussed in FM 21-10. Should a soldier receive a bite or sting from one of these venomous animals, the first aid measures outlined below should be followed:

a. Snake Bite.

(1) Reassure the soldier and keep him quiet. Within practical limits achieve immediate, absolute immobilization of the affected part in a position below the level of the heart.

(2) If the bite is on an extremity, place an improvised *lightly* constricting band (shoestring, bootlace, handkerchief, strip of cloth) between the bite site and the heart at a point 2 to 4 inches above the site of the bite. If swelling progresses up the arm or leg, reapply this constricting band ahead of the swelling. The constricting band should be applied tightly enough to stop the flow of blood in the vessels near the skin surface but not tightly enough to stop the arterial flow or the pulse. You should be able to insert a finger between the band and the limb. As soon as the veins under the skin stand out prominently, the appropriate flow of blood has been properly halted. Also, the presence of a pulse in the part below the band indicates the continuance of arterial flow. The pulse can be checked by placing two fingers, not the thumb, over the pressure point in the wrist or ankle as appropriate (fig 4-2). Do not attempt to cut open the bite or suck out the venom.

(3) Remove all watches, rings, and bracelets from the bitten limb. Tissue swelling makes their removal painful and difficult at a later time.

(4) Continue to reassure the soldier but do not give him alcohol or medication.

(5) Since medical aid is urgent in all cases of poisonous snake bite, send someone to summon assistance. If a litter or a vehicle is available, transport the soldier to the nearest medical treatment facility at once. The snake should be killed (if possible, without damaging its head) and taken along so that it can be identified to aid medical personnel in determining the proper antivenom serum for the soldier.

(6) Observe him closely for signs of difficult breathing, since

some types of snake poison affect the breathing mechanism. Should breathing stop, initiate artificial respiration (chap 3) at once.

Note: If ice or some type of freeze-pack is available, it should be placed around the region of the body where the bite occurred to help prevent the venom from spreading.

b. Black Widow or Brown Recluse Spider Bite.

(1) Keep the soldier as quiet as possible.

(2) If ice or some type of freeze-pack is available, place an ice pack around the region of the body where the bite occurred to keep the venom from spreading.

(3) Get the soldier to the nearest medical treatment facility without delay.

c. Scorpion Sting. In most areas of the world, scorpions are not highly dangerous; however, in South America certain types can cause death if proper treatment is not administered.

(1) For an ordinary scorpion sting, put a piece of ice or some type of freeze-pack, if available, on the site of the sting as soon as possible. This may decrease the absorption of the venom by the body. Baking soda applied as a paste to the site of the bite will often relieve the pain.

(2) If the site of the sting is on the face, neck, or genital organs or if the sting is from a scorpion in the area of the world mentioned above, keep the soldier as quiet as possible and get him to the nearest medical treatment facility without delay.

9-7. Skin Eruptions from Poisonous Plants

The sap or juice of certain plants will cause skin eruptions on some persons. The most common plants are poison ivy, poison oak, and poison sumac. Skin eruptions from these plants can be prevented by learning how to identify the plants and by taking the proper control measures (FM 21-10). Should you develop a skin eruption several days after possible exposure to any of these plants, avoid scratching it and seek medical aid. The skin eruption first appears as redness and swelling accompanied by severe burning and itching; blisters appear later.

9-8. Conditions Caused by Extreme Heat

Conditions caused by extreme heat are heat exhaustion, heat-stroke, and heat cramps, as well as sunburn and prickly heat. The person who has suffered heat injury should be taken immediately

to the nearest medical treatment facility. Heat injuries can cause permanent damage. These conditions can be prevented by proper acclimatization to heat, adequate consumption of water and salt, and consistent practice of the prescribed preventive measures (FM 21-10).

a. Heat Exhaustion. This condition is caused by excessive loss of water and salt from the body. The symptoms of heat exhaustion are headache, excessive sweating, weakness, dizziness, nausea, and muscle cramps. Also, the skin is pale, cool, moist, and clammy. Heat exhaustion may come on gradually or suddenly. A victim of heat exhaustion should be given first aid as follows:

(1) Lay the soldier in a cool shaded area and loosen his clothing.

(2) If he is conscious, have him drink three to five canteens full of cool salt water during a period of 12 hours. Prepare the salt water by dissolving two crushed salt tablets or one-fourth teaspoonful of table salt in a canteen (quart) of cool water.

b. Heatstroke. Prolonged exposure to high temperature may cause heatstroke, which is sometimes referred to as "sunstroke." The first sign of heatstroke may be stoppage of sweating, which causes the skin to feel hot and dry. Collapse and unconsciousness may come suddenly or may be preceded by headache, dizziness, fast pulse, nausea, vomiting, and mental confusion. It is necessary to work fast to save the life of a soldier with heatstroke, since the heat regulators of the body have been damaged and the temperature may rise as high as 108° F. The following first aid measures should be administered promptly:

(1) Immerse the soldier in the coldest water available. If ice is available, add it to the water.

(2) If a cold water bath is not possible, get the soldier into the shade, remove his clothing, and keep his entire body wet by pouring water over him. Cool him further by continuously fanning his wet body.

(3) Transport him to the nearest medical treatment facility at once and continue to cool his body on the way.

(4) When the soldier becomes conscious, give him cool salt water to drink (a(2) above).

c. Heat Cramps. Heat cramps are painful spasms of the muscles, usually those of the legs, arms, and abdomen. They may be either mild or severe. Cramps are due directly to loss of salt from the body. Give a soldier with heat cramps large amounts of cool salt

water to drink (a(2) above). If he has severe heat cramps, it may be necessary to send him to a medical treatment facility.

9-9. Conditions Caused by Cold

Conditions caused by cold are trench foot, immersion foot, frostbite, and snow blindness. These conditions can be prevented by practicing the prescribed preventive measures (FM 21-10).

a. Trench Foot. Trench foot is an injury which results from fairly long exposure of the feet to wet conditions, generally at temperatures from approximately freezing to 50° F. If the feet are also inactive, the possibility of developing trench foot is even greater. Trench foot can be very serious; it can lead to loss of toes or parts of the feet. Usually a symptom of trench foot is numbness. There may be a tingling or aching sensation or cramping pain. If exposure of the feet has been prolonged and severe, the feet may swell so much that pressure closes the blood vessels and cuts off the circulation. Should you develop trench foot, dry your feet thoroughly and get to a medical treatment facility by the fastest means possible. If transportation is available, avoid walking.

b. Immersion Foot. Immersion foot is similar to trench foot, except in the manner in which it is caused. It results from immersion of the feet in water or constant wetness of the feet for a prolonged period, usually in excess of 12 hours. Immersion foot will develop more rapidly if the water is below 50° F. It can occur, however, when the feet are exposed even to warm water for a period exceeding 24 hours. In immersion foot the soles of the feet become wrinkled and white; standing or walking becomes extremely painful. Other portions of the body may be similarly affected. Should you develop immersion foot, dry your feet thoroughly and get to a medical treatment facility by the fastest means possible. If transportation is available, avoid walking.

c. Frostbite. Frostbite is the injury of tissue from exposure to cold. The body parts most easily frostbitten are the cheeks, nose, ears, chin, forehead, wrists, hands, and feet. Frostbite may involve only the skin, or it may extend to a depth below the skin. Deep frostbite, which is much more serious requires different first aid to avoid or minimize the loss of the parts of the fingers, toes, hands, or feet. Frostbitten skin is white, stiff, and numb rather than painful. For this reason, soldiers must watch one another's face and hands for signs of frostbite. If the part has been numb for only a short time, the frostbite probably involves only the skin; other-

wise, assume it to be deep. The following measures should be taken for frostbite:

(1) *First aid measures for frostbite involving only the skin.*

Note: Do not rub the frostbitten parts with snow nor apply cold water soaks. Neither should you warm or rewarm the parts by such measures as massage and exposure to open fire.

(a) *Parts of the face.* Cover the frostbitten part with your warm hands until pain returns.

(b) *Hands.* Place the bare hands next to the skin in the opposite armpits.

(c) *Feet.* In the most sheltered area available, place the bare feet under the clothing and against the abdomen of another soldier.

(2) *Measures to take when deep frostbite occurs.*

(a) Get to a medical treatment facility by the fastest means possible.

(b) Protect the frostbitten part from additional injury, but do not attempt to treat it or thaw it in any way. Thawing in the field increases the possibilities of infection, further damage, and gangrene. There is less danger of walking on your feet while they are frozen than after they have been thawed. Thawing may occur spontaneously during transportation to the medical facility; but this cannot be avoided, since the body in general must be kept warm.

d. Snow Blindness. Snow blindness is the effect which glare from an icefield or snow field has on the eyes. This condition can occur even in cloudy weather. In fact, it is more likely to occur in hazy, cloudy weather than when the sun is shining. The early stages of snow blindness can be recognized by the scratchy feeling in the eyes when the eyelids are closed. Should a person develop snow-blindness, his eyes should be covered with a dark cloth to shut out all light. Then he should be taken to a medical treatment facility at once.

9-10. Carbon Monoxide (CO) Poisoning

a. Carbon monoxide poisoning can be severe, prolonged, and sometimes fatal. It results from inhaling carbon monoxide, which is a colorless, tasteless, and practically odorless gas produced by the incomplete combustion of coal, oil, and other fuels used in such equipment as motor vehicles, field ranges, and lighting and heating devices. This carbon monoxide destroys the ability of the red blood cells to carry the needed oxygen to the body tissues. Carbon

monoxide poisoning is usually the result of faulty equipment, improper use of equipment, or inadequate ventilation. It can be prevented by following the precautionary measures discussed in FM 21-10.

b. The symptoms of carbon monoxide poisoning come on rapidly and in quick succession. Dizziness, headache, noises in the ears, and throbbing in the temples are quickly followed by a feeling of sleepiness and weakness. Vomiting and convulsions may occur, followed by unconsciousness and death. The skin and lips are often bright red. The individual who is becoming poisoned may realize what is taking place, but he may not have enough strength left to get into the fresh air. Under circumstances in which there is muscular exertion or where there are extremes of temperature or humidity, the effects of poisoning act more rapidly.

c. The following first aid measures should be taken for a person who is overcome by carbon monoxide:

(1) Move the soldier into fresh air immediately and administer artificial respiration (chap 3). It is safe to administer mouth-to-mouth respiration to a carbon monoxide victim.

(2) Keep the soldier quiet and transport him to a medical treatment facility.

9-11. Drowning

Drowning occurs when air is shut off from the airway by water or any other fluid, causing spasm of the vocal cords and blockage of the airway. Many soldiers who appear lifeless may recover if artificial respiration (chap 3) is performed promptly and efficiently. Speed is essential. Every moment of delay decreases the soldier's chance of survival. It is frequently possible to start the mouth-to-mouth method of artificial respiration (para 3-4) before the soldier is brought ashore. As soon as his head is clear of the water and his mouth is within reach of your mouth, start artificial respiration. If other rescuers can help carry the soldier ashore, do not make a break in the artificial respiration. Once the soldier is ashore, do not waste valuable seconds to turn him in an attempt to drain water from his lungs; but continue the artificial respiration.

9-12. Electric Shock

Electric shock accidents frequently result from contact with a "live" wire and occasionally occur when a person is struck by lightning. If a person has come in contact with an electric current, take the following steps:

a. Turn off the switch if it is nearby, but do not waste time looking for it. Instead use a dry wooden pole, dry clothing, dry rope, or some other material which will not conduct electricity to remove the person from the wire. If a pole is not handy, simply drag the soldier off the wire by means of a loop of dry rope or cloth (fig 9-2). Do not touch the wire or the soldier with your bare hands or you will also get a shock.

b. Administer artificial respiration (chap 3) immediately after freeing the person from the wire, as electric shock causes breathing to cease. Also check the soldier's pulse, since electric shock may also cause his heart to stop. If you do not feel a pulse immediately, administer closed-chest heart massage (chap 3) with the artificial respiration.

9-13. Unconsciousness or Delirium

It is often impossible to find the cause of unconsciousness. Bleeding, heatstroke, or head injury may be the cause.

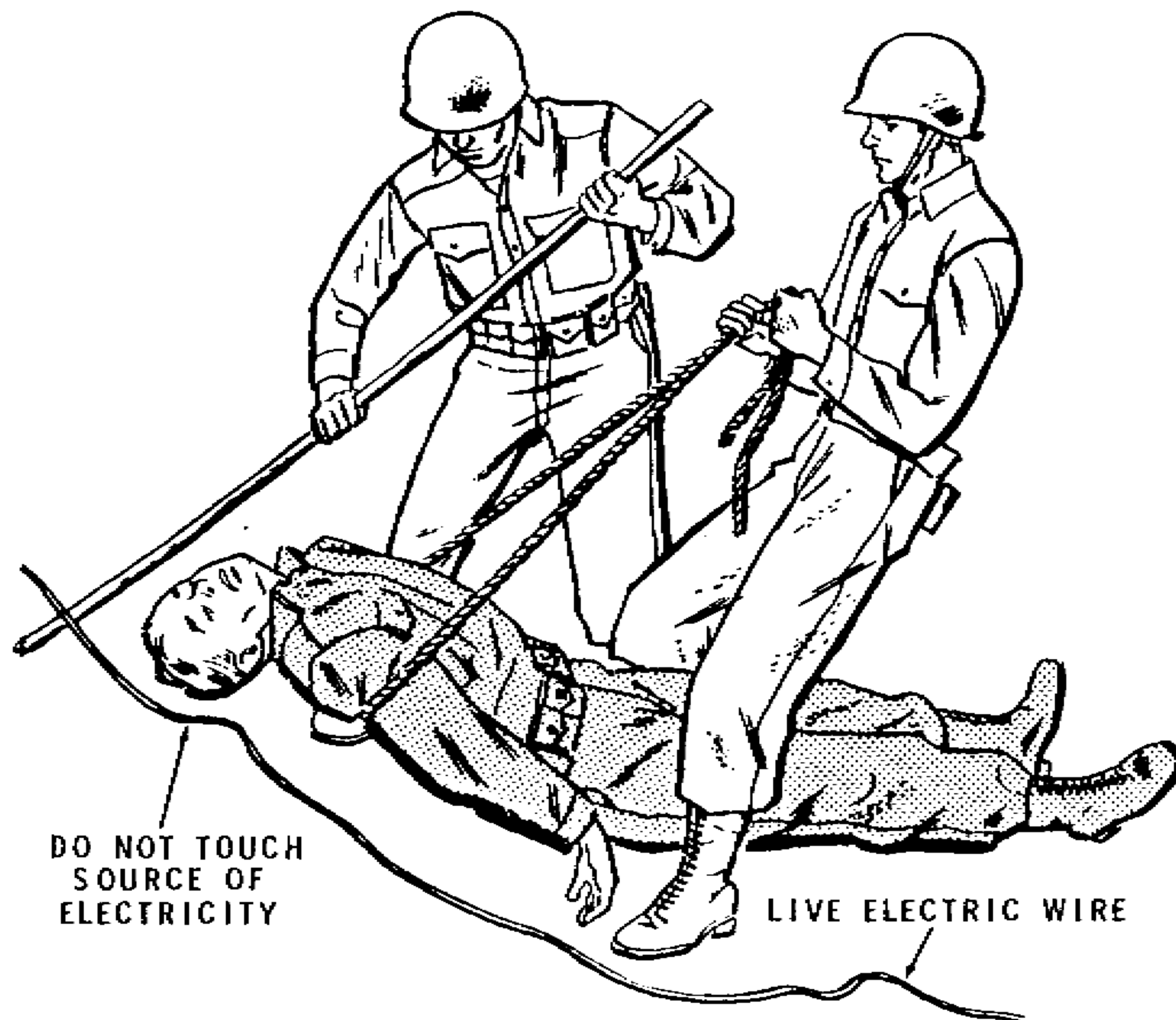

Figure 9-2. Rescuing a soldier who has had an electric shock.

a. If a soldier is unconscious, apply the lifesaving measures A, B, C, and D (chap 3-6) as appropriate. If he has a head injury or a heatstroke, apply the special measures discussed in paragraph 7-5 or 9-8b. If the soldier remains unconscious after first aid measures have been applied, be sure to place him on his side or on his abdomen with his head turned to one side to prevent his choking or vomitus, blood, or other fluids (c, fig 5-1). Do not give an unconscious soldier liquid.

b. If a soldier has merely fainted, he will regain consciousness within a few minutes. If an ammonia inhalant solution (app B) is available, break the ampul and place it near his nose several times for a few seconds each time. If he is in a sitting position, lay him down gently. Loosen his clothing, apply a cloth which has been wet with cool water to his face, and let him lie quietly. Any time that a person is about to faint while sitting up, lower his head between his knees so that blood may flow to his head. Hold him so that he does not fall and injure himself.

c. Delirium is a condition of brain damage which stops short of unconsciousness. It may arise because of high fever (malaria), head injury, head infections (encephalitis), pneumonia, chest wounds, severe burns with fluid loss, severe pain, poisoning by chemical agents, drug intoxication (amphetamines, inhaling motor fuels, glue-sniffing, impure LSD, atropine), drug withdrawal (alcohol, barbiturates), and numerous other medical conditions. The delirious soldier often becomes the unconscious soldier.

(1) The delirious soldier is periodically confused as to where he is, who he is, what day it is, and what he is supposed to be doing. His memory for what happened only 2 minutes before is poor. He may be extremely restless, anxious, and panicky; or he may be more quiet and withdrawn than usual. If he is restless, he may hallucinate or believe others will harm him. His speech may be slurred, and his thoughts are difficult to understand.

(2) The delirious soldier must be approached in a calm, confident manner. If you show fear, he will be convinced that danger surrounds him and may strike out. Explain to the soldier who he is, where he is, and what has happened to him. Keep his attention focused on you, away from his own imagination. With the help of friends, get him to a quiet place; and if he has a weapon, disarm him. A buddy must stay with him until he is evacuated, as he cannot be trusted to think clearly and he may injure himself or others.

(3) Delirium, like unconsciousness, is a medical signal that the brain is not working well. Whereas psychological first aid (chap 12),

which consists of getting through, ventilation, and organized activity, are appropriate for the psychological soldier, delirium requires prompt medical or surgical attention.

9-14. Obstruction of Trachea

The person whose trachea is obstructed by food cannot breathe, cannot speak, turns cyanotic, and collapses. He has only four minutes to live unless you save him by applying the Heimlich hug:

a. If the victim is standing or sitting (fig 9-3):

(1) Stand behind him and wrap your arms around his waist.

(2) Make a fist with one hand and place it against the victim's abdomen slightly above the navel and below the rib cage; then grasp the wrist of this hand with your other hand.

(3) Press your fist forcefully into the victim's abdomen with a quick upward thrust; causing a sharp exhalation of air to blow the food out the airway.

(4) Repeat several times, if necessary.

b. If the victim is lying on his back (fig 9-4):

(1) Facing him, kneel astride his hips.

(2) With one of your hands on top of the other, place the heel of your bottom hand on the victim's abdomen slightly above the navel and below the rib cage.

(3) Press forcefully with the heel of your hand into the victim's abdomen with a quick upward thrust.

(4) Repeat several times, if necessary.

c. If the victim is lying face down, turn him over and proceed as above.



Figure 9-3. Doing the Heimlich hug with victim standing or sitting.

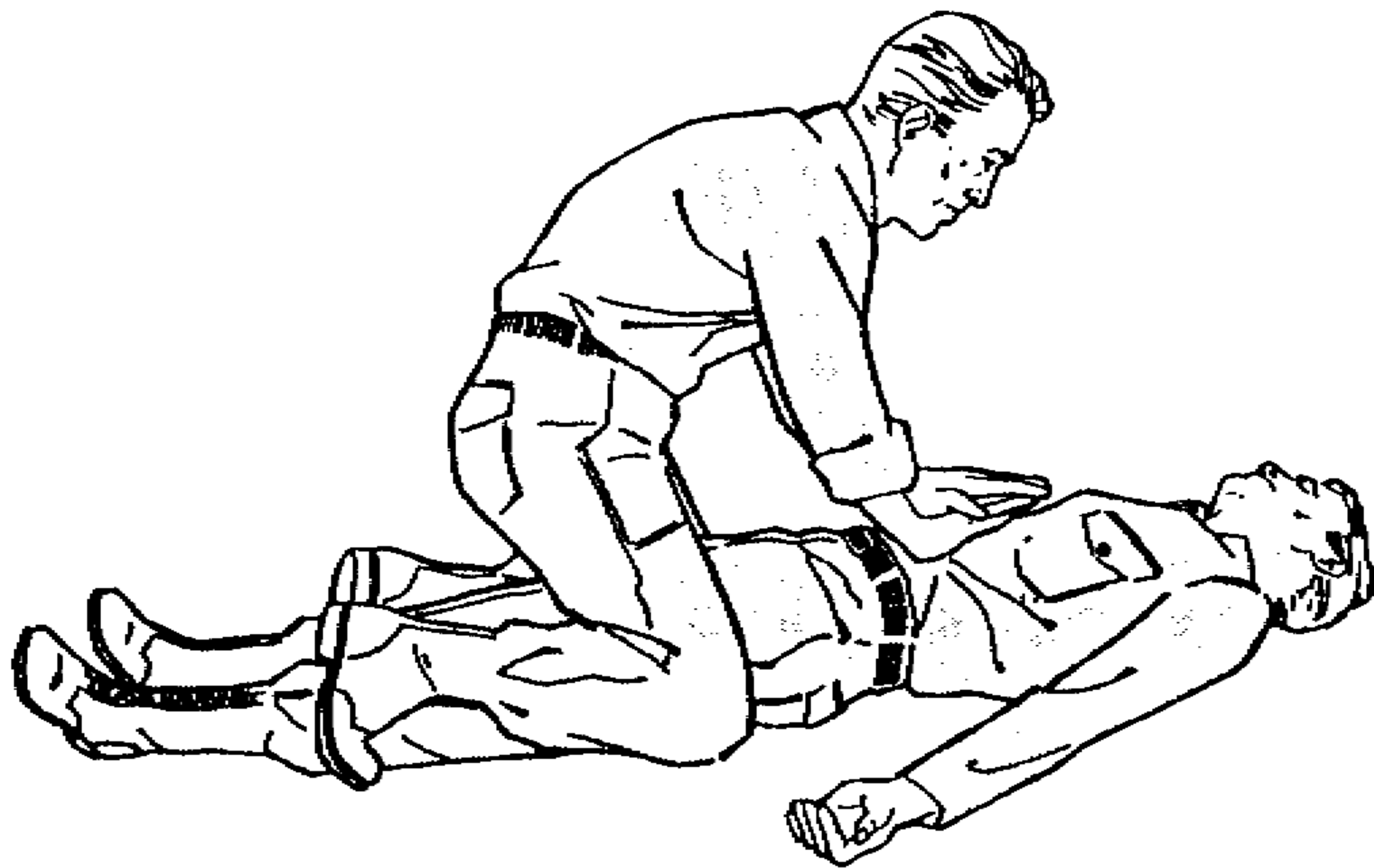

Figure 9-4. Doing the Heimlich hug with victim lying on his back.

CHAPTER 10

TRANSPORTING THE WOUNDED SOLDIER

Section I. INTRODUCTION

10-1. General

a. Transportation of the sick and wounded is the responsibility of medical personnel who have been provided special training and equipment. Therefore, unless a good reason for your transporting a wounded soldier arises, wait for some means of medical evacuation to be provided. When the situation is urgent and you are unable to obtain medical assistance or know that no medical evacuation facilities are available, you will have to transport the wounded soldier. For this reason, you must know how to transport him without increasing the seriousness of his condition.

b. Transporting a wounded soldier by litter (FM 8-35) is safer and more comfortable for him than it is by manual means. It is also easier for you. Manual transportation, however, may be the only feasible method because of the terrain or the combat situation; or it may be necessary to save a life. In these situations, the soldier should be transferred to a litter as soon as one can be made available or improvised (para 10-6).

10-2. Handling the Wounded Soldier

Although the wounded soldier's life may have been saved through the application of appropriate first aid measures (chap 2-9), it can be lost through careless or rough handling in transporting him. Therefore, before you attempt to move the wounded soldier, you must evaluate the type and extent of his injury and insure that dressings over wounds are adequately reinforced and that fractured bones are properly immobilized and supported to prevent them from cutting through muscle, blood vessels, and skin. Based

upon your evaluation of the type and extent of the soldier's injury and your knowledge of the various manual carries (para 10-3-10-5), you are to select the best possible method of manual transportation. If the wounded soldier is conscious, he should be told how he is to be transported. This will help allay his fear of movement and gain his cooperation.

Section II. MANUAL CARRIER

10-3. General

a. This section contains illustrations of manual carries with explanation of basic step-by-step doctrine included in the illustrations. In the application of the doctrine, certain flexibility is permitted.

b. Manual carries (figs 10-1 through 10-21) are accomplished by one bearer or by two bearers. Two-man carries are used whenever possible. They provide more comfort to the injured soldier, are less likely to aggravate injuries, and are also less tiring for the bearers, thus enabling them to carry the soldier farther. The distance which the injured soldier can be transported by manual carries depends upon many factors, including the strength and endurance of the bearer(s), the weight of the soldier, the nature of the soldier's injury, and the obstacles encountered by the bearer(s). Some carries cause less fatigue to the bearer(s) than others. Also, some carries may be inappropriate because of the nature of the soldier's injury. For example, certain carries cannot be used if the soldier has a fractured arm, neck, back, hip, thigh, or leg. The position in which the injured soldier should be placed for lifting (fig 10-1) depends upon the particular carry to be used.

10-4. One-Man Carries

a. *Fireman's Carry.* The fireman's carry (fig 10-2-10-6) is one of the easiest ways for one man to carry another. After an unconscious or disabled soldier has been properly positioned (a, fig 10-1), he is raised from the ground in the first four steps of the carry (fig 10-2). An alternate method for raising a soldier from the ground is illustrated in figure 10-6; however, it should be used only when the bearer believes it to be safer for the soldier because of the location of his wounds. When the alternate method is used, care must be taken to prevent the soldier's head from snapping back and causing a neck injury. The steps for raising an injured soldier from the ground for the fireman's carry are also used in other one-man carries.

b. Supporting Carry. In the supporting carry (fig 10-7), the injured soldier must be able to walk or at least hop on one leg, using the bearer as a crutch. This carry can be used to transport a soldier as far as he is able to walk or hop.

c. Arms Carry. The arms carry (fig 10-8) is useful in carrying an injured soldier for a short distance and for placing him on a litter.

d. Saddleback Carry. Only a conscious soldier can be transported by the saddleback carry (fig 10-9), as he must be able to hold onto the bearer's neck.

e. Pack-Strap Carry. In the pack-strap carry (fig 10-10), the injured soldier's weight rests high on the bearer's back, making it easier for the bearer to carry him a moderate distance. To eliminate the possibility of injury to the soldier's arms, the bearer must hold the soldier's arms in a palms-down position.

f. Pistol-Belt Carry. The pistol-belt carry (fig 10-11—10-13) is the best one-man carry for a long distance. The injured soldier is securely supported by a belt upon the shoulders of the bearer. The hands of both the bearer and the soldier are left free for carrying a weapon or equipment, climbing banks, or surmounting other obstacles. With the hands free and the soldier secured in place, the bearer is also able to creep through shrubs and under low hanging branches.

g. Pistol-Belt Drag. The pistol-belt drag (fig 10-14) as well as other drags are generally used for short distances. The pistol-belt drag is useful in combat. The bearer and the injured soldier can remain closer to the ground in this drag than in any other one.

h. Neck Drag. The neck drag (fig 10-15) is useful in combat because the bearer can transport an injured soldier as he creeps behind a low wall or shrubbery, under a vehicle, or through a culvert. If the soldier is unconscious, his head must be protected from the ground.

i. Cradle Drop Drag. The cradle drop drag (fig 10-16) is effective in moving an injured soldier down or up steps.

10-5. Two-Man Carries

a. Two-Man Supporting Carry. The two-man supporting carry (fig 10-17) can be used in transporting a soldier who is conscious or unconscious. If the soldier is taller than the bearers, it may be necessary for the bearers to lift his legs and let them rest on their forearms.

b. Two-Man Arms Carry. The two-man arms carry (fig 10-18) is useful in carrying an injured soldier for a moderate distance and for placing him on a litter. To lessen fatigue, the bearers should carry the soldier high and as close to their chests as possible. In extreme emergencies when there is no time to obtain a board, this manual carry is the safest one for transporting a soldier with a back injury. Two additional bearers should be used to keep the soldier's head and legs in alignment with his body.

c. Two-Man Fore-and-Aft Carry. The fore-and-aft carry (fig 10-19) is a most useful two-man carry for transporting an injured soldier for a long distance. The taller of the two bearers should position himself at the head of the soldier. By altering this carry so that both bearers face the soldier, it is also useful for placing the soldier on a litter:

d. Four-Hand Seat Carry. Only a conscious soldier can be transported with the four-hand seat carry (fig 10-20), as he must help support himself by placing his arms around the bearers' shoulders. This carry is especially useful in transporting the soldier with a head or foot injury for a moderate distance and in placing a soldier on a litter.

e. Two-Hand Seat Carry. The two-hand seat carry (fig 10-21) is used in carrying an injured soldier for a short distance and in placing him on a litter.

10-6. Improvised Litters

a. A litter can be improvised from many different things. Most flat-surface objects of suitable size can be used as litters. Such objects include boards, doors, window shutters, benches, ladders, cots, and poles tied together. If possible, these objects should be padded.

b. Satisfactory litters can also be made by securing poles inside such items as blankets, shelter halves, tarpaulins, jackets, shirts, sacks, bags, bedticks, and mattress covers. Poles can be improvised from strong branches, rifles, tent supports, skis, and other items.

Caution: If rifles are used, make certain they are unloaded.

c. If no poles can be obtained, a large item such as a blanket can be rolled from both sides toward the center; then the rolls can be used to obtain a firm grip when carrying the soldier. Several methods of improvising litters are illustrated and explained in figures 10-22 through 10-24.

(A) ROLLING SOLDIER FROM HIS BACK TO ABDOMEN

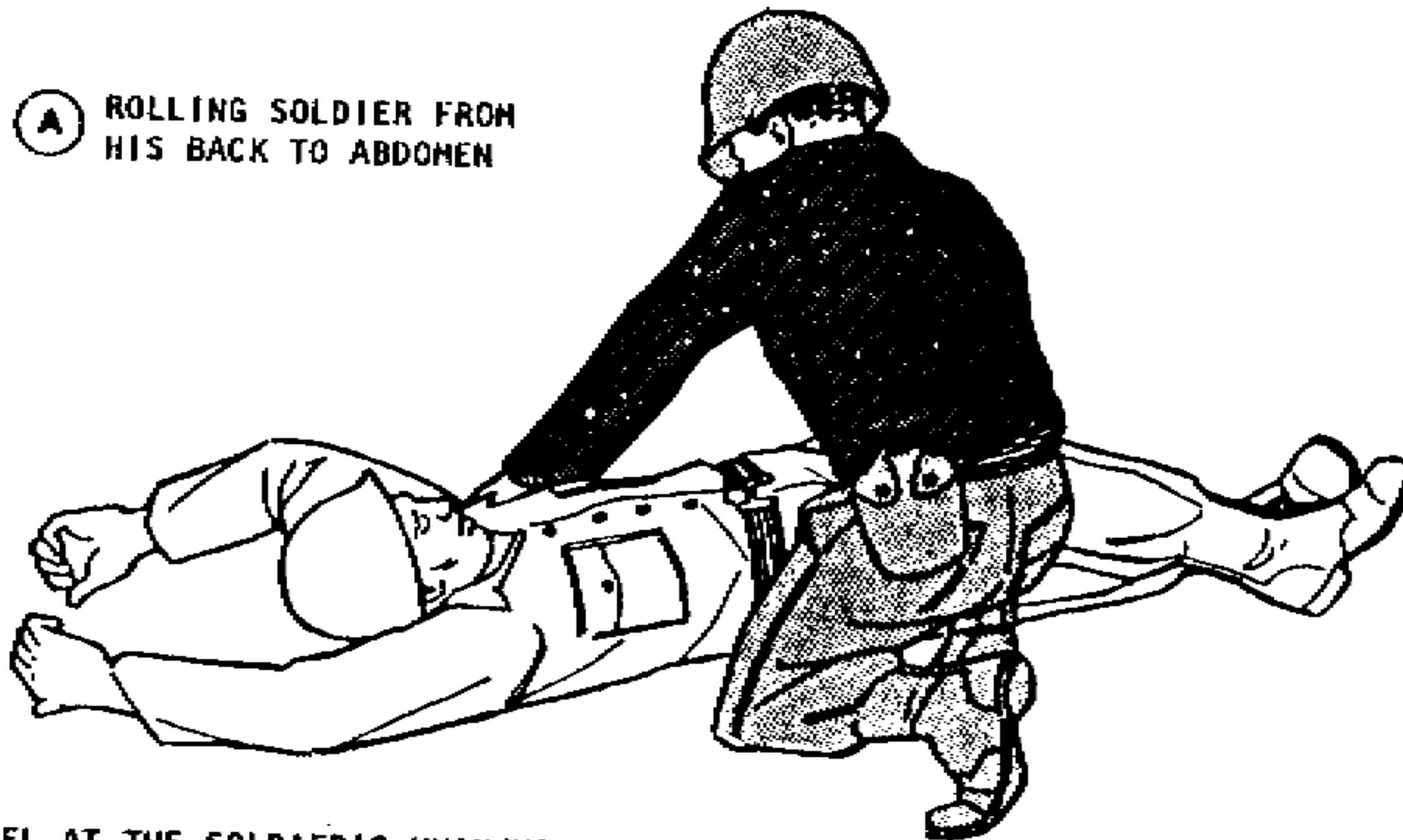

KNEEL AT THE SOLDIER'S UNINJURED SIDE. PLACE HIS ARMS ABOVE HIS HEAD AND CROSS HIS ANKLE FARTHER FROM YOU OVER THE ONE CLOSER TO YOU. PLACE ONE OF YOUR HANDS ON THE SHOULDER FARTHER FROM YOU AND YOUR OTHER HAND IN THE AREA OF HIS HIP OR THIGH; THEN GENTLY ROLL HIM TOWARD YOU ONTO HIS ABDOMEN.

(B) ROLLING SOLDIER FROM HIS ABDOMEN TO BACK

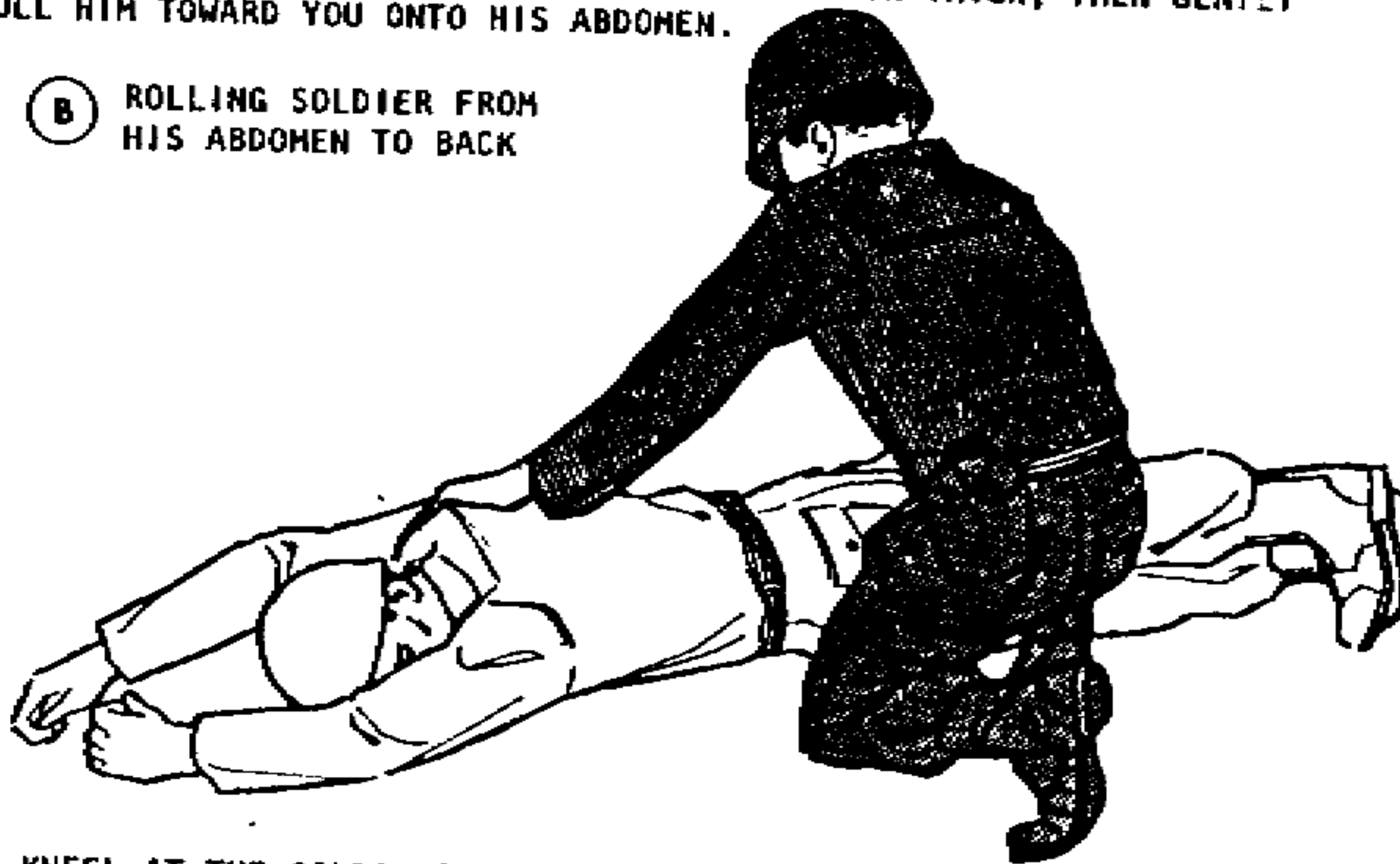

KNEEL AT THE SOLDIER'S UNINJURED SIDE. PLACE HIS ARMS ABOVE HIS HEAD AND CROSS HIS ANKLE FARTHER FROM YOU OVER THE ONE CLOSER TO YOU. PLACE ONE OF YOUR HANDS ON THE SHOULDER FARTHER FROM YOU AND YOUR OTHER HAND IN THE AREA OF HIS HIP OR THIGH; THEN GENTLY ROLL HIM TOWARD YOU ONTO HIS BACK.

Figure 10-1. Positioning the soldier to be lifted.

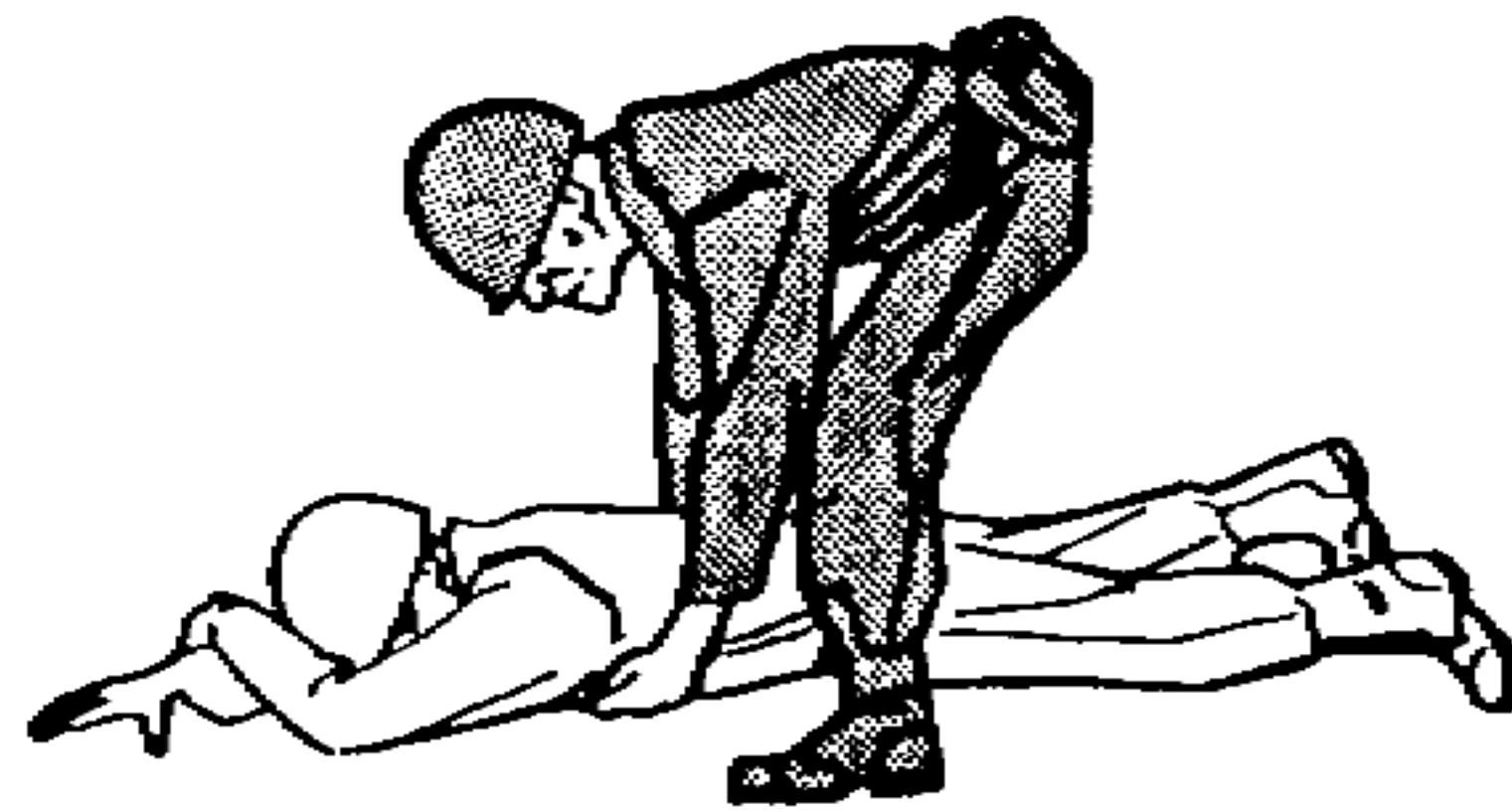

STEP ONE: AFTER ROLLING THE SOLDIER ONTO HIS ABDOMEN, STRADDLE HIM; THEN EXTEND YOUR HANDS UNDER HIS CHEST AND LOCK THEM TOGETHER.

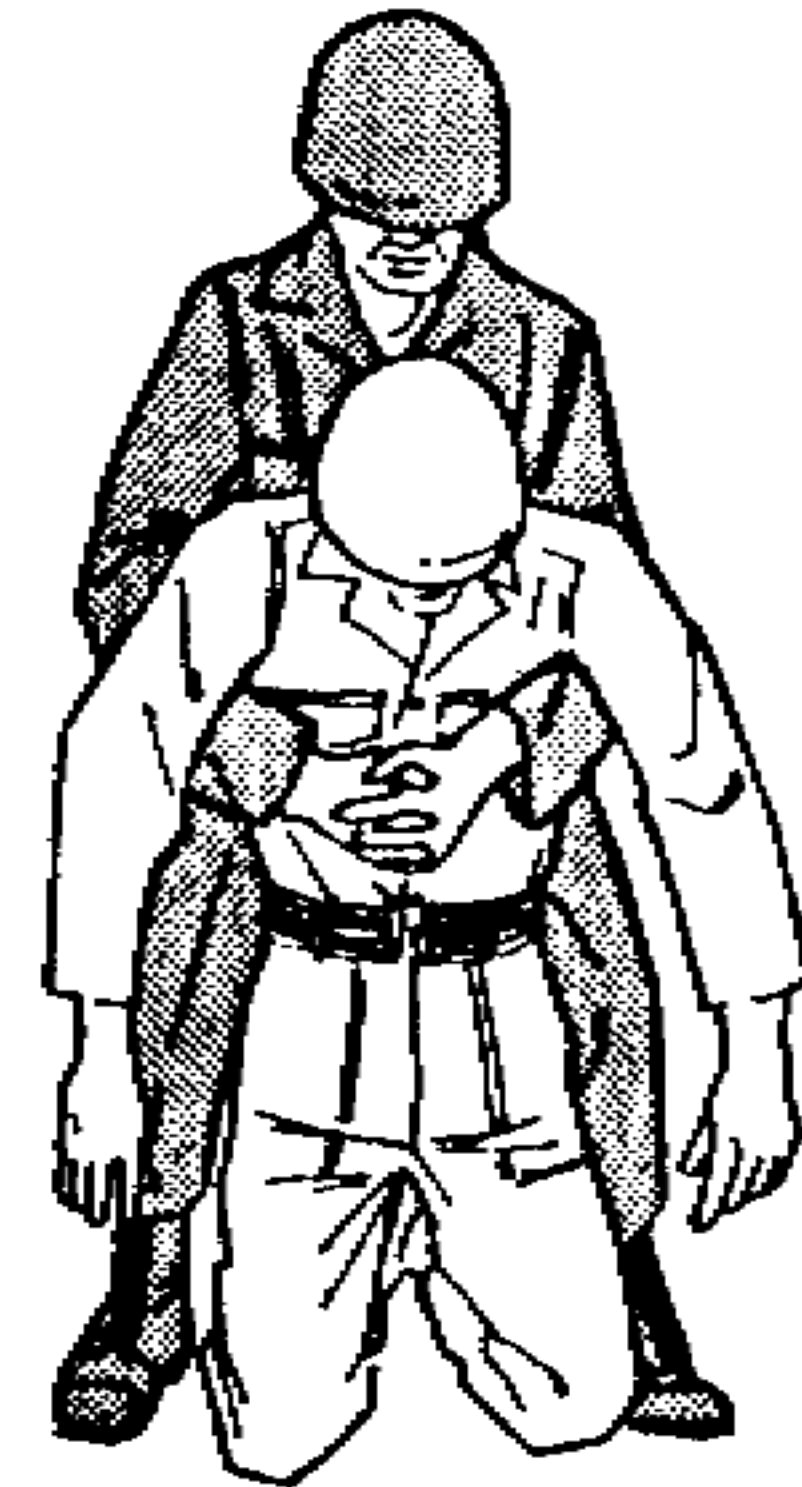

STEP TWO: LIFT THE SOLDIER TO HIS KNEES AS YOU MOVE BACKWARD.

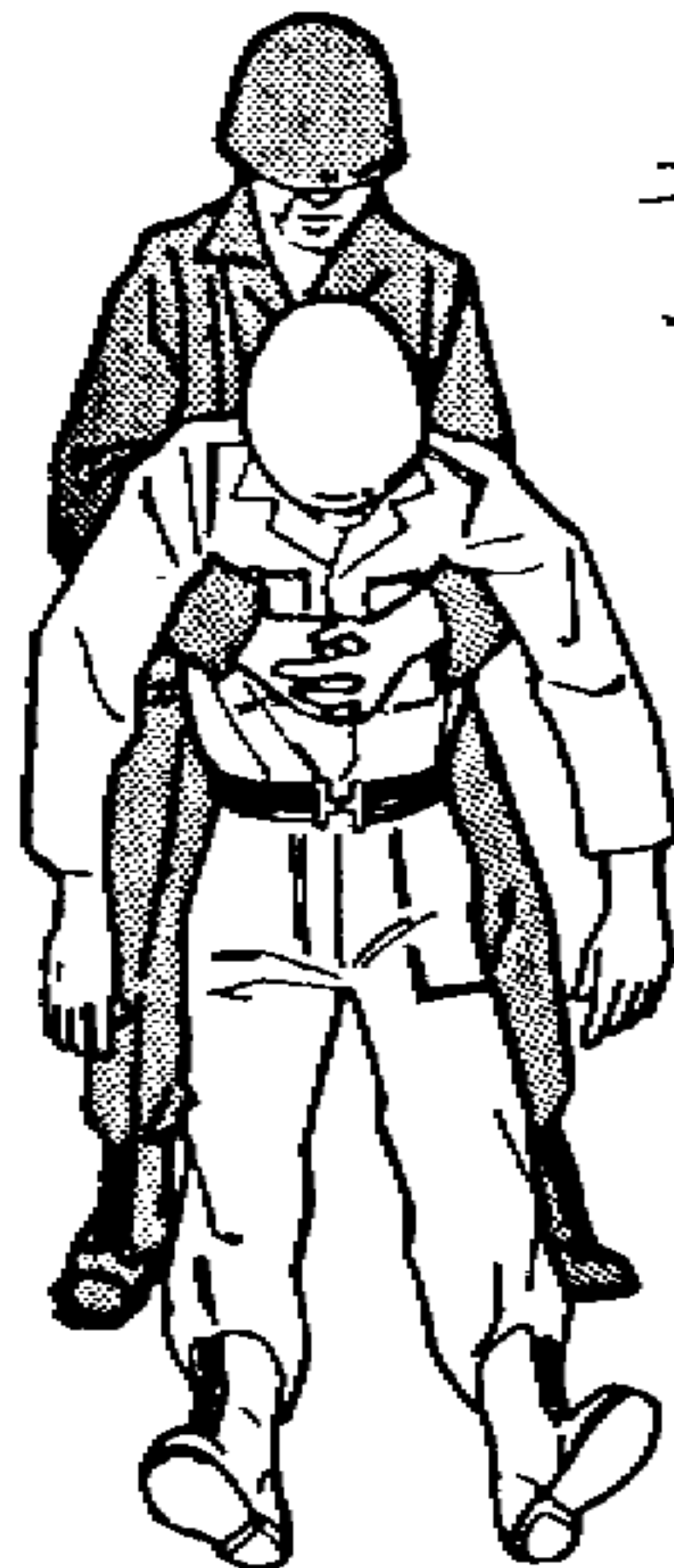

STEP THREE: CONTINUE TO MOVE BACKWARD, THUS STRAIGHTENING THE SOLDIER'S LEGS AND LOCKING HIS KNEES.



ALTERNATE LOCK

STEP FOUR: WALK FORWARD, BRINGING THE SOLDIER TO A STANDING POSITION BUT TILTED SLIGHTLY BACKWARD TO PREVENT HIS KNEES FROM BUCKLING.

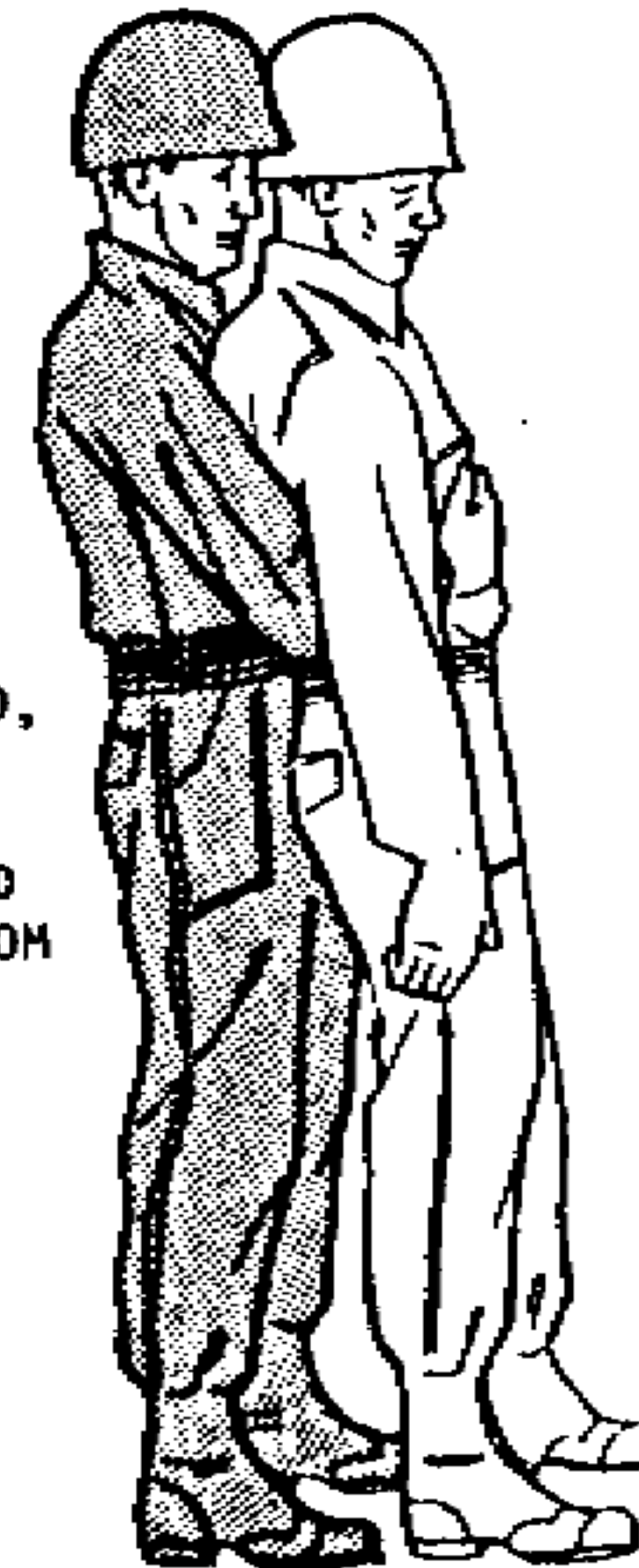
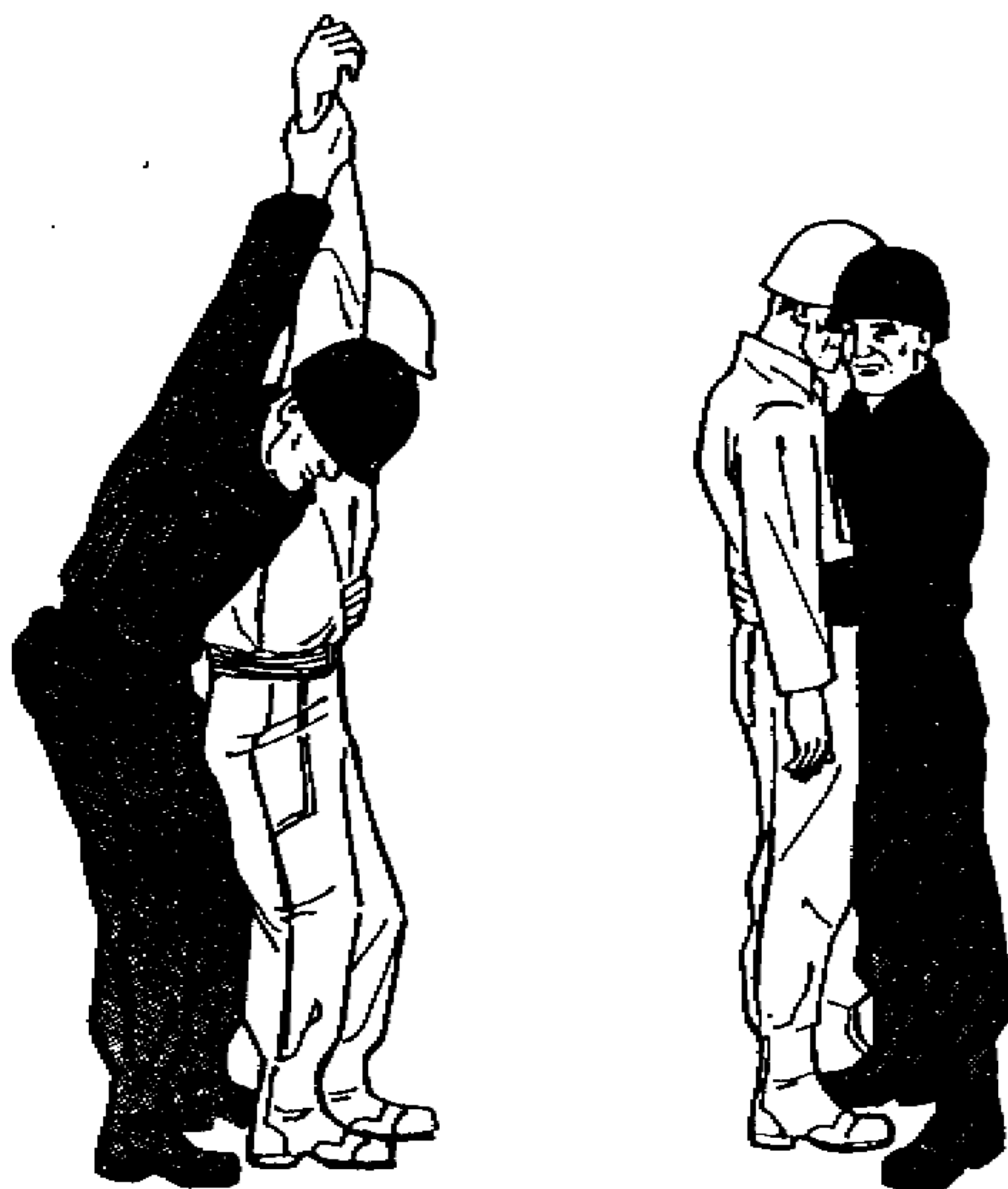

Figure 10-2. Fireman's carry (steps one, two, three, and four).



STEP FIVE: AS YOU MAINTAIN CONSTANT SUPPORT OF THE SOLDIER WITH YOUR LEFT ARM, FREE YOUR RIGHT ARM, QUICKLY GRASP HIS RIGHT WRIST, AND RAISE HIS ARM HIGH. INSTANTLY PASS YOUR HEAD UNDER HIS RAISED ARM, RELEASING IT AS YOU PASS UNDER IT. MOVE SWIFTLY TO FACE THE SOLDIER AND SECURE YOUR ARMS AROUND HIS WAIST. IMMEDIATELY PLACE YOUR RIGHT TOE BETWEEN HIS FEET AND SPREAD THEM 6 TO 8 INCHES APART.

Figure 10-3. Fireman's carry (step five).



STEP SIX: WITH YOUR LEFT HAND, GRASP THE SOLDIER'S RIGHT WRIST AND RAISE HIS ARM OVER YOUR HEAD.



STEP SEVEN: BEND AT THE WAIST AND KNEES; THEN PULL THE SOLDIER'S ARM OVER AND DOWN YOUR LEFT SHOULDER, THUS BRINGING HIS BODY ACROSS YOUR SHOULDERS. AT THE SAME TIME, PASS YOUR RIGHT ARM BETWEEN HIS LEGS.

Figure 10-4. Fireman's carry (steps six and seven).



STEP EIGHT: PLACE THE SOLDIER'S RIGHT WRIST IN YOUR RIGHT HAND AND PLACE YOUR LEFT HAND ON YOUR LEFT KNEE FOR SUPPORT IN RISING.

STEP NINE: RISE WITH THE SOLDIER CORRECTLY POSITIONED. YOUR LEFT HAND IS FREE FOR USE AS NEEDED.

Figure 10-5. Fireman's carry (steps eight and nine).

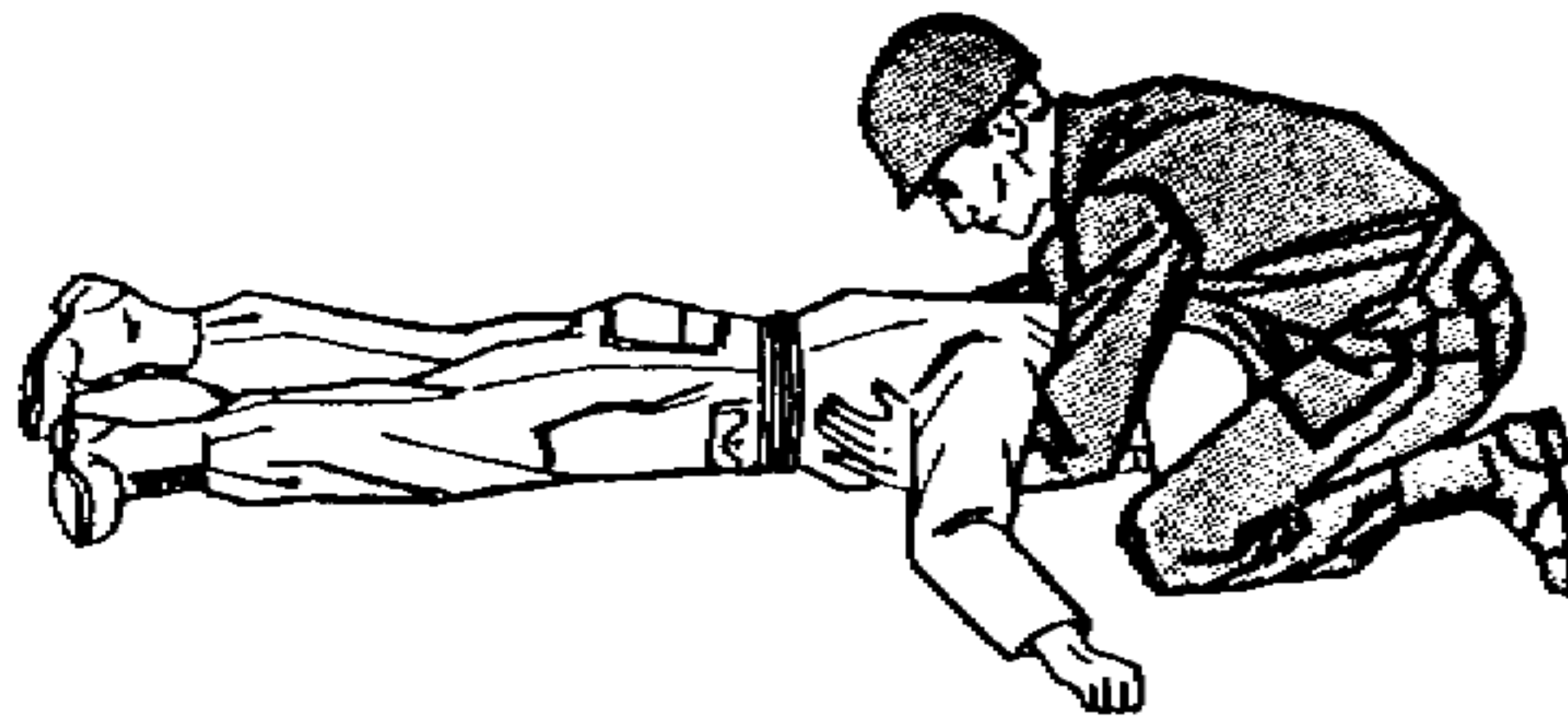

STEP ONE: KNEEL ON ONE KNEE AT THE SOLDIER'S HEAD, FACING HIS FEET; THEN EXTEND YOUR HANDS UNDER HIS ARMPITS, DOWN HIS SIDES, AND ACROSS HIS BACK.

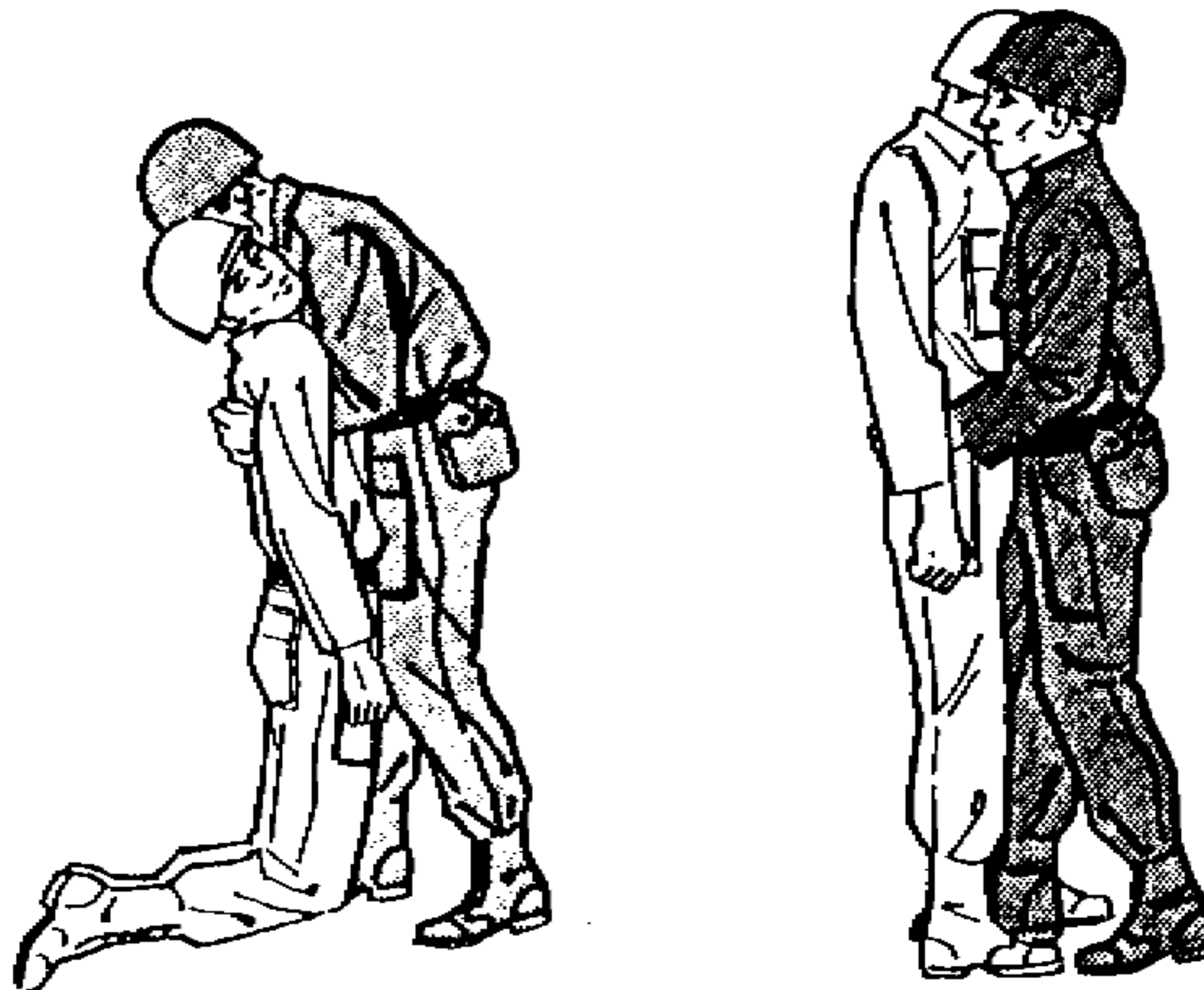

STEP TWO: AS YOU RISE, LIFT THE SOLDIER TO HIS KNEES; THEN SECURE A LOWER HOLD AND RAISE HIM TO A STANDING POSITION WITH HIS KNEES LOCKED.

STEP THREE: SECURE YOUR ARMS AROUND THE SOLDIER'S WAIST, WITH HIS BODY TILTED SLIGHTLY BACKWARD TO PREVENT HIS KNEES FROM BUCKLING. PLACE YOUR RIGHT TOE BETWEEN HIS FEET AND SPREAD THEM 6 TO 8 INCHES APART.

Figure 10-6. Fireman's carry (alternate method for lifting an injured soldier to a standing position).

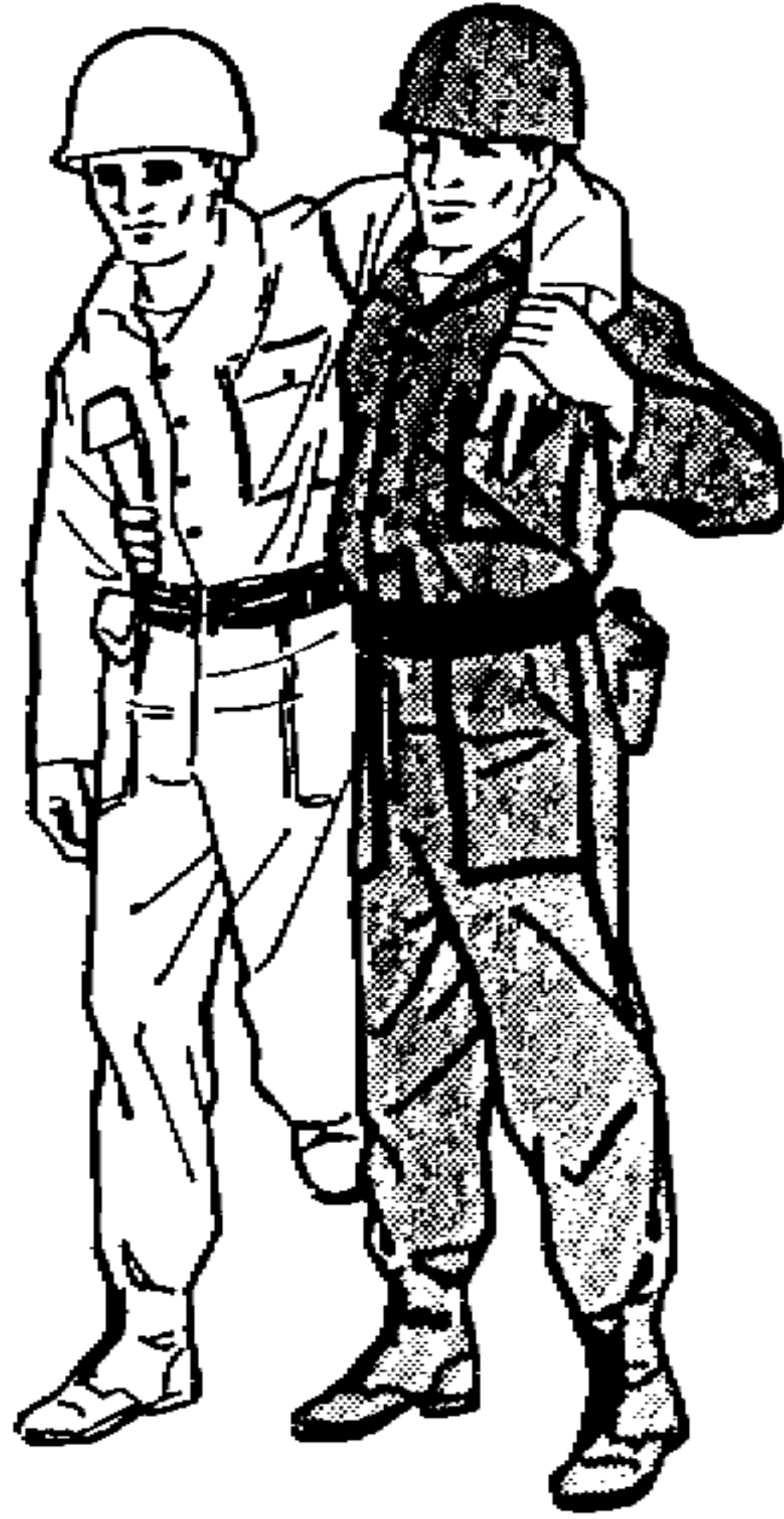

STEP ONE: RAISE THE SOLDIER FROM GROUND AS IN FIREMAN'S CARRY.

STEP TWO: WITH YOUR LEFT (RIGHT) HAND GRASP THE SOLDIER'S LEFT (RIGHT) WRIST AND DRAW HIS ARM AROUND YOUR NECK. PLACE YOUR RIGHT (LEFT) ARM AROUND HIS WAIST.

(THE SOLDIER IS THUS ABLE TO WALK, USING YOU AS A CRUTCH.)

Figure 10-7. Supporting carry.



LIFT SOLDIER OFF GROUND AS IN FIREMAN'S CARRY. CARRY SOLDIER HIGH TO LESSEN FATIGUE.

Figure 10-8. Arms carry.



STEP ONE: RAISE SOLDIER TO UPRIGHT POSITION AS IN FIREMAN'S CARRY.

STEP TWO: SUPPORT SOLDIER BY PLACING AN ARM AROUND HIS WAIST AND MOVE IN FRONT OF HIM.

STEP THREE: HAVE SOLDIER ENCIRCLE HIS ARMS AROUND YOUR NECK.

STEP FOUR: STOOP, RAISE HIM UPON YOUR BACK, AND CLASP HANDS BENEATH HIS THIGHS.

Figure 10-9. Saddleback carry.

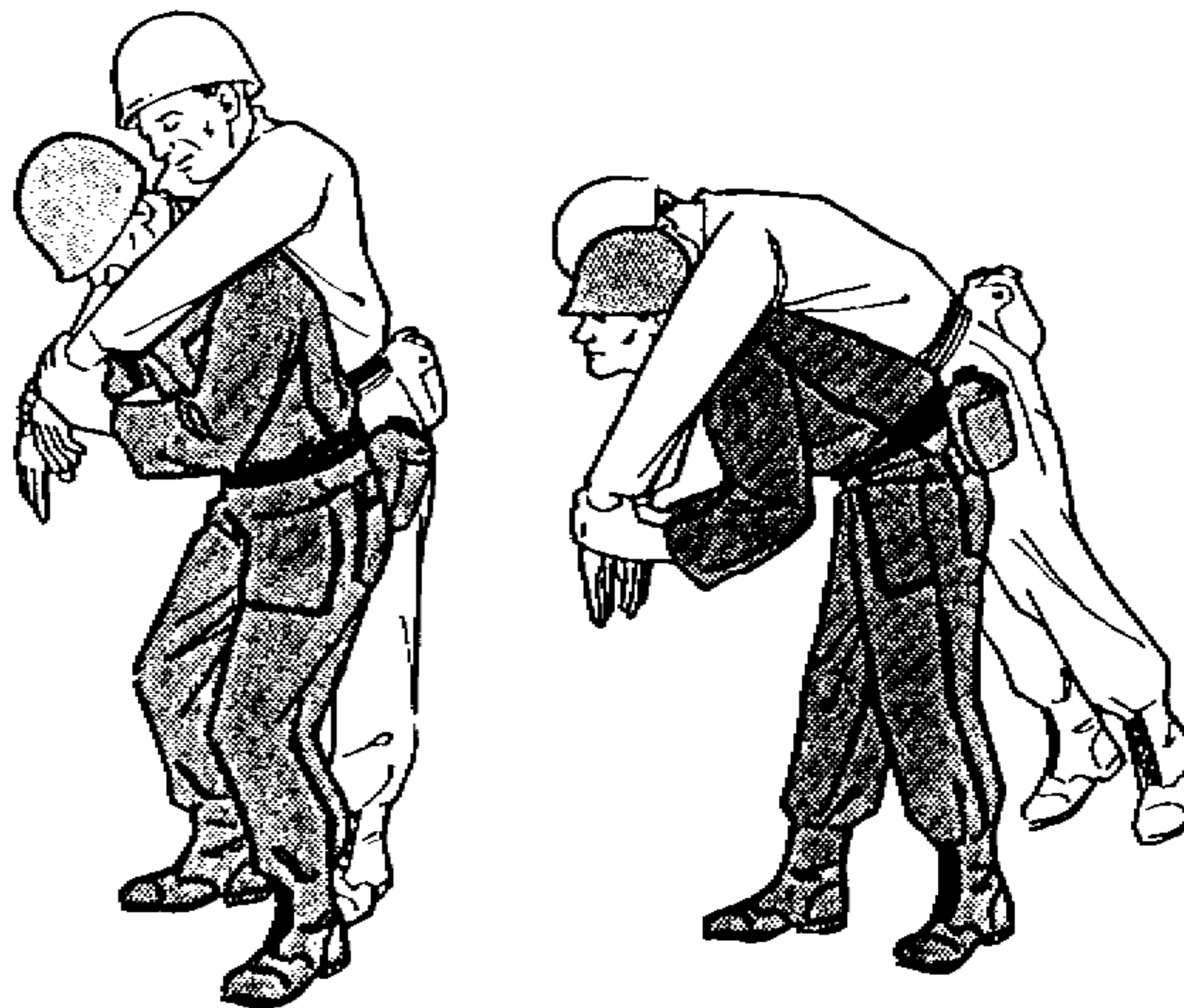

STEP ONE: LIFT SOLDIER FROM GROUND AS IN FIREMAN'S CARRY.

STEP TWO: SUPPORTING THE SOLDIER WITH YOUR ARM AROUND HIM, GRASP HIS WRIST CLOSEST TO YOU AND PLACE HIS ARM OVER YOUR HEAD AND ACROSS YOUR SHOULDER. MOVE IN FRONT OF HIM WHILE SUPPORTING HIS WEIGHT AGAINST YOUR BACK, GRASP HIS OTHER WRIST, AND PLACE THIS ARM OVER YOUR SHOULDER.

STEP THREE: BEND FORWARD AND HOIST HIM AS HIGH ON YOUR BACK AS POSSIBLE SO THAT ALL HIS WEIGHT IS RESTING ON YOUR BACK.

Figure 10-10. Pack-strap carry.

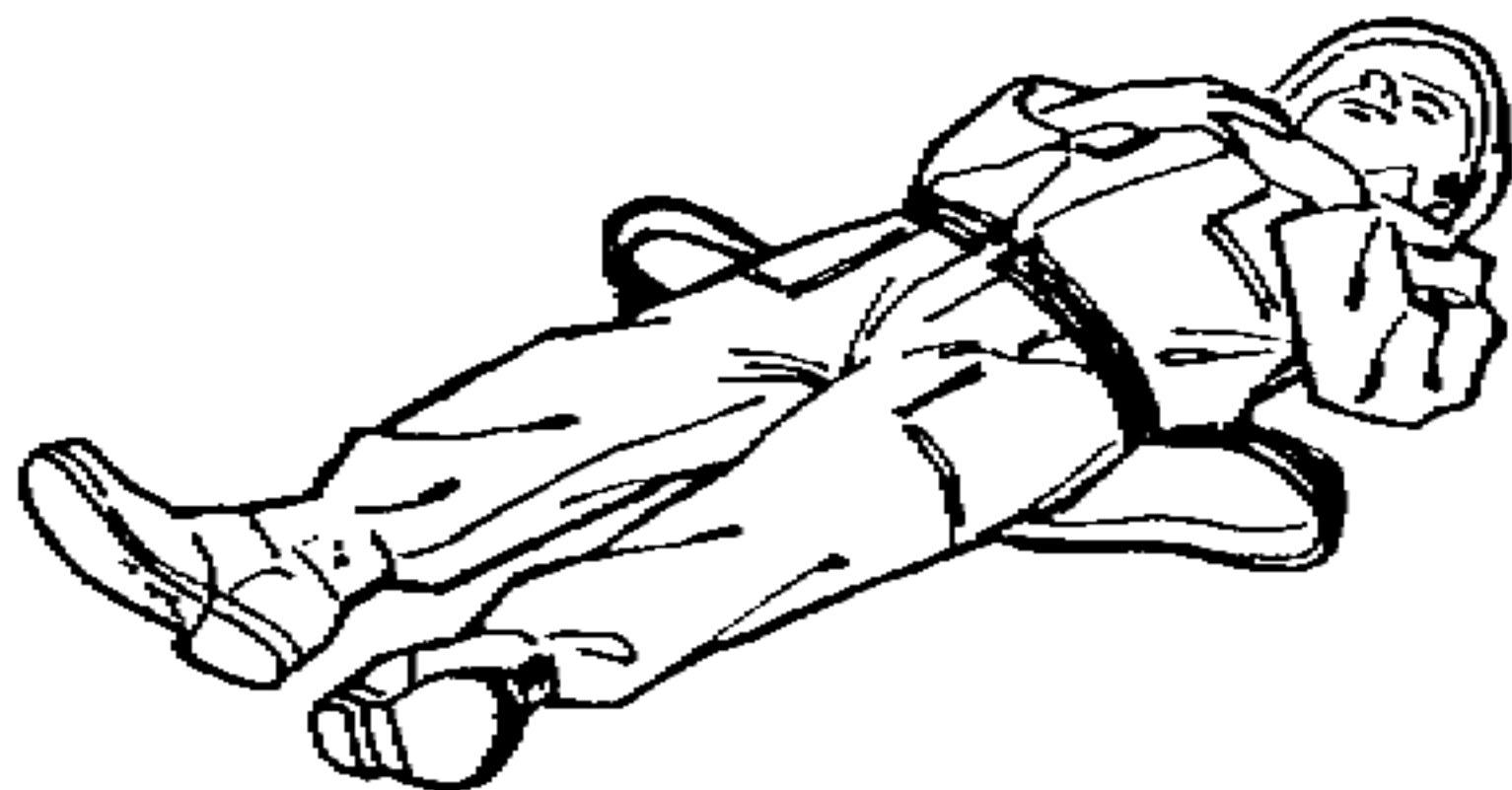

STEP ONE: LINK TOGETHER TWO PISTOL BELTS TO FORM A SLING. (IF PISTOL BELTS ARE NOT AVAILABLE FOR USE, OTHER ITEMS, SUCH AS ONE RIFLE SLING, TWO CRAVAT BANDAGES, TWO LITTER STRAPS, OR ANY SUITABLE MATERIAL WHICH WILL NOT CUT OR BIND THE SOLDIER, MAY BE USED.) PLACE THE SLING UNDER THE SOLDIER'S THIGHS AND LOWER BACK SO THAT A LOOP EXTENDS FROM EACH SIDE.

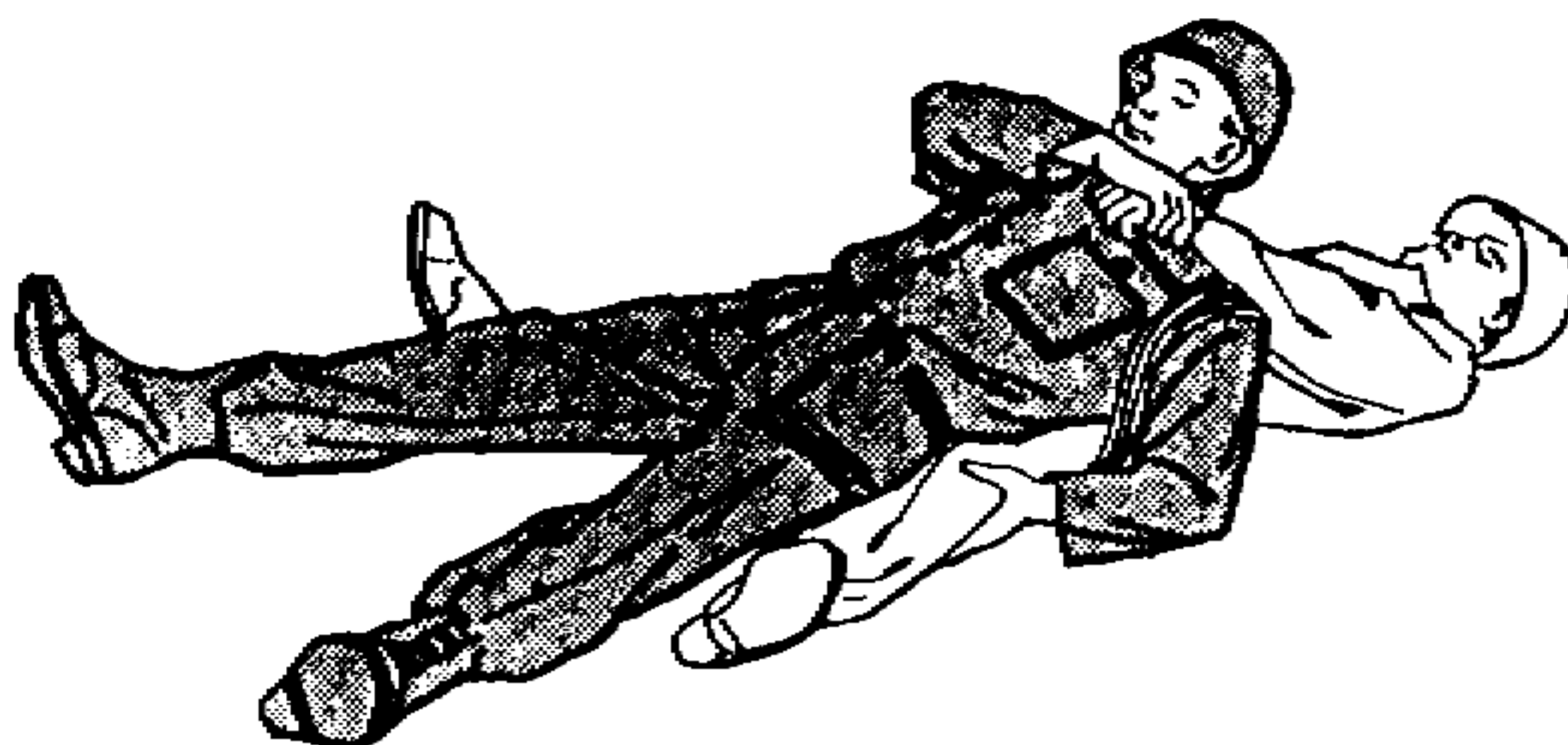

STEP TWO: LIE BETWEEN THE SOLDIER'S OUTSTRETCHED LEGS. THRUST YOUR ARMS THROUGH THE LOOPS, GRASP SOLDIER'S HAND AND TROUSER LEG ON HIS INJURED SIDE.

Figure 10-11. Pistol-belt carry (steps one and two).

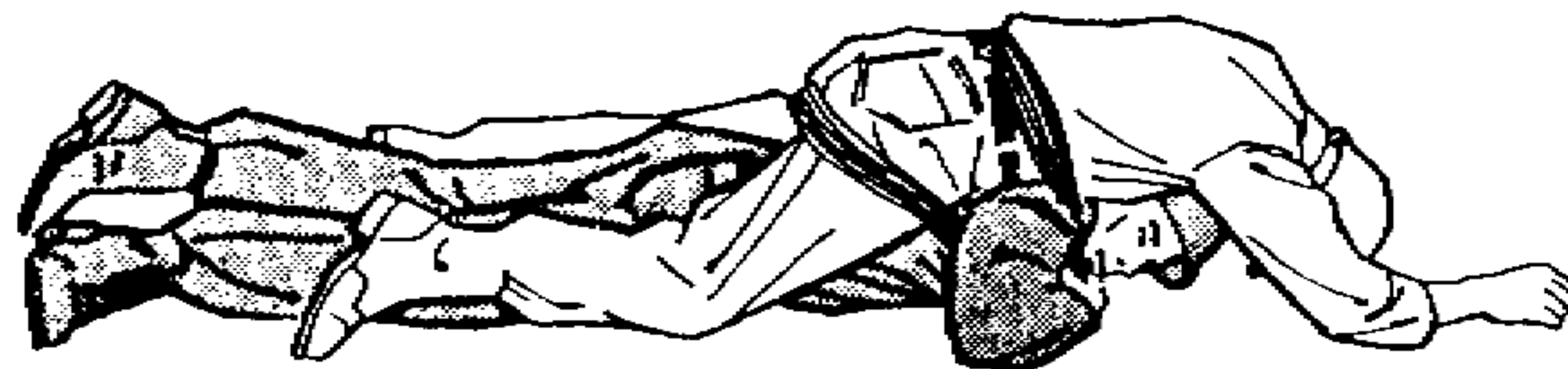

STEP THREE: ROLL TOWARD THE SOLDIER'S UNINJURED SIDE ONTO YOUR ABDOMEN, BRINGING THE SOLDIER ONTO YOUR BACK. ADJUST SLING AS NECESSARY.



STEP FOUR: RISE TO A KNEELING POSITION. THE BELT WILL HOLD THE SOLDIER IN PLACE.

Figure 10-12. Pistol-belt carry (steps three and four).

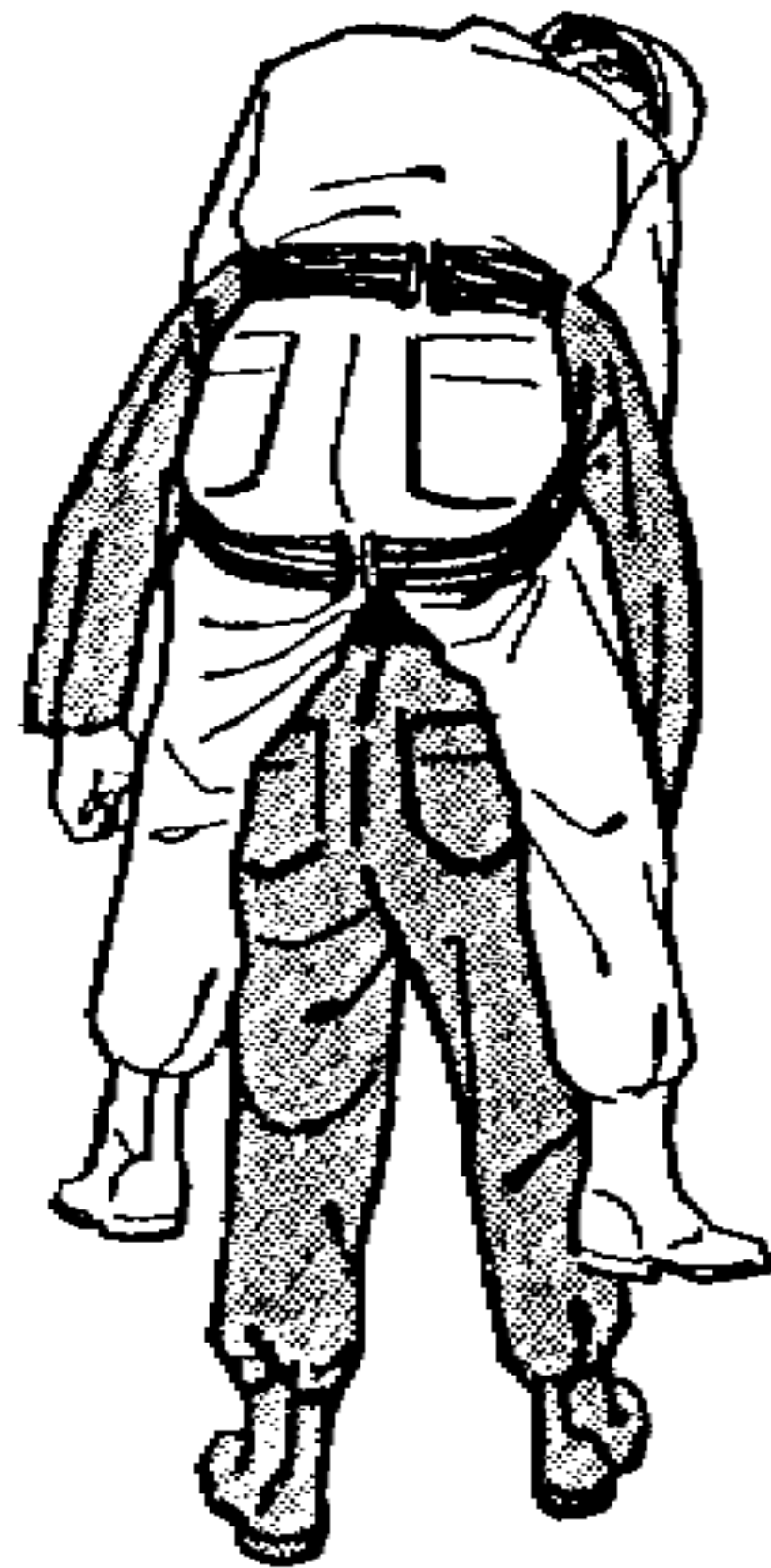

STEP FIVE: PLACE ONE HAND ON YOUR KNEE FOR SUPPORT AND RISE TO AN UPRIGHT POSITION. THE SOLDIER IS NOW SUPPORTED ON YOUR SHOULDERS.



STEP SIX: CARRY THE SOLDIER WITH YOUR HANDS FREE FOR USE IN FIRING RIFLE, CLIMBING BANKS, OR SURMOUNTING OBSTACLES.

Figure 10-13. Pistol-belt carry (steps five and six).

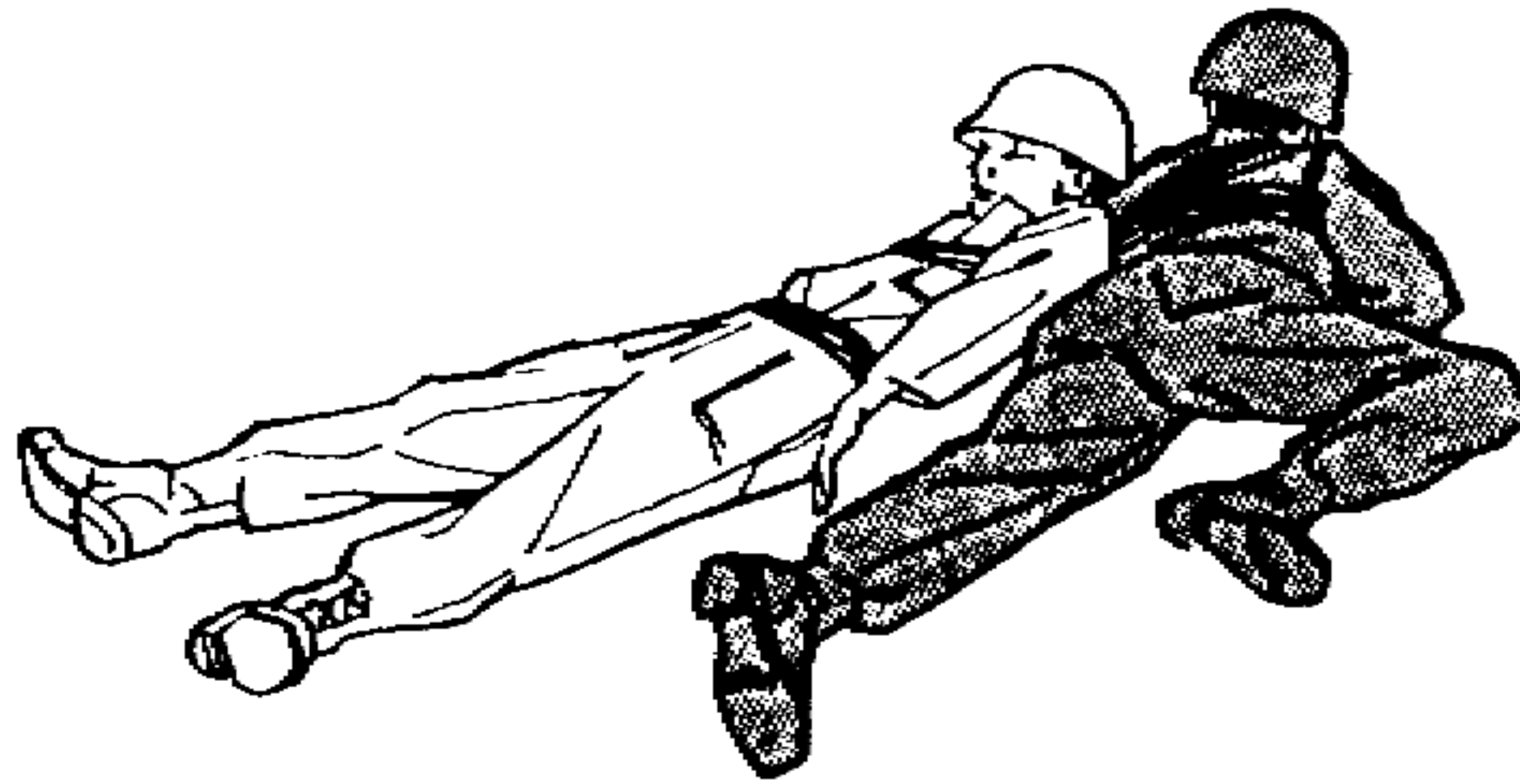

STEP ONE: EXTEND TWO PISTOL-BELTS OR SIMILAR OBJECTS TO THEIR FULL LENGTH AND JOIN THEM TOGETHER TO MAKE A CONTINUOUS LOOP.

STEP TWO: ROLL THE SOLDIER ON HIS BACK.

STEP THREE: PASS THE LOOP OVER THE SOLDIER'S HEAD AND POSITION IT ACROSS HIS CHEST AND UNDER HIS ARMPITS; THEN CROSS THE REMAINING PORTION OF THE LOOP, THUS FORMING A FIGURE EIGHT.

STEP FOUR: LIE ON YOUR SIDE WITH YOUR BACK AWAY FROM THE SOLDIER, RESTING ON YOUR RIGHT ELBOW.

STEP FIVE: SLIP THE LOOP OVER YOUR RIGHT ARM AND SHOULDER AND TURN ONTO YOUR ABDOMEN, THUS ENABLING YOU TO DRAG THE SOLDIER AS YOU CRAWL.

Figure 10-14. Pistol-belt drag.

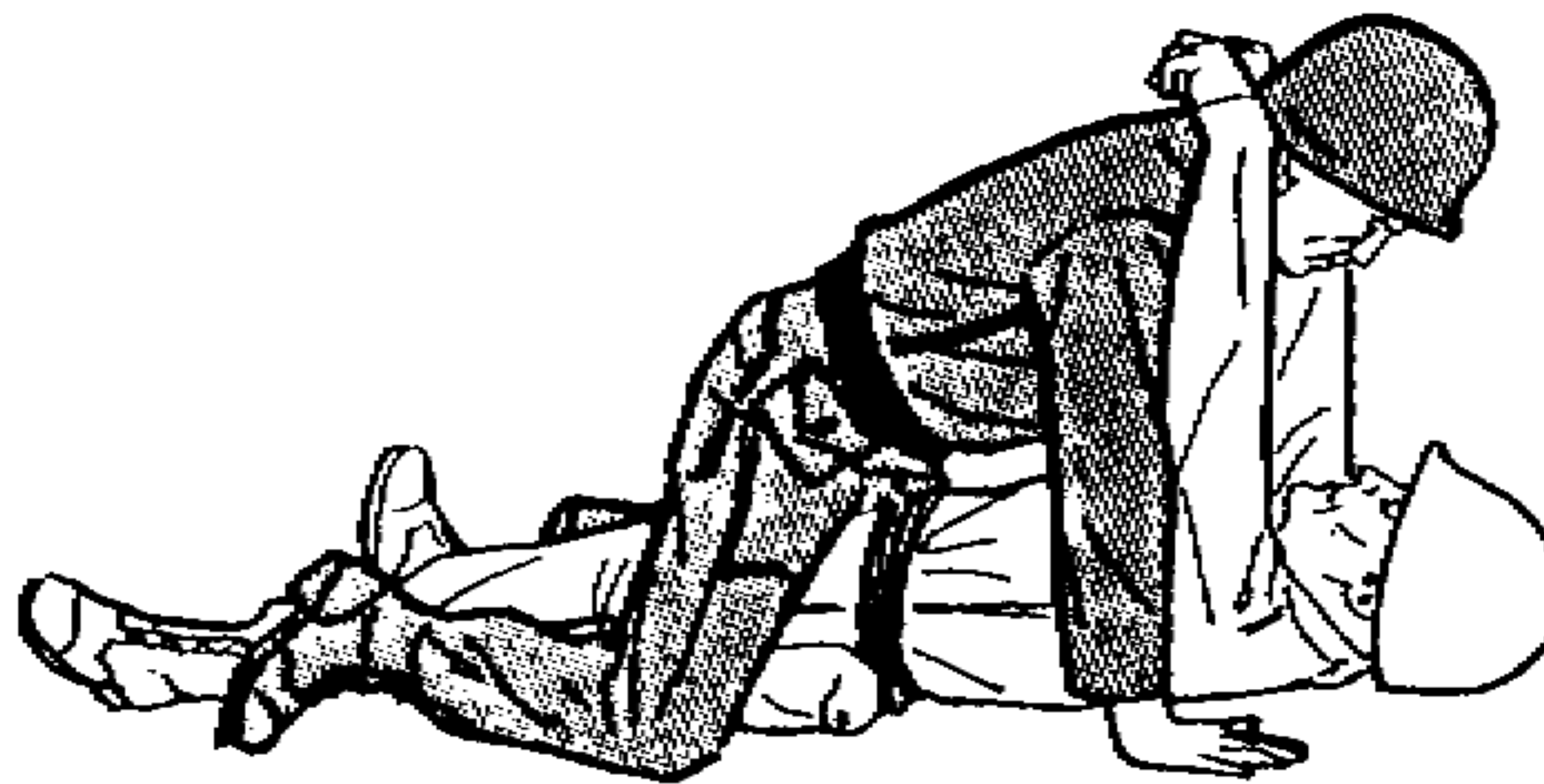

STEP ONE: TIE SOLDIER'S HANDS TOGETHER AND LOOP THEM AROUND YOUR NECK.

STEP TWO: CRAWL, DRAGGING SOLDIER WITH YOU.

Figure 10-15. Neck drag.

STEP ONE: WITH THE SOLDIER LYING ON HIS BACK, THE BEARER KNEELS AT HIS HEAD. THE BEARER THEN SLIDES HIS HANDS, WITH PALMS UP, UNDER THE SOLDIER'S SHOULDERS AND GETS A FIRM HOLD UNDER HIS ARMPITS.



STEP TWO: THE BEARER PARTIALLY RISES, SUPPORTING THE SOLDIER'S HEAD ON ONE OF HIS FOREARMS. (THE BEARER MAY BRING HIS ELBOWS TOGETHER AND LET THE SOLDIER'S HEAD REST ON BOTH OF HIS FOREARMS)



STEP THREE: WITH THE SOLDIER IN A SEMISITTING POSITION, THE BEARER RISES AND DRAGS THE SOLDIER BACKWARD.

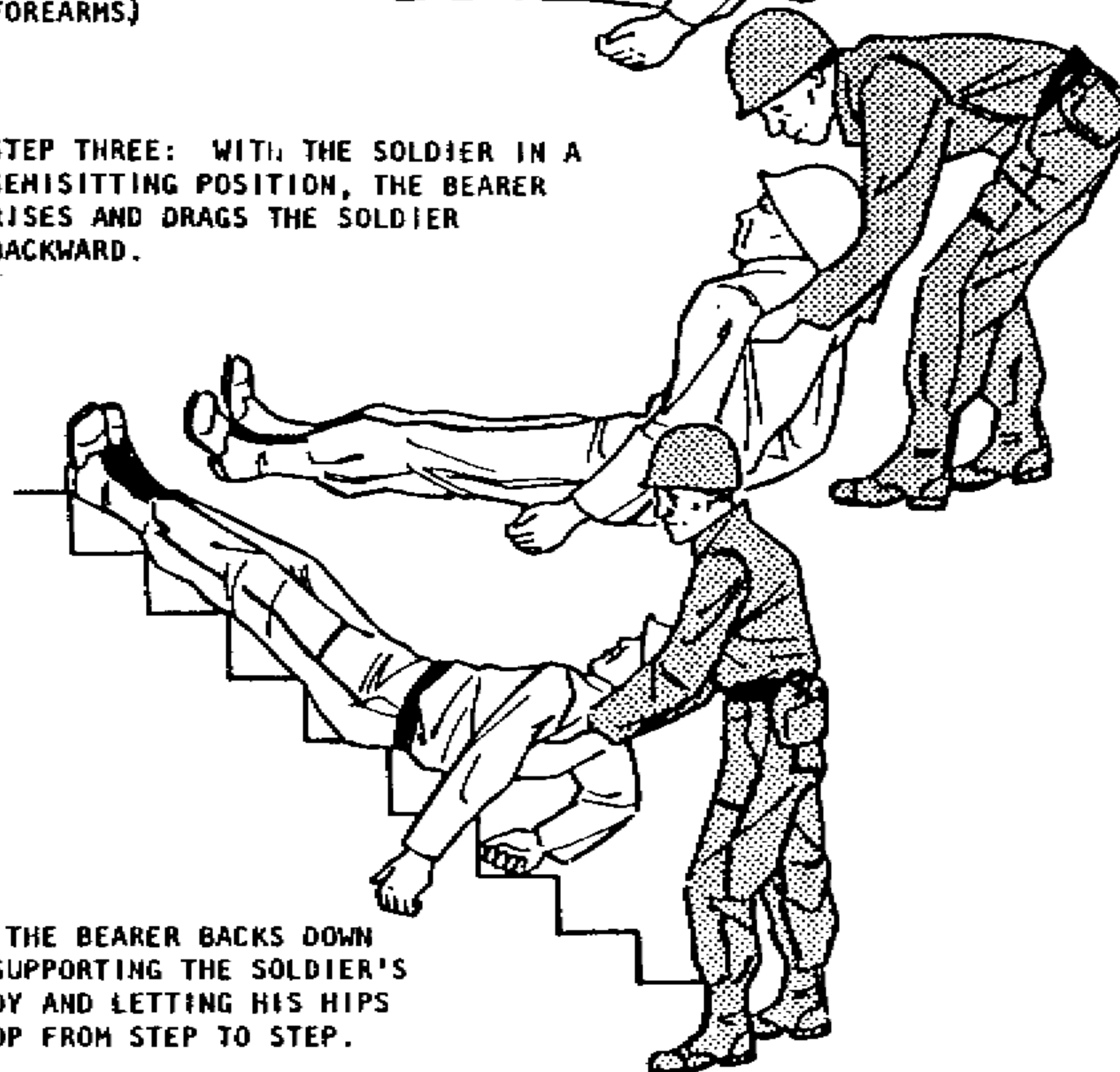

STEP FOUR: THE BEARER BACKS DOWN THE STEPS, SUPPORTING THE SOLDIER'S HEAD AND BODY AND LETTING HIS HIPS AND LEGS DROP FROM STEP TO STEP.

Figure 10-16. Cradle drop drag.



ALTERNATE METHOD
FOR USE WHEN
SOLDIER IS TALLER
THAN BEARERS.

STEP ONE: TWO BEARERS HELP THE SOLDIER TO HIS FEET AND SUPPORT HIM WITH THEIR ARMS AROUND HIS WAIST.

STEP TWO: THEY GRASP THE SOLDIER'S WRISTS AND DRAW HIS ARMS AROUND THEIR NECKS.

Figure 10-17. Two-man supporting carry.

STEP ONE: TWO BEARERS KNEEL AT ONE SIDE OF THE SOLDIER, EXTEND HIS ARMS ABOVE HIS HEAD, AND PLACE THEIR ARMS BENEATH THE SOLDIER'S BACK, WAIST, HIPS, AND KNEES.



STEP TWO: THE BEARERS LIFT THE SOLDIER AS THEY RISE TO THEIR KNEES.



STEP THREE: AS THE BEARERS RISE TO THEIR FEET, THEY TURN THE SOLDIER TOWARD THEIR CHESTS. THEY CARRY HIM HIGH TO LESSEN FATIGUE.

Figure 10-18. Two-man arms carry.

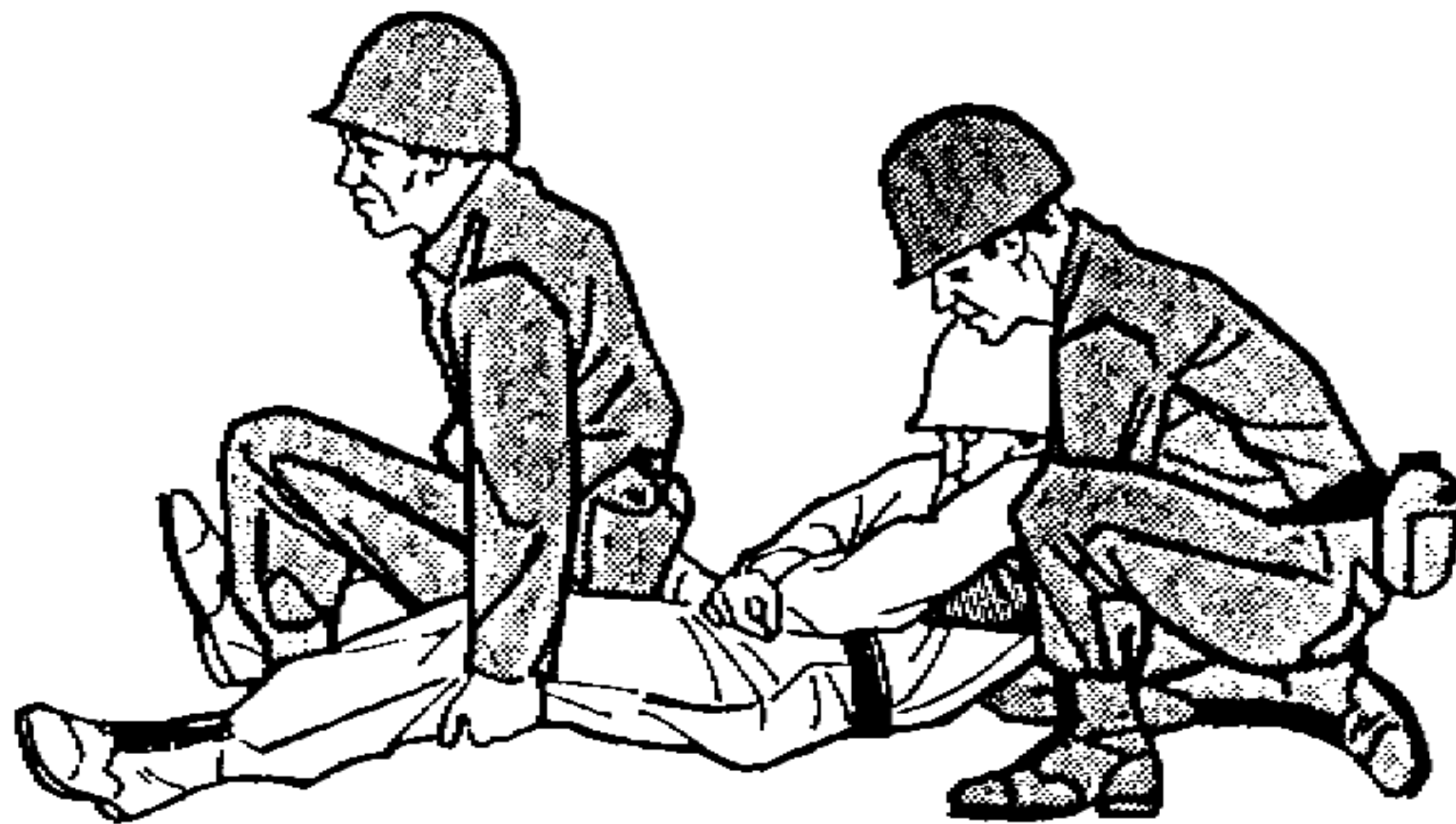

STEP ONE: ONE BEARER SPREADS THE SOLDIER'S LEGS, KNEELS BETWEEN THE LEGS WITH HIS BACK TO THE SOLDIER, AND POSITIONS HIS HANDS BEHIND THE KNEES. THE OTHER BEARER KNEELS AT THE SOLDIER'S HEAD, SLIDES HIS HANDS UNDER THE ARMS AND ACROSS THE CHEST, AND LOCKS HIS HANDS TOGETHER.

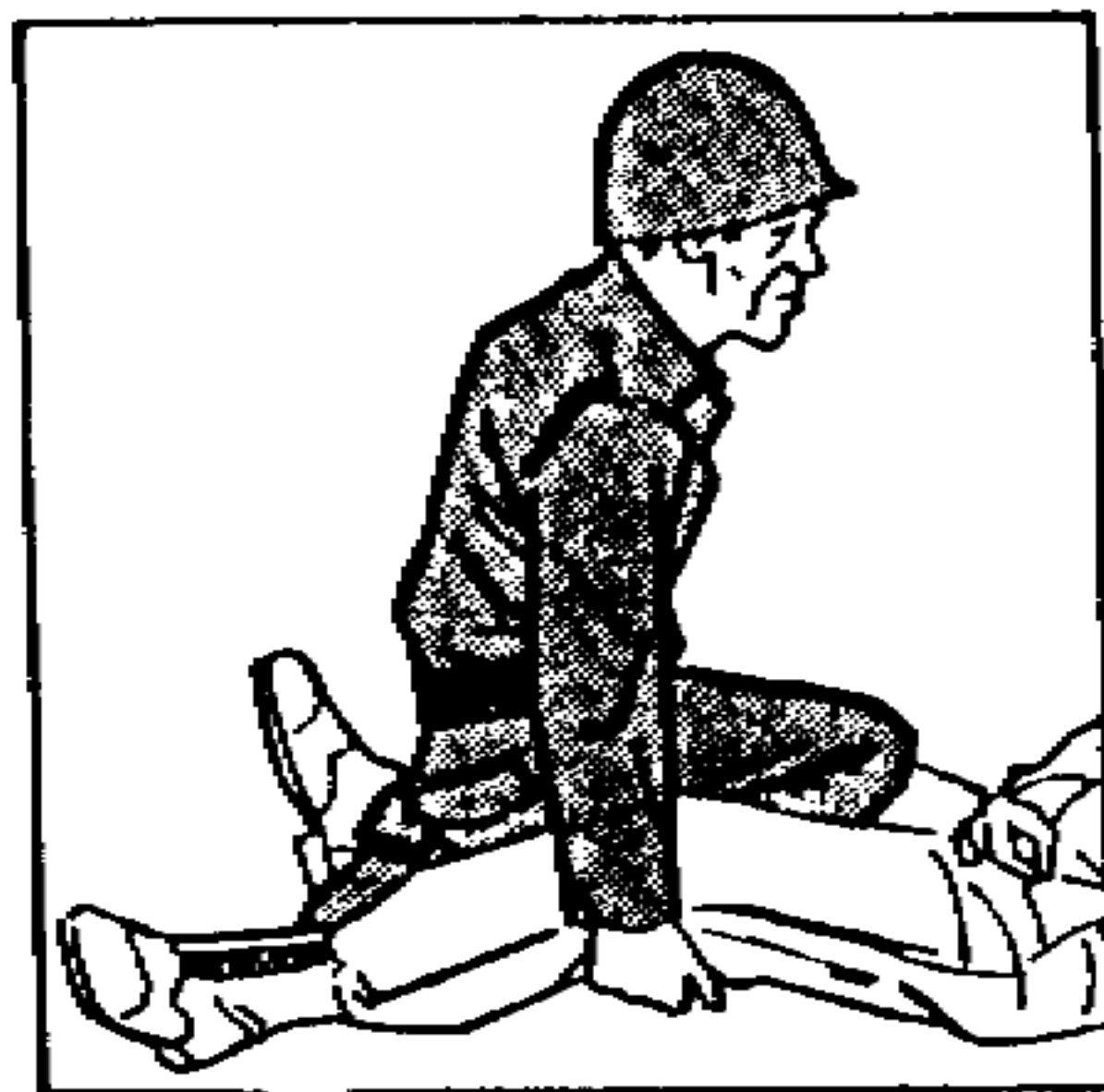

ALTERNATE POSITION--
FACING SOLDIER

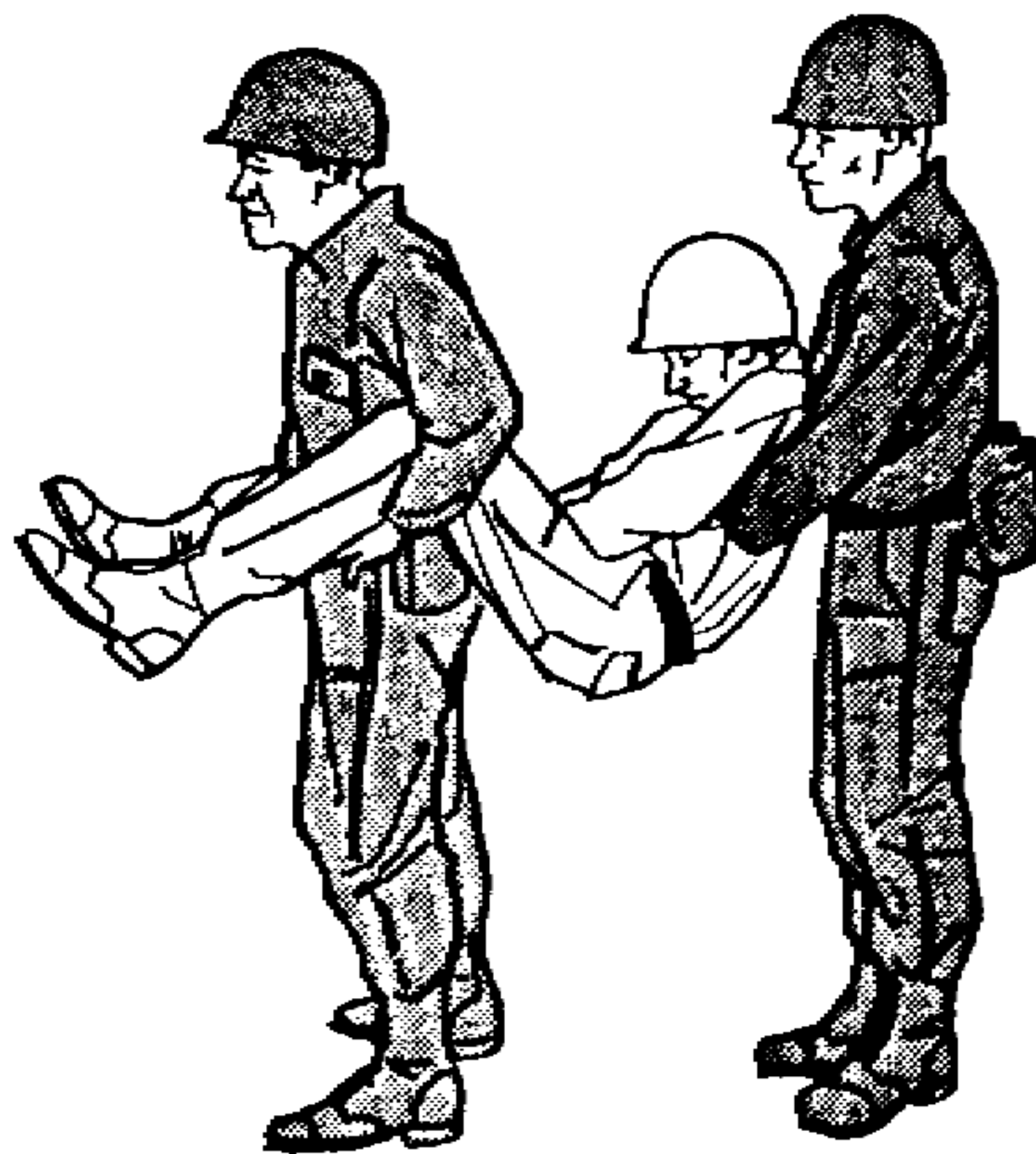

STEP TWO: THE TWO BEARERS RISE TOGETHER, LIFTING THE SOLDIER.

Figure 10-19. Two-man fore-and-aft carry.

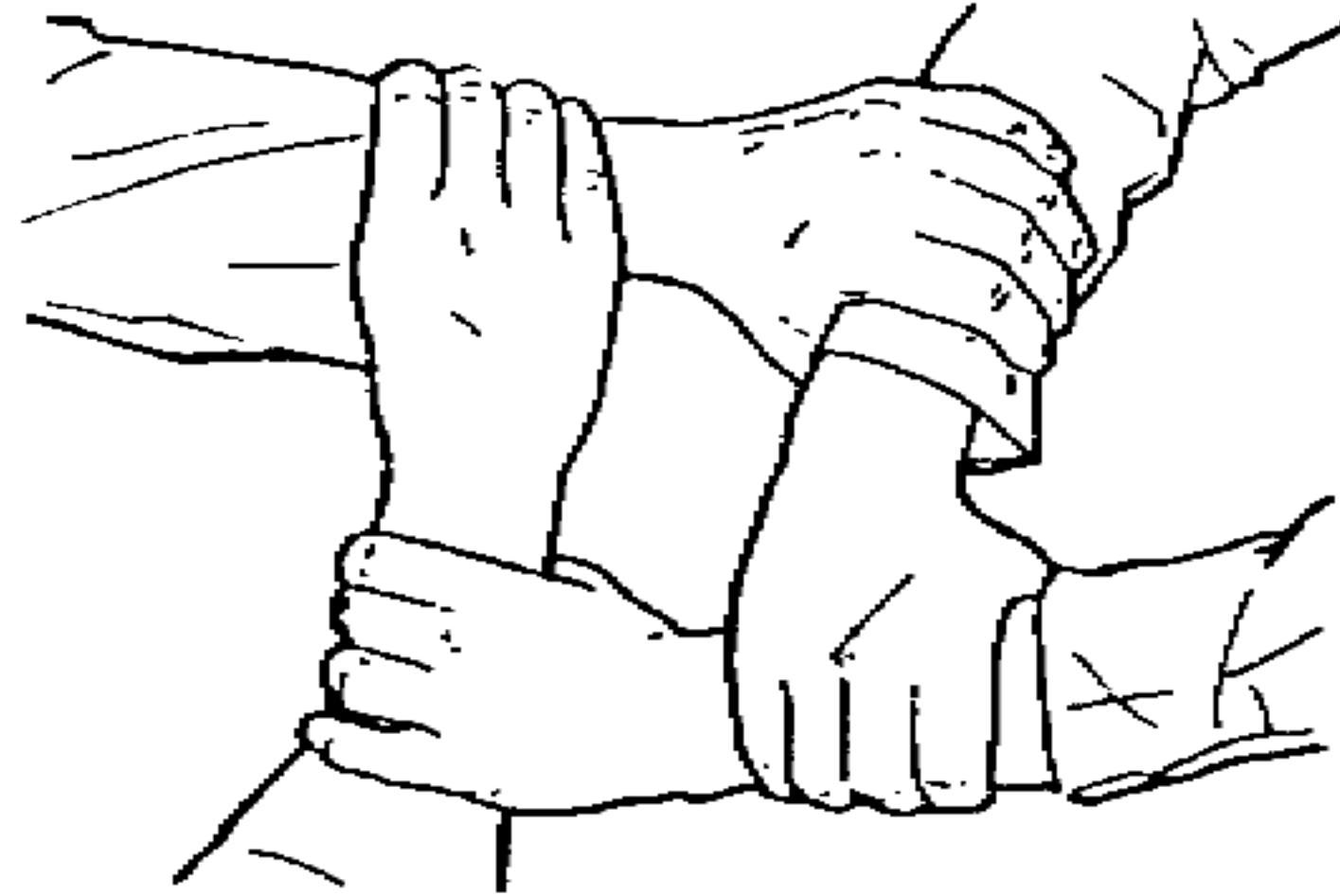

STEP ONE: EACH BEARER GRASPS ONE OF HIS WRISTS AND ONE OF THE OTHER BEARER'S WRISTS, THUS FORMING A PACKSADDLE.



STEP TWO: THE TWO BEARERS LOWER THEMSELVES SUFFICIENTLY FOR THE SOLDIER TO SIT ON THE PACKSADDLE: THEN THEY HAVE THE SOLDIER PLACE HIS ARMS AROUND THEIR SHOULDERS FOR SUPPORT BEFORE THEY RISE TO AN UPRIGHT POSITION.

Figure 10-20. Four-hand seat carry.



FRONT VIEW

STEP ONE: WITH SOLDIER LYING ON HIS BACK, A BEARER KNEELS ON EACH SIDE OF HIM AT SOLDIER'S HIPS.

STEP TWO: EACH BEARER PASSES HIS ARMS UNDER THE SOLDIER'S THIGH AND BACK, AND GRASPS THE OTHER BEARER'S WRISTS.

STEP THREE: THE BEARERS RISE, LIFTING THE SOLDIER.

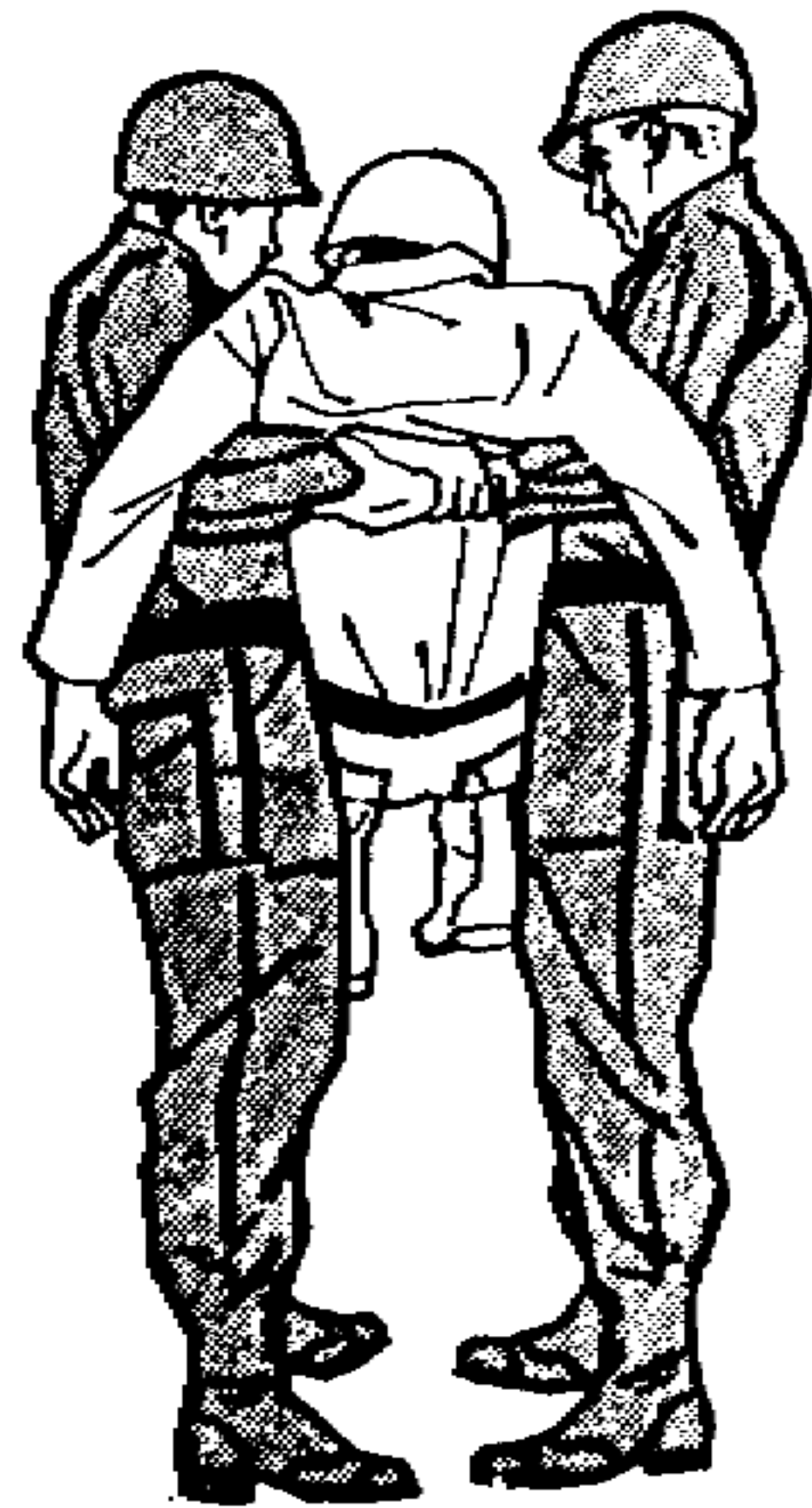

BACK VIEW

Figure 10-21. Two-hand seat carry.

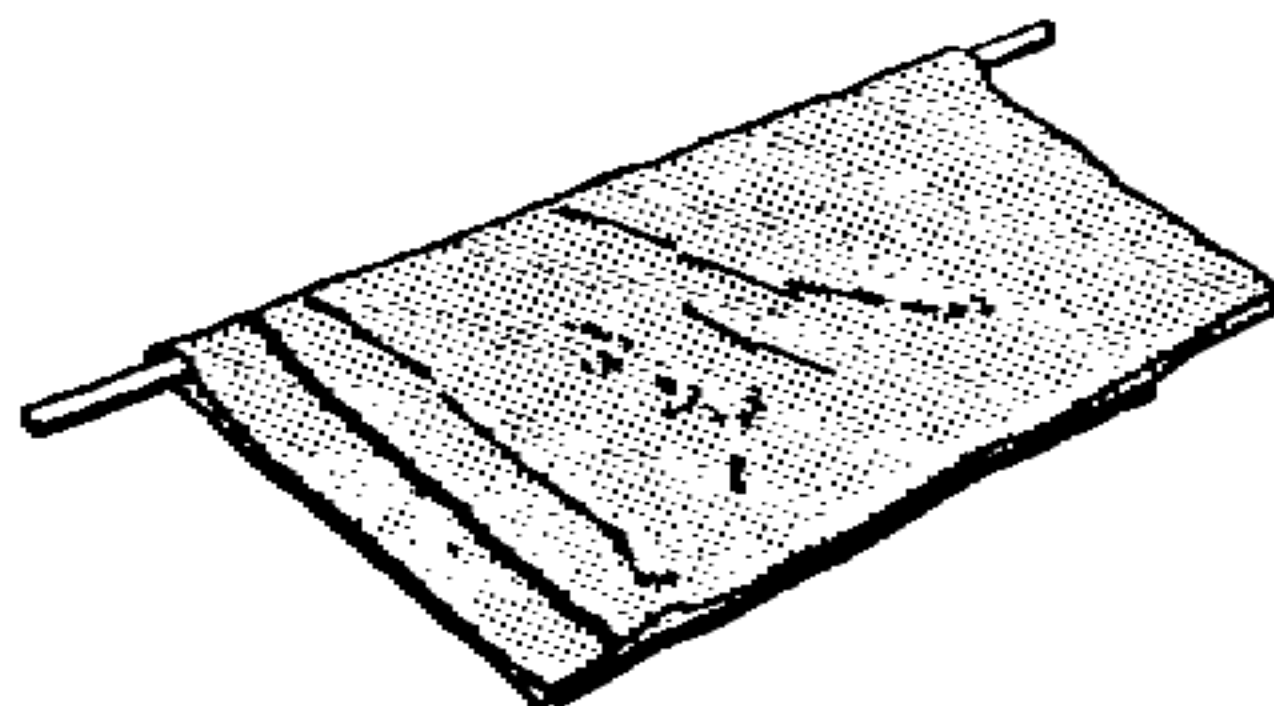

- a** OPEN THE BLANKET AND LAY ONE POLE LENGTHWISE ACROSS THE CENTER; THEN FOLD THE BLANKET OVER THE POLE.

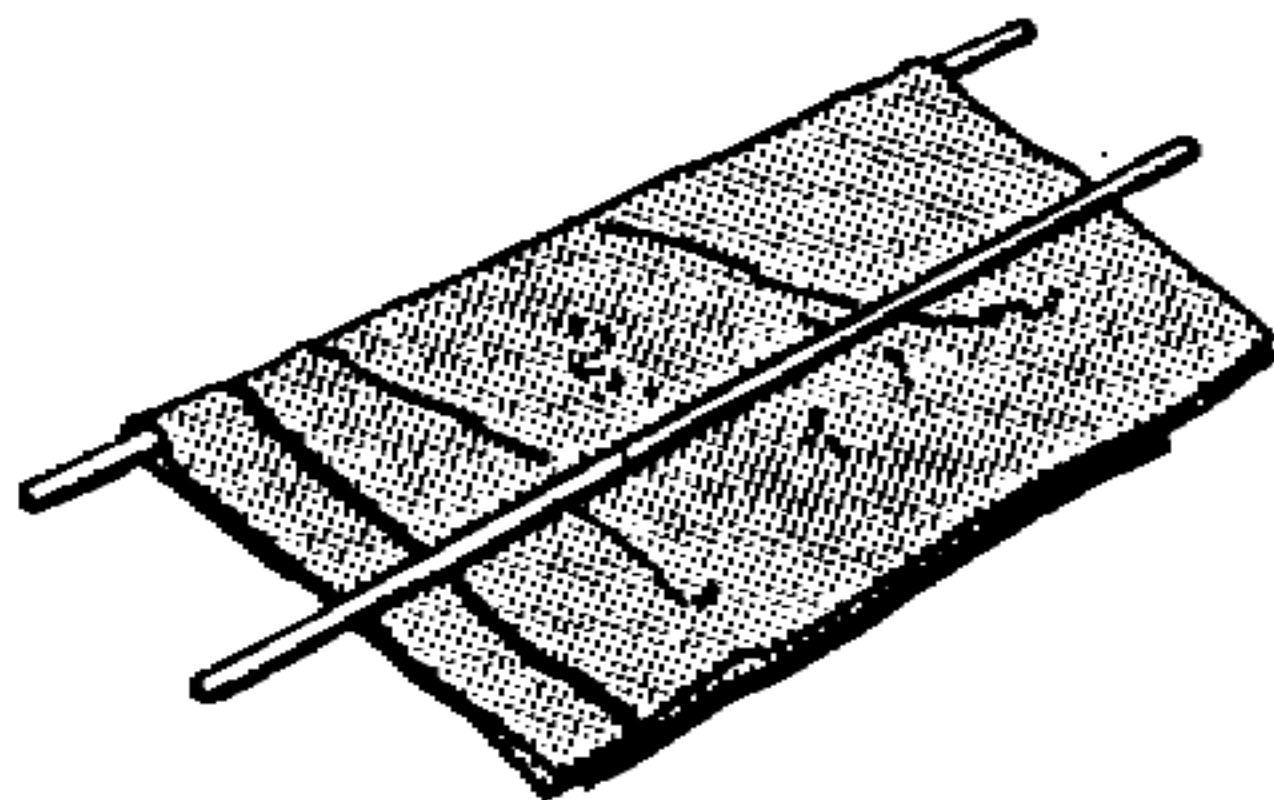

- b** PLACE THE SECOND POLE ACROSS THE CENTER OF THE FOLDED BLANKET.

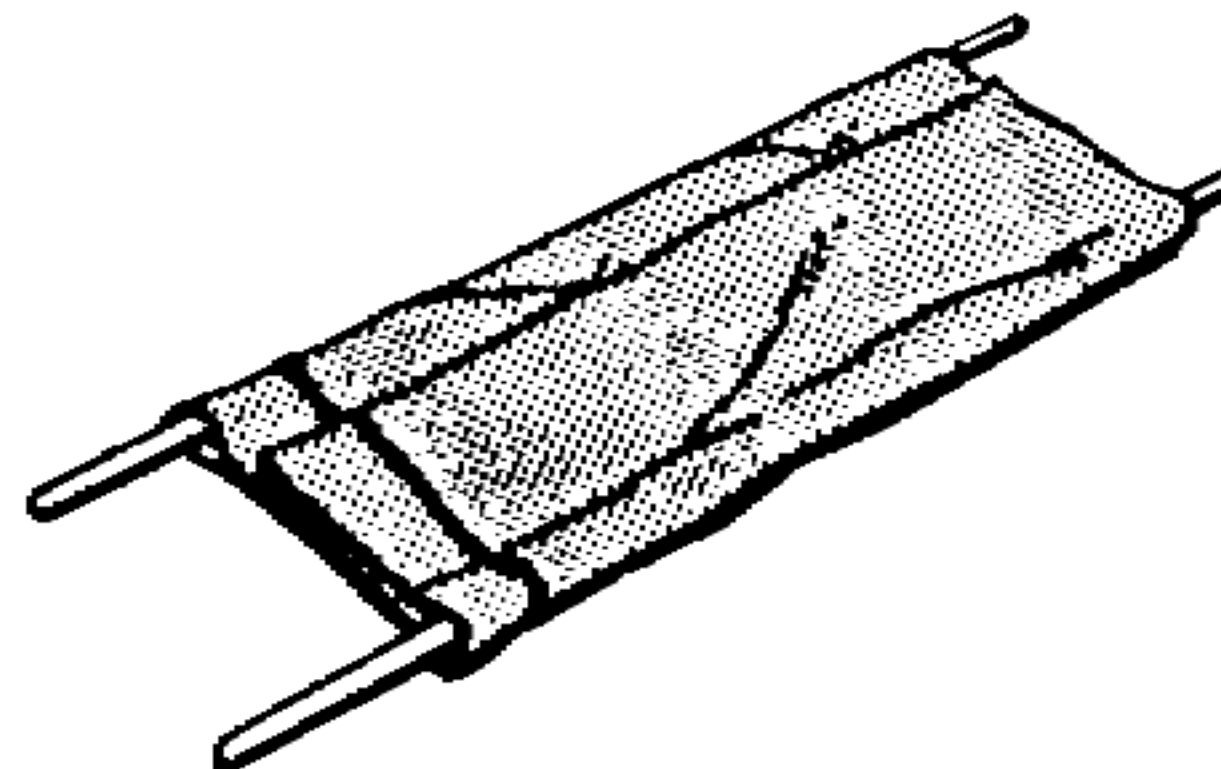

- c** FOLD THE FREE EDGES OF THE BLANKET OVER THE SECOND POLE.

Figure 10-22. Litter made with poles and blanket.



a
BUTTON TWO OR THREE
SHIRTS OR JACKETS AND
TURN THEM INSIDE OUT,
LEAVING SLEEVES INSIDE.

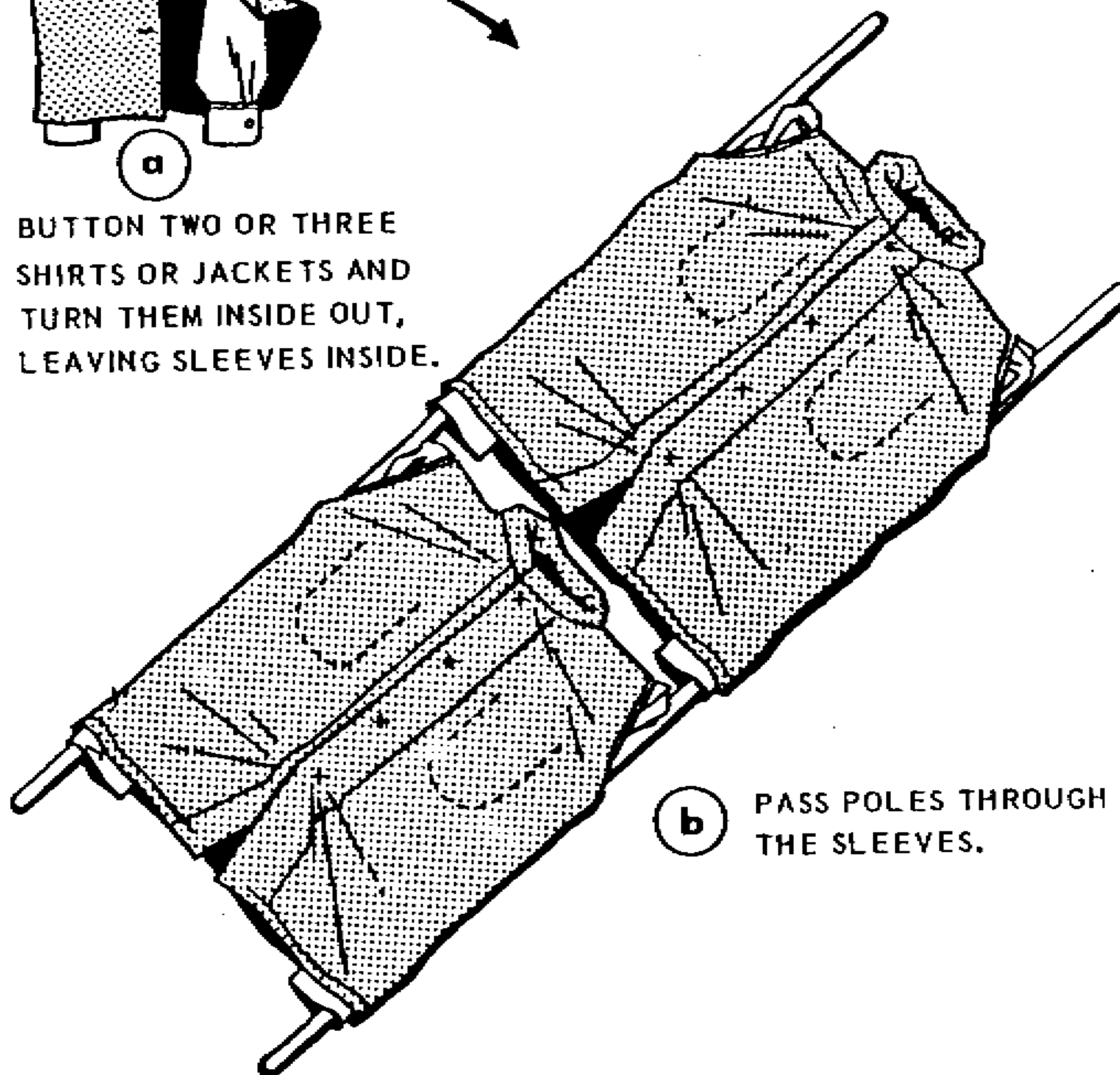

b PASS POLES THROUGH
THE SLEEVES.

Figure 10-23. Litter made with poles and jackets.

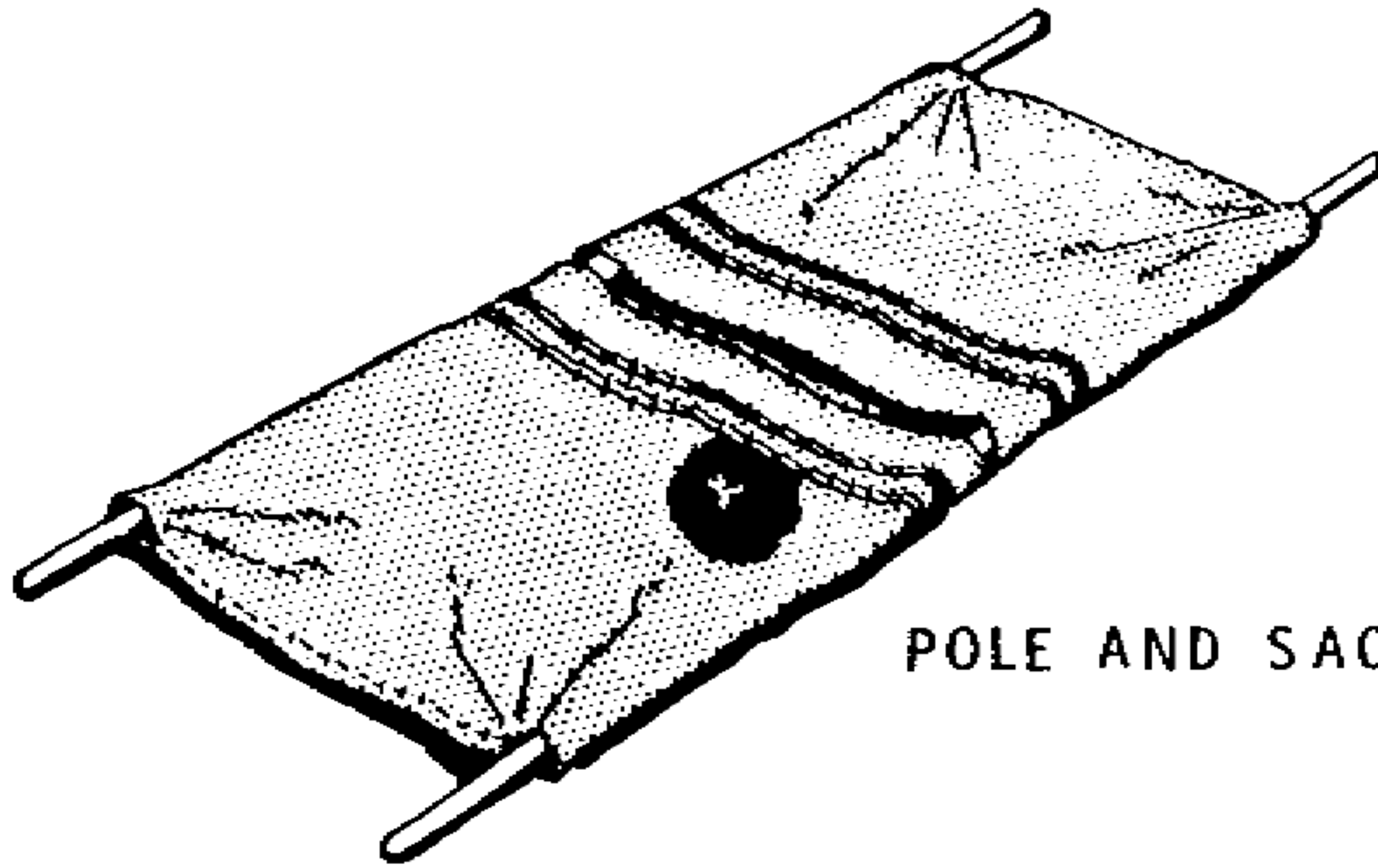

POLE AND SACK LITTER

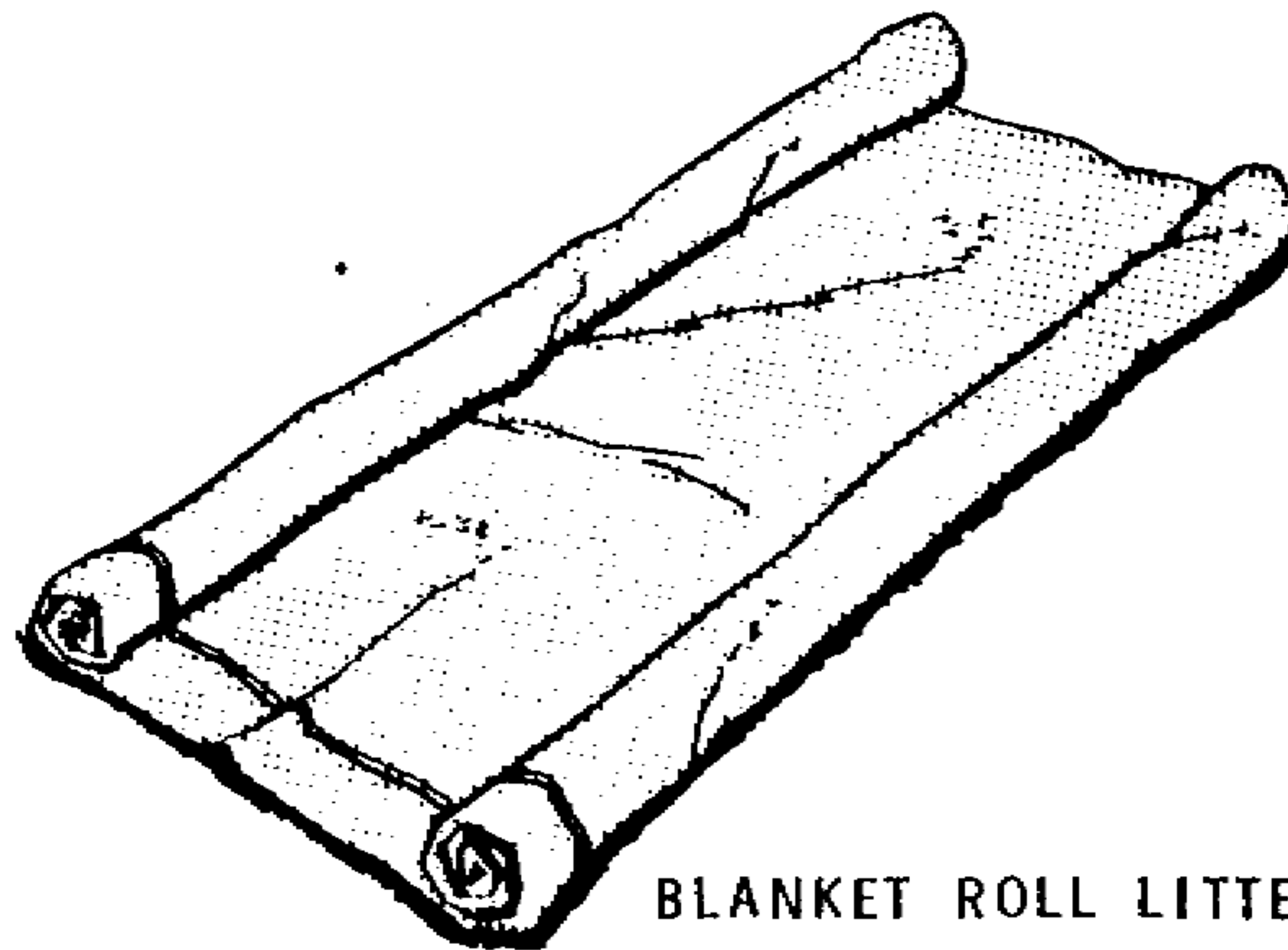

BLANKET ROLL LITTER

Figure 10-24. Litters made by inserting poles through sacks and by rolling blanket.

CHAPTER 11

FIRST AID IN A TOXIC ENVIRONMENT

Section I. INTRODUCTION

11-1. General

a. Gasoline, chlorine, and pesticides are examples of common toxic substances. They may exist in the physical state as a solid, liquid, or gas, depending upon temperature and pressure. Gasoline, for example, is a vaporizable liquid; chlorine is a gas; and DDT, a pesticide, is a solid. Some substances are more injurious to the body than others when they are inhaled, are eaten, or come in contact with body surfaces. Whether they are solids, liquids, or gases (vapors and aerosols included), they may irritate, inflame, burn, freeze, or destroy tissue such as that associated with the respiratory tract or the eyes. They may also be absorbed into the bloodstream, thus causing disturbance to any one or several of the body's major functions.

b. You may come in contact with toxic substances in everyday activities. Examples are the use of disinfectants and bleach solutions for cleaning clothes, through accidents in handling chemicals, or through exposure to chemical agents used as a means of warfare. Ordinarily, exposure to a toxic substance would be for only a period of minutes; however, in warfare any toxic substance employed by the enemy would be such that it could persist for hours or days. This would produce a toxic environment in which you would have to live. You must, therefore, be prepared to protect yourself and others against the injurious effects of these agents and to give first aid, when necessary, within this toxic environment.

11-2. Protective and First Aid Equipment

You are issued equipment for protection and first aid treatment in

a toxic environment (a through d below). You must know how and when to use these items. When considered necessary, you will also be issued special protective clothing, "dubbing" for boots (vesicant agent resistant leather dressing), and other prophylactic and first aid drug as required.

a. *Field Protective Mask (Model ABC-M17 or M17A1)*. Your field protective mask is a *most important* piece of protective equipment. You are given special training in its use and care. (See paragraph 7-13b(3) for explanation of the drinking tube and the protective canteen cap of the M17A1 protective mask.)

b. *M258 Skin Decontaminating Kit*. This kit includes five gauze pads, two wiping sticks, and two large plastic capsules, each contained in a gauze bag. It is used to decontaminate the skin.

c. *Nerve Antidote Injectors*. Each soldier is authorized to carry two nerve antidote injectors (ComboPens) to be used in the treatment of nerve agent symptoms.

d. *M13 Decontamination and Reimpregnation Kit*. This kit consists of two bags. In each bag are the following items:

(1) A dye capsule for use in revealing the presence of liquid chemical agents on your clothing and personal equipment.

(2) Chloramide powder for use in neutralizing the chemical agents.

(3) A cutter to remove the parts of your clothing shown by the use of the dye to be contaminated.

Section II. CHEMICAL-BIOLOGICAL AGENTS

11-3. General

a. Chemical agents for warfare uses may be classified according to the primary physiological effects they produce, such as nerve, blister, blood, choking, and incapacitating agents. Your field protective mask gives protection against chemical agents as well as biological agents and the breathing in of radioactive particles. Previous practice enables you to mask in 9 seconds or less.

b. Ingesting water or food contaminated with nerve, blister, and other chemical agents and with some biological agents can be fatal. Never consume water or food which could have become contaminated until it has been tested and found safe for consumption (FM 21-10).

11-4. Conditions for Masking Without Order or Alarm

Once an attack with a chemical or biological agent is detected or suspected or information is available that such an agent is about to be used, you must mask immediately. Under the following circumstances, do not wait to receive an order or alarm when—

- a. Your position is hit by—
 - (1) Artillery or mortar fire.
 - (2) Missiles or rockets.
 - (3) Smoke or mists.
 - (4) Aerial spray or bombs.
- b. Smoke from an unknown source is present.
- c. A suspicious odor, liquid, or solid is present.
- d. You are entering an area suspected of being contaminated.
- e. You have one or more of the following symptoms:
 - (1) An unexplained runny nose.
 - (2) A feeling of choking or tightness in the chest or throat.
 - (3) Dimming of vision.
 - (4) Irritation of the eyes.
 - (5) Difficulty in or increased rates of breathing without obvious reasons.

11-5. First Aid For A Chemical Attack

a. *Step ONE.* Stop breathing, put on your mask and clear it, give the alarm, and continue the mission.

Note: Keep your mask on until it has been determined that the area is no longer hazardous and you are told to unmask.

b. *Step TWO.* If symptoms of nerve agent poisoning (para 11-7) appear, give yourself a nerve agent antidote (para 11-8c).

Note: Do not inject a nerve agent antidote until you are sure that it is needed.

c. *Step THREE.* If you suspect chemical agent droplets in your eyes, accomplish the following actions as rapidly as possible. To be effective against mustard agents (para 11-9), they must be accomplished within 2 minutes.

- (1) Unscrew the cap on your canteen.
- (2) Remove your helmet.
- (3) Take and hold a deep breath and raise your mask so that your face is uncovered.

(4) To flush your right eye, tilt your head back and slightly to the right. To flush your left eye, tilt your head back and slightly to the left.

(5) Looking upward, pour water into your eye slowly, if possible, so that the water will not run onto your face and clothing. If you cannot keep your eye open, pull your eyelids away from your eye with uncontaminated fingers.

(6) Reseat and clear your mask.

d. Step FOUR. If you suspect that your face is contaminated, use the M258 kit as explained in paragraph 11-8b.

e. Step FIVE. As soon as your mission permits, remove any liquid contamination from other skin areas (para 11-8b).

f. Step SIX. If nerve agents are used and your mission permits, watch for persons who need nerve agent antidotes and artificial respiration and administer them respectively (para 11-8c and 11-8d).

g. Step SEVEN. When your mission permits, decontaminate your personal clothing and equipment, using the bags of chloramide powder and cutter from your M13 kit (para 11-2d).

Section III. NERVE AGENTS

11-6. General

a. Nerve agents may enter the body through the eyes and the skin and by breathing and eating. Although the nerve agents can be absorbed into the body through unbroken skin, they do not produce a localized irritant effect. Smoking is not permitted for at least 24 hours after exposure to a nerve agent, since the tars and nicotine will increase and prolong the nerve agent effects.

b. If any of the symptoms of nerve agent poisoning are present, administer appropriate first aid (para 11-8c).

11-7. Symptoms of Nerve Agent Poisoning

a. An unexplained runny nose.

b. Marked difficulty in breathing with tightness in the chest.

c. Possibly, blurred or reduced vision, resulting from pinpointed pupils of the eyes.

Note: Upon exposure to vapor or aerosol, the pupils of the eyes become pinpointed immediately; however, if the nerve agent is only absorbed through

the skin or by consuming contaminated food or water, the pinpointing does not occur immediately and may be absent.

d. Drooling, excessive sweating, nausea, vomiting, cramping, and involuntary urination and defecation.

e. Jerking, twitching, and staggering.

f. Headache, confusion, drowsiness, coma, convulsions.

g. Stoppage of breathing.

Note: If a soldier has the symptoms listed in *d* through *g* above, he probably will not be able to help himself, since they indicate severe poisoning.

11-8. First Aid for Nerve Agent Poisoning

a. Protective Mask (para 11-2a and 11-4).

b. M258 Skin Decontaminating Kit. If properly used this kit will destroy blister and nerve agents on the skin.

(1) The kit has a plastic cover with a list of contents printed on top. The handle is held down to the side by a piece of tape. Inside the top is a metal cutter or spike. On the side of the plastic case are the instructions for using the kit. Inside the kit are *five gauze pads, two wiping sticks, and two large plastic capsules, each contained in a gauze bag.* The gauze pads are used to soak up liquid drops on the skin and to apply decontaminant solutions to the skin. The wiping sticks are used to remove liquid contamination that resists removal with gauze pads, for example, a thickened toxic agent. The plastic capsules, labeled 1 and 2, contain the decontaminating solutions. Number 1 is smaller than number 2.

(2) The key to successful use of the kit is *immediate action when finding the contamination.*

(a) First, put on your protective mask. You may detect exposure to a chemical agent through appearance of a strange liquid on you or in your area or by appearance of agent symptoms. *Your first action is to put on your protective mask.*

(b) Open the M258 kit. Insert the T-shaped handle of the cover through the web strap so it will not be lost.

(c) Soak up any liquid on the skin with one of the gauze pads. Discard the pad.

(d) If you find the agent difficult to remove or thickened, use the wiping stick(s) to remove it from the skin. Discard the wiping stick(s).

(e) Remove capsule 1 and puncture its end, using the spike in the cap of the kit. Wet a gauze pad with the solution and apply

it to all areas of the skin that were contaminated with the agent. While applying the decontaminating solution, you may hold the capsule or replace it in the case as you prefer. Discard the gauze pad after use.

(f) Now strike capsule 2 on a hard surface such as the heel of your boot, weapon, or a rock to break the glass vial inside. Shake the capsule about 12 times in order to mix the wet and dry components.

(g) Puncture the end of capsule 2 with the spike of the kit's cover. Wet a piece of gauze and swab the contaminated area again. You may hold the capsule or replace it in the kit case as you prefer. Discard the gauze pad after use.

(h) If you detect the agent soon enough and perform the decontamination properly, you should suffer no ill effects. If blisters develop later, treat them as you would a normal heat burn. (Nerve agent symptoms are to be treated with the nerve agent antidote (c below).)

(3) The skin decontaminating kit should be kept with the mask by attaching it with the snap clip to the mask carrier D ring or by putting the D ring strap through the hole in the web strap of the kit.

c. Nerve Agent Antidote. The soldier is authorized to carry two nerve agent antidote injectors (ComboPens) (fig 11-1).

(1) Each injector is used as follows:

(a) Pull out the safety cap.

(b) Place the needle-end on outer thigh and press until the injector functions. The injector should be held firmly against the thigh for 10 seconds to allow for complete injection of the antidote.

(c) Give the first injection at the onset of the symptoms. If nerve agent symptoms are still present after 5 minutes, give the second injection. If symptoms still exist after an additional 5 minutes, do not use another injector but seek medical attention.

(2) The injectors will be carried in the top, outside pocket on the carrier for the M17 masks. Because the size of the outside pocket varies, it may be necessary to carry the injectors in the pocket inside and at the rear of the carrier. For personnel issued the M24 or M25 series masks, the injectors should be carried in the pocket for the M13 kit located inside the carrier. In cold weather (45° or lower) to prevent freezing and for maximum effectiveness, the antidote injectors should be carried in a pocket next to the body.



Figure 11-1. ComboPen auto-injector.

d. Mask-to-Mouth Artificial Respiration. Administer artificial respiration, if needed. If your mission permits, look around and see if anyone needs your assistance. If a soldier's breathing has become faint or has stopped, administer artificial respiration. If he needs a nerve agent antidote, give it first; then start artificial respiration immediately. In a toxic environment a soldier must be given artificial respiration by either the mask-to-mouth method or the back-pressure arm-lift method, which is an alternate method. (The back-pressure method has been discussed in paragraph 3-7.) The mask-to-mouth method of artificial respiration is a modification of the mouth-to-mouth method (para 3-4). The objective is to get uncontaminated air into the soldier's lungs through the use of your M17A1 Field Protective Mask and M1 Resuscitation Tube. The mask-to-mouth method is performed as follows:

(1) Prepare your mask (a, fig 11-2) for administering artificial respiration:

(a) Turn the valve handle (b, fig 11-2) to the left, thus positioning the breathing tube bitepiece (inside the mask) between your teeth.

Note: The breathing tube bitepiece will spring back to the neutral position if you release your bite.

(b) Using your left hand, raise the voicemitter cover (a, fig 11-2). Then with your right hand insert the outlet valve of the resuscitation tube (c, fig 11-2) into the air outlet well, which is under the voicemitter cover. To obtain a tight, leakproof seal, first insert the unflanged edge of the air outlet valve (c, fig 11-2) with an upward push and then press the flanged edge inward as hard as possible.

(c) To determine whether or not a leakproof seal has been obtained, fold back and pinch the lower end of the corrugated tube (c, fig 11-2) and blow into your breathing tube bitepiece. If the corrugated tube does not tend to expand, remove and reinsert the outlet valve as explained in (b) above; then check again.

(2) Raise the soldier's protective mask only enough to expose his mouth and nose; then clear his airway (para 3-4).

(3) Position the soldier on his back, his head in a chin-up position, and his jaw in a jutting-out position as described for mouth-to-mouth (nose) method (para 3-2).

(4) Insert and secure the mouthpiece of the resuscitation tube (c, fig 11-2) between the soldier's lips and teeth (fig 11-3):

(a) To insert the mouthpiece between the soldier's lips and teeth, slide only one-half of it into his mouth at a time. Insert the indented part of the mouthpiece under the upper lip. Insure that the edges of the mouthpiece are completely sealed with the soldier's lips.

(b) Secure the mouthpiece in place by forming a seal over the soldier's lips with your thumb and index finger. Hook the other three fingers under the soldier's chin to keep his jaw in a jutting-out position.

(5) Administer artificial respiration (fig 11-3):

(a) With your free hand, pinch the soldier's nose closed, take a deep breath, and blow into your breathing tube bitepiece ((1)(a) above).

(b) Continue blowing while watching for the soldier's chest to rise. If his chest does not rise, hold his chin up more forcefully and blow harder. If his chest still does not rise, check all connections for leakage of air.

(c) When the soldier's chest rises, stop blowing and release

his nose, thus allowing him to exhale. Be sure to close his nose again as soon as he exhales.

(d) Continue blowing breaths into the soldier and allowing him to exhale. The first four breaths should be full and quick to provide for rapid reoxygenation of blood. Thereafter, the breaths should be blown at a rate of approximately once every 5 seconds. If exhalation is noisy, hold the chin up more forcefully or check for the presence of secretions in the soldier's upper airway (para 3-4d(2)).

(e) When the soldier begins to breathe on his own, adjust your breathing to assist him. Blow when he is inhaling, not when he is exhaling.

(f) When the soldier continues to breathe regularly, stop blowing air into his lungs but leave the resuscitation tube in place, thus allowing him to inhale uncontaminated air through your mask. Be sure to close his nose when he inhales and open it when he exhales. If he does not continue to breathe regularly, resume mask-to-mouth resuscitation.

(g) When the soldier is able to breathe without assistance, remove the resuscitation tube from his mouth and quickly replace his mask. Be sure that his mask is properly sealed. Continue to observe him to insure that he does not stop breathing again as the result of toxic vapor which may have accumulated in his mask.

Note: Nerve agent poisoning tends to constrict the patient's breathing passage and makes inflation of his lungs more difficult. You may have to blow harder for chest inflation.

(6) After completing resuscitation, readjust your mask:

(a) Release your bite on the breathing tube bitepiece, thus allowing it to spring back to its *neutral* position (b, fig 11-2).

(b) Disconnect the resuscitation tube from your mask by pulling it outward and upward, and replace the voicemitter cover.

(c) Wipe the mouthpiece of the resuscitation tube clean and stow it in your carrier.

(7) Notify medical personnel of the soldier's location in accordance with the standing operating procedure of the unit.

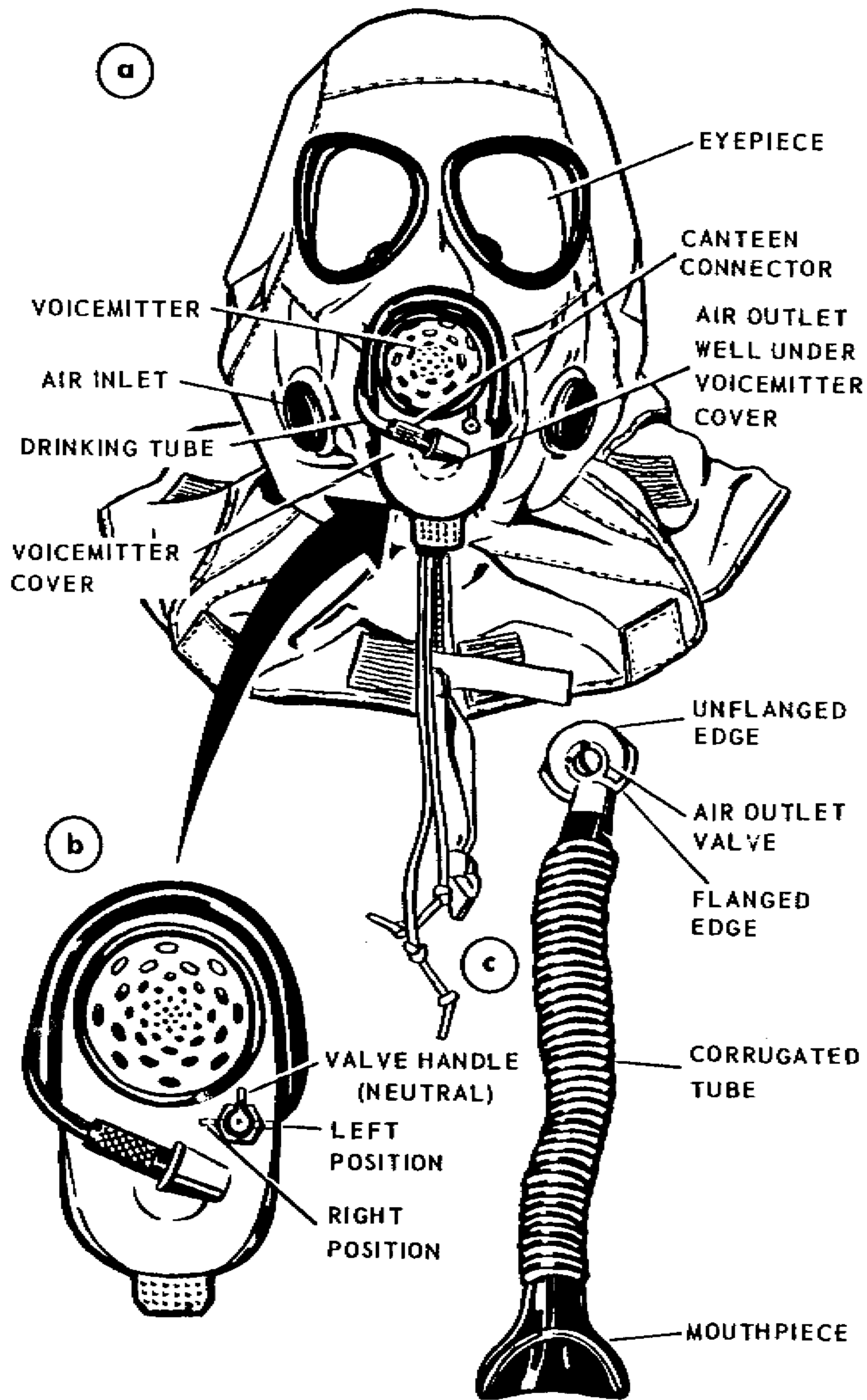

Figure 11-2. M17A1 Field Protective Mask and M1 Resuscitation Tube.

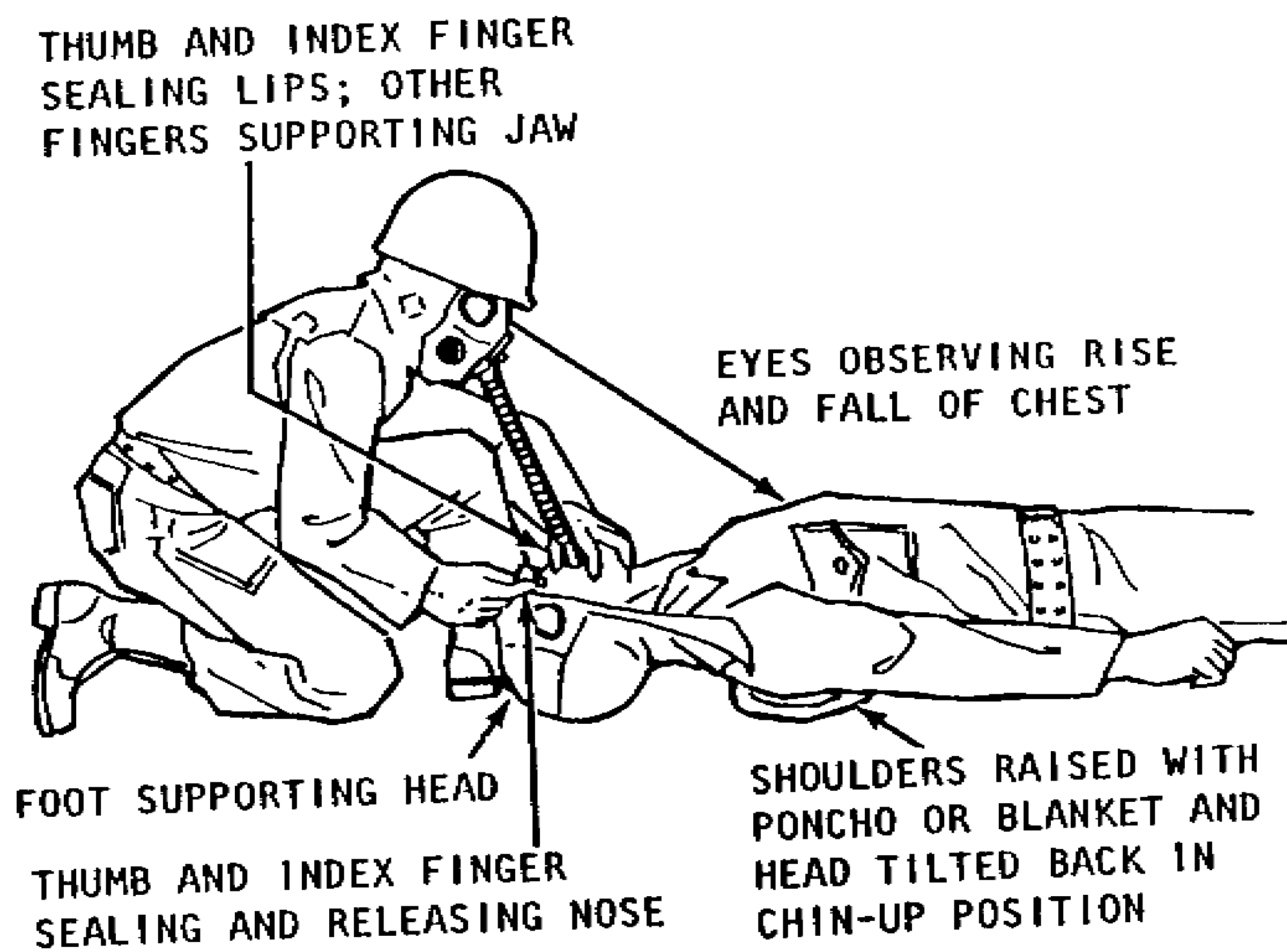

Figure 11-8. Mask-to-mouth artificial respiration.

Section IV. OTHER AGENTS

11-9. Blister Agents

a. General. Blister agents (vesicants) include mustards and arsenicals. Relatively low doses may be serious; they can cause serious injury to the eyes, the upper respiratory tract, and the skin. If it is known or suspected that blister agents are being used, you should take cover, mask, and use the M258 kit to decontaminate your exposed skin (para 11-8b). If protective clothing has been issued, you should, of course, be wearing it.

b. Symptoms of Blister Agent Poisoning.

(1) Instant eye pain upon contact with lewisite. No pain upon contact with mustard.

(2) Inflammation, blisters, and tissue destruction. The longer the agent is in contact with the tissue and the larger the area affected, the more serious the injury will become.

c. First Aid Measures for Blister Agent Poisoning. After you have accomplished the applicable steps outlined in paragraph 11-5, take the following measures as required.

(1) If blisters form, cover them with loose sterile dressing and secure with bandage. Avoid breaking blisters, if possible.

(2) If large areas of the body become covered with blisters, seek medical treatment.

(3) If a serious burn results from contact with the agent, seek medical treatment.

11-10. Choking Agents

Your mask provides you complete protection against choking agents such as phosgene and chlorine. You can continue your mission unless exposure to a choking agent before putting on your mask has been sufficient to cause difficulty in breathing, nausea, vomiting, or more than the usual shortness of breath upon exertion. If these symptoms occur, loosen your clothing, avoid unnecessary exertion, keep warm, and wait for medical aid.

11-11. Blood Agents

a. The so-called blood agents consist of the cyanides and arsine. Your mask provides you complete protection against these agents. You must change the filter elements after each blood agent attack.

b. Exposure to the blood agents before masking can cause rapid, severe interference with your respiration. If exposure to a cyanide blood agent does occur before masking, the first aid measures are inhalation of amyl nitrite and administration of artificial respiration (para 11-8d). Amyl nitrite ampuls may be issued to you if intelligence indicates a blood agent will be used. Rapid action is paramount, since a person's respiration is immediately affected after exposure to a blood agent. "Buddy help" will probably be essential. Crush two ampuls of amyl nitrite and place them within the facepiece of the mask. Repeat this procedure at intervals of 4 minutes, using two ampuls each time, until normal breathing returns or until a total of eight ampuls have been used. *No more should be given*, since amyl nitrite is poisonous and a larger dose would be harmful. If a person does not respond to this dose, he must be treated further by a medical officer. If respirations are feeble or have stopped, artificial respiration must be initiated until spontaneous breathing occurs.

11-12. Tear Agents (CS or CN)

a. Should you be exposed to a tear agent before masking, it can cause an increased flow of tears and intense eye pain. It may irritate the upper respiratory tract. If you mask after exposure, be

sure to clear your mask and keep your eyes open as much as possible. When you remove your mask after the all-clear signal, the recovery from the tear agent effects will be spontaneous.

b. If heavy skin contamination occurs in a hot, humid, close environment, blistering may result unless the agent is rinsed from the skin with water. If the agent in liquid or solid form has entered your eyes, force your eyes open and flush them with water. A one-fourth percent solution of sodium sulfite, if available, is more effective in dissolving and neutralizing the irritating agent.

11-13. Vomiting Agents

a. DM (Adamsite), DA, and DC typify this group of agents. Your mask provides you protection against them. Exposure to such an agent before masking may cause sneezing, nausea, salivation, and vomiting. If excessive salivation or vomiting makes lifting your mask necessary, be sure to clear your mask after you reseal it. Vigorous activity helps reduce nausea and its duration.

b. The symptoms reach their climax after 5 to 10 minutes and completely disappear after 1 to 3 hours. First aid consists of inhaling chloroform which gives instant relief. Chloroform capsules (para 11-2) can be crushed in a wad of cotton or a handkerchief and pushed inside the mask. Do not smoke for several hours. If necessary, rinse your mouth with water but do not swallow it. Skin and eyes can be washed with water. Clothing can be brushed.

11-14. Incapacitating Agents

Generally speaking, an incapacitating agent is any compound which can interfere with the performance of military duties by affecting the central nervous system and by producing muscular weakness and abnormal behavior. It is likely that such agents will be disseminated by smoke-producing munitions or aerosols, thus making breathing their means of entry into the body. The use of the protective mask is, therefore, essential for protection against the agents.

a. There is no special first aid for the relief of the symptoms of incapacitating agents. Supportive first aid and physical restraint may be indicated. Weapons and other potentially harmful materials should be removed from the possession of individuals who are suspected of having these symptoms. This includes cigarettes, matches, medications, and small items which might be swallowed accidentally. Delirious persons have been known to attempt to eat items bearing only a superficial resemblance to food.

b. Anticholinergic drugs (BZ type) may produce alarming dryness and coating of the lips and tongue; however, there is usually no danger of immediate dehydration. Fluids should be given sparingly, if at all, because of the danger of vomiting and because of the likelihood of temporary urinary retention due to paralysis of bladder muscles. An important medical consideration is the possibility of heatstroke because of stoppage of sweating. If the environmental temperature is above 78° F, remove excessive clothing from the soldier and dampen him to allow evaporative cooling and prevent dehydration. If the soldier does not readily improve, apply first aid measure for heatstroke (para 9-8b) and seek medical attention.

11-15. Screening Smokes

a. *Titanium Tetrachloride (FM) Smoke.* This smoke is relatively nontoxic, but the liquid burns the skin like a strong acid. The smoke is irritating to the nose and throat but only mildly so at the concentration usually found in a smoke cloud. The protective mask should be worn in heavy concentrations of FM. Flush any liquid FM from the skin with water.

b. *Sulfur Trioxide-Chlorosulfonic Acid Solution (FS) Smoke.* Smoke of this solution causes a prickling sensation on the skin because of the minute acid particles of which it is composed. Liquid FS is highly corrosive to the skin. Splashes of liquid FS in the eyes produces extremely painful acid burns. Exposure to heavy concentrations or prolonged exposure to ordinary concentrations may cause severe irritation of the eyes, the skin, and the respiratory tract. The protective mask should be worn in high FS smoke concentrations. Flush any liquid FS from the skin and eyes with water from your canteen (para 11-5c).

c. *HC Mixture (HC).* This smoke in high concentrations such as might be encountered near an operating munition, in an inclosed space, or near dense HC smoke screens and in ordinary field concentrations for a prolonged period may have a sufficient amount of zinc chloride built up to produce toxic effects. The protective mask should, therefore, be worn. The effects of exposure to HC may include irritation of the nose and throat, coughing, choking, headache, fever, chest and muscular pains, and suffocation. If nausea, vomiting, or difficulty in breathing occurs, get medical aid as soon as conditions permit. Aspirin will ease general discomfort.

d. *Oil Smoke.* Inhalation of oil smoke produces no apparent

symptoms immediately even though it is inhaled for extended periods. Operating personnel exposed to prolonged high concentrations of oil smoke should wear protective masks as much of the time as possible, since the development of pneumonia may occur with prolonged breathing of the smoke.

e. White Phosphorus (WP) Smoke. This smoke is harmless in normal field conditions; however, injuries from burning solid or liquid WP are serious. These burns heal very slowly. For first aid measures, see paragraph 11-16a.

11-16. Incendiaries

Incendiaries can be grouped as white phosphorous, thickened fuel, metal, and oil and metal. You must learn to protect yourself against these types of incendiaries.

a. White phosphorus (WP) is used primarily as a smoke producer but can be used for its incendiary effect to ignite field expedients and combustible flame material. The burns from WP are usually multiple, deep, and variable in size. When particles of WP get on the skin or clothing, they continue to burn until deprived of air. They also have a tendency to stick to a surface and must be brushed off or picked out. Should burning WP strike you—

(1) Smother the flame by submerging yourself in water or by dousing the WP with water from your canteen or any other source. Urine, a wet cloth, or mud can be used. Copper sulfate pads, if available, can be wet and put over the burning WP. The copper sulfate reacts chemically to coat the phosphorus particles and to prevent further activity. You may be able to take off contaminated clothing quickly before the phosphorus burns through to the skin.

Note: Since WP is poisonous to the system, grease or oil should NOT be used to smother the flame because the WP will be absorbed into the body with the grease or oil.

(2) Keep the WP particles covered with wet material to exclude air until you can remove them or get them removed from your skin.

(3) Remove the WP particles from the skin by brushing them with a wet cloth and by picking them out with a knife, bayonet, stick, or similar object.

(4) Report to a medical facility for treatment as soon as your mission permits.

b. Thickened fuel mixtures (napalm) have a tendency to cling to the clothing and the body surfaces, thereby producing prolonged

exposures and severe burns. The first aid for these burns is the same as for other heat burns (para 7-12, 7-13, and 9-2). The heat and irritating gases given off by these combustible mixtures may cause lung damage, which must be treated by a medical officer.

c. Metal incendiaries pose special problems. Thermite and thermate particles on the skin should be immediately cooled with water from your canteen and then removed. Even though thermate particles have their own oxygen supply and continue to burn under water, it helps to cool them with water. The first aid for these burns is the same as for other heat burns (para 7-12 and 7-13). Particles of magnesium on the skin burn quickly and deeply. Like the other metal incendiaries, they must be removed. Ordinarily, the complete removal of these particles should be done by trained personnel at a medical treatment facility, using local anesthesia. Immediate medical treatment is required.

d. Oil and metal incendiaries have much the same effect on contact with the skin and clothing as those discussed in *b* and *c* above. Appropriate first aid measures are described in paragraphs 7-12 and 7-13.

CHAPTER 12

PSYCHOLOGICAL FIRST AID

Section I. GENERAL

12-1. Importance of Psychological First Aid

First aid can be applied to "injuries" of the mind as well as to those of the body. You must, therefore, know how to give psychological first aid in order to help yourself, your buddies, and your unit to keep fighting. An emotional upset which results in poor judgment can be just as fatal as a bullet in the heart. It can be even more dangerous if other persons are affected by the judgment of an emotionally upset person.

12-2. Explanation of Term "Psychological First Aid"

Psychological first aid is as natural and reasonable as physical first aid and is as familiar if you stop to think about it. When you were hurt as a child, the understanding attitude of your parents did as much as the "Band Aid" or the "Mercurchrome" to ease the pain. Later on, disappointment or grief was eased by encouraging words from a friend. Certainly, taking a walk and talking things out with a friend are familiar ways of dealing with an emotional crisis. The same natural feelings that make us want to help a person who is injured make us want to give a helping hand to a buddy who is feeling emotionally "all shook up." You see, psychological first aid really means nothing more complicated than helping people with emotional injuries whether they result from physical injury, disease, or excessive or unbearable strain on their emotions. Emotional injuries are not as visible as a wound, a broken leg, or a reaction to pain from physical damage; but severe fear, excessive worry, depression, or overexcitement is evidence that emotional damage has occurred. The more noticeable the

symptom, the more urgent the need is for you to be of help and the more important it is for you to know how to help.

12-3. Situations in Which Psychological First Aid May be Needed

The situations which present the greatest need for psychological first aid are those in which trained medical personnel are not immediately available. These situations occur in combat and civilian disasters such as floods, hurricanes, and catastrophes of nuclear warfare. It is worthwhile to remember that emotional reactions to such situations are usually temporary, lasting only for minutes, hours, or at the most a few days. However, they may be seriously disabling, are often contagious, and may result in danger not only to the emotionally upset individual but also to the entire unit. In such situations you may be working beside someone who cannot handle the impact of disaster upon his emotions. Even when there is no danger of physical injury, psychological harm may occur.

12-4. Interrelation of Psychological First Aid and Physical First Aid

Psychological first aid often goes hand in hand with physical first aid. The discovery of a physical injury does not rule out the possibility of a psychological injury. A physical injury and the circumstances surrounding it may actually cause an emotional injury. Both need treatment. The person suffering from pain, shock, fears of serious damage to his body, or even death does not respond well to joking, indifference, or fearful-tearful attention. Fear and anxiety may take as high a toll of the soldier's strength as does the loss of blood.

12-5. Goals of Psychological First Aid

The goals of psychological first aid are to—

- a. Return the soldier to duty as soon as possible.
- b. Minimize his immediate disability even if prompt return to duty is not possible.
- c. Decrease the intensity of his emotional reaction until more complete care, if needed, can be arranged.
- d. Prevent actions harmful to him and to the efforts of others.

Section II. PRINCIPLES OF PSYCHOLOGICAL FIRST AID

12-6. General

Just as no one expects you to substitute for a surgeon it is not planned that you replace medical personnel in providing psychological aid. Your help, however, can be of great value until more qualified personnel become available. Effective first aid will help get the psychologically disabled soldier back into action sooner. An emotional reaction should not be too strange to you because you probably have experienced an emotional reaction yourself or have seen something like one but perhaps not as severe. Here are a few principles that will make your first aid job easier.

12-7. Respect Everyone's Right to Have His Own Feelings

a. Accept the soldier whom you are trying to help without censorship or ridicule. Accept his right to his own feelings. Just because your feelings, beliefs, and behavior are different, do not blame or make light of him for the way he feels or acts. Your job is to help him in this tough situation, not to be his critic. A person does not want to be upset and worried; he would "snap out of it" if he could. When he seeks help, he needs and expects consideration of his fears, not abrupt dismissal, chidings, or accusations. You may be impressed with the fact that *you* made it through in good condition, but you have no guarantee that the situation will not be reversed the next time.

b. Realize that people are the products of a wide variety of factors. All persons do not react the same way to the same situation. Each individual has complex needs and motivations, both conscious and unconscious, that are uniquely his own; thus, an injury or an emotional catastrophe will have a personal meaning for each individual. Even though you may not share the reactions or feelings of another person and even though the reactions seem foolish or peculiar, you must realize that he feels this way for a reason. You can help him most by accepting this fact and by doing what you can for him during this difficult time. He is doing the best he can under the circumstances. You must help him the best you can.

12-8. Accept Emotional Disability As Being Just As Real As Physical Disability

a. If a soldier's leg is blown off by a landmine, no one (including the wounded man himself) expects him to walk right away. If a

soldier's emotions are shattered by the overwhelming stress of more "blood and guts" than he can take for a while or by the explosion of a nuclear bomb, many people seem inclined to expect him to pull himself together immediately and carry on without a break. Some individuals can do this, but some cannot. The person who cannot has just as real a disability as the soldier who has lost his leg. There is an unfortunate tendency in many people to regard as real only those things they can see, such as a wound, bleeding, or an X-ray picture of a diseased lung. Some people tend to assume that damage which involves the mind and emotions is probably just imagined, that the person is not really sick or injured, and that he could overcome his trouble by using his willpower.

b. The terms, "It's all in your head," "Snap out of it," "Buck up," and "Get control of yourself" are often used by people who believe they are being helpful. Actually, these terms are expressions of hostility because they show lack of understanding. They only "goad" and emphasize weakness and inadequacy. Such terms are of no use in psychological first aid. A psychological patient or a physical patient with strong emotional reactions to his injury does not want to feel as he does. He would like to be effective, but he is temporarily overcome with fear and anxiety. He feels lost and unable to control his emotions for a while. Reminding him of his failure to act as others do only "rubs salt into the wound."

12-9. Realize That Every Physically Injured Person Has Some Emotional Reaction to the Fact That He Is Injured.

a. A slight injury such as a cut finger gives most people a start. It is normal for an injured person to feel upset. The more severe the injury, the more insecure and fearful he becomes especially if the injury is to a body part which is highly valued. For example, an injury to the eyes or the genitals, even though a relatively minor one, is likely to be severely upsetting. An injury to some other part of the body may be especially disturbing to an individual for his own particular reason. For example, an injury of the hand may be a terrifying blow to a baseball pitcher or a pianist; a facial disfigurement may be especially threatening to an actor.

b. An injured person always feels less secure, more anxious, and more afraid not only because of what has happened to him but because of more dire things he imagines may still happen as a result of his injury. This fear and insecurity may cause him to be irritable, stubborn, or unreasonable; he may seem uncooperative,

unnecessarily difficult, or even emotionally irrational. As you help him, always keep in mind that such behavior has little or nothing to do with you personally. He needs your patience, reassurance, encouragement and support. Even though he seems disagreeable and ungrateful at first, get across the idea that you want to help him.

12-10. Realize There Is More Strength in Most Disturbed Soldiers Than Appears at First Glance

An injured or sick person may not put his best foot forward. The strong points of his personality are likely to be hidden beneath his fear, anguish, and pain. It is easy to see only his failures even though he worked efficiently beside you only a short time ago. With your aid he will be helping you or someone else again. Whatever made him a good soldier, rifleman, or buddy is still there. He is needed.

Section III. COMMON TYPES OF REACTIONS TO DISASTER

12-11. Normal Reactions, Nonproblematic Type

Most people react to a disaster (military or civilian, personal or public, threatened or actual) by doing something about it immediately or within a few minutes after they "collect" themselves. With a few exceptions all people feel some fear. This fear may be greater than any you experienced at any other time, or you may be more aware of your fear. In such a situation you should not be surprised if you feel shaky, perspire profusely, and become a little nauseated and confused. These reactions are normal and are not cause for concern. After a while, if you get busy, your heart will stop pounding, your breath will come back, and you will feel less tense.

12-12. Normal Reactions, Problematic Type

Some reactions can be easily recognized as problematic. The following are the most usual:

a. Emotional Outbursts. Severe reactions to a disaster or accident usually appear first in the form of uncontrolled emotional outbursts such as crying, shouting, or both. In this state, a person is extremely restless and cannot be still. Typically, he runs about apparently without purpose. Inside of him he feels great rage or fear, and his physical acts often show this. He may strike out at others indiscriminately in his anger or try desperately to hide in

fright, which is usually accompanied by pounding heart, rapid breathing, nausea, or loss of bowel control.

b. Loss of Ability to Adapt to The Environment. In his desperate attempt to get away from the danger which has overwhelmed him, a person may suffer an unintentional loss or decrease in a number of his abilities. In the midst of a mortar attack, he may suddenly lose the ability to hear or to see. His intellectual ability may be so impaired he cannot think clearly or follow even simple commands. He may stand up in the midst of enemy fire or rush into a burning building, because his judgment is impaired and he cannot understand the likely consequences of his behavior. He may lose his ability to move and may seem paralyzed; he may faint; or he may lie down and babble like a child. In other cases overwhelming stress may produce symptoms which are often associated with head injury. For example, he may appear dazed or be found wandering about aimlessly. He may appear confused and disoriented and may seem to have a complete or partial loss of memory. In such cases, especially when no eye witnesses can provide evidence that the person has *not* suffered a head injury, it is necessary for medical personnel to provide rapid evaluation for that possibility.

c. Sleep Disturbance and Repetitions. A person who has been overwhelmed by disaster or some other stress rarely can sleep in his restless state. Although he is calmer and days or weeks have passed, he may start to have violent and terrifying nightmares in which all or a part of the original event is repeated, frequently in a distorted form. He may awaken and behave as though the disaster has struck again. For a while he may not be able to realize that it was, in fact, a dream. Even when awake, he may think repeatedly of the disaster, feel as though it is happening again, and act out parts of his stress over and over again. For some persons, this repetitious reexperiencing of the stressful event may be necessary for eventual recovery; therefore, it should not be discouraged or viewed as abnormal. For the person reexperiencing the event, such reaction may be somewhat disruptive and disturbing regardless of the reassurance given him that it is normal. In such a situation, a "short cut" that is often possible entails getting the person to talk extensively, even repetitiously about the experience, his feelings, etc. This should not be forced; rather, the person should be given repeated opportunity and supportive encouragement to talk in private, preferably to one person. This process which is known as "ventilation" is discussed further in paragraph 12-15a.

d. Psychiatric Complications. Although the behaviors described in *a* through *c* above usually diminish with time, some do not. A person who has not improved within a day or two or who becomes worse needs specialized medical-psychiatric care.

12-13. Helpful Hints in Recognizing Emotional Reactions

You do not need much training to recognize severe problematic reactions. Reactions that are less severe, however, are more difficult to detect. To determine whether or not a person needs help, you must observe him to learn whether or not he is doing something meaningful and is able to perform his duties and take care of himself.

Section IV. PSYCHOLOGICAL FIRST AID

12-14. General

Psychological first aid measures are simple and easy to understand. Improvisation is in order, just as it is in splinting a fracture. Your judgment as to what to do depends upon your ability to observe the soldier and understand the needs to be met. Time is on your side and so are the resources of the soldier whom you are helping. Making the best use of his resources requires ingenuity on your part.

12-15. Making Contact and Getting Through

The emotionally disturbed soldier has erected a barrier against fear. If he finds that he does not have to be afraid and that there are normal, understandable things about him, he will feel safer in dropping this barrier. Persistent efforts to make him realize that you want to understand him will be reassuring. Familiar things such as a cup of coffee, the use of his name, attention to even a minor wound, or the sight of familiar people and activities will add to his ability to overcome his fear. He will not respond well if you are excited, angry, or abrupt.

a. Ventilation. As stated in paragraph 12-12*c*, after the soldier becomes calmer, he is likely to have dreams about the stressful event, to think about it when he is awake, or even to repeat his personal reaction to the event. One benefit of this natural pattern is that it helps him master the stress by going over it just as one masters the initial fear of jumping from a diving board by repeated performances. Eventually, it is difficult to remember how frightening it was initially. In giving first aid to the emotional

soldier, you are to let him follow this natural pattern. Encourage him to talk and be a good listener. Let him tell his story in his own words about what actually happened. Your patient listening will prove to him that you are interested in him and, by describing his personal catastrophe, he can work at mastering it. If he becomes overwhelmed in the telling, suggest a cup of coffee or a break but assure him that you will listen again as soon as he is ready. With this psychological first aid, most soldiers start toward recovery quickly. Nature is with them.

b. Activity.

(1) A person who is emotionally disturbed as the result of combat or a catastrophe is basically a casualty of fear. He is disabled because he has become temporarily overwhelmed by fear. A good way to control fear is through activity. Almost all soldiers, for example, experience a considerable sense of fear while they are poised, awaiting the opening of a big offensive; but this is normally relieved and they actually feel better once they begin to move into action. They take pride in effective performance and pleasure in knowing that they are good soldiers, perhaps being completely unaware that overcoming their fears was their first accomplishment.

(2) Useful activity is very beneficial to the emotionally disturbed soldier who is not physically incapacitated. After you help a soldier to get over his initial fear, to regain some self-confidence, and to realize his job is to continue to function as best he can, you should then help him find something useful to do. Encourage him to be active. Get him to carry litters, help load trucks, clean up debris, dig foxholes, or assist with refugees. If possible, get him back to his usual duty. Seek out his strong points and help him to apply them. Avoid having him just sit around. You will have to provide direction by telling him what to do and where to do it. The instructions should be clear and simple; they should be repeated; they should be reasonable and obviously possible. A person who is in panic is likely to argue. Respect his feelings but point out more immediate, obtainable, and demanding needs. Channel his excessive energy, and above all do not argue. If you cannot get him interested in doing more profitable work, it may be necessary to enlist aid in controlling his overactivity before it spreads to the group and results in more panic. Prevent the spread of such infectious feelings by restraining and segregating if necessary.

(3) Involvement in activity helps a soldier in three ways:

(a) He forgets himself.

(b) He has an outlet for his excessive tensions.

(c) He proves to himself he can do something useful.

It is amazing how effective this is in helping a person overcome feelings of fear, ineffectiveness, and uselessness.

c. Rest. There are times, particularly in combat, when physical exhaustion is a principal cause for emotional reactions. For the weary, dirty soldier, adequate rest, warm food, and a change of clothes with an opportunity to bathe may provide spectacular results.

d. Usefulness of Group Spirit. You have probably already noticed that a person works better, faces danger better, and handles serious problems better in a group. Each individual in a group supports the others and seems to be strengthened in turn by the group. For example, you can see the group spirit in the football team and in the school fraternity, as well as in the gang that is up to some devilment. Because the individuals share the same interest, goals, and problems, they do more and better work; furthermore, they are less worried because everyone is helping. It is this group spirit that wins games, elects mayors, and takes a strategic hill in battle. It is so powerful that it is one of the most effective tools you have in psychological first aid. Getting the soldier back into the group and letting him see its orderly and effective activity will reestablish his sense of belonging and security and will go far toward making him a useful member of the unit again.

12-16. Your Reactions and Limitations

a. Up to this point the discussion has been primarily about the feelings of the emotionally disturbed soldier. What about your feelings toward him? Whatever the situation, you will have emotional reactions (consciously or unconsciously) toward this soldier. Your reactions can either help or hinder your ability to help him. Especially when you are tired or worried, you may very easily become impatient with the person who seems to be "dragging his heels" or "making mountains out of molehills." You may even feel resentful toward him. At times when many wounded lie about you, it will be especially natural for you to resent disabilities that you cannot see. Physical wounds can be seen and easily accepted. Emotional reactions are more difficult to accept as injuries. On the other hand, will you tend to be overly sympathetic? Excessive sympathy for an incapacitated person can be as harmful as negative feelings in your relationship with him. He needs strong help but not your sorrow. To overwhelm him with pity will make him feel even more inadequate. You must expect your buddy to recover, to be able to return to duty, and to become a useful

soldier. This expectation should be displayed in your behavior and attitude as well as in what you say. If he can see in you calmness, confidence, and competence, he will be reassured and will feel greater security in the world around him.

b. Above all, you must guard against becoming impatient, intolerant, and resentful on one hand and overly solicitous on the other. Remember that such emotion in you will rarely help the soldier and can never increase your ability to make clear decisions.

c. As with the physically injured soldier, the medical personnel will take over the care of the emotionally disturbed soldier as soon as possible. The first aid which he has received from you will be of great value to his recovery.

12-17. Basic Guides

a. Learn to detect problematic reactions in an individual who has undergone stressful situations and keep aware of the importance of psychological first aid to his recovery. Remember that your help can be of great value.

b. Realize that a soldier with an emotional disability is just as truly sick as a physically disabled one and just as able to recover if he is given the proper care.

c. Accept the soldier's reactions and feelings as the best he can do under the circumstances. Realize that he cannot change without help; otherwise, he would.

d. Find effective ways of making contact with the soldier. In doing so, take into consideration the facts that he is disturbed, excessively frightened, and overly worried and that he has lost his ability to act as other persons do. By your words, attitude, and behavior, let him know of your willingness and ability to understand his feelings. Show patience and a real desire to help.

e. Help him to regain his confidence and to feel more secure in the world about him. Assure him that you expect him to recover fully, that there is much he can do, and that there is a pressing need for his help.

APPENDIX A REFERENCES

- | | |
|------------------|---|
| AR 310-25 | Dictionary of United States Army Terms. |
| AR 310-50 | Authorized Abbreviations and Brevity Codes. |
| FM 21-10 | Field Hygiene and Sanitation. |
| FM 21-40 | Chemical, Biological, Radiological and Nuclear
Defense. |
| FM 21-41 | Soldier's Handbook for Defense Against Chemical
And Biological Operations and Nuclear
Warfare. |

APPENDIX B

CONTENTS OF FIRST AID CASE AND KITS

<i>National stock No.</i>	<i>Nomenclature</i>	<i>Unit of issue</i>	<i>Quantity</i>
1. 8465-00-261-4999	CASE FIELD FIRST AID DRESSING		
6510-00-159-4883	Dressing, First Aid Field, Individual Troop, Camouflaged, 4 by 7 inches	Ea	1
6505-00-663-2636	Sodium Chloride-Sodium Bicarbonate Mixture	Pg	2
2. 6545-00-922-1200	FIRST AID KIT, General Purpose (Rigid Case)		
6545-00-113-3722	Case, Medical Instrument and Supply, Set, Plastic, Rigid, Size A, 7½ inches Long by 4½ inches Wide by 2¾ inches High	Ea	1
6505-00-106-0875	Ammonia Inhalation Solution, Aromatic, Ampules, ⅓ cc, 10s	Pg	1
6505-00-914-3593	Povidone-Iodine Solution, NF, 10%, ½ fl oz (14.8 cc), 50s	Bx	1/50
6510-00-159-4883	Dressing, First Aid, Field, Individual Troop, Camouflaged, 4 by 7 inches	Ea	3
6510-00-200-3075	Compress and Bandage, Camouflaged, 2 by 2 inches, 4s	Pg	1
6510-00-200-3185	Bandage, Gauze, Compressed, Camouflaged, 3 inches by 6 yards	Ea	2
6510-00-201-1755	Bandage, Muslin, Compressed, Camouflaged, 37 by 37 by 52 inches	Ea	1
6510-00-202-0750	Gauze, Petrolatum, 3 by 26 inches, 3s	Pg	1
6510-00-782-6426	Adhesive Tape, Surgical, Camouflaged, 1 inch by 1 yard, 100s	Bx	3/100
6510-00-913-7909	Bandage, Adhesive, ¾ by 3 inches, 300s	Bx	18/300
6515-00-754-0426	Blade, Surgical Preparation Razor, Straight, Single Edge, 6s	Pg	1
6545-00-853-6309	First Aid Kit, Eye Dressing	Ea	1
-----	Instruction Card, Artificial Respiration, Mouth-to-Mouth Resuscitation (In English)	Ea	1
-----	Instruction Sheet, First Aid (In English)	Ea	1
-----	Instruction Sheet and List of Contents (In English)	Ea	1

<i>National stock No.</i>	<i>Nomenclature</i>	<i>Unit of issue</i>	<i>Quantity</i>
3. 6545-00-919-6650	FIRST AID KIT, General Purpose (Panel-Mounted)		
6545-00-912-0869	Case, Medical Instrument and Supply Set, Nylon, Nonrigid, No. 2, 7½ inches, Long by 4¾ inches Wide by 4½ inches High	Ea	1
<i>In Upper Pocket</i>			
6505-00-106-0875	Ammonia Inhalation Solution, Aromatic, Ampuls, ½ cc, 10s	Pg	1
6510-00-200-3075	Compress and Bandage, Camouflaged, 2 by 2 inches, 4s	Pg	1
6510-00-201-1755	Bandage, Muslin, Compressed, Camouflaged, 37 by 37 by 52 inches	Ea	1
6510-00-202-0750	Gauze, Petrolatum, 3 by 36 inches, 3s	Pg	1
6515-00-754-0426	Blade, Surgical Preparation Razor, Straight, Single Edge, 6s	Pg	1
<i>In Lower Pocket</i>			
6505-00-914-3593	Povidone-Iodine Solution, NF, 10%, ½ fl oz (14.8 cc), 50s	Bx	1/50
6510-00-159-4883	Dressing, First Aid, Field, Individual Troop, Camouflaged, 4 by 7 inches	Ea	3
6510-00-200-3185	Bandage, Gauze, Compressed, Camouflaged, 3 inches by 6 yards	Ea	2
6510-00-782-6426	Adhesive Tape, Surgical, Camouflaged, 1 inch by 1 yard, 100s	Bx	3/100
6510-00-913-7909	Bandage, Adhesive, ¾ by 3 inches, 300s	Bx	18/300
6545-00-853-6309	First Aid Kit, Eye Dressing	Ea	1
-----	Instruction Card, Artificial Respiration, Mouth-to-mouth Resuscitation (In English)	Ea	1
-----	Instruction Sheet, First Aid (In English)	Ea	1
-----	Instruction Sheet and List of Contents (In English)	Ea	1

	Paragraph	Page
Breathing (See Respiration.)		
Burns:		
Incendiaries, from	11-16	138
Minor	9-2	84
Screening smokes, from	11-15	137
Severe	7-12, 7-13	61
Canteen cap, M1 protective	7-13b(3)	62
Capillaries	2-1b	8
Carbon:		
Dioxide	2-1a	8
Monoxide poisoning	9-10	91
Carries, manual:		
One-man carries:		
Arms carry	10-4c	99
Cradle drop drag	10-4i	99
Fireman's carry	10-4a	98
Neck drag	10-4h	99
Pack-strap carry	10-4e	99
Pistol-belt:		
Carry	10-4f	99
Drag	10-4g	99
Saddleback carry	10-4d	99
Supporting carry	10-4b	99
Two-man carries:		
Arms carry	10-5b	100
Fore-and-aft carry	10-5c	100
Four-hand seat carry	10-5d	100
Supporting carry	10-5a	99
Two-hand seat carry	10-5e	100
Chemical agents:		
Blister	11-9	134
Blood	11-11	135
Choking	11-10	135
Incapacitating	11-14	136
Incendiaries	11-16	138
Nerve	11-6	127
Screening smokes	11-15	137
Tear	11-12	135
Vomiting	11-13	136
Chemical attack, first aid for	10-5	99
Chest cage	2-1a(1), 3-9b	8, 21
Circulation	2-1b	8
Closed-chest heart massage	3-8-3-14	21-27
Clothing	1-5b(2), 5-4, 5-8	7, 37, 39
Cold, conditions caused by	9-6	87
ComboPen Auto-Injector	11-8c	129
Contamination	2-2d	10
Contents of First Aid Case and Kits		151
Delirium	9-13c	94
Diaphragm	2-1a(2)	8
Digital pressure	4-8	31
Disaster, reactions to	12-11-12-13	144-146

	Paragraph	Page
Dislocation of bone	8-2	64
Dressing:		
Field first aid	1-4 <i>d</i> , 6-4	4, 41
Wounds	4-3—4-6, 6-1—6-5	29—31, 40—43
Drowning	9-11	92
Ear, foreign body in	9-4	85
Electric shock	9-12	92
Elevation of lower extremities	1-5 <i>b</i> (7), 5-7	7, 37
Emotional disability	12-8	142
Equipment (See First aid.)		
Exhalation	2-1	8
Eye, foreign body in	9-3	85
First aid:		
Case, field	1-4, app B	4, 151
Do's and do not's	1-5	6
Equipment for toxic environment	11-2	124
Guides, basic	1-5	6
Importance of	1-4	4
Items	1-4, app B	4, 151
Kit:		
Decontaminating	11-2 <i>b, d</i>	125
General purpose	app B	151
Measures:		
Common emergencies	9-1—9-14	84—95
Immobilization of fractures	8-1—8-11	64—81
Lifesaving (A)	3-4—3-14	11—28
Lifesaving (B)	4-1—4-14	29—35
Lifesaving (C)	5-1—5-8	36—39
Lifesaving (D)	6-1—6-18	40—55
Psychological	12-1—12-17	140—149
Special	7-1—7-13	56—63
Toxic environment	11-1—11-16	123—139
Foot:		
Frostbite	9-9 <i>c</i>	90
Immersion	9-9 <i>b</i>	90
Trouble	9-5	86
Trench	9-9 <i>a</i>	90
Fractures:		
Closed	8-2 <i>a</i>	64
Open	8-2 <i>b</i>	64
Signs of	8-3	64
Splinting and immobilizing:		
Bandages for	8-6 <i>c</i>	67
Collarbone	8-9 <i>b</i>	77
Improvisations for	8-6	67
Jaw	8-9 <i>a</i>	77
Lower extremities	8-8	74
Neck	8-11	81
Padding for	8-6	67
Purpose for	8-4	66
Rules for	8-5	66
Shoulder	8-9 <i>c</i>	77
Slings for	8-6 <i>d</i>	67

	Paragraph	Page
Spinal column	8-10	78
Upper extremities	8-7	67
Frostbite	9-9c	90
Germs	2-2d	10
Heart:		
Defined	2-1b	8
Massage, closed-chest:		
Application	3-8—3-11	21—23
Cessation	3-14	28
One rescuer, with	3-13	27
Two rescuers, with	3-12	23
Heartbeat	2-1b(1), 2-2a, 3-3b	8, 10, 14
Heat:		
Cramps	9-8c	89
Exhaustion	9-8a	89
Heatstroke	9-8b	89
Heimlich hug	9-14	95
Immersion foot	9-9b	90
Infection, prevention of	2-2d, 4-5, 6-1—6-18	10, 30, 40—55
Inhalation	2-1	8
Injector, nerve agent antidote	11-2c, 11-8c	125, 129
Kit:		
Decontaminating	11-2b,d	125
First aid, general purpose	app B	151
Life-saving measures:		
A—Airway, breathing, heartbeat	3-1—3-14	11—28
B—Stop bleeding	4-1—4-14	29—35
C—Prevent shock	5-1—5-8	36—39
D—Prevent infection	6-1—6-18	40—55
Litters, improvised	10-6	100
Lungs	2-1a(1)	8
Maintenance of manual	1-3	4
Mask, protective:		
Conditions for use	11-4	126
Equipment	11-2a	125
Artificial respiration with	11-8d	130
Measures, first aid (See First aid measures.)		
Nerve agents	11-6—11-8	127—128
Nose, foreign body in	9-4	85
One-man carries	10-4	98
Oxygen	2-1b, 2-2	8, 10
Poisoning from:		
Carbon monoxide	9-10	91
Nerve agents	11-6—11-8	127—128
Plants, from	9-7	88
Positioning injured soldiers with/for:		
Abdominal wound	7-11c	60
Artificial respiration	3-2, 3-4a, 3-6a(2), 3-7b	11, 15, 17, 18

	Paragraph	Page
Chest, sucking wound of -----	7-9b	60
Closed-chest heart massage -----	3-10	22
Face wound -----	1-5b(1), 7-7b	6, 58
Fractures:		
All -----	1-5b(5), 4-7, 8-5a	7, 31, 66
Neck -----	8-11a(2)	81
Spinal column -----	8-10a(2), b	79
Head injury -----	1-5b(7), 7-5b	7, 57
Neck wound -----	1-5b(1), 7-7b	6, 58
Shock prevention -----	5-7	37
Snake bite -----	9-6a(1)	87
Unconscious -----	1-5b(1), 9-13a	6
Pressure points -----	4-8	31
Prickly heat -----	9-8	88
Psychological first aid:		
Basic guides -----	12-17	140
Defined -----	12-2	141
Goals of -----	12-5	140
Importance of -----	12-1	146-149
Measures -----	12-14-12-17	141
Need for -----	12-3, 12-4	142-144
Principles of -----	12-6-12-10	144-146
Reaction requiring -----	12-11-12-13	10, 21
Pulse -----	2-1b(2), 3-8	3
Purpose of manual -----	1-1	
Rate of:		
Artificial respiration -----	3-4f, 3-6b(3), 3-7b(5)	15, 17, 18
Closed-chest heart massage with:		
One rescuer -----	3-13	27
Two rescuer -----	3-12	23
Pulse -----	2-1b(2)	10
Respiration -----	2-1a(2)	8
Reassuring injured soldier -----	5-5	37
References -----		150
Respiration:		
Artificial -----	3-3-3-7, 3-12, 3-13	14-18, 23, 2
Defined -----	2-1a	8
Scorpion sting -----	9-6c	88
Shock:		
Defined -----	2-2c	10
Electric -----	9-12	92
Prevention -----	5-1-5-8	36-39
Signs -----	6-1b	36
Skin eruptions from plants -----	9-7	88
Snake bite -----	9-6a	87
Snow blindness -----	9-9d	91
Sodium chloride-sodium bicarbonate -----	1-4d, 7-13b(1)	4, 62
Spider bite -----	9-6b	88
Splinting of fracture (See Fractures, splinting.)		

	Paragraph	Page
Sprains	8-2a	64
Sunburn	9-8	88
Sunstroke (See Heatstroke.)		
Supplies (See First aid.)		
Throat, foreign body in	9-4, 9-14	85, 95
Tourniquet:		
Application of	4-9—4-13	31—35
Marking	4-14	35
Toxic environment:		
First aid for:		
Blister agents	11-9c	134
Blood agents	11-11	135
Chemical attack	11-5	126
Choking agents	11-10	135
Incapacitating agents	11-14	136
Incendiaries	11-16	138
Nerve agents	11-8	128
Screening smokes	11-15	137
Tear agents	11-12	135
Vomiting agents	11-13	136
Protection from	11-2, 11-4	124, 126
Trachea, obstruction of	9-14	95
Transporting the wounded soldier	10-1—10-6	97—100
Trench foot	9-9a	90
Two-man carries	10-5	99
Unconsciousness	9-13	93
Veins	2-1b	8
Vital body functions	2-2	10
Wounds:		
All	4-1—4-14	29—35
Minor	9-1, 9-2	84
Severe:		
Abdominal	7-10, 7-11	60
Burns	7-12, 7-13	61
Chest, sucking	7-8, 7-9	58, 59
Face	7-6, 7-7	57
Head	7-3—7-5	56—57
Neck	7-6, 7-7	57

By Order of the Secretary of the Army:

FRED C. WEYAND
General, United States Army
Chief of Staff

Official:

PAUL T. SMITH
Major General, United States Army
The Adjutant General

Distribution:

Active Army, ARNG, USAR: To be distributed in accordance with DA Form 12-11A requirements for First Aid for Soldiers (Qty rqr block no. 161).