

CIVIL DISTURBANCES

TABLE OF CONTENTS

	Page
Chapter 1 Civil Disturbances	1-1
Federal Intervention and Aid	1-1
Causes	1-2
Locations	1-3
Mission of Military Forces in a Civil Disturbance	1-3
2 The Participants	2-1
Crowd Behavior	2-2
Crowd Tactics	2-3
3 Federal Intervention	3-0
Civil Disturbances in Civilian Communities	3-0
Civil Disturbances on DOD Installations	3-3
Command and Control	3-3
Task Force Organization	3-5
4 Information Planning and Threat Analysis	4-0
Information Needs and Sources	4-0
Information Restrictions	4-1
Threat Analysis	4-2
5 Operations Planning	5-1
Coordination of Civilian and Military Efforts	5-1
Funding and Military Resources	5-2
Logistics	5-3
Communications	5-6
Relief	5-6
Administration	5-8
Media Relations	5-8
Plans and Reports	5-10
6 Control Force Operations	6-0
Isolate the Area	6-0
Protect Likely Targets	6-4
Exert Control	6-5
Establish Area Control	6-9
Neutralize Special Threats	6-13
7 Force Options	7-1

8	Crowd Control Formations	8-0
	Types of Formations	8-1
	Weapon Positions	8-3
	Commands	8-4
	Cadence	8-4
	Interval and Distance	8-4
	Commander and Leader Positions	8-5
	Squad Formations	8-5
	Four-Squad Platoon Formations	8-7
	Three-Squad Platoon Formations	8-19
	Company Formations	8-21
9	Riot Control Agents	9-1
	Grenades	9-5
	Dispersers	9-5
	Water	9-13
10	Riot Batons	10-0
	Employment	10-0
	Baton Grip and Positions	10-2
	Offensive Techniques	10-4
	Defensive Techniques	10-6
11	Extreme Force Options	11-1
	Ring Airfoil System	11-1
	Shotguns	11-5
	Rifles	11-5
	Machine Guns	11-6
12	Apprehension and Detention Operations	12-1
	Apprehensions	12-2
	Searches	12-3
	Come-Along Techniques	12-5
	Detention Facility Operations	12-13
13	Training for Civil Disturbances	13-1
	Unit Training	13-2
	Leadership	13-4
	Special Reaction Team Training	13-5
	Appendix	A-1
	Glossary	Glossary-0
	References	Reference-1
	Index	Index-0

Civil Disturbances

Civil disturbances arise from acts of civil disobedience. They occur most often when participants in mass acts of civil disobedience become antagonistic toward authority, and authorities must struggle to wrest the initiative from an unruly crowd. In the extreme, civil disturbances include criminal acts of terrorism. Civil disturbances, in any form, are prejudicial to public law and order.

FEDERAL INTERVENTION AND AID

Under the US Constitution and the US Code, the President is empowered to direct federal intervention in civil disturbances to:

- Respond to state requests for aid in restoring order.
- Enforce the laws of the United States.
- Protect the civil rights of citizens.
- Protect federal property and functions.

Under the Constitution, each state is responsible for protecting life and property within its boundaries. State and local governments use their civil forces to maintain law and order and to quell civil disturbances. However, if a civil disturbance exceeds the resources of a state, federal troops may be called upon to help restore and maintain law and order.

The Constitution and federal statutes authorize the President to direct the use of federal armed troops within the 50 states, the District of Columbia, Puerto Rico, and US possessions and territories and their political subdivisions. The President is also empowered to federalize the National Guard of any state to suppress rebellion and enforce laws.

Federal aid is given to a state when the state has used all of its resources, including its National Guard, to quell a disorder

and finds the resources not sufficient. Usually, active-duty federal forces are used to augment the requesting state's National Guard. But the President may choose to federalize another state's National Guard and use them, alone or with other forces, to restore order.

The President also can employ federal troops to ensure the execution of US law when a state opposes or obstructs US law or impedes the course of justice under those laws. And the President can employ armed federal troops to suppress insurrection, domestic violence, unlawful assemblies, and conspiracy if such acts deprive the people of their constitutional rights and privileges and a state's civil authorities cannot or will not provide adequate protection.

The President is also authorized to use armed federal troops to protect federal property and functions when the need for protection exists and the local civil authorities cannot or will not give adequate protection. The right of the United States to protect all federal property and functions regardless of their locations is an accepted principle of our government.

As a temporary measure, federal military equipment and facilities may be loaned to

state and local governmental bodies and law enforcement agencies for use during civil disturbances. These resources may also be loaned to a state's National Guard and to nonDOD federal agencies. *The*

requesting agencies are expected to provide enough resources of their own to minimize the need for US military resources. And the loan of the resources must not conflict with US military needs.

CAUSES

Civil disturbances may arise from a number of causes. Most often they arise from political grievances, urban economic conflicts and community unrest, terrorist acts, or foreign influences. The event may be triggered by a single cause. Or it may arise from a combination of causes.

Demonstrations of political grievances range from simple protests of specific issues to full-scale civil disobedience. Many forms of political protest, while disruptive, are not unlawful. These protests may be spontaneous, but they generally are planned events. They may even be coordinated with local authorities. Most protestors are law-abiding citizens. They intend their protests to be nonviolent. Violence occurs mainly when control forces must try to contain a protest or arrest protestors involved in civil disobedience. The presence of agitators increases the chance of violence. Agitators want to provoke the control force into overreacting. This embarrasses authorities. It can also gain media and public sympathy for the protestors.

Urban conflicts and community unrest arise from highly emotional social and economic issues. Economically deprived inner-city residents may perceive themselves treated unjustly or ignored by the people in power. Tension can build in a community over a variety of issues. Community services and housing and labor issues are often disputed. Tension creates the potential for violence. When tension is high, it takes only a minor incident or a rumor of an injustice to ignite a civil disturbance. This is particularly true if the

community's relations with local police are part of the problem.

Significant cultural differences in a community can create an atmosphere of distrust. Unrest among ethnic groups competing for jobs can erupt into civil disturbance. Sometimes a large group of refugees resettles in one community, creating unrest in the community. If jobs are in short supply and refugees are taking what jobs there are, feelings of animosity can arise. As emotions run high, violence becomes likely.

Civil disturbances may be organized by disaffected groups. These groups like to embarrass the government. Or they may demonstrate as a cover for terrorism. Their goal is to cause an overreaction by authorities. They think this will generate sympathy for their cause among the general population. Foreign nations may promote civil disturbances through surrogate organizations. The surrogates involve themselves in activities that promote a particular nation's interests. Their actions may be quite overt. Sometimes they even conduct fund-raising and membership drives. The surrogate's sponsors provide support in many ways. The sponsors give money, organizational help, and moral support. They may also help by training members of the surrogate group in civil disobedience, vandalism, and agitation and manipulation of crowds and media. Agents of foreign nations may influence civil disturbances. Agents infiltrate disaffected groups to increase their potential for violence. If they are successful and government forces overreact, the targeted government may be seen as repressive.

LOCATIONS

Civil disturbances may arise from a symbolic of a grievance, near the cause of a grievance, or close at hand to an aggrieved crowd. Examples of such places are nuclear weapons facilities or power plants, in urban areas, at refugee camps, or at government facilities. Nuclear weapons facilities and power plants are subject to demonstrations by anti-nuclear activists. These activists demonstrate at places they know or think are used to develop, build, transport, or store nuclear weapons or their parts. The facilities can belong to federal agencies or to businesses with DOD contracts. Active involvement with nuclear weapons is not necessary. Past involvement or the activists' belief of past involvement can make the facilities targets for demonstrations. Nuclear power plants are also targets of environmentalists and other activist groups. The plants are seen as dangers to society and the environment. Demonstrations at plants or plant construction sites may be held to try to interfere with plant operations.

US government facilities like recruiting offices, federally-leased buildings, ROTC buildings, and federal courthouses also can be the targets of demonstrations. A government facility may be targeted simply because a protesting group attaches a symbolic value to, or perceives a connection with, a protested policy. This is especially true of anti-war and anti-nuclear protest groups. They may choose a facility because they see it as the source of their grievance. Or they may target a facility because the people working there are seen as having the power to address the group's grievance.

Urban areas can be the scene of inner-city conflicts, labor disputes, and political struggles. Disturbances in urban areas are usually fueled by aggrieved members of the community. However, an urban area having symbolic value to a particular group may be the stage used by outside demonstrators to draw attention to their cause.

Refugee and resettlement camps can become the focus of a civil disturbance. Large numbers of refugees entering the US in mass are often placed temporarily in refugee camps until they can be resettled. Resettlement can be a slow and difficult process. The boredom, frustration, and other stresses refugees experience in these camps can create tensions that may erupt into violence. And agitators may infiltrate refugee camps to exploit these tensions in ways that will embarrass the US.

Demonstrations at US government facilities are not limited to those in the US. US facilities in foreign nations can be locations of civil disturbances. DOD installations, US embassies, and US consulates in foreign nations are favorite targets of demonstrators. DOD installations in foreign nations are often scenes of protests against US foreign policies. The actual installation and its mission may or may not be the true target. Often the installation is just used as a highly visible symbol of US government. American embassies and consulates also are subject to disturbances. They too are highly visible, concrete representations of the US government.

MISSION OF MILITARY FORCES IN A CIVIL DISTURBANCE

The mission of the military forces in a civil disturbance is to help local authorities restore law and order. The preservation of law and order in the civilian community

is the responsibility of state and local governments and law enforcement authorities. The preservation of law and order on the federal property of a military

installation is the responsibility of the installation commander and military law enforcement authorities. The military performs civil disturbance operations in support of these local authorities. Most often the military is used to disperse unauthorized assemblages and to patrol disturbed areas to prevent unlawful acts. Military forces may be used to maintain the mechanics of essential distribution, transportation, and communications systems. Military forces are also used to make a show of force, set up roadblocks, cordon off areas, disperse crowds, release riot control agents, and serve as security forces or reserves. And the military may be tasked to initiate needed relief measures.

The commitment of military forces to civil disturbance control operations does not automatically give these forces police power. The police power of military forces is bound by legal constraints as well as humanitarian consideration. Only the degree of force reasonably needed in a circumstance is permitted. All military leaders and planners must be familiar with the laws, regulations, and policies that govern military involvement in civil disturbances. They must know the laws and policies that have a direct impact on military civil disturbance control plans and actions. Those laws and policies dictate how the military can and should act when controlling a civil disturbance.

Military control force commanders must know what options are available to them. Commanders must be able to be highly

flexible and selective in their responses. A commander must select the option that is the best response to a given civil disturbance in that specific physical and psychological environment. He must be able to both reduce the intensity of the confrontation and restore order.

In all contacts with the civilian population and the participants of the disturbance, military forces must display fair and impartial treatment. And they must adhere to *the principle of minimum force*. Whenever possible, civil police apprehend, process, and detain civil-law violators. Military forces perform these functions only when necessity dictates and only to the minimum extent required. These functions are returned to civil authorities as soon as possible. When military forces have achieved enough order to allow the local authorities to resume control, the military's mission is accomplished and their active role in controlling the disturbance ends.

As the disturbance subsides, the commander takes steps to restore control to the civil authorities. The control force gradually reduces the number and scope of its operations and begins removing its equipment from the area. But the control force takes care not to give the impression that all controls have been removed. Withdrawal is not immediate. That would create the impression of abandonment and could lead to a resurgence of the disturbance. The control force gradually withdraws in a phased return of control to civil authorities.

The Participants

A civil disturbance occurs only in a particular environment. That environment is a fusing of cause, place, and willingly confrontive participants. Civil disturbance participants come from all walks of life. Participants cover the political spectrum from the far right to the far left. They range from members of special interest groups to the ranks of the unemployed. They may be environmentalists, anti-nuclear activists, or foreign and domestic opponents of US policy. They come from all age groups and from all classes.

They may be curious onlookers who have become swept away by the excitement of an event. They may be demonstrators or counterdemonstrators who have become emotional about their cause. Whoever they are, they have become subject to the social and psychological factors that can turn a large gathering of people into a disruptive, disorderly mass. Understanding these factors can help reduce confrontation and permit order to be restored with a minimum of force.

The basic human element sparking a disturbance is the presence of a crowd. There are almost as many types of crowds as there are reasons for people to assemble. There are casual crowds like the crowd that assembles for a football game or gathers at an accident. Persons in such a crowd probably have no common bonds other than enjoyment of the game or curiosity about the accident. And there are “planned” crowds like the crowd that assembles at the call of a leader to accomplish a goal. Members of a planned crowd have common bonds of interest and purpose.

Simply being a part of a crowd affects a person. Each person in a crowd is, to some degree, open to actions different from his usual behavior. Crowds provide a sense of anonymity because they are large and often temporary congregations. Crowd members often feel that their moral responsibility has shifted from themselves to the crowd as a whole. Large numbers

of people discourage individual behavior; the urge to imitate is strong in humans. People look to others for cues and disregard their own background and training. Only well-disciplined persons or persons with strong convictions can resist conforming to a crowd's behavior. Crowd behavior influences the actions of *both* the disorderly participants and the authorities tasked to control them.

Under normal circumstances, a crowd is orderly. It does not violate any laws. It does not threaten life or property. It does not present a problem to authorities. But when a crowd's collective behavior becomes unacceptable to the common good, cause for concern arises. When a crowd's law-abiding collective behavior breaks down and takes a dramatic form, a civil disturbance ensues.

Civil disturbances arise when a crowd—

- Gathers to air grievances on issues and transfers its anger from the issues to the people dealing with the issues.
- Swells uncontrollably as curious bystanders and sympathetic onlookers join forces with the activists or protectors.
- Is incited to irrational action by skillful agitators.
- Adopts irrational behavior and becomes a mob.
- Consists of two or more groups with opposing views, and they become engaged in a violent confrontation.

CROWD BEHAVIOR

Crowd behavior is influenced by the presence or absence of social factors like leadership, moral attitudes, and social uniformity. Crowd behavior is also influenced by the psychological factors of suggestion, imitation, anonymity, impersonality, emotional release, emotional contagion, and panic.

Crowd behavior expresses the emotional needs, resentments, and prejudices of the crowd members. However, a crowd only does those things that most of its members want to do. The crowd is influenced by the concerns of its members as to what is right, based on local custom, convention, and morality. But the emotional stimulus and protection of being in a crowd encourages its members to unleash impulses, aggressions, and rages that they usually restrain. When blocked from expressing its emotions in one direction, a crowd's hostility often is or can be redirected elsewhere. In a civil disturbance environment, any crowd can be a threat to law and order because it is open to manipulation.

Leadership has a profound effect on the intensity and direction of crowd behavior. In many crowd situations, the members become frustrated by confusion and uncertainty. They want to be directed. The first person to give clear orders in an authoritative manner is likely to be followed. When crowd members become frustrated, radicals can take charge. They can exploit a crowd's mood and turn them against a convenient target. A skillful agitator can increase a crowd's capacity for violence. He or she can convert a group of frustrated, resentful people into a vengeful mob. An agitator can direct a crowd's aggression toward any target included in their resentment. In fact, skillful agitators using television, radio, and other communications media can reach large portions of the population and incite them to unlawful acts without having direct personal contact. On the other hand, one person can sometimes calm or divert a crowd by a

strategic suggestion or command. An experienced leader may be able to calm a crowd, appeal to the reasoning powers of its members, and avoid a serious situation.

Crowd behavior is influenced by emotional contagion. Excitement, transmitted from one person to another, creates a high state of collective emotion. Ideas conceived by crowd leaders and dominant crowd members pass rapidly from person to person. These ideas and the general mood of the crowd sweep to bystanders and curiosity seekers, who can become caught in the wave of excitement and crowd action. Emotional contagion exceeds the bounds of personal contact. It can be passed by mass media.

Emotional contagion is especially significant in a civil disturbance environment. It provides the crowd psychological "unity." The unity is usually temporary. But this unity may be the only momentum a crowd needs to turn it to mob action. When emotional contagion prevails, self-discipline is low. Normal controls give way to raw emotions. Personal prejudices and unsatisfied desires, which usually are restrained, are readily released. This is a strong incentive for individuals to follow the crowd, to do things they have wanted to do but dared not try alone. This contagion can cause a crowd to lose its concern for law and authority. A crowd that follows its leaders into unlawful and disruptive acts becomes a mob. Mob behavior is highly emotional. It is often unreasonable. It is always potentially violent.

Panic also affects crowds. It prompts unreasoning and frantic efforts to seek safety. Panic is extremely contagious and spreads rapidly. In a state of panic, people become so irrational they endanger themselves and others. Panic can occur during a civil disturbance when crowds—

- Think or feel danger is so close at hand that the only course of action is to flee.

- Think escape routes are limited or that only one escape route exists.
- Think the limited routes are blocked or congested and passage is slowed or stopped.
- Believe an escape route is open after it is blocked and in trying to force a way to the exit, cause those in front to be crushed, smothered, or trampled.
- Are not able to disperse quickly after being exposed to riot control agents and begin to believe their lives are at risk.

Like participants, control force members are also susceptible to crowd behavior. They, too, are likely to become emotionally stimulated during a tense confrontation. The highly emotional atmosphere of a disturbance can infect control force members despite their disciplined training. When emotional tension is high, members may lose their feeling of restraint. Then they may commit acts they normally would suppress. Emotional contagion can also make a control force easily affected by rumor and fear. Commanders must watch for this and counteract it quickly.

In a large control force dealing with masses of demonstrators, control force members can lose their sense of individuality. Control force members must not be allowed to develop a feeling of

anonymity. Leaders must know their subordinates' names and address them by name at every opportunity. Commanders must ensure that soldiers of questionable emotional stability or with strong prejudices against the group being controlled do not participate directly in civil disturbance control operations.

Control force members, like crowd members, tend to imitate the actions of others. One improper act copied by others can result in a chain of wrong behavior. But rigorous training, effective supervision, and immediate correction of improper acts can prevent this. During confrontations a control force also must guard against coming to see the participants impersonally rather than as people. The control force should have a racial and ethnic balance to reduce the chance of seeing the disturbance as a confrontation between "them" and "us." Some control force members may harbor ill feelings toward people who look, think, or behave unlike themselves. If they take advantage of the confrontation and show their ill will, their behavior will inflame rather than reduce a confrontation. A control force must be thoroughly briefed on fair and impartial performance of their duties. *All members* of the control force must be aware that they *are accountable for all their actions.*

CROWD TACTICS

In civil disturbances, crowds employ any number of tactics to resist control or to achieve their goals. Tactics may be unplanned or planned, nonviolent or violent. The more purposeful the disturbance, the more likely is the possibility of well-planned tactics.

Nonviolent tactics may range from name-calling to building barricades. Demonstrators may converse with control force members to distract them or to gain their sympathy. Demonstrators may try to convince control force members to leave their posts and join the demonstrators.

They may use verbal abuse. Obscene remarks, taunts, ridicule, and jeers can be expected. Crowd members want to anger and demoralize the opposition. They want authorities to take actions that later may be exploited as acts of brutality.

Sometimes women, children, and elderly people are placed in the front ranks. This plays on a control force's sympathy to try to discourage countermeasures. When countermeasures are taken, agitators take photographs to stir public displeasure and to embarrass the control force. Demonstrators may form human blockades to

impede traffic by sitting down in roads or at the entrances to buildings. This can disrupt normal activity, forcing control personnel to physically remove the demonstrators. Demonstrators may lock arms, making it hard for the control force to separate and remove them. It also makes the control force seem to be using excessive force.

Groups of demonstrators may trespass on private or government property. They want to force mass arrests, overwhelm detainment facilities, and clog the legal system. Or demonstrators may resist by going limp, forcing control force members to carry them. They may chain or handcuff themselves to objects or to each other. This prolongs the demonstration. Agitators may spread rumors to incite the crowd and to try to force the control force to use stronger measures to control or disperse the crowd. The agitators want to make the control force appear to be using excessive force. Terrorist groups may try to agitate crowds as a diversion for terrorist acts. They also try to provoke an overreaction by the control force.

Mass demonstrations tend to consist of people on foot. But sometimes groups organize mobile demonstrations using cars, vans, and trucks. Mobile groups often coordinate their actions by CB radios and walkie-talkies. Demonstrators also may monitor police frequencies by using scanners. They may even try to use transmitters to jam police communications or to confuse control forces through misinformation.

Violent crowd tactics, which may be extremely destructive, can include physical attacks on people and property, setting fires, and bombings. Crowd use of violent tactics is limited only by the attitudes and ingenuity of crowd members, the training of their leaders, and the materials available to them. Crowd or mob members may commit violence with crude, homemade weapons. Or they may employ sophisticated small arms and explosives. If un-

planned violence occurs, a crowd will use rocks, bricks, bottles, or whatever else is at hand. If violence is planned, a crowd can easily conceal makeshift weapons or tools for vandalism. They may carry—

- Balloons filled with paint to use as “bombs.”
- Bolt cutters to cut through fences.
- Picket signs to be used as clubs.
- Pipes wrapped in newspapers to throw as deadly missiles.
- Firecrackers dipped in glue and covered with BBs or small nails to use as deadly grenades.
- Plywood shields and motorcycle helmets to protect against riot batons.
- Safety goggles to protect against tear gas.

A crowd may erect barricades to impede troop movement or to prevent a control force from entering certain areas or buildings. They may use vehicles, trees, furniture, fences, or any other material that may be handy. In an effort to breach barriers, rioters may throw grapples into wire barricades and drag them. They may use grapples, chains, wire, or rope to pull down gates or fences. They may use long poles or spears to keep control forces back while removing barricades or to prevent the use of bayonets. They also may crash vehicles into gates or fences to breach them.

Rioters can be expected to vent their emotions on individuals, troop formations, and control force equipment. Rioters may throw rotten fruits and vegetables, rocks, bricks, bottles, improvised bombs, or any other objects at hand from overpasses, windows, and roofs. In the past, troops, firefighters, and utility workers on duty during a civil disorder have been beaten, injured, or killed. Vehicles have been overturned, set on fire, or otherwise damaged.

Rioters may direct dangerous objects like vehicles, carts, barrels, and liquids at troops located on or at the bottom of a

slope. On level ground, they may drive wheeled vehicles at the troops, jumping out before the vehicles reach the target. This tactic is also used to breach roadblocks and barricades.

Rioters may set fire to buildings and vehicles to block the advance of troops. Fires are also set to create confusion or diversion, to destroy property, and to mask looting and sniping. Rioters may flood an area with gasoline or oil and ignite it. Or they may pour gasoline or oil down a slope or drop it from buildings and ignite it.

Weapons fire against troops may take the form of selective sniping or massed fire. The fire may come from within the ranks of the rioters or from buildings or other adjacent cover. The weapons used can vary from homemade one-shot weapons to high-powered rifles. Snipers may try to panic

control force members into firing a volley into the crowd. Innocent casualties make a control force appear both undisciplined and oppressive.

Explosives may be used to breach a dike, levee, or dam. Bombs can be exploded ahead of troops or vehicles so rubble blocks a street. They can be used to block an underpass by demolishing the overhead bridge. In extremely violent confrontations, bombs placed in buildings may be timed to explode when troops or vehicles are near. Demolition charges can be buried in streets and exploded as troops or vehicles pass over them. Explosive-laden vehicles can be rolled or driven at troops. Animals with explosives attached to their bodies can be forced toward troops to be set off by remote control. Even harmless looking objects like cigarette lighters and toys have been loaded with explosives and used.

CHAPTER 3

Federal Intervention

Federal intervention in civil disturbances begins with the issuance of a presidential proclamation to the citizens engaged in the disturbance. The proclamation directs all persons engaged in acts of domestic violence and disorder to cease and desist and to disperse and retire peaceably. If the proclamation is not obeyed, the President issues an executive order directing the use of federal forces to suppress the violence and authorizing the Secretary of Defense to use whatever forces are needed to accomplish the mission. Federal intervention in a civil disturbance ends when order is restored and the Secretary of Defense directs the withdrawal of federal forces.

CIVIL DISTURBANCES IN CIVILIAN COMMUNITIES

A state requesting federal help to restore and maintain law and order addresses its request to the Attorney General of the United States, the chief civilian officer in charge of coordinating all federal activities relating to civil disturbances. The Attorney General has been designated by the President to receive and coordinate preliminary requests from states for federal military assistance. (Applicants presenting a request to a local commander are informed of the need to address the request to the Attorney General. The commander then immediately informs the Director of Military Support of the request and any facts pertaining to it.) When a request for federal assistance is received by the Attorney General, he sends a representative to assess the situation and make recommendations.

When the representative's assessment shows that a need for federal assistance exists, the Attorney General advises the President, who issues the proclamation directing that order be restored. If the

disorder continues, the President issues the executive order directing the Secretary of Defense to employ such National Guard and federal troops as are needed to restore law and order. The Secretary of the Army alerts and, if necessary, pre-positions control forces through the CSA, but such forces do not become involved in the disturbance until the executive order is issued.

When directed by the Secretary of the Army the CSA directs the FORSCOM commander in CONUS or appropriate commanders in US territories outside CONUS to position ground forces near disturbance areas or to move such forces into disturbance areas. The CSA alerts the Air Force to provide required air transport. He tasks other military services and DOD components to provide military resources as planned and required. He also informs the JCS, and commanders of unified commands if the operations are outside CONUS, of the actual or potential use of military resources.

Civil disturbance deployment occurs as follows:

1. Following coordination with the JCS (and OCONUS commanders, if applicable), the CSA issues a warning order or CIDCON message. This is done as far in advance as possible to allow airlift and ground force preparedness measures to begin. (For more information on CIDCONs, see Appendix.)
2. The FORSCOM commander (in CONUS) or commanders of unified or designated commands (OCONUS) nominate the task force commander and units to make up the task force.
3. CSA (COMAAC in Alaska) directs the designated task force commander and his staff to reconnoiter the disturbance area to assess the situation. The reconnaissance is made in civilian clothing using commercial transportation and communications equipment.
4. The National Guard Bureau chief notifies the state or territorial adjutant general of the task force commander's arrival.
5. The task force commander submits recommendations concerning the commitment of federal forces directly to the CSA within two hours of his arrival in the disturbance area.
6. Meanwhile, the FORSCOM commander or appropriate commander OCONUS ensures that the military forces are prepared to move. In CONUS the FORSCOM commander submits airlift and surface transportation requirements for all designated ground forces to Director of Military Support. Outside CONUS the commanders of unified or designated commands provide transportation within their capabilities. When additional transport is needed, they submit their request to the Secretary of the Army. If additional units are needed from CONUS forces to augment the forces assigned to the command concerned, REDCOM nominates the required units, provides surface transportation, and submits airlift requirements to the Secretary of the Army.
7. At the appropriate time, the CSA (COMAAC in Alaska) issues a letter of instruction to the task force commander. The content of the letter of instruction—
 - Provides for planning and preparatory actions when received. It is effective for execution on order of the CSA.
 - Specifies the task force commander's mission and designates the task force units. It also instructs the commander to be prepared to assume operational control of additional federal troops and others when so ordered.
 - Designates a command post location and authorizes direct communication with other armed forces commanders in the vicinity.
 - States that the task force commander will consult with the Attorney General's senior civilian representative, who will coordinate the federal civilian effort and assist the task force commander's liaison activities with civil authorities.
 - Directs the task force commander to cooperate with, but not take orders from, civilian law enforcement officials.
 - Advises that an on-site DOD public affairs chief will be designated to furnish public affairs advice and guidance.
 - Designates a personal liaison officer to provide assistance and advice.

- Designates the Director of Military Support as responsible for setting up and maintaining communications between the task force and the Director of Military Support watch team.
- Provides specific instructions on the applications of force, the use and control of firearms, the detention of civilians, searches of individuals and private property, and cooperation with civil police in these matters.
- Directs the submission of situation reports to DA at stated times and of interim reports on major changes or significant events.
- Provides a code name for the task force for communications purposes.

8. When the task force commander receives an execution message directing him to proceed with his mission, military forces move into the disturbance area, and the task force commander assumes command of all military forces placed under his OPCON. At the discretion of the CSA, the liaison officer is withdrawn or remains in the area to assist the task force commander.

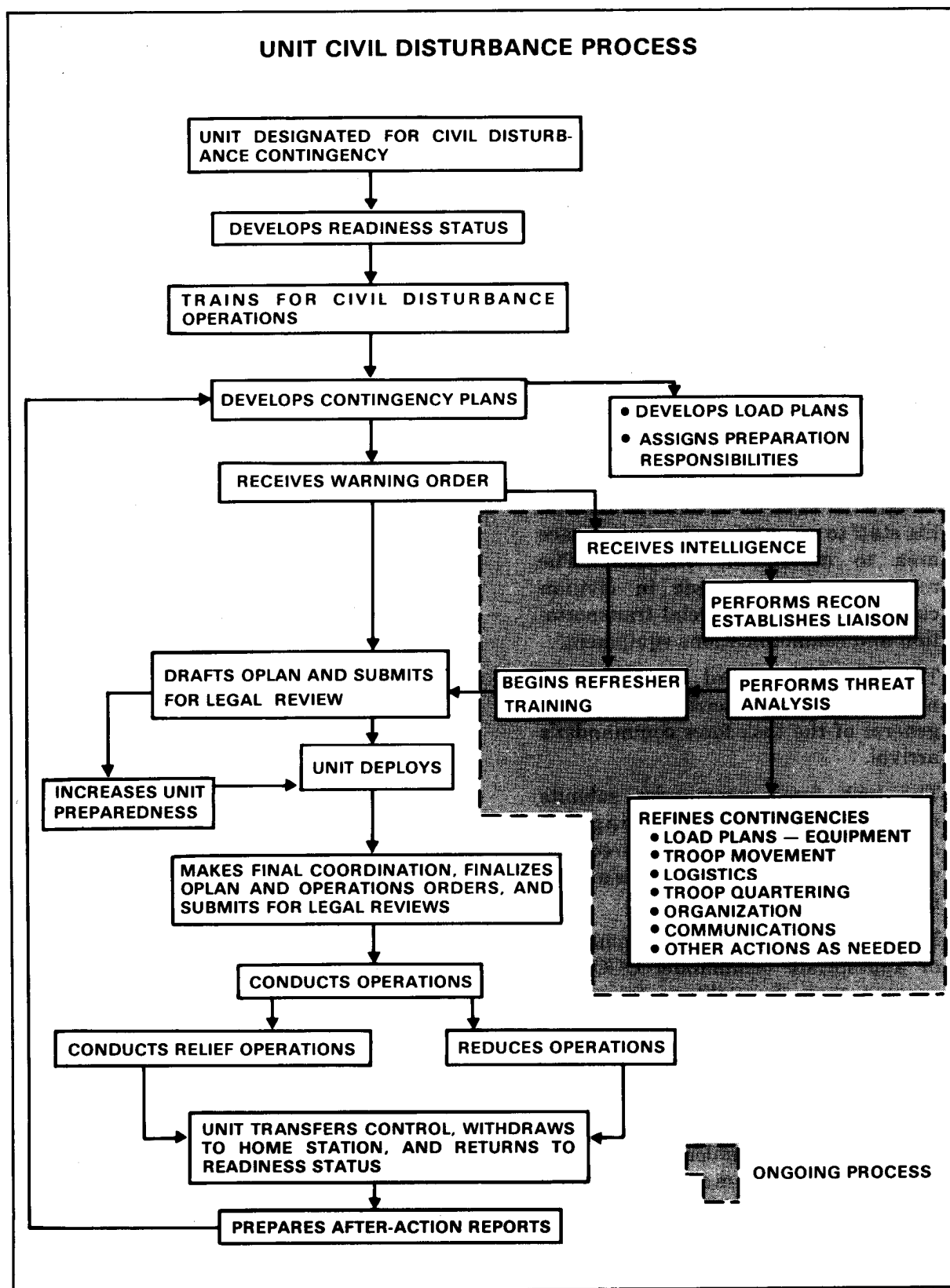

CIVIL DISTURBANCES ON DOD INSTALLATIONS

When a civil disturbance occurs on a US DOD installation, commanders immediately take action to control the disturbance. Commanders have the authority and responsibility to control the personnel under their military jurisdiction. And commanders have the authority to apprehend and restrain or remove from the installation those persons who do not come under military jurisdiction. A commander may exercise this authority by taking such actions as are reasonably necessary and lawful based on applicable regulations.

In general, a commander's employment of the installation's military, law enforcement and security forces is sufficient to fragment, and carry out civil disturbance operations on the military reservation. (Before using nonmilitary installation security forces during civil disturbance operations, commanders obtain advice from the SJA. The SJA advises on DOD policy limiting or prohibiting the use of DOD civilian police and guards or contract security guards for civil disturbance.) But additional Federal aid may be requested if a civil disturbance presents a threat to persons, property, or functions on an installation or activity and the threat is beyond the combined capabilities of local resources.

The installation or activity commander requests support through appropriate channels to the Director of Military Support. He also advises the appropriate HQDA staff agency of the request. If an installation commander learns of a need to protect other federal property or functions,

he notifies the Director of Military Support through command channels. At the direction of HQDA, FORSCOM and MDW commanders employ augmentation forces to reinforce the internal security forces of installations and activities.

If the civil disturbance erupts so suddenly that notifying DA and awaiting instructions through normal channels presents a danger to life and property, an active Army troop commander may take such actions as the circumstances justify. Actions taken without prior authority must be for the protection of life, the preservation of law and order, and the protection of property. The overall situation may cause the commander at the site to limit his mission to the protection of life and federal property. The officer taking such action immediately reports his action and the circumstances requiring it to the Director of Military Support.

On DOD installations overseas and at US embassies and consulates, because of the possible international political ramifications of foreign civil disturbances, host-nation forces generally control disturbances targeted at US facilities. Status of forces agreement define the legal considerations that guide and constrain actions by US military commanders. Commanders must have an effective liaison with host-nation authorities. Through close coordination with host-nation authorities, US commanders can determine the level of visibility and the involvement, if any, of US forces.

COMMAND AND CONTROL

Unlike conventional military operations under a unified command, civil disturbance operations may not have a single commander with the required authority to direct all control forces. When federal

forces are deployed to enforce US laws because civil authorities have not or will not, the federal forces serve as a part of the military power of the United States and act under the orders of the President. The

Secretary of the Army, through the Army Chief of Staff, directs the federal forces committed for civil disturbances. At a disturbance site, the task force commander has operational control of military ground forces. The on-site commander accomplishes his mission under the authority of reasonable necessity. That authority, however, is subject to instructions he receives from his superiors.

The issue of command and control is more complex when federal forces are deployed to help civil authorities control a disturbance. The federal forces are under the command of their superiors in the military chain of command. They cannot be placed under the command of unfederalized National Guard nor local or state civil officials. If directed by the Army

Chief of Staff, commanders can be made responsible to authorized federal civil officials.

The task force commander has command and control of all federal forces including the federalized National Guard. National Guard units subject to a call or order to federal active duty must be thoroughly familiar with the provisions of AR 135-300 and be prepared to meet the requirements. Special attention must be paid to having troops oriented on their status as federal troops and on their mission. When a state's National Guard is federalized by the President, the letter of instruction to the task force commander usually states that he is in command of the National Guard units. The military chain of command and the rank structure then operate as usual.

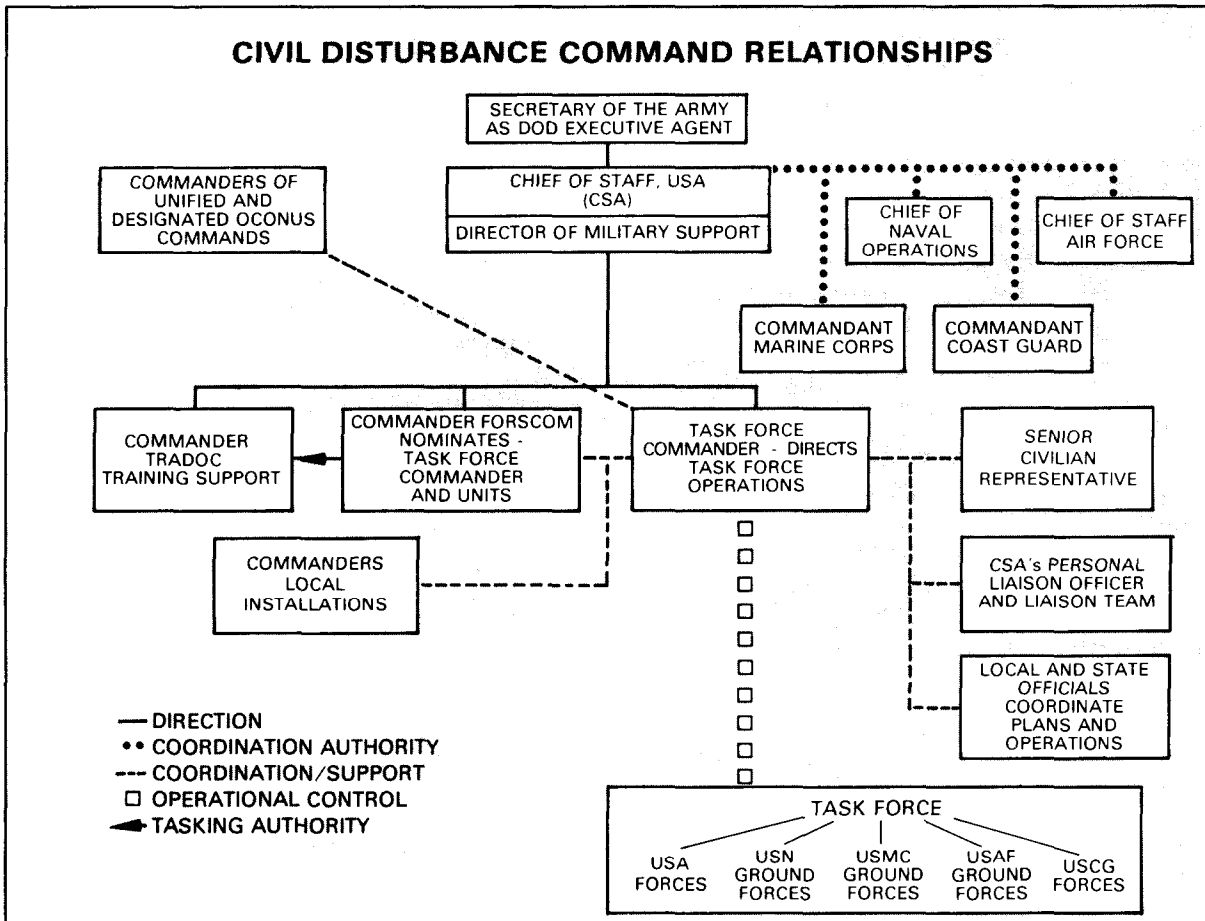

But, just as the task force commander does not turn his command over to civilian authorities, civilian authorities are not required to turn their local and state police over to the task force commander. And civilian police cannot be federalized. Thus operational unity sometimes must be sought through such means as collocating operational centers, integrating communications systems, and establishing organizational responsibilities.

Even on federal installations, the control force may consist of more than military forces. US marshals, DOD police or guards, and contract security guards may have a role in protecting an installation and preserving order. Responsibilities of non-military security and law enforcement agencies must be consistent with legal restrictions and prohibitions on their use. Job descriptions, contracts, and local laws determine how these agencies can be used to protect the installation and what duties they can perform.

Military authorities cooperate with civilian law enforcement officials to the maximum extent possible consistent with—

- The tradition of limiting direct military involvement in civilian law enforcement activities.
- National security needs and military preparedness.
- The requirements of applicable law.

The task force commander cooperates to the fullest extent possible with the governor and other civil authorities and forces unless, or until, such cooperation interferes with the mission. The task force commander, when he reasonably can, honors requests for help from civil authorities. He may direct elements of his command to assist civil authorities, but he does not place military personnel under the command of civilians. This does not preclude such measures as having joint patrols and jointly-manned fixed posts.

TASK FORCE ORGANIZATION

An effective civil disturbance task force depends on an organizational structure that allows for inclusion of a variety of military units and personnel, including National Guard and reserve units. It also must allow for the possible integration of military units and civilian agencies within an overall force structure. The organization must take into account the responsibilities of the civil authorities and agencies that will be a part of the control force. This includes not only law enforcement agencies but community support agencies as well. Units organized for a civil disturbance mission must be in accord with the organizational principles of:

- Essentiality.
- Balance.
- Coordination.
- Flexibility.
- Efficiency.

Each part of the organization must be needed to accomplish the mission. Each element of the organization must be designed to do its part of the mission effectively without duplicating the missions of the other organizational elements. The organization must provide effective channels of communications to ensure complete coordination of all plans and operations and to prevent gaps and overlaps. The organization must be designed to perform its mission without disruption as the operation changes in scope or as the environment changes. A unit's ability to task-organize to meet mission needs, and to do so quickly, is imperative for civil disturbance operations. The total organization must provide for the efficient use of men, money, material, and facilities.

The DA Civil Disturbance Plan, known as Garden Plot, provides guidance to

all DOD components in planning civil disturbance missions. It addresses the use of military resources for civil disturbances. It sets the requirements for DOD representation at a task force's headquarters. It is published under the authority of the Secretary of the Army, DOD's executive agent for military involvement in civil disturbances. The FORSCOM commander publishes guidance on model Garden Plot organizations for FORSCOM and TRADOC units. The Director of Military Support maintains the DA Civil Disturbance Plan.

TASK FORCE CONTROL ELEMENT

Responsibility for controlling the civil disturbance resides with the task force. Its control element consists of the command group and the crisis management team. The command group of city, county, state, and military command personnel sets policy and issues directives. They coordinate the activities of civil and military support agencies, supervise the crisis management team, and coordinate with outside agencies. The CMT, made up of representatives of civilian and military staff sections, advises the command group and coordinates operations and support for the action element of the task force. The control elements locate in an EOC to facilitate information processing, resource management, and operational control. If community leaders have established an EOC, the task force commander may use the EOC for his command post. If an EOC has not been set up, the commander establishes one and makes provisions for including civil authorities to ensure a unity of effort.

Not all CMT members are located at the EOC. Some key people may use liaisons to represent them at the EOC. The key people can then research and discuss ideas freely, away from the confusion associated with crisis management. The liaison can transmit guidance and answers to the EOC. Some agencies may not be needed in the

EOC. Still, they may need to be notified to be prepared for inclusion. Inclusion in the EOC is based on the likelihood of an agency having to take an action or a support role and on the agency's importance to the mission.

TASK FORCE ACTION ELEMENT

The threat management force is the action element of the task force. The TMF carries out the orders of the command group to accomplish the overall mission of restoring order. The command group employs the TMF consistent with the rules of force and the force options. The TMF consists of three subelements: the control force, the negotiation team, and the special reaction team. The control force performs most of the operational tasks. The negotiation team establishes and maintains communications with demonstration leaders, if possible, and reduces the threat to life in special circumstances like hostage situations or bomb threats. The special reaction team serves as the final force option for handling special threats like snipers or hostage takers. When federal forces are supporting civil authorities, the TMF, like the command group and CMT, is likely to be a mix of civil and military components. Civilian and military control force assets often perform control force tasks jointly. However, civilian negotiations teams should be used rather than USACIDC negotiations teams whenever possible. And military SRT assets are used only when civilian SRT assets are not available in civilian communities.

Control Force

The diversity of missions in civil disturbance operations creates the need for simultaneous commitment of forces in a variety of operations. The control force must be task-organized to accomplish the mission. The control force must be composed of small units able to function separately, as well as part of the total force. The small units and teams must be able to be

committed independently of each other. The small units must be responsive to changes in the situation. And they must be able to react immediately to their leaders' orders.

Small-unit leaders must receive clear, specific, and complete guidance so they know what actions to take to deal with rapidly changing situations. Clearly defined responsibilities must be assigned and exercised at the lowest practicable level. Small-unit leaders must have adequate authority to allow them to do their jobs effectively. At the same time, organizational development must be based on unit integrity. For example, in an infantry unit the squad may be considered the basic patrol unit. If smaller units are needed, fire teams can be used. Other types of units may have to organize in a similar fashion.

Military police units are particularly well suited for employment in civil disturbance operations. MP are trained and experienced in orderly confrontation management. With very little augmentation, an MP company possesses the basic capabilities needed for successful civil disturbance operations. MP capabilities include mobility, communications, and a structure that readily adapts to task organization. MP units also have special equipment, such as hand irons, recognizable symbols of authority, and vehicle emergency equipment. MP units are routinely task-organized to accomplish MP missions. This makes the transition from one configuration to another relatively easy for MP.

Negotiation Team

The negotiation team's primary purpose is to assist in hostage situations that may accompany a disturbance. The team's mission is to peacefully resolve the event. It is preferable that civilian teams be employed for hostage negotiations. The task force commander coordinates with civil authorities to obtain this support. If civilian negotiators are unavailable, he

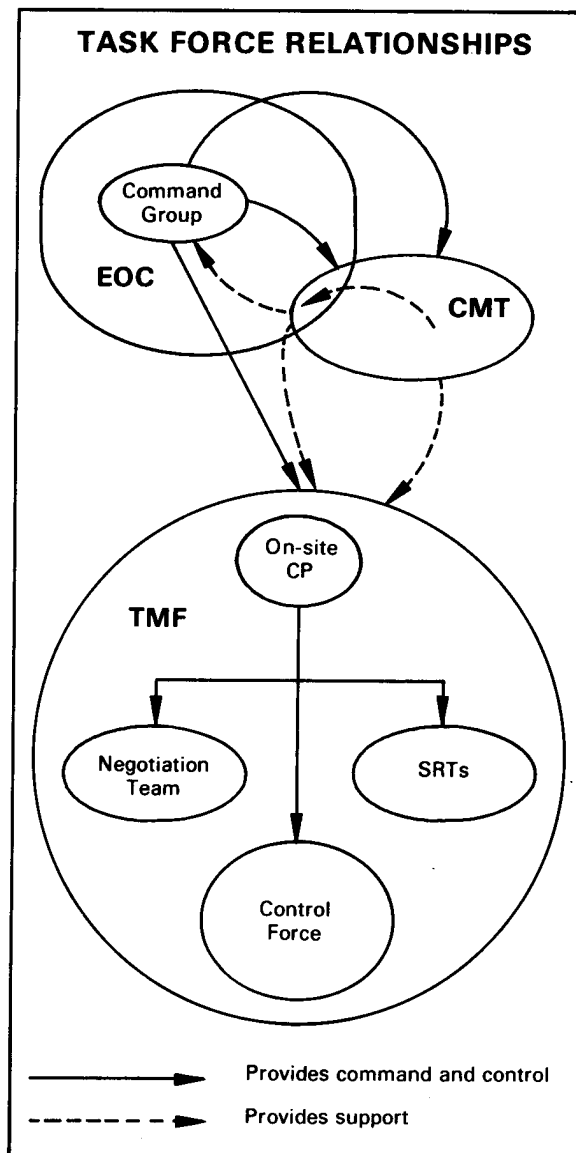

coordinates with USACIDC for a team of trained hostage negotiators.

A USACIDC negotiation team usually consists of a team leader, a coordinator, a record keeper, and trained negotiators. A linguist may be added if a language other than English is spoken by many residents in the disturbance area, especially OCONUS. The team leader coordinates the team's efforts. He commands the team and ensures that the negotiator is located away from the mainstream of CP operations, free

from distractions and interference. He also keeps the negotiator apprised of needed intelligence. The coordinator collects reported intelligence. His work is extensive when collecting intelligence on hostages, hostage takers, weapons and explosives, and the seige area. He gets intelligence from many sources, including the control force, witnesses, released hostages, and family members. The record keeper maintains a chronological record of all conversation between the negotiator and subjects, especially when dealing with hostages and hostage takers. He keeps a separate list of any and all demands and deadlines set by hostage takers. He also keeps a separate list of any and all promises and deceptions made by the negotiator.

Hostage negotiators establish a rapport with hostage takers to prolong contact and promote concessions while allowing demands to be delayed or refused. Prolonging the situation by constructively stalling for time produces advantages for the control force. These advantages are:

- The longer a situation is prolonged, the more intelligence can be gathered on the location, motivation, identity, and *modus operandi* of the hostage taker.
- The passage of time generally reduces anxiety, allowing the hostage taker to assess the situation rationally.
- Given enough time, one, some, or all of the hostages may find a way to escape on their own.
- In time, hostage takers may tire or fall asleep. This would allow peaceful resolution of the situation.
- The necessary resolve to kill or to hold out lessens with time.
- Time gives the hostage taker a chance to make the mistakes on which an alert control force can capitalize.
- Transference, also known as the Stockholm Syndrome, may take effect (see TC 19-16).

The negotiation team also can be very helpful when control force representatives meet with demonstrators to communicate concerns of the control force, to resolve issues allowing withdrawal from occupied buildings, or even to plan ways permitting peaceful demonstrators in a disturbed area. In these circumstances, the negotiator serves as a “neutral” who attempts to align the interests of the subjects with the responsibilities of the control force. The negotiator strives to—

- Be a mediator, not an arbitrator.
- Allow the subjects to set the pace, mood, and topic of conversation.
- Accept the subject’s views neutrally, expressing neither approval nor disapproval.
- Keep the subjects talking.

**SUGGESTED
NEGOTIATION TEAM
EQUIPMENT**

- STANDARD AUDIO CASSETTE TAPE RECORDERS AND 10 HOURS OF TAPES.
- MICROCASSETTE AUDIO TAPE RECORDERS AND 10 HOURS OF TAPES.
- VIDEO RECORDING EQUIPMENT.
- ELECTRONIC MONITORING EQUIPMENT.
- EAR MICROPHONES FOR TELEPHONES FOR RECORDING AND LISTENING.
- PORTABLE TYPEWRITERS AND OTHER WRITING SUPPLIES.
- FIELD TABLES AND CHAIRS.
- PUBLIC ADDRESS SYSTEMS OR BULLHORNS.
- RELIABLE COMMUNICATIONS FOR USE BETWEEN THEMSELVES AND THE SUBJECTS.
- HAND-HELD RADIOS.
- PROTECTIVE MASKS.
- INDIVIDUAL CONCEALABLE BODY ARMOR.

The negotiation process is physically and mentally exhausting. Hostage situations especially are often lengthy. It is recommended that each team have two negotiators. If more than one negotiator is used, a gradual shift from one negotiator to another helps to maintain the desired level of rapport. Successful negotiators are mature, mentally and emotionally stable, and neither overbearing nor antagonistic in their attitudes. They are experienced in communication techniques, including being good listeners. They also are sincere, flexible in their dealings, and physically fit.

Special Reaction Team

If high-risk incidents posing a grave danger occur during civil disturbance operations, the control force must have access to specially-trained teams to neutralize the special threat effectively and safely. Special threat incidents include—

- Hostage rescues.
- Barricaded criminals.
- Barricaded criminals with hostages.
- Sniper incidents.
- Terrorist incidents.
- Apprehensions of dangerous suspects.
- VIP protection and escort.
- Threatened suicides.
- Search and evacuation operations.
- Barricaded, mentally disturbed people.

The control force commander can quickly and successfully resolve a special threat by requesting the support of an SRT. A highly-motivated, well-conditioned team specially equipped and trained to function as a tactical unit can be effectively and safely employed in such special threat

situations. The commander uses civilian SRTs, if possible. If civil authorities do not have SRT assets, then a military SRT may be employed. A low-level threat only requires a general SRT manpower and equipment response capability. A sophisticated threat, posed by groups having unique abilities and seeking specific targets, requires responding SRTs to possess specialized training and equipment.

SRT actions are based on a thorough knowledge of the situation, a tactical plan, and a minimum use of deadly force. The priority of actions by SRTs during an operation is—

1. Protecting lives, including hostages, law enforcement personnel, bystanders, suspects, and offenders.
2. Securing the safe release of hostages.
3. Apprehending the offenders.
4. Isolating and containing the incident.
5. Gathering information and intelligence. This is a continuous responsibility from the start of an incident until its resolution.
6. Protecting property and equipment.
7. Conducting an assault if all other available options have been exhausted or the situation has deteriorated to the point where loss of life is considered imminent. An SRT assault is a last resort.

These priorities apply to nearly all special threat situations. The one exception to these priorities is a special threat situation involving a nuclear weapon. The recovery of the weapon is the overriding consideration. See AR 50-5.

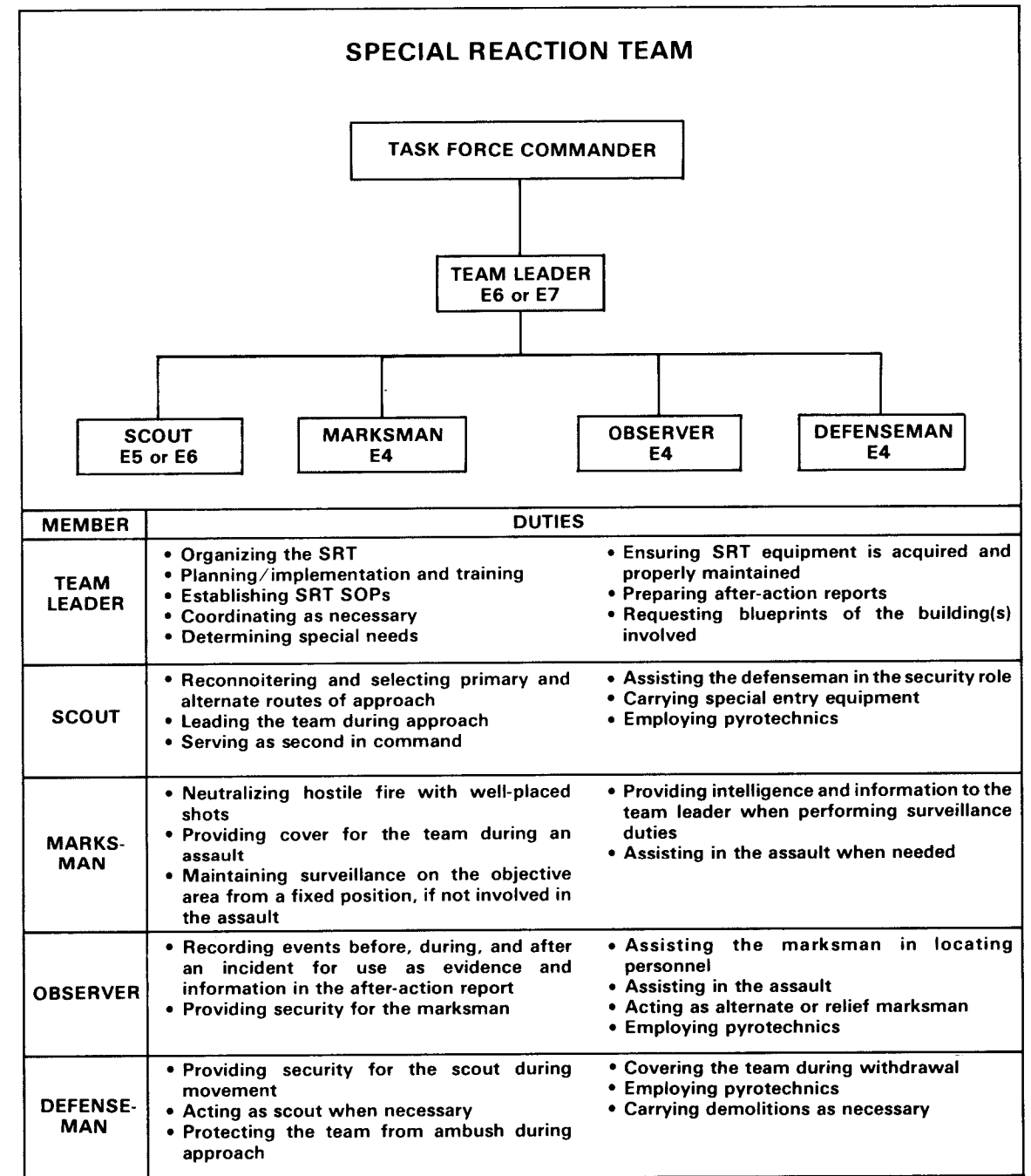

Information Planning and Threat Analysis

Information is the key to developing civil disturbance plans. Who are the demonstrators? When and where will they demonstrate? What are their capabilities and possible courses of action? A civil disturbance task force commander's need for current, valid information cannot be overemphasized. He must learn as much as he can about the participants, their motivations, their strategies and tactics, their targets, and their dedication. The more knowledge he has about the participants, the better equipped he is to counter their actions. He needs sound information to decide how best to use his available resources.

To be useful, collected data must be processed into "intelligence." It must be seen in relation to the social, economic, and political climate of the area, and the likelihood of active participation or support from the local populace. Obtaining and developing intelligence in a timely manner is a top priority in order to use the information to assess the threat. Threat analysis begins with a broad examination of all

information bearing on the security of an installation or a community. It focuses on potential threats. It identifies likely targets and vulnerabilities. Completed, it enables a commander to assess the threat of a civil disturbance to an installation, a mission, or a community. It forms the basis for his operational plans to counteract a civil disturbance.

INFORMATION NEEDS AND SOURCES

Planners must decide what data is needed to develop a threat assessment. They must also develop a list of information sources. Planners must be able to obtain information quickly during a disturbance. And they must have ways to obtain information from many sources at once.

Useful information can come from open sources, law enforcement sources, and military sources. Having a diversity of sources is the best approach. Information from many sources prevents biased behavior.

Open sources of information are perhaps the most overlooked valuable sources of

information. The installation library is usually a good source of information. It may have a wealth of open-source material on past and current political events relating to a disturbance. Newspapers and news periodicals are also good sources of information. They run articles or special sections on events that may lead to or have led to a disturbance. Often, they publish interviews with organizers. These interviews may provide insights into the thoughts, perceptions, and intentions of a crowd's leaders. Radio and television interviews are very informational. And they provide more real-time information than newspapers, which have less flexible deadlines. In some cases, radio and TV

provide live coverage of a disturbance. For this reason access to a TV and a radio is a must.

Law enforcement sources can provide useful information on criminal activists. Provost marshals, military police, and criminal investigators routinely work with criminal information. Information also can be obtained from local, state, and federal law enforcement agencies. Criminal information provided by law enforcement agencies may reveal potential agitators. It also may provide information on criminals or terrorists who may try to exploit a disturbance.

The intelligence community is the most restricted source of information. Liaison

with agencies that routinely collect information or intelligence is needed to know if they can support civil disturbance control operations. The DOD intelligence organizations operate under limitations imposed by regulations and executive orders. Attempts to skirt these restrictions may violate regulations or federal statutes. But intelligence organizations often can provide important, reliable data for operational planning within these limitations. Local MI field offices must be an integral part of all plans. They know the rules for collecting and storing intelligence. And they can provide valuable advice in this area. If any doubts arise about the legality of collecting and storing intelligence, the SJA must be consulted.

INFORMATION RESTRICTIONS

Collecting information related to a civil disturbance is strictly limited to protect the civil rights of people and organizations not affiliated with DOD. Civil disturbance plans and materials must not include lists of groups or people not affiliated with DOD. But lists of local, state, and federal officials who have direct responsibility for the control of civil disturbances are exempt. Data on vital public, commercial, and private facilities that are believed to be civil disturbance targets also are exempt from this prohibition. Information on civilians and civilian organizations can be collected only with specific authorization from the Secretary or the Under Secretary of the Army. Conditions for collecting information include the existence of threats against Army personnel, functions, or property. (See AR 380-13 and AR 381-10.) Civil disturbance information available in public documents, or open source information, may be collected. But specific rules regarding its storage must be followed. Commanders must coordinate with SJA, MI, and USACIDC personnel before collecting any such information.

The Army cannot gather, process, store, or report information on civilians unless civilian activities can be linked directly to a distinct threat of a civil disturbance that may involve federal military forces. Even when information can be collected, certain restrictions apply. The key restrictions include the following

- Computerized data banks for storage of civil disturbance information are established or retained only with the approval of the Secretary of the Army.
- Civil disturbance information relating to persons or organizations is stored only when DA so orders.
- Spot reports generated by information collection efforts must be destroyed within 60 days after the disturbance ends.
- After-action reports may, for clarity's sake, contain names of people and organizations who were directly involved in the civil disturbance being reported. But the inclusion of names must be kept to an absolute minimum.

- When a civil disturbance ends, the nature and extent of all accumulated files other than spot reports and after-action reports must be reported to DA. The report also must recommend that the Department of Justice either release the files or destroy them.

Classification of information also limits storage, access, and handling. In general, classified information cannot be shared with local and state law enforcement agencies. This restriction can hinder working relationships with these agencies. The law enforcement agency may see the military only as a receiver of intelligence, providing nothing in return. If this problem arises, and time is available, planners can ask the source to release an unclassified version. Secure transmission capabilities must be used to discuss any portions of classified information being requested.

If the Department of Justice determines federal intervention in a civil disturbance is likely, information relating to the disturbance is provided to the Army Assistant Chief of Staff for Intelligence. The information is analyzed and then provided to the Director of Military Support

and the task force commander for planning purposes.

Military intelligence collection efforts, except liaison, may begin only when DA so orders. During a civil disturbance, the orders must come through the CSA's personal liaison officer and the task force commander. Covert operations to gather information on nonDOD individuals and groups must be approved by the Under Secretary of the Army. Such approval is on an operation-by-operation basis, and it must come through the personal liaison officer and the task force commander.

When DA approves collection efforts, MI elements establish and maintain liaison with the appropriate local, state, and federal authorities. Using these liaisons, the MI elements collect information on incidents and the general situation. They estimate the civil authorities' ability to control the situation. Based on current plans, they report the results of their collection efforts to DA. They keep the appropriate commander informed. They provide intelligence support to the personal liaison officer and the task force commander. They also recommend other overt collection methods to DA for DA approval.

THREAT ANALYSIS

Threat analysis is a fluid and continuous process. As data for the analysis change, so do the results. Planners must adjust their plans to incorporate changes that occur during the threat analysis.

Three kinds of information are analyzed to produce a valid threat analysis: intelligence and criminal information, threat information, and installation/community vulnerabilities. Intelligence and criminal information provide information on the goals, methods of operation, techniques, strategies, tactics, and targets of individuals and groups. Threat information identifies individuals and groups. Vulnerability information identifies security weaknesses and high-risk targets.

Both subjective and objective information are analyzed. Public perceptions are compared with more objective, measurable information. This can show how much public opinion differs from the objective measurement. Key factors to be analyzed include:

- State of the economy.
- Standard of living.
- Effectiveness of law enforcement.
- Stability of the government and of the population's social and economic situation.
- Morale of the population, their support of the government, and the government's support of them.

Some factors change slowly or infrequently. These factors include the terrain of the area being analyzed and the political and ethnic traits of the population. Dynamic factors like weather, economic conditions, and security and law enforcement resources change often. Some dynamic factors can be controlled. Movements of money and weapons, security of local sites, and allocations of military personnel can all be controlled. But many dynamic factors cannot be controlled. These include the weather and the actions of local law enforcement agencies.

Planners can use the Installation Vulnerability Determining System as an analytic tool. It will help them identify vulnerabilities, set up training priorities, and allocate resources. IVDS was developed to help counter terrorist threats. But by exchanging terms, like demonstrators for terrorists and community for installation, IVDS can be tailored for civil disturbances. IVDS is a guide only. A low score does not necessarily mean that there is not a problem. For detailed information on the IVDS, see TC 19-16.

IVDS assesses:

- The installation's or community's characteristics and its attractiveness as a target for terrorist acts or civil disturbances.
- Status of training.
- Availability of communications.
- Nonmilitary law enforcement resources.
- Time and distance from US military installations that can lend assistance.
- Time and distance from urban areas.
- Geographic region.
- Proximity to foreign borders.
- Access to the installation or the community.
- Population density of the installation or the community.
- Terrain.

There are other techniques for making a threat analysis. Planners can apply a think-like-the-opposition technique and develop plans that the opposition might use. This technique can help identify vulnerabilities and how they could be exploited. Games can be used to develop scenarios to identify the threat and to plan countermeasures. Scenarios can be developed for situations involving passive resistance, blockades, violent confrontations, bombings, arson, hostages, and occupations of buildings. Although scenarios are unlikely to occur exactly as conceived, they are beneficial. They help identify potential problems that can be corrected before a disturbance becomes a reality. Command post exercises and field training exercises are useful methods for training personnel to respond to civil disturbances. CPXs can help identify high-risk targets. They also are useful in training the people who will operate the EOC. An FTX allows planners to assess response capabilities. FTXs also provide opportunities for evaluating vulnerabilities from the demonstrators' viewpoint. If an FTX cannot be held in the community where a disturbance may be expected, a community or an area with similar characteristics can be used. And committees or councils are another means of evaluating threats and vulnerabilities. Such groups should include people who would play a major role in a civil disturbance operation, particularly logistics personnel and key community officials. Groups such as these ease the exchange of information and make for more effective civil disturbance planning.

When available information has been collected and the vulnerability study is complete, an assessment of the threat can be made. Although some weaknesses cannot be corrected, others may only require the careful use of resources. Plans must be made to obtain resources that are not readily available. Using the identified vulnerabilities, planners categorize these

weaknesses based on the specific countermeasures needed to offset them. An overview of the countermeasures can reveal additional weaknesses.

To be of value, threat analysis must be a continuous function. As vulnerabilities are reduced in some areas, other areas

man become more vulnerable. Changes in mission, tasks, and personnel also may have an impact on the status of the current threat analysis. Failure to update a threat analysis on a regular basis or to correct or compensate for vulnerabilities can adversely affect response capabilities for civil disturbances.

INFORMATION NEEDS FOR PLANNING CIVIL DISTURBANCE OPERATIONS

- **Goals of the groups that are likely to cause or are causing civil disturbances.**
- **Times and locations of disturbances.**
- **Causes of disturbances.**
- **Identity of persons, groups, or organizations that have distinctly threatened to cause or are causing disturbances.**
- **Estimated number of people who will be or are involved in the disturbance.**
- **Likely places where crowds could assemble.**
- **Presence and location of leaders and individuals who have threatened to cause a civil disturbance.**
- **Group structure and types of activities group can carry out.**
- **Sources, types, and locations of arms, equipment, and supplies available to the group.**
- **Possible use of sewers, storm drains, and other underground systems by participants.**
- **Attitude of general populace toward groups causing civil disturbances, toward civil law enforcement authorities, and toward federal intervention.**
- **Presence of threats to utilities that serve the public.**
- **Kinds of communications and control methods used by participants and organizers.**

Operations Planning

Successful civil disturbance operations depend on adequate plans and well-trained control forces. Planning for civil disturbance operations is a continuous process. Such planning involves coordination of personnel, logistics, and operational considerations. It provides for the actions to be taken before, during, and after civil disturbances. It is based on the assumption that federal military resources may be committed at any time, with or without warning, to assist local and state authorities or to enforce federal law. Such commitment may involve either limited or massive employment of forces.

COORDINATION OF CIVILIAN AND MILITARY EFFORTS

When federal forces are requested to help civil authorities attempting to control a disturbance, coordination with local civil authorities is a must to prevent duplication

of effort. The task force commander must know what civilian resources have been and will be committed to disturbance operations.

SUGGESTED COORDINATION CONTACTS

- CITY/COUNTY/STATE GOVERNMENTS
- CITY/COUNTY/STATE LAW ENFORCEMENT AND SECURITY AGENCIES
- IMMIGRATION AND NATURALIZATION SERVICE AND ITS BORDER PATROL
- CAMPUS SECURITY POLICE
- PRIVATE POLICE AND SECURITY ORGANIZATIONS
- FIRE DEPARTMENTS
- EMERGENCY RESCUE AND MEDICAL SERVICES
- PUBLIC WORKS DEPARTMENTS
- PUBLIC UTILITIES
- PARKS AND RECREATION DEPARTMENTS
- CITY SOCIAL SERVICES DEPARTMENTS
- CITY ENGINEERS
- CITY ATTORNEYS
- CITY PUBLIC RELATIONS OFFICIALS
- CIVIL AIR PATROL
- CIVIL DEFENSE ORGANIZATIONS
- INDEPENDENT SOCIAL RELIEF AGENCIES, SUCH AS THE RED CROSS AND THE SALVATION ARMY

Civil agencies and their responsibilities, organization, and authority vary considerably from community to community. The task force commander must have an index of the various agencies, their responsibilities, lines of communication, and points of contact. Based on this index, he can plan for liaison needs and for joint civilian and military efforts. Local authorities and National Guard troops can supply valuable information. They know the area, the local agencies, and the population. Among the major areas requiring coordination are the following:

- Preservation of law and order.
- Custody of offenders.
- Documentation of evidence.
- News releases.
- Traffic and circulation control.
- Exchanges of situation information.
- Care of the injured.
- Evacuation, housing, and feeding.
- Protection of key areas, facilities, and personnel.
- Delineation of areas of responsibility and establishment of joint patrols.
- Removal of debris that interferes with operations.
- Explosive ordnance support.
- Equipment.
- Use of facilities.

Sometimes commanders must undertake joint civilian and military efforts with agencies that provide resources under "mutual aid" agreements. Mutual aid agreements and their legal considerations vary from community to community. Some states have more detailed agreements than others. Lines of responsibility and authority between state, county, and local

authorities can be confusing. Civilian command is not clear cut. State laws and local ordinances vary widely on this point. The legal aspects of mutual aid agreements may affect the types of activities in which the agencies may become involved. Joint operational plans must be drawn up with due consideration to legal authority. Legal and jurisdictional boundaries also affect the process of controlling the disturbance, especially if the disturbance crosses these boundaries. Because control of a disturbance within a given jurisdiction is the responsibility of that jurisdiction, command and control of the disturbance may suddenly shift when the disturbance crosses boundaries. In some states, especially where mutual aid is not clearly defined, law enforcement personnel operating outside of their normal jurisdiction only have the power of citizens arrest. And the laws concerning citizens arrest also vary considerably from community to community. Early discussion of jurisdictions with the agencies involved can reduce possible confusion and provide for a smooth transfer of control.

Whenever practical, assigned unit boundaries should coincide with local police subdivisions. This simplifies coordination of activities in the area. Boundaries usually are located along streets or alleys, with coordinating points at intersections. When a street is designated as a boundary, responsibility for both sides of the street is given to one unit to ensure proper coverage. Arrangements should be made to have troops and civil police operate together. In addition to the joint patrols and posts, arrangements should be made to exchange liaison officers at each headquarters, from company through division, on a 24-hour basis.

FUNDING AND MILITARY RESOURCES

Federal forces participate in civil disturbance operations as an unprogrammed

emergency requirement, and Army resources under DA control are loaned to

state and local governments and law enforcement agencies as a temporary emergency measure. Therefore the costs incurred by the Army as a result of such operations are financed in accordance with AR 500-50. And the policies and procedures for equipment loans, including property issued to the National Guard are delineated by AR 500-50.

Army resources are classified in three groups. Requests are considered for approval in the following order:

- **Group One** — Personnel, arms, ammunition, tank-automotive equipment, and aircraft. Requests for personnel to be used for direct law enforcement must be made by the state's legislature or governor. Requests for other Group One resources can only be granted by the Secretary of the Army or, when so designated, the Under Secretary of the Army.
- **Group Two** — Riot control agents, concertina wire, and similar military equipment that is not included in Group One. Requests for these can only be granted by the Secretary of the Army, the Under Secretary of the Army, or the Director or Deputy Director of Military Support in coordination with the

General Counsel of the Army. When authorized by the Secretary of the Army, the task force commander also may approve Group Two requests.

- **Group Three** — Firefighting resources, including personnel; protective equipment and other equipment not included in Group One or Two; and the use of Army facilities. Requests for these resources may be granted by the Secretary or Under Secretary of the Army, major Army commanders, commanding generals of CONUS armies, the MDW commander, and commanders-in-chief of unified commands outside CONUS.

Commanders who have Group Three approval authority can approve requests for Group Three military resources, less active duty and reserve forces, to nonDOD federal agencies before or during civil disturbances. Commanders who have Group Three approval authority also can approve requests for Army resources less personnel, regardless of classification, to National Guard units in an active duty status. Loans of Army resources will be approved, if possible, when the National Guard is authorized such resources, but DA cannot provide them on a permanent basis.

LOGISTICS

Civil disturbance operations involve special consideration of logistical needs. Logistics planning must provide for obtaining supplies, services, and facilities through local procurement. This includes food and beverages, laundry services, and sanitation facilities. When planners set up lines of supply, they should consider using nearby installations or National Guard and Reserve facilities. Logistics planners should visit the disturbance area to identify sources and to coordinate support. Authorities must identify all civil and military equipment and material

assets, regardless of ownership, that are available within a disturbance area to supplement military resources.

TASK FORCE SUPPLIES AND EQUIPMENT

Supplies and equipment that will accompany a unit must be ready so the unit can respond rapidly in emergencies. Supply lists must be developed with unit integrity in mind. Units must be able to operate with self-sufficiency. Among the items that must be provided for are

ammunition, food, water, gasoline, lubricants, spare parts, riot control agents, maps, and administrative supplies. A running inventory must be kept and complete inspections made as necessary. Procedures must be in place for the periodic replacement of certain items. Bulk riot control agents, ammunition, food, and gasoline deteriorate in prolonged storage. Retention of unserviceable materials can have grave consequences in an emergency. Ammunition must be segregated by type. That way, if there is a late notification of weapons restrictions, nonessential ammunition can be separated before shipment.

Some equipment or supply items that the task force may need are not organic to the unit or may not be transportable by the available means of transportation. If this situation should arise, commanders must advise the chain of command so that these items can be made available to the task force through special transportation arrangements, by drawing from pre-positioned stocks, or by borrowing them from units close to the objective area. For example, STANO equipment, which not all units may have, can be used to—

- Locate and neutralize snipers.
- Secure roadblocks and checkpoints.
- Prevent ambushes or frontal attacks by crowds.
- Augment security patrols of isolated areas.
- Identify friendly and hostile elements.

Individual and organizational equipment prescribed in CTA and TOE for troops and units are often not sufficient for civil disturbance operations. Ways to obtain additional equipment must be considered when planning logistical support. For example, vehicle augmentation may be needed to meet mission requirements. Other additional equipment that may be needed includes:

- Locally purchased or manufactured body shields.
- Armored vehicles.
- Riot batons.
- Flexcuffs.
- Riot control agent dispersers.
- Floodlights, spotlights, and searchlights.
- Night observation devices.
- Communications equipment, particularly hand-held equipment.
- Videotape and instant-developing film cameras.
- Public address systems.
- Heavy construction equipment.
- Concertina wire.
- Aircraft, especially helicopters.
- Ambulances, first aid kits, and firefighting equipment.
- Grappling hooks, ladders, and rope.
- Special weapons.
- Generators.
- Personal protective equipment, such as faceshields and protective vests.

Planners should consider the need for extra tents, cots, and, perhaps, tent stoves. Plans also should provide for barricade and roadblock materials and equipment needed to build, set up, and remove barricades.

Procedures must be established for resupply in the disturbance area. Logistical contact teams can be set up in the disturbance area. Contact teams must have direct communications with support units so they can get critical supplies as soon as needed. Requisition priorities must be set to ensure a fast response to resupply requests.

Suggested supplies and equipment to accompany the task force are listed in Appendix 1 to Annex D of Garden Plot. The list of supplies contained in Garden Plot is the *minimum* needed to support a civil disturbance operation. Commanders and other planners should not rule out other items of equipment just because they are not on this list.

ASSEMBLY AND TROOP QUARTERING AREAS

When possible, assembly and troop quartering areas should be on federal, state, or public property to reduce claims for property damages, contract costs, and the dissatisfaction over perceived inequities among the populace. Reserve centers and National Guard armories are ideal locations. As a general rule, assembly areas should be located away from the direct observation of disturbance crowds. This improves operations security and avoids direct harassment of the troops. Quartering areas are selected only after careful consideration of the physical security measures needed to protect the area and the troops. But assembly and quartering areas must be close enough to a disturbance area to ensure that troops can be committed quickly. And there must be adequate main and alternate routes between the areas. Other factors to be considered when selecting quartering areas are

- Weather that is likely to be encountered.
- Number of troops that are likely to be using the area.
- Length of time that the troops will be using the area.
- Availability of sanitation facilities and recreation areas.

TASK FORCE MOVEMENT

Movement to and within disturbance areas must be considered when developing operational plans. The means of movement is critical to the success of the operation because of the time factor involved. Usually, troops are committed to civil disturbance missions on extremely short notice. They must arrive promptly if the disturbance is to be contained with minimal injuries and property damage. Troops must be moved to the objective area in a mission-ready status, while minimizing the cost to DOD and to the military departments concerned.

Because rioters can use tactics that will delay the arrival of troops, the commander selects the most direct routes that are least vulnerable. Close coordination with the movements officer is vital. The commander plans reconnaissance patrols for security en route and at arrival points. The main body must be preceded by a party of sufficient strength to prevent interference with the main body's arrival. The commander also plans alternate routes and arrival points.

Coordination with transportation units must be a part of task force development. Each mode of transportation must be carefully developed during logistics planning. The final plans must be able to be executed quickly. Foot, rail, water, air, and motor movements all offer certain advantages and disadvantages. Some modes require more coordination and earlier preparation than others. Rail movements usually involve the use of special trains, the selection of entraining and detraining points, and the calculation of departure and arrival schedules. Coordination with railroad officials, therefore, is an important planning step. When selecting air travel, task force planners must determine the characteristics of available aircraft to facilitate proper loading. In motor moves, provisions must be made for supplies of gasoline and repair parts. When forces are to be airlifted into a disturbance area, planning must include provisions for sufficient ground transportation and communications equipment in the disturbance area.

Planners must also consider transportation for use within the disturbance area. They consider the use of commercial buses and rental cars. The buses could be used for mass transportation in the disturbance area. Unit vehicles can be augmented with additional vehicles to provide sufficient flexibility and mobility for operational and support elements and mobile cordons. Helicopters and fixed wing aircraft also should be included in transport planning

for use within a disturbance area. Whenever possible, helicopters are employed to provide command and control, surveillance, medical evacuation, troop lift, and supply lift capabilities. Planning also must address the selection of landing zones and the use of air traffic control measures in the disturbance area.

All units with civil disturbance missions must maintain qualified personnel for preparing load plans and certifying special

handling data forms. Load plans must be developed for each mode of transportation. Personnel and equipment load plans must be based on unit integrity to ensure that the control force arrives in the disturbance area prepared for immediate employment. Except for limitations in handling hazardous equipment, each element of the force should take its required equipment and a small reserve of ammunition, riot control agents, and basic supplies. Load plans must be rehearsed and made a part of unit SOPs.

COMMUNICATIONS

Civil disturbance operations require adequate and versatile communications equipment. Communications must be maintained at the disturbance scene and between the scene and the operations headquarters. Planners must consider using every means of communication available, including

- Telephones.
- Hand-carried and vehicle-mounted public address systems.
- Commercial radio and television stations.
- Teletype machines.
- Taxicab radio nets.
- Military and civilian police radios.

Civilian communications systems should be used as much as possible, but they must be supported by an independent military system. And the military system must be able to sustain all essential communications. If military equipment is not compatible with the civilian equipment, plans must be made to collocate stations, exchange equipment, allocate frequencies, or

set up net radio interface/phone patches. (Net radio interface stations connect mobile radios to switching systems. From there, the routing goes to telephone subscribers.) Signal security measures, including authentication systems, are used during disturbance operations. Radio operators working close to rioters use headsets to receive messages and a low voice to send messages to keep rioters from hearing the messages. And troops must know emergency procedures for clearing the radio nets.

Public address systems are useful in issuing proclamations and psychological pronouncements or persuasions. They can drown out vocal demonstrations. They help prevent vocal communications between crowd leaders and crowd members. And they can be used by commanders to direct and control troops. Control force leaders wearing protective masks can use megaphones with battery-operated loudspeakers to convey instructions to troops.

Visual signals also can be useful. Flares can signal the beginning and ending of operational phases. Hand and arm signals and messengers also can be used.

RELIEF

Civil disturbance operations are demanding, both mentally and physically. Troops

need relief if efficiency and discipline are to be maintained. During civil disturbance

operations, units assigned an area control mission may be totally committed, preventing relief operations within the unit. Relief must be provided by a higher echelon retaining uncommitted units. Ready reserve forces should not be used for relief because they may become actively involved in operations. Relief must be accomplished in place to ensure that the relieving unit physically occupies assigned facilities and the area of operation. Relief during civil disturbance operations must be conducted during the least critical times. Relief priorities must be set to ensure that forces employed at the most vulnerable facilities and in the most riot-prone areas are relieved first. The relief units may have more or fewer troops than the units being relieved, depending on the situation.

Relief operations must be coordinated with civil police, fire departments, and other agencies operating in the disturbance area. Civilian relief operations must be conducted in such a way that they do not conflict with military relief operations. Any time that unit capabilities or the task force commander change, the incoming commander reviews the joint control and support agreements. If it is necessary, he coordinates new agreements. This action helps ensure available resources are used in the most effective manner possible.

Commanders at each echelon should be present at the field CP of the outgoing unit to facilitate command and control. The commander of the outgoing unit directs the relief procedures. He usually remains responsible for the area of operations until most of the relieving unit is in position and communications and control have been established by the incoming commander. The exchange of responsibility is agreed upon by the commanders concerned and is verified by the concurrence of the next higher commander. If riotous activity occurs before the incoming commander assumes responsibility, he assists the outgoing commander with all means available.

Commanders at each level must conduct a thorough reconnaissance of their operational areas. All unit leaders must receive a complete briefing from the outgoing unit. Routes into the areas must be reconnoitered. Critical facilities, barricades and roadblocks, patrol routes, and other items of operational importance must be identified. And unit leaders must familiarize themselves with their assigned area and establish a rapport with the law-abiding citizens in the area.

Commanders of the incoming and outgoing units must arrange for the exchange of special equipment items essential to the mission that may be in short supply. Vehicles and radios may be exchanged because the need for them in civil disturbance operations usually exceeds the TOE issue authority. Other items, such as barricade and roadblock material, wirelines, switchboards, extra ammunition, and riot control agent munitions, can be left with the relief unit. Equipment exchanges are based on the authority included in the relief order of the next higher commander. Equipment exchange must be made using proper accountability procedures.

KEY ELEMENTS OF A RELIEF ORDER

- Time for the relief to begin and end.
- The time or the condition for exchanging responsibility for the operational area.
- Routes to be used by the incoming and outgoing units.
- Civil authorities who are operating in the area.
- Locations of critical facilities and barricades and roadblocks.
- Patrol routes, guard posts, and other security measures that are in place.
- Any requirements for periodic reports by subordinate leaders during the relief effort.

ADMINISTRATION

Plans and administrative procedures must be developed to handle personnel actions resulting from the commitment of forces to civil disturbance duty. Personnel plans must provide for care of dependents and personal property left at home station, indebtedness, emergency leave, sickness, and injury. To ensure personnel matters are properly handled in the disturbance area, members of unit personnel sections must accompany the task force.

DISCIPLINE, LAW, AND ORDER

Directives must be published that clearly set the standards of conduct and appearance expected of the troops in the performance of their missions. Troop relationships with, and attitudes toward, civilians must be stressed. The provost marshal can provide helpful advice on matters of discipline, law, and order. Troops must refrain from acts that could be damaging to the high standards of personal conduct and discipline of the Army.

Appearance and discipline of federal forces have a psychological impact on the populace and facilitate mission accomplishment. Leaders must ensure that subordinates are clean, well-groomed, neat, and conduct themselves in the highest standards of military courtesy and discipline. *The importance of strict adherence to prescribed standards of conduct and fair treatment of civilians must be stressed continuously.*

MORALE AND WELFARE

Morale and welfare are areas of particular concern in civil disturbance planning because of the restrictions and demands imposed on the troops. Because control forces must perform very sensitive duties under great physical and mental stress, the

following services are extremely important:

- Rest and recreational facilities, such as free movies, special service activities, TVs in barracks, and athletic equipment and facilities.
- Assistance to dependents and access to American Red Cross and Army Emergency Relief services.
- Post exchange facilities, including barber shop and laundry facilities.
- Financial services and access to a bank.
- Medical and dental services.
- Postal services.
- Leave and passes.
- Religious services.
- Legal assistance.
- Decorations and awards.

These services are necessary to maintain high morale and to allow soldiers to concentrate on the complex, sensitive, and stressful tasks that they must perform during civil disturbance operations.

MEDICAL SERVICES

Emergency medical attention must be available for military and civilians. Medical support for civilians, however, should be provided by civilian medical facilities. Military facilities should be used by civilians only to prevent undue suffering or loss of life or limb. Plans must provide for qualified medical personnel, air and ground ambulance service, medical facilities, medical supplies, medical evacuations, and casualty reporting. Casualty notification procedures are prescribed in AR 600-10. Factors to consider for medical facilities include location, sources of power and water, and sanitation facilities. Existing medical facilities, military and civilian, can be used whenever practical.

MEDIA RELATIONS

Whenever federal forces are committed to a disorder, media interest is generated. In a

disturbance area the public is directly affected by actions taken individually and

collectively by military personnel. Similarly, the public outside the area has an intense interest in events taking place within the area. Press interest in most cases will be high. Unless timely, accurate information is furnished, the press will be forced to rely on speculation and rumor.

Soldier responsibilities with regard to media contact must be made clear. Soldiers must be informed that they must treat media members with courtesy and respect. They also must be cautioned not to make any comments concerning upcoming or active civil disturbances and unit missions, even if told their remarks will be “off the record.” Soldiers, when approached, refer media members to superiors or the PAO.

The task force commander must anticipate media contact. Plans must include the clearance of all news releases with the Assistant Secretary of Defense for Public Affairs, the on-site public affairs chief, or a higher authority, whichever is appropriate. Procedures must be established for confiscating film and videotape of prohibited areas. Both the PAO and the SJA must review the procedures to ensure that the ability of the media to gather and report news is not unduly restricted. To help maintain media relations, plans also must include:

- Procedures for furnishing accredited media members with press passes to facilitate their passage through police lines and military checkpoints. News media members must be allowed freedom of movement as long as they do not interfere with control force operations.
- SOPs for coordinating press requests to cover operations in the disturbance area, including furnishing military escorts.
- Establishment of a newsroom by the task force PAO. The newsroom can be used for periodic press briefings and for furnishing the media with fact sheets

and other background data concerning the operation.

- Regular news conferences and periodic briefings. They should be held by senior civilian and military officials who can provide timely, accurate information and the opportunity for the media to question senior commanders. When it is practical, the task force commander should consider allowing the media to accompany senior officials on tours of the affected area.
- Making news releases concerning civil disturbance operations and instructions for public cooperation. These releases must comply with AR 360-5.
- Liaison and coordination with local civilian public affairs officials and information agencies. This simplifies the exchange of information, ensures the information’s accuracy, and generally aids the news-gathering effort.
- Setting up a rumor control center. A rumor control center helps reduce the adverse effects of misinformation.

DA public affairs policy is to provide the public, through cooperation with the news media, prompt, responsive, and accurate information. Emphasis must be placed on the fact that the Secretary of the Army has been assigned a mission, assisted by DOD components, to help civil authorities in restoring and/or maintaining law and order. It also must be pointed out that the mission will be accomplished using the minimum force needed. Maximum disclosure of accurate information on the situation in the disturbance area with minimum delay is the governing principle, subject only to security and operational needs. Annex F of Garden Plot provides the commander with guidance on the responsibilities for disseminating public information. Annex F also provides guidance that can aid in planning for personnel and equipment to conduct information activities in the disturbance area.

Appropriate operating procedures and command guidance must be issued in writing to prevent the release of information potentially harmful to the military mission. Members of the news media must be clearly informed of the location of prohibited areas that may not be photographed or videotaped and restricted areas where they must have a proper escort. If soldiers must detain or apprehend members of the media for entering restricted areas without proper authorization or for trying to film or videotape prohibited areas, the soldiers notify their leaders immediately. Operating procedures should include the locations of

newsrooms and the access control procedures for restricted areas. In most instances, the media will not be furnished communications or transportation, nor will a press center be set up in the disturbance area. But a newsroom should be set up. The media should be afforded the use of tables, chairs, typewriters, and other equipment associated with a newsroom operation when this use does not interfere with control force operations. If the military is the only source capable of providing communications and transportation support, such support will be provided, if possible. However, prior arrangements must be made for reimbursement.

PLANS AND REPORTS

Detailed plans for civil disturbance operations at each level of command implement the plans of the next higher echelon. Contingency plans are prepared based on a reconnaissance of the disturbance area and a comprehensive review of after-action reports of similar operations. Each plan shows an assembly area, routes and alternate routes to the assembly area, tentative locations of roadblocks and OPs, and temporary facilities for billeting, feeding, and detention. Maps, overlays, aerial photographs, and sketches of the area should be obtained. Plans for distribution and reserve stockpiling are developed. Usually, contingency plans are not implemented exactly as written. Their value is not in rigid application, but as a firm base from which to mount flexible tactics in response to developing situations.

Operational plans provide for the main tasks to be accomplished in controlling a civil disturbance. The plans include:

- A plan to isolate the affected area.
- A patrol plan.
- Plans for crowd control.
- Plans for the neutralization of special threats and for rescue operations.

- Plans for deployment.
- Plans for withdrawing after order is restored.
- Plans for medical care and for evacuation operations.
- A security plan for priority facilities that are vulnerable to dissident activity, that are critical to the community's well-being, and that have value to the dissidents.

Operations plans must also provide for establishing and maintaining command posts. Locations for the EOC and tactical command posts should be selected in advance. Collocation of command posts and establishment of joint operations centers facilitate liaison and coordination between military and civil authorities. Plans must be made for staffing and equipping the CPs with a minimum of delay.

The EOC must have security. Key personnel can become targets for terrorists. An alternate EOC, and people to staff it, also must be considered. The primary EOC could be overrun by the disturbance. The need for an alternate EOC can be determined by threat analysis. If an alternate

EOC is needed, procedures for evacuating the primary EOC or for passing command and control must be in place.

The EOC must have extensive radio and wire communications. Sufficient phone lines must be installed to facilitate coordination and information dissemination with outside agencies and operational forces. If a particular agency must be able to communicate without delays, some lines may have to be dedicated. And the EOC must have sufficient radio equipment to monitor all civilian and military operational frequencies. The EOC also must have space for individual work areas and for conference rooms for meetings and briefings. An overcrowded EOC is noisy and raises the stress level of EOC members. Distracters have an adverse impact on the decision-making process.

Planning considerations must cover both the main CP and the tactical CPs in the various areas where rioting is most likely to occur. Security measures must be taken to ensure that CPs are not penetrated or overrun by riotous elements. Each CP must have an evacuation/relocation plan.

Plans must include the collecting of data for reports and lessons learned. Task force personnel must keep detailed records and journals during and after operations. An important part of the termination process is preparing and submitting an after-action report. The after-action report is as detailed as the commander feels is necessary. Or it is based on higher headquarters requirements. National Guard Regulation 500-50 sets the format for submitting National Guard after-action reports. The report's contents are not limited to just the findings of the commander and his staff. The report may include materials or lessons learned contributed by subordinates or other sources that the commander feels are valuable.

In the aftermath of civil disturbance operations, many claims and investigations are likely to occur. There must be accurate and timely information for processing claims and conducting investigations. Legal matters are a service responsibility and all third party tort claims must be processed according to AR 27-20. Plans also must include provisions for resolving legal problems of task force personnel.

Control Force Operations

To restore order in a civil disturbance, a control force must isolate the disturbance area to prevent the disturbance from spreading. It must protect the people, facilities, and services likely to become targets of attacks in a continuing disturbance. It must exert control over the disobedient crowds. It must establish control of the disturbance area. And it must neutralize any special threats that arise.

Federal forces can expect to do one, some, all, or any part of these operational tasks. Which operational tasks they perform and to what extent depends on the kind of disturbance and the reason for federal intervention.

ISOLATE THE AREA

The initial task in controlling a disturbance is to isolate the people creating the disturbance from those who have not yet become actively involved. Once a crowd is isolated, time is on the side of the commander. The first action is to identify the area and the people to be isolated. The second is to seal off the disturbance area. The objectives of the task are to—

- Prevent disorder from spreading to unaffected areas.
- Move uninvolved people from the area quickly.
- Prevent unauthorized people from entering the affected area.
- Prevent the escape of people who are bent on expanding the disturbance.

Every effort must be made to allow a crowd to leave an area peacefully. This reduces the number of people who may have to be apprehended or dispersed.

Useful measures for isolating an area include barriers, patrols, pass and ID systems, and control of public utilities. Some measures may be in place before the disturbance. Civil authorities usually have

a means to control public utilities. Street lights, gas, electric, water, and telephone service must be able to be turned on or off to support control force tactics. Passage into and out of the isolated area must be controlled. Persons connected with the disturbance should not be able to move into or out of the area. But emergency medical personnel, public work crews, media members, and others may need to enter or leave the disturbance area. And persons residing within a disturbance area may need to travel to and from work. Installation and/or municipal contingency plans usually include a pass and ID system to allow authorized personnel into and out of restricted areas. To be effective, a pass and ID system must be carefully planned in detail before it is needed.

Barriers like barricades and roadblocks can be used to stop the passage of people and vehicles to and from an area. Or they may be constructed to permit specific people and vehicles to pass. Often it is impractical to seal off an area due to physical and geographical limitations. College campuses and suburban areas, for example, often have woods and open fields that make them difficult to seal off.

Temporary barriers of troops can be set up until more permanent barriers can be made. When a troop perimeter is used to isolate an area, the control force sets up an inner and an outer perimeter. The inner perimeter contains the area of the disturbance and keeps the disorder from spreading. Troops on the inner perimeter face the disturbance. The outer perimeter prevents outsiders from entering the disturbance area. Outer perimeter troops

face away from the disturbance. The use of two perimeters protects the backs of the troops in each line. The use of two perimeters also creates a clear zone in which to stop people who breach one of the lines. In large crowds control force stand shoulder-to-shoulder. In small crowds they stand double arm's length apart. If a closed perimeter is needed, they can link themselves together with riot batons.

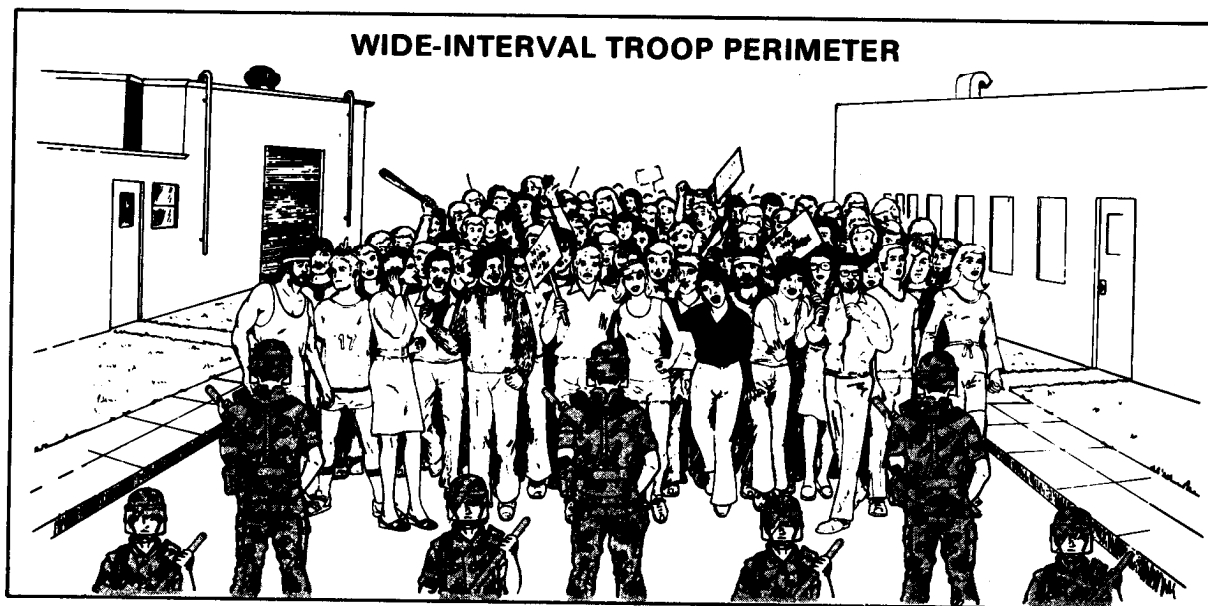
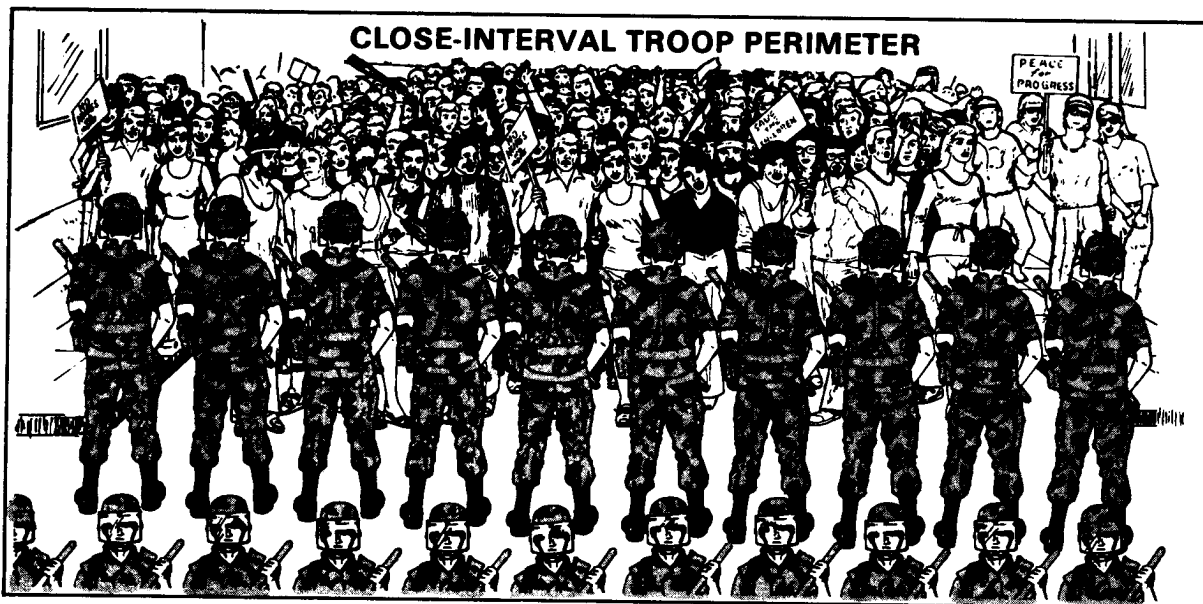

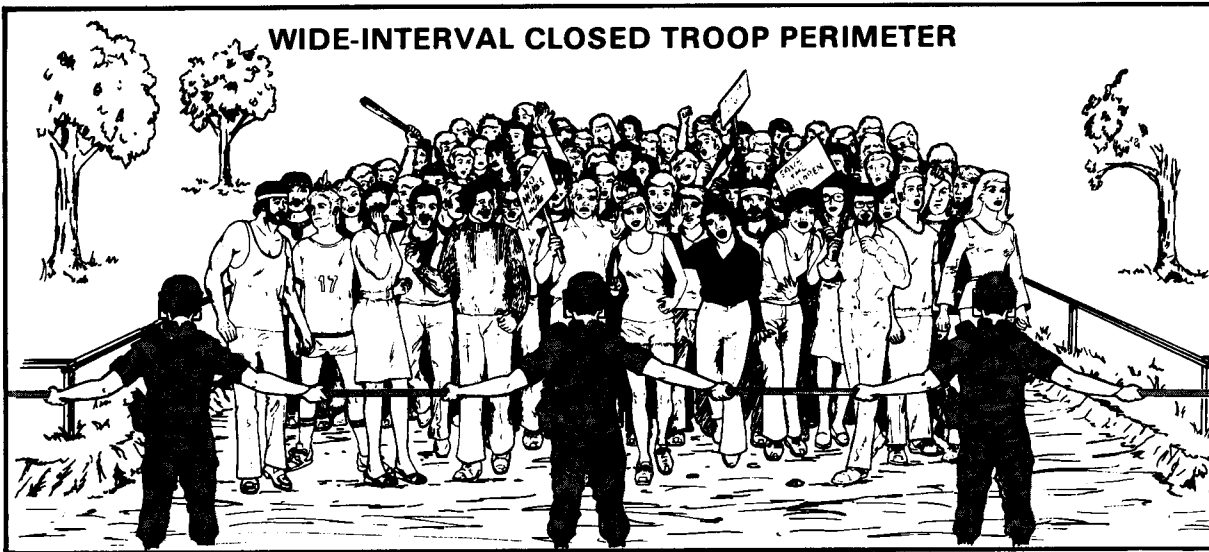

Portable barricades of sawhorses, ropes, and other field-expedient devices can be used to impede pedestrian traffic. Concertina wire is a suitable material for rapidly constructed, effective barricades.

But concertina wire is used only under the most serious circumstances. And then it is used sparingly, because it is indicative of violent disorders.

CONSTRUCTION OF A PORTABLE BARRICADE

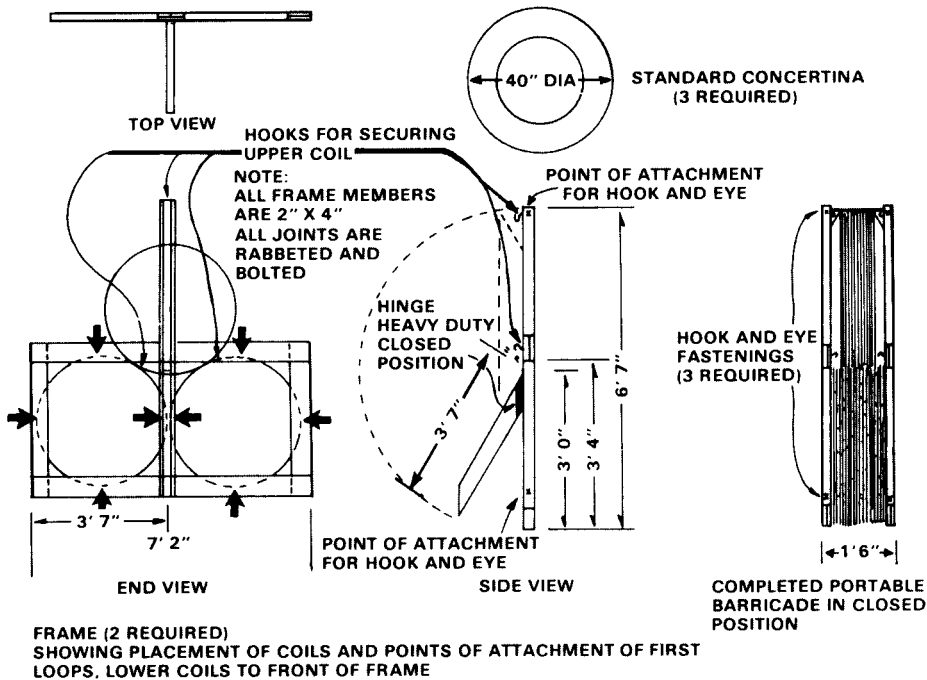

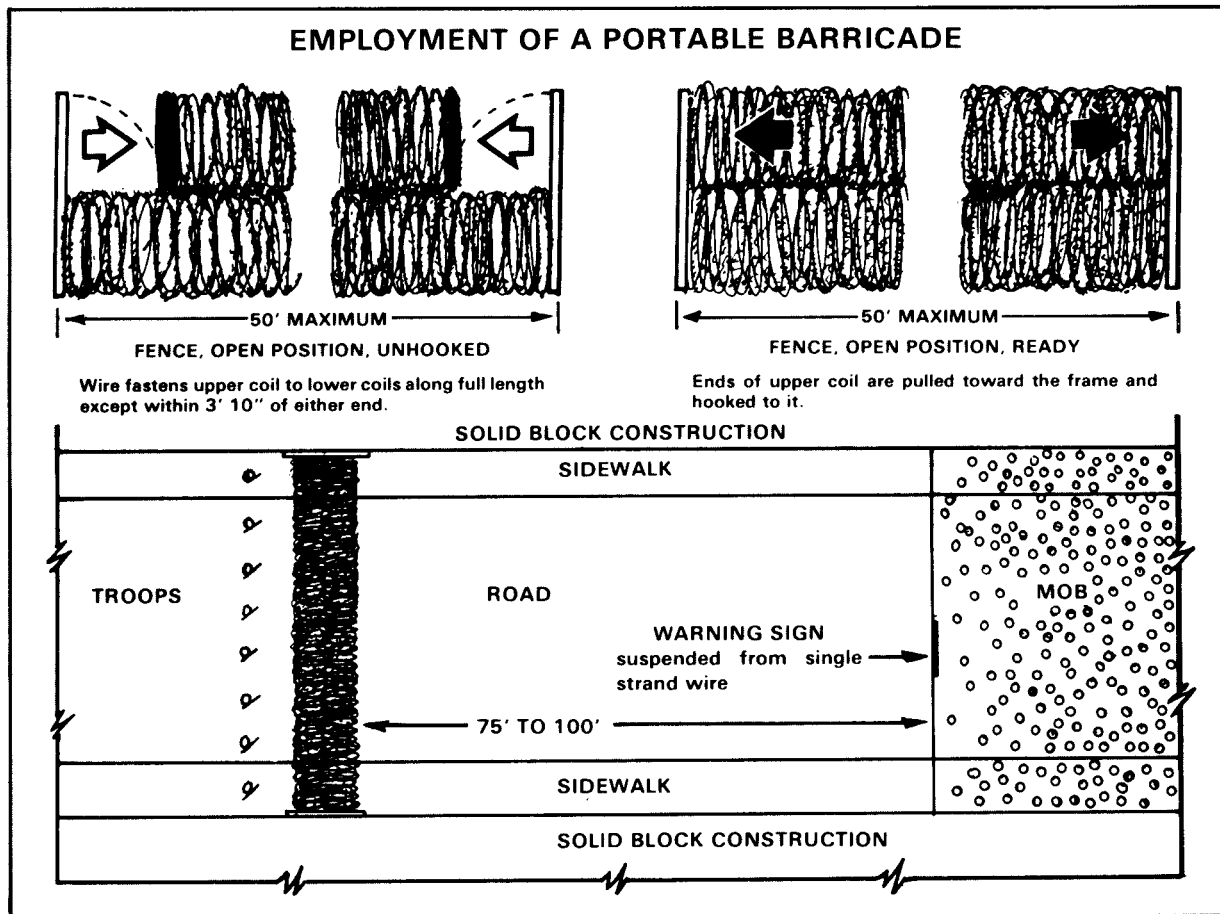

Roadblocks that cannot be easily breached by vehicles require large and heavy construction materials. Barrier materials are loaded on staged trucks for rapid emplacement. A quickly-erected barrier can be made by parking vehicles bumper-to-bumper. However, the vehicles may be damaged by a hostile crowd. A vehicle-mounted barricade is useful both as a barricade and as part of a formation. It can be made locally by fitting a wire-covered wood or metal frame on the bumper of a vehicle. More permanent roadblocks can be made from 55-gallon drums filled with water or earth. Sandbags, earthworks, and trees can also be used to block roads. Several roadblocks placed at intervals of 25 to 50 feet will usually prevent breaches by heavy or high-speed vehicles. If small arms fire is likely, barricades and roadblocks must provide cover.

Approaches to the position must be illuminated without silhouetting the people manning it. Auxiliary lighting may include hand-carried lights, vehicle-mounted searchlights, spotlights, floodlights, flashlights, and vehicle headlights. Canvas or sandbags should cover materials that could chip or shatter when hit by thrown objects. And signs must be placed in front of the position to warn unauthorized personnel not to approach.

Perimeter patrols are useful to prevent entry to and exit from the disturbance area of people or groups trying to bypass barricades and roadblocks. These patrols operate along the outer operational boundary of the disturbance area. Their routes can be integrated with patrol routes within the disturbance area.

PROTECT LIKELY TARGETS

In most civil disturbances, civil police enforce the laws in the disturbance area, and military forces protect likely targets. Key buildings, utilities, and services critical to the functioning of a community must be protected. Also, key people and VIPs can be targets for crowds angered by official policy.

VIPs may be at risk in public, at work, or at home. Off-duty control force members may be targets if they are recognized by demonstrators with whom they have been in conflict. Control force members on patrols too small to defend themselves against a violent crowd also may be in danger.

Armories, arsenals, hardware and sporting goods stores, pawnshops, gunsmiths, construction sites, outlets for chemical products, and other places where weapons or ammunition are stored must be protected. To conserve manpower, the control force may move dangerous items to a central facility. Facilities that could be symbolic targets for radicals must also be identified and protected when possible. Likely targets for such attacks are control force CPs, billeting areas, and motor parks.

Priorities for providing physical security must be established. Effort and manpower must be placed where they will do the most good. When setting priorities for the protection of facilities, for example, consideration is given to the facility's importance to the well-being of the community or the installation. The loss of water and electric utilities endangers the health of the community. The loss of government buildings disrupts government functions. Radio and TV stations, if seized by demonstrators, can be a powerful tool for spreading disorder. A facility's susceptibility to damage or loss must be considered. The degree of risk to a facility is based on its physical layout, its type of construction, and its existing protective measures. When developing priorities for protection, the intent and ability of the crowd is always a

factor to be considered. Planners must analyze the destructive intent and the capabilities of the participants. This analysis will help identify both likely targets and the degree of violence likely to occur.

The military must anticipate the need for the rapid implementation of physical security measures. (Detailed information on physical security measures and procedures is found in FM 19-30.) Perimeter barriers, protective lighting, alarm systems, and intrusion detection devices help deter and detect intruders. These preventive measures impede unauthorized access to a facility.

Measures of this type may or may not be in effect at the time of the disturbance. Troops also can be used to implement security measures. Troops used as sentinels or walking guards and at checkpoints must be committed jointly with guards from the facility being protected. Existing guard forces can be augmented with additional equipment. Fixed security posts must be manned by enough guards to be effective and to protect themselves until relieved. And troops can be used as a highly mobile response force, centrally located near likely targets. A mobile response force reduces the need for fixed security, freeing troops for other operational tasks.

MEASURES TO PROTECT LIKELY TARGETS		
VIP	<ul style="list-style-type: none"> ● Restrict release of personal data. ● Do not identify parking areas; identify parking spaces by number. ● Urge key personnel and VIPs to keep a low profile. 	<ul style="list-style-type: none"> ● Brief personnel on their environment and report any suspected surveillance by strangers. ● Use duress codes to alert others of possible threat. ● Limit access to data on itineraries and travel arrangements to as few people as possible.
CONTROL FORCE	<ul style="list-style-type: none"> ● Use at least squad-size patrols when extensive looting or group violence is occurring. ● Prohibit off-duty control force members from the disturbance area. 	<ul style="list-style-type: none"> ● Brief personnel on procedures to follow when ambushed.
BUILDINGS	<ul style="list-style-type: none"> ● Prevent direct access by public to EOC, CPs, and staging and billeting areas. ● Equip visitor entrances with duress alarms. ● Escort visitors; control access to sensitive and command areas. ● Control entrances to sensitive areas; patrol locked entrances periodically. 	<ul style="list-style-type: none"> ● Select an interior safe room for sensitive facilities in case they are attacked. ● Store supplies for extended operations and emergencies, including first aid equipment, bomb blankets, food, candles, and lanterns.

EXERT CONTROL

The measures used to exert control in a disturbance affects the crowd's behavior. Each crowd is unique. The makeup of a crowd can vary during the disturbance. Control force measures must be geared to each crowd's size, temperament, cooperativeness, and degree of organization and uniformity. Measures should change as the crowd's characteristics change. Even a change of one characteristic can drastically alter a crowd's response to control force measures. Large crowds may be easy to control if they are organized, cooperative, and nonviolent. Nonviolent crowds are often easy to control with a very limited show of force. Small crowds can be hard to control if they are organized, uncooperative, and violent.

To control a cooperative crowd, a control force may only have to direct traffic, provide information, and control isolated criminal acts like theft and vandalism. A cooperative crowd may even have its own security force, which can provide liaison and assist the control force. But uncooperative crowds do not have to be violent to evade control. They can passively resist attempts to disperse them. They can form human blockades, occupy buildings, or chain themselves to objects to force arrests and bodily removal.

Crowd size has a direct impact on the selection and use of crowd control measures. Small crowds can be very mobile. They are easily dispersed, but they can quickly re-form elsewhere. Because of this, crowd control formations are seldom effective against small crowds. Large crowds are less mobile. Because they are easier to contact, most crowd control formations are effective against them.

A control force can disperse a disorganized crowd more easily than an organized crowd. A disorganized crowd lacks the leadership that gives a crowd direction. If violence has not broken out, a proclamation and an organized show of

force may be enough to disperse a disorganized crowd. But organized crowds have leaders to give the crowd direction. Leaders can plan actions to frustrate or counteract control force plans and tactics. They may use small groups, operating independently of the main crowd, to divert or fragment the control force.

A generally uniform crowd having a common cause and belief in their actions may respond to control attempts in a predictable manner. The response of a varied crowd is harder to predict. A varied crowd often has conflicts between factions within the crowd. These conflicts can lead to heated arguments and, eventually, to violence. A control force is open to charges of favoritism if it appears that they do not treat all factions evenhandedly. The control force must balance its responses to the actions of the various factions. They must be careful not to show favoritism toward any one faction.

The military control force uses carefully selected tactics and wisely committed resources to exert control over disobedient crowds. The task force commander chooses the control measures most useful for controlling a particular crowd. The variables that influence his choice include:

- Intensity level of the disturbance.
- Public opinion.
- Current policies.
- Crowd mood, intent, composition, and activity.
- Capabilities and readiness of control forces.
- Immediate and long-range benefits of control force action.
- Weather, terrain, and time of day.

In general, the commander has four options available to him. He can monitor, disperse, contain, or block the crowd. These crowd control options are often used in combination. He chooses his options based on his evaluation of the particular crowd.

He selects any combination of control techniques and force options he thinks will influence the particular situation. He must always try to choose the response that can be expected to reduce the intensity of the situation. (Control techniques and force options not fully discussed below are detailed in separate chapters later in the manual.)

MONITORING

The commander may task control force teams to monitor crowd activity and note developments. The monitoring done by these observation teams enables the commander to gauge the crowd's activity and intent in relation to the overall disturbance. It also may allow him to influence the crowd by persuasion. Monitoring is employed throughout crowd control operations. Monitoring is appropriate when more decisive action is not feasible due to crowd size or when the intensity of a situation might escalate. It is particularly useful in large, nonviolent demonstrations. Monitoring can serve as an interim measure until more control forces arrive. Monitoring includes establishing communications with crowd leaders to convey official interest and intent to the crowd. It also includes efforts to gain the cooperation of crowd leaders.

Observation teams monitor a crowd's activities to gather information. They observe and report on crowd size, location, mood, and on the developing situation. An observation team may consist of a marksman, a radio operator, and an observer equipped with binoculars. They may be posted on strategic rooftops and other high terrain that overlooks the crowd. Sometimes observers use helicopter-mounted observation devices. This also affords security for the control force. The control force must know where observation teams are located so they do not mistake the teams for snipers.

Communications with crowd leaders and participants can help a commander to

control a situation without need for more severe measures. If communications exist with crowd leaders, the authorities may be able to divert either the leaders or the crowd from their stated or apparent goal. Pressure can be put on the leaders to channel the crowd into an area that minimizes disruption to the community and aids control force operations. March routes and demonstration areas can be limited to those that will help contain the crowd and reduce their potential for disrupting the community. Pressure can be positive, like offering concessions, or negative, through the use of deterrents.

If the control force can gain the cooperation of crowd leaders, it can decrease the crowd's potential for disorder. If crowd leaders seek cooperation from authorities, officials should try to be accommodating. Crowd leaders can be placed in liaison positions between the crowd and the control force. Leaders can be made responsible for managing the crowd by policing their own activities.

When planned demonstrations, marches, or rallies within a disturbance area are announced, the task force commander and local authorities meet with the organizers. Authorities convey the control force's interests and learn the organizer's plans. Crowd leaders can be encouraged to help plan ways for the protectors to peacefully demonstrate. Joint guidelines can lessen a demonstration's impact on the community. The following matters, if they apply, are discussed:

- Parade or demonstration permits.
- Locations of the demonstration and the march routes.
- Time limits for the activity.
- Provision of marshals by activity organizers.
- Prevention of violence.
- Safety of all involved.

The task force commander and local authorities can also inform the organizers how authorities plan to deal with violence, unlawful actions, and violations of limits imposed on the activity. But they do not express their plans as an ultimatum. If they do, the organizers may hold the demonstration in defiance of authority. Instead, they solicit the cooperation of all concerned so the demonstration, rally, or parade can occur without incident.

Taking pictures of the faces of crowd members can prevent or reduce unlawful and violent acts. Knowing they can be recognized lessens crowd members' sense of anonymity. And, if needed, photographs or videotapes can be used as evidence for prosecutions. To be effective, crowd members must see their presence being recorded. The photographer or cameraman should be in uniform to let the crowd know he or she is a member of the control force. The photographer must be close enough to the crowd to be easily seen, but not close enough to be endangered.

DISPERSING

The commander may task the control force to disperse the crowd. The intent of dispersal is to fragment a crowd. This option is most useful for small crowd situations in congested urban sites. But dispersal may increase and spread lawlessness rather than reduce it. Thus the control force must control the dispersal routes and the areas in which dispersal will occur. The force must protect the facilities that are likely targets for dispersing groups. And dispersal operations may need to be followed by apprehensions of small groups still active in the area. The use of proclamations, a show of force, crowd control formations (see Chapter 8), and riot control agents (see Chapter 9) can disperse crowds.

Issuing a proclamation can help disperse a crowd. A proclamation officially

establishes the illegal nature of a crowd's actions. A proclamation puts the populace on notice that the situation demands special measures. It prepares the people for the presence of military authority. It tends to inspire respect. It supports law-abiding elements. It psychologically bolsters military forces trying to restore order. It also demonstrates to all concerned the gravity of the situation. It is an excellent way to make a commander's intentions known to a crowd. And it is a good way to reduce a crowd's size before direct action is taken. The control force commander can make a verbal proclamation similar to the following: "In the name of the President of the United States, I command that you disperse and retire peaceably to your homes." Such a proclamation may even make direct action unnecessary.

In making a proclamation, a commander may consider imposing a time limit. But the situation may change, and the lack of a time limit would leave the commander free to choose other actions when he wants. A proclamation must be specific in its instruction. If a time limit is stated, it must allow a reasonable length of time for the crowd to comply with the instructions. When drafting a proclamation, the commander must consult closely with his SJA. He must use the simplest language possible to maximize the proclamation's effect. If proclamations must be translated to a local language, the translation must be made with great care. The commander at the scene may direct that a proclamation be issued over public address systems. The force of the words used in the proclamation must be gaged to the composition of the crowd. If the crowd consists of usually law-abiding citizens who are presently assembled to show disagreement with an existing situation, the proclamation requires less force. On the other hand, if the crowd consists of militant rioters, the proclamation requires more force. The text may take a number of forms, depending on the situation.

SAMPLE ANNOUNCEMENTS	
I. DISPERSAL	II. EMPLOYMENT OF TROOPS
<p style="text-align: center;">UNLAWFUL GATHERING</p> <p>“ATTENTION! ATTENTION! THIS AREA MUST BE CLEARED AT ONCE! NO FURTHER UNLAWFUL BEHAVIOR CAN BE TOLERATED. CLEAR THIS AREA AT ONCE OR THE NECESSARY FORCE TO DO SO WILL BE USED.” *</p> <p style="text-align: center;">DEMONSTRATION</p> <p>“DISPERSE AND RETIRE PEACEABLY! DISPERSE AND RETIRE PEACEABLY! ATTENTION ALL DEMONSTRATORS!</p> <p>THE DEMONSTRATION IN WHICH YOU ARE PARTICIPATING ENDS AT _____ THE PERMIT THAT WAS AGREED TO BY THE LEADERS OF THE DEMONSTRATION EXPIRES AT THAT TIME. ALL DEMONSTRATORS MUST DEPART FROM THE _____ BY _____ ALL PERSONS WHO WISH TO LEAVE VOLUNTARILY CAN BOARD POSITIONED BUSES. THESE BUSES WILL GO TO THE _____ THOSE WHO WISH TO TAKE THE BUSES SHOULD MOVE TO THE _____ THOSE DEMONSTRATORS WHO DO NOT LEAVE VOLUNTARILY BY _____ WILL BE ARRESTED AND TAKEN TO A FEDERAL DETENTION CENTER. ALL DEMONSTRATORS ARE URGED TO ABIDE BY THE PERMIT.” *</p> <p style="text-align: center;">WARNING OF LOOTING</p> <p>“RETURN TO YOUR HOMES! SOMEONE MAY BE LOOTING THEM AT THIS MOMENT! DURING A DISTURBANCE, CRIMINAL ACTIVITY IS AT ITS PEAK. YOUR FAMILY OR YOUR PROPERTY MAY BE IN DANGER!” *</p>	<p style="text-align: center;">EMPLOYMENT</p> <p>“ATTENTION! ATTENTION! TROOPS ARE PRESENT IN THIS AREA. THEY ARE PREPARING TO ADVANCE. ORDER MUST AND WILL BE MAINTAINED. DISPERSE PEACEABLY AND LEAVE THIS AREA. TO AVOID POSSIBLE INJURY, LEAVE AT ONCE.</p> <p>DISPERSE NOW AND AVOID POSSIBLE INJURY! DISPERSE NOW AND AVOID POSSIBLE INJURY!” *</p> <p>(Repeat until troops are committed.)</p> <p style="text-align: center;">WHEN TROOPS ARE COMMITTED</p> <p>“TROOPS ARE ADVANCING NOW. THEY WILL NOT STOP UNTIL THE CROWD IS DISPERSED AND ORDER IS RESTORED. TO AVOID INJURIES, LEAVE THE AREA AT ONCE. RETURN TO YOUR HOMES AS PEACEFUL CITIZENS. TROOPS HAVE THEIR ORDERS, AND THEY WILL NOT STOP UNTIL THE CROWD IS DISPERSED. DO NOT GET HURT. LEAVE THIS AREA.” *</p>
	<p style="text-align: center;">III. PRESENCE OF CHILDREN</p> <p style="text-align: center;">(Used in conjunction with other announcements)</p> <p>“ATTENTION! ATTENTION! DO NOT ATTEMPT TO CAUSE FURTHER DISORDER. DISPERSE NOW IN AN ORDERLY MANNER AND AVOID POSSIBLE INJURY TO CHILDREN. RETURN AT ONCE TO YOUR OWN AREA.” *</p>
<p>* INDICATE THE METHOD, THE STREETS, AND THE DIRECTION THAT THE CROWD SHOULD USE WHEN DISPERSING.</p>	

Marching troops in a show of force is often a useful measure for dispersing a crowd. Troops arriving by truck dismount and assemble out of sight of the crowd. This point is as close as possible to save time and conserve troop energy, but far enough away to ensure security. When

troops arrive by helicopter, the psychological impact of the helicopters can be used. Troops dismount from the helicopters in sight of the crowd, but far enough away to prevent damage to the aircraft by thrown objects. (The first echelon to dismount from the aircraft secures the

landing area.) When small groups are scattered throughout a large disturbance area, a show of force can be made by marching troops, by motor marches through an area, by saturation patrolling, and by setting up static posts. Sometimes marching a well-equipped, highly-disciplined control force into view of a crowd may be all that is needed to convince them to disperse and retire peacefully. However, a show of force may attract people to an event. And it may provoke a nonviolent crowd into a violent confrontation.

CONTAINING

The commander may task the control force to contain the crowd. Containment limits a crowd to the area they are presently occupying. It prevents the disorder from spreading. Containment is a suitable option for a campus disorder. It keeps demonstrators from spreading out to surrounding communities. It keeps outsiders from entering the campus. Containment also is useful when crowd members must be apprehended. Crowds can be contained by crowd control formations, perimeter patrols, and barriers.

Armored vehicles are adaptable to roadblock operations, serving as barriers. They also can provide added protection for the troops. They provide an easily accessible barrier for troops to crouch behind and protection for those troops inside. Military vehicles traveling at close intervals in a column formation next to a crowd is a largely psychological barrier. They can be used to contain a large, fast-moving crowd. The moving cordon creates

a temporary obstacle between a crowd and a line beyond which they will not be allowed to cross. A well-trained mobile cordon can effectively do the job of as many as 10 times the number of dismounted soldiers. But troops must train intensely to be able to execute safe, quick reversals of direction for mobile cordons on narrow roads. By-the-numbers commands issued over vehicle radios is a good method for coordinating cordon movements. The cordon's speed is usually about 5 miles per hour with an interval of at least 20 feet. Troops must be silent and alert. Blue and red lights, sirens, blinkers, and horns may or may not be used. Armored vehicles also can serve as mobile CPs. They provide security, communications, and mobility.

Vehicles equipped with a public address system are useful. The address system can be used to issue commands and directives during control operations. And the vehicle itself may be used as a command post or a rally point. It can also serve as a weapons carrier and a barricade for channeling crowd movement.

BLOCKING

The commander may task the control force to block a crowd. Blocking physically denies a crowd's advance. It may be used to protect a facility or area that is a potential or actual target. Crowd control formations, mainly the line formation, and barricades are used to block. Barricades of vehicles, concertina wire, and water-filled barrels are used to block or to channel the movement of the crowd.

ESTABLISH AREA CONTROL

Unimpeded government operations are essential. Public transportation, communications, and other public services and utilities also must continue operations during periods of unrest and tension. Disruption of such services works hardships

and increases unrest and the possibility of group violence. The control force must prevent acts of interference with public functions and help maintain those functions.

Control of a civil disturbance area usually does not require the imposition of martial rule. The role of the military is to support, not supplant, civil authority. Thus military forces never take over. They issue orders and regulations only to support and enforce civil law and to restore civil authority.

The concept of martial rule is unusual in that it is not written, neither in the form of law nor as a military regulation. Martial rule is based on public necessity. Public necessity in this sense means public safety. Martial rule usually is exercised at the direction of the President. But state authorities may take such action within their own jurisdictions. And local military commanders do have emergency authority if time factors would thwart effective action. For example, after the 1906 earthquake General Funston ordered buildings in San Francisco dynamited to halt the spread of fire. At the same time, he announced and enforced measures against looting.

Whether or not martial rule has been proclaimed, commanders must weigh each proposed action against the threat to public order and safety. If the need for martial rule arises, the military commander at the scene must so inform the Army Chief of Staff and await instructions. If martial rule is imposed, the civilian population must be informed of the restrictions and rules of conduct that the military can enforce. The information, whether announced by proclamation or order, is given the widest possible distribution by all media.

LOOTING AND ARSON

Control in the disturbance area must prevent looting and arson. Liquor, drugs, weapons, ammunition, and explosives must not fall into the hands of rioters. Liquor stores, drug stores, sporting goods stores, pawn shops, and hardware stores are highly sensitive targets in a disturbance area. Simply ordering that they be closed is not sufficient. Quick action must be taken

to prevent these businesses from being looted.

Looting may start at any time or any place. It may start as an isolated incident and quickly spread throughout an affected area. Looting often involves women, children, and the aged. Troops dealing with looters must exercise extreme caution, being careful to apply the principle of minimum force. Most children found looting have no idea of the seriousness of their actions.

Commanders must be familiar with the antilooting measures that can be taken by civil authorities. These measures include boarding up windows, covering windows with two sheets of plastic containing CS agents or luminescent particles between the sheets, and promptly posting looting penalty warnings. Antilooting measures that can be taken by the control force include:

- Foot and motor patrols.
- Fixed guard posts.
- Roadblocks and barricades.
- Illumination of likely looting targets.

Troops can be posted in likely businesses, and patrols can be increased in and around these businesses. Weapons can be temporarily confiscated and stored in a central, secure facility. Troops at fixed posts must be briefed not to leave their posts to pursue individual looters on foot. They must remain on post and prevent looters from approaching their areas of responsibility.

Troops must be briefed that deadly force will not be used to apprehend looters. *Deadly force is not authorized to control looting.* Even the looting of weapons and ammunition does not justify the use of deadly force. But the potential danger that such looting represents dictates that every available measure, short of deadly force, be employed immediately to prevent looting.

Acts of arson frequently accompany outbreaks of lawlessness. Lives and property must be protected from lawless firestarters. Once a fire breaks out, the firefighting task force must be able to respond rapidly. The control force is also responsible for providing security for the firefighters.

Fires may be started without apparent purpose. They may be planned to destroy public and commercial records. Or they may be reprisals for past grudges. Fires can be set by an ordinary person with little sophisticated knowledge. The equipment consists of easy-to-obtain common items, such as a candle, a jar lid, some rags, and lighter fluid. But their destructive potential is considerable. Because of the innocuous appearance of makeshift arson materials and the ease with which an arsonist can move through the chaos of a disturbance, detection and prevention are extremely difficult.

Arsonists can present a grave threat to life. The immediate saturation of a disturbance area by a control force may impede an arsonist's mobility and reduce his ability to strike. Lighting the disturbance area at night reduces an arsonist's chances to operate undetected. Portable lights can augment the existing lighting system for this purpose. The threat of arson must be reduced with a minimum of force. But when deadly force is the only way to prevent the arson and all of the conditions for using deadly force are met, deadly force may be used.

CIVIL LAWS, ORDINANCES, AND RESTRICTIONS

Civil laws and ordinances that can be helpful to control forces may already exist in the disturbance area. Some of these laws, because they limit civil liberty, are enforceable only during times of civil violence. The Civil Disorders Act of 1968 makes it a federal offense to obstruct, impede, or interfere with any fireman or law enforcement officer who is lawfully

performing his official duties. The act includes members of the National Guard and of a federal control force in its definition of law enforcement officers. Close coordination with local governmental bodies can help the commander make use of civil laws, ordinances, and restrictions. And the advice of the SJA will ensure that no improper actions are taken by a control force in regard to civil law. News media provide a means by which laws, ordinances, and similar restrictions can be publicized and explained to the populace.

Except in the unlikely event of martial rule, federal forces cannot impose restrictions on a civilian population. But restrictions may be imposed by civilian authorities to aid the control of lawlessness. Military leaders can recommend which restrictions have the most value in comparison to the amount of effort needed to enforce them. The most commonly recommended restrictions are curfews and sales restrictions.

Imposing a curfew is a highly effective control measure in many civil disturbances. It restricts the movement of people on streets and in public places, especially at night. Before curfews are imposed, joint civilian-military planning must address:

- Coordination of the initiation, enforcement, and termination of a curfew.
- Public proclamations to initiate and terminate curfews.
- Curfew exemptions and guidance on who should receive the exemptions, including written authorizations and passes.
- Provisions for the apprehension and disposition of curfew violators.

Local civil authorities set up a curfew and pass system based on local laws and ordinances. Control forces help enforce the system. Some persons must be granted passes so essential businesses and public

utilities can operate during the curfew period. Sometimes all travel must be restricted. As tensions ease, limited travel can be allowed if permission is granted by civil authorities.

Restrictions on the sale, transfer, and possession of certain materials can help reduce the chance and likelihood of violence. Access to alcohol, drugs, gasoline, firearms, ammunition, and explosives needs to be controlled to prevent violence. Civil authorities can also prohibit the carrying of firearms, ammunition, and explosives. This can apply to automatic weapons, grenades, shotguns and sporting rifles, pistols, revolvers, firing devices, and some chemical agents. This prohibition would allow seizure of privately-owned weapons being carried in vehicles or in the open in public.

Receipts must be provided for all confiscated items to maintain accountability. Receipts ensure that any items that can be returned will get to the right people. Civil law enforcement agents may have authority to confiscate not only weapons but items that could be used as weapons. If so, vehicles and people entering or leaving a disturbance area can be inspected, and objects like clubs, bottles, and chains can be confiscated.

Other restrictions that may be imposed include restrictions on:

- Assembly.
- Interference with public functions.
- Communications.

During a civil disturbance, it may be advisable to prevent people from assembling. Civil law can make it unlawful for people to meet to plan an act of violence, rioting, or civil disturbance. Prohibitions on assembly may forbid gatherings at any place and time. Or gatherings may be restricted to certain places at certain times. Civil law may also specify the number of people that may lawfully gather in an area at one time. Inciting or participating

in rioting and public disorder may be made unlawful. Making hostile or inflammatory speeches advocating the overthrow of the lawful government and threats against public officials, if it endangered public safety, could violate such law. Such laws, if imposed at an early stage, reduce the danger of disorder and riot by large groups of people.

As tensions ease, assemblies can be allowed if permission has been granted by the proper civil authority. A group can apply for a permit to meet at a certain place and time for a specific reason. Use of permits lets civil authorities prepare for and be alert to potential trouble areas. Permits are appropriate for large events like parades, rallies, athletic events, political and labor meetings, and similar gatherings.

Laws and ordinances may already be in place to reduce communications interference with official messages to the public. These laws also place an effective limit on the ability of agitators and mob leaders to reach a large number of people. It helps if all communications equipment able to transmit or interfere with official messages are required to be registered. Sound trucks and electronic megaphones would also come under these restrictions.

CONTROL FORCE PATROLS

Alert, aggressive patrolling of the disturbance area deters the gathering of crowds. The use of saturation patrolling is most effective for this purpose. It allows information to be collected. And it creates the psychological impression of the control force being everywhere at once.

Standard military transport vehicles provide mobility and communications for area coverage. Troops must be deployed with enough vehicles to provide the flexibility to handle all situations in the disturbance area. The vehicles can be modified with sandbags, armor plate, wire

screen, or similar materials to protect against sniper fire and thrown objects.

Armored vehicles patrolling an area of violence provide an added psychological effect. And they allow troops to maneuver close to snipers to make an apprehension. They also may be used as rescue vehicles to extract hostages or people surrounded by a hostile crowd.

Varying patrol routes and times for mounted and dismounted patrols keeps lawbreakers from being able to pick a safe place or time to act. Patrols are particularly useful in preventing overt arson and violence. Patrol members can also spot and promptly report fires. Whenever possible, military patrols are integrated with civil police patrols. Joint patrols conserve military forces and aid civilian-military communications. They also help troops become familiar with an area quickly. And the civil police are available to make apprehensions if they are needed. Patrol members must practice proper standards of conduct and fair treatment of civilians at all times. They are performing an important community relations function as well as a control function.

Several types of patrols can be employed effectively for area control. Foot patrols are most effectively used in small areas or in areas where many people are moving about. Foot patrols must be able to control the disorderly. They must also be able to

protect themselves. The size of the patrols may vary with the degree of violence and the extent of activity in the patrol area. But most often foot patrols are squad-size. A squad has enough patrol members to keep the use of force minimal. It also keeps the patrol from being easily isolated or placed in jeopardy.

Land or water motor patrols, because of their speed and mobility, provide timely reconnaissance and broad area coverage. Motor patrols are in radio contact with task force headquarters. They can make periodic contacts with foot patrols and stationary posts that lack communications. And motor patrols can respond quickly to calls for help from other patrols and from guard posts. Land patrols should have at least two vehicles with four men in each. The patrol must have strength in numbers. And it must not be easily isolated or placed in jeopardy. All motor patrols are equipped with fire extinguishers to put out small fires, thus reducing the burden on the fire department.

Air patrols are helpful in directing the overall control effort in the disturbance area. They can perform reconnaissance and surveillance over the disturbance area. They are an excellent means of providing timely information. They can monitor rioters' actions, the extent of damage, the status of access routes, the locations and conditions of road barriers, and other important conditions.

NEUTRALIZE SPECIAL THREATS

Control forces can be exposed to special threats that pose grave danger to both the control force and the general community. These threats include, hostage/barricade situations, sniping, bomb threats, and fires. Quick, organized action by the control force can reduce or possibly prevent the tragedy that these events can cause.

SNIPER FIRE

Troops who take part in civil disturbance operations may be fired upon by snipers. And when crowd control formations are being used, the threat of sniper fire increases. Troops must be prepared to react immediately. Measures to counteract sniper

fire must be executed with speed and precision.

The troops must be aware, however, that persons in the crowd may try to disrupt a formation with loud noises, such as fireworks or bursting paper bags. The troops must be alert to such tactics. Automobile backfires, firecrackers, light flashes, accidental weapon discharges, indiscriminate firing by control forces, or distant sounds of firing can all be misconstrued as sniper fire.

The normal reaction of a well-trained combat soldier is to respond to sniper fire with an overwhelming mass of firepower. In a civil disturbance, this tactic endangers innocent people more than snipers. The preferred tactic is to use an SRT to enter the building from which the sniper fire originates. Troops must not return a sniper's fire unless the prerequisites for using deadly force exist and they have a positively identified target. The control force leader must not permit a mass return of fire that may endanger innocent people. If firing is necessary, it must be done by a selected marksman acting on orders from the senior military person present. And the marksman must consider the possibility of ricochets before engaging a target.

When troops encounter possible sniper fire they:

1. Take cover immediately.
2. Notify bystanders to clear the area or seek cover.
3. Verify that it is sniper fire that has, in fact, been encountered.
4. Report verified sniper fire and request assistance.
5. Locate the sniper's position.

When sniper fire is verified, the troops inform the appropriate people of the situation so help can be sent to the scene.

Usually this will be an SRT and a negotiation team. The troops should try to fix the exact position of the suspected sniper so they can inform the SRT leader.

Measures must be taken to secure the area. If the control force unit on the scene is large enough, they can secure the area. In most situations, however, it will be necessary to commit reserves or other control force elements. Regardless of what units are used, they must take steps to isolate, evacuate, observe, and support.

A security unit sets up an inner and an outer perimeter to isolate the area and to block the sniper's escape routes. The perimeters are set up far enough from the danger area to prevent exposure to sniper fire. The unit notifies all other control force units that are not involved in neutralizing the sniper to stay clear of the area.

If the sniper is encountered in a lightly populated area or building, the unit advises residents to leave using a specific route or exit. As the residents exit, the security unit screens and identifies them to make sure that the sniper is not among them. Witnesses and people suspected of being involved with the sniper are detained. Some residents may be unwilling, unable, or afraid to leave. The unit then makes a second announcement advising the remaining residents to seek cover, stay where they are, and stay away from exposed areas and windows.

Control force units set up observation posts on rooftops and in windows of nearby buildings. The observers must have communications equipment. Control force units must be ready to support the SRT. That support may include:

- Setting up a staging area for the SRT and for emergency and support equipment.
- Setting up a field CP.
- Controlling crowds.

When the SRT takes action, team members will:

- Surround the building in which the sniper is concealed and gain access. They may use armored vehicles if necessary and if they are available.
- Illuminate the area during darkness. Darkening a street to gain protection from sniper fire is counterproductive. They may use night observation devices if they are available.
- Employ riot control agents initially, if feasible, rather than small arms fire. If the agents are not successful, then the team may use well-aimed fire by a specifically designated expert marksman. The number of rounds fired is kept to a minimum to reduce the hazard to innocent people.

HOSTAGE/BARRICADE SITUATIONS

In a hostage situation, the control force's main concerns are to contain the event and to remove bystanders from the area to reduce the chances of more hostages being taken. The control force contains the hostage site by setting up two perimeters. The inner perimeter of troops must be located so they can restrict the hostage taker's mobility without endangering the hostages. The outer perimeter of troops must be located where they can prevent innocent bystanders from getting injured or killed or from interfering with the activities at the hostage site. It also helps prevent observation by bystanders. The presence of onlookers may only inflame the situation.

As security is being established and innocent people are being evacuated from the area, the commander requests the negotiation team and alerts the SRT. The SRT may prepare for an assault, but they must be very careful not to interfere with the negotiation effort. For the SRT to

be ready when needed, they may have to stand by as part or all of the inner perimeter. If the hostage taker tries to communicate demands to the control force before the negotiators arrive, the demands are recorded and communications are maintained, but no commitments are made. They tell the hostage taker that a negotiator will be there shortly. Any demands made and any additional information about the event are provided to the hostage-site CP. The demands and information must be provided to the negotiation team and the responding SRT.

The negotiation team must have information to support negotiations. They get their information from interviews with initial response personnel, witnesses, escaped and released hostages, and captured suspects. It is critical that the team quickly learns the identities, personalities, motives, habits, and abilities of the offenders. This information helps the negotiator relate to the offenders persuasively and on a personal level. The negotiator must know to whom he is talking. The intelligence must be organized to answer the following questions:

- Do the offenders have criminal records? If so, a wealth of personal information may be derived from their records.
- Do the offenders possess special skills and knowledge? Could they possibly be trained in explosives and sniper tactics? This information must be considered before deciding to make a straight-on assault.
- Do the offenders have any special affiliation? Are they members of any group or religious sect that may dictate or influence their behavior?
- What habits or addictions do they have that could predictably influence their behavior?

- What immediate needs do they have, such as transportation, medical care, food, water, or other basic concerns, that could be negotiable?
- If they are recognized terrorists, what are their previous methods of operation? Do they shoot hostages?

The physical descriptions of the offenders and other people inside the barricade are important. They must be distributed immediately to all persons involved in the operation. Any photographs help to identify offenders quickly if they come out pretending to be hostages. Hostage takers have forced hostages to trade clothes with them in an effort to fool control force personnel. And hostage takers have been known to give hostages empty rifles and force them to a window to see if control force personnel will fire.

Intelligence about the hostages is equally important. First, it helps ensure hostage safety. Second, it helps evaluate what might happen inside a barricade before a seige is ended. As well as knowing the number of hostages, their identities, and their descriptions, every effort must be made to learn the following information:

- Sexes and ages.
- Relationships with each other.
- Special training or skills.
- Special food and medical needs.
- Degree to which they are being threatened.
- Susceptibility to hysteria or other adverse reactions to extreme excitement or stress.

These factors can help determine the order in which a negotiator may try to have hostages released. If possible, all information about hostages should come from outside the barricade.

The control force commander must maintain strict control of firepower at all

times. All the efforts and progress of a negotiation team can be destroyed with one accidental or unauthorized shot. The goal is for the negotiation team to resolve the situation without resorting to violence. The decision to commit the SRT must not be based on trying to obtain a quick resolution to the problem. Negotiations must be given time to succeed. If negotiations fail, the SRT is employed as a last resort.

FIRES

Fire, and its potential for destruction, requires detailed plans to provide immediate and effective responses to limit its effects. The actions of the firefighting task force must be closely coordinated with those of the control force. Local authorities are responsible for the task force. The firefighting task force consists of firefighting and lifesaving equipment and operational and security personnel. Additional equipment and people may be requested through mutual aid if additional resources are needed. The firefighting task force must be able to move rapidly with enough equipment to quickly put out or contain large fires and then move on. More than one firefighting task force may be needed. Each firefighting task force has its own area of operation. When large-scale fires occur in a limited area, several task forces operate together.

The firefighting task force is totally committed to containing fires. It depends on other agencies for its security. Firefighters and their equipment are extremely vulnerable to harassment and attacks. Security for firefighters usually is provided by military units. The military leaders work closely with the senior fireman or with a designated liaison to ensure that adequate and timely assistance is provided. The size of the security force varies with the size of the firefighting task force. It also varies with the level of hostility in the area and the number of people and equipment that can be allocated to the security mission.

Mobility is a must. Control force elements tasked with security must have enough vehicles and communications equipment to move rapidly. Vehicles must be equipped with flashing emergency lights to enable them to move safely through traffic and intersections. Military police vehicles, if they are available, can escort the security force.

The following actions are taken at the fire scene:

- A protective cordon is set up around the firefighters' area of operation. The cordon includes security of hoses and hydrants. The cordon concentrates on activities outside the cordon. Small units are assigned areas of responsibility like they would be for any defensive posture.
- Observation posts are positioned in and on nearby tall buildings to prevent sniping or other attacks.
- Hostile crowds are controlled with crowd control techniques. If necessary, reinforcements are called up.
- Traffic trying to enter the area is blocked and diverted.

BOMB THREATS

Bomb threats often occur during civil disturbances. Frequently, warnings are given to avoid the loss of innocent lives when a bomb has been planted. However, after an explosion, cranks or disturbed persons occasionally may make threats or give false notice to interrupt activities or business by forcing evacuations. If a fake threat successfully causes an evacuation, then more threats usually follow. But any doubts concerning safety must always be resolved in favor of evacuation.

Most bomb threats are received by telephone operators of businesses and schools. Bomb threats also may be received at rumor control centers, police headquarters,

and joint operational facilities during civil disturbances. If possible, each facility should have a telephone tracing capability.

Switchboard operators and others likely to receive bomb threats can be provided with a checklist so they will know to—

- Activate the telephone tracer system if one is available.
- Learn and record the bomb's location; the time of detonation; the type of device, including physical description; the sex, approximate age, and attitude of the caller speech peculiarities or accent; distinguishing sounds or background noises coming from the caller's location; and the reason for placing the bomb.
- Inform the appropriate people of the threat.

The checklist needs to be placed near as many telephones as possible.



When a bomb threat is received, the responsible commander notifies appropriate control force elements, fire and medical services, utilities, and EOD units. He has them report to a staging area near the threatened facility. He orders roadblocks or checkpoints set up as needed to keep unauthorized people out of the area. Perimeters to isolate the area must be far enough away to prevent danger from an explosion.

If the occupants must evacuate the building, the evacuation must be orderly. This is best accomplished by using a bomb evacuation plan, a fire plan, or announcements and directions to building occupants. The plan must designate withdrawal to a building or an area that offers shelter from the elements. Care must be taken not to create panic. Occupants should be told to check their immediate

SAMPLE TELEPHONE CHECKLIST (FRONT)

6-136 (Rev. 8-27-77)



FBI BOMB DATA CENTER

PLACE THIS CARD UNDER YOUR TELEPHONE

QUESTIONS TO ASK:

1. When is bomb going to explode?
2. Where is it right now?
3. What does it look like?
4. What kind of bomb is it?
5. What will cause it to explode?
6. Did you place the bomb?
7. Why?
8. What is your address?
9. What is your name?

EXACT WORDING OF THE THREAT:

Sex of caller: _____ Race: _____
 Age: _____ Length of call: _____
 Number at which call is received: _____
 Time: _____ Date: ___/___/___ FBI/DOJ

BOMB THREAT

SAMPLE TELEPHONE CHECKLIST (BACK)

CALLER'S VOICE:	
<input type="checkbox"/> Calm	<input type="checkbox"/> Nasal
<input type="checkbox"/> Angry	<input type="checkbox"/> Stutter
<input type="checkbox"/> Excited	<input type="checkbox"/> Lisp
<input type="checkbox"/> Slow	<input type="checkbox"/> Raspy
<input type="checkbox"/> Rapid	<input type="checkbox"/> Deep
<input type="checkbox"/> Soft	<input type="checkbox"/> Ragged
<input type="checkbox"/> Loud	<input type="checkbox"/> Clearing throat
<input type="checkbox"/> Laughter	<input type="checkbox"/> Deep breathing
<input type="checkbox"/> Crying	<input type="checkbox"/> Cracking voice
<input type="checkbox"/> Normal	<input type="checkbox"/> Disguised
<input type="checkbox"/> Distinct	<input type="checkbox"/> Accent
<input type="checkbox"/> Slurred	<input type="checkbox"/> Familiar
<input type="checkbox"/> _____ Whispered	
If voice is familiar, who did it sound like? _____ _____	
BACKGROUND SOUNDS:	
<input type="checkbox"/> Street noises	<input type="checkbox"/> Factory machinery
<input type="checkbox"/> Crockery	<input type="checkbox"/> Animal noises
<input type="checkbox"/> Voices	<input type="checkbox"/> Clear
<input type="checkbox"/> PA System	<input type="checkbox"/> Static
<input type="checkbox"/> Music	<input type="checkbox"/> Local
<input type="checkbox"/> House noises	<input type="checkbox"/> Long distance
<input type="checkbox"/> Motor	<input type="checkbox"/> Booth
<input type="checkbox"/> Office machinery	<input type="checkbox"/> Other _____

THREAT LANGUAGE:	
<input type="checkbox"/> Well spoken (educated)	<input type="checkbox"/> Incoherent
<input type="checkbox"/> Foul	<input type="checkbox"/> Taped
<input type="checkbox"/> Irrational	<input type="checkbox"/> Message read by threat maker
REMARKS: _____ _____ _____ _____	
Report call immediately to: _____ _____	
Phone number _____	
Date ___/___/___	
Name _____	
Position _____	
Phone number _____	

surroundings for any unusual or out-of-place objects or packages before evacuating the building. Employees should take their briefcases, overcoats, and like items with them when they evacuate.

Selected employees or residents of the building and control force members are organized into search teams. The teams must be equipped with communications. Teams must be warned that the *use of radios* during a bomb search *can be dangerous*. Radio transmissions can cause premature detonation of a blasting cap.

The search teams also must be warned *not to touch* any suspicious items. Bombs may have antitampering devices that set them off when someone tries to move or open them. Searchers also must be warned that bombs can be disguised in many ways. Bombs can be hidden in fire extinguishers, shoe boxes, briefcases, lunch pails, and parcels. Because of this, building occupants who are on the team should look primarily for something that does not belong in the building or is out of place. Control force members on the team are there to ensure that the search is systematic and thorough. They are not there to conduct the search. Control force members record suspicious items and their

locations and report their findings to the on-site commander.

The teams first search public access areas. These areas include:

- Building utilities.
- Hallways.
- Administrative areas.
- Dining areas.
- Grounds outside the building.
- Shipping and loading areas.
- Vehicles parked near the building.
- Supply rooms.
- Stairwells.
- All accessible closets and storage areas.

They report suspicious objects or packages found during the search. These objects or packages must not be handled. Even when a bomb is located, the search must continue because there may be more than one bomb. Bomb dogs can be used to aid in the search if they are available.

When the bomb itself or a suspicious object or package is found, EOD or a police bomb squad is summoned to neutralize the bomb or suspect packages. (For further guidance on bomb threats see FM 19-30.)

Force Options

The task force commander's mission is to help restore law and order. In carrying out this mission, the task force commander ensures that only minimum force is used. In selecting an operational approach to a civil disturbance situation, the commander and his staff must adhere scrupulously to the "minimum necessary force" principle. For example, crowd control formations or riot control agents must not be used if saturation of an area with troops will suffice. The presence of large numbers of troops can prevent the development of situations in which the use of deadly force is necessary. A large reserve of troops should be maintained during civil disturbance operations. Knowing that a large reserve force is available builds morale within the control force and helps prevent them from overreacting to provocative acts by disorderly persons. Any doubts about the number of troops required usually should be resolved in favor of large numbers.

Every effort is made to avoid appearing as an invading force. The commander has many troops at his disposal. But he commits them only when and in the numbers necessary. When he does commit troops, he ensures that they function in a highly organized and disciplined manner. The control force must present the image of a restrained and well-disciplined force whose sole purpose is to assist in restoring law and order with a minimum loss of life and property and with due respect for those citizens whose involvement may be purely accidental. While control force personnel must be visible, their tactics or force concentrations should be those that will calm rather than those that may excite.

All troops, before taking part in civil disturbance operations, must be briefed on—

- The background of the situation and the specific mission of the unit.

- Rules governing the application of force as they apply to the specific situation.
- The psychological aspects of the local situation, specifically addressing types of abuse that the troops can expect to receive and the proper responses to that abuse.
- Identification to be used by news media representatives and civil officials, if known.
- The special orders contained on GTA 21-2-7.

When the troops arrive at the disturbance area, they must know and understand operational restrictions and the permissible degrees of force. They must have a written copy of the special orders. All troops must understand and comply with the special orders.

The intent of the special orders is to achieve a balance in the use of force and thereby avoid indiscriminate firing in civil disturbance situations while protecting the soldier's right of self-defense. These special orders can be supplemented by additional written orders for special posts, positions, or operations. Such orders must be as simple and brief as possible.

Each unit commander must ensure that his troops have all the personal protective equipment needed for civil disturbance operations. Civil disturbance equipment is not stockpiled or issued in quantity. It is requested or acquired when it is needed. Generally, each soldier's equipment consists of the battle dress uniform, a helmet, a faceshield, a flak or protective vest, a pistol belt, a first-aid kit, a canteen, a protective mask, leather gloves, and a body shield (2 1/2 feet x 4 1/2 feet). Protective vests are required when violence is expected. The vest protects the vital organs in the torso. On the other hand, protective vests are heavy and cumbersome. In very hot weather, they may increase the risk of heat injuries. There is a trade-off between protection and a loss of effectiveness, mobility, and visibility caused by the equipment.

The helmet and the faceshield protect the head and face. Protective masks are vital items when CS agents and/or smoke are present during a civil disturbance. The soldiers must know how to use the mask in

stressful situations. The masks, especially when worn with the hood, can increase the risk of heat casualties. They limit the amount of strenuous activity that soldiers can perform. Proper training is the best way to reduce the disadvantages of wearing the protective mask. The protective mask carrier is worn in the front to give added protection to the groin area.

The black leather gloves with inserts protect the hands. However, soldiers using equipment or weapons may not need the protection of the gloves. They may need flexibility more than protection.

Body shields provide protection that complements the protective vest. They may replace the flak vest altogether. Body shields are very effective protection against thrown objects. When pushing back a crowd, body shields deny demonstrators something to grab. When body shields are used in groups or formations, they provide a protective wall for rescue forces and have strong psychological effects on the crowd. The Army does not stock body shields. However, they may be purchased locally from police equipment manufacturers or distributors. Body shields also may be constructed locally using aluminum sheets. In any case, they must be sturdy and lightweight. They must cover the body's width from the chin to the knees. If the resources are available, viewing slits can be cut in the shields approximately 6 inches from the top.

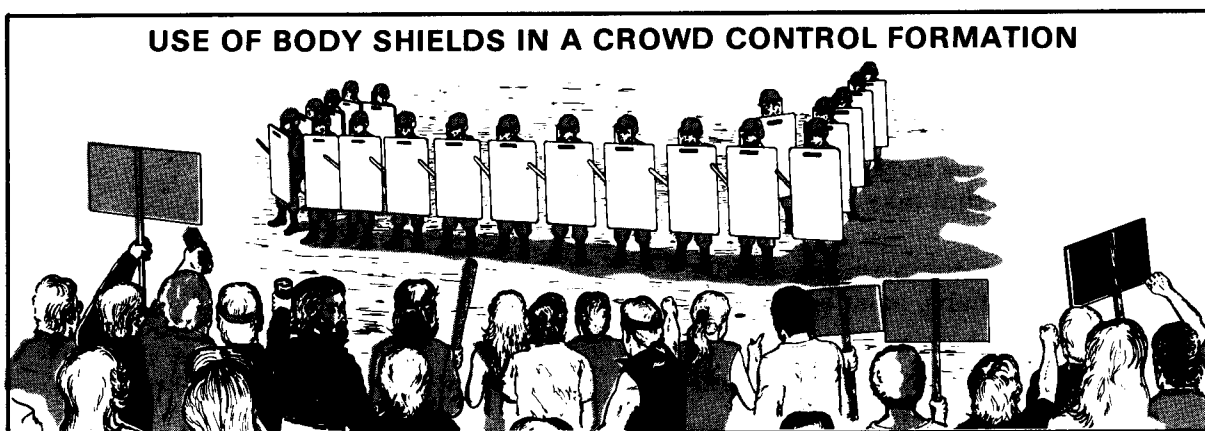

Hand irons are needed for apprehensions. The use of hand irons requires special training to avoid damaging the detainee's wrists and to ensure their efficient use. Hand irons require a key to double-lock and to open them. A good alternative to hand irons are flexcuffs. Flexcuffs require minimum training. One soldier can carry several without hindering his mobility. Flexcuffs require no equipment for applying them. But they require wire cutters to take them off and to clip off the tail end after application.

Riot control agents have many advantages over other measures. They have an immediate effect on large groups of people without causing permanent harm. Riot control agents, when properly used, disperse large crowds without troops having to come into contact with the crowds. The troops must understand the capabilities and limitations of riot control agents in order to use them in the safest and most efficient manner. Only the task force commander has the authority to order the use of riot control agents. Based on the situation, he may delegate this authority to qualified personnel.

People do not easily develop a tolerance to riot control agents. But experience and knowledge tend to reduce the fear that gives the control force an added psychological advantage. Riot control agents lose some of their advantages in crowd control as they are more widely used and understood.

Short of masking, there are no effective defensive measures against a well-planned and executed riot control agent deployment. Surplus masks and other types of masks are available to the public. Troops can expect masks to be used by highly motivated members of the crowd. Therefore, riot control agents are not a cure-all. They are a tool that must be used in conjunction with well-trained and well-equipped troops.

The commander may elect to arm his troops with riot batons, shotguns, or rifles.

But his choice will always be consistent with the principle of using only the minimum force needed to accomplish the mission.

The task force commander is authorized to issue live ammunition to troops under his command. But he must ensure positive control over the loading and the firing of weapons. Guidance concerning placing magazines in weapons must be specified when the ammunition is issued. Individual soldiers must be instructed, however, that they may not place a round in the chamber unless authorized by an officer or, if they are not under the direct control and supervision of an officer, unless circumstances justify the use of deadly force. Retention of control over the loading of weapons by an officer until the need for such action is clearly established is of critical importance in preventing the unjustified use of deadly force. Whenever possible, command and control arrangements must be specifically designed to facilitate careful control of deadly weapons. Planners must realize that if a participant in the disturbance seizes a loaded weapon from a control force member, the potential for escalated violence will increase greatly.

The presence of loaded weapons in tense situations may invite the use of deadly force in response to provocations that, while subject to censure, are not sufficient to justify its use. It also increases the hazard that an improper discharge of a weapon by one or more soldiers will lead others to fire reflexively on the mistaken assumption that an order to fire has been given. Officers must be clearly instructed that they have a personal obligation to withhold permission for loading until circumstances indicate that deadly force will very likely be necessary and justified. Strong command supervision ensures that the loading of weapons is not authorized in a routine, premature, or blanket manner.

Task force commanders must exercise positive control over the use of weapons at all times. Each soldier must be instructed

that he may not fire his weapon except when authorized by an officer or when he is not under the direct control and supervision of an officer and circumstances justify the use of deadly force. He must be thoroughly acquainted with not only the prerequisites for the use of deadly force, but also that whenever he is operating as a part of a unit or element under the immediate command and control of an officer, the officer decides whether the firing of live ammunition is necessary. For this reason, control force members should have ready access to an officer.

The use of deadly force can be justified only by extreme necessity. Accordingly, its use is not authorized for the purpose of preventing activities like curfew violations or looting that do not pose a significant risk of death or serious bodily harm. If a mission cannot be accomplished without the use of deadly force, but deadly force is not permitted under the guidelines authorizing its use, the mission must be delayed until sufficient nondeadly force can be brought to bear. The commander reports the situation and seeks instructions from higher authority. The use of deadly force is authorized only when all of the following conditions exist:

- Lesser means have been exhausted or are unavailable.
- The risk of death or serious bodily harm to innocent people is not significantly increased by its use.
- The purpose of its use is one or more of the following:
 - Self-defense to avoid death or serious bodily harm.
 - Prevention of a crime that involves a substantial risk of death or serious bodily harm, such as setting fire to an inhabited dwelling or sniping, including the defense of other people.

- Detention or prevention of the escape of a person who, during detention or while escaping, presents a clear threat of loss of life or serious bodily harm to another person.

Every soldier has the legal right to use reasonably necessary force to defend himself against violent and dangerous personal attack. The limitations described above are not meant to infringe on this right. However, it must be emphasized that a control force member is part of a unit and is subject to a chain of command. As such, he must act in accord with his orders and as a member of a unit. Therefore, unless an attack is directed at him personally and unless his response can be directed specifically at the attacker, his response must be governed by the guidance of his immediate supervisor.

In the United States and its territories, the acts of individual soldiers are subject to civil laws as well as the provisions of the UCMJ. Reckless or malicious use of force may subject soldiers to civil or criminal liability under local law or to administrative or criminal liability under military law. The US Code guarantees any member of the Armed Forces the right to trial before a federal court, rather than a state court, for any charge or claim against him for any act committed while performing his official duties. Acts found to be outside the scope of military authority can result in the loss of this right. In a criminal prosecution, civil courts ordinarily do not convict a subordinate for acts done in good faith while obeying orders from superiors. However, if an act is so obviously illegal that it would be immediately apparent to a reasonable person, obeying the order probably would not be a valid defense.

In each situation where federal forces are committed, the task force commander must determine which facilities within his area of operation constitute vital facilities and, as such, justify the use of deadly force in protecting them. Those troops assigned to

security missions must know if a particular facility or activity is so vital to the health and safety of the public that the use of deadly force would be justified to protect it.

The degree of force authorized for securing a facility must be consistent with the rules of force. The task force commander must ensure that a community's or an installation's vital facilities are designated as such. Vital facilities can be protected by the use of deadly force if the prerequisites for using deadly force exist.

In addition, the following policies regarding the use of deadly force must be observed:

- Task force commanders, at their discretion, may delegate the authority to authorize the use of deadly force if such delegation is consistent with the policies that follow and if the person to whom such delegation is made understands the constraints on the use of deadly force.
- Even when the use of deadly force is authorized pursuant to established constraints, it must be employed with great selectivity and precision against the particular threat that justifies its use. For example, receiving sniper fire—no matter how deadly—from an

unknown location can never justify returning fire against any or all persons who may be visible on the street or in nearby buildings. Such an indiscriminate response is far too likely to result in casualties among innocent bystanders or fellow law enforcement personnel. The appropriate response is to take cover and to try to locate the source of fire so the threat can be neutralized, either through negotiation or by force.

- When possible, the use of deadly force should be preceded by a clear warning to the person or group that the use of deadly force is contemplated or imminent.
- Warning shots must not be used. They constitute a hazard to innocent people and can lead citizens and fellow law enforcement personnel to mistakenly believe that sniping is widespread.
- When firing, the marksman should aim to wound rather than to kill if it is at all possible.

Task force commanders may use force to control a disturbance, to prevent crimes, and to apprehend or detain people who have committed crimes. But the degree of force used must be no greater than that reasonably necessary under the circumstances.

Crowd Control Formations

Crowd control formations, when properly employed and executed against a crowd of limited size, are one of the most practical methods of crowd control. In selecting force options, the riot baton generally is the main weapon of the control force. If the situation is serious, the commander may consider employing a mix of batons and rifles. For example, the first line of the formation is armed with batons and the second or supporting ranks are armed with rifles or rifles with fixed bayonets.

Crowd control formations may be employed to disperse, contain, or block a crowd. When employed to disperse a crowd, they are particularly effective in urban areas because they enable the control force to split a crowd into smaller segments. When a crowd has been dispersed, the control force must not assume that they have capitulated and returned to peaceful activities. Small groups can initiate dispersed riotous acts. Therefore, the use of formations is only a part of the total dispersal effort. If the crowd refuses to move, the control force may have to employ other techniques, such as riot control agents or apprehensions.

Commanders must realize the limitations of formations. Formations are not the answer to all civil disturbance situations. The commander must not subject his troops to unnecessary sniper fire and violence simply to impress the crowd with a show of force. When small, dispersed mobs are rampant in an area, formations are of little value. Even when a large mob has been split up, the problem is not necessarily solved. The small elements that break away from the large mob may engage in small-mob tactics, such as sniping, looting, and burning. Commanders then, of necessity, must revert to area control measures,

such as building searches, saturation patrolling, and other tactics.

Rooftops must be secured to help prevent sniper fire from these vantage points. Helicopter observation is one method of visually securing rooftops. Occupation of the rooftops is another. When troops are stationed in high buildings or on rooftops, all other troops must be informed of this to avoid the possibility of control force members being mistaken for snipers.

Crowd control formations also may be used for more than just dispersal operations. If the decision is made to apprehend crowd members, the crowd control formation may be used as a blocking formation. Apprehension teams then escort apprehended crowd members back through the formation. (See Chapter 12.) A crowd control formation also may be used to aid containment operations by using blocking, flanking, and confrontation elements of the formation.

Commanders analyze the threat, the control force's missions, and how crowd control formations can be used to aid mission accomplishment. Experience has shown that the formations, to be effective, must be tailored to meet the situation.

Whatever the modification, troops must be proficient in the basic formation movements to be able to react or adjust to a changing situation.

Civil disturbance training must ensure that the soldiers understand the need to

stay in formation. Troops are much more vulnerable to attack when individual soldiers break ranks and chase after crowd members. The individual soldiers place themselves in danger, and the entire formation may be threatened if it begins to break down.

TYPES OF FORMATIONS

Past civil disturbances indicate that the most frequently used formations are the line, the wedge, and the echelon. The line formation is used more often because of its offensive and defensive applications. As an offensive formation, the line is used to push or drive crowds straight back, across an open area, or up a city street. As a defensive formation, the line is used to hold the crowd or to deny access to restricted streets or areas. The echelon is an offensive formation used to turn or divert groups in either open or built-up areas and to move crowds away from buildings, fences, and walls. The wedge is an offensive formation that is used to penetrate and split crowds. The diamond, as an offensive formation, is used to enter a crowd and is suitable for apprehending ring leaders. As a defensive formation, the diamond is used when all-around security is required. The circular formation may be used for the same purposes as the diamond. The decision to use either the diamond or the circle is based on the conformation of the crowd.

When a control force encounters large riotous groups, it may be best to employ vehicles with troops on foot in crowd control formations. Although vehicles add strength to formations, certain precautions must be taken. Precautions include:

- Ensuring windshields of vehicles are upright, removed, or completely depressed. If the windshields are safety glass, they offer some protection in the upright position, minimizing the danger of injury from glass fragments.

- Building shields for mobile barriers by mounting a wooden or metal frame strung with barbed wire across the front of a vehicle.
- Having foot troops in formation walk as near the front corners of each vehicle as possible to keep rioters from attacking the sides and rear of the vehicles.

Armored vehicles are employed when practical. They have a strong psychological effect, and they offer protection for the occupants. Wheeled armored vehicles are best because they do not deface the pavement.

Vehicles are used only in conjunction with troops on foot. Whenever vehicles and foot troops are employed, the commander of the foot troops commands the unit. He joins the leader of the motor section in the command vehicle, where he has a vantage point. In every instance, his commands are executed through the subordinate leaders.

Many suitable variations of the crowd control formations can be employed. But appropriate commands and signals must be devised to execute the formations. Because of their somewhat complicated nature and the coordination required for these formations, new variations must be practiced extensively before they are used in an actual civil disturbance.

HAND SIGNALS FOR FORMATION

HAND SIGNALS FOR FORMATIONS



LINE

Raise both arms from the sides until they are horizontal. The arms and hands should be extended with the palms down.

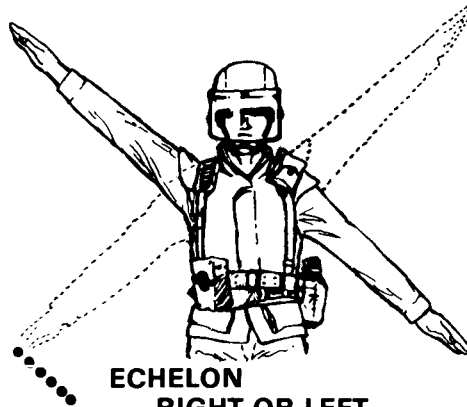

ECHELON RIGHT OR LEFT

Extend one arm 45 degrees above the horizontal and the other 45 degrees below the horizontal. The arms and hands should be extended. The upper arm shows the direction of the echelon when the commander faces the troops.



WEDGE

Extend both arms downward and to the sides at a 45-degree angle. The arms and hands should be extended with the palms down and in.

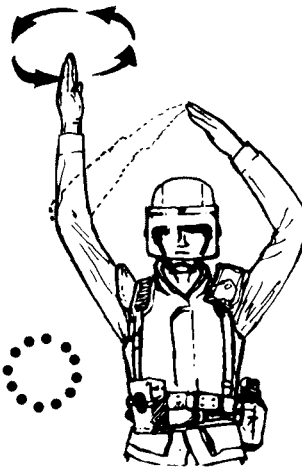

CIRCULAR

Give the diamond signal. Then give a circular motion with the right hand.



DIAMOND

Extend both arms above the head. Bend the elbows slightly, and touch the fingertips together.

WEAPON POSITIONS

At the commander's discretion, the members of the crowd control formation may carry their weapons in any of the positions prescribed in FM 22-5. Port arms is especially useful for resting support troops who are not in direct contact with the crowd. The positions for safe port, safeguard, and on guard shown below are for the M16 rifle. These positions are equally suited for the M14 rifle and the M1 rifle. The hand grasps need only be altered where necessary.

The safe-port position is quite effective when making a show of force. In this elevated position, bayonets can be seen by participants in the rear of the crowd. The sight of bayonets can create an impression of strength and numerical superiority.

Troops move into and assemble from all crowd control formations with weapons in the safe-port position. Troops automatically assume the safe-port position on the preparatory command for a crowd control

formation and when commanded to assemble.

Commanders use the safe-port position to impress rioters. However, troops should not be kept in the position very long as it is very tiring.

The safeguard position is a position of semireadiness. It is less tiring than the on-guard position. It is used to rest troops when circumstances permit. For example, as troops advance, they maintain the safeguard position until just before contact is made or resistance is expected. The safeguard position can also be used when troops are pursuing a crowd that is withdrawing without resistance.

On guard is a position of complete readiness. It is used whenever troops are in contact with a group that is showing any kind of resistance or hesitation to withdraw. It also is a tiring position to maintain for extended periods of time. Commanders must rest their troops at every opportunity by using less tiring positions.

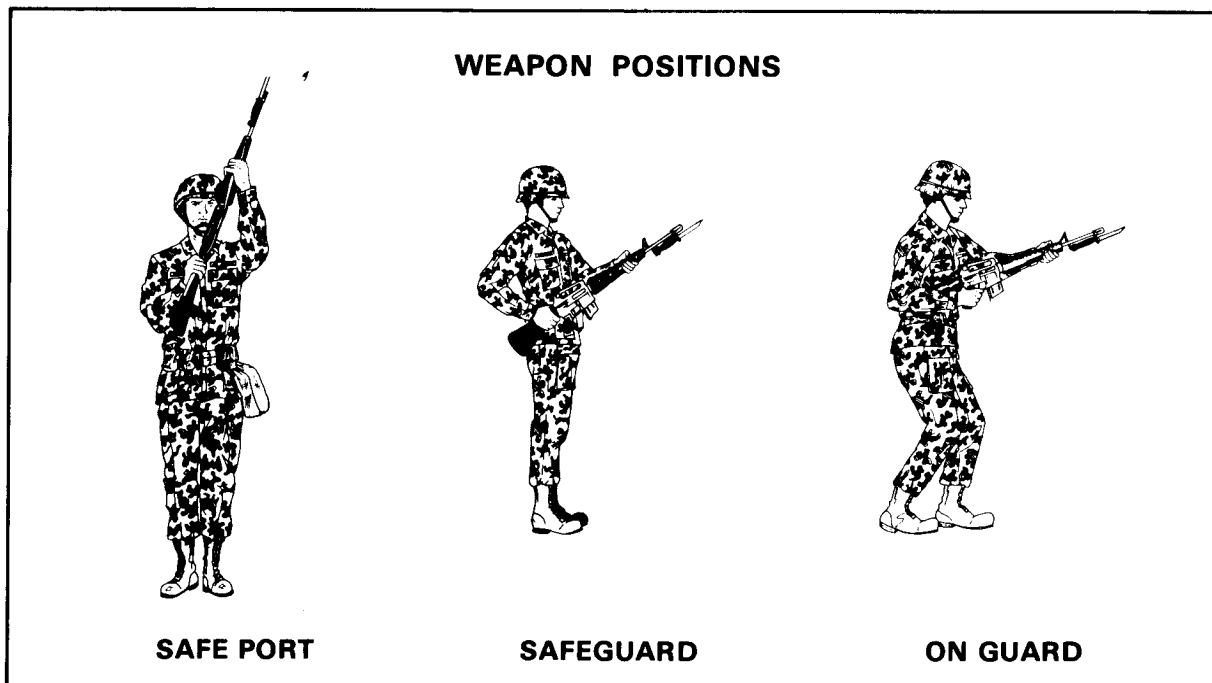

COMMANDS

Commands can be given to crowd control units in formation either orally or with hand signals. The oral commands for safe port, safeguard, and on guard are given in one count. All other commands are given in two counts, a preparatory command followed by an execution command. Oral commands cannot be relied on completely. Commanders must plan to use alternate methods for relaying commands. When it is necessary, commanders use hand and arm signals with oral commands.

The unit marches in column formation a reasonably safe distance from the crowd and within plain view of it. The unit halts and remains in formation. The commander decides on what crowd formation he desires for the situation. The unit is ordered into or assembled from crowd control formations while halted. As each soldier reaches his proper position, he automatically faces in the direction of the unit's intended advance and comes to a halt. He remains halted in the safe-port position and awaits further orders. On the preparatory command, the troops automatically assume the safe-port position. On the execution command, they form the formation. Once the troops

are in the crowd control formation, the commander commands, "Safeguard," and issues the proclamation. Following the proclamation, the commander informs the participants that they have a specific time in which to comply with the order to disperse. If the participants fail to disperse within the given time, the commander employs the measures needed to disperse the crowd.

When the commander gives the safe-guard and on-guard commands, the commands are for the lead element only. When using squads in support and the commands for safeguard and on guard are given, the support squads automatically move to the port-arms position when the command of safeguard is given to the lead element. If the squads are in general or lateral support and must move to another support position, they assume the safe-port position. They move to the new support position and are then commanded to port arms. The support elements give a re-sounding stomp with the left foot when the lead element goes to the on-guard position. On the command, "Forward march," the support elements maintain the same half-step cadence as the lead element.

CADENCE

The usual cadence for moving troops into and out of crowd control formations is double time. The troops are at safe port when performing these maneuvers. When troops in a crowd control formation are moving in the safeguard position, the usual cadence is quick time. When they are moving in the on-guard position, the usual cadence is 60 steps per minute. For psy-

chological effect, troops using the on-guard cadence may accentuate each left-foot step with a stomp.

The commander may increase or decrease the cadence, depending on the situation. For example, the commander may call a quick-time cadence to keep pressure on a crowd that is withdrawing.

INTERVAL AND DISTANCE

Interval is the lateral space between elements. Distance is the space between elements in a column. The usual interval

and distance between soldiers in crowd control formations are one pace or 30 inches.

Interval and distance can be adjusted for particular situations. The 30-inch interval may not be sufficient in some situations. It may have to be lengthened. Some police

forces have found that a greater interval makes formation members less vulnerable to thrown objects.

COMMANDER AND LEADER POSITIONS

When a unit is in a column formation, each echelon commander usually takes a position at the head of the column. In crowd control formations, squad leaders and their assistants, platoon leaders and their assistants, and company commanders take positions where they can best direct and control their units. For diamond and circle formations, they place themselves in the center of the formation. For all other formations, they place themselves at the rear of the unit. However, these are only guidelines. The leaders can adjust their position with respect to their unit as they see fit.

In column formations, messengers, radio operators, marksmen, disperser operators,

and other platoon HQ members usually take positions at the front of the column. In a crowd control formation, HQ personnel, at the commander's discretion, may be positioned near the commander. If the situation does not allow this kind of positioning, HQ personnel may be positioned behind the control element.

Control force formations can be based on 12-man squads, 4-squad platoons, 3-squad platoons, and 3-platoon companies with 4-squad platoons. However, a 9-man or a 10-man squad can be adapted easily to the example for a 12-man squad. Any size squad, platoon, or larger unit can be employed, and a crowd control formation can be adapted to fit the unit's organization.

SQUAD FORMATIONS

When moving a squad into a crowd control formation from a column formation, the squad leader takes one or more steps to the right of the squad and faces the squad. He gives the hand and arm signal for the formation that he wants. He then gives the

preparatory command. As he gives the execution command, he points to where he wants the unit to form. The squad's number two man, or base man, moves to that position. The squad forms on the base man's position.

SYMBOLS FOR FORMATION ELEMENTS	
COMPANY COMMANDER	
PLATOON LEADER	
PLATOON SERGEANT	
SQUAD LEADER	
FIRE TEAM LEADER OR ASSISTANT SQUAD LEADER	
SQUAD MEMBER	
MESSENGER AND RADIO OPERATOR	
SELECTED MARKSMAN	
DISPERSER	
VEHICLE	

SQUAD LINE

The command for having a squad form in a line formation is "Squad as skirmishers, move." On the execution command, the base man moves to the place indicated by the squad leader. The squad members align themselves in sequence on the base man, one pace to the side and one pace to the rear.

indicated by the squad leader. The squad members align themselves in sequence on the base man, one pace to the side and one pace to the rear.

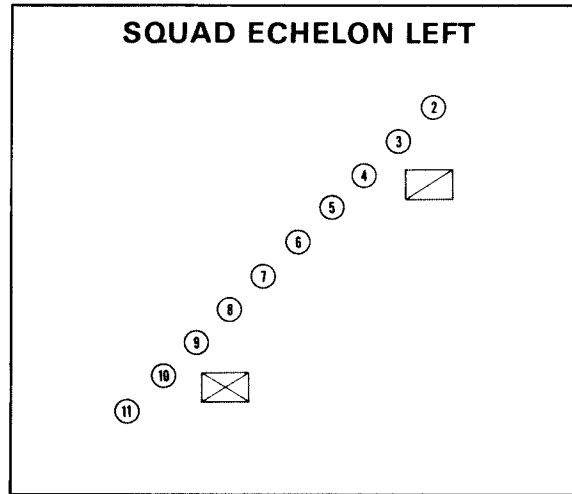
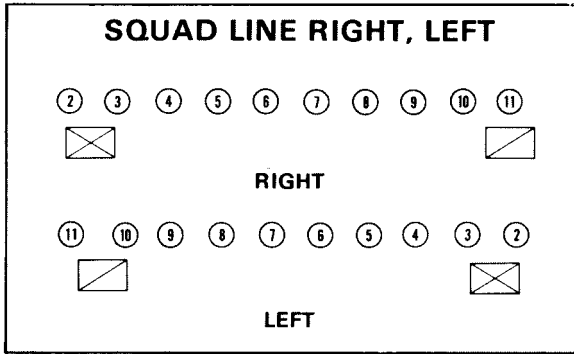

Based on the situation, the squad leader may designate a specific interval. He does this when he gives the preparatory command. If no interval is specified, the squad automatically forms using a one-pace interval.

SQUAD ECHELON

The command for having a squad form in an echelon formation is "Squad echelon right (left), move." On the execution command, the base man moves to the place

SQUAD WEDGE

The command for having a squad form in a wedge formation is "Squad wedge, move." On the execution command, the base man moves to the place indicated by the squad leader. Even-numbered squad members align themselves in sequence on the base man, one pace to the right and one pace to the rear of each preceding man. Odd-numbered members align themselves in the same way to the left of the base man.

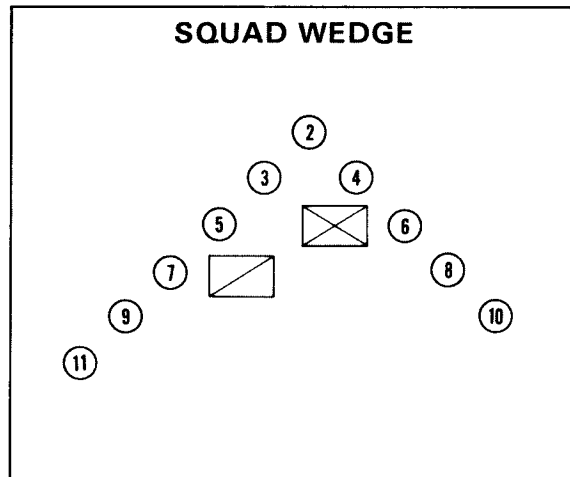
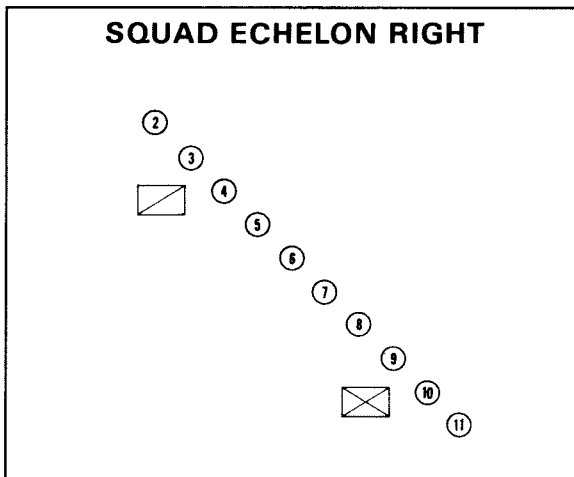

SQUAD ASSEMBLY

When assembling a squad from the line formation, the squad leader takes a position a sufficient distance to the rear of the squad and commands, "Squad assemble." At the same time, he raises his right hand in the air and makes a circular motion. Squad members who hear the command automatically come to the safe-port position. The base man does an about-face. The other squad members face toward the base man. On the execution command, "Move," the squad leader points to the place where he wants the base man to assemble. The base man double-times to the designated spot, and the other members of the squad follow the base man. When the

squad is in a column formation again, they are ordered to port arms.

To assemble from a squad echelon formation, the squad leader takes the same steps as for the line formation. The base man does an about-face. The squad members do either a half left face for an echelon right or a half right face for an echelon left and follow the base man.

To assemble from a squad wedge formation, the squad leader takes the same steps as for the line and echelon formations. The base man does an about-face. All even-numbered men do a half left face, and all odd-numbered men do a half right face. They then follow the base man in sequence.

FOUR-SQUAD PLATOON FORMATIONS

Platoon headquarters consists of the following four people:

- Platoon leader.
- Platoon sergeant.
- Selected marksman.
- Messenger or radio operator.

When directed by the platoon leader, other people, such as disperser operators and firefighters, may augment the platoon headquarters.

In forming all crowd control formations from the column, the platoon leader moves to the right of the platoon and faces them when giving his commands. He gives the arm and hand signal and the preparatory command. On the execution command, "Move," he points to the approximate location where he wants the platoon to form. The platoon leader pauses between the preparatory command and the execution command to allow each squad leader to issue a preparatory command to his squad.

PLATOON LINE

The command for forming a platoon line is "Platoon as skirmishers, move." Immediately following the platoon leader's preparatory command, the squad leaders of the first and fourth squads command, "Follow me." The squad leaders of the second and third squads command, "Stand fast." On the platoon leader's execution command, the first and fourth squads move forward to the point designated by the platoon leader. The number two man of the fourth squad is the base man for the platoon formation. The fourth squad forms a squad line to the right of the base man, and the first squad forms a squad line to the left of the base man, dressed on the fourth squad. After the first and fourth squads have cleared the platoon, the second and third squad leaders command, "Follow me." The second squad forms a squad line to the left of the first squad. The third squad forms a squad line to the right on the fourth squad, all squads dressing on the fourth squad.

PLATOON LINE

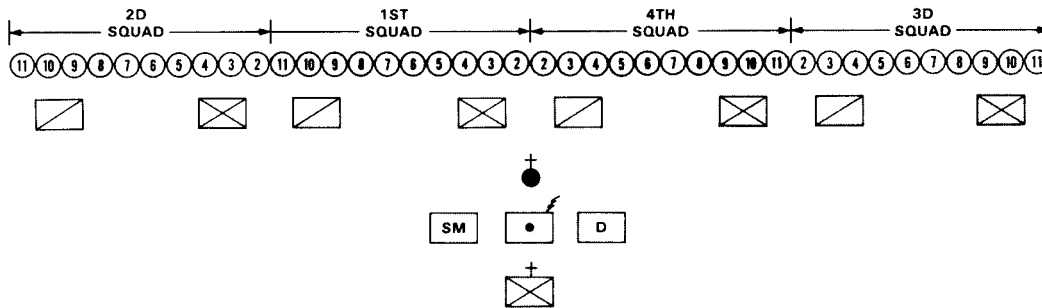

When assembling the platoon from the platoon line formation, the platoon leader and his HQ personnel take a position to the rear of the platoon. He then gives the command, "Platoon assemble," raising his right arm and making a circular motion above his head. The members of the platoon automatically assume the safe-port position. All squad leaders go to their number two men and face the platoon leader. All number two men do an about-face. All other squad members do a facing movement toward their respective number two men. On the platoon leader's execution command, he points to where he wants the platoon to assemble. The squad leaders of the fourth and third squads command, "Follow me," and together they move toward the platoon leader. As the fourth and third squads clear the line formation, the first and second squad leaders command, "Follow me," and together they move toward the platoon leader, dressing to the left of the fourth and third squads. All squads halt automatically behind the platoon HQ and dress. After the squads are in column, the platoon leader commands, "Port arms." If the platoon leader wants

the platoon facing back in the direction of the crowd control formation, he commands, "Counter-column, march."

PLATOON LINE WITH GENERAL SUPPORT

Whenever the command for establishing a crowd control formation contains the phrase, in support, without modification, it means that the support element is to remain in general support.

The command for forming a platoon line with two squads in general support is "Platoon as skirmishers, second and third squads in support, move." The first and fourth squads execute the line, while the second and third squads remain in the column. The number two man of the fourth squad is the base man for the formation.

To assemble a platoon with two squads in general support, the procedure is the same as for the platoon line, except the second and third squads do a counter-column. The fourth squad then dresses to the right of the third squad, and the first squad dresses to the left of the second squad.

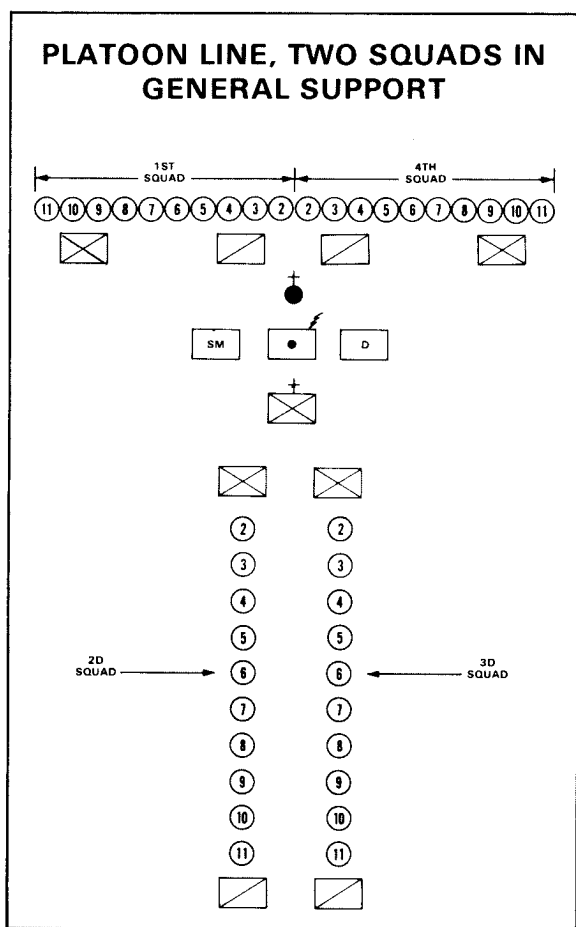

PLATOON LINE WITH LATERAL SUPPORT

The command for forming a platoon line with two squads in lateral support is "Platoon as skirmishers, second and third squads in lateral support, move." The fourth and first squads execute the line as before, and the second and third squads stand fast. After the line has been formed, the squad leaders of the second and third squads command, "Follow me." The second and third squads move out to their respective flanks. The second squad forms a column behind the last man on the line to the left. The third squad forms a column behind the last man on the line to the right.

The second and third squads may be moved from general support to lateral

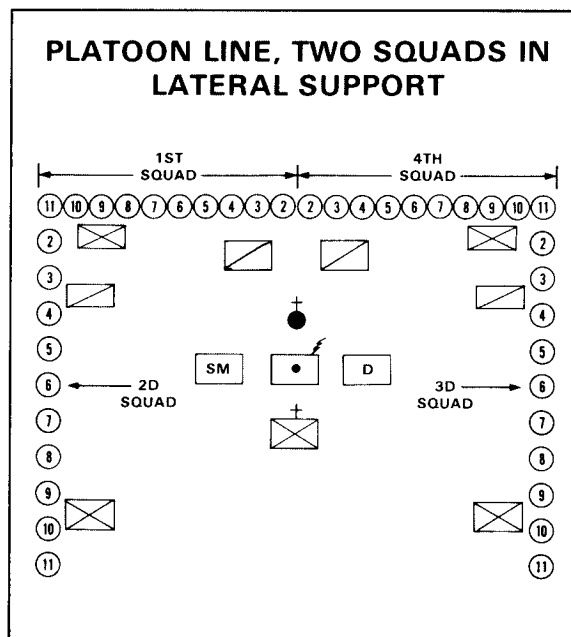

support at any time by the platoon leader. He commands, "Second and third squads, lateral support, move." To have the second and third squads join the line from either support position, the platoon leader commands, "Second and third squads, extend the line, move." The second and third squad leaders command, "Follow me." On the execution command, the squads set up individual lines, closing and dressing on the existing line.

To assemble the platoon from a platoon line with lateral support is the same as for the platoon line, except the number two men of the second and third squads do a right face and a left face, respectively, toward their squad leaders. On the execution command, the fourth and third squads move to the point designated by the platoon leader. As the fourth and third squads clear the formation, the first and second squads move.

PLATOON LINE WITH CLOSE SUPPORT

The command for forming a platoon line with two squads in close support is "Platoon as skirmishers, second and third squads in close support, move." The first

and fourth squads execute a line as before. The second and third squads execute a second line to the rear of the first line and close in on the first line. The men in the supporting line cover the intervals between men in the first line. To do this, the squad leaders of the second and third squads command, "Stand fast." After the first and fourth squads are in position, the second and third squads form lines as indicated.

To assemble the support squads from any position to general support, the platoon leader commands, "Second and third squads in support, move." The second and third squads then return to a column behind the line formed by the other two squads.

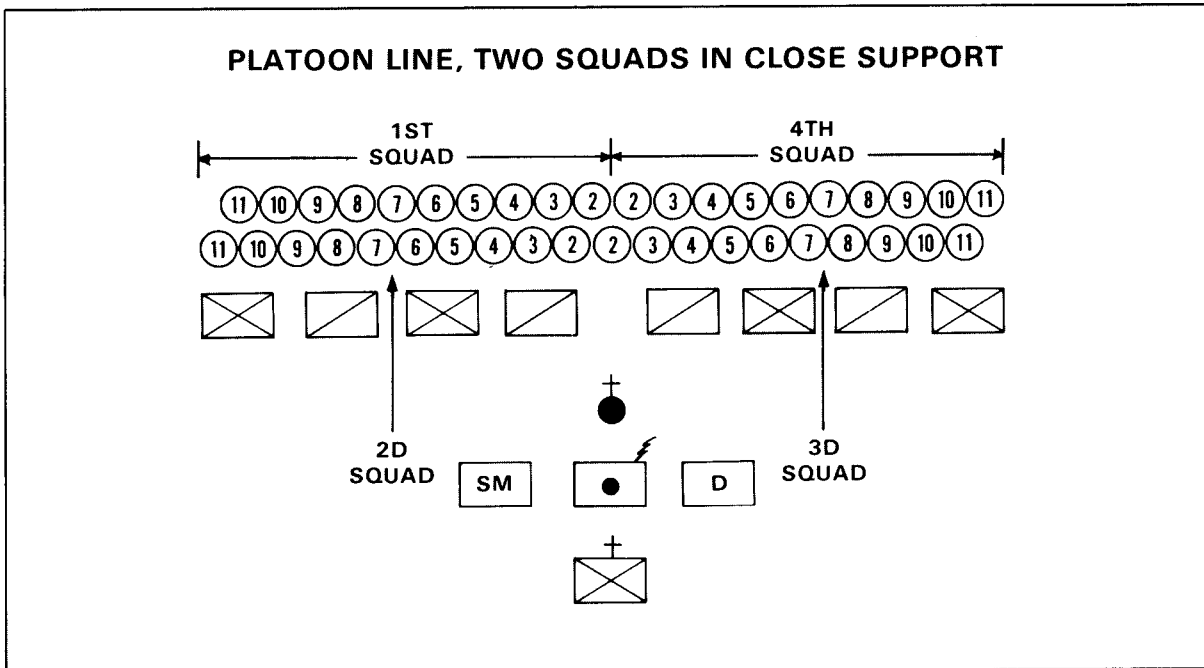

PLATOON LINE WITH ONE SUPPORT SQUAD

The command for forming a platoon line with one squad in support is "Platoon as skirmishers, third squad in support, move." The second squad moves out and executes a squad line right. The first and fourth squads form lines on the second squad to the left and the right, respectively. The third squad remains in column formation.

The support squad may be used in lateral support on one or both sides of the formation. It also can be used in close support of any segment of the formation.

To assemble the platoon, the commander takes his position as before. On the execution command, the third squad does a counter-column. The fourth squad moves and dresses to the right of the third squad. The first and second squads then move and dress to the left of the third squad. When the third squad is in lateral support, the commander assembles the third squad first. He then assembles the fourth, second, and first squads as before. The same procedure applies when the third squad is in close support.

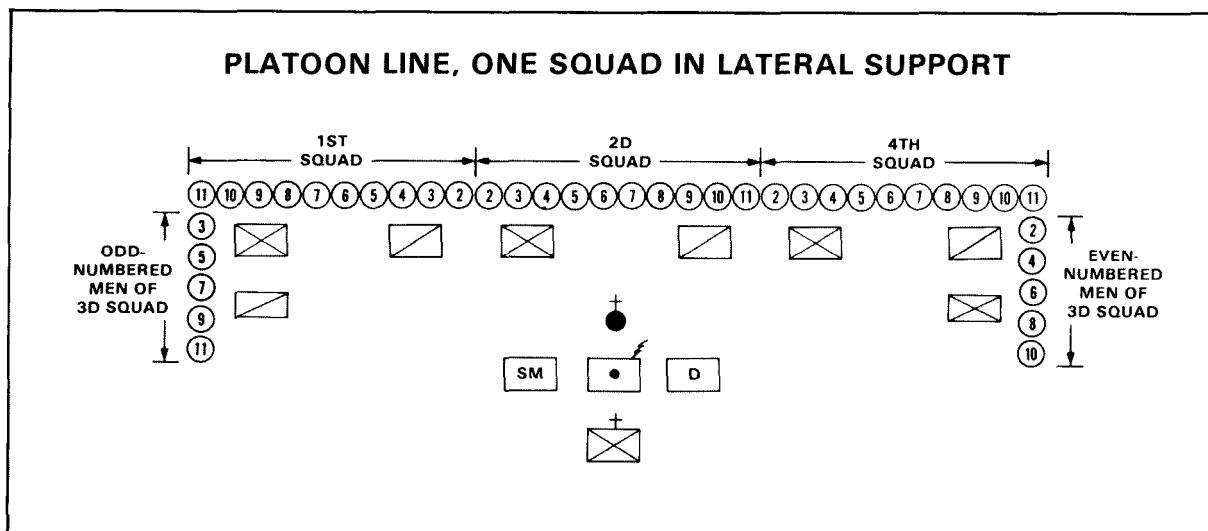

PLATOON ECHELON RIGHT

The command for forming a platoon echelon right is "Platoon echelon right, move." After the platoon leader's preparatory command, the squad leader of the first squad commands, "Follow me." The squad leaders of the second, third, and fourth squads command, "Stand fast." On the execution command, the first squad moves out and executes an echelon right at the location designated by the platoon leader. As each squad clears the column, the next successive squad moves out and extends the echelon that has been formed.

To assemble the platoon, the commander takes his position to the rear of the formation with the platoon HQ. On the preparatory command, "Platoon assemble," all squad leaders go to their number two men and face the platoon leader. The number two man of the first squad does an about-face. The number two men of the second, third, and fourth squads do a left face. All other platoon members do a half left face. On the command, "Move," the first squad moves first, then the second squad, third squad, and fourth squad. Each squad dresses as it reaches the column formation.

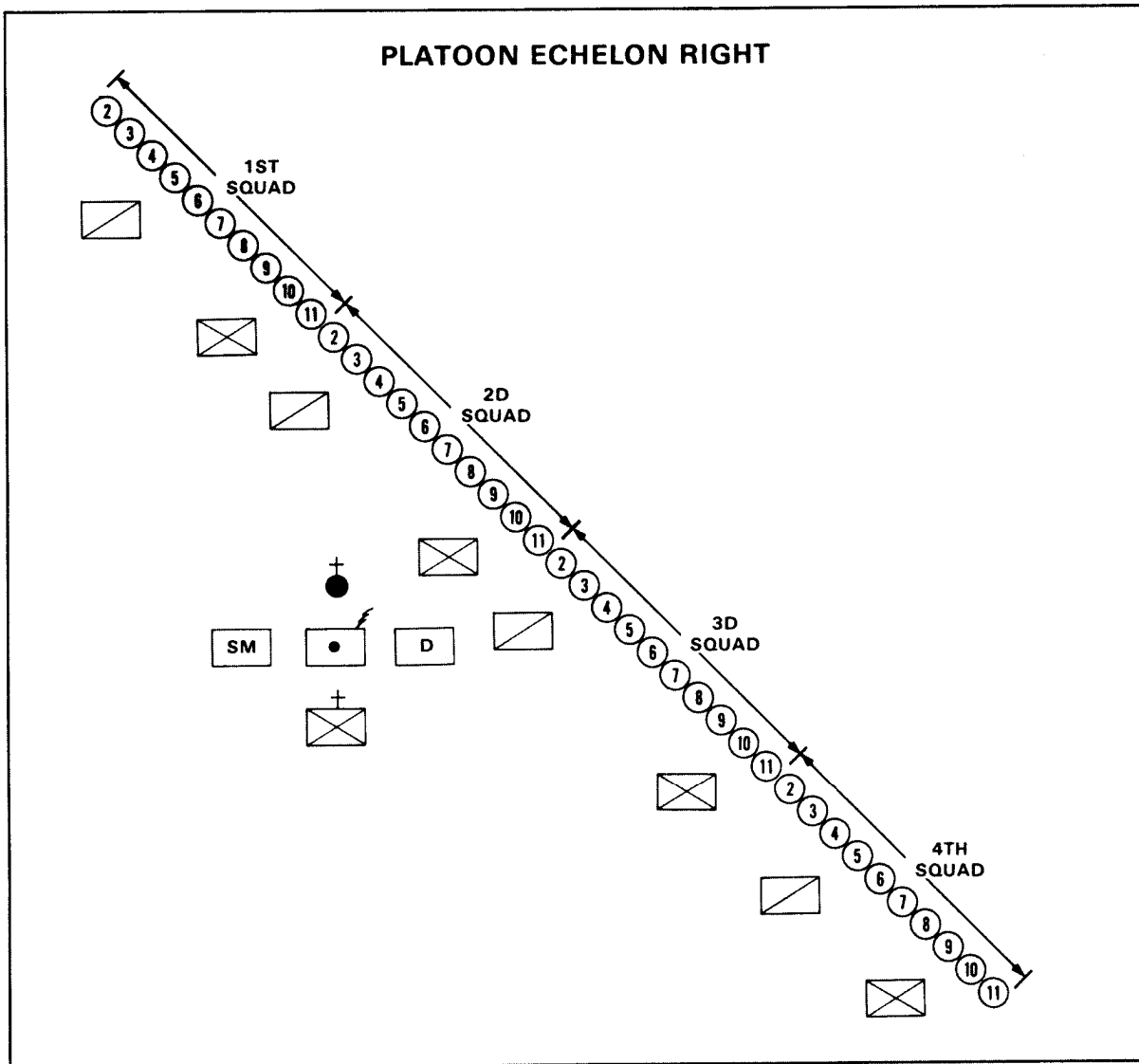

PLATOON ECHELON LEFT

The command for forming a platoon echelon left is "Platoon echelon left, move." The platoon echelon left is formed in the same manner as the echelon right, but in reverse order. The fourth squad is the base squad and the remaining squads extend the echelon in reverse sequence.

Assembly of the echelon left formation is the reverse of the echelon right. The fourth squad assembles first, followed by the third, second, and first squads.

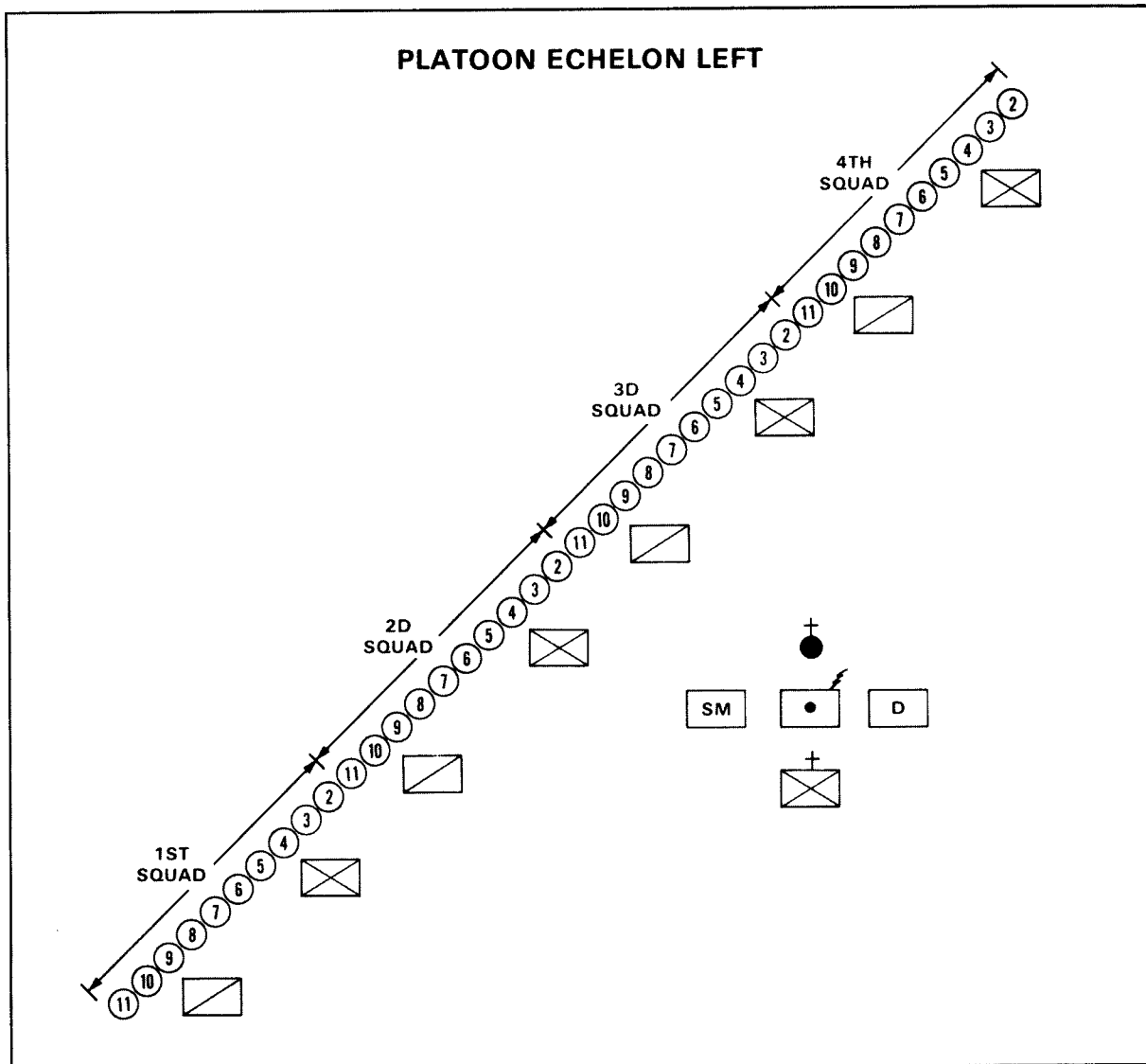

PLATOON ECHELON

WITH ONE SQUAD IN LATERAL SUPPORT

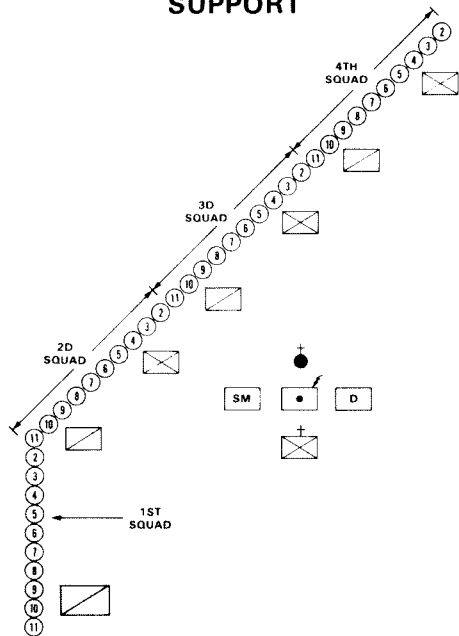

WITH TWO SQUADS IN GENERAL SUPPORT

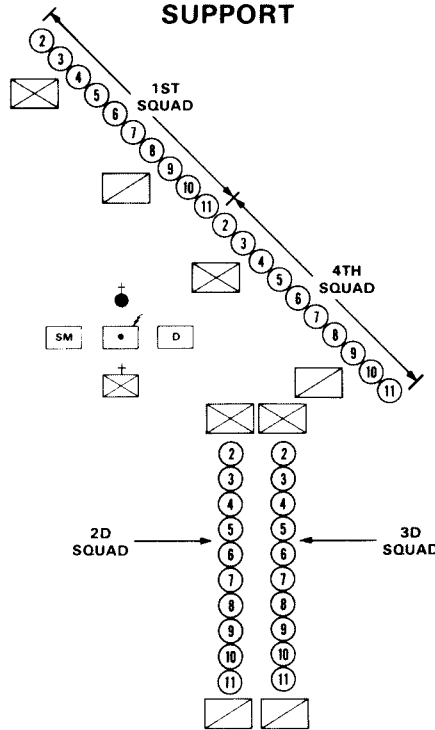

WITH TWO SQUADS IN LATERAL SUPPORT

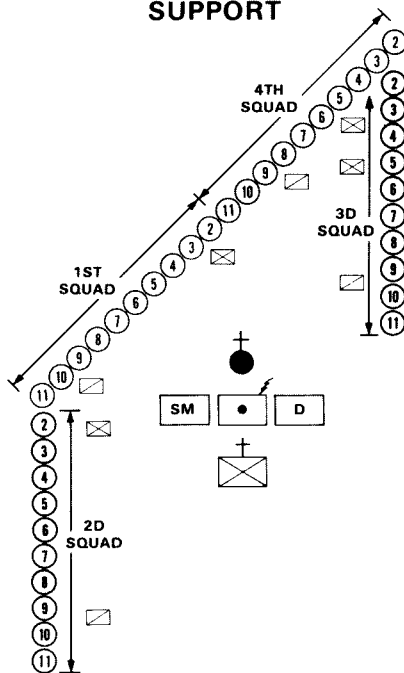

WITH TWO SQUADS IN CLOSE SUPPORT

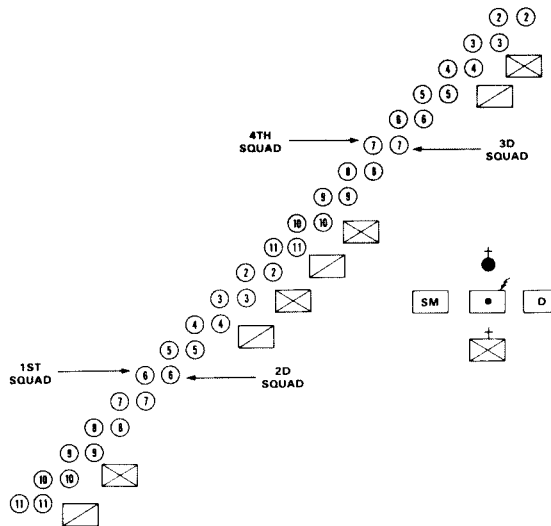

PLATOON WEDGE

The command for forming the platoon wedge is "Platoon wedge, move." After the platoon leader's preparatory command, the squad leaders of the first and fourth squads command, "Follow me." At the same time, the squad leaders of the second and third squads command, "Stand fast." On the platoon leader's execution command, the first and fourth squads move directly to the front. When the last men of the first and fourth squads clear the second and third squads, the squad leaders of the second and third squads command, "Follow me," and move out to the left and right, respectively. The number two man of the fourth squad is the base man for the formation. The fourth squad executes an echelon right. The first squad executes an echelon left on the base man. The second squad forms an echelon left on the last man of the first squad. The third squad forms an echelon right on the last man of the fourth squad, completing the wedge formation.

Assembling the wedge formation is basically the same as assembling the platoon line. The fourth and third squads assemble first. The first and second squads assemble to the left of the fourth and third squads.

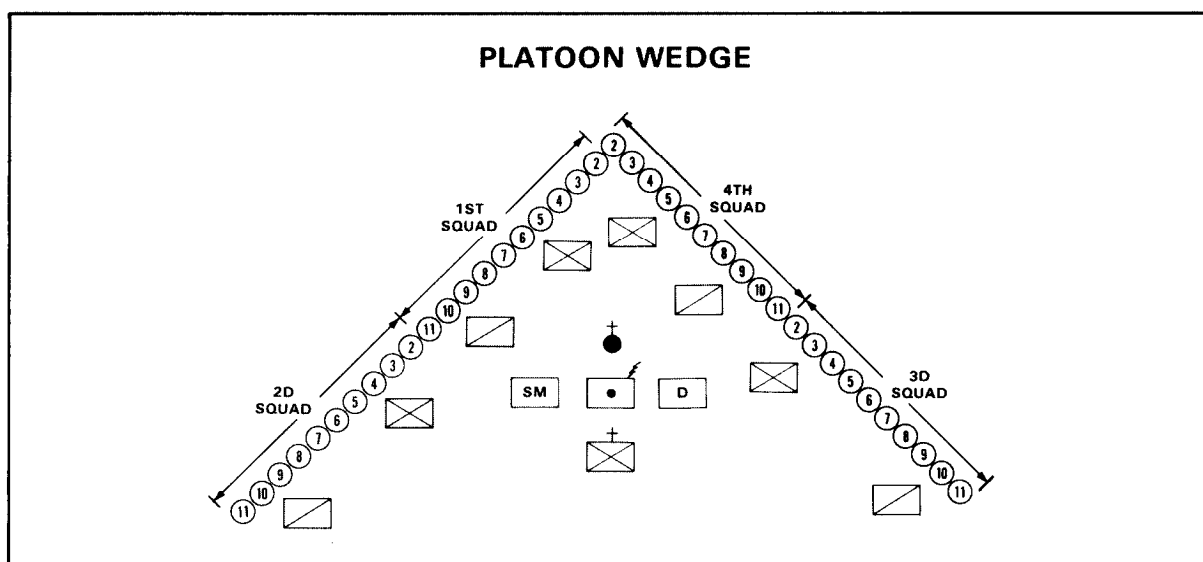

PLATOON WEDGE WITH GENERAL SUPPORT

The command for forming a platoon wedge with two squads in support is "Platoon wedge, second and third squads in support, move." The first and fourth squads execute the wedge while the second and third squads remain in column formation.

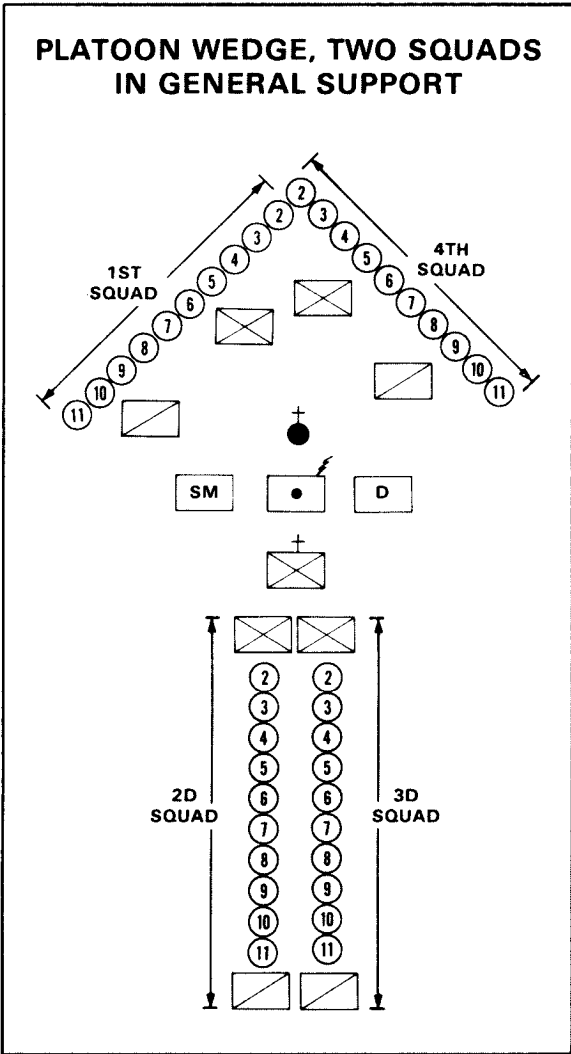

squads execute the wedge while the second and third squads stand fast. After the first and fourth squads have cleared the column, the second and third squad leaders command, "Follow me," and move out to the left and right, respectively. The second squad forms in column behind the last man of the first squad. The third squad forms in column behind the last man of the fourth squad.

To move the second and third squads from general support to lateral support, the platoon leader commands, "Second and third squads, lateral support, move." To have the second and third squads join the wedge from either general support or lateral support, the platoon leader commands, "Second and third squads, extend the wedge, move." The second and third squad leaders command, "Follow me," and move out to the left and right, respectively, to extend the wedge on the first and fourth squads.

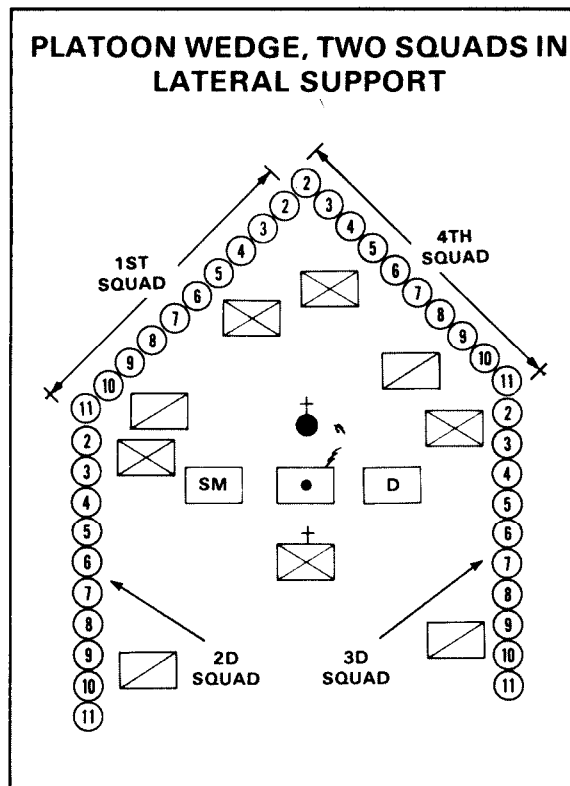

PLATOON WEDGE WITH LATERAL SUPPORT

The command for forming a platoon wedge with lateral support is "Platoon wedge, second and third squads in lateral support, move." The first and fourth

PLATOON WEDGE WITH CLOSE SUPPORT

The command for forming a platoon wedge with two squads in close support is "Platoon wedge, second and third squads in close support, move." The first and fourth squads execute a wedge. The second and third squads also execute a wedge and close in on the leading wedge. The men in the supporting wedge cover the intervals between men in the leading wedge. To do this, the squad leaders of the second and third squads command, "Stand fast." After the first and fourth squads are in position, the second and third squads then form a second wedge.

To assemble the support squads from any position to general support, the platoon leader commands, "Second and third squads in support, move." The second and third squads then form a column behind the wedge formed by the other two squads.

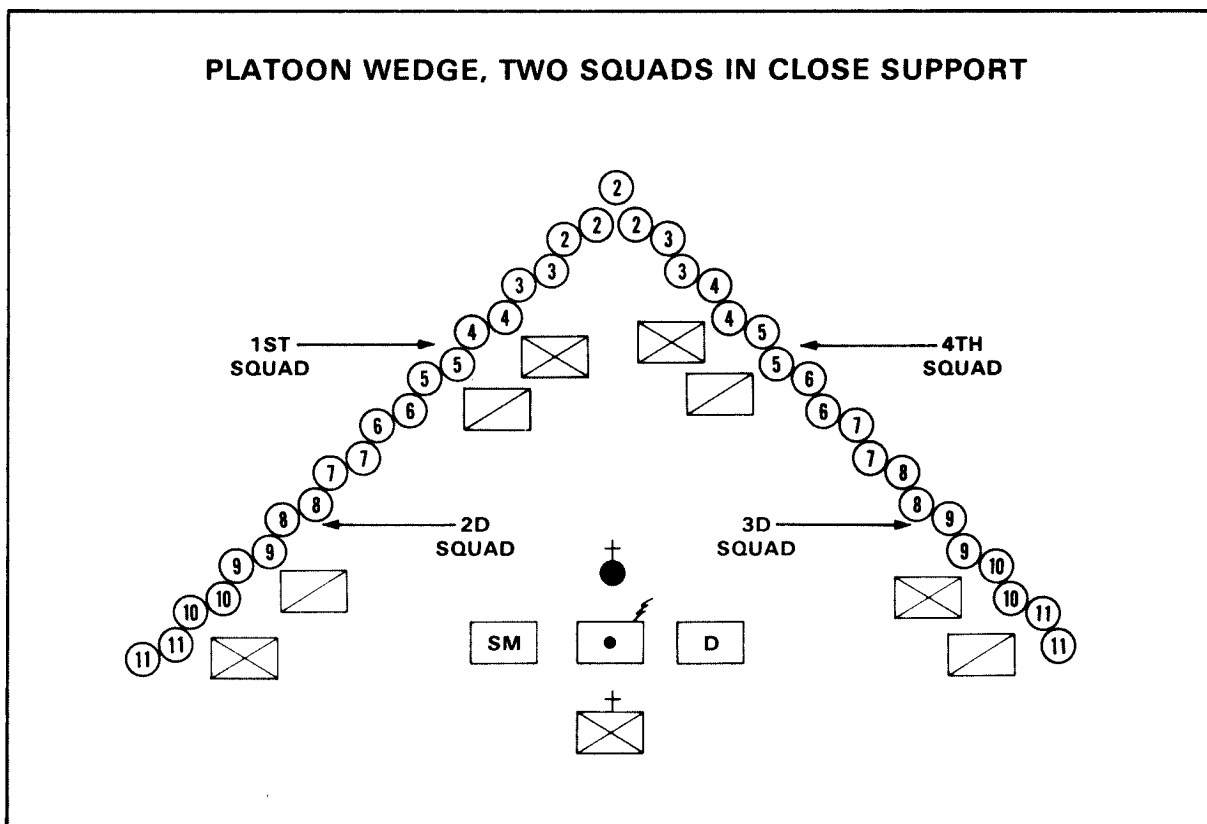

PLATOON WEDGE WITH ONE SUPPORT SQUAD

The command for forming a platoon wedge with one squad in support is "Platoon wedge, third squad in support,

move." The second squad moves out and executes a squad wedge. The first and fourth squads form echelons left and right, respectively, on the second squad. The third squad remains in the column formation.

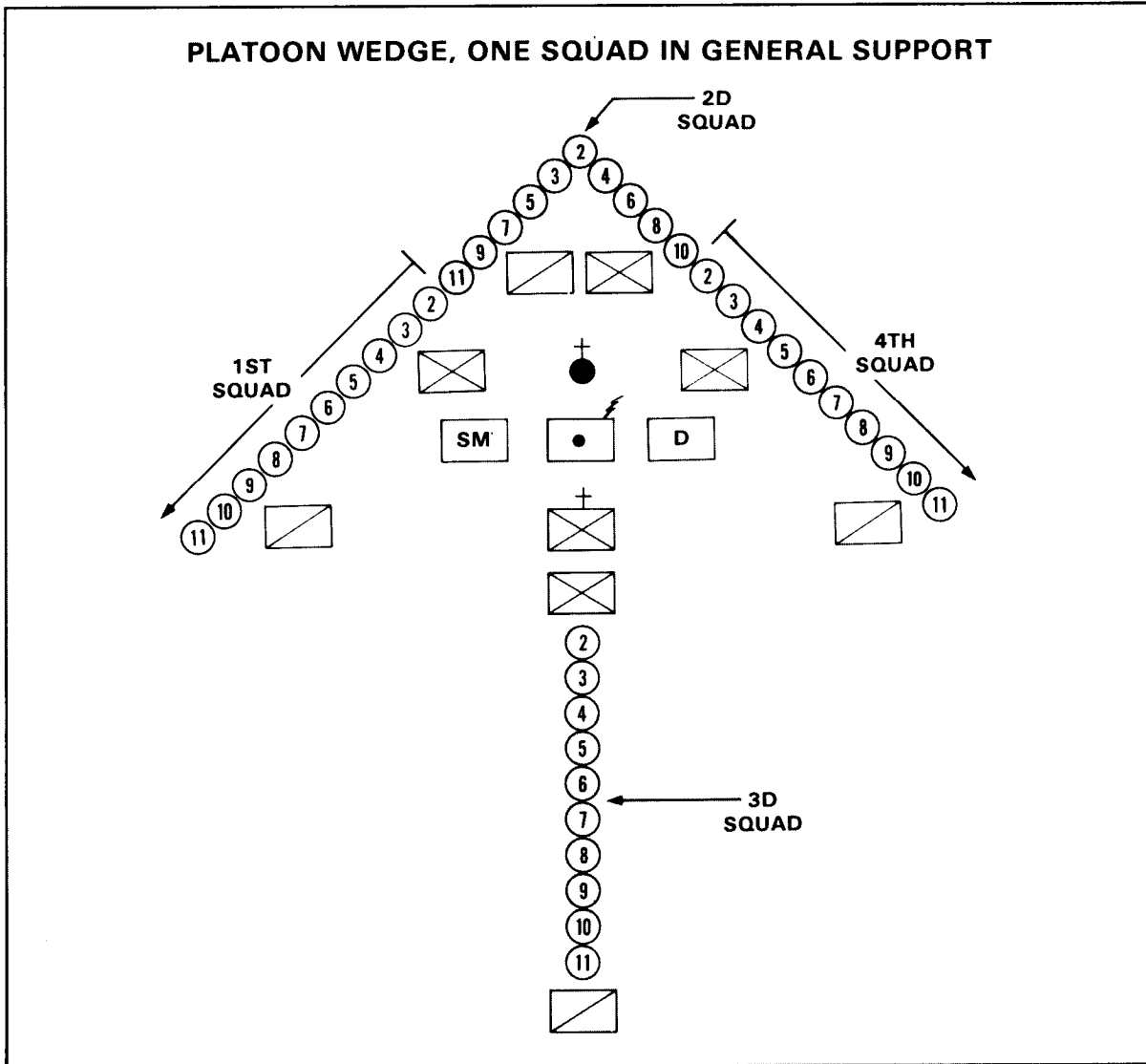

FORMATION VARIATIONS

During crowd control operations, the platoon leader may rotate his squads in the lead elements of the formation to give the squads a rest. He is not limited to using only those squads specified in the preceding examples as the lead elements of the

formations. By changing his preparatory command, he may choose other squads to lead his unit. If he wants the first and third squads to lead his platoon wedge, he issues the command, "Platoon wedge, second and fourth squads in support, move." By designating the support squad or squads in the preparatory

command, the platoon leader tells the remaining squads that they will lead the formation. The number two man of the third squad becomes the base man.

The platoon leader also may relieve squads in the lead element by forming the

same formation with the support squads. The support element then passes through the lead element. This procedure is often necessary when protective masks are donned for riot control agent employment.

THREE-SQUAD PLATOON FORMATIONS

The execution of crowd control formations using a three-squad platoon is essentially the same as a four-squad platoon. The exceptions are that—

- The first and third squads usually are used as the lead element in all formations in which one squad provides general support or lateral support.
- The second squad is the base squad in a platoon line when all three squads are committed to the lead element.

- The support squad, usually the second squad, may be held in general support in single column or in column of two's.

The command for forming a platoon formation with one squad in support in a single column is "Platoon as skirmishers (echelon right, echelon left, or wedge), second squad in support, move." The first and third squads execute the formation while the second squad remains in column formation.

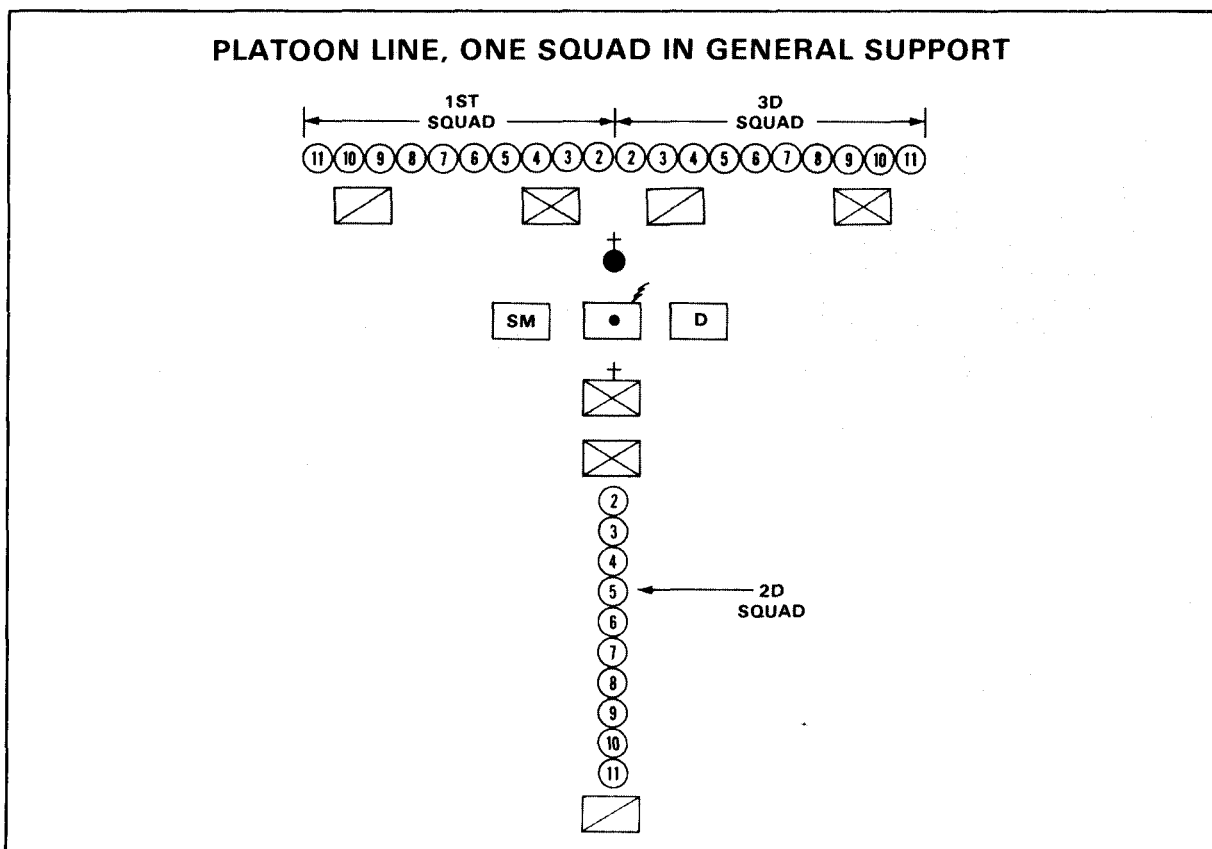

The command for forming a platoon formation with one squad in general support in a column of twos is "Platoon as skirmishers (echelon right, echelon left, or wedge), second squad in support in column of twos, move." The first and third squads execute the formation. The second squad, at the command of its squad leader, executes a column of twos to the right.

When the support squad moves to either lateral support or to extend the existing formation, the even-numbered men move to the right, and the odd-numbered men move to the left. They execute these movements in the same manner as the support squads for a four-squad platoon. The squad leader usually controls the even-numbered men, and the assistant squad leader controls the odd-numbered men.

A three-squad platoon is assembled in the same manner as a four-squad platoon.

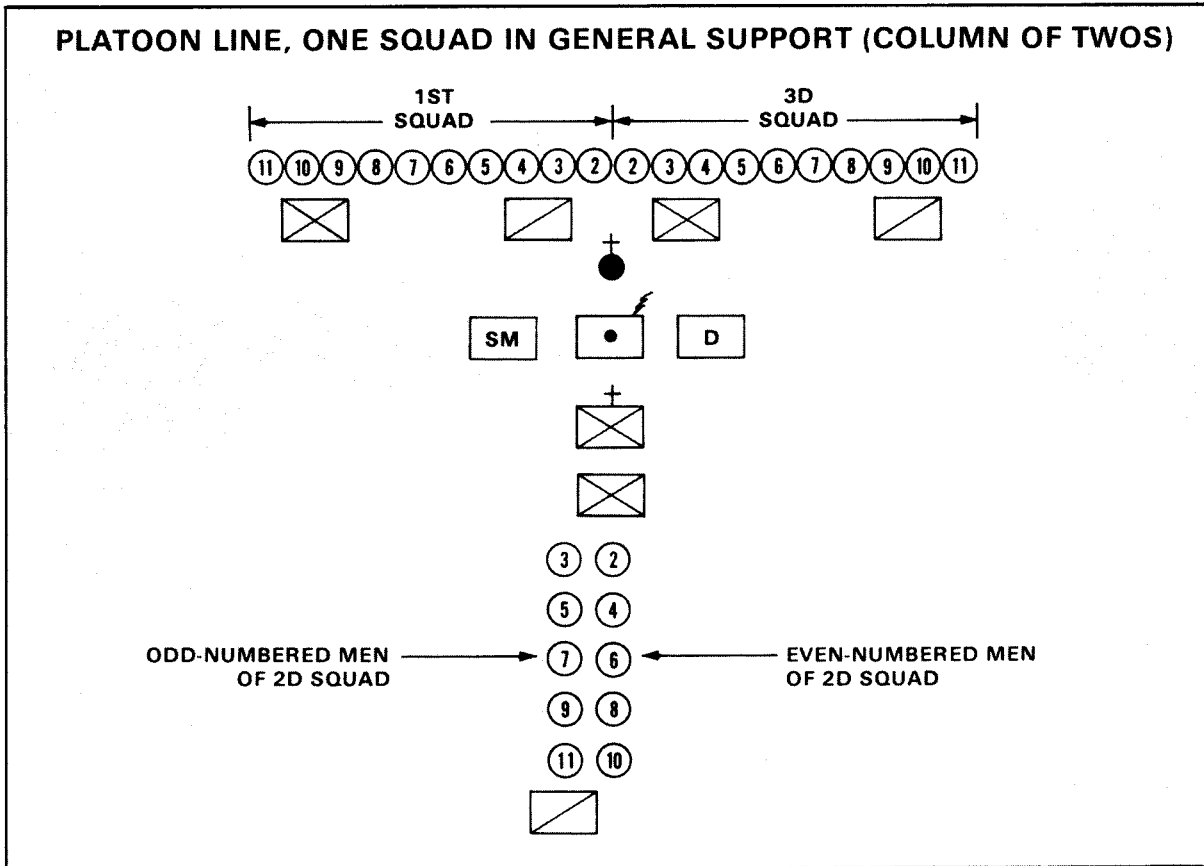

COMPANY FORMATIONS

When a company commander orders his company into crowd control formations from a column, he moves to the left or the right near the head of the column so he can be seen by the platoon leaders. He then faces the company. As he gives his preparatory command, he points to where he wants the formation. If he does not indicate a location, the company forms immediately in front of the lead platoon.

COMPANY LINE IN DEPTH

The command for forming a company line in depth is "Company as skirmishers in depth, move." After the company commander's preparatory command, each

platoon leader gives the command, "Platoon as skirmishers." The squad leaders follow with their respective commands to their squads to form the platoon line. On the execution command, each platoon establishes a platoon line immediately to its front.

If the company commander wants a more formidable formation, he commands, "Second platoon, close support, move." The second platoon moves forward and covers the intervals between the men of the lead platoon. The second platoon automatically assumes the same weapons position being used by the lead platoon, usually the on-guard position. The platoon leader of the

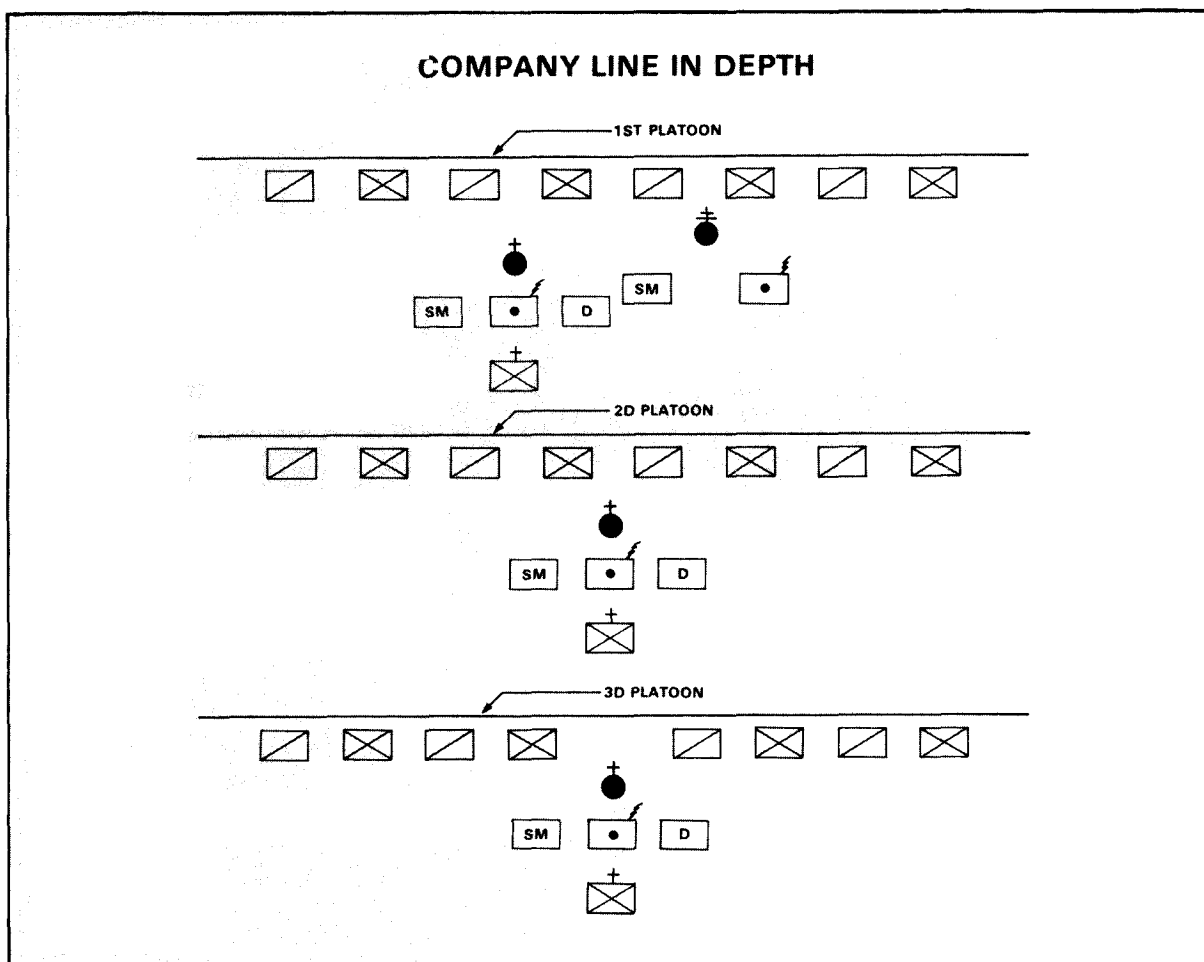

third platoon then moves his platoon forward to occupy the position formerly held by the second platoon.

If the third platoon is called on to support the company line, it moves forward and takes up a position directly behind the second platoon. The men of the third platoon hold their weapons at safe port. Platoon and squad leaders and their assistants help each other in controlling the company.

COMPANY LINE IN MASS

The command for forming a company line in mass is "Company as skirmishers in mass, move." The company line in mass is the same as a company line with both platoons in close support. Instead of forming it in stages, the company commander indicates his desire for this formation in his initial command. The platoons each form a line, and the second and third platoons close on the first platoon without further commands.

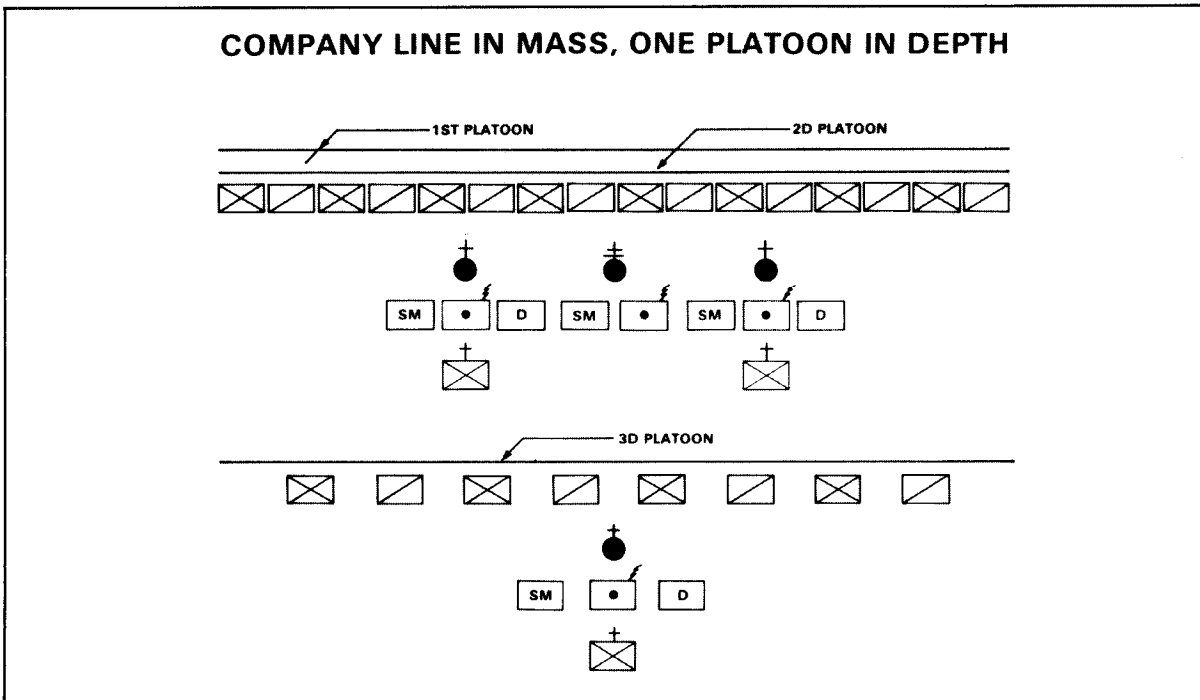
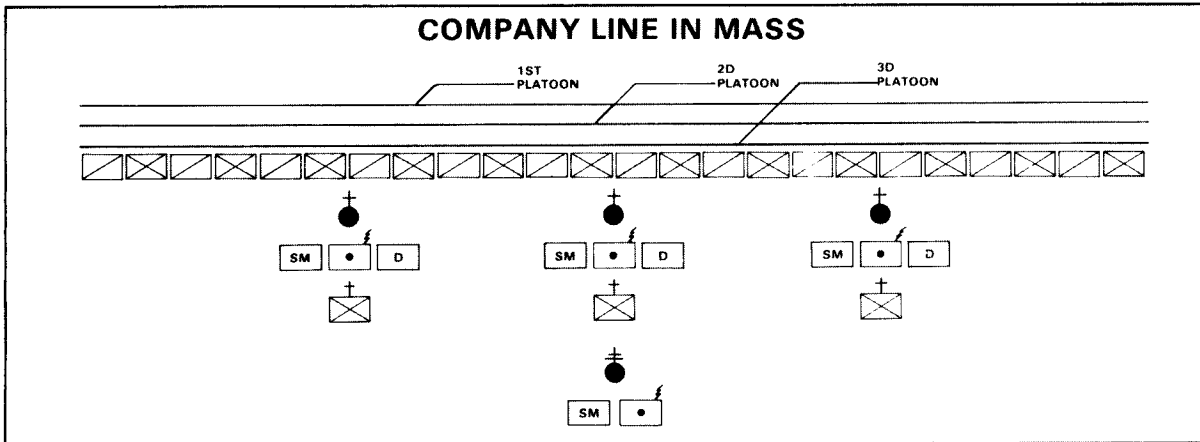

COMPANY LINE WITH SUPPORT

In company formations, the first platoon usually forms the lead element and the second and third platoons provide support. The support platoons can be employed in

the same manner as the support squads in platoon formations. One platoon can be relieved from the lead element by another platoon while in formation by having a support platoon pass through the lead platoon.

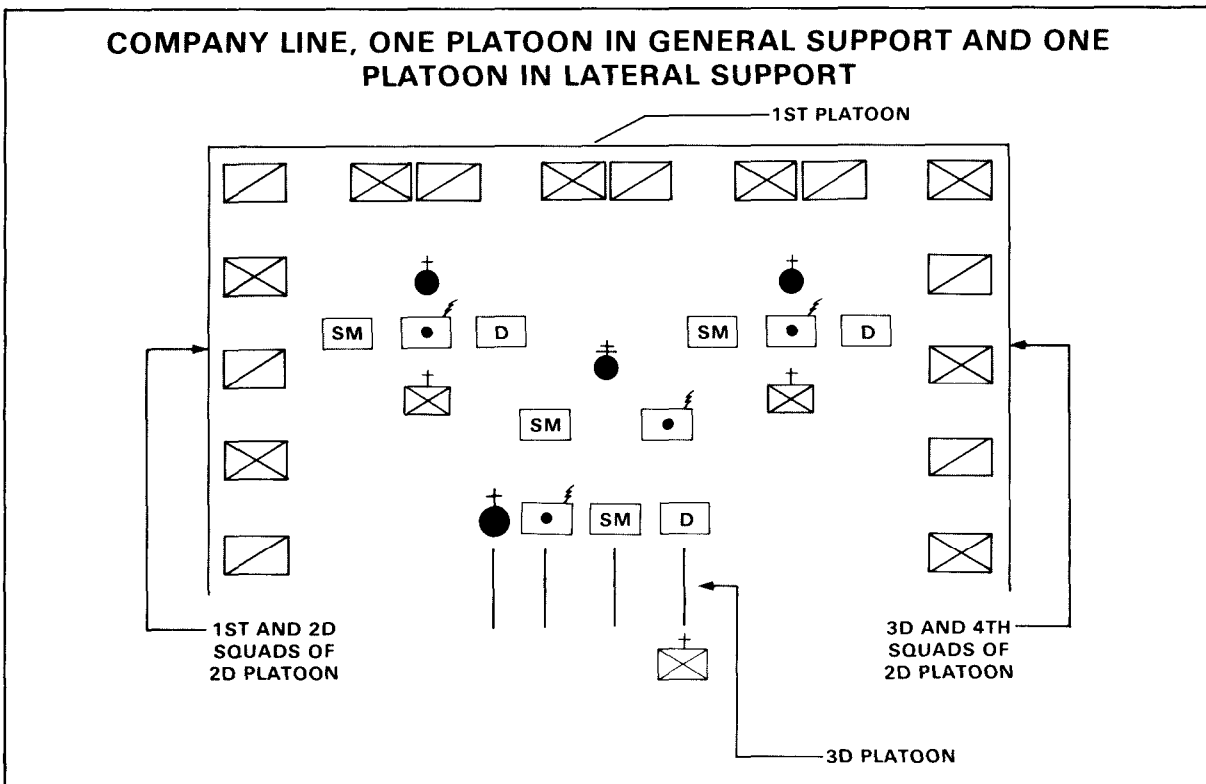
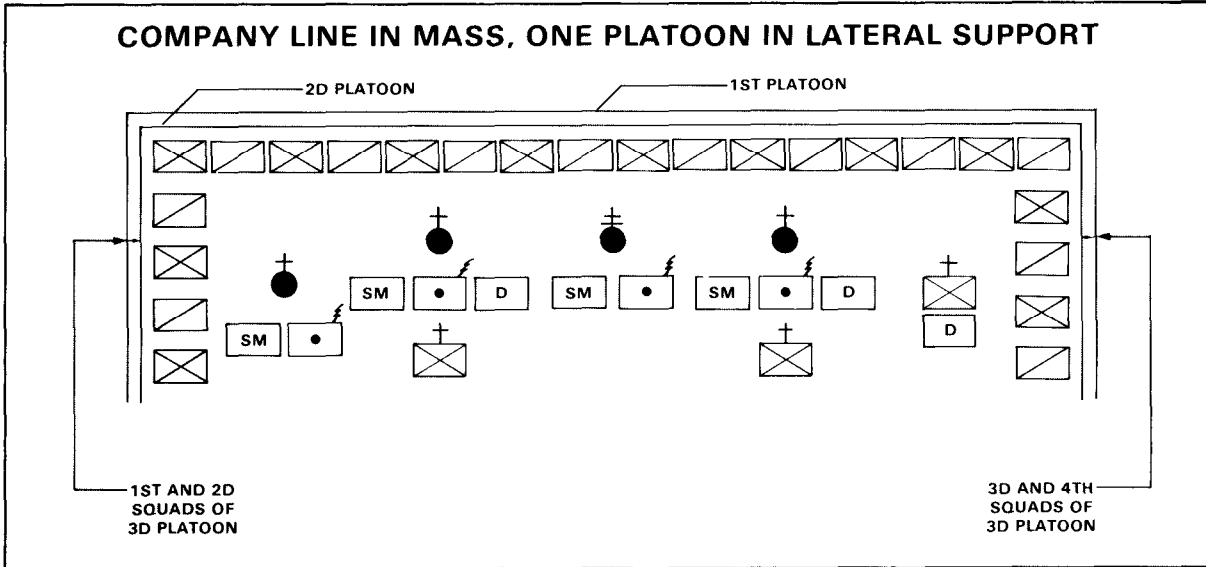

COMPANY ECHELONS AND WEDGE

Company echelons and the company wedge are formed in the same manner and with the same variations as the company line.

A company assembles from a crowd control formation the same way a platoon or a squad does. However, due to the size of company formations, the commander must consider the area that the company is operating in when he assembles the company. If he follows the guidelines of platoon assembly, he will have no difficulty. When assembling the company, the commander takes a position to the rear of

the formation and commands, "Company assemble." The platoon leaders take charge of their respective platoons. Usually, the third platoon assembles first, just behind the formation. After the third platoon is assembled, the second platoon assembles in front of the third platoon. Then the first platoon assembles in front of the second platoon. All platoons assemble facing the commander. The second and third platoons then dress on the first platoon. As each platoon is assembled, they are ordered to port arms by the platoon leader to await further orders from the commander. If four platoons are used, the fourth platoon assembles first.

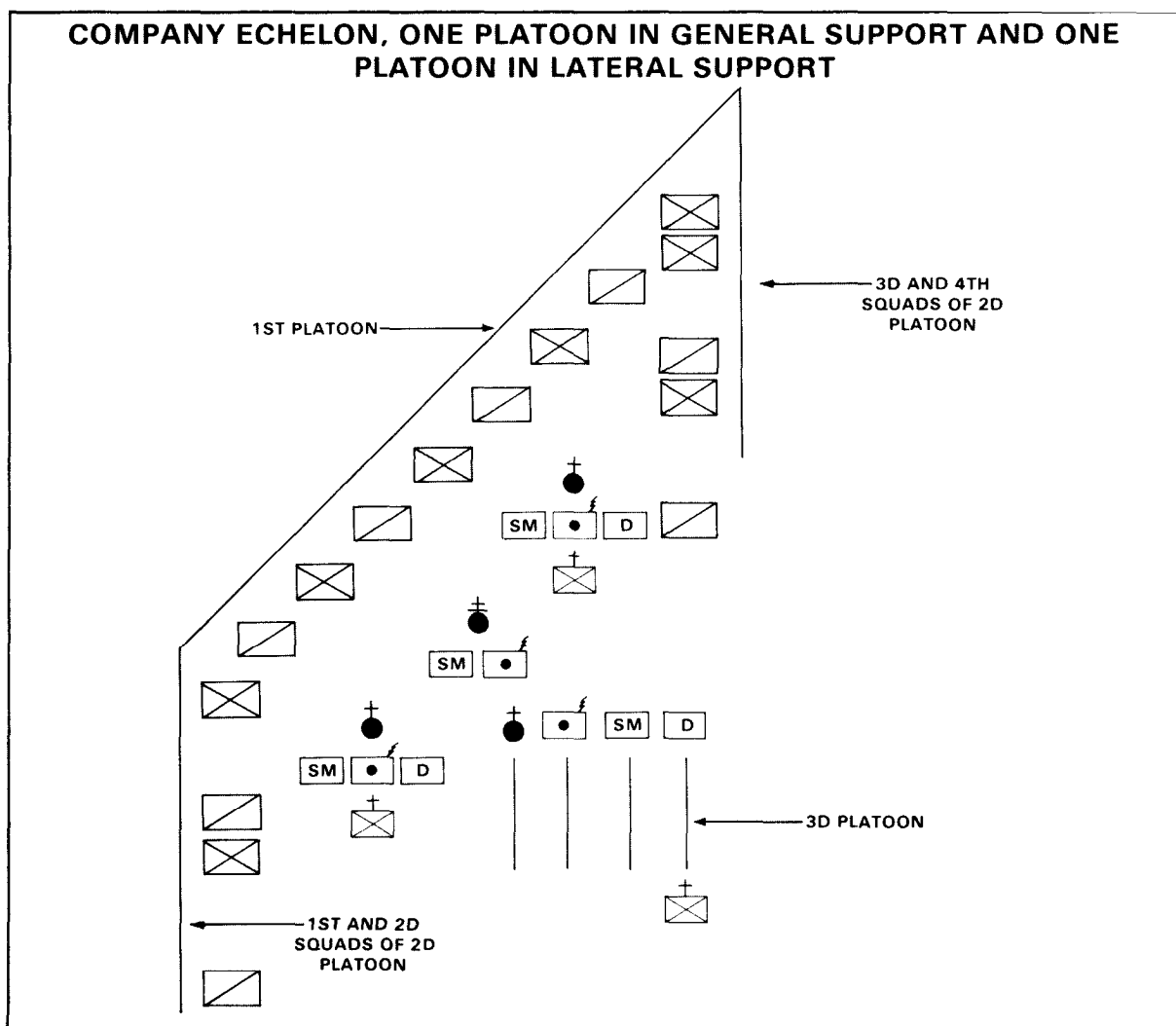

COMPANY ECHELON IN MASS, ONE PLATOON IN LATERAL SUPPORT

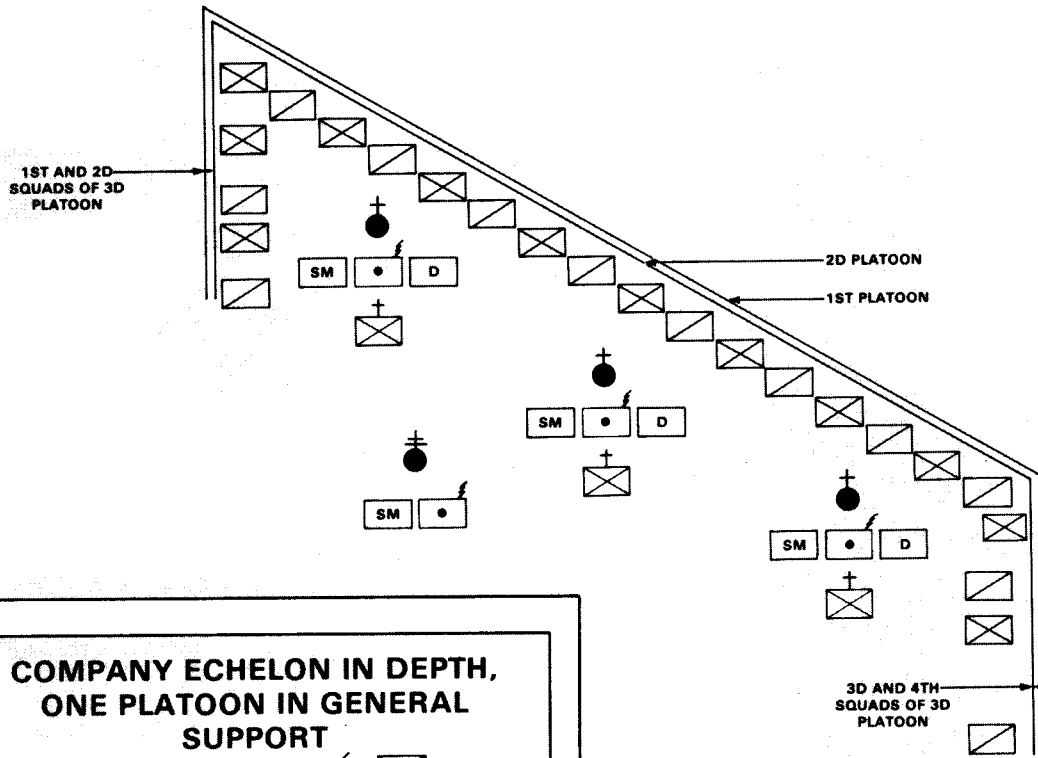

COMPANY ECHELON IN DEPTH, ONE PLATOON IN GENERAL SUPPORT

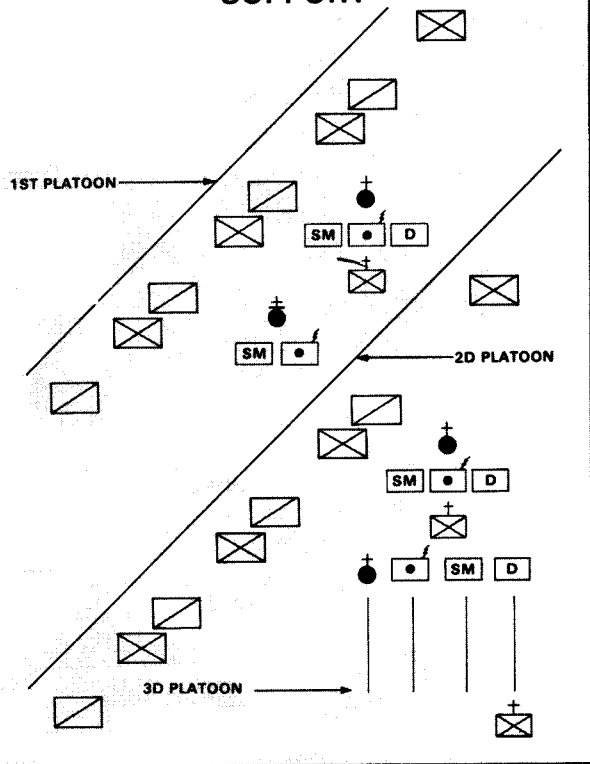

COMPANY ECHELON IN MASS, ONE PLATOON IN GENERAL SUPPORT

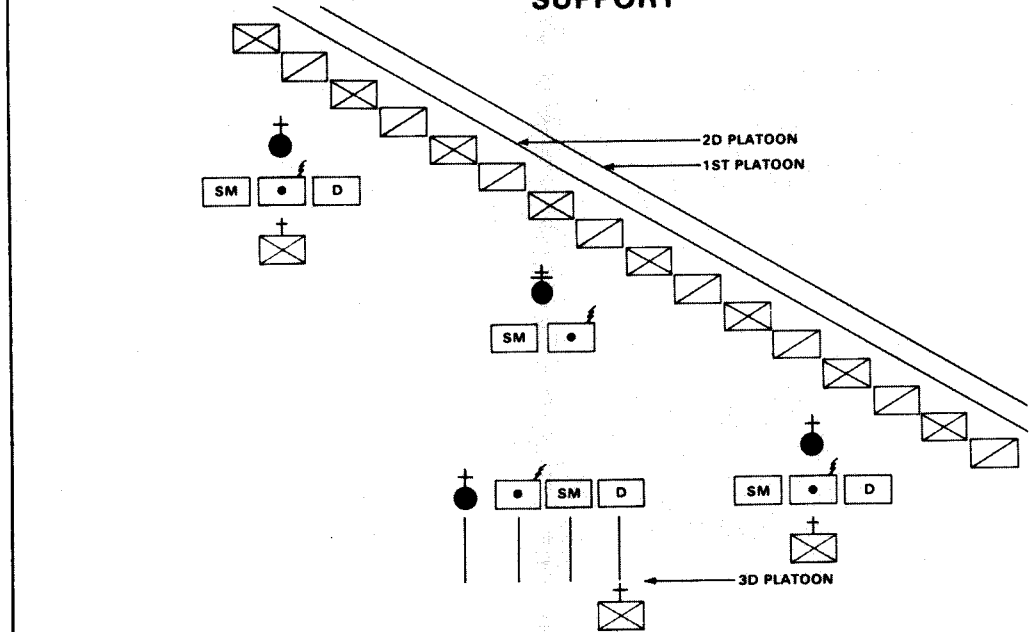

COMPANY WEDGE

WITH TWO PLATOONS IN GENERAL SUPPORT

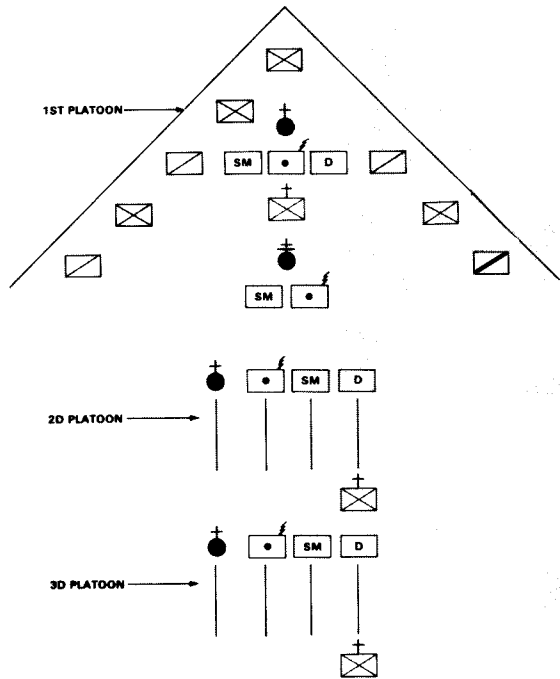

IN MASS, ONE PLATOON IN CLOSE LATERAL SUPPORT

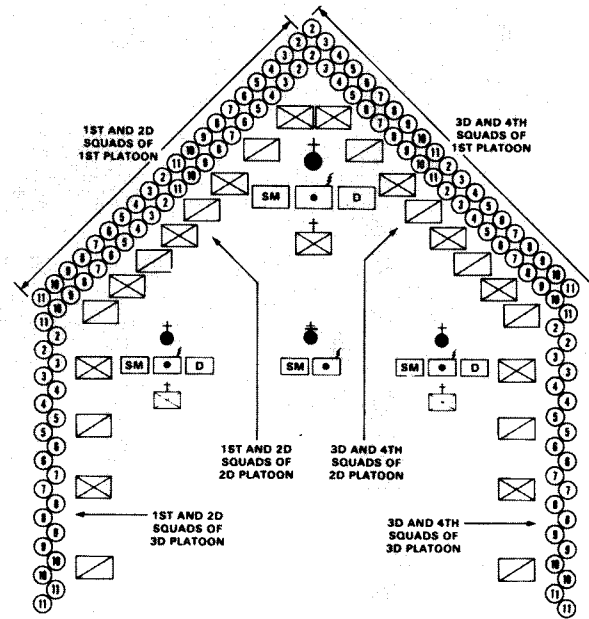

WITH ONE PLATOON IN LATERAL SUPPORT

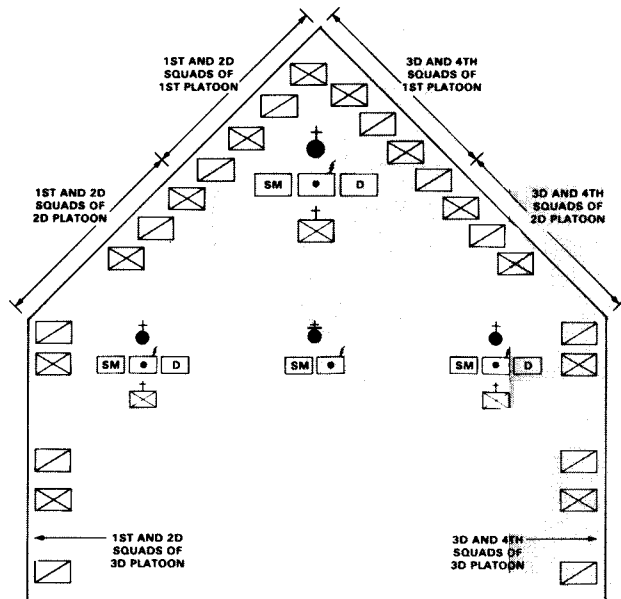

WITH ONE PLATOON IN GENERAL SUPPORT, ONE PLATOON IN LATERAL SUPPORT

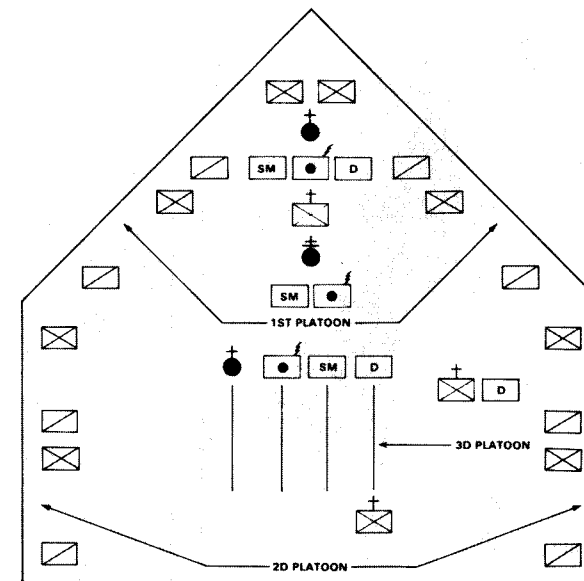

fold out

COMPANY FORMATIONS WITH VEHICLES

The commands for vehicles and foot troops are the same as for foot troops alone. Because of the additional noise and distances involved, the company commander gives the arm and hand signal for the line. The command and the signal apply to the lead platoon only. The other platoons remain in general support until further directed.

The motor section moves out first. The number two vehicle, moving to the right, passes the lead vehicle and establishes the position for the center of the line. At the same time, the third and fourth vehicles swing out to the left and right, respectively. They form to the left and right and slightly to the rear of the number two vehicle. The first and fourth squads of the lead platoon then move forward and form lines to the left and right, respectively, on the front end of the number two vehicle. As soon as the troops are in position, the third and fourth vehicles close in on the squads and tighten the formation. The second and third squads of the lead platoon then form a line to the left and right of the third and fourth vehicles to complete the company line. The command (number one) vehicle takes up a position behind the line where the commander can direct and control the unit. The second and third platoons move forward and are used in general, lateral, or close support. In some instances, the foot troops may move into position first, and the vehicles join the formation as needed.

To form company echelons or a company wedge with vehicles, the company follows the same procedures used for company formations without vehicles. Vehicles are moved into appropriate positions using procedures similar to those used for a company line.

To assemble troops and vehicles, the command vehicle moves to a position behind the formation. The commander

faces the formation and gives the vehicle section the hand signal for assembly. Immediately, the vehicles return to their proper positions in column behind the command vehicle while the troops stand fast. The second in command then assembles the troops in the usual manner.

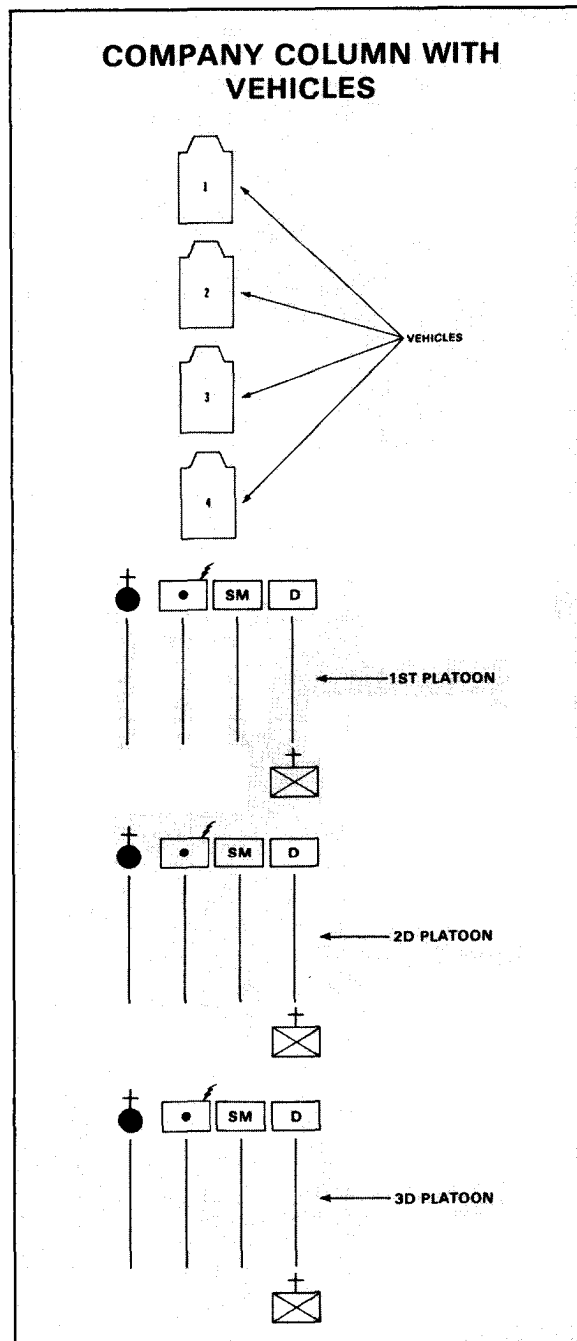

COMPANY LINE WITH VEHICLES, TWO PLATOONS IN GENERAL SUPPORT

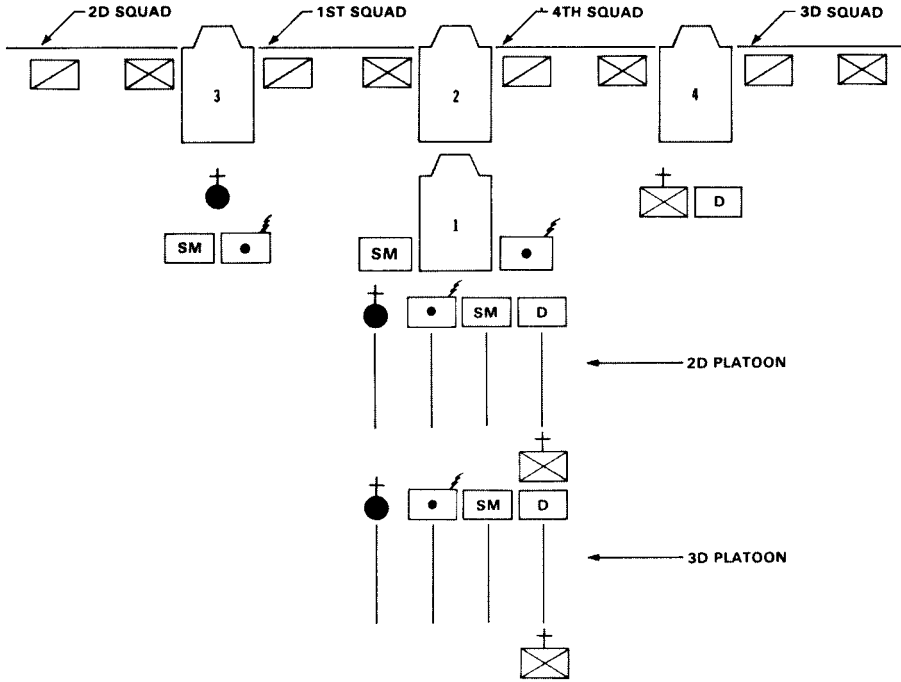

COMPANY LINE WITH VEHICLES, ONE PLATOON IN GENERAL SUPPORT, ONE PLATOON IN LATERAL SUPPORT

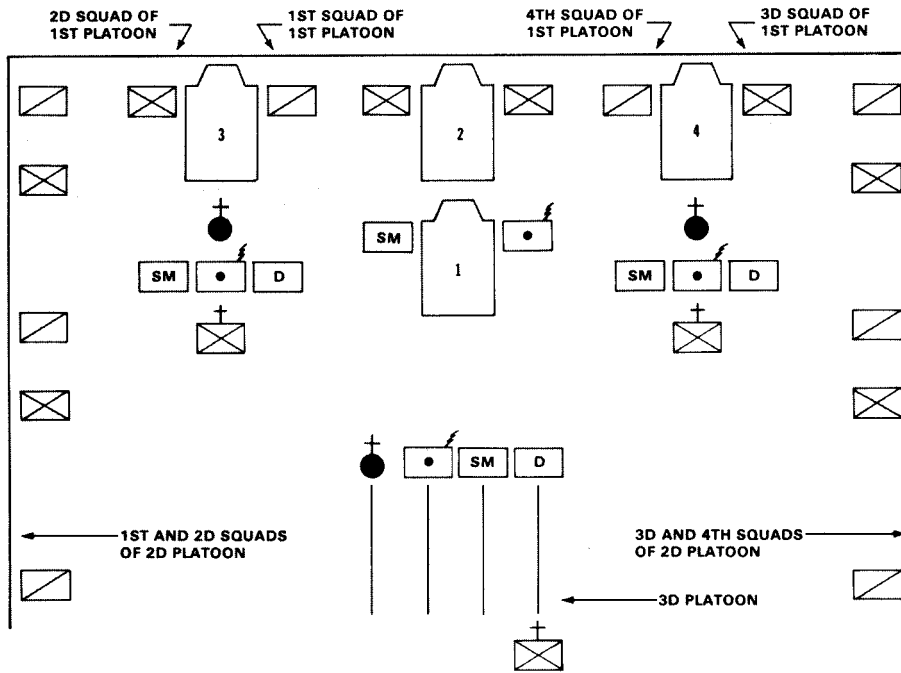

COMPANY ECHELON WITH VEHICLES, ONE PLATOON IN GENERAL SUPPORT, ONE PLATOON IN LATERAL SUPPORT

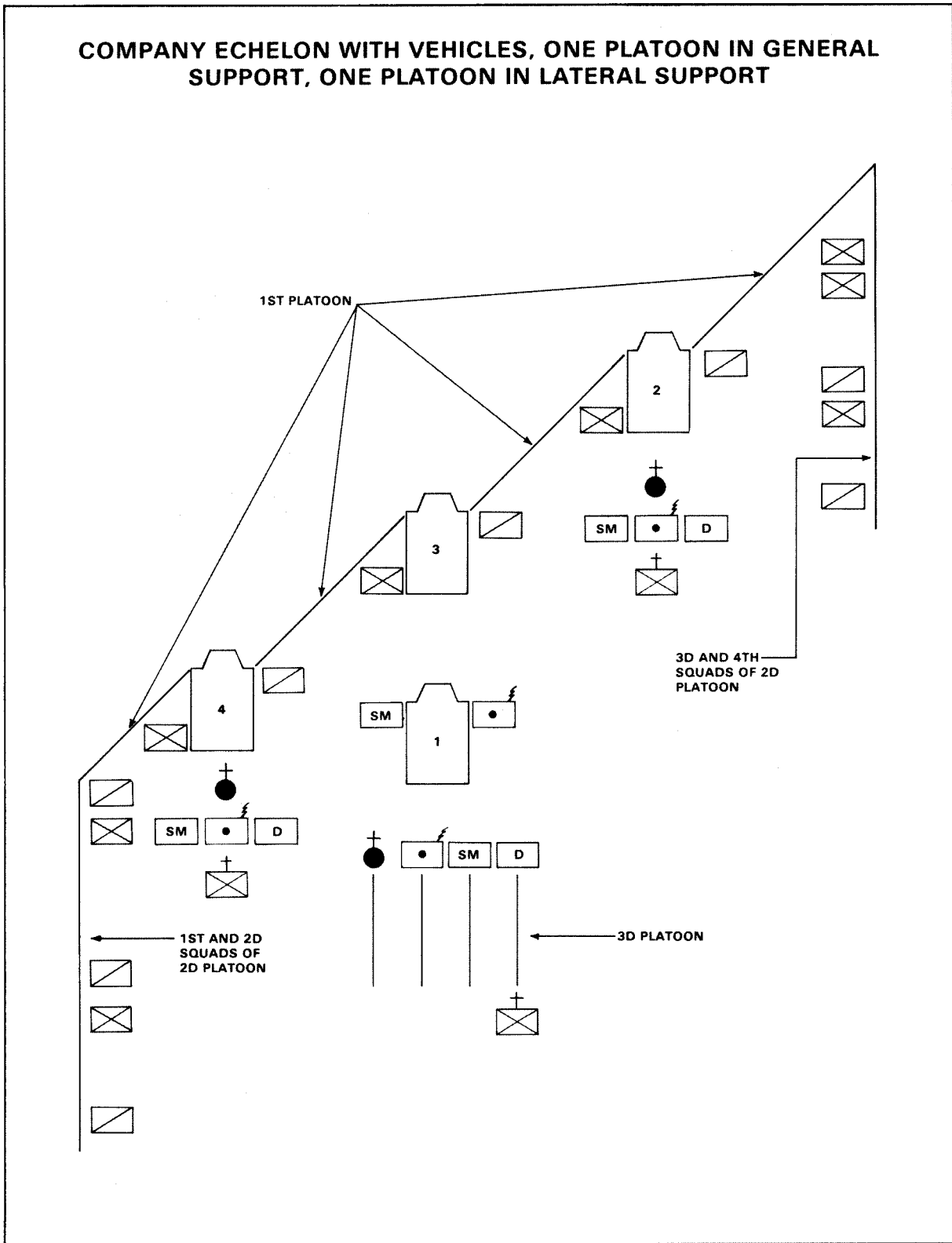

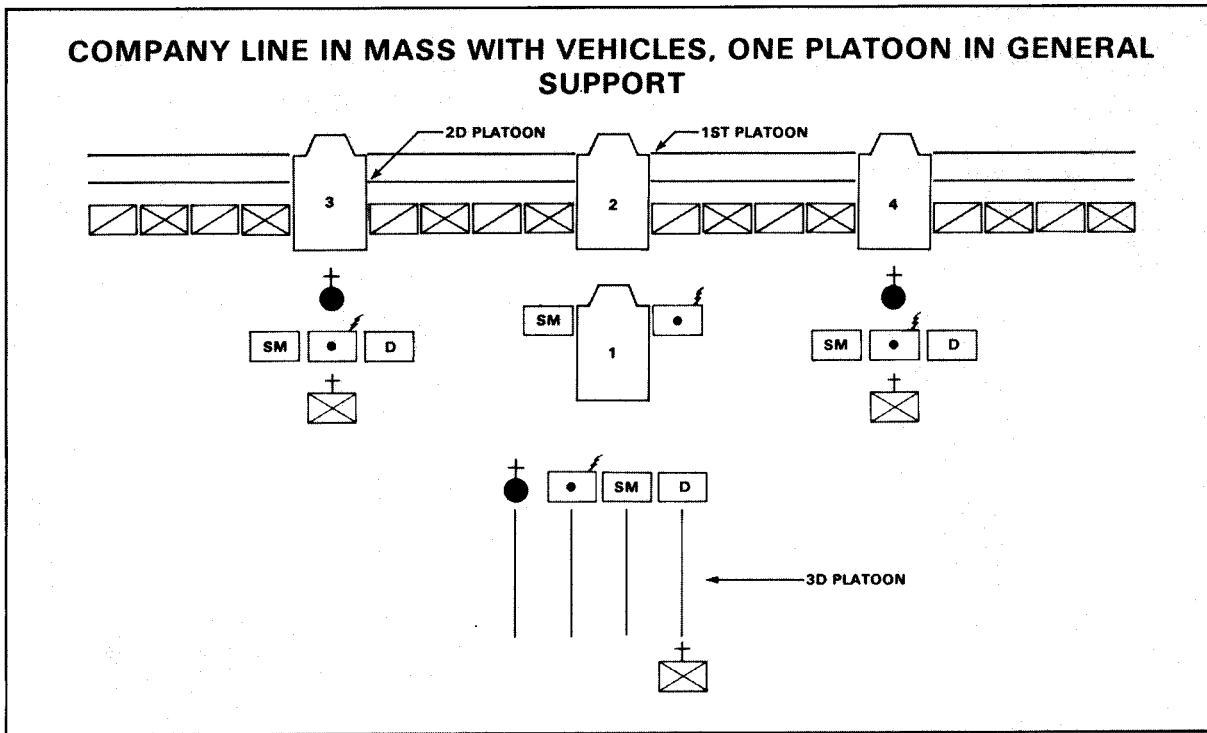

Riot Control Agents

Riot control agents or water can be used to distract, deter, or disable disorderly people. Usually their effects are temporary and disappear within minutes of exposure. The choice of whether to use a particular riot control agent or water in a given situation is based on the physical characteristics of the target area. Weather, especially wind, affects the employment of riot control agents and water.

Planning is essential for the successful use of riot control agents. The plans must be flexible to accommodate changes in the situation and the weather. Above all, strict accountability and control of the employment of riot control agents is a must. Riot control agents are employed only when the task force commander specifically authorizes their use. Employment must be strictly controlled. Every instance of employment must be duly reported.

Other planning factors are the cause, nature, and extent of a disturbance and the crowd's demeanor and intent.

Based on an analysis of these factors, the commander makes an estimate of the situation. The estimate must be as thorough as time permits. Using the estimate, the commander considers courses of action, selects riot control agents, and determines munitions needs. The main factors in choosing a course of action are the desired effects, the crowd's demeanor and intent, the weather, and the types of munitions available.

Plans also must address security of riot control agents during storage, transportation, and employment. The use of riot control agents must be coordinated with all crowd control forces. Leaders who supervise the employment of riot control agents should have wireless communications equipment.

Civil disturbance operations in cities often take place either on narrow streets or in park areas. Standard control procedures do not work well in such instances. Wind direction, the size of the area, and the proximity of health facilities may preclude the use of large quantities of riot control agents. In such cases it may be necessary to use low concentrations to break a crowd into smaller groups.

The on-site commander obtains weather forecasts for the operational area. The forecasts must cover the times when dispersal operations will be performed. The commander evaluates the forecasts in conjunction with a map, a detailed reconnaissance, an aerial photograph, or a mosaic study of the terrain in the operational area. Through his evaluation, he estimates the effects of a dispersal operation.

When dealing with large crowds, the control force's objective is to disperse the crowd and to move it in a specific direction, usually away from the disturbance area. Against large crowds, riot control agents usually are employed to cover the target area with a cloud of sufficient strength to produce decisive results. Once the proper concentration is reached, the control force must maintain that concentration until the crowd has been dispersed. When dispersers are used, the dispersal team maintains the

concentration by moving the disperser along the release line at an even rate. They maintain the concentration by repeating the application as necessary.

The control force must have a follow-up plan for exploiting the advantage gained by employment of riot control agents. Clear escape routes prevent panic and the melee that may result as the crowd scrambles for

an exit. Public address systems may be used to direct the crowd to the escape route. They also may be used to give first aid instructions. It may be necessary to move masked troops into the target area to disperse lingering groups, to prevent regrouping, or to prevent further illegal activity. During follow-up operations, troops must be ready to help unconscious or incapacitated people in the contaminated area.

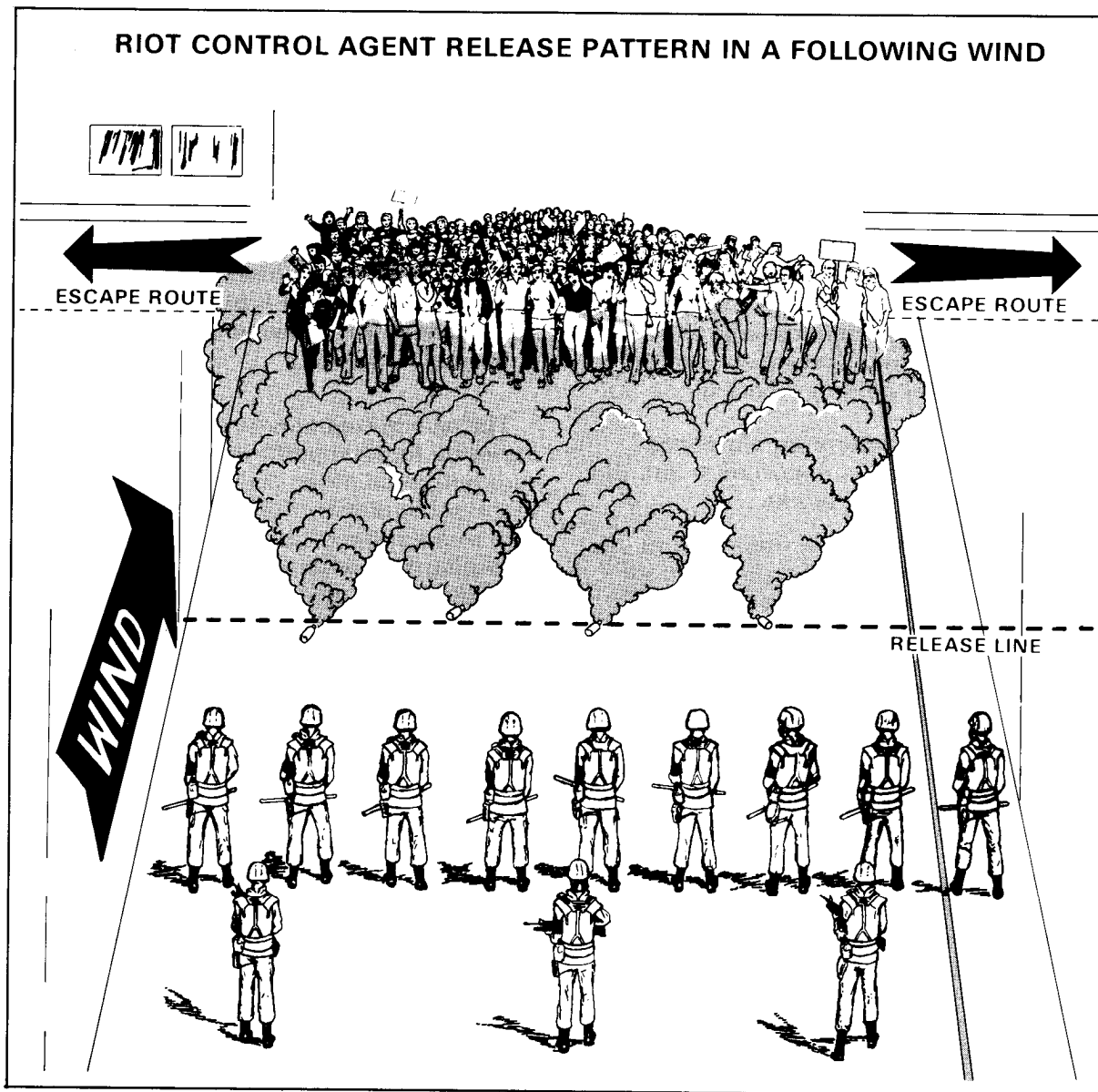

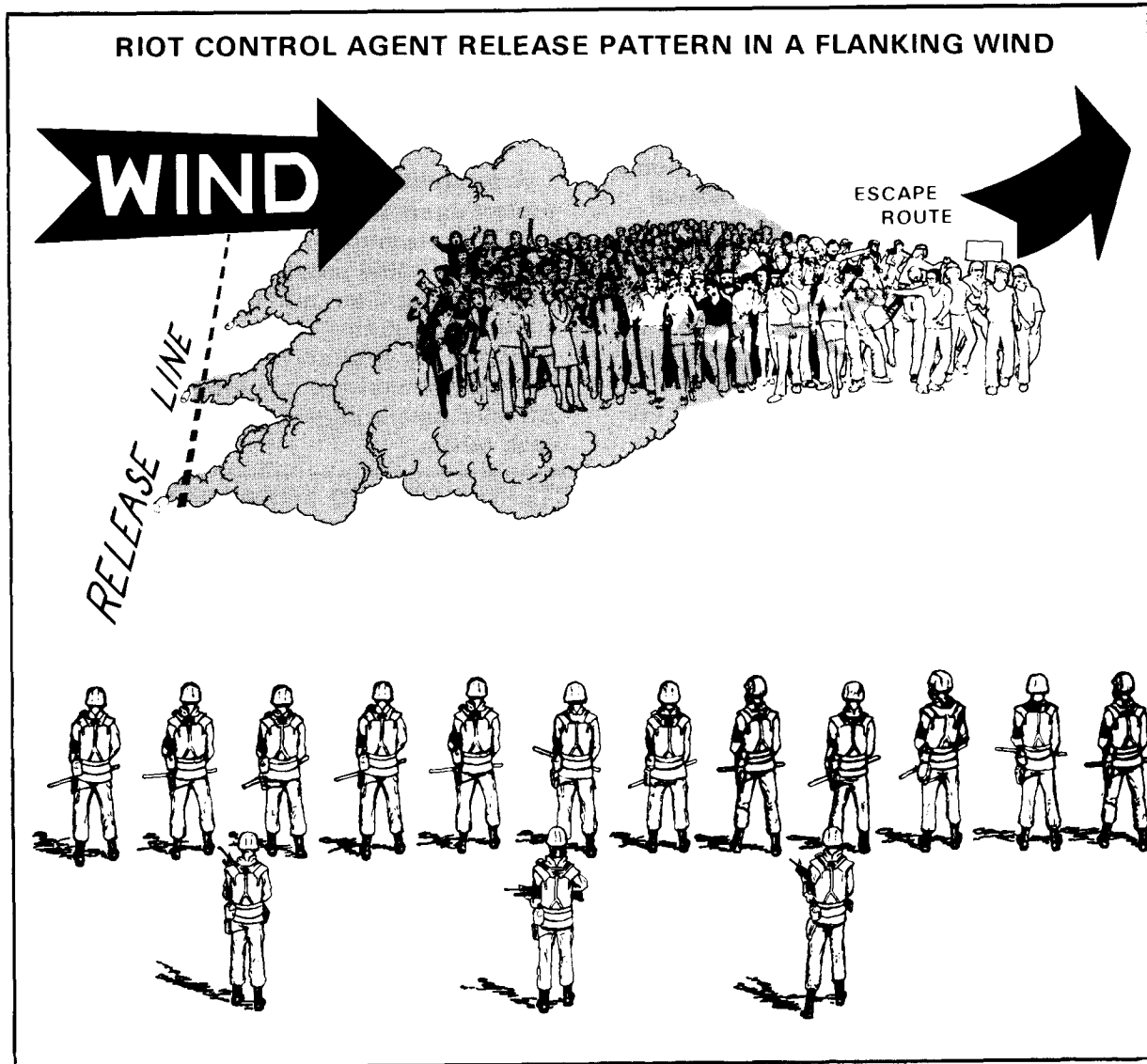

Small groups of 25 to 50 people may gather during disorders and throw objects at cars or congregate near stores that have been partially looted. Patrols can employ low-volume riot control grenades to break up small groups and temporarily prevent further misconduct. This low volume use of riot control agents enables a few troops to disperse a group without calling for more manpower and equipment. The limited use of an agent must be preceded by a careful assessment of the composition and mood of the group. If the group is highly motivated or inclined to violence, a small amount of

agent may only provoke an attack on the outnumbered patrol. High-pressure water can be effective for moving small groups on a narrow front, such as a street, and for defending a barricade or a roadblock.

When used against rioters, riot control agents must be used in sufficient quantities to produce an immediate, decisive effect. Troops using the agents must provide avenues of escape for the crowd. Except for extreme emergencies, riot control agents are not used when hospital patients or school children may be affected.

The riot control agent CS comes in two forms: a pyrotechnic mixture and a powder. It has a pungent pepperlike odor. Its persistency varies according to wind conditions. In powder form, it has greater persistency when there is no wind or when it is dispersed in wooded terrain. Its effects occur within a few seconds after exposure.

As a pyrotechnic mixture, CS is dispersed by means of an M47 hand grenade or a 40-millimeter cartridge and the M203 or M79 grenade launcher. When using the M203 or M79 and the 40-millimeter cartridge, the troops must be warned that, because of the projectile's high velocity, *it can cause*

serious injury or death at close range. Troops must exercise extreme caution when using this munition. In the powder form, CS is dispersed by means of the M47 hand grenade and by mechanical dispersers.

A protective mask and field clothing protect against the effects of CS. First aid for CS contamination is rendered by moving affected people to uncontaminated areas, facing them into the wind, and cautioning against rubbing the eyes or touching the genitals or mucous membranes. Showers provide further relief. Affected people should be kept away from each other.

RIOT CONTROL AGENT CHARACTERISTICS AND TREATMENT		
	CS	CR
DELIVERY MEANS	Delivered by hand grenades, rifle grenades, ring airfoil soft projectiles, or as a dry spray by M33A1 or M5 disperser	Delivered as a wet spray or stream by M33A1 or M36 disperser
EMPLOYMENT CONDITIONS	Has greatest effect when there is little or no wind; effectiveness greatly diminished by rain	Is effective under all conditions except high winds; effectiveness only slightly diminished by rain
PERSISTENCY	Varies according to wind conditions; powder form persists longer in still air and in wooded terrain Is not to be used in buildings, near hospitals, or in areas where lingering contamination could cause problems	Lingers in air, long lasting, and less likely windblown; extremely persistent on surfaces Is not to be used in buildings, near hospitals, or in areas where lingering contamination could cause problems
TIME TO MAXIMUM EFFECT	Requires 20 to 60 seconds	Acts immediately on exposed areas
DURATION OF EFFECTS	Lasts 5 to 10 minutes	Lasts a few minutes when victim is moved to an uncontaminated area
EFFECTS	Causes extreme burning sensation in the eyes, abundant flow of tears, coughing, breathing difficulty, tightness in chest, involuntary closing of eyes, stinging sensation on moist skin areas, sinus and nasal drip, and nausea and vomiting on exposure to high concentrations, especially when ingested	Causes irritation of nose and throat; stinging sensation of skin; and irritation of respiratory system, including coughing, chest pains, and feeling of suffocation
MINIMUM PROTECTION	Requires protective mask and field clothing	Requires protective mask, hood, and rubber gloves
FIRST AID	Move victim to uncontaminated area, face victim into wind, caution victim not to rub eyes; keep affected people well apart; have victim shower first with cool water for 3 to 5 minutes, then proceed with normal showering, for gross contamination, flush body with large amounts of cool water, then wash with a 5% sodium bisulfite solution (except in and around eyes), and flush again with water (a 1% solution of sodium carbonate or of sodium bicarbonate may be substituted for the sodium bisulfite solution)	Move victim to uncontaminated area, flush eyes with water, check eyes for abrasions, shower well or wash and scrub exposed areas with soap and water; get victim to doctor if reaction persists WARNING: Household bleach (sodium hypochlorite solution) is NOT to be used in wash or rinse water to decontaminate clothing, equipment, or people. CR and household bleach react to produce a harmful vapor

GRENADES

There are two types of riot control grenades in the Army inventory, a burning type and a bursting type. In a wind of about 6 miles per hour, a burning-type grenade can cover an area about 5 meters wide to a downwind distance up to 25 meters. At the same wind speed, a bursting-type grenade can cover an area about 10 meters wide to a downwind distance up to 25 meters.

Burning-type CS grenades and agent dispersers are the means usually employed against large crowds. Bursting-type grenades may be used for psychological effect or to discourage crowd members from trying to throw back grenades.

Burning grenades are thrown by hand or delivered by a grenade launcher to the upwind side of the crowd. Burning grenades must not be thrown into a crowd because they can be picked up and thrown back. Bursting grenades are thrown into the air so that they burst several feet above the crowd.

When the control force is in almost direct contact with the crowd, burning grenades are not used. Either the grenades will be thrown back at the control force or the front ranks of the crowd will be driven into the control force. In this situation, dispersers are used if conditions favor their use behind disturbance control lines.



DISPERSERS

Dispersers provide commanders with a means of disseminating riot control agents in sufficient quantities to provide effective coverage in a variety of situations and conditions. But their use is limited to outdoor areas. Control force leaders must

be careful when employing riot control agents in confined areas and in areas with restricted avenues of escape. Dispersers usually are transported by soldiers, by 1/4-ton or larger vehicles, or by helicopters. When transported on the ground, the

dispersers may be directly integrated into the crowd control formations. Or they may be operated in direct support of civil disturbance operations. Helicopter-mounted dispersers are used in close conjunction with the control force. The exact placement of the aircraft with respect to the formation is determined by current wind direction and speed and by physical obstacles that may restrict the movement and positioning of the aircraft.

All unit members should know the operation and employment capabilities of the riot control agent dispersers. But the unit must depend on specially selected and trained soldiers. The criteria for selecting disperser operators include initiative, ability to learn, and the ability to deal with large numbers of agitated people calmly.

The disperser operator works under the immediate control and direction of an officer or an NCO. Riot control agents are released only on the direct orders of the commander. If the commander is not fully qualified in employing riot control agents, a qualified officer must be designated to determine the appropriate time, place, and amount of agent to be released and to issue appropriate commands to the operators.

Disperser operators and dispersal team members must be well qualified in their primary MOS and thoroughly trained in riot control operations. Preferably, they should receive special training in the use of riot control agents.

Riot control agent dispersers can release a large amount of riot control agent in a very short time. Operators must be especially careful to avoid releasing intolerable concentrations of the agents. The operators must determine the average release rate for each disperser in terms of pounds of the agent released per second. The dispersers are not used to deliver riot control agents directly into a closed structure except in extreme circumstances.

Commands are given the disperser operators by voice or by hand and arm

signals. The troop commander maintains radio contact with the officer or NCO who is in command of the crowd control formation or of the disperser operators.

Troops who are involved in filling, operating, or transporting dispersers wear ordinary field uniforms with collar and cuffs buttoned and trouser legs tucked into their boots. They also wear a protective mask, a hood, and rubber gloves for protection.

The commander must decide which riot control agent will be used in each disperser before the mission begins. Wet and dry agents cannot be interchanged in the same disperser during a civil disturbance mission. Not only must nozzles be changed, but the whole system must be decontaminated before changing types of agents. For further information on decontamination procedures, see FM 3-5.

To ensure the dispersers operate properly, operators must perform inspections and maintenance systematically each time the equipment is used. They also service the equipment periodically whether it has been used or not. Because of the corrosive effects of some riot control agents, the agents must be removed from the surface of dispersers and the vehicles or helicopters that dispersed the agents. Detailed maintenance, inspection, and repair instructions can be found in the applicable technical publications.

M36 DISPERSER

The M36 disperser, like other aerosol irritant dispersers, serves as an alternative to traditional weapons, such as nightsticks, riot batons, and firearms. As with other riot control weapons, the M36 must be backed at all times by troops with weapons of greater force.

The M36 disperser is a lightweight, aluminum and plastic container filled with pressurized CR solution. It is small enough to be carried and operated with one hand.

To use the M36, the soldier holds the can upright, aims at the person's face, and presses the activator button. The stream of wet CR vaporizes. It causes a temporary, reflexive closing of the eyes, tearing, and a burning sensation on the skin and in the upper respiratory tract.

The most effective way to use the M36 is in one-second bursts. The maximum range is 10 to 12 feet. This allows the soldier to adjust his aim with a minimum waste of the riot control agent. The soldier must not spray a person for *more than five seconds when closer than 3 feet*. After being subdued, the person can best be decontaminated by facing the wind or by generous flushing with water for several minutes.

See FM 8-285 for more information on first aid procedures.

Troops using the M36 must be thoroughly trained in the use and hazards of the disperser. Training must include situations in which the M36 may be used, how to use it, a demonstration of the stream trajectory, safety requirements, and decontamination procedures. Because the use of the M36 does not cause immediate incapacitation, training on tactics and disperser limitations is necessary.

The disperser is carried and stored in a compact vinyl case with a sna button and a belt loop. The ammo pouch may be used as a field expedient carrying case.



M33A1 DISPERSER

The M33A1 disperser is a lightweight, portable riot control agent disperser that uses either dry or wet riot control agents. The agent is released through a nozzle on a hand-held gun assembly. Different nozzles are used for the powder and the liquid. The special nozzle for the wet agent allows the

operator to vary the amount and range of the solution by choosing spray or stream. The operator controls dispersal by varying the pressure on the trigger.

The hose and gun group controls the amount of riot control agent released. The agent may be released in a continuous

stream or spray or in short bursts ranging from less than one second to several seconds. Operators must determine the particular release rate for each disperser that they operate, both for talc and for riot control agents.

Worn as a backpack, the M33A1 looks and functions like the portable M33 disperser. The difference lies in the units' capabilities. The M33A1 disperser's modular design allows quick replacement of empty agent and pressure containers. The M33A1 can use either dry or wet agents without having to modify the unit itself. The M33A1 is replacing the M33 on a one-for-one basis as the M33s wear out.

The effective use of the M33A1 depends on a following or slightly quartering wind with a speed of less than 20 miles per hour.

M33A1 EMPLOYMENT DISPERSING A WET CR STREAM

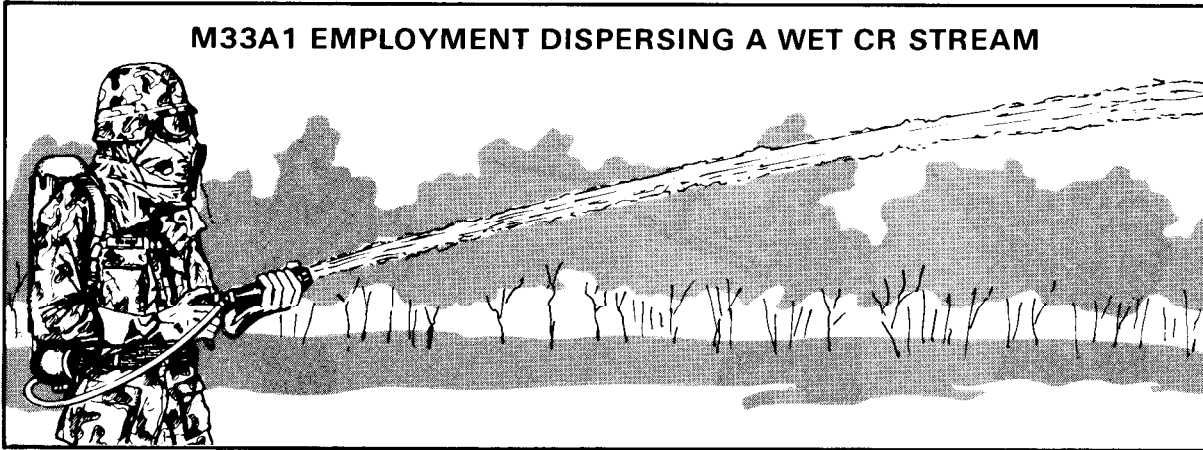

M33A1 EMPLOYMENT DISPERSING A DRY CS SPRAY

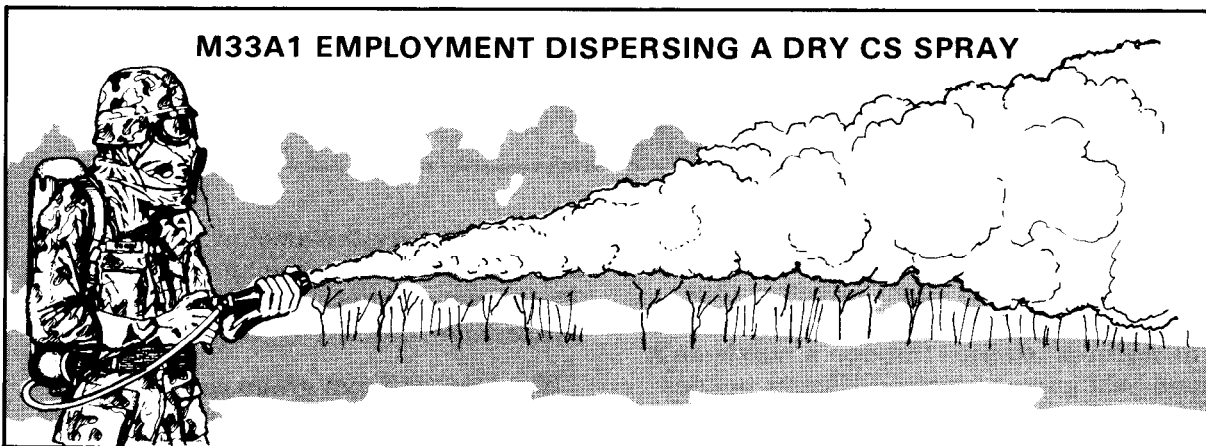

Optimum wind speed is 3 to 5 miles per hour. Usually, the use of this disperser is backed up by other dispersers to ensure adequate coverage of the target area.

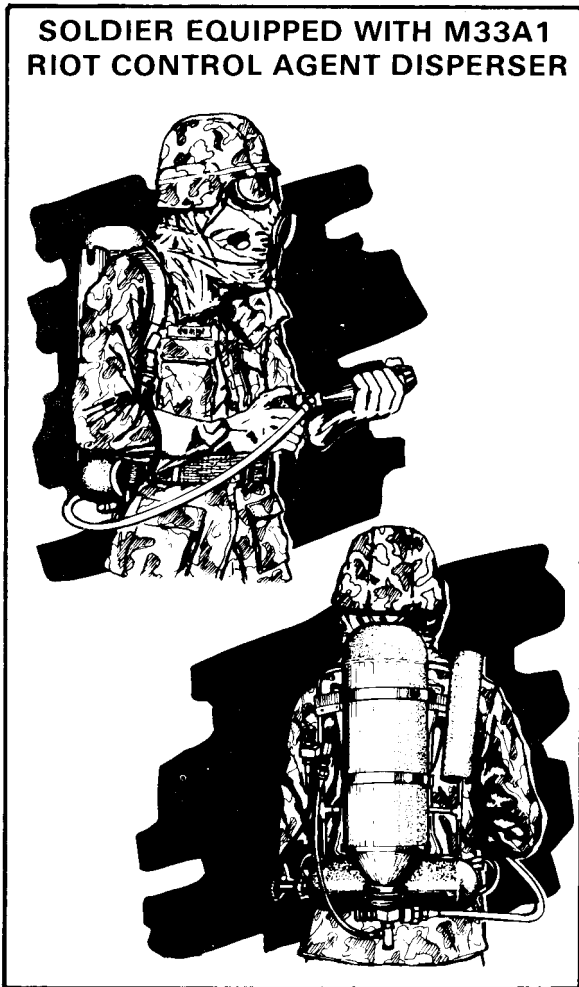

The agent tank and the air pressure bottle both have a quick-disconnect capability. But unless there are sufficient tanks and bottles available, the disperser may be out of action for a period of time, depending on the location of the compressor and the soldiers' ability to reload and repressurize the disperser. Because of its compactness, portability, and low cost, the M33A1 provides the user with an immediately available and very effective crowd control weapon.

The disperser operator may be positioned in front of, as a part of, or behind the crowd control formation. Proximity to the crowd and the disperser's role determine where the disperser is placed. When riot control agents are employed in advance of a close approach by the crowd control formation, the disperser operator may be a part of, or slightly in front of the formation. These positions give the operator the greatest freedom in using the disperser. It also minimizes troop exposure. Freedom to move right and left may help to disperse a more uniform cloud over the target. It also allows, to a limited extent, coverage over specific sections of the target area. If the disperser is to be held in reserve, the operator is positioned from one to several feet behind the center of the formation. From this position, the operator can quickly move to the front of the formation. When the disperser is not being used, the operator moves behind the formation for protection from thrown objects.

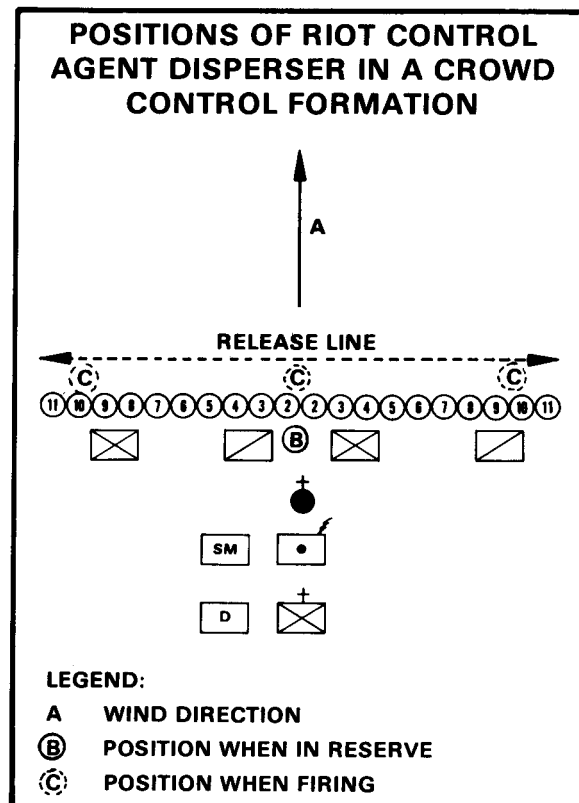

The optimum distance for firing the disperser to produce the greatest effect depends on the wind speed and the operator's freedom of movement across the front of the target area. Generally, the distance of the agent release point or line from the target area ranges from 15 meters to 100 meters or more depending on wind speed. As wind speed increases, dilution of the powder becomes more rapid. When this occurs, the distance between the target area and the release point must be reduced to place an effective concentration on the target.

Factors that affect the amount of a particular agent needed to produce an effective concentration are too varied to permit exact guidance. However, the operator must understand the agent's effectiveness, the amount that can be

released in a given time, and the makeup and determination of the crowd. The operator also must closely observe the agent's dispersal pattern and effect on the target. Too heavy a concentration may result in reaching a tolerance inconsistent with objectives. Too weak a concentration, particularly against an organized and determined group, may encourage more violence.

M5 DISPERSER

The M5 riot control agent disperser consists of an M9 portable disperser gun for vehicles or a delivery hose for helicopters, a tank that holds approximately 50 pounds of CS, a hose assembly, a pressure tank, and a pressure regulator. These components are mounted on a tubular frame. The complete unit measures approximately 4 feet by 2.5 feet by 2 feet.

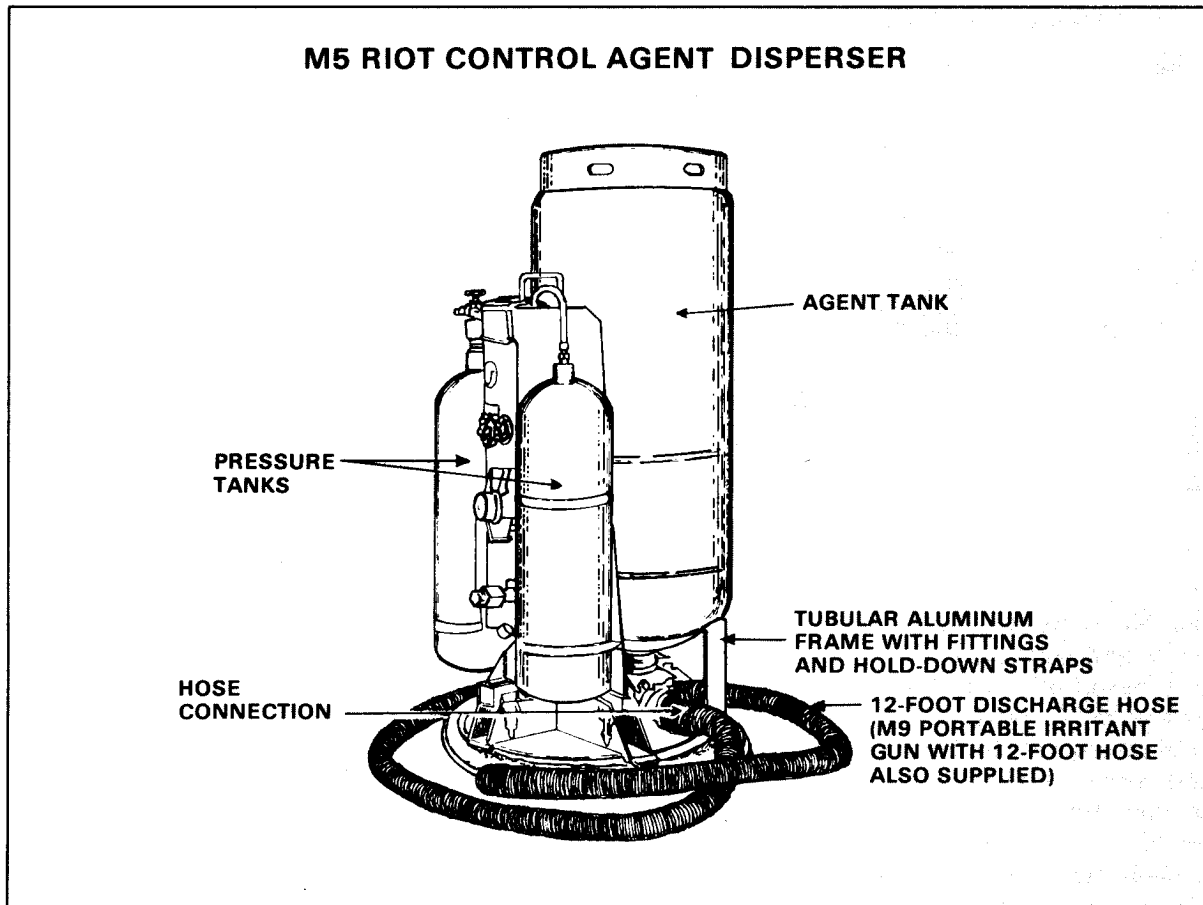

The M5 disperser has an effective range of 12 meters when dispersed with the M9 gun during calm winds. It is effective to 46 meters when dispersed from a helicopter at an absolute altitude of 24 to 30 meters. The duration of fire per fill is two minutes with the M9 gun and 20 seconds with the helicopter delivery hose. The disperser plus the agent weighs approximately 210 pounds. The M5 disperser can be mounted on a helicopter or on a 1/4-ton or larger vehicle. See TM 3-1040-220-12&P for more information.

The M5 disperser provides an air-to-ground dispersal capability when mounted in a helicopter. Situations best suited for the employment of the helicopter-mounted M5 include large-scale civil disturbances requiring large quantities of riot control agents and conditions that prevent its use on the ground.

When a helicopter is used, the agent can be released from either a hovering position above or on the windward side of the target area or along a line above or on the windward side of the target. When mounted on a vehicle and employed against open-area targets, the disperser is operated from positions slightly in front of or in the crowd control formation.

The release of riot control agents from a helicopter must be far enough in front of the crowd control formation that the agent dissipates shortly before the formation arrives. The location of the release point or line with respect to the target is determined by wind speed and direction and by physical obstacles. Other factors include the effects of the rotor wash on dispersal and the ground speed of the helicopter.

Initial release of the agent when hovering over the target is accomplished in short bursts of three to five seconds duration. The operator watches the crowd's reactions to determine the number and length of subsequent bursts. When hovering to the windward side of the target, the same procedure

is followed, except the agent may be released in slightly longer bursts. Release of an agent along a line must begin in time to assure coverage of the side of the target being approached. Dispersal must cease shortly before reaching the far side of the target. This helps avoid dispersal over areas other than the target. The exact moments for beginning and for ceasing the release are governed by the helicopter's speed and by wind speed and direction. Operating dispersers from a helicopter while it is hovering or flying at speeds less than effective translational lift speed when in ground effect may contaminate the helicopter, the crew, and the occupants due to circulation of the agent in the rotor wash. Therefore, *either the pilot or the co-pilot must wear a protective mask.*

The agent may be released from one or more stationary ground positions or along a line on the windward side of the target. When released from a stationary point, the agent is dispersed in intermittent bursts as the gun muzzle is swung through an approximate 160° arc to the front. When dispersed along a line, the agent may be released continuously or intermittently, depending on the agent used, the rate of movement, and the wind factors.

Commanders and disperser operators must ensure that the target area is not covered with an intolerable concentration of riot control agents. This is particularly true when the wind lies calm and when the target area is partially enclosed by buildings. Also, the operator must remember that 1 pound of CS is the equivalent of five bursting-type CS grenades and, further, that 50 pounds of CS can be released in two minutes or less with the M5.

The M9 gun group is used when mounted with the M5 on a vehicle. The M9 permits close control of the amounts of agent released. Operators must determine the release rate for each disperser that they operate.

Each M5 dispersal team has three members: a commander who is an officer, an operator who is an NCO, and an assistant

operator. Inclusion of the vehicle driver the helicopter pilot as a member of the team is desirable, but not mandatory.

DUTIES OF M5 DISPERSAL TEAM	
TEAM COMMANDER	<ul style="list-style-type: none"> • Supervises operation, employment, and maintenance of the M5 disperser. • Reconnoiters target area and prepares employment plans. • Supervises movement of equipment to operation site and assigns soldiers to specific jobs. • Selects the release point or line. • Controls the amount of riot control agent released. • Observes and evaluates dispersed agent to ensure proper coverage and concentrations without interfering with the control force's mission. • Teaches or demonstrates operating techniques and procedures. • Supervises and conducts team training. • Supervises the preparation of records and reports related to the disperser's operation.
OPERATOR AND ASSISTANT OPERATOR	<ul style="list-style-type: none"> • Operate and maintain the disperser. • Operate and adjust the disperser to get the best possible control agent dispersal pattern. • Inspect and test defective equipment or components to determine types and causes of malfunction, extent of repairs needed, and quality of repair work performed. • Clean, make minor adjustments, and replace defective parts using common hand tools. • Make final adjustments to equipment for optimum operation. • Estimate needs for maintenance supplies.

WATER

When using water, a number of factors must be considered. The Army does not have a water-dispersing system that is specifically designed for use in civil disturbance operations. Such a system can be improvised from existing equipment. The use of a large water tank—750 to 1,000 gallons—and a powerful water pump mounted on a truck with a high-pressure hose and a nozzle capable of searching and traversing enables troops to employ water as they advance. By having at least two such water trucks, one can be kept in reserve.

Employing water as a high-trajectory weapon, like rainfall, is highly effective

during cold weather. When using water, as with other measures of force, certain restraints must be applied. Troops try to avoid using water on innocent bystanders like women and children. When water is used, the troops must provide the crowd with escape routes. Troops employing water must be protected by formations and, in some instances, by shields. The more severe use of water, the flat trajectory application, is employed only when necessary. Because fire departments are associated with saving lives and property rather than maintaining law and order, *fire department equipment must not be used for crowd control and dispersal.*

Riot Batons

The riot baton is an invaluable weapon in crowd control situations. Except for extremely violent crowds, the baton in the hands of well-trained troops is the most appropriate weapon. The riot baton is not meant to replace the rifle as the main weapon used by control forces. Rather, the riot baton is used in situations in which the rifle is not needed. The presence of rifles, with or without bayonets, tends to escalate the intensity of a civil disturbance. And unlike the rifle, the loss of a baton to the crowd does not present a serious threat.

Most control forces are armed with riot batons. This very versatile offensive weapon can be from 26 to 42 inches long. But the optimum length is 36 inches. The baton is made from any dense hardwood like rosewood or walnut that does not shatter or break easily. Both ends of the

baton are rounded to prevent unnecessary injury. The suggested diameter of the baton is 1.25 inches. A hole is drilled 9 inches from the grip end. The wrist thong is inserted through the hole. Either one or both ends of the baton should have a series of rounded ridges to aid gripping.

EMPLOYMENT

The use of the baton is based on the commander's appraisal of the situation and his choice of a force option. Units committed with the baton must have marksmen and riot control agent teams in direct support. If the confrontation is intense, the commander also may elect to have reserve forces with rifles or shotguns, with or without bayonets, positioned for rapid reinforcement.

The riot baton is used by units that are employed defensively to protect people and property. During the termination phase of the disturbance when the violence has subsided and is expected to stay that way, troops are in a defensive posture. They may be equipped with the riot baton to perform their tasks.

The riot baton can be used in offensive crowd control formations. It can be employed so that the unit confronting the crowd is equipped with rifles and bayonets. Or it can be employed so that the element

in direct contact with the crowd is equipped with batons, and the supporting element is equipped with rifles and bayonets.

The riot baton is never the only weapon available to control forces. An element deployed with riot batons must have a marksman as a precaution against snipers. Reserve forces with rifles and bayonets must be available for immediate employment. The commander must be able to withdraw the riot baton elements, issue them other weapons, and redeploy them as a ready reserve force.

The riot baton, in the hands of trained troops, is a formidable weapon. But it must be used in conjunction with other measures to be most effective. The soldier who is skillful in using the riot baton can adequately cope with most situations that require physical restraint. Troops must be trained with the riot baton to the point that they use the various techniques automatically.

Troops using riot batons must have a thorough knowledge of the vulnerable points on the human body. Troops must deter, discourage, or disperse individuals threatening their position. But they must try to avoid blows that could kill or permanently injure.

When deployed, troops usually avoid any riot baton techniques that could result in

death or permanent injury. The riot baton is *never raised above the head* to strike an adversary in club fashion. Not only is this likely to cause permanent injury, it also projects an unfavorable image of the control force. Also, the soldier is vulnerable to an attack on his rib cage when his arm is raised.

VULNERABLE BODY POINTS

FRONT OF BODY

- 1 ABOVE CLAVICLE
- 2 SHOULDER
- 3 OUTER BICEP
- 4 RIBS
- 5 SOLAR PLEXUS
- 6 INNER ELBOW
- 7 FOREARM
- 8 HAND
- 9 GROIN
- 10 THIGH
- 11 KNEECAP
- 12 SIDE OF CALF
- 13 SHIN
- 14 ANKLE FRONT
- 15 TOES

REAR OF BODY

- 16 BEHIND SCAPULA
- 17 KIDNEY
- 18 COCCYX
- 19 BEHIND KNEE
- 20 CALF MUSCLE
- 21 ANKLE TENDON
- 22 ANKLE BONE

FATAL IMPACT POINTS

A HEAD

B SIDE OF NECK

C THROAT

D HEART AREA

E ARMPIT

BATON GRIP AND POSITIONS

Three steps are necessary to obtain a secure grip on the riot baton. First, the thong of the baton is placed around the right thumb. Then the baton is held so the thong hangs over the back of the hand. Finally, the hand is rolled into the baton handle so that the thong is pressed into the palm of the hand. This method of gripping the baton provides a secure grasp. The baton can be released quickly by simply relaxing the hand.

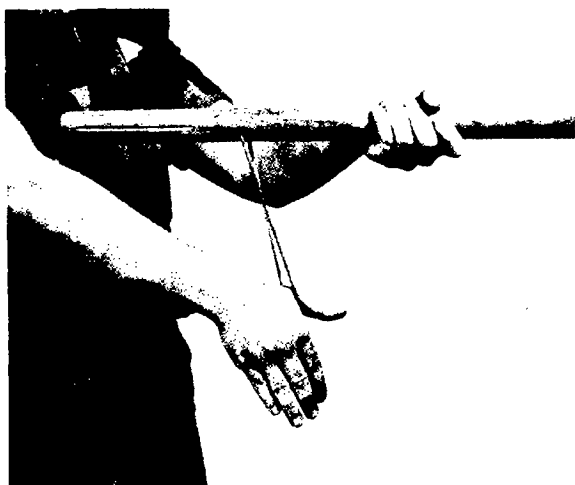
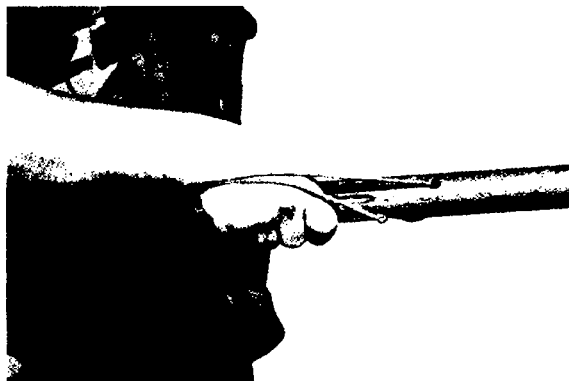

PARADE-REST POSITION

Parade rest is the relaxed ready position. The feet are shoulder width apart. The left palm is facing out. The right palm is facing in toward the body. The hands are approximately 6 inches from the ends of the baton.



PORT POSITION

The port position is a ready position. It is particularly well suited for individual defense. The right hand and forearm are parallel to the ground. The left hand is level with the left shoulder. The striking end of the baton bisects the angle between the neck and the left shoulder. The baton is held approximately 8 inches from the body. The feet are shoulder width apart.



ON-GUARD POSITION

The on-guard position is the ready position. It should not be maintained for long periods of time because it is tiring. To assume the position, the left foot is placed forward of the right foot. The feet are spread apart, and the knees are slightly bent. The right hand and the butt end of the baton are placed snugly against the hip. The body is bent slightly forward at the waist. The left arm is bent so that the forearm protects the soldier's throat area, yet allows a thrust to be made.



OFFENSIVE TECHNIQUES

Control forces use one of four techniques when employing riot batons in offensive operations. They perform the short thrust, the long thrust, the butt stroke, or the baton smash.

SHORT THRUST

The short thrust is made from the on-guard position. The body is thrust forward rapidly by advancing the left foot. The left arm is snapped straight, driving the striking end of the baton into a selected vulnerable point of the opponent's body. The soldier must never direct the thrust directly at the central throat area because it can cause permanent injury or death. The soldier returns to the on-guard position after delivering the short thrust.



LONG THRUST

The long thrust is made from the on-guard position. The body is thrust rapidly forward by advancing the right foot. The baton is held in the right hand. The baton

is snapped forward, driving the striking end of the weapon into a vulnerable point of the opponent's body. The soldier returns to the on-guard position after delivering the long thrust.

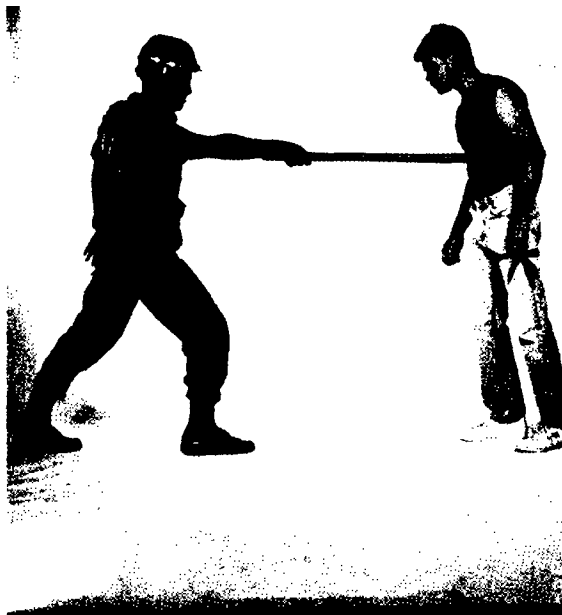

BUTT STROKE

The butt stroke is delivered from the on-guard position. The right hand is elevated until the baton is almost parallel to the ground. The butt stroke is made by advancing the body rapidly off the right foot. The right arm is snapped straight. The butt end of the baton is driven to the left, striking the opponent's shoulder, chest, or jaw. The left hand is kept even with the left shoulder. The butt stroke may be fatal to the opponent if either the side of the neck or the head is struck. After delivering the butt stroke, the soldier returns to the on-guard position.



smash is executed by advancing the left foot rapidly. Both arms are snapped straight, smashing the length of the baton across the opponent's chest. After delivering the smash, the soldier returns to the on-guard position.



BATON SMASH

The baton smash can be delivered from the parade-rest, the port, or the on-guard positions. The baton is held horizontal to the ground, approximately chest high. The

DEFENSIVE TECHNIQUES

In some situations, troops may have to employ the riot baton to defend themselves. They may have to defend against armed or unarmed attackers. The defensive techniques enable troops to defend against blows to the head, jabs to the body, stabs, and hand holds.

DEFENSE AGAINST BLOWS TO THE HEAD

To defend against a blow to the left side of the head, the soldier starts from the parade-rest, port, or on-guard position. He smartly snaps the left hand to the left side of the body and the right hand up and to the left. The baton is then in a nearly vertical position that blocks the opponent's blow.

Immediately after blocking the opponent's blow, the soldier snaps both arms up and level with the baton. The left hand is near the left shoulder, and the right hand is in front of the left shoulder. The grip end of the baton is pointing towards the opponent. The soldier is now in position to execute a jab or a smash. The body is

driven forward. The right hand is snapped straight, driving the grip end of the baton into the opponent's upper body, avoiding the head. After delivering the jab or smash, the soldier returns to the on-guard position.



DEFENSE AGAINST BACKHAND BLOWS

An opponent's backhand blow can be blocked from the parade-rest, port, or on-guard position. Both arms are snapped out and to the right front of the body. The left hand is raised above the right hand so that the grip end of the baton is pointing down. This position blocks the opponent's blow. After blocking the opponent's blow, the right hand is brought up near the right shoulder. The left hand is moved down and to the front of the chest. The striking end of the baton should be pointing slightly to the left front and toward the opponent. The soldier is now in position to execute the butt stroke. The body is rapidly advanced off the right foot. The right hand is driven forward and to the left. The left hand is held in place as the baton is driven against the opponent's shoulder, chest, or jaw. This blow can result in a fatal injury if any other area of the head is struck.



DEFENSE AGAINST THE LONG THRUST

The long thrust can be countered from the parade-rest, port, or on-guard position. The left hand is moved toward the left. The right hand is moved smartly down and toward the left. The opponent's weapon is engaged and deflected to the left and away from the body. As soon as the opponent's weapon has been deflected, allow the left hand to slide down to the right hand. The body and baton are now in position for a counterblow against a vulnerable point.



DEFENSE AGAINST OVERHEAD STABS

This defensive technique can best be accomplished from the parade-rest, port, or on-guard position. As the opponent stabs down, the body is moved to the rear by withdrawing the left foot. The left hand is allowed to slide down the baton to the right hand, and the baton is raised up over the left side of the body. The baton is brought down and snapped against the opponent's wrist or forearm, disarming him. After disarming the opponent, the left hand is slid back up to its original position on the baton, ready to execute the baton smash.





opponent drops his weapon, the soldier brings both hands up close to his shoulders. The baton is held across the chest. The counterblow is delivered by moving forward with the right foot and executing the baton smash.

DEFENSE AGAINST THE UPWARD THRUST

The upward thrust can be blocked effectively from the parade-rest, port, or on-guard position. The riot baton is brought quickly to a position parallel to the ground, about 6 inches away from the lower chest. Both arms are snapped straight down, driving the length of the baton downward to strike the opponent's wrist. As the



Once an opponent has been disarmed, he must not be allowed to recover his weapon. Any blow delivered to a vulnerable point of the body is effective.



DEFENSE AGAINST AN UNARMED ATTACKER

The riot baton is extremely effective when used against an aggressive or violent person. These defensive tactics may be performed from all three basic positions. The body is moved slightly to the rear by withdrawing the left foot. The left hand is slid down the riot baton to the right hand, and both hands are brought up to the left shoulder, the baton parallel to the ground. Against an opponent's left-handed blow, the soldier delivers a counterblow to the opponent's collar bone or shoulder. Against an opponent's right-handed blow, the soldier delivers a counterblow to the opponent's forearm.

If a soldier is grabbed by an opponent, the baton can be effectively employed as a defensive weapon. The baton can be jabbed into the groin or stomach of the opponent.



Extreme Force Options

When a crowd engages in violent activities, a control force may have to resort to forceful measures to control the crowd. Strong measures of force are used only against crowds who employ defenses, arms, or tactics that make lesser measures of force ineffective or impractical. These measures include the use of firearms, the most extreme measure of force. The use of firearms ranges from the M234, which is a nondeadly force measure, to the machine gun, which is the most deadly force measure. The commander employs these firearms in a manner that is consistent with the principle of using minimum force. When employing firearms, the commander tries to ensure that they are used in a way that minimizes the chances for fatalities.

RING AIRFOIL SYSTEM

The M234 launcher is a riot control weapon that uses nondeadly force. The launcher, mounted on the M16 rifle, fires a projectile that causes pain on impact. The

force of the projectile's impact repels or distracts rioters while causing minimal injuries.

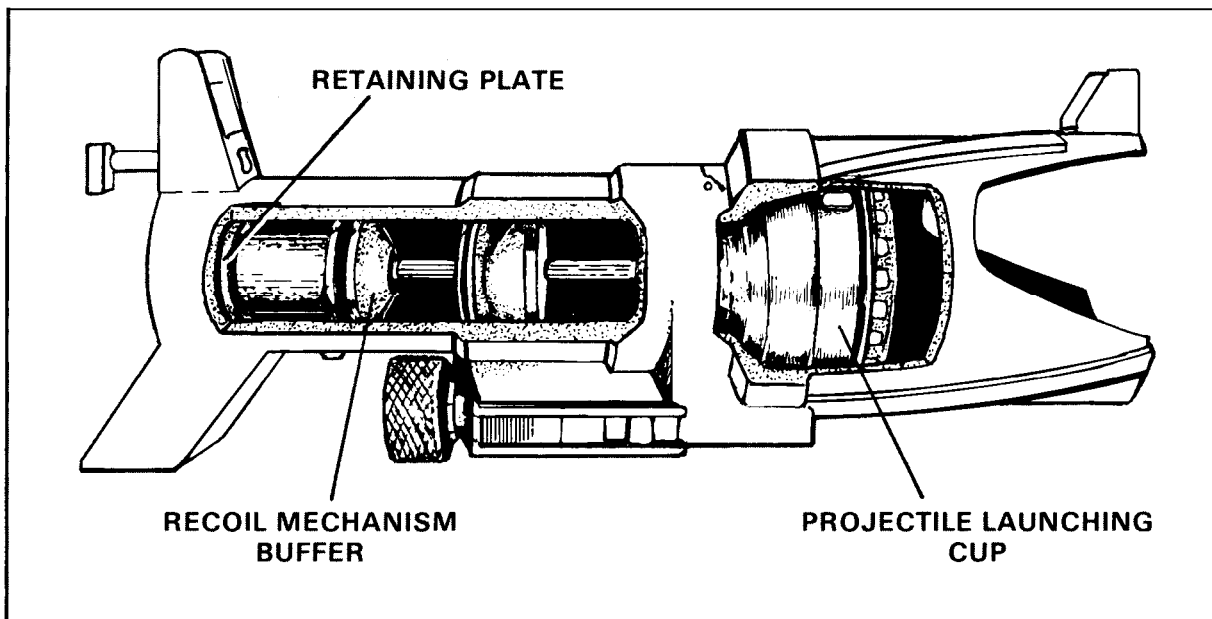

The ring airfoil projectile is shaped like a ring or doughnut. It is 2.5 inches in diameter. It consists of a one-piece, molded rubber body weighing approximately 1.25 ounces. The projectile is available in two variations: the soft projectile and the sting projectile. Both are identical in their external appearance. The sting projectile is a kinetic energy projectile that inflicts a painful blow. The soft projectile is identical to the sting projectile, but it contains riot control agent powder in small compartments in the projectile's body. On impact, the powder is spread directly on the person.

The M234 launcher is mounted on the closed-end flash suppressor of the M16 (if so equipped) or on the M16A1 rifle. An upper arm and a buffer housing on the rear of the launcher mate with the rifle's forward sight and bayonet stud to keep the launcher from moving on the barrel. The launcher is aimed using the launcher sights. The rifle is fired in the usual manner. The speed and flat trajectory of the spinning projectile make it extremely difficult to dodge, catch, or deflect.

The firing rate is about four to six projectiles per minute. The maximum range is 100 meters, but the weapon works best against individuals at ranges to 40 meters and against small groups to 60 meters. It is most effective when the person is lightly clothed.

M234 LAUNCHER MOUNTED ON AN M16A1

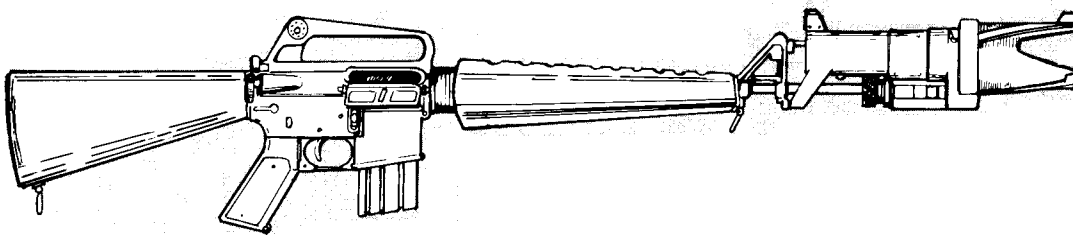

EMPLOYMENT

The M234 launcher is issued two per squad for each authorized company. The weapons may be deployed in several ways. Soldiers armed with the launcher may be used as members of foot or motor patrols. They also may be placed in or behind a crowd control formation. They must be positioned behind other squad members because they are vulnerable and make likely targets. Also, they must be positioned where they can easily hear the squad leader and fire team leader and react quickly to calls for fire support.

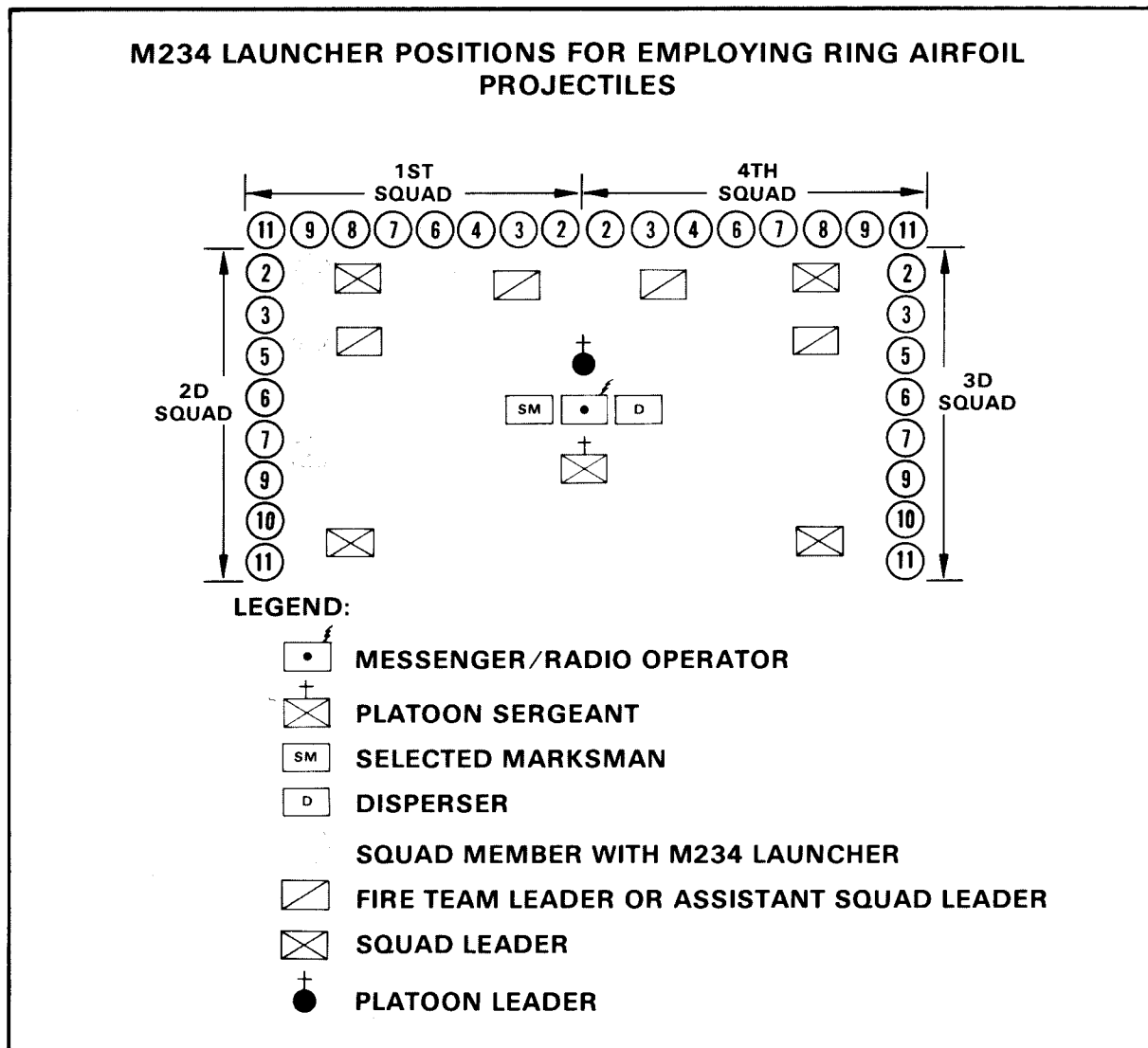

The soft projectile produces a CS agent cloud 4 to 5 feet in diameter. It is specifically designed to provide the commander with a less lethal means of engaging specific people or small groups under conditions in which other riot control weapons would be prohibited, undesirable, or ineffective. *Ball ammunition is used only in extreme circumstances.* Dispersing greater amounts of a riot control agent by other means is often undesirable or not possible. The soft projectile may be particularly useful against individuals or groups who are highly motivated, are wearing heavy clothing, or are using protective gear or shields.

The sting projectile produces a sharp stinging blow on impact. Through its painful effects, it repels, deters, or distracts crowd members. The sting projectile is employed in essentially the same way as the soft projectile. Whether the soft or the sting projectile is employed in a given situation is largely a judgmental decision. The sudden and painful impact of the sting projectile is particularly effective when used against lightly clothed people or people wearing masks that protect against the effects of the soft projectile. Against small area targets, employing soft and sting projectiles in combination can be highly effective. Troops must be very careful with the sting projectile. They must avoid accidental shots that can hit windows, streetlights, or other fragile structures. The sting projectile can easily break ordinary windows and may crack heavier glass like that used on store fronts.

Troops using M234 launchers also may be a part of security elements protecting critical facilities. Their positioning depends on the shape and physical limitations of the perimeter barrier. Whenever M234 firers are used, other members of the unit must be equipped with lethal firearms.

Use of the M234 must be controlled at all times. In crowd control formations,

authority to fire the M234 launcher is retained at the platoon or company level. In a patrol or a security element, that authority belongs to the person in charge. Its use must be limited to people who pose a serious threat to security forces or critical facilities or to people who are bent on violence or destruction. Any other use may incite more violence and destruction, thus promoting sympathy for the participants.

FIRING TECHNIQUES

Firing techniques for the M234 launcher include selective, volley, and combination fires. Selective fire employs fire aimed at point targets. For greatest effect, the projectile should hit the front, upper half of the torso. To prevent eye damage, the soldier avoids aiming directly at a person's head.

Volley fire is used against area targets to cover as much of an area as possible. Volley fire must be restricted to situations in which serious destruction of property could occur or life is at stake.

Combination fire is the joint use of the M234 and riot control agents. It capitalizes on the incapacitating effects of agents and the shock of M234 projectiles. Combination fire is used against attacks by determined groups of rioters.

Although the M234 is designed to keep injuries light, misuse of the weapon can cause permanent injury. Follow these precautions:

- Take special care to avoid accidental use of ball ammunition. Ball ammunition *must not be issued to soldiers using the M234.*
- Avoid, if possible, using launchers for volley firing. An M16 firing blank ammunition sounds the same as it does when firing ball ammunition. To prevent panic and unfavorable crowd reaction, wait until the crowd realizes blank ammunition is being used. Then the launchers may be fired in greater numbers.

- Do not use the M234 launcher for indiscriminate or harassing firing.
- Do not fire at older people, pregnant women, or children.
- Do not aim at the head or the neck. The projectile's speed gives it enough force to severely damage an eye.
- Take every precaution to ensure a stray projectile does not hit an onlooker or the

property of residents. Not only can the projectile cause pain, it also can damage windows, streetlights, or other fragile structures.

- Give annual training to all members of units using the M234. Training must include related equipment and the disassembly, assembly, and use of the launcher.

SHOTGUNS

The riot shotgun is an extremely versatile weapon. Its appearance and capability have a strong psychological effect on rioters. It is particularly suited to certain applications in civil disturbance operations. When used with No. 00 buckshot, it is effective at a limited range. However, the use of No. 00 buckshot should be limited to specific missions. For example, it is ideally suited for use as a "covering" weapon in the antisniper role, during room-to-room searches, and at critical static posts that could be penetrated by a high-speed vehicle. By varying the ammunition from No. 00 to No. 7 1/2 or No. 9 birdshot, the shotgun can be used with considerably less possibility of serious injury or death. This gives the commander flexibility in choosing the ammunition that is most appropriate for the existing conditions.

When using No. 7 1/2 or No. 9 shot, the riot shotgun is suited to close-in firing against isolated targets like those encoun-

tered in antisniper operations. Because of the shotgun's short range, the danger of producing accidental casualties at ranges over 60 to 70 meters is much less than other types of weapons. However, the high lethality potential of the shotgun at shorter ranges places a severe restraint on its use during civil disturbance operations. The use of No. 00 buckshot, because of its high lethality at ranges beyond 100 meters, must be limited during civil disturbance operations.

Regardless of the type of shot used, the shotgun, like any other firearm, constitutes a deadly force that can be used only pursuant to the provisions of the rules on the use of deadly force. Positive control measures must be established to ensure that when shotguns are used, the commander specifically designates the type of ammunition to be used, and the troops armed with shotguns use only that type of ammunition.

RIFLES

The rifle is the primary individual weapon used in civil disturbance operations. The exception is crowd control operations. The primary weapon for crowd control is the riot baton. The rifle also may be used for antisniper operations.

When arming his troops with rifles, the commander may, in keeping with the principle of minimum force, select from several options. The options consist of

various combinations of the rifle, the bayonet, the magazine, and the rifle's chamber. Each option represents an escalation in the level of force. The options are not sequential in the sense that a commander must start with the first option and proceed from one option to the next in order. As long as the option that he chooses is appropriate for the threat, he is in keeping with the principle of minimum force.

RIFLE READINESS OPTIONS

RIFLE at sling BAYONET in scabbard MAGAZINE in pouch or on belt CHAMBER empty	RIFLE at port BAYONET in scabbard MAGAZINE in pouch or on belt CHAMBER empty	RIFLE at port BAYONET fixed MAGAZINE in pouch or on belt CHAMBER empty	* RIFLE at port BAYONET fixed MAGAZINE in weapon CHAMBER empty	* RIFLE at port BAYONET fixed MAGAZINE in weapon CHAMBER round in place
---	--	--	--	---

* This option is usually reserved for selected marksmen

The rifle and the rifle with bayonet affixed have very limited offensive use in civil disturbances as both can constitute deadly force. The main value of the rifle with bayonet affixed is its psychological impact on a crowd. However, the danger of accidental or intentional injury to demonstrators or other control force members precludes the use of fixed bayonets except against extremely violent crowds. The rifle with a round in the chamber is an option that usually is reserved for the commander of selected marksmen, such as an SRT leader.

The troops fix bayonets only on orders. The order to lock and load rifles can only be given when the criteria for the use of deadly force have been met. When the M16 rifle is used, a lock plate must be installed to prevent automatic fire. The lock plate, a prefabricated insert, fits between the pistol grip and the receiver group. It prevents the selector switch from being inadvertently flipped to the automatic mode. A soldier can install the lock plate in less than a minute using only a screwdriver. Once in place, it ensures that the selector switch stays in the semiautomatic mode.

MACHINE GUNS

All automatic weapons, especially machine guns, are closely controlled by the task force commander. It is almost inconceivable that machine guns would be used, short of guerilla warfare. Only the most drastic circumstances would justify their use. Individual automatic weapons must be modified so that they only fire semi-automatically.

Automatic weapons larger than 7.62 millimeter are not taken on a civil

disturbance mission. They usually are not needed or used. If a need develops, they can be obtained later.

Machine guns, 7.62 millimeter and below, may accompany units on civil disturbance missions. They are not taken on operations unless their use is imminent. Machine guns are available to the control force, but they are kept in a secure area.

Apprehension and Detention Operations

During civil disturbances many people engage in unlawful behavior. The control force may be called upon to take into custody crowd members who have broken the law. Apprehension and detention operations are conducted to halt illegal acts and to deter future disorders. All apprehensions are made by the civil police force unless it is not possible for them to do so. If it becomes necessary for a military control force to apprehend or temporarily detain such lawbreakers, the offenders are turned over to the civil authorities at the earliest possible moment. Apprehension is justified only for a person who breaks the law. The person must be known to have committed an illegal act, or there must be "probable cause" to believe he or she has done so. When possible, the military limits its concerns to serious offenses involving injury or death.

When the military must detain or apprehend violators, certain policies must be observed. Apprehended people must be treated firmly, but with reasonable courtesy and dignity. The attitude and behavior of the apprehending officials is very important. Treating offenders with contempt, hostility, or excessive force increases the likelihood of resistance. And apprehending people without probable cause or without concern for their constitutional right to due process can prevent prosecution of the offender and, in some cases, result in prosecution of or a civil suit against the apprehending officials.

When it is at all possible, civil law enforcement agents are integrated with the military control force team making apprehensions. The team making apprehensions must carry out all procedures carefully. For each apprehension, the apprehension team must document the specific conduct that violates a law. The team must provide careful descriptive data for each offender. The description must be good enough that at a later time that person can be clearly

identified as the offender in question. The team must obtain and provide the names and addresses of witnesses. They should use DA Form 3316-R (Detainee Turnover Record) for this purpose. The team must retain and tag each item of physical evidence like a weapon or stolen goods that supports the apprehension. And the team must give the owner a receipt for each item of evidence that is retained.



Troops must not question offenders at the scene. Failure to advise an offender of his rights and improper questioning about law violations can prevent a conviction. Troops must limit their questions to asking the offender's name, place of residence, and place of employment. If offenders must be questioned, civilian police are asked to conduct the interrogations. If civilian police are not available, CID agents or military police may conduct interrogations essential to the civil disturbance mission.

EXAMPLE OF COMPLETED DA FORM 3316-R

DETAINEE TURNOVER RECORD	
<p>1. Detainee</p> <p>SMITH, JOHN O.</p> <p>Address 704 Central Ave Penrock, AR</p> <p>Description Male, Cav, 5'10", 170 lbs Brown hair, brown eyes</p>	<p>3. Who made arrest/apprehension</p> <p>Name JAMES P. JONES</p> <p>Grade or Title SP4</p> <p>Unit 213 MP Co</p>
<p>2. What detainee did</p> <p>Describe incident LARCENY (stealing) B+W, General Electric, portable T.V. set, ser # 0143458, from Depot Sales Store, Penrock, AR.</p> <p>When did incident occur (Date and Time) 1930 hrs, 20 Dec 1971</p> <p>Where did incident occur Depot Sales Store 1115 Main St Penrock, AR</p>	<p>4. Who escorted detainee to detention center</p> <p>Billy D. DOE</p> <p>Grade or Title CPL</p> <p>Unit 9 Inf Co</p> <p>Remarks: <i>Attempting to avoid apprehension, Smith dropped the T.V. set, causing extensive damage.</i></p>

DA FORM 3316-R, 1 MAR 68 (FRONT)

<p>5. WITNESSES (Give name, grade or title if applicable and unit or address)</p> <p>a PFC Sam L. Brown, 213 MP Co</p> <p>b</p> <p>c</p>	<p style="text-align: center;">DETAINEE TURNOVER RECORD</p> <p>This card will be filled out on each person detained and will be turned in at the Detention Center with the detainee. When possible, the person making the detention should do this. If this is not possible, the person designated to escort the detainee to the Detention Center will fill out the card (preferably before accepting the detainee), based on verbal information from the person making the detention.</p> <p style="writing-mode: vertical-rl; transform: rotate(180deg);"> (Fold to fit in pocket) </p>
<p>6. WEAPONS AND ARTICLES REMOVED:</p> <p>1 TV set, 12", B+W, General Electric, serial # 0143458, with broken picture tube and a 4-inch crack on the right side of the cabinet.</p> <p><i>Property receipt for T.V. set given to store manager, Mr. Tom H. PUBLIC.</i></p>	

DA FORM 3316-R, 1 MAR 68 (BACK)

APPREHENSIONS

It is best to use apprehension teams, especially if it is likely that a lot of people will be apprehended. The teams provide an organized response to the situation. The teams can be organized at squad or platoon level, depending on the number of apprehensions expected.

Each team, if possible, consists of an apprehension officer, a movement element, and a recorder. If the control force cannot provide security for the team, a security element is added to the team. The team apprehension officer makes the actual apprehension with the help of the other elements. The TAO may be either an officer or an NCO. If possible, a civilian policeman or a US marshal serves as TAO. The TAO determines who is to be apprehended. He informs the offender of the reason for the apprehension. He supervises the handling of the offender. And he ensures that the apprehension process is properly conducted and documented. The TAO is responsible for the overall apprehension. This limits the number of people who will be subpoenaed to court to document the apprehension. The movement element helps the TAO handle the people being apprehended. This element moves, restrains, and searches the offenders under the supervision of the TAO. The security element watches the crowd and acts as a blocking element to keep the crowd from interfering with the apprehensions. The recorder helps the TAO document the event. He helps fill out the DA Form 3316-R. If possible, the recorder also photographs the TAO with each apprehended person. This aids the identification process. And it provides the TAO with documentation of the apprehension for use in court.

If people and equipment are available, a videotape or photographic element accompanies the team. This element records the scene before, during, and after the apprehensions. The element provides pictorial documentation for use in court.

And having control force members taking pictures can help control crowd reaction. It reduces the impact of anonymity on the crowd's behavior, making crowd members less prone to unruly acts.



If apprehension teams are not used, each soldier must make a quick mental estimate of the situation as he approaches a person he intends to apprehend. He observes the scene carefully, noting details and conditions that relate to the incident. He considers what course of action to take. Each soldier considers the attitudes of the offender and the crowd in light of the manpower available. There must be sufficient manpower to cope with the situation, especially if the crowd might turn hostile. It is better to wait for help than to have too few troops to handle a situation. Trying to force an apprehension in a hostile environment can escalate violence and endanger the persons making the apprehension.

The behavior of the offender is observed to decide if the offender is violent, cooperative, or passive. Unless there is good reason to believe otherwise, the offender must be considered dangerous. The mood of the crowd is observed to estimate what they might do. The crowd may be just curious onlookers, or they may support the person to be apprehended.

The soldier selects a course of action that seems best in view of what the offender or the crowd may do. He bases his decisions on the nature and seriousness of the incident and the factors he used in estimating

the situation. Actions must be kept as simple as the situation allows. The element of surprise can give him an immediate advantage over the offender. But it is best not to use surprise if the offender might panic and injure someone. And it is wise to make the apprehension at a place offering the most advantages to the team and the fewest to the offender. Apprehensions in a crowded area are avoided if possible. Crowded areas provide avenues of escape. Also, the offender may have supporters in the crowd who will come to his aid.

Each soldier must give commands in a voice and manner appropriate for the purpose and the situation. He must state his commands in simple, concise language. His manner of speaking must be convincing. It must convey an expectation that his instructions will be obeyed. With frightened people, sympathy combined with an attitude of firm assurance on the soldier's part avoids trouble. With uncooperative people, an attitude of forceful authority may be needed. The soldier's commands must be of such a nature and content that the offender does what the soldier wants and only that.

The offender should be searched immediately. But circumstances may dictate postponing the search until a safer place can be found. The longer the apprehension takes, the greater the risk of drawing a hostile crowd. The crowd may sympathize with the offender and try to help him or to escalate the violence. The offender's actions may also incite the crowd to violence. The longer an offender is the focal point of an apprehension, the more easily he may stir

a crowd to violence. The team may choose to move the offender out of the crowd's view. If an uncooperative offender is moved only a very short distance, a come-along hold or carry may be used. If the distance is somewhat longer, flexcuffs or hand irons are applied.

After being searched, offenders are transported from the area. Vehicles like trucks, buses, or sedans that are used to transport apprehended offenders must be modified with barriers to separate the offenders from the driver. If a barrier cannot be provided, then a guard is placed in the vehicle. The passenger compartment is checked for items that could be used as weapons. When the guard must sit next to a prisoner, the guard always sits with his weapon away from the prisoner. Prisoners must be placed where they can best be controlled, but they are not fastened to the vehicle with hand irons or flexcuffs. Seat belts must be fastened.

When women are transported and no women are available as escorts, measures must be taken to avoid false charges of molestation. The names and addresses of witnesses must be taken before leaving the scene. The net control station must be notified of the departure time and the vehicle's mileage reading. And the arrival time and the mileage reading at the destination must be recorded. At least two male escorts must be present at all times when a female escort is not present. These procedures also apply when the male and female roles are reversed.

SEARCHES

Apprehended offenders must be searched immediately for weapons and for evidence that can be easily destroyed or discarded. It is during the first contact with an apprehended person that the greatest caution is needed to prevent surprise and dangerous acts. Due caution, however, must be exercised constantly from the time a person is apprehended until proper disposition is

made. Searches must be conducted by at least two people. One person searches while the other person provides back-up or security. If the offender is thought to be armed, the searcher's assistant covers the offender with a weapon, and the searcher ensures that his own weapon, if he has one, is secure.

Searches of people and property that are not usually subject to military law may be made by military forces during a civil disturbance. When possible, *civilian police should search civilians and civilian property*. If police are not available, military personnel may search people incident to an apprehension. Either the stand-up search or the wall search may be used. The choice depends on the situation. The search is made not only of the person, but also of the immediate area. This prevents the person from grabbing a weapon or from destroying evidence. Control forces may search private property, including vehicles, if—

- Reasonable belief exists that a person has committed or is committing a violent crime and is hiding in a building or a vehicle.
- Reasonable belief exists that a vehicle contains weapons or instruments of violence.
- Probable cause exists for searching a building or a vehicle.
- Probable cause exists to believe that, unless immediate action is taken, evidence of a crime will be destroyed before a warrant can be obtained.

Control force members must *not* search a member of the opposite sex. The TAO must wait until a member of the opposite sex is available to make the search. If there are no female control force members available to search a female offender, any qualified woman, such as a medical professional, can be called on to conduct the search. A member of either sex can search items that can be easily removed, such as luggage, packages, shoes, hat, coat, and handbags. For more information on searches, see FM 19-10.

STAND-UP SEARCH

The stand-up search is a quick search of the offender for weapons and evidence. In making the search, the searcher has the offender stand with his back to the searcher. The searcher's assistant takes a position where he can watch the offender.

The searcher commands the offender to spread his feet and extend his arms above his head. The searcher then searches the offender from head to feet, crushing the clothing to locate any concealed weapons. When the search is complete, flexcuffs or hand irons are put on the offender.



WALL SEARCH

When a weapon is found, or when other factors indicate the need, a wall search is conducted. By rendering an offender helpless by placing him in an awkward position, the wall search affords safety to the searcher. Wall searches are particularly useful when searching several offenders. Any upright surface can be used.

To begin the search, the soldier has the offender face the wall or other surface and lean spread-eagled against it. The soldier makes sure the offender's feet are well apart. The offender's head must be kept down. The searcher's assistant stands on the side of the offender opposite the searcher and to the rear. When the searcher moves to the other side of the offender, the

assistant also changes position. The searcher walks around the assistant when changing sides to avoid coming between the offender and the assistant guarding the offender.



If the offender resists or tries to escape and must be restrained before the search is completed, the entire search is repeated from the beginning. If flexcuffs or hand irons are applied before the wall search is completed, the offender's forehead is placed against the wall to provide support in place of the hands. Flexcuffs or hand irons are applied when the wall search is complete.

When searching two or more offenders, the searcher has them lean spread-eagled against the same wall, but far enough apart so they cannot reach one another. The searcher's assistant takes a position a few paces to the rear of the offenders. The searcher begins the search with the offender on the right. After searching each offender, the searcher has him move to the left end of the line and resume the wall-search position. This keeps the searcher from coming between the assistant and an offender.

COME-ALONG TECHNIQUES

Come-along techniques can be used to move resisting offenders. The apprehension team must be able to move the offender quickly and without the use of excess force. Flexcuffs or hand irons are placed on resisters before moving them. This reduces a resister's ability to fight if he or she suddenly tries to do so.

CARRY METHODS

The two-person carry is the best come-along technique if there are enough troops available. This carry avoids injuries caused by excessive lifting. It also avoids injuries to an offender. A soldier stands on either side of the offender and grasps him under the legs and through his arms and around his back. The soldiers may grasp each other's arms to prevent their hold from slipping. They also can perform this carry using riot batons. They place one baton under the legs behind the knees and the other baton horizontally across the back. Both soldiers then grasp the batons, forming a cradle.





hands in front of the offender's chest for a more secure hold. The second soldier stands to one side of the offender and encircles the offender's legs at the knees with his arm.

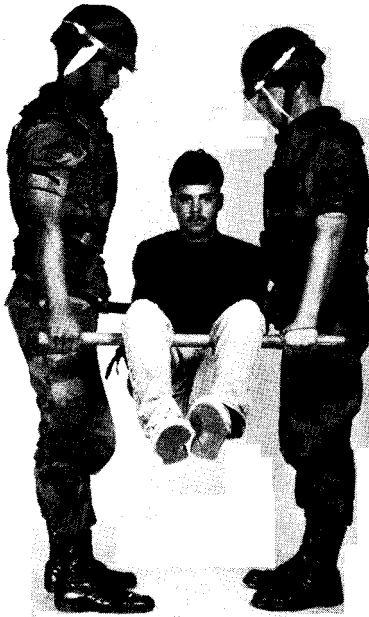

The offender may try to resist by stiffening and forcing himself out of the cradle. To counteract this resistance, one soldier gets behind the offender and grasps the offender under the arms. He locks his



A one-person carry has a disadvantage. It involves lifting considerable weight. This can tire the carrier quickly or cause a back injury. The soldier lifts the offender from the rear by grasping him under the arms. The soldier locks his hands in front of the offender's chest. The soldier then pulls the

offender backward with the offender's heels dragging the ground. A riot baton also may be used for this technique. The soldier approaches the offender from behind. He lays the baton to the side of the offender, slightly behind the offender's buttocks. He then forces the offender into a sitting position, reaches under the offender's arms, and picks up the baton. He then rotates the baton to the front of the offender's chest. He places his free hand under the offender's arm and grasps the other end of the baton. Again, the soldier pulls the offender backward with the offender's heels dragging the ground.

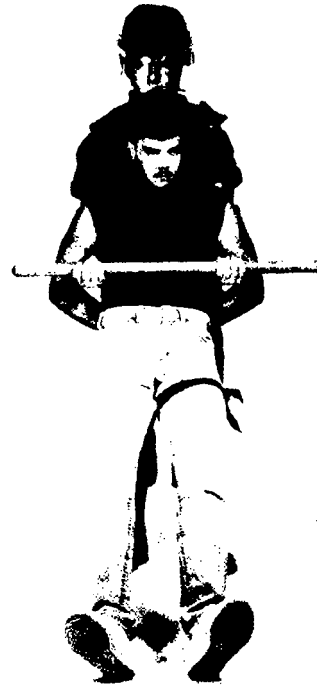

COME-ALONG HOLDS

A come-along hold is used to move an unrestrained, unwilling person from one place to another. It controls the person's movements without injuring him. A come-along hold puts pressure on a sensitive part of the body and causes discomfort. The hold must be executed quickly and with as little commotion as possible. Speed is essential in applying these holds. Such holds are used only for short distances until the offender can be restrained. Each soldier must know which holds are best suited to his capabilities.

Baton as a Restraint and Come-Along

The riot baton may be used as a restraining device and as a come-along hold at the same time. The soldier has the offender cross his hands behind his back. He slips the offender's hand through the baton's leather thong. He then twists the baton until the slack in the thong is taken up. The thong can be tightened or loosened depending on the amount of pressure needed to secure the offender. With his left



hand, the soldier grasps the left shoulder or the clothing over the shoulder of the offender. He pulls the offender slightly backward so that the offender cannot pull away from the baton end, which is pressed against the small of the offender's back.



Gooseneck Come-Along

To apply a gooseneck come-along the soldier approaches the offender from the rear. He steps forward with his left foot along the outside of the offender's right foot. He grasps the inside of the offender's right arm at the elbow with his left hand. He then grasps the offender's right hand with his right hand, placing his thumb inside the bend of the offender's wrist and his fingers across the back of the offender's right hand. With both hands, the soldier sharply pulls the offender off balance and to the rear so the offender's weight falls on the soldier's left shoulder. The soldier then bends the offender's right arm at the elbow and locks the offender's right arm against his chest. He reinforces his right hand with his left hand, placing both thumbs inside the bend of the wrist and his fingers across the back of the offender's hand. He locks both his elbows tightly to his side and steps up beside the offender. He applies pressure as he steps up beside the offender. He presses down on the back of the offender's hand, bending it under toward the forearm.





The soldier applies pressure by turning the offender's head to the right, pushing down

with his left hand, and pulling up with his left elbow.



Front Hammerlock

For the front hammerlock the soldier faces the offender. He steps forward with his right foot to the outside of the offender's right foot. He grasps the offender's right arm at the elbow with the soldier's right hand palm up. The soldier breaks the offender's balance by pulling the offender's right arm slightly away from the offender's body. As he pivots behind the offender, he strikes the offender's right wrist with his left wrist and bends the offender's arm to the rear. As the soldier completes the pivot behind the offender, he drives his left fist straight up until the offender's right wrist rests in the bend of the soldier's left arm. He then rotates his left hand down, grasping the offender's right elbow. He pulls the offender's right elbow tightly against his stomach. The offender may be leaning forward in this position. The soldier completes the hold by reaching with his right hand over the offender's shoulder and grasping the left side of the offender's face.



Fingers Come-Along

The fingers come-along is tiring to maintain, but it is extremely useful in moving an offender for a short distance. The soldier faces the offender. He steps forward with his right foot to the outside of the offender's left foot. As he steps, he reaches with both hands and grasps the offender's left wrist with his left hand. He grasps two or three fingers with his right hand. He then pivots counterclockwise on his right foot until he is standing beside the offender. He thrusts the offender's arm straight out in front of him at shoulder height, maintaining a tight grip on the offender's wrist with his left hand and bending the offender's fingers down with his right hand. The soldier applies pressure by keeping the offender's arm locked straight and by pulling the offender's fingers straight back toward the offender's elbow. This hold can be applied on either hand.



Groin Lift

The groin lift is used to remove a resisting offender from a wall or move him through a doorway. The soldier approaches the offender from the rear. He steps forward and places his left foot next to the offender's left foot. He grasps the offender's left wrist with his left hand, pulling the offender's hand sharply down between the offender's legs. The soldier then grasps the offender's left hand with his right hand and pulls the offender's arm up into the offender's groin. He reaches with his left hand and grabs the offender's shoulder or collar. He can then move the offender forward or backward by lifting the offender's arm against the offender's groin as he pushes down on the offender's shoulder with his left hand.



12-10

fold out

Baton Come-Along



For the baton come-along the soldier grasps the center of the baton with his right hand. He approaches the offender from behind. He rotates the baton to a position parallel with his right arm and pointed toward the offender. He thrusts the baton between the offender's legs. He rotates his right hand so that his palm is turned up. He then pulls back and up, placing the baton across the offender's upper thighs.

The soldier reaches up with his left hand and grasps the offender's collar near the back of his neck. To move the offender, the soldier keeps his right hand as straight as possible and exerts upward pressure from the shoulder. Simultaneously, he pushes forward with his left hand. This keeps the offender on his toes and off balance to his front.

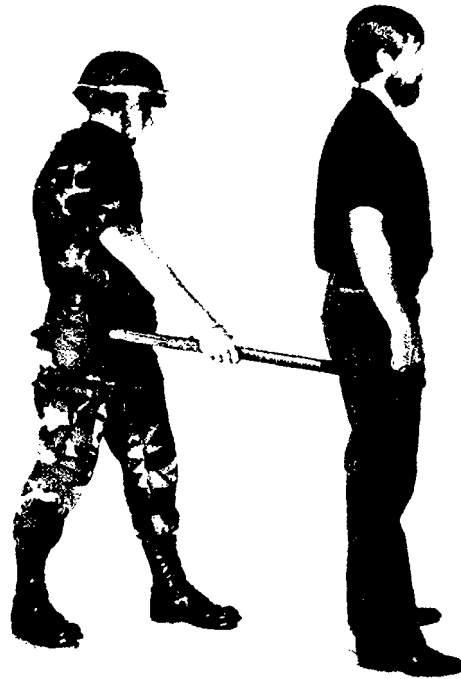

Hammerlock Come-Along

For the hammerlock come-along the soldier holds the baton in his right hand. He steps forward with his right foot and tweeks the offender's left arm and body. As the baton passes to the rear of the offender's body, the soldier pushes up and to the rear. He steps forward with his left foot to the outside of the offender's left foot. He then reaches across the offender's left shoulder with his left hand and grasps the striking end of the baton. Pivoting on the ball of his left foot, he moves to the offender's left rear. At the same time, he presses down with his left hand on the striking end of the baton in the direction of the offender's left front. He also presses up on the grip end of the baton with his right hand. This bends the offender well forward at the waist.





jaw bone and forces the offender's face to the left, straightening him up. To apply pressure, he presses down on the striking end of the baton with his left upper arm and pulls up on the grip of the baton with his right hand.



After the offender has been subdued, the soldier holds the baton firmly with his right hand and releases his left hand. He reaches across the striking end of the baton with his left hand and grasps the right side of the offender's face under the

DETENTION FACILITY OPERATIONS

Civil authorities must provide adequate detention facilities for all apprehended people. Authorities must be prepared to detain large numbers of people. They may choose to expand existing detention facilities or to set up temporary facilities to accommodate the extra load. If possible, large-scale arrests are delayed until sufficient detention facilities have been provided.

When federal forces are committed, the commander coordinates with civil authorities to ensure adequate detention facilities are available and to learn their locations and capacities. If there are more detainees than civil detention facilities can

handle, civil authorities may ask the control forces to set up and operate temporary facilities. *Army correctional facilities cannot be used to detain civilians.* A temporary Army detention facility can be set up if—

- Federal troops have been employed under the provisions of AR 500-50.
- The task force commander has verified that available civilian detention facilities can no longer accommodate the number of prisoners who are awaiting arraignment and trial by civilian courts.
- Prior approval has been granted by the Army Chief of Staff.

Use of the temporary facility ends as soon as civil authorities can take custody of the detainees. The Army is responsible for the custody, health, comfort, and sustenance of all people detained in its facilities until custody is transferred to civil authorities. The temporary facilities cannot be used to confine people arraigned or convicted in civilian courts. Women are detained in these facilities only under the most extreme circumstances. And women must be transported to a civilian facility as soon as possible.

The same operational procedures that apply to the management of an installation confinement facility apply to the management of temporary detention facilities, except for training, employment, and administrative discipline. The facilities are supervised and controlled by MP officers and NCOs trained and experienced in Army correctional operations. Guards and support personnel under direct supervision and control of MP officers and NCOs need not be trained or experienced in Army correctional operations. But they must be specifically instructed and closely supervised in the proper use of force, their custodial procedures, and their completion of military and civilian forms and reports that they might have to use. Troops who may be tasked to operate a temporary detention facility should be familiar with the forms and reports used for civilian apprehensions.

The temporary facilities are set up on the nearest military installation or on suitable property under federal control. Ideally, the facility is close enough to the disturbance area to minimize transportation and escort needs. But it should be far enough away not to be endangered by riotous acts. Whenever possible, existing structures are adapted for this use. But construction may be needed to provide the segregation for ensuring effective control and administration.

The basic structure must include:

- Search areas.
- Holding areas for incoming men and women.
- A processing area.
- Holding areas for men and women who have committed misdemeanors.
- Holding areas for men and women who have committed felonies or are violent.
- A holding area for property and evidence.
- A holding area for administrative support and records.
- A medical station.
- Latrines.

Facility personnel must ensure that proper sanitation is maintained. When large numbers of people are detained or processed through a facility, sanitation becomes a problem. Medical personnel must conduct regular health inspections to detect unsanitary practices and conditions. (For more information on health inspections of detention facilities, see AR 190-38.)

The facility must be organized for a smooth flow of traffic. Processing stations must be set up so there is a linear or circular sequence of movement. Processing areas are set up out of sight of the holding areas. If possible, the areas are separated by a door to reduce noise in the processing area. To reduce distractions, each station may be partitioned. Detainees may be more cooperative if they are out of the sight of each other.

Injured people are given prompt medical treatment and transportation to medical facilities when necessary. A medical aid station for screening detainees and treating minor injuries is set up inside or next

to the detention facility. The treatment area, however, must be out of sight of the processing and holding areas. If possible, access to the medical facility bypasses the holding and processing areas. Facility personnel also may consider setting up a separate holding area for injured detainees.

Detention facility operation plans must contain emergency procedures. As a minimum, the following areas must be addressed:

- Fire evacuation.
- Detention facility disturbance control.
- Detention facility defense and security.

Other emergency procedures may be needed, depending on the situation.

On arrival at the detention facility, the detainee is logged in and searched. The search is conducted even if the apprehending team made a complete search in the field. Separate search areas are set up for men and women. Weapons, contraband, flame-producing devices, suspected evidence, money, and high-value items are confiscated. Medications also are confiscated. Detainees that have had medications confiscated are screened by medical personnel. Receipts are provided for any property or evidence that is confiscated. Confiscated items are tagged. The items are stored in a controlled property area.

When a detainee is brought to the facility, a file is initiated. The detainee's case number is used on all paperwork, such as logs, evidence tags, reports, and visual documentation. All paperwork, including photographs, begun outside the detention facility is marked with the case number. Facility personnel also may use hospital ID tags. Using indelible ink, they write the case number and attach the tag to the detainee's wrist. Different colors may be

used to identify different offender classifications, such as misdemeanor, felony, or violent. If opposing factions are involved, procedures are established to ensure members of opposing factions are not processed together or detained in the same holding area.

After a detainee has been searched and classified, he is taken to a processing station. There, his paperwork is processed. If offenders passively resist by going limp, they may be moved by wheelchair. This reduces the number of escorts needed and the fatigue to facility personnel.

Equipment like height charts, scales, fingerprinting equipment, and cameras must be available for completing the police report and for identifying the offender. Because detainees may use aliases and not carry identification, special attention is paid to obtaining as much information as possible about the detainee's physical characteristics. The paperwork is reviewed to ensure that information is complete, including charges, witnesses, and reasons for the apprehension.

After the processing is complete, the detainee is placed in an appropriate holding area. The paperwork is forwarded to the administrative section. The file is reviewed for completeness and to determine the disposition of the detainee. Information from the file may be placed into a computer to find repeat offenders. The computer may be used to file criminal information only.

Custody transfers and release procedures must be coordinated with civil authorities and appropriate legal counsel. Every effort must be made to arraign offenders quickly. The purpose of a detention facility is not to keep people off the streets, but to aid in processing offenders through the legal system. To speed up the release process, planners should consider issuing citations or subpoenas for minor offenses.

Control force members may have to respond to writs of habeas corpus. These writs are court orders addressed to a prisoner's custodian. Such a writ directs the custodian to bring the prisoner to court to determine the legality of the prisoner's apprehension and detention. The custodian must be sure to bring all documentation concerning the case with him to court.

Military personnel must obey writs issued by federal courts. For writs issued by a state court, the custodian or his legal advisor should respectfully reply that the prisoner is being held by authority of the United States. The SJA can answer any questions and explain the correct procedures.

Training for Civil Disturbances

Civil disturbance training must enable personnel to function effectively, as individuals and as members of a control force. To be effective, the training must be intensive, realistic, and continuous. Individual, team, and unit training are vital to develop personnel who are able to perform distasteful and dangerous duties with discipline and objectivity. A lack of training on the part of even one person can adversely affect the unit's performance. That person may not be able to fulfill his responsibilities as a team member. For this reason, the unit must conduct makeup training. The unit also must make provisions for training replacement personnel. Garden Plot's Annex A and AR 500-50 provide guidance on civil disturbance training requirements.

Each commander structures his unit's training program based on expected contingencies, prior training, the unit's degree of experience, and the degree of proficiency that the unit has attained. The unit must be trained, equipped, and maintained in readiness for rapid deployment. The training must cover all aspects of civil disturbance operations. And the training must entail more than just mechanical proficiency in crowd control formations. Training must also address the sensitivity and high visibility of civil disturbance operations. It must emphasize protection of firefighters and their equipment, area inhabitants, and other people trying to control the disturbance.

Training must include operational techniques for use in urban, suburban, and campus areas, as well as procedures for neutralizing special threats. Training must also include use of and functioning with personal equipment. For example, unit members may expect to be equipped with body armor, protective masks, or face-shields. Thus they should train wearing this equipment to help them become accustomed to wearing it for long periods of

time. And rehearsing alert plans, load plans, and operational plans must be done as often as necessary to reach and maintain the required degree of proficiency. Commanders should also consider training in courtroom procedures. After the event, soldiers may be called as witnesses in civilian trials.

Civil disturbance trainers can keep abreast of current developments from reports in the news media, after-action reports, and a number of other sources. Lessons learned from such reports and sources are useful for enhancing training and keeping it current. The following subjects are a guide for refresher training:

- Policies and legal considerations.
- Standards of conduct.
- Use of minimum force.
- Use of riot control agents and munitions.
- Use of riot batons.
- Search and seizure techniques.
- Apprehension and detention.
- Neutralization of special threats.
- Media relations.

UNIT TRAINING

Unit training must be realistic. Field training exercises can be conducted in built-up areas on the installation or at mock-ups. The unit commander should try to include local government officials in FTXs. The officials can be either witnesses or participants. But care must be taken to prevent adverse psychological effects on the local populace, especially if tension is high. Exercises with local officials work best if based on a detailed scenario. Then participants have a chance to test command and staff relationships, communications, coordination, logistics, and joint development of intelligence. Experience has shown joint exercises can identify and help solve problems before a civil disturbance occurs. The task force headquarters staff must periodically test their organization and procedures with command post exercises. They also must establish a civil disturbance SOP. Proper training can reveal problems to be corrected before actual operations. This reduces confusion during civil disturbance operations.

STRESS

Training can make it possible to function in a highly disciplined and organized manner under stressful conditions. Stress training has two goals: to improve understanding of crowd and mob behavior and to prepare troops to control their own actions and emotions. The troops study the typical causes of civil disturbances to gain a better understanding of their role in helping to control civil disturbances. Group behavior must be discussed in enough detail to show the troops what to expect. Also, the troops must learn how psychological factors influence their own behavior.

Troops must control their emotions and carry out their orders with determination and discipline when in formation, on patrol, or posted as guards. They must be physically and emotionally prepared for

crowd members shouting at them, insulting them, calling them abusive names, throwing objects at them, screaming and rushing at them, tearing off their own clothes, or deliberately injuring or maiming themselves. They cannot allow personal feelings to interfere with executing their mission. They must ignore these actions and use evasive movements to avoid thrown objects. They must never throw the objects back. Troops must understand that the well-disciplined execution of orders is the most effective measure against rioters.

A way to familiarize soldiers with confronting a mob is to conduct an exercise using part of the unit as violent demonstrators and part as the control force. This exercise must be realistic, but safe. This training, however, must not be conducted unless the soldier is also trained to deal with his internal stress. Installation mental health personnel may be available to help with stress training. They can teach methods to help reduce the soldiers' stress and fatigue. They may also be able to advise the commander on other factors that increase the soldiers' stress levels.

WEAPONS AND SPECIAL EQUIPMENT

Every member of the control force must be trained to use his weapon and special equipment. Weapons and special equipment include riot batons, riot control agent dispersers and CS grenades, grenade launchers, shotguns, sniper rifles, cameras, portable videotape recorders, portable public address systems, night illumination devices, firefighting apparatus, grappling hooks, ladders, ropes, bulldozers, Army aircraft, armored personnel carriers, and roadblock and barricade materials. Training time can be used to construct some special equipment, such as wire barricades and wire coverings for vehicles.

Troops equipped with riot batons must be well trained in their use. Riot baton training covers employment, the human body's vulnerable and fatal points of impact, the basic positions, and defensive procedures and use of the baton in riot control formations. The procurement of riot batons depends on their availability in the Army's inventory. If they are unavailable through Army supply channels, they can be procured by local purchase at the installation level.

Each service is responsible for providing, organizing, equipping, and training its forces to use riot control agents in civil disturbances. The training includes individual and unit training. Individual training covers—

- Policy on the employment of riot control agents.
- Characteristics of riot control agents.
- Individual protection, first aid, and decontamination.
- Maintenance of riot control agent munitions and equipment.

Unit training covers—

- Riot control agent squad organization.
- Tactical employment of riot control agents in crowd control.

These are the minimum training needs. Other training may be added as needed.

Designated personnel also receive training in the operation, employment, and maintenance of riot control agent dispersers. They must know and be proficient with the following:

- The nomenclature and characteristics of the respective dispersers and the riot control agents.
- The effects of weather, terrain, and distance on the dispersal of riot control agents.

- Methods of operating the dispersers.
- Techniques that give the greatest assurance of placing an effective concentration on the target area with a minimum spillover outside the target area.
- Maintenance of dispersers.
- Use, care, and inspection of protective clothing.
- Decontamination of equipment.
- Safety precautions.

Practical exercises are conducted under varying weather conditions and differing crowd control situations. Whenever possible, training should be integrated with unit disturbance control exercises. Drills are conducted periodically to test the readiness and proficiency of the operators and the equipment. For training purposes, technical talc, T1, is used in place of CS.

Each unit must have an SOP that provides guidance to all soldiers, including drivers and helicopter pilots, who operate dispersers. The SOP must cover specific individual duties and actions to be performed before, during, and after operation of the disperser.

When special equipment training cannot be accomplished before a unit is committed to a civil disturbance, the unit commander must get qualified personnel to operate the equipment. If that cannot be done, the equipment should not be used.

During training with bayonets, the bayonets *must be encased in their scabbards* for safety. Trainers must emphasize that the only time the rifle is used with fixed bayonets is when the control force is confronted by a violent crowd, and the commander authorizes their use. Also, troops who will be armed with shotguns during civil disturbance operations must be well-trained in their use.

COMMUNICATIONS SYSTEMS

Personnel must be trained in the use of communications systems. Communications operating procedures must be included in special instructions. The telephone system, for instance, is usually simple. But it can

be confusing because of various systems that exist in different areas. Troops must receive training on the telephone systems used in a projected disturbance area. They also must be provided a list of emergency numbers.

LEADERSHIP

Civil disturbance operations place unusual demands on the leadership skills of members of a control force. The complex nature of a civil disturbance requires a combination of determined execution of duty and individual restraint. Soldiers and small-unit leaders must be aware of these demands and be prepared to deal with them. Training must include a careful review of military leadership.

Because effective employment of the unit is a goal of leadership, a good leader must thoroughly understand span of control. Task organizing for civil disturbance operations is more than usually dependent on span of control. Span of control is the number of people or groups that one leader can control effectively. A leader's span of control in civil disturbances is limited by his span of attention, the personal attitudes of unit members, and the interaction of human relationships.

A leader's span of attention—his ability to give equal attention to a number of tasks simultaneously—will be severely tested. Unit members often must learn new tasks for civil disturbance operations. Because these tasks are not part of the unit's usual mission, leaders must closely supervise these tasks to ensure they are properly performed.

How a soldier works within his unit or reacts to a civil disturbance is determined by his attitude. Emotions and preconceived views and attitudes can impair a soldier's ability to reason logically. Again, close supervision is the key to preventing improper behavior.

A leader with two subordinates has two relationships, one with each subordinate. As the span of control becomes greater, the interaction of relationships becomes more complex. Emotions and stress further compound the complexities of these relationships.

As the need for close supervision increases and relationships become more complex, the span of control a leader can effectively handle decreases. If a leader's span of control is overextended, bad decisions and improper behavior are likely to result. This, in turn, has an adverse effect on the unit's ability to perform its civil disturbance mission.

Other factors that must be understood concerning span of control include:

- Experience and training of the leader.
- Experience and training of subordinates.
- Amount of clearly understood communication between a leader and his subordinates.
- Degree of similarity among subordinates' jobs.
- Time available for the organization to translate the leader's decisions into actions.
- Distance by which the leader and his subordinates are separated.
- Leader's personality and the personality of each of his subordinates.
- Mental and physical conditions of the leader and his subordinates.
- Complexity of the organization.

SPECIAL REACTION TEAM TRAINING

Past civil disturbance operations show that there is a need for personnel to be trained to deal with special threats, such as arson, sniping, and sabotage. Commanders, in planning their organization and training, must consider the need for special reaction teams to counteract special threats. SRT leaders and members must get intensive, specialized training in all areas of civil disturbance operations, with emphasis on counteracting and controlling special threats. This training also includes extensive training in combat in urban terrain, marksmanship, rappelling, physical fitness, first aid, and the use of specialized equipment.

The team must know their equipment's potential. They must know how to use their equipment properly. And they must develop confidence in their equipment. In most cases TOE or TDA military equipment and weapons are more than adequate to deal with special threats if the team's training is sufficient. The equipment available through supply channels or authorized by TOE or TDA must be used to the maximum extent possible to equip SRTs. However, local procurement may be needed to obtain special equipment that is deemed absolutely necessary for the safety of the SRT and for successfully resolving special threat situations. And SRT training must include the use of such equipment. An example of special equipment is soft body armor with ceramic-fiberglass inserts that is used at static positions.

The goal of civil disturbance planners is to have one SRT available at all times. They should consider training three or four 5-man SRTs so that one is available for standby. It may be necessary to alert or employ more than one team and to combine or augment teams to deal with threats that are beyond the capabilities of one team.

SRT training should be conducted in two phases. The first phase is the development stage. The team identifies team and individual weaknesses that require additional training. This stage requires frequent training sessions to achieve the desired response capability, to familiarize the members with individual and team responsibilities, to sharpen individual skills, to improve team cohesiveness, and to establish esprit de corps. The second phase is the maintenance stage. This stage requires fewer training sessions, but it is no less important. In this stage, members learn advanced skills, develop new techniques, and reinforce and hone the skills learned in the first phase.

SRTs must be thoroughly trained not only in basic soldiering skills but in specialized and unique skills that enhance team flexibility. This is vital because each special threat situation is different and must be dealt with individually.

The SRT is designed to neutralize or apprehend a barricaded offender with a minimum of danger to hostages, team members, control force members, and others. All team members must cross-train in the specialized duties of the other team members. SRTs must be tested in many varied scenarios so team and individual strengths and weaknesses can be identified and corrected. It is important that SRT members train in a manner that builds teamwork and develops confidence in themselves and their teammates. The capabilities of an SRT influence the commander's decision on how and when to employ the team. Therefore, commanders should be briefed on their teams' status after each training session.

Stress training is invaluable in preparing SRT members for situations in which they must use their weapons. Stress courses provide team members with training in firing their weapons while they are running,

firing rapidly, firing from difficult firing positions, reloading rapidly, firing with accelerated heart and respiration rates, and in other perceived circumstances that might confront team members. How well the teams are trained in these areas can make the difference between life and death for team members, hostages, and offenders.

Training the marksman requires additional emphasis and consideration and must be oriented more to the individual. But it also must integrate the marksman's actions with those of the team. The

marksman must have self-discipline. He must be tested under many different and extreme conditions. He must always train with the same weapon and with the same grade of ammunition to ensure consistent round strikes. He must fully understand the capabilities of his weapon, how to identify targets, and how to engage targets rapidly. This training can only be accomplished by continuous practice under varying weather and visibility conditions. For a detailed discussion of individual and team training, see FM 21-75, FM 23-9, FM 90-10, TC 19-16, TC 23-14, and TC 90-6-1.

PRESCRIBED LEVELS OF PREPAREDNESS FOR A CIVIL DISTURBANCE CONTROL MISSION

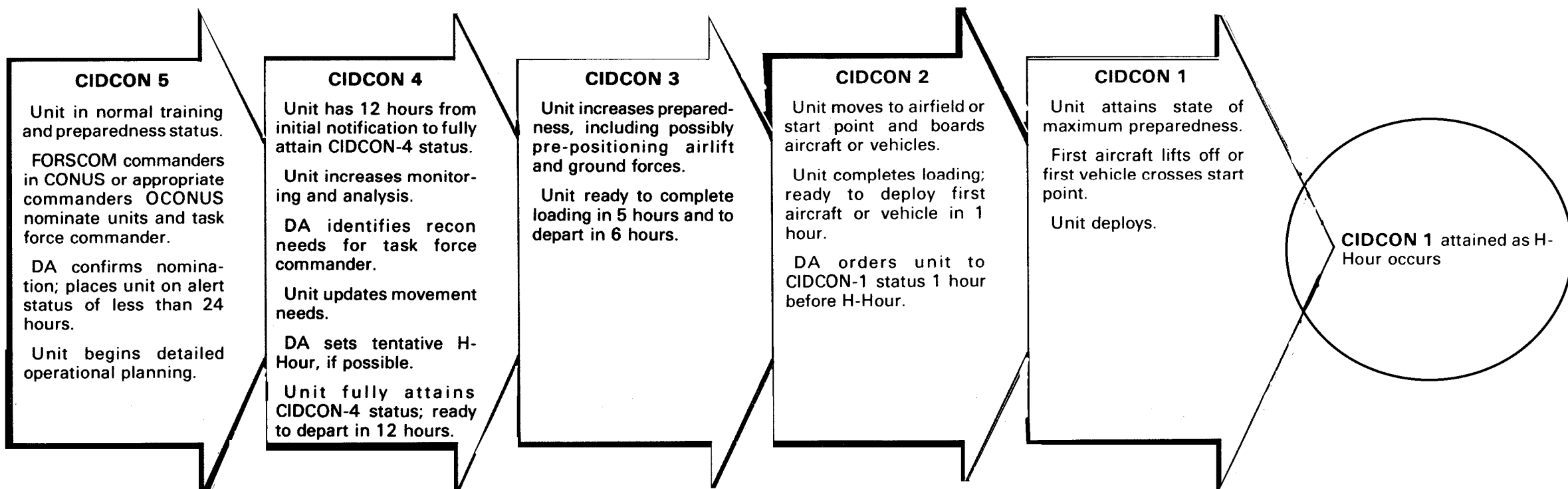

Civil Disturbance Conditions, or CIDCONs, are required levels of preparedness that must be attained by units designated for civil disturbance operations. **CIDCONs** are a means of measuring that preparedness. **CIDCON 5** is the normal state of preparedness, which can be sustained indefinitely. **CIDCON 1** is the state of preparedness at which the unit deploys.