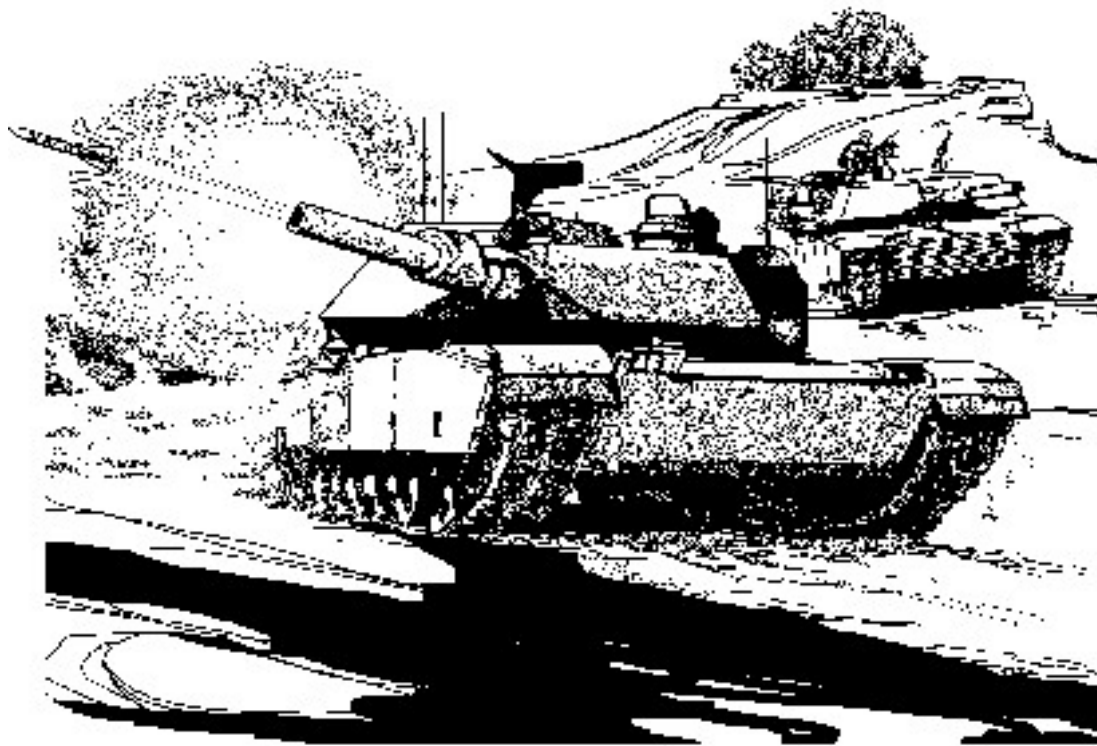


**FM 17-15**

# **TANK PLATOON**



**Headquarters  
Department of the Army**

**April 1996**

**Distribution Restriction: Approved for public release;  
distribution is unlimited.**

*TABLE OF CONTENTS*

**PREFACE**

**CHAPTER 1..... INTRODUCTION**

**CHAPTER 2..... BATTLE COMMAND**

**CHAPTER 3..... OFFENSIVE OPERATIONS**

**CHAPTER 4..... DEFENSIVE OPERATIONS**

**CHAPTER 5..... OTHER TACTICAL OPERATIONS**

**CHAPTER 6..... COMBAT SUPPORT**

**CHAPTER 7..... COMBAT SERVICE SUPPORT**

**APPENDIX A..... ORDERS AND REPORTS**

**APPENDIX B..... LIGHT/HEAVY OPERATIONS**

**APPENDIX C..... CONTINUOUS OPERATIONS**

**APPENDIX D..... NUCLEAR, BIOLOGICAL, CHEMICAL, AND SMOKE  
OPERATIONS**

**APPENDIX E..... OPERATIONS OTHER THAN WAR**

**APPENDIX F..... FRATRICIDE PREVENTION**

**GLOSSARY**

**REFERENCES**

**Distribution Restriction:** Approved for public release; distribution unlimited.

**This publication supersedes FM 17-15, 7 October 1987.**

## PREFACE

---



This manual describes how the tank platoon fights. It focuses on the principles of platoon operations and the tactics, techniques, and procedures (TTP) the platoon uses to exploit its combat power and minimize its vulnerabilities while conducting move, attack, and defend operations.

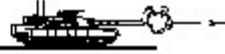
FM 17-15 is for tank platoon leaders and members of M60A3, M1, M1A1, M1A2, and M8-AGS crews. Because weapons and equipment vary among units, users should adapt information to fit their specific situations. Where capabilities of the various systems differ significantly, this manual examines alternative considerations and techniques for their use.

In addition to FM 17-15, three publications are critical reference sources for the tank platoon. ARTEP 17-237-10-MTP, the mission training plan for the tank platoon, contains collective platoon tasks and outlines training procedures and exercises. The other two manuals are published as Fort Knox Supplementary Material (FKSM). FKSM 17-15-1 contains information on TTP for platoons equipped with a variety of enhanced technologies. Included are the latest updates on systems covered in FM 17-15, such as the intervehicular information system (IVIS), and on newly developed equipment like the missile countermeasure device (MCD). FKSM 17-15-3 contains a detailed example of tactical standing operating procedures (TSOP). Each tank platoon can modify the TSOP to meet its unique mission requirements. For information on obtaining FKSM publications, call (502) 624-2987/5848 (commercial) or 464-2987/5848 (DSN).

The proponent of FM 17-15 is HQ TRADOC. Record comments and recommendations on DA Form 2028, and send the form directly to Commander, 2d Squadron, 16th Cavalry Regiment, United States Army Armor School, ATTN: ATSB-SBB-D, Fort Knox, Kentucky 40121-5200.

Unless otherwise stated, masculine nouns and pronouns do not refer exclusively to men.

## CHAPTER 1



# INTRODUCTION

The fundamental mission of the tank platoon is to close with and destroy the enemy. The platoon's ability to move, shoot, communicate, and provide armored protection is a decisive factor on the modern battlefield. It moves, attacks, defends, and performs other essential tasks to support the company team or troop mission. In accomplishing its assigned missions, the platoon uses fire, maneuver, and shock effect, synchronized with other maneuver elements and with combat support (CS) and combat service support (CSS) assets. When properly supported, it is capable of conducting sustained operations against any sophisticated threat.

The tank platoon can survive and win in battle, however, only if it is well trained, effectively led, and highly motivated. Crews must be aggressive, and their tactics must reflect the tempo and intensity of maneuver warfare. Platoon training must prepare them to operate in hostile territory with the enemy to their front, flanks, and rear.

## CONTENTS

SECTION I. Organizations

SECTION II. Responsibilities

SECTION III. Capabilities and Limitations

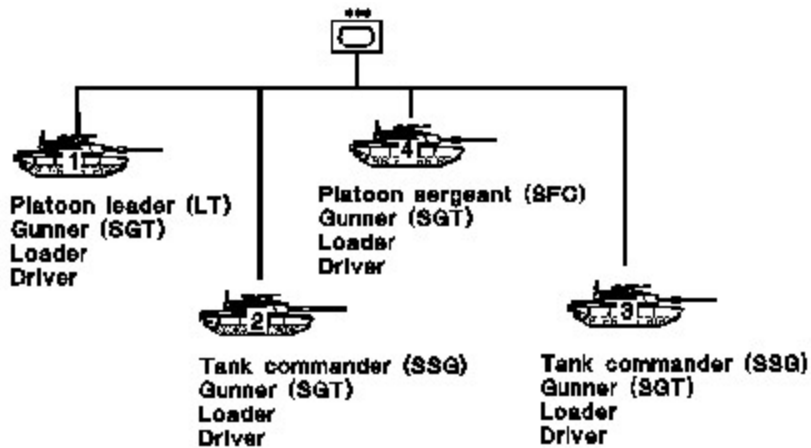
# Section I. ORGANIZATIONS

## The Tank Platoon

By itself, any tank can be vulnerable in the face of diverse battlefield hazards (such as enemy forces or unfavorable terrain) and situations; these vulnerabilities are significantly reduced when tanks are employed as units.

The tank platoon is the smallest maneuver element within a tank company. Organized to fight as a unified element, the platoon consists of four main battle tanks organized into two sections, with two tanks in each section. The platoon leader (Tank 1) and platoon sergeant (Tank 4) are the section leaders. Tank 2 is the wingman in the platoon leader's section, and Tank 3 is the wingman in the platoon sergeant's section (see Figure 1-1).



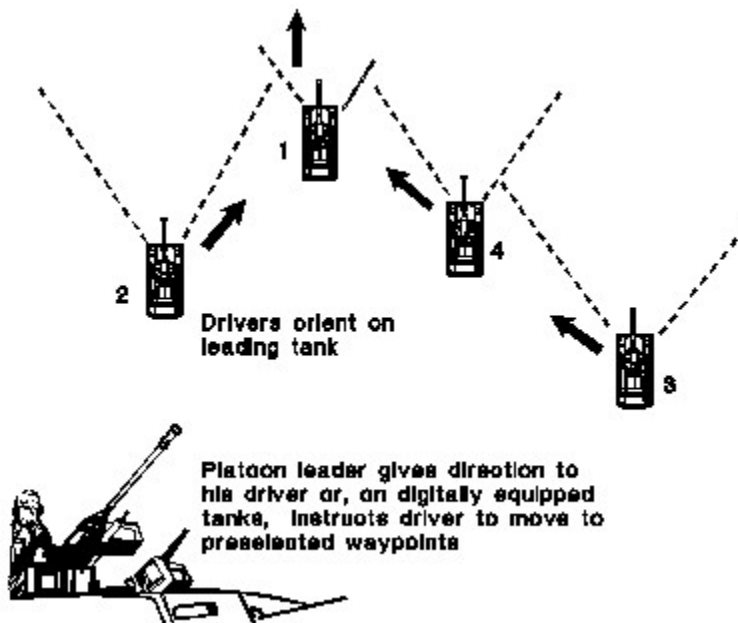


**NOTE:** Loader and driver are in grades E1 to E4.  
On the M8-AGS, the loader is replaced by an autoloader.

**Figure 1-1. Tank platoon organization.**

The tank platoon is organic to tank companies and armored cavalry troops. The platoon may be cross-attached to a number of organizations, commonly a mechanized infantry company, to create company teams. It may also be placed under operational control (OPCON) of a light infantry battalion.

Under battlefield conditions, the wingman concept facilitates control of the platoon when it operates in sections. The concept requires that one tank orient on another tank on either its left or right side. In the absence of specific instructions, wingmen move, stop, and shoot when their leaders do. In the tank platoon, Tank 2 orients on the platoon leader's tank, while Tank 3 orients on the platoon sergeant's tank. The platoon sergeant (PSG) orients on the platoon leader's tank. (See Figure 1-2.)



**Figure 1-2. The wingman concept.**

## The Tank Company

The tank company is organized, equipped, and trained to fight pure; it can also be task organized by higher headquarters to fight with infantry as a company team. The tank company consists of a headquarters and three tank platoons. The company headquarters is equipped with two tanks, one M113A2 armored personnel carrier (APC), two M1025 or M998 high-mobility multipurpose wheeled vehicles (HMMWV), and one cargo truck with a 400-gallon water trailer (see Figure 1-3, page 1-4). A maintenance section from the battalion maintenance platoon is normally attached to the tank company. The maintenance section consists of one APC, one heavy recovery vehicle, and one utility truck with trailer carrying spare parts based on the prescribed load list (PLL). A medic, normally attached from the battalion medical platoon, travels in another APC.

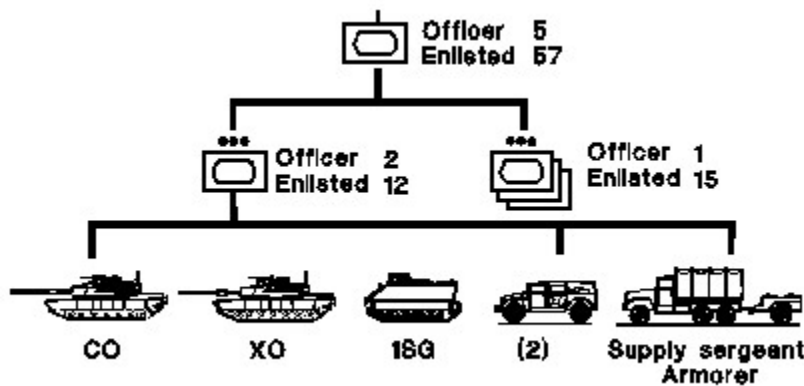


Figure 1-3. Tank company organization.

## The Armored Cavalry Troop

The cavalry troop is organized, equipped, and trained to protect and conserve the combat power of other combined arms forces. While its primary missions are reconnaissance and security, the cavalry troop may be called upon to execute attack, defend, and delay missions as part of squadron and regimental missions.

The armored cavalry troop consists of a headquarters, two tank platoons, two scout platoons, and mortar and maintenance sections. The headquarters section is equipped with one main battle tank, one command post (CP) carrier, one APC, one cargo truck, and two utility trucks. The scout platoons consist of six M3 cavalry fighting vehicles (CFV). Equipment in the mortar and maintenance sections includes two 107-mm mortars mounted in self-propelled carriers, one APC, one heavy recovery vehicle, etc. (See Figure 1-4.)

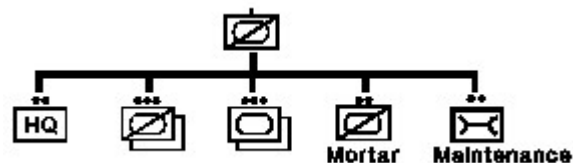


Figure 1-4. Armored cavalry troop organization.

The light armored cavalry troop has the same basic configuration. The main battle tanks are replaced by the M8 armored gun system (M8-AGS); instead of M3s, there are 10 M1025 or M1026 HMMWVs in each platoon. The mortars are towed by M1025 HMMWVs. For additional information, refer to FM 17-97.

**NOTE:** For information on light infantry organizations, refer to Appendix B of this manual and to FM 7-20. Additional information concerning task organized company teams is in Appendix B and in FM 71-1.

## **Section II. RESPONSIBILITIES**

The tank crew is a tightly integrated team. Though all members have primary duties, success depends on their effectiveness as a crew. They must work together to maintain and service their tank and equipment, and they must function as one in combat. Crews must cross-train so each member can function at any of the other crew positions.

### **Platoon Leader**

The platoon leader is responsible to the commander for the discipline and training of his platoon, the maintenance of its equipment, and its success in combat. He must be proficient in the tactical employment of his section and of the platoon in concert with a company team or troop. He must have a solid understanding of troop-leading procedures and develop his ability to apply them quickly and efficiently on the battlefield.

The platoon leader must know the capabilities and limitations of the platoon's personnel and equipment; at the same time, he must be well versed in enemy organizations, doctrine, and equipment. He must serve as an effective tank commander (TC). Most important of all, the platoon leader must be flexible, using sound judgment to make correct decisions quickly and at the right times based on his commander's intent and the tactical situation.

Platoon leaders must know and understand the task force mission and the task force commander's intent. They must be prepared to assume the duties of the company commander in accordance with the succession of command.

### **Platoon Sergeant**

The PSG is second in command of the platoon and is accountable to the platoon leader for the training, discipline, and welfare of the soldiers in the platoon. He coordinates the platoon's maintenance and logistics requirements and handles the personal needs of individual soldiers. The PSG is the most experienced TC in the platoon. His tactical and technical knowledge allow him to serve as mentor to crewmen, other NCOs, and the platoon leader. His actions on the battlefield must complement those of the platoon leader. He must fight his section in concert with the platoon leader's section.

## **Tank Commander**

The TC is responsible to the platoon leader and signed equipment, the reporting of logistical needs, and the tactical employment of his tank. He briefs his crew, directs the movement of the tank, submits all reports, and supervises initial first-aid treatment and evacuation of wounded crewmen. He is an expert in using the tank's weapon systems, requesting indirect fires, and executing land navigation.

The TC must know and understand the company mission and company commander's intent. He must be prepared to assume the duties and responsibilities of the platoon leader or PSG in accordance with the succession of command. These requirements demand that the TC maintain situational awareness by using all available optics for observation, by eavesdropping on radio transmissions, and by monitoring the intervehicular information system (IVIS) or appliqué digital screen (if available).

## **Gunner**

The gunner searches for targets and aims and fires both the main gun and the coaxial machine gun. He is responsible to the TC for the maintenance of the tank's armament and fire control equipment. The gunner serves as the assistant TC and assumes the responsibilities of the TC as required. He also assists other crewmembers as needed. Several of his duties involve the tank's communications and internal control systems: logging onto and monitoring communications nets; maintaining digital links if the tank is equipped with the IVIS or appliqué digital system; inputting graphic control measures on digital overlays; and monitoring digital displays during the planning and preparation phases of an operation.

## **Driver**

The driver moves, positions, and stops the tank. While driving, he constantly searches for covered routes and for covered positions to which he can move if the tank is engaged. He maintains his tank's position in formation and watches for visual signals. If the tank is equipped with a steer-to indicator, the driver monitors the device and selects the best tactical route. During engagements, he assists the gunner and TC by scanning for targets and sensing fired rounds. The driver is responsible to the TC for the automotive maintenance and refueling of the tank. He assists other crewmen as needed.

## **Loader**

The loader loads the main gun and the coaxial machine gun ready box; he aims and fires the loader's machine gun (if the vehicle is equipped with one). He stows and cares for ammunition and is responsible to the TC for the maintenance of communications equipment. Before engagement actions are initiated, the loader searches for targets and acts as air or antitank guided missile (ATGM) guard. He also assists the TC as needed in

directing the driver so the tank maintains its position in formation. He assists other crewmembers as necessary. Because the loader is ideally positioned both to observe around the tank and to monitor the tank's digital displays, platoon leaders and TCs should give strong consideration to assigning their second most experienced crewman as the loader.

**NOTE:** On the M8-AGS, the function of loading the main gun is handled by the autoloader. Loading of the coaxial machine gun, as well as the stowage and care of ammunition, becomes the duty of the gunner. The absence of a loader also means the TC assumes a greater degree of responsibility for air and ATGM watch.

## **Section III. CAPABILITIES AND LIMITATIONS**

To win in battle, leaders must have a clear understanding of the capabilities and limitations of their equipment. Figures 1-5 through 1-9, pages 1-9 through 1-13, list the specifications, characteristics, and significant features of the M60A3 and M1-series main battle tanks and the M8-AGS. These listings will assist the platoon leader in evaluating transportability, sustainment, and mobility considerations for his own vehicles and for those with which the platoon may operate as part of a company team or troop.

### **Capabilities**

Tanks offer an impressive array of capabilities on the modern battlefield: excellent cross-country mobility, sophisticated communications, enhanced target acquisition, lethal firepower, and effective armor protection. In combination, these factors produce the shock effect that allows armor units to close with and destroy the enemy in most weather and light conditions. Tanks can move rapidly under a variety of terrain conditions, negotiating soft ground, trenches, small trees, and limited obstacles. In addition, global positioning systems (GPS) and inertial position navigation (POSNAV) systems allow today's tanks to move to virtually any designated location with greater speed and accuracy than ever before. Use of visual signals and the single channel ground/airborne radio system (SINCGARS) facilitates rapid and secure communication of orders and instructions. This capability allows tank crews to quickly mass the effects of their weapon systems while remaining dispersed to limit the effects of the enemy's weapons. On-board optics and sighting systems enable the crews to acquire and destroy enemy tanks, armored vehicles, and fortifications using the main gun or to use machine guns to suppress enemy positions, personnel, and lightly armored targets. The tank's armor protects crewmembers from small arms fire, most artillery, and some antiarmor systems.

### **Limitations**

Tanks require extensive maintenance, proficient operators, and skilled mechanics, as well

as daily resupply of large quantities of bulky petroleum products such as fuel, oil, and grease. They are vulnerable to the weapons effects of other tanks, attack helicopters, mines, ATGMs, antitank guns, and close attack aircraft. When tanks operate in built-up areas, dense woods, or other close terrain, reduced visibility leaves them vulnerable to dismounted infantry attacks as well. In such situations, they are usually restricted to trails, roads, or streets; this severely limits maneuverability and observation. Existing or reinforcing obstacles can also restrict or stop tank movement.

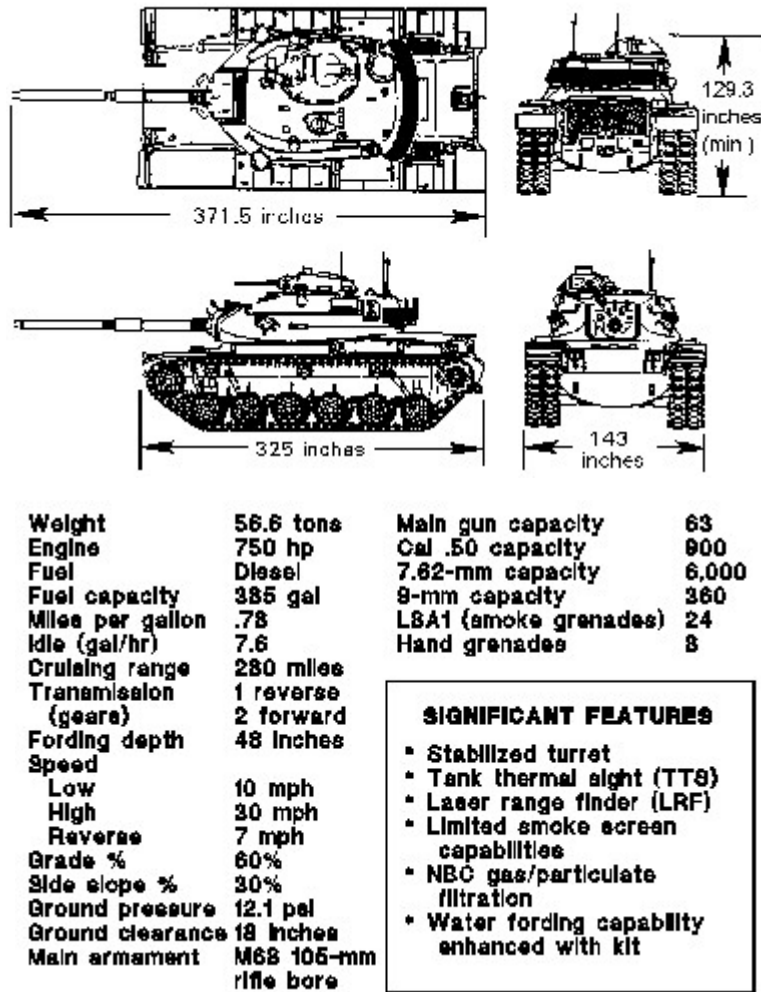
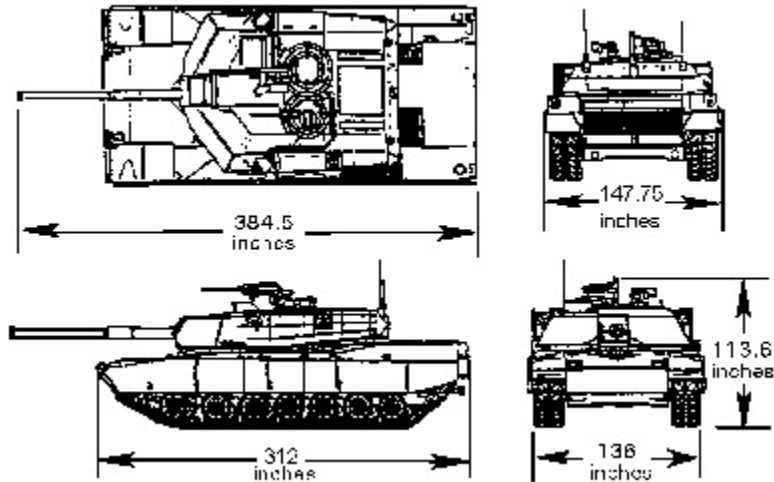


Figure 1-5. M60A3 characteristics.

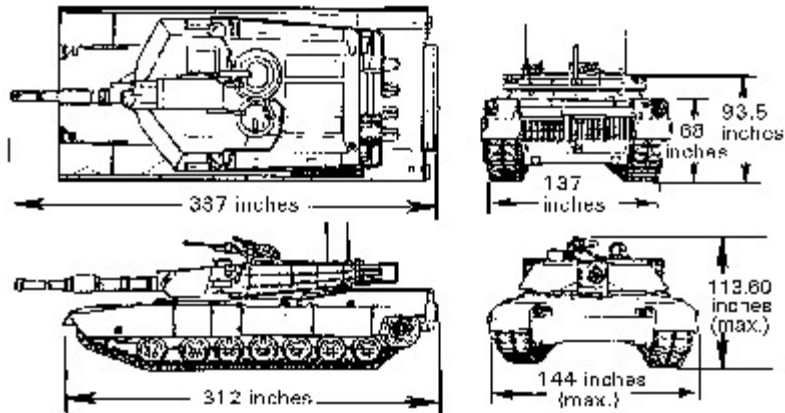


<b>Weight</b>	<b>80 tons</b>	<b>Speed</b>	
<b>Engine</b>	<b>1,500 hp Turbine</b>	<b>Maximum</b>	<b>45 mph</b>
<b>Fuel</b>	<b>Diesel, Mogas, Jet fuel</b>	<b>Cross-country</b>	<b>30 mph</b>
<b>Fuel capacity</b>	<b>504.4 gal</b>	<b>Grade %</b>	<b>80%</b>
<b>Miles per gallon</b>	<b>.85</b>	<b>Side slope %</b>	<b>40%</b>
<b>Idle (gal/hr)</b>	<b>11.2</b>	<b>Ground pressure</b>	<b>18.50 psi</b>
<b>Tau idle (gal/hr)</b>	<b>30.8</b>	<b>Main armament</b>	<b>M88A1</b>
<b>Cruising range</b>	<b>310 miles</b>	<b>Main gun capacity</b>	<b>105-mm</b>
<b>Transmission (gears)</b>	<b>2 reverse 4 forward</b>	<b>Cal .50 capacity</b>	<b>55</b>
<b>Fording depth</b>		<b>7.62-mm capacity</b>	<b>900</b>
<b>Without kit</b>	<b>48 inches</b>	<b>5.58-mm capacity</b>	<b>11,400</b>
<b>With kit</b>	<b>Turret roof</b>	<b>L8A1 (smoke grenades)</b>	<b>24</b>
		<b>Hand grenades</b>	<b>8</b>

#### SIGNIFICANT FEATURES

- Improved survivability
- Improved armor
- High agility
- Speed
- Low silhouette
- Advanced suspension (torsion bars/rotary shock absorbers)
- Hydraulically stabilized turret/gun system
- Ballistic computer
- Laser range finder (LRF)
- Thermal imaging night sight (TIS)
- NBC gas/particulate filtration

Figure 1-6. M1 characteristics.

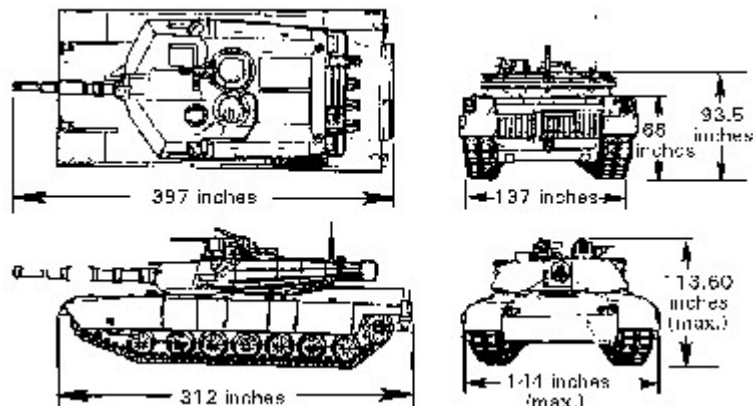


<b>Weight</b>	<b>63 tons</b>	<b>Speed</b>	
With 156 track	68.0 tons	Maximum	42 mph
<b>Engine</b>	<b>1,500 hp</b>	Cross-country	30 mph
	Turbine	Grade %	60%
<b>Fuel</b>	<b>Diesel, Mogas,</b>	Side slope %	40%
	Jet fuel	Ground pressure	15.00 psi
<b>Fuel capacity</b>	<b>504.4 gal</b>	Main armament	M256
Miles per gallon	.58	Main gun capacity	40
Idle (gal/hr)	6.5	Cal .50 capacity	900
Tau idle (gal/hr)	30.6	7.62-mm capacity	11,400
Cruising range	298 miles	5.56-mm capacity	210
<b>Transmission</b>	<b>2 reverse</b>	LBA1 (smoke	24
(gears)	4 forward	grenades)	
<b>Fording depth</b>		Hand grenades	6
Without kit	48 inches		
With kit	Turret roof		

#### SIGNIFICANT FEATURES

- Improved survivability
- Improved armor
- High agility
- Speed
- Ease of maintenance
- Advanced suspension (torsion bar/rotary shock absorbers)
- Onboard malfunction detection system
- Automatic shift/steering transmission
- Single channel ground/air radio system (SINCGARS)
- NBC overpressure system
- Hydraulically stabilized turret/gun system
- Digital ballistic computer
- Laser range finder (LRF)
- Thermal imaging night sight (TIS)
- Compartmented fuel/ammunition
- Increased external stowage
- Low silhouette

Figure 1-7. M1A1 characteristics.



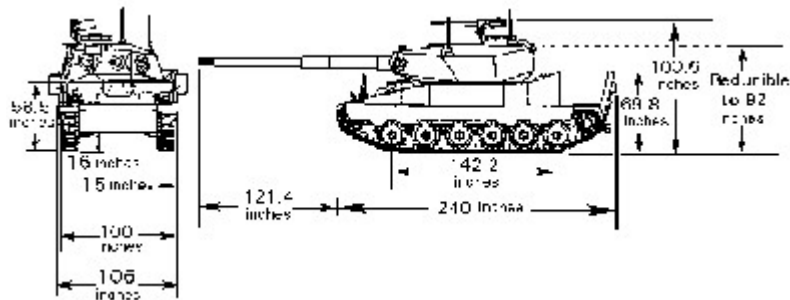


<b>Weight</b>	68 tons	<b>Speed</b>	
<b>Engine</b>	1,500 hp Turbine	<b>Maximum</b>	42 mph
<b>Fuel</b>	Diesel, Mogas, Jet fuel	<b>Cross-country</b>	90 mph
<b>Fuel capacity</b>	504.4 gal	<b>Grade %</b>	60%
<b>Miles per gallon</b>	.69	<b>Side slope %</b>	40%
<b>Idle (gal/hr)</b>	8.5	<b>Ground pressure</b>	15.5 psi
<b>Tac idle (gal/hr)</b>	30.6	<b>Main armament</b>	M256 120-mm smooth bore
<b>Cruising range</b>	298 miles	<b>Main gun capacity</b>	42
<b>Transmission</b>	2 reverse	<b>Cal .50 capacity</b>	900
<b>(gears)</b>	4 forward	<b>7.62-mm capacity</b>	11,400
<b>Fording depth</b>		<b>5.56-mm capacity</b>	210
<b>Without kit</b>	48 inches	<b>L8A1 (smoke</b>	24
<b>With kit</b>	Turret roof	<b>grenades)</b>	
		<b>Hand grenades</b>	8

#### SIGNIFICANT FEATURES

- Improved armor
- Increased lethality
- High agility
- Low silhouette
- Thermal imaging night sight (TIS)
- Fully stabilized sight
- Ease of maintenance
- Onboard malfunction detection system
- Advanced torsion bars/rotary shock absorbers
- Automatic shift/steering transmission
- Compartmented fuel/ammunition
- Increased external stowage
- NBC overpressure system
- Digital electronic control unit
- Single channel ground/air radio system (SINCGARS)
- Intervehicular Information system (IIG)
- Driver's thermal viewer (DTV)
- Commander's independent thermal viewer (CITV)
- Position navigation system (POSNAV)
- Improved commander's weapon station (CWS)
- Commander's integrated display
- Driver's integrated display
- Gunner's control and display panel

Figure 1-8. M1A2 characteristics.



<b>Weight</b>		<b>Grade %</b>	<b>80%</b>
Level 1	19.25 tons	<b>Side slope %</b>	<b>40%</b>
Level 2	22.25 tons	<b>Ground pressure</b>	
Level 3	24.75 tons	Level 1	9 psi
<b>Engine</b>	<b>550 hp</b>	Level 2	10.4 psi
	Diesel	Level 3	11.8 psi
<b>Fuel</b>	Diesel or JP 8	<b>Main armament</b>	<b>M35</b>
<b>Fuel capacity</b>	150 gal	(soft recoil)	105-mm
<b>Miles per gallon</b>	2	<b>Main gun capacity</b>	30
<b>Cruising range</b>	300	<b>Cal .50 capacity</b>	600
<b>Transmission</b>	Hydromechanical	<b>7.62-mm capacity</b>	4,500
<b>Fording depth</b>	40 inches	<b>5.56-mm capacity</b>	210
<b>Speed</b>		<b>LBA1 (smoke</b>	16
Maximum	45 mph	grenades)	
Cross-country	30 mph	<b>Hand grenades</b>	8

#### SIGNIFICANT FEATURES

- Lethality
- Mobility
- Firepower
- Low silhouette
- Laser range finder (LRF)
- Stabilized day/night thermal imaging sight (TIS)
- Fire control computer
- Ballistic and nonballistic protection
- Autoloader
  - Firing rate: 12 rds/min
  - Automated round selection: 21 ready rounds
- System reliability
- System maintainability
- Single channel ground/air radio system (SINGARS)

Figure 1-9. M8-AGS characteristics.

## CHAPTER 2



### BATTLE COMMAND

Battle command is the process of assimilating thousands of bits of information and using the data to visualize the battlefield, assess the situation, and direct military action required to achieve victory. Thinking and acting are simultaneous activities for leaders in battle.

The command and control of combat elements are the biggest challenges faced by combat leaders on the modern battlefield. Command involves directing various combat, CS, and CSS elements; control entails the measures taken to ensure these directions are carried out. Even the most knowledgeable tactician will be ineffective if he cannot properly use the techniques available to direct and control his combat elements.

The tank platoon leader, assisted by the PSG, employs a variety of techniques to prepare for operations, issue orders, employ the platoon, and communicate. The success of this command and control process rests mainly on leadership, training, thoroughly understood standing operating procedures (SOP), and the effective use of communications equipment. For maximum efficiency, the platoon leader must keep the process as simple as possible while ensuring that he provides the platoon with all required

information and instructions.

## CONTENTS

SECTION I. Command

SECTION II. Control

### Section I. COMMAND

Command has two vital components: decision-making and leadership. This section examines in detail how the platoon leader and his subordinate leaders use these elements to develop the flexible, productive command structure that is the catalyst for success on the battlefield.

## Decision-making

Decision-making is a conscious process for selecting a course of action from two or more alternatives. At platoon level, many decisions are based on SOPs and standard unit drills. SOPs and drills cover an array of routine and emergency actions, such as evacuation of wounded soldiers, rearming and resupply procedures, and individual crew responsibilities; they allow the platoon to operate quickly and efficiently without constant guidance from the platoon leader. SOPs are especially critical in helping to maintain combat preparedness when leaders are tired or under stress as a result of continuous operations. Because of this, it is absolutely necessary that everyone in the platoon thoroughly understand all applicable SOPs. FKSM 17-15-3 contains a sample SOP that can be adapted for use in various tank platoon organizations.

## Troop-leading Procedures

Most tactical decisions are made by the commander, who then announces them in the form of orders that include his intent and concept of the operation. Based on these orders, the platoon leader uses troop-leading procedures to organize his time during planning and preparation and to translate the operation into instructions his soldiers can understand. He can then lead the platoon more effectively in the execution of the mission.

Troop-leading is a dynamic process that begins when the unit receives a new mission or is notified by warning order (WO) that a new mission is imminent. Whenever possible, troop-leading procedures are integrated and accomplished concurrently rather than sequentially. Time management is the key. The platoon leader normally uses one-third of the available time to plan, prepare, and issue the order; his TCs then have the remaining two-thirds of the time available to prepare their tanks and crews for the operation.

The following discussion focuses on the eight steps of troop-leading procedures:

- Receive and analyze the mission.
- Issue a warning order.
- Make a tentative plan.
- Initiate movement.

Conduct reconnaissance and coordination.  
Complete the plan.  
Issue the order.  
Supervise and refine.

***Receive and analyze the mission.*** The platoon leader normally receives his orders as an oral operation order (OPORD) or as a fragmentary order (FRAGO) updating a previously issued OPORD. Graphics may be copied from the commander's overlay or sent by digital transmission (see the discussion on pages 2-23 through 2-25). Initial coordination with other platoon leaders and the company FIST should be accomplished upon receipt of the mission. (**NOTE:** Before the OPORD or FRAGO arrives, the platoon leader may receive a series of WOs from the company commander providing advance notice of an impending operation. The platoon leader should disseminate all pertinent information contained in the WOs as quickly as possible after they are received.)

Upon receipt of the order, the platoon leader's first task is to extract his mission from the commander's overall plan. The key to understanding the platoon mission as part of the company team or troop mission lies in two elements of the plan: the commander's intent and the purpose he envisions for the company and for each platoon. One platoon will be designated as the company's main effort. This platoon's performance is critical to the company's success. The other platoons are supporting efforts; their purpose will be to assist the main effort in some way.

The platoon leader's knowledge of the intent and purpose allows him to use his initiative, exploit battlefield opportunities, and accomplish the commander's plan. If he does not understand the intent or purpose, he should ask the commander for clarification.

The platoon leader analyzes the mission using the factors of METT-T: mission, enemy, terrain (and weather), troops, and time available. These factors allow the platoon leader to identify the platoon's purpose; the specified, implied, and essential tasks it must perform; and the timeline by which the platoon will accomplish those tasks. The following outline of METT-T factors will assist the platoon leader in analyzing the mission and creating a timeline.

### **Mission.**

What is the battalion commander's intent?

What is the company commander's intent and purpose?

What tasks did the commander say I must accomplish (specified tasks)? In the OPORD, specified tasks are contained in paragraphs 3, 4, and 5.

What other tasks must be accomplished to ensure mission success (implied tasks)? Implied tasks are those that are not specified in the OPORD but that must be done to complete the mission. They do not include tasks that are covered in the unit SOP. The platoon leader identifies implied tasks by analyzing the enemy, the terrain, friendly troops available, and the operational graphics. As an example, the commander may direct the platoon to occupy a support by fire position near a known enemy observation post (OP). The platoon leader will immediately recognize that he must occupy the designated position (the specified task);

through his analysis, he will probably determine that the platoon must also destroy or neutralize the enemy OP because it can affect the platoon and/or company mission (the implied task). If time is available, the platoon leader should confirm implied tasks with the commander.

### **Enemy.**

What have been the enemy's recent activities?

What is the composition of the enemy's forces?

What are the capabilities of his weapons?

What is the location of current and probable enemy positions?

What is the enemy's most probable course of action? The platoon leader must apply knowledge of the enemy's doctrine and his most recent activities and locations to answer the following questions:

- Will the enemy attack or defend?
- What is the enemy's objective?
- What formations will he use?
- Where are his engagement areas?
- Where and when will he execute his operations?

Enemy information is included in paragraph 1 of the OPORD. It is important that the platoon leader analyze this information in terms of the platoon's role in the operation. For example, if the company commander only identifies platoon-size center-of-mass locations for a defending enemy, the platoon leader should identify probable enemy vehicle locations based on the terrain and the enemy's doctrine.

**Terrain (and weather).** The platoon leader analyzes the terrain using the factors of OAK-OC (obstacles; avenues of approach; key terrain; observation and fields of fire; and cover and concealment). Elements of this analysis include the following:

Obstacles.

- Where are natural and existing obstacles located, and how can they affect maneuver?
- Where are likely areas for enemy-emplaced obstacles, and how can they affect maneuver?
- Are there bypasses, or must obstacles be breached?

Avenues of approach. Where are the best avenues of approach (mounted and dismounted) for enemy and friendly forces?

Key terrain.

- Where is the key terrain?
- How can key terrain be used to support the mission?

Observation and fields of fire. These are influenced by key terrain that dominates avenues of approach.

- Where can the enemy observe and engage my platoon (danger areas)?
- Where are the natural firing positions my platoon can use to observe and engage the enemy, including locations for battle positions (BP), support by fire and attack by fire positions, and overwatch positions?

Cover and concealment.

- What routes within the area of operations offer cover and concealment for my platoon or for enemy elements?
- Do the natural firing positions in the area of operations offer cover and concealment for the platoon or enemy?

Weather. The platoon leader can use these questions as he analyzes the impact of weather on the mission:

- What are the light conditions (including percentage of night illumination) and visibility? What are the times for beginning of morning nautical twilight (BMNT), sunrise, sunset, end of evening nautical twilight (EENT), moonrise, and moonset?
- How has recent weather affected the area of operations?
- sion?
- How will fog, rain, dust, heat, snow, wind, or blowing sand affect my men and equipment during the mission?

**NOTE:** The effects of weather on smoke or NBC weapons should also be considered.

### **Troops.**

- What is the supply status of ammunition, fuel, and other necessary items?
- What is the present physical condition of the soldiers, as well as of vehicles and equipment?
- What is the training status of the platoon?
- What is the state of morale?
- How much sleep have the men had?
- How much sleep will they be able to get before the operation begins?
- Does the platoon need any additional assets to support or accomplish its mission?
- What attachments are available to help the platoon accomplish its mission?

### **Time available.**

- What times were specified by the commander in the OPORD for such activities as movement, reconnaissance, rehearsals, and logistics package (LOGPAC) operations?
- What priorities of work can the platoon accomplish (examples include security, maintenance, resupply, coordination, rehearsals, inspections, and sleep)?

The platoon leader conducts reverse planning to ensure that all specified, implied, and essential tasks can be accomplished in the time available. He develops a reverse planning

schedule (timeline) **beginning with actions on the objective and working backward through each step of the operation and preparation to the present time.** This process also helps the platoon in making efficient use of planning and preparation time.

Once his METT-T analysis is complete, the platoon leader can then write the platoon mission statement answering the questions of WHO, WHAT, WHEN, WHERE, and WHY. This is a clear, concise statement of the purpose of the operation and the essential task(s) that will be crucial to its success. The essential tasks (the WHAT) should be stated in terms that relate to enemy forces, friendly forces, and/or the terrain (for example, "SUPPRESS THE ENEMY"; "OVERWATCH 2D PLATOON"; or "SEIZE AN OBJECTIVE"). The purpose (the WHY) explains how the platoon mission supports the commander's intent. The elements of WHO, WHERE, and WHEN add clarity to the mission statement.

**NOTE:** Simultaneous planning and preparation are key factors in effective time management during the troop-leading procedures. The next five steps (issue a warning order; make a tentative plan; initiate movement; conduct reconnaissance and coordination; and complete the plan) may occur simultaneously and/or in a different order.

**Issue a warning order.** The platoon leader alerts his platoon to the upcoming operation by issuing a WO that follows the five-paragraph OPORD format (see Appendix A). WOs maximize subordinates' planning and preparation time by providing essential details of the impending operation and detailing major timeline events that will support mission execution. The amount of detail included in a WO depends on the available time, the platoon's communications capability, and the information subordinates need to initiate proper planning and preparation. The WO may include the following information:

- Changes to task organization.

- Updated graphics (platoons equipped with IVIS or appliqué digital systems send new overlays).

- Enemy situation.

- Company mission.

- Commander's intent (if available).

- Platoon mission.

- A tentative timeline, to include the following:

  - Earliest time of movement.

  - Readiness condition (REDCON) and vehicle preparation schedule. See Appendix C for a discussion of REDCON levels.

  - Reconnaissance.

  - Training/rehearsal schedule. (**NOTE:** Some individual and collective training may be initiated by the platoon leader before he issues the OPORD; this technique maximizes preparation time and allows the platoon to focus on tasks that will support the anticipated operations. For example, a tank platoon equipped with a plow tank may practice the crew task of dropping the plow as well as platoon-level actions at an obstacle.)

  - Time and location at which the platoon OPORD will be issued.

  - Service support instructions (if not included in the timeline).

As critical information is received or updated, the platoon leader should issue subsequent or updated WOs to keep the platoon informed.

***Make a tentative plan.*** The platoon leader begins developing his maneuver plan as he listens to the commander issue the company OPORD. Based on the commander's plan and the results of his mission analysis, the platoon leader develops a tentative plan that addresses all specified, implied, and essential tasks using the OPORD format (see Appendix A). The tentative plan also covers reconnaissance and coordination requirements between the platoon and adjacent and supporting units. The PSG and TCs are excellent sources of ideas concerning the platoon plan. A more detailed discussion of planning considerations is in Chapters 3 and 4 of this manual.

***Initiate movement.*** Many company-level operations require movement to forward assembly areas and BPs during the planning phase of an operation. The platoon leader addresses movement in his timeline; he orders the platoon to begin moving in accordance with the company plan. Activities may include sending platoon representatives to an assembly area with the company quartering party or beginning priorities of work.

***Conduct reconnaissance and coordination.*** Effective reconnaissance takes into account the factors of METT-T and OAK-OC from both friendly and enemy perspectives. As a minimum, the platoon leader conducts a detailed map reconnaissance. If time and security considerations permit and authorization is obtained from higher headquarters, an on-site ground reconnaissance is the best way to survey the area of operations. The platoon leader should take as many TCs as possible on his reconnaissance.

For offensive operations, the platoon leader should attempt to find a vantage point that will allow him to see as much of the objective as possible. Ground reconnaissance for offensive operations usually is limited to checking routes to the start point (SP), the line of departure (LD), and the axis just beyond the LD. For defensive operations, the platoon leader should conduct a reconnaissance of the engagement area, all platoon BPs, and the routes to be used.

During the reconnaissance (or during company-level rehearsals), the platoon leader or his representative should coordinate routes, movement speed, and sectors of observation and fires with other platoon leaders.

***Complete the plan.*** The platoon leader refines the plan based on the results of the reconnaissance and coordination. He then completes the plan using these results and any new information from his commander, other platoon leaders, and members of his platoon. He should keep the plan as simple as possible, at the same time ensuring that the platoon scheme of maneuver supports the commander's intent.

***Issue the order.*** If possible, the platoon leader issues the order from a vantage point overlooking the terrain on which the platoon will maneuver. If not, he uses a terrain model, sand table, sketches, or his map to orient the platoon. He can also build a model of the area of operations using a briefing kit that contains such items as engineer tape, colored yarn, 3-by-5-inch index cards, and "micro" armor vehicle models. When time and security permit, the platoon leader issues the order to as many members of the platoon as possible. As a minimum, he assembles the TCs and his gunner. He briefs the platoon using the five-paragraph OPORD format (see Appendix A).



To ensure complete understanding of the operation, the platoon leader and TCs conduct confirmation briefings immediately after the OPORD is issued. The TCs brief the platoon leader to confirm their understanding of his intent, the specific tasks their crews must perform, and the relationship between their tasks and those of other units in the operation. If time permits, the platoon leader should lead the TCs in a walk-through using a sand table.

***Supervise and refine.*** Flexibility is the key to effective operations. The platoon leader must be able to refine his plan whenever new information becomes available. If he adjusts the plan, he must inform the platoon and supervise implementation of the changes. Once the operation has begun, the platoon leader must be able to direct his platoon in response to new situations and new orders.

Crew orders, back-briefs, rehearsals, and inspections are essential elements of the supervision process as the platoon prepares for the mission. The following paragraphs discuss these procedures in detail.

**Crew orders.** The platoon leader and PSG make sure all crewmembers have been briefed by their TCs and understand the platoon mission and concept of the operation.

**Back-briefs.** The back-brief is, in effect, a reverse briefing process; those who receive an OPORD confirm their understanding of the order by repeating and explaining details of the operation for their leader or commander. In the tank platoon, the platoon leader should conduct back-briefs after the TCs have had a chance to review the OPORD but before the platoon rehearsal begins. The TCs brief the platoon leader on **how** their crews will accomplish the specific tasks assigned to them in the order.

**NOTE:** Although the back-brief is an effective means of clarifying the specifics of the plan, it does not require tank crews to practice or perform their assigned tasks. By itself, therefore, it is not an ideal rehearsal technique.

**Rehearsals.** A rehearsal is a practice session conducted to prepare units for an upcoming operation or event. The tank platoon leader should never underestimate the value of rehearsals. Many units, in fact, consider rehearsals as a separate (ninth) step of troop-leading procedures. The platoon leader uses well-planned, efficiently run rehearsals to accomplish the following:

- Reinforce training and increase proficiency in critical tasks.

- Reveal weaknesses or problems in the plan.

- Synchronize the actions of subordinate elements.

- Confirm coordination requirements between the platoon and adjacent units.

- Improve each soldier's understanding of the concept of the operation, the direct fire plan, anticipated contingencies, and possible actions and reactions for various situations that may arise during the operation.

Effective rehearsals require crewmen to **perform** required tasks, ideally under conditions that are as close as possible to those expected for the actual operation. Participants maneuver their actual vehicles or use vehicle models or simulations while interactively verbalizing their elements' actions. In a platoon-level rehearsal, the platoon leader will select the tasks to be practiced and will control execution of the rehearsal. He will usually

designate someone to role-play the enemy elements he expects to face during the operation. (**NOTE:** A rehearsal is different from the process of talking through what is supposed to happen. For example, in a rehearsal, TCs should actually send SPOTREPs when reporting enemy contact, rather than simply saying, "I would send a spot report now.")

The platoon can prepare for operations using reduced-force rehearsals and/or full-force rehearsals. The platoon leader conducts reduced-force rehearsals when time is limited or the tactical situation does not permit everyone to attend. Platoon members who can take part practice their actions on mock-ups, sand tables, or actual terrain (usually over a smaller area than in the actual operation). The full-force rehearsal is the most effective, but consumes the most time and resources. It involves every soldier who will participate in the operation. If possible, it should be conducted under the same conditions (such as weather, time of day, and terrain) that the platoon expects to encounter during actual operations.

The platoon leader can choose among several techniques in conducting rehearsals, which should follow the crawl-walk-run training methodology to prepare the platoon for increasingly difficult conditions. Rehearsal techniques include the following:

**Special rehearsal.** Individual and/or crew tasks that will be critical to the success of the operation are rehearsed as necessary. The platoon leader may initiate special rehearsals when he issues the WO.

**Map rehearsal.** This is usually conducted as part of a back-brief involving the TCs or a complete crew. The leader uses the map and overlay to guide participants as they back-brief their role in the operation. If necessary, he can use a sketch map.

**Communications rehearsal.** This reduced-force or full-force rehearsal is conducted when the situation does not allow the platoon to gather at one location. Crewmen check their vehicles' communications systems and rehearse key elements of the platoon fire plan.

**Key leader rehearsal.** Usually conducted as part of a larger force, this rehearsal involves leaders moving over the key terrain in wheeled vehicles while discussing the mission.

**Sand table or terrain model.** This reduced-force or full-force technique employs a small-scale table or model that depicts graphic control measures and important terrain features for reference and orientation. Participants walk or move "micro" armor around the table or model to practice the actions of their own vehicles in relation to other members of the platoon.

**Force on force.** This is used during a full-force rehearsal. The platoon may rehearse with sections or individual tanks

going "force on force" against each other, or the entire platoon may go against another platoon in the company. Platoons should first rehearse with good visibility over open terrain. Rehearsals become increasingly realistic until conditions approximate those expected in the area of operations.

**Inspections.** Inspections allow the platoon leader to check the platoon's operational readiness. The key goal is to ensure that soldiers and vehicles are fully prepared to

execute the upcoming mission. Inspections also contribute to improved morale.

It is essential that the entire platoon chain of command know how to conduct precombat checks in accordance with FKSM 17-15-3, the platoon SOP, or ARTEP 17-237-10-MTP. Procedures for a comprehensive inspection include the following:

- Perform before-operation maintenance checks; report or repair deficiencies.

- Perform prepare-to-fire checks for all weapons; report or repair deficiencies. Weapons are boresighted, and all sights are referred. Machine guns are test-fired, if possible.

- 

- Upload vehicles in accordance with platoon SOP. The standardization of load plans allows the platoon leader and PSG to quickly check accountability of equipment. It also ensures standard locations of equipment in each vehicle; this can be an important advantage if the platoon leader is forced to switch to a different vehicle during an operation.

- Review the supply status of rations, water, fuel, oil, all types of ammunition, pyrotechnics, first-aid kits, and batteries

(for such items as flashlights, night vision devices, and NBC alarms). Direct resupply operations as necessary.

- Ensure vehicles are correctly camouflaged so they match the area of operations.

The platoon leader and/or PSG should observe each crew during preparation for combat. They should conduct the inspection once the TCs report that their crews and vehicles are prepared.

## **Abbreviated Troop-leading Procedures**

When there is not enough time to conduct all eight troop-leading steps in detail, such as when a change of mission occurs after an operation is in progress, the platoon leader must understand how to trim the procedures to save time. Most steps of these abbreviated troop-leading procedures are done mentally, but the platoon leader skips none of the steps. Once the order is received, the platoon leader conducts a quick map reconnaissance, analyzes the mission using the factors of METT-T, and sends for the TCs. He makes sure the TCs post the minimum required control measures on their maps and issues a FRAGO covering the key elements of the enemy and friendly situations, the platoon mission, and the concept of the operation. The service support and command and signal paragraphs can be deleted if they are unchanged or covered by SOP. FRAGOs are discussed in Appendix A. The platoon leader and TCs may also conduct a quick walk-through rehearsal of critical elements of the maneuver plan using a hastily prepared terrain model or sand table.

In some cases, there may not be enough time even for these shortened procedures. The platoon may have to move out and receive FRAGOs by radio or at the next scheduled

halt. It then becomes critical for the platoon leader to send FRAGOs of his own to the TCs explaining the platoon's purpose within the overall company maneuver plan.

Digital and global positioning systems are valuable tools when the platoon is forced to use abbreviated troop-leading procedures and FRAGOs. They allow the platoon leader to designate waypoints to assist in navigation and target reference points (TRP) to assist in weapons orientation.

Other keys to success when abbreviated procedures are in effect include a well-trained platoon; clearly developed, thoroughly understood SOPs; and an understanding by all members of the platoon of the current tactical situation (situational awareness). The platoon leader and PSG must keep the platoon informed of the ever-changing enemy and friendly situations. They accomplish this by monitoring the company net and issuing frequent updates to the other crews using the radio and digital information systems.

Whenever time is available, however, there is no substitute for effective, thorough troop-leading procedures. The odds of success increase still further when detailed planning and rehearsals are conducted prior to an operation, even if time is limited. Successful platoon leaders make the most of every available minute.

## Leadership

Competent, confident leadership inspires soldiers, instilling in them the will to win and providing them with purpose, direction, and motivation in combat. Leadership involves numerous important personal principles and traits: taking responsibility for decisions; exemplifying and demanding loyalty; inspiring and directing the platoon toward mission accomplishment; fostering a climate of teamwork that will engender success; demonstrating moral and physical courage in the face of adversity. FM 22-100 and FM 100-5 describe the qualities of effective leadership. The following are the five characteristics of successful combat leaders, as described in the 1984 study titled *Leadership in Combat: An Historical Appraisal* conducted by the History Department at the United States Military Academy:

**Terrain sense.** Understand terrain; match tactics and weaponry with the terrain at hand.

**Single-minded tenacity.** This is the quality that compels the successful platoon leader to harness the combat power necessary to overwhelm the enemy. The platoon leader sees the mission through and never gives up.

Practical, **practiced judgment.** Common sense and constant practice allow the platoon leader to prioritize effectively, enabling him to separate critical tasks from the noncritical and preventing him from being overwhelmed by the demands of the information-rich battlefield.

**Ferocious audacity.** Risk-taking is a must if the platoon is to exploit enemy weaknesses as they present themselves.

**Physical confidence.** Leaders can maintain their ability to meet the demanding requirements of leadership only if they are in top physical condition.

## Section II. CONTROL

# Situational Awareness

Situational awareness is the ability to maintain a constant, clear mental "picture" of the tactical situation. This picture includes an understanding of relevant terrain and of the relationship between friendly and enemy forces. It also includes the ability to correlate battlefield events as they develop. For platoon leaders and PSGs, situational awareness is the key to making sound, quick tactical decisions. It allows them to form logical conclusions and to make decisions that anticipate future events and information. A critical benefit of situational awareness on the part of TCs is a reduction in fratricide incidents. Situational awareness also gives leaders the ability to compress the time necessary to conduct troop-leading procedures; this is especially critical when there is limited time to plan and prepare for an operation.

The commander will structure the battlefield based on his intent and the conditions of METT-T. How he does this affects the tank platoon leader's mission planning and his ability to maintain situational awareness. The framework of the battlefield can vary from a highly rigid extreme, with obvious front and rear boundaries and closely tied adjacent units, to a dispersed and decentralized structure with few secure areas and unit boundaries and no definable front and/or rear boundary.

Between these extremes is an unlimited number of possible variations. Maintaining situational awareness becomes more difficult as the battlefield becomes less structured. Modern, highly mobile operations involving small forces lend themselves to a less rigid framework that challenges the platoon leader's ability to maintain an accurate picture of the battlefield.

## “Seeing” the Battlefield

To "see" the battlefield accurately, the platoon leader must have virtually perfect knowledge of the friendly situation one level higher than his own (the company team or troop situation). It is also important that he update the TCs periodically regarding the higher situation. The platoon leader must also have a relatively complete knowledge of the terrain and the enemy situation. He must be able to visualize enemy and friendly elements through time and to picture how the terrain will affect their actions. (**NOTE:** This requirement to maintain a real-time awareness of the battlefield one level higher does not relieve the platoon leader of his responsibility to understand the situation and commander's intent two levels higher than his own. The difference is that his understanding of the situation two levels higher does not have to be as specific or as timely.)

Most of the information the platoon leader requires comes from what he can observe from his tank and from reports he receives through his communications systems. Although few voice and digital reports are specifically addressed to him, particularly on

the company team net, the platoon leader must monitor them by eavesdropping. He then can track enemy and friendly elements and plot all movement on his map and/or IVIS display. This allows him to adjust his own movement so the platoon makes contact with the enemy from positions of advantage, which are identified during the map/ground reconnaissance step of troop-leading procedures.

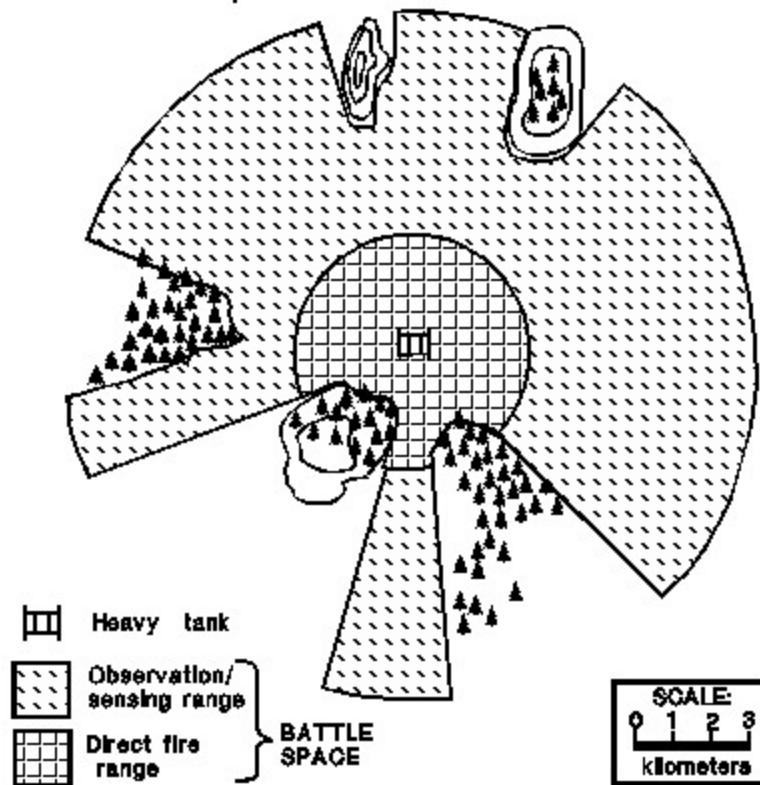
How effectively the platoon leader can keep track of events on the battlefield is, to some degree, experience-dependent. No matter what his experience level, however, he is responsible for learning techniques that allow him to relate the information he is receiving to his map or display and thereby track the tactical situation.

## Battle Space

The ability to see the battlefield provides the platoon leader with important tactical information, including friendly and enemy positions and relevant terrain. In turn, complete understanding of the military significance of this picture requires knowledge of the concept of battle space; this is the key element in the intellectual process of visualizing the battlefield.

**At the most fundamental level, battle space is the three-dimensional area in which the platoon can acquire enemy forces and influence them with effective fires.** This space is defined by several battlefield factors: the locations of friendly forces, including the platoon's individual tank crews and OPs; the effects of terrain, weather, and movement; and the ranges of all available platoon weapons and sensing systems. Each tank crew has its own battle space (see Figure 2-1). The platoon's total battle space is the sum of the individual tanks' battle spaces. Platoon battle space is not restricted by boundaries; it can overlap the battle space of adjacent units.

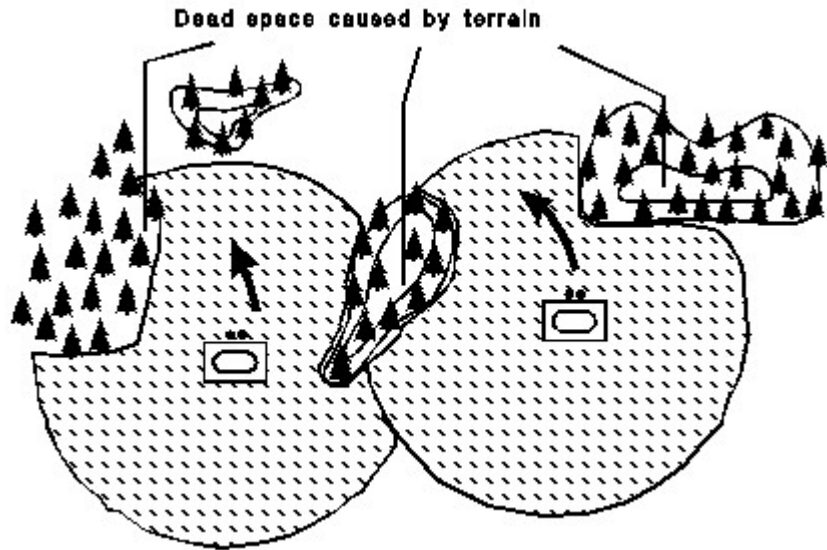
**NOTE:** The depiction of battle space in this and following illustrations is two-dimensional. Leaders MUST keep in mind at all times that battle space is three-dimensional and includes the air space above the platoon.



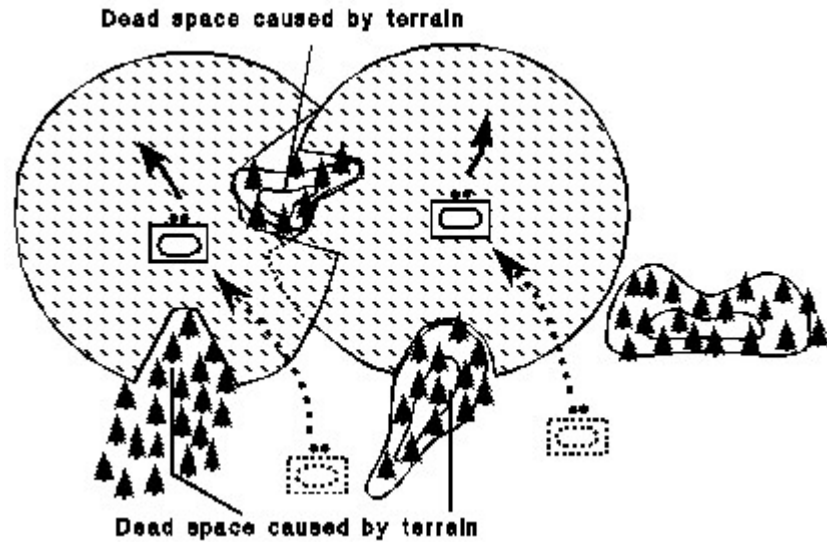
**Figure 2-1. Individual tank's battle space (two-dimensional view).**

Battle space has applications in all phases of mission planning, preparation, and execution. During the planning process, it is a critical factor in the selection of routes, tentative positions, and potential engagement areas. In the preparation phase, battle space information aids in the synchronization of tactical movement and overwatch. Once mission execution begins, the platoon leader's knowledge of his battle space is critical to his ability to issue timely and effective orders as the situation changes.

The importance of battle space demands that the platoon leader direct most of his battle command effort toward managing and enhancing his space. He must be aware at every moment of how battle space is changing as friendly and enemy forces move and as terrain and visibility conditions change (see Figures 2-2A and 2-2B). As the operation progresses, the platoon leader must take active measures to shape the battle space to his best advantage.



**Figure 2-2A. Effects of movement and terrain on battle space.**



**Figure 2-2B. Effects of movement and terrain on battle space (continued).**

One vital step in this process is to eliminate or reduce any gaps, or dead space, that exist within the platoon's battle space. The platoon leader can accomplish this in several ways. In the offense, for example, he can maintain a section in overwatch during movement through a choke point or a danger area. In the defense, he can emplace OPs or reposition individual tanks to cover potential gaps in the platoon's battle space (see Figures 2-3A and 2-3B, page 2-22). In all cases, the platoon's position in relation to other friendly elements is an important factor in defining and enhancing the battle space. The platoon leader can shape his space more effectively if he applies the principles of mutual support and thorough coordination with adjacent units.



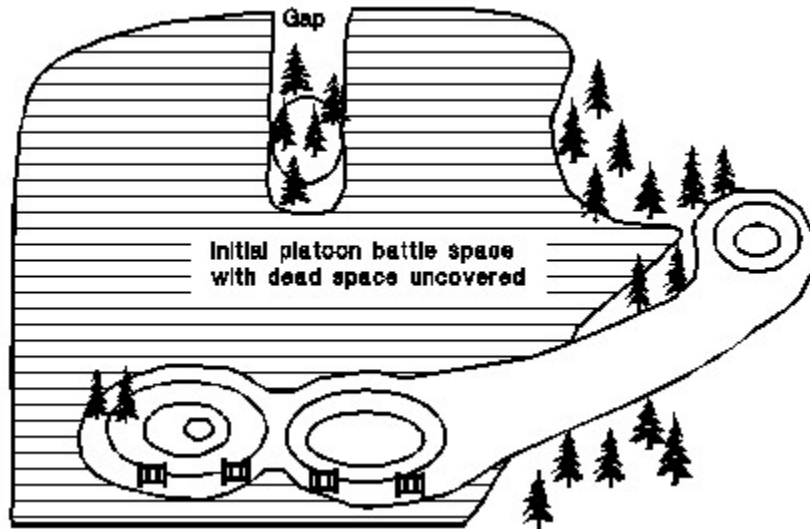


Figure 2-3A. Reshaping the battle space.

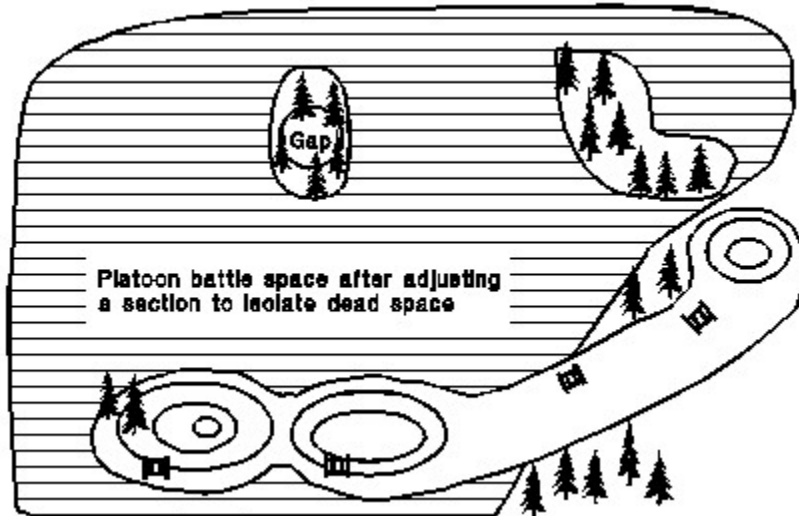


Figure 2-3B. Reshaping the battle space (continued).

## Maps, overlays, graphic control measures, and navigation

### Maps and Overlays

The most important role of maps and the accompanying overlays is in helping the platoon to understand and visualize the scheme of maneuver. They are the primary tool the platoon leader uses to organize information concerning the battlefield and to synchronize his assets once the battle begins. They also provide TCs with a visual reference they can consult as needed. The platoon leader must ensure that each TC has an updated map with

the latest graphic control measures posted on the overlay.

The map and overlay also assist the platoon leader in performing a variety of other functions. He consults them constantly during reconnaissance operations, which can vary in complexity from a quick map reconnaissance to a fully mounted ground reconnaissance of the area of operations. The map and overlay help him to communicate the company commander's concept while he is issuing the OPORD or briefing the TCs on the plan. During mission execution, the map and overlay play an invaluable role in helping leaders to maintain situational awareness.

Overlays can be prepared either in traditional fashion (written out by hand) or digitally. The platoon leader may receive one or more types of overlays from the commander covering such areas as maneuver, enemy forces, obstacles, fire support, and CSS. All of the information is important; the key for the platoon leader is to combine, augment, and declutter the overlays so the information needed for a specific situation is readily available to the platoon on one simple, combined overlay.

**Traditional overlays.** Copied on acetate, these display graphic control measures as illustrated in Figure 2-4, page 2-24. Traditional overlays should be prepared even if a platoon is equipped with IVIS or appliqué digital systems in case the platoon loses digital data or has its digital link broken.

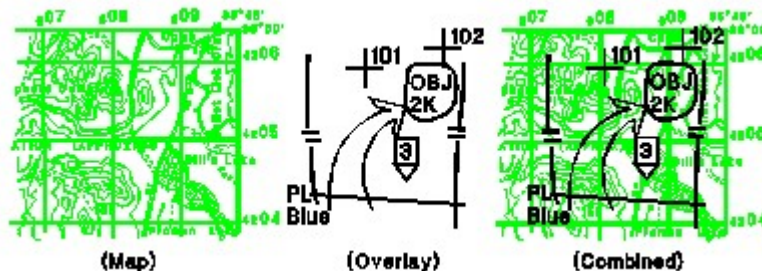
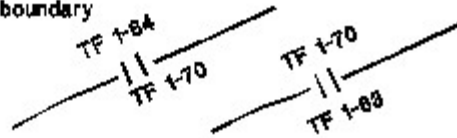


Figure 2-4. Traditional overlay.

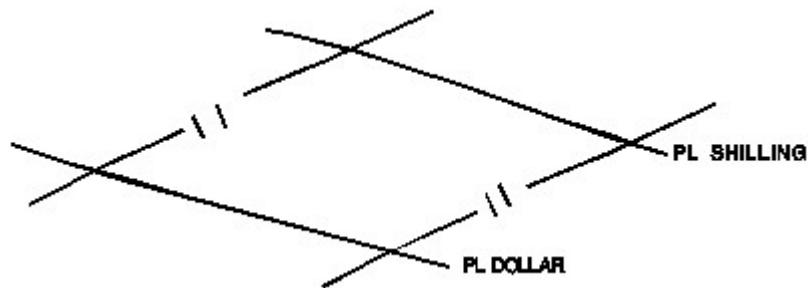
**Digital overlays.** The IVIS and appliqué digital systems allow the platoon leader to receive and transmit graphics virtually on a real-time basis within the platoon and to and from higher headquarters. When these systems are integrated with automatic position/location updates, the platoon leader has a nearly perfect situational awareness "link." His display shows the positions of his platoon and adjacent unit leaders as well as the most current enemy disposition. These positions and locations are displayed on a menu of overlays using the most recent graphics. The platoon leader can combine, augment, and declutter the overlays as needed; when appropriate, he can choose not to display any of them on his digital screen. Figure 2-5 illustrates a sample IVIS-generated overlay.



General tactical boundary



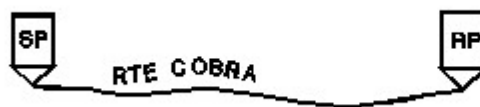
**Phase line.** Phase lines are used to control and coordinate movement and synchronize tactical actions. Platoons may report crossing phase lines, but they normally do not halt unless directed to do so. The abbreviation on overlays is "PL."



**Assembly area.** Abbreviated "AA" on overlays, this is a location at which the platoon gathers (usually as part of the company) to conduct maintenance and resupply activities and to make other preparations for future operations. The platoon must be able to defend from the assembly area.



**Route.** This is the prescribed course of travel from a specific point of origin (the SP) to a specific destination (the RP). The route should be named, and checkpoints should be designated at key locations. The abbreviation on overlays is "RTE."



**Checkpoint.** Checkpoints are used to control and direct the maneuver of the tank platoon and tank section. They are usually placed on identifiable terrain features.



**Attack position.** This is the last position the platoon occupies or passes through before crossing the LD. The platoon assumes the proper formation and performs last-minute checks of its weapon systems. The abbreviation on overlays is "ATK POS."



**Contact point.** A contact point is a designated location, usually an easily identifiable terrain feature, where two or more units are required to physically meet. The headquarters assigning the contact point must specify what sort of activity is required when the units meet. The platoon leader may be tasked to man or move to a contact point for coordination.



**Passage lane.** This is the area or route through which a passing unit moves to avoid stationary units and obstacles. Tank platoons may move on a lane or serve as the overwatch for a passing unit moving through a lane.



**Passage point.** This is the place where a unit physically passes through another unit. Tank platoons may move through a passage point or overwatch other units moving through a passage point. The abbreviation for a passage point is "PP."



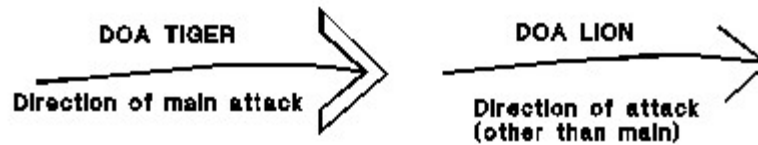
**Objective.** copy some portion of the company objective. The abbreviation on overlays is "OBJ."



**Axis of advance.** This is the general route and direction of advance extending toward the enemy. It graphically portrays the commander's intent, such as envelopment of the enemy. The unit may maneuver and shoot supporting fires to either side of the axis provided it remains oriented on the axis and the objective. For example, platoons may maneuver on or to the side of the axis assigned to their company as long as deviations do not interfere with the maneuver of adjacent units.



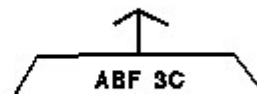
**Direction of attack.** This is the specific direction and route that the main attack or center of mass of the unit will follow. Tank platoons move along directions of attack specified by the commander to take advantage of terrain or to ensure maximum control of the moving unit. The abbreviation on overlays is "DOA."



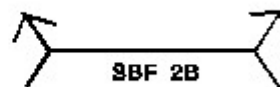
**Assault position.** This is the location from which a unit assaults the Tank platoons may occupy an assault position or serve as overwatch for the occupation of the position by the assault force. The abbreviation on overlays is "ASLT POS."



**Attack by fire position.** This is the location from which a unit employs direct fire to destroy the enemy from a distance. Tank platoons occupy an attack by fire position alone or as part of the company. From this position, the platoon can attack the enemy on the objective when occupation of the objective is not advisable; the position can also be used in an attack on a moving enemy force. In addition, this type of position can serve as a counterattack option for a reserve force. The overlay abbreviation is "ABF."



**Support by fire position.** This is another type of position from which a maneuver element can engage the enemy by direct fire, with the fires providing support for operations by other units. The tank platoon usually occupies a support by fire position when providing supporting fires for an assault or breach force or when serving as the overwatch for a moving force. The overlay abbreviation is "SBF."



**Battle position.** This is a defensive location, oriented on the most likely enemy avenue of approach, from which a unit defends. Tank platoon BPs and direct fire orientations are designated in the OPORD.



**Target reference point.** This is an easily recognizable point on the ground (either natural or man-made) used to locate enemy forces or control fires. TRPs can designate either the center of an area on which the platoon can mass its fires or the left or right limit of such an area. The tank platoon leader controls platoon fires by designating platoon TRPs as necessary to supplement company TRPs issued by the commander. When designated with target numbers issued by the FIST or FSO, TRPs become indirect fire targets.



## Navigation

To protect his platoon, the platoon leader must learn to use terrain to his advantage. Land navigation of armored vehicles requires him to master the technique of terrain association. This entails the ability to identify terrain features on the ground by the contour intervals depicted on the map. The platoon leader analyzes the terrain using the factors of OAK-OC and identifies major terrain features, contour changes, and man-made structures along his axis of advance. As the platoon advances, he uses these features to orient the platoon and to associate ground positions with map locations.

The intellectual concept of battle space is vital to the platoon's survival during navigation and movement. The platoon leader must constantly be aware of key terrain and enemy fields of observation and fire that may create **danger areas** as the platoon advances. This allows him to modify movement techniques, formations, and routes and to maintain cross-talk with overwatch elements to ensure the platoon is not surprised by the enemy.

Navigation under limited visibility conditions is especially challenging. Vehicle thermal sights and night vision goggles provide assistance, but leaders nonetheless can easily confuse terrain features and become disoriented. See Appendix C for a discussion of limited visibility operations.

The platoon can employ a variety of techniques and equipment to assist in navigation.

These are summarized in the following paragraphs.

***Compass and odometer.*** This method of navigation entails use of a dismounted compass and the vehicle's odometer. Follow these steps:

Divide the route or operation into legs or parts, each with a unique direction and distance and a checkpoint at both ends.

Measure the map distance of each leg or part.

Determine the magnetic azimuth of each leg or part.

Develop a chart listing the legs or parts, azimuths, and distances. Write a description of each leg or part. Refer to Figure 2-6, page 2-32, for an example.

For each leg or part, move the gun tube to the direction of the magnetic azimuth. Maintain turret stabilization at all times; do not traverse the turret except at the start of the next leg or part.

Use the odometer to measure the distance traveled for each leg or part.

Review the written description of the route to help prevent navigational errors.



LEG/PART	AZIMUTH	DISTANCE	DESCRIPTION OF ROUTE TRAVELED
AA BLUE to SP	180°	2.5 miles	From AA Blue, travel downhill to the SP, a three-way, hardtop intersection.
SP to RP	90°	5.5 miles	At the SP, turn left and travel on a flat hardtop road for about 4 miles. The road becomes uphill as you approach the four-way intersection (RP). A downhill grade on azimuth will mean the RP has been passed.
RP to PP1	183°	6.3 miles	At the RP, turn right and travel downhill for 6.3 miles, linking up with the XO at PP1. The PP is 400 meters past a bridge and is near two houses.
PP1 to 12	92°	7.4 miles	At PP1, turn left and travel a flat, cross-country stretch for 7.4 miles until you reach three houses (12). Reaching an uphill grade or a hardtop road along the same azimuth will mean 12 has been passed.
12 to 5	60°	5.5 miles	From 12, travel on a 60° azimuth uphill for about 5.5 miles, crossing a dirt road and a hardtop road. At hill (5), tanks will be oriented on a 90° azimuth.

**Figure 2-6. Route chart for compass and odometer navigation method.**

**Fires.** Using artillery or mortars to fire smoke (during the day) or ground-burst illumination (day or night) can provide a useful check on estimated locations or preplanned targets.

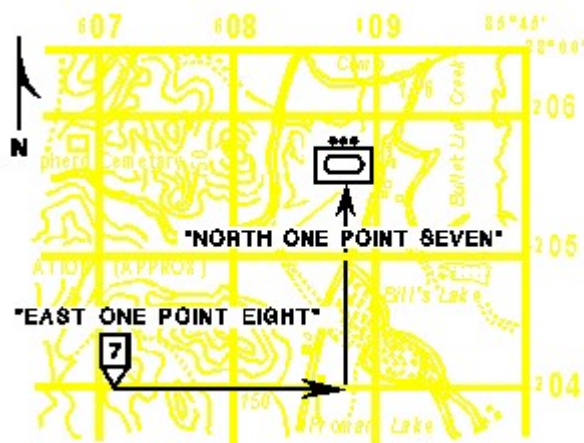
**Global positioning systems.** These systems receive signals from satellites or land-based transmitters. They calculate and display the position of the user in military grid coordinates as well as in degrees of latitude and longitude. Most GPS navigation readings are based on waypoints, the known positions entered into the system's memory. The platoon leader identifies points along the route or at the destination and designates them as waypoints. Once waypoints are entered in the GPS,

the device can display information such as distance and direction from point to point. Leaders must still know how to employ terrain association while navigating in case satellite or land signals are inoperative or unavailable. For more information on GPS, see FKSM 17-15-1.

**Inertial navigation systems.** Based on an initial calculation of the vehicle's location from a known point, inertial navigation systems use the rotation of the track to determine the location of the vehicle. The M1A2's POSNAV system is an example. POSNAV allows the TC to determine his exact location and gives him the ability to plot up to 99 waypoints. Tank drivers can then use the steer-to function on their driver's integrated display as they move toward the designated waypoints. To compensate for track slippage that could affect the accuracy of the inertial system, TCs should reinitialize their systems often using a GPS or a known point. For more information on POSNAV, see FKSM 17-15-1.

**NOTE:** In using the GPS or POSNAV, the platoon leader must remember that waypoints are only one of several navigational tools he can use. He must still be prepared to use terrain association and map-reading skills in case of digital system failures. In addition, the platoon leader must not disregard the effects of terrain on the direction of movement. Terrain features that do not show up on the digital display (such as hills, valleys, and cliffs) may cause deviations in the route the platoon must take to reach the next waypoint.

**Shift from a known point.** Shifting from a known point is a convenient tool for the platoon leader to use as he maneuvers the platoon and disseminates control measures. The known point is usually a previously distributed graphic control measure. Referencing a location from a known point is done in kilometers. For example, 500 meters is given as "POINT FIVE," 1,000 meters as "ONE," and 3,500 meters as "THREE POINT FIVE." Cardinal directions are used. Shifts to the east or west are given first, then: "RED SET FROM CHECKPOINT SEVEN - EAST ONE POINT EIGHT - NORTH ONE POINT SEVEN." This means, "We (the Red element) are set at a position 1,800 meters east and 1,700 meters north from checkpoint 7." Figure 2-7 illustrates this example.



**Figure 2-7. Example of shifting from a known point.**

Shifts from known points are used routinely to control combat operations. They make

reporting of current platoon and enemy positions easier. The platoon leader could report his location by referencing a graphic control measure, such as a checkpoint as shown in Figure 2-8, or a grid location. The enemy, however, will quickly figure out the known points if they are continually used in the clear on a nonsecure net. The platoon leader should avoid using the same point more than twice. Instead, he should use a different known point to reference the same location. Enemy locations are identified only by using shifts from TRPs (see Figure 2-9).

**NOTE:** Many units routinely use the terrain index reference system (TIRS) or the grid index reference system (GIRS) to make shifts from a known point. TIRS identifies locations based on terrain points previously designated on an overlay; GIRS uses intersections of four grid squares as the known points.

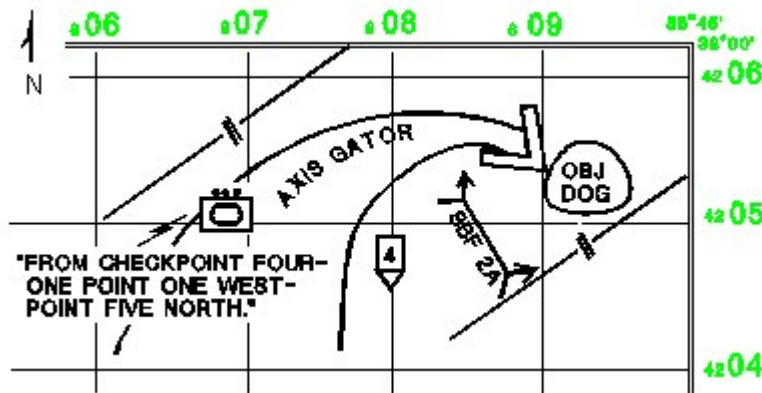


Figure 2-8. Platoon reports own position using shift from a known point (checkpoint).

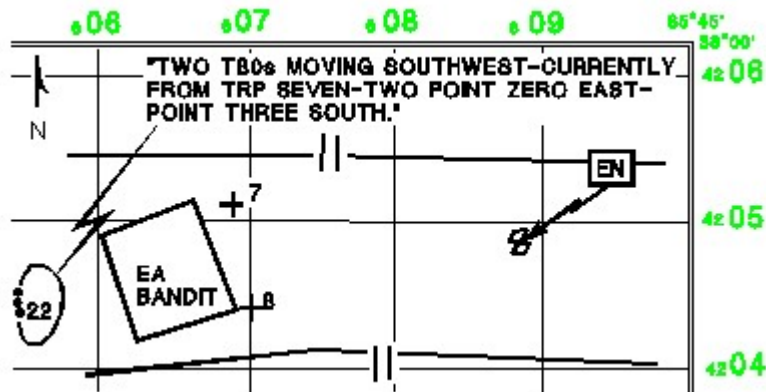


Figure 2-9. Platoon reports enemy position using shift from a known point (TRP).

## COMMUNICATIONS

During virtually all maneuver and combat operations, dispersion will force the tank platoon to rely heavily on effective communications by means of wire, visual signals, radio, and digital systems. The platoon must understand the proper procedures for using

the available systems, the proper application of operational terms, and procedures for constructing and sending effective, concise messages using each type of system. The platoon leader is responsible for the planning, training, and employment related to use of the platoon's communications systems. He is also responsible for maintaining communications within the company communications system.

## Means of Tactical Communications

The tank platoon has several available means of communications. Whether it is using messenger, wire, visual, sound, radio, or digital communications, the platoon must remain flexible enough to react quickly to new situations. The platoon leader must carefully plan the use of these resources, ensuring there is redundancy in the platoon's communications systems while avoiding dependence on any single means.

SOPs play a critical role in ensuring that platoon communications enhance situational awareness and contribute to mission accomplishment. They prescribe hand-and-arm and flag signals that can aid in platoon movement and clear, concise radio transmissions that help to reduce transmission times. On digitally linked vehicles, crews can monitor the commander's integrated display, with its standardized graphics; this significantly reduces the need to send voice updates of friendly vehicle positions.

**Messenger.** Messenger service is the most secure means of communications available to the tank platoon. When security conditions and time permit, it is the preferred means. It is generally very flexible and reliable. A messenger can be used to deliver platoon fire plans, status reports, or lengthy messages. When possible, lengthy messages sent by messenger should be written to prevent mistakes and confusion.

**Wire.** This method of communications is especially effective in static positions. The platoon will frequently employ a hot loop in initial defensive positions, OPs, and assembly areas. Unit SOPs, tailored to counter the enemy's electronic warfare capability, will dictate the use of wire. M60A3 and AGS crews can communicate directly with dismounted infantry by means of the vehicle's external field phone. On M1-series tanks, the crew can route wire from the AM-1780 through the loader's hatch or vision block to a field phone attached to the outside of the tank.

**Visual.** Visual communications are used to identify friendly forces or to transmit prearranged messages quickly over short distances. These signals must be clearly understood by TCs as they operate across the battlefield; each TC must be ready to pass on visual signals from the platoon leader to other vehicles in the platoon. Standard hand-and-arm or flag signals work well during periods of good visibility. Crews can use thermal paper, flashlights, chemical lights, or other devices during periods of limited visibility, but they must exercise extreme care to avoid alerting the enemy to friendly intentions. See STP 17-19K1-SM (the skill level 1 soldier's manual for MOS 19K) and FM 21-60 for a description of hand-and-arm signals.

**Pyrotechnics.** Pyrotechnic ammunition can be used for visual signaling. The meaning of these signals is identified in paragraph 5 of the OPORD and in the signal operation instructions (SOI). The main advantage of pyrotechnics is the speed with which signals

can be transmitted. The main disadvantage is the enemy's ability to detect and imitate them.

**Sound.** This form of communications is used mainly to attract attention, transmit prearranged messages, and spread alarms. Sound signals, however, carry only short distances, and their range and clarity are greatly reduced by battle noise. In addition, since they are open to enemy interception, use of sound signals may be restricted for security reasons. They must be kept simple to avoid creating confusion. Prearranged meanings for sound signals are covered in the unit SOP and SOI.

**Radio.** The radio is the platoon's most flexible, most frequently used, and least secure means of communications. It can quickly transmit information over long distances with great accuracy. Secure equipment and the ability of the SINCGARS to frequency-hop provide the platoon with communications security against most enemy direction-finding, interception, and jamming capabilities. Sophisticated direction-finding equipment, however, can trace almost any radio signal; the transmitter then can easily be destroyed. Survival of the tank platoon depends on good communications habits, especially when it is using the radio; the platoon leader must strictly enforce radio discipline. The most effective way to use the radio is to follow standard radiotelephone procedures (RTP), including brevity and proper use of authentication tables and approved operational terms.

**Digital.** IVIS and appliqué digital systems enable the platoon leader to transmit digitally encoded information over the SINCGARS radio to other similarly equipped vehicles. Linkup refers to the ability of the tank's radio to transmit and receive digital information. When properly "linked," the platoon leader receives continuously updated position location information for the platoon's vehicles, as well as for those of adjacent platoon leaders and PSGs, the company commander, and the executive officer (XO). Using the digital link with other platoon vehicles and the company commander, the platoon leader can also send and receive preformatted reports and overlays with graphic control measures. FKSM 17-15-3 discusses the use of digital systems, including IVIS-specific log-on and linkup procedures.

## Tank Platoon Nets

The platoon leader, PSG, TCs, and crewmen employ and/or monitor the following radio nets.

**Platoon.** This net is used to conduct all platoon operations. All tanks within the platoon must have the ability to monitor and transmit on this net at all times. Some units do not use platoon radio nets; in such a situation, it is critical that all platoon vehicles adhere to communications SOPs and observe strict radio discipline. Every crewman should understand the net control guidelines, including proper RTP and techniques for effective communications, discussed later in this section.

**Company/troop command.** This net is used to maneuver the company as well as to process routine administrative/logistical (A/L) reports. Platoon leaders and PSGs monitor this net to keep abreast of the current tactical situation from the reports of the commander, XO, and other platoon leaders. They transmit on it to keep the commander

in formed and to talk to other platoon leaders to coordinate the tactical actions of their platoons. Both the platoon leader and PSG must always have the ability to monitor and transmit on this net. All TCs must be able to switch to this net to send reports and receive guidance if they are unable to contact their platoon leader or PSG.

## Net Control

The tank platoon net is the key to command and control of the platoon. The smooth functioning of this net allows accurate information to be passed quickly to and from the platoon leader. This information flow is critical in maintaining the platoon leader's situational awareness. Every soldier in the platoon must be trained how to provide the platoon leader with essential information efficiently and without redundancy. This becomes especially important when contact has been made and the volume of traffic on the platoon and company nets increases drastically. The following techniques and suggestions will help to ensure that information flowing over the net is organized and controlled in a manner that permits the platoon leader both to understand it and to issue orders in response to it.

**Digital traffic.** Digital traffic may precede, replace, or follow voice transmissions; in many cases, it will reduce the need for and redundancy of voice traffic. Do not duplicate digital traffic with voice messages if digital transmissions precede or can replace voice traffic in a timely manner. Because digital systems are not totally reliable, it may be necessary to verify the receipt of critical digital traffic.

**Routine traffic.** The PSG normally receives and consolidates A/L reports and other routine communications from the TCs and passes the reports to the platoon leader or higher headquarters using the procedures prescribed in unit SOPs.

**Initial contact.** Any vehicle can alert the platoon to a threat. The section leader in contact (platoon leader or PSG) deploys and fights his section according to the platoon leader's intent. The section leader not in contact forwards the report to higher headquarters. If the entire platoon is in contact, the platoon leader fights the platoon while the PSG reports the contact to the commander.

**Reporting.** In keeping the platoon leader informed, TCs must avoid redundant voice and digital reports. They monitor the platoon net so they can avoid reporting information the platoon leader has already received from other TCs. The PSG pays close attention to the company net while the platoon net is active; he then relays critical information to the platoon. This technique allows the platoon leader to concentrate on fighting the platoon. Once the platoon leader begins to develop the situation, he is responsible for reporting the platoon's tactical situation to the commander using spot reports (SPOTREP) and situation reports (SITREP). Refer to FKSM 17-15-3 for information on report formats.

**Radiotelephone procedure.** Proper RTP is the cornerstone of effective command and control in the tank platoon. Every platoon member must be an expert in communications procedures. This ensures efficient communications within the platoon and allows members of the platoon to communicate effectively with outside elements such as other platoons or the company or troop headquarters.

Depending on the enemy's electronic warfare capability, the company commander may elect to use standardized call signs to simplify RTP. These call signs allow all users of a net to instantly recognize the calling station. Examples would be the use of RED, WHITE, and BLUE to designate 1st, 2d, and 3d platoons, respectively, and the use of bumper numbers to identify tanks within a platoon.

***Techniques of effective communications.*** The platoon leader and PSG must ensure that every member of the platoon understands and adheres to the following techniques and guidelines, which can contribute to more effective, more secure tactical communications.

**Minimize duration.** All messages sent within or from the tank platoon must be short and informative. The longer the message, the greater the opportunity for enemy elements to use electronic detection to pinpoint the platoon's location. Message length can be controlled in several ways:

Write down the message and then eliminate all unnecessary words from the written message before sending it.

Read the message as written when sending it.

Use brevity codes that reduce the need to explain the tactical picture in detail.

Break long messages into several parts and send each part separately.

**Minimize signature.** When sending a message, every tanker must be conscious of the size and nature of the electronic signature that he is emitting. To reduce the size of the signature, he can use terrain to mask his transmissions from known or suspected enemy positions. He should set the transmitter to the lowest possible power that will provide sufficient range.

**Know the system.** Each crewman must be an expert in the technical aspects of his voice and digital communications systems. In particular, he must understand how to maintain each system, how to place it into operation, and how to troubleshoot it whenever he suspects it is not functioning properly.

## **Fire Distribution and Control**

To maximize the effects of its fires, the platoon must know how to effectively focus, distribute, and control them. Depending on the situation, fire distribution and control may be accomplished by individual tanks, by section leaders' tanks and their wingmen, or by the platoon as a whole. On many occasions, particularly in defensive operations, the platoon leader will be in a position to direct the fires of the entire platoon. At other times, especially during offensive operations, fire distribution and control may begin with the PSG or a wingman; as the situation develops, the platoon leader then takes control of the platoon fires and distributes them effectively. Refer to FM 17-12-1-1 and FM 17-12-1-2 for a complete discussion of target acquisition and destruction procedures during direct fire engagements.

## Focus

The platoon's ability to focus fires on the enemy is critical to combat survival. Proper scanning techniques and the violent execution of battle drills (refer to the discussion in Chapter 3) will initially orient the platoon toward the enemy. At that point, the platoon leader must supplement the drills by using TRPs to mass the platoon's fires at one location.

The platoon leader identifies and references each TRP using a terrain feature or by means of a digital overlay. When TRPs are used to delineate the left and right planning limits for the center of the sector. The center TRP roughly divides the left and right sectors in which each section will scan and engage targets. Each section should have the ability to engage targets in the other section's sector of fire from its primary, alternate, or supplementary position. This allows the platoon leader to distribute fires in response to changes in the enemy situation.

One section will then scan for and engage targets to the left of the TRP while the other section does the same to the right of the TRP. (**NOTE:** If he has M1A2 target-designation capability, each TC can base in the vicinity of the TRP and orient his main gun on the TRP using the commander's digital display.)

The outer limits of the sector of fire can be supplemented with TRPs identified by the section leader or can be left to the discretion of individual TCs based on the tactical situation.

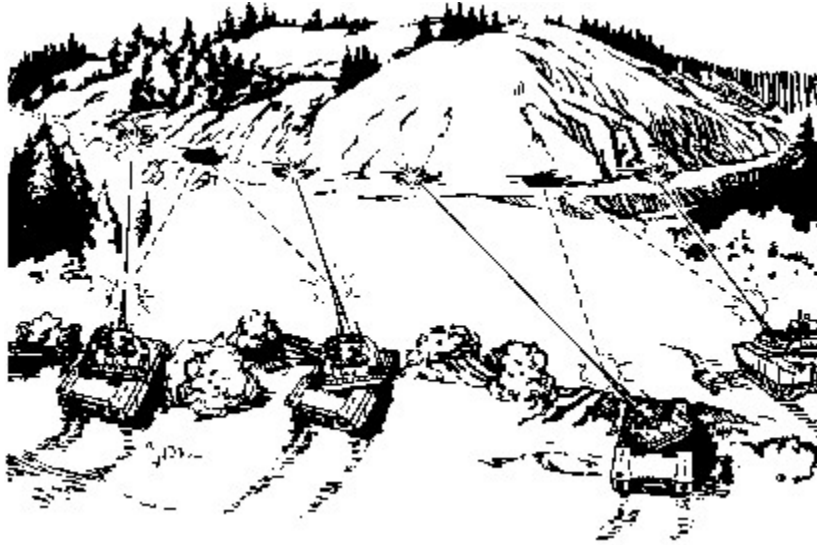
## Distribution

The entire platoon must thoroughly understand the three basic fire patterns: frontal, cross, and depth. In most situations, these allow the platoon leader to distribute platoon fires rapidly and effectively. Regardless of the fire pattern used, the goal is to engage near and flank targets first, then shift to far and center targets. Tanks should engage **near to far** and **most dangerous to least dangerous** in their sector. A "most dangerous" threat is any enemy antitank system preparing to engage the platoon. The platoon sector is defined by TRPs, which are used to mass platoon fires at specific locations and to mark the left and right planning limits for platoon fires.

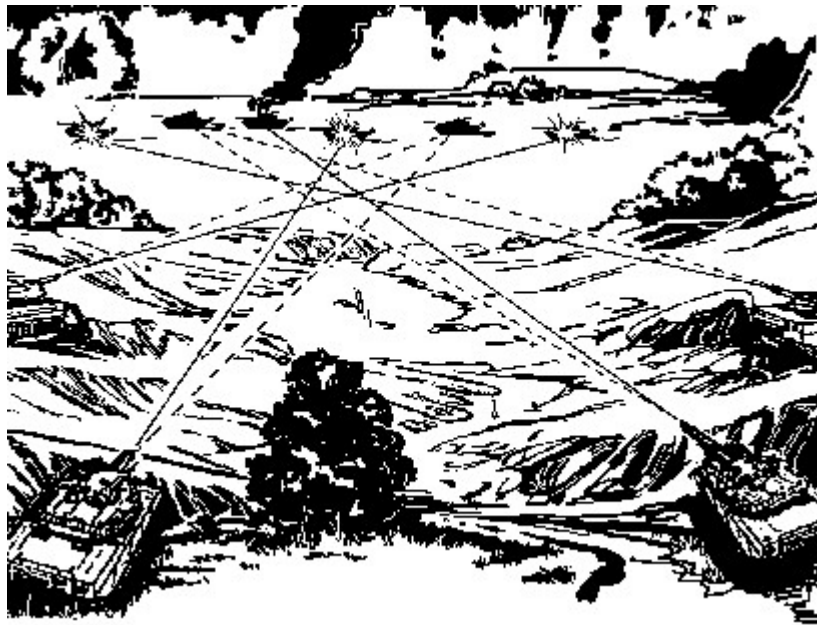
**Frontal pattern.** The frontal pattern is used when all tanks within the platoon can fire to their front (see Figure 2-10). Flank tanks engage targets to their front (right tank shoots right target, left tank shoots left target) and shift fires toward the center as targets are destroyed. The frontal fire engagement rule is "near to far, flank to center."

**Cross pattern.** The cross pattern is used when obstructions prevent some or all tanks within the platoon from firing to the front or when the enemy's frontal armor protection requires use of flank shots to achieve penetration. In this pattern, each tank engages targets on the flank of its position. The right flank tank engages the left portion of the target area while the left flank tank engages the right portion. As targets are destroyed, tanks shift fires inward. The cross fire engagement rule is "outside in, near to far." An example of the cross pattern is shown in Figure 2-11.





**Figure 2-10. Frontal fire pattern.**



**Figure 2-11. Cross fire pattern.**

***Depth pattern.*** The depth fire pattern is used when targets are exposed in depth. Employment of depth fire is dependent on the position and formation of both the engaging platoon and the target. For example, the entire platoon may be required to fire on a column formation in depth; in other cases, individual tanks engaging in their sector may have to fire in depth. If the whole platoon is firing, it may be possible for each 12). The far left tank engages the far target and shifts fire toward the center of the formation as targets are destroyed; the left center tank engages the center target and shifts fire toward the rear as targets are destroyed. The right center tank engages the closest (front) target and shifts fire to the rear as targets are destroyed; the far right tank engages the center target and shifts fire to the front as targets are destroyed.



**Figure 2-12. Depth fire pattern.**

## **Control**

ning and fire commands. He decides how to control fires based on the factors of METT-T.

**Fire planning.** The more thoroughly the platoon leader can plan an operation, the more effective the platoon's fires are likely to be. The amount of time available for fire planning, however, depends almost entirely on the collective factors of METT-T. For example, some defensive operations may allow the platoon leader hours or days to conduct fire planning. Intelligence assets may be able to acquire, track, and report enemy elements as they move toward the platoon. The platoon leader can then initiate fires with a platoon fire command or a predetermined event (such as the enemy crossing a trigger line). In other situations, especially during offensive operations, a member of the platoon may acquire and engage a "most dangerous" target before the platoon leader has an opportunity to initiate a fire command. Offensive and defensive fire planning is discussed in detail in Chapters 3 and 4.

In the absence of adequate planning time, the platoon leader must initially rely on preestablished, well-rehearsed SOPs to distribute and control fires and ensure fast, predictable engagement by all tanks. No matter what kind of situation it expects to face, the platoon must learn and rehearse target acquisition responsibilities, use of TRPs and fire patterns, and procedures for initiating, shifting, and stopping fires. Its survival depends on it.

**Platoon fire commands.** The battlefield situation and/or platoon SOP dictate the number

of elements used in a fire command. The standard platoon fire command includes up to six elements, transmitted in the following order:

- Alert.
- Weapon or ammunition (optional).
- Target description.
- Orientation.
- Control (optional).
- Execution.

**Alert.** The alert element addresses the tanks that are being directed to fire; it does not require the individual initiating the fire command to identify himself. (**NOTE:** Wingman tanks or sections not designated to engage should sense the target effects and be prepared to engage targets as necessary.)

Platoon or company SOP code words may be used to standardize the alert element, as in the following example:

- RED--Entire platoon prepare to fire.
- ALPHA--Platoon leader and his wingman prepare to fire.
- BRAVO--PSG and his wingman prepare to fire.

**Weapon or ammunition (optional).** The weapon is not announced unless specific control measures are required. Ammunition is not announced unless a specific type is dictated by the situation. The TC selects ammunition based on the platoon SOP, the number and type of enemy targets, and the supply status of ammunition (how much of each type is on hand).

**Target description.** This element briefly describes the target in terms of number, type, and activity ("THREE TANKS MOVING EAST TO WEST").

**Orientation.** Target location is described using one of two methods:

**Reference point or terrain feature.** This method is used for most defensive engagements and can also be applied to offensive situations. If the platoon leader designates separate targets for each section, he assigns responsibility and clarifies target location in the orientation element. For example: "ALPHA - TWO TANKS - TRP 3126 - BRAVO - BMPs AND TROOPS - ROAD JUNCTION."

**Direction of target.** This method is used most often in the offense when no TRP or definitive terrain feature is near the target. Direction is indicated from the projected line of movement (LOM) of the platoon in the offense or from the center of sector (COS) in the defense (for example, "LEFT FRONT" or "RIGHT FLANK"). The clock option indicates direction starting with the LOM or COS at 12 o'clock (examples: "TWO O'CLOCK"; "NINE O'CLOCK"). The cardinal direction may also be used ("NORTHWEST" or "SOUTHWEST"). When using the direction method, the platoon leader will announce a range to help his TCs locate the targets, for example, "RIGHT FRONT - ONE EIGHT HUNDRED" or "TEN O'CLOCK - TWO FOUR HUNDRED."

**Control (optional).** The control element tells the platoon what type of fire pattern (frontal, cross, or depth) the platoon leader has selected based on his plan for fire distribution. If the control element is omitted, the platoon engages targets using the frontal pattern. All tanks normally engage simultaneously. If the platoon leader wishes to designate a firing tank or section, he specifies which tanks will fire in the alert element of the fire command. Additionally, the platoon leader may designate the amount or type of ammunition or weapons to be fired. For example, he might direct four bursts from the coax machine gun for every two main gun rounds fired.

**Execution.** The execution element indicates when firing will begin. Normally, this is simply the command "FIRE." If simultaneous fire is desired or if the platoon's fire is to be coordinated with other direct or indirect fires, the execution element "AT MY COMMAND" is given first. The resulting delay allows the coordination of all fires to be completed; the individual crews select their targets, issue their own fire commands, and prepare to engage. The platoon leader must remember that tanks have to occupy hull-down positions before firing. A proword can be used to signal this move.

During execution, the platoon leader controls fires by issuing subsequent fire commands or individual elements of the fire command; this serves to focus and distribute the fires of individual tanks, a section, or the entire platoon. The engagement is terminated when all targets are "CEASE FIRE." Figure 2-13 illustrates an example of a platoon fire command; note that the weapon/ammunition element has been omitted.

Alert "RED-  
Target description THREE TANKS-  
Orientation VICINITY TRP ZERO ZERO SIX-  
Control (optional) CROSS-  
Execution AT MY COMMAND-FIRE"

**Figure 2-13. Example platoon fire command.**

## CHAPTER 3



## OFFENSIVE OPERATIONS

Offense is the decisive form of war. While tactical considerations may call for the platoon to execute defensive operations for a period of time, defeat of the enemy requires a shift to offensive operations. To ensure the success of the attack, the tank platoon leader must understand the fundamentals of offense and apply troop-leading procedures during the planning and preparation phases of the operation.

### CONTENTS

- SECTION I. Fundamentals of the Offense
- SECTION II. Planning
- SECTION III. Preparation
- SECTION IV. Execution - Tactical Movement
- SECTION V. Execution - Actions on Contact

SECTION VI. Execution-Platoon Tactical Tasks

SECTION VII. Execution - Consolidation and Reorganization

## **Section I. FUNDAMENTALS OF THE OFFENSE**

### **Purposes of the Offense**

The main purpose of the offense is to defeat, destroy, or neutralize an enemy force. Additionally, offensive operations are undertaken to secure key terrain, to gain information, to deprive the enemy of resources, to deceive and divert him, to hold him in position, to disrupt his attack, and to set the conditions for successful future operations.

### **Characteristics of the Offense**

FM 100-5 describes the common characteristics of all offensive operations: surprise, concentration, tempo, and audacity. To maximize the value of these characteristics, tank platoons must apply the following considerations:

**Surprise.** Platoons achieve surprise by following operations security (OPSEC) procedures and making the best possible use of vehicle speed and covered and concealed routes during tactical movement.

**Concentration.** Platoons achieve concentration by massing the effects of their weapon systems without necessarily massing platoon vehicles at a single location. Modern navigation and position location/reporting systems allow the platoon leader to disperse his vehicles while retaining the ability to quickly mass the effects of the platoon's weapon systems whenever necessary. In addition, these advanced systems allow him to maintain command, control, and OPSEC at all times. The platoon leader must remember that it is more important to move using covered and concealed routes to positions from which the platoon can mass fires and engage the enemy than it is to maintain precise formations and predetermined speeds.

**Tempo.** Tempo, the rate of speed of military action, can range from fast to slow. While a fast tempo is preferred, the platoon leader must remember that synchronization sets the stage for successful platoon operations; to support the commander's intent, he must ensure that his platoon's movement is synchronized with the company team's movement and that of the other platoons. If the platoon is forced to slow down because of terrain or enemy resistance, commander can alter the tempo of company movement to maintain synchronization.

**Audacity.** At the platoon level, audacity is marked by violent initiative. Knowledge of the commander's intent two levels up allows the platoon leader to take advantage of battlefield opportunities whenever they present themselves, enhancing the effectiveness of the platoon's support for the entire offensive operation.

### **Forms of Offense**

The four general forms of tactical offense described in FM 100-5 are movement to contact, attack, exploitation, and pursuit. Company teams can execute movements to contact and either hasty or deliberate attacks on their own; the nature of these operations depends largely on the amount of time and enemy information available during the planning and preparation phases. Company teams execute an exploitation or pursuit as part of a larger force.

## **Role of the Tank Platoon**

The tank platoon is an integral part of company team maneuver. The platoon conducts tactical movement, actions on contact, consolidation, and reorganization in support of company operations. It can destroy, fix, or bypass an enemy as required by the commander's intent, the tactical situation, and the rules of engagement (ROE).

## **Section II. PLANNING**

The planning phase begins when the platoon receives the higher WO or OPORD and ends when the platoon leader issues his own OPORD or FRAGO. During this phase, the platoon leader conducts troop-leading procedures as outlined in Chapter 2. After he issues the WO, he may initiate rehearsals of tactical movement, battle drills, or breaching actions. These generic rehearsals allow the platoon to begin preparing for the mission. Once the platoon leader completes his plan, the generic rehearsals are matched to the actual terrain and anticipated actions on enemy contact. In developing his OPORD or FRAGO, the platoon leader pays close attention to the following considerations applicable to the battlefield operating systems (BOS). Arranged in order, BOSs roughly follow the five-paragraph OPORD process, allowing the platoon leader to logically organize his thoughts to cover the mission. BOS elements are the following:

- Command and control.
- Intelligence.
- Maneuver.
- Fire support.
- Mobility and survivability.
- ADA.
- CSS.

### **Command and control**

The platoon leader's key function in this BOS is conducting troop-leading procedures. Immediately after the company order is issued or during the company rehearsal, he should coordinate unresolved issues with the other platoon leaders, the XO, and the company commander. The coordination should specify routes, intervals, movement speed, orientations, fire control measures, and signals between platoons.

### **Intelligence**

### **Enemy**

Most analysis of the enemy situation and probable courses of action is done at the battalion and company level; however, it is the platoon leader's responsibility to understand how the enemy's disposition and possible courses of action may affect the platoon's battle space and the accomplishment of its mission. The platoon leader identifies and plots on his overlay all known and suspected enemy positions that affect his battle space and identifies indirect and direct fire range fans of enemy weapon systems. The enemy overlay for IVIS or appliqué digital systems should also be updated to include the latest enemy information.

The platoon leader then identifies terrain features or determines the standoff distance of friendly weapon systems that will negate the effects of threat weapons. Next, he determines the enemy's most probable course of action. Using information from his own analysis and from higher headquarters, he identifies anticipated contact situations. This process includes estimating whether the enemy will defend in place, delay, or counterattack upon contact; when and where contact is most likely to be made; and what type and size of enemy force the platoon will face. Finally, the platoon leader must develop specific plans for the platoon's actions against the enemy. Refer to the discussion of enemy analysis on pages 2-4 and 2-5.

### **Terrain**

The platoon leader conducts a map reconnaissance and uses the factors of OAK-OC, as discussed in Chapter 2, to systematically analyze the terrain in his battle space. He pays close attention to key terrain that could support positions offering unobstructed observation and fields of fire. These are **danger areas** that can be used by enemy or friendly forces when contact is made during the execution of the mission. This analysis is followed by a ground reconnaissance, conducted with the commander as far forward as possible and as extensively as time and security considerations permit. The ground reconnaissance covers the platoon's movement routes to the LD, routes to the objective, and the objective itself. The platoon leader should check and record the time-distance factors to any SPs or to the LD.

### **Maneuver**

### **Movement**

The platoon leader develops the platoon maneuver plan so that it matches the commander's intent and specific instructions and supports the company main effort. He determines the platoon's route, movement technique, and formation based on his battle space (including terrain factors), the company scheme of maneuver, and the likelihood of enemy contact. He pays particular attention to fields of observation and fire; these factors can help him to define potential enemy engagement areas. The platoon leader war-games anticipated actions on contact and execution of essential tasks. He also addresses actions on the objective (consolidation and reorganization).

### **Direct Fires**

The platoon leader identifies attack by fire and support by fire positions from which the platoon can engage known or suspected enemy positions. He designates TRPs and assigns sectors of fire, observation, and weapons orientation. He specifies platoon fire patterns (if different from those identified by SOP) and addresses restrictions on direct fire imposed by the rules of engagement (ROE) in effect for the operation.

### **Fire Support**

Most fire support planning is conducted at company level and higher. The platoon leader reviews the plan to ensure that responsibilities for initiating, lifting, and shifting indirect fires are designated. As necessary, he identifies additional indirect fire targets on known or suspected enemy positions and submits recommendations to the company FIST. The platoon leader evaluates and recommends the use of smoke to help conceal or obscure movement and suppress likely enemy positions while the platoon is moving through danger areas; in addition, he evaluates the need for illumination or smoke rounds for marking and/or to assist in navigation. See the discussion of navigation in Chapter 2.

## **Mobility and Survivability**

### **Obstacle Types**

The platoon will encounter two types of obstacles, existing and reinforcing. The enemy will employ both types in its defensive plan.

Existing obstacles are those that are present on the battlefield but were not emplaced through military effort. They may be natural (such as streams, lakes, thick forests, and mountains) or cultural (towns or railroad embankments).

Reinforcing obstacles are placed on the battlefield through military effort to slow, stop, turn, or canalize the enemy. Examples include minefields, wire, road craters, log cribs, and tank ditches.

### **Breach Planning**

The commander will designate his platoons to be part of the support force, the breach force, or the assault force. The support force usually leads the company during movement and identifies the obstacle. It then suppresses any enemy elements overwatching the obstacle to give the breach force the opportunity to penetrate the obstacle. A tank platoon can conduct breach force operations only if it is equipped with the assets required to breach the type of obstacle encountered; such assets include demolitions, grappling hooks, rakes, mine plows, and mine rollers. The breach force is responsible for creating, proofing, and marking a lane through the obstacle and for securing the far side. It then suppresses remaining enemy forces as the assault force moves through the breach to continue the attack. (See Chapter 5 for more information on breaching operations.)

**NOTE:** NBC defensive operations are a critical consideration within the mobility and survivability BOS. These are discussed in detail in Section V of this chapter (as part of the execution of battle drills) and in Appendix D.

### **Air defense artillery**

Refer to Chapter 6 for a discussion of ADA planning considerations.

### **Combat Service Support**

The platoon leader ensures that soldiers are familiar with maintenance and medical evacuation (MEDEVAC) procedures as outlined in paragraph 4 of the platoon OPORD or



in the unit SOP. See Chapter 7 for more details concerning logistics operations.

### **Section III. PREPARATION**

The preparation phase ends when the platoon crosses the LD and deploys for the attack. The platoon leader takes into account the following BOS considerations.

#### **Command and Control**

During the preparation phase, the platoon leader continues with his troop-leading procedures and conducts rehearsals and inspections to ensure the platoon is ready for the upcoming operation. Near the end of the phase, the platoon leader conducts a precombat inspection (PCI) of his soldiers and equipment. The soldier inspection includes checking each crewman's personal knowledge of the operation as well as the readiness of his equipment. As a rule, TCs must understand the company scheme of maneuver; other crewmen must understand the platoon scheme of maneuver. The equipment inspection consists of checking each tank crew's ability to move, shoot, and communicate. The inspection should be as thorough as time permits; for a detailed PCI checklist, see FKSM 17-15-3. Rehearsals and inspections are discussed in detail in Chapter 2.

#### **Intelligence**

During this phase, the platoon leader will receive updated SPOTREPs listing known and suspected enemy locations as well as the latest friendly actions. He should plot the updated enemy and friendly locations on his overlay and on the enemy overlay (digital systems); based on his terrain reconnaissance, he adjusts the maneuver plan accordingly.

#### **Maneuver**

Following the last company rehearsal, the platoon should conduct a final rehearsal of its own to incorporate any adjustments to the company scheme of maneuver. The platoon rehearsal should follow the procedures outlined in Chapter 2. It should cover the following subjects:

- Movement from current positions.
- Routes.
- Platoon and company formations and movement techniques.
- Vehicle positions within the platoon formation.
- Weapons orientation and fire control.
- Decision points.
- Actions on contact.
- Actions on the objective (consolidation and reorganization.)
- Reporting procedures.
- Signals.

#### **Fire Support**

During the rehearsal, the platoon leader should address responsibility for targets in the platoon battle space. He should cover any scheduled indirect fires and the effects of smoke on the battlefield. In addition, he should discuss the direct fire plan, with emphasis on platoon responsibilities, known and suspected enemy locations, friendly unit locations, and applicable ROE.

## **Mobility and Survivability**

Actions at obstacles should be rehearsed during the preparation phase. Breaching equipment should be checked during the PCI.

## **Air Defense Artillery**

ADA preparations during this phase should include a rehearsal of the react to air attack drill, which is outlined in Section V of this chapter.

## **Combat Service Support**

During the preparation phase, tank crews conduct resupply operations to replenish their combat loads. They also perform preventive maintenance checks and services (PMCS) on their vehicles and equipment.

Rehearsals should cover aspects of the logistical plan that will support the upcoming operation, including emergency resupply and personnel and vehicle evacuation procedures. For more information on logistics, refer to Chapter 7.

## **SECTION IV. EXECUTION-TACTICAL MOVEMENT**

The company OPORD will normally specify company and platoon formations and techniques of movement. This allows the commander to position his elements where they will optimize the company's battle space and facilitate execution of his scheme of maneuver. The platoon leader has the responsibility to recommend a different formation or technique of movement if a change will allow the platoon to more effectively contribute to the accomplishment of the company mission and protection of the force. If no formation or technique of movement is given in the order, the platoon leader selects the one that will make the most efficient use of his battle space and will best support the company scheme of maneuver.

While moving, the platoon uses terrain to provide cover and concealment, employing the following rules:

Do not move forward from an overwatch position or BP. Back away from your position and go around on the low ground.

Stay on low ground as much as possible. Moving on top of ridgelines and over hilltops will silhouette (skyline) platoon vehicles.

Scan the ground for disturbed earth, out-of-place features, and surface-laid mines. These are indicators of an obstacle or mine field.

Select the formation and movement technique that maximizes the platoon's battle space while minimizing gaps and dead space.

If your move is being covered by an overwatch element, remember that the overwatch element cannot cover all of the platoon's gaps and dead space.

If the move is being overwatched, also keep in mind that the distance of each move (or bound) must not exceed the direct fire range of the overwatch element.

Always plan actions at danger areas. If necessary, direct the TC or loader to dismount and either observe around blind spots or check the trafficability of a route or defile before the tank moves over or through these locations.

## Techniques of Movement

The commander or platoon leader selects a technique of movement based on several battlefield factors:

The likelihood of enemy contact.

The availability of another element to provide overwatch for the moving element.

The terrain over which the moving element will pass.

In open terrain, such as deserts, one company will normally overwatch the movement of another company. In close terrain, such as rolling hills or countryside, platoons will normally overwatch other platoons. In restrictive terrain, such as mountains, forests, or urban areas, a tank section will rely on another tank section or dismounted infantry to overwatch movement.

The tank platoon must be able to employ any of the following techniques of movement:

**Traveling.** Characterized by continuous movement of all elements, traveling is best suited to situations in which enemy contact is unlikely and speed is important.

**Traveling overwatch.** Traveling overwatch is an extended form of traveling that provides additional security when contact is possible but speed is desirable. The lead element moves continuously. The trail element moves at various speeds and may halt periodically to overwatch the movement of the lead element. The trail element maintains dispersion based on its ability to provide immediate suppressive fires in support of the lead element. The intent is to maintain depth, provide flexibility, and sustain movement in case the lead element is engaged.

**Bounding Overwatch.** Bounding overwatch is used when contact is expected. It is the most secure, but slowest, movement technique. There are two methods of bounding:

- **Alternate bounds.** Covered by the rear element, the lead element moves forward, halts, and assumes over-watch positions. The rear element advances past the lead element and takes up overwatch positions. The initial lead element then advances past the initial rear element and takes up overwatch positions. Only one element moves at a time. This method is usually more rapid than successive bounds. (Refer to Figure 3-1, page 3-12.)

**Successive bounds.** In this method, the lead element, covered by the rear element, advances and takes up an overwatch position. The rear element advances to an overwatch position abreast of the lead element and halts. The lead element then moves to the next position, and so on. Only one element moves at a time, and the rear element avoids advancing beyond the lead element. This method is easier to control and more secure than the alternate bounding method, but it is slower (Refer to Figure 3-2, page 3-12.)

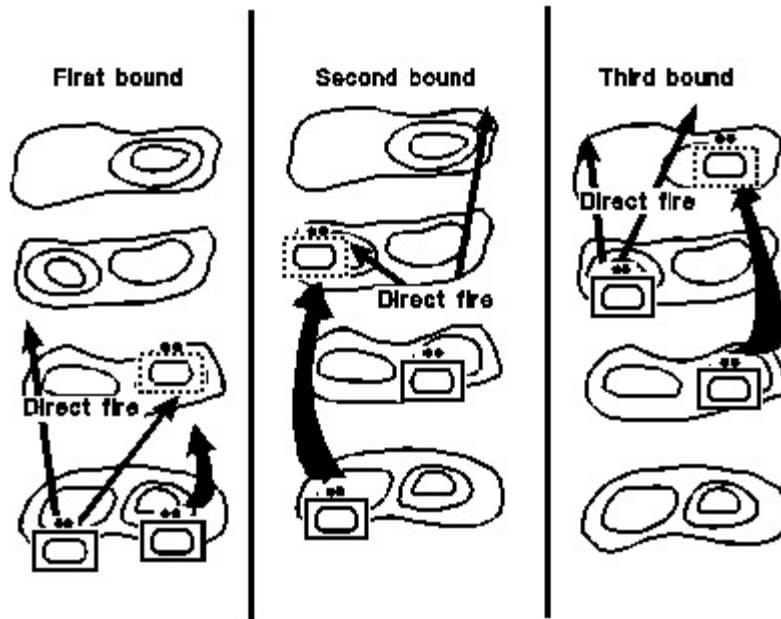


Figure 3-1. Movement by alternate bounds.

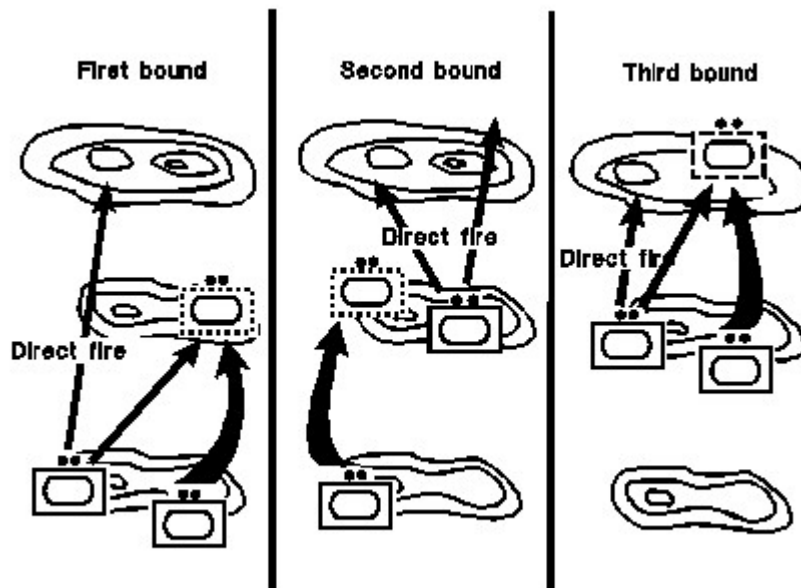


Figure 3-2. Movement by successive bounds.

## FORMATIONS

Formations are used to establish tank positions and sectors of responsibility during tactical operations. They facilitate control, alleviate confusion, and increase protection, speed, and the effectiveness of fires.

Formations are not intended to be rigid, with vehicles remaining a specific distance apart at every moment. The position of each tank in the formation

depends on the terrain and the ability of the wingman driver to maintain situational awareness in relation to the lead tank. At the same time, individual tanks should always occupy the same relative position within a formation. This will ensure that the members of each crew know who is beside them, understand when and where to move, and are aware of when and where they will be expected to observe and direct fires. Weapons orientation for all tanks should be adjusted to ensure optimum security based on the position of the platoon in the company formation.

The following paragraphs and illustrations describe the six basic movement formations the platoon will use. (**NOTE:** In these examples, vehicle numbers are used to illustrate the wing man concept. In the field, the location and sequence of vehicles in the formation will be prescribed in the platoon SOP and/or the orders for the operation. The tactical situation will also influence vehicle location.)

### Column

The column provides excellent control and fire to the flanks, but permits less fire to the front. It is used when speed is critical, when the platoon is moving through restrictive terrain on a specific route, and/or when enemy contact is not likely. (See Figure 3-3, page 3-14.)

### Staggered Column

The staggered column is a modified column formation with one section leading and one section trailing behind to provide overwatch. The staggered column permits good fire to the front and flanks. It is used when speed is critical, when there is a limited area for lateral dispersion, and/or when enemy contact is possible. (See Figure 3-4.)

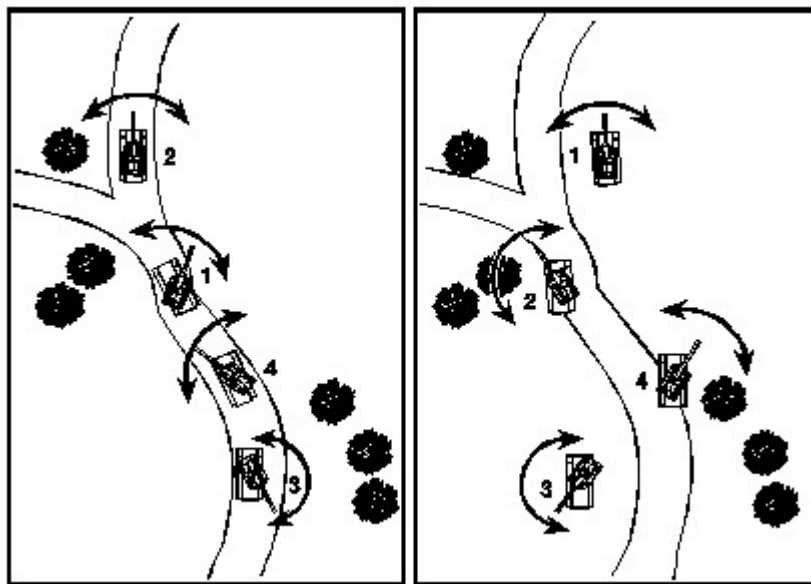


Figure 3-3. Column formation. Figure 3-4. Staggered column

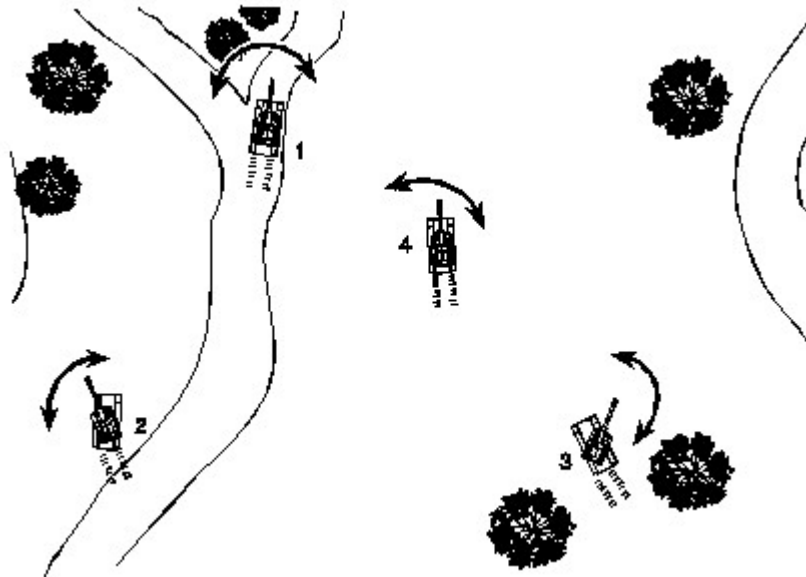
**formation.**

### **Wedge**

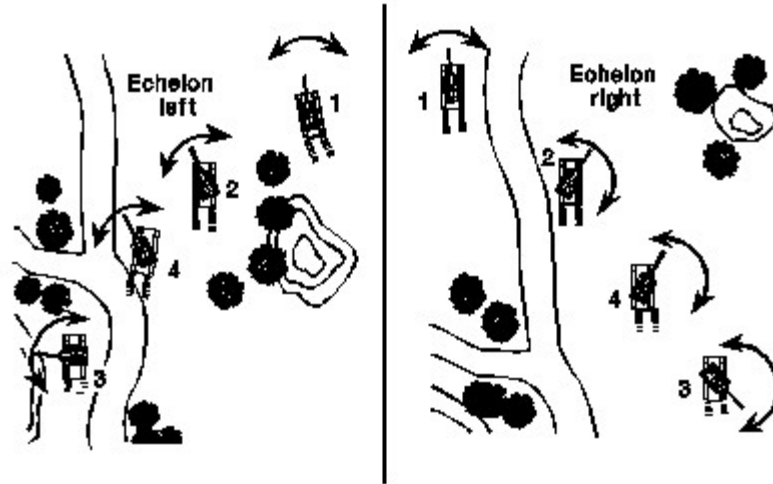
The wedge permits excellent firepower to the front and good firepower to the flanks. It is employed when the platoon is provided with overwatch by another element and is moving in open or rolling terrain. Depending on the platoon location within the company formation, the platoon leader and PSG (with wingmen) can switch sides of the formation. When the platoon leader's tank is slightly forward, one flank has more firepower. (See Figure 3-5.)

### **Echelon**

The echelon formation permits excellent firepower to the front and to one flank. It is used to screen an exposed flank of the platoon or of a larger moving force. (See Figure 3-6.)



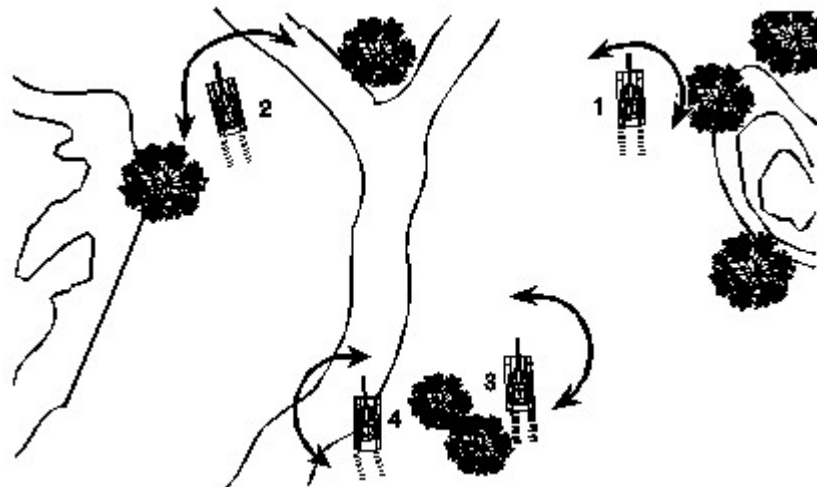
**Figure 3-5. Wedge formation.**



**Figure 3-6. Echelon formation.**

**Vee**

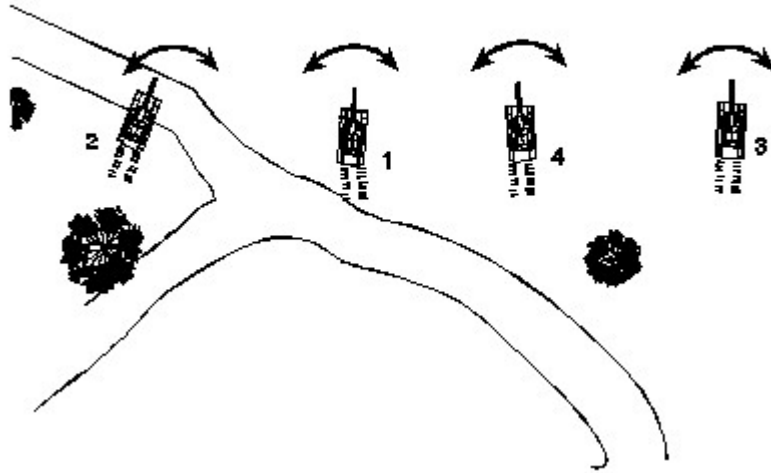
The vee formation provides excellent protection and control, but limits fires to the front. This formation is used when terrain restricts movement or when overwatch within the platoon is required. (See Figure 3-7.)



**Figure 3-7. Vee formation.**

**Line**

The line formation provides maximum firepower forward. It is used when the platoon crosses danger areas and is provided with overwatch by another element or when the platoon assaults enemy positions. (See Figure 3-8.)



**Figure 3-8. Line formation.**

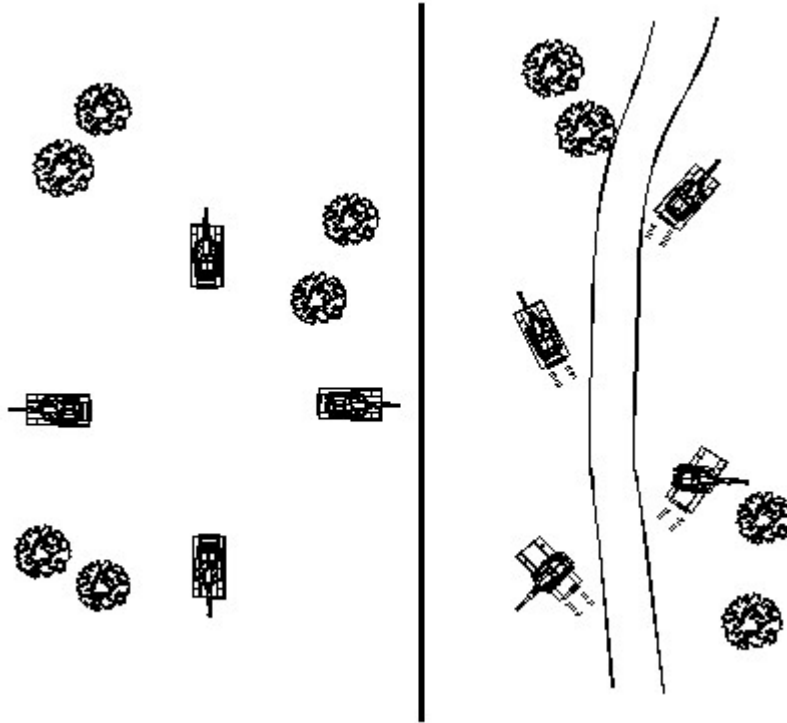
### **Coil and Herringbone**

These formations are employed when the platoon is stationary and 360-degree security is essential. Figure 3-9 illustrates the coil and herringbone.

**Coil.** When it is operating independently, the platoon uses the coil formation to establish a perimeter defense during extended halts or lulls in combat. The lead vehicle, normally the platoon leader, will halt his vehicle in the direction of travel (12 o'clock) while the other vehicles position themselves to form a circular formation covering all suspected enemy avenues of approach.

**Herringbone.** The herringbone formation is used when the platoon must assume a hasty defense with 360-degree security while remaining postured to resume movement in the direction of travel. It is normally employed during scheduled or unscheduled halts in a road march. If terrain permits, vehicles should move off the road and stop at a 45-degree angle, allowing passage of vehicles through the center of the formation.





**Figure 3-9. Coil and herringbone formations.**

### **Overwatch**

Overwatch is the tactical mission in which an element observes and provides direct fire support for a friendly moving element. Situational awareness is a crucial factor in all overwatch missions, whose objective is to prevent the enemy from surprising and engaging the moving unit. The overwatch force must maintain communication with the moving force and provide early warning of enemy elements that could affect the moving force. It also scans gaps and dead space within the moving element's formations. If the overwatch is unable to scan dead space and engage the enemy, it must alert the moving element of the lapse in coverage. The overwatch must also be able to support the moving force with immediate direct and indirect fires. The overwatch element can be either stationary or on the move. Figure 3-10 illustrates what to look for and where to look during an overwatch mission. (**NOTE:** While the main function of overwatch is to provide early warning and/or timely supporting fires for a moving element, overwatch crews must also maintain 360-degree observation and security for themselves.)

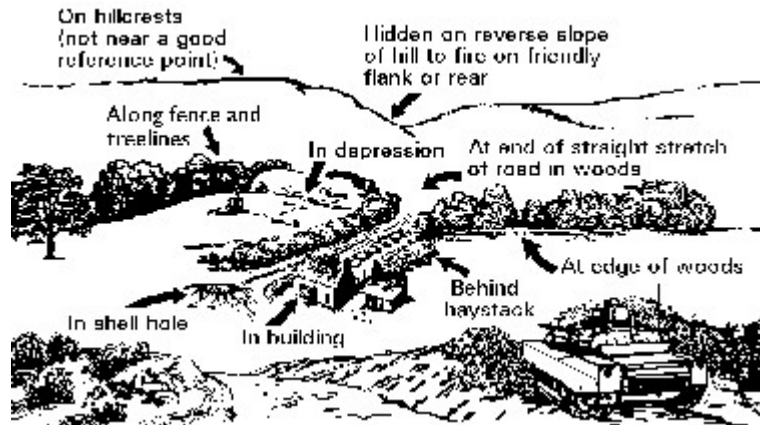
### **Stationary Overwatch**

The section or platoon occupies hull-down firing positions that provide effective cover and concealment, unobstructed observation, and clear fields of fire. (**NOTE:** Firing positions are discussed in Chapter 4.)

The section or platoon leader assigns sectors of fire. Individual crews aggressively scan their sectors using applicable search techniques to identify enemy positions. They employ all available sights, including the thermal channel (using various polarities) and daylight channel of the gunner's primary sight, binoculars, PVS-7s, and commander's independent thermal viewer (CITV). (See FM 17-12-1-1 for search techniques.) The overwatch element scans the battle space of the moving element, paying close attention to gaps and dead space. If contact is made, the overwatch element initiates a high volume of direct and indirect suppressive fires; it moves as necessary between primary and alternate positions to avoid being decisively engaged.

### Overwatch on the Move

The trail section or platoon maintains a designated location in the formation. It continuously scans the lead element's battle space, closely monitoring gaps and dead space. The trail element maintains an interval dictated by the capabilities of its weapon systems and the effects of terrain. As needed, it can execute a short halt on key terrain to provide more effective overwatch.



WHAT TO LOOK AND LISTEN FOR:	WHERE TO LOOK (see figure above):
<b>TANKS</b> <ul style="list-style-type: none"> <li>• Engine noise, track clatter.</li> <li>• Exhaust smoke.</li> <li>• Antenna masts.</li> <li>• Engine, suspension heat sources.</li> <li>• Dust and reflections.</li> <li>• Firing signature (flash, blast).</li> </ul>	<ul style="list-style-type: none"> <li>• Within 2,000 meters of moving element.</li> <li>• Near crests, next to buildings, in treelines.</li> </ul>
<b>ATGM</b> <ul style="list-style-type: none"> <li>• Smoke signature of missile in flight.</li> <li>• Missile controller may be up to 100 meters from launch site.</li> <li>• Human heat sources.</li> </ul>	<ul style="list-style-type: none"> <li>• 400 to 4,000 meters from moving element.</li> <li>• May be launched from behind hillslope and ridgelines.</li> <li>• Rooftops.</li> </ul>
<b>OTHER ANTITANK WEAPONS</b> <ul style="list-style-type: none"> <li>• Usually well-camouflaged.</li> <li>• Firing signature.</li> <li>• Handheld and crew-served weapon systems.</li> <li>• Human heat sources.</li> </ul>	<ul style="list-style-type: none"> <li>• Within 1,000 meters of moving element.</li> <li>• 360° observation needed to protect against tank ambush teams using handheld weapons.</li> <li>• Two or more may be employed on reverse slopes, protected by mines.</li> <li>• Usually on a flank.</li> </ul>

Figure 3-10. Overwatch locations and techniques.

## Section V. EXECUTION - ACTIONS ON CONTACT

In both offensive and defensive operations, contact occurs when any member of the platoon observes enemy personnel or vehicles, observes or receives direct or indirect fire, or encounters any situation that requires an active or passive response to the enemy. This includes reports of enemy contact through the chain of command or from an adjacent friendly element. The platoon initiates actions on contact when it recognizes one of the defined contact situations or on order from higher headquarters.

As discussed in Section II of this chapter, the platoon leader should use the planning process to anticipate the actions on contact that the platoon may be required to execute based on the enemy situation. The platoon can then rehearse these potential actions during the preparation phase of the operation.

The commander's OPORD will assist the platoon leader in two ways. First, the commander's scheme of maneuver will direct the platoon leader in planning how to kill the templated or anticipated enemy force. The scheme of maneuver will define the platoon's role in maneuver and direct fire as part of the company or task force plan. Second, the commander's coordinating instructions should specify for the platoon leader the actions on contact that, based on the size and activity of the anticipated enemy force, are related to the maneuver plan. These specific instructions may

include engagement criteria, bypass criteria, displacement criteria, and the course of action the commander expects to employ. By learning and planning for these details in advance, the platoon leader will be able to develop contact situations rapidly and determine the most effective course of action.

### **THE FOUR STEPS OF ACTIONS ON CONTACT**

The following four steps allow the platoon leader to execute actions on contact using a logical, well-organized decision-making process:

- Deploy and report.
- Evaluate/develop the situation.
- Choose a course of action.
- Recommend/execute a course of action.

The four-step process is not a rigid, lockstep response to the enemy contact. Rather, the goal is to provide an orderly framework that enables the platoon to survive the initial contact, then apply sound decision-making and timely actions to complete the operation. In simplest terms, the platoon must react instinctively and instantly to the contact, and the platoon leader must decide, with equal dispatch, whether to execute a preplanned battle drill or course of action or to recommend and execute an alternate drill or action.

At times, the platoon leader, and the platoon, will have to execute several of the steps simultaneously. This makes thorough preparation an absolute requirement in contact situations. To ensure the platoon functions as a team, reacting correctly and yet instinctively, the platoon leader must establish SOPs and conduct comprehensive training and rehearsals covering each step.

#### **Deploy and Report**

The platoon leader deploys the platoon when he recognizes one of the general categories of initial contact or receives a report of enemy contact. Contact situations include (but are not limited to) the following:

- Visual contact (friendly elements may or may not be observed by the enemy).
- Physical contact with a superior, inferior, or unknown enemy.
- Indirect fire contact.
- Contact with obstacles of enemy or unknown origin.
- Contact with enemy or unknown aircraft.
- Situations involving NBC conditions.
- Situations involving electronic warfare tactics (such as jamming, interference, and imitative deception).

When the platoon makes contact with the enemy, it responds according to the circumstances of the situation. The tank that makes initial contact must

react as appropriate. This covers a range of actions that correspond to the nature of the contact. Most critically, if the contact entails enemy antitank fire, the tank returns fire immediately. In all cases, it alerts the rest of the platoon with a contact report (see FKSM 17-15-3 for report formats).

The platoon leader has several choices in deploying the platoon. In many cases, he will initiate one of the seven battle drills. This usually will be a contact or action drill, with the platoon attempting to acquire and engage the enemy. (**NOTE:** Refer to the discussion and illustrations of the battle drills on pages 3-31 through 3-44.) The platoon leader can also order his tanks to immediately seek the best available covered and concealed position. The position should afford unobstructed observation and fields of fire and allow the platoon to maintain flank security. Tank crews will also seek cover and concealment in the absence of a deployment order from the platoon leader.

This step concludes with the platoon leader or PSG sending a contact report to the commander, followed as soon as possible by a SPOTREP.

### **Evaluate/Develop the Situation**

While the platoon deploys by executing a battle drill or occupying a covered and concealed position, the platoon leader must begin to evaluate the situation and, as necessary, develop it. His primary focus is on determining and/or confirming the size (inferior or superior), composition (available weapon systems), activity, and orientation of the enemy force. He analyzes how obstacles and terrain in the area of operations will affect enemy and friendly capabilities and possible courses of action. The platoon leader uses SPOTREPs from the TCs, other platoon leaders, the XO, and the company commander to make his evaluation. (**NOTE:** Because the tank platoon usually operates as part of a company team or cavalry troop, additional infantry, scout, or tank platoons will be available to assist the commander and platoon leader in developing and confirming the enemy situation.)

There are no hard and fast rules for determining the superiority or inferiority of an enemy; the result is dependent on the situation. An inferior force is defined as an enemy element that the platoon can destroy while remaining postured to conduct further operations. A superior force is one that can be destroyed only through a combined effort of company- or battalion-level combat and CS assets.

The platoon leader bases his evaluation on the enemy's capabilities, especially the number of lethal weapon systems the enemy force is known to have, and on the enemy's current activity. Lethality varies; the enemy may employ rapid-fire antitank weaponry, slow-firing wire-guided systems, or dismounted soldiers with automatic weapons. Likewise, enemy activity can range from an entrenched force using prepared fighting positions to a unit conducting refueling operations with little security.

After making contact and evaluating the situation, the platoon leader may discover that he does not have enough information to determine the superiority or inferiority of the enemy force. To make this determination, he can further develop the situation using a combination of techniques, including fire and maneuver, indirect fire, reconnaissance by fire, and dismounted surveillance. In such a situation, however, the platoon leader must exercise caution, ensuring that his actions support the commander's intent. Mission accomplishment and the survivability of the platoon are crucial considerations. Once he determines what the platoon is up against, the platoon leader sends an updated SPOTREP to the commander.

Once the platoon leader develops the situation and determines that he has enough information to make a decision, he selects a course of action that both meets the requirements of the commander's intent and is within the platoon's capabilities. He has several options in determining the course of action:

Direct the platoon to execute the original plan. The platoon leader selects the course of action specified by the commander in the OPORD.

Based on the situation, issue FRAGOs to refine the plan, ensuring it supports the company commander's intent.

Report the situation and recommend an alternative course of action based on known information in response to an unforeseen enemy or battle field situation.

Direct the platoon to execute tactical movement (employing bounding overwatch and support by fire within the platoon) and reconnaissance by fire to further develop the situation and gain the information he needs to clarify a vague battlefield picture.

***Considerations in choosing a course of action.*** Because he will have little time for analysis at this point, the platoon leader should already have developed a clear understanding of the available courses of action. As noted earlier in this section, he first analyzes the commander's OPORD to determine how it will affect his choice of a course of action. In most cases, the commander will have identified the criteria for anticipated actions on contact in terms of the enemy's capabilities (that is, whether the enemy is a superior or inferior force). He also will have specified criteria for destroying, fixing, and bypassing the enemy as well as the applicable disengagement criteria. The platoon leader can then evaluate various responses to possible enemy actions during the planning phase, in the company rehearsal, and in informal war-gaming and rehearsals with the platoon.

Refinements to the original plan or development of a new course of action may change the scheme of maneuver. In most situations, the intent of maneuver is to gain positions of advantage over the

enemy, forcing him to fight in two directions. One element moves to the position of advantage while another element overwatches and supports.

If necessary, the platoon leader should issue a revised set of graphic control measures as part of the FRAGO. Examples include waypoints to assist in navigation along desired routes to a position of advantage and TRPs to help the platoon orient weapons and fires.

***Use of platoon tasks as courses of action.*** During execution of actions on contact, the platoon collective tasks described in Section VI of this chapter are available as courses of action. These include destroy an inferior force; attack by fire; overwatch/support by fire; assault; bypass; reconnaissance by fire; hasty defense; and hasty/in-stride breach. If the commander's plan has already addressed the situation adequately, the platoon leader directs the platoon to execute the specified task or course of action. If the situation dictates adjustments to the plan, he can recommend an alternative course of action to the commander.

### **Recommend/Execute a Course of Action**

Once he has chosen a course of action, the platoon leader continues his evaluation of the situation by determining whether or not the course of action is the same one ordered by the commander in the OPORD or during the rehearsal. If it is, he orders the platoon to execute it and reports his intentions to the commander.

If the situation dictates a change to the course of action specified in the original plan, however, the platoon leader must recommend a new course of action to the commander. He then directs the platoon to execute the course of action selected by the commander, who may or may not follow the recommendation. The platoon leader cross-talks with other platoon leaders as necessary to obtain support in accordance with the commander's intent.

More information will become available as the platoon executes the course of action. The platoon leader or PSG keeps the company commander abreast of the situation with SPOTREPs and SITREPs; accuracy of these reports is critical because the task force commander and S2 use them to confirm or deny the situational template.

Key information the commander needs includes the number, type, and location of enemy elements the platoon has **observed**, **engaged**, **destroyed**, or **bypassed**. Additionally, the platoon leader must inform the commander of the platoon's current location (or that he is **moving to** or **set at** a particular location). Finally, he must inform the commander of any changes in the platoon's combat power or logistical status.

Based on details of the enemy situation, the platoon leader may have to

alter his course of action during execution. For example, as the platoon maneuvers to destroy what appears to be a lone enemy tank, it discovers six more tanks in prepared fighting positions; in this situation, the platoon leader would inform the commander and recommend an alternate course of action, such as an attack by fire against the enemy tank company. (Figures 3-12A through 3-12D, pages 3-29 and 3-30, illustrate a similar situation in which changes to the course of action become necessary.)

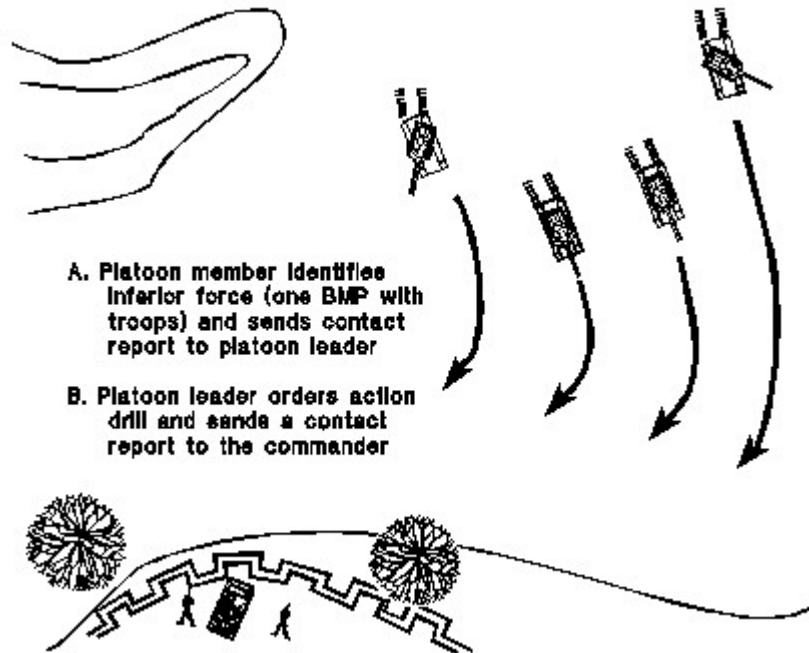
The platoon continues to execute the selected or refined course of action until it accomplishes the original mission, receives a FRAGO from the commander changing the mission or course of action, or is ordered to execute consolidation and reorganization on the objective.

### **EXAMPLES OF ACTIONS ON CONTACT**

The following examples illustrate actions on contact for two potential situations. The illustrations are organized to show the four-step process for executing actions on contact.

#### **Actions on Contact with an Anticipated Inferior Force**

Figures 3-11A through 3-11C, pages 3-26 through 3-28, show actions on contact when the platoon encounters an inferior enemy element. In this case, the commander and platoon leader have anticipated contact with such a force and have planned for actions on contact by including possible courses of action in their OPORDs and/or rehearsals.



**Figure 3-11A. Platoon makes initial contact, deploys using action drill, and reports.**



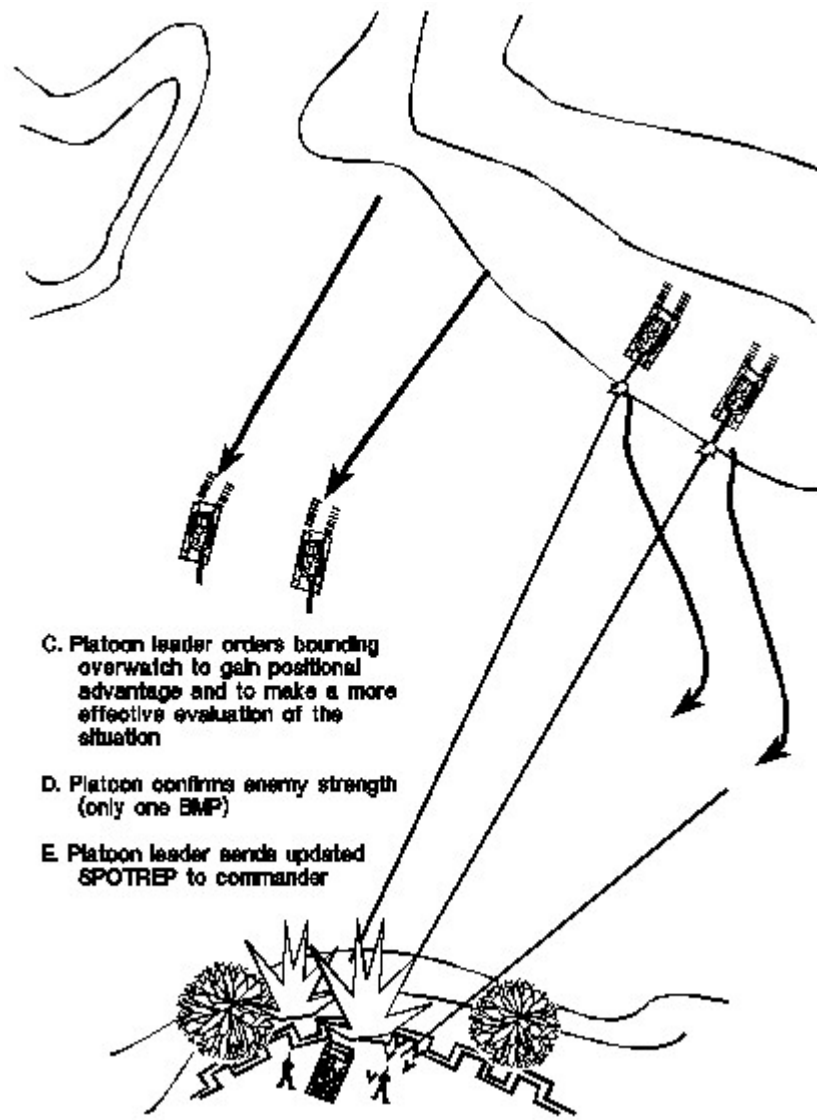
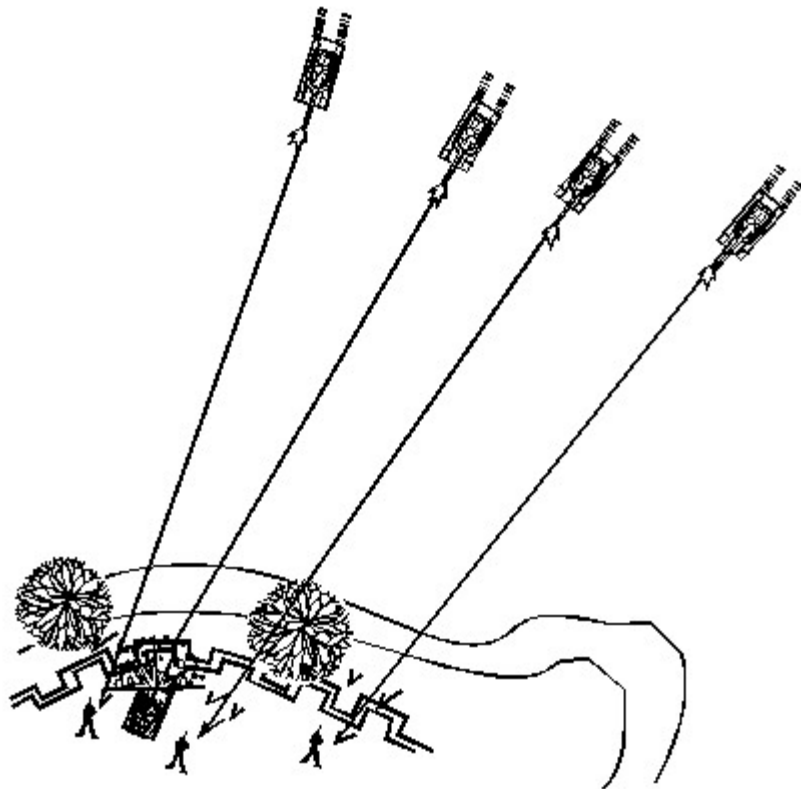


Figure 3-11B. Platoon develops the situation.

- F. Platoon leader chooses to assault (in accordance with commander's OPORD)
- G. Platoon leader informs the commander and orders the platoon to execute the assault
- H. Platoon assaults and destroys BMP



**Figure 3-11C. Platoon leader chooses course of action; platoon executes the assault.**

### **Actions on Contact with an Unanticipated Superior Force**

Figures 3-12A through 3-12D, pages 3-29 and 3-30, show actions on contact when the platoon unexpectedly encounters a superior enemy force.

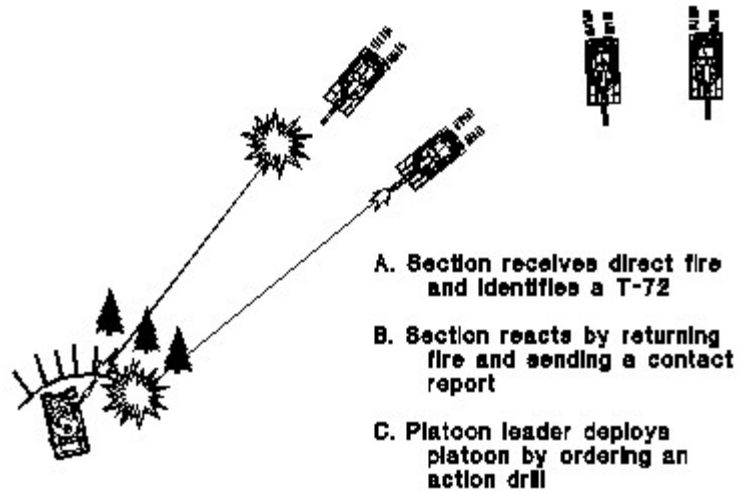


Figure 3-12A. Platoon makes initial contact, deploys, and reports.

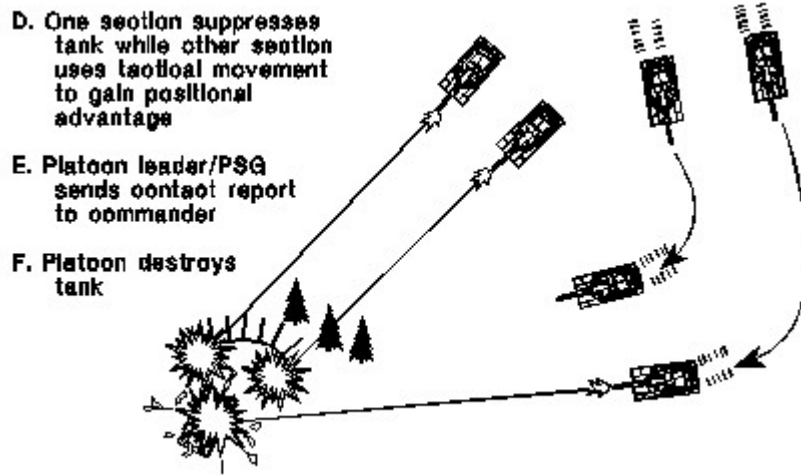
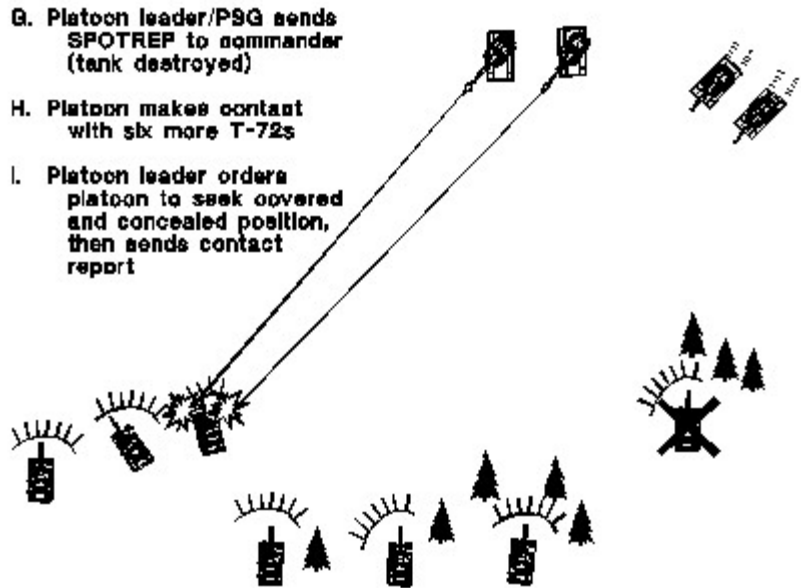
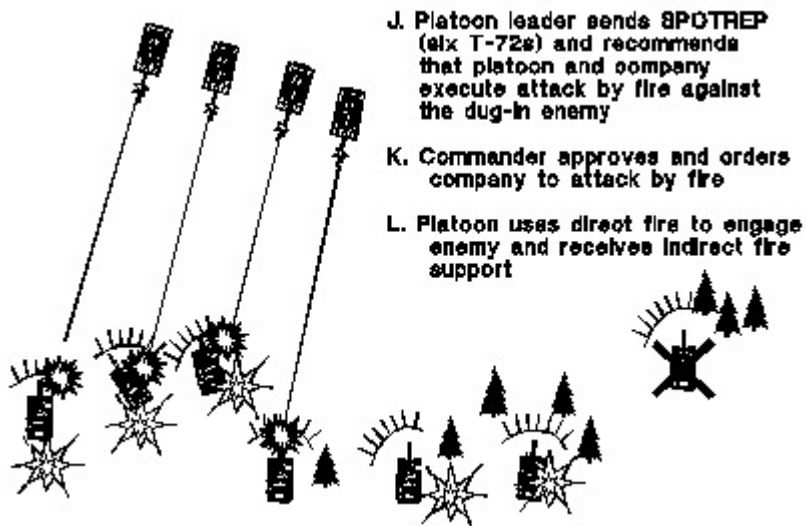


Figure 3-12B. Platoon executes battle drill; platoon leader evaluates the situation as drill is executed.



**Figure 3-12C. Platoon develops the situation and identifies superior enemy force.**



**Figure 3-12D. Platoon leader chooses and recommends alternate course of action; platoon executes new course of action.**

### BATTLE DRILLS

When the tank platoon makes contact with the enemy, the platoon leader usually initiates a battle drill. Drills can be initiated following reports or observation of enemy activity, but are most commonly ordered upon receipt of enemy fires.

Battle drills provide virtually automatic responses to situations in which the immediate and, as appropriate, violent execution of an action is vital to the platoon's safety or to its success in combat. They allow the platoon leader to protect the platoon from the effects of enemy fires, to quickly

mass the platoon's combat power and fires, or to move the platoon to a position of advantage over the enemy.

Drills are standardized collective actions, executed by each tank crew with minimal instruction and without application of a deliberate thought process. They can be carried out under almost any type of battlefield conditions and from any formation or technique of movement, although execution can be affected by the factors of METT-T. (**NOTE:** Platoon leaders should note that the use of battle drills does not relieve them of the requirement for logical, timely decision-making when critical situations arise on the battlefield.)

The platoon can expect to execute any of the following standard battle drills: change of formation drill, contact drill, action drill, react to indirect fire drill, react to air attack drill, react to a nuclear attack drill, and react to a chemical/biological attack drill. Commanders and leaders at all levels must be ready to augment or adjust these seven basic drills based on the threat, terrain, and ROE. In addition, they must ensure their platoons rehearse battle drills until they are able to execute the drills perfectly no matter what command and control problems arise.

**NOTE:** In the figures that accompany the following discussion of the seven battle drills, vehicle numbers are used to illustrate the wingman concept. In the field, the location and sequence of vehicles during the drill will be prescribed in the platoon SOP and/or the orders for the operation. The tactical situation will also influence vehicle location.

### **Change of Formation Drill**

This drill is executed to accomplish a rapid change of formation in response to a change in terrain or enemy situation. The platoon leader must ensure that each TC knows the new formation and the relative position of each tank in the new formation. He uses visual signals and/or the radio to initiate the drill. Figure 3-13 illustrates the movement of individual tanks during a change of formation from column to wedge to line.

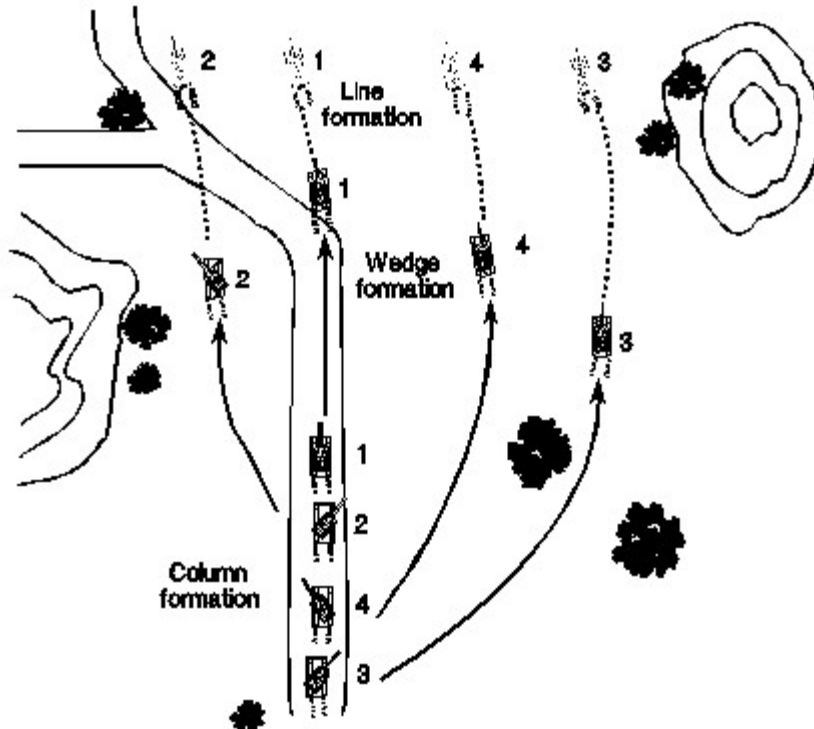


Figure 3-13. Change of formation drill.

### Contact Drill

The contact drill enables the platoon to orient weapon systems and engage an enemy without changing its direction or speed of movement along the axis of advance. This drill is used when contact is made with small arms fire or when the platoon sights the enemy without being engaged and does not want to stop or slow its movement. The platoon leader initiates the contact drill using visual signals and/or the radio. Over the radio, he uses the contact report format and adds the execution element "FIRE" as a platoon fire command.

Figure 3-14 illustrates a contact drill from a wedge formation. Note the main gun orientation for wingman Tank 2. If a tank's weapon systems are masked by another tank, the masked tank maintains weapons orientation and flank security as prescribed in the OPORD; this helps to prevent fratricide.

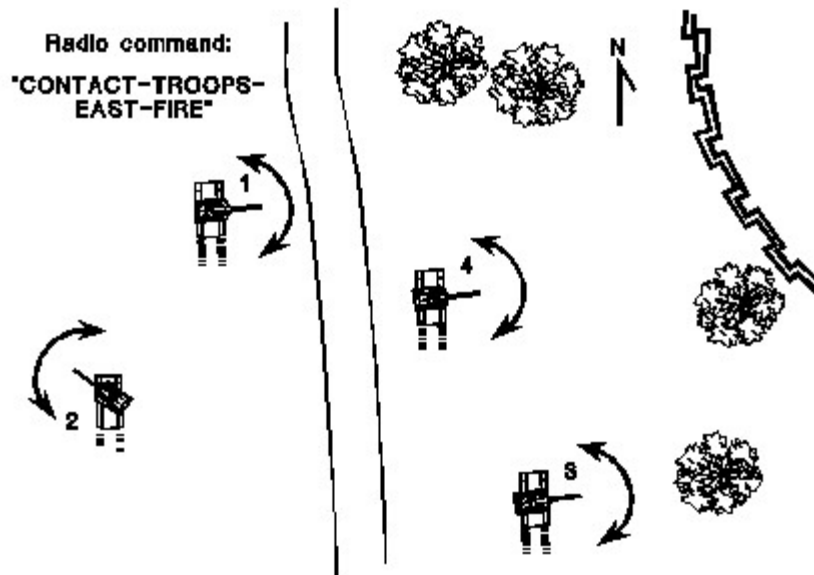


Figure 3-14. Contact drill.

## Action Drill

The action drill permits the entire platoon to change direction rapidly in response to terrain conditions, obstacles, FRAGOs from the commander, or enemy contact. The platoon leader uses visual signals or the radio to order the action drill, which can be initiated with or without enemy contact.

***Action drill without enemy contact.*** The platoon leader can execute an action drill to avoid a danger area or obstacle or to respond to FRAGOs from the commander. When the platoon leader initiates the action drill, tanks come on line and continue to move in the prescribed direction unless the platoon leader directs a change of formation. Figures 3-15A and 3-15B illustrate tanks' relative positions during various action drills without contact.

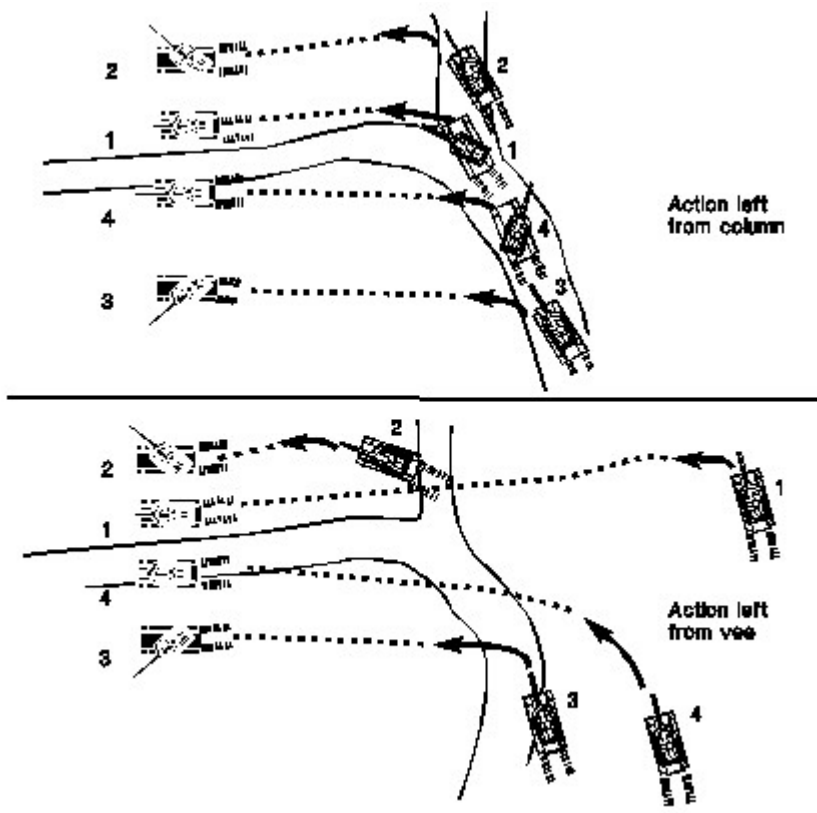
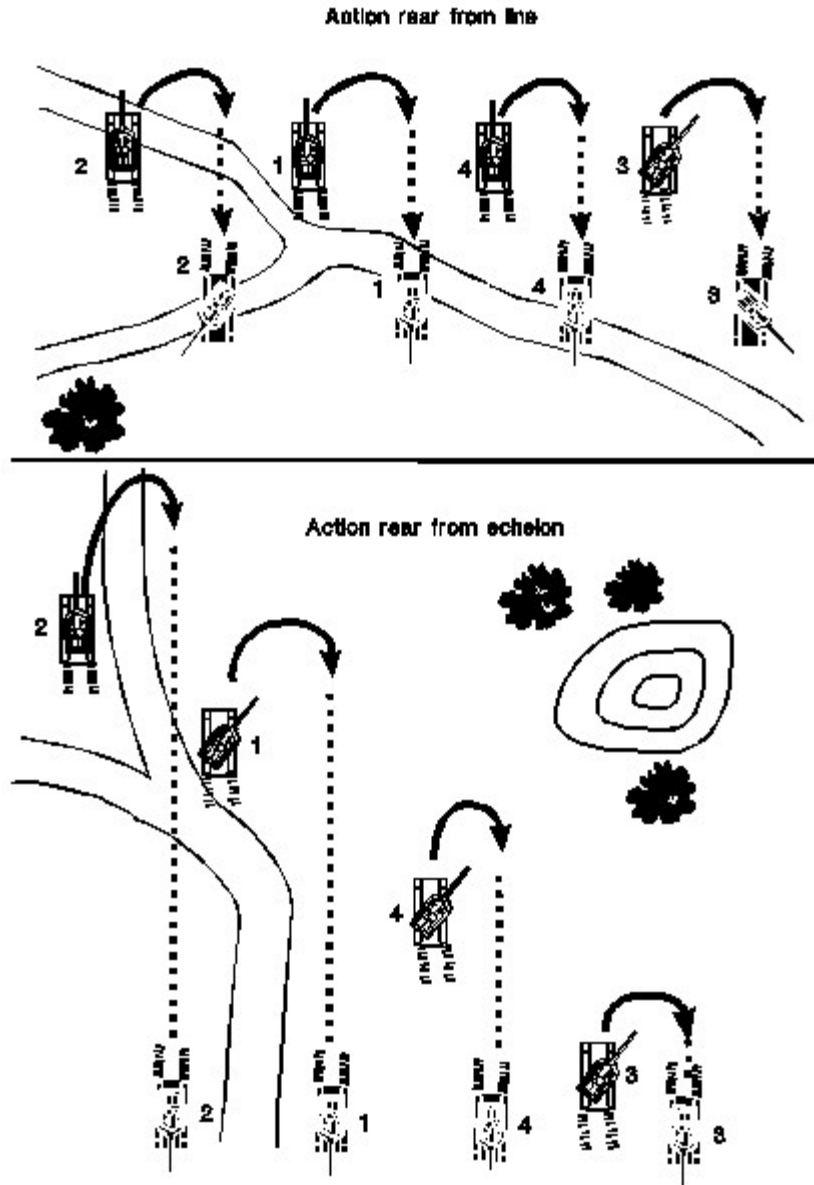


Figure 3-15A. Action drill without enemy contact.





**Figure 3-15B. Action drill without enemy contact (continued).**

**Action drill with enemy contact.** Following a contact report alerting the platoon that enemy contact involves antitank weapon systems, the platoon leader can direct an action drill to orient his platoon's frontal armor toward the antitank fire while moving to cover and concealment. If the platoon cannot reach a covered and concealed position or achieve weapon standoff, the platoon leader directs 36 through 3-38, illustrate examples of action drills in reaction to enemy contact.

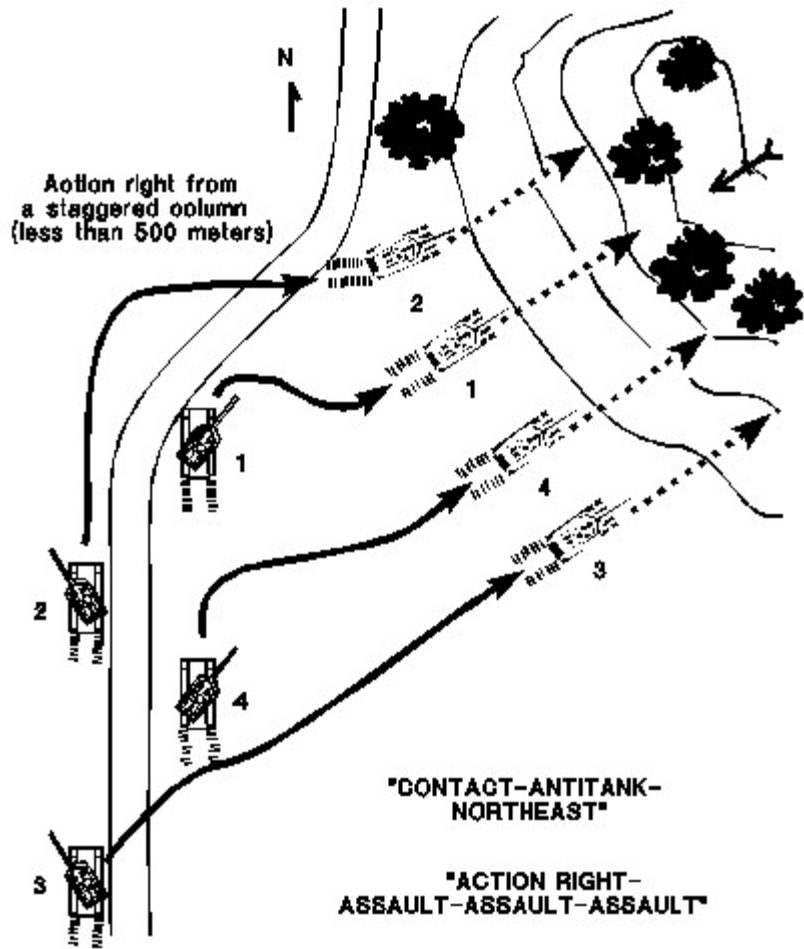


Figure 3-16A. Action drill with enemy contact.

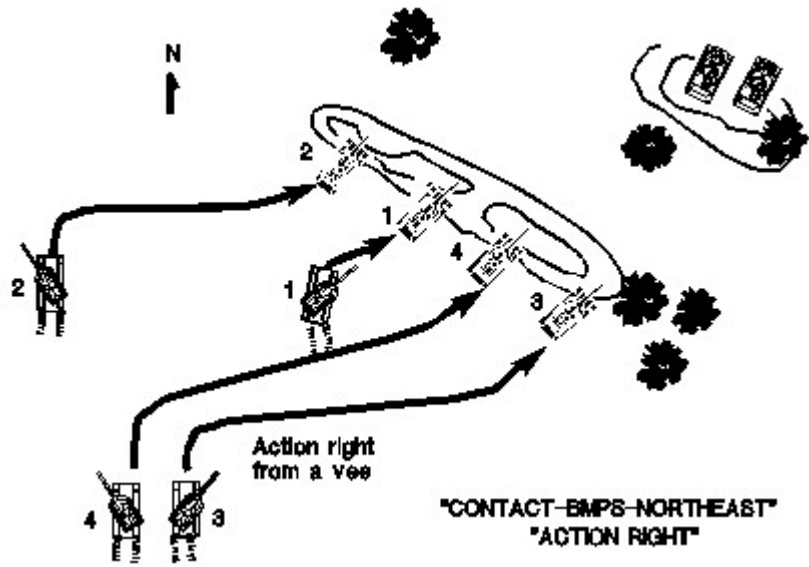


Figure 3-16B. Action drill with enemy contact (continued).

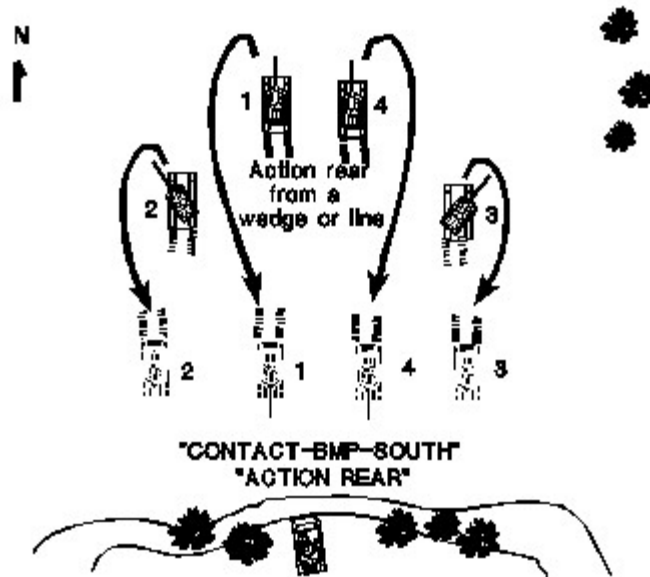


Figure 3-16C. Action drill with enemy contact (continued).

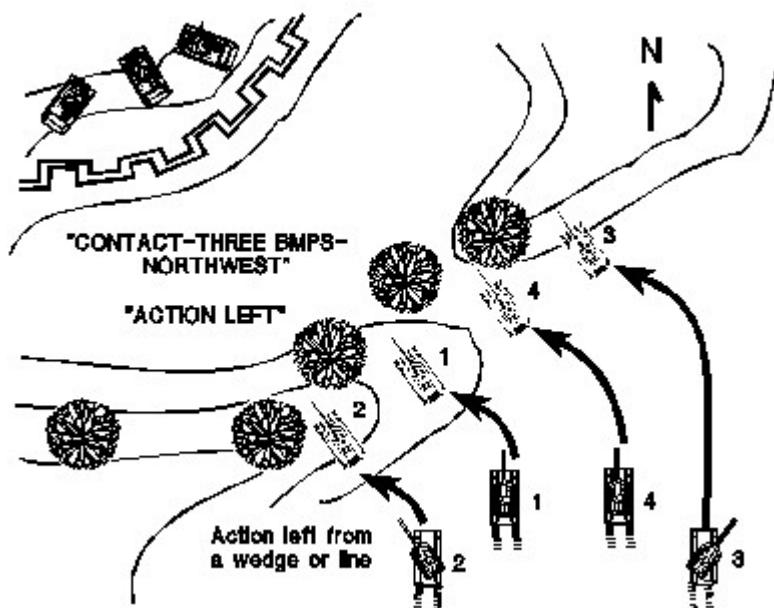


Figure 3-16D. Action drill with enemy contact (continued).

### React to Indirect Fire Drill

When the platoon receives unexpected indirect fire, it moves out of the impact area unless it is also engaged in direct fire contact or is directed to remain stationary. TCs place their hatches in the open protected position; other crewmen close their hatches. Crews also close ballistic doors (M1A2 crews stow the CITYV). They mask based on the automatic masking criteria established in the OPORD or if they suspect the use of chemical agents. The platoon leader sends a SPOTREP to the commander.

If the platoon is moving when it receives suppressive artillery fire, it executes an action drill to avoid the impact area or continues to move to clear the impact area and continue the mission (see Figure 3-17). If it is stationary, the platoon should attempt to clear the impact area. (**NOTE:** Several factors, such as the commander's orders or the enemy situation, may prevent the platoon from moving during direct fire engagements or defensive operations. For example, the commander may require the platoon to occupy hide or turret-down positions while continuing the mission. In such a case, the platoon leader must request permission from the commander before clearing the impact area.) Once the platoon clears the artillery impact area, individual crews place their hatches in the appropriate position, open ballistic doors (M1A2 crews turn on the CITV), check antennas, and return to positions or continue the mission.

The commander should address the platoon's reaction to anticipated indirect fires in the actions on contact subparagraph of the OPORD. When the platoon receives anticipated indirect fires, it reacts according to the commander's guidance, which it should already have analyzed and rehearsed. If the platoon needs to execute a course of action different from that directed by the commander, the platoon leader should request permission from the commander before executing the alternate action.

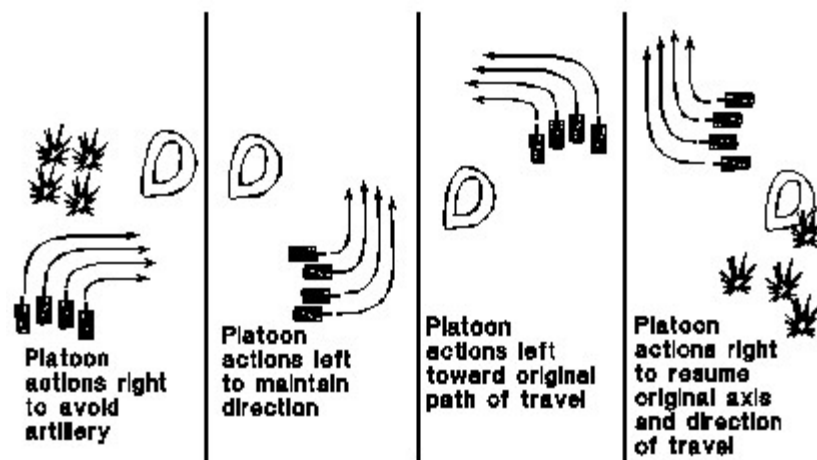


Figure 3-17. React to indirect fire drill.

### React to Air Attack Drill

When the platoon observes high-performance aircraft, helicopters, or unmanned aerial vehicles (UAV) that could influence its mission, it initially takes passive air defense measures unless the situation requires immediate active measures. In a passive air defense, the platoon takes actions (such as dispersing or stopping) to avoid detection altogether and/or to minimize the aircraft's target acquisition capability. The platoon also prepares for active air defense measures. (**NOTE:** When the platoon is operating as part of a company team or troop, tank crews must be familiar with required actions in the company-level battle drill.) Passive air defense involves three steps:

Step 1. Alert the platoon with a contact report.

Step 2. Deploy or take the appropriate actions. If the platoon is not in the direct path of an attacking aircraft, the platoon leader orders tanks to seek cover and concealment and halt with at least a 100-meter interval between vehicles; the platoon also may be ordered to continue moving as part of the company.

Step 3. Prepare to engage. TCs and loaders get ready to engage the aircraft with machine gun or main gun fire on order of the platoon leader.

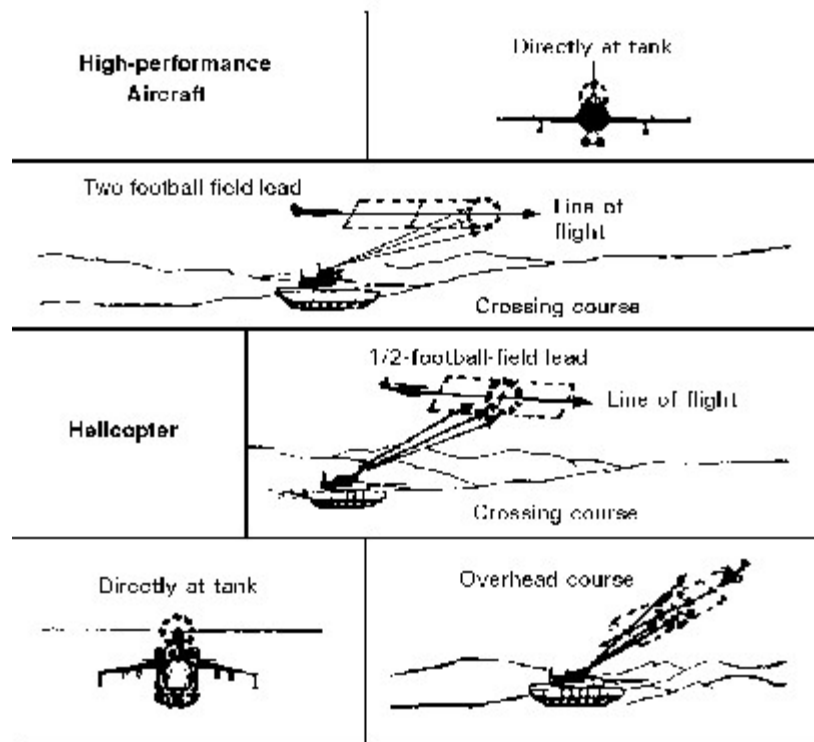
If the platoon leader determines that the platoon is in the direct path of an attacking aircraft, he initiates the active react to air attack drill, which entails these actions:

Step 1. The platoon initiates fire. The primary intent is to force aircraft to take self-defense measures that alter their attack profile and reduce their effectiveness. The platoon leader may use a burst of tracers to designate an aim point for platoon machine gun antiaircraft fires (see Figure 3-18). Volume is the key to effectiveness of these fires; tanks throw up a "wall of steel" through which aircraft must fly. The main gun is effective against hovering attack helicopters. The platoon leader may also direct some vehicles to engage high-performance aircraft with MPAT main gun rounds.

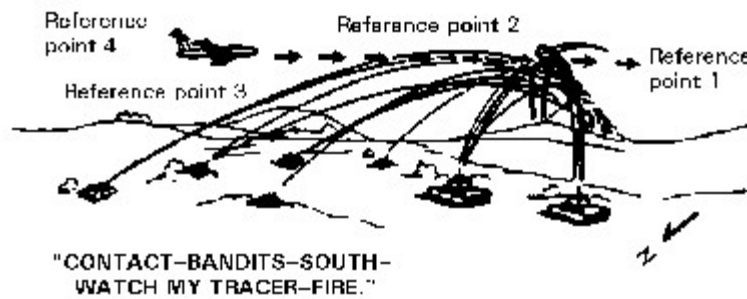
Step 2. Tanks create a nonlinear target by moving as fast as possible at a 45-degree angle away from the path of flight and toward attacking aircraft (see Figure 3-19, page 3-42). The platoon maintains an interval of at least 100 meters between tanks, forcing aircraft to make several passes to engage the entire platoon.

Step 3. Tanks move quickly to covered and concealed positions and freeze their movement for at least 60 seconds after the last flight of aircraft has passed.

Step 4. The platoon leader sends a SPOTREP to update the commander.



**"Wall of Steel" Technique**



**Figure 3-18. Machine gun aim points.**



Exposed vehicles move at an oblique angle to the direction of aircraft flight toward the nearest cover or concealment

**Figure 3-19. Evading enemy aircraft.**

### **React to a Nuclear Attack Drill**

When the platoon observes a brilliant flash of light and a mushroom-shaped cloud, crewmembers must act quickly to minimize the effects of a nuclear detonation. This drill involves four steps:

Step 1. Take immediate protective actions, including the following:

If mounted, button up and close the breech and ballistic doors (M1A2 crews stow the CITV). If time permits, position the vehicle behind a protective terrain feature and turn off the master power until the effects of the blast have passed.

Dismounted crewmen drop to the ground and cover exposed skin until blast effects have passed.

Step 2. Implement SOPs and accomplish related actions in the following areas:

Reestablish communications.  
Prepare and forward an NBC-1 report.  
Implement continuous monitoring.  
Submit a SITREP to the commander.

Step 3. Reorganize the platoon:

Evacuate casualties and fatalities.  
Redistribute personnel as needed.  
Conduct essential maintenance.

Step 4. Continue the mission.

## **React to a Chemical/Biological Attack Drill**

The platoon initiates this drill during an operation whenever an automatic masking event occurs, the chemical agent alarm sounds, M8 detection paper indicates the presence of chemical agents, or a soldier suspects the presence of chemical or biological agents. (See Appendix D for more information on NBC operations.) This drill involves four steps:

Step 1. Crewmen recognize and react to the hazard:

- Put on protective mask (and hood) within 15 seconds.
- Alert remainder of the platoon and company.
- Within 8 minutes, assume MOPP 4 (refer to the discussion in Appendix D), then button up and/or activate the tank overpressurization system.

Step 2. Implement SOPs in these areas:

- Administer self-aid and buddy-aid to platoon members with symptoms of chemical/biological agent poisoning (see Appendix D).
- Ensure individuals decontaminate their skin.
- Conduct operator's spraydown and decontamination of equipment as necessary.
- Initiate continuous monitoring with M256 detection kits; submit NBC-1 and follow-up reports as needed.

Step 3. Continue the mission.

Step 4. Monitor for chemical/biological agents; as the situation warrants, initiate actions to reduce MOPP levels and discontinue agent monitoring. (See Appendix D for additional information.)

**NOTE:** If the M256 detection kit records a negative reading inside an overpressurized M1A2 tank, the crew can initiate unmasking procedures.

## **Section VI. EXECUTION - PLATOON TACTICAL TASKS**

The commander may direct the platoon to execute the collective tactical tasks described in this section as part of the company's planned scheme of maneuver. He will cover employment of the tasks in the company OPORD. In addition, the platoon can use the tactical tasks as courses of action when it executes actions on contact (refer to the discussion in Section V).

### **Destroy an inferior force**

To maintain the tempo of an attack, the commander may order the platoon to destroy an inferior force, based either on his original plan or on recommendation of the platoon leader. The platoon leader usually employs maneuver techniques (fire and tactical movement) in executing this task or course of action. When the platoon is in contact with the enemy, he

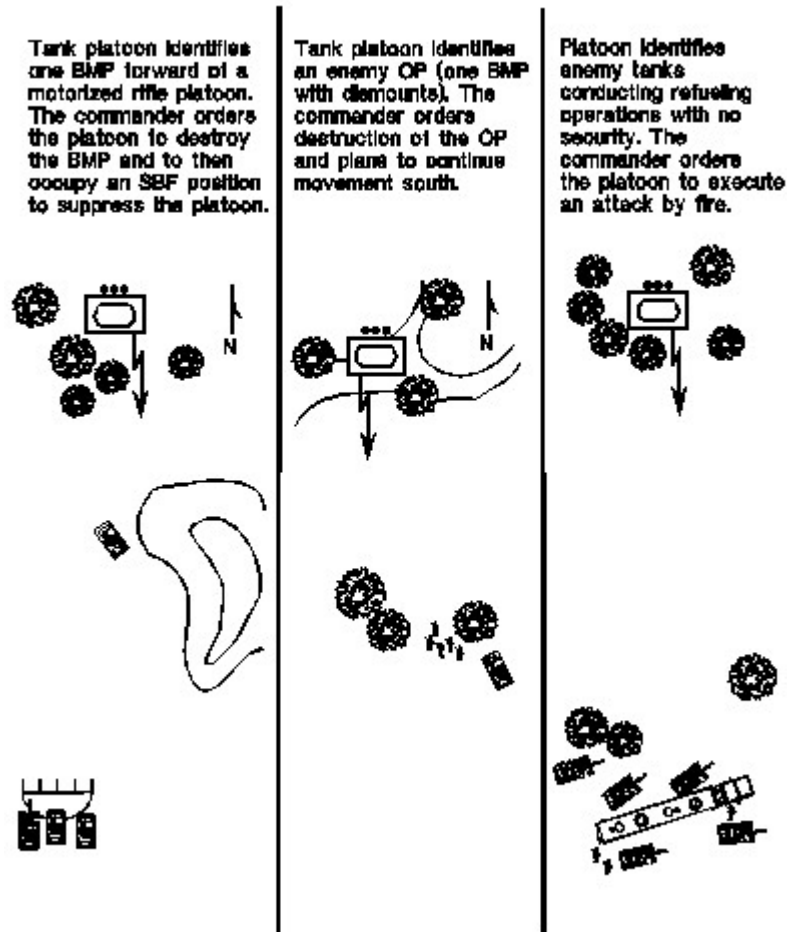


designates one section to overwatch or support by fire to suppress and/or destroy the enemy while the other section moves.

The moving element uses appropriate movement techniques as well as covered and concealed routes to move to a position of advantage over the enemy. This position may offer dominating terrain that allows the platoon to attack enemy positions by direct fire, or it may provide covered routes that enable the section to close with and assault the enemy.

After the platoon leader designates the route to the next possible overwatch position, the overwatch leader identifies graphic control measures and assigns responsibility for suppression of identified enemy positions. Cross-talk among sections and vehicles is important in ensuring mutual support while the overwatch is providing supporting fires during the other section's movement to the position of advantage.

After successfully destroying the inferior enemy force, the platoon positions itself where it can most effectively prepare for subsequent actions. Figure 3-20 illustrates three potential situations in which a platoon is ordered to destroy an inferior force.



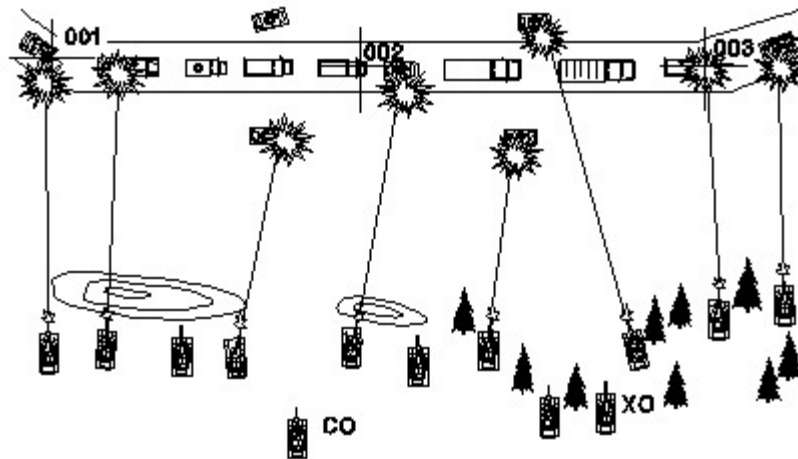
**Figure 3-20. Scenarios for destruction of an inferior enemy force. Attack by fire**

The commander may order the platoon to execute this task, either as specified in his original plan or on recommendation of the platoon leader. The purpose is to destroy the enemy using long-range fires from dominating terrain or using standoff of the main gun. The platoon can use an attack by fire to destroy inferior forces when the platoon leader does not desire to close with the enemy or when the platoon is part of a company-level effort. In addition, the platoon may occupy an attack by fire position as part of a company-level hasty defense with the goal of destroying a superior force.

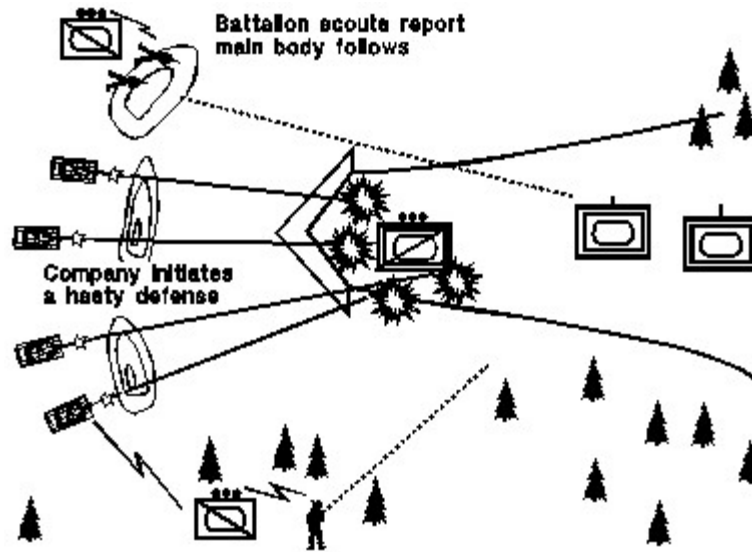
In executing this task, the platoon uses tactical movement to move to a position that allows it to employ weapon standoff or that offers cover for hull-down firing positions. It also must be ready to move to alternate firing positions for protection from the effects of enemy direct and indirect fires.

As time permits, the platoon leader designates TRPs and as signs sectors of fire and tentative firing positions for individual tanks. He issues a platoon fire command specifying the method of fire, firing pattern, and rate of fire the platoon must sustain to accomplish the task in support of the company.

A successful attack by fire destroys the enemy force. Figures 3-21A and 3-21B illustrate attack by fire situations.



**Figure 3-21A. Company employs attack by fire against convoy.**



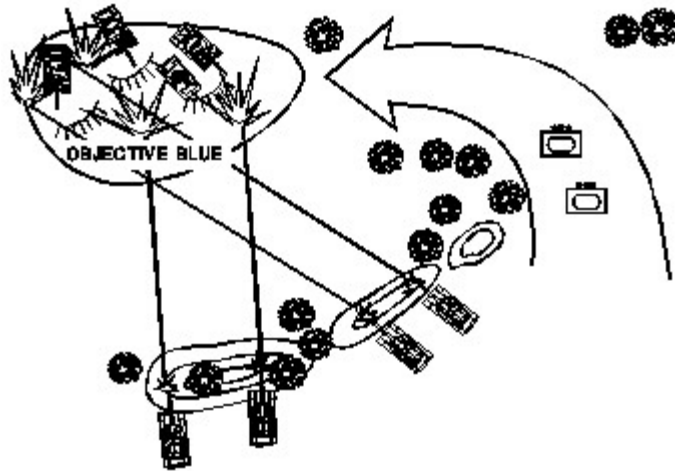
**Figure 3-21B. Platoon uses attack by fire against enemy reconnaissance platoon as part of a hasty defense.**

### **Overwatch/support by fire**

Either as specified in his original plan or on recommendation of the platoon leader, the commander may order the platoon to provide overwatch or support by fire during the movement of a friendly force. The purpose is to suppress the enemy using long-range direct and indirect fires from a dominating piece of terrain or using the standoff of the main gun. This support sets the conditions that allow moving (supported) friendly elements to engage and destroy the enemy.

The techniques involved in occupying an overwatch or support by fire position and in focusing and controlling fires are similar to those for an attack by fire. Some specific considerations exist, however. As noted, the overwatch/support by fire task is always tied directly to the movement and/or tactical execution of other friendly forces. In executing overwatch or support by fire, the platoon must maintain a high level of situational awareness relative to the supported force so it can lift and shift direct and indirect fires as required to prevent fratricide. Throughout this type of operation, the supporting platoon maintains cross-talk with the moving force on the company net. In addition to reducing fratricide risk, cross-talk allows the platoon to provide early warning of enemy positions it has identified and to report battle damage inflicted on the enemy force.

A successful overwatch/support by fire operation suppresses the enemy, permitting the moving (supported) force to conduct tactical movement, breaching operations, or an assault. Figure 3-22 illustrates a support by fire situation in support of an assault.



**Figure 3-22. Platoon supports by fire to suppress an enemy element during a company assault.**

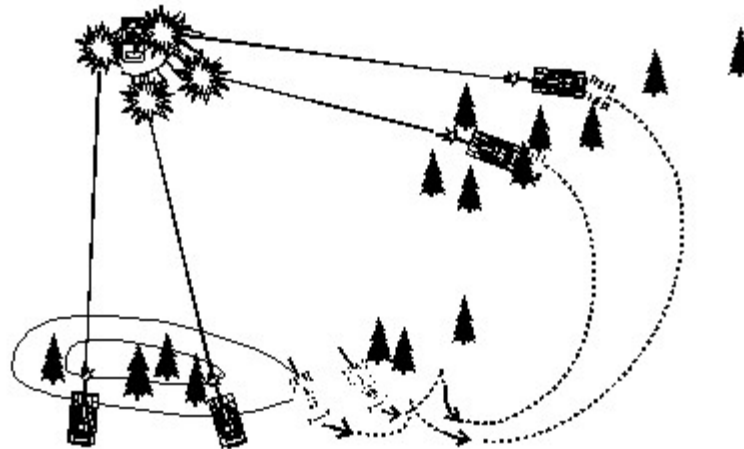
### Assault

The commander may direct the platoon to execute an assault, either on its own or as part of a larger assault force. The purpose of the assault is to seize key terrain or to close with and destroy the enemy while seizing an enemy-held position. Designation of the platoon as the assault force may be made as part of the commander's original plan or on recommendation of the platoon leader.

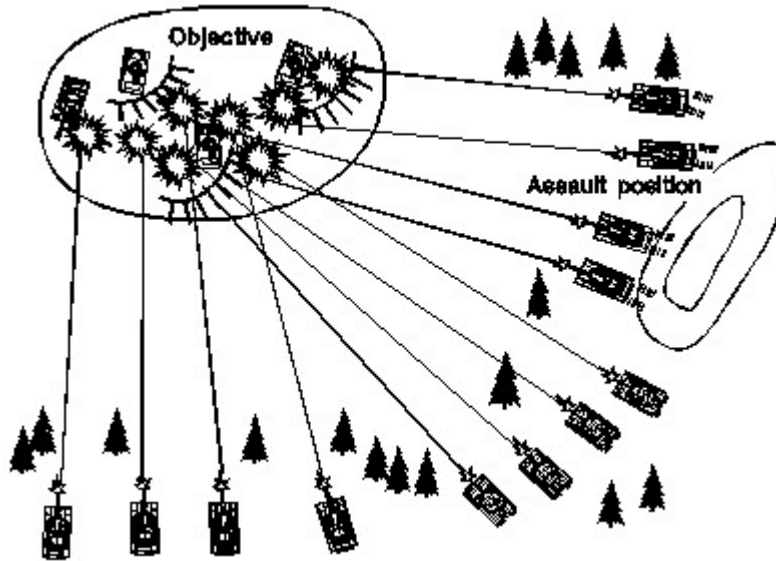
The platoon usually assaults the enemy while receiving supporting fires from an overwatch element. If supporting fire is not available, the platoon conducts tactical movement to a position of advantage over the enemy, then conducts the assault. A successful assault destroys the enemy elements or forces them to withdraw from the objective.

To prepare for the assault, the assault force occupies or moves through an assault position. This should be a predetermined covered and concealed position that provides weapon standoff from the enemy. The platoon leader receives updated enemy information from support by fire elements. He assigns targets or weapons orientations and confirms the axis and limits of advance for the assault. On order, the platoon assaults on line, moving and firing as quickly as possible to destroy the enemy and seize the objective. The assault must be extremely violent. If the platoon assaults buttoned up, machine gun fire from the support force or wingman tanks can provide close-in protection against dismounted enemy elements on the objective. If tanks are unbuttoned, the TCs and loaders use personal weapons, hand grenades, and machine guns to provide close-in protection.

Following a successful assault, the assault force occupies a defensible position, either on the objective or on the far side of it, and begins consolidation and reorganization procedures. Figures 3-23A and 3-23B (pages 3-49 and 3-50) illustrate two assault situations.



**Figure 3-23A. Tank section assaults an inferior force as another section supports by fire.**



**Figure 3-23B. Platoon executes an assault as two other platoons support by fire.**

### **Bypass**

As part of his original plan or on recommendation of the platoon leader, the commander may order the platoon to bypass the enemy to maintain the tempo of the attack. This course of action can be taken against either an inferior or superior force. The commander may designate one platoon to suppress the enemy, allowing the other platoons to use covered and concealed routes, weapon standoff, and obscuration to bypass known enemy locations. (**NOTE:** Units may have to execute contact drills while executing the bypass.)

Once clear of the enemy, the supporting platoon hands the enemy over to another force, breaks contact, and rejoins the company. If necessary, the

platoon leader can employ tactical movement to break contact with the enemy and continue the mission; he can also request supporting direct and indirect fires and smoke to suppress and obscure the enemy as the platoon safely breaks contact. See Figures 3-24A and 3-24B, pages 3-51 and 3-52, for an example of a bypass.

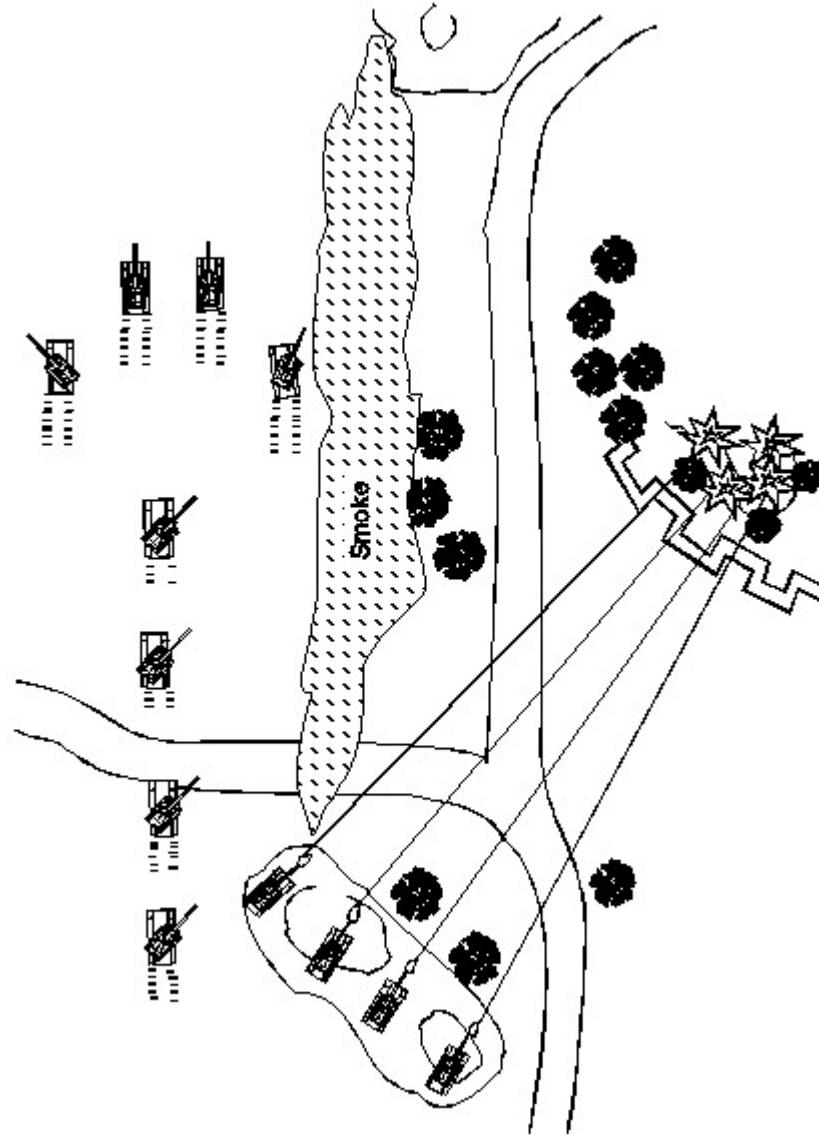
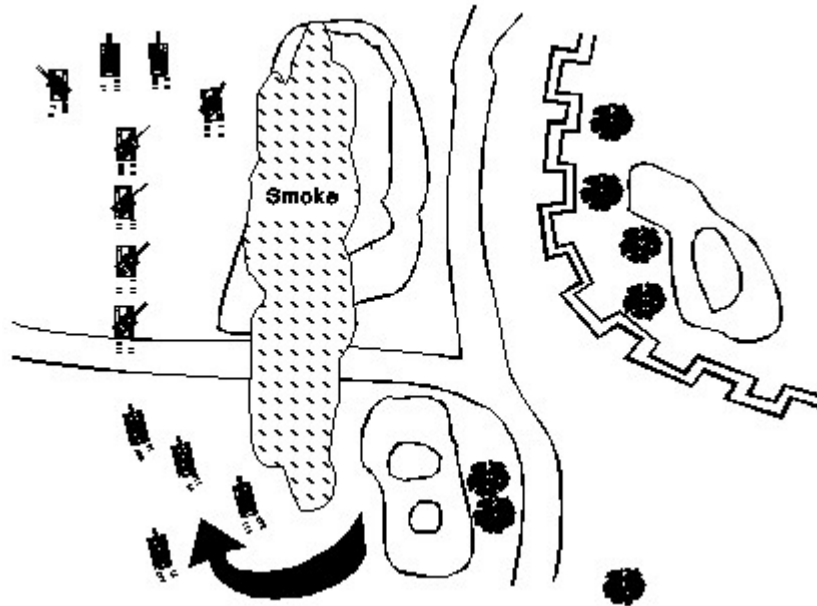


Figure 3-24A. Bypass.



**Figure 3-24B. Bypass (continued).**

### **Reconnaissance by fire**

Based on his original plan or a recommendation from the platoon leader, the commander may direct the platoon to execute reconnaissance by fire when enemy contact is expected or when contact has occurred but the enemy situation is vague. The platoon then conducts tactical movement, occupying successive overwatch positions until it makes contact with the enemy or reaches the objective.

At each overwatch position, the platoon leader may designate TRPs. He then either requests indirect fires or employs direct fires on likely enemy locations to cause the enemy force to return direct fire or to move, thus compromising its positions. He directs individual tanks or sections to fire their caliber .50 and/or coax machine guns into targeted areas. (**NOTE:** In some circumstances, main gun fire can also be used.)

Individual tanks and sections not designated to reconnoiter by fire observe the effects of the firing tanks and engage enemy forces as they are identified. Focus of the reconnaissance by fire is on the key terrain that dominates danger areas, on built-up areas that dominate the surrounding terrain, and on uncleared wooded areas. (**NOTE:** A disciplined enemy force may not return fire or move if it determines that the pattern or type of fires employed will be nonlethal. The platoon leader must analyze the situation and direct the use of appropriate fires on suspected positions. For example, he would use small arms fire against suspected dismounted elements but employ main guns to engage bunkers or other fortified positions.)

### **Hasty occupation of a platoon BP (hasty defense)**

The platoon may use this task if it is fixed or suppressed by enemy fire and

no longer has the ability to move forward or bypass. It may also set up a hasty defense when the enemy executes a hasty attack. The platoon maintains contact or fixes the enemy in place until additional combat elements arrive or until it is ordered to move. When the platoon must conduct a hasty defense, the commander has responsibility for continuing to develop the situation.

### **Hasty/in-stride breach**

When they expect to make contact with enemy obstacles, the commander and platoon leader must plan and rehearse actions at an obstacle, tailoring their preparations to templated locations for the expected obstacles. They must ensure the platoon knows how to accomplish early detection of both anticipated and unexpected obstacles and how to react instinctively when contact is made.

A critical consideration is that the tank platoon has only limited ability to deal independently with an obstacle or restriction. If it is equipped with mine plows or other breaching assets, the platoon can create track-width lanes through most wire, mine, and other reinforcing obstacles. The commander and platoon leader must keep in mind, however, that the platoon cannot internally accomplish all of the SOSR elements of the breach (**suppress** the enemy; **obscure** the breach; create the lane and **secure** the far side; **reduce** the obstacle). Refer to the discussion of breaching operations, including SOSR procedures, in Chapter 5.

When tanks encounter an unexpected obstacle, crewmembers must assume that the enemy is covering the obstacle with observation and fire. They must immediately seek cover and establish an overwatch to evaluate the situation. The overwatch tanks scan for evidence of enemy forces in and around the obstacle and on dominant terrain on the far side of the obstacle. They attempt to locate a bypass so the operation can continue without delay. If no bypass is found, the overwatch determines the dimensions of the obstacle and sends a report to the commander so he can designate a course of action. (**NOTE:** It is critical that the tank platoon initially remain under cover while evaluating the situation. The platoon must **NEVER** attempt to approach the obstacle area or breach the obstacle without first killing or obscuring enemy elements overwatching the obstacle.)

If he needs to develop the situation further, the commander ideally will use scouts or infantry to reconnoiter the obstacle, with the tanks continuing to provide overwatch. This usually requires him to move mounted or dismounted elements to the far side. If this reconnaissance locates a bypass route, the commander often will order the unit to execute a bypass as the preferred course of action. If a bypass is not possible, he may order a breaching operation, with the tanks either executing a hasty breach within their capabilities or supporting a deliberate breach.

## **Section VII. EXECUTION - CONSOLIDATION AND REORGANIZATION**



The platoon executes consolidation and reorganization on the objective to ensure that it is prepared to destroy an enemy counterattack or is prepared to resume the attack as soon as possible.

### **Consolidation**

Consolidation consists of actions taken to secure an objective and to defend against an enemy counterattack. The company commander designates platoon positions and weapons orientations. The platoon takes these steps:

- Eliminate remaining enemy resistance and secure enemy prisoners of war (EPW).

- Occupy positions on defensible terrain as designated in the OPORD or FRAGO. Tanks move to hull-down positions, and the platoon leader assigns sectors of fire. If the location designated in the OPORD/FRAGO is not defensible, the platoon leader notifies the commander and searches for terrain that is defensible and supports the commander's intent. The platoon leader informs the commander of the new location.

- Establish OPSEC and coordinate mutual support with adjacent platoons.

- 4 for details on hasty defense).

### **Reorganization**

Reorganization, the process of preparing for continued fighting, is normally accomplished by SOP. Responsibilities during reorganization include the following:

- TCs take these actions:

  - Reload machine guns and redistribute main gun ammunition to ready areas.

  - Move crewmen wounded in action (WIA) to a covered position and provide first aid.

  - Send a SITREP to the PSG reporting casualties and supply status of equipment, ammunition, and fuel.

  - Conduct essential maintenance.

- The PSG takes these actions:

  - Compile SITREPs from TCs and, as required by unit SOP, submit a consolidated report to the platoon leader or first sergeant (1SG).

  - Direct cross-leveling of supplies within the platoon.

  - Oversee evacuation of casualties.

  - Coordinate the movement of EPWs to the EPW collection point.

- The platoon leader takes these actions:

  - Forward a consolidated SITREP to the commander.

Redistribute personnel as necessary to maintain combat readiness.  
Oversee consolidation of soldiers killed in action (KIA).  
Reestablish communications with elements that are out of contact.

**NOTE:** SITREPs are sent using voice or digital format (or a combination). Refer to FKSM 17-15-1, FKSM 17-15-3, and unit SOPs for additional information.

## CHAPTER 4



## DEFENSIVE OPERATIONS

The immediate purpose of any defensive operation is to defeat an enemy attack. Military forces defend until they gain sufficient strength to attack. Additionally, defensive operations are undertaken to gain time, to hold key terrain, to preoccupy the enemy in one area so friendly forces can attack elsewhere, and to erode enemy resources at a rapid rate while reinforcing friendly operations.

## CONTENTS

SECTION I. Fundamentals of the Defense  
SECTION II. Planning  
SECTION III. Preparation  
SECTION IV. Execution

### Section I. FUNDAMENTALS OF THE DEFENSE

## Characteristics of the Defense

FM 100-5 describes several characteristics of an effective defense: preparation; security; disruption, mass, and concentration; and flexibility. To optimize these characteristics in the defense, the tank platoon leader must consider the following factors.

### Preparation

The critical element affecting preparation is time management, beginning with receipt of the WO, OPORD, or FRAGO. Effective use of the available time allows the platoon leader to conduct a thorough reconnaissance of engagement areas, BPs, displacement routes, and the axis for possible counterattacks. Section III of this chapter describes preparation at the platoon level in detail.

## **Security**

The OPSEC measures discussed in Appendix C will assist the platoon leader in maintaining security during the planning, preparation, and execution of the defense. The platoon leader must integrate his security plan with that of the company. He enhances the platoon's early warning capability by identifying potential mounted and dismounted avenues of approach and then positioning early warning devices and OPs to cover these avenues.

## **Disruption, Mass, and Concentration**

Augmenting the platoon's direct fires with reinforcing obstacles and indirect fires is a key step in disrupting enemy operations. Platoons achieve mass and concentration by maximizing the number of tanks that can fire into an engagement area or that can move from primary positions to alternate and supplementary positions to concentrate fires on the enemy.

## **Flexibility**

The platoon leader contributes to the flexibility of company operations by developing a thorough understanding of the company plan, including on-order and be-prepared missions. He must be alert to any possible contingencies that have not been addressed by the commander. During the preparation phase of the defense, the platoon increases flexibility by conducting thorough reconnaissance and mounted rehearsals of all possible plans. A crucial indicator of the platoon's flexibility is its ability to move quickly, and under all battlefield conditions, between primary, alternate, and supplementary fighting positions as well as subsequent and supplementary BPs.

## **Defensive patterns**

The two patterns described in FM 100-5 are mobile and area defenses. A mobile defense is executed to destroy the attacking force by permitting the enemy to advance into a position that exposes him to counterattack by a mobile reserve. The focus of area defenses is on retention of terrain; defending units engage the enemy from an interlocking series of positions and destroy him, largely by direct fires. In support of mobile and area defensive operations, a company team may be tasked to execute one or more of the following missions and tasks: defend BPs, defend in sector, defend a strongpoint, counterattack, screen, delay, execute a reserve mission, and withdraw.

# Role of the Tank Platoon

## Section II. PLANNING

The planning phase of a defensive operation is a continuous process that begins when the platoon leader receives the higher order (WO, FRAGO, or OPORD). It ends when the platoon leader issues his own OPORD or FRAGO. Planning may continue into the preparation phase as the platoon gains more information through the higher headquarters plan and from further reconnaissance and rehearsals.

Ideally, the platoon leader takes part in two reconnaissance operations during the planning phase. He is normally part of the commander's reconnaissance, along with the XO, other platoon leaders, the FIST, and the 1SG. The platoon leader's own reconnaissance includes his TCs and PSG. To save time, the commander and platoon leader attempt to issue their OPORDs or, as a minimum, a detailed WO during the respective ground reconnaissance operations.

During the commander's reconnaissance, the platoon leader must identify, record, and mark the tentative TRPs, decision points, fighting positions, and routes he thinks the platoon will use in executing the defense. It is important for him to have sufficient day and night marking materials such as engineer stakes and tape, chem lights, or thermal paper. He records the eight-digit grid coordinates of each position; this will allow him to provide precise locations that the platoon can use in navigation or orientation. Ideally, the platoon leader can record positions electronically using a hand-held GPS or the POSNAV system; if neither is available, he must rely on his map-reading skills to manually identify and record accurate position locations.

As planning progresses, it is important that the platoon leader make a careful evaluation of the following considerations based on the BOSSs.

## Intelligence

Security decisions are based on enemy capabilities. Platoons use OPs to provide early warning of the enemy's actions; their REDCON status and other OPSEC preparations then enable them to respond in a timely manner. See Appendix C for more information on OPSEC measures.

OPSEC is especially critical during the platoon leader's ground reconnaissance. The platoon leader ensures that he provides security for the reconnaissance based on the commander's guidance. Because it is probable that enemy elements are already in the area, he must ensure that platoon reconnaissance elements have the capability to protect themselves effectively.

As he conducts the reconnaissance, the platoon leader orients his map and references graphic control measures to the terrain. He conducts a terrain analysis, using the results in conjunction with his knowledge of possible enemy courses of action to identify key terrain that may define potential enemy objectives. He identifies mounted and

dismounted avenues of approach and determines the probable formations the enemy will use when occupying support by fire positions or when assaulting the platoon's position. Based on his analysis and available fields of observation and fire, the platoon leader confirms vehicle positions that will allow the platoon to mass fires into the company engagement area.

The platoon leader should complete his reconnaissance by conducting initial coordination with adjacent platoons to establish mutual support and to cover dead space between the platoons. At the conclusion of the reconnaissance, he may leave an OP to report enemy activity in the area of operations.

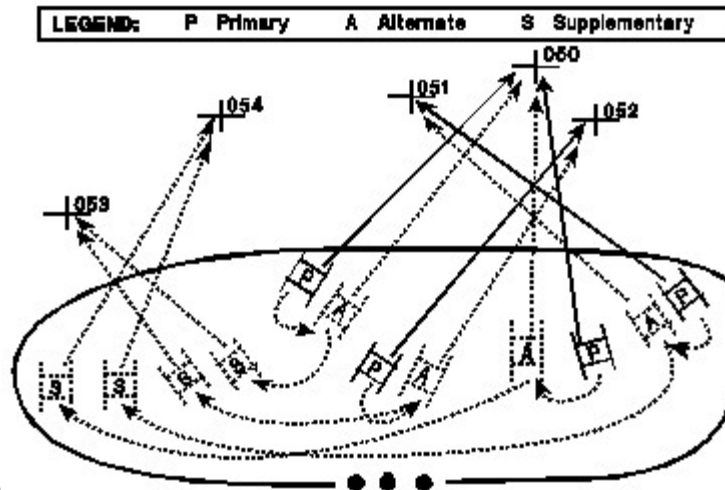
## **Command and CONTROL & Maneuver**

The platoon leader must understand the company plan and decision points; he develops his plan based on these factors as well as the commander's intent. The commander normally determines operational considerations such as OPSEC, occupation of firing positions, initiation of direct fires, primary and supplementary platoon sectors of fire, and disengagement criteria; however, he may allow the platoon leader to make decisions covering some or all of these areas.

The primary concern in selecting fighting positions is the platoon's ability to concentrate and mass lethal fires into its sectors of fire. Whenever possible, primary and alternate fighting positions should allow engagement of the enemy in the flank and from two directions. Supplementary fighting positions should always be planned to allow the platoon to defend against enemy forces that penetrate adjacent platoon positions or that move along additional avenues of approach for which the commander has assumed risk. Dispersion among fighting positions reduces vulnerability of platoon vehicles to enemy fires; however, dispersion increases the demands for local security in the area between vehicles.

Ideally, the platoon will occupy hull-down firing positions as the enemy crosses the direct fire trigger line. The trigger line should optimize weapon standoff, while the firing positions and the designated firing pattern should be selected to create the opportunity for flank engagements.

**NOTE:**



360-360

Figure 4-1. Fighting positions.

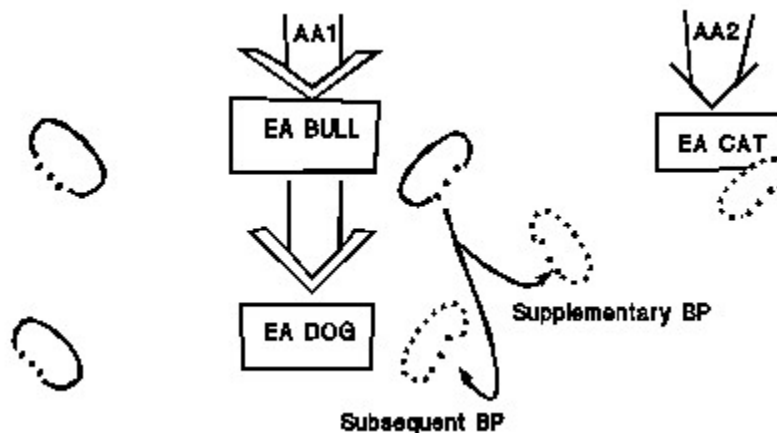
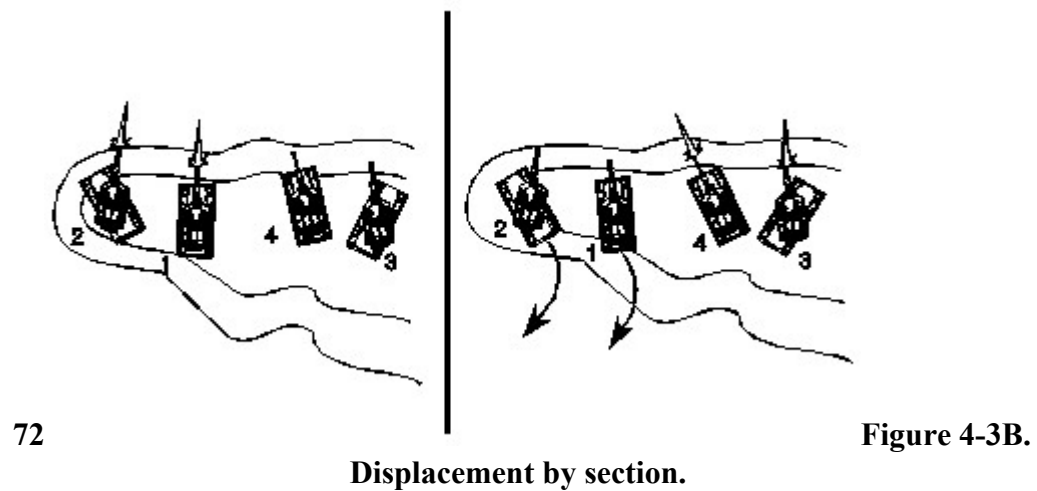
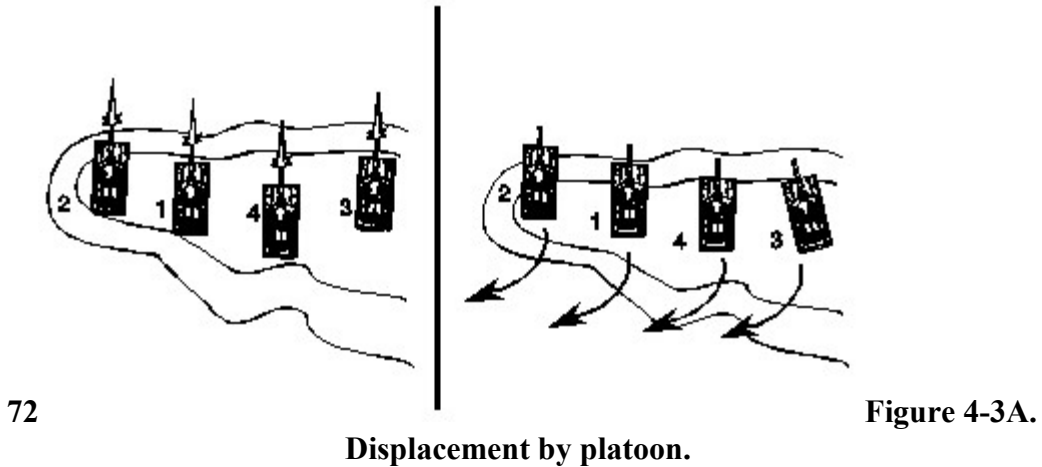


Figure 4-2. Battle positions.

Disengagement criteria and the resulting disengagement plan should identify a break point and provide for internal overwatch if it is not provided by another platoon (see Figures 4-3A and 4-3B). The plan should designate covered routes to alternate, supplementary, and subsequent fighting positions and BPs.

As the planning phase progresses, individual TCs, under the direction of the PSG, should begin executing priorities of work to prepare their vehicles and soldiers based on guidance contained in the platoon WO. In addition, crews may conduct rehearsals of standard actions, such as berm drills and ammunition transfer.



## Fire Support

The platoon leader posts targets on his overlays (in both traditional and digital format). Although most fire support planning is done by the company FIST, the platoon leader can, if necessary, provide the FIST with nominations for additional targets for inclusion in the battalion fire support plan. As these targets are approved, he plots them on his overlays. If a target is disapproved, the platoon leader notes its grid coordinates so he can, if needed, submit a speedy call for fire using the grid method. See Chapter 6 for methods of transmitting calls for fire.

The platoon leader should plan and request artillery targets on potential avenues of approach, at choke points along the avenues of approach, at possible enemy support by fire positions, at obstacles, and in dead space within the platoon's battle space. He should also be prepared to request a mix of smoke and DPICM rounds in front of his BP to break an enemy assault or behind his BP to help the platoon disengage from the enemy.

Each artillery target should have a decision point overwatched by at least a crew or section. The decision point triggers the call for fire on a target to ensure that the impact of the rounds coincides with the enemy's arrival. The platoon's laser range finders or target-

designation capabilities (on digitally equipped tanks) enhance its effectiveness in triggering artillery fires using decision points (see FKSM 17-15-1 for additional information). The location of the decision point is based on the enemy's expected rate of advance over the terrain, the time of flight of the rounds, and the priority of fires. The company FIST should assist in determining all decision points.

The platoon leader should plan and coordinate mortar targets on dismounted avenues of approach. In addition, because mortar smoke is generally more responsive than smoke delivered by field artillery (FA), he may be able to gain a tactical advantage by employing mortar support in certain situations. (See Appendix D for information on smoke operations.)

## Mobility and survivability

The platoon leader may be responsible for supervising engineer efforts. He should incorporate plans for linkup, supervision, and handoff of engineer assets into his timeline.

The platoon leader's key considerations in countermobility planning are a thorough understanding of the commander's intent for each planned obstacle and knowledge of the time and personnel he must allocate to supervise or assist emplacement of the obstacle. He must keep in mind that both the platoon and the company have only limited ability to transport and emplace obstacles. This means that in most situations the platoon will have to depend on the task force for obstacle planning and transport and on engineers for emplacement.

The commander's intent will guide the emplacement of obstacles based on the following principles and characteristics:

- Obstacles are integrated with and reinforce the scheme of maneuver and the direct fire plan.

- They are integrated with existing obstacles.

- They are employed in depth and positioned where they will surprise enemy forces.

- They should be covered by direct and indirect fires at all times.

In general, obstacles are used to disrupt, turn, fix, and block the enemy based on the factors of METT-T. Figure 4-4, page 4-10, illustrates considerations for obstacle employment in relation to platoon BPs. If the commander does not specify an intent for obstacles, the platoon leader should analyze the situation and plan hasty or engineer-emplaced obstacles to meet these purposes:

- To block the final assault of an enemy force to the front of the platoon (the circled number "1" in Figure 4-4).

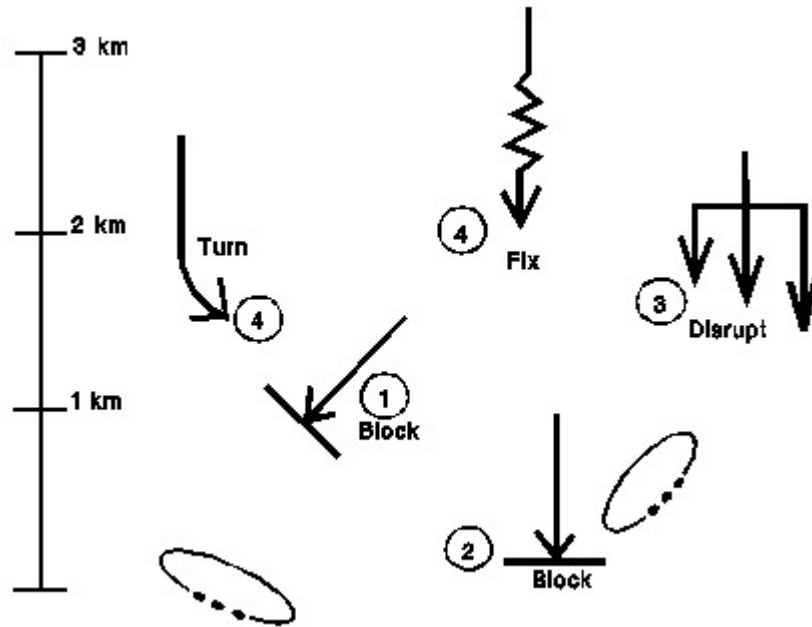
- To block the seams between vehicles or between adjacent platoons (the circled "2").

- To disrupt enemy forces that are assaulting on the flanks of the platoon (the circled "3").

- To shape the engagement area by forcing enemy elements to turn, slow

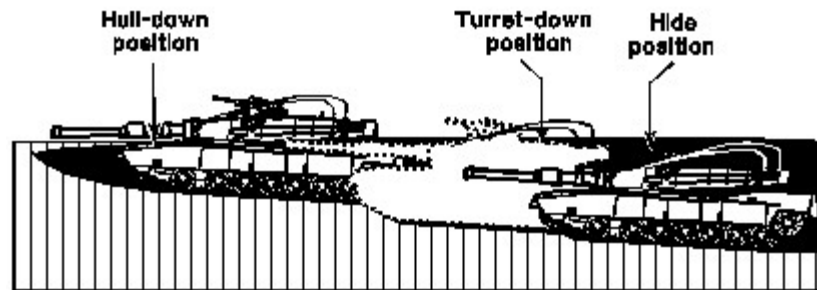


down, stop, or flank themselves at known ranges in the engagement area (the circled "4").



**Figure 4-4. Considerations for obstacle employment.**

The platoon leader must plan the priority of survivability efforts. His plan should specify the sequence (first through fourth) in which his tanks will receive digging assets. When designating priorities, he considers the survivability of unimproved positions and the relative importance of each firing position within the BP. The engineer platoon leader, section leader, or dozer operator can estimate how much time it will take to improve firing positions. These estimates will range from 45 minutes to 2 hours depending on soil and light conditions and the type and amount of engineer equipment available. Figure 4-5 illustrates dug-in positions and lists considerations for their construction and use.



- Berms attract attention. Dig down, not up.
- Do not put spoil to the front, sides, or rear of the firing position. Reduce spoil so that it blends into existing terrain.
- Tie down all antennas and keep reflective surfaces covered.
- Make sure the firing position has a covered exit route and a covered route to the next firing position.
- Construct overhead cover and add camouflage to create a hide position if time and materials are available.

240-240

Figure

4-5. Dug-in firing positions.

## Air defense artillery

See Chapter 6 for a discussion of ADA planning and employment.

## COMBAT SERVICE SUPPORT

The platoon leader conducts resupply operations to replenish basic loads in accordance with the company plan. Ammunition may be pre-positioned on the battlefield to facilitate resupply once the battle begins. The platoon leader determines prestock requirements based on the commander's intent and scheme of maneuver. He discusses prestock requests with the commander, identifying resupply locations, the types (usually ammunition) and amounts of supplies involved, the time required to conduct resupply, and any necessary security considerations.

### Section III. PREPARATION

Preparation of a BP begins after the platoon leader has issued his order and ends at the "defend not later than" time specified in the OPORD. (Some preparation activities may occur while the platoon leader is preparing his order or after the "defend NLT" time.) The platoon leader designates these preparations as priorities of work and identifies them in the platoon WO or OPORD. He must weigh competing demands of security, firing position and obstacle preparation, rehearsals, and coordination against the amount of time available for the preparation; this requirement places a premium on effective troop-leading procedures and time management during the preparation process.

The commander may designate the level of preparation for each BP. There are three

levels, listed here in descending order of thoroughness and time required:

Occupy. This is complete preparation of the position from which the platoon will initially defend. The position is fully reconnoitered, prepared, and occupied prior to the "defend NLT" time in the OPORD.

Prepare. This level includes the steps conducted during the planning and preparation phases for the deliberate occupation of a BP.

Reconnoiter. This level of preparation consists of the steps conducted during the ground reconnaissance of the planning phase.

The following discussion of the preparation phase is based on the organization of BOSs.

## **Intelligence**

OPSEC is critical during defensive preparations. The platoon should adhere to the procedures outlined in Appendix C to limit the effectiveness of enemy reconnaissance efforts.

Intelligence is constantly updated by higher headquarters as the battlefield situation develops, such as when the enemy fights through a screening or covering force. The platoon leader keeps the platoon informed with periodic intelligence updates. The updated information may force him to reevaluate and adjust his timeline to ensure preparations are as complete as possible. For example, the platoon leader may determine that engineer assets only have time to dig hull-down firing positions rather than turret-down and hide positions; in another situation, he may direct the engineers to prepare fighting positions for only one section because the other section has access to terrain that provides excellent natural hull-down firing positions.

During the preparation phase, the platoon leader may conduct reconnaissance of subsequent or supplementary BPs. This simultaneous planning of subsequent positions during the preparation of initial positions is a critical component in effective time management.

## **COMMAND and CONTROL & MANEUVER**

Based on the amount of time available and the results of the commander's reconnaissance with the platoon leader, tank platoons occupy a BP by executing either a hasty occupation or a deliberate occupation.

### **Hasty Occupation**

Tank platoons conduct a hasty occupation under a variety of circumstances. During a movement to contact, the platoon may prepare to destroy a moving enemy force by

conducting a hasty occupation of BPs or attack by fire positions in defensible terrain. During defensive operations, hasty occupation may take place during counterattack missions, after disengagement and movement to subsequent or supplementary BPs, or in response to FRAGOs reflecting a change of mission.

A hasty occupation usually occurs in response to a prearranged signal or a FRAGO. Often, only a minimum of planning time and information is available prior to execution, although in some situations, such as after disengagement, the platoon may occupy prepared positions it has previously reconnoitered. **As a minimum, the platoon leader must have the following information when he orders a hasty occupation of a BP:**

Where the commander wants to kill the enemy. The commander designates company TRPs that define the company engagement area and platoon sectors of fire or that identify locations where the platoon will mass its fires.

The tentative location of the BP.

**The platoon leader passes this information to the platoon.** He may supplement it with tentative section or vehicle fighting positions within the BP and platoon TRPs defining section sectors of fire, or he can elect to use the company TRP alone to mass platoon fires to the left and to the right of the TRP. Depending on the situation, the platoon leader issues the information in person, over the radio, or by digital overlay (if available).

**The platoon leader then directs the platoon to approach the position from the flank or rear.** Based on terrain factors, the platoon assumes a modified line formation facing the center of the engagement area. Vehicle dispersion is generally 100 to 250 meters between tanks, again based on engagement area and terrain considerations. TCs automatically move to turret-down positions; they execute a short halt and overwatch the engagement area.

**The platoon leader continues to develop the situation.** He identifies additional TRPs defining the company engagement area and/or platoon or section sectors of fire; he also designates tentative vehicle positions (as necessary), routes into and out of the BP, and the location of subsequent BPs. **As time permits, the platoon leader establishes the following fire control measures:** the trigger line and engagement criteria; the fire pattern to be used; and disengagement criteria and the disengagement plan.

The platoon is now ready to move to hull-down firing positions to engage the enemy.

**The platoon leader reports "ESTABLISHED" to the company commander.** If the enemy has not reached the trigger line and time is available, the platoon leader initiates the steps necessary for a deliberate occupation of the BP.

## **Deliberate Occupation**

The tank platoon can conduct deliberate occupation of a BP when all of the following conditions exist: time is available, the enemy is not expected or has not been located within direct fire range, and a friendly element is forward of the BP with the mission of providing security for the occupying force.

The platoon begins by occupying a hide position behind the BP. It assumes a formation

that will provide 360-degree security based on considerations of METT-T and OAK-OC. TCs move to the platoon leader's vehicle and prepare to reconnoiter the position. The platoon leader briefs his gunner on actions to take if the reconnaissance group does not return by a specified time or if contact occurs.

The platoon leader, TCs, and a security element (usually the loaders from the wingman tanks) dismount and move to the BP. If possible, platoon vehicles provide overwatch for the reconnaissance group. Otherwise, the platoon leader positions dismounted OPs as necessary. The reconnaissance group can then move mounted or dismounted around the BP and engagement area.

**NOTE:** AGS-equipped platoons must use gunners to man dismounted OPs. A better option, when available, is to use dismounted infantry.

If the platoon leader has already conducted a leader's reconnaissance with the commander, he uses his own reconnaissance to acquaint his TCs with the BP, briefing his OPORD from an advantageous location within the BP. If there has been no prior leader's reconnaissance, the platoon leader should, if possible, conduct a complete ground reconnaissance with the TCs. This allows him to confirm his map reconnaissance and tentative plan before he issues the OPORD. (**NOTE:** If he is unable to issue the full OPORD during the reconnaissance, the platoon leader should, as a minimum, issue a detailed WO.)

Members of the reconnaissance party should use marking materials (for daylight and limited visibility recognition) to indicate key locations. They should record the eight-digit grid coordinates for these locations, either manually on their maps or by using electronic means such as the GPS or POSNAV system (if available).

To be most effective, the reconnaissance begins from the enemy's perspective in the engagement area, with the party looking toward the BP. (The platoon leader must receive permission from the commander to move in front of the BP.) The platoon leader should explain the enemy situation, outlining probable courses of action and the effects of terrain on enemy movement. He also identifies the enemy's potential support by fire positions as well as assault avenues through the platoon's BP.

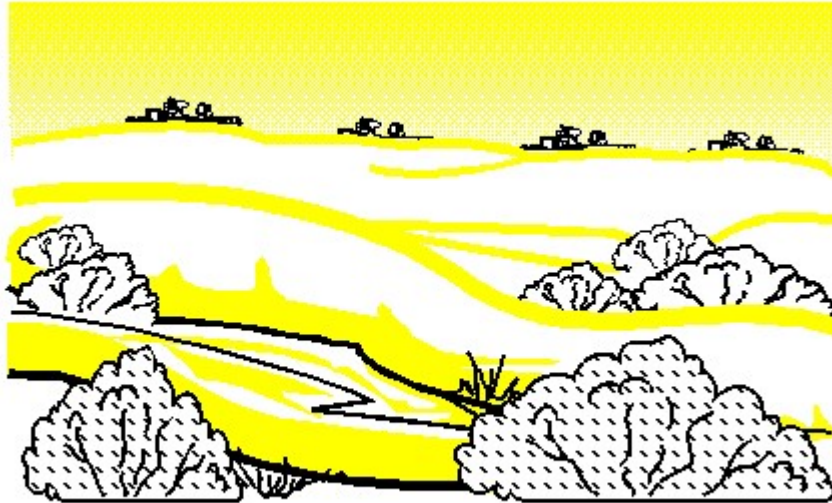
The platoon leader and TCs then mark the company engagement area with platoon and section sectors of fire. Artillery TRPs, decision points, and tentative obstacle locations may also be marked. As necessary, fire control measures may be designated and/or marked using easily identifiable terrain features.

When reconnaissance of the engagement area is complete and all TCs are sure of where the platoon leader wants to kill the enemy, the platoon leader and TCs move back to the BP. They discuss details of the platoon fire plan, including the trigger line, engagement criteria, fire pattern, disengagement criteria and disengagement plan, and routes to supplementary or subsequent BPs. They also make plans to identify and mark primary and alternate fighting positions.

Prior to departing the BP, the platoon leader briefs the OPs on actions to take if the platoon does not return on time or if contact is made with the enemy. He also must coordinate with adjacent platoons to establish overlapping fields of fire and to eliminate gaps and dead space between the platoons. More information on coordination is found

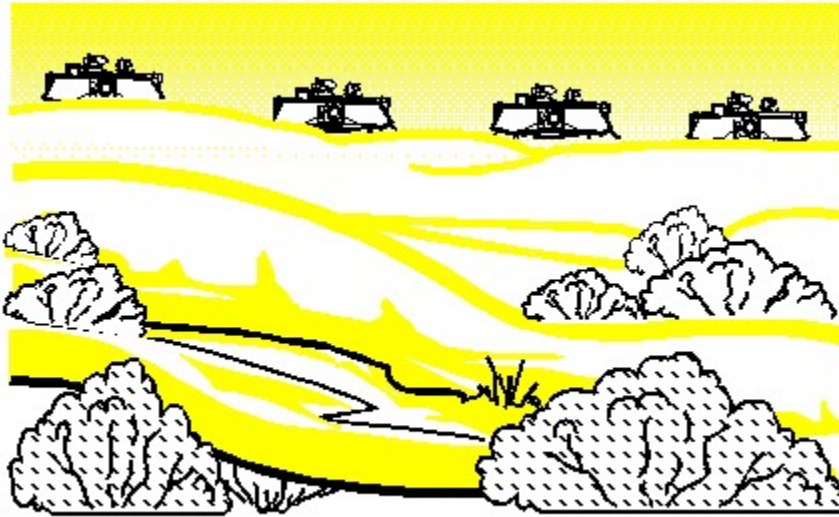
later in this section.

After completing the reconnaissance and coordination, the platoon leader and TCs move back to their vehicles. The TCs remount, start vehicles simultaneously, and move to hide positions behind their primary fighting positions. On order, the platoon moves simultaneously into turret-down firing positions (see Figure 4-6A). These positions allow the tanks to fire only their caliber .50 or loader's M240 machine gun. Observation can be executed using the CITV (if available); the gunner's primary sight also provides observation capability.



**Figure 4-6A. Turret-down positions.**

The platoon leader checks with the OPs to ensure that the enemy situation has not changed, then orders platoon vehicles to occupy their primary hull-down firing positions (see Figure 4-6B). Tank crews orient on the engagement area and complete their sketch cards. Each crew sends its completed sector sketch to the platoon leader, either by messenger or by digital transmission (IVIS or appliqué system, if available); the crew retains a copy of the sketch card for its own reference. Tanks then move individually to their hide positions and assume the appropriate REDCON status (see Appendix C for a discussion of OPSEC).



**Figure 4-6B. Hull-down positions.**

Using the sector sketches and his knowledge of the situation, the platoon leader prepares the platoon fire plan. He begins this process by plotting grid lines on a piece of acetate placed over a map of the engagement area and platoon BP. He then plots the following information:

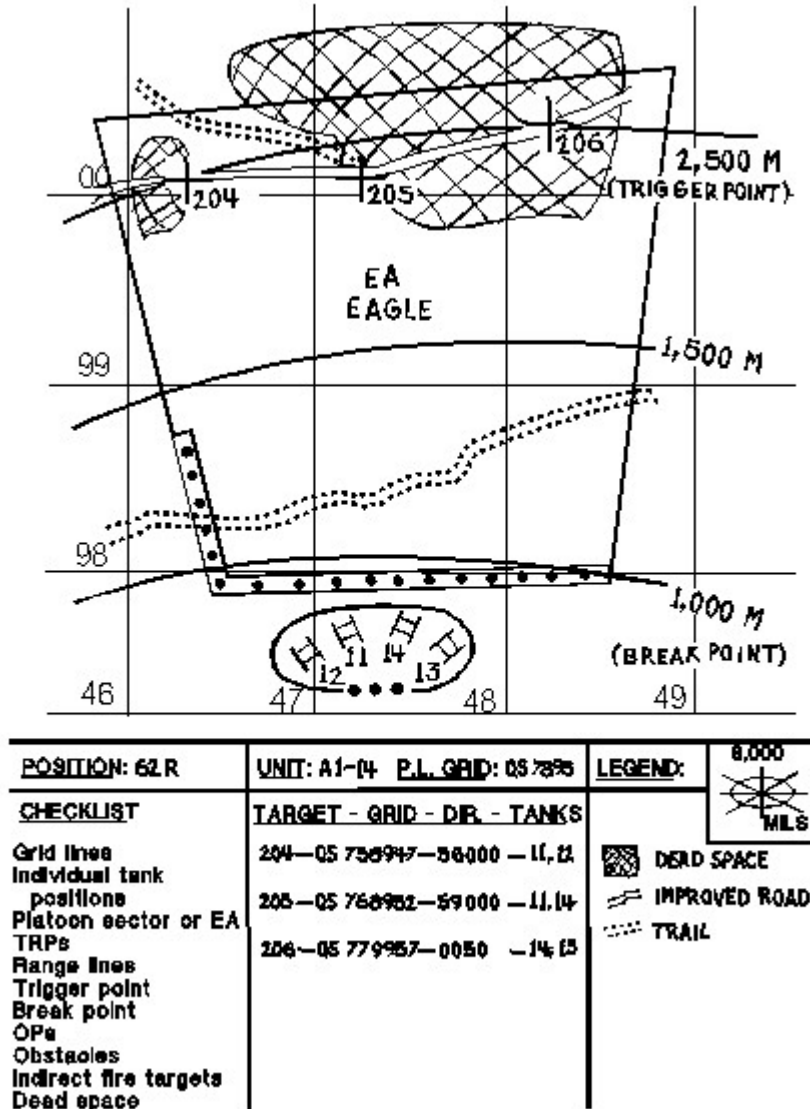
- Individual tank positions.
- Platoon sector or engagement area.
- TRPs.
- Range lines, trigger points, and break points (these may coincide).
- OPs (if used).
- Obstacles (if used).
- Indirect fire targets, including final protective fires (FPF), if allocated.
- Dead space.

The platoon leader completes the fire plan, entering all required marginal information. He reports "ESTABLISHED" to the commander and forwards the fire plan to him by runner or digital transmission; he also disseminates the plan within the platoon. Figure 4-7 illustrates a traditional handwritten platoon fire plan. See FKSM 17-15-1 for information on digital platoon fire plans.

At this point, the platoon executes its defensive priorities of work. These priorities include the following:

- Maintain platoon OPSEC and surveillance of the engagement area (see Appendix C for more information).
- Verify each vehicle's location, orientation, and sector of fire.
- Supervise any allocated engineer assets.
  - Conduct rehearsals.
- Oversee vehicle maintenance and prepare-to-fire checks.
- Improve the position by emplacing M8 alarms and hot loops and by

upgrading camouflage protection.



912-144

Figure 4-7. Example platoon fire plan.

## Coordination

Throughout the preparation phase, the platoon leader coordinates with adjacent platoons and other elements to ensure that platoon sectors of fire overlap and that CS and CSS requirements are met. Coordination is initiated from left to right and from higher to lower. The platoon leader, however, should initiate CS and CSS coordination if he desires support not specified in the company OPORD.

**Adjacent unit coordination.** The information exchanged by adjacent platoons includes the following:

Locations of primary, alternate, and supplementary firing positions and locations of flanks.



Overlapping fields of observation and direct fire.  
Locations and types of obstacles.  
Locations of any dead space between units and procedures for how dead space is to be covered.  
Indirect fire targets and SOI information.  
Locations of OPs and patrol routes.  
Routes into and out of BPs and routes to subsequent and supplementary BPs.

***Platoon coordination.*** Effective platoon coordination enhances the situational awareness of tank crews and alerts them to the actions needed to prepare the defense. One method of ensuring coordination within the platoon is dissemination of enemy and friendly information in the form of intelligence updates, discussed earlier in this chapter. In addition, sector sketches and the platoon fire plan allow coordination of fires before the fight begins.

Rehearsals are especially effective in helping the platoon to practice and coordinate necessary tactical skills, including these:

- Occupation procedures.
- Calls for fire.
- Initiation, distribution, and control of direct and indirect fires.
- Movement to alternate and supplementary firing positions.
- Displacement to subsequent and supplementary BPs.

Rehearsals can begin as soon as the platoon receives the company WO, with individual crews practicing berm drills, snake board exercises, and ammunition transfer drills. Initial walk-through rehearsals on a sand table can focus on deliberate or hasty occupation procedures, fire distribution, and the disengagement plan. The platoon can then conduct mounted movement rehearsals and force-on-force rehearsals, continually raising the level of difficulty by conducting the rehearsals at night and at various MOPP levels. The platoon leader should integrate voice and digital radio traffic as well as calls for fire during all rehearsals.

## Fire support

The platoon leader should confirm locations of artillery and mortar targets, adjust them as necessary, and mark them for daylight and limited visibility recognition. He should also mark decision points that will be used to request artillery on moving targets; these locations are based on the enemy's doctrinal rates of movement, the terrain, the time of flight of artillery rounds (the company FIST has this information), and the priority of the target. Marking of decision points also may be necessary when readily identifiable terrain features are not available.

The platoon leader can use either of two methods to accurately mark decision points and target locations. In one method, a member of the platoon moves to the locations using the map, GPS, or POSNAV and marks the sites. In the second, a

member of the platoon notes the impact location of rounds during artillery registration and moves to and marks these target locations. In both methods, markings must be visible under daylight and limited visibility conditions.

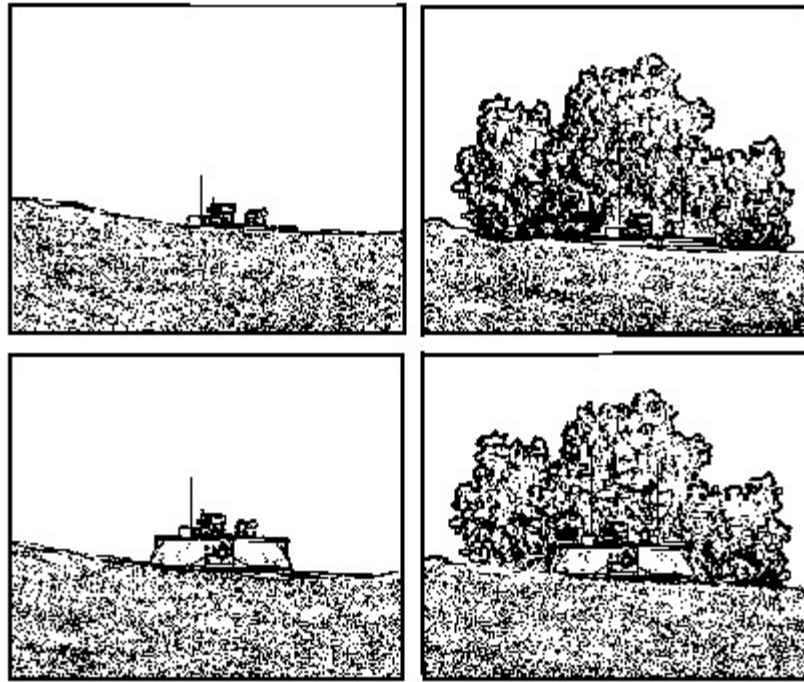
## **Mobility and survivability**

Because engineer assets are at a premium during defensive preparations, they should never be allowed to remain idle for any reason other than maintenance checks and services. A member of the platoon, either the platoon leader or a designated TC, must physically link up with the engineers as directed in the platoon OPORD and escort them to each firing position. The escort provides local security and instructions to the engineers.

Engineers improve the platoon's survivability by digging or improving hide, turret-down, or hull-down positions (see Figure 4-5, page 4-11). Each TC should be responsible for the improvement of his firing position. He must ensure the location, orientation, and depth of the hole are correct before the engineer departs for the next fighting position. He should also be aware of the importance of selecting a site with a background that will break up the silhouette of his vehicle (see Figure 4-8); this helps to prevent skylining.

Several factors can help the platoon to significantly increase the number of kills it achieves while executing the defense. Firing positions should maximize weapon standoff and/or the platoon's ability to mass fires from survivable positions. As discussed previously, firing positions and obstacles should be complementary. The platoon leader must coordinate with engineers to ensure that the platoon's direct fires can cover the entire area of any obstacle that the commander intends to emplace in the platoon's sector of fire. Additionally, the platoon should know the exact location of the start point, end point, and turns of the obstacle. This knowledge contributes to the accuracy of calls for fire. The platoon leader can also locate a TRP on the obstacle to ensure more accurate calls for fire.

In the defense, engineer mobility operations normally are of lower priority than survivability and countermobility. Engineers can improve routes from the platoon's hide position to its primary, alternate, and supplementary fighting positions as well as to subsequent and supplementary BPs. These efforts are labor-intensive, however, and should be evaluated carefully based on the commander's priority of work for the engineers.



**Figure 4-8. Using background to prevent skylining.**

## **COMBAT SERVICE SUPPORT**

is authorized by the commander, the platoon leader determines the amount and type of prestock (normally ammunition) that will be required for the operation. For example, to calculate ammunition requirements, he evaluates the number and type of enemy vehicles the platoon expects to engage and the amount of time available to conduct resupply between engagements. He then directs the PSG to select and prepare the prestock location and coordinate the delivery of the prestock supplies.

Prestock resupply can be accomplished successfully in virtually any location where supplies can be hidden and protected, such as in or behind the primary fighting position, along the displacement route, or in the firing positions of a subsequent BP. Preparation of the site includes providing cover, concealment, and protection of platoon and delivery personnel and vehicles during the transfer process. The site must also protect the supply materials from enemy observation and the effects of artillery and weather.

Once the supplies are delivered, the prestock site should be concealed; the platoon should conduct periodic security checks or keep the site under constant surveillance to ensure safekeeping of the prestock.

## Section IV. EXECUTION

This section contains a "best case," chronological discussion of the procedures and considerations that apply during the execution of a typical tank platoon defensive mission.

### Hide position

The platoon's hide positions are located behind its primary battle and/or fighting positions. The platoon occupies hide positions in one of two ways: either as a unit, using perimeter defense techniques discussed in Chapter 5 (this method is used when hide positions are behind the BP), or with individual vehicles occupying hide positions behind their primary fighting positions.

While in the hide position, the platoon employs all applicable OPSEC measures to limit aerial, thermal, electronic, and visual detection. It deploys OPs as discussed in Appendix C to provide surveillance of its sectors of fire and early warning for vehicles in the hide position. It also maintains the REDCON status prescribed in the OPORD. The hide position should not be located on or near obvious artillery targets.

**NOTE:** The platoon leader may decide to occupy turret-down positions rather than hide positions based on terrain considerations, such as availability of cover and concealment, or if the enemy situation is vague and observation of the engagement area is necessary.

### Occupation of firing positions

The platoon leader monitors intelligence reports provided on the company net and upgrades the platoon's REDCON status as the enemy approaches or as directed. When previously identified occupation criteria are met, he orders the platoon to occupy its primary fighting positions. Based on reconnaissance, rehearsals, and known time-distance factors, each TC moves to his position along a previously reconnoitered route. If the GPS or POSNAV is available, TCs use waypoints to assist in controlling movement. Ideally, the platoon occupies turret-down positions with enough time to orient weapon systems and acquire and track targets before the enemy crosses the direct fire trigger line.

Because the observation range of OPs is usually limited to the engagement area, OP reports should not be the sole criterion triggering the platoon's occupation of fighting positions. If the enemy situation becomes unclear, the platoon leader may request permission to occupy turret-down positions for the purpose of scanning the engagement area.

# Calls for fire

As the enemy approaches the direct fire trigger line, the platoon leader keeps his crews updated on the situation being reported on the company net. He monitors the SPOTREPs and calls for fire being sent on the company net and compares these reports with the SPOTREPs from his platoon net. He reports any new enemy information higher using the SPOTREP format (see FKSM 17-15-3). The platoon leader employs available artillery to engage targets that are not being requested by other platoon leaders or the company commander; he initiates calls for fire on moving enemy elements using previously identified decision points and the "AT MY COMMAND" method of control (calls for fire are discussed in Chapter 6).

Crews of M1A2 tanks can track enemy vehicle movement toward a target location by employing the "far target designate" capability; they can use this information to initiate artillery fires. Additionally, they can use "far target designate" to determine the location of stationary targets and to quickly process a TACFIRE or IVIS call for fire message to attack unplanned targets.

## Direct Fires

The platoon leader initiates tank direct fires using a fire command as discussed in Chapter 2. The fire command enables him to engage single targets (for example, a reconnaissance vehicle) using a single section or an individual vehicle without exposing the entire platoon. It also allows the platoon to maintain the element of surprise by simultaneously engaging multiple targets with a lethal initial volley of tank fires. Sectors of fire and the preplanned fire pattern should be selected to help prevent target overkill and the resulting waste of ammunition.

The trigger line is a backup to the fire command. In the absence of communications from the platoon leader, a preestablished direct fire trigger line allows each TC to engage enemy vehicles in his sector of fire. The criteria for the direct fire trigger line should specify the number of enemy vehicles that must pass a designated location before the TC can engage without any instructions from the platoon leader. Selection of the trigger line is dependent on METT-T factors. Considerations might include the following:

A maximum range or a point, such as an obstacle, at which the platoon will initiate fires to support the company scheme of maneuver.

The survivability of enemy armor.

The fields of fire that the terrain allows.

The planning ranges for the platoon's weapon systems (planning range for the 105-mm main gun is 2,000 meters; for the 120-mm main gun, it is 2,500).

Individual TCs move from hull-down to turret-down firing positions within their

primary and alternate positions based on two considerations: the necessity to maintain direct fire on the enemy and the effectiveness of enemy fires. Influencing each TC's decision to move between firing positions are such factors as enemy movement rates, the number of advancing enemy vehicles, the accuracy with which the enemy is acquiring and engaging friendly fighting positions, and the lethality of enemy weapon systems.

During the direct fire fight, TCs describe the situation for the platoon leader, who in turn describes what is happening for the commander. Contact reports, SPOTREPs, and SITREPs are used as appropriate. In the defense, contact reports are used to alert the platoon to previously unidentified enemy targets. **SPOTREPs and SITREPs are sent to list the number, types, and locations of enemy vehicles observed, engaged, and/or destroyed and to provide the strength and status of friendly forces.** Everyone involved in this process must avoid sending redundant or inflated descriptions of the situation. Such reports not only are confusing, but also may trigger unnecessary, and possibly dangerous, actions by higher headquarters.

The platoon may expend main gun ammunition quickly in a direct fire fight. Based on the terrain and expected enemy situation, the platoon leader must develop and execute resupply procedures to maintain a constant supply of main gun rounds. He must balance the necessity of maintaining direct fires on the enemy against the demands imposed on the platoon's crews by the ammunition transfer process and the retrieval of prestock supplies.

## Displacement

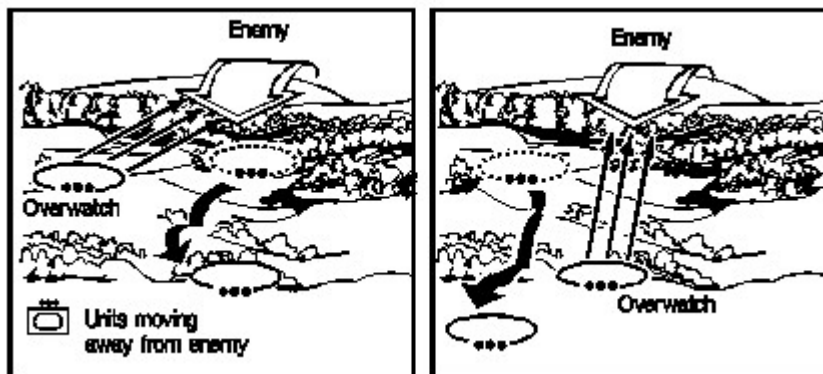
Displacement may become necessary in several types of situations. A numerically superior enemy may force the platoon to displace to a subsequent BP; a penetration or enemy advance on a secondary avenue of approach may require the platoon or section to occupy supplementary BPs or firing positions.

The company commander establishes disengagement criteria and develops the disengagement plan to support the company scheme of maneuver. Disengagement criteria are primarily based on a specified number and type of enemy vehicles reaching a specified location (this is sometimes called the break point) to trigger displacement. Other considerations, such as ammunition supplies and friendly combat power, also influence the decision to displace. The platoon leader chooses between two methods of displacement depending on whether or not the move is overwatched (covered) by an adjacent platoon.

If the displacement is covered, the entire platoon usually displaces as a whole and employs smoke grenades and on-board smoke generators to screen the displacement. (**NOTE:** JP-8 fuel may restrict the use of on-board smoke generators.)

In a covered displacement, the platoon leader issues instructions or uses a prearranged signal to initiate movement. The platoon simultaneously backs down

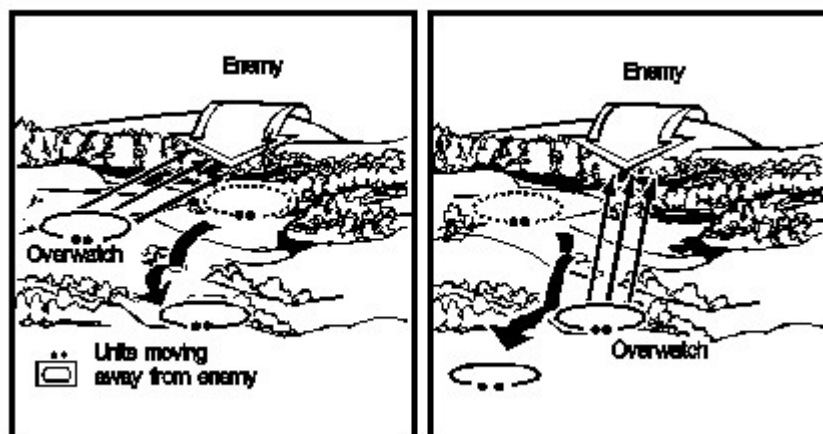
to hide positions, keeping front hulls toward the enemy until adequate cover protects each tank. Individual tanks orient weapon systems toward the enemy as they move to the subsequent or supplementary positions along previously identified and reconnoitered routes. (See Figure 4-9A.)



**Figure 4-9A. Displacement covered (entire platoon moves at once with cover from another platoon).**

If the displacement is not covered, the platoon leader designates one section to overwatch the displacement of the other section. The overwatch section is responsible for providing suppressive fires covering the entire platoon sector of fire. It also initiates artillery calls for fire, mixing smoke overwatch is no longer necessary to cover the displacing section's movement, the overwatch section may request one last artillery call for fire in front of its own position, then displace to the subsequent/supplementary BP.

**NOTE:** In some instances, the platoon may have to use bounding overwatch to the rear during tactical movement to the subsequent position. This may become necessary when such factors as the distance to the subsequent position, the enemy's rate of advance, and terrain considerations (fields of fire) do not allow the original overwatch section to displace without the benefit of an overwatch of its own (see Figure 4-9B).



**Figure 4-9B. Displacement uncovered (sections move using bounding overwatch).**

The displacement is complete when the platoon has occupied the subsequent BP and all vehicles are prepared to continue the defense. If the platoon leader and TCs were able to reconnoiter and rehearse the disengagement and occupation, the occupation should go quickly. If reconnaissance and rehearsals were not possible, the platoon leader must conduct the steps of a hasty occupation outlined earlier.

## **Counterattacks**

The platoon is capable of conducting limited counterattacks, either alone or as part of a larger force (usually the company team), to accomplish the following:

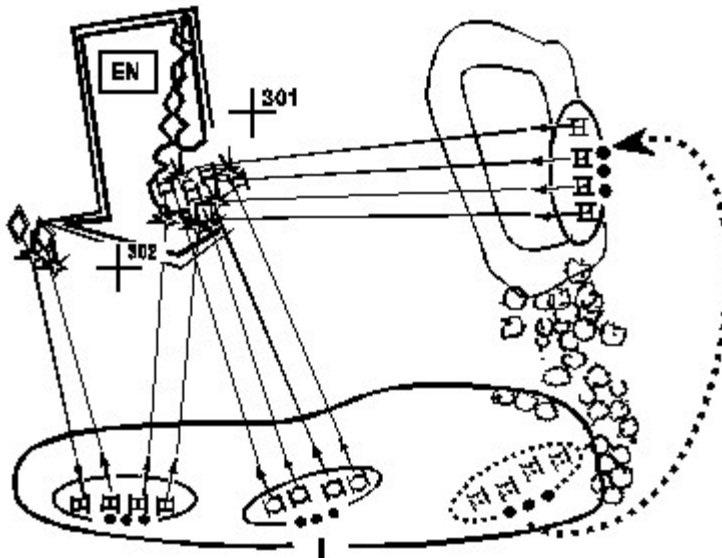
- Complete the destruction of the enemy.
- Regain key terrain.
- Relieve pressure on an engaged unit.
- Initiate offensive operations.

Two methods are available to the platoon: counterattack by fire and counterattack by fire and movement. In both types, coordination and control are critical to the success of the counterattack. Locations of routes and positions must be planned and disseminated to all units; this assists the counterattack force and other elements in controlling indirect and direct fires. If adjustments to any route or position become necessary, the counterattack force must take immediate action to ensure that other forces lift and shift fires; otherwise, fratricide becomes a distinct danger.

### **Counterattack by Fire**

When the company team executes a counterattack by fire, one platoon conducts tactical movement on a concealed route to a predetermined BP or attack by fire position from which it can engage the enemy in the flank and/or rear. The remaining platoons hold their positions and continue to engage the enemy (see Figure 4-10). The intent of this method is to use weapon standoff and/or cover to full advantage and destroy the enemy by direct fires.





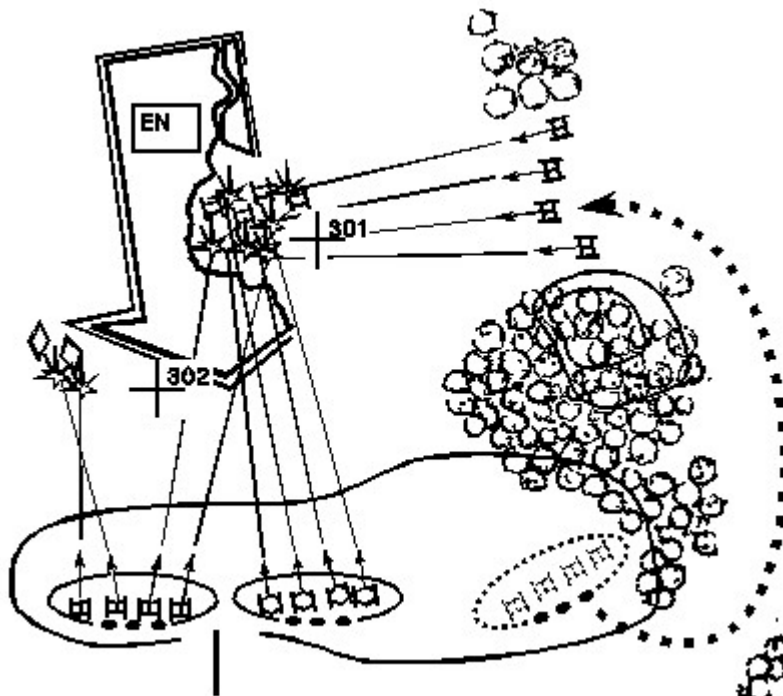
48-312-288

Figure 4-

10. Counterattack by fire.

## Counterattack by Fire and Movement

The intent of this method is to close with and destroy the enemy. The counterattack force uses tactical movement to gain a position of advantage from which it attacks the enemy (from the flank, whenever possible). It conducts hasty attacks and assaults based on the particular situation and the factors of METT-T (see Figure 4-11).



72-72

Figure 4-11.

Counterattack by fire and movement.

# Consolidation and Reorganization

Once an enemy assault is defeated, leaders must ensure their soldiers are ready to continue with defensive operations, to shift to the offense, or to displace. If the platoon is directed to hold its current positions, it must consolidate and reorganize quickly so it will be ready to destroy follow-on enemy forces and to execute any other required tasks.

To consolidate a defensive position, the platoon takes these steps:

Eliminate remaining enemy resistance by conducting a counterattack as directed by the commander.

Ensure positions are mutually supporting; check all sectors of fire to eliminate gaps and dead space that result when tanks are disabled.

Secure EPWs.

Reestablish communications.

Reestablish OPSEC by emplacing OPs and early warning devices (such as M8 alarms) and recamouflaging positions.

Replace or repair obstacles.

Improve positions in accordance with procedures for a deliberate defense and established priorities of work.

Reorganization, the process of preparing for continued fighting, is usually conducted by unit SOP. Reorganization in the defense is accomplished in the same manner as in the offense. See Chapter 3 for a detailed discussion.

## CHAPTER 5



## OTHER TACTICAL OPERATIONS

This chapter describes additional tasks the tank platoon may have to conduct to complement or support its primary operations of move, attack, and defend. The platoon executes these additional tasks separately or as part of a larger force.

## CONTENTS

SECTION I. Tactical Road March

SECTION II. Assembly Areas

SECTION III. Linkup

SECTION IV. Convoy Escort

SECTION V. Passage of Lines

SECTION VI. Breaching Operations

SECTION VII. Follow and Support

SECTION VIII. Perimeter Defense

SECTION IX. Screen

SECTION X. Delay

SECTION XI. Relief in Place

SECTION XII. Withdrawal

## **Section I. TACTICAL ROAD MARCH**

Tank platoons conduct tactical road marches to move long distances and position themselves for future operations. The main purpose of the road march is to relocate rapidly, not to gain contact. It is conducted using fixed speeds and timed intervals. Road marches are planned at the battalion and company levels. They are, however, executed by platoons.

The success of a road march depends on thorough preparation and sound SOPs. Platoon preparations should address movement to the SP, speed control, formations, intervals, weapons orientation, actions at scheduled halts, and actions at the RP. SOPs should cover actions at unscheduled halts, actions in case a vehicle becomes lost, actions if a vehicle becomes disabled, and actions on contact.

A road march is composed of three elements: the quartering party (or advance party), the main body, and the trail party. The tank platoon normally travels as a unit in the main body. Before the march begins, the platoon may provide individual soldiers or a vehicle and crew to assist with quartering party activities (see Section II of this chapter).

## **March Columns**

There are three primary road march techniques. The commander bases his decision on the formation to be used during the march on which technique is employed. The road march is usually executed in column or staggered column formation.

### **Open Column**

The open column technique is normally used for daylight marches. It can be used at night with blackout lights or thermal vision equipment. The distance between vehicles varies, normally from 50 meters to 200 meters depending on light and weather conditions.

### **Close Column**

The close column technique is normally used for marches conducted during periods of limited visibility. The distance between vehicles is based on the ability to see the vehicle ahead; it is normally less than 50 meters.

## **Infiltration**

The infiltration technique involves the movement of small groups of personnel or vehicles at irregular intervals. It is used when sufficient time and suitable routes are available and when maximum security, deception, and dispersion are desired. It provides the best possible passive defense against enemy observation and detection. (**NOTE:** Infiltration is most commonly used by dismounted elements.)

## **Control measures**

The following control measures assist the platoon leader in controlling his platoon during the conduct of a road march.

### **Map with Overlay**

As a minimum, the overlay must show the SP, the RP, and the route. The SP location represents the beginning of the road march route. It should be located on easily recognizable terrain. It is far enough away from the unit's initial position to allow the platoon to organize into the march formation at the appropriate speed and interval. If time is available, the platoon leader should determine the time-distance factor to the SP. This will help the platoon to arrive at the SP at the time designated in the commander's OPORD. The RP location is at the end of the route of march. It also is located on easily recognizable terrain. Elements do not halt at the RP. They continue to their respective positions with assistance from guides, waypoints, and graphic control measures. The route is the path of travel connecting the start and release points.

### **Digital Overlays**

Digital overlays serve as a backup to maps with overlays. They display waypoints and information concerning unit locations along the route of march that can assist TCs in navigation and help them in maintaining situational awareness.

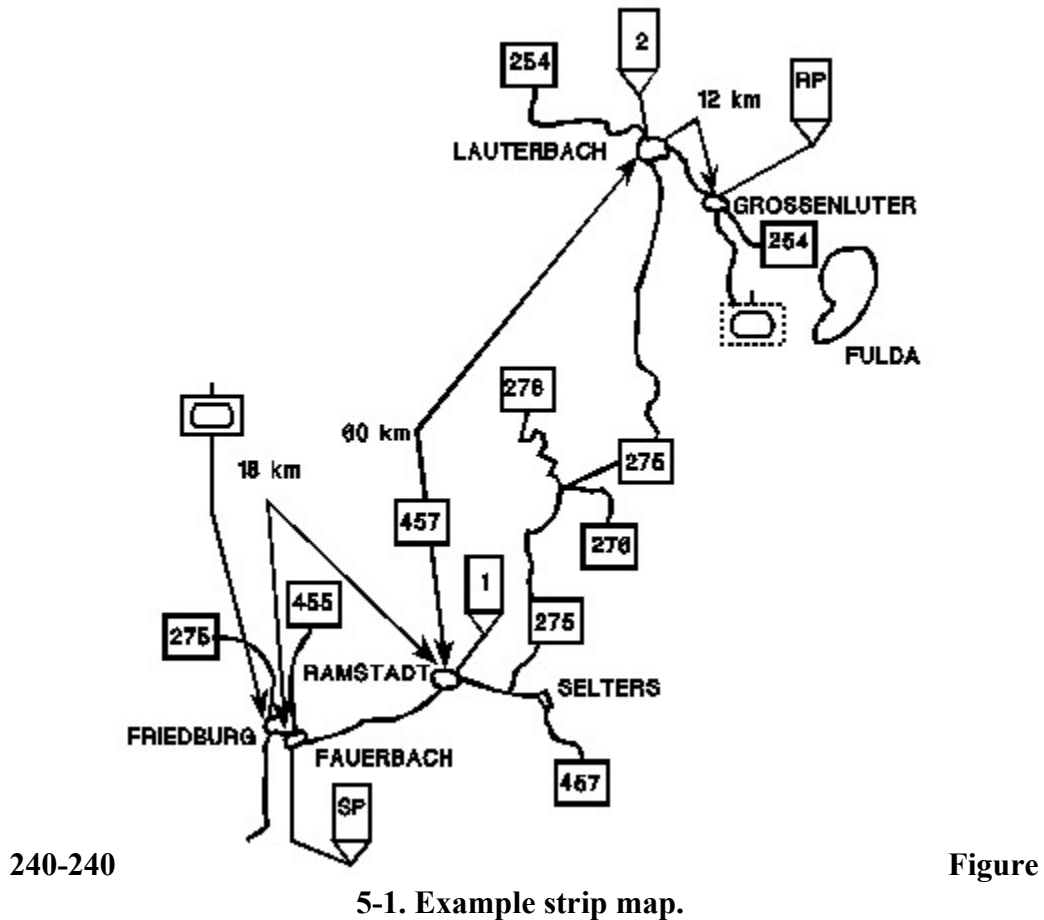
### **Critical Points**

These are locations along the route of march where interference with movement might occur or where timing is critical. They are represented using checkpoints. The SP, RP, and all checkpoints are considered critical points.

### **Strip Maps**

A strip map can be used to assist in navigation. It must include the SP, RP, and

checkpoints and must list the distances between these points. Detailed blow-up sketches should be used for scheduled halt locations and other places where confusion is likely to occur. Strip maps are included as an annex to the movement order; if possible, a copy should be provided to all vehicle drivers. See Figure 5-1 for an example of a strip map.



## Visual Signals

Because radio silence is observed during most road marches, hand-and-arm signals provide the primary means of passing messages between vehicles.

## Traffic Control

Road guides and traffic signs may be posted at designated traffic control points by the headquarters controlling the march. At critical points, guides assist in creating a smooth flow of traffic along the march route. Military police, members of the battalion scout platoon, or designated elements from the quartering party may serve as guides. They should have equipment that will allow march elements to identify them during the hours of darkness.

# Actions During the March

## Moving to the Start Point

The platoon must arrive at the SP at the time designated in the company OPORD. Some companies designate a staging or marshaling area that enables platoons to organize their march columns and conduct final inspections and briefings before movement. Other units require platoons to move directly to the column from their current positions. To avoid confusion during the initial moveout, the platoon leader and TCs conduct a reconnaissance of the route to the SP, issue clear movement instructions, and conduct thorough rehearsals, paying particular attention to signals and timing.

## March Speed

An element's speed in a march column will vary as it encounters difficult routes and road conditions. This can produce an undesirable accordion effect. The movement order establishes the march speed and maximum catch-up speed. The lead vehicle must not exceed the fixed march speed. In addition, it should accelerate slowly out of turns or choke points; this allows the majority of the platoon to gradually resume the march speed after moving past the restriction.

## Orientation

Each tank in the platoon has an assigned sector of gun tube orientation (see Figure 5-2). TCs assign sectors of observation to crewmen both to cover their portion of the platoon sector and to achieve 360-degree observation.

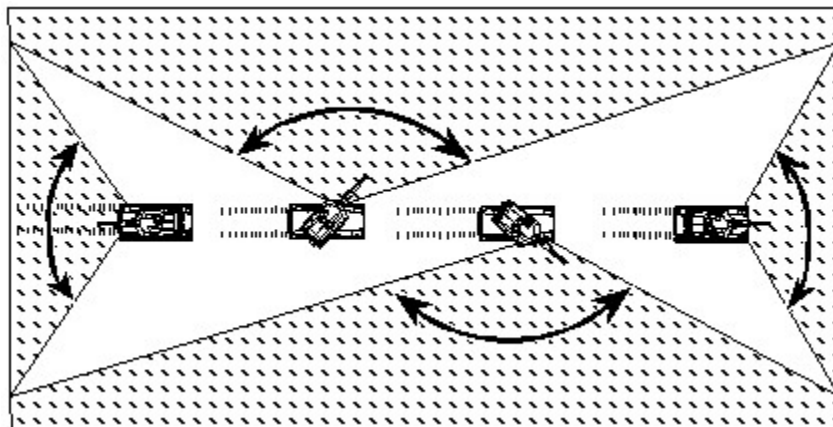


Figure 5-2. Sectors of gun tube orientation.

## **Halts**

While taking part in a road march, the platoon must be prepared to conduct both scheduled and unscheduled halts.

***Scheduled halts.*** These are conducted to permit maintenance, refueling, and personal relief activities and to allow other traffic to pass. The time and duration of halts are established in the movement order; unit SOP specifies actions to be taken during halts. The first priority at a halt is to establish and maintain local security (see Appendix C). A maintenance halt of 15 minutes is usually taken after the first hour of the march, with a 10-minute break every two hours thereafter.

During long marches, the unit may conduct a refuel on the move (ROM) operation. Depending on OPSEC considerations and the company OPORD, the platoon may conduct a ROM for all vehicles simultaneously or by section. The OPORD will specify the amount of fuel or the amount of time at the pump for each vehicle. It will also give instructions for OPSEC at the ROM site and at the staging area to which vehicles move after refueling.

***Unscheduled halts.*** Unscheduled halts are conducted if the unit encounters obstacles or contaminated areas or if a disabled vehicle blocks the route. Whenever an unscheduled halt occurs, each TC sends a messenger to the vehicle to his front; the movement commander must then take action to determine the cause of the halt. A disabled vehicle must not be allowed to obstruct traffic. The crew should move the vehicle off the road immediately, report its status, establish security, and post guides to direct traffic.

If possible, the crew repairs the vehicle and rejoins the rear of the column. Vehicles that drop out of the column should return to their original positions only when the column has halted. Until then, they move at the rear just ahead of the trail element, which usually comprises the maintenance team with the M88 recovery vehicle and some type of security (the XO will handle security if he is not part of the quartering party). If the crew cannot repair the vehicle, the vehicle is recovered by the trail element.

## **Actions on Contact**

If enemy contact occurs during the road march, the platoon executes actions on contact as described in Chapter 3.

## **Actions at the Release Point**

The platoon moves through the RP without stopping. The platoon leader picks up the assigned guide or follows the guide's signals to the assembly area. Depending on terrain and the equipment available (GPS or POSNAV), guides and marking materials may be posted at or near exact vehicle locations (see assembly area procedures in the following section).

## **Section II. ASSEMBLY AREAS**

An assembly area is a site at which maneuver units prepare for future operations. A well-planned assembly area will have the following characteristics:

- A location on defensible terrain.
- Concealment from enemy ground and air observation.
- Good drainage and a surface that will support tracked and wheeled vehicles.
- Suitable exits, entrances, and internal roads or trails.
- Sufficient space for dispersion of vehicles and equipment.

Normally, a quartering party (also known as an advance party) assists the platoon in the occupation of an assembly area. Established in accordance with company SOP, the quartering party may consist of one or two soldiers from each platoon or even one tank per platoon. It is led by the company XO or 1SG or by a senior NCO. The quartering party takes these actions in preparing the assembly area:

- Reconnoiter for enemy forces, NBC contamination, condition of the route to the assembly area, and suitability of the area (drainage, space, internal routes). If the area is unsatisfactory, the party contacts the commander and requests permission to find a new location for the site.
- Organize the area based on the commander's guidance; designate and mark tentative locations for the platoon, trains, and CP vehicles.
- Improve and mark entrances, exits, and internal routes.
- Mark and/or remove obstacles (within the party's capabilities).
- Mark tentative vehicle locations.

Once the assembly area has been prepared, the quartering party awaits the arrival of the company, maintaining surveillance and providing security of the area within its capabilities. Quartering party members guide their platoons from the RP to their locations in the assembly area. SOPs and prearranged signals and markers (for day and night occupations) should assist the TCs in finding their positions. The key consideration is to move quickly into position to clear the route for other units.

**Once in position, 4. It establishes and maintains security (see the OPSEC discussion in Appendix C) and coordinates with adjacent units. These actions enable the platoon to defend from the assembly area as necessary.** The platoon can then prepare for future operations by conducting troop-leading procedures and priorities of work in accordance the company OPORD. Preparations include the following:

- Establish and maintain security (REDCON status).
- Conduct troop-leading procedures.
- Perform maintenance on vehicles and communications equipment.
- Verify weapon system status; conduct boresighting, MRS updates, test-firing, and other necessary preparations.
- Conduct resupply, refueling, and rearming operations.
- Conduct rehearsals and training for upcoming operations.
- Conduct PCIs.
- Eat, rest, and conduct personal hygiene activities.

Normally, the platoon occupies an assembly area as part of a company team. The



company team may be adjacent to or independent of the task force (see Figures 5-3A and 5-3B, page 5-10). The company commander assigns a sector of responsibility and weapons orientations for each platoon. If the platoon occupies an assembly area alone, it establishes a perimeter defense (explained later in this chapter).

In some cases, a company will occupy an assembly area without first sending out a quartering party. During this "occupation by force," the platoon leader orders a hasty occupation of a BP at the platoon's designated location. He establishes local security, directs adjacent unit coordination, begins troop-leading procedures, and establishes priorities of work.

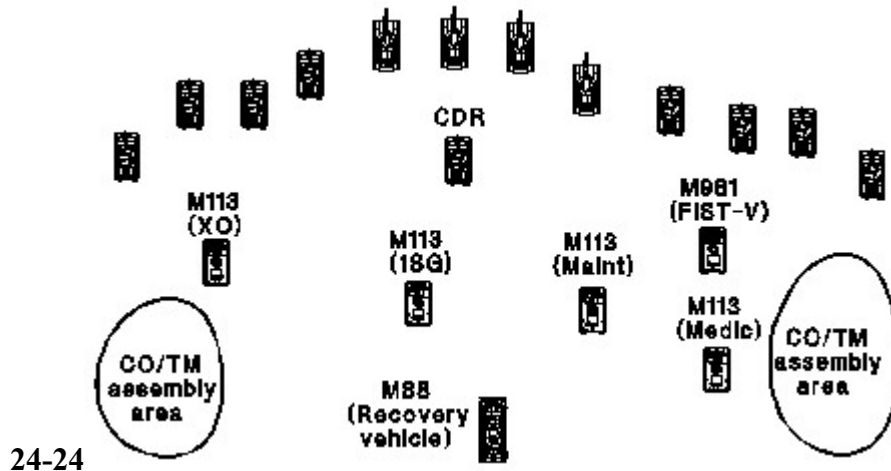


Figure 5-

3A. Assembly area adjacent to other company teams.

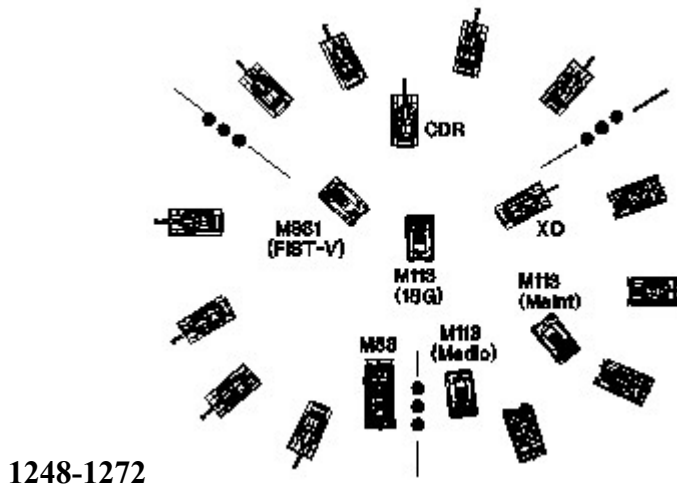


Figure 5-3B. Company

team assembly area independent of the task force.

### Section III. LINKUP

A linkup is the meeting of friendly ground forces. It may occur in, but is not limited to, the following situations:

- Advancing forces reaching an objective area previously secured by air assault or airborne forces.
- Units conducting coordination for a relief in place.

Cross-attached units moving to join their new organization.

A tank platoon moving forward during a follow and support mission with dismounted infantry or scouts.

A unit moving to assist an encircled force.

Platoons conduct linkup activities independently or as part of a larger force. Within a larger unit, the tank platoon may lead the linkup force. The linkup consists of three phases; the following actions are critical to the execution of a speedy, safe operation:

**Phase 1 - Far recognition signal.** During this phase, the two units should establish communications before they reach direct fire range. The lead element of the linkup force should

**Phase 2 - Coordination and movement to the linkup point.** The forces coordinate the following information: known enemy situation; type and number of friendly vehicles; disposition of stationary forces (if either unit is stationary); routes to the linkup point; fire control measures; near recognition signal; finalized location for the linkup point; and any special coordination, such as

**Phase 3 - Linkup.** The units enforce strict fire control measures to help prevent fratricide. If both units are moving, the controlling headquarters designates a location in the formation for the subordinate unit. If one unit is stationary, the moving unit moves through the linkup point to a predetermined location.

## **Section IV. CONVOY ESCORT**

This mission requires the tank platoon to provide the convoy with security and close-in protection from direct fire while on the move. The platoon is well suited for this role because of its vehicles' mobility, firepower, and armor protection against mines and direct and indirect fires. Depending on a variety of factors (size of the convoy, escort assets available, METT-T factors), the platoon may perform convoy escort either independently or as part of a larger unit's convoy security mission.

### **BATTLE COMMAND**

Battle command is especially critical because of the task organization of the convoy escort mission. The relationship between the platoon and the convoy commander must provide for unity of command and effort if combat operations are required during the course of the mission. In most cases, the tank platoon will execute the escort mission under control of the security force commander, who is usually OPCON or attached to the convoy commander. At times, however, the platoon will be OPCON or attached directly to the convoy commander. This occurs when the platoon is providing security for tactical operations centers (TOC) or when it is operating independently with a small convoy.

The convoy commander should issue a complete OPORD to all vehicle commanders in the convoy prior to execution of the mission. This is vital because the convoy may itself be task organized from a variety of units and because some vehicles may not have tactical radios. The order should follow the standard five-paragraph OPORD format, but special emphasis should be placed on the following subjects:

Route of march (to include a strip map for each vehicle commander).

- Order of march.
- Actions at halts.
- Actions in case of vehicle breakdown.
- Actions on contact.
- Chain of command.
- Communications and signal information.

## Tactical disposition

During all escort missions, the convoy security commander and tank platoon leader must establish and maintain security in all directions and throughout the length of the convoy. They can adjust the disposition of the platoon, either as a unit or dispersed, to fit the security requirements of each particular situation. As noted, several factors, including convoy size and METT-T, affect this disposition. Perhaps the key consideration is whether the platoon is operating as part of larger escort force or is executing the escort mission independently.

## Large-scale Escort Missions

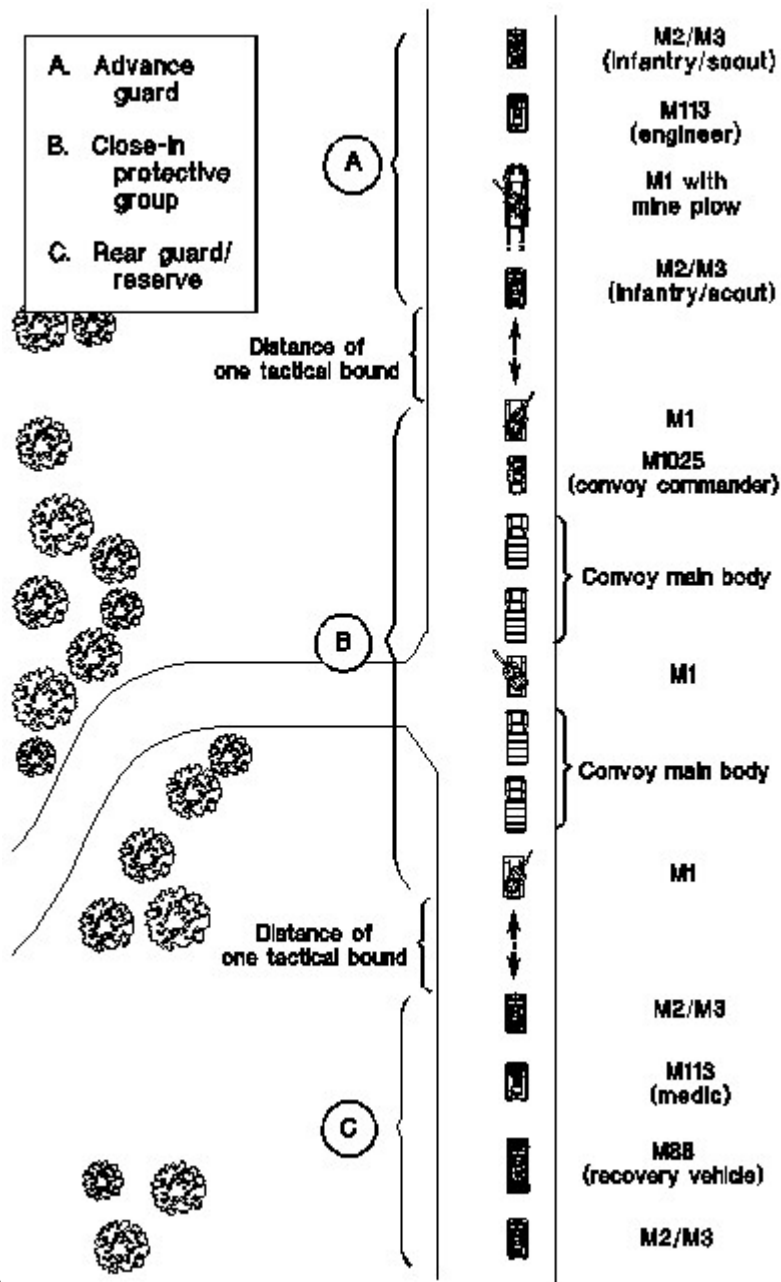
When sufficient escort assets are available, the convoy commander will usually organize the convoy into three distinct elements: advance guard, close-in protective group, and rear guard. Figure 5-4, page 5-14, shows a convoy in which the tank platoon is part of a company team-size escort force.

The tank platoon will normally be task organized to operate within the close-in protective group. This group provides immediate, close-in protection for the vehicle column, with escort vehicles positioned either within the column or on the flanks. The convoy commander's vehicle is located within this group.

The advance guard reconnoiters and proofs the convoy route. It searches for signs of enemy activity, such as ambushes and obstacles. Within its capabilities, it attempts to clear the route and provides the convoy commander with early warning before the arrival of the vehicle column. In some cases, an individual tank platoon vehicle, a section, or the entire platoon may be designated as part of the advance guard. The platoon leader may also be required to attach a mine plow or mine roller to this element.

The rear guard follows the convoy. It provides security in the area behind the main body of the vehicle column, often moving with medical and recovery assets. Again, an individual vehicle, a section, or the entire tank platoon may be part of this element.

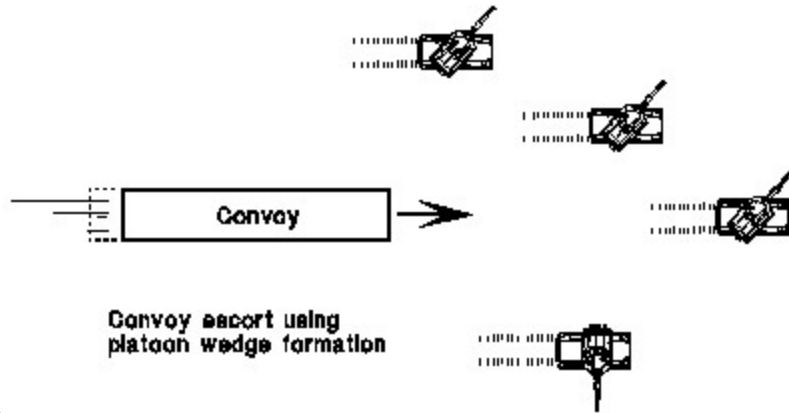
**NOTE:** The convoy commander may also designate the tank platoon as part of a reserve (reaction) force for additional firepower in the event of enemy contact. The reserve will either move with the convoy or be located at a staging area close enough to provide immediate interdiction against the enemy.



120-120

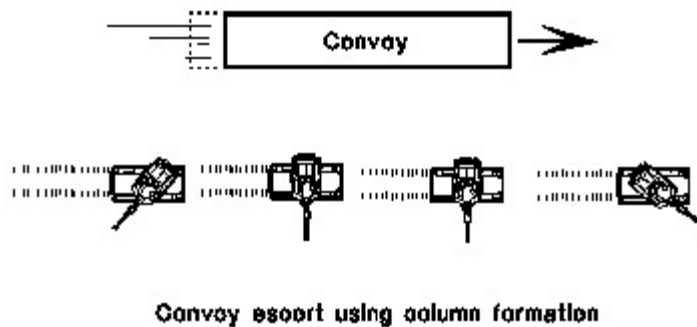
**Figure 5-4. Tank platoon as part of larger escort force.**

When the platoon is deployed as a unit during a large-scale escort operation, it can provide forward, flank, or rear close-in security. In such situations, it executes tactical movement based on the factors of METT-T. Figures 5-5A through 5-5C (pages 5-15 and 5-16) show the platoon using various formations while performing escort duties as a unit.



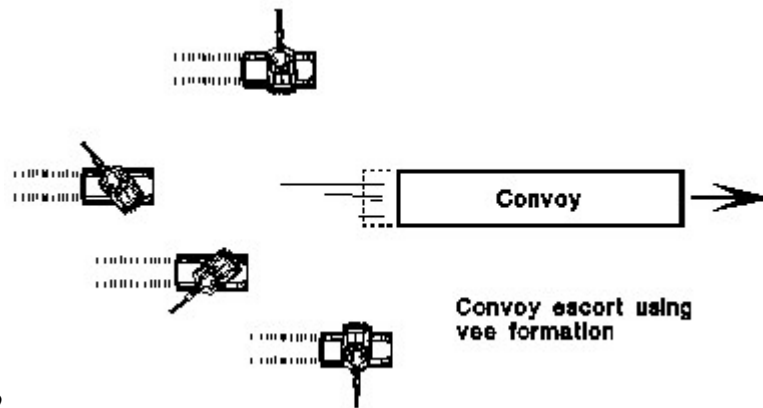
72-72-72-72

**Figure 5-5A. Platoon performing forward security for a convoy.**



480-480-288-528

**Figure 5-5B. Platoon performing flank security for a convoy.**



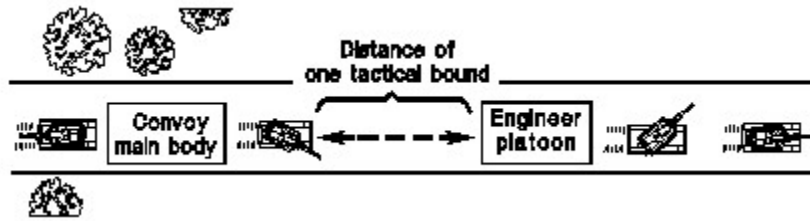
480-480-240-192

**Figure 5-5C. Platoon performing rear security for a convoy.**

### **Independent Escort Operations**

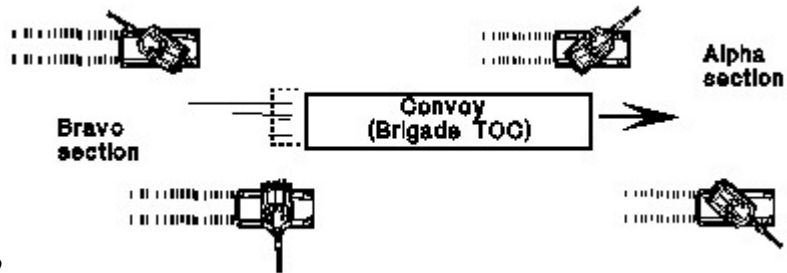
When the tank platoon executes a convoy escort mission independently, the convoy commander and platoon leader will disperse the tanks throughout the convoy formation to provide forward, flank, and rear security. Whenever possible, wingman tanks should maintain visual contact with their leaders. Tanks equipped with mine plows or mine rollers (and engineer assets, if available) should be located near the front to respond to obstacles. At times, these assets may be required to move ahead of the convoy, acting as the reconnaissance element or moving with scouts to proof the convoy route. Figure 5-6

illustrates this kind of escort operation.



**Figure 5-6. Platoon performing convoy escort independently.**

In some independent escort missions, variations in terrain along the route may require the platoon to operate using a modified traveling overwatch technique. Figure 5-7 illustrates such a situation. It shows one section leading the convoy while the other trails the convoy. Dispersion between vehicles in each section is sufficient to provide flank security. Depending on the terrain, the trail section may not be able to overwatch the movement of the lead section.



600-600-48-192

**Figure 5-7. Platoon escort using modified traveling overwatch.**

## Actions on contact

As the convoy moves to its new location, the enemy may attempt to harass or destroy it. This contact will usually occur in the form of an ambush, often with the use of a hastily prepared obstacle. The safety of the convoy then rests on the speed and effectiveness with which escort elements can execute appropriate actions on contact.

Based on the factors of METT-T, portions of the convoy security force, such as the tank platoon or a tank section, may be designated as a reaction force. The reaction force performs its escort duties, conducts tactical movement, or occupies an assembly area as required until enemy contact occurs; it then is given a reaction mission by the convoy commander.

## Actions at an Ambush

An ambush is one of the most effective ways to interdict a convoy. Conversely, reaction to an ambush must be immediate, overwhelming, and decisive. Actions on contact must be planned for and rehearsed so they can be executed as a drill by all escort and convoy elements, with care taken to avoid fratricide.

In almost all situations, the platoon will take several specific, instantaneous actions when

it must react to an ambush. These steps, illustrated in Figures 5-8A and 5-8B, include the following:

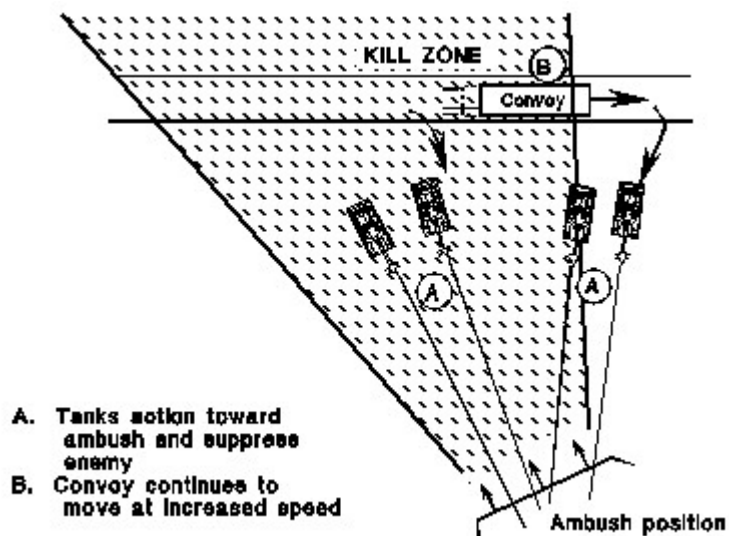
As soon as they acquire an enemy force, the escort vehicles action toward the enemy (Figure 5-8A). They seek covered positions between the convoy and the enemy and suppress the enemy with the highest possible volume of fire permitted by the ROE. Contact reports are submitted to higher headquarters as quickly as possible.

The convoy commander retains control of the convoy vehicles and continues to move them along the route at the highest possible speed (Figure 5-8A).

Convoy vehicles, if they are armed, may return fire only if the escort has not positioned itself between the convoy and the enemy force.

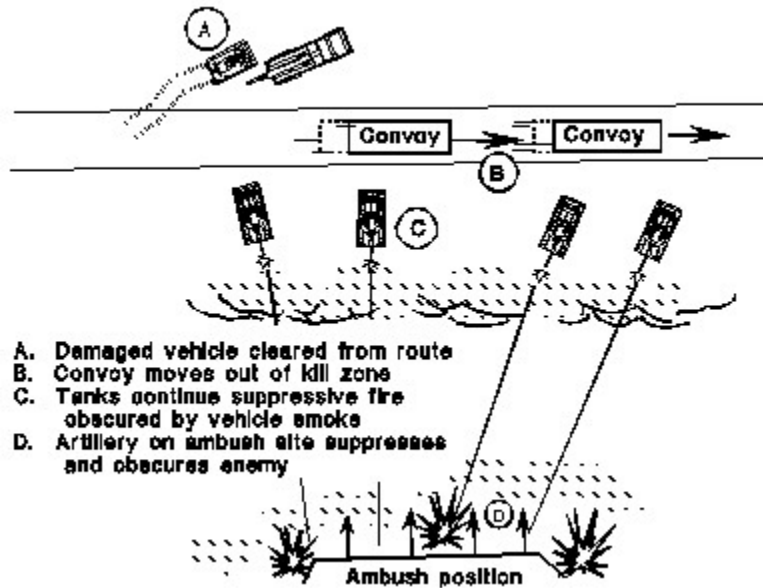
The platoon leader or the convoy commander may request that any damaged or disabled vehicles be abandoned and pushed off the route (Figure 5-8B).

The escort leader (in the example included here, this is the tank platoon leader) uses SPOTREPs to keep the convoy security commander informed. If necessary, the escort leader or the convoy security commander can then request support from the reaction force; he can also call for and adjust indirect fires.



168-144

Figure 5-8A. Convoy escort actions toward ambush.



144-144-216-144

**Figure 5-8B. Convoy continues to move.**

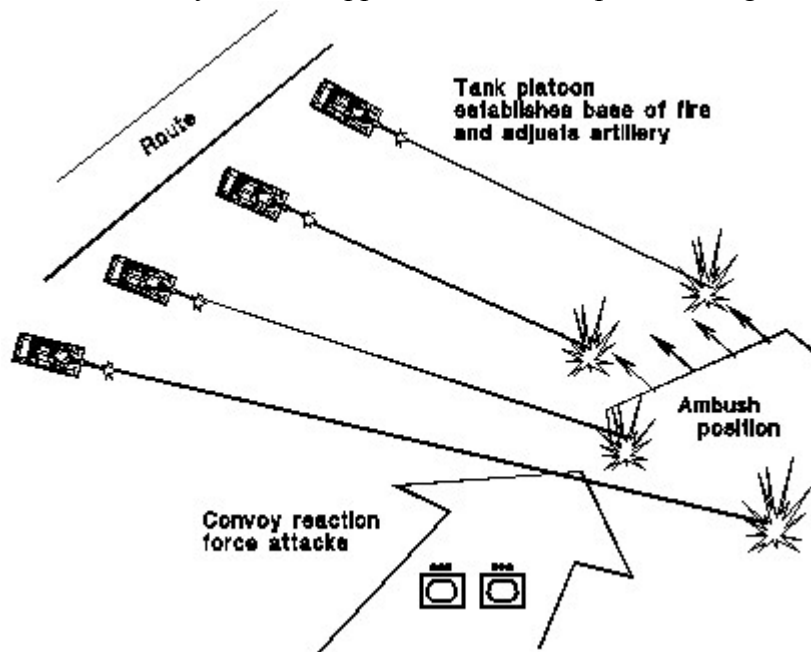
Once the convoy is clear of the kill zone, the escort element executes one of the following courses of action based on the composition of the escort and reaction forces, the commander's intent, and the strength of the enemy force:

Continue to suppress the enemy as combat reaction forces move to support (see Figure 5-9A).

Assault the enemy (see Figure 5-9B).

Break contact and move out of the kill zone (see Figure 5-9C).

In most situations, tanks will continue to suppress the enemy or execute an assault. Contact should be broken only with the approval of the tank platoon's higher commander.



72-72

**9A. Escort suppresses ambush for**

**Figure 5-**



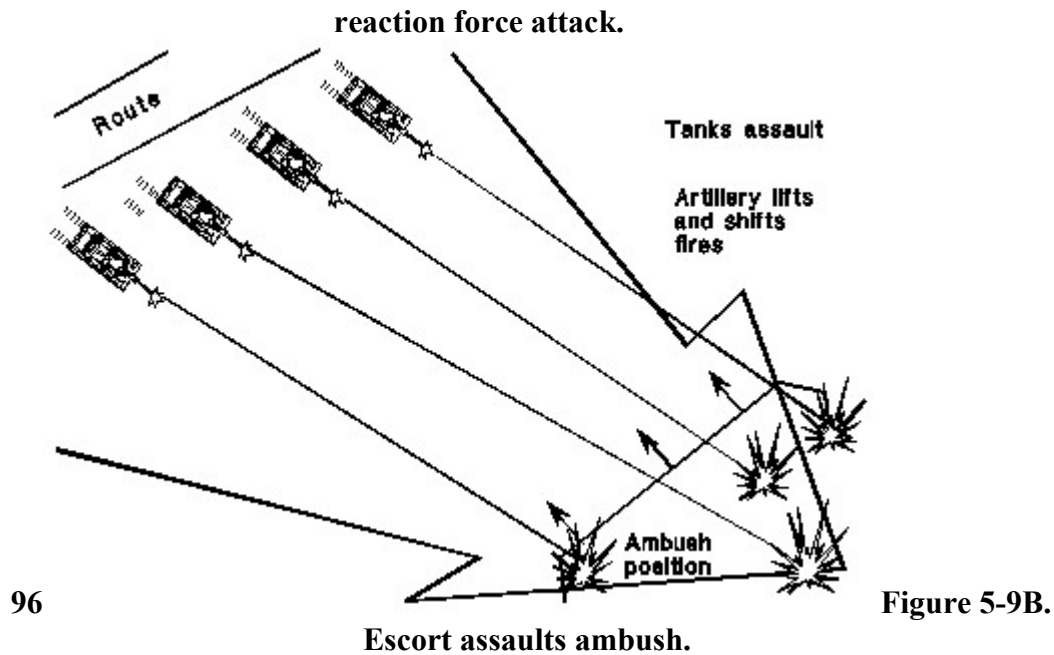


Figure 5-9B.

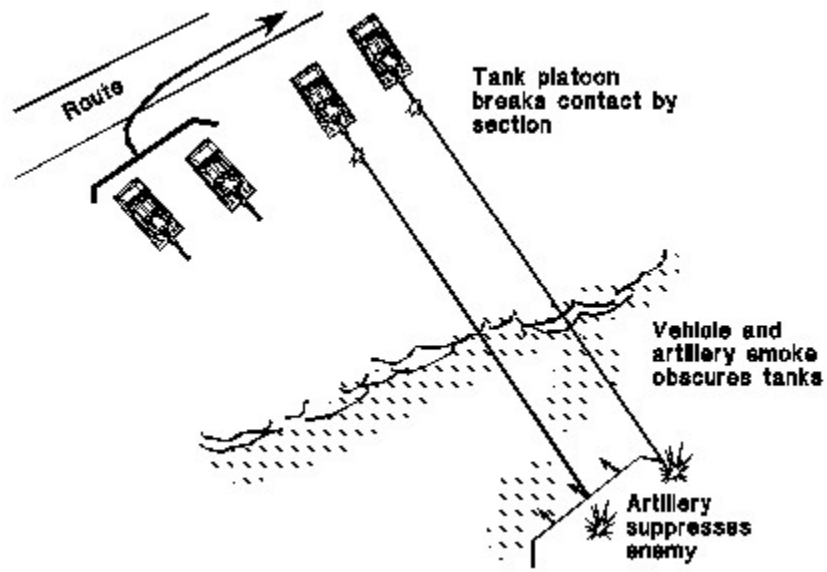


Figure 5-9C. Escort breaks contact.

## Actions at an Obstacle

Obstacles are a major threat to convoys. The purpose of the route reconnaissance ahead of a convoy is to identify obstacles and either breach them or find bypasses. In some cases, however, the enemy or its obstacles may avoid detection by the reconnaissance element. If this happens, the convoy must take actions to reduce or bypass the obstacle.

Obstacles can be used to harass the convoy by delaying it; if the terrain is favorable, the obstacle may be able to stop the convoy altogether. In addition, obstacles may canalize or stop the convoy to set up an enemy ambush. When an obstacle is identified, the convoy

escort faces two problems: reducing or bypassing the obstacle and maintaining protection for the convoy. Security becomes critical, and actions at the obstacle must be accomplished very quickly. The convoy commander must assume that the obstacle is overwatched and covered by the enemy.

To reduce the time the convoy is halted and thus to reduce its vulnerability, the following actions should occur when the convoy escort encounters a point-type obstacle:

The lead element identifies the obstacle and directs the convoy to make a short halt and establish security. The convoy escort overwatches the obstacle (see Figure 5-10) and requests that the breach force move forward.

The convoy escort maintains 360-degree security of the convoy and provides overwatch as the breach force reconnoiters the obstacle in search of a bypass.

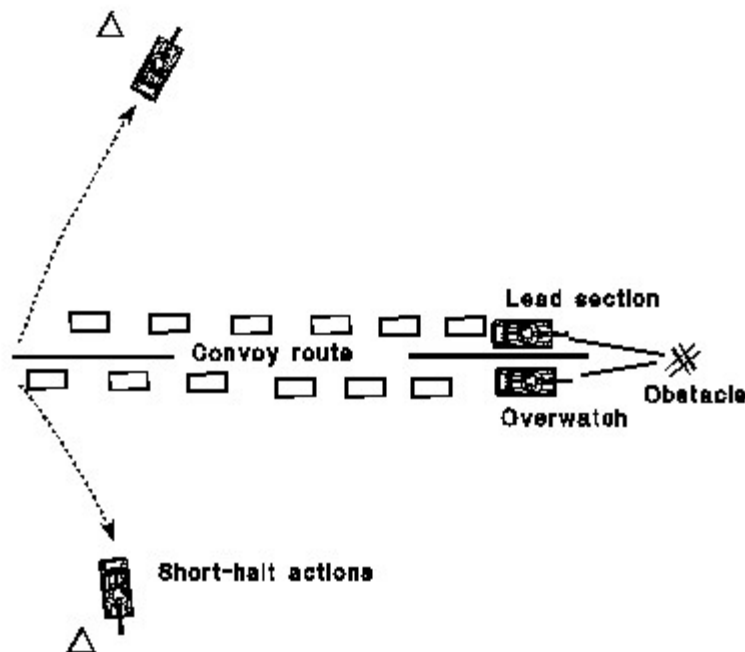
- Bypass the obstacle.

Breach the obstacle with the assets on hand.

Breach the obstacle with reinforcing assets.

The convoy security commander relays a SPOTREP higher and requests support by combat reaction forces, engineer assets (if they are not part of the convoy), and aerial reconnaissance elements.

Artillery units are alerted to be prepared to provide fire support.



72-48

**Figure 5-10. Convoy escort overwatches an obstacle.**

Tanks equipped with mine plows are ideal for breaching most obstacles encountered during convoy escort missions. If the convoy escort is required to breach limited obstacles using plow tanks, the platoon leader must maintain the security of the convoy,

ensuring that adequate support forces are in place to overwatch the breach operation.

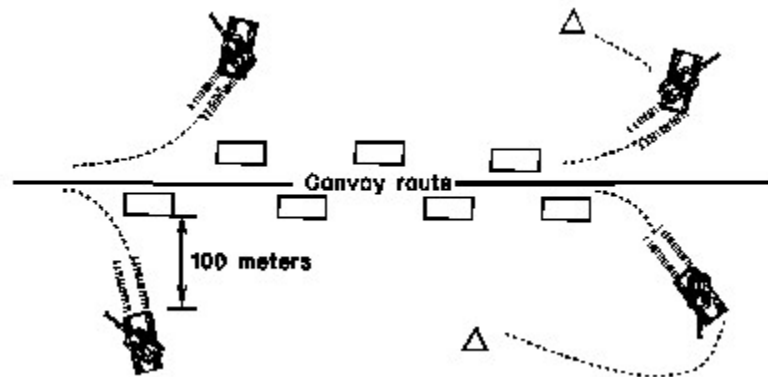
## Actions during halts

During a short halt, the convoy escort remains at REDCON-1 regardless of what actions the convoy vehicles are taking (refer to Appendix C for more information on REDCON levels). If the halt is for any reason other than an obstacle, the following actions should be taken:

- If possible, escort vehicles are positioned up to 100 meters beyond the convoy vehicles, which are just clear of the route (see Figure 5-11A). Escort vehicles remain at REDCON-1 but establish local security based on the factors of METT-T.

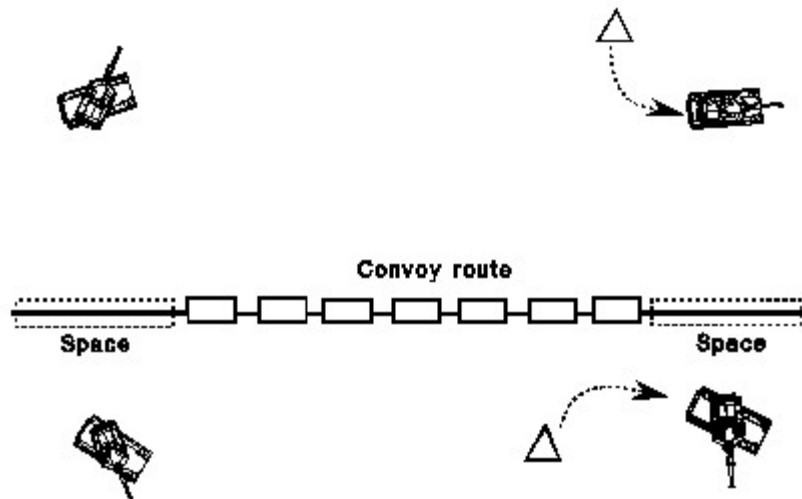
When the order is given to move out, convoy vehicles reestablish the movement formation, leaving space for escort vehicles (see Figure 5-11B). Once the convoy is in column, local security elements (if used) return to their vehicles, and the escort vehicles rejoin the column (refer to Figure 5-11C).

When all elements are in column, the convoy resumes movement.



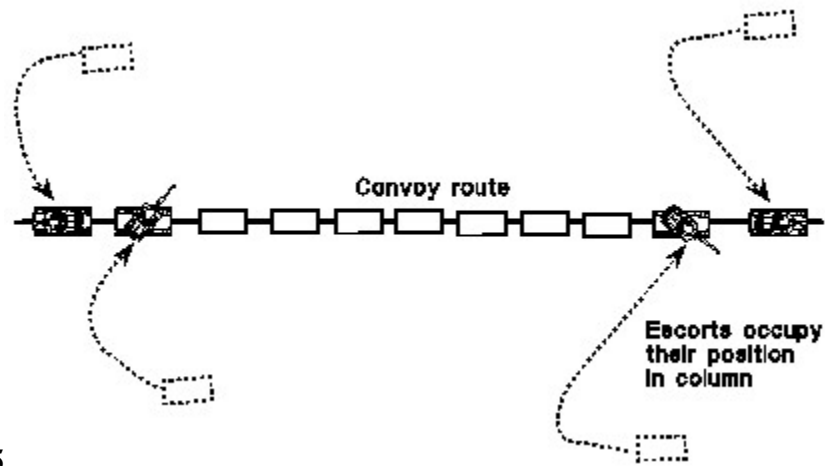
240-240-144-144

Figure 5-11A. Convoy assumes herringbone formation.



312-240-24

**Figure 5-11B. Convoy moves back into column formation.**



475-245

Figure

**5-11C. Convoy escort vehicles rejoin column.**

## **Section V. PASSAGE OF LINES**

The tank platoon participates in a passage of lines, in which one unit moves through the stationary positions of another, as part of a larger force. If it is part of the stationary force, the platoon occupies defensive positions and assists the passing unit. If it is part of a passing unit, the platoon executes tactical movement through the stationary unit. A passage may be forward or rearward.

Units are highly vulnerable during a passage of lines. Vehicles may be concentrated, and fires may be masked. The passing unit may not be able to maneuver and react to enemy contact.

Detailed reconnaissance and coordination are critical in overcoming these potential problems and ensuring the passage of lines is conducted quickly and smoothly. The commander normally conducts all necessary reconnaissance and coordination for the passage. At times, he may designate the XO, ISG, or a platoon leader to conduct liaison duties for reconnaissance and coordination. The following items of information are coordinated (an asterisk indicates items that should be confirmed by reconnaissance):

- Unit designation and composition; type and number of passing vehicles.
- Passing unit arrival time(s).
- Location of attack positions or assembly areas. \*
- Current enemy situation.
- Stationary unit's mission and plan (to include OP, patrol, and obstacle locations). \*
- Location of contact points, passage points, and passage lanes. (**NOTE:** The use of GPS/POSNAV waypoints will simplify this process and, as a result, speed the passage.) \*
- Guide requirements.
- Order of march.
- Anticipated and possible actions on enemy contact.
- Supporting direct and indirect fires, including location of the restrictive fire line (RFL). \*

NBC conditions.

Available CS and CSS assets and their locations. \*

Communications information (to include frequencies, digital data, and near and far recognition signals).

Chain of command, including location of the battle handover line (BHL).

Additional procedures for the passage.

## **Forward passage of lines**

During the forward passage, the passing unit first moves to an assembly area or an attack position behind the stationary unit. Designated liaison personnel move forward to link up with guides and confirm coordination information with the stationary unit. Guides then lead the passing elements through the passage lane.

The tank platoon conducts tactical movement to maximize its battle space within the limitations of the passage lane. Radio traffic is kept to a minimum. Disabled vehicles are bypassed. The platoon holds its fire until it passes the RFL. Once clear of passage lane restrictions, the platoon conducts tactical movement in accordance with its orders.

## **Rearward passage of lines**

Because of the increased chance of fratricide during a rearward passage, coordination of recognition signals and direct fire restrictions is critical. The passing unit contacts the stationary unit while it is still beyond direct fire range and conducts coordination as discussed previously. RFLs and near recognition signals are emphasized.

The passing unit then continues tactical movement toward the passage lane. Gun tubes are oriented on the enemy, and the passing unit is responsible for its own security until it passes the RFL. If guides are provided by the stationary unit, the passing unit may conduct a short halt to link up and coordinate with them. The passing unit moves quickly through the passage lane to a designated location behind the stationary unit.

## **Assisting a passage of lines**

As noted, the platoon provides this assistance while it is in stationary defensive positions. This can occur after the platoon has consolidated on an objective or has occupied a BP. Coordinating instructions may be in the form of a company OPORD or a FRAGO issued over the radio. The platoon leader may or may not have coordinated directly with the passing unit.

The platoon leader ensures that the platoon understands the points of coordination listed previously in this section. If the platoon is to provide guides to assist the passing unit, he selects the personnel and briefs them on the points of coordination. The guides are responsible for linking up with and guiding the passing unit through the passage lane and

for closing obstacles as necessary.

Control of direct fires is a critical role for the element that is assisting the passage of lines. In a forward passage, the stationary unit engages known enemy targets until the passing unit moves past the RFL (sometimes designated as the BHL). During a rearward passage, the passing unit contacts the stationary unit by radio at a point beyond the direct fire range of weapon systems. The stationary unit then holds all fires until the passing unit reaches the RFL.

## **Section VI. BREACHING OPERATIONS**

# **Obstacles**

Obstacles are any obstructions that stop, delay, divert, or restrict movement. They are usually covered by observation and enhanced by direct or indirect fires. There are two categories of obstacles.

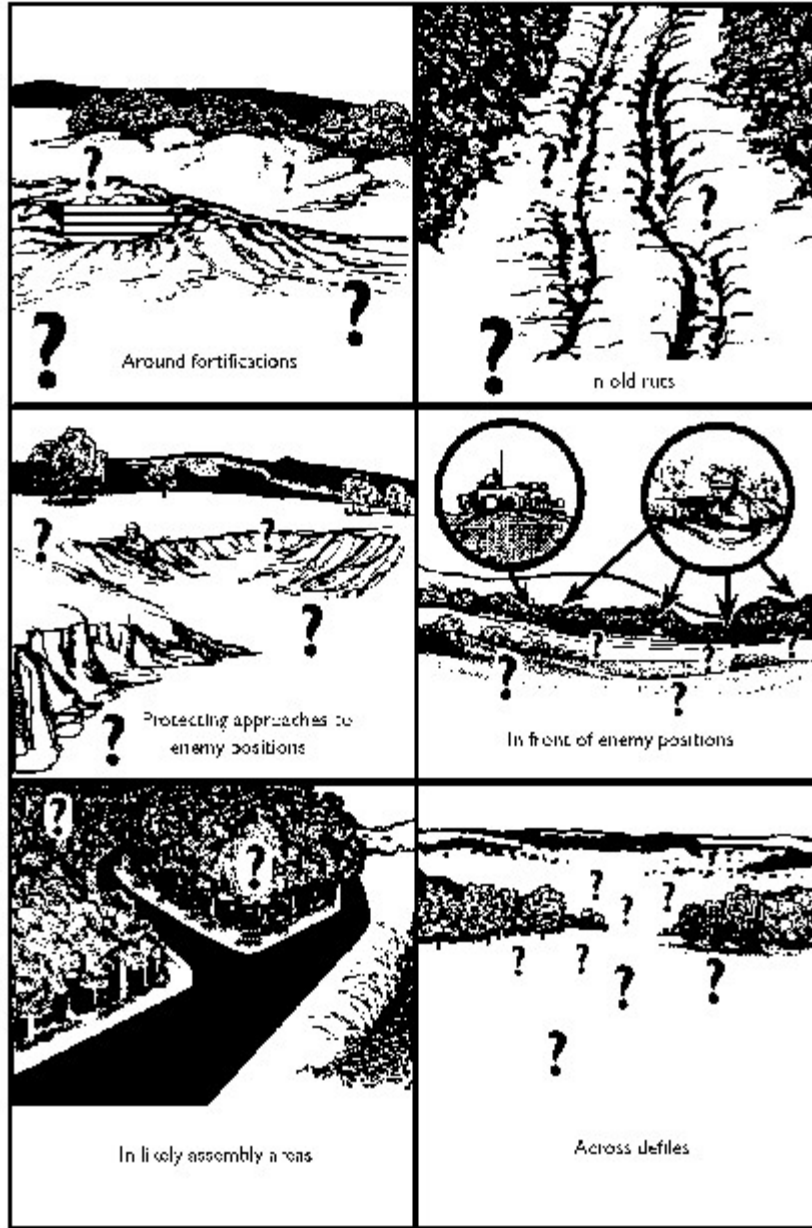
## **Existing Obstacles**

These are already present on the battlefield and are not emplaced through military effort. They may be natural or man-made. Examples of natural obstacles include the following: ravines, gullies, gaps, or ditches over 3 meters wide; streams, rivers, or canals over 1 meter deep; mountains or hills with a slope in excess of 60 percent (30 degrees); lakes, swamps and marshes over 1 meter deep; tree stumps and large rocks over 18 inches high; and forests or jungles with trees 8 inches or more in diameter and with less than 4 meters of space between trees on a slope. Man-made obstacles include built-up areas such as towns, cities, or railroad embankments.

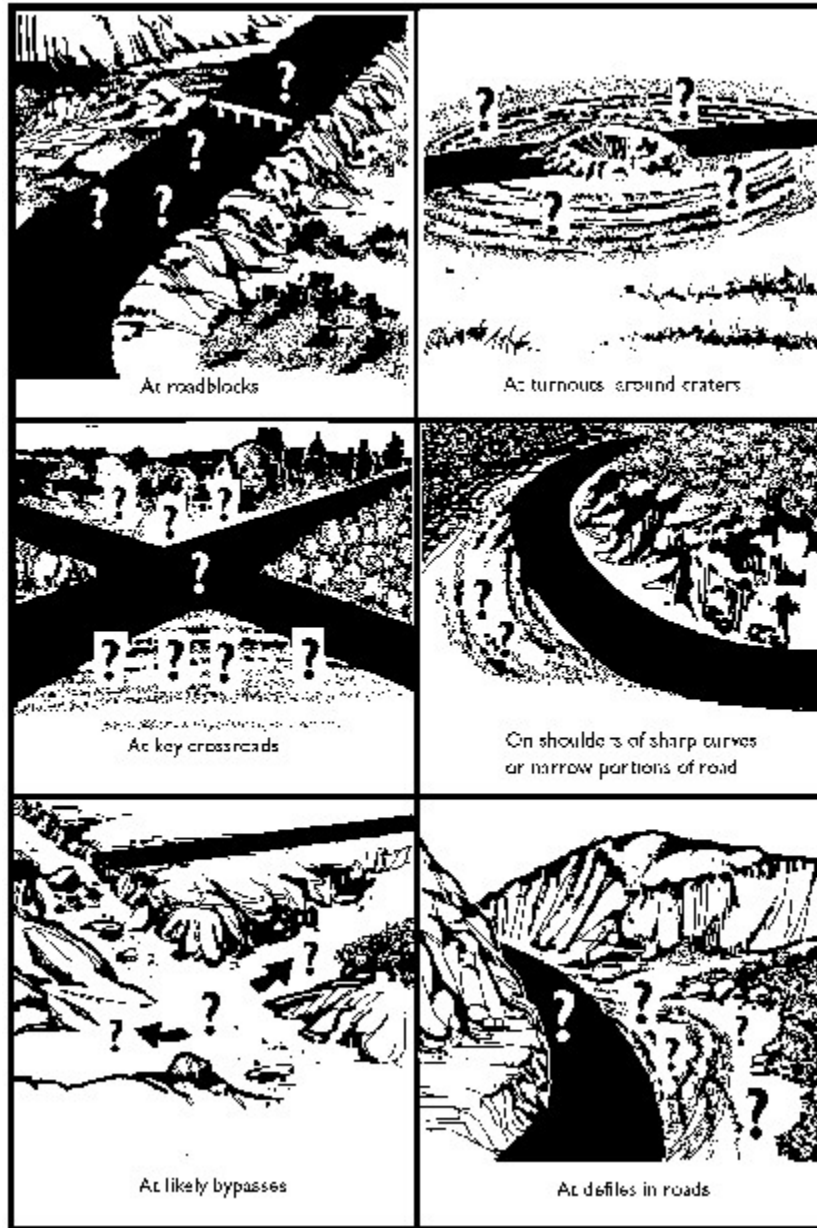
## **Reinforcing Obstacles**

Placed on the battlefield through military effort, these are designed to slow, stop, or canalize the enemy. Whenever possible, both friendly and enemy forces will enhance the effectiveness of their reinforcing obstacles by tying them in with existing obstacles. Examples of reinforcing obstacles are examined in the following paragraphs.

The minefield is the most common reinforcing obstacle the platoon will encounter on the battlefield. It is easier and quicker to emplace than other obstacles and can be very effective in destroying vehicles. The minefield may be emplaced in several ways: by hand, by air or artillery delivery using the family of scatterable mines (FASCAM), or by mechanical means (the Volcano system). It can be used separately or in conjunction with other obstacles (refer to Figure 5-12, pages 5-30 and 5-31, for possible minefield locations).



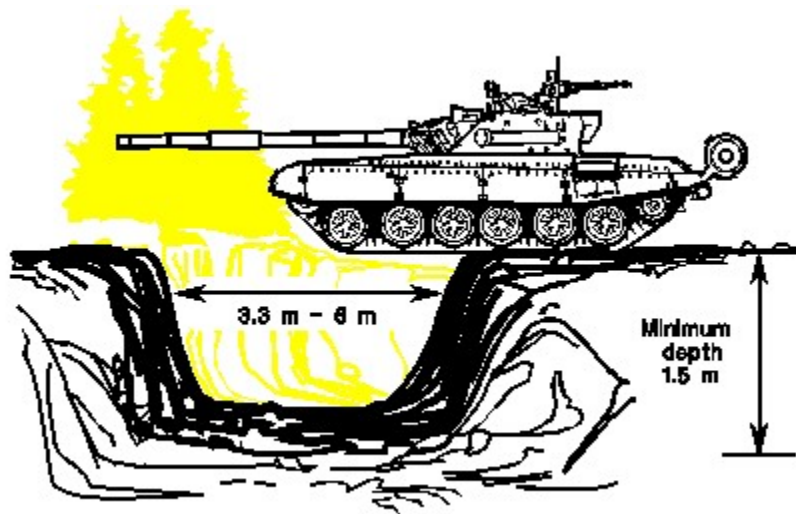
**Figure 5-12. Potential minefield locations.**



**Figure 5-12. Potential minefield locations (continued).**

The antitank ditch, illustrated in Figure 5-13, may be reinforced with wire and/or mines to make it more complex and more difficult for the attacker to overcome. In addition, soil from the ditch can be built up into a berm on the emplacing unit side.





**Figure 5-13. Antitank ditch.**

Road craters can be rapidly emplaced and are especially effective where restrictive terrain on the sides of a road or trail prevents a bypass (refer to Figure 5-14). Craters are at least 1.5 meters in depth and 6 meters in diameter and are usually supplemented with mines and/or wire.



**Figure 5-14. Road craters.**

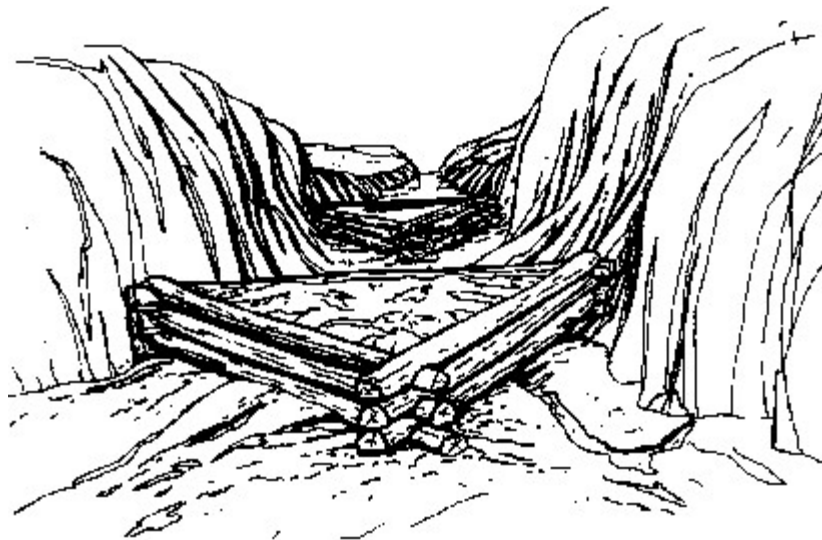
An abatis provides an effective barrier against vehicle movement. Trees are felled either by sawing or by use of explosives; the cut is made at least 1.5 meters above the ground, with the main trunks crisscrossed and pointed toward the enemy at approximately a 45-degree angle. The abatis is usually about 75 meters in depth and ideally is located on trails where there is no bypass; the trunk of each tree should remain attached to the stump to form an obstacle on the flanks of the abatis (see Figure 5-15). Abatises are usually mined or booby-trapped.



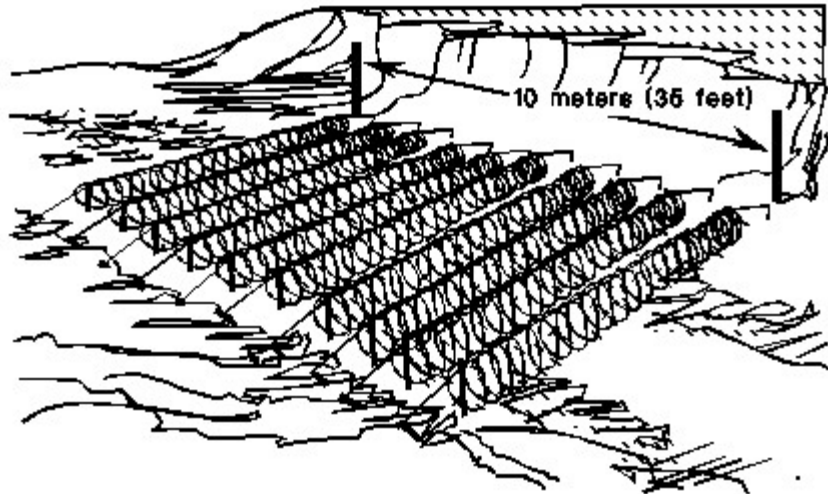
**Figure 5-15. Abatis.**

A log crib is a framework of tree trunks or beams filled with dirt and rock (see Figure 5-16, page 5-34). They are used to block roads or paths in wooded and mountainous terrain.

Wire obstacles are an effective and flexible antipersonnel barrier; they are frequently employed on dismounted avenues of approach in the form of tanglefoot, double- or triple-strand concertina, and four-strand fences. Employed in depth or in conjunction with mines, wire obstacles are also very effective against tanks and similar vehicles (see Figure 5-17). A single wire obstacle, however, will have little effect on armored vehicles; the sprocket of M1-series tanks is designed to cut wire.

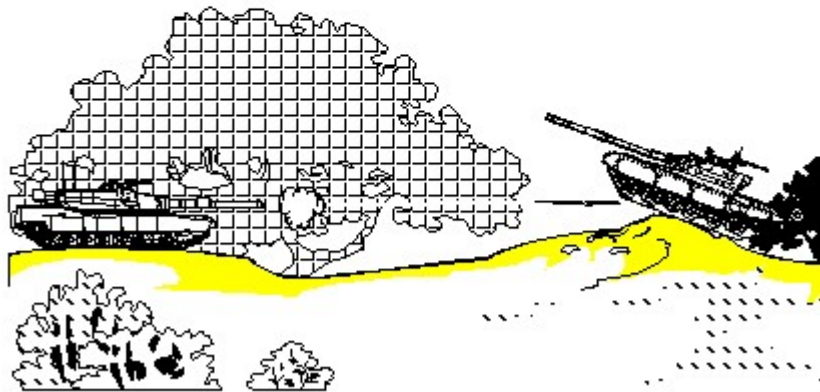


**Figure 5-16. Log cribs.**



**Figure 5-17. Wire obstacle in depth.**

A tank wall or tank berm is constructed of dirt and rock to slow or canalize enemy tanks; it also gives the defender "belly" shots while the attacker is unable to engage (see Figure 5-18).



**Figure 5-18. Belly shot created by tank berm.**

## Breaching procedures

Breaching operations entail the coordinated efforts of three task organized elements: the support force, the breach force, and the assault force. The discussion in this section covers the actions and responsibilities of these elements as well as the tank platoon's role

in the operation.

The following actions, known by the abbreviation SOSR, occur during a breaching operation:

Sufficient support elements are employed to **suppress** enemy elements that are overwatching the obstacle. The support force uses direct and indirect fires to accomplish its mission.

The support force requests immediate or preplanned smoke to **obscure** breach force operations.

The breach force creates and proofs a lane through the obstacle, allowing the assault force to **secure** the far side of the obstacle.

Actions taken to further mark and **reduce** the obstacle allow follow-on forces to continue the attack.

## Support Force

The support force usually leads movement of the breach elements. After identifying the obstacle, it moves to covered and concealed areas and establishes support by fire positions. The support force leader sends a voice or digital SPOTREP to the commander. This report must describe the location and complexity of the obstacle, the composition of enemy forces that are overwatching the obstacle, and the location of possible bypasses. The commander decides whether to maneuver to a bypass or to breach the obstacle. (**NOTE:** He must keep in mind that a bypass may lead to an enemy kill zone.)

In either case, the support force suppresses any enemy elements that are overwatching the obstacle to allow the breach force to breach or bypass the obstacle. The support force should be in position to request suppressive artillery fires and smoke for obscuration. As the breach and assault forces execute their missions, the support force lifts and shifts supporting fires. Because the enemy is likely to engage the support force with artillery, the support force must be prepared to move to alternate positions while maintaining suppressive fires.

## Breach Force

The breach force receives the location of the obstacle or bypass by means of a voice or digital SPOTREP. It then must organize internally to perform these responsibilities:

Provide local security for the breach site as necessary.

Conduct the actual breach, creating, proofing, and marking a lane through the obstacle or bypass.

Move through the lane to provide security for the assault force on the far side of the obstacle. In some instances, the breach force may move to hull-down firing positions that allow it to suppress enemy elements overwatching the obstacle. At other times, it may assault the enemy, with suppressive fires provided by the support force.

A tank platoon can create a lane by itself if it is equipped with the assets required to breach the type of obstacle encountered. If the platoon does not have this capability, it may be required to provide close-in protection for attached engineers with breaching assets. Three breaching methods are available to the platoon:

Mechanical breaching, usually with mine plows or mine rakes.

Explosive breaching, employing such means as the mine-clearing line charge (MICLIC), M173 line charge, or 1/4-pound blocks of TNT.

Manual breaching, with soldiers probing by hand or using such items as grappling hooks, shovels, picks, axes, and chain saws. Manual breaching is the least preferred method for the tank platoon.

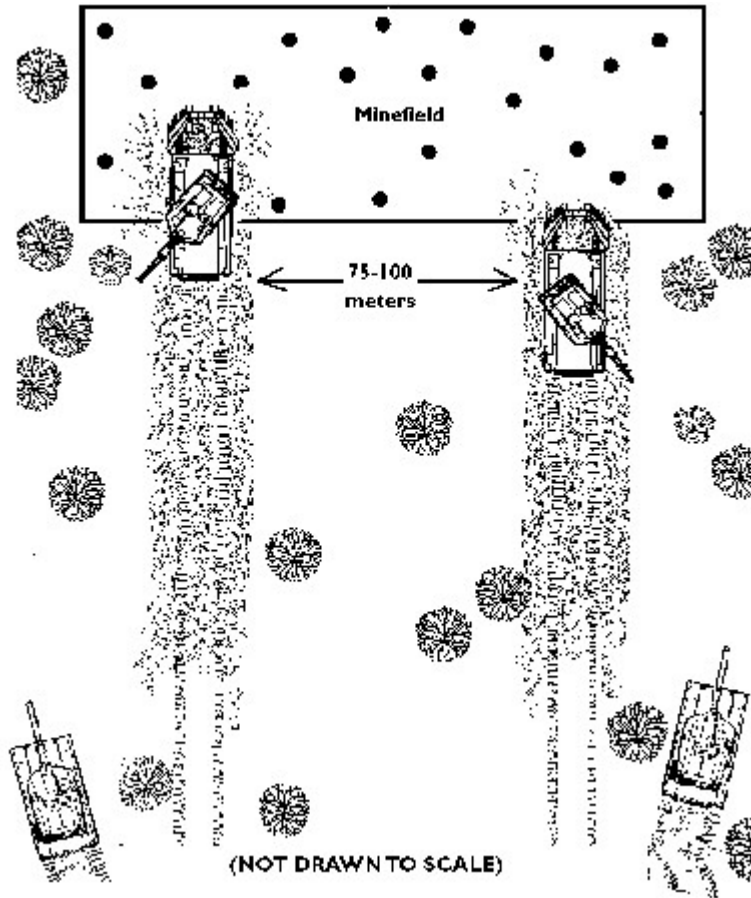
**NOTE:** In extreme cases, the commander may order the platoon to force through an obstacle. This technique requires the breach force to move in column formation through the obstacle location. If available, a disabled vehicle can be pushed ahead of the lead breach vehicle in an attempt to detonate mines.

The mine plow is the breaching device most commonly employed by the tank platoon. The battalion or company commander may allocate one to three plows per platoon. When properly equipped and supported, the platoon can create up to two lanes through an obstacle.

Plow tanks lead the breach force. Immediately following them are vehicles that proof the lane; these are usually tanks equipped with mine rollers. This process ensures that the lane is clear. (**NOTE:** If the location and/or dimensions of the obstacle are unknown, the platoon leader may choose to lead with tanks equipped with mine rollers to identify the beginning of the obstacle.)

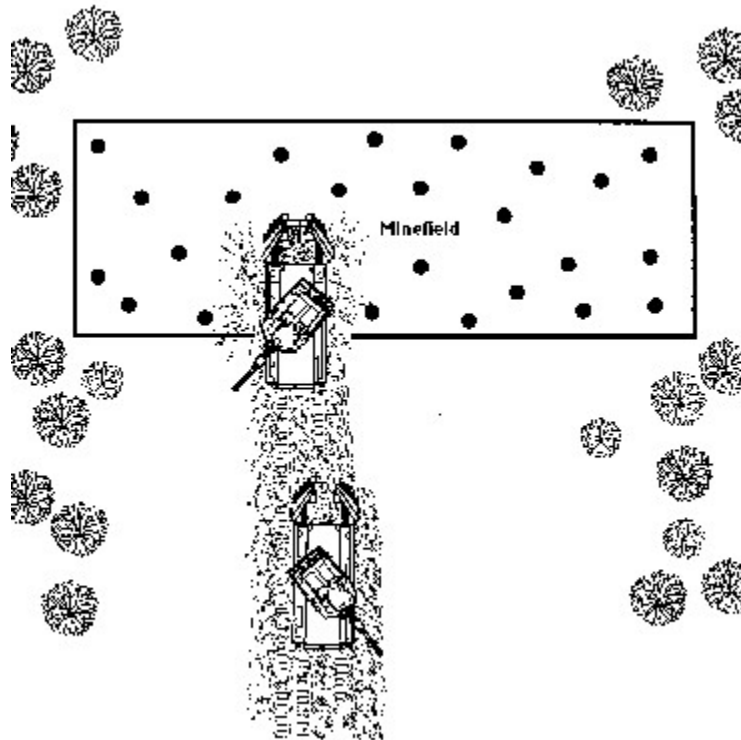
If the platoon is allocated one plow, the PSG's wingman normally serves as the breach tank. The PSG follows immediately behind to proof the lane and provide overwatch. The platoon leader's section follows the PSG.

If the platoon has two or more plows, it can create multiple lanes, usually 75 to 100 meters apart. The wingman tanks are normally equipped with the plows, with the section leaders' tanks following to proof the lanes and provide overwatch (see Figure 5-19A).



**Figure 5-19A. Plow tanks create multiple lanes while the section leaders' tanks provide overwatch.**

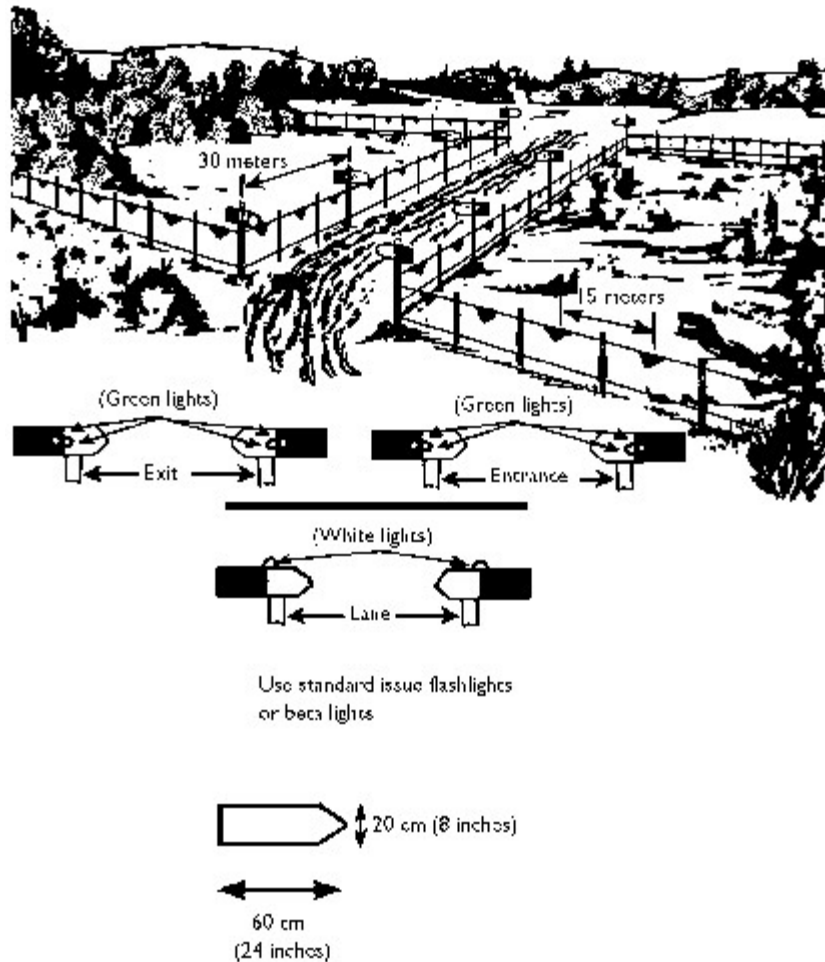
To create a wider lane, two plow tanks can stagger their movement along a single lane (see Figure 5-19B). An alternative method is for a plow tank to complete its initial pass through the obstacle, then to turn around and move back toward the friendly side to widen the lane or create a new lane.



**Figure 5-19B. Plow tanks use staggered movement to create a wider lane.**

After the lane is created and proofed, it can then be marked to ensure safe movement by vehicles and personnel; this is critical for follow-on forces that may not know the exact location of the cleared lane. Distinctive markers must show where the lane begins and ends. A visible line down the center is effective. Another technique is to mark both sides of the breached lane. Figure 5-20, page 5-40, shows a sample marking method. To minimize the necessary breaching time, the proofing vehicle may simultaneously mark the lane. Unit SOPs will dictate marking methods and materials, which commonly include the following:

- Cleared lane mechanical marking system (CLAMMS).
- Pathfinder system.
- Engineer stakes with tape.
- Guides.
- Chem lights.
- Expendable shell casings.



**Figure 5-20. Sample technique for obstacle lane marking.**

Throughout the operation, the platoon leader provides continuous updates of the breach force's progress to higher headquarters and other elements involved in the breach. He also coordinates with the support force for suppressive fires.

After marking is complete, the platoon leader uses voice and digital systems to report the location of the lane and the method of marking to expedite the movement of the assault force. Digital overlays enable units to move quickly to the breach lanes using the POSNAV or GPS. (**NOTE:** The assault force will often move behind the breach force and closely follow the breach vehicles through the new lane.)

## Assault Force

While the breach is in progress, the assault force assists the support force or follows the breach force while maintaining cover and dispersion. Once a lane is cleared through the obstacle, the assault force moves through the breach. It secures the far side of the obstacle by physical occupation and/or continues the attack in accordance with the commander's



intent. Tank units are ideally suited for assault force operations against mobile enemy defenses in open terrain. Tanks also work well with mechanized infantry as an assault force attacking dug-in enemy positions in close terrain.

## **Section VII. FOLLOW AND SUPPORT**

The tank platoon conducts follow and support missions when the enemy situation is extremely fluid or unknown. Normally, it executes the mission in support of dismounted infantry or scout platoons. On rare occasions, the platoon will follow and support other tank platoons or mechanized forces.

During the follow phase of the mission, the platoon conducts tactical movement or occupies hasty BPs while the lead (supported) element moves. There is no requirement to overwatch the movement of the lead element. In fact, this could be counterproductive; for example, the noise of a tank platoon that is following too closely could alert the enemy to the presence of the supported scout platoon or dismounted infantry. The tank platoon does, however, maintain a high degree of situational awareness. It maintains communications with the lead element, either by transmitting on a higher net or by monitoring the supported unit's net.

When the lead element makes contact with an enemy force it cannot destroy or bypass, it requests the support of the tank platoon to destroy or suppress the enemy. Based on the request, the platoon conducts linkup and coordination, then executes an offensive course of action as discussed in Chapter 3 of this manual. Appendix B contains additional information on light/heavy operations involving the tank platoon and dismounted (light) infantry.

## **Section VIII. PERIMETER DEFENSE**

The perimeter defense is conducted in the same manner as a defense from a BP (hasty or deliberate) except that it orients on a full 360-degree sector, normally through use of the coil formation (see Chapter 3). The purpose of the perimeter defense is to protect the force or hold key terrain when the force is not tied in with adjacent units. Common situations for the use of the perimeter defense include the following:

- Defense of assembly areas.

- Defense of specific installations or equipment (such as a TOC, downed aircraft, bridge, or roadblock).

- Defense of key terrain (such as a bridge, hilltop, pickup zone, or landing zone).

- When a unit has been isolated or bypassed by the enemy.

- As part of a larger force's perimeter defense; examples include the defense of lodgement areas, airfields, or assembly areas.

The tank platoon will normally execute a perimeter defense while attached to company- or battalion-size dismounted infantry units. The platoon may also establish a perimeter defense when it is operating alone and requires 360-degree security, such as during screen missions or while occupying platoon hide positions. Considerations for the execution of a perimeter defense include the following:

- One section or the entire platoon orients on the most likely mounted

avenues of approach.

A section or the entire platoon may occupy an assembly area within the perimeter as a reserve or reaction force. Missions of this force include moving to BPs that block potential areas of enemy penetration, conducting counterattacks to destroy an enemy penetration, and moving to BPs that add firepower to a portion of the defense.

To avoid disrupting other fighting positions, the platoon must carefully coordinate, reconnoiter, and conduct rehearsals on mounted movement routes to positions within the perimeter.

Tanks must never fire over the heads of unprotected personnel. The concussion of the main gun as well as discarded sabot petals can endanger these troops.

## **Section IX. SCREEN**

The screen is a common security mission for cavalry troops and company teams. Cavalry troops conduct stationary or moving flank screens. Company teams usually establish screen lines (for counterreconnaissance purposes) in front of a task force as part of a defense. Purposes of the screen include the following:

- Provide early warning of enemy approach.

- Provide real-time information, reaction time, and maneuver space to the protected force.

- Impede and harass the enemy.

- Facilitate counterreconnaissance operations, allowing the screening force, within its capability, to destroy enemy reconnaissance elements.

During stationary screens, the tank platoon will normally occupy a hide position or a hasty defensive position in depth behind OPs. The OPs are provided by scout or mechanized infantry platoons. When the OPs identify the enemy, the commander issues FRAGOs for the tank platoon to conduct tactical movement and occupy a hasty defensive position or an attack by fire position; the platoon also may conduct a hasty attack to destroy the enemy. At times, the tank platoon may occupy a hasty BP as part of the screen line, acquiring and killing the enemy forward of the position. During the conduct of a stationary screen, the tank platoon may be required to break contact or conduct a withdrawal and then execute a passage of lines. These tasks are discussed in other sections of this chapter.

In a moving flank screen (platoons normally execute this as a follow and support operation, discussed earlier in this chapter), the tank platoon conducts tactical movement to the rear of scout platoons. It may periodically occupy hasty BPs. When the scouts identify enemy elements, the commander issues a FRAGO for the tank platoon to occupy a hasty defensive position or attack by fire position or to conduct a hasty attack to destroy the enemy.

It is critical that the tank platoon leader keep these considerations in mind during all screen operations:

- OPSEC requirements.** During screen missions, the platoon may be

required to operate apart from other units.

**Location and identification of friendly forces.** The platoon leader should know all patrol routes and OP locations within the platoon's battle space.

The platoon should maintain voice and digital (if available) communications with the OPs.

**Engagement criteria.** To reduce the potential for fratricide, engagement criteria should be as specific as possible when friendly units operate to the front and flanks of the tank platoon as it executes a screen mission.

## **Section X. DELAY**

The delay is a continuous series of defensive actions over successive positions in depth. The purpose is to trade the enemy space for time while retaining freedom of action. Tank teams involved in a delay operation maximize the use of terrain and obstacles, maintaining contact with the enemy but avoiding decisive engagement. In some instances, local counterattacks are used to assist units during a disengagement or to take advantage of battlefield opportunities.

The tank platoon conducts the delay as part of a company team. In some cases, it will occupy either a hasty or deliberate BP; it will then disengage and occupy subsequent BPs in depth as part of the delaying force. The platoon may also be required to conduct local counterattacks or to support the movement of other platoons during the delay. The considerations involved in planning and executing a delay at platoon level are the same as for offensive operations (refer to Chapter 3) and defensive operations (refer to Chapter 4).

## **Section XI. RELIEF IN PLACE**

A relief in place occurs when one unit assumes the mission of another unit. It may be accomplished during either offensive or defensive operations, preferably during periods of limited visibility.

A relief requires detailed planning. OPSEC is critical. When time is available and the situation permits, the incoming platoon leader coordinates with the in-place platoon leader and conducts a reconnaissance to confirm details of the relief. The two leaders should coordinate and exchange the following information:

- The enemy situation and other pertinent intelligence.

- The platoons' maneuver and fire support plans.

- The location of weapons and fighting positions.

- Sketch cards and fire plans (this includes grid locations for input into digital systems).

- Details of the relief, to include the sequence, the use of recognition signals and guides, and the time of change of responsibility for the area.

- The transfer of excess ammunition, POL, wire lines, and other materiel to the incoming unit.

- Command and signal information.

Reconnaissance of the position is the same as for any BP. The incoming platoon leader should note the following:

- The engagement area, to include decision points, trigger lines, TRPs,

obstacles, and the break point.  
Primary, alternate, and supplemental fighting positions.  
Routes to and within the BP.  
Hide positions.  
Location of guides.

After reconnaissance and coordination are complete, the platoon leaders continue with their troop-leading procedures and prepare to execute the relief. There are two methods by which to conduct a relief in place:

Simultaneous. All elements are relieved simultaneously.  
Sequential. The relief takes place one element at a time (by individual vehicle or by section).

Initially, the relieving unit moves to an assembly area behind the unit to be relieved. Final coordination is conducted, and information is exchanged between the two units. The relieving unit links up with guides or finalizes linkup procedures. Individual vehicles then relieve forward positions using one of three techniques:

The relieving vehicles occupy primary positions after the relieved unit has moved to alternate positions. Once OPs are in place, the relieved unit can withdraw.  
The relieving vehicles occupy alternate positions while the relieved unit remains in primary positions. Once OPs are in place, the relieved unit withdraws. The platoon leader then orders the relieving unit to occupy primary positions as necessary.  
The relieving unit occupies a hide position while the relieved unit occupies hide, primary, or alternate positions. Once OPs are in place, the relieved unit withdraws.

As noted, OPSEC is critical in preventing enemy reconnaissance and intelligence assets from identifying the weaknesses and vulnerabilities that occur during the relief. Net discipline is the key to an effective, and secure, relief operation. Before beginning the relief, the relieving unit changes to the outgoing unit's frequency, and the two units operate on the same net throughout the relief. The incoming unit observes radio listening silence while the outgoing unit maintains normal radio traffic.

By monitoring the same frequency and maintaining digital links, leaders at all levels have the ability to contact other units involved in the relief to warn of emergency situations, such as enemy contact. Because of the proximity of the relieved and relieving elements, however, leaders must remember that the net will be crowded, with many stations and digital links competing for limited availability of "air time."

Once the relief is complete, there are two methods for returning to separate unit frequencies. One technique is to have the incoming unit switch back to its original frequency. The other is to have the outgoing unit switch to an alternate frequency. There are several advantages for the latter technique:

The relieving unit establishes voice and digital communications and is prepared to defend immediately upon the exit of the relieved unit.  
The relieving unit never loses the digital link (if applicable) as it assumes

the new mission. Once the relief is complete, the relieved unit simply logs off the digital net and switches to an alternate FM frequency; it can then reestablish a digital link after leaving the relief site.

Maintaining radio traffic on the same frequency before, during, and after the operation will help deceive the enemy as to whether a relief has occurred.

## **Section XII. WITHDRAWAL**

The purpose of this retrograde operation is to free a force in contact with the enemy so it can execute a new mission. Conducting a withdrawal at platoon level is identical to disengagement (see Chapter 4). The withdrawal may be conducted under pressure (with direct or indirect fire enemy contact) or with no pressure.

## **CHAPTER 6**



# **Combat Support**

The tank platoon must take full advantage of available CS assets to accomplish its mission and to reduce its vulnerability on the battlefield. CS may be provided by mortars, FA, combat engineers, ADA, and aviation assets. These assets are not organic to the tank platoon, but they may be available to the platoon through its parent battalion, company, or cavalry troop. The platoon leader must understand the capabilities and limitations of each CS asset.

## **CONTENTS**

Section 1 Indirect Fire Support

Section 2 Army Aviation

Section 3 Combat Engineers

Section 4 Air Defense

Section 5 Air Support

## **SECTION 1 - INDIRECT FIRE SUPPORT**

Mortars and FA are the primary means of indirect fire support available to tank platoons. In addition to understanding the capabilities and limitations of these assets, platoon leaders and their TCs must know what fire request channels to use to request fires. They must also understand how to work with the FIST at company team/troop level to plan and coordinate indirect fires. FM 6-30 explains how to call for and adjust fires.

### **MORTAR SUPPORT**

Mortars afford indirect fire support that is immediately responsive to the tank platoon's needs. A 120-mm mortar platoon of six tubes is organic to armor and mechanized infantry battalions. A 120-mm mortar section is organic to the armored cavalry troop (two tubes) and divisional cavalry troop (two tubes).

## Capabilities

With a maximum effective range of 7,200 meters, 120-mm mortars can provide a heavy volume of accurate, sustained fires. They are ideal weapons for attacking a variety of targets, including the following:

- Infantry in the open.

- Targets on reverse slopes.

- Targets in narrow ravines or trenches.

- Targets in forests, towns, and other areas that are difficult to strike with low-angle fires.

In addition to these highly flexible targeting options, mortars have the following capabilities and advantages:

- They offer fast response time.

- They are effective against low-density targets.

- Mortar rounds afford highly destructive target effects.

## Limitations

Mortars are limited in the following ways:

- Their maximum range is limited in comparison to the indirect fire support capability of FA elements.

- They cannot be used against targets inside their minimum effective range (770 meters from the mortar tube position).

- Only limited types of ammunition are available.

- Mortar elements carry limited amounts of ammunition.

- Their fire direction center (FDC) and tubes are not linked to the tactical fire direction system (TACFIRE).

## Employment considerations

Mortars can be extremely effective when used for the purposes outlined in the following discussion.

***Destruction. High explosive (HE) rounds, mounted with variable-timed (VT) fuzes, can be used to destroy or disperse dismounted infantry and vehicles that are in the open. HE mortar rounds have the capability to destroy or disable some armored vehicles.***

***Suppression. HE rounds can be used to force the enemy to button up or move to less advantageous positions.***

***Smoke. Mortar smoke builds up more rapidly than artillery smoke. White phosphorus (WP) rounds are used for obscuration and screening. See Appendix E of this manual for detailed information on the use of smoke.***

***Illumination. Illumination rounds are used to light an area or enemy position during periods of limited visibility. Illumination can increase the effectiveness of the tank platoon's image intensification devices (passive sights). This helps the platoon in***

*gathering information, adjusting artillery fire, and engaging enemy targets. Ground-burst illumination can also be used to mark enemy positions and to provide a thermal TRP for control of fires.*

*Units must be careful, however, not to illuminate friendly positions. Also, because US night vision devices are superior to those of most potential adversaries, illuminating the battlefield may be unnecessary or even counterproductive.*

### **FIELD ARTILLERY SUPPORT**

*Tank platoon leaders must fully understand how to use artillery support to their best advantage. It is often their primary means of impeding and disrupting enemy formations and suppressing enemy positions. FA can provide immediate, responsive, accurate fires with a wide variety of munitions.*

*FA support is normally provided by an artillery battalion in direct support (DS) of a committed maneuver brigade. Each ground squadron in the armored cavalry regiment (ACR) has its own organic howitzer battery to provide dedicated indirect fire support. The platoon generally receives FA support through its attached company or troop FIST.*

#### **Capabilities**

*In support of the tank platoon, FA elements can accomplish the following tasks:*

*They can be employed to provide immediate suppression on unplanned targets.*

*Through careful positioning and timely displacement, they can provide continuous fire support on planned targets in all weather conditions and types of terrain.*

*They allow commanders and platoon leaders to shift and mass fires rapidly.*

*They offer a variety of conventional shell and fuze combinations.*

*They can provide obscuration smoke to conceal movement.*

*They can fire battlefield illumination rounds as necessary.*

#### **Limitations**

*FA support has the following limitations:*

*It has only limited capability against moving targets.*

*It has limited capability to destroy point targets without considerable ammunition expenditure.*

*Because of its firing signature, it is highly vulnerable to detection by enemy target acquisition systems.*

#### **Employment considerations for FA munitions**

*FA elements employ several types of munitions. These can be tailored for the engagement of different types of targets, as well as for other missions such as smoke and illumination. The following discussion outlines uses of FA munitions.*

*High explosive. HE munitions are used against personnel, field fortifications, and vehicles.*

*White phosphorus. WP is used for obscuration, screening, and burning.*

*Illumination. Employment of FA illumination rounds is similar to that for mortar rounds. Refer to the discussion of mortar employment earlier in this section.*

*Cannon-launched guided projectiles (Copperhead). These rounds are employed against high-priority point targets.*

*Improved conventional munitions and dual-purpose improved conventional munitions. Improve conventional munitions (ICM) are designed for antipersonnel (AP) use. DPICM are employed against personnel and light armored vehicles in the open. The danger to friendly troops in areas where AP munitions are fired must be considered. The dud rate of ICM makes maneuver in the area of an ICM field hazardous.*

*Scatterable mines. These include area denial munitions (ADAM) for use against personnel and remote antiarmor mines (RAAM) for use against armored vehicles. A mission involving scatterable mines requires the support of FA assets up to battery-size; it must be planned and requested with significantly more lead time than is needed for other FA-delivered munitions.*

### **FIRE TEAM SUPPORT**

*The FIST is attached to companies or troops for combat operations. It may be pushed forward with a security force in support of operations when on-target designation is required for special munitions engagements. The FIST, however, is a valuable resource because of its command and control link with the artillery; it should not be exposed to direct fire except when absolutely necessary.*

### **Support considerations**

*FISTs are organized, equipped, and trained to provide the following personnel and support to the company or troop:*

*A fire support advisor and coordinator.*

*A communications link to all available indirect fire support assets.*

*On-the-spot support for infantry companies (10-man team) or for armor companies and cavalry troops (4-man team).*

### **Communications**

*The armor or mechanized infantry FIST normally monitors the following radio nets:*

*Attached unit command net (battalion, company team, or troop).*

*Battalion mortar fire direction net.*

*DS battalion fire direction net (digital).*

*Battalion fire support net (voice).*

*The armored cavalry troop FIST normally monitors these radio nets:*

*Troop command net.*



*Troop fire support net.*

*Supporting artillery fire direction net (digital and voice).*

*Squadron fire support net.*

*The FIST serves as the net control station (NCS) on the troop fire support net, while the fire support element (FSE) serves as the NCS on the maneuver battalion fire support net. The FIST relays calls for fire to supporting artillery on a digital net (TACFIRE) or sends the fire mission to the mortar platoon or section. The command net allows the FIST to monitor operations and links the FIST to the commander and platoon leaders for planning and coordination.*

### **FIST vehicle**

*The FIST usually rides in and operates from the M981, known as the FIST-V. Refer to Figure 6-1 for an illustration.*



**Figure 6-1. Fire support team vehicle.**

### **FIRE REQUEST CHANNELS**

*In a tank company, all requests for indirect fire support are normally sent through the FIST on the company or troop command net. The commander approves the request using a prearranged method (oral approval or silence). The FIST selects the best available fire support asset to engage the target. Adjustments of the fire mission normally are also sent to the FIST, which then relays the message to the artillery unit on a digital fire direction net or to the battalion mortars on the fire support net. In cavalry troops, the FIST may pass the fire mission to the troop mortars; all adjustments are sent directly to the mortars.*

*Besides specific requests sent to the FIST, the platoon can obtain fire support in several other ways:*

*Calls for fire can result from SPOTREPs sent on the company or troop command net; the company FIST eavesdrops on the net and requests fires on targets of opportunity and on targets approved by the commander.*

*Requests for fire can be "tagged" onto preformatted SPOTREPs and contact reports sent via IVIS or FBCB2. The TC presses the button for "request fire," "immediate suppression," or "immediate smoke" when sending an IVIS or FBCB2 report (see Figures 6-2 and 6-3).*

*Requests for fire support can be entered directly into the TACFIRE system using IVIS or FBCB2. Using the digital system, the platoon leader can exit a*

communications net and link into the TACFIRE system. Once the request is complete, the platoon leader exits the TACFIRE system and reenters the unit's net. Unit SOP will dictate the use of this TACFIRE capability; see FKSM 17-15-3 for details.

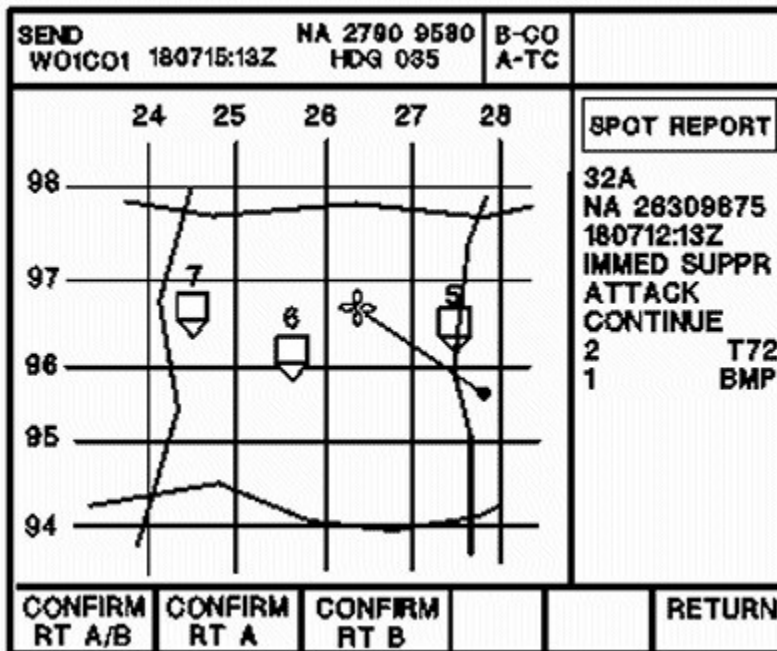


Figure 6-2. IVIS SPOTREP (immediate suppression request).

**Combat Messages**

Equipment:  ▼  + - DTG:  Now

▼  + - Fire Request Type:  ▼

▼  + - Protection Level:  ▼

Location:  Method of Control:  ▼

No messages sent this session.

*Figure 6-3. FBCB2 SPOTREP (immediate suppression request).*

**CALL FOR FIRE**

*The call for fire is the primary means by which a unit requests indirect fire support. The following discussion of the call for fire process covers three phases of the indirect fire mission:*

*The initial call for fire, which encompasses six elements and is sent in a standard three-transmission format.*

*Subsequent adjustments to the indirect fire support.*

*The refinement and surveillance actions necessary to complete the mission.*

**Initial call for fire**

*As noted, the standard call for fire consists of three basic transmissions, which in turn comprise six elements:*

*Observer identification and warning order (first transmission).*

*Target location (second transmission).*

*Target description, method of engagement, and method of fire and control (third transmission).*

*Observer identification and warning order (first transmission). Observer identification tells the FDC who is calling. It also clears the net for the duration of the call. The*

*warning order tells the FDC the type of mission and the method of locating the target. The types of indirect fire missions are the following:*

*Adjust fire. This is used when the observer is uncertain of the exact target location. The observer says, "ADJUST FIRE."*

*Fire for effect. The observer should always attempt first-round fire for effect if he is sure his target location is correct. He should also be sure the rounds of the first volley will have the desired effect on the target so little or no adjustment will be required. The observer announces, "FIRE FOR EFFECT." (NOTE: On IVIS- or FBCB2-equipped vehicles, properly updated POSNAV data and an accurate lase to the target provide extremely accurate target designation capability. This enables observers to call "FIRE FOR EFFECT" on the first transmission.)*

*Suppression. The word "SUPPRESS" is used to quickly bring fire on a preplanned target. This is a simplified call for fire and is sent in one transmission. Example: "G24 – THIS IS G59 – SUPPRESS AF2401 – OVER." Target description is not announced.*

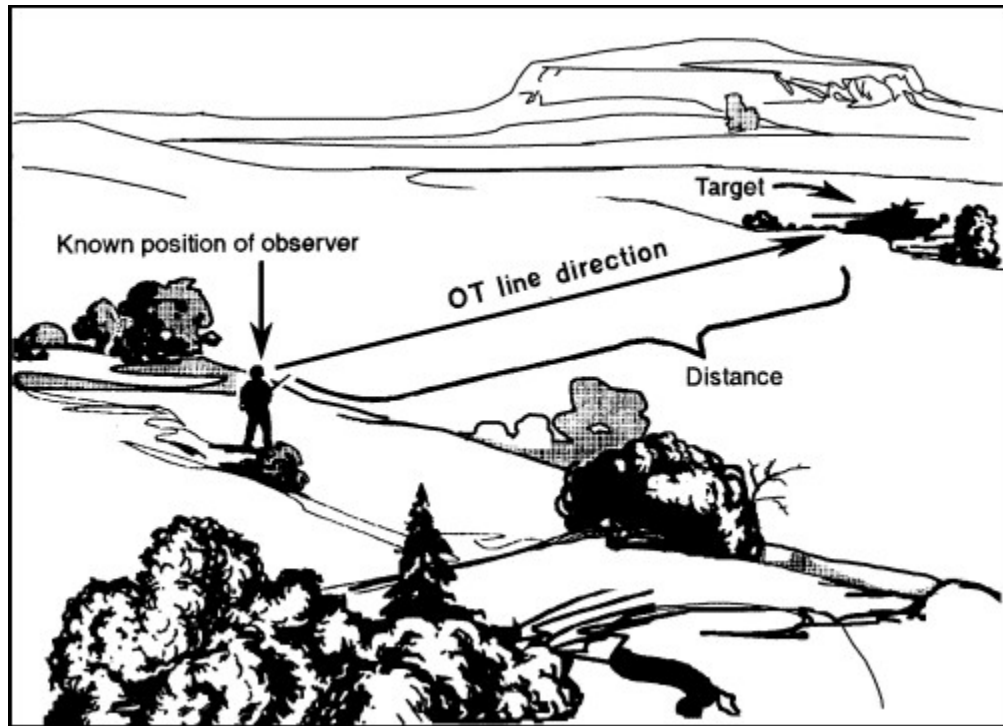
*Immediate suppression. This is used to bring fire quickly on a planned target or a target of opportunity that is firing at a friendly unit or aircraft. As an example, the observer says, "G24 – THIS IS G57 – IMMEDIATE SUPPRESSION AF2402 – OVER." Target description is not announced.*

*Immediate smoke. This is used to place smoke quickly on a planned target or a target of opportunity that is firing at a friendly unit. Sample transmission: "G24 – THIS IS G54 – IMMEDIATE SMOKE AF2405 – OVER."*

**Target location (second transmission).** Following the type of mission, the method of target location is announced; this prepares the FDC to receive the data sent by the observer and apply it to locate the target. The three methods for locating targets are grid, polar plot, and shift from a known point. The polar and shift methods are announced to the FDC. If the observer does not specify either polar or shift, the FDC knows the grid method is being used; the word "grid" is not announced. Example: "H24 – THIS IS H67 – FIRE FOR EFFECT – POLAR – OVER."

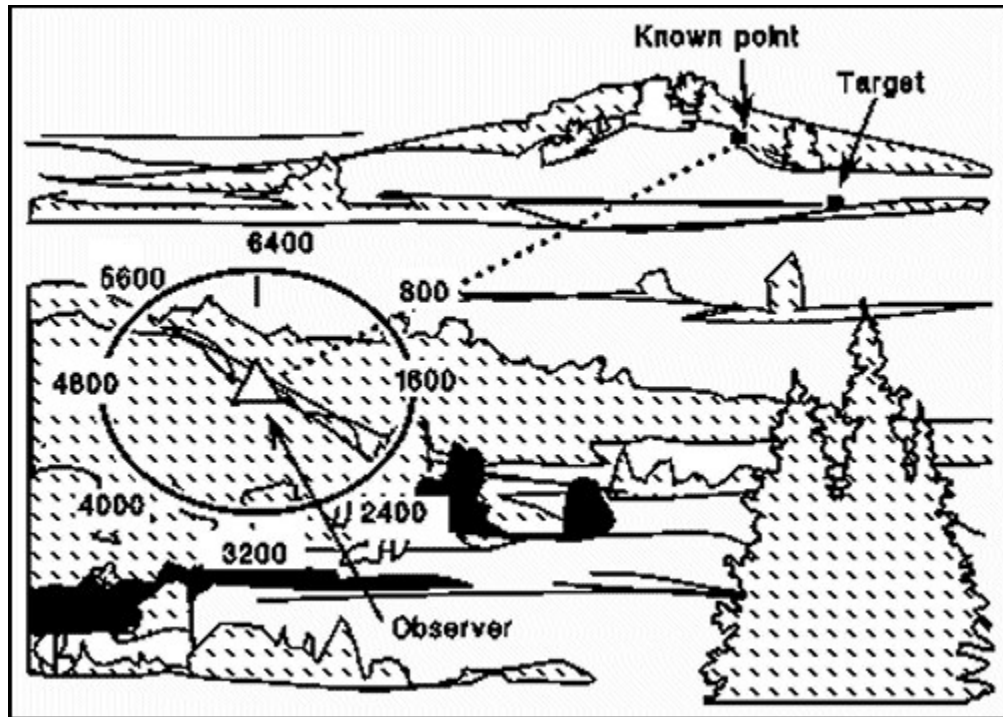
**Grid method.** In the grid method, the target location normally consists of a two-letter grid zone identifier with six digits (example: "AB180739"). The direction from the observer to the target (in mils, if possible) must be given to the FDC after the call for fire, but before the first adjusting rounds are shot.

**Polar plot method.** This method requires that the observer and the FDC know the observer's exact location. The observer determines the direction (to the nearest 10 mils) of the observer-target (OT) line and the distance (to the nearest 100 meters) from his position to the target (see Figure 6-4).



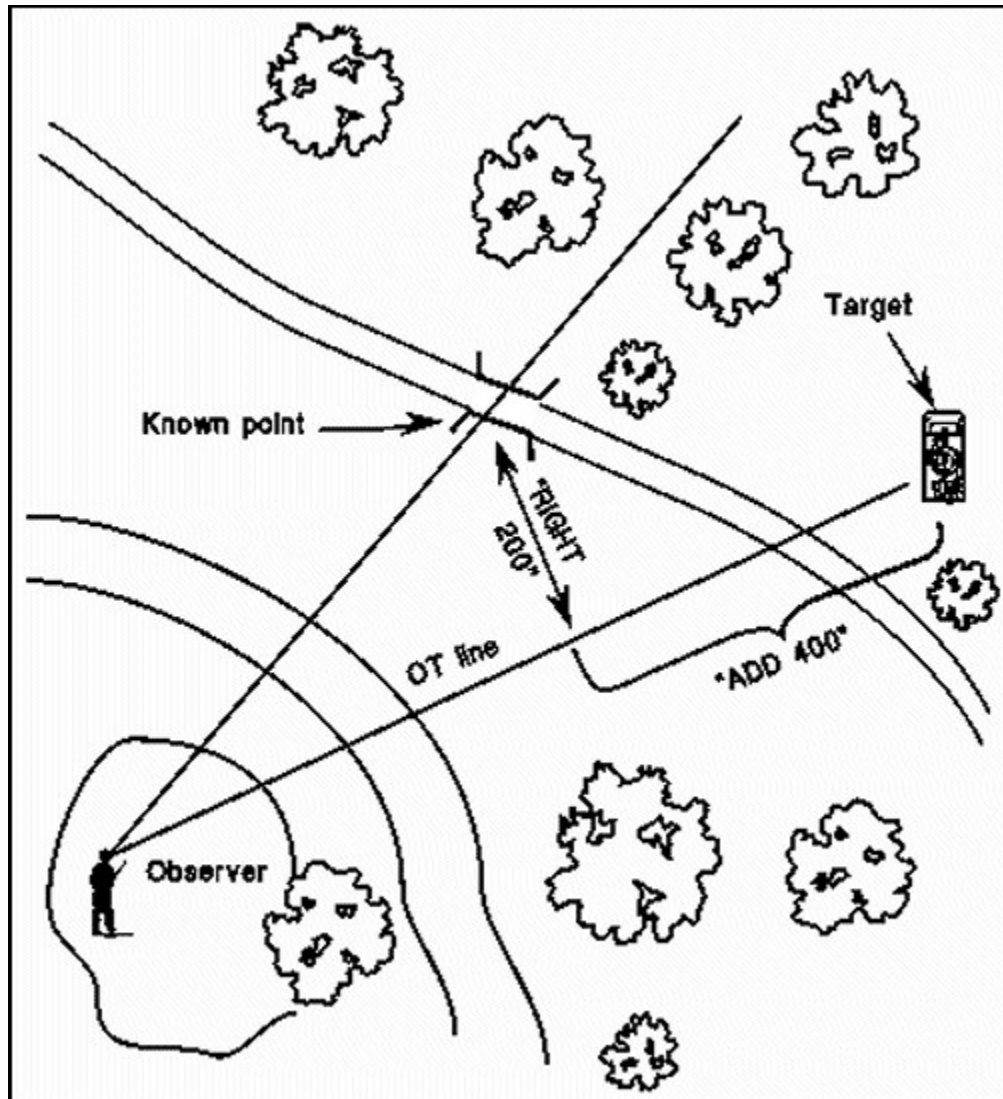
***Figure 6-4. Polar plot method of target location***

***Shift from a known point method. This method can be used if the observer and the FDC have a common known point (see Figure 6-5). Normally, this point is an artillery target. To locate the target, the observer must first determine the direction to the known point to the nearest 10 mils. If the observer has no compass, he can determine the direction by using a map and protractor or by using his binocular reticle pattern and a known direction to the known point. He then determines direction to the target using the RALS rule (right add, left subtract).***



**Figure 6-5. Shift from a known point method using direction (in mils).**

**The observer then determines the lateral and range shifts (see Figure 6-6). Lateral shifts are left or right from the known point to the OT line and are given to the nearest 10 meters. Range shifts are given as "ADD" (when the target is beyond the known point) or "DROP" (when the target is closer than the known point). Range shifts are given to the nearest 100 meters. FM 6-30 explains in detail how to determine lateral and range shifts.**



***Figure 6-6. Lateral and range shifts from a known point.***

***Target description, method of engagement, and method of fire and control (third transmission). The observer includes these elements in his call for fire using the guidelines discussed in the following paragraphs.***

***Target description. The observer describes the target to the FDC; see Figure 6-7 for examples. The FDC then determines the type and amount of ammunition needed. The target description should be brief but accurate. This is the last required element in the call for fire.***

	EXAMPLES								
What the target is:	Tanks and dismounted infantry, or truck convoy, or artillery battery								
What the target is doing:	Attacking, or digging in, or moving on Route 45, or firing								
Strength of the target:	Company of Infantry with 10 tanks, or 20 trucks, or 6 guns								
Degree of protection:	In the open, or dug in, or in bunkers with overhead cover								
Target shape and size:	Generally used for linear (trench lines or roads), circular (assembly areas or strongpoints), or rectangular targets. Examples:								
	<table border="1"> <thead> <tr> <th>SHAPE</th> <th>SIZE</th> </tr> </thead> <tbody> <tr> <td>Linear</td> <td>Grid 186278, length 800 meters, attitude 2,150 (azimuth of target's long axis) or</td> </tr> <tr> <td>Circular</td> <td>Grid 186278 to 192284, radius 200 or</td> </tr> <tr> <td>Rectangular</td> <td>400 by 200, attitude 3,450 (azimuth of target's long axis)</td> </tr> </tbody> </table>	SHAPE	SIZE	Linear	Grid 186278, length 800 meters, attitude 2,150 (azimuth of target's long axis) or	Circular	Grid 186278 to 192284, radius 200 or	Rectangular	400 by 200, attitude 3,450 (azimuth of target's long axis)
SHAPE	SIZE								
Linear	Grid 186278, length 800 meters, attitude 2,150 (azimuth of target's long axis) or								
Circular	Grid 186278 to 192284, radius 200 or								
Rectangular	400 by 200, attitude 3,450 (azimuth of target's long axis)								

**Figure 6-7. Target description.**

**Method of engagement.** *The observer tells how he wants to attack the target (including type of ammunition, fuze, and distance from friendly troops). The FDC may change the ammunition type and fuze based on availability or other constraints. If the target is within 600 meters of friendly troops, the observer announces "DANGER CLOSE" to supporting mortars and artillery.*

**Method of fire and control.** *The observer states who will give the command for fire to begin. If the observer wants to control the time of firing, he will say, "AT MY COMMAND." The FDC will tell the observer when the unit is ready to fire. At the proper time, the observer will say, "FIRE." If the observer does not say, "AT MY COMMAND," the FDC will fire as soon as the platoon or battery is ready.*

### **Adjusting indirect fire**

**Once the call for fire has been made, the observer's next concern is to get the fire on the target. If he can locate the target accurately, he will request fire for effect in his**

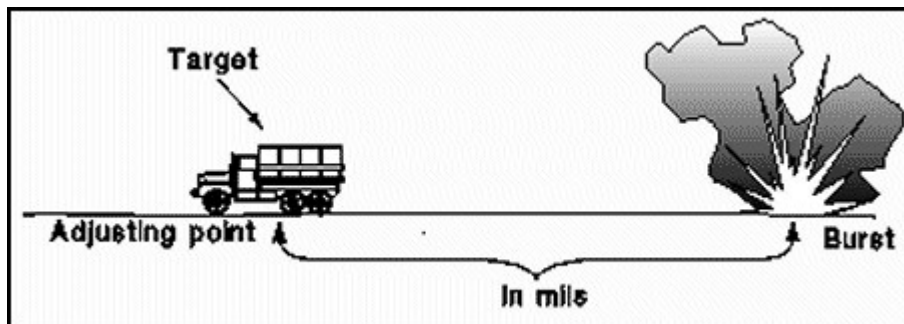


initial call for fire. When the observer cannot accurately locate the target for any reason (such as deceptive terrain, lack of identifiable terrain features, or poor visibility), he must execute an adjustment to get the fire on target. Normally, one artillery piece or mortar is used in adjustment.

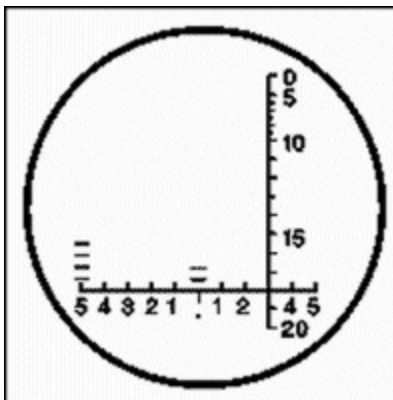
The observer must first pick an adjusting point. For a destruction mission (precision fire), the target is the adjusting point. For an area target (area fire), the observer must pick a well-defined adjusting point at the center of the area or close to it. The observer must spot the first adjusting round and each successive round and send range and deviation corrections, as required, back to the FDC until fire hits the target. The observer spots by relating the burst or group of bursts to the adjusting point. For a further discussion of adjusting mortar and artillery fire, see [FM 6-30](#).

Deviation spotting. As applied to deviation (left or right), spotting involves measuring the horizontal angle (in mils) between the burst and the adjusting point (see Figure 6-8). A burst to the right (or left) of the target is spotted as "(number) MILS RIGHT (LEFT)."

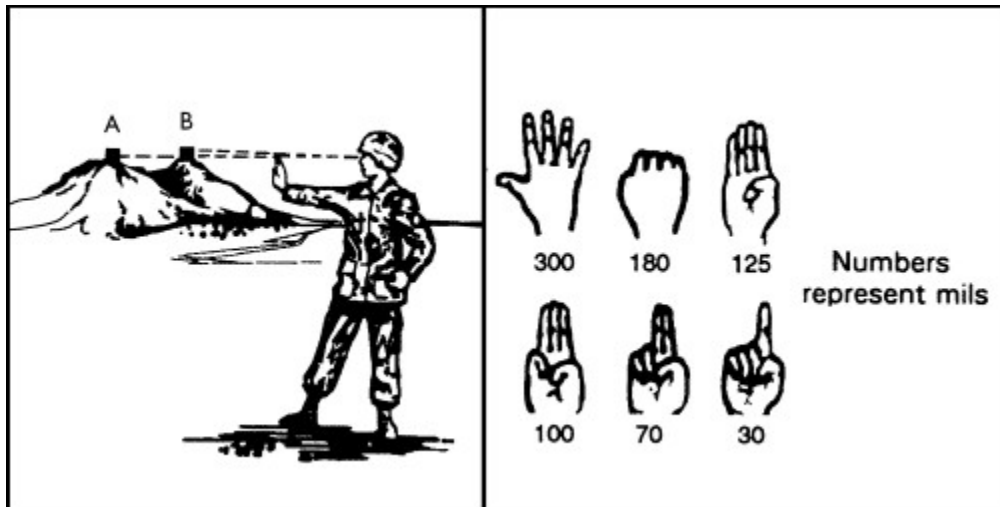
An angle-measuring device or technique, such as the mil scale on military binoculars or the hand-and-fingers method, is required to determine deviation. The reticle in binoculars is shown in Figure 6-9. The horizontal scale, divided into 10-mil increments, is used for measuring horizontal angles. The vertical scales, in 5-mil increments in the center and on the left side of the reticle, are used for measuring vertical angles. The scale on the right, if present, is no longer used. The hand-and-fingers technique may be used as shown in Figure 6-10.



**Figure 6-8. Deviation spotting.**

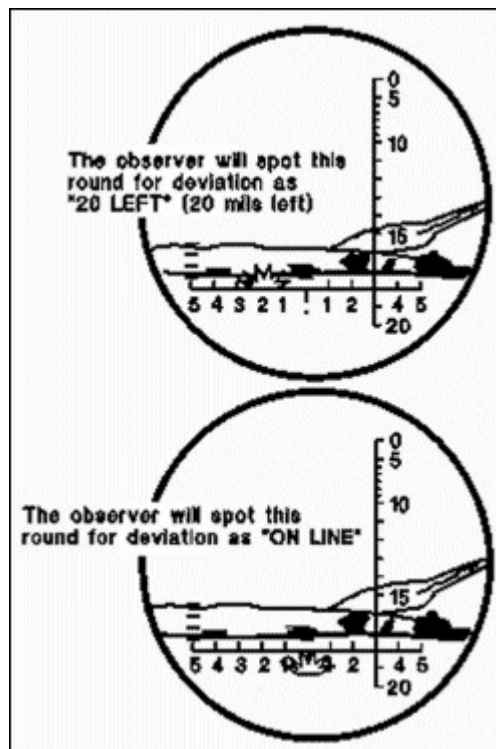


**Figure 6-9. Mil scale in binocular reticle.**



**Figure 6-10. Use of hand and fingers method to determine deviation.**

A burst on the OT line is spotted as "ON LINE." Deviation to the left or right should be measured to the nearest 5 mils for area targets, with measurements taken from the center of the burst. Deviation for a destruction mission (precision fire) is estimated to the nearest mil. Figure 6-11 shows the adjusting point at the center of the binoculars' horizontal scale.



**Figure 6-11. Deviation spotting with binoculars.**

Deviation correction. Once he determines the observed deviation (in mils), the observer must convert it into a deviation correction (in meters). Deviation correction is the distance in meters the burst must be moved to be on line between observer and target.

It is sent, with the range correction, to the FDC for the next adjusting round or when calling for fire for effect.

The first step in determining deviation correction is to calculate the OT factor, the distance from the observer to the target in kilometers. The observer calculates the distance to the target in meters and divides by 1,000; see Figure 6-12 for examples of this process. The precise correction is determined by multiplying the observed deviation by the OT factor; it is expressed to the nearest 10 meters (see Figure 6-13).

<b>GUIDE FOR DETERMINING THE OT FACTOR</b>	OT distance greater than 1,000 meters. Round to the nearest thousand, and express in thousands of meters
	EXAMPLES: OT distance, 4,200 meters- OT factor, 4.0
	OT distance, 2,700 meters- OT factor, 3.0
	OT distance less than 1,000 meters. Round to the nearest 100 meters and express in thousands of meters
	EXAMPLES: OT distance, 800 meters- OT factor, 0.8

Figure 6-12. Determining the OT factor.

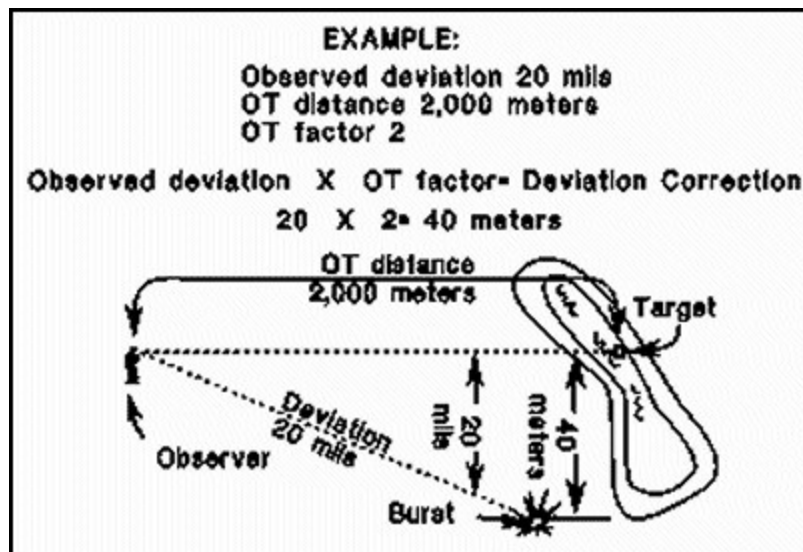


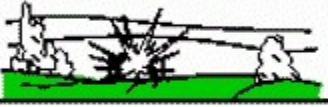


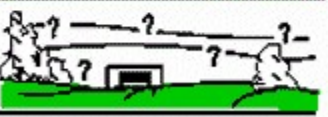
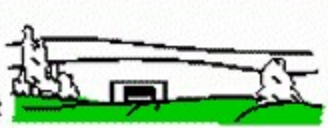


Figure 6-13. Converting mil deviation to deviation correction.

The observer's goal in making the correction is to move the adjusting rounds close enough to the OT line so that range spotting can be made accurately. Minor deviation corrections (10 to 20 meters) are necessary in adjustment of precision fire. In adjustment of area fire, however, small deviation corrections (20 meters or less) should be ignored except when such a small change is necessary to determine a definite range spotting.

Range spotting. Range spotting is the second type of adjustment required to get fire on the target (see Figure 6-14). Any range spotting other than "DOUBTFUL" or "LOST" is definite. Usually, an adjusting round's burst that is on or near the OT line will give a

definite range spotting.

TRANSMISSION/EXPLANATION	SIGHT PICTURE
<b>"OVER."</b> A burst that appears beyond the adjusting point	
<b>"SHORT."</b> A burst that appears between the observer and the adjusting point	
<b>"TARGET."</b> A burst that hits the target. This spotting is used only in precision fire (destruction missions)	
<b>"RANGE CORRECT."</b> A burst that appears to be at the correct range	
<b>"DOUBTFUL."</b> A burst that can be observed but cannot be spotted as OVER, SHORT, TARGET, or RANGE CORRECT	
<b>"LOST."</b> A burst whose location cannot be determined	
<b>"UNOBSERVED OVER." or "UNOBSERVED SHORT."</b> A burst that is not observed but that is definitely known to be beyond or short of the adjusting point	

*Figure 6-14. Range spotting.*

The observer can sometimes make a definite range spotting even when the burst is not on or near the OT line. He uses his knowledge of the terrain or wind and observes debris scattered by the explosion. If the observer is not sure ("DOUBTFUL"), the correction he sends to the FDC should be for deviation ("LEFT" or "RIGHT") only. He does this to bring the burst on line so he can get a definite range spotting ("OVER," "SHORT," or "TARGET").

Range correction. The observer gives range corrections so that, with each successive correction, the adjusting round intentionally lands over or short of the adjusting point, closing on the target.

Bracketing. In the bracketing technique, fire for effect is called for when a range correction would bring the next round within 50 meters of the adjusting point. See Figure 6-15. (NOTE: This technique is also called successive bracketing, as opposed to the faster and less involved technique of hasty bracketing, which is covered later in this discussion.)

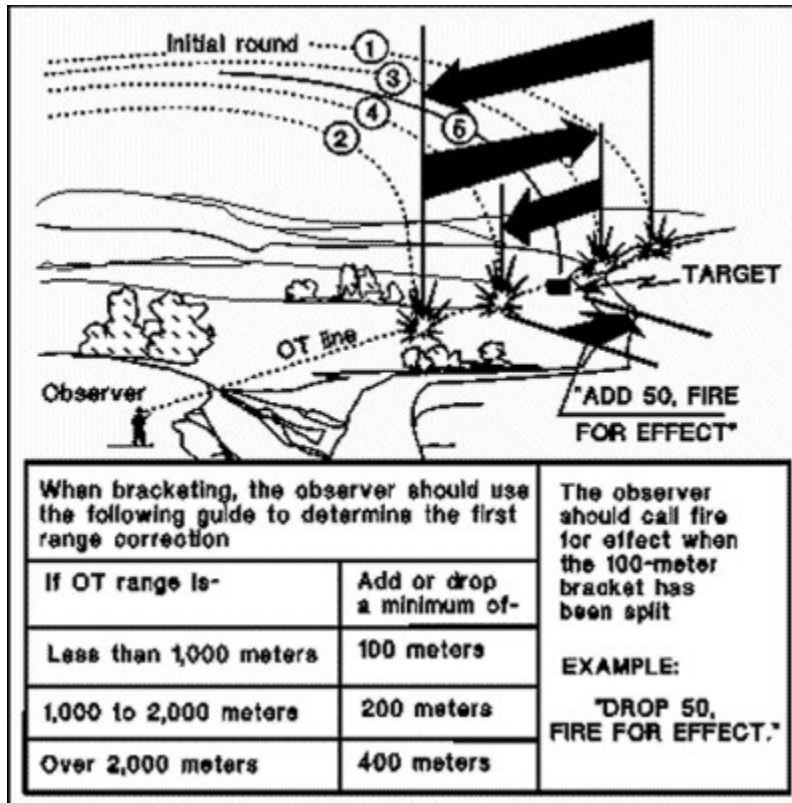


Figure 6-15. Bracketing.

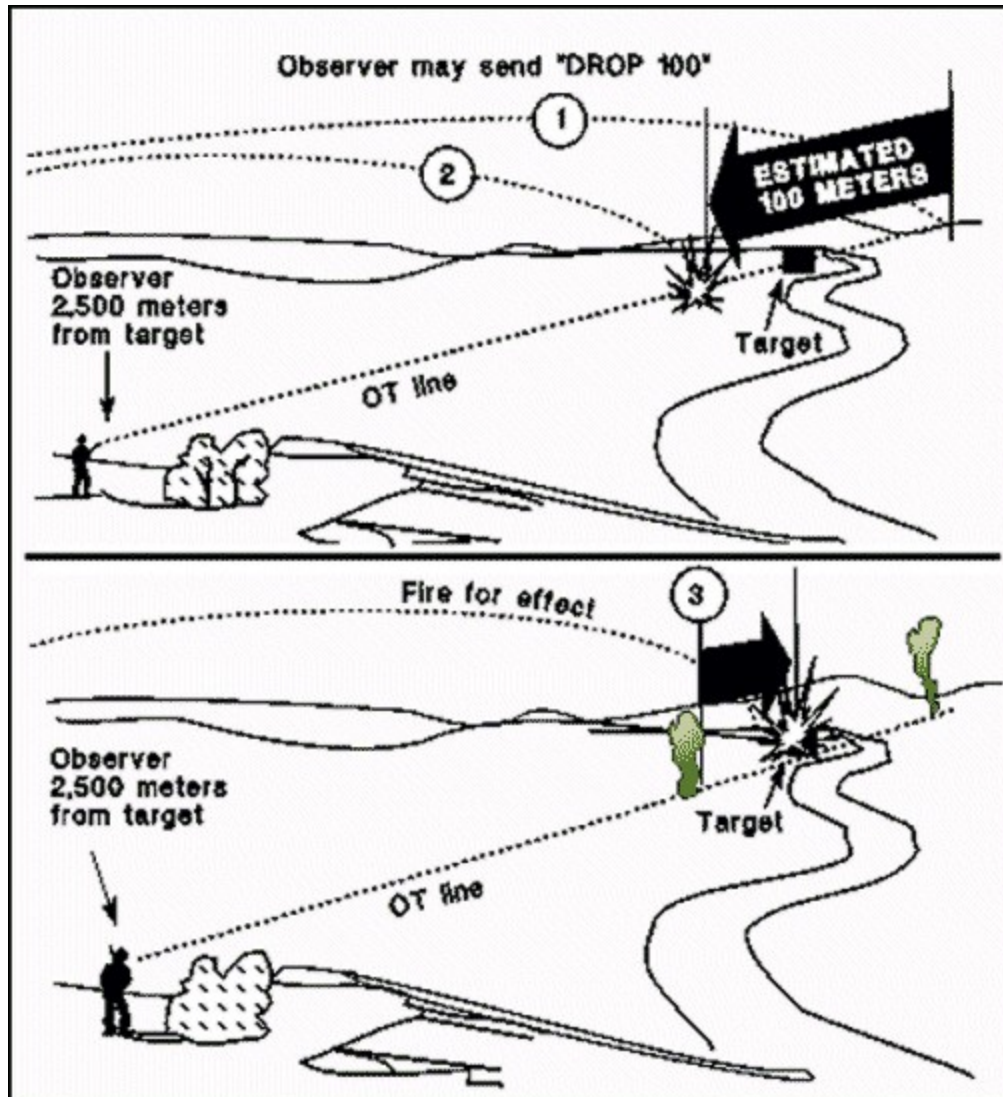
Bracketing is an effective technique in that it is sure to bring fire on the target. Time is important, especially when targets are moving or may move to seek cover when they find fire coming their way. Accurate initial location data allow the adjustment to be made more quickly and make the requested fire more effective. To shorten adjustment time, the observer should try to bracket the target quickly (in the first two or three adjusting rounds), then adjust on the target using as few subsequent rounds as possible.

Hasty bracketing. Experience has shown that effectiveness on the target decreases as the number of rounds used in adjustment increases. An alternative to successive bracketing is hasty bracketing. While successive bracketing mathematically ensures that the fire-for-effect rounds will strike within 50 meters of the adjusting point, it is a relatively slow and unresponsive technique. Therefore, if the nature of the target dictates that effective fires are needed faster than successive bracketing can provide them, hasty bracketing should be used.

The success of hasty bracketing depends on a thorough terrain analysis that gives the observer an accurate initial target location. The observer obtains a bracket on his first correction in a manner similar to that used for successive bracketing. Once the observer has this initial bracket, he uses it as a yardstick to determine his subsequent correction. He then sends the correction to the FDC so it can adjust the rounds to the target and employ fire for effect (see Figure 6-16).

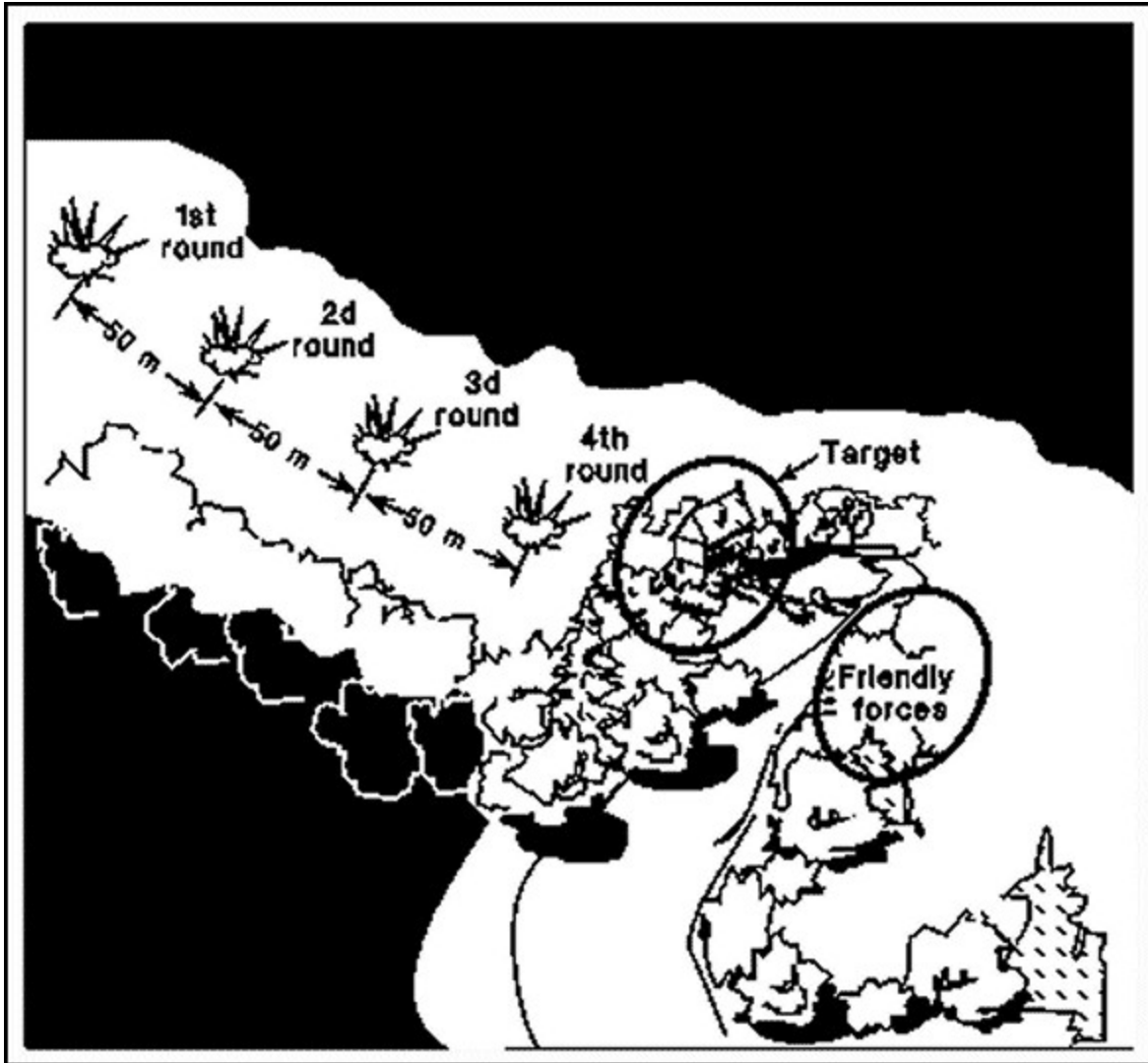
Hasty bracketing improves as the observer gains experience and judgment. Every observer must strive to improve his abilities and increase his responsiveness on the battlefield.





**Figure 6-16. Hasty bracketing.**

**Creeping.** *The creeping method of adjustment is used in "DANGER CLOSE" situations. The initial round is fired beyond the target. Adjusting rounds are moved closer to the target, 50 meters or less at a time, until the target is engaged (see Figure 6-17). This method is slow and tends to use more ammunition than other adjustments; therefore, it should be used only when soldier safety is a major concern.*



*Figure 6-17. Creeping method of adjustment.*

### **Refinement and surveillance**

*The observer notes the results of the fire for effect and then takes whatever action is necessary to complete the mission. Figure 6-18 illustrates various alternatives available to the observer after fire-for-effect rounds have been fired.*

<b>RESULTS OF FIRE FOR EFFECT</b>	<b>OBSERVER'S ACTIONS (RADIO TRANSMISSIONS IN PARENTHESES)</b>
Accurate and sufficient	End of mission, surveillance ("END OF MISSION, RPG SILENCED, OVER")
Accurate, sufficient, target replot desired	Request replot, end of mission, surveillance ("RECORD AS TARGET, END OF MISSION, BMP NEUTRALIZED, OVER")
Inaccurate and sufficient	Refinement, end of mission, surveillance ("RIGHT 20, ADD 20, END OF MISSION, RPG SILENCED, OVER")
Inaccurate, sufficient, target replot desired	Refinement, request replot, end of mission, surveillance ("RIGHT 10, RECORD AS TARGET, END OF MISSION, BMP NEUTRALIZED, OVER")
Inaccurate and insufficient	Refinement, repeat and reenter, adjust fire ("RIGHT 10, ADD 50, REPEAT, or RIGHT 10, ADD 100, ADJUST FIRE, OVER")
Accurate and insufficient	Repeat ("REPEAT, OVER")

Figure 6-18. Observer's actions after fire for effect.

### **TANK PLATOON FIRE SUPPORT PLANNING**

The fire support plan is developed along with the scheme of maneuver, which it supports and complements. It discusses the use of all available indirect and direct fires. The goal is to destroy as many enemy elements as possible and to suppress any others to keep them from firing on friendly forces. The company commander and FSO plan indirect fires; however, the platoon leader may plan and request more targets if needed.

After receiving the company offensive fire plan, the platoon leader checks it to ensure that targets are planned on all known or suspected enemy positions in front of, on, behind, and to the flanks of the objective. The company defensive fire plan should list planned targets in front of, on, behind, and to the flanks of BPs; likely areas for these targets include observed choke points, avenues of approach, obstacles, and likely support by fire positions. If more targets are necessary for either the offensive or defensive plan, the platoon leader coordinates them with the commander and the FIST.

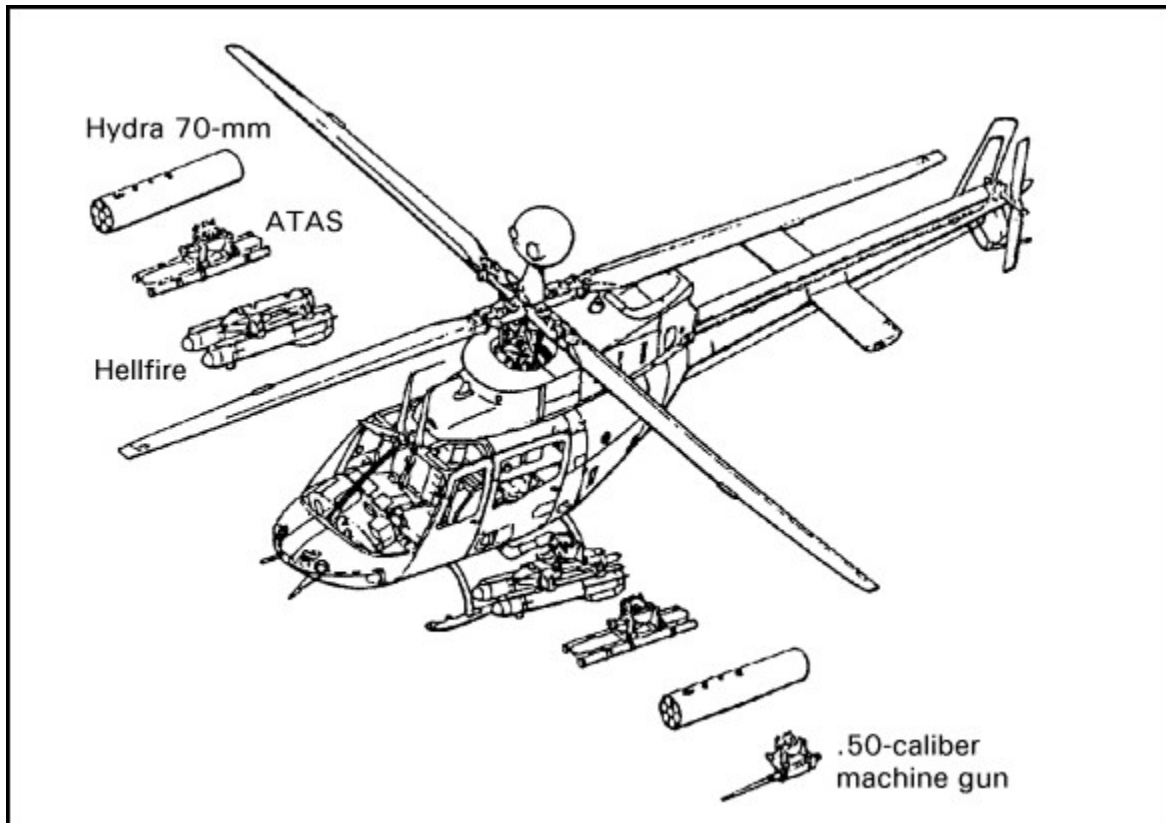
## **SECTION 2 - ARMY AVIATION**

Army aviation assets are important participants on today's battlefield. Their flexibility enables them to perform a variety of roles: reconnaissance, security, attack, transportation, and resupply. Army aviation is a divisional asset that may be attached or placed OPCON to brigades, but rarely to lower-level units.

### **AIR CAVALRY**



Air cavalry, found in division and regimental cavalry units, is organized, equipped, and trained to conduct reconnaissance and security missions. The primary aircraft in air cavalry units is the OH-58D. This helicopter provides substantial limited-visibility and all-weather acquisition capability. The aircraft features a stabilized mast mounted sight (MMS) with a low-light TV camera, TIS, and laser range finder/designator. It can acquire armored vehicle targets at night at ranges up to 10 kilometers. It can be armed with a wide assortment of weapons and thus can be configured for a variety of threat situations (see Figure 6-19).



**Figure 6-19. OH-58D armed helicopter.**

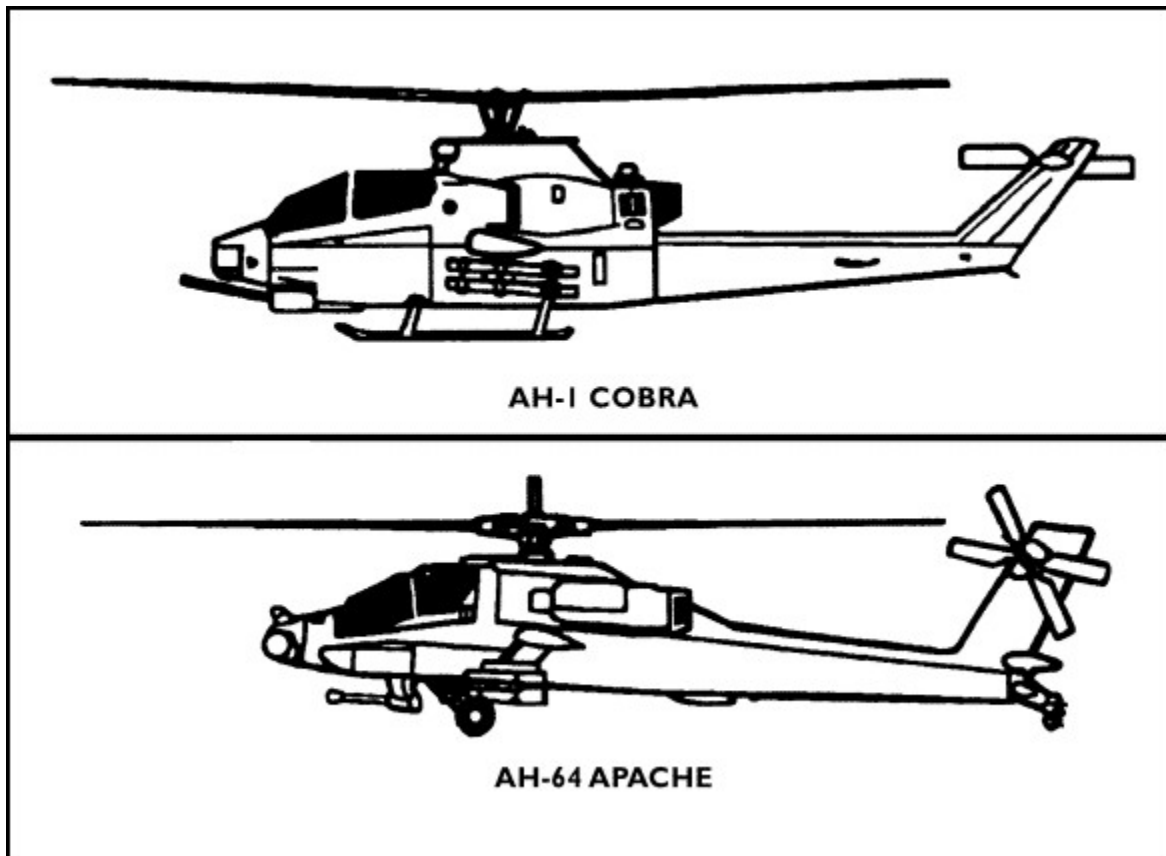
### **ATTACK HELICOPTERS**

Attack helicopter units operate either as separate elements within a division or as part of the air cavalry. Attack helicopter companies are maneuver units and are normally integrated into the ground scheme of maneuver. When working with ground maneuver units, the attack helicopter unit may be placed OPCON to the ground force. Normally, it is OPCON to a maneuver brigade or regiment; on rare occasions, it can be OPCON to a battalion or squadron.

Aeroscouts usually arrive before attack aircraft, establish communications with ground forces, and coordinate the situation and mission with the commander. The aeroscouts identify targets, choose general BPs, and control attack helicopter fires.

The attack helicopter is primarily employed as an antiarmor weapon system. Figure 6-20 shows two types of attack aircraft in the Army's inventory, the AH-64 Apache and the AH-1 Cobra. (NOTE: The Army is scheduled to field a new helicopter, the RAH-66

*Comanche, which will feature both attack and reconnaissance capabilities.)*



*Figure 6-20. Army attack helicopters.*

### SECTION 3 - COMBAT ENGINEERS

*Brigade/regiment and battalion/squadron commanders decide how best to employ their engineer assets: as a distinct unit, attached to their subordinate elements, or in DS of the subordinate elements. In fast-moving offensive operations, one technique is to place engineers OPCON to the lead company team or troop to support breaching operations. In the defense, commanders generally keep engineer units intact to construct major obstacles and execute survivability operations, designating the priority of work to be accomplished. Engineers are trained to fight as infantry as a secondary mission; however, they are employed as infantry only if absolutely necessary.*

#### **CAPABILITIES**

*The combat engineer platoon is organized, trained, and equipped to conduct mobility, countermobility, and survivability missions in support of ground operations. The engineers' specific tasks and responsibilities in these three roles are determined by the higher unit commander.*

#### **Organization and equipment**

*Organization. The combat engineer platoon consists of three squads mounted in M113s (see Figure 6-21). Each squad has a demolition set, chain saw, and two mine detectors.*

The platoon headquarters is authorized one M9 ACE, which is highly mobile, armored, and amphibious (see Figure 6-22).

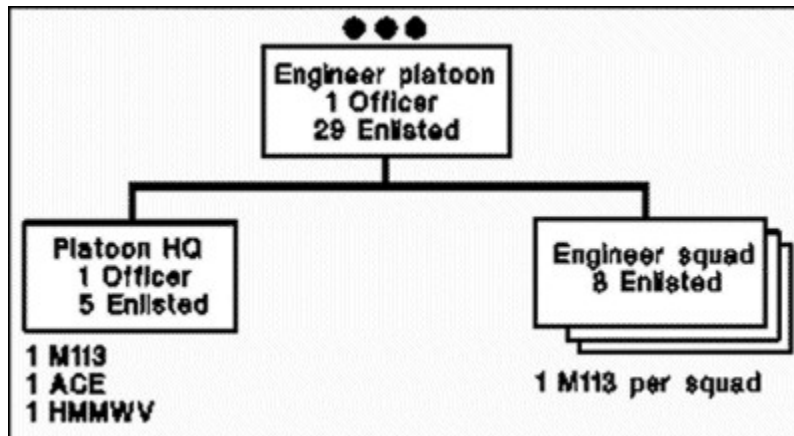


Figure 6-21. Combat engineer platoon organization.

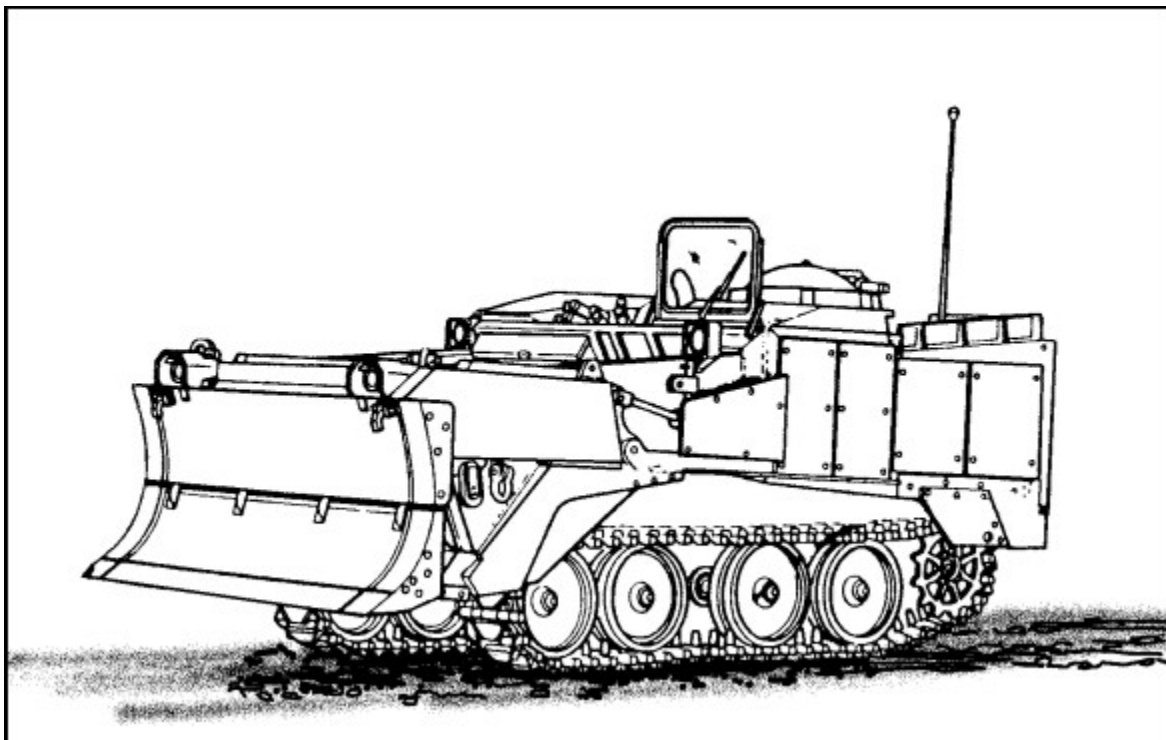


Figure 6-22. M9 armored combat earthmover.

Equipment. The platoon may also be supplemented with equipment from the engineer company, including the items covered in the following discussion.

Armored vehicle launched bridge (AVLB) or Wolverine. The AVLB uses an M48 or M60 tank chassis to transport, launch, and retrieve a 60-foot bridge. The bridge is capable of supporting military load class (MLC) 70 tracked vehicles across a 15-meter gap (see Figure 6-23). The Wolverine, which will replace the AVLB, is based on an M1 chassis. It will be able to support MLC 70 traffic across gaps of up to 24 meters.

MICLIC launcher. The MICLIC system employs a rope-like demolition charge to create

lanes for combat vehicles during minefield breaching operations. The charge, containing nearly a ton of composition C4 explosive, can clear a lane up to 100 meters long and 14 meters wide. The MICLEIC launcher can be mounted either on a towed trailer or on an M60A1 chassis (this vehicle is called the armored vehicle launched MICLEIC, or AVLM). It fires a 5-inch rocket motor that tows the MICLEIC over the target minefield (see Figure 6-24). The system, designed for deployment in virtually all types of terrain and weather conditions, can be reloaded with a new charge and rocket motor in about 30 minutes.

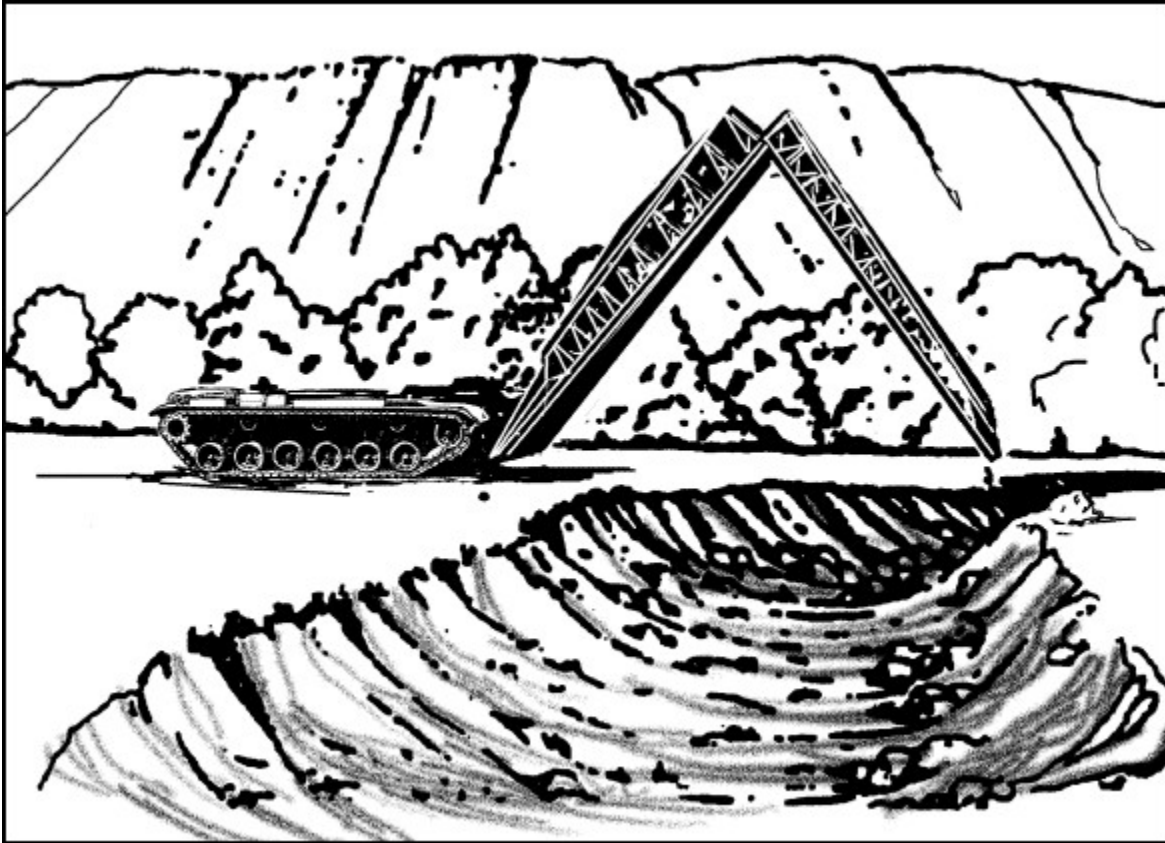
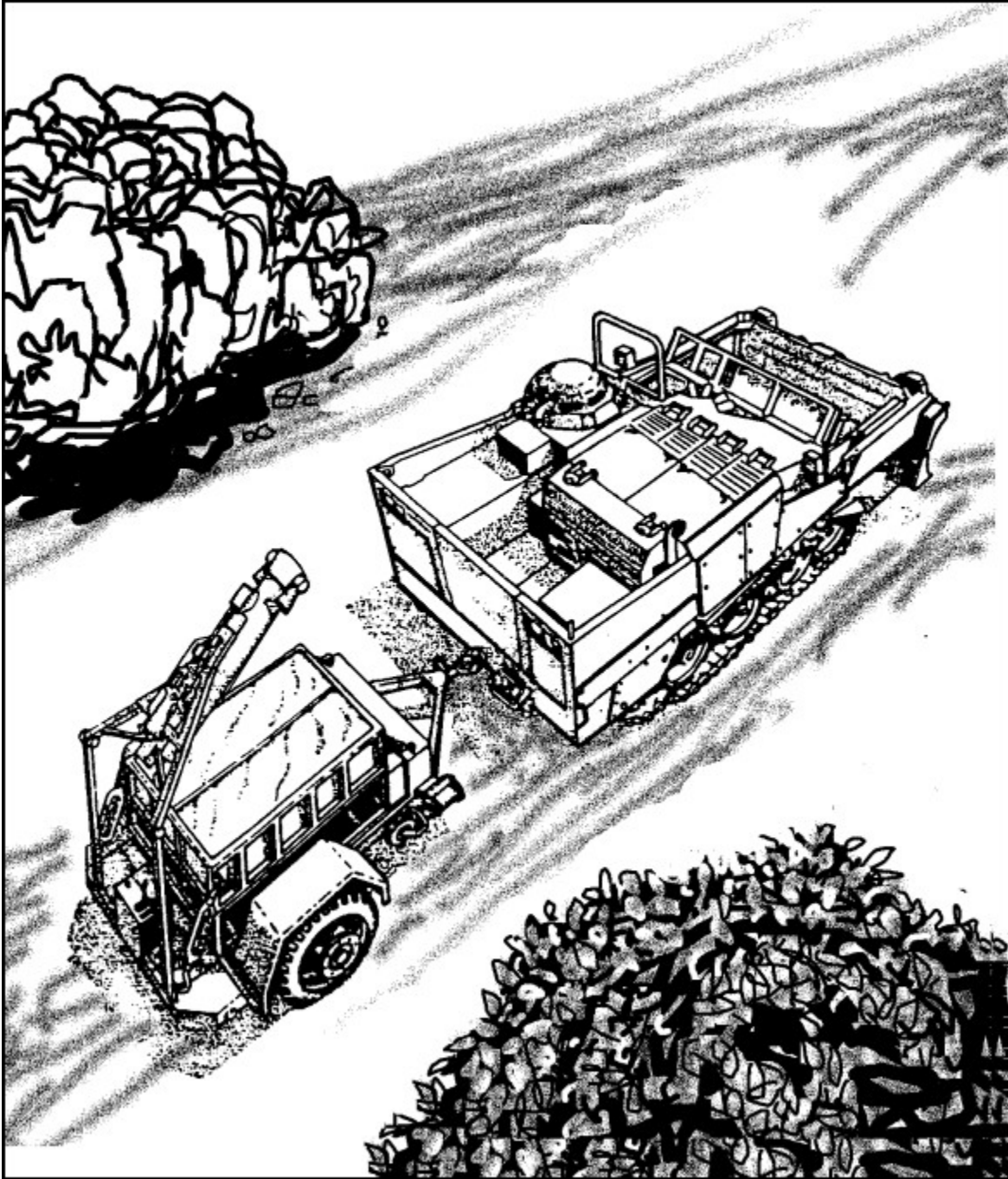


Figure 6-23. Armored vehicle launched bridge.



*Figure 6-24. Mine-clearing line charge system.*

### **Operational considerations**

*In mobility operations, the engineer platoon can provide the following support:*

*Obstacle reduction. The engineers can reduce or negate the effects of obstacles, thereby improving their supported unit's maneuver capability.*

*Route construction. The engineers can construct, improve, and maintain roads, bridges, and fords.*

In a countermobility role, engineers can assist with obstacle construction to obstruct the enemy's scheme of maneuver. They can reinforce terrain and existing obstacles to disrupt, fix, turn, or block the enemy force.

Engineers can improve survivability by constructing dug-in positions and overhead protection to reduce the effectiveness of enemy weapons.

### **ENGINEER SUPPORT TO THE TANK PLATOON**

Combat engineers normally support the company team as a platoon under the direction of the company team commander. During planning for mobility, countermobility, and survivability work, the engineers can advise the commander on construction time and materials needed; the company normally must order much of the material through battalion supply channels.

The tank platoon leader frequently will be tasked to provide security while the engineer platoon conducts its missions. To speed up the construction process, the engineers may need the help of armor crewmen. Additional details on engineer support and employment are in Chapters 3, 4, and 5 of this manual.

## **SECTION 4 - AIR DEFENSE**

Air defense assets are scarce; maneuver units cannot always count on receiving dedicated air defense protection. As a result, the tank platoon must be able to protect itself from enemy air attacks during all combat operations. Air defense measures include actions to avoid enemy air attack, actions to limit the damage if an attack occurs, and (as necessary) actions required to fight back.

### **AIR DEFENSE WARNINGS**

Local air defense warnings are used to indicate the air threat. They are used in conjunction with the weapon control status (discussed in the active air defense portion of this section) to provide early warning of and planned responses to enemy aircraft. There are three local air defense warning levels:

**DYNAMITE.** Aircraft are inbound or attacking locally now.

**LOOKOUT.** Aircraft are in the area of interest but are not threatening. They may be inbound, but there is time to react.

**SNOWMAN.** There are no aircraft posing a threat at this time.

**NOTE:** Air defense warnings of RED, YELLOW, and WHITE are established at levels higher than division. These roughly parallel the local warning levels, but they cover a larger area of operations, such as a theater.

### **PASSIVE AIR DEFENSE**

Passive air defense is the tank platoon's first line of defense against enemy air attack. It includes all measures, other than active defense, taken to minimize the effects of hostile air action. There are two types of passive air defense: attack avoidance and damage-limiting measures.

## **Attack avoidance**

**If an enemy pilot cannot find friendly elements, he cannot attack them. The platoon should use concealment, camouflage, deception, communications security, and any other necessary action to prevent enemy detection. Refer to the discussion of OPSEC in Appendix D of this manual.**

**Whenever possible, static positions must provide effective overhead concealment. When concealment is not available, vehicles must be camouflaged to blend into the natural surroundings. Track marks leading into the position must be obliterated. All shiny objects that could reflect light and attract attention must be covered.**

## **Damage-limiting measures**

**Dispersion. Dispersion is one of the most effective ways to reduce the effects of enemy air attack. It is essential when a unit is occupying static positions such as assembly areas or is preparing to cross a water obstacle or pass through a breached obstacle. When the platoon is on the move and air guards identify an enemy air attack, vehicles disperse quickly, move to covered and concealed positions if possible, and stop (a stationary vehicle is more difficult to see than a moving vehicle). Refer to the discussion of the react to air attack battle drill in Chapter 3 of this manual. An early warning system that includes both visual and audible signals can help to limit damage by enabling the platoon to begin dispersion at the earliest possible moment.**

**Cover. Another damage-limiting measure is the use of natural or man-made cover to reduce the effects of enemy munitions. Folds in the earth, depressions, buildings, and sandbagged positions can provide this protection.**

## **ACTIVE AIR DEFENSE**

**Although passive measures are the first line of defense against air attack, the tank platoon must be prepared to engage enemy aircraft. The decision to fight back against an air threat is based on the situation and the capabilities of organic weapon systems. All platoon members must understand that they can defend against a direct attack but cannot engage aircraft that are not attacking them unless the weapon control status allows it.**

## **Weapon control status**

**The weapon control status describes the relative degree of control in effect for air defense fires. It applies to all weapon systems. The platoon leader receives the status from the company or troop commander. The three control statuses are the following:**

**WEAPONS FREE. Crews can fire at any air target not positively identified as friendly. This is the least restrictive weapon control status.**

**WEAPONS TIGHT. Crews can fire only at air targets positively identified as hostile according to the prevailing hostile criteria.**

**WEAPONS HOLD. Crews are prohibited from firing except in self-defense or in response to a formal order. This is the most restrictive control status.**

## **Platoon air defense fires**

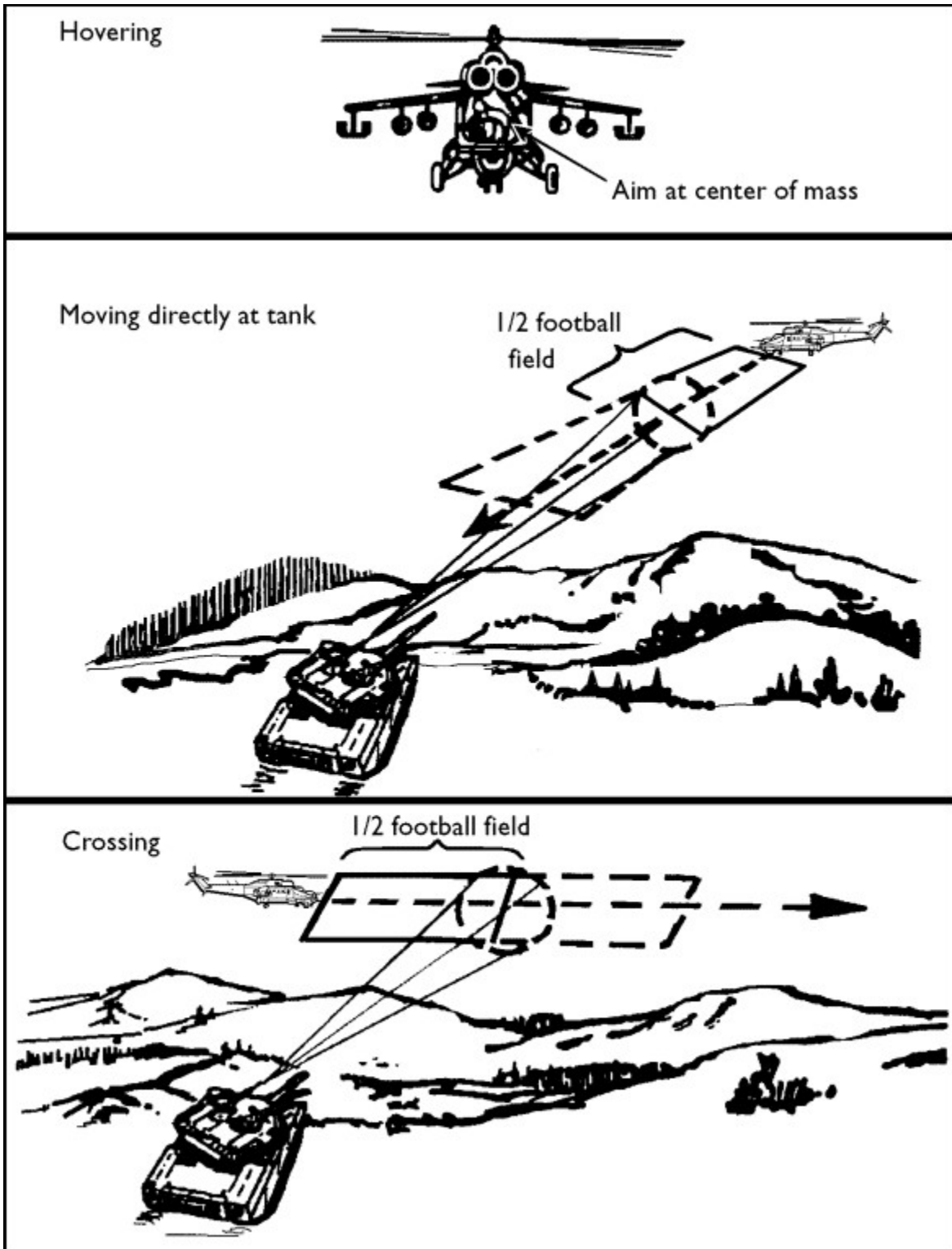
**When it must fight back, the platoon can use the tank's main gun and machine guns against attacking aircraft.**

**Machine gun fires. Engaging aircraft with volume fire is the key to effective use of the machine guns. These fires must be coordinated to be effective. Delivered on the platoon leader's command, they are directed at an aim point; gunners do not attempt to track the target with machine guns. Figures 6-25 and 6-26 illustrate guidelines and procedures for selecting machine gun aim points. These rules are simple and logical; everyone in the platoon must learn and retain them.**

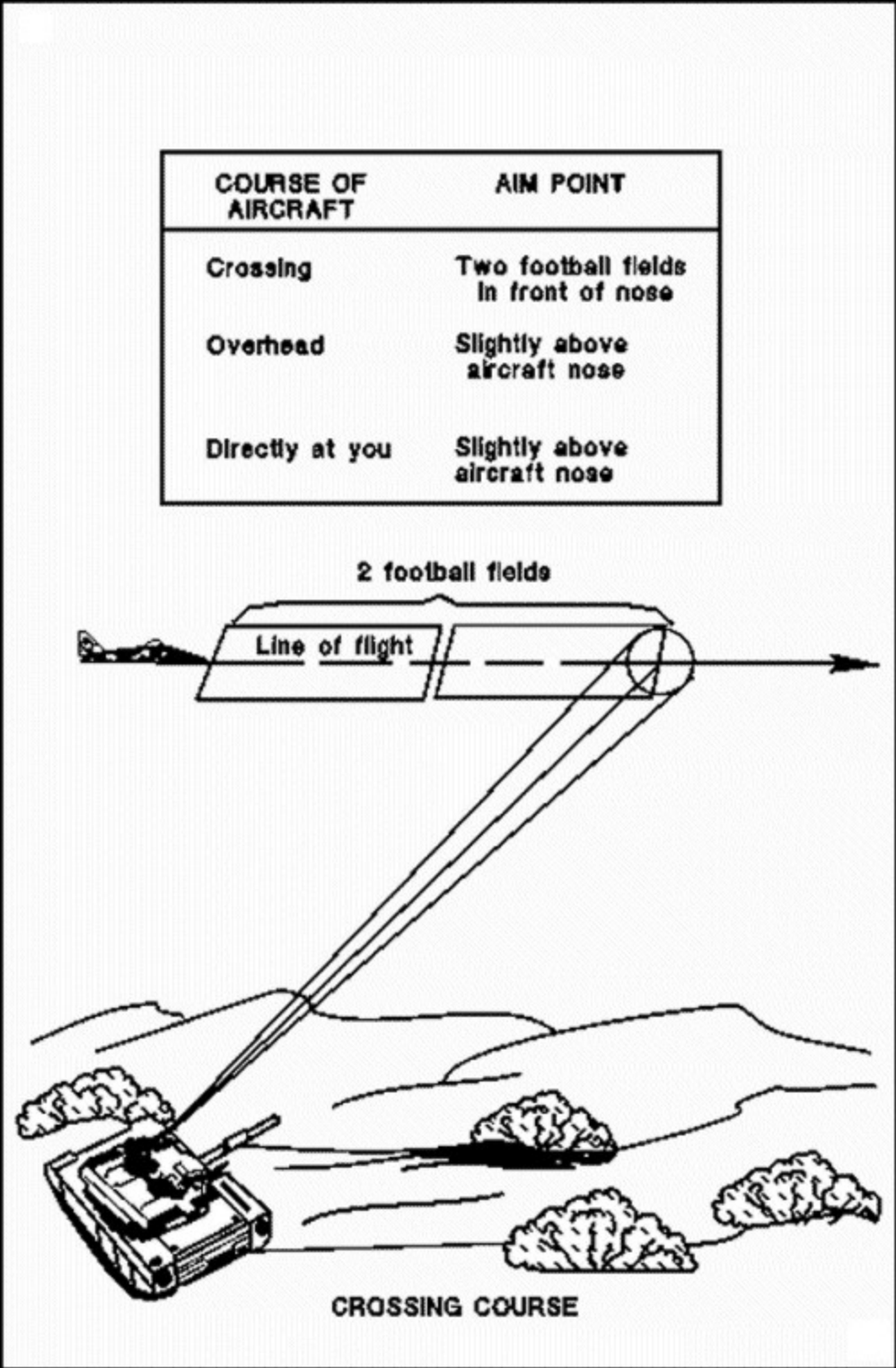
**Main gun fires. Several types of main gun ammunition are effective against helicopters, including MPAT, high explosive antitank (HEAT), and armor-piercing discarding sabot (APDS) rounds. The main gun aim point is always center of mass.**

**NOTE: Refer to the battle drill for reaction to air attack in Chapter 3 of this manual. For further information on MPAT ammunition, refer to 17-12-1-1.**





*Figure 6-25. Machine gun aim points against helicopters.*



*Figure 6-26. Machine gun aim points against high-performance aircraft.*

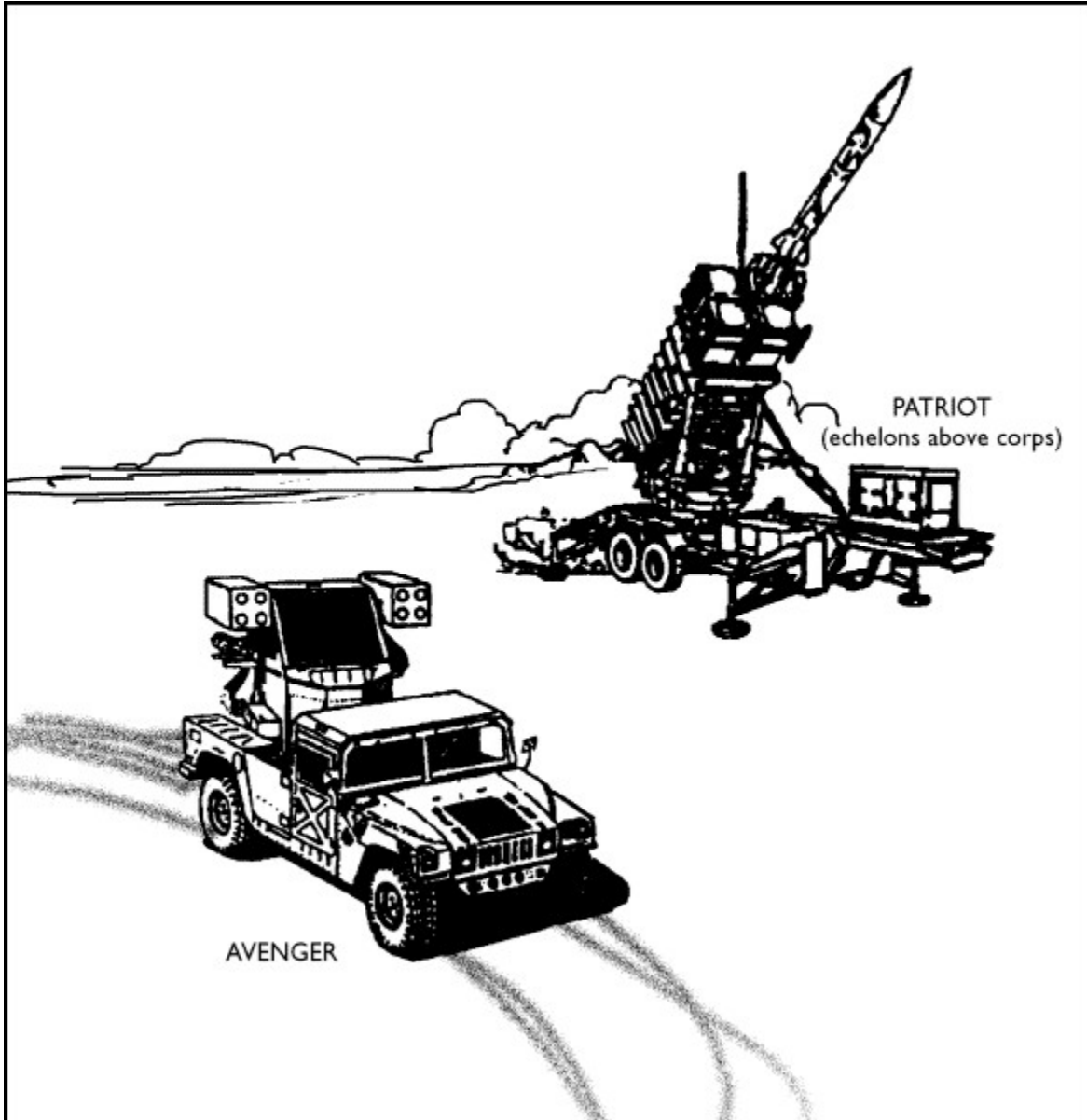
**AIR DEFENSE ARTILLERY SYSTEMS**

*The mission of the ADA is to protect friendly forces and selected geo-political assets.*

from aerial attack, missile attack, and surveillance. The air defense commander employs several types of systems, at various operational levels, to provide low- to high-altitude air defense coverage.

**Corps level and higher**

At corps level and higher, the primary ADA systems are the Avenger and the Patriot (see Figure 6-27).



**Figure 6-27. Air defense systems at corps level and above.**

**Tactical level (division and below)**

At the tactical level, low- to medium-altitude air defense is accomplished by the air defense battalion organic to the division. The battalion or squadron uses the systems described in the following paragraphs to complement and support the maneuver force.

Stinger. This is the primary air defense weapon system for the battalion or squadron, employing short-range, shoulder-fired, heat-seeking guided missiles (see Figure 6-28). The Stinger is designed to counter high-speed, low-level ground attack aircraft. It is also a lethal weapon against helicopters, observation and transport aircraft, and UAVs. The missile has a range in excess of 5 kilometers.

The Stinger can be employed as a man-portable air defense system (MANPADS). The two-man Stinger team, consisting of an operator and a crew chief, is transported in a HMMWV or in the Bradley Stinger fighting vehicle (BSFV) or Bradley Linebacker vehicle. (NOTE: The BSFV and Bradley Linebacker are discussed later in this section.)



**Figure 6-28. Stinger air defense system.**

Bradley Stinger fighting vehicle. The BSFV, which replaces the Vulcan air defense system, provides the air defender with armor protection and gives him the ability to maneuver with the supported force and position the Stinger system forward on the battlefield (see Figure 6-29). The Stinger team must dismount to fire the missiles.

The BSFV carries a basic load of six Stinger missiles as its primary air defense weapon; the Bradley's 25-mm chain gun can be used to augment the Stinger and cover dead space to a range of 2,000 meters. The vehicle also carries five TOW missiles. Future versions of the BSFV will include the Stinger vehicle-mounted launcher (SVML) in place of the TOW system. The SVML will provide the vehicle with fire-on-the-move capability.



**Figure 6-29. Bradley Stinger fighting vehicle.**

**Bradley Linebacker. This vehicle replaces the BSFV's TOW system with four ready-to-fire Stinger missiles, housed in the Stinger vehicle mounted launcher (SVML). The Bradley Linebacker, with its ability to shoot on the move, is designed specifically to provide air defense on the battlefield.**

## **SECTION 5 - AIR SUPPORT**

### **CLOSE AIR SUPPORT**

**Close air support (CAS), provided by the Air Force, can be employed to destroy large enemy armor formations. CAS strikes can be either preplanned (at brigade, battalion, or squadron level) or requested on an immediate-need basis through the battalion forward air controller (FAC). The FAC on the ground or in the air acts as a link between the ground element and the CAS aircraft.**

**Army air cavalry is best equipped to coordinate with Air Force assets in joint air attack team (JAAT) and attack helicopter operations. The air cavalry can see the battlefield and the target better than ground forces can, and it has the radio equipment needed to talk to Air Force aircraft. The attack aircraft organic to air cavalry units can assist CAS aircraft in suppressing the enemy ADA threat.**

### **MARKING FRIENDLY POSITIONS**

**Whenever possible, friendly positions should be marked during close air strikes.**

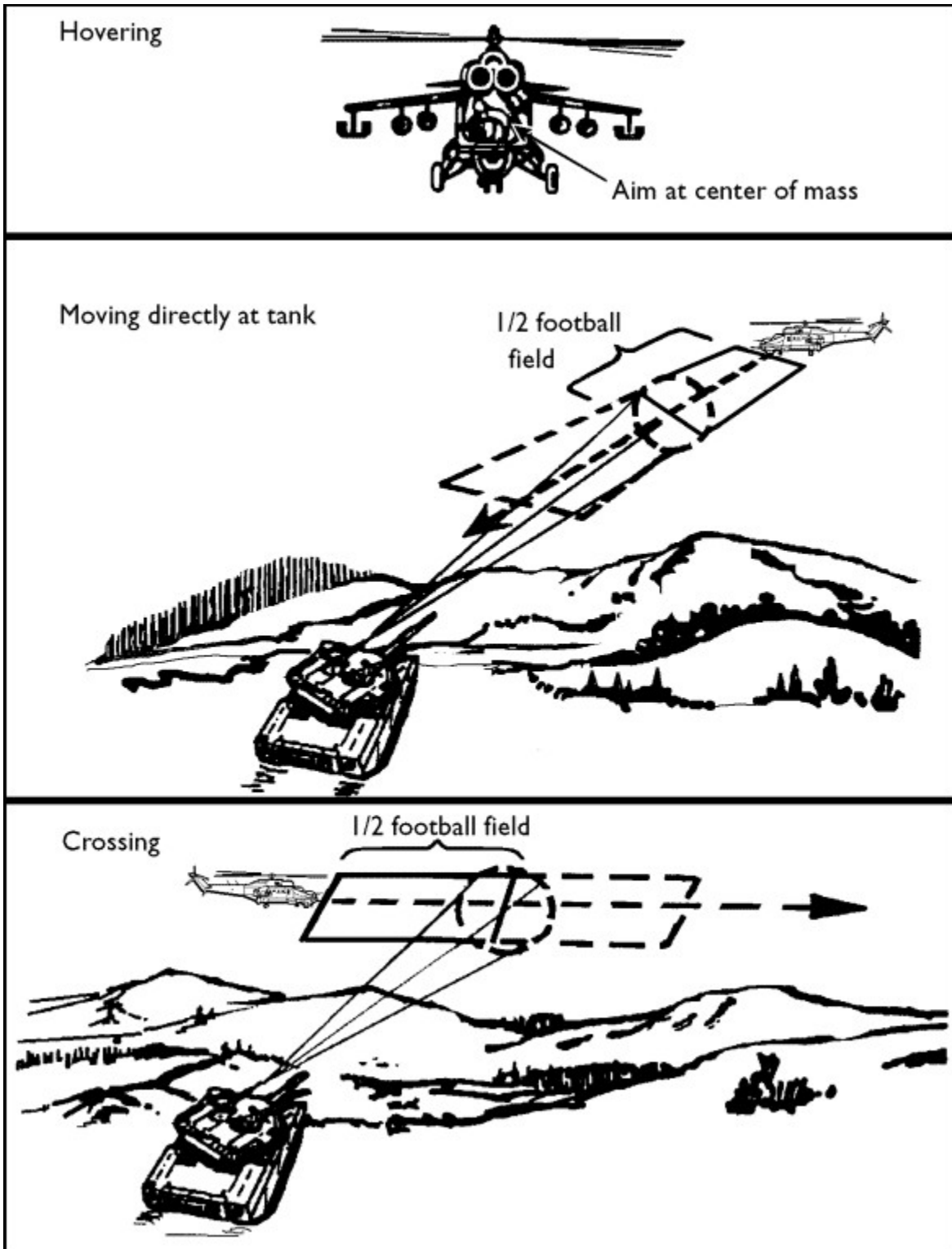
especially when friendly troops are within 300 meters of the target. Resources for marking positions include the following:

Smoke. The smoke grenade is the most commonly used marker, but it has limitations. Wind may cause smoke to drift above trees, and some colors can blend with the background. Violet or white smoke shows up well against most background colors.

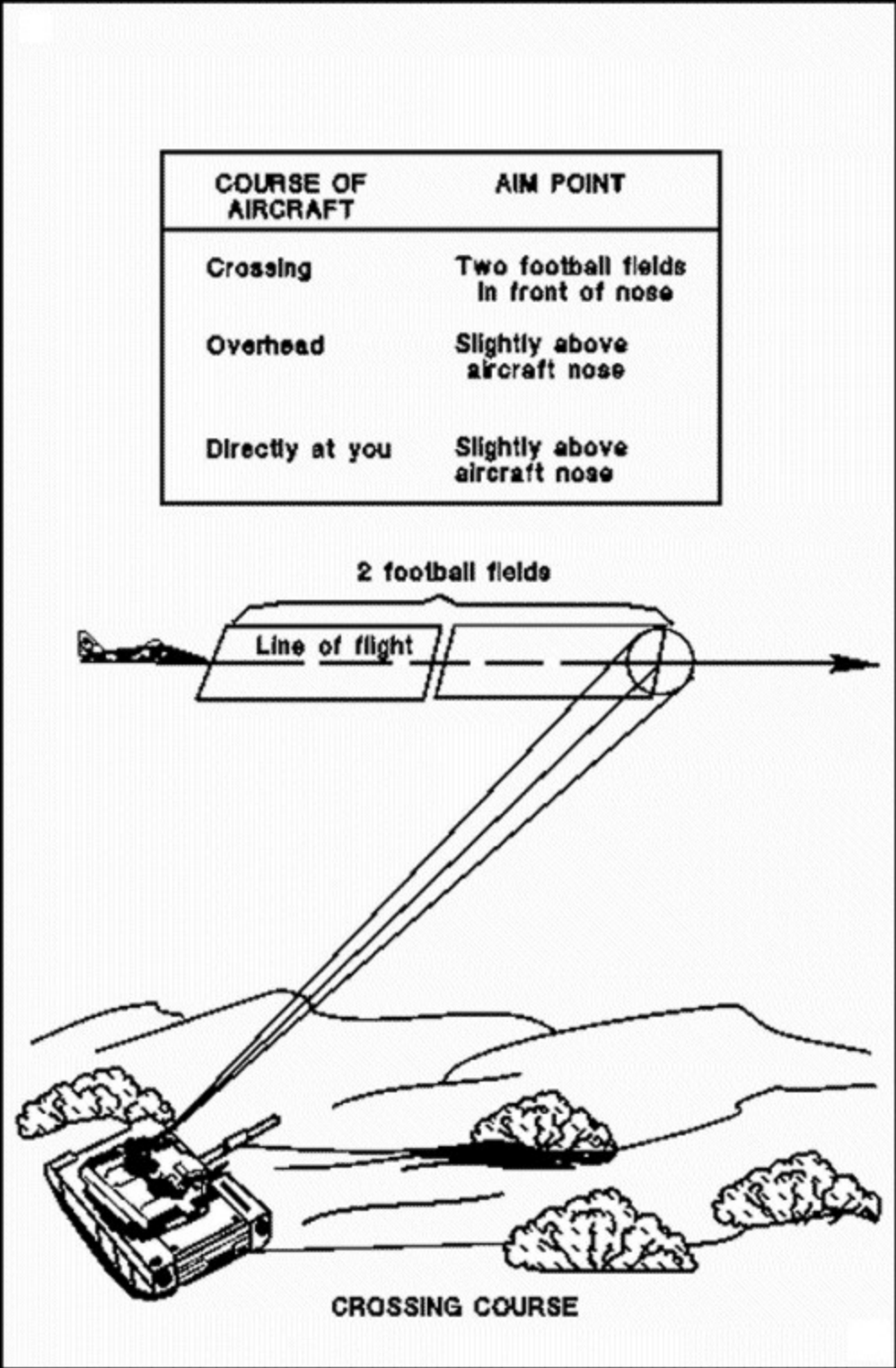
Flares. Rocket or 40-mm flares are useful for attracting attention at night; they can sometimes be employed effectively during the day.

Mirrors and signal panels. Signal mirrors are probably the best ground-to-air devices for attracting attention. If the sun is shining and the operator is skillful, pilots can see a mirror flash miles away. VS-17 signal panels are also good visual references for pilots.

Lights. Pocket-size, battery-powered strobe lights produce brilliant white or blue flashes at about 1 1/2-second intervals. The flash is visible at night for 1 to 3 miles. Vehicle lights, such as an unshielded red taillight, are visible to a pilot for several miles at night. Chemical glow lights can also be used to mark friendly positions. One technique that can be used at night is to tie an infrared (IR) or green chem light on a 10-foot string. When aircraft are in the area, a crewman can swing the light in a circular motion to mark the location.



*Figure 6-25. Machine gun aim points against helicopters.*



*Figure 6-26. Machine gun aim points against high-performance aircraft.*

**AIR DEFENSE ARTILLERY SYSTEMS**

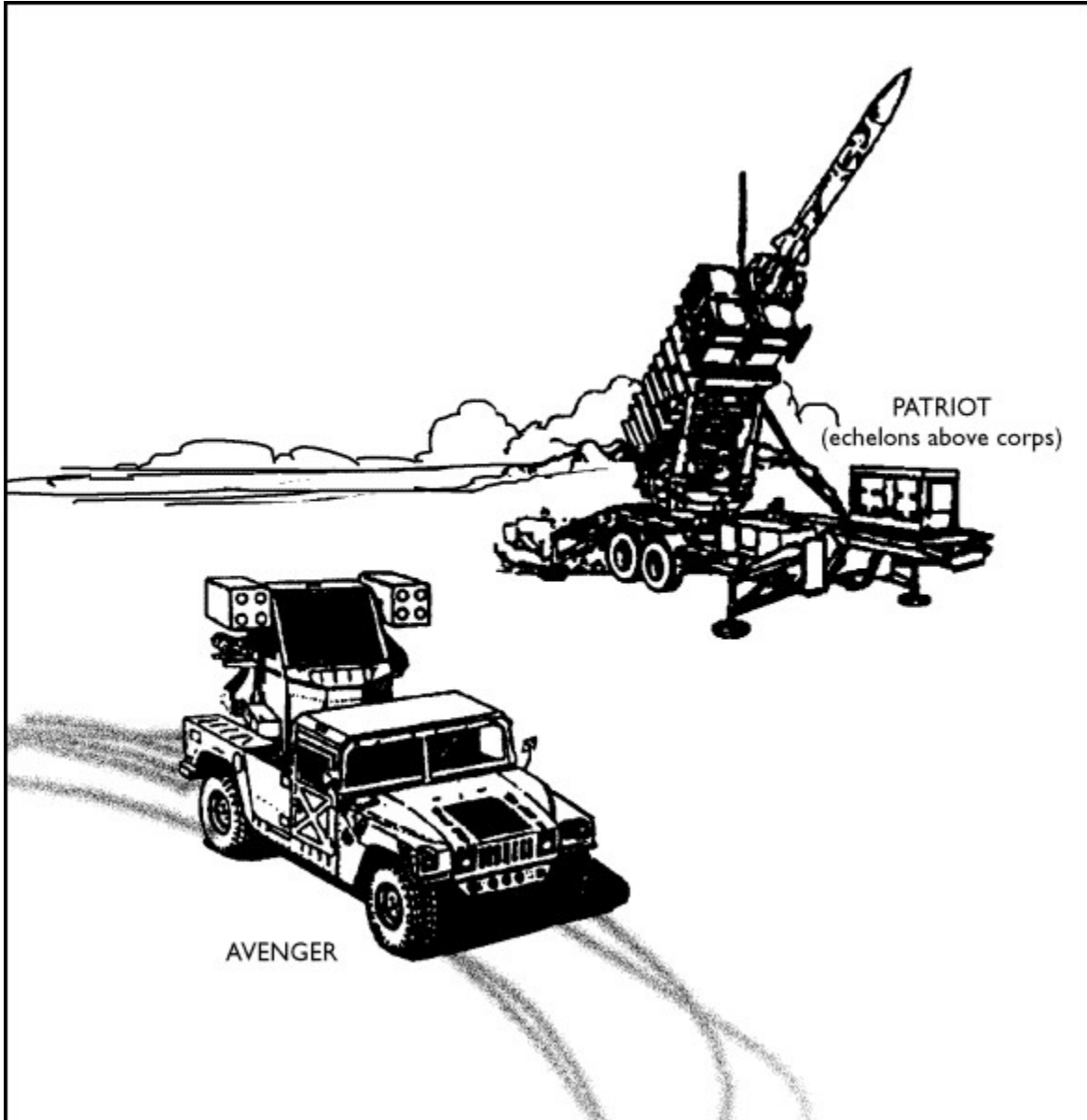
*The mission of the ADA is to protect friendly forces and selected geo-political assets.*



from aerial attack, missile attack, and surveillance. The air defense commander employs several types of systems, at various operational levels, to provide low- to high-altitude air defense coverage.

**Corps level and higher**

At corps level and higher, the primary ADA systems are the Avenger and the Patriot (see Figure 6-27).



**Figure 6-27. Air defense systems at corps level and above.**

**Tactical level (division and below)**

At the tactical level, low- to medium-altitude air defense is accomplished by the air defense battalion organic to the division. The battalion or squadron uses the systems described in the following paragraphs to complement and support the maneuver force.

Stinger. This is the primary air defense weapon system for the battalion or squadron, employing short-range, shoulder-fired, heat-seeking guided missiles (see Figure 6-28). The Stinger is designed to counter high-speed, low-level ground attack aircraft. It is also a lethal weapon against helicopters, observation and transport aircraft, and UAVs. The missile has a range in excess of 5 kilometers.

The Stinger can be employed as a man-portable air defense system (MANPADS). The two-man Stinger team, consisting of an operator and a crew chief, is transported in a HMMWV or in the Bradley Stinger fighting vehicle (BSFV) or Bradley Linebacker vehicle. (NOTE: The BSFV and Bradley Linebacker are discussed later in this section.)



Figure 6-28. Stinger air defense system.

Bradley Stinger fighting vehicle. The BSFV, which replaces the Vulcan air defense system, provides the air defender with armor protection and gives him the ability to maneuver with the supported force and position the Stinger system forward on the battlefield (see Figure 6-29). The Stinger team must dismount to fire the missiles.

The BSFV carries a basic load of six Stinger missiles as its primary air defense weapon; the Bradley's 25-mm chain gun can be used to augment the Stinger and cover dead space to a range of 2,000 meters. The vehicle also carries five TOW missiles.

Future versions of the BSFV will include the Stinger vehicle-mounted launcher (SVML) in place of the TOW system. The SVML will provide the vehicle with fire-on-the-move capability.



Figure 6-29. Bradley Stinger fighting vehicle.

Bradley Linebacker. This vehicle replaces the BSFV's TOW system with four ready-to-fire Stinger missiles, housed in the Stinger vehicle mounted launcher (SVML). The Bradley Linebacker, with its ability to shoot on the move, is designed specifically to provide air defense on the battlefield.

## SECTION 5 - AIR SUPPORT

### CLOSE AIR SUPPORT

Close air support (CAS), provided by the Air Force, can be employed to destroy large enemy armor formations. CAS strikes can be either preplanned (at brigade, battalion, or squadron level) or requested on an immediate-need basis through the battalion forward air controller (FAC). The FAC on the ground or in the air acts as a link between the ground element and the CAS aircraft.

Army air cavalry is best equipped to coordinate with Air Force assets in joint air attack team (JAAT) and attack helicopter operations. The air cavalry can see the battlefield and the target better than ground forces can, and it has the radio equipment needed to talk to Air Force aircraft. The attack aircraft organic to air cavalry units can assist CAS aircraft in suppressing the enemy ADA threat.

## **MARKING FRIENDLY POSITIONS**

**Whenever possible, friendly positions should be marked during close air strikes, especially when friendly troops are within 300 meters of the target. Resources for marking positions include the following:**

**Smoke. The smoke grenade is the most commonly used marker, but it has limitations. Wind may cause smoke to drift above trees, and some colors can blend with the background. Violet or white smoke shows up well against most background colors.**

**Flares. Rocket or 40-mm flares are useful for attracting attention at night; they can sometimes be employed effectively during the day.**

**Mirrors and signal panels. Signal mirrors are probably the best ground-to-air devices for attracting attention. If the sun is shining and the operator is skillful, pilots can see a mirror flash miles away. VS-17 signal panels are also good visual references for pilots.**

**Lights. Pocket-size, battery-powered strobe lights produce brilliant white or blue flashes at about 1 1/2-second intervals. The flash is visible at night for 1 to 3 miles. Vehicle lights, such as an unshielded red taillight, are visible to a pilot for several miles at night. Chemical glow lights can also be used to mark friendly positions. One technique that can be used at night is to tie an infrared (IR) or green chem light on a 10-foot string. When aircraft are in the area, a crewman can swing the light in a circular motion to mark the location.**

## **CHAPTER 7**



## **COMBAT SERVICE SUPPORT**

CSS elements arm, fuel, fix, feed, clothe, and provide transportation and personnel for the platoon. The platoon leader is responsible for supervising CSS within the platoon. The PSG is the CSS operator for the platoon, as the 1SG is for the company and troop. The PSG advises the platoon leader of logistical requirements during preparation for combat operations. He also keeps the platoon leader informed of the platoon's status. During combat operations, the PSG coordinates directly with the 1SG, informing him of the platoon's supply, maintenance, and personnel requirements and problems. The PSG is assisted by the other TCs and the gunners on the platoon leader's and PSG's vehicles.

## **CONTENTS**

- SECTION I. Organization
- SECTION II. Supply Operations
- SECTION III. Maintenance Operations
- SECTION IV. Personnel Operations

SECTION V. Medical Treatment and Evacuation

SECTION VI. Prisoners

## **Section I. ORGANIZATION**

The platoon has no organic CSS assets. The PSG coordinates directly with his supporting 1SG for all CSS. The PSG is also the primary recipient of all maintenance, supply, and personnel reports within the platoon. He is assisted by the TCs, but it is his responsibility to keep the platoon leader informed of the current status of the platoon.

Most routine CSS functions are accomplished by SOP. These procedures and services include the following:

- Accountability, maintenance, and safeguarding of assigned equipment.
- Reporting of the status of personnel, equipment, and classes of supply.
- Requests for resupply.
- Turn-in of equipment for repair.
- Evacuation of personnel (WIA, KIA, EPW).
- Evacuation of equipment and vehicles for replacement and/or repair.

## **Section II. SUPPLY OPERATIONS**

Each platoon has a large amount of equipment and requires frequent resupply to accomplish its mission. All leaders must make periodic checks to ensure that the platoon's equipment, especially high-use items, is accounted for and ready to use. They must anticipate expenditures and request supplies before an operation begins.

The company delivers supplies to the platoon. Priorities for delivery are established by the company commander. The PSG distributes supplies within the platoon.

## **BASIC LOAD**

For supply classes other than ammunition, basic loads are supplies kept by units for use in combat. The quantity of each item of supply in a basic load is based on the number of days the combat unit may have to sustain itself without resupply. For ammunition, the basic load is the quantity of ammunition required to be on hand to meet combat needs until resupply can be accomplished. The basic ammunition load is specified by the theater army and is expressed in rounds, units, or units of weight, as appropriate.

# **CLASSES OF SUPPLY**

## **Class I**

This class includes subsistence items and gratuitous-issue health and welfare items. MRE rations, usually a three- to five-day supply, are stocked on each vehicle. Hot meals are brought forward when possible, if only to supplement MREs. Potable water should be

replenished daily, either by refilling from the water trailer or by rotating 5-gallon cans with the 1SG or supply sergeant. Each combat vehicle should maintain a minimum of 10 gallons of potable water, more during operations in arid climates or in MOPP gear. The platoon should also maintain a minimum amount of nonpotable water for vehicle and equipment maintenance; one technique is to recycle water previously used for personal hygiene.

All meals should be eaten in shifts, and they should never be served at one centralized location. The platoon leader and PSG must make sure not only that the platoon is fed, but also that their soldiers eat nutritious meals to maintain the energy levels required in combat. During continuous or cold-weather operations, soldiers will eat more than three meals per day. This extra allowance must be planned for and requested.

## **Class II**

This class includes items of equipment, other than principal items, that are prescribed in authorization and allowance tables. Individual tools and tool sets, individual equipment and clothing items, chem lights, batteries, engineer tape, tentage, and housekeeping supplies are requested through the supply sergeant.

## **Class III and Class V**

Class III comprises all types of POL products. Class V is ammunition, to include small arms, artillery and tank rounds, mines and demolitions, fuzes, missiles, and bombs. Rearming and refueling or optimum security, they should be executed

The platoon leader must control redistribution of supplies when fuel and ammunition cannot be delivered or when only limited supplies are available. The PSG continually monitors the platoon's supply status through logistical reports and, on digitally equipped vehicles, automated SITREPs. Refer to FKSM 17-15-3 for report formats. The PSG notifies the platoon leader before a specific vehicle or the platoon as a whole is critically short of these major classes of supply. He should take steps to ensure ammunition is equally distributed throughout the platoon before the start of any tactical operation, after direct fire contact with the enemy, and during consolidation on an objective.

In planning for refueling operations, the platoon leader should balance the range and fuel capacity of his vehicles against the requirements of future operations. The platoon must top off vehicles whenever the tactical situation permits. When time is limited, however, the platoon leader must choose between topping off vehicles that need the most fuel first or giving limited amounts to each. Each vehicle crew needs to maintain a stock of oil, grease, and hydraulic fluid, replenishing these POL products every time refueling takes place.

## **Class IV**

This class includes construction and barrier materials used by the platoon to construct

OPs and obstacles and to improve fighting positions. Barrier materials include lumber, sandbags, concertina or barbed wire, and pickets. Based on unit SOP, some Class IV materials may be part of the tank load plan; other materials are requested through the company headquarters.

## **Class VI**

This class covers personal demand items. Tobacco products, candy, and toiletry articles are normally sold through the exchange system during peacetime or for units not in a combat environment. In a combat environment, these items are sent with Class I as sundry packs.

## **Class VII**

This class includes major end items. These are major pieces of equipment, assembled and ready for intended use, such as combat vehicles, missile launchers, that are destroyed are reported immediately by reports will be replaced by the parent unit as they are reported and as available.

## **Class VIII**

This class includes medical supplies, which are provided through the battalion or squadron medical platoon and ordered through the MEDEVAC team supporting the platoon or company. Included are individual medical supplies such as first-aid dressings, refills for first-aid kits, water purification tablets, and foot powder.

## **Class IX**

This class comprises repair parts carried by the maintenance team. These basic load supplies are part of the prescribed load list (PLL). PLL items carried by the platoon usually include spare track, road wheels, assorted bolts, machine gun parts, and light bulbs. Class IX supplies are requisitioned through the company or troop maintenance section.

# **METHODS OF RESUPPLY**

The tank platoon uses three methods in conducting supply operations: pre-positioning, routine resupply, and emergency resupply. The method to be used is determined after an analysis of the factors of METT-T.

## **Pre-positioning**

Pre-positioning of supplies, also known as prestock, may be required in some defensive operations. Normally, only Class V items will be prestocked, but Class I and Class III supplies may be included in some situations. The location and amount of a prestock must be carefully planned and then verified through reconnaissance and rehearsals. Each TC must be informed of prestock locations. The following considerations influence selection of prestock sites and execution of the resupply operation:

- Availability of overhead cover for the prestock location.
- Cover and concealment for the location and routes that vehicles will take to reach it.
- Security procedures required to safeguard the resupply operation.
- Procedures for protecting friendly personnel and vehicles in the event prestock ammunition is ignited.







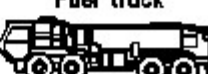
There are several techniques for accomplishing prestock resupply in the defense. Normally, Class V (ammunition) is positioned next to or within a vehicle's fighting position. This enables the tank crew to resupply during an engagement without displacing. Another technique is to locate Class V supplies en route to or within a subsequent BP. Use of this method requires consideration of security procedures to safeguard the prestock. Resupply of Class III (specifically fuel) is usually accomplished behind a unit's current BP or en route to a subsequent BP. In the defense, the platoon leader directs the PSG to rotate vehicles or sections through prestock positions based on the enemy situation and shortages within the platoon.

## **Routine Resupply**

These operations include regular resupply of items in Classes I, III, V, and IX and of any other items requested by the company or troop. Routine resupply is planned at battalion level and normally takes place at every opportunity. The company LOGPAC is a mixture of company and battalion assets that transport supplies to the company (see Figure 7-1).

The company supply sergeant assembles his LOGPAC in the battalion field trains area under the supervision of the support platoon leader. Replacements and hospital returnees travel to company locations on LOGPAC vehicles as required. Once the LOGPAC is prepared for movement, the supply sergeant moves the vehicles forward from the field trains as part of the task force resupply convoy to the logistic release point (LRP). The company ISG or his representative meets the LOGPAC and guides it to the company resupply point. The company then executes tailgate or service station resupply; refer to the discussion of these resupply techniques later in this section.



PERSONNEL	VEHICLE
Supply sergeant	Supply truck (supplies, rations) and water trailer 
*PLL clerk**	PLL truck and trailer 
Systems mechanic** Mechanic	Tool truck and trailer 
Driver	Ammo truck 
Driver	Ammo truck 
Driver	Fuel truck 
Driver	Fuel truck 

\* Optional, based on the situation.  
\*\* These personnel and assets usually meet the 1SG at the LRP.

Figure 7-1. Company LOGPAC.

## Emergency Resupply

Emergency resupply, normally involving Classes III and V, is executed when the platoon has such an urgent need for resupply that it cannot wait for the routine LOGPAC.

Emergency resupply procedures start with immediate redistribution of ammunition in individual vehicles, followed by cross-leveling of ammunition

Once requested through the commander or 1SG, emergency supplies are brought forward by the battalion support platoon. Based on the enemy situation, the platoon may have to conduct resupply while in contact with the enemy. Two techniques are used to resupply platoons in contact:

Limited supplies are brought forward to the closest concealed position, where the tailgate technique of resupply is used.

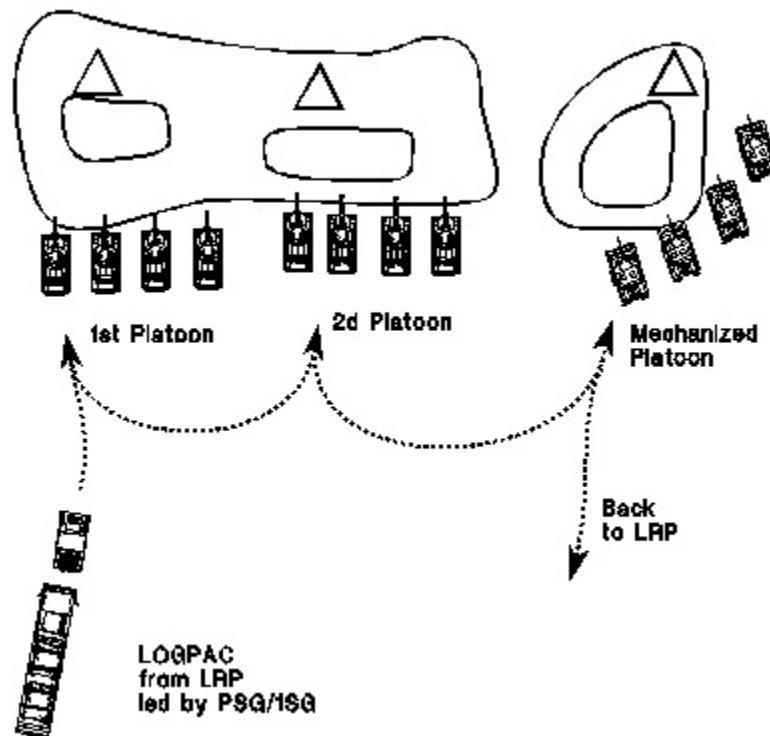
Individual vehicles or sections disengage and move to a resupply point, obtain their supplies, and then return to the fight. This is a version of the

service station technique.

## TECHNIQUES OF RESUPPLY

The tactical situation will dictate which technique of resupply the platoon will use: tailgate, service station, a variation of one type, or a combination of both types. The situation will also dictate when to resupply. Generally, the platoon should attempt to avoid resupply during the execution of offensive operations; resupply should be done during mission transition. Resupply is unavoidable during defensive missions of long duration.

In the tailgate technique, fuel and ammunition are brought to individual tanks by the PSG or another responsible individual who is assisting him (see Figure 7-2). This method is used when routes leading to vehicle positions are available and the unit is not under direct enemy observation and fire. It is time-consuming, but it is useful in maintaining stealth during defensive missions because tanks do not have to move



**Figure 7-2. Tailgate resupply technique.**

In the service station technique, vehicles move to a centrally located point for rearming and refueling, either 10). Service station resupply is inherently faster than the tailgate method; because vehicles must move and concentrate, however, it can create security problems. During defensive missions, the platoon must be careful not to compromise the location of fighting positions.

A platoon leader can vary the specifics of the two basic techniques, or he can use them in

combination. During a defensive mission, for example, he may use the tailgate technique for a mounted forward OP and the service station method for the remainder of the platoon located in hide positions (see Figure 7-4, page 7-11).

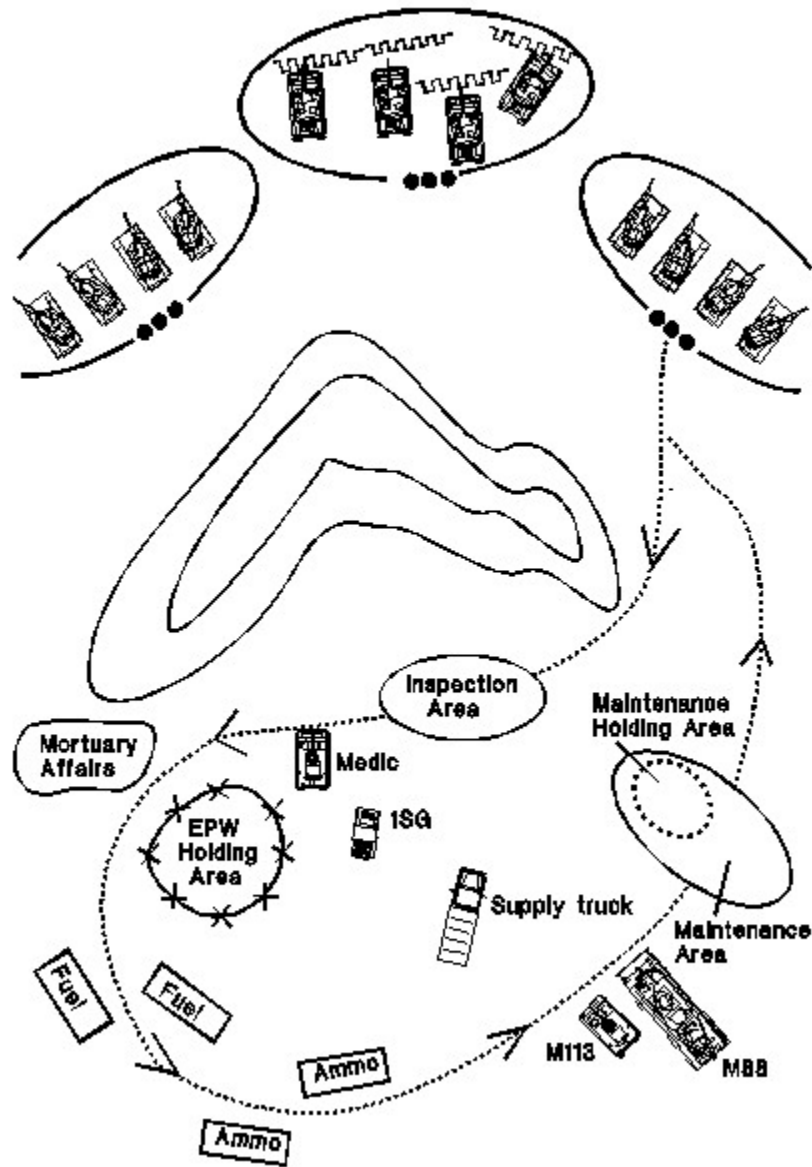


Figure 7-3. Service station resupply technique.

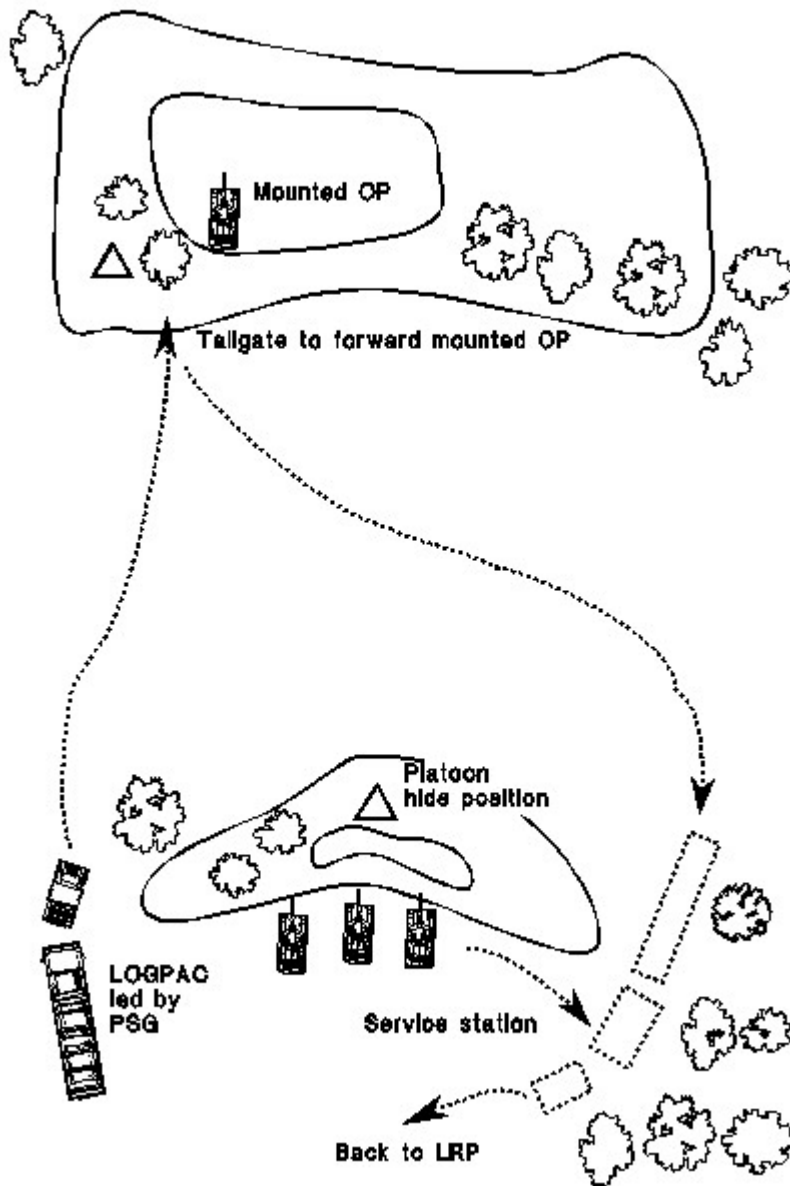


Figure 7-4. Combination of resupply techniques.

### Section III. MAINTENANCE OPERATIONS

Proper maintenance keeps equipment and materiel in serviceable condition. It includes PMCS, as well as the functions of inspecting, testing, servicing, repairing, requisitioning, recovering, and evacuating equipment and materiel whenever necessary.

Maintenance tasks are divided into four levels: unit (which includes both operator and organizational maintenance), direct support (DS), general support (GS), and depot. The platoon leader is concerned primarily with supervising operator maintenance, ensuring scheduled services are performed as part of organizational maintenance, and providing support for DS maintenance elements when equipment must be evacuated.

Repair and recovery are accomplished as far forward as possible. When equipment cannot be repaired on site within two hours, it is moved to the rear (but only as far as necessary for repair) to a unit maintenance collection point (UMCP).

## **LEADER RESPONSIBILITIES**

### **Platoon Leader**

The platoon leader has ultimate responsibility for the condition and performance of the platoon's equipment and materiel. In that role, his duties include the following:

Ensuring that all platoon vehicles, weapon systems, and equipment such as night vision devices, mine detectors, and communications equipment are combat-ready at all times, within the platoon's maintenance capabilities. The platoon leader also ensures that equipment that cannot be repaired at platoon level is reported to organizational maintenance as soon as possible using DA Form 2404 or DA Form 5988E.

Knowing the status of current platoon maintenance activities, including corrective actions for equipment faults, job orders to DS maintenance elements, and requisition of repair parts. The platoon leader keeps his commander informed of the platoon's maintenance status.

Coordinating with the maintenance officer in planning, directing, and supervising unit maintenance for the platoon.

Developing and supervising an ongoing maintenance training program.

Ensuring crews have appropriate technical manuals and are trained and supervised to complete operator maintenance properly.

Ensuring unit-level PMCS are performed on all assigned equipment in accordance with appropriate operator's manuals.

Ensuring that drivers are trained and licensed to operate platoon vehicles and equipment.

Planning and rehearsing a maintenance evacuation plan for every mission.

### **Platoon Sergeant**

The PSG has primary responsibility for most of the platoon's maintenance activities. His duties include the following:

Directing and supervising unit maintenance of platoon equipment, vehicles, and weapon systems.

Helping the platoon leader to comply with his responsibilities and assuming these responsibilities in his absence.

Coordinating with the 1SG to arrange organizational or DS maintenance.

Supervising and accounting for platoon personnel during maintenance periods.

Ensuring repair parts are used or stored in a timely fashion as they are received.

Collecting reports of the platoon's maintenance status in the field and sending the appropriate consolidated reports to maintenance personnel.

Ensuring that vehicles are always topped off with fuel in garrison and that they receive fuel in the field.

Keeping the platoon leader informed of the platoon's maintenance and logistics status.

## **Tank Commanders/Gunner**

The TCs and the gunner from the platoon leader's tank are the platoon's first-line maintenance supervisors. In large part, the platoon's maintenance status, and thus its combat readiness, depends on their commitment to proper maintenance procedures. Their duties in this area include the following:

Ensuring that the equipment inspection and maintenance worksheet is filled out accurately and updated in accordance with DA Pam 738-750.

Ensuring that dispatch records are completed accurately and turned in on schedule.

Ensuring that the crew is properly trained in PMCS procedures and that PMCS are performed on the vehicle in accordance with the appropriate technical manuals.

Ensuring that, as a minimum, the assigned driver is properly trained and licensed. In preparing for continuous operations, the TC must ensure that all crewmembers are trained and licensed as drivers.

Ensuring repair parts are installed upon receipt or are stored in authorized locations.

Ensuring that all tools and basic issue items (BII) are properly marked, stored, maintained, and accounted for.

Ensuring that the vehicle is always topped off in garrison and that it receives as much fuel as possible at every opportunity in the field.

Constantly updating the PSG on the maintenance and logistics status of the vehicle.

## **UNIT MAINTENANCE - OPERATOR**

Operator maintenance includes proper care, use, and maintenance of assigned vehicles and crew equipment such as weapons, NBC equipment, and night vision devices. The driver and other crewmembers perform daily services on the vehicle and equipment, to include inspecting, servicing, tightening, performing minor lubrication, cleaning, preserving, and adjusting. The driver and gunner are required to record the checks and services, as well as all equipment faults that they cannot immediately correct, on the equipment inspection and maintenance worksheet. The worksheet is the primary means

of reporting equipment faults through the TC to the PSG and platoon leader and ultimately to organizational maintenance personnel.

The M1A2 and the M8-AGS are equipped with embedded nonintrusive and intrusive diagnostic test capabilities (BIT/FIT). These tests enable crews to identify and isolate many system and component failures prior to the arrival of organizational mechanics. Unit SOP should specify how to report the results of these tests as well as identify the duties of organizational mechanics.

Checks and services prescribed for the automotive system, weapon systems, and turret are divided into three groups:

- Before-operation.
- During-operation.
- After-operation.

These checks and services are explained in every operator's manual and should be conducted as stated in the manual. Although operators must learn to operate equipment without referring to the manual, **maintenance must be performed using the appropriate technical manual--not from memory!**

## **UNIT MAINTENANCE - ORGANIZATIONAL**

's design allows rapid modular replacement of parts, many faults can be corrected, and the vehicle returned to the platoon, with minimum delay.

When the operator identifies a problem that is beyond his level of maintenance capability, he notifies his chain of command so the problem can be isolated and corrected. The company or troop maintenance team has trained mechanics who are authorized to perform unit maintenance tasks as prescribed in the technical manuals for the vehicle. When company, troop, battalion, or squadron maintenance teams are not authorized to make a particular repair, they will arrange to have it done by DS maintenance assets.

The built-in diagnostic tests on the M1A2 and the AGS facilitate replacement of defective components and systems. When the crew isolates a problem using these tests, the organizational mechanic can verify the fault as soon as he arrives on site and replace the component without further diagnostic testing.

## **DIRECT SUPPORT MAINTENANCE**

This level is performed by personnel from the DS maintenance company, which normally supports a brigade or regiment. It consists of repair and/or replacement of parts, assemblies, and components. Maintenance support teams from DS units are usually located forward with the squadron or battalion field trains. These support teams may go forward to fix disabled equipment on site, but they are limited in what they can fix and

where they can go.

## **EVACUATION**

Evacuation is necessary when a damaged vehicle cannot be repaired on site within two hours or when evacuation is the only means (besides friendly destruction) available to prevent capture or destruction by the enemy. When a vehicle needs to be evacuated, the platoon leader or PSG reports its exact location, the vehicle type, and the extent of damage, if known, on the company net to personnel designated in the unit SOP. The crew should remain with the vehicle to assist in evacuation and repair, to provide security, and to return the repaired vehicle to the platoon as soon as possible.

A recovery vehicle from the company, troop, or battalion maintenance team will evacuate the damaged vehicle. The vehicle is evacuated to an LRP, the main supply route (MSR), or the UMCP as necessary.

The recovery team normally employs an M88A1 recovery vehicle. This vehicle travels with the company maintenance team under the direction of the 1SG. The location of the company maintenance team during operations is designated in the company OPORD.

If a recovery vehicle is not available or if time is critical, other platoon vehicles can evacuate the damaged vehicle for short distances. The decision to do this rests with the platoon leader. Towing procedures are listed in the operator's manual. Self-evacuation by the platoon is a last resort that should be considered only to prevent losing the damaged vehicle to the enemy.

If the damaged vehicle will be lost for an extended period, the platoon can replace other vehicles' damaged equipment (such as weapons and radios) with properly functioning items from the damaged vehicle. Damaged equipment can then be repaired or replaced while the vehicle is being repaired.

## **DESTRUCTION**

When damaged or inoperable equipment cannot be evacuated and it becomes apparent that enemy capture is imminent, the equipment must be destroyed. Platoon leaders must ensure crews are trained to destroy their vehicles rather than allow them to fall into enemy hands. Instructions for destroying equipment are included in the operator's manual for each item.

The platoon leader should get the commander's permission before destroying any equipment. When communications fail, however, the platoon leader must use his judgment to decide whether or not evacuation is possible. Every reasonable effort must be made to evacuate secure equipment, classified materials, and all weapons.

### **Section IV. PERSONNEL OPERATIONS**



## **PERSONNEL SERVICES**

Personnel services include clothing exchange and showers, awards and decorations, leaves and passes, command information, mail, religious services, financial services, legal assistance, welfare, rest and relaxation, and any other service designed to maintain the health, welfare, and morale of the soldier. Many of these are provided automatically by higher-level support elements; nonetheless, the platoon leader is ultimately responsible for coordinating personnel services and providing them to his platoon.

## **PERSONNEL MANAGEMENT**

Personnel management includes classification, assignment, promotions, and reenlistments. Although the platoon leader requests these actions through the company or troop, they are normally performed by the battalion or squadron staff or by a division-level organization. The platoon leader must submit accurate strength reports to ensure that positions in which critical shortages exist, such as TCs and gunners, are filled with qualified personnel.

### **Section V. MEDICAL TREATMENT AND EVACUATION**

## **HEALTH AND HYGIENE**

Leaders must emphasize high standards of health and hygiene. Soldiers must shave daily so their protective masks will seal; bathing and changing clothes regularly are essential in preventing disease. Each crewman should carry shaving equipment, soap, a towel, and a change of clothing in a waterproof bag inside his pack.

During cold weather, soldiers must check their hands and feet regularly to prevent frostbite, trench foot, and immersion foot. They must also learn that the effects of windchill on exposed skin are equal to those of temperatures much lower than the thermometer shows. A moving vehicle will cause a windchill effect even if the air is calm.

## **SOLDIERS WOUNDED in action**

It is the TC's responsibility to make sure that WIA crewmen receive immediate first aid and that the platoon leader or PSG is notified of all casualties. The use of crewmen who are trained as combat lifesavers is absolutely critical. As a minimum, one member of each tank crew must be a trained combat lifesaver. If wounded crewmen require evacuation, the platoon leader or PSG takes one of these steps:

- Coordinate with the 1SG or company team aidman for ground evacuation.
- Coordinate with the company commander for self-evacuation using

organic platoon assets.

Coordinate with the 1SG or company commander for aerial evacuation.

Aerial evacuation, if it is available, is preferred because of its speed. The platoon leader or PSG coordinates with higher headquarters and then switches to the designated frequency to coordinate directly with the MEDEVAC aircraft. He must pick a relatively flat, open, and covered and concealed position for the aircraft's landing zone. The location should be given to the aircraft by radio and marked with colored smoke as the aircraft approaches the area. The tank platoon provides local security of the landing zone until the evacuation is complete.

Regardless of the method of evacuation, all TCs must have the necessary CSS graphics available, to include company and battalion casualty collection points. Evacuation procedures must be included in the platoon plan and should be rehearsed as part of mission preparation.

After evacuation is complete, the PSG compiles and submits casualty feeder reports in accordance with unit SOP. The platoon leader redistributes crewmen and directs TCs to organize for three-man crews as necessary. It is extremely difficult for platoons equipped with main battle tanks to sustain continuous operations with three-man crews; AGS-equipped platoons are unable to conduct continuous operations after the evacuation of crewmembers.

A wounded crewman's individual weapon becomes the responsibility of the TC. Personal effects, weapons, and equipment are turned in to the company or troop supply sergeant at the earliest opportunity. The crewman's protective mask stays with him at all times. All sensitive items, such as maps, overlays, and SOPs, remain with the vehicle.

## **SOLDIERS KILLED IN ACTION**

The company or troop commander will designate a location for collection of KIA personnel. The remains of each KIA soldier are placed in a body bag or sleeping bag or rolled in a poncho and are evacuated by the PSG or 1SG. The lower dog tag is removed and retained by the PSG or 1SG. The personal effects of the KIA soldier remain with the body. The soldier's weapon, equipment, and issue items become the responsibility of the TC until they can be turned over to the supply sergeant or 1SG.

As a rule, the bodies of KIA soldiers should not be placed on the same vehicle as wounded soldiers. If evacuation cannot be expedited by the PSG or 1SG, however, a vehicle may have to carry dead and wounded personnel together to its next stop. In the attack, this may be the objective. In the defense, it may be the next BP.

### **Section VI. PRISONERS**

If enemy soldiers want to surrender, it is the tank crew's responsibility to take them into custody and control them until they can be evacuated. EPWs are excellent sources of combat intelligence; however, this information will be of tactical value only if the prisoners are processed and evacuated to the rear quickly.

The platoon leader directs crewmen to take the EPWs to an area designated by the commander. The prisoners are then evacuated to the rear for interrogation. If an EPW is wounded and cannot be evacuated through medical channels, the platoon leader notifies the XO or 1SG. The EPW will be escorted to the company or troop trains, or the 1SG will come forward with guards to evacuate him.

## **HANDLING PRISONERS OF WAR**

The basic principles for handling EPWs are covered by the "five-S" procedures: search, segregate, silence, speed, and safeguard. See Figure 7-5 for an outline. The unit SOP or company OPORD should designate specific EPW handling procedures, such as collection points, responsibilities for safeguarding prisoners, and procedures for movement of prisoners.

The rights of EPWs have been established by international law, and the United States has agreed to obey these laws. Once an enemy soldier shows he wants to surrender, he must be treated humanely. It is a court-martial offense to physically or mentally harm or mistreat a EPW or to needlessly expose him to fire. In addition, mistreated EPWs or those who receive special favors are not good interrogation subjects.

Never approach an enemy soldier. He may have a weapon hidden nearby, or he may be booby-trapped. Gesture for him to come forward, then wait until it is clear that he is honestly surrendering and not trying to lure friendly troops into an ambush. Use a thermal sight to locate possible ambushes. When searching the prisoner, always have another friendly soldier cover him with a weapon. Do not move between the enemy and the soldier covering him.

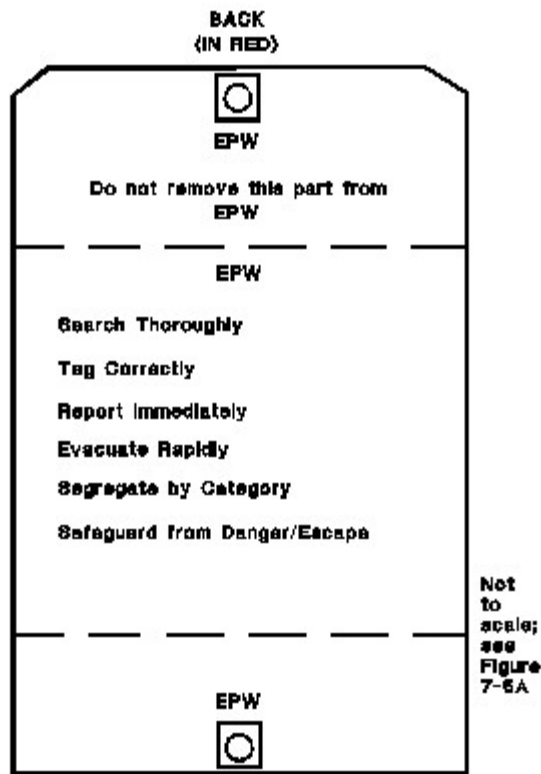
<b>SEARCH</b>	<b>Remove and tag all weapons and documents. Return to the EPW those personal items of no military value. Allow him to keep his helmet, protective mask, and other gear that will protect him from immediate dangers of the battle area.</b>
<b>SEGREGATE</b>	<b>Break the chain of command; separate EPWs by rank, sex, and other suitable categories. Keep the staunch fighter away from those who willingly surrender.</b>
<b>SILENCE</b>	<b>Prevent EPWs from giving orders, planning escapes, or developing false "cover stories."</b>
<b>SPEED</b>	<b>Speed EPWs to the rear to remove them from the battle area and to obtain and use their information.</b>
<b>SAFEGUARD</b>	<b>Prevent EPWs from escaping. Protect all EPWs from violence, insults, curiosity, and reprisals of any kind.</b>

**Figure 7-5. The "five-S" principles for handling EPWs.**

The senior officer or NCO on the scene is legally responsible for the care of EPWs. If the unit cannot evacuate a prisoner within a reasonable time, he must be provided with food, water, and medical treatment.

Before evacuating the EPW, attach a tag to him listing all pertinent information and procedures. Tags may be obtained through supply channels or made from materials available on the battlefield. An example is illustrated in Figures 7-22 and 7-23.





**DESCRIPTION:**

1. The tag should be made of durable material and perforated into three parts
2. Each part of the tag should measure approximately 10x15 centimeters
3. The tag should be pierced at top and bottom, with added reinforcement around the holes, to facilitate attachment

Figure 7-6B. Sample standardized EPW tag (back).

## CAPTURED ENEMY DOCUMENTS AND EQUIPMENT

Captured enemy documents (such as maps, orders, records, and photographs) and equipment are excellent sources of intelligence information. If captured items are not handled properly, however, the information in them may be lost or delayed until it is useless. These items must be evacuated to the next level of command as rapidly as possible.

The platoon should tag each captured item (see Figure 7-7 for an example). If the item is

found in the EPW's possession, include the prisoner's name on the tag and give the item to the guard. The guard delivers the item with the EPW to the next higher headquarters.

**TYPE OF DOCUMENT/EQUIPMENT** \_\_\_\_\_

**DATE/TIME OF CAPTURE** \_\_\_\_\_

**PLACE OF CAPTURE (Grid coordinates)** \_\_\_\_\_

**CAPTURING UNIT** \_\_\_\_\_

**CIRCUMSTANCES OF CAPTURE** \_\_\_\_\_

\_\_\_\_\_

**Figure 7-7. Sample tag for captured documents and equipment.**

## **CIVILIANS**

Civilians who are captured as the result of curfew violations or suspicious activities are treated the same as EPWs. The platoon evacuates them quickly to higher headquarters using the "five-S" principles discussed earlier in this section.

## **APPENDIX A**



## **ORDERS AND REPORTS**

Orders and reports are the means by which the tank platoon receives and transmits information, from the earliest notification that an operation will occur through the final phases of execution. They are absolutely critical to mission success. In a tactical situation, the platoon leader and PSG work with these vital tools on a daily basis; obviously, they must have precise knowledge of orders formats and reporting procedures. At the same time, they must ensure that every member of the platoon understands how to receive and respond to the various types of orders and how to compile and submit accurate, timely reports.

## **CONTENTS**

SECTION I. Orders

SECTION II. Reports

### **Section I. ORDERS**

The tank platoon leader must be familiar with the formats of WOs, OPORDs, and

FRAGOs. He must be able to convert these into concise, yet thorough, orders for the platoon.

Before the commander issues the OPORD, the platoon leader may receive one or more WOs. He analyzes all information in these orders and transmits important details to the platoon as soon as possible.

When the higher headquarters issues a complete five-paragraph OPORD, analysis of the order is a fairly simple, straightforward process for the platoon leader. Commanders, however, do not always have the time to issue a full OPORD; instead, they may have to issue a FRAGO.

The tank platoon leader normally issues instructions to his platoon in the OPORD format. He derives much of the content from the higher order he received during execution of his troop-leading procedures. He should always plan to issue his own five-paragraph order when time permits. When time is short, he still issues as complete an order as possible, but he does so using a FRAGO.

Once an operation begins, FRAGOs become the normal method of issuing orders. Digital systems allow commanders and leaders to supplement oral orders with overlays and a limited text capability; these items can enhance their subordinates' understanding of the FRAGOs.

## **WARNING ORDERS**

During the planning phase of an operation, commanders and leaders use WOs as a shorthand method of alerting their units and individual soldiers. The company commander usually sends a series of WOs to his platoon leaders. These orders help subordinates prepare for new missions by providing directions and guidelines for platoon-level planning and preparation. Each platoon leader immediately analyzes the information, then issues a WO of his own to alert the platoon to the upcoming operation.

WOs generally follow the five-paragraph OPORD format (illustrated in Figure A-2, pages A-5 through A-9). The key consideration is that they should be as brief as possible while giving units and soldiers the information they need to begin preparing for the operation. A company-level WO normally includes these elements:

- Enemy situation.
- Higher headquarters' mission.
- Commander's intent (if available).
- Earliest time of movement.
- Specific instructions for preliminary actions (including security, reconnaissance, rehearsals, training, maintenance, resupply, rest, movement, and coordination requirements).
- Time and place at which the company OPORD will be issued.

Before he issues his own WO, the platoon leader should send graphics to the TCs, either by traditional overlay or using digital systems (if available). The order is almost always given orally and in person, but it may be issued by radio or, on digitally equipped tanks,



using the free-text message capability. As a minimum, the platoon WO includes the following information:

- Updated enemy situation.
- Company and platoon mission statement.
- Company commander's intent (if available).
- A tentative timeline to include the following:
  - Earliest time of movement.
  - Specific instructions for preliminary actions (including security, reconnaissance, rehearsals, training, maintenance, resupply, rest, movement, and coordination requirements).
  - Time and location at which the platoon OPORD will be issued.

If he knows other times, events, or details related to the operation, the platoon leader may include the information in the WO. Figure A-1 shows an example of a platoon WO.

**"REFERENCE OPERATIONS ONE OVERLAY: AN ENEMY BMP PLATOON HAS SET UP A HASTY DEFENSE ON OBJECTIVE DOG. AT 2300 HOURS, THE COMPANY ATTACKS ALONG AXIS THUNDER TO SEIZE OBJECTIVE DOG. WE WILL LEAD THE COMPANY FORMATION AND SUPPORT BY FIRE ASSAULTS BY BLUE AND WHITE."**

**Figure A-1. Sample platoon warning order.**

## **OPERATION ORDERS**

When time and information are available, the company commander will normally issue a complete OPORD as part of his troop-leading procedures. The OPORD provides platoon leaders with the essential information required to conduct the operation and to carry out the company commander's intent. The commander should distribute graphics (traditional and digital) before issuing the OPORD.

### **Five-paragraph OPORD Format**

Whenever possible, the OPORD is issued orally in the five-paragraph format. This helps to ensure that required information is presented in a logical manner. Although the five-paragraph format is straightforward, every commander will develop techniques that allow him to make a clearer, more concise OPORD presentation. The platoon leader should request a copy of his commander's OPORD format to facilitate note-taking. See FM 71-1 for more information concerning company OPORDs. Figure A-2 (pages A-5 through A-9) illustrates a sample platoon OPORD format.

### **Issuing the Platoon OPORD**

Issuing the OPORD is, in effect, a type of drill, with contents and delivery procedures

covered by SOPs and other guidelines. The platoon leader must understand, however, that simply reading off the five paragraphs word for word is usually ineffective. His number-one consideration is effective communication. He must fully understand all aspects of the operation and know how to describe and discuss them. He must integrate the friendly and enemy situations and the effects of terrain and weather into the platoon maneuver plan. To make the order even more understandable, the platoon leader should use visual aids to illustrate key points. These premade and field-expedient materials may include the operation map and accompanying overlays; terrain models or impromptu sand tables; and sketches on dry-erase boards, MRE boxes, butcher paper, or the back of a map.

As far as possible, the platoon leader must establish optimum physical conditions that will allow effective presentation of the OPORD. For example, the site at which the platoon order will be issued should afford adequate security and minimum distractions. At night, this may require gathering the TCs in one tank or under a tarp supported by gun tubes. The platoon leader must ensure that the TCs post correct graphics on their overlays and/or digital displays. TCs should arrive at the OPORD site early to study maps and to post graphics. Units with digital capability should already have posted the graphics on their vehicle displays before the platoon leader issues the order.

#### **TASK ORGANIZATION (company).**

##### **1. SITUATION**

###### a. Weather and light data.

(1) Light conditions: BMNT: \_\_\_\_\_; Sunrise: \_\_\_\_\_;  
Sunset: \_\_\_\_\_; EENT: \_\_\_\_\_;  
Moonrise: \_\_\_\_\_; Moonset: \_\_\_\_\_;  
Percent Illumination: \_\_\_\_\_.

(2) Weather forecast for the operation.

(3) Effects of weather and light conditions on the operation.

(a) Trafficability.

(b) Visibility.

(c) Effect on lasers/thermals.

###### b. Terrain.

(1) Obstacles, hills, valleys, road types and conditions, streams, rivers, bridges, built-up areas.

(2) Avenues of approach.

(a) Size unit that can be supported.

(b) Start and end point.

(c) Objective.

(3) Key terrain (discuss how friendly and/or enemy forces may attempt to use it to their advantage).

(4) Observation and fields of fire.

(5) Cover and concealment.

(6) Engagement areas.

(7) Overall effect of terrain on the operation.

- c. Enemy forces.
  - (1) Identification.
  - (2) Activity.
  - (3) Location.
  - (4) Disposition.
  - (5) Strength.

**Figure A-2. Sample platoon OPORD format.**

- (6) Composition, to include type and capabilities of equipment.
- (7) Other enemy information critical to the upcoming operation, to include the following:
  - (a) Chemical and nuclear capabilities.
  - (b) Air defense artillery (ADA).
  - (c) Aviation, including helicopters.
  - (d) Electronic warfare.
- (8) Enemy courses of action (discussion should focus on identifying enemy's most probable courses of action).

d. Friendly forces (include the following items as applicable).

- (1) Mission of higher headquarters (company team/troop), including commander's intent and scheme of maneuver. (This may include a review of the task force or squadron scheme of maneuver or commander's intent.)
- (2) ID/mission of adjacent units (left, right, front, rear).
- (3) ID/mission of reserves in higher headquarters.
- (4) ID/mission of supporting units with a direct support/reinforcing (DS/R) role to higher headquarters (field artillery, engineer, ADA).
- (5) Which higher headquarters element has priority of fires.
- (6) Close air support (CAS) allocated to higher headquarters, including number of sorties available.

e. Attachments and detachments to the platoon and higher.

**2. Mission.** This is the WHO, WHAT, WHEN, WHERE, and WHY. State essential task(s) to be accomplished by the entire unit, to include on-order missions. Clearly define the platoon's objective.

**3. Execution.**

Intent. Using the commander's intent as a guideline, the platoon leader may issue his own intent to define the purpose, method, and end state of the operation. The *purpose* is the WHY of the operation. The *method* tells how the platoon leader visualizes achieving success with respect to the company/troop mission as a whole and outlines, in general terms, use of combat multipliers. The *end state* specifies final disposition of forces and explains how the end state will facilitate future operations.

a. Concept of the operation. This paragraph further explains and expands on the platoon leader's (and/or commander's) intent, particularly his vision of HOW he will conduct the operation and WHO he will assign to execute it. The platoon leader uses a concept statement when he feels more detail is necessary to ensure subordinates will take the appropriate actions in the absence of additional communications or further orders. The sequence of subparagraphs is as follows:

- (1) Scheme of maneuver. This is how the platoon will maneuver to kill the enemy or to accomplish its mission. It conforms with the commander's intent. In offensive operations, it specifies the platoon's formation, movement technique, routes or avenues of advance, and plans for direct fire and overwatch. In defensive operations, it specifies the platoon engagement plan, battle positions, orientation of weapons, and

the plan for movement to subsequent positions.

(2) Fires.

- (a) Purpose for field artillery and mortar fires (how fires will be used to support the maneuver).
- (b) Priority of fires within the platoon/company.
- (c) Allocation of final protective fires (FPF).
- (d) Preparation starting time and duration of fires.
- (e) Triggers (trigger line/point or event).
- (f) Description of enemy fires in the area of operations.
- (g) Special fire allocation/use (smoke, illumination, CAS).
- (h) Restrictions.

(3) Engineer support (obstacles, mines, and fortifications).

- (a) Priority of engineer effort (mobility, countermobility, survivability).
- (b) Priority of engineer support.
- (c) Obstacle overlay.
- (d) Obstacle list.
- (e) Logistical constraints.
- (f) On-order missions.

b. Specific instructions. List specific missions, in "battle sequence," for each tank, including attached elements. Include movement techniques, flank coordination requirements, other details, and be-prepared missions.

c. Coordinating instructions.

(1) Time schedule for critical events.

- (a) Rehearsals.
- (b) Confirmation briefings (back-briefs).
- (c) Precombat inspection.
- (d) First movement.
- (e) Arrival of any attachments/detachments.
- (f) Boresighting.

(2) Movement instructions.

(3) Passage of lines.

- (a) Contact points.
- (b) Passage points.
- (c) Lanes, to include identification/markings.

(4) Actions at danger areas.

(5) Actions on expected contact.

(6) Rally points.

(7) Rules of engagement (ROE).

(8) Intelligence requirements (IR), to include priority intelligence requirements (PIR).

(9) Air defense warning and weapons control status.

(10) MOPP level and OEG data.

(11) Any changes regarding battlesight and battlecarry ranges.

(12) Be-prepared tasks or other general information not pro-

vided in concept of the operation or specific instructions.

#### **4. Service Support.**

a. Location and movement plan of the company/troop trains (initial and subsequent grids).

b. Material and services.

(1) Supply.

(a) Priorities of supply.

(b) Resupply points and prestock sites.

(c) Ration cycle.

(d) Location of task force trains.

(2) Transportation.

(a) Supply routes.

(b) LRPs.

(c) Priorities established on MSRs.

(3) Services. Handling of KIAs.

(4) Maintenance.

(a) Maintenance procedures.

(b) Vehicle evacuation.

(c) Task force UMCP location.

c. Medical evacuation and treatment.

(1) Location of company/troop medics.

(2) Location of battalion/squadron aid station.

(3) Procedures for treatment and evacuation of WIAs.

(4) Aeromedical evacuation information.

(5) Location of ambulance exchange points.

(6) Handling of contaminated WIAs.

d. Personnel.

(1) Handling and disposition instructions for enemy prisoners of war (EPW).

(2) EPW guard instructions.

(3) Location of EPW collection point.

(4) Instructions for interaction with local civil populace (ROE).

(5) Number of expected replacements.

(6) Cross-leveling procedures.

e. Miscellaneous.

#### **5. Command and Signal.**

a. Command.

(1) Location of commander, XO, TOC, and/or TAC CP.

(2) Succession of command.

b. Signal.

(1) SOI index and edition in effect.

- (a) Key frequencies.
- (b) Key call signs.
- (c) Current item number identifier.
- (2) KY-57 fill and changeover data.
- (3) Listening silence instructions.
- (4) Challenge and password.
- (5) Special signals, to include use of pyrotechnics.
- (6) Code words.
- (7) Digital traffic instructions (IVIS and digital systems only).
- (8) Actions to counteract jamming or "hot mike" situations.

**TIME CHECK (for synchronization).**

**Figure A-2. Sample platoon OPORD format (continued).**

## **FRAGMENTARY ORDERS**

The FRAGO is a brief oral or written order that can serve any of the following purposes:

- Implement timely changes to existing orders.
- Provide pertinent extracts from more detailed orders.
- Provide instructions until a detailed order is developed.
- Provide specific instructions to subordinates who do not require a complete order.

There is no specific format for a FRAGO. For simplicity and complete clarity, it normally follows the five-paragraph OPORD structure; however, it includes only the information required for subordinates to accomplish their mission. To enhance understanding of voice FRAGOs, digitally equipped units can quickly develop hasty graphics and transmit digital overlays.

The platoon FRAGO normally includes the following information:

- Updated enemy or friendly situation.
- Mission (ensure platoon tasks and purpose are clear).
- Scheme of maneuver.
- Specific instructions as necessary.

Figure A-3 illustrates a platoon FRAGO transmitted by voice over a secure net.

**"RED, THIS IS RED ONE. FRAGO FOLLOWS."**

**"WHITE IS IN CONTACT AND SUPPRESSING 2 T80s VICINITY NK77368900. BLUE IS MOVING TO CHECKPOINT 26 TO SUPPRESS THE T80s."**

**"OUR MISSION IS TO ASSAULT AND DESTROY THE T80s TO ALLOW BRAVO COMPANY TO CONTINUE THE ATTACK NORTH."**

**"WE WILL MOVE IN A PLATOON WEDGE THROUGH WAYPOINTS 2 AND**

**5, GET ON THE FLANK OF THE T80s, AND ASSAULT FROM EAST TO WEST."**

**"RED 4, ENSURE THAT BLUE AND WHITE SHIFT FIRES WEST AS WE BEGIN OUR ASSAULT, OVER."**

**Figure A-3. Sample platoon FRAGO.**

## **Section II. REPORTS**

Reports are the primary means of providing information for plans and decisions. They must be accurate, timely, and complete.

Procedures for preparing, transmitting, and safeguarding reports will vary from unit to unit and from situation to situation. Among the factors influencing report procedures are the preferences and requirements of the chain of command, the tactical environment in which the platoon is operating, available equipment, terrain, and the electronic warfare situation. Digital systems, for example, enable the transmission of accurate preformatted reports.

One factor, however, remains constant for leaders at all levels: the importance of compiling timely, accurate information and of relaying that information by the clearest, quickest, and most secure method possible. Every platoon leader can save time, ensure completeness, and reduce confusion in this process by developing and implementing thorough SOPs covering report procedures.

FKSM 17-15-1 and FKSM 17-15-3 provide additional information, including line-by-line descriptions of voice and digital report formats used by the tank platoon.

## **APPENDIX B**



## **LIGHT/HEAVY OPERATIONS**

Tanks never fight alone. Open terrain such as desert, plains, and flat countryside is conducive to the employment of massed armor formations. In such terrain, mechanized infantry supports the forward movement of the armor units by providing local security, retaining key terrain, clearing dug-in enemy positions, and enhancing direct fires with organic small arms and antitank fires. On the other hand, restrictive terrain (such as built-up areas, forests, and jungles) increases the vulnerability of armor units. In such terrain, it is more advantageous for tanks to take a supporting role in the forward movement of the infantry. Armor provides close-in direct fire support against hard and soft targets that could slow the infantry's advance.

Regardless of terrain, infantry and armor units fight as part of a combined arms team to maximize their respective capabilities and minimize their limitations. The principles of offense, defense, and movement discussed in Chapters 3, 4, and 5 are applicable. This chapter examines in detail how the tank platoon is employed to support the advance of dismounted infantry.

# CONTENTS

## Page

SECTION I. Task Organization

SECTION II. Liaison

SECTION III. Operational Considerations

SECTION IV. Transporting Infantry

## Section I. TASK ORGANIZATION

When an armor unit is task organized to support infantry, the mix of units is referred to as light/heavy. For example, light battalion/heavy platoon refers to a light infantry battalion supported by a tank or AGS platoon; this is the most common type of light/heavy task organization. Light company/heavy section refers to a light infantry company supported by a tank or AGS section. (**NOTE:** Conversely, a heavy/light operation is one in which the controlling headquarters is a heavy unit, either armor or mechanized infantry, with light infantry in support.)

Task organized to support a light infantry battalion task force, armor platoons generally perform in one of several ways: as the primary maneuver element (main effort); in a direct fire support role when infantry is the primary maneuver element; or as part of the task force reserve, often with a reactive role in an antiarmor defense (AAD) mission. The commander bases his decision on which method to use on METT-T factors. (**NOTE:** In some situations, the armor platoon also may be used as a separate special platoon, or it may be attached to one of the infantry companies for direct support.)

The platoon is the lowest level at which the armor leader must be trained to interact with a controlling headquarters. The platoon leader must act as the armor force advisor to the battalion commander. He must rely on the infantry staff for immediate CS and CSS. If the platoon's parent company is in the vicinity, he may be able to coordinate some assistance through the company commander or XO; however, this support may not be available.

It is important that the armor platoon leader understand the infantry unit he supports; this generally will be a light infantry, air assault, or airborne battalion. Characteristics of these battalions vary by the composition and mission of the forces involved, as discussed in the following paragraphs.

## Light Infantry Battalion

This is the most austere conventional combat battalion. The light infantry battalion has only three rifle companies and a headquarters and headquarters company (HHC). Of the three types of infantry units described in this section, the organization of the light infantry battalion differs most from that of the armor battalion.

There are also differences among this battalion and the air assault and airborne battalions, the greatest being the organization of support and logistics. The light infantry battalion has no trucks larger than its 27 cargo HMMWVs. There is only one mechanic in the



entire battalion; repairs are handled at brigade level. The battalion has only 18 long-range radios. It has limited antiarmor capability: 4 HMMWV-mounted TOW systems in one platoon at battalion level and 6 Dragon (Javelin) launchers at company level.

## **Air Assault Battalion and Airborne Battalion**

The air assault battalion and airborne battalion are similarly organized, with three rifle companies, an antiarmor company (with five AT platoons of four vehicles each), and a headquarters company. Tactical movement for both is usually accomplished by a combination of air insertion and foot marches. A major difference is in the number and types of wheeled vehicles available in each type of battalion.

The air assault battalion has six 5-ton cargo trucks and 45 HMMWVs. There is a mess section and a 17-person maintenance platoon. Communications are served by 29 long-range radios. In the line companies, AT capability is provided by a Javelin- or Dragon-equipped section within the company headquarters.

Once inserted, the airborne battalion performs tactically much like a light infantry battalion; walking is the principal means of transportation. The battalion does have 10 2-1/2-ton trucks and 36 cargo HMMWVs, allowing it to execute nontactical movement by truck. It has a mess section and a 16-member maintenance platoon. The airborne battalion has 30 long-range radios. Its rifle squads also have antiarmor capability.

### **Section II. LIAISON**

Light/heavy operations demand effective coordination between the armor platoon and the infantry unit it is supporting. The tank platoon leader's first responsibility is to have a thorough tactical and technical knowledge of his tank's systems and its logistical needs; he must understand its capabilities as well as its limitations (see Chapter 1). Based on these factors, he then works with the infantry commander and S3 to formulate plans to support the infantry. They maximize use of the tank's capabilities for lethal firepower, enhanced target acquisition (including night sights), and effective armor protection; the most common limitations they must overcome are the tank's relative lack of mobility and the need for close-in security in restrictive terrain situations and OOTW environments.

Besides understanding the capabilities and limitations of his tanks, the armor platoon leader must appreciate the tactical assets and liabilities of the infantry. He must realize that infantry moves much more slowly than tanks over certain types of terrain; at the same time, he will learn that infantry can use terrain extremely well to gain a positional advantage over the enemy and that terrain has a direct impact on survivability for the infantryman. The tank platoon leader must ensure the controlling infantry headquarters understands that considerations for positioning and control of the tank's crew-served direct fire weapon systems are the same as those for the infantry's crew-served and AT weapons. In addition, he must be able to anticipate the effects of his weapon systems on both friendly and enemy forces; for example, he must remember that SABOT ammunition cannot be fired over the heads or flanks of unprotected infantry because of

the danger created by the discarding sabot petals and the concussion of the main gun.

Finally, light/heavy liaison must emphasize the need for combined arms training. Armor and infantry must train together, or they will not be able to execute combined arms operations smoothly in combat. Ideally, this training is conducted prior to deployment; to enhance coordination and execution, however, light/heavy forces must take advantage of every training opportunity that arises.

### **Section III. OPERATIONAL CONSIDERATIONS**

The following considerations apply when the tank platoon operates in support of dismounted infantry.

## **COMMAND and CONTROL**

As previously discussed, the armor platoon leader becomes the principal advisor to the infantry battalion commander regarding the employment of his tanks. They may consolidate the platoon to provide a larger antiarmor force; in some instances, the platoon or a section may be placed OPCON to support a company. (**NOTE:** A section should normally be OPCON to a company for only a limited time to accomplish a specific direct fire support mission. In longer-duration operations, the logistical demands of the armor section would overwhelm the separate infantry company's CSS capabilities.)

The tank platoon leader and PSG maintain communications with the controlling infantry battalion headquarters. When attached at lower levels, the platoon leader or PSG gains and maintains contact with the company commander and talks to other platoon leaders on the company net. Individual tanks and dismounted infantry communicate with each other using one of these techniques:

**Visual signals.** Visual signals, either prescribed by SOP or coordinated during the linkup, will facilitate some simple communications.

**Wire.** M60A3 and M8-AGS crews have telephone boxes on the rear of their vehicles for communicating with dismounted infantrymen. M1-series crewmen can route WD-1 wire from the AM-1780 through the loader's hatch or vision block and attach it to a field phone on the back of the tank.

**Hand-held radios.** Infantry squad radios or other short-range hand-held radios can be distributed during the linkup to provide a reliable means of communications between infantry and supporting TCs. These radios allow the infantry to use terrain more effectively in providing close-in protection for the tank; infantrymen can watch for enemy elements while limiting exposure to enemy fires directed against the tank.

**FM radio.** The infantry platoon leader uses his SOI information and contacts the supporting tank on the tank platoon frequency. This is a fast, reliable method of communications that does not require any additional assets.

# Intelligence

The platoon leader must obtain information from the battalion S2 on enemy capabilities, especially those of antiarmor assets. He should focus not only on direct fire capabilities, but also on the capacity of the enemy's mines, artillery, and mortar fires to disable his vehicles.

Terrain analysis is another area of supreme importance in which the platoon leader must work closely with the S2. They determine trafficability of the terrain, examining the effects of weather, obstacles, and limited visibility on the speed and mobility of armored vehicles. Following this detailed analysis, TCs and section leaders conduct a ground reconnaissance of the area of operations. The reconnaissance confirms the trafficability of routes and aids in the effective positioning of weapon systems. The terrain analysis and subsequent reconnaissance also confirm whether the platoon needs to employ ground guides who are knowledgeable of the terrain

# Maneuver

When operating with infantry, the tank platoon may execute missions "pure," either on its own or as part of a tank company. In such a situation, the platoon executes reserve/reaction force missions, attacks separate objectives, or supports the advance of infantry with close-in direct fires. Either the tanks or the infantry can lead. The following discussion of moving with infantry covers a situation in which terrain and

In situations when the infantry leads, the tank platoon can be employed in one of three ways:

- It can remain stationary at the battalion or company CP until called forward.

- It can follow and support the infantry, staying close enough to provide direct fire support when requested.

- During company-level tactical movement, it can overwatch the forward movement of the infantry from stationary positions.

Infantrymen conduct tactical movement until they identify an enemy force that halts their progress (see Figure B-1). They deploy into position, suppress enemy AT weapons with direct and indirect fires, and request tank support to destroy the enemy. The tanks move forward and link up with the infantry (see Figure B-2). At the linkup point, the tank platoon or section leader (depending on the size of the supporting armor element) dismounts and coordinates the following information with the infantry leader:

- Enemy disposition.

- Friendly disposition.

- The tentative maneuver plan.

- Any additional tactical information not already covered in the OPORD or maneuver plan, including the use of guides, control of direct and indirect fires, close-in protection for the tank, and communications and signal

information.

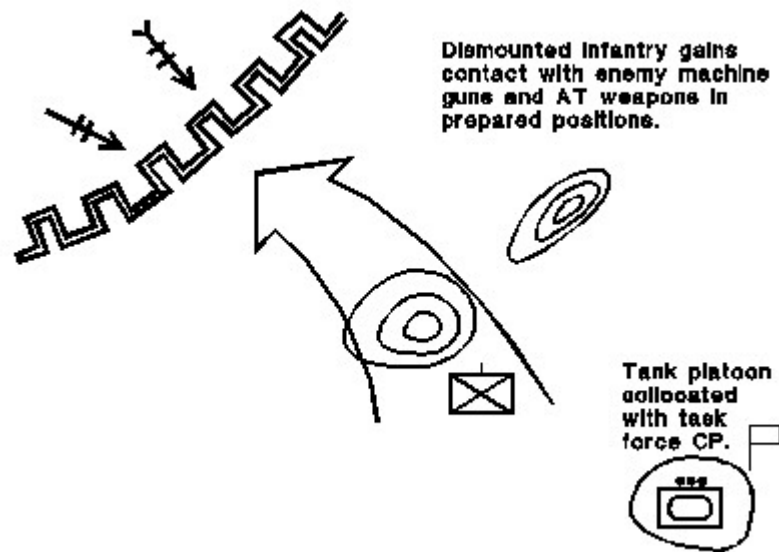


Figure B-1. Infantry leads while tank platoon remains stationary.

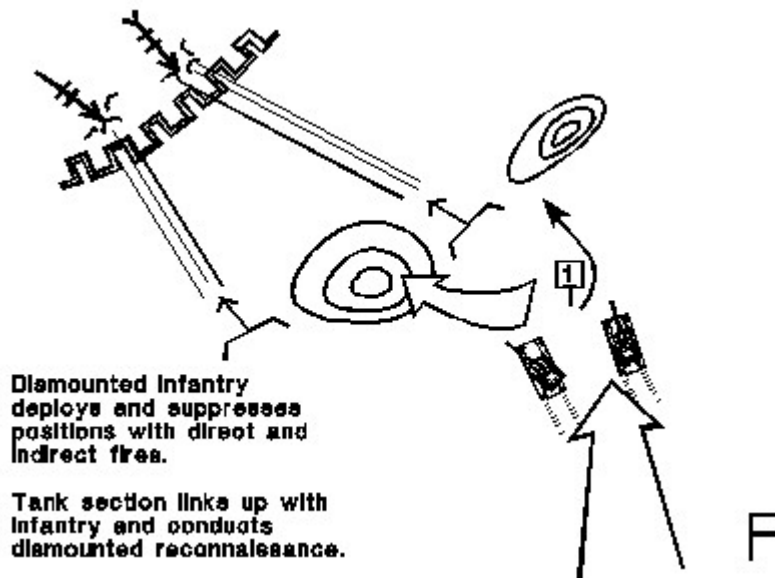
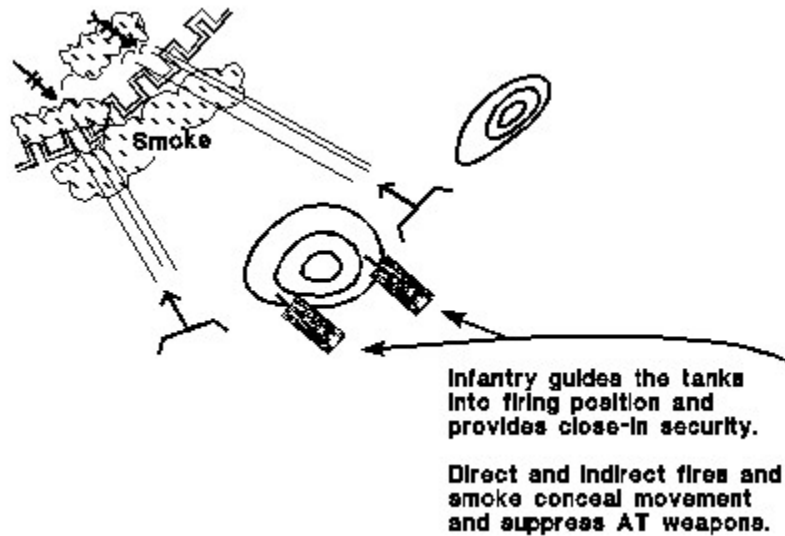


Figure B-2. Tanks move forward to link up with infantry.

The armor leader conducts a ground reconnaissance of the route to the final firing position and finalizes the plan with the infantry leader. He then returns to the platoon or section and briefs the plan to his crewmen.

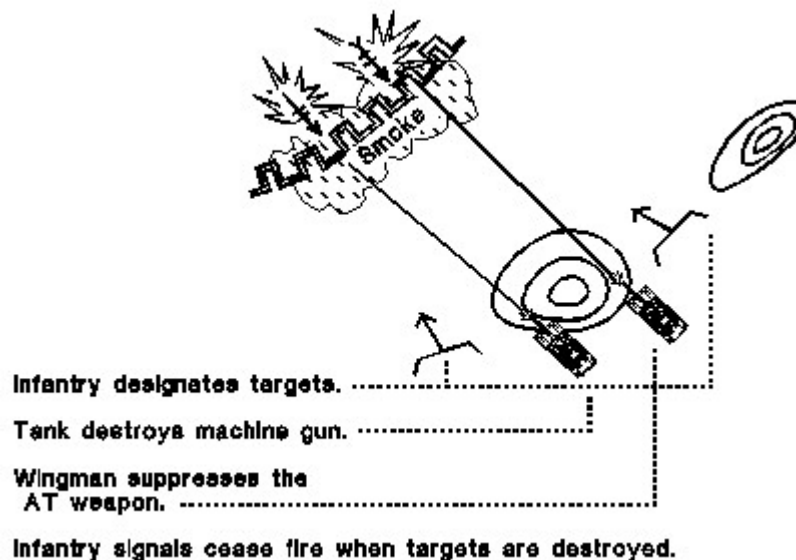
Depending on task organization and terrain factors, the platoon or section moves forward to the firing position, using guides provided by the infantry (see Figure B-3). If the entire platoon is involved, one section overwatches the movement of the lead section to the firing position. If a single section is used, the trail vehicle must overwatch the movement of the lead vehicle to the firing position.

Depending on the amount of suppressive fires received, the firing tank may move to the position buttoned up, with the ballistic doors closed (M1A2 crews may stow the CITV). This provides better protection for the crew and helps to prevent damage to the gunner's sights; at the same time, however, it degrades the tank's target acquisition capability and makes it easier for dismounted enemy forces to attack the tank with small arms or machine gun fires.



**Figure B-3. Infantry guides tanks to firing position.**

If tank crews cannot immediately identify targets when they reach the firing position, the infantry designates each target using tracers, smoke grenades, or grenades fired from the M203 grenade launcher. TCs open the ballistic doors as necessary to acquire and laser to their targets; tanks then suppress or destroy targets using main gun or machine gun fire. When targets are destroyed, the infantry signals the tanks to cease fire (see Figure B-4).



### **Figure B-4. Tanks destroy enemy targets.**

Certain situations may require that tanks lead the infantry; this is, however, the least preferred method of light/heavy employment. Tanks must move very slowly when they lead infantrymen (approximately 2 1/2 miles per hour). This hinders their ability to use speed as a survivability tool.

In addition, restrictive terrain severely limits the mobility of the tank platoon. It further increases the platoon's vulnerability by limiting visibility for tank crews. Without the aid of infantrymen serving as guides and providing security, tanks have a much greater chance of becoming stuck in close terrain or of being the target of enemy fires. In these situations, the infantry must provide close-in protection and early warning against dismounted and mounted threats.

When tanks lead, the infantry's antitank assets should stay close enough to overwatch them during tactical movement. Tank crews maintain constant communication with the infantry so they do not outrun the ground force. The infantry maintains a standoff distance to prevent injury from the "splash" and ricochet of enemy AT weapons and small arms fire aimed at the tanks. Additionally, the light/heavy force can expect tanks to attract the attention of mortar and artillery gunners. The enemy will use indirect fires to strip away supporting infantry and to force tank crews to button up, further reducing their ability to acquire targets. All armor and infantry leaders must plan actions to counter the effects of these fires.

## **Fire support**

The use and control of indirect and direct fires are critical to the effective employment of armor with infantry.

Indirect fires are used to suppress enemy AT weapons and dismounted infantry in the area of operations. The tank platoon uses its optics to detect targets and its communications systems to initiate calls for fire in support of infantry. In addition, the noise of mortar and artillery fires, combined with the use of smoke, helps to conceal the movement of tanks moving forward, adding the element of surprise to the operation.

One of the primary assets of armor in working with infantry is its ability to provide accurate, lethal direct fires from a mobile, survivable platform. The weapon systems on each tank in the Army inventory (including the AGS) offer unique capabilities and limitations that must be considered in relation to infantry support; these characteristics are discussed in the "bullets" on the following page. The TC's caliber .50 machine gun is effective against both personnel and materiel. The coax machine gun is an effective antipersonnel weapon. The capabilities of the main gun vary depending on the vehicle. All current tanks fire SABOT and HEAT rounds. These have great penetrating power against armored vehicles, but may not have the destructive capability necessary to destroy prepared fighting positions or penetrate walls in built-up areas. Not all tanks can fire WP, high explosive plastic (HEP), and beehive rounds. WP is an effective antipersonnel, antimateriel, and antibunker weapon because of the "splash" of phosphorus on the target. Additionally, the round is effective in marking targets for CAS. HEP has

enough destructive power to destroy most prepared positions and to create large holes in walls. The beehive is an antipersonnel round that is extremely effective for area suppression.

The Army's tanks have the following firepower capabilities and limitations:

**M60A3.** This vehicle fires all main gun ammunition discussed in the preceding paragraph. Its capabilities are enhanced by the large onboard storage capacity of main gun rounds (63). The M85 caliber .50 caliber machine gun can be fired by the TC while buttoned up. The M60A3 1). Major limitations of this vehicle are its large silhouette and lack of mobility in terrain that does not support heavy tracked vehicles.

**M1.** Terrain that does not support heavy tracked vehicles.

**M1A1 and M1A2.** Both vehicles are limited in ammunition storage capacity (40 rounds in the M1A1, 42 in the M1A2). They can fire SABOT, HEAT, and MPAT ammunition; however, rounds that are more effective for infantry support, such as HEP, WP, and beehive, are not available. The M1A1 TC can fire the M2 caliber .50 without exposing himself; the M1A2 TC must expose himself to fire the M2. Both vehicles consume fuel at a high rate, and their mobility is limited in terrain that does not support heavy

**M8-AGS.** A key capability of this vehicle is that it fires all types of main gun ammunition. The AGS is smaller and lighter than the other tanks. This gives it a lower fuel consumption rate and makes it more mobile in terrain that does not support larger, heavier tracked vehicles. On the other hand, the AGS is limited in the number of main gun rounds it can carry (30), and the TC must expose himself to fire the caliber .50. In addition, the AGS provides less armor protection than do other tanks.

## Mobility and Survivability

Although the mobility and survivability of the tank are well known, these capabilities suffer significantly when tanks are employed by themselves in close terrain. The following paragraphs list techniques the tank platoon can use to operate more safely and effectively under these conditions.

The following factors can help enhance the tank's mobility in restrictive terrain:

**Information from the S2.** As previously discussed, the S2 must provide mobility information to the platoon leader.

**Ground reconnaissance.** Ground reconnaissance by a knowledgeable individual (preferably the section leader or TC) will confirm or deny the S2's estimate.

**Ground guides.** In restrictive terrain, the use of ground guides is critical in leading tanks to their firing positions, especially during periods of limited visibility. The ground guide can be either an infantryman or the section leader who conducted the reconnaissance.

**Knowledge of vehicle capabilities.** The tank has an awesome ability to

bull or force through walls, small trees (up to 12 inches in diameter), wire obstacles, and other hasty barricades such as cars or trucks blocking a road or trail. The addition of a mine plow enhances the tank's breaching capability, but also hinders movement in rough terrain.

**Engineer support.** Engineers can enhance tank mobility by spanning unfordable rivers or gaps, reducing obstacles, and cutting down larger trees to construct hasty tank trails.

The survivability of the Army's tanks differs by system. They offer varying degrees of protection against small arms fire, time-fuzed artillery, and AT weapons, with the M60A3 at the low end of the survivability scale. The M8-AGS provides effective protection against small arms and time-fuzed artillery; various levels of protection, in the form of appliqué armor, can be added to the vehicle to increase survivability against light AT weapons. The tank platoon can enhance the survivability of the various systems using these techniques:

**Terrain driving.** The old maxim still holds true: "What can be seen can be hit; what can be hit can be killed." Every potential enemy has the ability to employ weapons that can disable or destroy any tank. Terrain driving techniques, discussed in Chapter 3, are still extremely important for the tank platoon.

**Suppression.** Suppression of enemy AT and dismounted infantry forces by artillery and close infantry support is critical.

**Overwatch.** Wingman tanks or sections scan not only their sector of fire, but also the area around moving vehicles. This enables overwatch vehicles to fire their coax machine guns to protect the moving vehicles if they are attacked by dismounted forces.

**Moving into the attack by fire position buttoned up.** When tanks move into an attack by fire position to engage a prepared enemy position, they will face intense small arms, artillery, mortar, sniper, or AT fires. In addition to the factors listed previously, the survivability of the crew depends on its ability to take full advantage of the armor protection of the vehicle.

**Having individual weapons ready.** Crewmembers must be ready to use their M16A2 and 9-mm personal weapons, as well as grenades, to repulse close-in dismounted attacks.

## Air Defense Artillery

ADA capabilities and employment considerations are discussed in Chapter 6.

## Combat service support

When attached to infantry, the tank platoon must prepare to operate under austere conditions. The key to effective logistics support in this situation is to maintain a constant



flow of reports updating the platoon's supply status and requirements. In an infantry task force, the tank platoon leader and PSG will do much of their logistical coordination directly through the battalion staff. They coordinate reporting procedures within the platoon and notify the staff when classes of supply fall below the levels of 80 percent (identified by the code word AMBER), 70 percent (RED), and 60 percent (BLACK). When a class of supply falls below 70 percent, the platoon leader or PSG requests resupply.

Fuel, ammunition, recovery, and maintenance are the primary concerns of the attached platoon. Other logistical needs are usually handled through the normal CSS functions of the battalion. These considerations apply:

**Fuel.** Fuel conservation must be a priority at all times. Engines should be shut down whenever possible. REDCON status should be used to help regulate engine start-up requirements and to assist in operational preparations. The tank platoon can normally support infantry operations for 24 hours before refueling.

**Ammunition.** The tank platoon's ammunition requirements present a unique challenge for the infantry battalion. The type of rounds requested should be based on the S2's analysis to fit the needs for direct fire support of the light/heavy mission. A basic load of ammunition should be on hand to provide for emergency resupply during periods of heavy contact.

**Recovery and maintenance.** When a tank is disabled, the platoon should first attempt self-recovery. If this is not possible, the crew makes the necessary coordination to secure the vehicle until recovery and maintenance personnel reach it. Infantry personnel can be employed to provide local security during recovery operations or to protect the vehicle as the attack progresses. Recovery and maintenance assets may be part of the infantry battalion's attached slice within the brigade forward support battalion, or they may be on call from the tank platoon's parent company headquarters.

## **Section IV. TRANSPORTING INFANTRY**

At times, the platoon leader may be required to transport infantrymen on his tanks (as illustrated in Figure B-5, page B-17). This is done only when contact is not expected. If the platoon is moving as part of a larger force and is tasked to provide security for the move, the lead section or element should not carry infantry.

Infantry and armor leaders must observe the following procedures, precautions, and considerations when infantrymen ride on tanks:

Infantry teams should thoroughly practice mounting and dismounting procedures and actions on contact.

Passengers must always alert the TC before mounting or dismounting. They must follow the commands of the TC.

Infantry platoons should be broken down into squad-size groups, similar to air assault chinks, with the infantry platoon leader on the armor platoon leader's vehicle and the infantry PSG on the armor PSG's vehicle.

Platoon leaders, PSGs, and team leaders should position themselves near the TC's hatch, using the external phone (if available) to talk to the TC and relay signals to the unit.

Tank crewmen must remember that the vehicle cannot return fire effectively with infantry on board.

Whenever possible, passengers mount and dismount over the left front slope of the vehicle. This ensures that the driver can see the infantrymen and that the infantrymen do not pass in front of the coax machine gun. Passengers must always have three points of contact with the vehicle; they must watch for low-hanging objects like tree branches.

Passengers must ensure that they remain behind the vehicle's smoke grenade launchers. This will automatically keep them clear of all weapon systems.

All passengers should wear hearing protection.

Infantrymen should not ride with anything more than their battle gear.

Rucksacks and B-bags should be transported by other means.

Passengers should be prepared to take the following actions on contact:

Wait for the vehicle to stop.

At the TC's command, dismount **IMMEDIATELY** (one fire team on each side). **DO NOT** move forward of the turret.

Move at least 5 meters to the sides of the vehicle. **DO NOT** move behind or forward of the vehicle.

If possible, the lead vehicle should not carry infantrymen. Riders restrict turret movement and are more likely to be injured or killed on initial contact.

Infantrymen should scan in all directions. They may be able to spot a target the vehicle crew does not see.

Passengers on the M8-AGS must stay clear of the vehicle's canister ejection device. Canisters ejected from the main gun can cause serious injury or death.

**DO NOT** move in front of vehicles unless ordered to do so.

**DO NOT** dismount a vehicle unless ordered or given permission to do so.

**DO NOT** dangle arms or legs, equipment, or anything else off the side of a vehicle; they could get caught in the tracks, causing death, injury, or damage to the equipment or vehicle.

**DO NOT** carry too many riders on the vehicle. Falls, burns, and clogged air intakes can result.

**DO NOT** fall asleep when riding. The warm engine may induce drowsiness; a fall could be fatal.

**DO NOT** smoke when mounted on a vehicle.

**DO NOT** stand near vehicles during refueling and rearming.

**DO NOT** stand near a moving or turning vehicle at any time. Tanks have a deceptively short turning radius.

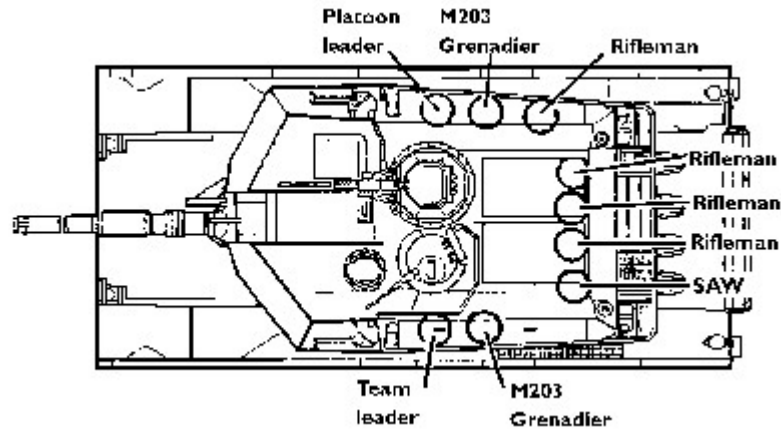


Figure B-5. Sample positions for infantry riding on a tank.

## APPENDIX C



## CONTINUOUS OPERATIONS

US forces execute continuous operations to maintain constant pressure on the enemy without regard to visibility, terrain, and weather conditions. The ability to effectively sustain this pressure is often a key to success on the battlefield. It is also the most difficult challenge that Army units face, placing enormous stress on soldiers, vehicles, and equipment alike. Continuous operations demand that units conduct planning, preparation, and execution activities around the clock, at the same time maintaining OPSEC.

Numerous factors, which will vary with each situation, influence the actions and requirements of friendly forces during continuous operations. The tempo will range from slow to fast. Some units may remain in constant enemy contact, or under the threat of contact, for several days. Other units will operate in low-threat areas with only a remote possibility of contact. Throughout the area of operations, enemy forces will, at any given moment, be attempting to acquire intelligence information and gain the tactical advantage.

Tank platoon leaders must understand the demands of continuous operations under all possible conditions. They then must provide their soldiers with the training and leadership they will need to meet the challenges of the battlefield.

## CONTENTS

SECTION I. Planning and Preparation

SECTION II. Operations Security

SECTION III. Limited Visibility Operations

### Section I. PLANNING AND PREPARATION

Time management is the key to success in continuous operations. During the planning and preparation phases of an operation, the commander dictates priorities of work, rest, and security (OPSEC is discussed in Section II of this chapter). These priorities, in conjunction with REDCON levels, enable the platoon leader to develop his internal platoon timeline. He then uses troop-leading procedures (discussed in Chapter 2) to outline time requirements and disseminate them to the platoon.

REDCON levels allow quick responses to changing situations and ensure completion of necessary work and rest plans. The commander uses the REDCON status as a standardized way to adjust the unit's readiness to move and fight (see Figure C-1).

**REDCON-1.** Full alert; unit ready to move and fight.

**NBC** alarms and hot loop equipment stowed; OPs pulled in.

**All** personnel alert and mounted on vehicles; weapons manned.

**Engines** started.

**Platoon** is ready to move immediately.

**NOTE:** A variant of REDCON-1 is REDCON-1(-); the same conditions apply except that the vehicles are not started in REDCON-1(-).

**REDCON-2.** Full alert; unit ready to fight.

**Equipment** stowed (except hot loop and NBC alarms).

**Precombat** checks complete.

**All** personnel alert and mounted in vehicles; weapons manned.

(**NOTE:** Depending on the tactical situation and orders from the commander, dismounted OPs may remain in place.)

**All** (100 percent) digital and FM communications links operational.

**Status** reports submitted in accordance with company SOP.

**Platoon** is ready to move within 15 minutes of notification.

**REDCON-3.** Reduced alert.

**Fifty** percent of the platoon executes work and rest plans.

**Remainder** of the platoon executes security plan. Based on the commander's guidance and the enemy situation, some personnel executing the security plan may execute portions of the work plan.

**Platoon** is ready to move within 30 minutes of notification.

**REDCON-4.** Minimum alert.

**radio** and man turret weapons.

**Digital** and FM links with company and other platoons maintained.

**Platoon** is ready to move within one hour of notification.

**Figure C-1. REDCON levels.**

# Work Plan

The work plan enables TCs and crewmen to focus their efforts in preparing vehicles, equipment, and themselves for operations. Activities designated in the timeline include, but are not limited to, the following:

- Reconnaissance, as required and within capabilities.**
- Orders at crew and platoon level.**
- Crew- and platoon-level training and rehearsals.**
- Vehicle maintenance.**
- Vehicle preparation (camouflage, stowage, boresighting, communications checks).**
- Individual soldier preparation (training, orders, rehearsals).**
- Resupply (Classes I, III, and V).**
- Preparation of fighting positions.**
- Obstacle emplacement.**
- Crew- and platoon-level PCIs.**

# Rest Plan

The rest plan allows some soldiers to sleep while other crewmen conduct priorities of work and maintain security. To be effective in sustained combat, a soldier should get a **minimum** of 4 to 6 hours of uninterrupted sleep every 24 hours. Less than 4 hours of sleep can significantly degrade combat performance.

Planning and decision-making are among the skills that suffer most dramatically when soldiers cannot get enough sleep. The platoon SOP must provide for an adequate division of duties to allow leaders to get sleep. This may require the platoon leader, PSG, and one or both of the other TCs to share duties. When soldiers are tired, confirmation briefings (back-briefs) become critical whenever orders are issued, even for the most simple task.

Whenever possible, the tank platoon leader should coordinate with the commander to use infantrymen to assist with security. This coordination may enable the platoon leader to rest more soldiers for longer periods of time as the infantry mans OPs and conducts dismounted patrols to augment the security of the platoon. Because of the reduced capability of crews of AGS-equipped platoons to sustain continuous operations, it is critical that these platoons augment their security plans with infantry support.

## **Section II. OPERATIONS SECURITY**

OPSEC entails all measures taken to deny the enemy information about

the actions and intentions of friendly forces. OPSEC measures consist of countersurveillance, information security, signal security, and physical security.

## Countersurveillance

The following considerations and procedures will assist the tank platoon in executing countersurveillance operations:

**Enforce noise and light discipline. Follow these procedures:**

**Turn off the circuit breaker for the brake lights.**

**Dim or cover all sources of light in the turret. Use a passive night observation device (NOD) to check vehicles for light leaks before operations begin.**

**Move only when necessary.**

**Use headsets or the combat vehicle crewman (CVC) helmet to monitor the radio; do not use the radio's external speakers.**

**Do not slam hatches.**

**Use short-count procedures to start engines simultaneously.**

**Use terrain to mask resupply and maintenance areas.**

**Use hand-and-arm signals and digital communications whenever possible.**

**Do not allow smoking outdoors at night.**

**Use camouflage to best advantage. Follow these procedures:**

**"profile."**

**Drape camouflage nets over gun tubes and turrets.**

**- Cover all headlights and optics whenever possible.**

**- Minimize track, tire, and foot trails that could be detected from the**

**air or from enemy positions.**

**- In heavily used areas such as CPs and trains, ensure vehicles travel**

**on existing tracks or roadways.**

**Maintain effective concealment. Follow these procedures:**

**Disperse vehicles and personnel under foliage or inside structures whenever possible.**

**Conceal vehicles and personnel behind objects that block the thermal**

**"line of sight" of enemy devices.**

**Ensure vehicles in hide positions protect against aerial observation by**

**minimizing or eliminating their thermal signatures.**

**Use challenge and password.**

## **Information Security**

Information security is the protection of all materials, both classified and unclassified, that may be of intelligence value to the enemy. These procedures will assist the platoon in maintaining information security:

**mander's name; and information on combat losses or morale.**

**Before leaving an area, police it to make sure items of intel-ligence value are not left behind.**

## **Signal security**

The discussion of communications in Chapter 2 outlines considerations and procedures for establishing and maintaining signal security.

## **Physical security**

Physical security is the protection of materiel and equipment. The following considerations and procedures can help the platoon maintain physical security:

When stationary, employ antiintrusion devices, such as the platoon early warning system (PEWS), trip flares, and concertina wire.

Maintain the prescribed REDCON status. The platoon should assume REDCON-2 each morning and evening to

ensure that all crewmen are ready for action and to allow them to adjust to the changing light conditions. As a minimum, the platoon goes to REDCON-2 from 30 minutes before BMNT until 30 minutes after BMNT and again for a similar period at EENT.

Do not allow foreign nationals and unauthorized observers in or near the unit's area or positions during operations. Establish procedures (in accordance with ROE and the company commander's intent) for handling civilian intruders.

Employ OPs to maintain surveillance on avenues of approach into the platoon's battle space.

## Observation Posts

OPs are especially important in maintaining the platoon's OPSEC and enhancing its battle space. They help to protect the platoon when long-range observation from current positions is not possible; this can occur when the platoon is in a hide position or when close terrain offers concealed avenues of approach to the platoon's position. OPs can be employed either mounted or dismounted.

## Selection of the OP Site

Before deploying an OP, the platoon leader analyzes the terrain in his sector; he also coordinates with adjacent platoons to discover ways to enhance his own battle space and eliminate gaps in battle space between units. Next, he decides on the type of OP necessary to observe the avenue of approach based on requirements for early warning and platoon security. The platoon leader must consider the platoon's reaction time based on the REDCON status. An OP should have the following characteristics:

Clear **observation of the assigned area or sector**. Ideally, the fields of observation of adjacent OPs and/or units will overlap to ensure full coverage of the sector.

Effective **cover and concealment**. Positions with natural cover and concealment help to reduce the OPs' vulnerability to enemy observation and attack.

**Covered and concealed routes to and from the OP**. Soldiers must be able to enter and leave their OPs without being seen by the enemy.

**A location that will not attract enemy attention**. OPs should not be in sites that would logically be the target of enemy observation or that would serve as artillery TRPs.

**A location that does not skyline observers**. Avoid hilltops. Position OPs farther down the slope of the hill.

**A location that is within range of platoon small arms**



**fire.** This enables the platoon to cover the OP if withdrawal becomes necessary.

## Mounted OPs

Mounted OPs are used when the platoon has access to hull-down or turret-down positions that afford unobstructed surveillance of mounted avenues of approach in the platoon sector. They allow the platoon leader to take advantage of his vehicles' capabilities: magnified thermal and daylight optics, sophisticated communications, lethal weapon systems, and survivability. The CITV on the M1A2 is especially valuable in the mounted OP. The M1A2 can occupy a turret-down position and use the CITV to scan the designated sector without moving its turret. All other types of vehicles must occupy turret-down or hull-down positions that allow them to move their turrets when scanning the sector.

A common mounted OP technique is to position one vehicle to observe an engagement area or obstacle while the remainder of the platoon occupies hide positions. Even when the mounted OP has clear fields of observation, it is advisable to dismount one or two members of the crew to provide close-in local security for the vehicle. The dismounted crewmen occupy positions far enough away that sounds from the vehicle do not prevent them from hearing an approaching enemy. Local security can also be enhanced by coordinating with infantry elements, which can conduct patrols and occupy dismounted OPs in accordance with the company commander's OPSEC plan.

## Dismounted OPs

Dismounted OPs provide local security along dismounted avenues of approach whenever the platoon must halt and occupy vehicle positions from which the terrain impedes observation or early warning of enemy activities. They also augment or replace mounted OPs based on the commander's OPSEC plan. The tank platoon uses the following steps to occupy, man, and improve a dismounted OP:

**The platoon leader or PSG determines the need for the OP and identifies the location based on the physical characteristics outlined previously in this section. The platoon leader or PSG assembles OP personnel at his vehicle. OP personnel are designated in the unit SOP, but are normally the loaders from wingman tanks. They must be trained in reporting procedures and individual camouflage techniques. In two-man OPs, one crewman observes the sector while the other provides local security. Some short-duration OPs may consist of one crewman providing local security for individual vehicles in close terrain. OP personnel should have the**

**following equipment (plus any additional items designated in the unit SOP):**

**Individual weapons and M16A1 rifle.**

**Communications equipment (wire, flag set, flashlight, radio).**

**Seasonal uniform with load-bearing equipment (LBE) and appropriate MOPP gear.**

**Binoculars and NODs.**

**Paper and pen/pencil for making a sector sketch.**

**The platoon leader or PSG leads OP personnel to the OP site and briefs them on the following information:**

**When and how to report.**

**When and how to withdraw. The withdrawal criteria should be specific; examples include withdrawal when an NBC attack is detected, when an enemy tank section crosses a phase line, or when enemy dismounted infantrymen approach to within 300 meters of the OP.**

**Challenge and password.**

**When they will be replaced. OP personnel should be replaced every 2 hours. During cold weather, this rotation may be done more frequently.**

**Once in place, OP personnel take these steps to improve the position:**

**Establish communications.**

**Camouflage the position and egress routes.**

**Prepare a sector sketch based on the platoon fire plan (see Chapter 4).**

**Dig in to provide protection from indirect and direct fires. A good rule of thumb is to dig when dismounted infantry dig. If possible, emplace hasty obstacles for additional protection.**

### **Section III. LIMITED VISIBILITY OPERATIONS**

Darkness obviously limits visibility on the battlefield, but there are other conditions that restrict visibility: dust, smoke, and other obscuration factors caused by weapon firing and movement of soldiers and equipment, as well as rain, snow, fog, sandstorms, and other weather conditions. If it is to use its superior technology and basic combat skills to sustain continuous operations and destroy the enemy, the tank platoon must train to fight effectively in all types of visibility conditions. The platoon must first master the execution of tasks under optimum visibility conditions and then continue its training in progressively more difficult situations.

# Equipment

The tank platoon is equipped with the following types of equipment for use under limited visibility conditions:

**Driver's night vision viewer.** This sight is either passive (the VVS-2) or thermal (the DTV). It enhances the driver's ability to move the tank and enables him to assist in target acquisition and to observe rounds in darkness or other limited visibility conditions.

**PVS-7.** This passive vision device enables the TC to observe from his opened hatch to control movement and provide close-in security. There are normally two PVS-7s per tank.

**Gunner's primary sight and commander's extension.** This integrated thermal sight gives the gunner and TC the capability to see and engage targets under almost any visibility condition.

**CITV.** This is a fully integrated, full-target engagement sight on the M1A2. It provides the TC with a redundant target acquisition and surveillance capability equivalent to that of the gunner's primary sight and the thermal imaging system (TIS). The CITV extends the TC's field of view, giving him 360-degree observation capability independent of the gunner's primary sight.

Figure C-2 lists the comparative characteristics, capabilities, and limitations of passive and thermal sights.

PASSIVE SIGHTS	THERMAL SIGHTS
1. Limited by the amount of available light.	1. Not affected by light conditions.
2. Can be "washed out" by bright flashes of light.	2. Not affected by flashes of light.
3. Narrow field of view.	3. Choice of narrow or wide field of view.
4. Poor depth perception.	4. Poor depth perception.
5. Excellent capability for identifying sources of light (including IR).	5. Unable to detect sources of light.

<p>6. Adverse weather conditions (heavy rain, dense fog, sandstorms, snow) limit the range of the sight and may render it useless.</p>	<p>6. Adverse weather conditions limit the range of the sight. On the other hand, the target acquisition capability of the sight may exceed the capability of the LRF to receive a return and compute an automatic ballistic solution.</p>
--	--

**Figure C-2. Comparison of passive and thermal sights.**

## Navigation

The platoon leader uses the GPS and/or POSNAV (if available), terrain association, and the compass and odometer method to navigate in limited visibility conditions. When they are fired to create a ground-burst effect, artillery or mortar illumination rounds can be helpful in confirming locations. Refer to Chapter 2 for a detailed discussion of navigation techniques.

## Vehicle Identification

The problem of vehicle identification is compounded in limited visibility conditions. TCs must be able to distinguish vehicles of their platoon and company/troop and of other friendly elements from those of the enemy. Most unit SOPs cover vehicle marking and identification procedures. In addition, the platoon can use the following techniques to enhance command and control and to help prevent fratricide:

- Attach color-coded lights or chemical lights to the rear of the turret or the hull.**
- Replace the brake light cover with color-coded plastic.**
- Cover the headlights.**
- Use luminous or thermal tape to "outline" vehicles or to make battle boards.**
- Use radio and digital systems (if available) to provide the platoon with frequent updates of friendly unit locations.**

## Tactical Movement and Attacks

The fundamentals for executing tactical movement and attacks discussed elsewhere in this manual are applicable during periods of limited visibility. The following paragraphs cover additional considerations for the planning, preparation, and execution of these operations when visibility is restricted.

During the planning phase, the platoon leader must pay particular attention to routes, formations, and navigational aids. He must conduct a thorough route reconnaissance to identify locations where the platoon could become

misoriented. The route reconnaissance must also focus on finding rough or restrictive terrain that will be even more difficult to negotiate with limited visibility. Such terrain may require a change in formation or movement technique or employment of dismounted ground guides.

In the preparation phase, the platoon leader conducts rehearsals in as many types of adverse conditions as possible to prepare the platoon for potential command and control problems. He must stress light discipline. During the PCI, the platoon leader or PSG views each tank using a passive sight to ensure that sources of light have been dimmed or covered so they are not visible to the enemy. During confirmation briefings and rehearsals, the platoon leader must ensure that all personnel understand the platoon's projected actions during each phase of the operation. One technique is to designate waypoints or phase lines as trigger points for platoon actions.

During the execution phase, TCs use the PVS-7 and the CITV (if available) to assist their drivers with navigation and to enhance situational awareness. The platoon leader must assume that the enemy possesses the same limited visibility observation capabilities as friendly units. Use of terrain to mask movement and deployment remains critical since limited visibility may create a false sense of protection from observation. During movement, the distance between platoon vehicles is reduced to allow vehicles to observe each other and to decrease the time necessary to react to enemy contact.

When the platoon encounters enemy elements, an effective technique is to have the vehicle that makes contact fire a steady burst of machine gun fire in the direction of the enemy to orient the rest of the platoon. The platoon must adhere strictly to applicable control measures, especially those covering the employment of direct fires.

## Limited Visibility Defense

The defensive fundamentals covered previously are applicable in limited visibility situations; additional considerations for planning, preparation, and execution of the defense in limited visibility are covered in the following paragraphs.

During the planning phase, the commander, the platoon leader, and the TCs conduct a thorough reconnaissance, usually during daylight hours, to mark positions and routes. They must keep in mind that obscurants that limit visibility may also degrade the effectiveness of their thermal sights and laser range finders. This may force them to designate engagement areas that are closer than anticipated to the unit's BPs. In marking their positions, they use materials that will facilitate occupation either in daylight or under limited visibility conditions.

During the preparation phase, the platoon leader ensures that decision points, TRPs, and artillery targets are "thermalized" to allow for positive

identification during limited visibility. Used with a sector sketch during direct fire engagements, thermalized TRPs also help TCs to more accurately estimate the range to their targets when smoke or other factors inhibit the use of the laser range finder. Ideally, rehearsals of occupation and displacement are conducted in limited visibility conditions; the same applies to preparation and occupation of fighting positions and to any necessary repositioning.

OPSEC is strictly enforced during all phases of defensive preparation. OPs are critical in providing security and early warning of enemy activities. The platoon leader emplaces mounted OPs to take advantage of the capabilities of his vehicles' thermal sights in scanning the engagement area and the platoon's assigned sector. Dismounted OPs provide local security and augment mounted OPs with shorter-range observation and the ability to listen for approaching enemy elements.

As the platoon enters the execution phase, the platoon leader must ensure that all crewmen thoroughly understand the occupation and displacement criteria and that TCs strictly enforce all fire control measures. TCs use sketch cards and the CITV (if available) to estimate target range when visibility factors prevent use of the laser range finder.

## APPENDIX D



### **NUCLEAR, BIOLOGICAL, CHEMICAL, AND SMOKE OPERATIONS**

Because many potential adversaries have the capability to employ nuclear, biological, and chemical weapons, the tank platoon must prepare to fight in an NBC environment. Collecting, processing, and disseminating needed NBC hazard information are also vital functions. To survive and remain effective on the integrated battlefield, the tank platoon must be proficient in the three fundamentals of NBC defense: contamination avoidance, NBC protection, and decontamination.

Additional-duty NBC personnel should be designated by the platoon SOP for operations in an NBC environment. Selected crews should be designated and trained as chemical agent detection and radiological survey and monitoring teams.

Smoke has a variety of uses on the battlefield; it is used extensively by enemy and friendly elements in both offensive and defensive operations. The effectiveness of smoke depends on the type that is used and the weather at the time it is employed. The tank platoon's success on the battlefield may depend on how well crewmen understand the effects of smoke on enemy and friendly acquisition systems in various weather conditions.

# CONTENTS

- SECTION I. Contamination Avoidance
- SECTION II. NBC Protection
- SECTION III. Decontamination
- SECTION IV. Movement in an NBC Environment
- SECTION V. Smoke Operations

## **Section I. CONTAMINATION AVOIDANCE**

Avoidance is the most important fundamental element of NBC defense because the best way to survive is to avoid being the object of a chemical or nuclear attack. Avoiding contaminated areas minimizes the risk of additional casualties; it also prevents the degradation of combat power that results when a unit must operate in MOPP level 3 or 4 for extended periods of time. In addition, the unit is not required to spend the time and resources needed for decontamination. Contamination avoidance measures include using passive avoidance techniques, locating contaminated areas, identifying NBC agents, warning other members of the platoon as well as other units, and reporting NBC threats to higher headquarters.

Passive avoidance measures can decrease the possibility of NBC attack or reduce the effects of an attack already under way. Effective use of concealment, dispersion, prepared positions, OPSEC, and signal security reduces the chances of being acquired as a target. The tank platoon should continually analyze its vulnerability to chemical or nuclear attack and take appropriate protective measures.

Attacks and contamination must be detected quickly and reported to adjacent units and headquarters elements. The tank platoon must have an effective method of quickly giving the alarm in the event of an NBC attack. Alarms can be passed by radio, audible signals, or hand-and-arm signals. The unit SOP should specify criteria and automatic procedures for employing detection teams and submitting the required NBC reports following an NBC attack or when contamination is encountered.

Whenever possible, all movement routes and future positions should be reconnoitered for nuclear and chemical contamination. Quarters party personnel should be prepared to conduct monitoring operations; if they detect contaminated areas, they identify, report, and mark them. The quarters party can then evaluate the location and type of hazard (nuclear radiation or chemical agent) to determine the best plan for bypassing, crossing, or operating in the contaminated area. Based on the situation, the platoon leader and company commander must be able to implement protective measures specified in the SOP to minimize personnel losses and limit the spread of contamination.

## **BIOLOGICAL DEFENSE**

The key protective measure against a biological attack is maintaining a high order of health, personal hygiene, and sanitation discipline. Biological attacks are difficult to detect. If an attack occurs, the chances of survival are better if crewmembers are healthy

and physically fit and maintain good personal hygiene. Keeping the body clean helps to prevent ingestion of biological agents. Small cuts or scratches should be covered and kept germ-free by means of soap, water, and first-aid measures. Since insects may carry biological agents, soldiers should prevent insect bites by keeping clothes buttoned and skin covered.

After an attack, you must assume that all surfaces have been exposed to germs. Do not eat food or drink water that may be contaminated. Eat or drink only food or water that has been stored in sealed containers; consume it only after you have washed and cleaned the outside of the container. All water must be boiled for at least 15 minutes.

**NOTE:** Refer to the battle drill for reaction to a chemical/biological attack in [Chapter 3](#).

## **DEFENSE BEFORE A NUCLEAR ATTACK**

The best defense against a nuclear attack is to dig in. Unit defensive positions, which range from individual foxholes to full-scale improved fighting positions, should be prepared whenever the tactical situation permits. Personnel should keep their individual weapons, equipment, clothing, and other issue items in their vehicles. Inside the vehicle, equipment and any loose items must be secured because the blast wave can turn unsecured objects into lethal missiles. Supplies, explosives, and flammable materials should be dispersed and protected.

Reverse slopes of hills and mountains give some nuclear protection. The initial radiation and the heat and light from the fireball of a nuclear blast tend to be absorbed by hills and mountains. The use of gullies, ravines, ditches, natural depressions, fallen trees, and caves can also reduce nuclear casualties.

## **DEFENSE BEFORE A CHEMICAL ATTACK**

Make sure all personnel have their protective masks available, and make sure each mask fits and functions properly. All personnel should wear the proper protective clothing in accordance with the MOPP level designated by the commander. Inform everyone to remain alert and to be constantly aware of the chemical threat. Protect all equipment and supplies from liquid chemical contamination by keeping them organized and covered.

The automatic alarm system is the primary means of detecting an upwind chemical attack. The system provides two essential elements of survival: detection of a toxic agent cloud and early warning to troops in the monitored position.

The platoon leader decides where to place the chemical alarm. In stationary operations, he first determines the wind direction, then places available detector units upwind of the nearest position to be protected. The detector unit should be no more than 400 meters



upwind from the alarm unit. The optimum distance is 150 meters. Operation of the alarm can be affected by blowing sand or dust, rain, sleet, snow, tropical conditions, and temperatures below 40 degrees Fahrenheit (4.5 degrees Celsius).

Space the available detector units approximately 300 meters apart, and make sure each detector unit is connected to each alarm unit by telephone cable (WD-1). Position the alarm units near radiotelephone communications; this makes it easy to alert the unit to an attack.

## Section II. NBC PROTECTION

Soldiers on the integrated battlefield face a combination of nuclear, biological, chemical, and conventional attacks. If the tank platoon cannot avoid an NBC hazard, it must be prepared to protect personnel and equipment from the effects of exposure. The type and degree of protection required will be based on the unit's mission and the hazard. Note that the line between contamination avoidance and protection is not distinct. Many actions contribute to both areas of NBC defense.

The key to effective protection in an NBC environment is the tank platoon's proficiency in automatically and correctly implementing NBC defense SOPs. Individual and unit protection against chemical attack or contamination hinges on effective use of the MOPP and on individual proficiency in basic NBC skills. The five levels of MOPP, illustrated in Figure D-1, should be listed in the SOP.

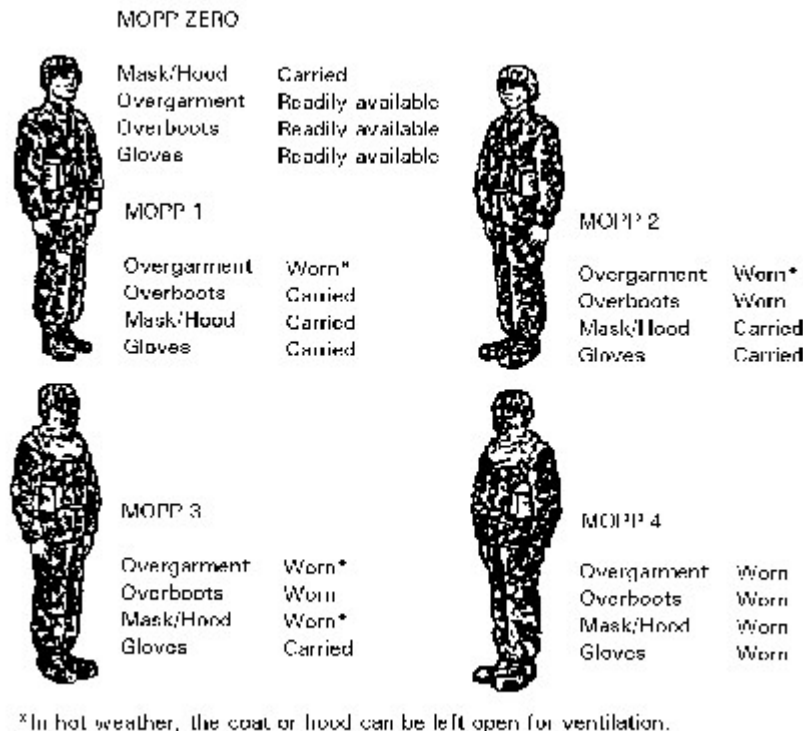


Figure D-1. MOPP levels.

# DEFENSE DURING A NUCLEAR ATTACK

## Dismounted Defensive Actions

*Never run for cover!* Immediately drop flat on the ground (face down) or to the bottom of a foxhole, facing away from the fireball. Cover as much exposed skin as possible. Close your eyes. Remain down until the blast wave has passed and debris has stopped falling. Stay calm, check for injury, check weapons and equipment for damage, and prepare to continue the mission.

## Mounted Defensive Actions

If time permits, take the following actions:

- Position your vehicle behind the best available cover with the front of the vehicle toward the blast.

- Point the gun away from the blast.

- Lock the brakes.

- Secure loose equipment inside the vehicle to prevent injuries and equipment damage.

- Secure all exterior components that could be damaged by the blast (such as water cans, duffel bags, and antennas) inside the vehicle.

- Turn off all radios as well as turret and master power.

- Close and lock all hatches, including ballistic shields.

- Wear your helmet and protect your eyes.

**NOTE:** Refer to the battle drill for reaction to a nuclear attack in Chapter 3 of this manual.

# DEFENSE AFTER A NUCLEAR ATTACK

Once the attack has ended, forward an NBC-1 nuclear report, organize survivors, secure and organize equipment, repair and reinforce the BP, assist casualties, improve protection against possible fallout, and begin continuous monitoring. If the radiation dose rate reaches a hazardous level after fallout has ended, be prepared to move, on order, to a less hazardous area.

When operating in or crossing radiologically contaminated areas, vehicles should be closed tightly. Crewmen cover their faces with a handkerchief or cloth; cargoes should be

covered by tarps or tenting. Mission permitting, vehicles should keep their speed down to prevent dust and should maintain adequate following distance to stay out of the dust raised by preceding vehicles. After the unit exits a contaminated area, personnel, equipment, and cargo should be checked for contamination and decontaminated, if necessary. Dose rates should be monitored closely to ensure compliance with operational exposure guidance (OEG). Radiation exposure status (RES) should be updated, if appropriate.

## **Fallout Warning**

The first person to detect the arrival of fallout is usually a member of the radiological survey and monitoring team. As soon as the recorded dose rate reaches 1 centigray per hour (cGy/hr or rad per hour) or higher, issue a fallout warning. All personnel hearing the warning relay it to others. If the mission allows, soldiers should get into a shelter with overhead cover and stay there until given an "ALL CLEAR" signal or until otherwise directed to move. If the mission does not allow the unit to take cover, decontamination becomes more important and, in many cases, more difficult.

## **Supervision of Radiological Monitoring**

Designate a point in your area where readings will be taken, and note the grid coordinates of that point. Check the monitor operator to make sure that he takes readings at least once each hour from this point, that he zeroes the radiacmeter before taking each reading, and that he uses the device properly. Ensure the operator immediately reports all readings showing the presence of radiation, as well as the time of these readings. Use this information and the location of the readings to prepare an NBC-4 report. Have the operator monitor continuously if any of the following conditions occur:

- A reading of 1 cGy/hr or more is obtained.
- A fallout warning is received.
- A nuclear burst is seen, heard, or reported.
- An order to monitor is received.
- The unit begins to move.

Continue these operations until monitoring shows a dose rate of less than 1 cGy/hr or until directed to stop.

## **Supervision of Tactical Dosimetry Operations**

A tank platoon will normally be issued two dosimeters. Select two soldiers, one from the vehicle of each section leader, to wear them. Before the operation begins, check all dosimeters; any that do not read zero should be turned in for recharging. If a charger is not available, note the original reading on the dosimeter and adjust subsequent readings accordingly. Make sure dosimeter readings are reported accurately. Collect readings at least once daily. Average these readings, round to the nearest 10, and report this average

to higher headquarters.

## **DEFENSE DURING A CHEMICAL ATTACK**

Give the alarm. Have all unmasked soldiers put on their protective masks and other MOPP gear. All personnel should move inside their tanks; in most cases, they should place their hatches in the closed position to protect against gross contamination. Direct the crews of vehicles that are equipped with NBC overpressurization to turn the system on. Use M256 chemical agent detector kits to determine the type of agent, and forward an NBC-1 chemical report. Continue the mission.

**NOTE:** Tactical and safety considerations (such as observation of the terrain, enemy disposition, and the amount of gross contamination that may be spread inside the vehicle) may outweigh the need to keep the tank's hatches closed. Depending on the tactical situation and unit SOP, platoon members may be required to keep their hatches in the open or open-protected position.

**NOTE:** Refer to the battle drill for reaction to a chemical/biological attack in Chapter 3.

## **DEFENSE AFTER A CHEMICAL ATTACK**

As directed by unit SOPs, forward follow-up NBC-1 chemical reports, treat casualties, perform immediate decontamination as required, and mark the contaminated area.

## **PASSING ALARMS AND SIGNALS**

When an NBC attack is recognized, everyone must receive the warning and assume the appropriate MOPP level (see Figure D-1, page D-5). Soldiers in immediate danger need warnings they can see or hear. The alarm or signal must be simple and unmistakable if it is to produce a quick and correct reaction. Units that are not immediately affected need the information as well, either to prepare for the hazard or to change plans. If an NBC hazard is located, the contaminated area should be marked. The NBC warning and reporting system (NBCWRS) and standardized contamination markers contribute to orderly warning procedures.

### **Vocal Alarms**

To give a vocal alarm for any chemical or biological hazard or attack, the person detecting the hazard stops breathing, masks, and shouts "GAS!" as loudly as possible.

Everyone hearing this alarm must immediately mask, repeat the alarm, and take cover from agent contamination and fragmentation of munitions. It may also be necessary to pass the alarm over the radio or telephone. Visual signals must supplement vocal alarms.

## **Automatic Alarms**

If an M8 automatic chemical agent alarm sounds or flashes, the first person to hear or see it stops breathing, masks, and yells "GAS!" This alarm is relayed throughout the unit by vocal and visual signals and radio.

## **Nonvocal Signals**

One person yelling "GAS!" to warn unit personnel may be drowned out by the sounds of the battlefield; therefore, sound signals by means other than voice may be required. These signals must produce noise that is louder than, and not easily confused with, other sounds of combat. The NBC hazard warning alarm will be specified in the unit SOP. Following are some suggestions:

Rapid and continuous beating together of any two metal objects to produce a loud noise. Sample SOP entry: "The audible warning of a chemical attack is rapid and continuous beating of metal on metal."

"While in convoy, five short blasts on a vehicle horn is the audible signal for a chemical attack."

An intermittent warbling siren sound. Sample SOP entry: "The audible alarm for impending chemical attack is the sounding of the installation siren as follows: 10 seconds on, 5 seconds off; sequence repeated for 2 minutes."

## **Visual Signals**

Visual signals may replace sound alarms when the sound may be lost amid battlefield noises or when the situation does not permit the use of sound signals. The standard hand-and-arm signal for an NBC hazard is illustrated in Figure D-2. Signaling is done by extending both arms horizontally to the sides with the fists closed and facing up, then rapidly moving the fists to the head and back to the horizontal position. This is repeated until other elements react. Colored smoke or flares may also be designated as visual signals for an NBC hazard, but these must be specified in unit SOPs.



Figure D-2. Hand-and-arm signal for NBC hazard.

## SYMPTOMS AND TREATMENT OF NBC CASUALTIES

Soldiers must be able to recognize NBC-related symptoms and conduct self-aid and buddy-aid. The basic steps of first aid apply in any combat environment.

### Nuclear Casualties

**Blast injuries.** Blast injuries can range from minor cuts and broken bones to severe lacerations and critical damage to vital organs. The first-aid treatment will be the same as that used for conventional combat casualties suffering similar injuries.

**Thermal radiation injuries.** The intense heat generated by a nuclear detonation can cause burn injuries. First-degree burns should heal with out special treatment, and there will be no scar formation. Second-degree burns resemble a severe sunburn with blistering; they should be treated as a burn to prevent infection. In third-degree burns, the full thickness of the skin is destroyed; the victim should be treated as a burn casualty and evacuated.

### Biological Casualties

Casualties resulting from live biological agents or toxins require medical treatment as quickly as possible. One indication of a live biological agent attack is large numbers of soldiers developing an unexplained illness over a short period of time. Soldiers showing symptoms of disease must be isolated to prevent infection from spreading to others.

A wide variety of toxins is available to potential adversaries for use on the modern battlefield. These can be dispensed alone or with other carriers or agents. Symptoms associated with some toxins mimic those of other types of illness or of exposure to chemical agents. Toxin symptoms may include any of the following:

- Dizziness, mental confusion, or double or blurred vision.
- Formation of rashes or blisters.
- Coughing.

- Fever, aching muscles, and fatigue.
- Difficulty in swallowing.
- Nausea, vomiting, and/or diarrhea.
- Bleeding from body openings or blood in urine, stool, or sputum (spit).
- Shock.

These symptoms may appear within minutes after the toxin attack, or they may be delayed several hours. Appropriate self-aid and buddy-aid measures vary, depending on the agent. Soldiers should first mask to prevent inhaling or ingesting additional agents; then they should remove agents from exposed skin, either by washing with soap and water or by using the M258A1/M291 kit. Soldiers use buddy-aid procedures to help each other clean exposed skin, to observe each other for early symptoms of toxic exposure, and to request medical assistance.

## Chemical Agent Casualties

Chemical agents fall into four major categories: nerve, blister, blood, and choking. Their primary routes of attack upon the body are through the respiratory system and the skin. These agents create an especially dangerous situation because they can kill or incapacitate quickly. The first, and most important, step in dealing with them effectively is to recognize symptoms so proper treatment can be administered.

***Nerve agents.*** Nerve agent poisoning can lead to a quick death; recognizing its symptoms is crucial. Immediate self-aid or buddy-aid is needed if most or all symptoms appear. Early symptoms usually appear in the following progression:

- Runny nose.
- Redness and tearing of the eyes.
- Sudden headache.
- Excessive flow of saliva (drooling).
- Tightness in the chest, leading to breathing difficulty.
- Impaired vision.
- Muscular twitching in the area of exposed or contaminated skin.
- Stomach cramps.
- Nausea.

Severe nerve agent poisoning is likely when any of the early symptoms are accompanied by all or most of the following symptoms:

- Strange or confused behavior.
- Gurgling sounds when breathing.
- Severely pinpointed pupils.
- Loss of bladder and/or bowel control.
- Vomiting.
- Convulsions.
- Breathing that becomes extremely labored or stops.

No effective drug exists to remedy the effects of nerve agents on vision. If soldiers

experience any of the other mild symptoms of nerve agent poisoning, they must perform the following self-aid measures:

Step 1. Put on your protective mask.

Step 2. Remove a Mark I nerve agent autoinjector kit (NAAK) from your protective mask carrier (see Figure D-3).

Step 3. Inject one thigh with the first injector from your kit (atropine in the small autoinjector). Hold the injector against your thigh for at least 10 seconds. Remove the injector.

Step 4. Immediately inject your thigh with the second injector (pralidoxime chloride in the large injector). Hold the injector against your thigh for at least 10 seconds.

Step 5. Remove the injector and place each injector needle through the jacket pocket flap of your overgarment, bending each needle to form a hook.

Step 6. Massage the injection area, if time permits and your suit is not contaminated.

Step 7. If symptoms persist or recur, wait 10 to 15 minutes and repeat both injections. Repeat again if needed. Allow 10 to 15 minutes between each set of injections. Do not administer more than three NAAK sets. Medical support personnel must authorize the administration of more than three sets.



**Figure D-3. Nerve agent autoinjector kit.**

If a soldier experiences severe symptoms from nerve agent poisoning and is unable to administer self-aid, another soldier must perform the following buddy-aid measures:

Step 1. Mask the casualty.

Step 2. Using the victim's NAAK, administer three sets immediately and in rapid succession in the thigh muscle of either leg. Do not wait between injections.

Step 3. Administer the back-pressure armlift method of artificial respiration if the casualty's breathing is labored or has stopped.

Step 4. Hook the expended autoinjectors to the casualty's overgarment jacket pocket flap.

Step 5. Obtain immediate medical attention for the victim.

**Blister agents.** Casualties resulting from blister agents may not be noticeable immediately. Symptoms may take several hours or days to appear. They include the following:



Redness or inflammation of the eyes.  
Temporary blindness or, with severe poisoning, permanent blindness.  
Itching, burning, or reddening of the skin.  
Welts or, in an advanced state, blisters on the skin.  
Hoarseness.  
Coughing.  
Difficult or labored breathing.  
Stomach pain.  
Nausea.  
Vomiting.  
Diarrhea.

If a blister agent comes in contact with skin or eyes, remove it immediately. To remove an agent from the eyes, flush repeatedly with plain water. Decontaminate the skin using the M258A1/M291 kit. If severe blisters form, seek medical attention as soon as possible.

***Blood agents.*** A seemingly mild case of blood agent poisoning can progress to death within 10 minutes. Symptoms include the following:

Rapid or shallow respiration (panting).  
Headache.  
Dizziness or giddiness.  
Red or pink color change in light-colored skin.  
Convulsions.  
Coma.

There is no self-aid or buddy-aid treatment for blood agent poisoning. Victims must receive immediate medical attention.

***Choking agents.*** These agents produce casualties by means of inhaled vapors. They damage blood vessels in the lung walls, causing body fluid to slowly fill the lung cavity. Ordinary field concentrations do not cause death, but prolonged exposure to high concentrations of the vapor and neglect or delay in masking can be fatal. Maximum damage will occur between 12 and 24 hours after exposure. In most cases, the excess fluid in the lungs will absorb back into the body. Slow recovery will begin approximately 48 hours after exposure.

During and immediately after exposure, symptoms may include the following:

Coughing.  
Choking.  
Tightness in the chest.  
Nausea.  
Headache.  
Tearing of the eyes.

Following the early symptoms, a symptom-free period of 2 to 24 hours is likely. This will be followed by these signs of fluid collecting in the lungs:

Rapid, shallow breathing.  
Painful coughing.

Blue lips and fingernails.

In severe cases, clammy skin and rapid heartbeat.

No self-aid or buddy-aid treatment exists for choking agent symptoms. If only minimum amounts were inhaled, the soldier may continue with normal duties. If definite symptoms occur, the soldier should keep warm and seek immediate medical attention and rapid evacuation to an aid station.

## **MARKING CONTAMINATION**

Contamination must be marked so unsuspecting personnel will not be exposed to it. When platoon monitoring teams detect or suspect an NBC hazard, they mark all likely entry points into the area and report the contamination to higher headquarters. The only exception to this policy is if marking the area would help the enemy. If this exception is made by the commander, the hazard must still be reported to protect friendly units.

### **Types of Markers**

US forces use NATO standard markers (illustrated in Figure D-4) to make it easier for allies to recognize the hazards. These markers are in the standard NBC marking set. The colors and inscriptions on a marker indicate the type of hazard. Additional information is written on the front of the sign.

### **Marking Procedures**

Markers face away from the contamination. For example, if markers are placed on the edge of a contaminated area to mark a radiological hot spot, they face away from the point of the highest contamination reading. Markers are placed along roads and trails and at other likely points of entry. When time and mission permit, additional markers should be emplaced. The distance between signs varies. In open terrain, they can be placed farther apart than in hilly or wooded areas. You should be able to stand in front of a marker and see the markers to the left and right of it.

Units discovering a marked contaminated area do not have to conduct elaborate, time-consuming surveys. They simply check the extent of contamination and use the information to adjust their plans, if necessary. If the size of the hazard has changed, they relocate the signs. If the hazard is gone, they remove the signs. Changes are reported to higher headquarters.

## NBC MARKERS

Surface of marker facing  
away from contamination  
(FRONT)

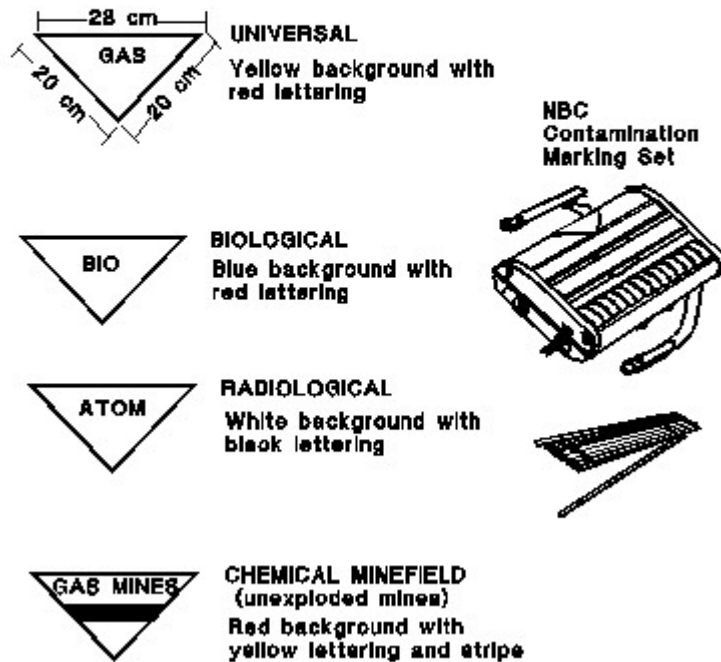


Figure D-4. NBC marking devices.

# UNMASKING PROCEDURES

Soldiers should unmask as soon as possible except when a live biological or toxin attack is expected. Use the following procedures to determine if unmasking is safe.

## With M256/M256A1 Kit

If an M256/M256A1 detector kit is available, use it to supplement the unmasking procedures. The kit does not detect all agents; therefore, proper unmasking procedures, which take approximately 15 minutes, must still be used. If all tests with the kit (including a check for liquid contamination) have been performed and the results are negative, the senior person should select one or two soldiers to start the unmasking procedures. If possible, they move to a shady place; bright, direct sunlight can cause pupils in the eyes to constrict, giving a false symptom. The selected soldiers unmask for 5 minutes, reseal, and clear their masks. Observe them for 10 minutes. If no symptoms appear, it is safe to give the "ALL CLEAR" signal and unmask. Continue to watch all soldiers for possible delayed symptoms. Always have first-aid treatment immediately

available in case it is needed.

## **Without M256/M256A1 Kit**

If an M256/M256A1 kit is not available, the unmasking procedures take approximately 35 minutes. When a reasonable amount of time has passed after the attack, find a shady area. Use M8 paper to check the area for possible liquid contamination. The senior person should select one or two soldiers. They take a deep breath and break their mask seals, keeping their eyes wide open. After 15 seconds, they clear and reseal their masks. Observe them for 10 minutes. If no symptoms develop, they again break the seals, this time taking two or three breaths; they then clear and reseal their masks. Again observe them for 10 minutes. If no symptoms appear, the selected soldiers unmask for 5 minutes and then remask. If no symptoms appear within 10 minutes after remasking, everyone can unmask. Continue to observe the selected soldiers in case delayed symptoms develop.

## **ALL-CLEAR SIGNAL**

The all-clear signal is passed by word of mouth through the chain of command. It is initiated by leaders after testing for contamination proves negative. The commander designates the specific all-clear signal and includes it in the unit SOP or the OPORD. If required, standard sound signals may be used, such as a continuous, sustained blast on a siren, vehicle horn, or similar device. When "ALL CLEAR" is announced on the radio, the receiving unit must authenticate the transmission before complying.

## **WARNING AND REPORTING SYSTEMS**

The NBCWRS is a rapid means of sending reports of an NBC attack. These reports inform other affected units of clean areas and possible contamination. They are also used to provide this information up and down the chain of command and to adjacent units. Each report has a specific purpose and uses standard codes to shorten and simplify the reporting process. The formats and letter codes for the standard NBC reports are in FKSM 17-15-3.

### **Section III. DECONTAMINATION**

During continuous operations in areas of nuclear or chemical contamination, decontamination is essential in preventing casualties and severe combat degradation. The tank platoon gains maximum benefit from the available time and decontamination resources by observing these considerations:

The platoon should execute decontamination as soon as possible and as far forward as possible.

Decontamination should be conducted only to the extent that is necessary to ensure the platoon's safety and operational readiness.

Decontamination priorities with regard to unit safety and mission accomplishment should be strictly observed.

These principles are consistent with doctrine that places the burden of decontamination at battalion or company level. For this reason, the tank platoon must develop a thorough SOP covering decontamination methods and priorities, using all available assets to the maximum extent possible.

Refer to FM 3-5 for a more detailed examination of NBC decontamination procedures.

## **IMMEDIATE DECONTAMINATION**

Immediate decontamination is a basic soldier survival skill. Any contact between chemical or toxic agents and bare skin should be treated as an emergency. Some agents can kill if they remain on the skin for longer than a minute.

The best technique for removing or neutralizing these agents is to use the M258A1/M291 skin decontamination kit. Leaders must ensure that their soldiers are trained to execute this technique automatically, without waiting for orders.

Personal wipedown should begin within 15 minutes of contamination. The wipedown removes or neutralizes contamination on the hood, mask, gloves, and personal weapon. For chemical and biological contamination, soldiers use packets from the M280 decontamination kit. For radiological contamination, soldiers wipe the contamination off with a cloth or simply flush or shake it away.

Operator's spraydown of equipment should begin immediately after completion of personal wipedown. The spraydown removes or neutralizes contamination on the surfaces operators must touch frequently to perform their mission. For chemical and biological contamination, operators can use on-board decontamination apparatuses like the M11/M13. For radiological contamination, they brush or scrape the contamination away with whatever is at hand or flush it with water and wipe it away.

## **OPERATIONAL DECONTAMINATION**

Operational decontamination allows a force to continue fighting and sustain momentum after being contaminated. It limits the hazard of transferring contamination by removing most of the gross contamination on equipment and nearly all the contamination on individual soldiers. This speeds the weathering process and allows clean areas (people, equipment, and terrain) to stay clean. Following operational decontamination, soldiers who have removed sources of vapor contamination from their clothing and equipment can use hazard-free areas to unmask temporarily and eat, drink, and rest.

Operational decontamination is accomplished using assets of the parent unit. It makes use

of two decontamination techniques: vehicle washdown and MOPP gear exchange. These procedures can be performed separately from each other; both are best performed at crew level. Uncontaminated vehicles and personnel should not go through either technique.

's decontamination team. It is most effective if started within one hour after contamination. There are two steps in vehicle washdown:

Step 1. Button up the vehicle and secure equipment.

Step 2. Wash down the vehicle and equipment with hot, soapy water for two to three minutes.

Because speed is important, do not check vehicles for contamination after vehicle washdown. Remove only gross contamination.

Step 1. Decontaminate gear and set it aside.

Step 2. Decontaminate hood and gloves, and roll up hood.

Step 3. Remove overgarment.

Step 4. Remove overboots and gloves.

Step 5. Put on new overgarment.

Step 6. Put on new overboots and gloves.

Step 7. Secure hood.

Step 8. Secure gear.

Step 1 is performed by both soldiers. Steps 2 through 7 are performed first by one soldier, then by the other. Step 8 is performed by both soldiers.

## **THOROUGH DECONTAMINATION**

Thorough decontamination operations restore the combat power of maneuver units by removing nearly all contamination from soldiers and individual equipment. Executed promptly and correctly, these detailed procedures reduce the danger of contamination exposure to negligible risk levels. Just as important, they allow soldiers to operate equipment safely for extended periods at reduced MOPP levels.

Thorough decontamination is usually conducted as part of an extensive reconstitution effort in brigade, division, and corps support areas; support sites at lower levels cannot provide the quantities of decontamination resources (such as water, decontaminants, and time) required for such an extensive process. In some cases, a contaminated unit can conduct a thorough decontamination operation with organic assets, but armor units usually must depend on support from a chemical unit.

Contaminated units conduct detailed troop (individual) decontamination under the supervision of the chemical unit. When equipment decontamination operations are required, the chemical unit usually selects a site, sets it up, and performs detailed procedures with assistance from the contaminated unit.

After completing thorough decontamination, the unit moves into an adjacent assembly area for reconstitution. Support elements from the brigade, division, or corps support area replenish combat stocks, refit equipment, and replace personnel and equipment. The newly reconstituted unit leaves the assembly area fully operational and fit to return to battle. A small risk from residual contamination remains, so periodic contamination checks must be made following this operation.

Thorough decontamination does the most complete job of getting rid of contamination and related hazards, but as noted, it requires large quantities of valuable resources that may not be immediately available. In addition, under a variety of tactical or operational conditions, it will be impossible to execute such a major effort. The next best solution is to decontaminate only to the extent necessary to sustain the force and allow it to continue the mission. This entails using a combination of immediate and operational decontamination procedures.

#### **Section IV. MOVEMENT IN AN NBC ENVIRONMENT**

As with other combat elements, one of the basic tactical requirements for the tank platoon is to be able to move through and operate in a contaminated area. To do so safely, the platoon should follow the procedures outlined in this section.

## **Crossing a Chemically/Biologically Contaminated Area**

Upon identifying a contaminated area, each tank crew makes preparations to cross. While one section provides security, the other section, positioned in a covered and concealed location, removes all externally stowed equipment. Crews mount and test M8A1 alarms and M9 paper. They adopt MOPP level 4 or prepare the vehicle's overpressure system (if it is available and METT-T factors permit). Once the section's preparations are complete, it moves into an overwatch position; the other section moves to a covered and concealed position and follows the same procedures.

When both sections have been prepared, they use standard tactical movement techniques (such as bounding overwatch) to cross the contaminated area. During this movement, the crews continuously monitor the M8A1 and the M9 paper.

Drivers and TCs take precautions to avoid low ground, overhanging branches, and brushy areas as much as possible. While the platoon is in the contaminated area, all personnel observe each other for signs of chemical poisoning.

Once the platoon has successfully crossed the contaminated area, it makes a temporarily halt. During the halt, detection teams monitor for the presence of chemical agents. Each crew in turn executes operational decontamination of its vehicle and, with higher headquarters' approval, initiates unmasking procedures. Once these procedures are complete, the platoon continues its mission.

# Crossing a Radiologically Contaminated Area

The procedures involved in crossing a radiologically contaminated area are similar to those for a chemically or biologically contaminated area, with the following additional considerations:

**Vehicle preparation.** Crews may store external equipment in the turret or cover it with a tarp. This prevents contaminated dust particles from accumulating on the equipment. Place wet sandbags or other materials on the turret floor to increase the amount of radiation shielding. When available, turn on the turret overpressure system to protect the crew compartment from contaminated dust.

**Movement.** Vehicles should limit their speed to minimize dust. In addition, they must maintain the correct dust interval.

**Monitoring.** Ensure IM-93 dosimeters are zeroed. Conduct continuous monitoring and report the results of dosimeter and radiacmeter surveys to higher headquarters and adjacent units.

**Decontamination.** During decontamination, each crewman should cover his nose and mouth with a handkerchief or cloth to avoid breathing contaminated dust particles.

## Section V. SMOKE OPERATIONS

One of the key features of the modern battlefield is the extensive use of smoke. Effective smoke is a combat multiplier. It can be used for identification, signaling, obscuration, deception, or screening. At the same time, employment of smoke must be carefully planned and coordinated to prevent interference with friendly units.

As it prepares for an operation, the tank platoon should plan to take advantage of smoke from all available sources. Mission accomplishment, however, should never depend on smoke for success; the platoon must develop alternative plans in case smoke delivery systems are not available.

## Uses of smoke

Smoke has four general uses on the battlefield:

**Identification and signaling.** Smoke is used to identify (mark) targets, supply and evacuation points, and friendly positions during CAS operations. As a means of prearranged battlefield communications, it can be employed to initiate such operations as displacement.

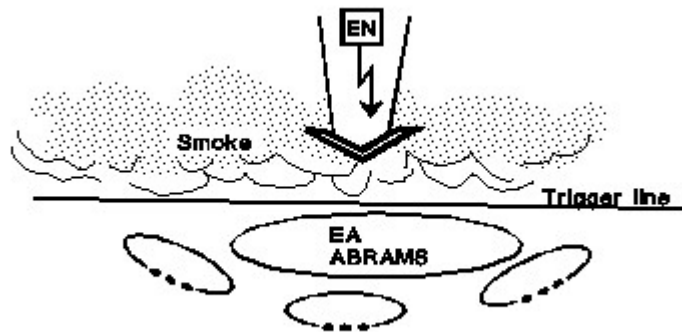
**Obscuration.** Smoke can be fired on enemy positions to degrade the vision of gunners and known or suspected OPs, preventing them from seeing or tracking targets and thereby reducing their effectiveness. Employed against an attacking force, nonthermal smoke can cause confusion and



disorien-tation by degrading the enemy's command and control capabilities; at the same time, friendly units retain the ability to engage the enemy using thermal sights and range bands. In addition, enemy vehicles become silhouetted as they emerge from the smoke. If smoke employment is planned and executed correctly, this will occur as the enemy reaches the trigger line (see Figure D-5, page D-26).

Deception. Smoke can mislead the enemy regarding friendly intentions. For example, it can be employed on several avenues of approach at once to deceive the enemy as to the direction of the main attack. In the defense, smoke may be fired at a remote location for the sole purpose of attracting attention and confusing the enemy.

conducts a bypass, breach, or assault mission. Figures D-6 through D-8, pages D-26 and D-27, illustrate uses of screening smoke.



**Figure D-5. Using smoke to confuse the enemy and silhouette his vehicles.**

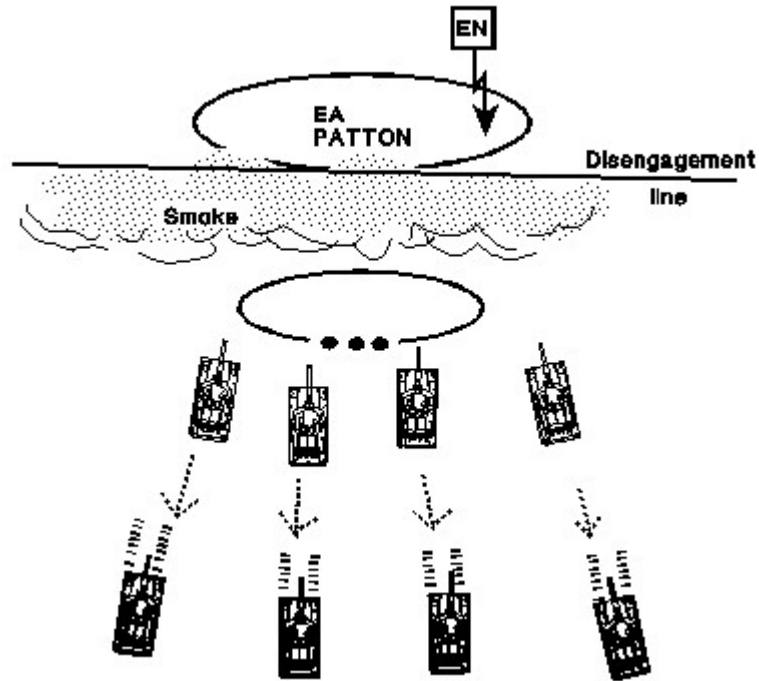


Figure D-6. Using screening smoke to conceal displacement.

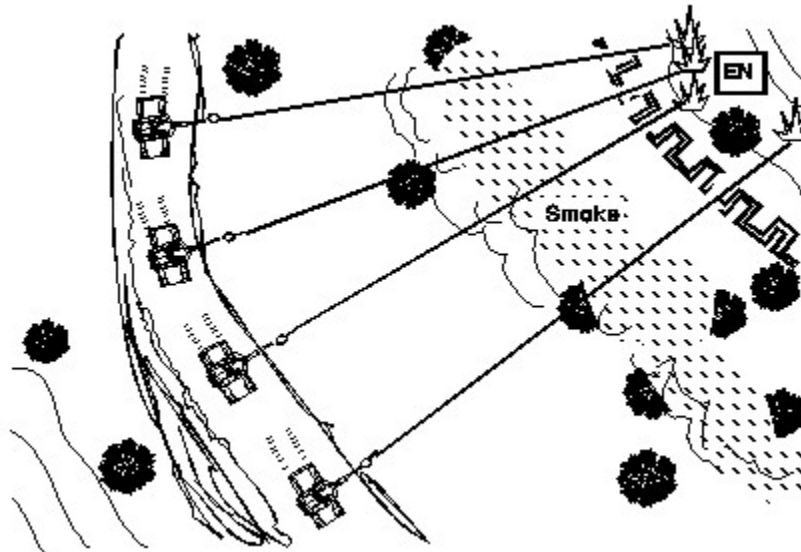
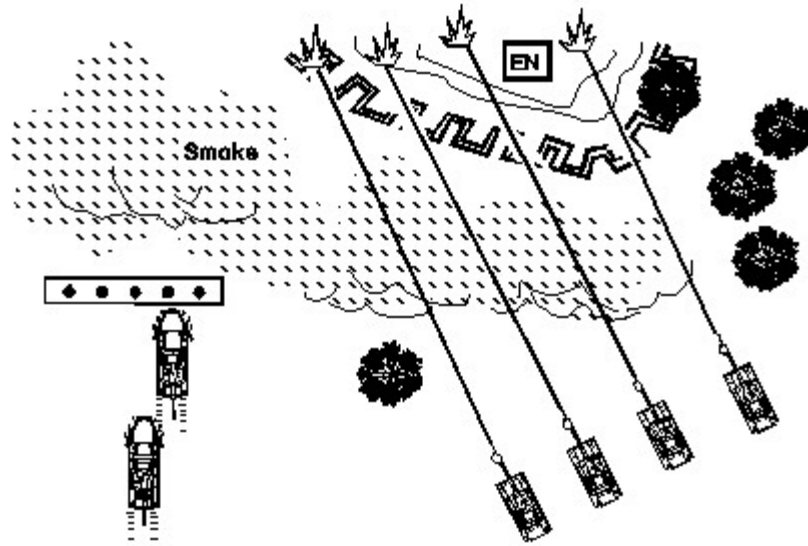


Figure D-7. Using screening smoke to conceal a bypass.



**Figure D-8. Using screening smoke to conceal a breaching operation.**

## Sources of smoke

There are a number of sources of smoke on the battlefield, including the residual effects of burning vehicles, equipment, and storage facilities. Depending on availability, the tank platoon can employ the following smoke delivery systems during tactical operations.

### Mortars

Mortar support, provided by the battalion task force mortar platoon or cavalry troop mortar section, is the most rapid and responsive means of indirect smoke delivery. The tank platoon leader coordinates the planning and execution of mortar smoke missions with the commander and the company or troop FIST. Mortars use WP rounds, which can degrade the effectiveness of thermal sights.

### Field Artillery

Cannons are used to place smoke on distant targets. Artillery-delivered smoke is not as responsive as mortar smoke support and may not be available if it is not planned and coordinated well in advance. Artillery smoke is made up of hexachloroethane (HC) and has less effect on thermal sights than does WP smoke.

### Smoke Pots

These produce a large volume of white or grayish-white smoke that lasts for extended

periods. The smoke has minimal effect on thermal sights. This is the only system that floats on water and that can be delivered by hand or vehicle. The tank platoon will normally employ smoke pots to screen displacement or breaching operations.

## **Hand-held Smoke Grenades**

These can produce white or colored smoke. White smoke grenades are most often used to screen individual vehicles. Colored smoke grenades are primarily used to signal displacement and other critical events or to identify (mark) friendly unit positions and breach and evacuation locations. Smoke from hand-held grenades has minimal effect on thermal sights.

## **Vehicle Smoke Grenade Launchers**

Grenade launchers, which can produce a limited amount of smoke, are used as a self-defense measure to screen or conceal the vehicle from enemy antitank gunners. They can also be used to screen individual vehicle displacement. Smoke from vehicle-launched grenades can degrade thermal sights.

## **Vehicle Engine Exhaust Smoke System**

The VEES injects diesel fuel into the engine exhaust to produce smoke. It serves primarily as a self-defense measure for individual vehicles, but a tank crew can also employ it to screen other friendly vehicles if wind conditions and the direction of vehicle movement allow. This system consumes fuel at the rate of 1 gallon per minute of operation. **It can be used only with diesel fuel because other fuels, such as JP 8, create a fire hazard.**

## **105-mm Tank Main Gun WP Rounds**

These can be employed as a marking device for CAS, as a means of marking TRP locations to control direct fires, and as a means of igniting a fire. Most basic loads do not include WP rounds. WP smoke degrades thermal sights.

## **Tactical Smoke Generators**

These wheel- or track-mounted devices are available through the division chemical company. Their use is prescribed at brigade or battalion level. This type of smoke normally does not affect thermal sights.

# Tactical Considerations IN Smoke Operations

## Weather

The effectiveness of smoke in tactical situations (including the time required to build the cloud and cloud duration) depends in large measure on the weather. Wind direction, wind speed, humidity, and cloud cover are important considerations. If the wind is strong or blowing in the wrong direction, it may be impossible to establish an effective smoke screen. Smoke clouds build up faster and last longer the higher the humidity and the greater the cloud cover. The best time to use smoke is when the ground is cooler than the air.

## Type of Smoke

Certain types of smoke will degrade visual, infrared, and thermal sights. Enemy capabilities and the desired effect of the smoke (such as screening or obscuration) will dictate what type is requested. (**NOTE:** Even types of smoke that do not affect thermal sights may prevent the tank's laser range finder from computing an accurate ballistic solution. Under such conditions, crewmen must rely on such techniques as range bands, range estimation, and battlesighting.)

## Navigation

Navigational aids such as POSNAV, GPS, and thermal sights assist individual vehicles during movement through smoke, while IVIS and other digital systems help the platoon leader to maintain situational awareness and control of the platoon. The platoon leader also decreases the interval between vehicles to further enhance control of the platoon.

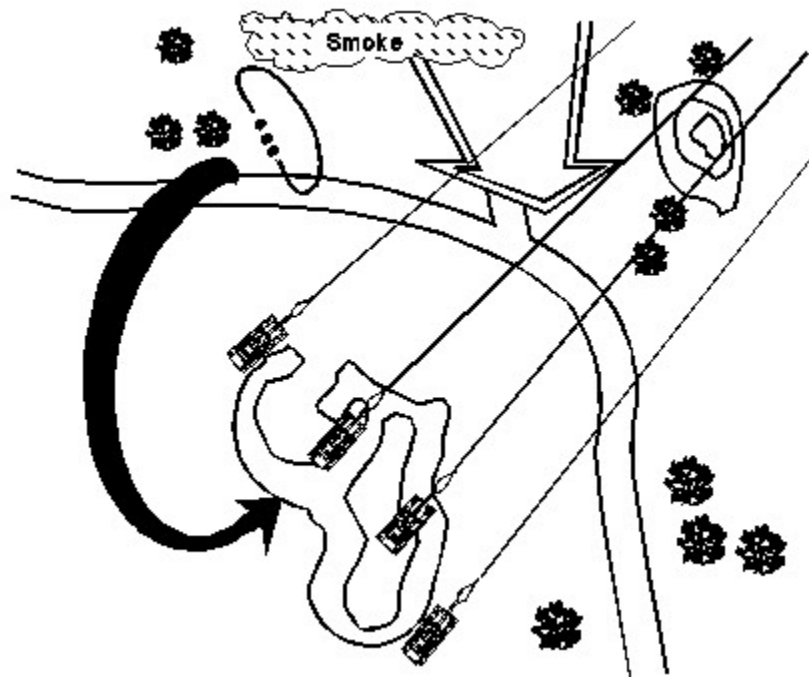
## Maneuver

**Offense.** A defending enemy may employ smoke to confuse and disorient the attacker. Whenever the platoon is traveling through smoke, whether it is of friendly or enemy origin, the platoon leader must remember that his tanks will be silhouetted as they emerge from the smoke. The critical consideration is for all vehicles to emerge at the same time. The navigational tools discussed previously enable the platoon to maintain command and control during movement and to be postured, as it exits the smoke, to mass fires against previously unidentified enemy vehicles.

During an assault, friendly smoke should be shifted in advance of the arrival of the assault element. The use of multispectral smoke for obscuration must be carefully

planned. The duration of the effects of the smoke should be controlled based on the capability of enemy and friendly units to acquire and engage targets through the smoke and on the ability of friendly units to maintain situational awareness during movement.

**Defense.** An attacking enemy may employ smoke on the tank platoon's positions or in the platoon's engagement area. As noted, this may not only "blind" thermal sights but also prevent laser range finders from accurately computing ballistic data. One solution is to occupy alternate BPs that conform with the commander's intent but that are not obscured by smoke (see Figure D-9). If multispectral smoke does not disable thermal sights, the TC can use sector sketches with grid lines, range bands, and TRPs to estimate the target range in the absence of a laser-computed range. On the M1A2, the choke sight of the CITV enables the TC to estimate and input ranges for a ballistic solution.



**Figure D-9. Platoon occupies alternate battle position that is not obscured by enemy smoke.**

## APPENDIX E



## OPERATIONS OTHER THAN WAR

The US Army organizes, trains, and equips to fight and win the nation's wars. This remains its primary mission. The leadership, organization, equipment, discipline, and skills gained in training for war, however, are also of value to the nation in operations other than war (OOTW). These are military activities executed in the operational environments of peace and conflict. In support of OOTW, the Army conducts force projection operations unilaterally, as a member of an international force (UN or coalition), or in cooperation with the involved countries or parties.

# CONTENTS

SECTION I. Operational Environments  
 SECTION II. The Tank Platoon in OOTW  
 SECTION III. Sample OOTW Situations

## Section I. OPERATIONAL ENVIRONMENTS

By definition, military participation in OOTW occurs in the peace and conflict states of the operational environment (the third state is war). Figure E-1, page E-2, illustrates the range of military operations and activities that can take place in the three states of the operational environment, while the following paragraphs focus on the peace and conflict environments.

STATES OF THE OPERATIONAL ENVIRONMENT	GOALS	MILITARY OPERATIONS	ACTIVITIES	PREVIOUS OPERATIONS
<b>WAR</b>	Fight and win	War	<b>Large-scale combat</b>  operations  <b>Attack</b> <b>Defend</b>	Desert Storm
<b>CONFLICT</b>	Deter war and resolve conflict	Other than war	<b>Peace</b> enforcement  <b>Peacekeeping</b> <b>NEO</b> <b>Support to</b> insurgency  <b>Antiterrorism</b> <b>Strikes and raids</b>	Restore Hope
				Hurricane Andrew

<b>PEACE</b>	Promote peace	Other than war	<b>Counterdrug</b> <b>Disaster relief</b> <b>Civil support</b> <b>Peace- building</b> <b>Nation- building</b>  assistance	Relief
--------------	------------------	----------------------	---	--------

**Figure E-1. The range of military operations.**

## Peace

Peace is characterized by the lack of active armed conflict between opposing groups. In this environment, nations or groups employ a variety of activities to achieve their policy objectives; these include political, economic, and informational measures and military actions short of offensive combat operations.

US forces may conduct military actions to demonstrate national resolve and support for civilian authorities. Examples include providing security assistance to allies and conducting training exercises and demonstrations as a show of force. In addition, specially trained and equipped US forces may perform nonmilitary functions, such as disaster relief, nation-building activities, and humanitarian assistance.

Confrontations and tensions may escalate during peacetime to reach a point of transition into a state of conflict. For example, such an escalation could occur when organized insurgent or belligerent forces use violence to disrupt civil support or security assistance operations.

## Conflict

Conflict is characterized by limited combat operations, tempered by ROE and executed to secure specific objectives. Examples of conflict situations include, but are not restricted to, armed clashes involving territorial disputes; military actions to gain control of political leadership within a nation; and armed clashes between nations or between organized parties within a nation to achieve economic, political, or military objectives.

Conflicts are usually confined to a specific geographic area and often are limited in the weaponry and amount of violence involved. In this environment, US forces may respond to a threat directly, or they may act as part of a UN or coalition force. At platoon level, involvement in a conflict situation closely resembles a conventional war environment. Conflict approaches the environment of war with the escalation over time of the number of nations and/or troops involved, the frequency of battles, and the amount of violence.



## Section II. THE TANK PLATOON IN OOTW

The tank platoon has unique capabilities that make it an important asset to US and combined forces executing missions in support of OOTW. Task organized to an armor or mechanized company team, a cavalry troop, or a light infantry company or battalion, the platoon may be called upon to support a wide range of operations in various political and geographical environments. Examples of these operations are included in Section III of this chapter.

Because of the relatively large slice of resources necessary to deploy, operate, and sustain armored forces, tank platoons are usually used to execute OOTW activities that take maximum advantage of their inherent capabilities of firepower, maneuver, shock effect, and survivability. They execute move, attack, and defend missions during OOTW using procedures similar to those described throughout this manual.

On the other hand, the factors of METT-T and the operational considerations prevalent in OOTW may modify the conditions for successful mission accomplishment. This means the tank platoon occasionally may be assigned operations that are normally handled by specially trained and equipped elements. For example, the platoon could be tasked for crowd and riot control if a shortage of military police exists.

Several problems arise when armored forces are used in this type of role. To perform with complete effectiveness and efficiency, **armor crewmen should receive special equipment and training before executing such operations.** In addition, dismounted missions effectively negate the tank platoon's inherent advantages (lethality, mobility, and survivability).

Disciplined, well-trained, combat-ready leaders and crewmen can adapt to the specialized demands of OOTW. To achieve this degree of readiness, however, the platoon must be thoroughly trained before deployment on such factors as the operational environment, the ROE, force protection, and individual soldier responsibilities. A discussion of these operational considerations begins on this page. The training must be updated continuously after deployment.

Flexibility and situational awareness are paramount requirements, especially for platoon leaders. The platoon's role and/or objectives in OOTW situations will not always be clear. The platoon leader will sometimes be called upon to make on-the-spot decisions that could have an immediate, dramatic effect on the strategic or operational situation. In this uniquely tense setting, leaders who disregard the will of belligerent parties and the lethality of these groups' weapons compromise the success of their mission and risk the lives of their soldiers.

## OPERATIONAL CONSIDERATIONS

**NOTE:** The term "environment" in the following discussion is not equivalent to the states of the operational environment (peace, conflict, war) examined earlier in this appendix. As an operational consideration in OOTW, the environment refers to the cultural, political, and military context in which these operations take place, as well as to the terrain and weather of the area of operations.

## Environment

OOTW can take place in any part of the world. To deal effectively with the diverse situations they may face, US forces must undergo orientation training on the complex conditions and factors at work in a specific region. Each soldier must understand the political and economic situation, as well as the cultures, climates, and terrain of the region. He should understand the military situation, especially the doctrine, tactics, and equipment that are employed by belligerent, guerrilla, and terrorist forces. Orientation training should also clarify the following environmental conditions: the tempo of operations, local news media, the US role in the operation, and requirements for peacekeeping and/or peace enforcement activities.

**Tempo.** Although extreme tension may underlie OOTW, the tempo of operations is generally slow. Nonetheless, the speed of military action can vary widely, from fast, violent tactical movement by a reaction force for the purpose of relieving encircled friendly forces to the deliberate occupation of stationary defensive positions to provide overwatch at traffic control points. Through out OOTW, the enemy can be expected to execute both overt and covert operations to test friendly reaction times and security procedures. Units that are predictable or that lack sound OPSEC leave themselves susceptible to attack. For the tank platoon involved in OOTW, the key to a secure environment is not only to maintain the highest possible level of OPSEC, but also to vary the techniques by which security procedures are executed.

**Media.** Soldiers must understand the implications of media coverage of OOTW. They must be briefed on how to interact with the local media and on any information restrictions imposed on the media. Soldiers must realize that their actions are subject to worldwide scrutiny and that actions that run counter to official US policy may damage the nation's interests and international standing.

**The US role in OOTW.** Soldiers should be aware of the role US forces will play in the overall mission; this is especially vital when Americans are part of a combined force that requires constant interaction and coordination with the soldiers of foreign nations. In all cases, the commander's intent and his projected end state should be simplified and presented in a way that gives soldiers the guidance they need to accomplish the mission.

**Peacekeeping versus peace enforcement.** OOTW training should also focus on the distinction between peacekeeping and peace enforcement. Peacekeeping is a highly visible activity; protection of armored forces is all the more difficult because they cannot use cover and concealment in all situations. Peace enforcement operations are more likely to involve the use of force, cover and concealment, and the tactical considerations of OPSEC. Leaders at every level must understand the role of US forces based on the commander's intent. If this role is not clear, they must seek clarification.

## Rules of Engagement

ROE are restrictions on military operations imposed by higher military authorities based on the political and tactical situations. As an example, ROE could restrict the weapons or

equipment friendly forces can use to defuse a situation, deter aggression, or execute a mission. In another instance, these restrictions might require that the forces involved restrain their use of firepower while operating in certain geographical areas.

ROE must be considered during the planning and execution of all operations; **leaders may have to adjust their TTP based on each particular situation's ROE.**

Understanding, adjusting for, and properly executing ROE are especially important to success in OOTW. The restrictions may change whenever the political or military situation changes; this means ROE updates must be provided to soldiers continuously.

**Each soldier must understand the ROE and be prepared to execute them properly in every possible confrontation.** This allows the soldier to work more effectively toward the overall end state for the operation.

ROE violations have operational, strategic, and political consequences. The enemy will exploit ROE and the limitations they impose on friendly forces. Leaders must be prepared to repulse any attempt to take advantage of these restrictions, but they must not violate the ROE in the process.

## **Force Protection**

As with any operation, force protection is a primary goal for every leader involved in OOTW. Mission accomplishment with minimum losses of personnel, equipment, and supplies is the standard. Risk assessment should focus on an evaluation of enemy elements, belligerent forces, and civilians and of terrain and weather considerations.

OPSEC, tempered by restrictions in the ROE, assists the platoon leader in accomplishing his force protection goals. It should encompass the full range of antiterrorist activities for every soldier and leader. Examples include proper RTP and strict noise and light discipline, as well as effective use of cover and concealment, obstacles, OPs and early warning devices, the protection afforded by armor vehicles, and safe locations for eating and resting.

A final consideration in force protection is hygiene. Many OOTW missions take place in underdeveloped nations; proper field sanitation and personal hygiene are mandatory if soldiers are to stay healthy.

## **Soldier Responsibilities**

As noted, the professionalism and discipline instilled in a well-trained, well-informed, effectively led soldier are critical to the safe accomplishment of the OOTW mission. During OOTW, the soldier is on display 24 hours a day. Whether he is interacting with civilians, assisting in negotiations with belligerent forces, or fighting hostile troops, his actions are subject to immediate, worldwide media coverage. As a result, his personal conduct has a significant impact on the opinions, and thus the support, of the local population. Soldiers must understand that misconduct by US forces can damage rapport that the nation seeks to establish with other nations and groups. They must treat local civilians and military personnel as personal and professional equals, affording them the

appropriate customs and courtesies.

Every soldier must be updated continuously on changes to operational considerations (environment, ROE, and force protection). Such changes can have immediate impact on his freedom to react to a given situation. Keeping the soldier informed of changes to the environment and ROE enhances his situational awareness and his ability to adapt to changing conditions. Leaders must disseminate this information quickly and accurately.

Soldiers must also understand their role in intelligence-gathering. This continuous process involves many sources, including friendly forces, enemy SPOTREPs, and the local populace. From the friendly standpoint, each soldier must be familiar with local intelligence requirements. At the same time, he must realize that belligerents can easily blend into the civilian population in their constant pursuit of intelligence on US actions. Because of this, soldiers must consciously use OPSEC procedures at all times.

The role of leaders is especially critical in OOTW because they must be prepared to make immediate decisions in response to confrontations, often under confusing conditions. When a leader is unclear on what to do, he should immediately report the situation to higher headquarters. If guidance from headquarters seems vague or incorrect, he should restate the situation and request further instructions to ensure he has not made errors in reporting. If lack of time or poor communications prevent him from obtaining higher guidance, the leader on the ground must make the decision using common sense and his knowledge of OOTW operational considerations (environment, ROE, force protection). His most important consideration is to avoid any action that could cause an international incident. At the same time, however, leaders and soldiers retain the right of self-defense under all conditions.

To emphasize soldier responsibilities, leaders conduct PCIs that focus on each soldier's knowledge of the environment and application of the ROE. PCIs should also identify possible OPSEC violations and deficiencies that could place the soldier and his equipment at risk. Leaders should stress that terrorists and thieves may attempt to infiltrate positions or mount tanks either to steal equipment and supplies or to cause harm to US forces or facilities.

### **Section III. SAMPLE OOTW SITUATIONS**

The following paragraphs and accompanying figures examine several situations the tank platoon may face during OOTW. The list is not all-inclusive; an assessment of METT-T factors and operational considerations (environment, ROE, force protection, and soldier responsibilities) in the area of operations may identify additional mission requirements.

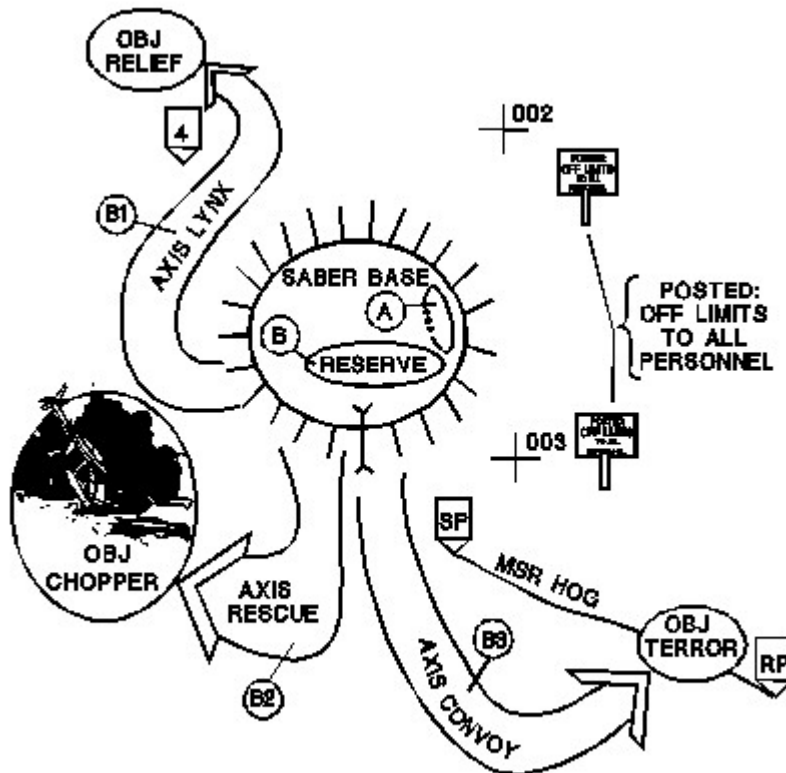
The platoon leader must keep in mind that the relatively simple situations illustrated here cannot adequately portray the ever-changing, often confusing conditions of OOTW. As noted, flexibility is a key to success (and survival) under such conditions. To the extent possible, the platoon leader should attempt to shape the role or mission to match the platoon's unique characteristics and capabilities. (**NOTE:** Appendix B covers information that may be especially critical during OOTW in helping the platoon to maintain coordination and synchronization with dismounted forces.)

## SITUATION A

The platoon establishes a BP or conducts a relief in place at a platoon BP as part of a company team perimeter or strongpoint defense (the circled "A" in Figure E-2). See Chapter 4 for detailed information on defensive operations. Dismounted infantry may or may not be integrated with the tank platoon. Coordination with dismounted patrols and OPs outside the perimeter is critical for situational awareness. Signs, in the local language, should be posted as necessary within the engagement area to identify movement restrictions on the local populace.

## SITUATION B

As the company team or task force reserve (sometimes referred to as the reaction force), the platoon occupies an assembly area or sets up a perimeter defense (the circled "B" in Figure E-2). Potential missions include linkup with and relief of encircled friendly forces (the circled "B1"); linkup and movement to secure an objective in an operation to rescue a downed heli chopper or stranded vehicle (the circled "B2"); and tactical movement to destroy enemy forces attacking a convoy (the circled "B3"). In all three scenarios, the platoon conducts tactical movement and actions on contact. Tasks such as linkup, support by fire, attack by fire, assault, hasty attack, and consolidation and reorganization are also critical to the reaction force/reserve mission. For more information on these operations, refer to Chapters 3 and 5.



**Figure E-2. Battle position and reaction force/reserve missions  
in OOTW.**

## **SITUATION C**

The platoon (or section) overwatches an infantry or MP traffic control point (the circled "C" in Figure E-3). In turn, the overwatch element must ensure its own local security; it usually does this by coordinating with dismounted infantry for OPs and dismounted patrols. Overwatch is covered in Chapter 3, occupation of a defensive position in Chapter 4.

## **SITUATION D**

The platoon (supported by infantry) occupies a perimeter defense to protect traffic and facilitate movement through a choke point along the MSR (the circled "D" in Figure E-3). Infantry is integrated into the perimeter defense to augment the tank platoon's firepower and to provide early warning and OPSEC for the defense by means of dismounted patrols and OPs. For detailed information on defensive operations, see Chapter 4.

## **SITUATION E**

("E" in Figure E-3). It coordinates with dismounted infantry for local security (OPs and dismounted patrols). Positions are improved using procedures for deliberate occupation of a BP (see Chapter 4).

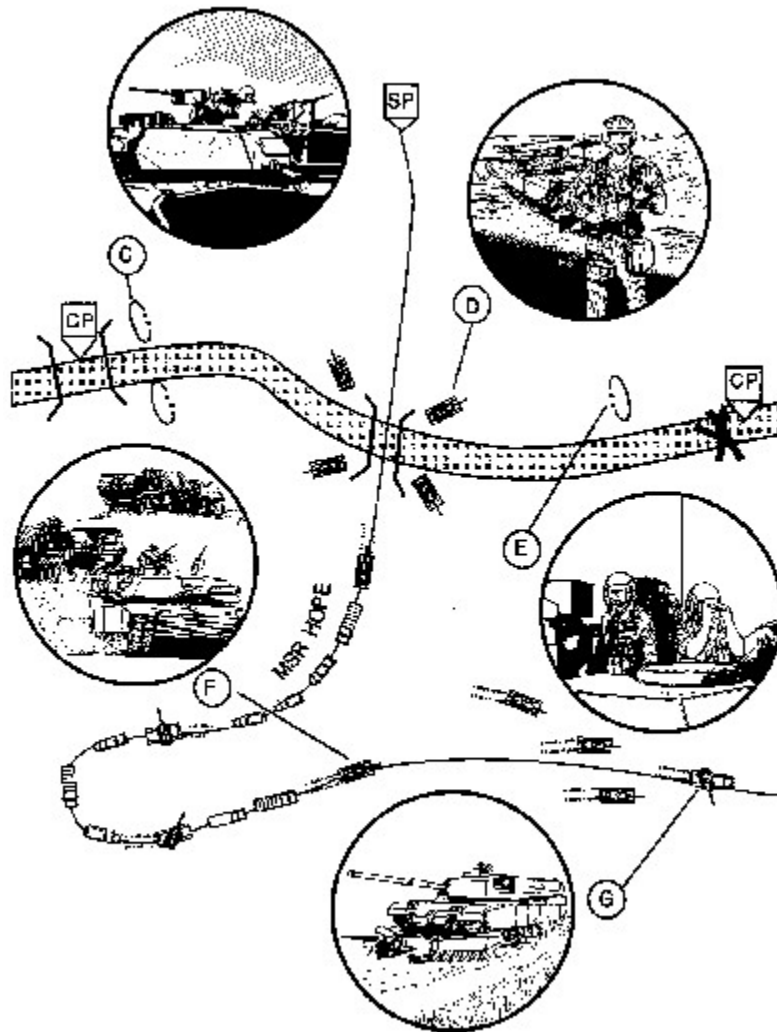
## **SITUATION F**

The tank platoon conducts convoy escort duties (the circled "F" in Figure E-3) using procedures covered in Chapter 5.

## **SITUATION G**

"G" in Figure E-3). Based on METT-T factors, the platoon may use tactical movement techniques to provide overwatch for the proofing vehicle, which can be a tank (equipped with a mine roller, if available) or an engineer vehicle. If mines are detected, the platoon conducts breach force operations within its capability; whenever possible, the platoon should be equipped with a mine plow and a breaching kit containing wire and bolt cutters, grappling hooks, and demolitions. If the obstacle is not within the platoon's breaching capability, engineers are called forward. At all times, the proofing and overwatch vehicles should take notice of anything that is out of the ordinary, such as new construction, repairs to damaged buildings, plants or trees that seem new or out of place,

and freshly dug earth. These conditions may indicate the presence of newly emplaced or command-detonated mines. The platoon conducts tactical movement as outlined in Chapter 3 and breaching operations as discussed in Chapter 5.



**Figure E-3. Traffic control point, choke point, blockade, convoy escort, and route proofing missions in OOTW.**

## **SITUATION H**

During cordon and search operations, the tank platoon occupies overwatch and/or hasty defensive positions to isolate a search area (see Figure E-4). Close coordination and communication with the search team are critical, as is employment of OPs and patrols to maintain surveillance of dead space and gaps in the cordoned area. The tank platoon (or section) must be prepared to take immediate action if enemy elements are identified by the search team or OPs. Enemy contact may require the platoon to execute tactical movement and linkup; it would then coordinate with other units to destroy the enemy using techniques discussed in Chapter 3 and Appendix B.

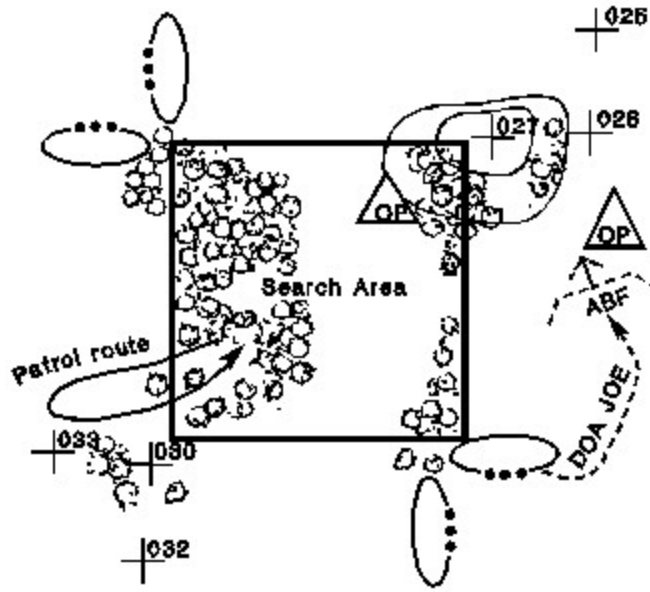


Figure E-4. Cordon and search operation during OOTW.

## SITUATION I

The tank platoon (or section) overwatches and/or follows and supports dismounted infantry in built-up areas or close terrain (see Figures E-5A and E-5B). Procedures for operating with infantry are discussed in Appendix B.



Figure E-5A. Tank section overwatches infantry movement.





**Figure E-5B. Tanks move forward (bounding overwatch) with infantry set.**

## APPENDIX F



### FRATRICIDE PREVENTION

Fratricide is as old as warfare itself, a complex problem that defies simple solutions. Fratricide can be broadly defined as the employment of friendly weapons and munitions, with the intent to kill the enemy or destroy his equipment or facilities, that results in unforeseen and unintentional death or injury to friendly personnel. This appendix focuses on actions leaders can take with current resources to reduce the risk of fratricide.

### CONTENTS

- SECTION I. Magnitude of the Problem
- SECTION II. Stopping a Friendly Fire Incident
- SECTION III. Risk Identification and Preventive Measures
- SECTION IV. Risk Assessment
- SECTION V. Fratricide Reduction Measures

#### **Section I. MAGNITUDE OF THE PROBLEM**

The modern battlefield is more lethal than any in history. The pace of operations is rapid, and the nonlinear nature of the battlefield creates command and control challenges for all unit leaders.

The accuracy and lethality of modern weapons make it possible to engage and destroy

targets at extended acquisition ranges. At the same time, however, the ability of US forces to acquire targets using thermal imagery and other sophisticated sighting systems exceeds our ability to accurately identify these targets as friend or foe. As a result, friendly elements can be engaged unintentionally and destroyed in a matter of seconds. Added to this is the problem of battlefield obscuration, which becomes a critical consideration whenever thermal sights are the primary source of target identification. Rain, dust, fog, smoke, and snow degrade identification capability by reducing the intensity and clarity of thermal images.

On the battlefield, positive visual identification cannot be the sole engagement criteria at ranges beyond 1,000 meters. Situational awareness is the key; it must be maintained throughout an operation.

## **Section II. STOPPING A FRIENDLY FIRE INCIDENT**

The tank platoon may become involved in a friendly fire incident in one of several ways: as the victim of the fire; as the firing element; or as an observer intervening in an attack of one friendly element on another. This section covers actions leaders and crewmen must be prepared to take when they encounter such situations.

### **Actions as Victim of Friendly Fire**

The following are recommended actions at crew and leader level in the event the crew falls victim to friendly fires:

- React to contact until you recognize friendly fire.
- Cease fire.
- Take immediate actions to protect soldiers and vehicles.
- Use a visual recognition signal directing the firing unit to cease fire.
- Report the following on the next higher unit net:
  - Announce that you are receiving friendly fire.
  - Request medical assistance as needed.
  - Give the location and direction of the firing vehicles.
  - Warn the higher unit not to return fire if you identify the firing unit as friendly.

### **Actions as Firing Element**

The following are recommended actions at crew and leader level when the crew has engaged friendly forces:

- Cease fire.
- Report the following on the next higher net:
  - Identification of the engaged friendly force (if the unit is unidentified, report number and type of vehicles).

The location.  
Direction and distance to victims.  
The type of fire.  
The target effects.

## **Actions as Observer of Friendly Fire**

The following are recommended actions at crew and leader level in the event the crew observes a friendly fire incident:

Seek Cover and Protect Yourself.  
Use a visual recognition signal directing the firing unit to cease fire.  
Report the following on the next higher net:  
Identification of the engaged friendly force (if the unit is unidentified, report number and type of vehicles).  
The location of the incident.  
Direction and distance to the victim and the firing unit.  
The type of fire.  
The target effects.  
Provide assistance as needed (when safe to do so).

## **Leader Responsibilities**

In all situations involving the risk of fratricide and friendly fire, leaders must be prepared to take immediate actions to prevent casualties as well as equipment damage or destruction. Recommended actions in fratricide situations include the following:

Identify the incident and order the parties involved to cease fire.  
Conduct an in-stride risk assessment.  
Identify and implement controls to prevent the incident from recurring.

### **Section III. RISK IDENTIFICATION AND PREVENTIVE MEASURES**

Reduction of fratricide risk begins during the planning phase of an operation and continues throughout preparation and execution. Risk identification must be conducted at all levels during each phase; the results then should be clearly communicated up and down the chain of command so that risk assessment can begin. This section covers considerations that influence risk identification; it also focuses on measures the platoon leader can implement both to make the identification process more effective and to help prevent friendly fire incidents from occurring. Section IV of this appendix covers the risk assessment process. Section V lists additional fratricide reduction measures and guidelines.

# Planning Phase

A plan that is thoroughly developed and understood helps to minimize fratricide risk. The following considerations will give leaders an indication of the potential for fratricide in a given operation:

- The clarity of the enemy situation.
- The clarity of the friendly situation.
- The clarity of the commander's intent.
- The complexity of the operation.
- The planning time available at each level.

Graphics are a basic tool that commanders at all levels use to clarify their intent, add precision to their concept, and communicate their plan to subordinates. As such, graphics can be a very useful tool in reducing the risk of fratricide. Commanders at all levels must understand the definitions and purpose of operational graphics and the techniques of their employment. See FM 101-5-1 for the definitions of each type of graphic control measure.

# Preparation Phase

The following factors that may contribute to fratricide risk are the focus of risk identification during the preparation process:

- Training and proficiency levels of units and individuals.
- The habitual relationships between units conducting the operation.
- The physical readiness (endurance) of the troops conducting the operation.

Confirmation briefings and rehearsals are primary tools in identifying and reducing fratricide risk during the preparation phase. The following are some considerations for their use:

- Use confirmation briefings or rehearsals to ensure subordinates know where fratricide risks exist and what to do to reduce or eliminate the risk. Confirmation briefings ensure subordinates understand the commander's intent. They often highlight areas of confusion, complexity, or planning errors.
- The number and type of rehearsals that the unit conducts will determine what types of risks can be identified.
- Rehearsals should extend to all levels of command and involve all key players.

# Execution Phase

During execution, in-stride risk assessment and reaction are necessary to overcome unforeseen fratricide risk situations. The following are factors to consider when assessing

fratricide risks once the operation has begun:

- Intervisibility between adjacent units.
- Amount of battlefield obscuration.
- Ability or inability to positively identify targets.
- Similarities and differences in equipment, vehicles, and uniforms among friendly and enemy forces.
- Vehicle density on the battlefield.
- The tempo of the battle.

Maintaining situational awareness at all levels and at all times is another key to fratricide reduction as an operation progresses. Units must develop and employ effective techniques and SOPs to aid leaders and crewmen in this process. These measures can include the following:

- Eavesdropping on the next higher net.
- Radio cross-talk between units.
- Accurate position reporting and navigation.
- Training and use/exchange of LOs.

#### **Section IV. RISK ASSESSMENT**

Risk assessment must be conducted whenever fratricide risks factors are identified. It must take place at all levels during each phase of operations. As with risk identification, the results of the assessment must be passed on to all levels of the chain of command so that fratricide reduction measures can be developed and implemented. Refer to Section V for a list of specific reduction measures.

Figure F-1 is a worksheet for evaluating fratricide risk in the context of mission requirements. The worksheet lists six mission-accomplishment factors that affect the risk of fratricide, along with related considerations for each factor. Assess the potential risk in each area as low, medium, or high, and assign a point value to each (one point for low risk, two for medium risk, three for high risk). Add the point values for the overall fratricide assessment score. Use the resulting score only as a guide. Your final assessment must be based both on observable risk factors like those on the worksheet and on your "feel" for the intangible factors affecting the operation. Note that descriptive terms are listed only in the low- and high-risk columns of the worksheet. Your assessment of each factor will determine whether the risk matches one of these extremes or lies somewhere between them as a medium risk.

<b>FACTORS</b>	<b>LOW(1)</b>	<b>MEDIUM(2)</b>	<b>HIGH(3)</b>
<b>1. UNDERSTAND PLAN</b> - Commander's Intent - Complexity - Enemy situation - Friendly situation - ROE	Clear Simple Known Clear Clear	← - - → ← - - → ← - - → ← - - → ← - - →	Foggy Complex Unknown Unclear Unclear
<b>2. ENVIRONMENT</b> - Intervisibility - Obscuration - Battle tempo - Positive target ID	Favorable Clear Slow 100%	← - - → ← - - → ← - - → ← - - →	Unfavorable Obscured Fast 0%
<b>3. CONTROL MEASURES</b> - Command relationships - Audio - Visual - Graphics - SOPs - Liaison personnel - Location/navigation	Organic Loud/Clear Well Seen Standard Standard Proficient Sure	← - - → ← - - → ← - - → ← - - → ← - - → ← - - → ← - - →	Joint/Combined Jammed Obscured Not understood Not used Untrained Unsure
<b>4. EQUIPMENT (Compared to US)</b> - Friendly - Enemy	Similar Different	← - - → ← - - →	Different Similar
<b>5. TRAINING</b> - Individual proficiency - Unit proficiency - Rehearsals - Habitual relationship - Endurance	MOS Qual Trained Realistic Yes Alert	← - - → ← - - → ← - - → ← - - → ← - - →	Untrained Untrained None No Fatigued
<b>6. PLANNING TIME (1/3 - 2/3 Rule)</b> - Higher HQ - Own HQ - Lower HQ	Adequate Adequate Adequate	← - - → ← - - → ← - - →	Inadequate Inadequate Inadequate
<b>OVERALL FRATRICIDE ASSESSMENT</b>	<b>26-46 points*</b>	<b>42-62 points*</b>	<b>58-78 points*</b>
* Commander may use total points as the situation dictates. * Point totals alone may not reflect fratricide risk accurately.			

Figure F-1. Fratricide risk assessment worksheet.

## Section V. FRATRICIDE REDUCTION MEASURES

The measures outlined in this section provide the platoon with a guide to actions it can take to reduce fratricide risk. They are not directive in nature, nor are they intended to restrict initiative. Apply them as appropriate based on the specific situation and METT-T factors. At the heart of fratricide reduction and prevention are five key principles:

- Maintain situational awareness, focusing on such areas as current intelligence; unit locations/dispositions; denial areas

(minefields/FASCAM); contaminated areas, such as ICM and NBC; SITREPs; and METT-T factors.

Ensure positive target identification. Review vehicle and weapons identification (ID) cards. Become familiar with the characteristics of potential friendly and enemy vehicles, including their silhouettes and thermal signatures. Know at what ranges and under what conditions positive identification of various vehicles and weapons is possible. Maintain effective fire control. Ensure fire commands are accurate, concise, and clearly stated. Make it mandatory for crewmen to ask for clarification of any portion of the fire command that they do not completely understand. Stress the importance of the chain of command in the fire control process; ensure crewmen get in the habit of obtaining target confirmation and permission to fire from their leaders before engaging targets they assume are enemy elements.

Establish a command climate that emphasizes fratricide prevention. Enforce fratricide prevention measures, placing special emphasis on the use of doctrinally sound TTP. Ensure constant supervision in the execution of orders and in the performance of all tasks and missions to standard.

Additional fratricide reduction guidelines and considerations include the following:

Recognize the signs of battlefield stress. Maintain unit cohesion by taking quick, effective action to alleviate stress.

Conduct individual, leader, and collective (unit) training covering fratricide awareness, target identification and recognition, and fire discipline.

Develop a simple, decisive plan.

Give complete and concise mission orders.

To simplify mission orders, use SOPs that are consistent with doctrine.

Periodically review and update SOPs as needed.

Strive to provide maximum planning time for you and your subordinates.

Use common language/vocabulary and doctrinally correct standard terminology and control measures, such as the fire support coordination line (FSCCL), zone of engagement, and restrictive fire line (RFL).

Ensure thorough coordination is conducted at all levels.

Plan for and establish effective communications.

Plan for collocation of CPs whenever it is appropriate to the mission, such as during a passage of lines.

Designate and employ LOs as appropriate.

Make sure ROE are clear.

Conduct rehearsals whenever the situation allows you the time to do so.

Be in the right place at the right time. Use position location/navigation devices (GPS and POSNAV); know your location and the locations of adjacent units (left, right, leading, and follow-on); and synchronize tactical movement. If you become lost or misoriented, contact your higher headquarters immediately for instructions and assistance.

Include a discussion of fratricide incidents in all after-action reviews

(AAR).

## GLOSSARY



### A

**AA** avenue of approach; assembly area (illustration text)  
**AAD** antiarmor defense  
**AAR** after-action review  
**ABF** attack by fire (position)  
**ACE** armored combat earthmover  
**ACR** armored cavalry regiment  
**ADA** air defense artillery  
**ADAM** area denial munitions  
**AGS** armored gun system  
**A/L** administrative/logistics  
**ammo** ammunition  
**AP** antipersonnel  
**APC** armored personnel carrier  
**APDS** armor-piercing, discarding-sabot (ammunition)  
**ARTEP** Army Training and Evaluation Program  
**ASLT POS** assault position (abbreviation on overlays)  
**AT** antitank  
**ATAS** air-to-air Stinger (missile)  
**ATGM** antitank guided missile  
**ATK POS** attack position (abbreviation on overlays)  
**AVLB** armored vehicle launched bridge

### B

**BCIS** battlefield combat identification system  
**bde** brigade  
**BFV** Bradley (infantry) fighting vehicle  
**BHL** battle handover line  
**BII** basic issue items  
**BIT** built-in test  
**BMNT** beginning of morning nautical twilight  
**bn** battalion  
**BOS** battlefield operating system  
**BP** battle position  
**BSFV** Bradley Stinger (missile) fighting vehicle

### C

**cal** caliber  
**CAM** chemical agent monitor  
**CAS** close air support



**cbt** combat  
**CBU** cluster bomb unit  
**cdr** commander  
**CEV** combat engineer vehicle  
**CFV** cavalry fighting vehicle  
**cGy/hr** centigray(s) per hour  
**chem** chemical  
**CITV** commander's independent thermal viewer  
**CLAMMS** cleared lane mechanical marking system  
**cm** centimeter(s)  
**cmd** command  
**CMH** US Army Center for Military History  
**cml** chemical (illustration text)  
**CO** commanding officer  
**co** company  
**co tm; co/tm** company team  
**coax** coaxially mounted (machine gun)  
**COLT** combat observation lasing team  
**COS** center of sector  
**CP** command post; checkpoint (illustration text)  
**CS** combat support  
**CSS** combat service support  
**CTCP** combat trains command post  
**CVC** combat vehicle crewman  
**CWS** commander's weapon station

## **D**

**DA** Department of the Army  
**DAP** decontamination apparatus (illustration text)  
**DD** Department of Defense  
**DOA** direction of attack (abbreviation on overlays)  
**DP** decision point  
**DPICM** dual-purpose improved conventional munitions  
**DS** direct support  
**DS/R** direct support/reinforcing  
**DTG** date-time group  
**DTV** driver's thermal viewer  
**dvr** driver

## **E**

**EA** engagement area  
**EENT** end of evening nautical twilight  
**en** enemy  
**EPLRS** enhanced position locating and reporting system  
**EPW** enemy prisoner of war  
**etc** et cetera (and so forth)

## F

**1SG** first sergeant  
**FA** field artillery  
**FAAD** forward area air defense  
**FAC** forward air controller  
**FASCAM** family of scatterable mines  
**FDC** fire direction center  
**FEBA** forward edge of the battle area  
**FIST** fire support team  
**FIST-V** fire support team vehicle  
**FIT** fault isolation test  
**FKSM** Fort Knox Supplemental Material  
**FLOT** forward line of own troops  
**FM** frequency modulation (radio); field manual  
**FMFM** Fleet Marine Field Manual  
**FO** forward observer  
**FPF** final protective fires  
**FRAGO** fragmentary order  
**FS** fire support  
**FSCL** fire support coordination line  
**FSE** fire support element  
**FSO** fire support officer  
**ft** foot; feet

## G

**gal** gallon(s)  
**gal/hr** gallons per hour  
**GEMSS** ground-emplaced mine scattering system  
**GHz** gigahertz  
**GIRS** grid index reference system  
**GPS** global positioning system; gunner's primary sight  
**GS** general support

## H

**H** hour (used for timeline designation)  
**HC** hexachloroethane  
**HE** high explosive  
**HEAT** high explosive antitank (ammunition)  
**HEP** high explosive plastic (ammunition)  
**HHC** headquarters and headquarters company  
**HMMWV** high-mobility multipurpose wheeled vehicle  
**hp** horsepower  
**HQ** headquarters  
**hr** hour(s)

## I

**IAW** in accordance with  
**ICM** improved conventional munitions  
**ID** identification  
**IFF** identification, friend or foe  
**IFV** infantry fighting vehicle  
**in** inch(es)  
**inf** infantry  
**info** information  
**IPB** intelligence preparation of the battlefield  
**IR** infrared; intelligence requirements  
**IVIS** intervehicular information system

**J**

**JAAT** joint air attack team

**K**

**KIA** killed in action  
**km** kilometer(s)

**L**

**lb** pound(s)  
**LBE** load-bearing equipment  
**LD** line of departure  
**ldr** leader  
**LO** liaison officer  
**LOA** limit of advance  
**LOGPAC** logistics package  
**LOM** line of movement  
**LRF** laser range finder  
**LRP** logistic release point  
**LT** lieutenant  
**LTC** lieutenant colonel  
**LTG** lieutenant general

**M**

**m** meter(s)  
**M8-AGS** M8 armored gun system  
**MACOM** major (US Army) command  
**MANPADS** man-portable air defense system  
**max** maximum  
**MBA** main battle area  
**MCD** missile countermeasure device  
**mech** mechanized  
**MEDEVAC** medical evacuation  
**METL** mission-essential task list  
**METT-T** mission, enemy, terrain (and weather), troops, and time available (factors in

situational analysis)  
**MHz** megahertz  
**MICLIC** mine-clearing line charge  
**min** minute(s); minimum  
**mm** millimeter(s)  
**MMS** mast mounted sight  
**MOPP** mission-oriented protective posture  
**mort** mortar(s)  
**MPAT** multipurpose antitank (ammunition)  
**mph** mile(s) per hour  
**MRE** meals, ready to eat  
**MRS** muzzle reference sensor  
**MSR** main supply route

## N

**NAAK** nerve agent autoinjector kit  
**NBC** nuclear, biological, chemical  
**NBCWRS** NBC warning and reporting system  
**NCO** noncommissioned officer  
**NCOIC** noncommissioned officer in charge  
**NCS** net control station  
**neg** negative  
**NEO** noncombatant evacuation operations  
**NET** new equipment training  
**NLT** not later than  
**no** number  
**NOD** night observation device

## O

**O** officer(s) (illustration text)  
**OAK-OC** obstacles; avenues of approach; key terrain; observation and fields of fire; and cover and concealment (considerations in evaluating terrain as part of METT-T analysis)  
**obj** objective  
**OEG** operational exposure guidance  
**OIC** officer in charge  
**OOTW** operations other than war  
**OP** observation post  
**OPCON** operational control  
**OPLAN** operation plan  
**OPORD** operation order  
**OPSEC** operations security  
**OT** observer-target

## P

**PCI** precombat inspection

**PEWS** platoon early warning system  
**PFC** private first class  
**PIR** priority intelligence requirements  
**PL** phase line; platoon leader (illustration text only)  
**PLL** prescribed load list  
**plt** platoon  
**plt ldr** platoon leader  
**PMCS** preventive maintenance checks and services  
**POL** petroleum, oils, and lubricants  
**pos** position; positive  
**POSNAV** position navigation (system)  
**PP** passage point (abbreviation on overlays)  
**PSG** platoon sergeant  
**psi** pound(s) per square inch

## R

**RAAM** remote antiarmor mine  
**rad** radiation absorbed dose  
**rd** round  
**recon** reconnaissance  
**REDCON** readiness condition  
**RES** radiation exposure status  
**retrans** retransmission  
**RFL** restrictive fire line  
**ROE** rules of engagement  
**ROM** refuel on the move  
**RP** release point  
**RPV** remotely piloted vehicle  
**rte** route  
**RTP** radiotelephone procedure

## S

**S1** adjutant (US Army)  
**S2** intelligence officer (US Army)  
**S3** operations and training officer (US Army)  
**S4** supply officer (US Army)  
**SALUTE** size, activity, location, unit identification, time, and equipment (format for report of enemy information)  
**SAW** squad automatic weapon  
**SBF** support by fire (position)  
**sct** scout  
**sec** section; second(s) (illustration text)  
**SFC** sergeant first class  
**SGT** sergeant  
**SHORAD** short-range air defense  
**SINCGARS** single channel ground/airborne radio system  
**SITREP** situation report

**SOI** signal operation instructions  
**SOP** standing operating procedure  
**SOSR** suppression, obscuration, security, and reduction  
(actions executed during breaching operations)  
**SP** start point  
**SPC** specialist  
**SPOTREP** spot report  
**SSG** staff sergeant  
**STAFF** smart target activated fire and forget (ammunition)  
**STANAG** standardization agreement (international)  
**SVML** Stinger vehicle-mounted launcher

## T

**TAC CP** tactical command post  
**tac idle** tactical idle (speed)  
**TACFIRE** tactical fire direction system  
**TC** tank commander  
**TCP** traffic control point  
**TEWT** tactical exercise without troops  
**TF** task force  
**TIRS** terrain index reference system  
**TIS** thermal imaging system  
**tm** team  
**TNT** trinitrotoluene (explosive)  
**TOC** tactical operations center  
**TOE** table(s) of organization and equipment  
**TOW** tube-launched, optically tracked, wire-guided (missile)  
**TRADOC** US Army Training and Doctrine Command  
**TRP** target reference point  
**trp** troop  
**TSOP** tactical standing operating procedure  
**TTP** tactics, techniques, and procedures  
**TTS** tank thermal sight

## U

**UAV** unmanned aerial vehicle  
**UMCP** unit maintenance collection point  
**UN** United Nations  
**USAARMS** US Army Armor School

## V

**VEESS** vehicle engine exhaust smoke system  
**veh** vehicle (illustration text)  
**VT** variable-timed

## W

**WIA** wounded in action

**WO** warning order  
**WP** white phosphorus

X

**XO** executive officer

## REFERENCES



## SOURCES USED

These sources are quoted or paraphrased in this publication.

### Army Publications

**ARTEP 17-237-10-MTP** Mission Training Plan for the Tank Platoon. 3 October 1988. (A revision is scheduled to be published during fiscal year 1996.)

**FM 1-112** Tactics, Techniques, and Procedures for the Attack Helicopter Battalion. 21 February 1991.

**FM 1-116** Tactics, Techniques, and Procedures for the Air Cavalry/Reconnaissance Troop. 20 February 1991.

**FM 3-3** Chemical and Biological Contamination Avoidance. 16 November 1992.

**FM 3-4** NBC Protection. 29 May 1992.

**FM 3-5** NBC Decontamination. 17 November 1993.

**FM 3-19** NBC Reconnaissance. 19 November 1993.

**FM 3-100** NBC Defense: Chemical Warfare, Smoke, and Flame Operations. 23 May 1991.

**FM 6-30** Tactics, Techniques, and Procedures for Observed Fire. 16 July 1991.

**FM 7-7J** Mechanized Infantry Platoon and Squad (Bradley). 7 May 1993.

**FM 7-8** Infantry Rifle Platoon and Squad. 22 April 1992.

**FM 7-10** Infantry Rifle Company. 14 December 1990.

**FM 7-20** The Infantry Battalion. 6 April 1992.

**FM 7-92** The Infantry Reconnaissance Platoon and Squad (Airborne, Air Assault, Light Infantry). 23 December 1992.

**FM 7-98** Operations in Low Intensity Conflict.  
19 October 1992.

**FM 17-12-1** Tank Combat Tables, M1. 3 November 1986.

**FM 17-12-1-1** Tank Gunnery (Abrams), Volume I.  
30 June 1992.

**FM 17-12-1-2** Tank Gunnery (Abrams), Volume II.  
30 June 1992.

**FM 17-18** Light Armor Operations. 8 March 1994.

**FM 17-97** Regimental Armored Cavalry Troop.  
3 October 1995.

**FM 17-98** Scout Platoon. 9 September 1994.

**FM 34-1** Intelligence and Electronic Warfare Operations. 2 September 1994.

**FM 34-130** Intelligence Preparation of the Battlefield.  
8 July 1994.

**FM 71-1** Tank and Mechanized Infantry Company Team. 22 November 1988.

**FM 71-2** The Tank and Mechanized Infantry Battalion Task Force. 27 September 1988.

**FM 90-3** Desert Operations. 24 August 1993.

**FM 90-10** Military Operations on Urban Terrain (MOUT). 15 August 1979.

**FM 100-5** Operations. 14 June 1993.

**FM 101-5-1** Operational Terms and Symbols.  
21 October 1985.

### **Command Publications**

The following materials, published by the US Army Armor Center and School as Fort Knox Supplementary Material (FKSM), are scheduled for initial publication during fiscal year 1996. They cannot be obtained through Armywide resupply channels. Determine availability by contacting the installation at the following address:

Commander, USAARMC  
ATTN: ATZK-IMO-RS  
Fort Knox, KY 40121-5000

**FKSM 17-15-1** Tank Platoon Tactics, Techniques, and Procedures for Digital and Enhanced Systems.

**FKSM 17-15-3** Tank Platoon SOP.

### **DOCUMENTS NEEDED**



These documents must be available to the intended users of this publication.

### Department of the Army Forms

**DA Form 581** Request for Issue and Turn-in of Ammunition. August 1989.

**DA Form 1155** Witness Statement on Individual. June 1966.

**DA Form 1156** Casualty Feeder Report. June 1966.

**DA Form 1594** Daily Staff Journal or Duty Officer's Log. November 1962.

**DA Form 2028** Recommended Changes to Publications and Blank Forms. February 1974.

**DA Form 2404** Equipment Inspection and Maintenance Worksheet. April 1979.

**DA Form 2765** Request for Issue or Turn-in. April 1976.

**DA Form 2765-1** Request for Issue or Turn-in. April 1976.

**DA Form 5368-R** Quick Fire Plan (LRA). December 1984.

**DA Form 5988-E** Equipment Inspection Maintenance Worksheet. March 1991.

### Department of Defense Forms

**DD Form 1380** US Field Medical Card. December 1991.

### **READINGS RECOMMENDED**

These readings contain relevant supplemental information.

#### Miscellaneous

**Battle Space:** Article by LTG Paul E. Funk. Military  
**A Commander's Tool** Review magazine, December 1993.  
**on the Future Battlefield**

**Leadership in Combat:** Study conducted by the History Department,  
**An Historical Appraisal** US Military Academy, under direction of  
LTC K.E. Hamburger. 1984.

Information on the following publication is available from the US Army Armor School Library at the following address:

Commander, USAARMS  
ATTN: ATSB-OPL  
Fort Knox, KY 40121-5200

**A Bigger Hammer** Armor Center monograph by LTC Arthur B.  
Alphin. May 1990.

### Joint and Multiservice Publications

**FMFM 6-18** Techniques and Procedures for Fire Support Coordination.  
27 March 1992.

**JCS PUB 3-50** National Search and Rescue Manual,  
Volume 1: National Search and Rescue System. 1 February 1991.

**STANAG 2014** Operation Orders, Warning Orders, and  
Administrative/Logistics Orders.

**STANAG 2029** Method of Describing Ground Locations, Areas, and  
Boundaries.

**STANAG 2099** Fire Coordination in Support of Land Forces.

**STANAG 2128** Medical and Dental Supply Procedures.

**STANAG 2144** Call for Fire Procedures.

**STANAG 2147** Target Numbering System (Non-nuclear).

**STANAG 3466** Responsibilities of Air Transport Units and User Units  
in the Loading and Unloading of Transport Aircraft in Tactical Air  
Transport Operations. Edition 2.

#### **Army Publications**

**DA Pam 738-750** Functional Users Manual for the Army Maintenance  
Management System.  
1 August 1994.

**FM 3-50** Smoke Operations. 4 December 1990.

**FM 5-33** Terrain Analysis. 11 July 1990.

**FM 5-36** Route Reconnaissance and Classification.  
10 May 1985.

**FM 5-100** Engineer Combat Operations.  
22 November 1988.

**FM 5-101** Mobility. 23 January 1985.

**FM 5-102** Countermobility. 14 March 1985.

**FM 5-103** Survivability. 10 June 1985.

**FM 5-114** Engineer Operations Short of War.  
13 July 1992.

**FM 5-250** Explosives and Demolitions. 15 June 1992.

**FM 6-20** Fire Support in the AirLand Battle.  
17 May 1988.

**FM 6-20-50** Tactics, Techniques, and Procedures for Fire Support for  
Brigade Operations (Light).  
5 January 1990.

**FM 7-30** Infantry, Airborne, and Air Assault Brigade Operations. 24

April 1981. (**NOTE:** This manual is currently under revision at the US Army Infantry School.)

**FM 7-90** Tactical Employment of Mortars.  
9 October 1992.

**FM 8-42** Medical Operations in Low Intensity Conflict. 4 December 1990.

**FM 8-55** Planning for Health Service Support.  
9 September 1994.

**FM 12-6** Personnel Doctrine. 9 September 1994.

**FM 14-7** Finance Operations. 17 August 1994.

**FM 16-1** Religious Support Doctrine for the Chaplain and Chaplain Assistant. 27 November 1989.

**FM 19-40** Enemy Prisoners of War, Civilian Internees, and Detained Persons. 27 February 1976.

**FM 20-22** Vehicle Recovery Operations.  
18 September 1990.

**FM 20-32** Mine/Countermine Operations.  
30 September 1992.

**FM 21-60** Visual Signals. 30 September 1987.

**FM 21-76** Survival. 5 June 1992.

**FM 26-2** Management of Stress in Army Operations. 29 August 1986.

**FM 31-20** Doctrine for Special Forces Operations.  
20 April 1990.

**FM 31-70** Basic Cold Weather Manual. 12 April 1968.

**FM 33-1** Psychological Operations. 18 February 1993.

**FM 41-10** Civil Affairs Operations. 11 January 1993.

**FM 44-1** US Army Air Defense Artillery Employment. 9 May 1983.

**FM 44-100** US Army Air Defense Operations.  
22 November 1988.

**FM 55-9** Unit Air Movement Planning. 5 April 1993.

**FM 57-38** Pathfinder Operations. 9 April 1993.

**FM 63-2-1** Division Support Command: Light Infantry, Airborne, and Air Assault Divisions.  
16 November 1992.

**FM 71-3** The Armored and Mechanized Infantry Brigade. 11 May 1988. (**NOTE:** This publication is currently under revision, with publication scheduled in fiscal year 1996.)

**FM 71-100** Division Operations. 16 June 1990.

**FM 71-123** Tactics and Techniques for Combined Arms Heavy Forces: Armored Brigade, Battalion Task Force, and Company Team. 30 September 1992.

**FM 90-2** Battlefield Deception. 3 October 1988.

**FM 90-4** Air Assault Operations. 16 March 1987.

**FM 90-5** Jungle Operations. 16 August 1982.

**FM 90-6** Mountain Operations. 30 June 1980.

**FM 90-8** Counter guerrilla Operations. 29 August 1986.

**FM 90-10-1** An Infantryman's Guide to Combat in Built-Up Areas. 12 May 1993.

**FM 90-13** River Crossing Operations. 30 September 1992.

**FM 90-13-1** Combined Arms Breaching Operations. 28 February 1991.

**FM 90-14** Rear Battle. 10 June 1985.

**FM 90-22** Multiservice Night and Adverse Weather Combat Operations. 31 January 1991.

**FM 90-26** Airborne Operations. 18 December 1990.

**FM 100-10** Combat Service Support. 18 February 1988.

**FM 100-15** Corps Operations. 13 September 1989.

**FM 100-19** Domestic Support Operations. 1 July 1993.

**FM 100-20** Military Operations in Low Intensity Conflict. 5 December 1990.

**FM 100-25** Doctrine for Army Special Operations Forces. 12 December 1991.

**FM 100-27** US Army/US Air Force Doctrine for Joint Airborne and Tactical Airlift Operations. 31 January 1985.

**FM 100-37** Terrorism Counteraction. 24 July 1987.

FM 101-5 Staff Organization and Operations. 25 May 1984.

**TB MED 524** Occupational and Environmental Health: Control of Hazards to Health from Laser Radiation. 20 June 1985