

By Order of the Secretary of the Army:

Official:



JOEL B. HUDSON

*Acting Administrative Assistant to the
Secretary of the Army*

00063

GORDON R. SULLIVAN
*General, United States Army
Chief of Staff*

DISTRIBUTION:

Active Army, USAR, and ARNG: To be distributed in accordance with DA Form 12-11E, requirements for FM 100-7, *Decisive Force: The Army in Theater Operations* (Qty rqr block no. 5317)

DECISIVE FORCE: The Army In Theater Operations

Contents

	Page
✓ PREFACE.....	iii
✓ INTRODUCTION.....	iv
✓ PART ONE BACKGROUND	
✓ CHAPTER 1 DECISIVE VICTORY	1-1
✓ Planning and Execution.....	1-1
p. Operational Art.....	1-4
Operations in War.....	1-5
Military Operations Other Than War.....	1-9
Multinational Operations.....	1-12
✓ CHAPTER 2 THE THEATER	2-1
Section I, The Strategic Hierarchy	2-1
National Security Strategy.....	2-3
National Military Strategy.....	2-4
Theater Strategy.....	2-4
Section II, The Chain of Command	2-5
National Command Authorities.....	2-5
Chairman, Joint Chiefs of Staff.....	2-5
Combatant Commander.....	2-5
Service Branch (Military Departments).....	2-6
Command Authorities.....	2-7
Section III, Joint Force Commands	2-9
Combatant Commands.....	2-10
Theater Combatant Commands.....	2-10
Section IV, Multinational Commands	2-14
Command Structure.....	2-14
Command and Control.....	2-16
Section V, Theater Organizations	2-17
Types of Theaters.....	2-17
Allocation of Resources Among Theaters.....	2-18
Internal Theater Organization.....	2-18

DISTRIBUTION RESTRICTION: Approved for public release; distribution is unlimited.

	Page
Section VI The Army in Theater	2-22
Army Operational-Level Commander.....	2-22
Army Service Component Commander	2-24
Army Commander as a Subordinate Joint Force Commander	2-27
Operational-Level Environment.....	2-27
CHAPTER 3 THEATER STRATEGIC AND OPERATIONAL-LEVEL PERSPECTIVE	3-0
Operational Art	3-0
Resources	3-4
Operational-Level Command	3-5
 PART TWO PLANNING AND EXECUTION	
CHAPTER 4 PLANNING FRAMEWORK	4-0
Campaigns	4-0
Major Operations.....	4-11
Interagency Operations.....	4-14
CHAPTER 5 EXECUTION	5-0
Operational Movement and Maneuver.....	5-0
Operational Fires.....	5-3
Operational Protection	5-9
Operational Battle Command.....	5-15
Operational Intelligence	5-17
Operational Logistics.....	5-19
 PART THREE ARMY COMPONENT OPERATIONS	
CHAPTER 6 FORCE PROJECTION	6-1
Crisis	6-1
Contingency Operations.....	6-2
Force-Projection Stages.....	6-14
CHAPTER 7 ARMY OPERATIONS IN WAR	7-1
Modern Warfare	7-1
Army Service Component Functions in War.	7-2
Termination of War/Postconflict Operations	7-18
CHAPTER 8 MILITARY OPERATIONS OTHER THAN WAR	8-1
Fundamentals of MOOTW	8-1
Responsibilities in Peacetime	8-1
Operations in Peacetime.....	8-8
Transition to Hostilities	8-10
Operations in Conflict.....	8-16
Transition to Peacetime or War.....	8-18
 APPENDIX A ARMY SERVICE COMPONENT COMMAND RESPONSIBILITIES AND ORGANIZATION	
	A-0
APPENDIX B SUBORDINATE CAMPAIGN PLAN MODEL	B-1
APPENDIX C MAJOR OPERATIONS PLAN MODEL: OPERATIONAL-LEVEL	C-1
APPENDIX D DIGITIZATION OF THE BATTLEFIELD	D-0
GLOSSARY	Glossary-1
REFERENCES	References-0
INDEX	Index-1

Introduction

The nation needs an Army to defeat our enemies, and it also needs an Army to deter potential foes, reassure and lend stability to our allies, and in times of emergency lend support to our communities at home.

Togo D. West, Jr., Secretary of the Army
General Gordon R. Sullivan, Chief of Staff, United States Army
Decisive Victory: America's Projection Army, A White Paper
October 1994

The nation's force for conducting prompt and sustained land combat is the Army. This has been the Army's mission throughout history. Its unique contribution to the joint team is its ability to dominate the land, including populations and resources. Army in-theater operations must support the nation's and theater commander's strategic intent and be synchronized with his strategic concept of operation.

The Army conducts operations as part of or in support of a joint and multinational force or with a US-only joint force to protect American vital national interests. The Army is the strategic component of the nation's military power that performs contingency force projection and sustained land operations to protect and further national interests. In response to the needs of America's national security interests, the Army is prepared to fight and win. The Army also assists the nation by conducting MOOTW.

- As an instrument of American policy, the Army must be ready to provide the nation a variety of tools to influence the international environment and ultimately force a decision. To do this, the Army must be *ready, deployable, and versatile*.
- It must be able to deploy throughout the world in a timely manner—a requirement that touches every aspect of the force.
- It must be lethal. Lethality is essential to the ability to win with minimum casualties, ensuring the rapid conclusion of hostilities and conflict resolution.
- It must be robust—structured, tailored, trained, and sustained to meet our nation's requirements.
- It must be expansible. Deterrence and rapid conflict resolution require the generation of superior combat power. Expansibility provides the required combat power at the required time—positioned on the battlefield and prepared to accomplish its purpose. The total Army (active and reserve components) must be expansible. The norm must be efficient and rapid mobilization and transition of reserve component personnel and organizations to active component status to reinforce or expand the active component to meet operational requirements across the range of military operations.

The senior army commander in a theater of operations performs three basic tasks:

- Establishes and maintains linkages to joint, multinational, interagency, nongovernment organizations (NGOs), and private voluntary organizations (PVOs).
- Provides logistical support to ARFOR and, when directed, to other services, allies, or multinational forces.
- Conducts major land operations to support the campaign or subordinate campaigns when assigned by the CINC as an operational-level commander to accomplish the joint commander's theater strategic and operational objectives.

With the advice and assistance of the Chairman of the Joint Chiefs of Staff (CJCS), the President—through the Secretary of Defense (SECDEF)—establishes the chain of command to the military departments for service functions and to the commanders of combatant commands for missions and forces assigned to their commands.⁶ The senior army leader in unified or subunified commands beneath the combatant commander is designated the ASCC.⁷ The senior army commander in the theater operates within the chain of command. He answers to the theater commander—known as the CINC—for operations and receives logistics and administration from his service. He prosecutes the logistics and administration responsibilities through administrative control (ADCON) authorized by the Secretary of the Army and the Army Chief of Staff.

ADCON is subject to the CINC's command authority (COCOM). The services operate under the authority, direction, and control of the SECDEF through the secretary of the military departments. This traditional service branch of the chain of command—for purposes of organizing, training, and equipping forces to fulfill specific combat functions and for administering and supporting such forces—runs from the President, through the SECDEF, to the Secretary of the Army, to the Department of the Army for ARFOR not assigned to a combatant commander. This service branch of the chain of command is separate and distinct from the chain of command that exists within a combatant command.

The CINC practices operational art. When the CINC assigns the senior army commander a warfighting mission, he also practices operational art. The joint force commander (JFC)—a term applied to a commander authorized to exercise COCOM or operational control (OPCON) over a joint force—plans, conducts, and supports theater campaigns, subordinate campaigns, major operations, and battles. His success is measured by the accomplishment of theater strategic objectives. Army commanders in joint and multinational operations function at the operational level of war, thus requiring a broad perspective. They link theater strategy and campaigns to tactical execution. ASCCs and senior army commanders use operational art—the skillful planning, conduct, and support of theater strategy, campaigns, major operations, and battles by ARFOR to attain strategic or operational objectives.

In a joint environment, when the Army is the dominant land force conducting major operations requiring decisive force, the CINC may assign the ARFOR commander as the joint force land component commander (JFLCC).⁸ As the JFLCC, he must integrate and synchronize all available assets to accomplish the mission with minimum casualties in terms favorable to the US and its alliance or coalition partners.

6. The commander of a unified or specified command.

7. The commander in chief and members of his staff are precluded from being a service component commander.

8. Joint Pub 0-2, *Unified Action Armed Forces (UNAAF)*, 11 August 1994.

Preface

This manual guides US Army forces (ARFOR) functioning at the operational level of war in concert with joint, multinational, and/or interagency organizations. It describes how the Army service component commander (ASCC), previously known as the theater army commander, applies the FM 100-5¹ fundamentals to ARFOR operating within a theater of operations. This is the Army's manual on *operational art* focused at the operational level of war: the link among theater strategy, campaign plans, and tactics and the bridge between theaterwide campaigns and localized battles and engagements.

This manual delineates the *National Security Strategy*, *National Military Strategy*, joint doctrine, and Army doctrine—that is, FM 100-5. It applies to the conduct of operations across the range of military operations and fills a doctrinal void. This is the first operational- level-of-war doctrinal manual to address the roles and functions of the Army service component and how the ASCC relates to the commander in chief (CINC), peers, and subordinates within the theater structure of the unified command. Additionally, this manual describes the ARFOR in a combatant commander's theater strategic and operational environments. It clarifies the various roles and responsibilities of senior army commanders in theater.

The manual outlines principles and functions for planning and conducting subordinate campaigns and major operations that require the integration of Army combat capabilities and support activities within a joint, multinational, or interagency framework. The manual describes Army operations, including force projection, throughout the full range of military operations—*war* and *military operations other than war (MOOTW)*.

FM 100-7 is designed to assist ASCCs, ARFOR commanders, and other senior army commanders and their staffs to develop a framework necessary to translate strategic guidance into operational and tactical execution in joint, multinational, and interagency environments. This manual implements relevant joint doctrine, incorporates lessons learned from recent operations, and conforms with the Army's keystone doctrine. Additionally, it links FM 100-15,² FM 100-16,³ FM 100-20,⁴ FM 100-25,⁵ and other tactical and logistics doctrinal manuals with joint and Army capstone manuals.

The proponent of this manual is HQ TRADOC. Send comments and recommendations on DA Form 2028 directly to Commander, US Army Training and Doctrine Command, ATTN: ATDO-A, Fort Monroe, VA 23651-5000.

Unless this publication states otherwise, masculine nouns or pronouns do not refer exclusively to men.

-
1. *Operations*, 14 June 1993.
 2. *Corps Operations*, September 1989.
 3. *Army Operational Support* (final draft), 4 April 1994.
 4. *Military Operations in Low Intensity Conflict*, December 1990.
 5. *Doctrine for Army Special Operations Forces*, 1 January 1991.

PART ONE

Background

Commanders employ forces within the three states (peacetime, conflict, and war) of the theater strategic environment. Army commanders, particularly at the operational level, operate with other services, government agencies, United Nations (UN) agencies, nongovernmental organizations (NGOs), private voluntary organizations (PVOs), and multinational partners. These unified operations—joint, multinational, and interagency efforts—require a thorough understanding of Army capabilities as they contribute to the unified structure. Combatant commands and theaters form the unified structure for this organizational environment. A combatant command is one of the unified or specified commands established by the President. A theater is the geographical area outside the continental United States (CONUS) for which a commander of a unified command has been assigned military responsibility. Combatant commanders conduct unified operations.

To discuss the US Army in theater operations at the operational level of war, commanders must understand the theater strategic and operational environment. To do that, they must understand the fundamentals that define that strategic environment and how the application of those fundamentals affects Army operations. Chapter 1 discusses planning and execution of major operations, operational art, operations in war, and military operations other than war (MOOTW). Chapter 2 describes the national and theater strategic environments and provides a means to assess Army operations at the operational level. Chapter 3 examines how the commander in chief (CINC) and the Army service component commander (ASCC) apply operational art and design. Operational art and design are the linkage between execution of tactical operations and campaign plans to obtain strategic objectives in theater. These chapters provide the basis necessary for understanding Army operations at the operational level.

Chapter 1

Decisive Victory

In peacetime, conflict, and war, the Army is the nation's predominant decisive land force. Whenever the Army is called upon, it fights to win and operates to achieve decisive results at minimum cost to life and treasure. Army forces (ARFOR) in combat seek to impose their will on the enemy. In MOOTW, they seek to create, set, or control conditions to achieve their purpose. The standard is to achieve the military commander's end state within the strategic end state articulated by the National Command Authorities (NCA).

PLANNING AND EXECUTION

In today's global-based, force-projection Army, planning and executing major operations to support a theater campaign is a formidable task. The theater strategic environment is uncertain and dynamic, with

ever-increasing threats and instabilities. Still, the opportunities for peace, growth, and stability are evident. Army capabilities to succeed in leveraging the environment consistent with national policy and strategy is

the key. Commanders at all levels must organize, resource, train, and employ their forces to be *the decisive force* when and where required. The Army operational-level commander's challenge is to shape the military environment and set the conditions for decisive results or victory—unqualified success in all major operations, whether in peacetime, conflict, or war. This chapter is synchronized with Joint Pubs 1, 0-2, 3-0, 4-0, and 5-0; multiservice publications (FMFM 1, NDP 1, AFM 1); and Army FMs 100-1 and 100-5.

THEATER CAMPAIGN

The theater campaign is the focus of army operations in war, conflict, or peacetime. It is linked to a theater strategy. The campaign is a series of related and integrated major operations with strategic, operational, and tactical complementary actions simultaneously and sequentially arranged to accomplish national strategic, theater strategic, and operational objectives within a given time and space. The campaign plan describes the conduct of air, land, sea, space, and special operations. If appropriate, it also includes interagency operations, NGOs and PVOs, and multinational operations, often in relation to UN actions. To win rapidly and decisively, both combat and noncombat operations occur simultaneously throughout the combatant commander's campaign space and the operational-level commander's battle space and against the enemy's theater depths.

In wartime, a broadly conceived theater campaign plan normally involves the employment of large unified and joint forces. A single, unifying strategic concept of operations synchronizes the actions taken at each level of war against the enemy's depth. The intent is to concentrate strategically the decisive force, simultaneously destroying and disrupting key enemy capabilities and functions, and exploiting the resultant strategic advantage and initiative before the enemy can react. Achieving the theater strategic objectives, while striving to incur minimum casualties, is the measure of success.

Other campaigns may also be broad in scope but usually call for smaller forces and may include UN forces as well as other

international agencies, NGOs, PVOs, and US Government agencies. Also based on theater strategies, these campaigns involve a series of integrated operations with strategic aims at international, national, and theater levels. The intent is to establish and maintain the desired military conditions while employing a wide range of military and nonmilitary capabilities to achieve theater strategic and operational objectives.

Campaigns covering the full range of military operations demand plans with sound linkages between theater strategy, the campaign plan, and major operations plans. The theater campaign must include forward-deployed forces and force-projection forces involved in peacetime engagement—for example, the Partnership for Peace Program, multilateral training, meetings—all part of the CINC's strategy.

THEATER STRATEGY, CAMPAIGN, AND MAJOR OPERATIONS LINKAGES

The vital linkage between national and theater strategic direction and the tactical employment of forces on the battlefield takes place in major operational-level planning. The theater strategy and campaign relate the ends, ways, and means of national strategy to the outcomes, methods, and resources for operational activities. Translating national, alliance, or coalition guidance, the theater commander devises theater strategic objectives, concepts, and resource implications for a broad range of activities in the theater, including provisions for both war and MOOTW. The theater strategy is the foundation for the campaign plan and forms the framework for the employment of forces.

With the outbreak of crisis or, more optimally, in anticipation of an outbreak, the CINC modifies portions of his strategy and campaign and, when necessary, develops a new campaign plan. His critical tasks are to identify the military operations that will achieve the desired military end state, thereby contributing to conditions for achieving the strategic end state. The military end state normally represents the conditions the CINC wants the campaign to achieve and is reflected

in his mission statement, concept, and intent. The NCA normally directs the military to support other elements of national power to achieve a strategic end state that may be broader in scope than the necessary military end state. The intent of the CINC to meet the necessary military end state must be nested inside the broader intent of the NCA. Within the theater of war and theaters of operations, the CINC's campaign plan supports the strategic intent, concepts, and objectives.

Operational-level commanders set the conditions for tactical plans and support the campaign with operational intents, concepts, and objectives. Commanders at the tactical level ensure their intents, concepts, and objectives are nested within those of the operational-level commander. Regardless of level, Army commanders consider the objective factors of mission, enemy, terrain, troops-time available (METT-T) in their battle space to achieve dominance over the enemy and to protect the force.

MAJOR OPERATIONS

Commanders of major operations require a fundamental understanding of the principles of planning. Operational and tactical planning share the same basic, self-evident requirements—a complete definition of the mission, clarity of the commander's intent, thoroughness of estimates, and sound concepts of operations. At the operational level, the imperative is to remain capable of responding to continually changing conditions. These principles assist operational-level planners significantly.

Mission

To the Army operational-level commander, a mission is more than expressing what the unit must accomplish and for what purpose. In analyzing the mission, he considers his superiors' intent and the battle space and anticipates the missions that could logically follow from the mission in the campaign plan. Anticipating and staying ahead of change requires the operational-level commander to continuously reassess the stated mission in light of changing strategic and operational conditions. Subordinates still require clear,

understandable statements of mission and intent before and during battle. In assigning missions, commanders consider that nested concepts contribute to the unified effort and dominance of the enemy.

Estimates

Just as at the tactical level, the operational-level commander's continuous estimate assists commanders in choosing the best course of action (COA) and in making adjustments to changing situations during execution. Commanders first consider the enemy's capabilities, his likely intent and COA, and wargame friendly alternatives to get from the current friendly state to the desired military end state. Once a commander selects a COA, he articulates the operational concept—a description of his vision for the operation. He also begins to formulate ways to support the CINC's plan to keep the public informed of the campaign, thereby gaining its understanding and support. The result of the estimate is an accurate assessment of the current enemy and friendly situation, a refined understanding of the mission, and a clear expression of alternatives, which is the basis for the rest of the plan.

Estimates never stop. Operational-level commanders continually review the situation by—

- Visiting subordinates and getting their estimates
- Observing operations.
- Meeting with higher and adjacent commanders.
- Receiving updated intelligence and information about support efforts.

Commanders revise their concepts accordingly. During the execution of the plan, they may adjust the operation. Estimates include changes in military and strategic conditions as a basis for future missions. Further consideration of estimates is important for resource allocation changes, particularly in support operations.

Commander's Intent

After mission analysis, the operational-level commander clearly describes the

operation's purpose, the desired end state, the degree of acceptable risk, and the method of unifying focus for all subordinate elements. The operational-level commander's intent contains the intent statement of the next senior commander in the chain of command. The commander's intent is meant to be a constant reference point for subordinates to discipline their efforts. It helps them focus on what they have to do to achieve success, even under changed conditions when plans and concepts no longer apply. For major operations, a clear statement of intent is essential to successful integration and synchronization of effort, including support operations throughout the depth of the battle space.

Concept of Operations

The concept of operations describes how a commander visualizes the major operation unfolding. The concept is based on the selected COA to accomplish the mission, expressing *what*, *where*, and *how* the various subordinate operations will affect the enemy. The concept addresses the sequence and timing of events most likely to produce the desired end state. Support, in particular, can be a dominant factor in the determination of the nature and tempo of operations. Operational-level commanders answer these questions—what, where, and how—in sufficient detail for the staff and subordinate commanders to understand what they are to do, how they are to fight, and how they are to provide support for the fight. In the concept of operations, subordinate commanders describe how they

Historical Perspective

The commander of VII Corps had received his order to attack into Iraq. En route to his headquarters he wrote out his intent for the operation: I intend to conduct a swift, violent series of attacks to destroy RGFC [Republican Guard Forces Command] and minimize our own casualties. Speed, tempo, and a coordinated air-land campaign are key. I want Iraqi forces to move so we can attack them throughout the depth of their formations by fire, maneuver, and air. The first phases of our operation will be deliberate and rehearsed. The latter will be more METT-T-dependent. We will conduct a deliberate breach with precision and synchronization resulting from precise targeting and continuous rehearsals. Once through the breach, I intend to defeat forces to the east rapidly, with one division as an economy of force, and pass three divisions and the ACR [armored cavalry regiment] as the point of main effort to the west of that action to destroy RGFC in a fast-moving battle with zones of action and agile forces attacking by fire, maneuver, and air. CSS must keep up because I intend no pauses. We must strike hard and continually and finish rapidly.

see the actions of each unit fitting together to accomplish the mission. They describe their view of probable enemy actions and how they plan to defeat the enemy. The operational-level commander ensures that his concept is consistent with his intent, the intent of the CINC, and the strategic purpose of the campaign.

OPERATIONAL ART

The subordinate commanders' application of operational art begins with understanding the theater strategic concept and guidance about the military end state. As strategic realities tend to constrain the strategic possibilities, the guidance also limits operational-level possibilities. Directly stated, strategic guidance allows the operational-level commander to proceed along clear lines in planning an operational concept to support a desired military end state.

Every subordinate campaign or operation plan (O-PLAN) requires an overarching operational concept. The subordinate joint force commander (JFC) is normally responsible for the concept—an idea that is initially a product of the higher commander's intent, mission analysis, personal estimate of the situation, and creative imagination and intuitive judgment. Initially, it exists only in his mind. Yet, the operational concept must be clearly articulated relative to the conditions in which it will apply. No finite set of principles

exists to help in formulating an operational concept, but history has validated the application of several key military notions or concepts.

Three commonly used concepts are center of gravity, lines of operations, and decisive points. Center of gravity usually relates to the main enemy force or capability. The concept of center of gravity is useful as a tool to analyze enemy strengths and vulnerabilities. By identifying and controlling decisive points, commanders gain a marked advantage over the enemy and can influence the outcome of an action. A line of operation connecting a force with its base of operations is useful for focusing the effects of combat power toward a desired outcome. A commander who uses more than one line of operation produces flexibility and creates opportunities for success. By applying all three concepts, either separately or in concert, the commander forms a concept to set conditions for operations and battles with conclusive, and sometimes, decisive results. Other useful theoretical concepts include culminating point, synergy, simultaneity and depth, anticipation, leverage, tempo, direct versus indirect approach, and termination.

In developing the concept, operational-level commanders should consider alternatives that lead to *decisive* operations and battles.

These operations are key to determining the outcome of engagements, battles, and major operations. Many other operations support decisive operations. For example, two supporting ground battles, an interdiction operation, and a deception operation all could support a separate, decisive ground battle during a single phase of a campaign.

Commanders at all levels provide focus by designating the main effort and *supporting* efforts, which help set priorities, determine risks, and unify the effort. The operational-level commander focuses by applying structure to the theater of war and his area of responsibility (AOR). Structure is a product of the strategic objectives, forces allocated for the theater, a concept for their employment, the factors of METT-T, and the presence of alliance or coalition structures.

Thinking more broadly and outside the structure, the commander synchronizes major actions within his battle space. The operational-level operating systems—*movement and maneuver, fires, protection, battle command, intelligence, and combat service support (CSS)*—are logical ways for commanders to describe systematically the integration of functions that occurs in each phase of the campaign plan within a given battle space.

OPERATIONS IN WAR

The Army operational-level commander dominates land combat to provide decisive results for the CINC. He recommends force projection into theaters; links strategy and campaigns to major operations and tactics through battle dynamics (described later in this chapter); integrates assigned and supporting joint capabilities effectively; and transitions smoothly from crisis back to peacetime. The Army operational-level commander also understands all aspects of the CINC's intent. More than merely comprehending the Army or land force role in the joint operation, he understands the planning considerations of the other service operational-level commanders and ensures a mutual understanding and contribution to the accomplishment of all subordinate missions.

He also realizes that the joint team shares limited resources. The CINC's vision for the campaign provides direction for the allocation of these limited resources. Most significantly, the Army operational-level commander recognizes that theater success requires more than the success of a single service component; it requires unified success of the joint team, as directed by the CINC.

FORCE PROJECTION AND EARLY ENTRY

Power projection is the ability of the US to apply any combination of economic, diplomatic, informational, or military instruments of national power. An effective power-projection capability serves to deter potential adversaries,

Historical Perspective

Operation Just Cause began in the early hours of 20 December 1989, as a United States (US) joint force conducted multiple, simultaneous strikes in the Republic of Panama. Elements of the Army's XVIII Airborne Corps formed the core of the US Southern Command's Joint Task Force (JTF) South in this force-projection operation. Forward-presence forces, special operations forces (SOF), parachute assault forces, and air elements of the joint force simultaneously attacked or secured 27 critical objectives throughout the depth of the JFC's and enemy's battle space. The synchronized attack of enemy command and control [C²] facilities and troop concentrations paralyzed and crushed the Panamanian Defense Force. The objectives included US family housing areas and critical US facilities, which JTF South secured during the attack on Panamanian forces. American forces established effective control of most Panamanian military targets and much of the infrastructure within 24 hours, with limited casualties.

The redeployment of conventional forces to CONUS began before the joint staff terminated Operation Just Cause. Limited military police and elements of the 82d Airborne Division departed Panama as other forces continued efforts to secure outlying regions of the country. These critical Army crisis-response forces returned to home stations to reestablish quickly their peacetime readiness posture.

Historians may declare Operation Just Cause as the first war of the twenty-first century. The speed and scope of the force projection, the simultaneity and depth of attacks at all levels of war, the integration of combat and MOOTW, and the rapid reconstitution of national strategic capabilities provide a model for future conflicts.

conduct joint, multinational, and interagency operations anywhere in the world from CONUS or forward-deployed locations.

Ensuring the projection of lethal force worldwide represents the operational-level commander's most critical and difficult task. This task is essential because power projection forms a central element of the *US National Security Strategy*. This task is challenging because it requires the operational-level commander to deploy limited forces thousands of miles and conduct a high-stakes, come-as-you-are operation. The importance of the anticipation, balance, and timing of offensive operations represents three critical force-projection considerations.

Anticipation

The operational-level commander improves his ability to project decisive force through anticipation. Predeployment and deployment decisions are crucial. Made under conditions of great uncertainty and friction, these decisions influence the success of entry, combat, and postconflict operations. Once made, the decisions are most often irretrievable. The operational-level commander improves these early decisions by anticipating alert and deployment. Anticipation also plays a key role throughout the deployment. Time remains a critical resource, while ambiguity and uncertainty continue to cloud the environment. Continuous force tracking, total asset visibility, and continuous intelligence-preparation-of-the-theater enable the operational-level commander to anticipate changes and maximize his freedom of action.

Balance

The most difficult predeployment decisions in support of the campaign plan concern force mix and balance. The operational-level commander must resolve requirements for quick, decisive victory with strategic constraints and uncertainty. Initially, he must seek a balance in joint capabilities instead of a balanced ARFOR. He will want to deploy credible, lethal forces early, but limited strategic lift, undeveloped theater infrastructure, and time constraints may prevent him from doing so. Conversely, he may require the maximum amount of combat power

at the cost of logistical support. Either way, the CINC can seldom afford duplicate capabilities among elements of the joint team. Maritime air and amphibious capabilities, naval gunfire, and fleet ballistic missiles represent lethal force often available to support early entry operations. These or other forward-presence forces may protect the lodgment, deter enemy attack, or initiate limited offensive operations if conditions limit the early entry of fully balanced Army combat power. The operational-level commander must exploit forward-presence forces; split-based operations; and host nation, coalition, and joint assets to balance early entry capabilities.

Timing

The operational-level commander also faces a critical decision as he plans the transition to offensive operations. Early entry units may initially secure the lodgment as additional forces arrive. However, American operations doctrine and the situation will prevent long-term defensive operations. The operational-level commander must decide when he has sufficient combat capability to transition to offensive operations. He must also consider other joint capabilities that complement Army force projection characteristics. He must apply the CINC's intent and guidance to evaluate trade-offs between the time required to assemble overwhelming combat force and the benefits of early offensive action against an enemy that is consolidating gains or preparing for offensive action. The preferred model remains Operation Just Cause, which emphasized overwhelming and paralyzing the enemy through decisive, simultaneous strikes throughout the depth of the battle space. This action resulted in minimal losses and rapid strategic conclusion.

BATTLE DYNAMICS WITHIN THE THEATER

Operational art links success in tactical engagements and battles with strategic aims. The aspects of battle dynamics establish this relationship: *battle command*; *battle space*; *depth and simultaneous attack*; *early entry*, *lethality*, and *survivability*; and CSS. Although FM 100-5 describes each of these dynamics,

TRADOC Pamphlet 525-5 is the first document that codifies the elements of battle dynamics.

Battle Command

Battle command describes one dimension of the linkage among strategy, operations, and tactics. Battle command is a commander's mental decision-making frame work. The attributes of battle command—assigning missions, prioritizing and allocating resources, assessing and taking risks, guiding and motivating the organization—contribute to positive impact on commanders at critical points in the battle or on the battlefield. Commanders visualize current and future states of friendly and enemy forces and then formulate concepts of operation to accomplish the mission. The Army operational-level commander faces unique responsibilities in this area. Time constraints and requirements during force projection strain the process of translating theater strategy and design into operational design and tactical objectives. The Army operational-level commander may proceed through the first iteration of the estimate process concurrently with the CINC and subordinate Army commanders. Consequently, the CINC may not fully develop and communicate his strategy in military terms early enough to support parallel planning. The Army operational-level commander must translate nonmilitary theater end states into clear military objectives to support the planning of his staff and subordinate commands.

Battle Space

Battle space characterizes another facet of the linkage among the levels of war. It represents the domain in which commanders conduct their operations at the tactical, operational, and theater strategic levels. The Army operational-level commander's battle space forms a subset of the CINC's and contains the battle space of all subordinate commanders. Its physical volume expands or contracts in relation to the Army operational-level commander's ability to acquire and engage the enemy. It includes the breadth, depth, and height in which he positions and moves assets over time. It also reflects the capabilities of the intelligence systems that support him and the deep operations

capabilities of the units and systems that support his command. The Army operational-level commander's battle space may extend beyond his operations area, and it may not be contiguous. It also extends back to CONUS, to include the deployment and logistical systems that support Army operations in theater.

Depth and Simultaneous Attack

Depth and simultaneous attack reinforce the linkage among strategy, operations, and tactics. The operational-level commander supports the CINC's aims by dominating the opponent in his battle space through depth and simultaneous attack. The operational-level commander cannot maximize depth through unilateral action. To achieve it, he must link the levels of war by augmenting his intelligence and deep operations systems with joint capabilities. The operational-level commander also joins the levels of war through simultaneous attack. His efforts to achieve simultaneity concentrate the effects of engagements, battles, and major operations in the dimension of time. Resulting concurrent operations at all levels of war increase the requirement for tightly integrated activities. Application of depth and simultaneous attack blurs the boundaries among tactics, operations, and strategy.

Early Entry, Lethality, and Survivability

Early entry forces are those operational deploying forces required to support the CINC or other JFC concepts of operations in a precrisis or crisis situation. Early entry forces must be able to deploy rapidly, enter the operational area, and secure the lodgment. They must either immediately have a decisive effect or create conditions for the arrival of substantial follow-on forces that can then conduct decisive operations. Early entry forces must consist of lethal and survivable units tailored to support or carry out the operational intent of the JFC.

Combat Service Support

The functions of CSS have not changed in many centuries. Logisticians have and will continue to have similar requirements to arm, fuel, fix, move, and sustain soldiers and their systems. The primary differences are in the

execution of the support provided. These differences are a result of diplomatic, economic, social, and technological changes. Successful armies recognize and adapt to this change, harness it to their benefit, and are ultimately victorious.

Rapid force projection from CONUS, extended lines of communication (LOCs), and potential forcible entry into logistically bare-based areas of operations (AOs) require Army development of a CSS system that is versatile, deployable, and expandable. The CSS system must be as capable as the joint and multinational forces, to include the SOF, it supports. The CSS system must include both the deployed force and the sustainment base. Its purpose must be to maintain readiness and sustain ARFOR in all operations across the range of military operations and at all levels of war—strategic, operational and tactical. The focus of the CSS system must continue to be soldiers and their weapons systems.

INTEGRATION OF JOINT CAPABILITIES

The operational-level commander plays a critical role in integrating joint capabilities. He understands all aspects of the CINC's intent and recognizes the importance of unity of effort. These two abilities underpin the concept of integrated joint capabilities. The operational-level commander integrates joint capabilities during the land phase of joint operations and as a service component commander reinforcing other members of the joint team.

The operational-level commander is the primary coordinator and integrator of joint capabilities during decisive land operations. The CINC seeks combinations of forces and actions to achieve concentration in various dimensions throughout all phases of the campaign. During the decisive phase of joint operations, the operational-level commander becomes the integrator of joint capabilities within his battle space. During this phase, the CINC coordinates the availability of resources and integrates supporting joint force operations elsewhere in the theater. The operational-level commander synchronizes the actions of theater intelligence assets, naval

gunfire and fleet ballistic missiles, air interdiction, close air support (CAS), joint electronic warfare assets, SOF, and other joint and national assets. He and his staff must exploit the capabilities of these resources.

The operational-level commander also integrates joint operations indirectly through the support of other services. He contributes to the integration of operations in which the CINC assigns him support missions. The attack of enemy air defenses to support air operations and the attack of small enemy naval vessels in support of maritime operations during the Gulf War are two examples of this. The operational-level commander also seeks opportunities to integrate his capabilities into the operations of the other members of the joint force. He understands the planning considerations of air, maritime, and SOF and seeks opportunities to contribute to unity of effort and the accomplishment of other service missions.

TRANSITION TO PEACETIME OR WAR

The operational-level commander considers postconflict operations early in the planning process. They fall in two broad categories:

- Actions to restore order and normal social activities following armed conflict.

- Operations to reestablish precrisis readiness levels.

Early decisions concerning mobilization and deployment establish conditions for critical postconflict operations. Long-term solutions to regional crises usually require more than the defeat of the enemy's military. The operational-level commander develops plans for conflict termination and postconflict operations early. He reviews them as branches and sequels to deployment and combat operations and plans for simultaneous combat. ARFOR assist the JFC in supporting the host nation with operations to handle refugees, clear minefield for immediate tactical purposes, control prisoners of war, provide humanitarian assistance, and provide other forms of support. Nonmilitary considerations often require the initiation of these MOOTW before the completion of combat operations.

Once the conflict ends, forces may deploy to their home stations or to another theater. The operational-level commander must plan for this possibility. He must expect the NCA to alert his forces, as in precrisis operations. His forces must be versatile enough to transition rapidly from one regional conflict to another. Once forces return to their home stations, they rapidly reestablish premobilization levels of readiness in anticipation of future operations.

MILITARY OPERATIONS OTHER THAN WAR

The Army operational-level commander's role in MOOTW is critical to achieving strategic success. Like the decisive phase of combat, most of these operations are land-based. Consequently, the Army operational-level commander functions as the central integrator of a joint and multinational team. He faces ambiguous threats, unpredictable conflicts, *ad hoc* staffs, and force packages, as well as a multitude of nonmilitary participants. The operational-level commander prepares for a mission of unknown duration and anticipates changes in its nature and scope. To ensure success, he applies operational art executed within the framework of battle dynamics. He achieves his desired end state by carefully planning, integrating complementary

capabilities, and using versatile forces. Transitions may have no clear division between combat and peacetime activities, may lack definable timetables for transferring responsibilities, and may be conducted in a fluid, increasingly diplomatic environment.

JTF Andrew coordinated with many federal, state, and private organizations. These included the Federal Emergency Management Agency, the Civil Air Patrol, the American Red Cross, the General Services Administration, the Public Health Service, the Department of Agriculture, the Salvation Army, the Boy Scouts of America, and many religious relief organizations. The commander of JTF Andrew determined that victory would be achieved when the local schools reopened. This had a

Historical Perspective

At 0500 on 24 August 1992, Hurricane Andrew devastated south Florida. The Governor of Florida requested federal assistance. The Secretary of the Army, as the President's executive agent, directed initiation of disaster-relief operations in support of the Federal Response Plan. As part of those operations, the commander in chief of Forces Command directed Second US Army to form JTF Andrew and begin humanitarian relief operations. Eventually composed of elements of all services and both active and reserve forces, JTF Andrew began operations on 28 August 1992.

JTF Andrew's mission was to provide humanitarian support by establishing field feeding sites, storage and distribution warehousing, cargo transfer operations, local and line haul transfer operations, and other logistics support to the populace in affected areas. The commander of JTF Andrew defined success as getting life support systems in place and relieving immediate hardships until non-Department of Defense (DOD) federal, state, and local agencies could reestablish normal operations. Operations were conducted in three phases.

- Phase I provided immediate relief through life support systems—food, water, shelter,

medical supplies and services, information, sanitation, and transportation.

- Phase II was a recovery phase that ensured sustainment of services provided in Phase I while assisting federal, state, and local authorities to reestablish public services.
- Phase III was a reconstitution phase that continued to reestablish services under federal, state, and local control while JTF forces redeployed.

During these operations, 1,014 sorties were flown, carrying over 19,000 tons of mission support materials. Almost 900,000 meals were served. Over 80,000 tons of humanitarian supplies were moved into the area by sea and over land. Almost 2,000 tons were moved by air. Over 67,000 patients received medical treatment, and over 1,000 tents were erected. A mobile radio station was established to provide emergency information to the local population and to provide route information to assist convoys as they arrived. Four life support centers were constructed, providing mass care for 2,400 people per day for approximately two months. Over six million cubic yards of debris were removed, and 98 schools were repaired.

significant focusing effect on the efforts of DOD and non-DOD participants and answered the question, "How do I know when I am done?"

This disaster-relief effort demonstrated the versatility of the US armed forces. The training for war that developed initiative, ingenuity, and flexibility in the conduct of operations served the nation well in a noncombat situation. The alert of the 10th Mountain Division for Somalia less than six weeks after sending more than 6,000 soldiers and their equipment to south Florida further highlights their versatility.

PLANNING CONSIDERATIONS

Military decision making and planning processes also apply to MOOTW. The operational-level commander faces unique

planning considerations because of the nature of MOOTW. Areas that require special planning considerations include interagency cooperation, parallel and continuous planning, intelligence, and constraints and restraints placed on the operation.

Gaining cooperation among the multitude of participants is a formidable task. The operational-level commander unifies the efforts of all participants operating within his battle space by attempting to reach agreement on common goals and objectives. Consensus on goals and objectives requires an understanding of the roles, missions, and capabilities of each participating member. Additionally, both national and international representatives of the media will likely cover the operation. Facilitating their mission keeps the service member, the local populace, and the

international community apprised of the situation and may contribute to the achievement of national aims and objectives.

Parallel planning is essential. Ideally, this begins with the NCA decision to commit military forces. The uncertainty surrounding the mission requires commanders to simultaneously begin planning at all levels. Parallel planning provides planners with the ability to influence task organizations, mission statements, and force caps and obtain access to critical strategic intelligence early in the planning process. The operational-level commander must participate in the development of end states, conditions, and measures of effectiveness (MOEs). He must understand the diplomatic, economic, and social objectives of the operation before determining the military end state and sequencing operations to achieve it. Clarity of mission and desired end state is critical.

Intelligence is the key to force protection. The Army operational-level commander acquires and disseminates information on the country, the people, and the diplomatic, economic, and military situations. Key items of information are shared with members of participating civilian organizations, who in turn can be vital sources of intelligence. Continuous access to strategic intelligence and reliable low-level sources is paramount to situational awareness. The viability of the rules of engagement (ROE) are assessed continuously with the current mission, friendly force capability, threat conditions, and environment within which operations are conducted. ROE protect the force and also provide a framework within which hostile acts are controlled.

The Army operational-level commander must conduct a continuous estimate process. He operates in a dynamic environment. Changes in strategic objectives, operational constraints, or the nature of the threat are three examples that may invalidate the initial mission analysis. Operations, intelligence, deployment, engineer, and logistics estimates are constantly updated as new information becomes available. The commander's continuous estimate process serves to integrate

the parallel planning and estimate processes ongoing in each functional area.

The operational-level commander obtains clear, strategic guidance on constraints and restraints early in the planning phase. He determines his authority and capability to enforce local laws and assesses restraints on weaponry, tactics, and levels of violence. Excessive force could impede the attainment of operational goals and hamper the efforts to maintain legitimacy and obtain international acceptance. Disciplined forces, measured responses, and patience are essential to successful outcomes.

INTEGRATION OF COMPLEMENTARY CAPABILITIES

The operational-level commander integrates and synchronizes complementary capabilities within his battle space. Establishing cooperation among many participants is demanding; integrating their capabilities is even more so. The simultaneous application of complementary strengths, concurrently conducted at all levels, provides the necessary leverage to achieve the desired end state. The key to developing this leverage is the ability to establish unity of military and civilian efforts. Without a formal interagency command structure, commanders ensure unity of effort through leadership. They must demonstrate the logic and soundness of their solutions and the competence of their execution. Robust liaison is critical in this role. Providing assistance to other participants promotes integration of their unique capabilities. Operational-level commanders enhance their integration efforts by—

- Collocating their headquarters with local and regional governments.
- Establishing a civil-military operations centers.
- Aligning military and diplomatic boundaries.

By planning, implementing, and continuously updating a complementary joint and interagency concept, operational-level commanders integrate diplomatic, military, and economic power across all dimensions of the environment.

TRANSITION TO WAR OR OTHER OPERATIONS

The operational-level commander plans MOOTW anticipating the requirement to transition to another, similar operation or even war. The experiences of the 10th Mountain Division (Light Infantry) during 1992 and 1993 set the precedent. MOOTW require flexible leaders with versatile forces. The operational-level commander must be able to address a wide array of missions against a multitude of diverse threats. His versatile force must be capable of fighting and winning our nation's wars, yet it must be fully capable of

transitioning from warfighting to other operations. Rapid changes in the strategic situation may force sequential commitment from one theater to another; while changes within the same theater may require a transition from one type of operation to another. Activities such as nation assistance, humanitarian support, and disaster-relief operations may continue when higher levels of violence arise. Commitments to MOOTW may precede combat, follow combat, or flow readily back and forth between the two.

MULTINATIONAL OPERATIONS

Throughout history, military operations have been conducted with armed forces of several nations in pursuit of common objectives. The changing world environment dictates that future operations will most likely require multinational involvement.

An operation conducted by forces of two or more nations is termed a *multinational operation*. An operation conducted by forces of two or more nations in a formal arrangement is called an *alliance operation*. An operation where the military action is temporary or informal is called a *coalition operation*. Campaigns and major operations may be conducted within the context of an alliance, coalition, or other international arrangement. Such operations, whether or not they involve combat, are planned through both international and US channels. In practice, each coalition operation is unique. Planning and conduct of the operations vary with the international situation and the composition of the forces. Alliance or coalition members may not have identical strategic perspectives, but there should be sufficient harmony of interests to ensure a common purpose for the campaign. The need to maintain consensus within the alliance or coalition is paramount to preserve a unified effort.

Multinational operations require close cooperation among all forces. Capabilities will often differ substantially among national forces, but higher considerations of national prestige will often be as important to the final success as the contributions to the overall effort. Seemingly small decisions, such as national composition of the main effort, may have significant consequences for the outcome of the operation. Members should be consulted on their recommendations for COA development, ROE, and assignment of missions.

To assure unity of effort, all plans require detailed coordination with essential supporting plans for liaison and the provision of mutual support. Host nation support and the capabilities of coalition partners in particular may dictate the tempo of the attack and its form. The commander must focus on lateral coordination across national and interagency boundaries, in particular the effective sharing of information. Though unity of command promotes unified effort, American commanders should be prepared to operate within the alliance or coalition under command of other than a senior US commander.

Chapter 2

The Theater

The *Unified Command Plan (UCP)* establishes criteria for a unified theater based on *National Security Strategy*, *National Military Strategy*, geography, and history. The President approves the *UCP*, which sets forth basic guidance to all unified combatant commanders; establishes their missions, responsibilities, and force structure; delineates the general geographical AOR for geographic combatant commanders; and specifies functional responsibilities for functional combatant commanders. A key consideration is strategic objectives. National strategic direction and evolution of geopolitical circumstances shape the theater's geographic boundaries.

Theater commanders provide strategic direction and operational focus to subordinate commanders. They develop a theater strategy and campaign plan, organize their theaters, and establish command relationships for effective unified (joint and multinational) operations. Through this process, theater commanders plan and conduct unified operations that ensure a united effort within the command.

The military instrument of national security policy requires synchronization with the diplomatic, informational, and economic efforts. Circumstances determine the extent of the synchronization required. The national synchronization effort is referred to as *unified action*; the theater level is referred to as *unified operations*. Interagency operations are another consideration for Army commanders in the theater.

The US Constitution requires civilian control (the NCA) of US military forces. Consequently, subsequent legislation has molded today's defense establishment and produced the concept of the unified theater. Unity of command requires that one responsible commander focus resources toward obtaining defined objectives and strategic end states. Across the range of military operations, unity of command gives a single, unified commander responsibility for all military operations within a designated theater strategic environment (see Figure 2-1). Command lines within the unified theater are established to designate one responsible commander.

Section I

The Strategic Hierarchy

The first round of the first battle is a strategic-level decision.

GEN William W. Hartzog
Commander, US Army Training and Doctrine Command

To accomplish unity of effort within the unified theater, the CINC devises a theater strategy for that geographic portion of the globe. This military strategy is a combination of the art and science of employing armed forces or

the potential threat posed by the presence and capabilities of that force to secure national security objectives through the application of force. The CINC derives his military strategy for a geographic region from a hierarchy of guidance and manifests it in the unified theater campaign plan and theater contingency plans.

The theater strategic environment is shaped by the special conditions, circumstances, and influences in the theater that affect the employment of military forces and the decisions of the chain of command. The theater strategic direction is expressed through hierarchical levels of strategy. *National Security Strategy*, *National Military Strategy*, and theater strategy all provide the basis for each theater’s strategic direction. These strategies integrate national security and military objectives (ends), national security policies and military concepts (ways), and national resources and military forces (means) to achieve national security objectives. The Army’s planning and conduct of major operations or MOOTW is the operational-level link between the tactical level force’s actions and the strategic hierarchy discussed above. This operational-level link is discussed later in this chapter and in the Chapter 3 discussion of operational art and design.

The *National Security Act (NSA) of 1947*, as amended, created the Department of Defense and the positions of Secretary of Defense (SECDEF) and Joint Chiefs of Staff (JCS). The *National Security Act of 1947*, and subsequent implementing memorandums, authorized the formation of unified and specified combatant commands. Commanders of these combatant commands are called CINCs.

STATES OF THE ENVIRONMENT	GOAL	MILITARY OPERATIONS	EXAMPLES
War	Fight and Win	War	<ul style="list-style-type: none"> • Large-scale combat operations • Attack • Defend
Conflict	Deter War and Resolve Conflict	Operations other than war	<ul style="list-style-type: none"> • Strikes and raids • Peace enforcement • Support to insurgencies • Antiterrorism • Peacekeeping • Noncombatant evacuation operations (NEO)
Peacetime	Promote Peace	Operations other than war	<ul style="list-style-type: none"> • Counterdrug • Disaster relief • Civil support • Peace building • Nation assistance

The states of peacetime, conflict, and war could all exist at once in the theater commander's strategic environment. He can respond to requirements with a wide range of military operations. Noncombat operations might occur during war, just as some MOOTW might require combat.

Figure 2-1. The Range of Military Operations

NATIONAL SECURITY STRATEGY

The NCA establish the *National Security Strategy* and appropriate strategic end states. The *National Security Strategy* announces US interests and objectives. This strategy is the art and science of developing, applying, and coordinating the instruments of national power—diplomatic, economic, military, and informational—to achieve objectives that contribute to national security. National values and principles form the foundation of US interests and objectives. The Army’s keystone doctrine (FM 100 5) reflects these values as *the American view of war*. US interests and objectives outlined in the 1994 version of *National Security Strategy* include—

- *Enhancing our security.* The survival of the US as a free and independent nation, with its basic values intact and its institutions and people secure.
- *Promoting prosperity at home.* A healthy and growing US economy to ensure opportunity for individual prosperity and resources for national endeavors at home and abroad.
- *Promoting democracy.* Healthy, cooperative, and diplomatically vigorous relations with allies and friendly nations. A stable and secure world where political and economic

freedom, human rights, and democratic institutions flourish.

The *1995 National Military Strategy* describes two fundamental strategic military objectives derived from the *National Security Strategy*.

- Promote stability through regional cooperation and constructive interaction.
- Thwart aggression through credible deterrence and robust warfighting capabilities.

To achieve these strategic objectives, US military forces must perform three tasks:

- One, remain constructively engaged in peacetime.
- Two, attempt to prevent the eruption of conflict.
- Three, should conflict prevention fail, fight and win our nation’s wars.

The overlapping and interrelated strategic concepts that allow the military to execute these three tasks are *overseas presence* and *power projection*. Figure 2-2 depicts the relationships between the strategic concepts of overseas presence and power projection and the national military objectives.

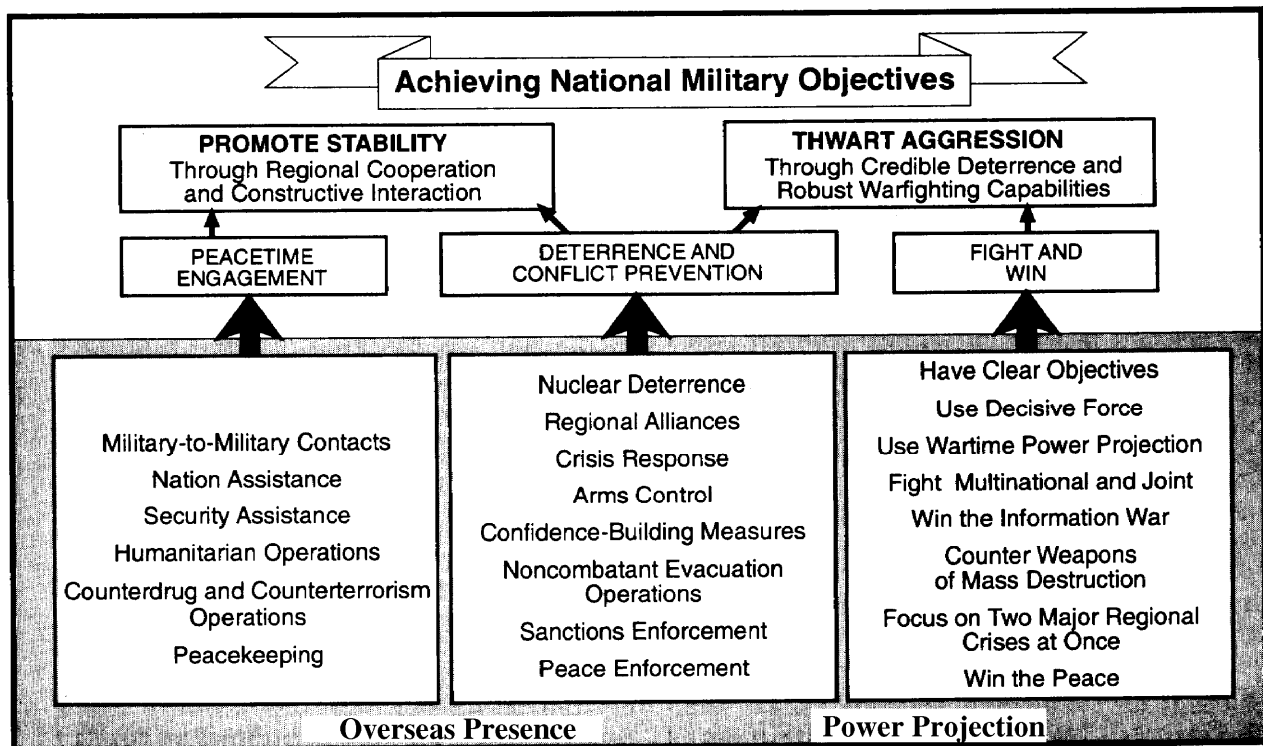

NATIONAL MILITARY STRATEGY

The *Goldwater Nichols DOD Reorganization Act of 1986* requires the Chairman of the Joint Chiefs of Staff (CJCS) to help the NCA in providing strategic direction for the armed services. The *National Military Strategy* and the Joint Strategic Planning System (JSPS) are the methods the CJCS uses for providing that assistance.

The *National Military Strategy* and defense policy provide strategic guidance for the employment of military forces. The Joint Strategic Capabilities Plan (JSCP) provides planning guidance to the CINCs and chiefs of the services to accomplish their missions based on current military capabilities.

THEATER STRATEGY

The CINC translates the national level strategic directives into a theater strategy. This strategy is the basis for developing a campaign plan and leads to operations plans for execution. Joint or multinational forces implement these plans in theater to achieve theater strategic objectives that, in turn, achieve national objectives.

The CINC's strategy has several components. First, it expresses his vision and intent (military objectives)—the theater *ends* to which operations are conducted. Next, it provides integrated strategic concepts, COAs, and guidance—the theater *ways* designed to secure national objectives, using the theater's wide-ranging military capabilities. Finally, it gives the service and functional component commanders guidance for planning and employing nuclear, conventional, and SOF theater *means*.

The plan's process allocates the theater means. Forces are allocated based on theater missions as they compete with requirements in other theaters. Means are expected to fall short of what would ideally be available. The theater campaign plan sequences unified activities over time and space to compensate for these shortcomings.

METT-T analysis is a traditional assessment method for tactical-level leaders. Under deliberate planning circumstances, tactical-level commanders and staffs should use the Army's deliberate decision making procedures in FM 101-5. As part of the Joint Operations Planning and Execution System (JOPEs) procedures, strategic and operational-level leaders use more formal methods, such as strategic estimates or commander's estimates, as they analyze military and diplomatic situations (see Joint Pubs 5-03.1 and 5-00.2).

At the strategic level, METT-T analysis focuses on conditions, circumstances, and influences of the theater strategic environment. At the operational level, it

includes the mission analysis and the assessment of the operational-level environment discussed in Section VI of this chapter. At the theater strategic level, the CINC develops his theater strategy by first identifying specified and implied missions and tasks for his theater. He derives these from many sources, including the national security and military strategies, policies, directives, the JSCP, the *UCP*, Joint Pub 0-2, and other directives and agreements.

While identifying theater missions, the CINC analyzes his theater strategic environment. Using the strategic estimate, which includes the factors of METT-T, he considers the potential instabilities or threats, the limitations, and the nature of anticipated operations. Assessment factors include the integration of capabilities by diplomatic, informational, and economic instruments of national power provided to the military. In addition, the CINC must consider international security agreements. This analysis leads to formulation of a strategic estimate that defines the strategic situation in the theater. Thus, the estimate produces broad, strategic concepts of what must be done in theater. Then, the CINC integrates these concepts into the theater strategy.

The CINC's staff and subordinates, to include his *service* and *functional component commanders*, contribute to the development of the theater strategy. The functional component commander is the commander in charge of a service or functional component command, which consists of all individuals, units, detachments, organizations, and installations under the command assigned to the unified CINC. The development of the multiple theater strategic concepts leads to a specific strategic COA for implementation in the theater campaign. Once the CINC selects the desired course, his staff and subordinate joint commands use the theater strategy to develop and integrate OPLANs, including campaigns.

Section II

The Chain of Command

The *Goldwater Nichols DOD Reorganization Act of 1986* prescribes the chain of command. The NCA exercises authority and control of the armed forces through the chain of command with two distinct branches. The first branch runs from the President to the SECDEF to the combatant commanders for missions and forces assigned to their commands. The second branch runs from the NCA to the secretaries of the military departments to the chiefs of the service forces for execution of service functions.

Commanders of combatant commands are responsible to the NCA for the preparedness of their commands and execution and accomplishment of assigned missions. The secretaries of the military departments are responsible for organizing, training, equipping, and providing forces. The authority exercised by the military departments is subject by law to the authority provided to the combatant commanders.

The *DOD Reorganization Act* placed the CJCS within the chain of command to communicate the directions of the NCA. Though he does not exercise military command over any combatant forces, all communications between the NCA and combatant commanders pass through the CJCS. Figure 2-3 displays the chain of command.

NATIONAL COMMAND AUTHORITIES

This portion of the chain of command begins with the President and SECDEF, who make up the NCA. They alone have the constitutional authority to direct US armed forces into military action. Once the NCA makes the decision, authorization for military

action is passed to combatant commanders. The President, with the advice of the SECDEF and CJCS, establishes combatant commands and appoints combatant commanders under the authority of the *National Security Act of 1947*. The JSCP apportions forces for each combatant command for planning.

CHAIRMAN, JOINT CHIEFS OF STAFF

While the CJCS does not exercise command over military forces, the SECDEF may assign oversight responsibilities to the CJCS to assist in controlling and coordinating the combatant commanders. The CJCS functions within the chain of command by conveying to the CINCs the orders of the President and SECDEF.

The CJCS coordinates all communications on matters of joint interest addressed to the CINCs by other authority. The CJCS acts as the spokesperson for the CINCs, especially on the operational requirements of their commands. The CJCS monitors the geographic regions of the world not assigned to a combatant command.

COMBATANT COMMANDER

A combatant commander is a commander of a unified or specified command. A combatant commander is called the CINC. A combatant commander is the only military leader with

statutory authority (combatant command) to organize and task all services under his control to accomplish military missions. Combatant commanders are key links in the chain of command.

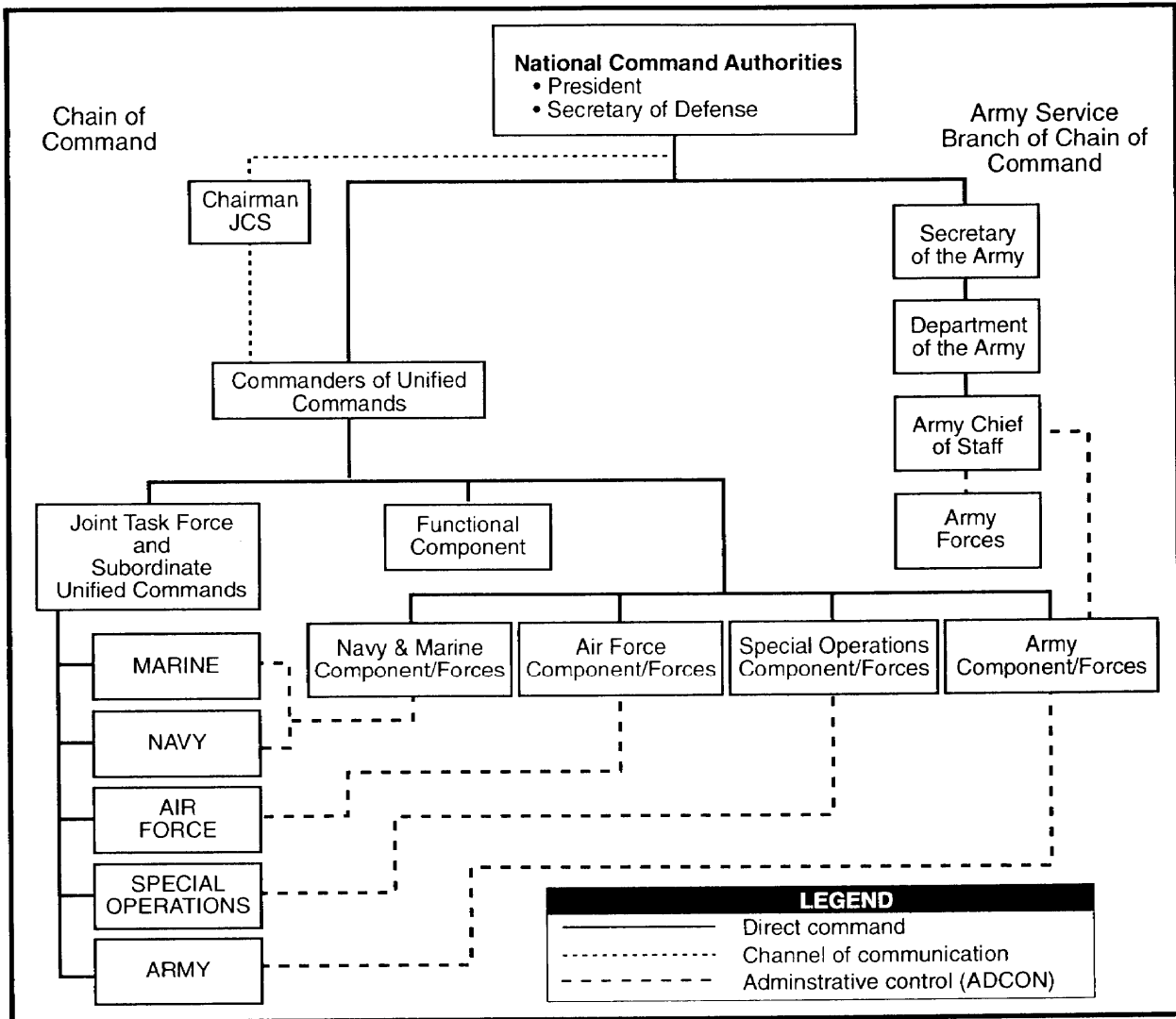

Figure 2-3. Chain of Command

SERVICE BRANCH (MILITARY DEPARTMENTS)

The chain of command for the military departments runs from the NCA to the secretaries of the military departments. The secretaries exercise authority, direction, and control through the service chiefs of their forces not assigned to combatant commands. This chain of command includes all military forces within the respective service. This branch of the chain of command is separate and distinct from the branch that exists within a combatant command.

The secretaries of the military departments are responsible for the administration and support of their forces, to include those assigned or attached to

combatant commands. The secretaries fulfill their responsibilities for forces apportioned to combatant commands by exercising administrative control (ADCON) through the service component commanders assigned to the combatant commands. ADCON is subject to the command authority of the combatant commander.

The ASCC, using ADCON authority, is responsible for preparing, maintaining, training, equipping, administering, and supporting ARFOR assigned to the unified and specified commands. The emphasis of the service branch of the chain of command is administrative (legal, personnel, finance) and

logistical support to respective service forces. Training during peacetime, in preparation for war, and before commitment of forces is also a key element and task for the ASCC.

The CINC provides the channel for strategic and operational guidance in theater and ensures the US unity of command. The service administrative and support channel provides administrative, training, and logistics support, ensuring that the CINC receives organized, equipped, and trained US military

forces. Figure 2-3 illustrates this branch of the chain of command.

Within the parameters set by the CINC's organization of the theater and the command relationships he establishes, the ASCC organizes the ARFOR to best accomplish the assigned missions. The CINC has the authority to direct certain Army organizational options but normally leaves internal Army organization and command relationships to the ASCC.

COMMAND AUTHORITIES

Command is central to all military actions. Unity of command is central to unity of effort. The authority vested in a commander must be commensurate with the responsibility assigned. Commanders in the chain of command exercise authority as prescribed by law or a superior commander. Commanders of US military forces use various levels of authority, which are described as command relationships and other authorities. Within the seven levels of authority, four are command relationships—combatant command (COCOM), operational control (OPCON), tactical control (TACON), and support. The other three are coordinating authority, ADCON, and direct liaison authorized (DIRLAUTH).

COMBATANT COMMAND

COCOM is the command authority authorized by Title 10, US Code, Section 164, or as directed by the President in the *UCP* to combatant command commanders (unified or specified). COCOM provides full authority to organize and employ commands and forces as the combatant commander considers necessary to accomplish assigned missions. This authority enables the CINC to organize and employ his commands and forces, assign tasks, designate objectives, and give authoritative direction over all aspects of military operations, joint training, and logistics necessary to accomplish the assigned missions. The CINC normally exercises COCOM through his service component commanders. COCOM is not transferable.

OPERATIONAL CONTROL

Commanders at or below the combatant commander exercise OPCON as their command authority. OPCON is inherent in

COCOM and is the authority to perform the functions of command over subordinate forces.

The CINC may delegate OPCON to his subordinates. OPCON is the most authority with which subordinates can direct all aspects of military operations and joint training needed to accomplish any assigned mission. A commander with OPCON may control forces from one or more services. OPCON does not normally include the authority to direct logistics, administration, discipline, internal organization, or unit training. The service component commander retains his service responsibility and authority for forces under OPCON of another command. Commanders must be aware of the US and North Atlantic Treaty Organization (NATO) terms of OPCON and not interchange the two. The NATO term *OPCON* more closely resembles the US definition of *TACON*.

TACTICAL CONTROL

The CINC uses TACON to limit the authority to direct the tactical use of combat forces. TACON is authority normally limited to the detailed and specified local direction of movement and maneuver of the tactical force to accomplish an assigned task. TACON does not provide organizational authority or administrative and support responsibilities. The service component continues to exercise these authorities.

SUPPORT

The CINC identifies support relationships for one force to aid, assist, protect, or logistically support another force. The *supporting force* gives the needed support to the *supported force*. Establishing supported and supporting relationships between

NATO OPERATIONAL AND TACTICAL COMMAND

During Operations Desert Shield and Desert Storm, the NATO terminology for subordinate command relationships caused some problems. The NATO terms *operational command* and *tactical command* are similar to the Army terms *OPCON* and *TACON*. With NATO forces working for a CINC outside the NATO structure, some confusion resulted.

OPCOM is a NATO term used to assign missions or tasks to subordinate commanders, to deploy units, to reassign forces, and to retain or delegate OPCON and/or TACON as necessary. OPCOM does not include responsibility for administration or logistics. OPCOM may indicate the forces assigned to a commander.

OPCON, as discussed in joint doctrine, is a slightly broader authority than OPCOM. OPCON, besides the authorities stated above, includes the authority to prescribe the chain of command; organize commands and forces; suspend or reassign officers; delineate functional responsibilities; and delineate geographic AORs.

Operational control is also a defined NATO term. In NATO, operational control is the authority delegated to a commander to direct forces assigned so that the commander may accomplish specific missions or tasks that are limited usually by function, time, or location. It further includes the deployment of units concerned and the retention or delegation of TACON to those units. It does not include authority to assign separate employment of components of concerned units. Neither does it, of itself, include administrative or logistical control.

TACOM, the NATO term, is the authority delegated to a commander to assign tasks to forces under his command for the accomplishment of the mission assigned by higher authority. This differs from TACON in that TACON involves only the necessary control of movements and maneuvers to accomplish a previously assigned mission. Both NATO and joint doctrine share the same definition for TACON.

These definitions demonstrate the complexity of multinational operations. The subtle differences in terms were a source of confusion among allies with a long history of multinational operations.

components is a useful option to accomplish needed tasks. This concept applies equally to all dimensions of the joint force organized by the CINC.

Each subordinate element of the joint force can support or be supported by other elements. Normally an establishing directive is issued to specify the purpose of the support relationship, the effect desired, and the scope of the action to be taken. Joint Pub 0-2 states, "Unless limited by the establishing directive, the commander of the supported force will have the authority to exercise general direction of the supporting effort." The execution of general direction includes the designation and prioritization of targets or objectives, timing and duration of the

supporting action, and other instructions necessary for coordination and efficiency. The supporting commander is responsible for ascertaining the needs of the supported commander. The supporting commander must fulfill those needs from within the existing capabilities, priorities, and requirements of other assigned tasks. The categories of support are general, mutual, direct, and close.

General Support

General support provides designated support to an entire supported force and not to any particular subdivision. General support is the most centralized support relationship. For

combat units, this relationship provides the most flexibility for influencing the battle during conduct of operations and is used when the enemy situation is unclear. It is more commonly used in the defense than the offense.

Mutual Support

Mutual support describes actions that units provide one another against an enemy because of their assigned tasks, their positions relative to one another and to the enemy, and their inherent capabilities.

Direct Support

Direct support provides designated support to a specific force and authorizes the supported force to seek this support directly. The supporting force provides support on a priority basis to the supported force. Also, the supporting force may provide support to other forces when it does not jeopardize the mission or put the supported force at risk. The authority to accomplish support of other than directly supported forces rests with the higher tactical or operational commander but also may be delegated. An example of this support is when the elements of a general support artillery brigade assigned a direct support mission are diverted temporarily to support a force other than the designated force.

Close Support

The fourth alternative, *close support*, is that action of the supporting force against targets or objectives that are sufficiently near the supported force as to require detailed integration or coordination of the supporting action with the fire, movement, or other actions of the supported force.

OTHER AUTHORITIES

Other authorities granted outside the command relations delineated above are coordinating authority, ADCON, and DIRLAUTH.

Coordinating Authority

Coordinating authority is a consultation relationship between commanders, but not an authority to exercise control. The CINC and other subordinate commanders designate coordinating authority to assist during planning and preparation for actual operations. The CINC specifies coordinating authority to foster effective coordination; however, coordinating authority does not compel any agreements.

Administrative Control

ADCON is the direction or exercise of authority necessary to fulfill military department statutory responsibilities for administration and support. ADCON may be delegated to and exercised by service commanders at any echelon at or below the service component command. The secretaries of military departments are responsible for the administration and support of their forces assigned or attached to unified commands. The secretaries fulfill this responsibility by exercising ADCON through the service component commander of the unified command. ADCON is subject to the command authority of the combatant commander.

Direct Liaison Authorized

DIRLAUTH is the authority granted by a commander at any level to a subordinate commander to coordinate an action directly with a command or agency within or outside the command. DIRLAUTH is a coordination relationship, not a command relationship.

Section III

Joint Force Commands

The NCA, with the advice and assistance of the CJCS, establishes combatant commands (unified and specified) on a regional or functional basis. Regionally oriented unified commands are called theater combatant commands. The CINC, using the COCOM options, establishes the theater command structure. He may establish subordinate JFCs (subunified commands and JTFs). These subordinate JFCs may be established on a regional or functional basis.

COMBATANT COMMANDS

With the advice and assistance of the CJCS, the NCA establishes combatant commands (unified and specified) to perform military missions and prescribes the force structure of such commands. Commanders of combatant commands are responsible to the NCA for the preparedness of their commands to execute assigned missions and for the accomplishment of the military missions assigned to them.

SPECIFIED COMMANDS

A specified command is a command that has broad, continuing missions. The NCA, with advice and assistance of the CJCS, establishes a specified command. A specified command is composed normally of forces from a single military department. Still, it may include units and staffs from other services. Currently, no specified commands exist.

UNIFIED COMMANDS

Unified commands are those combatant commands with significant forces from two or more services. Unified commands may be functionally or regionally oriented.

Functionally Oriented (Global) Unified Commands

Functionally oriented unified commands are the US Space Command (SPACECOM), the US Transportation Command (TRANSCOM), the US Special Operations Command (SOCOM), and the US Strategic Command (STRATCOM). Functionally oriented unified

commands operate globally across all geographic regions. The *UCP* provides missions, geographical areas, and forces assigned to unified commands. The *UCP* is normally reviewed biennially during an odd year. Suggested changes are submitted for consideration. Those that receive support are subsequently implemented.

Regionally Oriented (Theater) Unified Commands

Unified commands with regional responsibilities are the US Atlantic Command (ACOM), the US Southern Command (SOUTHCOM), the US European Command (EUCOM), the US Central Command (CENTCOM), and the US Pacific Command (PACOM). Each regional combatant command has a specific geographic AOR or theater that includes the land, sea, and airspace in the strategic region. UCP-designated AORs provide military focus and a basis for coordination worldwide.

A theater combatant commander has the flexibility to organize and employ forces wherever required to accomplish his assigned responsibilities in coordination with other supporting combatant commanders. Effective use of the nation's military power requires close integration of the separate services. Unity of effort is required for effectiveness and efficiency. Centralized direction provides for unified action by forces. Decentralized execution is essential because of the enormity of the command and control (C²) span.

THEATER COMBATANT COMMANDS

The theater combatant commander, referred to as the CINC, is a strategic-level commander of a unified command, who provides strategic direction and operational focus to his subordinate commands. CINCs serve as the vital link between national military strategy and theater strategy. They provide the strategic and operational direction required for major unified and joint land, air, and maritime operations. The CINC is not simply a planner and allocator of resources; he has a broad range of responsibilities established by public law and described in joint publications.

The CINC organizes his forces, assigns tasks, designates objectives, provides authoritative direction, and employs his forces. He designs and executes theater campaigns and unified operations, supports the operations of other theater CINCs, and continually assesses the environment, anticipating the need for theater operations where his forces may play a supporting or supported role.

A CINC is assigned a myriad of responsibilities to fulfill his unique command role. Joint Pub 0-2 discusses the CINC's responsibilities at length. It specifies that the CINC is responsible for maintaining the security of his command and protecting the

interests of the US, its possessions, and its bases against direct and indirect hostile threats. The CINC ensures that his command is prepared to carry out missions assigned by the NCA. The CINC assigns responsibilities and missions to his component forces and maintains unity of command.

The CINC executes his strategic planning responsibilities for developing a theater strategy and theater campaigns (war plans to achieve national strategic objectives). He uses operational art and theater design while performing the following critical tasks:

- Prepares the estimates (strategic and commander's) of the situation.
- Establishes a theater strategic end state.
- Determines strategic center of gravity.
- States his strategic vision and intent in his strategic concept of operations.
- Organizes the theater.
- Identifies subordinate commands and determining specific forces required to execute campaign plans.
- Establishes command relationships and delegating authority.
- States readiness shortfalls and developing programs to correct those shortfalls.
- Concentrates his forces and supplies strategically.
- Conducts strategic maneuver to destroy, dislocate, or neutralize the strategic center of gravity.
- Seeks strategic advantage and the initiative.
- Directs the development of theater contingency plans and concept plans leading to the conduct of operations in war or MOOTW.
- Achieves a theater strategic end state.

The CINC's campaign plan provides a common frame of reference within which operations of land, air, maritime, special operations, and space forces, as well as interagency, multinational, or UN forces, are unified, integrated, and harmonized. Joint campaign doctrine is found in Joint Pubs 3-0, 5-0, 5-00.1.

The services provide forces to operate within a subordinate JFC in the operational

areas that the theater commander organizes. They further subdivide these areas among their forces. The SECDEF directs the Secretary of the Army to assign ARFOR to the CINCs. Operating within national budget constraints, the NCA cannot satisfy all of the CINC's requirements. Therefore, during deliberate planning, CINCs identify their force shortfalls. The CJCS, through the military department chiefs, identifies forces to fill these shortfalls. The JSCP apportions forces to each CINC for planning purposes. This apportionment may not equal the current forces assigned. The NCA assigns additional forces when a CINC is required to implement a specific plan requiring more forces than assigned or apportioned for planning.

The CINC, by exercising COCOM authority, performs the following legal functions of command over assigned forces:

- Determines forces required to achieve the military end state, organizes available forces, allocates resources, and commands forces.
- Employs commands and forces.
- Assigns tasks.
- Designates objectives.
- Exercises authoritative direction over all aspects of military operations, signal support, logistics, and joint training to accomplish missions assigned to his command.

Combatant commanders alone exercise COCOM authority by establishing command relationships with subordinates, delegating appropriate authorities, and assigning responsibilities to their subordinates (see Figure 2-4). The CINC strives for centralized direction and decentralized planning and execution. The CINC has the following six options, including combining options, through which he may exercise COCOM authority (Joint Pub 0-2):

- Service component command.
- Functional component command.
- Subordinate unified command.
- Joint task force.
- Single-service force.
- Direct command.

SERVICE COMPONENT COMMAND

A service component command consists of those individuals, units, detachments, organizations, and installations of a single military service assigned to the unified command. Except for the CINC and members of his joint staff, the senior officer of the service component assigned to a unified command and qualified for command by the regulations of that service is designated the *service component commander*. His assignment is subject to the concurrence of the CINC. The service component commander is responsible for all command aspects of his force, to include logistics within the unified command.

The ASCC serves as the principal advisor to the CINC for supporting and employing ARFOR in theater and ARFOR outside the theater tasked to support theater operations. The ASCC may delegate part of this

responsibility as the theater becomes more complex, and it may become necessary to establish an intermediate headquarters, based on the complexity of the operational environment. This alternative is discussed further in Section VI of this chapter.

FUNCTIONAL COMPONENT COMMAND

Based on his mission analysis, the CINC may form a functional component composed of like functional forces from more than one service. Functional component commands may be established for MOOTW or war to perform particular operational missions that may be of short duration or may extend over time and involve forces from two or more services. The

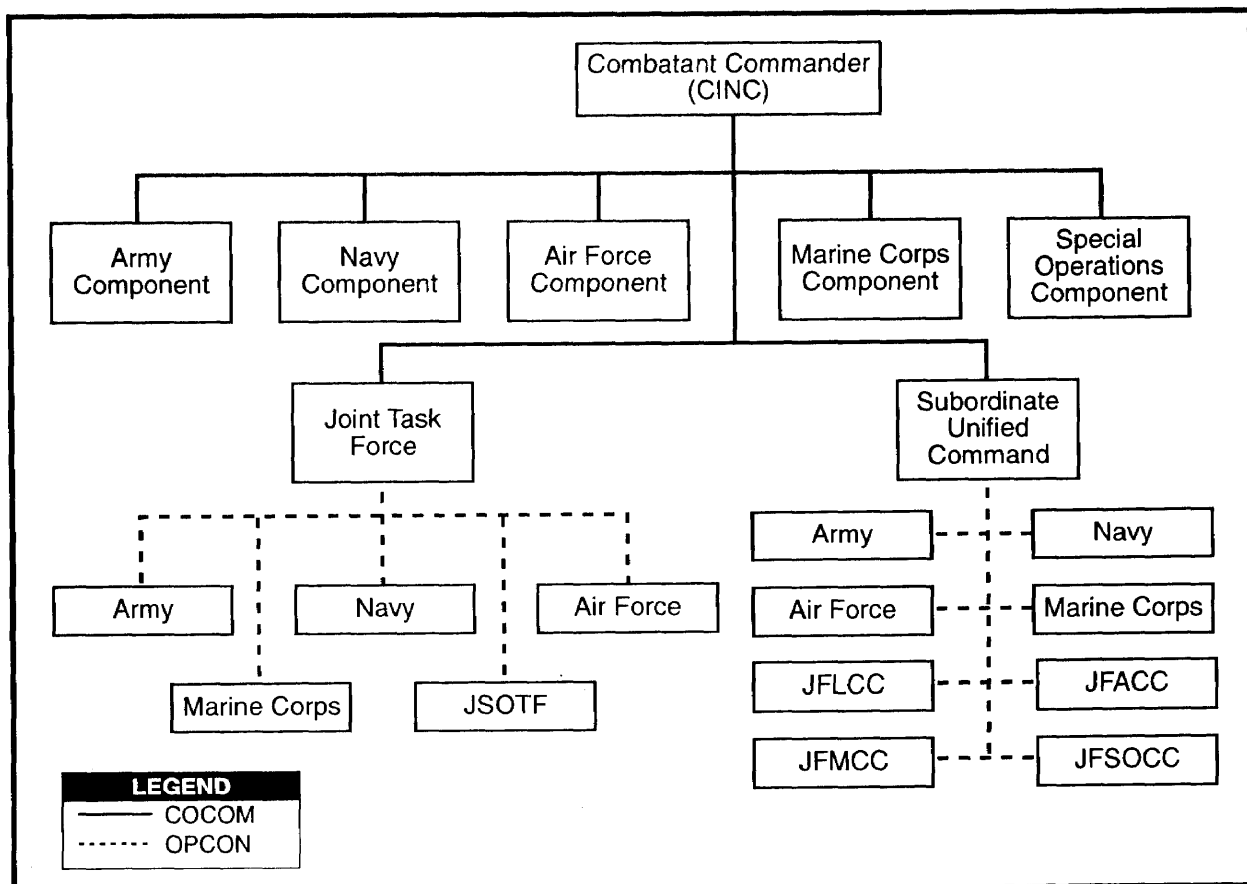

Figure 2- 4. Command Relationships

functional component commanders are as follows:

- Joint force land component commander (JFLCC).
- Joint force air component commander (JFACC).
- Joint force maritime component commander (JFMCC).
- Joint force special operations component commander (JFSOCC).

Each focuses on operational responsibilities, leaving logistical support to the respective service component commander. See Figure 2-5. Functional component commanders may serve simultaneously as service component commanders. For example, an Army JFLCC could direct Marine forces and serve as the ASCC commander.

SUBORDINATE UNIFIED COMMAND

Unified commanders, with approval from the NCA, may establish subordinate unified commands (also called *subunified commands*). CINCs establish subunified commands to conduct operations on a continuing basis according to the criteria that established the unified command.

The CINC may exercise COCOM through a subunified commander for operations on a continuing basis. The subunified commander exercises functions, authority, and responsibilities similar to those of a unified command CINC, except for COCOM. He exercises OPCON of assigned commands and forces within the assigned AOR or functional area. The CINC PACOM, for example, has three subordinate unified commands: Alaskan

Command (ALCOM), US Forces Japan (USFJ), and US Forces Korea (USFK).

The ASCC of subunified commands operates in the chain of command within the subordinate unified command. The ASCC of the subunified command normally communicates directly with the unified command ASCC on matters that relate specifically to that service and informs the subunified commander as that commander directs.

JOINT TASK FORCE

The SECDEF, a combatant commander, a subunified commander, a functional component commander, or an existing commander of a joint task force (CJTF) may establish a JTF. A JTF is established normally on a geographical area or functional basis to execute missions with specific limited objectives that do not require centralized control of joint logistics. A JTF is composed of elements of two or more services and exists until mission completion.

The CJTF exercises OPCON over forces assigned to the JTF. The unified command's ASCC places an ARFOR under OPCON of the CJTF for the conduct of operations and retains responsibility to provide service-specific support to the ARFOR. The JTF established in the Persian Gulf in 1988 to protect shipping and the JTF established in Panama in 1989 to conduct Operation Just Cause illustrate this type of organization.

SINGLE-SERVICE FORCE COMMAND

Normally, the Army will not be involved in this COCOM option due to its operational interdependence with the other services. Still,

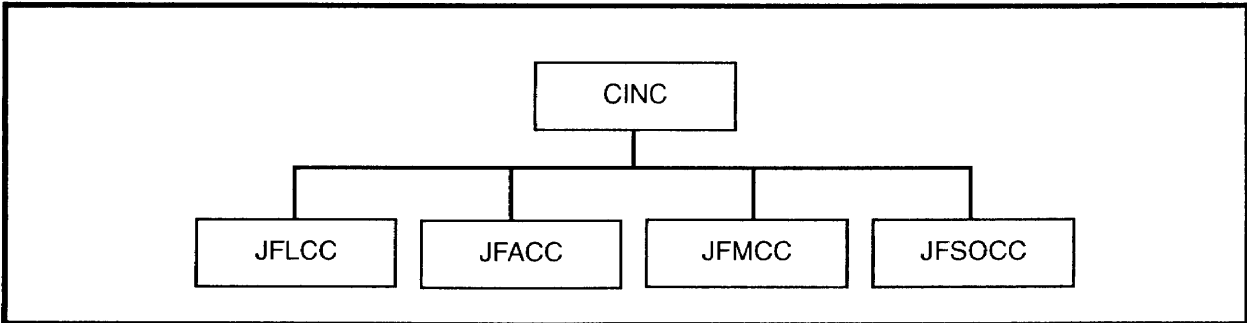

Figure 2-5. Functional Component Commands

on occasion, such as the support to Charleston, SC, by FORSCOM units in the aftermath of Hurricane Hugo, the Army may conduct a single-service operation.

DIRECT COMMAND

The CINC can retain direct command of specific operational forces. The direct command option is used when the circumstances of the

mission require urgency and the forces must remain immediately responsive to the CINC. Direct command of specific SOF is a prime example of this COCOM option. Such forces could be composed of forces from one or more services. This option would likely be employed for short, sensitive, and small-scale operations. Special operations often fall under this organizational option.

Section IV

Multinational Commands

Operations in a multinational environment have both similarities and differences to normal joint operations. This section highlights some of the differences found in a multinational environment. It details the differences between alliance and coalition operations. It discusses the need for mutual understanding and respect, for capitalizing on inherent operational strengths of a particular nation, and for obtaining unity of effort.

COMMAND STRUCTURE

Multinational operations can be categorized in one of two major groups: *coalitions* and *alliances*. Coalitions and alliances must create a structure that meets the needs, diplomatic realities, constraints, and objectives of the participating nations. Since no single command structure fits the needs of all alliances and coalitions, several different models could evolve.

COALITIONS

Coalitions normally form as a rapid response to unforeseen crises and are *ad hoc* arrangements between two or more nations for common action. During the early stages of such a contingency, nations rely upon their military command systems to control the activities of their forces. Therefore, the initial coalition arrangement will most likely involve a *parallel* command structure.

Under a parallel command, no single multinational army commander is designated. Usually, member nations retain control of their national forces. Coalition decisions are made through a coordinated effort among the participants. A coordination center can be

established to facilitate exchange of intelligence and operational information, ensure coordination of operations among coalition forces, and provide a forum for resolving routine issues among staff sections. During Operation Desert Storm, the coalition coordination, communications, and integration center (C³IC) was established to effect command relationships. Figure 2-6 depicts a parallel command.

As a coalition matures, the members may choose to centralize their efforts through establishing a *lead nation* command structure. A lead nation command is one of the less common command structures in an *ad hoc* coalition. A coalition of this makeup sees all coalition members subordinating their forces to a single partner, usually, the nation providing the preponderance of forces and resources. Still, subordinate national commands maintain national integrity. The lead nation command establishes integrated staff sections, with the composition determined by the coalition leadership. Figure 2-7 provides a model for a lead nation command structure in a coalition.

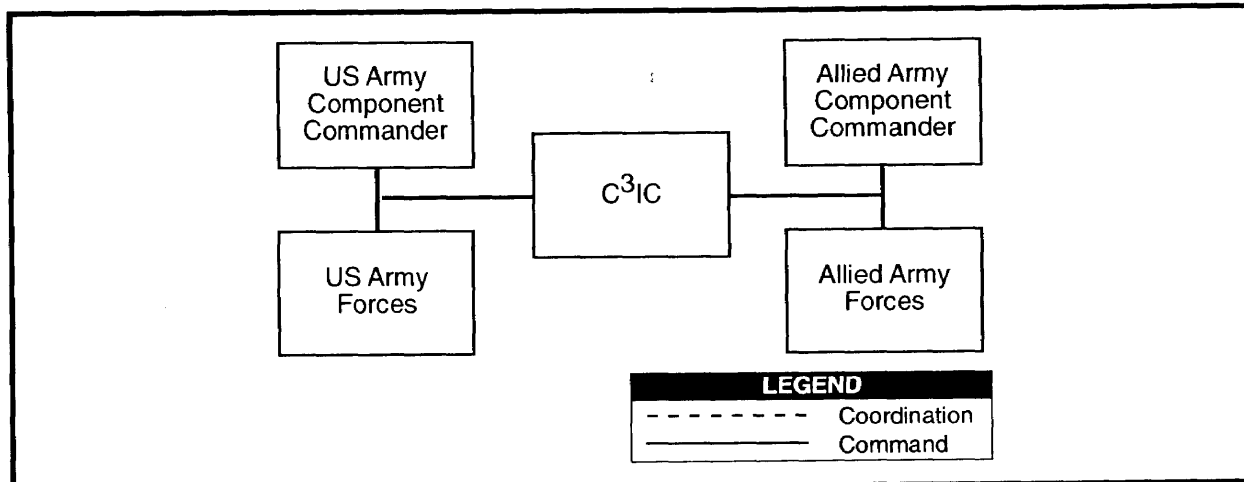

**Figure 2-6. Coalition Parallel Command Structure
(Forces Under National Control)**

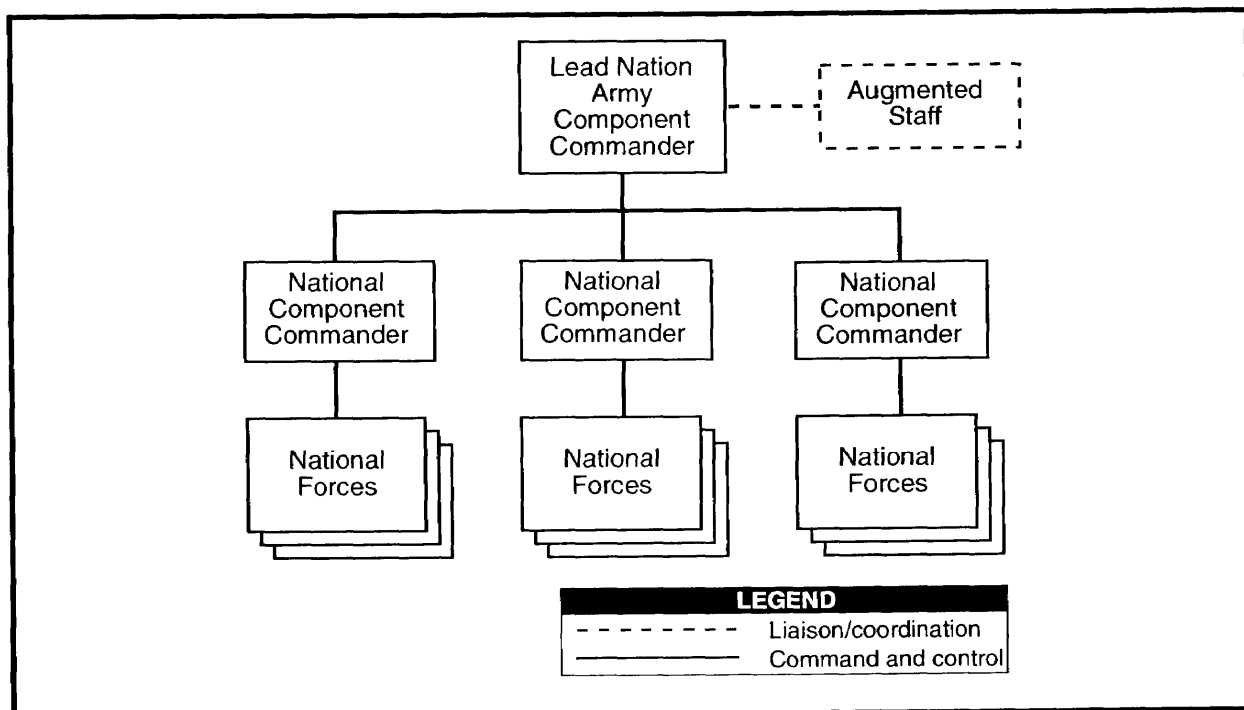

**Figure 2-7. Lead Nation Command Structure
(Augmented Staff and Multinational Subordinate Formations)**

ALLIANCES

Typically, alliances are formed because of formal agreements among two or more nations for broad, long-term objectives. Alliances are characterized by years of cooperation among nations. In alliances—

- Agreed-upon objectives exist.
- Standard operating procedures have been established.

- Appropriate plans have been developed and exercised among participants.
- A developed theater of operations exists, some equipment interoperability exists, and command relationships have been firmly established.

Cooperation among members of an alliance, such as NATO, is advantageous, since mutually developed procedures for making and executing decisions exist. Often, when members of such an alliance cooperate in operations outside of their alliance sphere, such as in naval operations in the Persian Gulf, procedures worked out within the alliance are adapted quickly.

As in a coalition, a *lead nation* command structure may exist in a developing alliance when all member nations place their forces under the control of one nation. This means that the lead nation's procedures and doctrine form the basis for planning for and coordinating the conduct of operations. Though this type of arrangement is unusual in a formal alliance, such a command structure may have advantages under certain treaty circumstances existing with Latin America, Southwest Asia, or Japan that may evolve into alliance arrangements.

A lead nation command in an alliance may be characterized by a staff that is integrated to the degree necessary to ensure cooperation among multinational or national subordinate Army formations. Usually, alliances are organized under an *integrated* command structure that provides unity of command in a multinational setting. The key ingredients in an integrated alliance command are that a single commander will be designated, that his staff will be composed of representatives from all member nations, and that subordinate commands and staffs will be integrated to the lowest echelon necessary to accomplish the missions. Figure 2-8 represents a typical multinational army force organized under an integrated command structure in an alliance.

If multinational formations exist below the multinational army component headquarters, the alliance membership will determine the command of those subordinate organizations. Multinational army force headquarters staffs will be integrated. Accordingly, heavy reliance will be placed on liaison between forces.

COMMAND AND CONTROL

International agreements should set forth the degree of authority for multinational

commanders and procedures that ensure unity of effort. Ideally, the coalition/alliance will

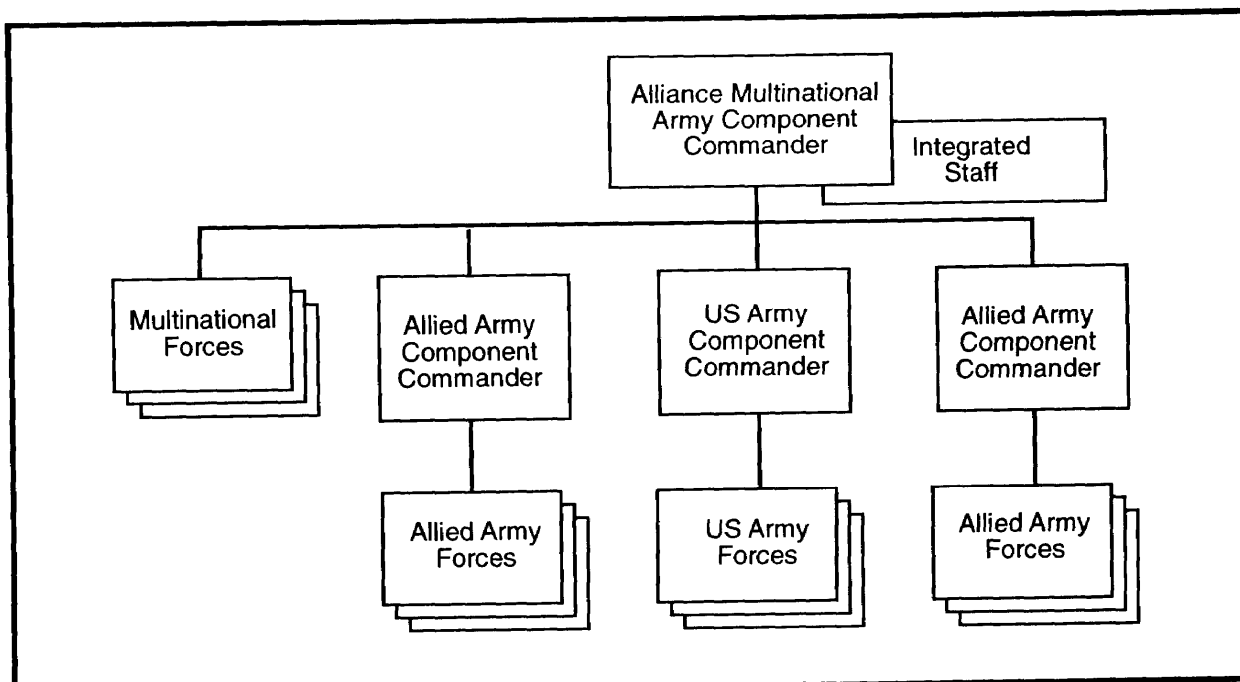

Figure 2-8. Alliance Multinational Army Command Structure (National Subordinate Formations)

designate a single military commander to direct the combined efforts of the participating forces. The US contingent of a multinational command may be a unified command, a specified command, a subordinate unified command, a functional component command, a JTF, or a force of a single service.

A common understanding of C² relationships facilitates the required unity of effort. The US chain of command, from the President to the lowest US commander in the field, remains inviolate. US forces in a multinational force will continue to recognize their COCOM relationship to a US unified or specified commander. Subject to NCA prior approval, a multinational force commander may exercise appropriate and negotiated OPCON over US units in specific operations authorized by a legitimizing authority such as the UN Security Council.

The multinational force commander and the US theater CINC providing the US forces to the multinational force must coordinate and agree to the command relationships. This agreement must be in consonance with the NCA criteria for C² within multinational operations, which may establish limits of

OPCON. For example, within these limits, a foreign UN commander cannot—

- Change the mission or deploy US forces outside the AOR agreed to by the NCA.
- Separate units.
- Redirect logistics and supplies.
- Administer discipline.
- Promote individuals.
- Change the internal organization of the US units.

Other national forces will likely remain aligned to their national command authority.

International agreements will specify when and how the transfer of authority from national command to multinational command takes place. At lower echelons, command relationships will be identical to US joint relationships (OPCON, TACON, support, coordinating authority) or at least similar (OPCOM, tactical command [TACOM]). Definitions of these terms differ slightly between US and NATO. Commanders of operating forces must clarify how each is applied. FM 100-8 describes the doctrine for multinational army operations.

Section V

Theater Organizations

A theater is an assigned geographic area outside CONUS and under the command of a regional combatant commander (unified command) (Joint Pub 0-2). Under the *UCP*, a theater or AOR is viewed from the strategic context, the level of international military cooperation required, or the degree of dedicated US military resources necessary in the theater. These perspectives influence how the Army conducts operations in each theater.

TYPES OF THEATERS

Military strategists often describe theaters as maritime, continental, or littoral, based on their dominant geographic and strategic characteristics. This description influences the predominant type of military forces used, the strategic missions assigned, and the strategic and operational objectives pursued in the theater.

Continental theaters primarily involve control of land and associated airspace. Maritime theaters focus on ensuring control of the seas and associated airspace. While

continental and maritime theaters are different, both demand the synchronized efforts of all services, both within and between theaters. Littoral theaters combine aspects of both continental and maritime theaters.

CONTINENTAL THEATERS

Continental theaters are established to control the land and associated airspace vital to the sustenance of a nation or nations or to destroy an opponent's means to exercise such control. EUCOM, CENTCOM, and SOUTHCOM are

Chapter 2

continental theaters. Military action in continental theaters may vary in purpose and scope from participation in the internal defense of another nation against subversion, lawlessness, and insurgency to major operations and campaigns to destroy enemy land forces. The focus of continental campaigns is on the combination and sequencing of air, space, land, sea, and SOF operations.

MARITIME THEATERS

Maritime theaters are established both for the forward defense of the nation and for strategic access to US resource needs, friends, and potential adversaries. ACOM and PACOM are maritime theaters. The focus of maritime campaigns is very similar to that of continental campaigns. Campaigns in maritime theaters may be composed of one or more of the following types of operations:

- Fleet operations to seize or maintain unobstructed access to ocean areas by destroying or blocking enemy forces.
- Joint operations to control key land areas.

ALLOCATION OF RESOURCES AMONG THEATERS

When considering the requirements of the many active theaters, national planners establish the priorities by providing planning guidance, allocating forces, and apportioning limited resources. Theaters are described as *theaters of focus*, *economy-of-force theaters*, or *deferred theaters*. This description corresponds to the relative prioritization of resources for the specific theaters.

THEATER OF FOCUS

A theater of focus is the theater of main military effort because it has the highest risk level and potential for conflict. NCA and CJCS provide guidance, forces, and resources accordingly. CENTCOM was the theater of focus during Operations Desert Shield/Storm.

INTERNAL THEATER ORGANIZATION

Theater combatant commanders develop a theater strategy and then organize the theater. Considerations for multinational operations should always be prominent as the

- Limited operations with limited objectives such as peacekeeping or nation assistance.

LITTORAL THEATERS

Operations in a littoral region require integration and synchronization of naval, air, and land forces. World political changes and affordability have reduced US access to land bases in forward areas near the most likely crisis regions. This has increased the importance of military operations that can capitalize on sea bases and land lodgments that, once synchronized, project land and air combat power deep into the region. Littoral theaters are not as predominant as the other two theaters but have been seen in previous campaigns along peninsulas or coastlines.

The deployment of US forces to Southwest Asia during Operation Desert Shield in 1990 was accomplished for the most part by sealift. However, maritime support and the maritime interdiction operations required synchronization forces operating within the CENTCOM continental theater, thus forming a littoral region.

ECONOMY-OF-FORCE THEATER

An economy-of-force theater receives a lesser level of forces and resources than the theater of focus because the associated risk and potential for conflict are lower. SOUTHCOM during the early 1980s illustrates this type of theater. Forces and resource requests are filled after those of the theater of focus. Those that cannot be filled are then identified and tagged for filling when the economy-of-force theater is upgraded to a theater of focus.

DEFERRED THEATER

A deferred theater receives the least priority for assigned forces and resources, based on its associated risk level and potential for conflict. CENTCOM during the early 1980s was an example of a deferred theater. Forces and resources are identified and tagged for deployment but not deployed other than during exercises.

commander considers his theater structure and command relationships. The Army, besides operating as part of a joint force, must be prepared to conduct multinational

OPTIONS FOR CONDUCT OF WAR

operations with land, air, and naval forces of other nations, as well as interagency operations. While unity of command may not be possible in multinational operations, unity of effort is essential.

Each CINC may assign associated areas within his theater to subordinate commanders. CINCs may designate joint areas or zones during war and MOOTW, while theaters of war and operations are designated only in time of war. Combat zones (CZs) and communications zones (COMMZs) may be established as needed. The CZ is an area required by forces to conduct combat operations. The COMMZ contains LOCs and those theater organizations and other agencies required to support forces in the field. The CINC organizes his theater to enable him to synchronize his unified operations or integrate single-service, joint, special, and supporting operations with allied and interagency activities and NGOs and PVOs.

In war, the CINC may use many of the structures identified above or others as required to subdivide the theater. When the NCA authorizes combat operations, the theater commander, with NCA and CJCS approval, delineates a *theater of war*.

Theater of War

A theater of war is defined as the air, land, sea, and space area which is or may become directly involved in the operations of war. Operations within a theater of war are invariably joint and usually multinational. The theater of war should be operationally self-sufficient, with a sustaining base adequate to support contemplated operations. The theater of war should encompass only that part of the areas or countries to be involved in the war. While part of the theater is in a state of war, it may be possible that all nations within the theater are not at war. See Figure 2-9.

Theater of Operation

If the CINC determines that he should subdivide his theater of war to contend with

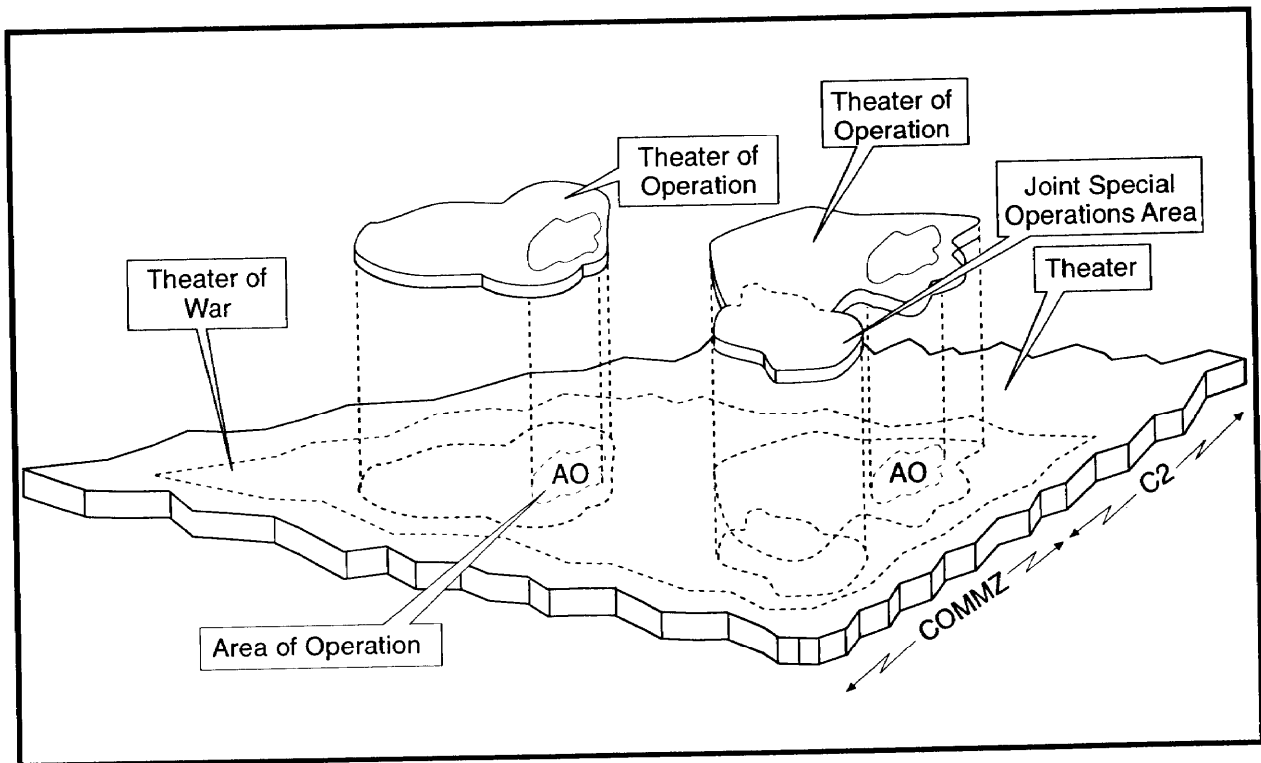

Figure 2-9. Theater Organization During War

more than one major threat, he may designate subordinate theaters or AOs for each major threat. Still, the theater commander must ensure that such divisions do not violate the principle of unity of effort. The theaters of operation refer to that portion of an area of war necessary for military operations and for the administration of such operations for extended periods. The theater of operations commander often has responsibilities similar to the theater CINC, but not of the same scope. During World War II, the Atlantic, European, Mediterranean, and Russian theater of strategic direction was divided into four similar subordinate theaters of operation. These theaters of operation were integrated geographically and focused upon enemy Axis forces.

The range of military operations also may require designating several geographic *subareas of responsibility* such as a joint operations area (JOA) or joint zone (JZ), a joint special operations area (JSOA), or a joint rear area (JRA). A subordinate theater also could be used in a larger theater for decentralizing the effort to a subunified commander. Subareas of responsibility are portions of a theater CINC's AOR and are delegated usually for a long term and often over large areas. See Figure 2-10.

Joint Operations Area

JOAs are geographic areas the CINC creates to conduct specific military missions and their supporting activities. JOAs are usually established for short-term operations. JOAs are particularly useful when operations are to be conducted on the boundaries between theaters. The JOA commander's authority is limited to that required to accomplish specific tasks. US operations in Panama during Operation Just Cause in 1989 offer an example of a JOA.

Joint Zone

A joint zone is a term for an area established to permit friendly surface, air, and subsurface forces to operate simultaneously. ARFOR transit but do not normally operate in a JZ.

Joint Special Operations Area

JSOAs are restricted areas of land, sea, and airspace that the CINC assigns to a JFSOCC to conduct special operations. JSOAs may be established for short or long duration special operations efforts, normally when they are independent of conventional operations. If conventional operations in the JSOA are required, coordination with forces operating

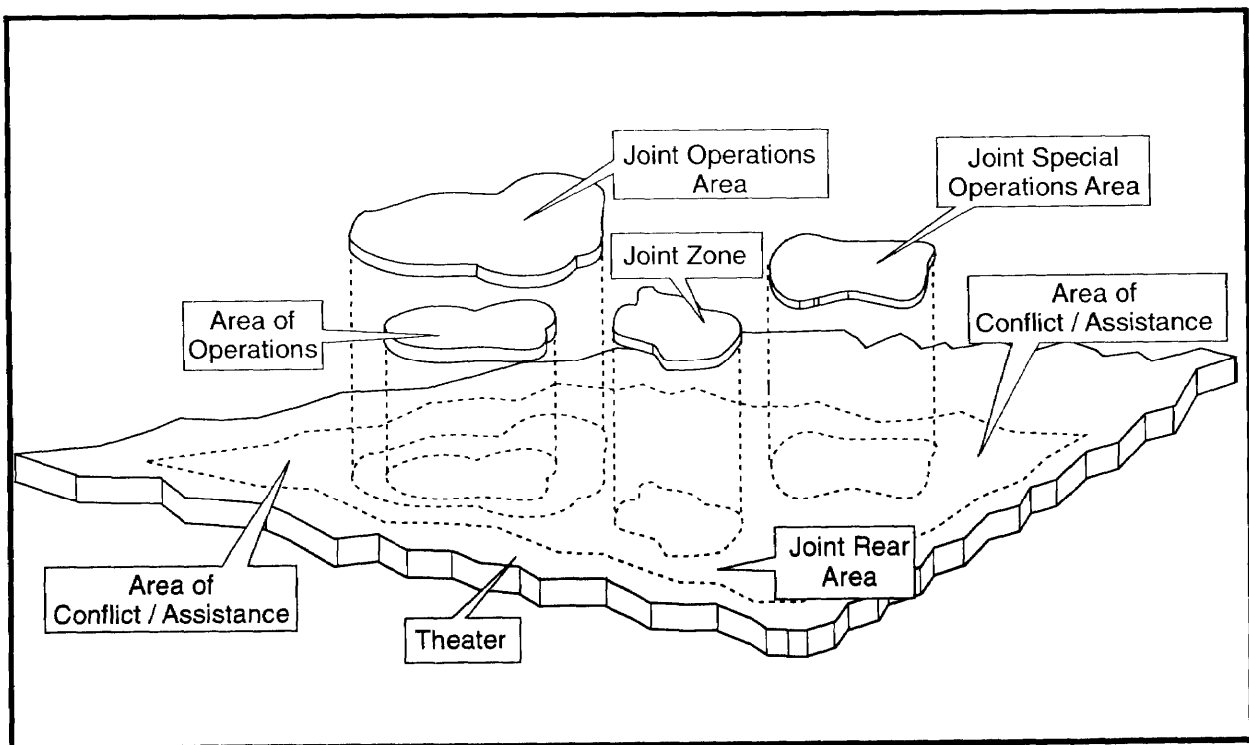

Figure 2-10. Theater Organization for Military Operations Other Than War

within the JSOA must be effected prior to initiation of operations. The CINC may delineate a JSOA to facilitate simultaneous conventional and special operations in the same general operating area. The capture of the hijacking terrorists of the *Achilles Lauro* in the Mediterranean in 1987 was in a JSOA.

Joint Rear Area

In war, as in peacetime and conflict, the CINC may designate a JRA. The JRA is designated to facilitate protection and operation of installations and forces that provide logistics and/or support to combat operations. The joint rear area coordinator (JRAC) is the officer given responsibility for the overall security of the JRA and for furnishing a secure environment to facilitate sustainment, host nation support (HNS), infrastructure development, and movements of the joint force.

The size of the JRA may vary considerably and is highly dependent on the size of the theater, logistics support requirements, the threat, or the scope of the joint operation. The JRA is usually to the rear of the theater or CZ, but it is not necessarily contiguous to the CZ. With split-based operations, much of the JRA could be in CONUS. A JRA can also be adapted to a modern, high-intensity, nonlinear battlefield. A JRA may be segmented and contain isolated pockets of relatively secure support areas that collectively make up a JRA.

Combat Zone, Communications Zone, and Theater Base

The CINC may additionally organize his theater of war into a CZ, a COMMZ, and a theater base. The CZ is that area required by combat forces to conduct operations. CINC's may further subdivide the CZ into forward and rear combat zones. They are normally forward of the Army rear boundary.

The COMMZ contains those theater organizations, LOCs, and other agencies in the JRA required to support forces in the field. Usually, the COMMZ is in the rear portion of the theater of operations, reaching back to the CONUS base or perhaps to another combatant commander's AOR. The theater CINC may establish these areas for long-term, continuing requirements or for short durations to meet a specific situation.

The theater base is a sizable portion of the JRA. It has logistics facilities such as ports of debarkation, marshaling areas, logistics

stockage areas, movement control points, logistics headquarters and units, the rear portion of the intratheater communications zone, airfields and air bases, transitioning land forces, theater missile defense forces, the theater rear headquarters, and strategic reserves. See Figure 2-11.

Subordinate Areas of Operations

Subordinate army commanders organize their assigned AOs for tactical operations. This organization is based on terrain orientation, security orientation, or a threat orientation. Subordinate army commanders establish necessary control measures to delineate responsibilities for zones of action or sectors of defense to coordinate fires and direct maneuver. These measures may include lateral boundaries, axes, objectives, phase lines, and special areas, for example, airspace control area or air defense area. If the enemy situation is known, a threat orientation is more appropriate. Accordingly, the subordinate army commanders would organize their AOs to accommodate all of the air, land, and sea forces necessary to impose their tactical battle space to defeat the enemy. For example, the main battle area (MBA) is the portion of the battlefield in which the decisive battle is fought to defeat the enemy. Only those control measures necessary for operations against the enemy should be imposed upon subordinate commanders, minimizing the use of lateral boundaries except where necessary to separate friendly forces or provide flank and rear security against an enemy situation.

OPTIONS FOR CONDUCT OF MILITARY OPERATIONS OTHER THAN WAR

The theater of war does not normally encompass the CINC's entire theater. In the remainder of his theater, the CINC may be conducting MOOTW. CINC's designate a theater structure that achieves strategic and theater focus in both MOOTW and war. This structure allows synchronization and integration of all instruments of power within the theater. At times, this synchronization requirement may extend to UN operations.

If hostilities are imminent, the CINC may designate an *area of conflict*— an area of land, sea, and air designated for the conduct of hostile MOOTW. However, if an MOOTW is required that does not include response to hostilities, such as a natural disaster or humanitarian

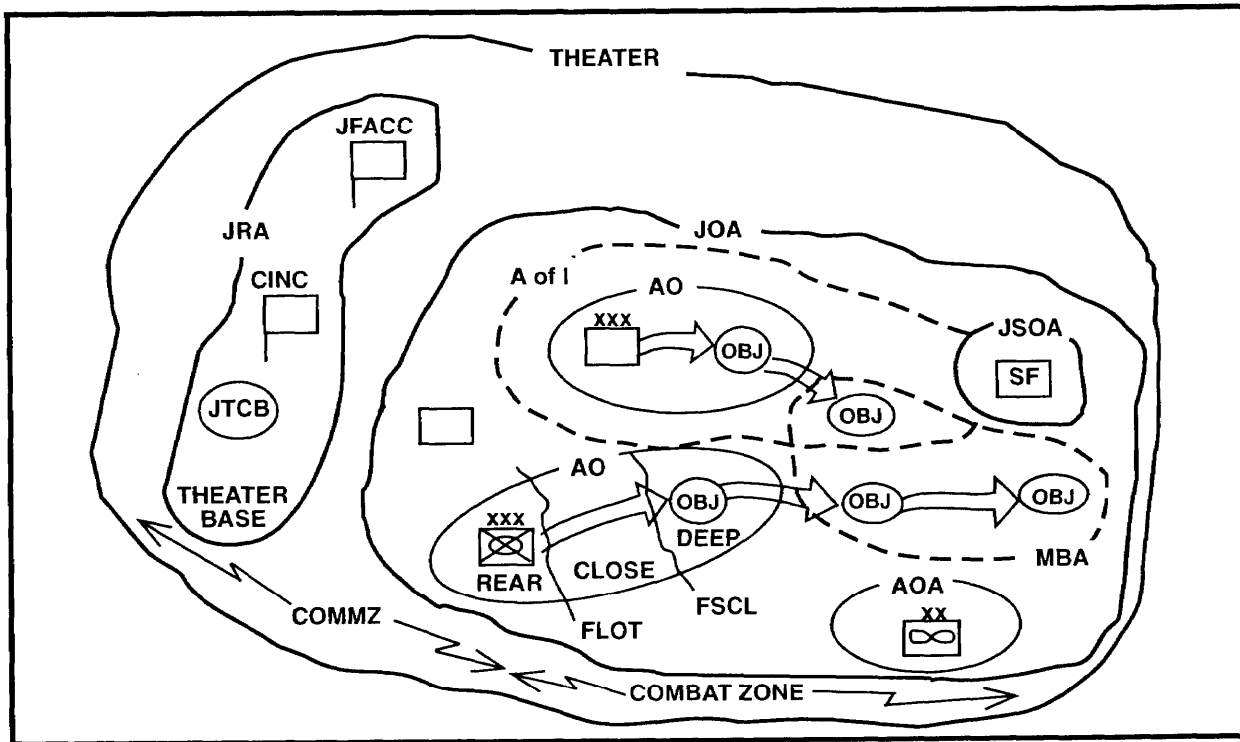

Figure 2-11. Combat Zone and Communications Zone Organization

assistance, the CINC may establish an *area of assistance* within his theater. The area of conflict or area of assistance may be further subdivided into several geographic subareas of

responsibility such as a JOA, JSOA, AO, or COMMZ or JRA. Establishment of these subareas is to provide the same functions and control measures as required for conducting wartime operations. See Figure 2-10.

Section VI

The Army in Theater

This section discusses the three tasks of the operational-level commander and how they influence theater organization, the environment, and the echelons of command within the Army. It discusses the ASCC and the Army commander as a subordinate JFC. Senior army leaders, using an operational-level perspective, task-organize the Army to maximize its capabilities in the theater. The Army's theater organization provides the means to execute the designs of operational art while facilitating joint operations.

ARMY OPERATIONAL-LEVEL COMMANDER

The ASCC supports the theater combatant CINC by conducting Army operations to support or attain the CINC's established objectives. The Army contributes forces to perform combat, logistics, and support activities in theater. The Army organizes,

trains, and equips these land forces to accomplish all assigned missions.

Unified C² results in assigning forces for employment, apportioning forces for planning, and allocating them for execution to combatant

commanders. In support of the CINC, the ASCC organizes the assigned forces to accomplish the three operational-level tasks of the senior army commander:

- Establishing the link among joint, multinational, interagency, NGO, PVO, or UN operations.
- Executing functions to support continuous operations by subordinate army forces.
- Planning and executing operations to support the joint campaign when designated as an operational commander by the CINC.

Other subordinate army commanders may perform the tasks; still, they remain the responsibility of the ASCC.

ESTABLISH JOINT, MULTINATIONAL, NGO, PVO, AND INTERAGENCY LINKAGE

The first task of the senior army commander in theater is to establish linkages to joint, multinational, and interagency organizations. These linkages include—

- Receiving joint, multinational, and interagency or UN direction.
- Advising the CINC on Army capabilities.
- Establishing liaison with joint, multinational, and interagency organizations and NGOs and PVOs.
- Augmenting the joint, multinational, and interagency staff as required.
- Linking with specific joint, multinational, NGO, PVO, and interagency systems.
- Coordinating intelligence collection, analysis, and dissemination.

The commander's guidance includes the subordinate commander's missions and tasks that are expected to contribute to the higher echelon's plan. The guidance should include the assignment of forces and sequencing of subordinates' assigned mission and tasks. The guidance will include any delegated authority, other information pertinent to the situation, and any changes that modify subordinate missions and tasks.

The ASCC of the unified or subunified command or the ARFOR commander of the JTF advises the CINC or CJTF, respectively, on employment of US Army organizations and their capabilities. The ASCC must ensure that

his subordinate commanders and staffs are trained, agile, and versatile to meet this requirement. The CINC looks to his ASCC for the nomination and selection of specifically Army-apportioned or assigned units for assignment to subordinate joint commands.

The Army conducts liaison with joint, multinational, NGO, PVO, and interagency organizations in theater. This liaison includes lateral liaison with other services, as well as higher and lower liaison with the appropriate joint or multinational force staff and any subordinate joint or multinational organizations as required. The ASCC must understand the capabilities that the other services bring to the theater. Such understanding enhances the opportunity for synergy within the joint force.

Similar to the exchange of liaison teams is the requirement of ARFOR to augment a joint force staff or receive augmentation from joint forces when the Army forms the core of a joint staff headquarters. The ASCC must interface with joint information and control systems such as intelligence and communications. These systems require specific hardware that may be unique to the joint force headquarters and may require special Army efforts for effective joint coordination.

Army intelligence elements closely coordinate with joint, multinational, and interagency organizations to establish the mutual supporting intelligence structure required to support the joint commander's operations. The intelligence structure should assign collection capabilities consistent with available assets, conduct timely all-source analysis, and provide rapid dissemination of available intelligence information.

CONDUCT SUPPORT OPERATIONS

The second task of the ASCC in theater is to execute his Title 10 responsibility by supporting operations. At theater level, the preponderance of operational considerations are logistical but may include significant engineer efforts, depending upon existing infrastructure. In the force-projection mode, decisions made early will be highly significant as the time for combat operations approaches. Decisions such as the sequencing of arriving forces and equipment will often not be reversible.

The answers to such questions as what is needed first—construction engineers or infantrymen, tanks or trucks—may sow the seeds of success or failure. The commander and his staff should analyze these kinds of questions, being careful not to eliminate any option before the need for such a decision is clear.

These analyses require a full assessment of the factors of METT-T and an understanding of where and how risks are taken. Army commanders retain responsibilities to support Army units through the service chain of command, regardless of the joint and multinational arrangements. The ground transportation system, common classes of supply, and construction of the infrastructure are examples of the Army's contribution to the overall theater effort.

Each joint or multinational organization with Army forces has an ARFOR commander

ARMY SERVICE COMPONENT COMMANDER

Each unified and subordinate unified command has an Army service component command. The CINC's Army service component command consists of the ASCC and all those elements under his command. The ASCC is responsible for—

- Recommending to the CINC or subunified commander the proper employment of Army component forces.
- Accomplishing assigned operational missions.
- Selecting and nominating specific units of the Army for assignment to theater forces.
- Conducting joint training, including training other service components as directed.
- Informing the CINC of Army logistics support effects on operational capabilities.
- Supporting operational and exercise plans as requested.
- Developing Army program and budget requests for the CINC.
- Informing the CINC of program and budget decisions that may affect planning and operations.
- Conducting Army-specific functions such as internal administration and discipline,

who ensures Army support requirements are met. These support requirements, which include logistics, personnel services, and health services, are service-specific and flow through the service chain of command. Support functions at the operational level are addressed in FM 100-16, FM 100-10, and FM 63-4.

CONDUCT OPERATIONS

The third task of the ASCC in theater is to conduct operations. When designated by the CINC as an operational-level commander, the senior army commander, in this role, serves in the chain of command, planning and executing major operations that support the joint campaign. He designates, sustains, and shifts the main effort of subordinate ground forces to support the joint or multinational plan. His understanding of *operational art* (see Chapter 3) is essential to his performance of this role.

training, normal logistics functions, and Army intelligence matters.

- Informing the CINC of joint nonstrategic nuclear support required by the Army.
- Ensuring signal interoperability.
- Providing logistical and administrative support to the ARFOR participating in a JTF.

SUPPORT

The Army service chain expects the ASCC to monitor and support all ARFOR in its geographic area. The ASCC, exercising ADCON, may communicate through the Army Chief of Staff to the Secretary of the Army for service-specific matters. The ASCC is responsible for command logistical support unless a higher command directs otherwise.

Sometimes, the CINC may direct the ASCC to provide common items to other services within his AOR. Additionally, the ASCC may support allied or coalition forces. Army commanders in joint organizations use the channel from the ASCC to the Department of the Army for service-specific requirements. This channel forms a hierarchy for Army support in theater but does not imply a superior-subordinate relationship. Army elements within subordinate joint

organizations perform functions similar to the ASCC. An illustration of this concept is the organization of the service channel in PACOM with a notional JTF (Figure 2-12).

In Figure 2-12, the ARFOR within the notional JTF coordinate logistics through US Army, Japan (USAR-J). USAR-J is the Army service component command of USFJ, a subunified command. USAR-J is responsible for coordinating support services through US Army, Pacific (USARPAC). Within PACOM, a unified command, USARPAC is the Army service component command and coordinates directly with the Department of the Army. The purpose of the service channel is the efficient use of Army resources within a theater. The JTF establishing authority's Army service component command is responsible for providing logistical and administrative support to ARFOR participating in a JTF.

COMMAND AND CONTROL

During conditions of peacetime, each regional CINC has an Army service component command through which he normally exercises COCOM of ARFOR assigned by the NCA to the CINC. In conflict and war, the CINC may transfer OPCON to the designated

headquarters. The organizational design of a headquarters to support C² tasks of the Army service component command, the JTF, the operational-level headquarters (numbered army), and corps must be versatile, agile, flexible, and modular in structure. Such a design provides the Army service component command the flexibility to establish the required C² capability, using assigned assets or preestablished functional and modular augmentation packages from other component forces or other Army assets.

The ASCC must determine the degree of participation within the AOR required by ARFOR. That participation can range from Army contributions to a JTF, to total involvement of the Army component in theater, to reinforcements from CONUS or other theaters. The assessment of the operational environment will determine how the Army organizes within the AOR.

The first option is for the ASCC to provide an operational-level C² capability. The Army contribution to a subunified command is an example of this option. This subunified command's ASCC has responsibilities within the designated AO similar to those of the unified commands ASCC. The deployment of

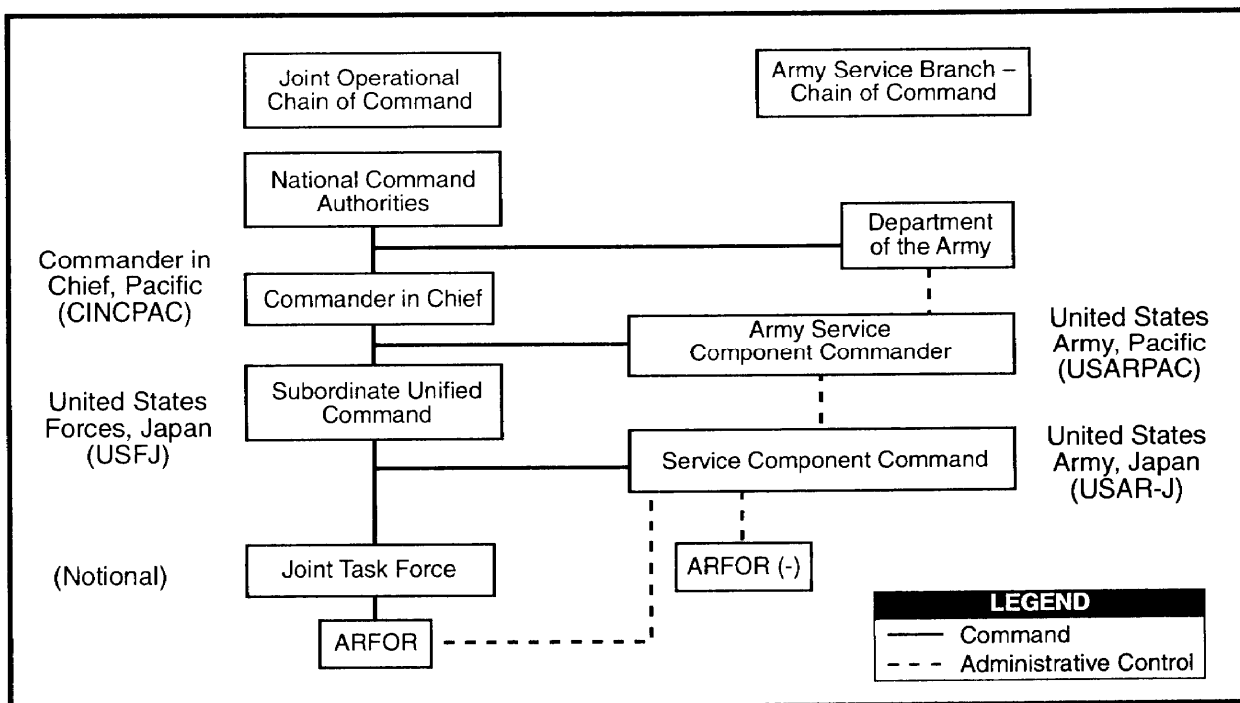

Figure 2-12. ASCC Support to ARFOR in a JTF

Army units to operate within a JTF requires the ASCC to establish an ARFOR operational-level headquarters to command and control those units. This headquarters may require augmentation from the ARFOR not assigned to the CINC or from other services. Another alternative is to augment the JTF headquarters. The complexity of the environment and the degree of Army participation determines the option selected.

A second option is the formation and deployment of an operational-level headquarters (for example, a numbered army) to control the conduct of operations. The ASCC makes this decision in consultation with the CINC. This presupposes a highly complex operational environment with the involvement of multiple ARFOR (usually more than one Army corps). The ASCC remains the senior army commander within the unified command and may or may not be physically located within the AO. If the ASCC is not located in the AO and does not deploy, he may constitute and deploy a requisite headquarters to perform C² for the ASCC's Title 10 support responsibilities therein. This requisite headquarters would be in addition to the operational-level headquarters conducting operations.

The first two options require coordination with the CINC. The third option is internal to the ASCC and concerns the organization of the Army operational-level component. The ASCC may determine a need to consolidate functions under a deputy commanding general responsible for operations and a deputy commanding general responsible for support and logistics. The DCG for Support would serve as the senior logistician responsible for battle command of all logistics and support forces and coordination of all logistics support. If designated as the executive agent, the DCG for Support would also be responsible for coordinating logistics support for joint and/or

multinational forces in the theater of operations.

The DCG for Operations would serve as the senior operator responsible for battle command of all maneuver forces, conducting major operations, battles, and engagements. In this arrangement, the ASCC would continue his service responsibilities and establish required linkages among joint, multinational, interagency, NGO, PVO, or UN. This option reduces the span of control required of the commander. As with the first option, complexity of the environment determines the selection of this organizational alternative.

These options provide an orderly means for the Army to accomplish the operational-level responsibilities in theater. The options also provide a means to evolve the Army theater structure as the complexity of the theater evolves.

Another set of circumstances in which the Army could be divided into separate elements is when the CINC requires a sense of urgency and direct responsiveness of an Army force to him. Under such exceptional circumstances, the theater organization may have two or more independent ARFOR operating directly under the theater CINC. These separate ARFOR would focus on specific missions, as determined by the CINC and ASCC. The ASCC continues to focus on the task of supporting the operations of all ARFOR within the theater. However, commanders of the ARFOR under COCOM (working directly for the CINC) focus primarily on operations and the establishment and maintenance of joint and multinational linkages. *Thus, the three tasks of the operational-level commander would be conducted by both Army commanders.* The structure of the ASCC is adaptable enough to meet the three crucial tasks in any theater situation. The ASCC's responsibility is to advise the CINC of a structure that meets the dictates of operational design.

Both the ASCC and numbered army commanders would be responsible for establishing linkages with joint, multinational, government, nongovernment, private voluntary, and interagency organizations. However, the ASCC would focus on support operations, and the numbered army commander would focus on the conduct of operations and the requirements of a joint force land component, if designated by the CINC.

ARMY COMMANDER AS A SUBORDINATE JOINT FORCE COMMANDER

The CINC may designate an ARFOR commander as a subordinate JFC. The designation may be as a subunified commander, a JFLCC, or a CJTF. Based on the ASCC structure, the Army JFC must reexamine his responsibilities and capabilities to perform the three tasks of the operational-level commander. Establishing a joint headquarters under these circumstances will be a unique extension of the joint linkage task.

As a JFLCC, the ARFOR commander retains the responsibility, through the service branch of the chain of command, to support subordinate Army forces. Because of the complexity of the two tasks—operations and support—the ASCC may delegate the authority for performing the support task to a subordinate Army headquarters. The ASCC,

when delegating this responsibility, must ensure his subordinate commander is aware and understands the CINC's intent and concept of operations. This delegation allows the ASCC, as the JFLCC, to focus on conducting operations.

As a subunified or CJTF, the ARFOR commander would normally expect to focus on the conduct of joint operations. Support of the ARFOR under control of the subunified command or JTF will flow through the CINC's ASCC. Depending on the method in which the CINC employs the Army component, the ASCC may appoint a single subordinate commander responsible for executing typical logistics and administrative functions. Chapter 6 has details on Army component operations.

OPERATIONAL-LEVEL ENVIRONMENT

The requirement to assess the environment in which operations are to be conducted exists at the strategic, operational, and tactical levels. The factors of METT-T provide a structure for the conduct of those analyses. In preparing and conducting major operations to support joint campaigns, the ARFOR commander and the CJTF must examine the operational environment, using the factors of METT-T and a regional analysis. The results of that examination serve as a means for assessing relative strengths and weaknesses of the theater and are used to guide and temper actions.

The ARFOR commander and the CJTF view the operational-level environment in much the same manner as the CINC views the larger theater strategic environment. Both commanders consider the factors peculiar to the area in which they will operate. The environment is determined by the circumstances, influences, and conditions that affect the employment of military force and the decisions of the operational levels of command.

The assessment of the strategic environment is based upon the circumstances, conditions, and influences of the theater. The operational environment within that theater is assessed in a similar manner. The commander's three operational-level tasks provide the structure for the METT-T

assessment and correspond to the three elements in the strategic assessment. Within these three tasks, eight components further define the operational METT-T assessment. Figure 2-13 is a model for the conduct of the operational-level assessment.

JOINT, MULTINATIONAL, AND INTERAGENCY LINKAGE (CIRCUMSTANCES)

Four components make up an assessment of joint, multinational, and interagency linkages.

Interoperability

Interoperability is the ability of forces to provide a capability or service, to accept services from other forces or agencies, and to use those capabilities and services to operate effectively together. The presence of government agencies is an aspect of operations in a joint environment. The degree of required Army interoperability with these agencies will be determined by the circumstances of the operational environment.

Alliances and Agreements

Alliances and agreements are the formal means that guide multinational operations. The degree of formality is a dynamic state

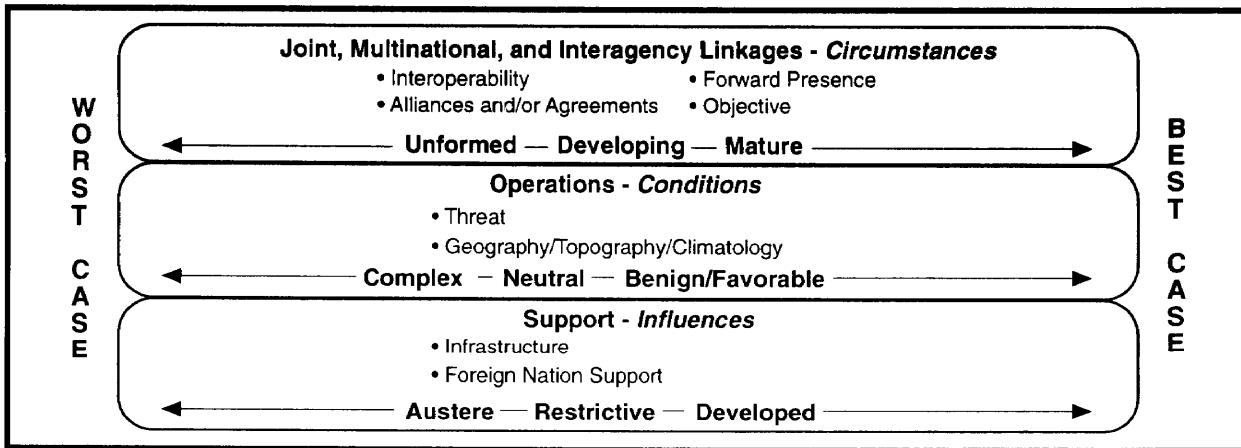

Figure 2-13. Operational Tasks/Environment

determined by mutual needs. Where need exists, the degree of formality increases with time. This same principle applies to interagency operations. These arrangements are initiated when a requirement for more formal arrangements exists.

Where arrangements are yet unformed or in early development, operations may be based on very informal agreements by representatives of the Army and the agency. Initially, participants may have only general principles from public law, presidential instructions, and agency policy or doctrine to guide their actions. As time permits and requirements demand, the arrangements are formalized in memorandums of understanding that outline specific responsibilities.

Forward Presence

US forces, in modest numbers, are forward deployed to sustain alliance commitments and to contribute to regional stability. *Forward presence* is accomplished also through the periodic deployment of CONUS-based forces for participation in training exercises, nation assistance activities, or counterdrug operations. Pre-positioning of forces and sustainment to include Army pre-positioned afloat (APA) contribute to mobility and flexibility of US forces. This supports the force-projection military strategy and provides for rapid response to a crisis or reinforcement and sustainment of forward-presence forces.

Objective

The operational-level commander derives the *objective* from the theater campaign plan developed from the theater military strategy. That plan and strategy is subject to

modification by allies/coalition leaders, which may have a subsequent impact on the operational objective. The time available is also a factor that must be addressed when considering the objective.

OPERATIONS (CONDITIONS)

The components of the operations task are the *threat* and the *geography, topography, and climatology*.

Threat

The *threat* is based on the ability of an enemy or potential enemy to limit, neutralize, or destroy the effectiveness of a current or projected mission, organization, or equipment item. The threat may be indirect by having the potential to adversely impact on US interests or the attainment of US objectives. The world remains extremely dangerous. Many nations can acquire technologically advanced, highly lethal weapons that could threaten US and allied forces. For example, third-dimension platforms, ballistic missiles, cruise missiles, armed helicopters, and weapons-carrying unmanned aerial vehicles (UAVs), combined with accurate guidance and mass casualty warheads, present a significant threat to a warfighting CINC's assets.

Instabilities

A variety of factors challenges the stability of various countries and regions. These *instabilities* can lead to increased levels of competition, regional conflicts, and civil war. Additionally, regional factions, some possessing forces and equipment equivalent to the US, may seek to expand their influence by coercion or direct force. These regional

challenges will often involve an adversary whose system of beliefs interprets differently such fundamental ideas as right or wrong, the value of human life, and the concept of victory and defeat.

Geography, Topography, and Climatology

The *geography* describes the land, sea, air, and the distribution of plant and animal life, including man and his industries. The *topography* describes the configuration of a surface, including its relief and the position of its natural and man-made features. *Climatology* describes the prevailing weather conditions of a region.

SUPPORT OPERATIONS (INFLUENCES)

Two components of the support task are the infrastructure and foreign nation support.

Infrastructure

Infrastructure is a term that applies to all fixed and permanent installations, fabrications (road, rail, communications networks, water networks, air networks, or utility systems), or facilities for the support and control of military forces.

Foreign Nation Support

Foreign nation support includes all civil or military assistance provided by a nation to foreign forces within its territory during peacetime, conflict, or war. Foreign nation support is based upon agreements mutually

concluded between nations. The coalition participants establish similar support arrangements at the theater strategic level. An additional concern, especially in alliances, is to determine the type of support that the US forces, when directed, may have to provide to the alliance partners or host nation.

RANGE OF OPTIONS

As the commander examines the operational environment, he begins to make judgments about the operational impact on his three tasks. These judgments are the subjective and objective measurements of the components of each task as they affect the employment of the Army force. They correspond to a range of options that describes the commander's ability to accomplish the three tasks in the operational environment. Figure 2-13 lists the three tasks, the operational environment components, and the broad values that describe the range over which these tasks and components may be measured.

The commander assesses the operational environment and assigns a cumulative assessment describing it as *austere*, *restrictive*, or *developed*. This perspective permits the comprehensive analysis of the operational environment through the examination of each task and the environmental components that align with each task of the operational commander. This analysis helps identify the areas that require more or less effort. The analysis also influences the commander's skillful synchronization of the operational functions.

Chapter 3

Theater Strategic and Operational-Level Perspective

A major concept essential to understanding Army theater operations at the operational level is *operational art* and *design*. Key elements of operational art and design apply across the range of military operations. Commanders must understand these elements when they plan and conduct Army operations in theater. This chapter discusses the Army operational-level commander's employment of *ways* and *means* to obtain *ends* established by theater strategy and campaign plans.

No particular echelon of command functions solely at the operational level. Command echelons may vary with the nature of the campaign or major operation, strategic and military objectives, organizational structure, or size of the joint force. The intended purpose—not the level of command—is the primary determinant of whether a force functions at the operational level.

OPERATIONAL ART

FM 100-5 describes *operational art* as "... the skillful employment of military forces to attain strategic and/or operational objectives in a theater of operations through the design, organization, integration, and conduct of theater strategies, campaigns, major operations, and battles. Operational art translates theater strategy and design into operational design which links and integrates the tactical battles and engagements that, when fought and won, achieve the strategic aim."

Operational art links tactical events to strategic objectives. Using operational art, the CINC envisions the theater strategic and operational design. To achieve theater strategic design and objectives, the CINC arranges unified operations, joint operations, major operations, and tactical-level battles. Operational art at the operational level uses major operations in support of joint campaigns to sequence these events over time and space. Senior army commanders and their staffs practicing operational art may operate in a joint and possibly combined arena. They sequence Army operations to achieve theater strategic and operational objectives.

KEY CONCEPTS OF OPERATIONAL ART AND DESIGN

The theater strategic and operational concepts that explain operational art and design include *center of gravity*, *decisive points*, *lines of operation*, *culminating point*, *indirect approach*, *positional advantage* and *strategic concentration of forces*, and *deception*. The CINC and his principal subordinates should agree on what design features are most important to accomplishing the mission. The CINC establishes the first use and priority of these concepts. Subordinates' use and priority is a subset of the CINC's. For example, the CINC selects the strategic center of gravity, and subordinates select decisive points on the path to attacking the center of gravity.

Center of Gravity

The essence of operational art is concentrating friendly military forces and resources against the enemy's main sources of strength (strategic center of gravity) in a manner that provides the JFC with the strategic and operational advantage and the initiative. The destruction, dislocation, or neutralization of the enemy center of gravity should prove decisive in achieving strategic

objectives. Similarly, the JFC must identify the theater friendly center of gravity and protect it.

The enemy center of gravity exists at all levels of war. A center of gravity is the foundation of capability—what von Clausewitz called "the hub of all power and movement, on which everything depends....the point at which all our energies should be directed." (*On War*, 1976) The center of gravity maybe seen in more complex components or abstract terms, such as *the enemy's alliance, solidarity, or national will* and in actual examples such as *strategic reserves, C, logistics, industrial base, and so forth*. The center of gravity is most useful at the operational level of war as an analytical tool to focus the effort against the enemy's strength.

In MOOTW such as disaster relief and humanitarian assistance the enemy's center of gravity is the threat of hunger or the elements of the environment. The uniqueness of these operations requires the commander and his staff to understand the military's role in relation to the total efforts of national power being used to resolve the situation. The military's role supports the other elements of national power.

Decisive Points

Decisive points provide commanders with a significant advantage. They are the keys to defeating or protecting the center of gravity. Normally, there are more decisive points in a theater than there are resources to attack them. The commander designates the most critical points and objectives as a means of gaining freedom of maneuver to gain and maintain momentum. By correctly identifying and then attacking (or protecting) decisive points, the commander is able to defeat the enemy's center of gravity. Decisive points serve as trigger points for friendly force actions that sustain the initiative. The AO will have more decisive points than available resources to commit against them. The commander and his staff must conduct a risk analysis to prioritize the friendly force efforts.

A stand-alone, individual information war action can be decisive. Winning the information battle before the war can be even more decisive than winning it during hostilities. Winning the information war before the war may preclude combat operations. The ability to get inside an adversary's decision-making cycle (his operational ability to react) is critical to attacking his centers of gravity,

exploiting his weaknesses, and effectively concentrating our own combat power. An area that must not be overlooked is using, and even driving, emerging technologies to access the tactical situation on the ground.

Lines of Operation

Lines of operation define the directional orientation of a force in relation to the enemy. They connect the force with its base of operations—from which it receives reinforcements and resupply—and its forward units—where it operates against the enemy. This concept is linked to the interior or exterior (or combination) directional orientation of a force in relation to the enemy. Lines of operation are used to focus combat power effects toward a desired end.

Culminating Point

The culminating point is the point in time and space at which the offensive becomes overextended, and offensive combat power no longer sufficiently exceeds that of the defender to allow continuation of the offense. While this point may not be precisely determined, the commander and his staff should consider it in the design concept.

A defensive culminating point is that point at which the defender's capability is reduced to such a degree that continued pursuit could result in the defender's defeat in detail. If the defender's aim is to transition to the attack, then the culminating point is where the defender must revert to a holding action and await reinforcement. If the defender's aim is to retain terrain, then the culminating point is where the defender must withdraw, delay, and so forth.

Indirect Approach

An indirect approach is a scheme that attacks the enemy center of gravity from unexpected directions or at unexpected times. The indirect approach seeks enemy vulnerabilities and avoids enemy strengths. The application of techniques to win the information war is one area that leads itself to the indirect approach. When possible, JFCs attack enemy centers of gravity directly. Where direct attack means attacking into an opponent's strength, JFCs should seek an indirect approach. Examples include attacks of flanks, rear areas, or C capabilities. Vulnerabilities are boundaries or seams between forces, the relative weaknesses of unprotected flanks or rear areas, or unhardened

command, control, communications, and intelligence (C²I) facilities.

Positional Advantage and Strategic Concentration of Forces

Strategic realities indicate that force ratios may not favor friendly forces across the theater. Therefore, the JFC determines where to strategically concentrate force and in what areas to accept risk. Clearly, this aspect ties in with the center of gravity, indirect approach, positional advantage, and deception. Joint forces seek to obtain positional advantage relative to enemy forces. Such advantage includes control of territory—air, land, sea, subsea, and space—from which to better operate and attack. Having positional advantage includes denying this territory and freedom of movement to the enemy. Attaining this advantage involves combat operations.

Deception

Deception manipulates enemy perceptions about friendly force intentions, positions, and timing. Deception has strategic, operational, and tactical aspects, and its planning is as complex and detailed as the overall plan. Deception relies heavily on intelligence information, which helps commanders identify appropriate targets, develop a credible story, and determine the effectiveness of the effort.

KEY ELEMENTS OF THEATER AND OPERATIONAL DESIGN

The key elements of theater and operational design reinforce the concepts of operational art and design. The elements consist of the—

- Objective.
- Sequence of operations and use of resources.
- Phases.
- Branches and sequels.
- Sequential and simultaneous warfare.
- Logistics.

The senior army commander's effective use of operational art and design elements translates theater strategy and the campaign into operational and, ultimately, tactical action. No specific level of command is concerned solely with operational art and design. The level of command that has the

responsibility to link strategic aims with tactical execution varies in military operations.

The theater commander and subordinate operational-level commanders may control large military formations over great geographic distances while sequencing tactical military operations in pursuit of strategic or operational objectives. Conversely, operational-level commanders may control relatively small military formations conducting specific, short-term operations for the same purpose. Senior army commanders practice operational art across the range of military operations. Whatever the environment (peacetime, conflict, or war), the operational-level commander links theater strategy and campaigns to tactical execution by effectively sequencing operations over time.

Objective

The objective is the central element of operational design because it establishes the condition necessary to achieve the strategic aim. While the CINC initially keys on national or alliance strategic objectives, he also supplements them with theater strategic and operational objectives. To ensure clarity of strategic and operational intent when conducting subordinate campaigns, JFCs may identify and carefully describe operational objectives from the CINC's specified and implied tasks.

Sequence of Operations and Use of Resources

The sequence of operations and use of resources are closely related elements of theater and operational design. The operational-level commander links theater strategy and campaigns to tactical execution by effectively sequencing major operations and battles over time. As described in FM 100-5, tempo and battle command contribute significantly to the effective sequencing of events.

The JFC visualizes the sequence of operations necessary to achieve the desired conditions of the strategic end state. Without this linkage, operations are apt to become a series of disjointed events less likely to achieve the desired theater objectives. The visualization includes identifying the enemy center of gravity and culminating points and protecting the friendly center of gravity. This process is useful when determining phases of a

campaign, applying resources against these phases, and enabling the JFC to envision requirements for branches or sequels.

Phases

Generally, the campaign is divided into phases that focus on major changes in the nature of the total effort, such as defensive to offensive, decisive maritime action, and decisive continental action. Some campaigns are naturally progressive in their phasing (establish sea control, gain a lodgment, initiate a major continental campaign), while others are more complex. The latter may be the case when the opponent has initiated hostilities and the theater commander must transition from an initial defense, to seizure of the initiative, and eventually to offensive operations to achieve the strategic goal. The main effort is to attack the centers of gravity simultaneously throughout the depth of the battle space. Often that effort is phased.

Each phase in the campaign should lay the groundwork for its successor until a final decisive effort can be joined. A phase may orient on a physical objective or on establishing a certain advantageous condition. The description of each phase should identify the strategic tasks to be accomplished, together with the ultimate purpose—the why—of the strategic tasks. The description should include a narrative of the theater commander's strategic concept of how and when these strategic tasks are to be accomplished. It should also include an estimate of force requirements, as well as major supporting operations necessary for the effort.

These concepts and force estimates should be continually refined up to the time the operation order implementing that phase is required. Prior to terminating the phase or meeting the necessary conditions for moving to the next phase, planning will have begun and the refinement process to facilitate the transition will continue.

The phasing and sequencing of operations should not be slow or methodical. However, as soon as conditions permit, the JFC strives to overwhelm the enemy throughout the depth of the battle space. He conducts simultaneous attacks throughout the depth to paralyze the enemy and force an early capitulation.

Branches and Sequels

Besides phases, the JFC visualizes requirements over the full range of operations for branches to preserve freedom of action. Branches are contingency plans for changing disposition, orientation, or direction of movement and for accepting or declining battle. Sequels are actions taken after an event or battle and are based on possible outcomes—victory, defeat, or stalemate.

Sequels, for example, might reflect a potential transition from the strategic defense to a counteroffensive, to a withdrawal, or to an occupation. The visualization of branches and sequels is not simply a thought process of events. This visualization is a parallel planning process that provides the command a valuable resource-time.

Sequential and Simultaneous Warfare

In considering phasing, the JFC addresses the problem of deployment to ensure that forces arrive at times and places that support the campaign. Because of limited resources, geographic considerations, and our system for organizing the force, the US may go to war in sequential phases.

At the strategic level, sequential actions include mobilization, deployment, and sustainment of the sequential employment of forces. Because the US is strategically insular, plans are driven to exterior LOCs, and, with limited resources, the campaign is phased to achieve strategic ends.

At the operational-level, sequencing may be seen more in terms of employment. Additionally, sustainment is a critical consideration in sequencing campaigns. The campaign establishes requirements for the procurement and apportionment of national resources from CONUS-sustaining bases. Forward bases must be established, LOCs must be opened and maintained, intermediate bases of operations must be established to support new phases, and priorities for services and support must be established by phase. Logistics considerations, then, become key to sequencing the campaign plan.

Notwithstanding the generally sequential nature of campaign phases, some phases are conducted simultaneously—particularly in depth. Deployment may continue well after employment begins. Sustainment is conducted throughout. Redeployment may begin during posthostility operations. Defense and offense

operations are always interrelated. Also, sequential operations may be conducted in a single operation, for example, the raid into Libya.

Logistics

Logistics is one of the combat functions that helps commanders build, sustain, and project combat power. It is also a major operating system at each level of war. Combat operations and logistics increasingly merge at higher levels of war. Neither can be conceived without consideration of the other.

Strategic and operational logistics support wars, campaigns, and major operations; tactical logistics supports battles and engagements. Strategic and operational

logistics interface in the theater. The combatant commander provides strategic guidance and priorities for operations, while the service component commanders identify operational requirements to the national industrial logistics base.

Deployment and integration of forces and logistics in the theater are based on the combatant commander's theater strategic design in his campaign plan. Centralized management and distribution of supplies and materiel at the strategic level facilitate decentralized execution of logistics at the operational and tactical levels. Further discussion of operational art and its corresponding components can be found in FM100-5.

RESOURCES

The resources provided to the operational commander are the *means*. The authoritative direction that governs the conduct of operations are the *ways*.

MEANS

The means allocated to the operational commander influence the selection of the operational objectives. Tangible resources include military forces and supplies made available to the commander. These may include other nonmilitary assets such as US civilian agencies or HNS and direct augmentation, for example, civilian reserve air, land, or maritime fleet transportation assets.

Intangible resources include the commander's authority over forces not under his direct command; authority over certain nonmilitary aspects of theater operations, for example, refugees; and public and diplomatic support of military operations.

WAYS

The allocation of resources provides capabilities and constraints on the conduct of operations. The concept for operations emerges from these capabilities and constraints. The concept is tempered by contingency plans (branches) that include deception. The authoritative guidance for the operational concept is the ways of the operation.

The nature of the strategic direction may require that the use of military force be limited such as by ROE. Limiting factors dictate how

the Army operational-level commander uses resources to attain a particular operational objective. The Army commander articulates these limiting factors in the form of *restrictions* and *constraints*.

Restrictions

Restrictions prohibit the operational-level commander from performing specific actions or categories of actions. The laws and treaties of the US embody some restrictions such as those on the treatment of noncombatants imposed by the Geneva Conventions. Others will be unique to the circumstances and locale of the particular conflict. Some restrictions may prohibit the use of certain weapons, preclude operations in certain geographical areas, or limit certain tactical methods such as the mining of harbors. Such restrictions may influence the achievement of operational-level objectives.

Constraints

Constraints shape operational alternatives. In contrast to restrictions, constraints denote actions that the commander must take or methods he must employ. Limits of advance and control measures in general are examples of constraints. The imperative to minimize casualties also may shape alternatives.

Methods may include objectives unrelated to operational military aims but which have inherent strategic significance. For example, the JFC may require the Army commander to

employ combined forces even though their use would make operations more complex from the Army perspective. Frequently, constraints require retaining or protecting areas deemed diplomatically or psychologically important but

tactically insignificant. The retention of Verdun in 1916 constituted such a constraint on French operations, though it resulted in no military gain and cost nearly a million lives.

OPERATIONAL-LEVEL COMMAND

The Army may act as a service component, functional component, subunified command, or JTF subordinate to the JFC during the conduct of operational-level activities. The ASCC, or ARFOR commander, acting in one or more of these roles at the operational level, plans and conducts subordinate campaigns, major operations, and operations to attain theater strategic and/or operational objectives to support the joint force mission.

The JFC translates strategic guidance to operational terms in the form of an OPLAN or operations order (OPORD). This OPLAN/OPORD includes a clear mission and specific tasks to which the traditional military decision-making cycle is applied. The JFC provides a clear definition of the conditions that constitute the strategic and military end states. The conditions for the end states must exist before planning and execution of military operations can be effective. The Army

operational-level commander may translate these conditions into a single military objective or phased military objectives expressed in major operations that support joint campaigns.

The Army commander participates in the joint concurrent (parallel) planning process to help the JFC translate strategic direction and aims into a clearly defined and achievable end state and objective. Usually, the more intense the conflict and the more predominant the military factors, the easier it is to translate strategic direction into operational-level objectives. When the nonmilitary elements of national power dominate, the full use of military capability may be limited. Joint Pub 3-O states that adaptive planning provides a range of options encompassing all the elements of national power (diplomatic, economic, informational, and military). The selection of military operational-level objectives tends to be more complex in MOOTW.

PART TWO

Planning and Execution

The two chapters in this part discuss the planning considerations for Army operations and the operating systems at the operational level in theaters. Chapter 4 presents planning considerations for Army participants at the operational level in theaters in the joint operations of subordinate joint campaigns. Chapter 5 discusses operational art requiring the synchronization of the six operational-level operating systems.

Chapter 4

Planning Framework

While the planning process is essentially the same at most levels of command, subordinate planning at the operational level demands a broader perspective over the whole range of military operations. Joint Pubs 3-0 and 5-00.1 describe the conditions under which subunified and JTF commanders write campaign plans to support the theater campaign plan. Functional and service components of the joint force conduct subordinate and supporting operations—not independent campaigns.

Operational-level Army planners use major operations as tools to synchronize ends, ways, and means to support the joint operations of a subordinate joint campaign. These major operations sequence tactical battles or activities to attain theater strategic and supporting operational-level objectives and guidance from the unified theater campaign. Theater strategic planners use unified operations to synchronize the ends, ways, and means of the theater combatant commander's theater strategic purposes.

CAMPAIGNS

Though commanders traditionally apply campaigns to conflict and war, they can also design them to accomplish theater strategic objectives in peacetime. A subordinate joint campaign plan serves as the key employment plan to be implemented in subordinate operating areas such as a theater of operation or other JOA. This plan is the basis for planning among the staff and various subordinate service component commands.

This campaign plan provides the subordinate commander's vision and intent. It does this through broad, operational concepts for operations and sustainment throughout the time frame necessary to achieve the theater commander's assigned strategic concept and objectives.

The subordinate JFC, in his campaign plan, considers an orderly schedule of theater strategic decisions and directions and the supporting operational focus of the theater campaign plan. He then provides a series of related joint operations within the joint campaign. The plan comprises subordinate forces and designates command relationships, subordinate tasks, and objectives.

The subordinate plan ensures synchronization and integration of joint and single-service forces but can integrate, when delegated, specific (special operations) and other supporting forces. The subordinate JFC might consider relationships, also delegated, with multinational, interagency, international, and UN forces. However, normally the theater

commander first integrates these types of forces into his unified operations to achieve unity of effort in the theater. Integrating these forces to achieve designated objectives, either directly or indirectly, contributes to obtaining the CINC's strategic objectives.

Theater-level or subordinate campaign planning is a dynamic and continuous process that occurs in peacetime, conflict, or war. It guides the development of supporting operations or campaign plans and facilitates the implementation of national strategic direction, priorities, and resources allocations.

Deliberate planning is designed as a cyclic process during peacetime conditions. Deliberate planning allows the opportunity to develop and refine plans (OPLANs, concept plans [CONPLANs], and concept summaries) to be used in wartime. Crisis action planning (CAP) procedures provide for the transition from peacetime to hostilities or war. Deliberate planning supports CAP by anticipating potential crises and developing the contingency plans that facilitate the rapid development and selection of a COA and execution planning during a crisis. The deliberate theater and supporting plans are based on evolving assumptions and/or an intelligence buildup.

The intelligence buildup is continuous throughout the range of military operations. Intelligence readiness begins in peacetime, before any crisis. The commander establishes intelligence requirements that direct peacetime intelligence operations supporting contingency planning. Two specific elements—*staying out front in intelligence planning* and *understanding how to get intelligence support*—are key components to contingency planning. As contingency plans are activated, the commander focuses intelligence and targeting to support specific mission decision and planning requirements. In addition, the commander begins planning for the crossover point in intelligence when initial reliance on higher echelon intelligence is augmented by tactical intelligence and electronic warfare (IEW) assets within the AO.

Intelligence readiness means that intelligence organizations must develop broad knowledge of priority contingency areas, update those data bases daily, and be prepared to surge in support of emerging missions. Commanders and J2s must direct the intelligence effort daily to ensure data bases are available if alerted to support contingency

planning and execution. The intelligence staff must provide commanders routine, direct, and habitual links into the intelligence system. These links provide an early focus on the commander's tactical and operational intelligence needs. When a regional crisis occurs, the intelligence system focuses on pushing intelligence and tailored products to the users and prepares for the unit to pull needed intelligence.

When a crisis develops, the CJCS issues a warning order. The supported CINC, subordinate force commanders, and supporting commanders adjust their plans as time permits and the probability of conducting operations increases. The supported commander develops COAs and recommends a specific COA to the NCA. The NCA selects a COA and the CJCS issues an alert order. During the execution planning phase, the supported CINC and his staff prepare the campaign plan and an OPOD, normally by modifying an existing OPLAN, to initiate the first phase of the theater campaign. Execution begins with the NCA decision, via the CJCS execute order, to execute the campaign plan and continues until the campaign reaches an end state favorable to the US and its allies.

ORIGINATING AUTHORITIES

Campaign planning can be directed by the NCA, assigned in the JSCP, undertaken by the theater commander, or undertaken to support the sequential requirements of subordinate JFCs. Existing OPLANs or CONPLANs may provide the basis for development of campaign plans.

The campaign plan is the basis for action within a hierarchy of decision making and guidance. That guidance links national security strategy and policy directives to tactical-level battles and engagements. Both levels of campaign plans ensure the linkage of those battles and engagements toward the accomplishment of the desired strategic end state. See Figure 4-1.

Upon approval by the NCA of a proposed military option with alternatives, the CJCS designates the supported and supporting combatant commanders and issues further planning guidance. The supported CINC has primary responsibility for all aspects of theater campaign plan development. The supported CINC develops his strategic estimate and intent, then prepares the recommended

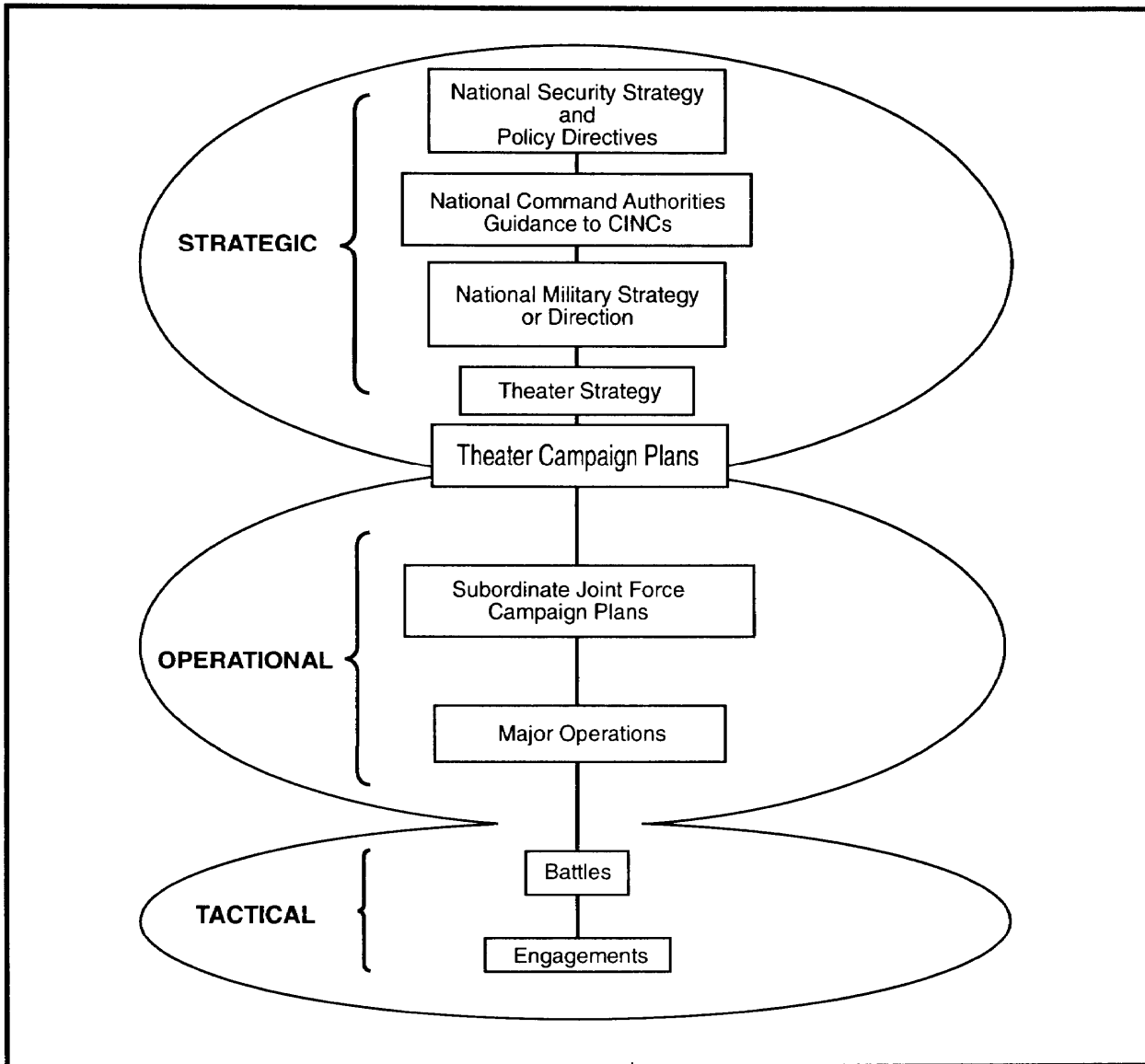

Figure 4-1. Hierarchy of Guidance and Implementing Operations

strategic concept as the preferred COA, which, upon approval, becomes the basis of his campaign plan.

When the CJCS approves the campaign plan, the supported CINC provides a copy of the plan to supporting CINCs and subordinates for their use as a basis for developing their supporting plans. In practice, the process is sequential only in meeting formal approval dates. All parties conduct concurrent planning throughout the process, via working papers, informal and formal drafts, liaison efforts, and action officer and commanders' conferences.

The supported CINC ensures that his theater organizational staffs can coordinate

effectively with supporting CINCs. The CJCS outlines to all involved CINCs the degree of coordination and cooperation required.

Unless limited by the establishing directive, the supported commander exercises general direction over the supporting effort. General direction includes—

- The designation of targets or objectives.
- Timing.
- Duration of the supporting action.
- Other instructions as necessary for coordination and efficiency with the unity of effort between supported and supporting efforts and plans.

The supported commander should consider the accepted operational and tactical practices of the services of the supporting forces.

The supporting commander is responsible for ascertaining the needs of the supported force. He fulfills those needs with existing capabilities and in keeping with the priorities and requirements of other assigned tasks. Normally, the supporting commander is permitted to prescribe the operations, tactics, methods, communications, and procedures the supporting force employs.

Occasionally, the NCA or CINC requires more rapid translation of strategic aims into direct, tactical execution, with an abbreviated operational-level link. This typically occurs during specific incidents or sensitive situations requiring NCA control. These direct actions of special operations are usually of short duration, requiring nearly simultaneous operations. The 1986 US raid on Libya is an example. As conventional operations become longer in duration or more complex in execution, they are likely to require an expanded operational-level link between the strategic aim and tactical execution.

CAMPAIGN DESIGN

The theater strategic environment significantly affects campaign design at the theater strategic or operational levels. Alliance and coalition requirements are obviously key factors to consider. The availability and capabilities of forward-presence forces—to include allied and international forces, interagency organizations, and NGOs and PVOs—influence force apportionment decisions. Mobilization, deployment, sustainment, and force-generation capabilities influence the type and timing of operations. ROE may impose limitations, constraints, or restraints.

Campaign plans are designed to conduct a series of related military operations to achieve strategic objectives in a given time and space. Theater campaigns achieve national strategic objectives, whereas subordinate campaigns achieve the CINC's theater strategic objectives. Campaign plans are the theater strategic and operational extensions of the CINC's theater strategy. They translate theater strategic or operational concepts into theater or subordinate campaign plans for military action by specifying how intelligence, operations,

logistics, and C² is used over time to attain national or theater strategic objectives.

The key to designing the theater campaign plan is understanding the desired strategic end state, determining the military end state, identifying the enemy's strategic center of gravity, and—having achieved the strategic advantage by strategic concentrations and subsequent strategic maneuver—attacking the center of gravity to achieve the end state. Though theater and subordinate campaigns have different levels of scope, purpose, and perspective, they share common fundamentals.

- They describe the situation affecting the conduct of military operations.
- They describe the strategic end state and conditions that constitute that end state.
- They orient on the enemy's strategic center of gravity and/or successive decisive points at all levels of war and levels of depth.
- They provide an orderly schedule of theater strategic or operational decisions—the commander's vision and intent.
- They provide concepts of operations and sustainment to achieve national or theater strategic objectives within a theater organization—the basis for all other planning.
- They describe the series of related unified or joint operations and major operations that lead to the campaign end state, to include objectives and conditions necessary to begin each subsequent sequence of operations.
- They phase the levels of campaigns to clearly define or focus sequential activities. Phases often correspond to changes in the purposes of unified or joint major operations.
- They identify the strategic center of gravity and/or key decisive points during the campaign. Key decisions are often based on attainment of conditions identified as necessary to begin phases or shift operations. Other key decisions involve shifting priorities and resources.
- They provide the CINC's or subordinate's design for synchronizing efforts.
- They describe the terms of priority of effort and resources by phase or subsequent operation. This aspect includes a description

of the supporting capabilities and their intended affect on operations.

- They provide the organization of the unified or joint force and designate command relationships between the theater CINC and his subordinates.
- They identify specific objectives and assign tasks and concepts for each subordinate that are sufficient to serve as the basis for subordinate planning.
- They synchronize and integrate joint, single-service, supporting, and special operations forces in conjunction with multinational and UN forces; international and interagency organizations; and NGOs and PVOs into a cohesive and synergistic whole that is unified in nature.

Campaign planning is the primary means by which the CINC provides for strategic unity of effort and through which he guides the planning of unified and joint operations within his theater and its subordinate operating areas.

Theater Campaign Plan

Through the theater campaign plan, the CINC—

- Defines theater strategic objectives.
- Describes a strategic concept of operations and sustainment.
- Sequences unified operations.
- Allocates subordinate forces.
- Establishes command relationships and delegates authority.

• Assigns objectives and tasks.

- Synchronizes joint, single-service, supporting, and special operations forces with allied, UN, NGO, PVO, and interagency or international efforts.

A theater campaign plan includes the CINC's strategic vision of the unified operations sequence necessary to attain the national strategic objectives assigned by higher authority. It orients on the enemy's strategic center of gravity; achieves unity of effort with the armed forces allocated by the nation; clearly describes the strategic end state; and serves as the basis for subordinate planning. Two of the most important aspects of this plan are the synchronization of forces in operations and the concept for their sustainment.

Integration and Synchronization of Forces and Operations

The campaign plan integrates and synchronizes unified, joint, and multinational/coalition operations by serving as the unifying focus for the conduct of operations. The CINC coordinates from among the total US, allied, or interagency and international capabilities and applies or focuses those necessary to prosecute the campaign. He orchestrates this application of force so that a variety of supporting capabilities is complementary and reinforcing—all oriented on achieving campaign objectives.

Concept for Sustainment

The campaign plan integrates and synchronizes unified, joint, and multinational logistics and support operations. It ensures that logistics and support planning are

Gaining the initiative at the operational-level has a momentum of its own that multiplies the value of tactical victories and ultimately leads to theater strategic advantage and conflict termination. The German victory in France during 1940 illustrates this phenomenon. Though they fought relatively few major engagements, the Germans sequenced and synchronized their tactical operations in such a manner that the operational-level result was much greater than the sum of these tactical battles. The momentum gained by the Germans during these operations led the French to believe their situation was hopeless, despite having major uncommitted combat forces.

centralized, comprehensive, and continuous. Although implementation and execution of logistics functions and support are normally a national and, specifically, a service responsibility, the CINC coordinates from among the total US, allied, or interagency or international capabilities and applies or focuses those necessary to prosecute the campaign. Logistics and support considerations are vital to the successful execution of the campaign plan.

Supporting Campaign Plans

Theater combatant commanders and their staffs prepare campaign plans. In addition, principal subordinate JFCs prepare subordinate or supporting campaign plans as required against multiple strategic threats. These include subunified and JTF commanders and their staffs.

The theater commander may decentralize the joint force by establishing theaters of operation or JOAs for subordinate JFCs who directly command the warfighting service forces. Subunified or JTF commanders, when assigned a strategic mission, prepare subordinate campaign plans that support the higher CINC's concept and contribute to the unified effort in the theater.

A JTF is established usually for different levels of command to achieve specific objectives of limited scope. The JTF mission may be of sufficient scope to achieve a strategic objective. In such a case, under direction of the theater CINC or, in certain circumstances, under direction of the NCA (through the CJCS), the commander of the JTF may be responsible for establishing a subordinate campaign plan.

DECISION MAKING

Strategic decision making that affects campaign planning occurs at three levels: national security level, national military level, and theater level.

National Security-Level Planning

At the national security level, the NCA uses the national security system to design national security objectives and guidance reflecting a strategic end state.

National Military-Level Planning

At the national military level, the CJCS uses sequential planning systems, such as JSPS and JOPES, to provide further national

strategic direction affecting the theater campaign plan process.

Joint Strategic Planning System

The JSPS is the primary formal means by which the CJCS, in consultation with other members of the JCS and CINCs, assists the NCA in providing national strategic direction. The JSPS is used to assess the strategic security and specific theater environments, evaluate the threat, and propose the national military objectives, strategic concepts and guidance, and force capabilities to support the achievement of national security objectives. It provides strategic rationale for the initiation of joint operations planning.

Joint Operation Planning and Execution System

Campaign planning occurs within the established deliberate or execution processes of JOPES. Campaign logic, sequence, and fundamentals go into the OPLAN format within JOPES. JOPES provides procedures to translate strategic direction into a plan of operations. A CINC can use JOPES to develop and select appropriate COAs. This COA development process can be also applied to campaign plan development.

Theater-Level Planning

At the theater level, within JOPES guidelines, the CINC employs a theater design process to develop the theater campaign plan. This design process —

- Begins with receipt of current national strategic direction.
- Follows with evaluation of the theater strategy and strategic estimate.
- Continues with specified planning considerations of operational art and a series of related sequential planning actions.
- Leads back to the national strategic guidance and end state to ensure that it can be successfully employed.

Subordinate JFCs receive guidance through the JOPES-related, theater-level campaign planning process. They formulate supporting plans based on the theater CINC's strategic guidance and intent. While campaign planning is a responsibility of the theater CINC and subordinate JFCs, it has a specific

relationship to JSPS and JOPES. These systems provide a process for the theater commander to receive strategic guidance from and provide input to the NCA and CJCS, as well as a methodology for developing the campaign plan.

Theater campaign planning (Figure 4-2) portrays an orderly series of related actions and operations that occur in the campaign design considerations within JOPES. The broad process begins when the CINC receives current strategic guidance and then systematically considers—

- Derived mission.
- Revised theater strategy and estimate.
- Commander’s estimate.
- Commander’s concept.
- Objectives, tasks, and concepts for subordinates.

- Command relationships.
- Theater organization.
- Requirements for supporting plans.

The final link in the process is a determination of plan feasibility and requests for change or augmentation. Planning may be self-regenerating, depending on changing conditions of the above actions or events.

Derived Mission

Specified and implied strategic tasks are determined from specific NCA guidance; from national or alliance documents, such as the JSCP, the UCP, or Joint Pub 0-2; or from CINC initiatives. The national military objectives form the basis of the campaign’s mission statement. Using these guides, the CINC derives his theater campaign mission—a strategic mission that accomplishes the purpose of national strategic direction.

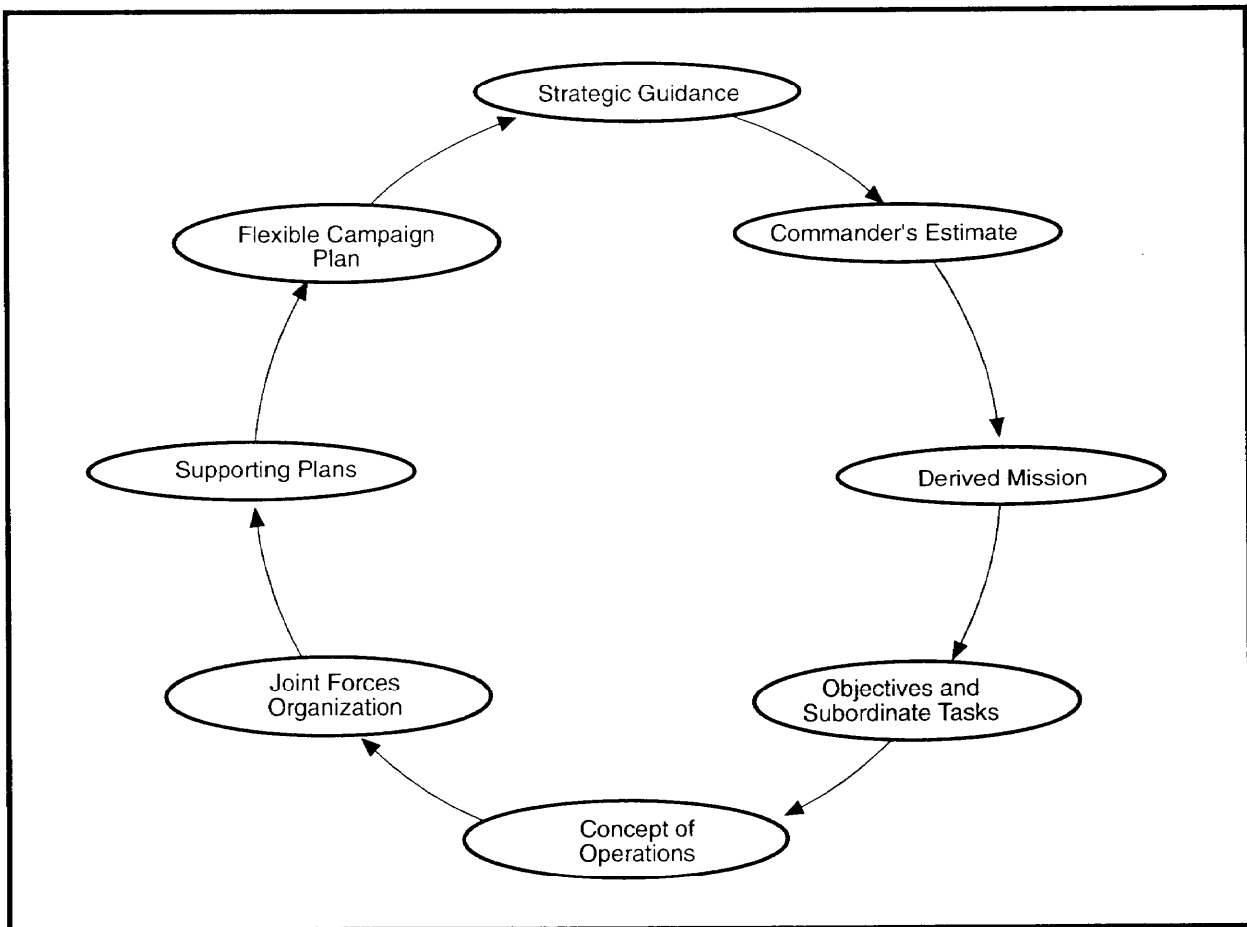

Figure 4-2. Theater Campaign Planning

Initially, the mission may be a general statement of the theater strategic objectives and their purposes, but it may later be refined after specific tasks and phases have been developed and delineated as a result of the commander's estimate. The mission evolves.

From the derived mission, the CINC determines what is to be done, what resources are available, and what obstacles or actions may prevent mission accomplishment. The CINC states this derived mission in succinct terms that are understandable to superiors and subordinates alike. The CINC provides guidance to subordinate commanders through his application of operational art and the description of his strategic intent.

The commander's intent is a concise expression of the purpose of the unit's activities, the desired results, and how operations progress toward that end. In his intent, the commander clarifies the *why* element of the mission statement for his subordinates. This helps them pursue the desired strategic end state without further orders, even when operations do not unfold as planned.

Revised Theater Strategy and Estimate

The national and multinational strategic guidance the CINC receives from higher authority, whether explicit or implicit, drives the campaign planning process. Guidance is expressed through national security strategy and national military strategy relative to the deliberate or crisis-action attainment of strategic objectives and guidance. During CAP, assumptions change and plans are adjusted.

The theater campaign plan must be flexible. It must be able to accomplish its designed purpose and adapt to changing assumptions, guidance, or situations affecting the desired outcome. The plan should be subjected to continued, detailed review and revised as required so that it does not become outdated, is not overcome by critical events, or does not become unworkable. Major components of the CINC's strategic estimate are strategic direction, the theater strategic situation, strategic concepts, specific COAs, and decisions. Joint Pub 5-00.1 describes these in detail.

Commander's Estimate

The CINC's study of the situation, coupled with his review of existing theater strategy and

strategic estimate, is a continuous process from which strategic concepts are formulated and COAs are derived to become the basis of the theater campaign plan. In practice, the commander's views, as expressed in the commander's estimate during deliberate or CAP, contribute to NCA deliberations in forming strategic guidance. As a minimum, the commander's estimate will include—

- The mission, situation, and COAs.
- Considerations that affect the COAs.
- Enemy capabilities.
- Analysis of enemy capabilities.
- Comparison of own COAs.
- Recommended COA.

For each COA, the estimate should address-

- Combat forces required; for example, airborne brigade, tank battalion. Identify types of units.
- The force provider.
- The destination.
- Required delivery dates.
- A coordinated deployment estimate.
- An employment estimate.
- Strategic lift requirements, if appropriate.

Concepts of Operation

The CINC's strategic concepts of operation and sustainment in the theater campaign plan are linked closely and derived from his strategic intent. They accomplish the following:

- Describe the strategic end state and requirements and conditions that constitute that end state.
- Design the theater strategic concept, objectives, and tasks and supporting operational direction, objectives, tasks, and concepts for subordinates to carry out their campaigns or operations.
- Organize joint, single-service, supporting, and special operation forces, in conjunction with multinational or UN forces, interagency organizations and NGOs and PVOs into a cohesive, unified force designed to plan and execute subordinate campaigns and operations.
- Retain strategic reserves.

- Establish command relationships.
- Integrate the nations's mobilization, deployment, and sustainment efforts into the CINC's employment and logistics concepts.
- Concentrate forces and materiel resources strategically so that the right force is available at the designated times and places to conduct decisive, winning operations.
- Seek to gain the strategic advantage over the enemy that affords an opportunity to take the strategic initiative through offensive operations.
- Defeat or destroy the enemy's strategic center of gravity to achieve the strategic end state.

In his strategic concept, the commander describes how he visualizes subordinates conducting campaigns, major operations, and the decisive battle, focusing on the employment of his force as a whole. This description includes conditions to be achieved, sequence of events, and expected enemy reactions to friendly forces as the battle progresses. Above all, the commander should specify the desired military end state—the results he expects the battle to achieve, including effects on the enemy and the desired posture of friendly forces after the fight. The commander should describe how this posture will facilitate transition to future operations or postconflict operations.

Objectives and Subordinate Tasks

The theater strategic and supporting operational objectives assigned to subordinates are critical elements of the theater strategic design of the theater campaign. These objectives establish the conditions necessary to reach the desired end state and achieve the national strategic objectives. The CINC focuses on national military or alliance strategic objectives to select his theater strategic and supporting operational objectives. Subordinate JFCs, in turn, are assigned specific theater strategic and supporting operational objectives for subordinate campaigns. The CINC carefully defines the objectives to ensure clarity of theater strategic and operational intent and to identify specific tasks required to achieve those objectives.

Command Relationships and Organization

The CINC organizes the subordinate operating areas within the theater and establishes the command relationships for these areas to support the campaign. Organizations and relationships are based on the campaign design, complexity of the campaign, and degree of control required. Within the campaign planning process, the CINC determines the organization and command relationships before assigning tasks to subordinates.

To establish command relationships the CINC must determine the types of subordinate commands and the degree of authority to be delegated to each. This further clarifies the intent of the CINC and contributes to decentralized execution and unity of effort. The CINC selects the types of subordinate commands from the six doctrinal options, for example, service components, subordinate joint commands, and so forth. The options for delegating authority emanate from COCOM and range from OPCON to support.

Requirements for Supporting Plans

The CINC considers a total resource support concept that is integrated both vertically and horizontally into supporting plans for theater and subordinate campaigns or operations. The CINC and subordinate JFCs and their staffs develop these plans based on unified support that can be provided from national-level assets, supporting CINCs, services, alliance or coalition partners, other government agencies, NGOs and PVOs, international agencies, UN agencies, and host nations. Supporting plans may—

- Address tasks and support requirements during mobilization, predeployment, deployment, entry, operations, postconflict operations, redeployment, and demobilization.
- Address requirements for diplomatic, informational, and economic coordination and support.
- Detail support during the various phases of the theater campaign.

Supporting commanders synchronize their plans with the theater campaign plan. They time-sequence mobilization to support deployment, deployment with execution, execution with sustainment, and vice versa. They identify resources and necessary liaison early—as the plan is being developed.

Supporting plans provide for liaison from the supporting CINC to the supported CINC, who has control over all support in the theater.

Coordination is required with allies, coalition forces, and host nations on intratheater movements. Plans to effect intratheater movement should provide the CINC maximum control of the movement and concentration of forces and materiel, which will permit rapid response to changing situations as the campaign develops.

The CINC identifies intelligence support requirements for the campaign through the development or revalidation of a supporting intelligence plan. This plan identifies requirements for national-level support from DOD intelligence agencies and military services.

Supporting and subordinate commanders and supporting US departments and agencies use the CINC's strategic concepts of operation and tasks for subordinates as the basis for determining the necessary support for each phase of the campaign plan. Supporting and subordinate commanders respond to the identified tasks by preparing supporting plans and by submitting them for approval to the supported CINC.

National Agencies and Industrial Resources

National-level intelligence organizations are essential to campaign planning and execution because of the need for access to different data bases, reconnaissance and surveillance capabilities, and finished intelligence. During the development of the theater campaign plan, the CINC should identify intelligence and mapping support requirements and request support from the Defense Intelligence Agency (DIA), the Defense Mapping Agency (DMA), and other national-level intelligence agencies. Such other federal agencies include the Central Intelligence Agency (CIA), the National Security Agency (NSA), and the intelligence staffs of the Department of State (DOS) and military services.

The list of agencies with which the Army may find it necessary to establish linkage varies based on the mission. FM 100-19 discusses MOOTW conducted to support US civil authorities and identifies the US agencies that must be considered. These agencies can

determine foreign counterpart organizations with which the Army may need to establish linkages.

The capacity of the nation to expand its industrial base may ultimately have a constraining effect on the campaign plan. The CINC must compare the expected consumption rates with the projected availability of critical supplies to ensure that the campaign plan is logistically feasible. To manage projected shortages, the CINC may plan to restrict or control the use of critical assets. The CINC may recommend that DOD implement industrial production and repair surge for specific shortfall systems.

Defense Intelligence Agency. The DIA is responsible for coordinating national-level support to the unified efforts of the CINC. DIA is also responsible for deploying national intelligence support teams to the theater to facilitate the flow of quality intelligence to the CINC. When actual operations commence, increased strategic intelligence support may be provided by a DOD joint intelligence center (JIC) to furnish an integrated defense intelligence position to the CINC.

Defense Information System Agency. The Defense Information System Agency (DISA) is responsible to the CINC for the employment of communication resources at designated defense communication system (DCS) entry stations and gateways to terminate long-haul trunks and circuits from the JOA. DISA ensures that the required entry station, gateways, and switching centers have appropriate equipment and cryptographic devices to assure worldwide interoperability of the CINC's command, control, communications, and computers (C⁴) assets.

Department of State. DOS involvement extends from policy formulation at the highest level to mission execution at the host nation and country team levels. At the country team level, the US ambassador is responsible for directing, coordinating, and supervising all US Government elements, except those under the command of an established US theater commander.

At the theater level, the CINC may use his diplomatic advisor to coordinate with US ambassadors and their country teams to plan and conduct campaigns. Throughout the range of military operations, the ambassador

remains an important player in the conduct of unified operations. The role of establishing and maintaining interagency linkage to this representative of the President is vital for accomplishing the strategic objectives.

United States Information Agency. The United States Information Agency (USIA) is responsible for supporting US foreign policy objectives by informing the public in other nations about US programs and policies. The USIA can advise the CINC on the implications of foreign opinion on the execution of present and future campaigns.

Defense Logistics Agency. The Defense Logistics Agency (DLA) is the CINC's link to the national industrial base. DLA provides supplies to the military services and supports their acquisition of weapons and other materiel. Support begins with joint planning among the services for weapons systems' parts, extends through production, and concludes with the disposal of materiel that is obsolete, worn out, or no longer needed. DLA provides supply support, contract administration services, and technical and logistics services to all military services.

US Army Materiel Command. The US Army Materiel Command (USAMC) operates the Army's national logistics system through its major subordinate commands and separated reporting activities (SRAs) to fulfill the Army's need for logistics support. USAMC—

- Performs assigned materiel functions and related functions for research, development, test, and evaluation (RDTE).
- Provides acquisition, logistics support, and technical assistance for materiel systems.
- Performs other materiel acquisition management functions.
- Provides the Army's national logistics system-level maintenance support for items of materiel used by the Army.
- Serves as the DOD single manager for conventional ammunition.
- Provides management of operational policies, programs, objectives, and resources associated with its worldwide Logistics Assistance Program.

Additionally, USAMC accounts for and manages Army Reserve and operational

projects (OP) worldwide. These functions and capabilities may be provided to the Army component command through the logistics support element (LSE).

Logistics Support Element. LSE is a flexible, deployable multifunctional unit. It commands and controls forward elements of the strategic base. These forward elements are composed primarily of DOD civilians and contractors. The LSE is structured to link the industrial base with the operational-level units and, through the logistics assistance representatives, with tactical logistics. The CINC and ASCC require a tailorable logistics C² element for forward elements of the national base. The LSE supports these needs by using a flexible combination of military, DOD civilian, and contractor personnel that allows it to alter its mission and size based on METT-T. The objective of the LSE is to sustain readiness by operating as far forward as feasible, minimizing the evacuation of critical repairable from the theater of operations and thus reducing the flow of replacement materiel.

Military Resources

CJCS considers theater strategies and plans when prioritizing and apportioning forces and resources among the combatant commanders. National strategic planning for mobilization, predeployment, deployment, entry operations, postconflict operations, redeployment, and demobilization is based on the planned employment and sustainment of forces by the various combatant CINCs.

The strategic concept of operations of the theater campaign plan imposes requirements on mobilization timing and generation of necessary force capabilities. Campaign planners and mobilization planners must coordinate and integrate closely. Strategic deployment planning focuses on intertheater movement of forces and sustainment of the theater for intratheater deployment, concentration, and employment to support the theater campaign plan. The CINC's priorities are the basis for either movement.

The NCA may direct the use of strategic forces or reserves to support the CINC's employment concept. The CINC considers that these forces may be apportioned to generate decisive combat power and provide protection and security for deploying theater forces or be used against external threats that could affect the outcome of the campaign.

Additionally, national-level assets may support the CINC's employment concept for conducting operations security (OPSEC), deception, psychological operations (PSYOP), SOF, civil affairs (CA) operations, and other operations as unique operations within unified operations.

Each service is responsible for providing personnel, administrative, and logistical support to its forces. The ASCC, in conjunction with his subordinate senior army commanders assigned to the unified or subunified command, develops supporting plans to provide and maintain adequate logistical support to Army service forces and other forces as directed throughout all phases of the campaign.

As a rule, the JTF does not have an ASCC. However, the CINC may designate the ASCC as the subunified commander or CJTF. The JTF has

an ARFOR headquarters that provides requisite support to ARFOR within the JTF and requests additional support from the controlling unified or subunified command ASCC. Based on the supporting plans developed by the controlling unified, subunified, or JTF command, the ARFOR headquarters develop its logistical plan.

In the event that national mobilization of forces accompanies campaign plan execution, special plans and management may be required to ensure available supplies to meet campaign priorities. In addition, as these mobilized forces deploy, planners develop theater distribution plans to eliminate bottlenecks at arrival and intratheater movement points. The CINC coordinates and effects support agreements with the host nation and allies for logistics, facilities acquisition, transportation, and other operations support.

MAJOR OPERATIONS

A major operation is the ARFOR's coordinated execution of land operations of a joint operation that is part of a particular phase of a subordinate's or CINC's campaign. A major operation sequences Army activities, battles, and engagements to attain operational-level objectives. Senior army commanders, as subordinates to a subordinate JFC, and their senior staff officers execute operational art through the design and conduct of major operations, including contingency operations.

Often the ASCC/ARFOR is the supported commander planning and executing a major operation. Then, the execution of the operation's general direction is exercised by the ASCC/ARFOR. This impacts in particular on the planning of deep operations; deep fires; interdiction; Army airspace command and control (A²C²); and reconnaissance, intelligence surveillance, and target acquisition (RISTA) within the senior army commander's AO.

Sometimes, the ARFOR commander is a supporting commander who plans and executes major operations of the campaign. For example, the ARFOR may be the supporting commander to the JFACC and the supported commander for the JFC's overall air interdiction effort.

Operational-level planners develop major operations to support the series of related joint operations of the joint campaign plan. These

major operations also support the unified operations of the theater campaign when subordinate missions require a phased, related series of joint operations to achieve theater strategic objectives. Major operations that support joint campaigns occur under certain circumstances.

- First, a CINC assigns theater strategic objectives and provides strategic guidance and operational focus to an immediate subordinate.
- Second, the CINC may establish multiple operating areas within a theater. Under both sets of circumstances, the strategic importance of the objectives, the guidance, and the complexity of the joint operations require the development of joint, single-service, supporting, and special operations forces that complement both the subordinates' joint campaign and the CINC's theater campaign.

OPERATIONAL-LEVEL PLANNING

Operational-level plans can include subordinate campaign plans and plans for major operations. These plans support the theater strategic objectives by linking those objectives to tactical-level operations.

Subordinate Campaign Plans

The combatant commander may opt to divide the theater of war into theaters of operations. When directed, principal subordinate JFCs develop subordinate campaign plans or OPLANs that accomplish or contribute to the accomplishment of theater strategic objectives. These plans support and extend the theater CINC's concept of operations in a sequence or set of joint operations composed of integrated major operations and battles. These plans support the theater campaign plan by achieving specific strategic objectives or by establishing conditions for further operations that lead to the specified end state.

The principal CINC reviews subordinate campaign plans, along with the necessary supporting plans, to ensure they are valid, synchronized, and support the concept and objective of the theater campaign plan. Appendix B provides an example of a subordinate campaign plan.

Major Operations Plans

ARFOR with employment roles that support JFCs develop major operations plans to support the theater or subordinate campaign plans. Plans are objective-driven and, when applied collectively to the joint force, provide the integrated and mutually supported effort to generate and concentrate combat power at the operational level of war. Appendixes C, D, and E provide examples of major operations plans for peacetime, conflict, and war, respectively.

SERVICE-COMPONENT-LEVEL PLANNING

The ASCC's planning responsibilities are contingent on the Army's role in supporting theater-level unified operations. These responsibilities can range from planning, to participating in joint operations with other components, to participating in major operations, to planning only for the service support of Army forces of the subordinate joint commands.

Major Operations Plans

The ASCC's responsibilities for planning and conducting major operations depend on how the combatant commander exercises his COCOM options. If the combatant commander elects to exercise COCOM through the ASCC by delegating OPCON to him, then the ASCC conducts major operations in conjunction with

the other service components and also provides logistical support for all ARFOR assigned to the theater and to other services as required. The ASCC plans and conducts major operations as directed by the CINC. In those instances where the CINC elects not to use the ASCC to plan and execute major operations, the ASCC, while providing logistical support for the Army forces, also recommends to the CINC the proper Army force composition and employment as part of the operational-level commander's delineated requirements.

Sustainment or Reinforcement Plans

The capability to sustain the campaign from beginning to end sets the tempo of operations. Sustainment or reinforcement planning—part of logistics-preparation-of-theater (LPT) process—identifies and provides the available supplies, equipment, materiel, replacement personnel, and HNS infrastructure to sustain the involved forces according to the CINC's concept of operations. LPT plans, developed by logisticians at all echelons, must include provisions for infrastructure development and defense and be consistent with the strategic aims and CINC's intent. FM 100-16 describes the LPT process in detail.

MULTINATIONAL OPERATIONAL-LEVEL PLANNING

Achieving unity of effort in multinational operations is critical for success. Multinational operations planners ensure success by determining how US campaigns integrate with alliance or coalition forces and how intelligence and logistics resources are shared. Understanding the personalities and sensitivities of the senior commanders and the national character of each of the allied armies is the key to successful leadership in multinational army operations. In addition, understanding their capabilities, personal and professional habits, and training background is important.

Commanders must establish effective working relationships among themselves. They must establish rapport, mutual respect, and unity of effort; use liaison officers; develop standardization agreements; and overcome language barriers. History has shown that it is possible for military leaders having a wide divergence of cultural backgrounds to cooperate

effectively while conducting multinational military operations.

Military capabilities of nations differ based on doctrine, training, and equipment. Even in the US Army, differences exist among commands concerning interpretation and execution of doctrine. Some doctrines may emphasize offensive operations; others defensive. Some nations prepare for highly mobile, mechanized operations, while others concern themselves with insurgent or other forms of warfare.

The multinational commander must recognize the relative strengths and differences of the multinational force cultures. Decisions on employment must include the capabilities of the multinational force. They must be made in consultation with the military leadership of those forces.

The multinational commander must carefully balance the allocation of capabilities. Subordinate commanders may have a tendency to request control of forces that provide capabilities not organic to that nation's forces. The guiding principle is not to hold assets that are needed by others, while at the same time not diluting the concentration of critical capabilities.

Relationship to Campaigns

Campaigns may be conducted within the context of an alliance, coalition, or other international arrangement. Planning is accomplished through US, multinational, or international channels. Coordinated planning on such matters as operations, logistics (including infrastructure), intelligence, deception, electronic warfare [EW], communications (including infrastructure), ROE, and diplomatic ends is essential for unity of effort. The preparation of supporting plans addressing coordination and liaison, HNS, and the provision of mutual support are examples of essential tasks that the theater CINC must accomplish.

Employment

During multinational operations, the multinational chain of command performs detailed employment planning, to include employment of national and international agencies. These multinational plans may serve as the basis for the US campaign plan and supporting plans, or the US campaign plan might provide the basis for employment

planning of multinational or coalition forces. Subordinate commands, such as service and functional component commands, subunified commands, and JTFs, prepare the necessary supporting plans for the conduct of joint operations that support multinational objectives.

Logistics Support

Traditionally, the responsibility for logistics support to national component forces remained with the responsible authorities of the nations concerned. In a multinational environment, logistics support must be the collective responsibility of the nations involved. The logistical objective in a multinational environment is to achieve the greatest degree of logistical standardization that is realistically achievable, given operational constraints, diplomatic and legal demands, and the existing capabilities of the multinational participants. Logistical standardization is affected by such factors as compatibility and interoperability of equipment, interchangeability of combat supplies, and commonality of procedures. Also, planners must develop methods to prevent competition for resources, particularly infrastructure and LOCs, that could adversely affect operations.

Planners should consider options for contracting, acquiring HNS, obtaining support from other national forces, and integrating such support within the multinational force. These options can furnish critical support and resources that are not available through normal organizational means. Planners should understand and consider rationalization, standardization, and interoperability (RSI) during planning.

Intelligence

Multinational commands include national and alliance intelligence systems. In keeping with the NCA guidance the CINC receives, intelligence information should be integrated and shared with the multinational command. If possible, the multinational command and other involved national forces must agree on these procedures well in advance of commencement of the campaign. Supporting plans should address such matters as information-sharing, complementary intelligence operations, and liaison. These plans also should address interaction with the multinational intelligence center (when established).

Information Operations

The Army applies information war/operations technology to support the CINC to enhance his battle command, improve battlefield agility, and make split-based operations possible. Effective use of information operations can prevent the initiation of hostilities by imposing the perception that taking hostile actions against the US or its allies would not be in the best interest of the potential adversary. Space-based systems offer an unrestricted environment to affect these operations.

Commanders must be able to access the *global grid* of worldwide information resources at any time and at any location in the world. The Army often takes the lead among service components for the entire joint and multinational theater signal support infrastructure. Essential planning considerations must include-

- Wide area network planning/management.

- Frequency management.
- Communications security (COMSEC) key management/distribution.
- Interfaces from theater systems to sustaining base.
- Integration of signal support assets in theater among joint and multinational forces.

The joint signal support architecture provides vertical and horizontal integration for army battlefield operating systems, as well as the interfaces that provide interoperability with joint and multinational forces' systems and the sustaining base. The key to future success is a seamless communications architecture that ties the many distributed communications and automation elements into an integrated, interoperable, and cohesive C⁴ network.

INTERAGENCY OPERATIONS

Interagency operations facilitate the implementation of all elements of national power. Interagency operations are critical to achieving the strategic end state, especially in MOOTW. The Army often operates in an interagency environment alongside other institutions of the US Government. This occurs when the military is the prime strategic option, as it is in war, but also when other instruments of national power are the preferred option and the military assists with forces.

Army forces must be prepared to conduct a variety of operations that integrate warfighting and MOOTW with a variety of government agencies, other services, and forces of other nations. These operations could include stability operations, NEO, counterterrorism, security, or arms control and verification.

Interagency operations facilitate unity and consistency of effort, maximize use of national resources, and reinforce primacy of the diplomatic element. DOD and CJCS coordinate interagency operations at the strategic level. This coordination establishes the framework for coordination by commanders at the operational and tactical levels. In some cases—such as peacekeeping—DOS is the lead agency and DOD provides support. In others—such as peace enforcement—DOD is the lead agency.

The CINC is the central point for planning and implementing theater and regional strategies that require interagency coordination. The CINC may establish an advisory committee to link his theater strategy to national policy goals and the objectives of DOS and concerned ambassadors. The CINC establishes a joint headquarters to conduct interagency coordination and planning. Military personnel may coordinate with other US Government agencies while operating directly under an ambassador's authority, while working for a security assistance organization or while assigned to a regional CINC.

Coordination among DOD and other US Government agencies may occur in a country team or within a unified command. Military personnel working in interagency organizations must ensure that the ambassador and CINC know and approve all programs. Legitimizing authorities determine specific command relationships for each operation. The command arrangement must clearly establish responsibility for the planning and execution of each phase of the operation.

Besides extensive US Government agency coordination, commanders also must fully integrate operations into local efforts when appropriate. Such integration requires close

coordination with local government agencies and bureaus; local military, paramilitary, or police forces, and multinational partners. A structure such as a mixed military working group comprised of senior officials of the military and other agencies may assist such an effort and include belligerent parties as appropriate.

As relationships among interagency participants mature, increased effectiveness can result. Interagency operations do not necessarily lend themselves to the joint geographic subarea of responsibility previously discussed. Overlapping operational and interagency boundaries can be a source of confusion.

Chapter 5

Execution

The Army commander executes major operations to support joint campaigns. He practices operational art requiring the synchronization of the six operational-level operating systems. (Minor differences exist between TRADOC Pam 11-9 and the Universal Joint Task List.)

- Operational movement and maneuver.
- Operational fires.
- Operational protection.
- Operational battle command. (FM 100-5 defines battle command and its impacts.
- Operational intelligence.
- Operational logistics. (TRADOC Pam 11-9 calls this “support.” Joint Pub 4-0 expands the definition of logistics to incorporate health services, engineer services, and current supply, maintenance, and distribution services.)

This functional approach is by no means the only way to look at the roles and responsibilities of the Army operational-level commander. The operational-level commander must successfully accomplish several complex operations that may not be easy to analyze. He should consider the operational-level operating systems as aids to identifying tasks that must be accomplished at the operational level. These systems provide a structure for the discussion in Part Three. They are a catalog of battlefield and support activities that place functions into logical—not procedural—relationships.

OPERATIONAL MOVEMENT AND MANEUVER

Operational movement and maneuver is the disposition of forces to create a decisive impact on the conduct of a campaign or major operation. The commander achieves this decisive impact either by securing the operational advantages of position before battle or by exploiting tactical success to achieve operational results. Simply put, operational movement and maneuver involves positioning the needed Army forces and resources at the critical time and place.

The theater CINC designs, organizes, and conducts campaigns. He sets the tempo and direction for the conduct of operations. He centralizes mobility planning, to include

supporting CINC's plans. His senior commanders consider mobility requirements from initial planning, or prehostilities, through mission accomplishment, or accomplishment of posthostility activities.

The CINC's theater strategic concept is the framework the senior army commander uses to develop his supporting plan. The essence of the Army commander's plan is the distribution of his available force to support the CINC's strategic concept. Operational movement and maneuver produces decisive impact on the campaign or major operation. All other operational-level operating systems seek to maximize the effect of movement and

maneuver. They are synchronized to produce a series of operational maneuvers that provide subordinate commanders with the necessary leverage to gain, retain, or sustain the initiative.

At the operational-level, the scope and complexity of movement and maneuver usually involve joint and multinational operations. Still, scale alone does not make movement or maneuver *operational*. Rather, operational movement and maneuver creates operational advantage; this can be achieved at various echelons.

OPERATIONAL MOVEMENT

Operational movement is the regrouping, deploying, shifting, or moving of service, joint, or multinational operational formations to and within the theater from less threatened or less promising areas to more decisive positions. From the Army commander's perspective, movement involves forces deployed into his area by the CINC and forces under his control that he moves within his AOR.

Strategic Deployment

Strategic deployment, specifically the time-phased arrival of forces in the theater, may be among the most challenging problems at the operational-level. An error in determining the proper sequencing of forces may be difficult, if not possible, to correct. The Army operational-level commander must ensure the correct mix of combat and support forces are sequenced to arrive in the theater to support the CINC's concept. He does this by influencing the development of the time-phased force deployment list (TPFDL) to ensure Army units and sustainment are sequenced into his operational area to support the planned sequence of operations. Forces required for port opening, reception, and onward movement must be sequenced early in the TPFDL to flow into the AO once the lodgment area is established.

The senior army commander is responsible for moving forces allocated by the CINC from ports of debarkation to specific locations within the Army's objective area. This responsibility includes the actual relocation or movement of operational forces by any means or mode of transportation. Prior to deploying the forces into combat formation, the senior army commander directs movement from positions within the operational area to a forward staging area or position.

Ground Combat Operations

Ground combat operations require coordinated movement and effective concentration of combat power against the enemy in spite of enemy interdiction efforts. Air defense, air and ground transportation, reconnaissance and security, service support, and traffic control are among the chief concerns as these large movements occur. Ground combat operations have the best chance of success when they are synchronized with air superiority and air interdiction operations. Senior army commanders direct the movement of subordinate forces, ensuring that by the end of a distinct phase of the major operation, forces are positioned in a way that enables rapid transition to subsequent phases.

OPERATIONAL MANEUVER

Maneuver is the means by which combat power is concentrated at the critical point to achieve the surprise, shock, momentum, and dominance that enable smaller forces to defeat larger ones. *Operational maneuver* is the means by which the commander sets the terms of battle, declines battle, or acts to take advantage of tactical actions. Throughout a combat operations area, attack, defense, and retrograde operations often take place simultaneously as each combatant attempts to mass, economize locally, and maneuver against his opponent.

Maneuver Operations

Prior to the conduct of offensive, defensive, or retrograde operations, senior army commanders, in conjunction with the JFC, posture their operational forces to influence the enemy. As the army commander postures his forces, he visualizes the depth of the campaign. Although initial deployment is important, army commanders posture for initial and subsequent operations, based upon their visualization of the operational end state.

Offensive Operations

The offensive is the decisive form of war and must be exercised in a coherent and cohesive manner. The key to success in an offensive operation is to defeat, destroy, or neutralize the enemy force. Offensive operations seek—

- To secure decisive terrain.
- To deprive the enemy of resources.
- To gain information.
- To deceive, divert, and hold the enemy in position.

- To disrupt the enemy's attack.
- To set up the conditions for future operations.

The goal is to mass effects, and not necessarily our forces, as we pursue offensive operations.

At the operational level, offensive operations may be directed against an element of the field force—the mass of enemy forces, the boundary between two of its major combat formations, a vital C² center, a logistical base, or LOCs. It also could be more abstract—the cohesion among allied forces, for example, or the mental and psychological balance of a key enemy commander. Operational-level commanders execute offensive maneuver simultaneously through operational envelopments, turning movements, infiltrations, penetrations, and frontal attacks—all of which must be integrated with air operations throughout the depth of their battle space to ensure the best chance for success.

Defensive Operations

Army leaders conduct defensive operations to defeat an enemy attack, gain time, concentrate forces elsewhere, control key terrain, wear down enemy forces as a prelude to offensive operations, or retain operational objectives. The defender must counter the attacker's initiative. At the operational-level, the defender may disrupt the enemy attack with spoiling, special deception, psychological, and interdiction operations. A successful defense has reactive and offensive air and ground elements working closely together to deprive the enemy of the initiative.

Army forces may either conduct a mobile defense that focuses on the destruction of the attacking force or an area defense that focuses on the retention of terrain. The mobile defense orients on the destruction of the enemy force by employing a combination of fire, maneuver, offense, defense, and delay to defeat its attack. The area defense absorbs the enemy into an interlocked series of positions from which the army commander destroys the enemy largely by fires.

Senior army commanders normally hold operational reserves in depth to seize the operational initiative during a defensive operation. These reserves may include dedicated forces, designated operating forces, generated forces from reconstitution, or incoming newly arrived forces.

Retrograde Operations

Retrograde operations are movements to the rear or away from the enemy. They gain time, preserve forces, avoid combat under undesirable conditions, or draw the enemy into an unfavorable position. Control of the airspace is the key to their success. The underlying reasons for retrograde operations are to improve an operational situation or prevent a worse one from occurring.

Peacetime Stationing Requirements

The CINC addresses peacetime stationing requirements in light of his potential warfighting needs and availability of forward-deployed forces. The ASCC controls trained and ready Army forces based overseas for CINC employment. Those forces are backed by rapid reinforcement by Army forces from the US or from other theaters. An evident mobilization capability and a demonstrated determination to respond effectively to crises can have significant deterrent value.

MOBILITY AND COUNTERMOBILITY

Operational mobility is linked closely to the concept of movement and maneuver. Operational movement and maneuver include the functions of providing mobility for operational forces and countering the mobility of enemy operational forces.

Facilitating maneuver of major formations without delays includes counteracting the effects of operationally significant obstacles. It also includes enhancing operational movement by preparing and improving facilities and routes critical to major operations.

Operational counter-mobility delays or otherwise hinders the movement of enemy operational formations, to include selecting and emplacing systems of obstacles for operational effect.

Terrain, both natural and man-made, significantly influences operational mobility. Terrain consists of coastal plains, mountain ranges, forests, jungles, deserts, rivers, river deltas, built-up areas, railroad embankments, pipelines, and so forth. Terrain affects the ability to sustain forces, often dictating the capacity of LOCs. This effect, in turn, can limit the size and composition of supported forces. In war, the operational-level commander considers the effect of terrain features upon ground movement and the ability of air power

to influence that movement by detecting ground forces and subsequently delaying, disrupting, and destroying the forces. In peacetime, the army commander may consider how these features affect accomplishment of missions supporting peacekeeping or humanitarian operations.

The commander must consider the effects of weather and be cognizant of its effects in the theater. Key terrain considerations for the

operational-level commander are linked to an understanding of battle space. The commander seeks to preserve freedom of operational movement by countering the effects of natural or man-made, operationally significant obstacles. He must be prepared to counter enemy movements by delaying, channeling, or blocking operational formations. The commander achieves this through the use of countermobility.

OPERATIONAL FIRES

The term *operational fires* refers to a commander's application of nonlethal and lethal firepower to achieve a decisive impact on the conduct of a campaign or major operation. Operational fires are a separate element of the commander's concept of operations (addressed separately from maneuver) but must be closely integrated and synchronized with the commander's concept of maneuver. Operational fires are joint, and potentially multinational, activities and are a vital component of any operational plan.

Operational maneuver and operational fires may occur simultaneously within a commander's battle space but may have very different objectives. In general terms, operational fires are *not* fire support, and operational maneuver is not necessarily dependent on operational fires. However, operational maneuver can be affected by such fires and can exploit opportunities created or developed by the JFC's operational firepower (Joint Pub 3-09). Operational fires are normally furnished by assets other than those required for the routine support of tactical maneuver. However, as the range of assets used to support tactical maneuver increases, those same assets will play a more significant role in the delivery of operational fires. The Army has significant capabilities for contributing to the joint, deep fight or planning and conducting its own deep operations, when necessary, using operational maneuver and/or organic operational fires.

Operational fires include targeting and attacking land and sea targets whose destruction or neutralization would have a significant impact on a campaign or major operation. Operational fires include the allocation of joint and multinational air, land, sea, and space means. In a war involving

weapons of mass destruction (WMD), fires could become the predominant operational instrument.

A synchronized, systematic, and persistent plan of attack among air and land and, when applicable, sea and space commanders is essential. Air superiority enables the ARFOR to execute operations without interference from enemy air forces and maintains tactical flexibility. Air component missions that contribute most directly to land operations are counterair, close air support (CAS), air interdiction, special operations, airlift, and surveillance and reconnaissance. An example is air interdiction operations flown against an enemy heavy division maneuvering to counterattack friendly forces during friendly offensive operations. The land forces contribute to air operations by fire—suppression of enemy air defenses (SEAD), land-based air defense, ground defense of air bases—and by maneuver through attack helicopter operations or seizure of air bases and air defense sites by ground forces.

THEATER AIR CONTROL SYSTEM

The supported CINC must effectively employ the air capabilities provided by the assigned or supporting service or functional component forces within his AOR. Each component within the unified command structure may conduct a variety of air operations in the CINC's AOR. Additionally, supporting CINCs may also fly missions to support the supported CINC's objectives. The supported CINC must integrate assigned and supporting forces into his theaterwide air operations and ensure component direct support air operations are coordinated with his theaterwide operations. The A²C² process

integrates the maneuver of Army aviation into the overall scheme of maneuver. Users of Army airspace achieve operational influence through the synchronization of air maneuver, using all battlefield operating systems focused throughout the depth of the AO. All Army airspace users fire and maneuver within the third dimension of the ground commander's AO. The A²C² process is used to synchronize these Army assets in the area above the ground commander's AO.

To ensure this integration, the CINC may choose to establish a functional component—the JFACC. This responsibility is normally assigned to the service that has the preponderance of air assets and the best capability to command and control joint air operations. Responsibilities of the JFACC are described in Joint Pubs 3-01.2 and 3-56.1. If the JFACC is not established, the air

component commander (ACC) is responsible for providing fixed-wing tactical air support to United States Army (USA) forces. Circumstances may require that the US Navy (USN) or US Marine Corps (USMC) provide all or part of the tactical air support for the ARFOR. Under such circumstances, the Naval component commander is responsible for providing the tactical air support. FM 100-103-1 describes multiservice tactics, techniques and procedures for integrating airspace C in a CZ. Figure 5-1 describes a notional C² structure for integration and coordination of joint fires.

The theater air control system (TACS) is not a formal system in itself but the actual sum of various component air-ground systems. The TACS includes the organizations, personnel, equipment, procedures, and techniques comprising the Army Air-Ground System

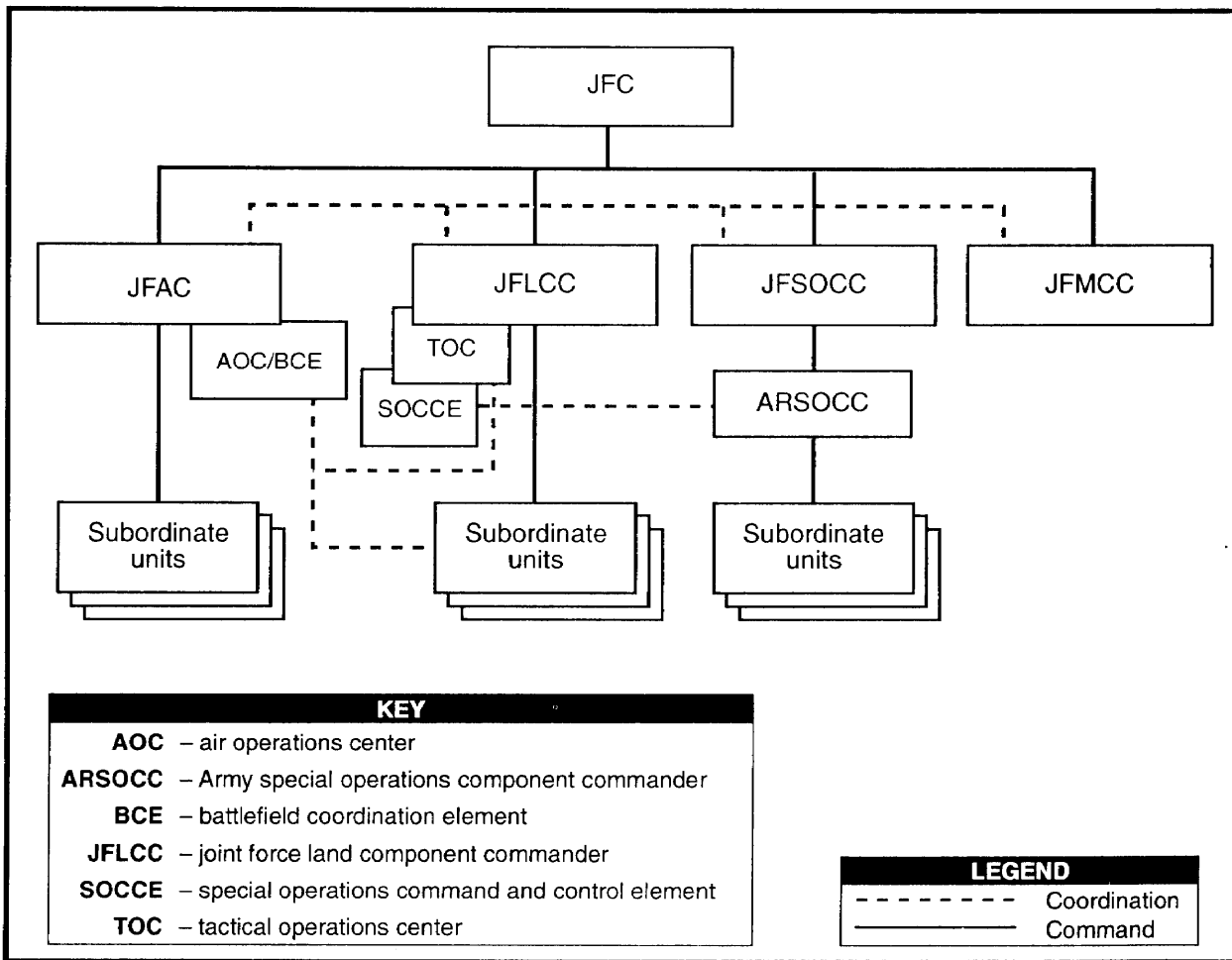

Figure 5-1. Notional Joint Fires Command and Control Structure

(AAGS) and the Air Force component commander's (AFCC's) TACS-related responsibilities and missions. The AAGS is the system necessary for providing the land component commander or ARFOR with the means for receiving, processing, and forwarding the requests of subordinate commands for air support missions and for the rapid dissemination of information and intelligence produced by air means.

TACS provides the same type of system for the AFCC. A similar system exists within the USN and provides the USN-USMC naval aviation C² system for naval aviation. FM 31-12 contains a detailed discussion of the USN-USMC C² system and the additional agencies included therein. Although components and agencies of the TACS belong to different services and sometimes to different nations, they function as a single entity in planning, coordinating, and integrating air support operations with ground operations.

The AAGS begins at the highest echelon in the theater and extends through all echelons down to maneuver battalions. This system is used for coordinating and integrating tactical air support with ARFOR ground operations. The AAGS is composed of operations, fire support, air defense, Army airspace C², and liaison elements. Each Army component of the system is designed to operate with an element of the US Air Force (USAF) TACS but is also compatible with both USN and USMC air control systems. Figure 5-2 illustrates the components of a typical TACS and the locations of the liaison elements within the AFCC.

OTHER SYSTEMS

Technology is improving extended-range acquisition and attack systems such as the multiple launch rocket system (MLRS), the Army tactical missile system (ATACMS), and the Apache attack helicopter. These systems allow the Army to extend battle space and play a larger role in decisive deep operations.

Senior army commanders must orchestrate available Army, joint, and multinational lethal delivery systems to disrupt, delay, destroy, or degrade enemy operational forces or critical functions and facilities. They must ensure that systems designed to impair, disrupt, or delay the performance of enemy operational forces, functions, and facilities are coordinated with fires. The extended range and flexibility of attack helicopters and fire support systems make it

possible to shift the focus and concentration of fires rapidly over the width and depth of the operational commander's battle space. EW, PSYOP, special reconnaissance, and SOF must be synchronized with operational fires in war, or they may be used by themselves in MOOTW.

PLANNING

In the past, theater air forces have provided operational fires; however, the increasing range and accuracy of projectile, rocket, and missile systems, combined with maneuver and attack capabilities from attack helicopters and light forces, now provide the Army commander with his own organic operational-fires capability. The ability of each service to engage targets at operational depths demonstrates the inherent joint and potentially combined nature of operational fires.

The senior army commander, in supporting the CINC's campaign plan, plans operational fires within his AO. His major role is to synchronize ground and air operational fires in his AO to achieve operational and tactical objectives. The army commander applies operational fires in depth to achieve operational objectives quickly with minimum casualties.

The army commander plans operational fires from the top down (the operational commander establishes objectives and designates and integrates targets, then passes them to the subordinate joint or allied units for execution). The Army commander executes those fires with organic and allocated assets and by nominating targets that he cannot strike with these assets to the JTCB. He uses the targeting process to shape the battle space and synchronize fire support, interdiction, and maneuver. He does this using the decide, detect, deliver, and assess (D³A) methodology and participating in the JFC's joint targeting process.

The D³A methodology enables commanders to respond rapidly with synchronized operations to events vital to establishing favorable conditions for mission accomplishment. The D³A methodology is a process that helps a commander's structured attack of critical targets and creates a favorable battle tempo for friendly forces, particularly at decisive points and times during the operation.

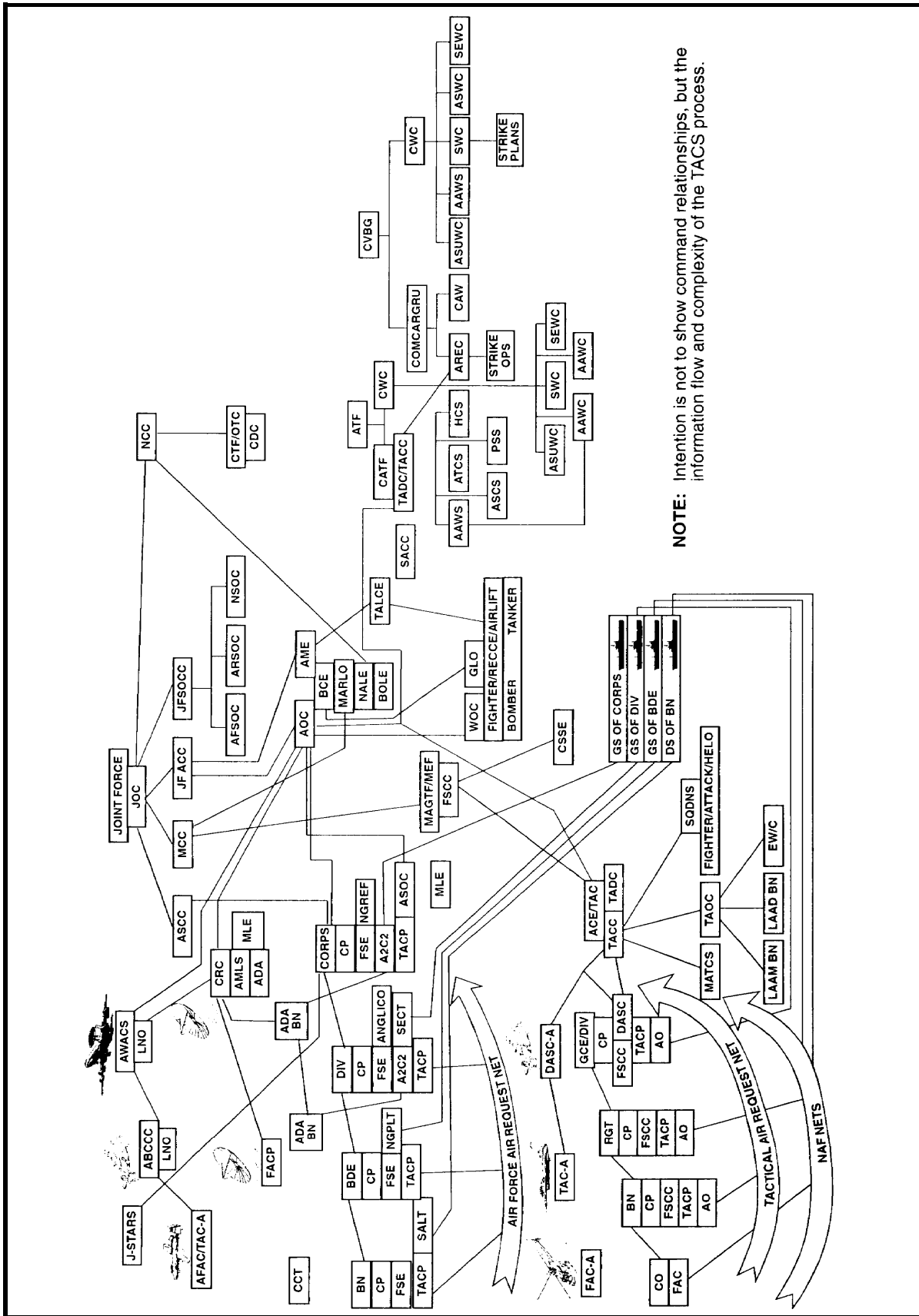

NOTE: Intention is not to show command relationships, but the information flow and complexity of the TACS process.

Figure 5-2. Theater Air Control System

During the air and artillery preparation of the Operation Desert Storm battlefield, the coalition forces delivered large numbers of cluster-type munitions and scatterable mines on the enemy. Due to several factors, including faster-than-anticipated rates of advance and a higher-than-expected dud rate coalition, ground forces operated in terrain heavily *seeded* with unexploded ordnance.

This methodology requires extensive lateral and horizontal coordination, which the staff does, based on the commander's intent. In planning operational fires, both ground and air component commanders consider the effects that all fires, especially scatterable mines and cluster-type munitions, may have on future ground operations. FMs 101-5 and 6-20-10 discuss the targeting process in detail.

Commanders concentrate the effects of their fires rather than massing the weapons themselves. Extended-range acquisition and attack systems allow the commander to reduce the vulnerability of his forces by dispersing the friendly forces and massing effects on the enemy. However, fires alone are unlikely to achieve completely operational objectives. Integrated properly with operational maneuver, fires can help achieve a decisive impact on the operation.

GENERAL TASKS

Operational fires help the Army commander accomplish his mission and protect the force. Operational fires achieve both operational and tactical objectives while holding enemy critical functions at risk throughout the depth of the battle space. Operational fires are more than *deep* fires. They achieve operational objectives by extending the battlefield in both space and time. Targets critical to the success of friendly operations exist throughout the depth of the battlefield. Current and emerging capabilities permit their acquisition and attack at increasing ranges and with faster response times. Operational fires expose or attack enemy centers of gravity. Attack of key operational targets helps to set the conditions for operational maneuver. Disrupting, delaying, or limiting critical enemy functions helps the commander dictate the terms for the close fight. Operational fires may hold or deny terrain in support of both operational and tactical objectives.

Tactical objectives are supported by the ability of operational fires to disrupt, delay, or limit enemy capabilities that would impact immediately on the current battle. Tactical objectives support the attack of committed enemy formations throughout their depth. This support helps the commander seize and retain the initiative, alter the tempo of operations, and set the conditions for decisive close combat.

Support of both operational and tactical objectives through operational fires is based on the ability of operational fires to hold all critical enemy functions at risk throughout the depth of the battle space. Operational fires neither leave the enemy a place to hide nor time to rest, critically limiting his freedom of action. As such, operational fires hasten the physical destruction of the enemy force and the disintegration of cohesive operations and demoralize the enemy's will to fight. In MOOTW, the availability of operational fires to the commander acts as a deterrent to escalation of conflict and, when necessary, provides him additional means to accomplish the mission and protect the force.

Also, the enemy may possess a sophisticated operational fires capability. The Army commander must consider enemy capabilities and establish measures to protect the force. Operational fires may be used to disrupt enemy capabilities before they can be used against friendly forces. Examples include theater missile defense, counterreconnaissance, surveillance and target acquisition, counterfire, and joint suppression of enemy air defenses (J-SEAD). Operational fires focus largely on one or more of three general tasks: facilitating maneuver, isolating the battlefield, or destroying critical enemy functions and facilities.

Facilitating Maneuver

Operational fires can facilitate maneuver in depth by suppressing the enemy's deep-strike systems, disrupting the enemy's operational maneuver and tempo, and creating exploitable gaps in tactical defenses. Interdiction and

maneuver are inseparable operations against a common enemy. *Interdiction* directs, disrupts, delays, or destroys the enemy's surface military potential before it can be used effectively against friendly forces (Joint Pub 1-02). Effective interdiction and maneuver are complementary operations designed to achieve the JFC's campaign objectives. Together they present the greatest dilemma to the enemy. The synergy achieved by integrating and synchronizing interdiction and maneuver assists commanders in optimizing leverage at the operational level.

When the campaign calls for ground operations to be decisive operations or defeat mechanisms, planning for the interdiction operations and target prioritization must be based on the ground commander's concept of operations. Just as air commanders (Naval and Air Force) know and understand the capabilities, strengths, and weaknesses of opposing air forces, ground force commanders must know and understand the capabilities, strengths, and weaknesses of opposing ground forces.

Proper interdiction planning requires both air and ground expertise. The interdiction and maneuver planning responsibilities of the operational-level commander fall into two areas: influencing joint air interdiction operations and ensuring that ARFOR and JFLCC target nominations are struck according to available assets. To ensure integration of interdiction and maneuver, the Army operational-level commander must—

- Define Army interdiction objectives and priorities and provide them to the JFACC.
- Establish allocation of CAS effort between subordinate Army forces and the operational headquarters.
- Ensure the deep operations coordination cell (DOCC) determines high-payoff and high-value targets.
- Ensure that consolidated target, nominations reflect ARFOR priorities.
- Recognize that Army targets do not automatically get higher priority.
- Facilitate notification to subordinate unit commanders when the JFC determines that the circumstances have changed and therefore alter asset allocation priorities.
- If designated as an appropriate ground forces commander, establish a fire support

coordination line (FSCL) within boundaries and in consultation with superior, subordinate, supporting, and affected commanders.

Isolating the Battlefield

Isolating the battlefield is another major task of operational fires. Operational-level commanders isolate the battlefield by interdicting enemy military potential before it can be used effectively against friendly forces. Commanders usually combine this isolation with other operations in a simultaneous attack designed to use superior combat power to achieve quick, decisive outcomes.

While interdiction destroys enemy forces, its primary contribution to the operation is curtailing the enemy's freedom of movement and information flow and influencing the enemy's battle tempo by diverting, delaying, and disrupting enemy forces. Interdiction can slow the action of enemy reserves and obstruct the redeployment or movement of forces.

Interdiction of the logistical support system disrupts enemy operations by choking off the enemy's combat power. Friendly ground and air forces must exploit the enemy's reduced freedom to maneuver and synchronize this reduction with other operations to achieve the desired tempo of operations.

Destroying Critical Enemy Functions and Facilities

Operational-level commanders may use operational fires to destroy critical enemy functions and facilities. Critical targets may include high-value C systems, mobility assets such as fixed and mobile bridging, air defense sites, and enemy long-range delivery systems such as surface-to-surface missiles, theater ballistic and cruise missiles, airfields, and aircraft.

The objective in such cases is the deliberate elimination or substantial degradation of critical enemy operational capabilities, for example, attaining air superiority by destroying enemy air operations and air defense capabilities. Operational fires do not necessarily depend on other concurrent operations for success; however, they may be employed with other systems and maneuver in a simultaneous attack of enemy operational capabilities. Operational fires are particularly attractive in a theater where lack of resources may preclude major ground offensive operations.

ORGANIZATION

The senior army commander ensures unity of effort and purpose by organizing fires in his operational battle space. He is a major planner of operational fires and a major allocator of fire support resources. He closely coordinates joint and multinational assets. He allocates or controls resources and designates missions to subordinates. They attach forces, establish support relationships, or control usage; specify the degree of risk; and retain systems control. A primary consideration for the Army commander is the allocation of scarce operational fires resources, especially air assets.

COORDINATION

The senior army commander and his staff play a major part in coordinating joint and multinational assets. Under the guidance of the JFC, land, air, and maritime components execute major operations designed to attain strategic objectives. The JFC synchronizes operational-level fires as part of the joint planning process. This process entails component coordination and cooperation in the employment of all fires.

Deep Operations Coordination Cell

The DOCC¹ is a proposed fire support element at the operational-level headquarters that plans, coordinates, and executes employment of operational fires. Chapter 7 discusses the DOCC in detail. J-SEAD is an example of this type of coordination and cooperation.

Battlefield Coordination Element

The Army DOCC effects coordination with other services through the battlefield coordination element (BCE). The ASCC

provides the BCE and collocates it either ashore or afloat with the ACC's air operations center (AOC) or theater equivalent. The BCE expedites the exchange of information through face-to-face coordination with elements of the AOC established by the ACC. The AOC is the operational facility in which the ACC centralizes the planning, direction, and controlling functions over all tactical air (TACAIR) resources.

The BCE's basic mission is to facilitate the synchronization of air support for Army operations. The BCE is responsible to the ASCC/ARFOR commander and coordinates with and receives objectives, guidance, and priorities from his operations officer (G3). Specific missions include processing land forces' requests for TACAIR support, monitoring and interpreting the land battle situation for the AOC, providing the necessary interface for the exchange of current intelligence and operational data, and coordinating air defense and airspace control matters.

Historically, the BCE has worked with the Air Force in this coordination role, but with the changes in world environment and joint doctrine, the Army BCE can expect to work in contingency operations with USMC and maritime air component commanders. Planners must identify and resolve problems that result from these less-practiced and less-refined linkages. If the BCE collocates with an AOC, it is organized into sections corresponding to the AOC's. Figure 5-3 illustrates the organization of the BCE and its interface with tactical air control. For more information on the BCE, consult FM 100-103, FM 100-15, and 71-100 series FMs.

OPERATIONAL PROTECTION

Operational protection conserves the fighting potential of a force so that it can be applied at the decisive time and place. Operational protection includes actions taken to counter the enemy's firepower and

maneuver by making soldiers, systems, and operational formations difficult to detect, strike, and destroy. Operational protection pertains to forces everywhere in the theater of war or operations. Operational protection includes, but is not limited to-

- Providing operational air defense.
- Conducting deception.
- Protecting operational forces and means.

1. To accomplish this mission, the 3d US Army formed a deep operations targeting cell during Operations Desert Shield and Desert Storm.

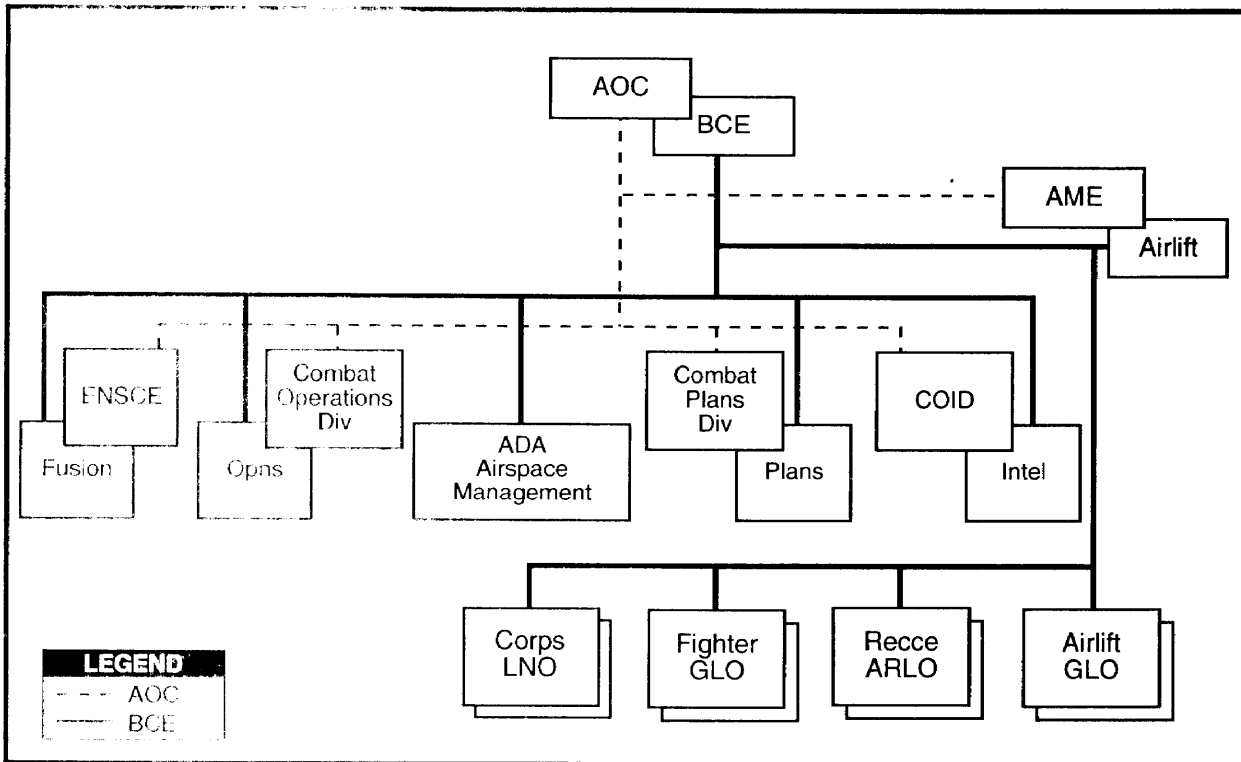

Figure 5-3. BCE/Tactical Air Control Interface

- Employing OPSEC.
- Providing security for forces and means.
- Conducting rear operations, which includes combatting terrorism.
- Conducting risk assessments.
- Planning for possible response or use of WMD.

PROVIDING OPERATIONAL AIR DEFENSE

All members of the combined arms team perform air defense operations; however, ground-based air defense artillery (ADA) units execute the bulk of the force protection mission. Army ADA provides protection to forces and selected geopolitical assets from aerial attack, missile attack, and surveillance. Significant considerations for employment of ADA in theater operations include its role in joint and multinational counterair operations, theater missile defense, the threat, available assets, and organizations.

Air Threats

The entire spectrum of threat air operations can be flown with theater-level

assets. Enemy air operations may include tactical ballistic missile (TBM), air-to-surface missile (ASM), and cruise missile (CM) attacks. The full spectrum of enemy air threat includes UAVs, rotary- and fixed-wing aircraft, and airborne and air assault operations. The current approach to theater missile and air defense places emphasis on leveraging the synergy of joint capabilities to the maximum extent possible to counter the threat. Each joint force component addresses the target sets that they are best equipped to engage and destroy.

The first target set is ballistic missiles. Ballistic missiles can be strategic, operational, or tactical. They may also have guided munitions. Because of detection difficulties and inadequate kill potential, manned aircraft are inappropriate platforms to counter TBMs in the terminal phase. The TBM target set is best engaged by ground-based systems as demonstrated by Patriot ADA during Operation Desert Storm. Manned aircraft are best suited by design for air-to-air engagements of other manned fixed-wing aircraft.

A second target set committed against theater assets is cruise missiles, UAVs, and fighter/bomber aircraft that evade the defense

counterair operations of the joint air forces. Ground-based air defense systems are best equipped to engage these targets. UAVs and helicopter platforms typically operate at altitudes where fixed wing air-to-air combat is not employed. These targets are destroyed through ground-based systems, thereby contributing to protection of forces and geopolitical assets and denying the enemy surveillance of friendly force activities.

The contribution of all services to theater missile and air defense offensive and defensive tactics engages all applicable target sets. These offensive and defensive tactics cover all aspects of active and passive defense measures throughout the theater.

Joint and Multinational Counterair Operations

Joint and multinational counterair operations are conducted to attain and maintain a desired degree of air superiority by destroying or neutralizing enemy forces. Joint and multinational counterair operations include both offensive and defensive measures taken against enemy air threats. Offensive counterair (OCA) operations destroy, disrupt, or limit enemy air threats as close to their source as possible, whereas defensive counterair (DCA) operations are conducted primarily to counteract enemy air offensive actions to nullify or reduce the effectiveness of hostile air attacks.

Air defense forces conduct DCA operations using both active and passive measures. Active DCA operations use ADA; EW; Army aviation; and chemical (smoke), combined arms, and air elements to disrupt or destroy airborne enemy aircraft, missiles, and other aerial vehicles that pose attack and surveillance threats. Passive DCA measures such as cover, concealment, signature reduction, smoke operations, and deception frustrate enemy targeting efforts and minimize the effects of enemy attacks.

Theater Missile Defense

FM 44-100 states that the objectives of theater missile defense (TMD) are—

- To reduce the probability of and to minimize the effects of damage caused by a theater ballistic missile attack.
- To detect and target theater missile platforms.

- To detect, warn of, and report theater missile launch.
- To coordinate a multifaceted response to a theater missile attack.
- To integrate TMD with other combat operations.

TMD has four operational elements—*passive defense, active defense, attack operations, and command, control, communications, computers, and intelligence (C²I)*. The Army contributes to all four. Passive measures reduce the vulnerability of critical forces and assets to theater missile attack. Active defenses engage missiles and enemy aircraft armed with air-to-surface missiles in flight. Attack operations are conducted to prevent the launch of theater missiles. C²I is required to coordinate and integrate the defense against the theater missile capability.

The senior Army air defense command in theater executes a key portion of the TMD concept. Air defense forces are task-organized to defend in a TMD task force. The TMD task force protects a mix of force organizations and geopolitical assets that represent a high priority for protection by the TMD. It is composed of two overlapping tiers. The upper tier is defended by theater high-altitude air defense (THAAD). The lower tier is defended by the Patriot. Through TMD, both OCA and DCA actions are taken against theater missiles. Simultaneous with the active defense operations to destroy inbound theater missiles are the attack operations to facilitate counterfires using the flight data of the threat TBM to locate the launch point. This is an operational action that can extend air defense activities far beyond the corps deep battle area. For additional details on TMD, refer to FM 44-100.

CONDUCTING DECEPTION

The conduct of deception contributes greatly to the protection and survivability of operational forces. Operational deception consists of those operations that purposely mislead enemy decision makers by distorting, concealing, and falsifying friendly intentions, capabilities, and dispositions. Deception includes protecting the commander's own intentions, disseminating misinformation to deceive the enemy about those intentions, obscuring areas of the theater, and determining the effect of the deception.

The ultimate goal of deception is to mislead the opposing military commander, prompting him to plan and conduct his activities in a manner that unwittingly serves the friendly force's objectives. Deception operations are planned and executed at the operational level of war and synchronized with strategic objectives. They can support theater objectives by deterring the escalation of conflict, destroying the enemy's warfighting means, gaining and maintaining the initiative, and shaping the enemy's scheme of maneuver.

The operational-level commander participates in the deception process at two levels. He may plan and execute deception operations within his mission purview, or he may be asked to provide planning and operational-level support for deception activities planned and executed by subordinate, adjacent, or higher command echelons. Deception operations at the operational level must complement or reinforce the theater deception plan effort. The operational-level commander reconciles operational and tactical deception plans to ensure they complement but do not contradict the strategic (theater) plan.

PROTECTING OPERATIONAL FORCES AND MEANS

The operational-level commander safeguards his operational force by reducing the effects of enemy operational-level actions (movement, radio electronic combat, and so forth). He does this by preparing operationally significant fortifications, removing operationally significant hazards, and protecting the use of the electromagnetic spectrum.

The operational commander provides protective construction hardening for operational forces and key facilities, for example, C², logistics, and rear area positions. However, even hardened facilities are vulnerable to a determined attack. The operational commander eliminates hazards that may adversely affect the execution of his plan. Additionally, he ensures that actions are taken to ensure friendly, effective use of the electromagnetic spectrum, despite the enemy's use of EW.

EMPLOYING OPERATIONS SECURITY

The operational-level commander attempts to hide friendly force indicators associated with

planning and conducting major operations. He does so by employing signal security (SIGSEC) and concealment techniques and avoiding operational patterns.

The operational-level commander protects emitters and information transmitted through friendly C² communications-electronic systems from enemy exploitation. He also hides operational forces and facilities from enemy observation and surveillance sensors. He ensures units vary activities and ways of conducting operations to avoid predictable patterns that are vulnerable to enemy interception.

PROVIDING SECURITY OF FORCES AND MEANS

By identifying and reducing friendly vulnerability to hostile acts, influence, or surprise, the operational-level commander enhances the force's freedom of action. Enhancement consists of measures to protect the force from surprise, observation, detection, interference, espionage, and sabotage. It includes protecting and securing the flanks of operational formations, critical installations, facilities, and systems.

CONDUCTING REAR OPERATIONS

The operational-level commander is responsible for rear operations subject to applicable host nation laws and agreements. Rear operations include those activities that allow freedom of maneuver in the COMMZ, continuity of sustainment, and uninterrupted battle command. The combatant CINC is ultimately responsible for all rear operations in the theater of operations. He normally assigns subordinate commanders the responsibility for operations in a JRA according to mission requirements, force capabilities, the strategic environment, and the threat. The CINC may assign the overall mission of rear operations to one commander—the JRAC. The JRAC must ensure integration of all rear operations missions and forces and synchronization with the CINC campaign plan.

The potential magnitude of the threat to the theater base and COMMZ dictates that US forces be trained to cope with threat forces when and where they attempt to interrupt COMMZ operations. The operational-level commander uses every appropriate active and passive measure for defense against detection

from the air, attack from the ground, and compromise of friendly defense systems.

Successful rear security operations are critical in the rear area since it contains the LOCs, establishments for supply and evacuation, and agencies required for immediate support and maintenance of field forces. The key tasks of successful rear security operations are—

- Coordinating base/base cluster defense plans.
- Collecting, integrating, analyzing, and disseminating timely and accurate intelligence.
- Patrolling aggressively in coordination with the host nation, to intercept and defeat small threat forces before they close on their objective.
- Deploying forces sufficient to counter the enemy intrusion.

CONDUCTING RISK ASSESSMENTS

Also integral to force protection is the conduct of risk assessments. Risk assessments identify hazards and examine the resulting risks associated with the mission. Special risk considerations must be made where the threat of WMD exists. Risk assessment is dynamic. As circumstances change and the command's experience level increases, risk assessments confirm and reconfirm critical information that affects decisions.

PLANNING FOR POSSIBLE RESPONSE OR USE OF WEAPONS OF MASS DESTRUCTION

US policy concerning nuclear warfare is to deter it, and, if deterrence fails, to terminate the conflict at the lowest possible level of violence consistent with national and allied policy objectives. This policy does not preclude US first use of nuclear munitions. Nuclear weapons may only be used following the specific directives of the President.

Since the Army no longer has an organic nuclear capability, it must rely on other services for delivery of nonstrategic nuclear weapons to support its operational warfare requirements. Nuclear weapons should be integrated with other fire support systems to achieve the greatest operational advantage.

The potential employment of WMD can have an enormous impact on the conduct of all operations. These strategic, operational, psychological, and political impacts affect campaign designs. The sheer killing and destructive power of these weapons create an illusionary battlefield effect. Further, the proliferation of WMD dramatically alters the nature of regional conflict.

As these weapons proliferate, the likelihood of their use against friendly forces or in response to an enemy's first use increases. The effects of these weapons on a campaign or major operation—either through use or the threat of use—can cause large-scale shifts in tactical objectives, phases, and/or COAs. Thus, planning for the possibility of their use against friendly forces is critical to campaign design. Commanders must be aware of the political as well as public sensitivities to the use of WMD and be prepared to respond to the possibilities of postuse public relations problems.

From the combatant commander's perspective, a swift end to a conflict will partially negate the escalator potential of these weapons. A combination of conventional offensive and defensive measures can help deter or reduce the likelihood of an enemy's use of these weapons. Offensive preventive measures may include raids, surgical air strikes, and operations designed to locate and neutralize the threat of such weapons. Commanders implement the defensive nuclear, biological, chemical (NBC) principles of avoidance, protection, and decontamination. They also plan for effective air and ballistic missile defense with different systems. US military policy attempts to deter enemy use of WMD through a defense posture that allows US forces to survive, fight, and win under conditions produced by these weapons.

Commanders must assess an enemy's willingness to employ these weapons and the conditions that would prompt him to do so. However, commanders should never assume rationality in the mind of the enemy. A virtually defeated enemy may resort to unrestricted warfare by any means at hand.

Army forces may support use of WMD with SEAD or with the reconnaissance and selection of targets. More importantly, however, Army officers must participate in drafting and executing campaign plans that envision friendly use of WMD. The campaign plan must identify the requirement for strikes with WMD

that support campaigns and major operations. Additionally, Army planners should identify appropriate WMD targets and ensure integration of WMD into the campaign plan and/or major operation plan.

The Mass Destruction Environment

When WMD are used, extensive destruction and mass casualties can result. Only cohesive, disciplined, physically fit, and well-trained units can function in this environment. But long-term operations in this environment degrade even the best individual and unit performance as a result of wearing protective equipment. Commanders must train and equip soldiers and civilians alike to endure these conditions. By being better prepared than the enemy for continuous operations under conditions produced by WMD, US forces can maintain an advantage over the enemy that deters him from using these weapons.

Force protection is an imperative in this environment. Units can survive the use of WMD by anticipating their employment. Commanders can protect their forces in a variety of ways. These include training, OPSEC, dispersion of forces, and proper use of terrain for shielding against effects.

In an NBC environment, battle command becomes more difficult. Command posts and headquarters at all levels are likely targets. Control is difficult even within the smallest unit. Personnel in protective clothing are slow to respond to rapid changes in mission. The employment of these weapons greatly alters the tempo of combat. So, commanders must never assume that they are immune to attack but consider ways of decreasing their risk.

Contamination avoidance is essential for successful operation when faced with an NBC threat. Avoiding contamination allows units to maintain tactical momentum and preserves combat power by keeping soldiers out of increased NBC protective postures. It also removes or lessens the need for decontamination. Detailed information on NBC contamination avoidance is found in FM 3-3.

Multinational operations become more risky with the threat of NBC use. Countries that cannot protect themselves against these weapons may become the primary target of an enemy whose aim is to disintegrate the coalition. The likelihood that an enemy will use

WMD against other coalition members will increase as US forces demonstrate the ability to defend effectively against their effects. Commanders should consider that possibility in all strategic, operational, and tactical planning.

Nuclear Weapons

As a force that now lacks organic nuclear capability, the Army must rely on Air Force and Navy nuclear capabilities to deter regional threats from using WMD and, should it be necessary, to respond to regional use of these weapons. The integration of nuclear weapons and long-range ballistic missile systems expands the scope of regional conflict. Ballistic missiles significantly reduce reaction times and create complex planning and decision criteria. The ability of some nations to employ nuclear weapons at extended ranges, using ballistic or cruise missiles and high-speed aircraft, will significantly enhance their effectiveness as instruments of terror. With the ability comes the possibility of conflict escalation beyond the boundaries of the region.

Using intelligence estimates, planners advise the commander of the enemy's capability to employ nuclear weapons and under what conditions he is most likely to do so. A significant intelligence task is locating these weapons and assessing the probability of their employment. Accordingly, the integration of national, joint, and multinational intelligence means is vital to this effort.

The immediate effects of a nuclear detonation are blast, thermal radiation, initial nuclear radiation, and electromagnetic pulse (EMP). These effects can cause significant personnel and materiel losses. Secondary effects include urban devastation, fires, and radiological contamination. The EMP from a nuclear detonation can affect unshielded electronic equipment and degrade C'I systems. Residual radiation can also have long-term effects on personnel, equipment, facilities, terrain, and water sources. Therefore, ensuring that friendly force dispositions do not provide lucrative targets for nuclear weapons is important.

Biological Weapons

While the US has renounced the use of biological weapons, many nations have not. The availability of biological weapons to possible enemies requires that commanders prepare for operations in a biological

environment. Defensive measures are necessary to mitigate the effects of a biological attack. Both military and civilian populations require information and psychological and medical preparation.

Chemical Weapons

All current and future operations have the potential to occur in a chemical environment. US policy does not condone or authorize first use of chemical weapons. However, preparedness to operate in this environment negates many possible advantages for an enemy to employ these weapons. This preparedness is itself a deterrent.

Chemical weapons produce immediate and delayed effects that can hamper operations through the contamination of equipment, supplies, and critical terrain features. Commanders can reduce the effects of chemical employment by applying the fundamentals of contamination avoidance, protection, and decontamination. Chemical reconnaissance and decontamination are two planning imperatives for all future missions; training is the key. Detailed information on providing NBC protection to the force, as well as risk analysis and assessment, is found in FM 3-4.

OPERATIONAL BATTLE COMMAND

Initially described in FM 100-5, *operational battle command* is the exercise of authority and direction by a commander to accomplish operational objectives. The control mechanisms support the exercise of battle command. The commander's vision and his stated intent guide the organization toward the accomplishment of their mission or assigned tasks. Battle command focuses efforts, establishes limits, and provides structure to operational functions. Battle command supports the organization in the conduct of current operations while planning and preparing for future operations.

anticipating requirements, and using initiative. The senior army commander translates these principles, the CINC's strategic direction, and the operational-level objectives into a clear statement of intent.

The concept of battle space was developed to help the commander visualize and organize the projection of combat power to gain physical dominance over the enemy. Battle space is the three-dimensional physical environment—that is not constrained by boundaries—in which commanders visualize conducting combat operations over time. Commanders use the concept of battle space to help determine how the terrain and all available combat power can be used to dominate the enemy and protect the force. Eventually, this vision becomes the battlefield framework from which the commander's intent and concept of operation are derived. Understanding of this concept contributes to the synchronization of full-dimensional operations.

THE COMMANDERS RESPONSIBILITIES

Visualizing the battlefield is a continuing requirement for commanders. Battle command at the operational level includes the collection and protection of information, the assessment of that information, the selection of appropriate actions, and the establishment of direction for the leaders of subordinate operational forces. In exercising battle command, the operational-level commander considers those assets available from higher headquarters as well as from other service components and allies. He then organizes his command and delegates responsibilities.

Understanding also allows commanders to synchronize combat power against the enemy and keep the enemy from extending his battle space to its greatest range. This helps commanders determine how they might task-organize and position their units. By understanding how to visualize operations to disrupt the enemy in depth, commanders can synchronize operations to disrupt the enemy in depth to throw him off balance, to attack his functions, and to set the conditions for decisive victory. Synchronization, sequencing, and phasing of the battle within the battle space is critical to success. New technology in

Operational-level battle command requires longer lead times, involves a greater span of control, and is inherently joint and often multinational. It includes tactical-level principles such as issuing mission orders,

digitization has provided opportunities for improved battlefield situational awareness and increased weapons systems lethality. Digitization efforts include ground maneuver battle space as well as the airspace above the theater. Digitization increases operational tempo and protects friendly forces. Battle space is discussed in detail in FM 100-5 and TRADOC Pamphlet 525-5.

The senior army commander maintains clear unity of command during changes of operational phases. This unity includes relationships with joint and multinational organizations. Significant changes in command relationships require phasing plans to avoid confusion. Any major organizational changes require a review of the existing battle command process.

THE COMMANDER'S VISION

A senior army commander performs four functions to implement his vision and achieve proper operational battle command. First, he decides upon and communicates his intent and provides direction so that others can understand and respond. Next, he establishes the structure to focus effort. Then, he plans and organizes the activities necessary to get results. Finally, he motivates, influences, and supervises the force to develop and sustain the organizational purpose required to accomplish the mission.

Communicating the Commander's Intent

The *commander's intent* is a concise expression of the commander's expected outcome of an operation. The commander's intent funnels an organization's collective activities to achieve the commander's desired outcome. The commander's intent is the central goal and stand-alone reference that enables subordinates to gain the required flexibility in planning and executing. It is the standard reference point from which all present and future subordinates' actions evolve.

Commanders and leaders—guided by their commander's intent—who can make decisions can better ensure the success of the force as a whole when conditions are vague and confusing and communication is limited or impossible. The design of commander's intent is not to restrain but to empower subordinates by giving them freedom of action to accomplish a mission.

Structuring to Focus Effort

Structure is critical for implementing the commander's vision. At the operational level, the complexity and scope of the mission contribute to uncertainty. Leaders cannot always draw upon experience or previous solutions to problems that may be entirely different. An important component is establishing the rules and defining the limits. ROE, control measures, degree of risk, success criteria, report formats, and other tools contribute to the function of establishing structure. Many of these matters are standard procedures in smaller units. However, at echelons above corps (EAC), the inherent joint and multinational nature of operations, along with the peculiarities of each theater, compel the senior army commander to specify certain elements.

Structuring focuses effort. Structure is a characteristic of the control function of leadership. The senior army commander applies structure when he assigns missions and communicates his vision. Structure is accomplished formally through orders and directives and informally in communicating with subordinate commanders.

Planning and Organizing

Operational planning begins with the assignment of a mission or with the commander's recognition of a requirement; it continues until the mission is accomplished. The staff uses the commander's intent to develop and coordinate the supporting operation plan. Once the commander develops the plan, he organizes his command and designates command relationships to accomplish the mission.

An operational-level commander keeps his eye on long-range objectives throughout any operation. He views tactical outcomes and task accomplishments from the perspective of how they contribute to the major operation. While tactical setbacks might cause adjustments to the operation, they should not unduly divert attention away from the operational objective.

In the plan development process, the commander and his staff interact continuously during the commander's analysis, the restated mission, guidance to the staff, estimates, and development of COAs. This interaction continues through the commander's decision to publish an order. Continuous feedback and coordination ensures that the staff and commander focus on the objective.

Motivating and Influencing the Force

At the operational level, leadership and command is no longer simply a direct influence process. It also includes a well-formed ability to exercise indirect, organizational leadership. Success depends on creating and maintaining cohesive teams, units, and organizations, using both direct and indirect modes of leadership. FM 22-103 discusses these modes of leadership.

The senior army commander must be able to sustain the appropriate command climate—a climate that fosters free communication—in order to generate the motivation to maintain cohesive teams. Free communication permits the senior commander to assess how well his vision is understood. It also assists him in influencing every level of his command.

OPERATIONAL INTELLIGENCE

Operational intelligence is that intelligence required for the planning and conduct of major operations within a theater of operations. At the operational level of war, the joint and multinational intelligence system does not concentrate just on the collection, identification, location, and analysis of the center of gravity and operational objectives. It also must focus its production effort downward and concentrate efforts on warfighting priority intelligence requirements (PIR).

- Basic (or finished) intelligence.
- Strategic indications and warnings.
- Tactical warnings.
- Current intelligence reporting.
- Intelligence-preparation-of-the-battlefield (IPB) on an operational or theater basis.
- Targeting intelligence.
- Battle damage assessment (BDA) and poststrike assessment.
- Collection requirements management (synchronization of intelligence product reports).

The operational-level intelligence organizations also provide unique counterintelligence (CI), signals intelligence SIGINT, imagery intelligence (IMINT), measurement and signatures intelligence (MASINT), technical intelligence (TECHINT), human intelligence (HUMINT), security countermeasures services, and force protection. These capabilities are found within the units of the operational-level military intelligence (MI) organization. An example of a typical theater MI structure is discussed in detail in Appendix A.

COLLECTION

Military leaders normally rely on DOD or other government agencies to monitor and

assess operational-level information applicable to nonhostile situations that could require military support. MI efforts focus normally on potentially hostile threats. This intelligence leads to the identification and location of high-payoff targets that, if successfully attacked, help achieve the assigned operational-level objective.

During hostilities, the focus of the operational-level intelligence effort is to analyze the enemy's operational capabilities and estimate his intent. Many elements of analysis that underwrite war or conflict tactical intelligence apply at the operational level, for example, enemy order-of-battle, enemy capabilities, WMD, doctrinal norms, and characteristics of the AOR.

Commanders and their intelligence and chemical officers should evaluate these elements and other products and reports in a broad context. They should also establish Army force collection requirements and allocate organic and supporting collection assets.

A key role for the Army service component is to expedite access to and facilitate dissemination of theater and national-level intelligence through the JIC. Intelligence at the operational-level requires information broader than that normally associated with the tactical echelons. Political, economic, and social factors affect the enemy decision-making process and the corresponding friendly collection plan.

PRIORITY INTELLIGENCE REQUIREMENTS

Intelligence at the operational level must project well into the future. The senior army commander drives the intelligence effort by articulating PIR and information requirements needed in his decision-making process. For intelligence to be timely, this commander must

plan and control the intelligence effort with the same level of interest and personal involvement he devotes to other functions. In particular, he must assure that his intelligence system distributes products and intelligence information that meet the needs of his staff and the requirements of his subordinate commanders.

INTEGRATION

Intelligence is vital to the design of a successful operation. The senior army commander must integrate intelligence with all the other operational-level functions. Tactical commanders must react quickly to unanticipated shifts in the flow of battle with forces reserved for that purpose. Operational-level commanders, however, must determine their lines of operations and lines of support much further in advance. Deployment of intelligence collection personnel as part of the force establishing a forward presence in a contingency area contributes to this capability. Commanders should consider both permanent stationing and periodic deployment of CONUS-based resources.

SYNCHRONIZATION

Synchronization is the arrangement of operations and battlefield activities in time, space, resources, and purpose to produce maximum relative combat power at a decisive point. It focuses the vast arsenal of intelligence resources available from national to division levels to accomplish the desired result—synchronized intelligence operations at each level that satisfy and deliver PIR to theater and combat commanders.

Synchronization ensures IEW operations are linked to the commander's requirements and respond in time to influence decisions and operations. In the synchronization process, the intelligence officer takes the commander's PIR and backward plans to orchestrate the collection and production efforts with the operation and deliver intelligence when required. Intelligence synchronization is a continuous process that ensures the intelligence system answers the commander's intelligence requirements in time to influence his decisions.

VULNERABILITIES

Operational-level commanders must clearly understand both enemy and friendly

capabilities and vulnerabilities. This understanding focuses on hostile situations but includes information applicable in nation assistance, disaster relief, and other nonhostile situations.

POTENTIAL THREAT CAPABILITIES

Potential threat operational doctrine and force capabilities across the range of military operations remain the largest part of military collection requirements. As collectors probe, the critical focus must be on the nature of the enemy's battle command structure.

Collectors must seek the identity and personal characteristics of opposing operational commanders, their relationships with their superiors and subordinates, and the effects of these relationships on the mechanisms through which the enemy makes operational decisions. Questions that may be asked include—

- What freedom of action does the opposing commander have?
- How aggressively is he likely to exercise it?
- What degree of compliance can he expect from his subordinates?
- How effective is his battle command system?

Such questions are more critical at the operational-level than at the tactical level, particularly for those military forces in which initiative is reserved at relatively high levels of command. A vital operational-level intelligence task is to discover who commands and how he exercises command in a given situation.

COMMANDER'S REQUIREMENTS

The senior army commander requires a risk assessment concerning friendly susceptibilities and vulnerabilities an enemy may exploit. This assessment is part of predictive products that support the commander's battle planning. Intelligence agencies also must obtain information concerning the nature and characteristics of the AOR, to include significant hazards. The commander needs to know the enemy's total capability, the area's basic physical features, climatological characteristics, and topography. Information should include significant military, technical, scientific, diplomatic, economic, industrial, geographic, demographic, topographic, hydrographic, climatic, cultural,

and psychological features of the area. This information contributes to hostile and nonhostile military preparations.

PROBLEMS

The operational-level intelligence collection process has some unique characteristics. No analytical method or mechanism completely eliminates the problems of uncertainty, volume, and security.

Uncertainty

The products of intelligence at this level are sometimes imperfect guides to action; therefore, senior army commanders may be required to take risks. Commanders can mitigate these risks by clearly articulating the PIR and information requirements they need for their decision making. The senior intelligence officer mitigates risk by ensuring that facts are distinguished clearly from assumptions and not by constraining intelligence estimates by preconceived expectations of preferences.

Volume

Another concern is the sheer volume of intelligence that can overwhelm the commander and his staff. The senior intelligence officer must manage this volume and clearly separate the key intelligence reports the commander and his staff need from the background intelligence- supporting analysis. A coordinated push mechanism that alerts senior army commanders of significant changes in the situation must be complemented by a pull mechanism that keeps theater, departmental, and national activities focused on support to military operations.

Security

Operational-level commanders must always consider security when working with sensitive intelligence information, especially in the multinational operational environment. Operational-level commanders normally have access to national strategic intelligence means. Often, these systems can provide valuable insights into probable enemy intentions. By their very nature, these national collection means are among the most sensitive of intelligence assets, especially those sources most likely to reveal probable enemy intentions. Commanders must therefore carefully balance their desire to act on information derived from these sources, with the realization that such action could risk exposing the source and compromising the national defense capability. The operational-level commander must make the decision on the information to be shared. In nonhostile situations, revealing information gained from national assets could compromise US defense capabilities. In multinational operations, the problem is compounded by questions concerning allied internal security.

DISSEMINATION

Senior commanders require free and timely exchange of intelligence to make decisions with confidence. Intelligence is timely if it allows the commander to act at the appropriate time. The dissemination means and the form employed affect the timeliness of the dissemination of intelligence. The timely dissemination of usable and pertinent intelligence is the most important intelligence problem that must be solved on the battlefield.

OPERATIONAL LOGISTICS

Operational logistics consists of logistical and other support activities required to support the force during campaigns and major operations within a theater of operations. Using the LPT process, logisticians at all echelons determine the logistics requirements to support the CINC's campaign plan. Logistics plays a dominant role in maintaining force readiness for operations, mobilizing critical human and materiel resources, moving the force to its intended AO, sustaining the force throughout the duration of operations, redeploying the force to its peacetime base or

next contingency area, restoring the Army's total capability, and demobilizing resources.

A force-projection army requires a logistics system that anticipates requirements and makes use of all available resources, improvising when required. The Army logistics system relies on local resources, when possible, whether they are those of host nations or those contracted or purchased. The system recognizes constraints of time and limits of strategic transportation systems and compensates by pre-positioning materiel, either afloat or ashore, in or near likely future

AOs. It makes use of all resources available, to include DA and those of other government agencies, as well as contractor personnel.

OPERATIONAL SUPPORT OF THE FORCE

Operational support of the force extends from the theater of operations logistics bases to the forward CSS units and facilities. Early in an operation, logistics planning and management cells within the ASCC structure are used to ensure rapid establishment of battle command of logistics and to determine future support requirements.

As the theater matures, a requirement for separate, more formal logistical battle command organizations may exist. Based on the CINC's campaign plan and the operations to be conducted, the ASCC determines the nature and scope of the logistical force structure. See FM 100-16 for a detailed description of the logistics function at the operational level of war.

Logisticians concentrate on providing capabilities, not organizations, to fulfill whatever support requirements exist. Logisticians use logistics support bases to fulfill support requirements as far forward as possible. They tailor logistics forces so that the required capability, and nothing more, is deployed and employed. Although local resources are used, logisticians rely on a CONUS-based support source through communications and reliable transportation and distribution systems.

The theater of operations logistics base, in performing its theater of operations logistics functions, links strategic sustainment to tactical CSS. At the operational level of activity, the familiar distinction between *operations* and *logistics* begins to blur. Logistics is synonymous with operations and becomes a significant undertaking of the ASCC and his staff. Commanders conducting operations across the range of military operations must concern themselves with operational support.

Operational logistics is the link between the strategic and tactical levels. It encompasses support required to sustain joint and multinational campaigns, other military activities, US forces, and forces of friendly countries or groups within an AO. Military units, augmented by DOD civilians, contractor personnel, and available host nation resources,

make up the organizational structure found at this level.

Operational-level logistics support may be complemented by the deployment of USAMC's LSE. The LSE, largely a table of distribution and allowances (TDA) activity, performs any logistics function not normally performed by table of organization and equipment (TOE) units. It is a self-contained organization that may be staffed with any combination of civilian and military personnel required to perform specialized tasks. Civilians may be DA or DOD, or they may be contractors who agree to deploy to support highly sophisticated equipment. Military personnel are battle-rostered from other duty assignments or brought in to fulfill special requirements of the LSE. The LSE's unique skills include depot maintenance, oil analysis, calibration of test equipment, ammunition surveillance, release of pre-positioned strategic stocks, materiel fielding, technology insertion, and BDA.

The primary focus of the operational logistician is on—

- Reception.
- Position of facilities.
- Materiel management.
- Movement control.
- Distribution management.
- Reconstitution and regeneration.
- Redeployment.

As the CINC develops his strategic concept of operation, he concurrently develops a concept of support in coordination with his service component commanders. They and their staffs consider a myriad of logistics factors that affect the ability of the operational forces to conduct operations. Among the most conspicuous, tangible resources are equipment and other materials of war. When resources are limited, the CINC/ARFOR must prioritize the allocation of materiel among his commands, giving the preponderance of support to forces making the main effort and sometimes shifting priorities as the campaign unfolds.

At the campaign- and major-operation-planning levels, logistics is a dominant factor in determining the nature and tempo of operations. Sound logistics planning and analysis are factors that allow for rapid changes to operations plans. Logistics cannot win a war, but its absence or inadequacy can

cause defeat. Operational-level activities are characterized by—

- High consumption of military materiel.
- A great diversity of equipment types.
- Expansion of the battle area, resulting from the employment of sophisticated weapons, communications, and sensors by both sides.
- Extended lines of operation.
- Constrained resources.

COMBAT SERVICE SUPPORT CHARACTERISTICS

Senior army commanders must effectively apply the five CSS characteristics: *anticipation, integration, continuity, responsiveness, and improvisation* in planning and conducting the tactical CSS functions of *manning, arming, fueling, fixing, moving the force, and sustaining soldiers and their systems*.

Anticipation

Anticipation ensures CSS operations are agile and characterized by the demonstration of initiative. Requirements must be accurately projected to provide resources at the necessary time and place. The synchronization of logistics with operations is also a part of anticipation. This synchronization requires a versatile and mobile organization structure that maintains an operational perspective.

Integration

Integration recognizes that CSS is integral to the conduct of operations and the two are mutually supportive. It ensures the agility and versatility of an operation by providing the maximum operational freedom. Standardization and interoperability agreements contribute to integration in the joint and multinational environment.

Continuity

Continuity provides for the continued flow of CSS that is essential to successful operations. It exploits operational lulls to restore logistics capabilities depleted during past operations. Alternative approaches are sought to avoid total reliance on any single source.

Responsiveness

Responsiveness provides for rapid reaction during a crisis. The CSS challenge is to make

required adjustments as the crisis response is refined and the situation evolves. Forces must be tailorable to meet force-projection requirements that restrict the deployment of entire CSS organizations. A split-based logistics concept complements this capability. Units must compensate for partial organizations deployed in tailored packages and for operating losses through the formation of provisional units. These units must be able to surge support at critical times and locations. The concept of modularity must be built into unit design to facilitate this process.

Improvisation

Improvisation helps units meet CSS needs with available resources and may call for nonstandard solutions. Improvisation permits solutions to anticipated and real problems where no solution has been identified previously.

TACTICAL COMBAT SERVICE SUPPORT FUNCTIONS

An operational perspective on logistics requires the translation of the five CSS characteristics into tactical-level applications as described by the CSS functions of *manning, arming, fueling, fixing, moving the force, and sustaining soldiers and their systems*.

Manning

The manning function provides for unit and individual replacements. In addition, it provides for personnel readiness management and casualty management.

Arming

The arming function replenishes arms, munitions, and equipment in an environment characterized by high consumption rates, the demands of which are controlled by throughput distribution and the establishment of controlled supply rates.

Fueling

The fueling function ensures the availability of fuels and packaged POL products for a highly mobile force with the potential for high consumption rates demanding a dependable fueling system.

Fixing

The fixing function provides for preserving availability of equipment. This function is

performed as far forward as possible and in minimum time. Expedited means of recovery, repair, and return are characteristic of the function.

Moving the Force

This function involves transportation operations of units and materiel. Often, this function may be done on short notice for large forces involved in major shifts of direction. Total asset visibility, in-transit visibility, and

contracting support are critical to the performance of this function.

Sustaining Soldiers and Their Systems

This function has five elements: *personnel service support*, *health service support*, *field services*, *quality of life*, and *general supply support*. Public affairs (PA), religious support, and legal support operations are elements of personnel service support. These areas are described in Appendix A of this manual, in FM 100-10, in FM 100-16, and in branch-specific manuals.

Historical Perspective

During the deployment stage of Operation Desert Shield, US forces were faced with the task of conducting operations in an austere theater. Having anticipated the difficulty of operations in this environment, plans had been made and resources put in place for this eventuality.

On 22 August 1990, the first Army pre-positioned ship, the USS Green Harbor, completed its 2,700-mile trip from Diego Garcia to discharge its cargo at ad Dammam, Saudi Arabia. During the mid-eighties, the Army had stocked the Green Harbor and three similar vessels with enough tentage, food, ammunition, and water purification and refrigeration equipment to provide a logistical jump-start to any Gulf operation until seaborne transport could arrive from the United States. After the Green Harbor arrived, the logistics was well under way and the theater in Saudi Arabia continued to build at an extraordinary rate. (Certain Victory, 2 August 1993)

Adaptability, innovation, and ingenuity worked to fill voids in the logistics system. Soldiers' and leaders' individual initiative and determination to get the job done made the

logistical system work. As an example, convoy support centers were established to increase road network efficiency. These centers resembled huge truck stops in the desert, and, like all truck stops, operated 24 hours a day, providing fuel, latrines, food, sleeping tents, and limited vehicle repair facilities. The convoy support centers became welcome oases for exhausted long-haul transporters.

Upon initiation of the ground war, logistics support was even more critical. During the planning stages, logisticians realized that as the LOCs extended, resupply efforts would become increasingly difficult. Therefore, moving as quickly as possible, yet stealthfully, to retain secrecy, the 22d Support Command began to establish forward logistics bases to counter the extended LOCs. Vast quantities of supplies were shifted also to the west by the 22d Support Command. These supply bases contained enough materiel to support combat operations for up to 60 days. Some supply bases were moved several times, to the west and then northward, once the ground operation commenced. (Conduct of the Persian Gulf Conflict, An Interim Report to Congress, July 1991)

PART THREE

Army Component Operations

This part includes three chapters that discuss Army service component operations during force projection, operations in war, and MÖOTW.

Chapter 6

Force Projection

Codified in the *National Security Strategy (NSS) of 1994* and further developed by the SECDEF, the US military strategy is built upon the central components of engagement and enlargement.. “to enhance our security by maintaining a strong defense capability and promoting cooperative security measures; work to open foreign markets and spur global economic growth; and promote democracy abroad.”

The Army represents a portion of the potential military power of the nation. That power translates directly to influence the international system. The US uses military power to compel an adversary to accede to US will. That potential power deters opponents from taking actions hostile to US interests. Peaceful employment of military forces reassures our allies, demonstrates our capabilities, promotes stability, and contributes to our ability to influence international outcomes.

CRISIS

A *crisis* is an incident or situation involving either an internal or external threat to the US, its territories, citizens, military forces, and possessions or vital interests. A crisis develops rapidly and creates a condition of such diplomatic, economic, or military importance that commitment of US forces and resources is contemplated to achieve national objectives.

During deliberate planning or CAP, commanders prescribe, in TPFDD format, who, what, when, and where forces will be deployed. Based on these initiatives and a unit’s ability to accurately identify its movement requirements, USTRANSCOM then identifies how the unit will move to meet *National Military Strategy* objectives.

With the knowledge that extended force closure times may directly increase the domestic and coalition support risks for a particular crisis, commanders rigorously discipline their strategic lift requirements to that needed for the operation. During the deployment process, US

forces are most vulnerable to significant casualties. Conversely, as closure times extend, the duration of a crisis extends, increasing the risk of casualties.

A crisis can occur in peacetime, conflict, and war. In peacetime, a crisis can be precipitated by a natural disaster or civil disturbance, resulting in a threat to civil authority. In war, the threat focus can be directed at the sovereignty of a nation. The extent to which the Army is prepared to respond to a crisis can significantly influence the eventual outcome.

Adaptive planning is required to ensure favorable outcomes. At the theater level, the CINC is responsible for developing a range of response options. These response options are not limited to the military instrument of national power but include economic, diplomatic, and informational alternatives. The requirement for interagency cooperation and multinational considerations is evident.

The Army Strategic Mobility Program

The Army Strategic Mobility Program (ASMP) was initiated to address the conclusions of the Mobility Requirement Study (MRS). The MRS concluded that the military can only increase its deployability through an expanded investment in sealift and airlift, pre-positioning, and transportation infrastructure. The ASMP Action Plan was published on 2 March 1993.

The Army develops the capability to provide a crisis-response force of up to corps size with the following mobility standards:

- A light or airborne, brigade-sized force to be inserted into a theater by C+4, with the remainder of that division to close not later than C+12. This force, including its personnel and equipment and logistical support structure, would be transported largely by air.
- An afloat heavy combat brigade with support APA to close into the theater and be ready to fight not later than C+15. The APA brigade force would be a 2x2 heavy brigade (two armored and two mechanized battalions, plus support). This force would be organized into force modules, tailoring them to meet the CINC's needs.
- By C+30 two heavy divisions (a mix of mechanized infantry, armor, or air assault forces, depending on the theater commander's priorities), to include the logistical support structure, would close in theater. The equipment for the heavy force would transit by sea.
- The remaining force (two divisions and support) would close by C+75.
- Air transport would be the preferred mode of travel for all contingency force personnel.

For this program to be successful, three key mobility initiatives are critical. The first is the acquisition of fast sealift shipping. The second is the creation of the APA capability. The third is the infrastructure and procedures necessary to rapidly and efficiently deploy forces from their location through CONUS ports.

Deterrence is preferable to war. Effective deterrence can prevent escalation of a crisis. Deterrent action can resolve a crisis on favorable terms. When the opportunity exists, the use of a deterrent action, such as a show of force, can send a clear signal of US resolve to intervene should the threat of unfavorable crisis resolution continue.

Sometimes, deterrent actions do not prevent the continued escalation of a crisis. The CINC requires an Army capability to rapidly project combat-ready forces. The goal of these forces is to deter conflict or, should deterrence fail, to win quickly, decisively, and with minimum casualties. This Army requirement demands a deployable, lethal, versatile, expandable, and sustainable force.

CONTINGENCY OPERATIONS

A contingency is the employment of military forces in response to a crisis caused by natural disaster, terrorists, subversives, or required military operations. Due to the uncertainty of the situation, contingencies require rapid planning, response, and development of special procedures to ensure the safety and readiness of personnel, installations, and equipment. Like crises,

contingency operations can occur in the environments of peacetime, conflict, and war.

A contingency may be a unique, stand-alone event in response to a natural disaster or a man-made event or change in the direction (branch) of an evolving campaign or major operation. Within a campaign or major operation, a branch is a contingency plan for the deviation of operations from the planned

line. It is a result of chance or uncertain events that are identified as crisis triggers.

Senior army commanders assess their operations. During this assessment, they anticipate the probability of an occurrence of a particular contingency, and they develop plans (OPLAN or CONPLAN) to respond to that contingency. If a crisis occurs, the commander updates the OPLAN or CONPLAN and converts it into an OPORD for execution. The characteristics of a contingency operation include crisis situations, NCA involvement with US national interests at stake, and operations that require a rapid military response.

UNIQUE REQUIREMENTS

Army commanders must understand and address additional requirements that are unique to contingencies. Rapid deployment, crisis action, and time-sensitivity make contingency operations unique. Contingency operations are usually joint undertakings conducted within the framework of the *UCP*. Once forces are deployed, the execution of specific missions remains similar to normal military operations in the peacetime, conflict, or war environments. Successful contingency operations, as in all military operations, require detailed planning and aggressive, synchronized execution.

IMPORTANT CHARACTERISTICS

Some particularly important characteristics of this type of operation include—

- Early response.
- Rapid projection of military power.
- Forcible-entry capability.
- Forces tailored to the situation.
- Unambiguous command relationships.
- Thorough coordination among all forces (joint and multinational) and interagency organizations.
- Timely, detailed intelligence.
- Lethality for early entry forces—hold enemy forces at risk, protect the force, deter.
- Strict OPSEC.
- Sensitivity to the diplomatic implications of the military operation.

- Quick resolution (win early with minimal casualties).
- Major impact of national and international news coverage.
- Effective instant communications with attendant interest by the NCA and senior service leadership in any operation.
- Effective theater air and missile defenses to provide force protection and ensure the security of lodgment areas and protection of US and multinational forces and interests.
- Under the national strategy, the requirement for possible redeployment with subsequent employment in another theater.

RESPONSIBILITIES

The Army has a major responsibility to execute a variety of contingency operations. This responsibility requires the commander and his staff to exercise operational art in applying joint and Army doctrine in a highly charged, time-sensitive environment. This ability is of particular importance to the ASCC in theater.

While the tactical combat operation may be somewhat limited in duration, scope, and intensity, the ASCC, in conjunction with the CINC and the other component commanders, sequences military operations that are not necessarily combat operations to achieve the desired end state. This sequencing includes close coordination with DOS to ensure that military operations support diplomatic objectives after completion of tactical combat operations.

The ASCC in theater has the following responsibilities relating to contingency operations:

- Training and sustaining the force to conduct operations required by the CINC.
- Installing, operating, and maintaining signal capabilities that are interoperable with joint, multinational, and/or interagency systems. To ensure interoperability, the ASCC may have to provide signal capabilities to the allies within the multinational force.
- Exercising OPCON of assigned and attached forces and exercising operational direction of supporting forces.

- Coordinating with other component commanders to ensure effective and efficient conduct of operations.
- Monitoring the operational situation and passing information to the CJTF (JFC).
- Planning and conducting operations according to JFC guidance and detailed plans.
- Ensuring administrative and logistics support as required and as directed by the JFC.
- Establishing liaison with the JFC and other joint organizations, multinational organizations, NGOs and PVOs, or government agencies.
- Coordinating with supporting commanders to redeploy the force effectively to home stations or to another theater.
- Planning and coordinating with supporting organizations to reconstitute effectively the force. This may require the use of operational project stocks.
- Coordinating effective support of the media and use of PA assets.
- Ensuring the units comply with federal, state, and local (to include host nation) environmental and pollution abatement requirements.

ORGANIZATIONAL OPTIONS

The NCA tasks a combatant commander with the responsibilities in a particular crisis as outlined in Chapter 2. Based upon the

required tasks, the NCA, CJCS, and CINC choose an appropriate command structure. They may select any of the six COCOM options (discussed previously in Chapter 2) for the organization of forces. Having selected the command structure, they select a commander. In this chapter, the JTF option is used for illustrative purposes. The CINC and ASCC determine the composition of the ARFOR of the JTF. Several options exist for the Army structure in a JTF. The commander of the ARFOR OPCON to the JTF determines the best option based upon an assessment of the operational environment.

Single Army Headquarters to a Joint Task Force

The commander of ARFOR, in conjunction with the JFC, may organize them under a single Army headquarters responsible for the three Army tasks: joint, multinational, NGO and PVO, and interagency linkage; operations; and internal support. He selects this option when the mission is simple, limited ARFOR are involved, and/or the threat is relatively small. (See Figure 6- 1). The three tasks include joint and multinational coordination. In this example, we have omitted the multinational coordination requirement because we assume that the JTF is composed of US forces.

This single Army headquarters may be a corps headquarters or smaller echelon of command. While the corps and division, as organizations, may be able to accomplish these missions, they are not currently staffed or trained to assume these and other operational-level missions. Therefore, both would require substantial additional training, personnel, and

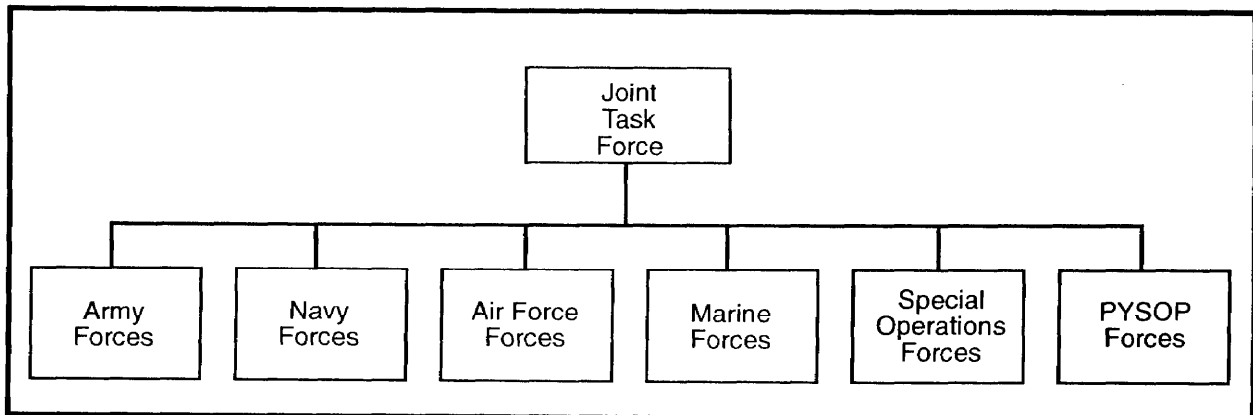

Figure 6-1. Single Army Headquarters in a Joint Task Force

Division as an ARFOR to a JTF

Precedent has been established designating a division as the ARFOR headquarters subordinate to a JTF. The 10th Mountain Division (L) was designated as the ARFOR HQ for Operation Restore Hope. The division worked for a JTF commanded by the commanding general of the 1st Marine Expeditionary Force (I MEF). While this is not a typical relationship, in the future it may very well be. US Army divisions may be required to perform operational-level missions during force-projection operations.

C² resources to be effective. Once the corps is designated as the ARFOR to a JTF, the corps commander is subordinated to the CJTF or the establishing headquarters and must look to him for guidance, strategic direction, and missions for the force. In turn, the CJTF exercises OPCON or TACON of assigned or attached forces. This includes the responsibility to train the joint force if the JTF was developed during a deliberate planning process to support existing OPLANs. Although the ARFOR of the JTF is responsible for operations and the direct support of his forces, the ASCC retains responsibility to provide overall support to all ARFOR, to include the forces in the JTF. As the ARFOR to the JTF, the corps and division staffs require training on—

- JOPES.
- Management of TPFDD.
- Operational-level functions.
- Theater movement control.

As the ARFOR, the corps or division maybe tasked to assume specific operational-level Army responsibilities within its AO. Under such circumstances, the corps or division would not only be responsible for all Army units but could also be responsible for providing support to all services for—

- Mortuary affairs.
- Casualty operations.
- Postal operations.
- Finance.
- Signal support.
- Environmental protection and cleanup.
- NBC decontamination.
- Rear area protection.
- Base security.

- Transportation and distribution of Class I, III, V, and VIII supplies.
- Real estate and contract support.
- Theater topography support.
- General engineering and real property maintenance activities (RPMA).

The corps/division would assume this support responsibility as the Army executive agency under agreements and memorandums of understanding previously established between services.

External augmentation of staff sections, to include equipment, is required to properly perform the ARFOR C² tasks. Augmentation is required for—

- Operational planning and control.
- Establishment of a JOPES cell.
- Diplomatic military planning activities.
- Signal support.
- Intelligence support.
- Liaison teams.
- PA support.
- Historical data collection of lessons learned.

The ARFOR's intelligence connection to theater and national assets must be deployed early into a theater. The deployable intelligence support element (DISE) accomplishes this. The DISE is a small, scalable, deployable element. It is the initial forward intelligence team of split-based operations. The DISE is tailored tactically from MI units according to the factors of METT-T, lift, and pre-positioned assets.

The mission of the DISE is to provide the deployed commander accurate, detailed, continuous, and timely intelligence to support

The 10th Mountain Division's (L) initial experience in planning Operation Restore Hope provides insight into the required augmentation packages and increased responsibilities when assigned the mission as ARFOR to a JTF. The 10th Mountain Division (L) expanded its division signal element into the ARFOR G6 (Communications) Section. The G6 controlled 10 different nondivisional signal units and over 300 added personnel during Operation Restore Hope. The G6 had staff responsibilities on a much greater scale than the normal division signal officer.

After-Action Report Executive Summary
US Army Forces, Somalia, 10th Mountain Division (L), May 1993 (Draft).

the rapid entry of US forces across the range of military operations. Its communications processing and downlink assets are linked to a national and theater intelligence support base located in CONUS or outside the AO. The two types of tailorable DISE configurations are mini-DISE (manpack) and DISE (vehicular). Together these DISE configurations provide the commander a robust intelligence capability to support deploying forces. The DISE provides split-based communications, broadcast intelligence, and intelligence processing.

Additionally, the ARFOR must plan and operate effectively with the media. The impact of the media on the conduct of operations is substantially greater today than in any previous time. The capability of the news media to transmit ongoing operations activities to news networks globally cannot be discounted. This new technology requires the JFC/ARFOR to establish points of contact and

procedures for releasing information regarding ongoing operations. The ARFOR's public affairs officer (PAO) should manage all media and public requests for information. The JFC/ARFOR must develop procedures and guidelines that provide releasable information to the media within security, accuracy, propriety, privacy, and safety considerations of the ongoing operation.

Two or More Army Forces to a Joint Task Force

The JFC may desire direct control of several separate Army ground operations. He establishes, with the advice of the ASCC in theater, two or more separate ARFOR headquarters that are directly subordinate to the JTF (see Figure 6-2). Each of these separate Army headquarters would maintain the three Army tasks of joint, multinational,

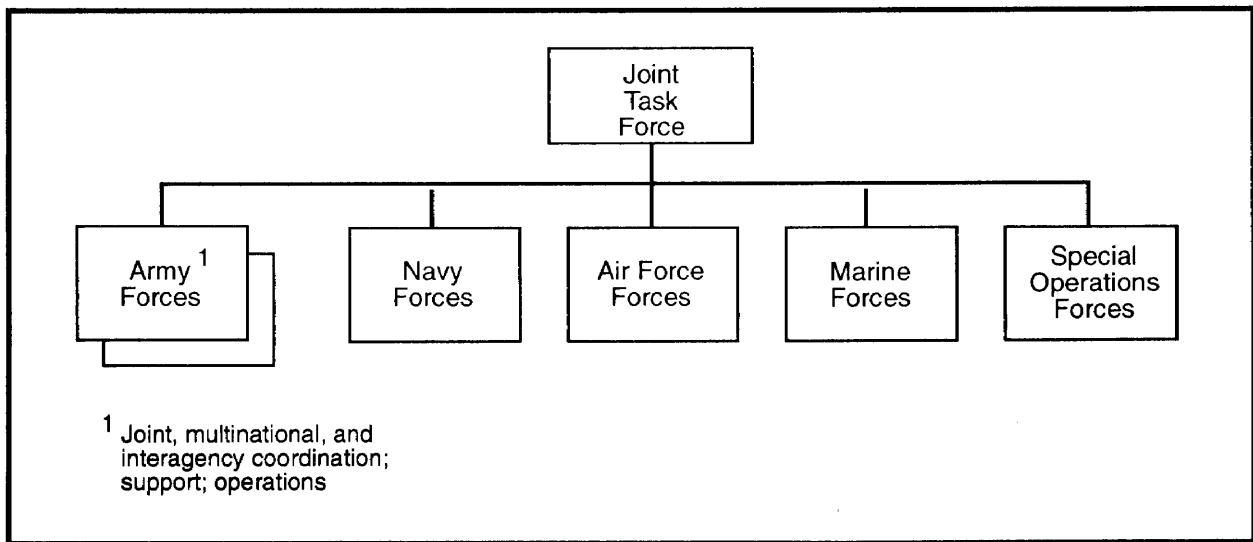

Figure 6-2. A Joint Task Force with Two or More Army Forces

and, perhaps, interagency coordination; operations; and internal support. The JFC might use this particular option when—

- The operation is relatively simple.
- Several large Army organizations are involved.
- Two or more lines of operation exist.
- The threat is located in two or more different geographic areas.
- The situation allows the JFC to focus on several dispersed ground operations without diffusing his joint responsibilities.

Separate Support and Army Forces Headquarters

As the situation grows more complex, the JFC and the ASCC may organize ARFOR to resemble a miniature theater organization. In this organization, one headquarters would focus on operations, while a separate headquarters would focus on support responsibilities (see Figure 6-3). These circumstances align with the chain of command discussed in Chapter 2.

The performance of the three tasks is a constant requirement within the operational-level environment. Under these circumstances, multiple commanders could share the tasks. The ASCC would retain traditional responsibilities as discussed previously. The responsibility for the conduct of operations at the operational-level could then be taken on by the ARFOR commander within the task force, assuming that the operation is of sufficient size and scope to require an operational and not solely tactical perspective. The requirement for joint, multinational, and, perhaps, interagency linkage would become a task that must be performed by both commanders.

This alignment of the responsibilities, though not expected to be a normal structuring, shows the flexibility of the design to meet a wide range of potential operational conditions. The Army might organize under this option when—

- The operation is extremely complex.
- More than one Army combat force headquarters exists.
- The Army has a significant support responsibility to other services/multinational forces.

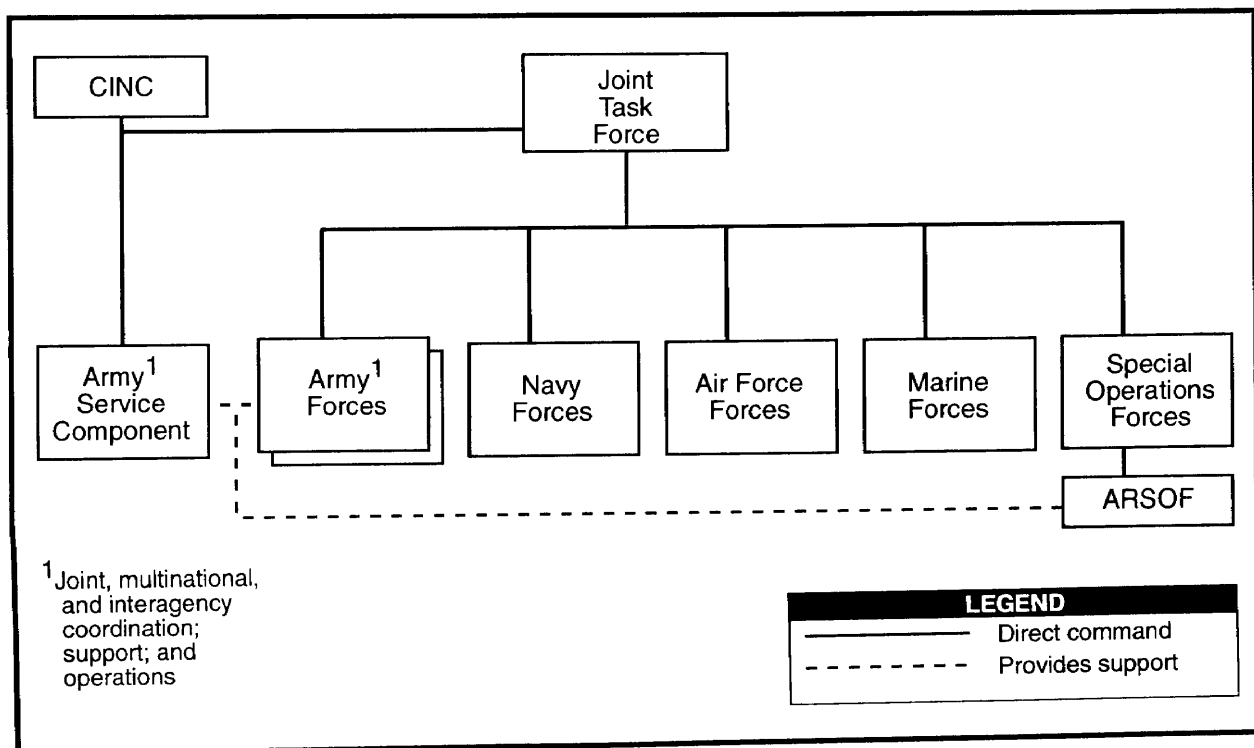

Figure 6-3. Separate Support and Army Combat Force Headquarters

- Two or more lines of support exist.
- Additional theater support organizations make a forward support element too large to control effectively without dedicated command effort.
- The JTF requires a significant support effort that exceeds normal corps support capabilities.

Army Commander as a Joint Force Functional Component Commander

The JFC may organize forces functionally under a single headquarters. As a norm, the service commander with the predominant number of forces is tasked to provide the controlling headquarters. The JFLCC may build his organization from an existing structure and augment it with joint staff billets for needed expertise. The Army force commander, as the functional component commander, would retain his responsibilities for joint, multinational, and interagency linkage operations and internal support of ARFOR. See Figure 6-4. In those cases where the Army force commander is not designated as the functional component commander, he still retains responsibility for internal support.

Army Commander as the Commander of a Joint Task Force

When the contingency is predominately a land operation, the CINC may designate an Army commander as the JFC. This JFC has considerable requirements placed upon him in addition to his three Army tasks of joint,

multinational, and interagency coordination; operations; and support. Under these circumstances, the multinational and interagency coordination task could require a significant resource increase. He may consider delegating some of the authority for his Army tasks to subordinate commanders.

This JFC may build his joint organization from an existing Army organization—a corps headquarters or a numbered army. Today’s corps will most likely find itself conducting force-projection operations as part of a tailored joint force and may be assigned the role of serving as a JTF headquarters. The unit can be designated as the JTF headquarters at any time during either the deliberate planning process or during CAP if the nature of the mission so warrants. The Army JFC may organize his subordinate Army units based upon the three options presented in Figures 6-1, 6-2, and 6-3.

Once the corps is designated as a JTF, the corps commander, as the CJTF, is subordinated to the combatant commander (or the establishing headquarters) and must look to him for guidance, strategic direction, and missions for the force. In turn, the CJTF exercises OPCON or TACON of assigned or attached forces. This includes the responsibility to train the joint force if the JTF was developed during a deliberate planning process to support existing OPLANs.

The CJTF must determine what augmentation requirements are needed for the task at hand and coordinate support through the establishing headquarters. Augmentation

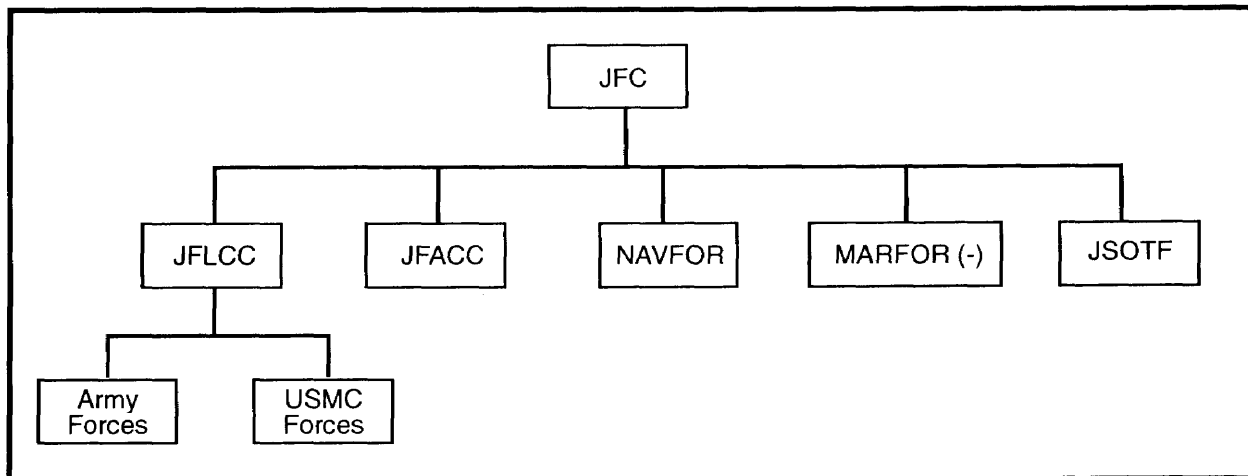

Figure 6-4. Army Commander as a Joint Force Land Component Commander

of the corps staff is essential in transitioning the corps to a JTF structure. Augmentation can be organized using a modular concept to address the various staff entities such as—

- Command and staff (joint staff and special staff).
- Headquarters support and sustainment (life support functions).
- Signal support.
- Security support for the JTF headquarters.
- Augmentation in technical areas such as CA, PSYOP, and so on (Joint Pub 5-00.2).

Although augmentation must be tailored for the specific situation and is different for every mission, some augmentation is almost always required in—

- Intelligence collection.
- Joint planning procedures.
- Logistics planning.
- Signal support, especially Army Global Command and Control System (AGCCS) access.
- Medical planning.

Augmentation in these areas assists in ensuring linkage between the JTF staff and the combatant command joint staff, especially concerning access to information and capabilities available at the combatant command level.

The corps cannot function simultaneously at both the tactical and operational levels. The

corps, as a JTF, can conduct either tactical- or operational-level planning and missions. The mission, not the size of the force, determines the level at which the JTF functions. Once fully engaged at one level, the corps cannot be expected to assume the additional functions and command responsibilities that correspond to the other. Still, the corps commander must fully understand both tactical- and operational-level environments to ensure a supportive relationship exists between his plans and operations and those of subordinate and higher headquarters.

The commander thinks not only in terms of military resources but also considers those interagency, diplomatic, economic, and other resources that may be available and appropriate for the task at hand. The CJTF must understand the strategic and regional environments, to include US policies, treaty commitments, status of forces agreements (SOFA), coalition parties' interests, and so on. These influences affect campaign and operational planning and the establishment of ROE for the force.

The Army JFC must have the additional flexibility to assume the joint coordination role and may choose to augment organic support units with additional divisional, corps, or operational-level support organizations. As such, subordinate Army combat force commanders would concentrate on operations while the JFC conducts a large portion of the joint, multinational, and interagency coordination and operations support tasks (internal and external). See Figure 6-5.

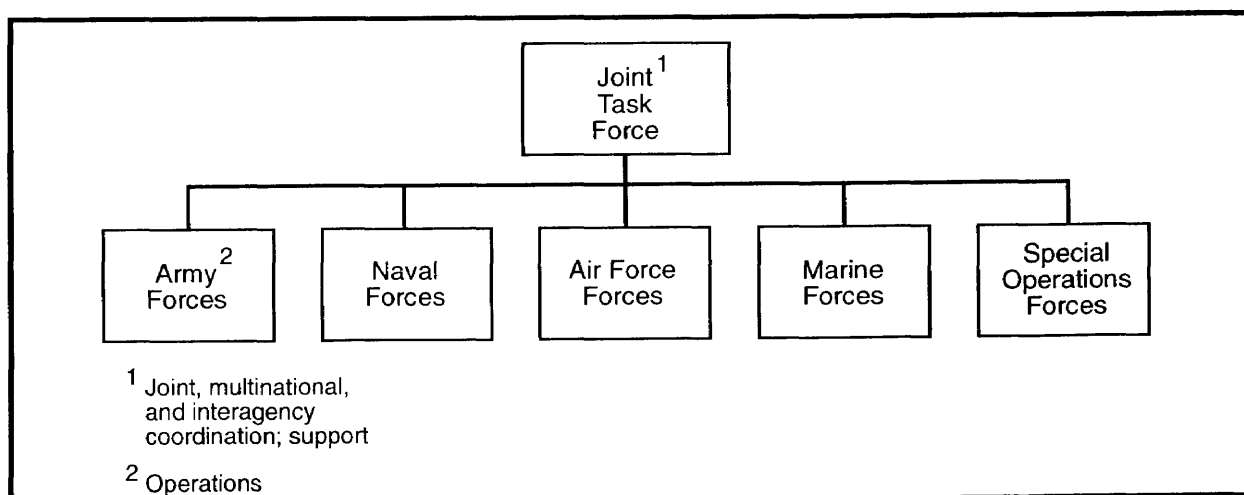

Figure 6-5. An Army Commander as the Commander of a JTF

The Army JFC could retain these coordination and support tasks when the operation is largely an Army ground operation, the other services play a support role to the Army, or the Army JFC has sufficient resources in his organization to accomplish these additional missions.

Establishing Authority

The authority who establishes the JTF designates the JFC, assigns the missions, prescribes the broad concept of operations, allocates the forces, and defines the command relationships. Generally, the establishing authority designates the JFC from within his own headquarters or from the preponderant service within the joint force. The establishing authority may direct formation of a joint staff from his own staff, or he may direct the JFC to form the JTF staff from his own resources and augment it as necessary from other service or component headquarters within the designated JTF.

Headquarters Functions

The Army JFC organizes the JTF headquarters to accomplish assigned missions. This headquarters may vary from a small group aboard a ship to a large staff and

support personnel at a ground location (see Figure 6-6). The CJTF and staff—

- Plan operations of the JTF in accordance with operational direction from the establishing authority.
- Direct, control, and coordinate operations of assigned forces.
- Coordinate planning activities of subordinate forces.
- Under supervision of the joint staff, establish, when required, joint boards and agencies to plan, control, and coordinate the use of joint assets in specific functional areas, for example, the JTCB.
- Coordinate with other joint and multinational forces, the UN, other government agencies not assigned, and NGOs and PVOs.
- Coordinate with other national forces and foreign governments when required by the establishing authority.
- Coordinate signal support.

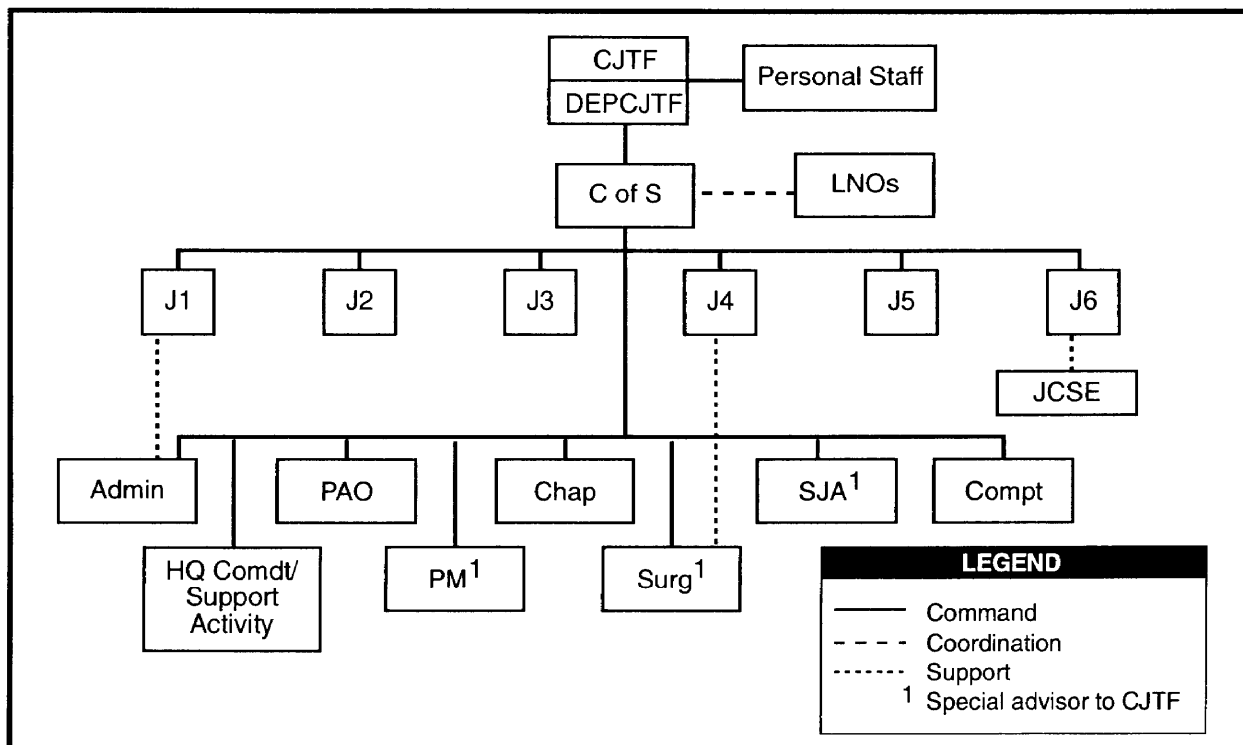

Figure 6-6. Joint Task Force Headquarters of an Army JFC

Planning. During the deliberate planning process, the CINC may designate the ASCC as a JTF or ARFOR planning agent. The ASCC director of plans coordinates the planning effort. The Army staff planners develop JTF and ARFOR plans in each functional area, using Joint Pubs 5-00.1 and 5-00.2 as guides. Each Army staff planner coordinates as required with functional area counterparts in the joint community. Planners should understand and consider RSI during planning. When agencies outside the Army must contribute to the planning effort, the Army force's director of operations, or G3, requests support from the appropriate agency. This planning process develops the base OPLANs and CONPLANs modified for execution during contingencies.

During CAP, the director of plans directs the planning effort until he receives an execution order. After he receives the execution order, the G3 completes execution planning and conducts operations. The G3 (plans) begins future planning, normally focusing on the next major operation or phase. The JOPES publications (Joint Pub 5-03 series) provide planning policies, procedures, formats, and guidance for joint operations.

Operations and Training. When designated as the joint force headquarters, the ASCC deputy chief of staff for operations (DCSOPS) organizes the J3 section, receives augmentation from other services, establishes the JOC, and initiates CAP. The J3 assists in planning, coordinating, and executing JTF operations. The J3 normally organizes a battle staff with representatives of all the directorates within a JOC in order to provide consolidated oversight. When the joint staff does not have a J5 (plans), the J3 performs long-range or future planning. However, the J3 has a plans cell to conduct near-term planning of branches to the current operation. Besides the JOC, the J3 also may supervise—

- A JTCB to coordinate targeting guidance and objectives and to develop the joint target list.
- A joint rescue coordination center (JRCC), although the CJTF may task a subordinate service force commander to perform this function.
- A joint information warfare staff composed of component representatives and representatives of the J2 and J6.

- A joint meteorological forecasting unit (JMFU) to provide weather support.

As a matter of principle, training remains a national responsibility. To ensure the units are able to execute their assigned missions and be operationally ready, the leaders must know and understand the capabilities and limitations of the other nations' units. The enhanced mutual understanding of the capabilities and limitations is to minimize the differences and optimize effectiveness. To that end, all command levels must conduct training, which should include the JFC's ideas and desired outcomes. These concepts, specified by content (basic tasks), scope (condition), and objectives (standard), are an essential basis for effective training. Training should be coordinated and integrated where feasible. Coordination is required among respective participants to ensure mutual understanding and compliance. Although the J3 must monitor and evaluate the training status of all units, the actual evaluation of the training status and operational readiness of the respective units remains a national responsibility. The standards and criteria used for evaluation should be published and understood by all parties.

Special Operations. At the theater level a special operations theater support element (SOTSE) performs special operations staff functions at the Army service component command headquarters. At corps level, a special operations coordination element (SOCOORD) serves as a functional staff element of the G3. The SOCOORD is the mechanism by which a corps plans for and obtains SOF support. As such, it has staff responsibility for SF and ranger integration in each of the battle operating systems' functional areas and serves as a focal point for SF and ranger support to the corps staff.

The SOCOORD develops SOF target nominations and mission requirements for the corps to forward to the JFC. These developments result in mission taskings from the JTCB to the JFSOCC, who assigns missions to appropriate SOF units. Service distinctions of SOF are transparent. The nature of the requirement and the total force capability determines whether Army special operations forces (ARSOF) or another element of SOF is tasked to meet a given requirement.

Communications. When designated as the joint force headquarters, the ASCC's theater signal officer organizes a J6 staff, receives augmentation from other services, and establishes a joint communications control center (JCCC) as required. Joint Pub 6-0 discusses the responsibilities and functions of the J6. A key function among these responsibilities is network management. The JCCC exercises staff supervision over C⁴ control centers belonging to deployed components and subordinate commands. Joint Pub 6-05.1 describes the JCCC and its functions.

Alternate communications means are essential. During planning, the primary means is the Worldwide Military Command and Control System (WWMCCS). (Once fielded, the Global Command and Control System (GCCS) replaces WWMCCS.) Communications networks include the four major networks of the DCS:

- Defense Switched Network (DSN).
- Secure Voice System (SVS).
- Automatic Digital Network (AUTODIN—the future defense message system).
- Defense Data Network (DDN).

Initially, tactical satellites (TACSAT) may be the only means of secure communication with operational forces,

The Army JFC establishes alternate communication means as soon as possible. The JTF, ASCC, and ARFOR headquarters establish communications during Phase I of contingency operations. Organic signal organizations provide signal support and identify and forward shortfalls to the JCCC for resolution. The JCCC requests JCS-controlled contingency communications assets as required.

Intelligence. When tasked as a joint force headquarters, the ARFOR G2 organizes a JTF J2 section, incorporating other service augmentation and establishing a JIC from organic assets. The other services may augment the JIC as required. The JTF J2 is responsible for determining the requirements and direction of the intelligence effort to support the CJTF's objectives. He assists the CJTF in ensuring that intelligence objectives are correct, understood, prioritized, synchronized, and acted upon. The J2 is also responsible for employing joint intelligence

resources, identifying and integrating additional intelligence resources such as the JIC, and applying national intelligence capabilities. He works with subordinate service G2s (S2s) to develop complementary intelligence operations that support the CJTF's requirements.

The JTF JIC is the primary J2 organization supporting the JFC and the ARFOR. The JIC facilitates efficient access to the entire DOD intelligence system. The composition and focus of each JIC varies according to the commander's needs, but each is capable of performing indications and warnings (I&W) and collecting, managing, and disseminating current intelligence. Through the JIC, ARFORs coordinate support from the Air Force, Navy, and Marine Corps and national, interagency, and multinational sources.

In addition to its other functions (I&W, situation development, target development, BDA, IPB, and force protection intelligence development), the JIC coordinates the acquisition of national intelligence between the JTF and the CINC's staff. The CINC posts special intelligence teams to the AOR. These teams are OPCON to the JFC and under staff supervision of the JTF J2. They may include DIA, the US Army Intelligence and Security Command, or the National Security Agency. Staff weather augmentation, as required, is under staff supervision of the JTF J2. The JTF J2, through the JIC, establishes and supervises required functional intelligence organizations that may include a—

- Joint interrogation facility (JIF).
- Joint captured materiel exploitation center (JCMEC).
- Joint documents exploitation center (JDEC).
- Joint imagery processing center (JIPC).

The JTF J2 requests a cryptologic support group (CSG) and an associated mobile cryptological support facility (MCSF) or equivalent SIGINT communications package from the CINC. The CSG works from within the JIC.

Successful IEW support during force-projection operations relies on continuous peacetime information collection and intelligence production. Peacetime IEW operations support contingency planning and develop baseline knowledge of threats and

environments. These operations engage and challenge the intelligence battlefield operating system to respond effectively to commanders' contingency planning intelligence requirements. During peacetime operations, commanders closely examine MI force structures, operations, and training, which ultimately leads to a combat-ready IEW force capable of successfully supporting force-projection operations.

IEW operations planners must anticipate, identify, consider, and evaluate potential threats to the force as a whole throughout force-projection operations. For smooth transition to hostilities, intelligence staffs must coordinate collection and communications plans before the crisis occurs. MI units continually update their contingency plans to reflect the evolving situation, especially during crisis situations. Immediately before deployment, intelligence activities update or *top off* deploying forces with the most recent intelligence on the AO. MI units continuously update technical data bases and situation graphics.

Logistics. The J4 (logistics) plans, coordinates, and supervises supply, maintenance, transportation, general engineering, health services, and other related logistics activities. Each service component of the combatant command is responsible for the logistics support of its respective forces, except when the CJTF designates a single-service responsibility for a particular logistics function. The CJTF establishes logistics priorities for the force, assigns terrain and facilities for use as support bases, and designates and maintains LOCs.

The J4 supervises the activities of any logistics-related coordinating centers and boards that may be required. These may include—

- A joint movement center (JMC) that coordinates strategic movement with USTRANSCOM and ensures effective use of transportation assets.
- A subarea petroleum office (SAPO) formed around elements from the combatant command's joint petroleum office (JPO) to augment the JTF in managing petroleum-related logistics.
- A joint facilities utilization board (JFUB) to manage real estate requirements (unless

the JTF engineer is designated a special staff officer and assigned these duties).

- A joint civil-military engineering board (JCMEB) to provide overall direction for civil-military construction efforts and development of a civil engineering support plan (again, the JTF engineer may manage this activity).
- A joint medical regulating office (JMRO) to coordinate the movement of patients in and out of the assigned AOR.
- A joint military blood program office (JMBPO) to coordinate the distribution of whole blood within the AOR.
- A joint central graves registration office (JCGRO) to handle mortuary affairs (normally tasked to the ARFOR).

Logistical considerations permeate the planning effort. These considerations are essential conditions and objectives in each phase of a plan or operation. The proper type of service support units must deploy early for port opening, reception, staging, and onward movement of incoming units; to support initially arriving forces; and to prepare lodgment for rapid force buildup. The CINC must decide whether to establish an in-theater COMMZ. In most force-projection contingency operations such a capability is not present. A COMMZ is required if the operational environment assessment identifies a requirement to stockpile support and logistics in theater.

Logistics planners should anticipate circumstances that could threaten logistics support capabilities. The plan should provide for alternative COAs as external and internal circumstances threaten the support capability. As circumstances warrant, the Army and JFC plan for operational replenishment to protect or regenerate combat power that has been dissipated in the conduct of operations. See Joint Pub 4-0 and FM 100-16 for a detailed discussion of theater logistics doctrine.

Influencing Factors

Whatever the organizational option chosen, the Army commander must have the capability to fulfill the tasks assigned him by the Army and the JFC. If assigned both the joint coordination and external support tasks, in addition to his operations tasks, the ARFOR commander must coordinate directly with the

required joint agencies and those Army logistics organizations that are part of the force-projection contingency operation.

The resources and capabilities of Army units correspond to their design and the missions they perform. Units designed for tactical operations do not have an operational capability as an inherent part of that tactical design. The three operational tasks are predicated upon a unit design that provides the capability to perform the operational functions described herein. Echelons at, division level and below have a tactical design and no inherent capability to perform the operational-level functions discussed in Chapter 5.

At corps level, more flexibility exists and augmentation can be used to correct specific design shortcomings for conducting operations at the operational level. The ASCC and numbered army are designed specifically for operational-level operations. The corps, however, when engaged in tactical operations, cannot perform simultaneously at both the tactical and operational levels. Though the corps commander must maintain an operational perspective, full-scale tactical operations preclude the performance of operational

functions. As ARFOR are designated to participate in force-projection contingency operations, the commander must consider that resource availability, media impact, US public will, the geopolitical structure/support, and the dynamics of the contingency environment may restrict his selection of optimal organizational structures. The commander selects lesser design options because of restraints, constraints, and the evolving nature of the operational environment.

Logistics units are particularly suitable for modular design so that entire units are not required to perform specified functions. Logistics units are also suitable for performing split-based operations, where only essential cells are deployed while the base organization performs its function in CONUS or from a forward-presence location elsewhere. Split-based operations are feasible only when communications and automation are assured.

As circumstances evolve, final design of the Army force must reflect the tactical and operational requirements. Where an operational requirement exists, the CJTF must allocate ARFOR from the appropriate echelon to perform those functions.

FORCE-PROJECTION STAGES

Contingency operations are undertaken in response to a crisis. That crisis can occur in isolation, as would be the expected case in MOOTW. But a crisis also can occur during the conduct of a major operation during hostilities. Viewing the contingency operation as a series of stages serves to sequence operations. When the contingency occurs during the conduct of a major operation, the stages assist in both resolving the crisis and in returning the contingency forces back into the ongoing operation as rapidly as possible.

The eight stages of a force projection—*mobilization, predeployment activities, deployment, entry, decisive operations, postconflict/postcrisis operations, redeployment, and demobilization*—provide the general structure for a contingency operation and can be adjusted to fit the needs of a particular contingency (FM 100-5). Execution of these stages may not be distinct. *Predeployment activities* and *deployment*, for example, might be so closely followed by *forced entry* and *initial operations* as to be indistinct. Operations might begin well before the entire

force has closed. At minimum, commanders and staffs must consider the—

- Coordination of sequencing and phasing of forces (combat, CS, and CSS).
- Requirement and time frame to establish and build up the theater base.
- Protection of forces, to include rear area operations (rear area rapid reaction force).
- Preparation time for deployment, operational readiness—types of units and their readiness, and so forth.
- CINC's critical items list in the TPFDD flow.
- Requirement and level of in-theater stocks.
- Host nation capability and availability.

Any particular contingency may not include all of the general stages. For example, a contingency operation may be the first phase of an evolving major operation. Redeployment of all forces may not begin until the end of the subsequent phases of the major operation, of which the contingency was a single phase.

STAGE I MOBILIZATION

Mobilization is the process that permits augmentation of the active force. The Army Mobilization and Operations Planning and Execution System (AMOPES) is the guide for planning and participating in the JOPEs. The five levels of mobilization are *selective mobilization, Presidential selected reserve call-up, partial mobilization, full mobilization, and total mobilization*. These options need not be executed sequentially and are part of the graduated mobilization response. Units mobilize through five phases: *planning, alert, home station, mobilization station, and port of embarkation*. FM 100-17 discusses mobilization in detail.

STAGE II PREDEPLOYMENT ACTIVITIES

This is a critical stage of a contingency force-projection operation for which units throughout the total force train. The ASCC recommends to the CINC the size and composition of the ARFOR required to support the mission, including forces that support assembly and deployment of the force. Additionally, the ASCC identifies the lift requirements to move the ARFOR and requirements for reception and onward movement upon arrival in the theater of operations. The ASCC's recommendation is based on the assessment of the operational environment. That assessment is revised to reflect the dynamics of the operational environment.

The JTF ARFOR commander maintains the Army's operational-level perspective within the JTF for the contingency. The attainment of strategic or operational objectives requires sequencing of Army military operations. In force-projection contingency operations, ARFOR commanders must keep this operational perspective, even if they conduct separate tactical operations directly for the JFC. The overall attainment of the strategic objective may require military operations not limited to combat missions. These sequenced military operations require an operational-level perspective over time.

The JFC's primary Army advisor for this perspective is the ARFOR commander assigned to the JTF. This commander provides operational-level perspective to the JFC during planning, deployment, employment, and redeployment. During planning, the ARFOR commander must receive a clear definition of the desired end state from the JFC. Because of

the inherent dynamics of the contingency environment, considerable effort may be involved in gaining clarity on the military end state. The military end state may include those diplomatic considerations that inevitably accompany contingencies over which the Army commander may have little direct control.

The CINC assigns the ways and means for mission accomplishment. His ASCC advises him on Army requirements to employ effective and efficient Army means. The NCA and the CINC assign the ways, in the form of constraints and restrictions, to the ARFOR commander. For example, the CINC may direct the seizure of objectives with psychological, rather than military, significance and may establish specific ROE. Once the ARFOR commander clearly understands the ends, ways, and means for the contingency, he begins the planning process in earnest or adjusts exiting plans.

Based on the CINC's concept of operations, the ASCC reviews all existing OPLANs and CONPLANs for suitability. He updates and adjusts these plans to develop an OPOD. Existing CONPLANs and lessons learned from the joint and Army repositories (Joint Universal Lessons Learned System [JULLS] and the Center for Army Lessons Learned [CALL]) should be the starting point when conducting crisis planning. If no suitable plan exists, the Army commander OPCON to the JTF develops OPODs, using the time-sensitive or CAP procedures outlined in Joint Pub 5-03.1.

The ARFOR commander develops his contingency OPODs based on the maximum capability the enemy can generate. In a crisis caused by a natural disaster, the enemy becomes the threat to human life and safety and the potential for damage to the environment. The ARFOR commander conducts parallel, but more detailed, execution planning with the JFC and normally issues a supporting Army OPOD with detailed instructions to subordinates. The concurrent planning occurs at all Army echelons involved in the contingency.

The ARFOR commander issues immediate warning orders to all subordinate units. Because of the time-sensitive nature of contingency operations and the crisis-action system, information must get to the appropriate unit as rapidly as it becomes available. Subordinate units must recognize

that they may not receive complete OPORDs from their higher headquarters until late. Subordinate OPLANs based upon earlier warning orders must be flexible enough to adapt to the evolving contingency operations. Therefore, horizontal and vertical coordination must occur between staffs so that plans can be made concurrently. Liberal use of warning orders should be used so subordinate commanders can begin work.

Certain planning considerations are critical during this stage. Anticipatory logistics requires appropriate commanders to project support requirements and synchronize support actions with tactical organizations. This action is necessary to ensure combat power can be sustained or reconstituted as required. The ARFOR commander identifies potential consequences to ensure that the JFC makes knowledgeable decisions on lift prioritization. Finally, as with all operations, OPSEC must not be sacrificed, despite the urgency of the crisis situation.

An important task facing the ARFOR commander is the organization of his staff and the Army augmentation of the JFC's staff to support the planning and execution of the contingency operation. The makeup of the JTF staff should reflect the composition of the operational forces. If the JFC's mission is largely an Army mission, Army personnel should predominate the staff. The Army contribution to the JTF may include light, armored, or special operations forces.

The Army augmentation package given to the JTF staff should reflect the proportional balance of the JTF force package. If the joint staff is not sufficiently and appropriately augmented, the ARFOR commander must spend more effort advising the JFC on the capabilities and limitations of the Army force. Therefore, ARFOR likely to conduct contingency operations should have designated augmentation cells (discussed earlier in this chapter) that automatically push forward to support JTFs. See Figure 6-7.

STAGE III DEPLOYMENT

The initial response force is the product of a combination of many factors. It reflects the mission of the JTF and the Army's corresponding tasks, along with the lift that has been made available to conduct the necessary strategic and operational movement.

Considerations During Predeployment Activities

The senior ARFOR commander tailors the force based upon the mission assigned and the resources available. He is responsible for informing the JFC when allocated means do not ensure the probability of success. If he is the land component commander, he also plans for the integration of all land forces allocated to the operation.

The Army service component command headquarters ensures that it integrates effectively with the joint communications plan. The ASCC ensures he has access to the DCS. Some links require specific hardware when the joint force headquarters and core staff are from another service. This communications link must be redundant and apply in all of the functional areas, not just in the maneuver control function.

The Army service component command headquarters must coordinate the use of space assets to support the operation. Some considerations include optimizing communications and global positioning systems and receiving current weather satellite data. Additionally, the headquarters must arrange for requirements for rapid response satellite image maps and terrain analysis products.

Corps and above intelligence organizations are critical to Army intelligence preparation. They provide the interface among tactical forces and the joint and national agencies that provide supporting intelligence. These Army organizations must link their intelligence networks into all sources. The ARFOR commander ensures he receives an intelligence *push package* and liaison officers for intelligence products.

Army commanders ensure adequate LNO representation at higher, lower, and adjacent organizations. These LNOs must be of appropriate rank and experience to be effective. LNOs during contingency operations are particularly important because each contingency is likely to be unique, and the organizational requirements are normally *ad hoc*. This type of situation demands rapid communication channels between different units and other service elements that have not had the opportunity to train extensively together. LNOs assist in rapidly establishing these important communication channels.

Figure 6-7. Stage II (Predeployment)

Other factors include the capabilities of the host nation to support ARFOR on either a long- or short-term basis. Finally, the contributions of alliance or coalition forces shape the initial response by ARFOR. The supported CINC's decision on the composition of this force requires the ASCC to project future events. The Army force commander seeks to maintain versatility, a flexible force mix, and the ability to generate superior combat power, sustainability, and the necessary internal lift capability.

STAGE IV ENTRY OPERATIONS

The execution stage—entry operations—encompasses the occupation of the initial lodgments in the operations area. In this stage the capability for force is generated. Initially, that capability does not go far beyond self-sustainment. The ARFOR commander sequences his resources into the operations area to create the conditions for decisive operations. This sequencing includes joint mobility of operational forces that seek to gain a positional advantage early.

Two alternative approaches exist to establishing positional advantage. The first is a long-term approach that focuses on building the force capability over time. Once sufficient capability is available, the ARFOR commander tries to resolve the cause of the crisis. In the second approach, rapid crisis resolution is sought through the positioning of initially deploying forces into the critical location. By rapidly positioning forces with the requisite capability, the crisis may be resolved earlier. However, the Army might have to conduct forcible entry operations. This approach has a high payoff. Risk is the price for such potential.

The ARFOR commander coordinates the movement of intertheater or intratheater forces into the operations area. Opposed-entry combat activities may take place during this stage. The ARFOR commander deploys operations and support forces into the contingency area and establishes C¹ to provide initial lodgments. While the focus during this phase is the deployment of forces, operations may be required to secure simultaneous entry zones that ensure force protection into the contingency area.

An effective air defense should be established in the lodgment area as rapidly as possible. Air defense is critical for the

protection of the lodgment area. TBM, CM, ASM, and UAV threats could seriously disrupt or compromise the security of lodgment operations. Based on the threat and availability of joint and/or multinational ADA systems, early entry forces tailor the ADA force packages that are deployed initially. An ADA task force is deployed to protect selected enclaves. This stage ends with the establishment of a secure airhead and/or beachhead. See Figure 6-8.

STAGE V DECISIVE OPERATIONS

A rapid buildup of force capability is the focus of this stage. This buildup includes establishing a forward-operating base, closing the remainder of the force, expanding the lodgment, linking up with other joint forces, and establishing multinational and interagency linkages. Decisive combat power is

Considerations During Entry Operations

The ARFOR commander coordinates all joint mobility assets required to deploy his forces and materiel. He requests support in a mission format to the JFC. He does not specify numbers and types of transportation.

This mission-type requirement to the USTRANSCOM avoids confusion and allows for a greater number of options for deployment. Specific requirements may be necessary and should be articulated by the ARFOR commander to the USTRANSCOM in terms of numbers of personnel, types of equipment, and required time schedule. The ASCC's staff works closely with the USTRANSCOM to ensure that the lift provided meets the specifications of the Army force.

The ARFOR commander, in conjunction with the JFC, tailors the entry force to accomplish specific operations in preparation for follow-on forces during this phase. This force may or may not participate in the following stages of the contingency. The entry force C² structure evolves as the operation progresses. A need exists early on for an operational-level C² element. This headquarters unburdens tactical-level leaders and permits them to focus on the tactical-level operations for which they were designed.

**Figure 6-8. Stage IV (Entry Operations)
Considerations**

positioned to resolve the crisis rapidly by synchronizing and simultaneously engaging enemy forces throughout the depth and space of the operational area.

Force protection becomes increasingly important during the operations stage. Reconnaissance assets are focused to provide the ARFOR commander with an accurate picture of the enemy force actions and intentions. OPSEC ensures the protection of the force in part by preventing the enemy reconnaissance from gaining similar information on friendly forces. Deception operations complement OPSEC by painting a false picture of the friendly force's intentions. Effective air defense and TMD remain a priority during this phase of the operation.

In MOOTW, decisive operations contain similarities and differences from the principles that guide operations in war. The principles of *objective, unity of effort, legitimacy, perseverance, restraint, and security* guide actions in MOOTW. Figure 6-9 describes areas for consideration during conduct of operations.

STAGE VI POSTCONFLICT OPERATIONS

During the previous stage, the ARFOR commander completes the Army contribution toward attaining those operational objectives to resolve the crisis that instigated the contingency operation. Postconflict operations secure the strategic objectives. Planning for postconflict operations must be an integral part of the overall Army plan, which is revised continually as the conclusion of hostilities approaches. The objective of this planning is to transition operations with minimum confusion to either the host nation, an international body, or DOS. The Army contribution to postconflict operations may include—

- Controlling prisoners.
- Handling refugees.
- Arranging for civilian contractors to clear minefield and conduct demining operations.
- Destroying explosive ordnance.
- Conducting civil affairs.

Simultaneously, units prepare for future operations by consolidating, reconstituting, and training. These future operations can

Considerations During Operations

The ARFOR commander adjusts his plan based upon the situation on the ground. Invariably, portions of the plan are based upon invalid assumptions or inaccurate information. No plan survives intact, but the flexible one is adjusted quickly to allow for changes. Adjustments to the plan affect other portions of the operation. This is particularly apparent when adjusting the flow of personnel and equipment into the area. As an illustration, changing the lift priorities may have extensive impact on employment operations during a subsequent stage.

The ARFOR commander receives follow-on forces during this stage. He ensures adequate airports and seaports of debarkation are available and that the force is equipped as required. He marshals and stages the follow-on forces in preparation for decisive operations.

The ARFOR commander determines if resources are adequate to accomplish the mission. He recognizes the dynamics of the operational environment and adjusts plans and operations to reflect those changes. He makes specific recommendations to the JFC within the constraints and restrictions of the operation.

The ARFOR commander receives administrative and logistics support from his service chain or from organic assets. The Army commander tasked with the support responsibility stages support resources forward to support the operation. This support includes directing the efforts of Army organizations temporarily tailored for the specific operation. The ASCC, in conjunction with the ARFOR commander, develops intermediate staging basing (ISB), if required. ISB may be located offshore afloat or in a third country close to the contingency area.

The CINC establishes movement control for the Army assets into the AO. He sets the priority for ARFOR entry and supervises the operational movement. He works closely with the JFC to enforce lift priorities. The supervision of lift into the contingency area becomes a critical task for several reasons: lift into the contingency area may be constrained, planned lift assets may be diverted, or the lodgment area may have limited reception capability. The sequencing of resources into the AOR becomes a critical task for the senior army commander during this stage.

Figure 6-9. Stage V (Decisive Operations) Considerations

Considerations During Postconflict Operations

The senior ARFOR commander desires overwhelming strength to execute the contingency operation. The mere presence of overwhelming strength is a force multiplier. At the same time, the reduction of collateral damage may be a major constraint during this phase. The ARFOR commander tightly controls the ROE (instructions, artillery position, azimuth-determining system, control measures). These controls are an important part in determining the complexity of postconflict operations.

Consolidation operations begin during this stage. These operations may be more significant long term than actual contingency operations for achieving strategic objectives. Restoration operations consist of a number of activities that have political, economic, or diplomatic impact. Some of these activities include nation assistance, CA, and infrastructure repair. The ARFOR commander carefully sequences these operations into the theater CINC's continuing major operation or campaign.

The ARFOR commander may focus on tactical-level operations during the contingency. However, he must maintain a larger perspective, looking beyond the relatively short-term contingency operation. The contingency operation alone seldom achieves the desired end state. The ARFOR commander must recognize how the contingency operation fits into the long-term strategic objectives of the theater CINC.

During the operations stage, the ARFOR commander responsible for the operational-level perspective may change. The JTF may have achieved its primary mission and the CINC may disestablish it. The senior army commander responsible for executing the contingency operation may redeploy with the main body of forces. A modified C² structure may replace the JTF, the CINC may assume direct control, or the theater may revert to its normal peacetime organization. Regardless, the Army's operational-level perspective must pass to the new senior ARFOR commander to continue postconflict operations. The new commander continues with postconflict operations and completes redeployment of the contingency force.

As part of postconflict operations, the ARFOR commander conducts operations to stabilize the situation. These include internal security, law and order, PSYOP, and CA programs. PSYOP emphasize the purpose of the US actions and balance any negative residual effects of the contingency operation.

Figure 6-10. Stage VI (Postconflict) Considerations

range from the resumption of hostilities to redeployment. See Figure 6-10.

STAGE VII REDEPLOYMENT AND RECONSTITUTION

During this stage, the force prepares for future operations. The force may be redeployed to its home station, to a staging base, or to another theater for subsequent operations. In addition, the ARFOR commander reconstitutes his force, within his capabilities, to ensure flexibility for future operations. (See Figure 6-11).

Reconstitution of the force requires an extensive reallocation of resources and skills. The LSE may play a major role during reconstitution operations. The LSE must be able to receive, identify, and determine disposition; maintain accountability; store, prepare for shipment, and arrange for movement of Class I, II, III (package), IV, V, VI, VII, and IX items to the port or a theater stockage location. Some of these functions can be performed by augmenting LSE personnel with TOE units or contractor personnel. Items requiring repair may be repaired by the LSE or a contractor within the theater or sent out of the theater to a repair facility. The theater materiel management center identifies the items requiring redistribution instructions.

Considerations During Redeployment and Reconstitution

The ARFOR commander controls the flow of Army assets out of the operations area. There is a natural inclination to redeploy all forces out of the area as quickly as possible upon the completion of tactical operations. This may be the CINC's stated objective, but it has diplomatic ramifications. The ARFOR commander must find a way to balance this objective with his requirement to conduct restoration operations. He does this by gaining additional guidance from the JFC, who in turn reconciles objectives with the CINC.

The ARFOR commander may change several times as the Army forces are reduced and their composition changes. However, the ARFOR commander remains the JFC's primary advisor on Army matters. Once the JTF achieves the CINC's designated objectives, the CINC dissolves it. Then, the CINC's ASCC assumes the remaining Army missions.

Figure 6-11. Stage VII (Redeployment and Reconstitution) Considerations

STAGE VIII DEMOBILIZATION

Demobilization is the process by which units, individuals, and materiel transfer from active to reserve status. Demobilization is accomplished in five phases: *planning actions*, *area of operations actions*, *transit actions*,

demobilization station/center actions, and *home station/horne-of-record actions*. As with mobilization, demobilization is discussed in detail in FM 100-17.

Chapter 7

Army Operations in War

The NCA may exhaust its options to achieve vital national interests with the diplomatic, economic, and informational elements of national power. Such would require the NCA to use the military element of national power as a primary instrument for protecting national interests.

When the military element becomes the predominant element for the execution of policy in a particular theater, the Army may enter the third state of the range of military operations—war. This chapter discusses modern warfare and the transition to war from peacetime or conflict. The chapter closes with a short look at the termination of war.

MODERN WARFARE

War is a state of hostile, armed combat. War is characterized by the sustained use of armed force between nations or organized groups within a nation. War involves regular and irregular forces in operations to achieve vital national security objectives. War may be limited or general in the resources employed and the risks of survival at stake.

Modern warfare may be nonlinear, thereby making air operations increasingly vital to the effectiveness of ground operations. The commander may, by choice or by lack of maneuver forces, place his force in dispersed, noncontiguous areas from which he can operate to destroy enemy forces. Nonlinear operations require commanders to seize the initiative through offensive action, to force the pace of battle, and to retain the flexibility to bring overwhelming force to destroy the enemy at a time and place where he is most vulnerable.

The long-term aim is to regain the initiative and flexibility needed to quickly destroy the enemy force. At the operational-level, this involves an appreciable amount of risk but offers an opportunity for high-payoff success. The Army organizes in war to fight effectively both linear and nonlinear operations.

TRANSITION TO WAR

During peacetime, the Army trains to deter war and, if necessary, to fight the nation's wars. The ASCC must ensure that during realistic training for war his subordinate units consider the effect of training on the environment and the effect of the environment on training. Federal laws require that Army activities

conducting training and operations during war and MOOTW comply with all federal, state, and local (to include host nation) environmental and pollution abatement requirements and standards. Environmental pollution standards cover solid waste management and control of pollutants in the air and water and on terrain. Other legal requirements cover resources such as endangered species and wetlands. Other environmental areas that must be addressed concern noise, terrain damage, ecological areas, and historical/archeological sites. Still, the environment should be treated as a resource, not a constraint.

The CINC structures the army in theater to transition to war, to receive reinforcements, to conduct major operations, and to terminate war on favorable terms. The CINC fixes area and organizational responsibilities for the Army in consonance with the theater strategy, the threat, available forces, and existing or prospective alliances. These responsibilities evolve significantly during the transition from peacetime to wartime.

Unity of Effort

At the operational level, Army operations in war are always part of unified and joint operations and often part of multinational operations. Therefore, the Army commander must have a unified, joint, and multinational view of operations. Army cooperation with the other components is necessary to produce unity of effort. Military operations are more than just combat operations and do not necessarily end with the cessation of hostilities. Some of the

military operations that occur during and after combat operations include—

- Processing and return of enemy prisoners of war (EPW).
- Return of displaced civilians.
- Transfer of responsibilities to peacekeeping forces.
- Restoration of basic life support services.
- Battlefield policing.

Units conduct these operations until acceptable peacetime conditions are achieved and the force is redeployed.

The Range of Military Operations

All states of the range of military operations may exist within the theater of war. Peacetime activities may characterize a portion of the theater, while other areas may experience conflict. Thus, the principles and operations that apply to peacetime and conflict discussed in previous chapters may apply to the theater of war. The primary focus of the war environment, however, remains on combat operations and those activities that ensure success.

Organizational Changes

When the Army in theater transitions to war, significant changes occur in Army organizations. Such changes require a rapid expansion of the Army in order to introduce large numbers of maneuver and support forces

to reinforce the theater. The ASCC evolves and expands to cope with the increased tempo of operational and support missions. The Army may introduce additional operational-level headquarters to assist the CINC in controlling the increased number of tactical organizations.

Depending on the analysis of METT-T and the extent of global conflict, the CINC may organize several theaters of operation within the theater of war. This has not been done since World War II. The CINC may form JTFs for specific missions in theater, as was done during Operation Desert Storm. Each of these will most likely include ARFOR. In theater, more than one Army commander may have operational-level responsibilities. These operational-level Army commanders sequence operations over space and time to attain operational or strategic objectives. The principles outlined in Chapter 3 for the design and execution of operational art apply to these commanders.

RETURN TO PEACETIME

The desired end state of war is the rapid return to peacetime on terms favorable to the US and its allies. This end state includes setting the conditions to prevent future war or conflict. Postwar or military consolidation operations may be necessary to ensure that the theater transitions to peacetime and remains there for the foreseeable future. Diplomatic and economic considerations may predominate during this process, with military operations supporting these elements of national power.

ARMY SERVICE COMPONENT FUNCTIONS IN WAR

The ASCC's primary mission is to contribute to the success of the joint or multinational commander's major operation. The ASCC must envision the long-range strategic objective in formulating his initial plans for positioning forces. Army service component functions during war include movement and maneuver, fires, protection, deception, C², joint information systems interface, IEW, and support.

MOVEMENT AND MANEUVER

The CINC requests forces stationed in CONUS or from other theaters. USTRANSCOM has overall responsibility to

move forces into the theater of war via strategic lift. Based upon operational requirements, the ASCC influences this process through JOPES, AMOPES, and TPFDD. He ensures that the proper types of Army personnel and materiel flow into the theater to conduct and support major operations. The CINC sequences this flow to ensure that it supports the concept of operations for current and future missions. Within the AO, movement and maneuver must be well-coordinated, integrated, and synchronized to maximize the combat power available to the theater commander. This coordination and synchronization is conducted on an area basis through maneuver control,

movement control, and battlefield circulation control.

Theater Commander

The CINC may designate the ASCC as a senior support headquarters without responsibilities for conducting combat operations. This becomes highly probable as the requirements for support increase and the CINC becomes more involved in directing Army combat operations.

Army Service Component Commander

The reception, preparation, and flow of ARFOR in the theater is a primary function of the ASCC. The ASCC sets clear movement priorities within the context of the current major operation and in preparation for future major operations. The ASCC uses the senior movement control agency (MCA) to provide the *movements program*, which allocates transportation support based on these priorities to support reception and onward movement activities. Execution of the program provides for the movement of units, supplies, and equipment from support areas forward to the deployed forces and ultimately retrograde of materiel from these forces.

The ASCC concentrates forces and creates economy of force through the use of intratheater movement. Through intratheater movement, the ASCC develops positional advantage in relation to the enemy to support the campaign. The ASCC carefully weighs the risks of concentration against the protection of forces, installations, and the infrastructure on which future operations depend.

The ASCC visualizes maneuver in the operational sense. His visualization is from the perspective of the entire theater army, not just one or several of its elements. Divisions, separate brigades, or regiments are the level of resolution of his perspective. An early decision is imperative. Once initial corps and division positions are selected, the ASCC will find it difficult to change the initial set.

Army Operational-Level Commander

Planning offensive and defensive operations and maneuvers to achieve the CINC's campaign plan is a primary function of the ARFOR operational-level commander. In addition, he plans large-scale operations and directs maneuver of subordinate forces.

Plans Offensive and Defensive Operations

The ARFOR commander at the operational level plans offensive operations in war to secure or retain the initiative, to exploit or pursue the enemy, and to prevent the enemy from regrouping and regaining the combat initiative. He also plans defensive operations to gain time or space to conduct decisive offensive actions. Even in the defense, the ARFOR commander seizes opportunities and plans for offensive maneuver, counterattack, and deep operations whenever possible.

Plans Large-Scale Operations

The ARFOR commander at the operational level plans large-scale maneuver of assigned forces to support the theater campaign, with a view to the theater CINC's ultimate objectives. The CINC sequences and/or integrates major operations by assigning zones or sectors, boundaries, objectives, priorities, resources, and phases. He integrates within his battle space resources such as space-based systems and information warfare assets. Planning responsibilities center on analyzing the assigned mission, visualizing major combat operations and logistical requirements, and disseminating plans and directives. The plans generally project future operations and provide details on mission accomplishment as directed by the CINC.

Directs Maneuver of Subordinate Forces

The Army operational-level commander directs the maneuver of subordinate forces to support the theater campaign plan. This direction is tied to the overall concept of operations and the estimate of the situation at key decision points during the operation. The primary emphasis of operational maneuver is on the concentration of combat power through the exercise of large land formations on broad fronts.

Synchronization of operational movement, fires, and support produces a series of operational maneuvers that provide the Army operational-level commander and subordinate commanders with the necessary leverage to shape the battle space to gain, retain, and sustain the initiative. The ARFOR commander synchronizes attacks on the enemy throughout the battlefield to counter known or anticipated enemy efforts, to exploit success, and to hasten the total collapse of enemy forces.

Tactical execution focuses on destruction of the enemy throughout his battle space through

use of depth and simultaneity. The Army operational-level commander, while sensitive to these immediate engagements, cannot allow himself to be preoccupied with the close operations and be distracted from the larger perspective. He reallocates forces, reprioritizes efforts, and conducts a continuous estimate throughout the battle space to react to current and future decisive points.

The Army operational-level commander initiates changes designed to facilitate the execution of current operations, with due consideration to the impact on future operations. He directs the movement of subordinate forces to ensure that after a distinct phase of the operation they are positioned in a manner that will enable rapid transition to subsequent phases.

Normally, deciding the specific form of maneuver to be used against tactical or operational objectives is left to the judgment and discretion of subordinate tactical commanders. Directing a tactical form of maneuver at the operational level reduces the flexibility of subordinates, narrows options, and may unnecessarily restrict subordinate commanders in developing optimum COAs.

To defeat the enemy's center of gravity, the commander can synchronize maneuver, fires, and operations simultaneously in depth against enemy forces at all levels. This synchronization is one of the most dynamic concepts available to a commander. Maneuver and fires should not be considered separate operations against a common enemy, but rather complementary operations designed to achieve the commander's objectives. The commander phases the operation against the enemy's decisive points at successive depths. This phasing helps him determine the most advantageous simultaneous employment of forces and firepower for decisive engagement to achieve the end state.

FIRES

JFCs use a variety of firepower means to divert, disrupt, delay, damage, or destroy the enemy's air, surface, and subsurface military potential. This paragraph discusses how the JFC thinks about applying joint fires to support his concept of operations.

The Firepower Model

Joint firepower can be classified as tactical, operational, or strategic, based on its intended effect.

Tactical Firepower

The primary purpose of tactical firepower is to directly and immediately support tactical operations of the joint force against appropriate tactical decisive points. Therefore, maneuver commanders exercise control over tactical firepower that supports their maneuver operations. Tactical firepower includes the coordinated and collective use of target acquisition data, indirect-fire weapons, armed aircraft (both fixed- and rotary-wing), and other means against enemy elements in contact or imminent contact. Included are artillery, mortars, other nonline-of-sight fires, naval gunfire, CAS, attack aviation assets, and electronic attack. Tactical firepower also could include the means for surface-to-air and air-to-air engagements.

Interdiction operations conducted by all elements of the joint force can also be designed to achieve or support tactical objectives. Some interdiction missions may therefore be considered as tactical. All interdiction missions affecting the land battle require coordination between several levels of command, both within and across service lines (see Figure 5-2).

Operational Firepower

Operational firepower achieves a decisive impact on a subordinate campaign or major operation. Operational firepower is joint and multinational. It is a separate element of the subordinate JFC's concept of operations (addressed separately from operational maneuver) but must be closely integrated and synchronized with his concept for maneuver. In that regard, operational firepower is integrated normally with operational land maneuver for synergistic effect, staying power, and more rapid achievement of strategic aims. Operational firepower is **not** fire support, and operational maneuver is not necessarily dependent upon operational firepower. Still, operational maneuver can be affected by such fires and can exploit opportunities created or developed by the JFC's operational firepower.

Today, all services contribute capabilities that can be used for operational firepower. To synchronize operations, the JFC may task one component to provide fires to support another component's operations. Still, as service means for operational firepower may be used for tactical firepower, the JFC should preserve that tactical capability as he develops his concept of fires.

Operational firepower includes targeting and attacking land and sea targets whose

destruction or neutralization will have a major impact on a subordinate campaign or major operation. Operational firepower includes the allocation of joint and multinational air, land, sea (surface and subsurface), and space means. In a war involving WMD, fires could be an operational instrument at decisive points that leads to the enemy's strategic center of gravity. Operational firepower can be designed to achieve a single, operationally significant objective that could have a decisive impact on the campaign and major operation. Operational firepower may include the interdiction of a major enemy force or forces to set the conditions for subsequent, decisive operations.

Operational firepower is planned *top down*. The operational commander establishes objectives, identifies targets, and then passes them to subordinate joint or multinational units for execution. Subordinate nominations contribute to this top-down approach. Operational firepower focuses largely on one or more of the following:

- Destruction of critical functions, facilities, and forces having operational significance.
- Isolation of a specific battle within the battle space.
- Facilitation of maneuver to operational depths.

Systems capable of providing operational firepower generally include land- and sea-based airpower and surface-to-surface, long-range missiles.

The ASCC has various means with which to execute operational firepower. He may mass fires, concentrate long-range missile fires, employ attack helicopters, or coordinate the use of air forces with Army resources. Application of operational firepower is a primary means for concentrating combat power.

Strategic Firepower

Strategic firepower is intended to achieve a major impact at the strategic level and thus an impact on the course of the theater campaign or war as a whole. Strategic firepower includes selection and assignment of strategic targets to attack capable forces. Strategic firepower also makes the forces and resources available for attacking those targets according to the theater strategy and campaign plan.

Systems capable of providing strategic firepower are generally those also capable of providing operational firepower. The intended effect or outcome qualifies a system, weapon, or operation as either strategic or operational. Nuclear munitions, because of the escalation they signal, are normally categorized as strategic firepower—whether they are delivered by aircraft, missile, or other means—and are closely controlled through a system the theater commander establishes.

Army Interface

The Army operational-level commander is the critical link for coordination of joint support for Army operations and Army support for joint operations. The Army operational-level commander has a key role in ensuring that ground and air operations, as devised by the JFC, complement and reinforce each other. The Army operational-level commander begins coordination with the JFC and ACC early in the operational planning process. During the operational planning process, the Army operational-level commander, in coordination with his subordinate commanders and staff, identifies Army requirements for air support (reconnaissance, CAS, air interdiction, and airlift). He also participates in the targeting process by nominating targets for Army and Air Force engagement.

Interdiction

Interdiction contributes substantially to operational firepower, although it also can have tactical and strategic effects. Interdiction diverts, disrupts, delays, or destroys the enemy's surface or subsurface military potential before it can be used effectively against friendly forces. Although interdiction can have tactical effects, it generally applies forward of or beyond units in contact or imminent contact. Its effects must be synchronized in time, space, and purpose with other supporting or supported operations of the joint force. Interdiction-capable forces include, but are not limited to—

- Fighter or attack aircraft and bombers.
- Ships and submarines.
- Conventional airborne, air assault, or other ground maneuver forces.
- SOF.
- Surface-to-surface, subsurface-to-surface, and air-to-surface missiles, rockets, munitions, and mines.

- Artillery and naval gunfire.
- Attack helicopters.
- EW systems.
- Antisatellite weapons.
- Space-based satellite systems or sensors.

Synchronizing interdiction and maneuver is critical to the successful execution of the campaign or major operation. Interdiction and maneuver should not be considered separate operations against a common enemy, but rather complementary operations designed to achieve the JFC's campaign objectives. Moreover, interdiction could be a maneuver itself to gain positional advantage over an enemy.

Potential responses to synchronized maneuver and interdiction can create an agonizing dilemma for the enemy. If the enemy attempts to counter the friendly maneuver, enemy forces can be exposed to unacceptable losses from interdiction; if the enemy employs measures to reduce such interdiction losses, enemy forces may not be able to counter the maneuver. The synergy achieved by integrating and synchronizing interdiction and maneuver assists commanders in gaining the greatest leverage against the enemy at the operational level.

The ARFOR operates within the theater operational battle space that the JFC establishes for the conduct of all operations. Strategic, political, and internal boundaries are examples of the further subdivision of the battle space that must be considered by the operational commander. The JFC establishes operational boundaries to facilitate the synchronization of maneuver and interdiction. Synchronization of efforts within these boundaries is of particular importance.

According to Joint Pub 3-0, the operational land commander is the supported commander for air interdiction in his AO, and he therefore specifies the target priority, effects, and timing of interdiction operations therein. While this may mean specifying individual targets or target sets and the desired effects to be achieved in attacking them, the often preferred method is for the land commander to specify the operational-level effects he intends the interdiction to achieve, the target priorities to achieve those effects, and the date/time by which the effects are required (for example, eliminate the counterattack capability of X

Guard's corps by destroying artillery, armor, and soft-skinned vehicles not later than D+7).

Interdiction operations, whether by land, air, or naval forces, complement overall maneuver to destroy the enemy's center of gravity. The ARFOR commander may choose to use interdiction as a principal means to achieve the intended objective (with his subordinate forces supporting the component leading the interdiction effort). For example, actual or threatened maneuver can force an enemy to abandon or reveal covered positions or attempt rapid resupply. These reactions provide excellent and vulnerable targets for interdiction.

Targeting

Targeting by the ARFOR staff follows the same targeting process used at subordinate echelons. This process is detailed in FM 6-20-10. The targeting process is an important part of the military decision-making process described by FM 101-5.

At the operational level, the focus of the targeting effort is more on planning and coordination, rather than on execution of operational firepower. Typically, when the ARFOR staff identifies high-payoff operational targets, it will coordinate with subordinate units for acquisition and attack by systems allocated or organic to the corps. There will be some critical targets that subordinate units are not capable of acquiring or engaging. The critical nature of these targets—and the requirement to coordinate and synchronize the employment of several joint acquisitions/attacks as quickly as possible—requires the ARFOR commander to establish a staff section to support the associated targeting effort. This section is the DOCC.

The DOCC is organized with appropriate joint service, multinational arms, and coalition force representatives. The primary functions of the DOCC are situational awareness, planning and coordination, targeting, and control of designated operational firepower. A description of the DOCC functions is shown in Figure 7-1. The primary mission of the DOCC is to provide centralized coordination and management of ARFOR deep operations. The DOCC ensures effective and efficient employment of critical assets and facilitates synchronization of joint operations. The primary functions of the DOCC apply across the range of military operations.

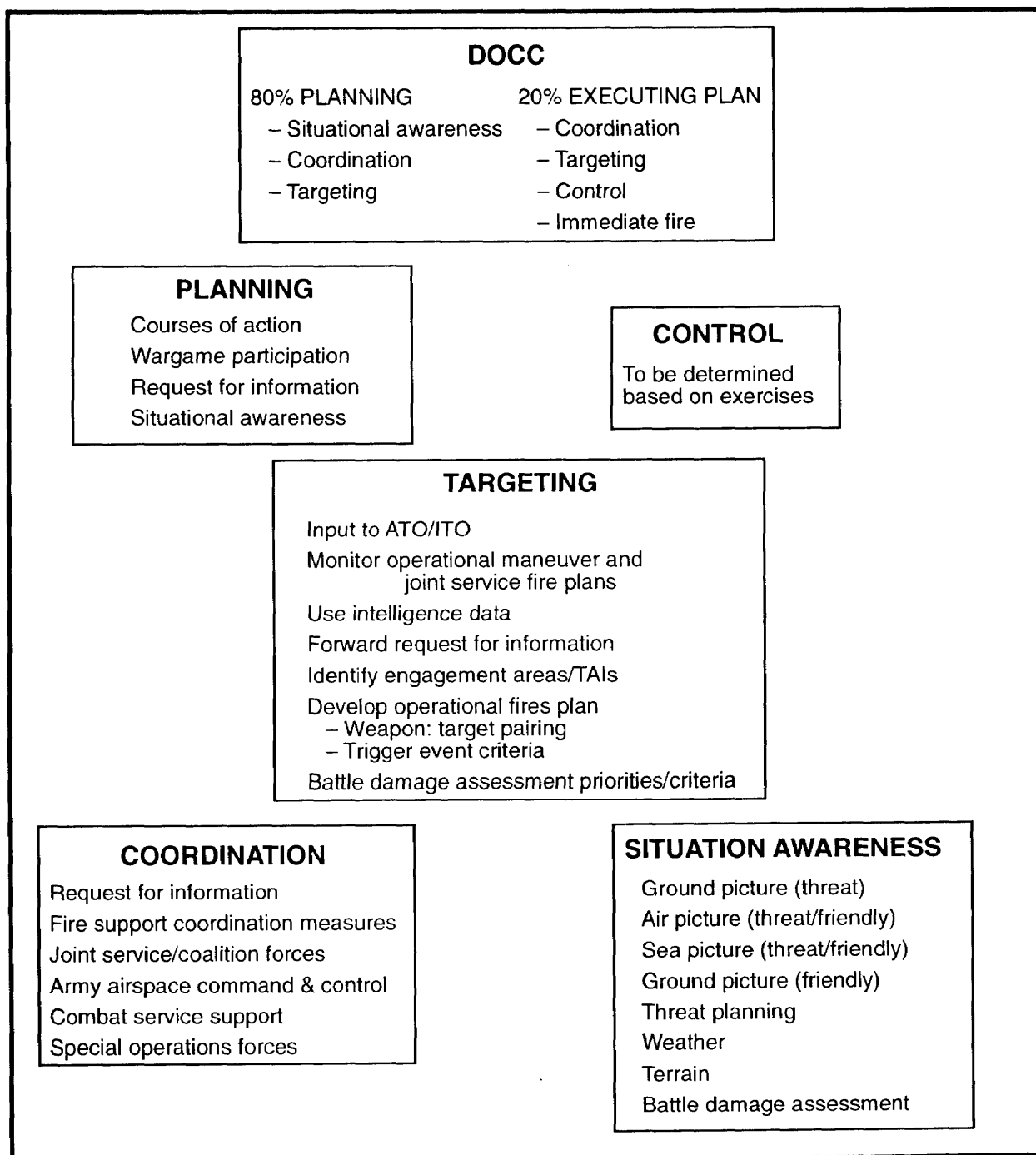

Figure 7-1. Deep Operations Coordination Cell Requirements

Fire Control Measures

JFCs employ various fire support coordination measures to facilitate effective joint operations. Many maneuver control measures have fire coordination implications. Specific joint fire support coordination measures and the procedures associated with those measures also assist in preserving the

fluidity and flexibility of successful joint operations.

Fire Support Coordination Line

The ARFOR may establish an FSCL within the AO to support his concept of operation. The ARFOR must coordinate the FSCL's location

with the appropriate ACC and other supporting elements. If an FSCL is established, its purpose is to allow the ARFOR, its subordinates, and supporting units, such as Air Force, to swiftly attack targets of opportunity beyond the FSCL. Such attacks by Army assets must be coordinated with all other affected commanders in sufficient time to allow necessary action to avoid friendly casualties. This coordination includes informing and/or consulting with affected commanders (that is, supporting air components). The inability to effect this coordination will not preclude the attack of targets beyond the FSCL; however, failure to coordinate this type of attack increases the risk of friendly casualties and could waste limited resources through duplicate attacks. If the land force commander desires to shoot or maneuver beyond his lateral boundaries, he must first coordinate with the appropriate commander. The interface within the DOCC among the various fire support representatives provides an excellent means of initially coordinating the attack of targets in the area.

The FSCL must complement the ARFOR commander's concept for deep operations and optimize the synergy between operational maneuver and operational firepower. To achieve this synergy, supported and supporting commanders must have clearly defined responsibilities, selective targeting, and coordinated operations. As the supported commander, the ARFOR provides necessary guidance (restrictions, constraints) for all operations in the area beyond the FSCL and within the designated ARFOR AO. The ARFOR commander does not necessarily have to control the supporting operations or joint service activities in this area. Still, supporting commanders must follow the ARFOR commander's intent and guidance for activities in this area. Control of interdiction provides a functional example.

Interdiction occurs both short of and beyond the FSCL. Attack of planned interdiction targets on either side requires no further coordination, assuming the attack is proceeding as planned. Deviation from the plan requires coordination with affected commanders. Attack of interdiction targets of opportunity short of the FSCL requires coordination with the affected commanders. Before attacking targets of opportunity beyond the FSCL, supporting commanders should coordinate with the ARFOR commander.

However, if he cannot effect coordination, the supporting commander controlling the attack must follow the ARFOR commander's guidance for attacking targets in this area. Thus, the ARFOR commander need not directly control the overall interdiction effort (air, ground) but, as the supported commander, he exercises general direction over interdiction and other activities of supporting commanders in his AO.

Besides the FSCL, other fire support coordination measures may be used to facilitate or restrict operational firepower. These include restrictive fire areas (RFAs) and no-fire areas (NFAs) to protect friendly elements on either side of the FSCL. If ROE permit, commanders should consider the use of free-fire areas (FFAs) to expedite fires or the jettisoning of ordinance in specific areas.

Whether attacking or defending, the ARFOR commander usually designates an initial FSCL and plans for a subsequent series of on-order FSCLs. Execution of on-order FSCLs must be transmitted in sufficient time to allow higher, lower, adjacent, and supporting headquarters time to effect necessary changes.

Warfighting Airspace

Warfighting airspace is the airspace directly above the ground commander's AO that provides for freedom of maneuver for those forces operating in the third dimension. Commanders in the field use various means to gain freedom of maneuver in this area, especially in the conduct of deep operations. Warfighting airspace uses the coordinating altitude to define this area. The coordinating altitude is an airspace permissive control measure designed to coordinate airspace between high performance fixed-wing and rotary-wing aircraft. The JFC has already designated the AO. The warfighting airspace presents a three-dimensional view of the battlefield. In the warfighting airspace, the ground commander retains freedom of maneuver without overly restricting any of the other users of airspace.

Coordination

To coordinate operational-level fires, the DOCC interacts with multiple Army, Air Force, and sometimes Naval aviation organizations. The DOCC works very closely with the command's MI organization and the echelons above corps (EAC) analysis and control

element (ACE). They are the DOCC's main source of targeting data.

To ensure that targeting data is developed into target lists, the manning of the section must include MI officers. The DOCC works with the command's subordinate unit's fire support element (FSE) to deconflict targets and targeting information, to task corps for operational fires support, and to forward air support requests to the AOC. The DOCC also provides the corps with target feedback, especially BDA received through the BCE. Assignment of artillery, WMD target analysts, and maneuver arms (especially aviation) officers to the coordination section is crucial to its effective coordination with the tactical-level headquarters.

The Army DOCC effects coordination with the US Air Force through the BCE located at the Air Force AOC, the ground liaison officers at the wings, and the Army liaison officer aboard the airborne battlefield command and control center (ABCCC). Similar functions are performed within the Navy Tactical Air Control System (NTACS) by its tactical air control center. These assets receive information from and provide feedback directly to the DOCC. An automated targeting support system to transmit targeting priorities, targeting lists with supporting intelligence data, and targeting damage assessments are essential to this coordination.

Joint Interface

The DOCC provides the Army members to the JTCB and the joint command, control, and communications countermeasures (C³CM) cell.

Joint Targeting Coordination Board

The CINC or JFC may establish a joint targeting coordination board to direct the theater targeting process, to include special operations targeting. The board consists of members of the joint staff and representatives of each subordinate command. The JTCB ensures the effective employment of all theater-level deep surveillance and attack resources, including SOF. It coordinates targeting information, provides targeting guidance and priorities, prepares or refines joint target lists (JTLs), and deconflicts lethal and nonlethal assets. The JTCB is usually chaired by the J3 or his representative.

Its organization reflects theater force composition, strategic objectives, geography, and the threat. The JTCB includes representatives of the land component commander, air component commander, naval component commander, special operations component commander, AOC, and marine, air, and electronic planning cells. Input from the joint staff element is used also to prepare the JTL.

The JTCB normally meets daily to ensure that JFC targeting and EW guidance is disseminated, to monitor the effectiveness of lethal and nonlethal targeting efforts, to coordinate and deconflict joint force operations, to validate fire support coordination measures, and to approve new target nominations for inclusion in the JTL. JTCB results are provided to the supporting forces. Joint Pubs 3-0 and 3-09 discuss the purpose and functions of JTCBs. Joint Pub 3-05.5 contains discussion of SOF mission tasking as part of the JTCB process.

Joint C³CM Cell

The JFC usually organizes a joint C³CM cell to coordinate EW targeting information, provide EW targeting guidance and priorities, prepare or refine JTLs, and compile a list of crucial friendly assets that must be protected from joint EW operations. The C³CM cell is normally chaired by the J3 or his representative and has representatives of the J2, J6, operational fires coordination section, and other staff elements and service components as appropriate.

The ASCC establishes a C³CM plan, in coordination with the CINC's plan, to attack high-value targets. The EAC C³CM plan, developed from the ASCC's intent, focuses on subordinate unit operations and complements joint operations with other component commands within the theater.

PROTECTION

Operational fires organic to the joint force are key in protecting the rear area from ground threats. A vital mission of Army ADA is to protect the force and critical theater assets from aerial attack, missile attack, and surveillance during warfighting operations. The priorities may shift to protecting major concentrations of combat forces and supplementing protection of maneuver forces.

Protection of LOCs remains critical as they extend to support maneuvering forces.

Army commanders are often responsible for the security and protection of facilities and units that support joint or multinational commanders conducting close and deep operations. Additionally, Army commanders may be tasked to provide security for air bases located within their AO. ARFOR commanders must continuously employ risk-management approaches to effectively preclude unacceptable risks to personnel and property, including protecting forces preparing for or en route to combat.

Risk management is the recognition that decision making occurs under conditions of uncertainty. Decisions must remain consistent with the commander's stated intent and offer a good expectation of success. The risk-taking skill requires competency as a prerequisite. Risks from WMD must be continually assessed to ensure force protection and deterrence and should be addressed in plan synchronization and force resourcing. Trained and disciplined organizations lessen risk.

Rear Operations

Rear operations include those activities that allow freedom of maneuver, continuity of support, and uninterrupted C². In linear battle terms, these actions occur behind forces engaged in active combat. The rear operations procedures discussed herein focus on operations during war. Similar actions could be required in MOOTW. Joint Pubs 3-10 and 3-10.1 and FMs 90-23 and 90-12 provide additional coverage of rear operations. Rear operations has four functions: *sustainment, movement, terrain management, and security*. An Army commander may execute these rear operations functions in a COMMZ/JRA or CZ.

Communications Zone/ Joint Rear Area

A JFC normally establishes a theater base communications zone (JRA) and the CZ within the territory of a sovereign host nation. Unlike the CZ, most host nations whose sovereignty remains viable maintain some level of control in a COMMZ.

The host nation may retain overall responsibility for security, movement, and terrain management. In such cases, commanders of US forces in the COMMZ own only the bases they physically occupy. They are responsible for the security of bases and

coordination with the host nation for additional security assistance or other rear operations support. HNS agreements, SOFA, or other legal instruments guide the US and host nation relationship. The US commander in the COMMZ directs and coordinates rear operations, using a single command headquarters. At this echelon, support is the principal operation. Several US organizations work with the host nation to execute each rear operation function.

Separate US functional commands and agencies control the movement of US assets in the COMMZ and coordinate these movements with host nation and US area commanders. The army organization with responsibility for rear operations is usually responsible for coordinating terrain management and security with host nation agencies in its AO.

- *Rear Area Operations Center*. A rear area operations center (RAOC) is a subordinate CP within the ARFOR's CP. The RAOC is responsible for collecting rear area information, managing terrain, controlling area damage, determining the impact of weather, and synchronizing the rear area battle plan to facilitate responses to enemy threats in the rear area. FMs 100-15, 90-12, and 90-23 detail these rear operations activities.
- *ARFOR Support*. The ARFOR designates a support organization (corps support command [COSCOM]) to execute the support function and assist in movement and terrain management. In contingency operations, ARFOR may hand off these rear operations responsibilities as the lodgment or AO expands. EAC organizations assume these responsibilities, thereby allowing the corps to focus on tactical operations.

Combat Zone

In a CZ, the ARFOR commander usually *owns* all the terrain on which his forces conduct operations and is responsible for synchronizing all rear operations. This discussion characterizes rear operations at corps and below in contingency situations with no developed COMMZ and environments with no viable HNS.

Chain of Command

Command and control of rear operations is the key to success across the width and depth

of the battle space. To ensure overall security of the rear area, commanders at all levels must clearly understand C², C³ responsibilities, and C² elements. Each unit in the rear area, regardless of its support function, should be able to defend itself. Ideally, threats to the rear should be engaged and defeated before they can affect rear operations. When they must be fought in the rear, a system of incremental responses must be able to eliminate the threat as quickly as possible.

The chain of command for rear operations is embodied in area commands for security, area damage control (ADC), and terrain management functions. Any unit in the COMMZ uses this channel to report information of intelligence value and to request engineer, chemical, explosive ordnance disposal (EOD), military police (MP), and host nation assistance.

The COMMZ tactical chain of command for rear operations flows from the theater CINC to the ASCC, to rear operations centers (ROCs), to base clusters, and to bases. This chain of command is used to coordinate protection of units and facilities within geographical areas of the COMMZ.

Commander in Chief

The CINC is responsible for rear operations. He normally designates a JRAC, often the ASCC. The ASCC as the JRAC would then assume US responsibility for coordinating rear operations in the COMMZ, which includes coordination with the host nation. The JRAC is responsible to his US superiors for the development and maintenance of US installations, control of US movements,

administration of the US support effort, and overall security of all US forces and resources present in or transiting the COMMZ.

Army Service Component Commander

The ASCC would likely delegate the responsibility for rear operations planning to his deputy chief of staff for operations. At theater, operational-level planning is conducted to sequence future rear operations, coordinate HNS, and synchronize the four rear operations functions (support, movement, terrain management, and security). The ASCC uses a decentralized control system of area commanders for rear operations covering large areas of the theater COMMZ. The area commander usually designates his deputy commander as the rear operations officer who, in turn, often executes this responsibility through the security, plans, and operations (SPO) officer.

Rear Operations Centers.

The ROC (as depicted in Figure 7-2) collects information and plans and coordinates security, ADC, and terrain management. The ROC is composed of functional sections that work closely with their area command structure. The ROC sections coordinate with host nation liaison elements in addition to NBC, EOD, MP, engineer, and other technical organizations.

The ROC maintains multiple communications channels using switched telephone services and combat net radios (CNRs) with higher and adjacent headquarters and units. The ROC conducts vulnerability and

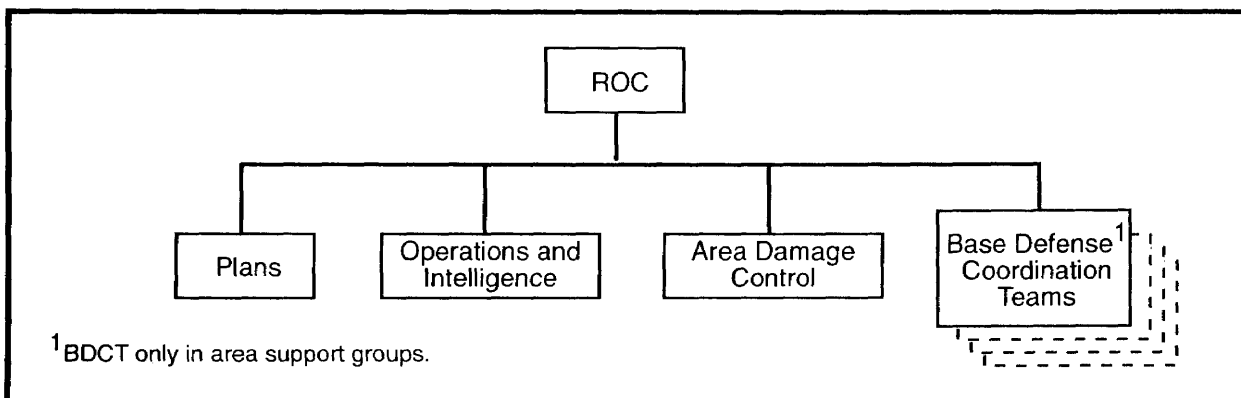

Figure 7-2. Typical Rear Operations Center

threat assessments within its AO. It then plans and coordinates protection of designated critical facilities and resources. It also advises MCAs of security issues, area surveillance responsibilities, response (combat) operations, positioning of units, and ADC. The ROC reacts to incidents most of the time but also looks to short-term planning. It has an FSE and mobile base defense coordination teams (BDCTs) to assist in detailed rear area defense planning.

The ROC's most important contribution to COMMZ/JRA security is the establishment and coordination of base defense plans. The ROC coordinates base siting with the technical chain of command and then organizes these bases into base clusters to provide mutual support. The rear operations commander, with ROC recommendation, designates base and base cluster commanders to coordinate defensive plans. Sometimes the ROC identifies single bases that are isolated, such as a specialized fixed facility, or clearly independent, such as an air base, and treats them as separate base clusters.

Base Cluster Commander

The base cluster commander communicates with all bases in his cluster through a base defense operations center (BDOC). Each base and base cluster is responsible for preparing its own defense plans. The ROC sends a BDCT to the base cluster commander's base cluster operations center (BCOC) to assist in consolidating individual base defense plans into a coordinated base cluster defense plan. Assets for forming the BDOC and BCOC are gathered from available base or cluster assets. See Joint Pub 3-10.1 for a detailed discussion of base defense. The BDCT reviews and assists in coordinating all needed US and host nation

security and damage control support, to include fire support and ADA support. It then ensures the completed defense plans are brought to the ROC for record and integration with the total protection concept.

Host Nation

The host nation, when capable, retains responsibility for security and ADC of all areas outside US bases. Despite the status of HNS, US commanders are always responsible for the defense of their base. They take measures to avoid detection by reducing the base signature, most notably through OPSEC, and the use of camouflage and concealment. US commanders take protective measures to withstand enemy attacks and employ measures to speed recovery and return to full mission capability should an attack occur. Measures include the emplacement of protective obstacles, fortification of critical facilities, and installation of NBC defense systems.

US commanders also plan graduated levels of response to enemy attack to defeat Level I threats and to delay and disrupt Level II and III threat forces until outside assistance arrives. See Table 7-1. If the host nation has limited capabilities to fulfill its rear operations responsibilities, or the AOR is hostile, the JFC or ASCC may designate US assets to execute these functions. The commander could require additional US engineer forces for ADC and other sustainment engineering tasks. He might provide more CSS and CS organizations for supply, movement, and terrain management. Without HNS, the ASCC may assume responsibility for overall security of the COMMZ/JRA, addressing all three levels of threat. All US commanders would concern themselves with greater security roles beyond their normal self-defense responsibility.

Table 7-1. Threat Levels

Level	Threat	Response
I	Agents, saboteurs, sympathizers, terrorists	Unit, base, base cluster self-defense measures
II	Small tactical units, unconventional warfare forces, guerrillas	Self-defense measures and response forces with supporting fires
III	Large tactical force operations, including airborne, heliborne, amphibious, infiltration, and major air operations	Commitment of tactical combat force

Units in the COMMZ are especially vulnerable to enemy attack because of their focus on support and limited combat capabilities. Combat units located in the COMMZ are usually newly arrived or regenerated and thus have limited combat potential. The ASCC must coordinate responses to all three levels of threat to prevent disruption of support activities, interdiction of LOCs, demoralization of forces, and diversion of combat forces.

In the COMMZ, US response forces handle Level II and III threats. Response forces are generally tactical combat forces (TCFs) and/or host nation forces, depending upon the viability of the host nation and established host nation agreements. In the COMMZ/JRA, security operations are economy-of-force operations. US MPs provide security support to all Army operations through execution of their battlefield mission of area security. MPs are normally designated as the rear operations response force to defeat Level II threats. The ASCC normally designates a TCF to defeat level III threats. The ASCC may designate a TCF from any of the following:

- Tactical units passing through the rear area to the forward-deployed force.
- Units assigned or reconstituted in the rear area. The ASCC may already have units assigned rear security operations (an MP brigade task force augmented according to the factors of METT-T).
- Tactical units of other service components or allies within the theater army under OPCON of the senior army commander.
- Tactical units from forward-deployed elements.
- A task-organized force from assets disembarking in the theater.

The theater commander's campaign would require significant change should the threat in the rear area grow to a level that required diverting combat units. The German Army experienced this situation during World War II on the eastern front. German rear area commanders—confronted with large numbers of partisan forces—bypassed enemy units and inserted conventional and special operations forces, disrupting their operations. This threat ultimately required over 25 German divisions dedicated to rear area security. Table 7-1 lists

the three levels of response and typical threats that can trigger the response.

DECEPTION

In war, the Army commander integrates Army deception plans with joint force deception plans to ensure unity of effort. The better the enemy is deceived, the more protection is provided to the friendly force. Deception operations must be closely coordinated with the JFC's deception staff element (DSE) and support the JFC's deception plan. The Army commander attaches representatives to the DSE to participate in deception planning. At the operational level of war, the Army commander uses deception as one of his major force multipliers. This is particularly important when the relative strength differential between opposing forces favors the enemy. In war, the Army commander finds deception particularly attractive as a means to influence the decisions of an opposing commander.

Deception requires planners to view the friendly force from the perspective of its opponent. That perspective and a notion of how that opposing commander believes the friendly force will act are key to the deception strategy. The purpose of the deception operation is to cause the enemy to act in a way prejudicial to his best interests. A deception plan seeks to exploit the expectations of the opposing commander by offering confirming evidence of those expectations. The resultant enemy action must be to his disadvantage as the actual friendly force plan unfolds. While deception can have a high payoff, it is difficult to execute successfully.

The Army operational-level commander blends his deception plans into the concept of operation. The deception plan is a viable COA that was considered but not selected. At the operational level of war, the commander forms a deception cell that includes functional representation from the entire staff. This cell requires considerable resources to be an effective element of the major operation.

The commander may execute the deception COA as a branch of the major operation. This execution requires the positioning of forces and the allocation of materiel. If required, the Army operational-level commander may execute the deception branch of the concept of operation if his selected COA is compromised. The deception operation must be a viable COA. To

be successful, it must cause the enemy to confirm its preconceived ideas of friendly force actions.

COMMAND AND CONTROL

Command relationships in war may evolve during the transition to war to be substantially different from those exercised during peacetime or conflict. This evolution is the result of several factors, to include additional ways and means available to the CINC to prosecute the war effort.

Developing the Chain of Command

During the transition from peacetime to wartime, a theater undergoes a process of development. As the theater expands, the purpose of combat operations grows in complexity and the size and scope of combat and support force structures increases. This may result in organization of the theater into theaters of war or theaters of operation as discussed in Chapter 2.

Intermediate Army Headquarters

The requirement to establish an intermediate Army headquarters between the ASCC and the corps depends on characteristics of the theater environment based on METT-T and the reasons identified in Section III of Chapter 2. The number of subordinate headquarters that a higher headquarters can control depends on a number of factors; mission, experience, training, communications abilities, and logistics are a few. The span of control will be as broad or narrow as the situation dictates.

Numbered Army

The ASCC, with the concurrence of the CINC, establishes a numbered army, designates a numbered army commander, and provides him with the directive or order that forms his command. This directive specifies the rationale for establishing the numbered army, the objectives it should meet, and the forces involved. Numbered armies plan and direct major operations. Operations at this level involve the deployment, movement and maneuver, and fires of land combat power over extended terrain and the integration of all Army and other service support into the operation. Subordinate tactical commanders determine the specific tactics in maneuver,

fires, intelligence, force protection, C², and allocated support. Primary emphasis at the numbered army level is on planning for future operations.

Exercising Control Through Planning

The Army operational-level commander actively participates in developing the subordinate JFC's theater of operations campaign plans. He interfaces with the commanders of the other services and directs the preparation of the Army's major operations to support the plan. He issues planning guidance, weighs various COAs, and develops and coordinates a concept of operations. The Army operational-level commander ensures that his concept is aligned with that of his superior commander. He coordinates vertically with senior and subordinate commands and horizontally with adjacent and supporting commands and activities. With representatives from the other services, the Army commander incorporates sea and airpower in the concept early in the planning process. This power includes fire support, reconnaissance, sealift, air defense, and airlift.

Planning in wartime at the operational level is continuous and more complex than in other environments for the following reasons:

- The synchronization of functions in large areas over greater periods of time introduces additional variables.
- The presence of an enemy with possibly equal or greater capabilities, pursuing actions independently, causes continuous updating of planning efforts.
- The planning process remains relatively the same, while the requirement for joint planning increases dramatically at nearly all echelons.
- The Army operational-level commander must plan for a large number of branches and sequels to help simplify decisions in a time-sensitive war environment.

Establishing Command Relationships

In the directive that creates the Army operational-level echelon, the theater commander establishes command relationships. These

relationships are responsive to the needs of the theater of operation commander and are unique to the environment in which the echelon is created. This operational-level echelon may be a numbered army, a designated corps, or any other Army organization that meets the needs of the JFC. The Army component designs the operational-level echelon to maximize unity of effort, to allow flexibility in employing subordinate echelons, and to effect a rapid response to changes in friendly and enemy situations. As the theater expands, the CINC may—

- Separate the Army's operations and support functions.
- Designate the ASCC as a support headquarters with OPCON of Army support organizations.
- Maintain control of major maneuver forces, or put maneuver forces under OPCON of subordinate joint commanders.

JOINT INFORMATION SYSTEMS INTERFACE

The JFC's staff maintains joint communications interfaces through the JCCC. The ASCC's communications staff participates in theater joint and multinational communications network planning and management through its interface with the JCCC. In cases where the ASCC provides the bulk of the joint force headquarters staffing, the ASCC may be required to operate an integrated JCCC/ASCC communications management center. Key duties center on network management of voice, data, and video systems signal interoperability. Frequency and COMSEC management are also key duties. Joint Pub 6-05.1 provides a detailed description of JCCC organization and functions.

INTELLIGENCE AND ELECTRONIC WARFARE

IEW is the commander's key to victory on a battlefield and to success in MOOTW. Intelligence enables commanders to focus, leverage, and protect the combat power and resources at their disposal to win decisively on the modern battlefield and succeed in endeavors short of war.

Tenets

Army MI is commander-driven, synchronized, disseminated, split-based, and tactically tailored.

Commander-Driven

The commander drives the intelligence effort. He focuses the intelligence system by clearly designating his PIR, targeting requirements, and priorities. He ensures that the intelligence efforts are employed fully and synchronized with maneuver and fire support. He demands that the intelligence battlefield operating systems provide needed intelligence in the correct form.

Synchronized

The G2/S2 synchronizes intelligence collection, analysis, and dissemination with operations to ensure the commander receives the intelligence he needs, in the form he can use it, in time to influence the decision-making process. Intelligence synchronization is a continuous process that keeps IEW operations tied to the commander's critical decisions and concept of operations.

Disseminated

Broadcast dissemination of intelligence is the simultaneous broadcast of near real-time intelligence from collectors and processors at all echelons. It permits commanders at all echelons to simultaneously receive the same intelligence, thereby, providing a common picture of the battlefield. It allows commanders to skip echelons and pull intelligence directly from the echelon broadcasting it.

Split-Based

Split-based intelligence operations provide deploying tactical commanders with high-resolution intelligence until their organic intelligence collection assets are employed. These operations augment organic intelligence production and employ collection and analysis elements from all echelons—national to tactical—to support bases from which they can operate against the target area.

Tactically Tailored

In force-projection operations, the commander tailors IEW support for each contingency, based on the mission and availability of resources. He must decide which key intelligence personnel and equipment to deploy early and when to phase in his remaining MI assets. The ASCC serves as the

intelligence integration headquarters for the Army operational-level commander. The ASCC must have timely intelligence on the enemy, weather, and terrain; the conditions of the AOR; the civil population; and related environmental factors. The collection of information and the production and dissemination of intelligence are continuing processes during peacetime as well as during war.

Sources

The ASCC processes and refines intelligence information from many sources to the degree of resolution necessary to support theater army operations. Sources include the Army, the US command's JIC, DIA, CIA, NSA, other services, allied forces intelligence agencies, and other federal intelligence investigative and law enforcement agencies. These sources produce intelligence information on the capabilities, vulnerabilities, and probable COAs of the armed forces of foreign nations and other forces they may sponsor. The ASCC accomplishes his intelligence mission through the ACE.

The intelligence support elements (ISE) of the MI organization provide 24-hour liaison with the US Army; with joint, multinational, and allied military organizations; with intelligence services; and with US corps. These liaison elements assist supported organizations in identifying IEW requirements, establishing priorities, and interfacing directly with the operational-level MI organization. The ISEs serve as extensions of the ACE and are collocated with the supported organization. These elements provide a mechanism for US and allied commands to request information on the enemy.

The ISEs facilitate the production and exchange of intelligence, as well as the coordination for EW support, to include civil broadcast jamming. ISEs also work with unit intelligence officers and assist with intelligence input to operational planning, situation and target development, and IPB. These support elements are located at such distances from the ACE that they operate independently. They respond to the needs of their counterpart agencies and commands at least as often as they respond to the needs of the ACE.

Operational-level MI organizations support operational planning at ASCC level. This planning provides predictive intelligence

as the ASCC link to coordinate, synchronize, and deconflict intelligence support, intelligence asset management, deep targeting priorities, and SOF operations conducted by subordinate units.

Direction and Coordination

The CINC provides overall direction and coordination of the intelligence effort of assigned forces. Through the ACE, the ASCC maintains the means of executing his intelligence function. However, the theater commander may establish an intelligence organization to perform theater intelligence functions. When established, this organization also provides the ASCC with the intelligence information required to supplement the component's organic intelligence capability. In war, Army operational-level commanders concentrate on several specific areas of intelligence to facilitate military combat operations. These include—

- Identifying enemy capabilities and likely COAs that could affect future major operations.
- Targeting specific enemy commanders and echelons for deception.
- Determining the best way to protect friendly vulnerabilities and exploit enemy weaknesses.
- Updating the PIR.
- Using all sources of intelligence efficiently by integrating collection assets to produce operationally useful products.

Operational Protection

The commander uses the entire intelligence system to support force protection. The intelligence system is active and proactive, identifying, locating, and targeting an enemy's ability to target and affect friendly forces. Force protection intelligence products—

- Identify and counter enemy intelligence collection capabilities.
- Assess friendly vulnerabilities from the enemy's perspective.
- Identify the enemy's perception of friendly centers of gravity and how he will attack them or influence them.
- Identify risks to the force.
- Identify potential countermeasures to deny enemy access to friendly critical areas.

- Contribute to threat avoidance once the risk is identified.
- Enable the commander to plan for both passive and active OPSEC, deception, and other security measures.

With this intelligence, the commander decides which countermeasures he must use to shield his intentions, present false images to the enemy commander, and protect his force.

Counterintelligence

CI operations counteract foreign intelligence and terrorist threats to the friendly force. Their specialty is support to force protection.

Rear Area Operations

IEW contributes to the rear battle by helping to identify, analyze, wargame, and provide early warning of potential threats to the friendly rear area. IEW also contributes by identifying terrain that supports friendly rear area operations.

SUPPORT

In war, the CINC may designate the ASCC to have a predominately support focus. In this role, the ASCC has a number of logistics and support responsibilities. The ASCC may also have support responsibilities for other US and allied forces as a result of established agreements or as assigned by the CINC. The ASCC provides primary support within the theater through subordinate groups, brigades, and commands specifically organized and allocated to accomplish the theater support mission. The ASCC maintains organizational flexibility by tailoring the type and number of support units to the mission requirements and by planning for the expansion of the support capability. Some specific support requirements the ASCC commander executes are base development; engineer support; replacement training; support; reception, staging, and onward movement; and reconstitution.

Base Development

The ASCC role in base development is key in the operational support capability because it focuses on long-term support. The ASCC is responsible for a portion of the joint sustainment base (LOCs, ports, bases, airfields, and units responsible for operating

each). The CINC assigns the Army's portion of the sustainment base.

Engineer Support

The ASCC supplies engineer support to provide the facilities needed in the COMMZ to receive, stage, move, and support combat forces. The ASCC must ensure that his LOCs remain open. He must either establish or maintain his supporting base and provide engineer support to other services. Engineers in the theater give priority to general engineering and survivability functions.

Replacement Training

The ASCC provides the means to train replacements. Normally, he establishes a training center that is the focal point for regeneration. The center trains replacements and assigns them individually or as crews, squads, and platoons. Resource constraints may require the commander to delay the training of replacements.

Responsiveness and Suitability

The ASCC ensures that support is suitable and responsive to the priorities of the CINC and to subordinate commands. At this level, ASCC resource management (prioritizing, stockpiling, and so forth) has a long-range perspective. The ASCC forms a logistics operations cell to orchestrate elements of the support process. This element ensures that current priorities, intentions, and operations support the requirements of the ARFOR in theater. This organization balances the needs for current operations against the needs for future operations and advises the ASCC accordingly.

Reception, Staging, and Onward Movement

The ASCC is normally responsible for reception and onward movement of Army forces. As the ASCC conducts reception operations, he receives forces at aerial ports and seaports and equips, fuels, fixes, arms, moves, decontaminates, if required, and protects these forces as they pass through the support base to their tactical assembly area. Operational-level army logistics commanders, support elements, and advance parties for incoming units must ensure that augmentation forces are equipped rapidly and deployed to designated marshaling areas. Incoming forces are required to perform many of their support

functions, receiving only minimum-essential services and support from the ASCC. Reception operations may begin before hostilities start and continue until hostilities cease. Reception operations and support operations are similar and occur concurrently.

Reconstitution

The ASCC plans and conducts operational- and tactical-level reconstitution operations. FM 100-9 defines reconstitution as "extraordinary actions taken by commanders to restore combat-attributed units to a desired level of combat effectiveness commensurate with mission requirements and availability of resources." The ASCC is concerned primarily with the regeneration option of reconstitution—the rebuilding of a unit through the large-scale replacement of personnel, equipment, and supplies; the establishment of C²; and the conduct of mission-essential training for the newly rebuilt unit. The ASCC must ensure time and resources are allotted to conduct reconstitution operations. The ASCC draws from the CONUS base, using intertheater and intratheater assets based upon the mission of the JFC. Reconstitution is normally done in preparation for future operations in the operational sequence. If regeneration of a unit is

undertaken, the ASCC must understand the effects those operations may have on established support operations. Reconstitution may adversely affect both support and reception operations.

A reconstitution planning cell is located in the ASCC operations section. Assignment of this task to the G3 (operations) section reveals that reconstitution is first and foremost an operational decision. This cell plans for the reconstitution operations in preparation for future operations. The ASCC employs the cell as part of the reconstitution assessment and evaluation team (AET) that performs liaison functions and assists the ASCC in implementing detailed reconstitution efforts. The reconstitution planning cell may be employed as part of the C of the reconstitution task force.

The ASCC synchronizes reconstitution with all other functions within the theater. Properly planned and executed reconstitution actions do not detract from combat efforts but enhance them. In the offense, well-executed reconstitution efforts maintain the momentum of the attack by prolonging the unit's arrival at its culminating point. In the defense, reconstitution preserves combat power potential and allows the operational-level commander greater freedom of action.

TERMINATION OF WAR/POSTCONFLICT OPERATIONS

Upon successful termination of combat operations, the deployed forces transition to a period of postconflict operations prior to redeployment. This transition may occur even if residual combat operations are occurring in other parts of the theater of operations. Anticipation and early planning for postconflict operations eases the transition process. The JFC must determine the conditions to which the operations area is to be returned.

According to the CINC's directives, the ASCC must oversee the orderly transition of authority to appropriate US, international, interagency, or host nation agencies. The ASCC and subordinate commanders emphasize those activities that reduce postconflict or postcrisis turmoil and help stabilize the situation. Commanders must also address the decontamination, disposal, and destruction of war materiel; the removal and destruction of unexploded ordnance; and the responsibility for demining operations. The

consolidation of friendly and available enemy mine field reports is critical to this mission. Additionally, the ASCC must be prepared to provide health service support (HSS), emergency restoration of utilities, support to social needs of the indigenous population, and other humanitarian activities as required.

The US historical perspective upon the successful termination of past conflicts has been rapid redeployment and demobilization. Redeployment and demobilization should occur at a pace that does not disrupt the ability of the ASCC to execute continuing missions. The successful termination of war activities leads to transition to the state of peacetime. Still, the possibility always exists that resumption of hostilities may occur. Thus, units must rapidly convert to a wartime posture and be prepared to conduct wartime operations. During this period, force protection is vital in order to prevent undue harm to US forces.

Chapter 8

Military Operations Other Than War

This chapter discusses Army MOOTW—operations in two states of the range of military operations: *peacetime* and *conflict*. Peacetime is a state in which diplomatic, economic, informational, and military powers of the nation are employed to achieve national objectives. Since peacetime is the preferred state of affairs (as opposed to conflict or war), how well the Army and other services accomplish their missions in peacetime is vital to US national interests.

Conflict is a unique environment in which the ARFOR commander works closely with diplomatic leaders to control hostilities, with the goal of returning to peacetime conditions. In conflict, the military, as an element of national power, takes on a more prominent role than in peacetime. The Army participates in conflict as a component of a joint organization that is usually an element of a multinational structure. Other US Government agencies, NGOs, PVOs, and international organizations (IOs) often participate.

FUNDAMENTALS OF MOOTW

Army warfighting doctrine is based on well-established principles of war. MOOTW are based on similar principles that guide the force's actions. The principles of war apply for those actions that involve our forces in combat. For MOOTW that do not require direct combat, the principles are *objective, unity of effort, legitimacy, perseverance, restraint, and security*. FMs 100-5 and 100-23 describe these principles and their application. These principles are not immutable, but serve as guides for action. Commanders must balance these principles against the specific missions and nature of the operation.

In planning for military operations in peacetime and conflict, commanders must tailor a force that is suitable for the mission. *Suitability* is the measure of a force's capability against possible threats and the diplomatic acceptability of the chosen force. *Acceptability* is based on the force's appropriateness, given diplomatic considerations, and qualities that are consistent with accomplishment of national interests and objectives. The commander's acceptability of the force includes the perceptions of the indigenous population, the international community, and the American public. *Force capability* is the

measure of a unit's ability to counter an expected threat and execute a mission. A force must have the capability to accomplish a military mission by virtue of its training, equipment, and structure.

The force composition for MOOTW must be proportionate to the stated goals of the sponsoring authority and provide sufficient capability to complete the mission and protect the force. The perception that the force employed exceeds the limits of its mandate lessens legitimacy with the international community, the US public, and the indigenous population. Capability and acceptability are not constants but vary based upon the threat, the intensity of operations, the missions to be performed, and changing international perceptions.

The composition of the force should reflect the commander's consideration of the military end state, METT-T, mission-specific training requirements, strategic lift, pre-positioned assets, joint and multinational military forces, reserve component forces, nonmilitary US agencies, NGOs, PVOs, and host nations forces. The nature of MOOTW is such that CS and CSS units may have an equal if not greater role than combat units.

RESPONSIBILITIES IN PEACETIME

The Army's responsibilities in peacetime are as important as its traditional combat roles.

During peacetime, senior army commanders are always postured to present a deterrent to

internal or external threats to US national interests. They do this by conducting routine peacetime operations and nonhostile activities.

UNIFIED COMMANDERS

At the direction of national leaders, CINCs may use ARFOR to perform noncombat missions that support diplomatic initiatives. Army leaders then carry out these activities as part of the overall unified command plan. These activities may include job training exercises, peace support operations, nation assistance activities, disaster relief and humanitarian assistance, security assistance, shows of force, and support for counterdrug operations.

The commander of a unified command, such as PACOM and ACOM, may control and coordinate military support to domestic emergencies in the states of Alaska and Hawaii and territories and possessions of the US. CINCs must continuously assess their regions to identify the strategic situation and situations requiring military forces for noncombat missions. Armed forces may be tasked with direct responsibility, or they may conduct operations that support other US Government agencies.

SENIOR ARMY COMMANDERS

The Army's role in peacetime is to support the regional CINC's efforts to prevent unstable situations from developing into the loss of local control or open conflict. Senior army commanders may do this by conducting routine activities that maintain the potential of ARFOR to conduct major operations. This potential may serve as a deterrent, or it can enhance the capability to react in emergencies. Army component forces may turn this potential into actual mission execution to actively control a situation. As ASCCs or other senior army commanders respond to the regional CINC, they may be required to conduct peacetime operations in one region while simultaneously conducting conflict and/or war operations in others.

SPECIAL OPERATIONS FORCES COMMANDERS

In peacetime, SOF help attain peacetime military objectives and may promote regional stability by advising, training, and assisting allies. SOF peacetime activities could be the conduct of US humanitarian assistance

programs, security assistance programs, and multinational training exercises. Like conventional forces, SOF are a deterrent. In multinational operations, SOF involvement with allies worldwide contributes to deterrence and provides a low-visibility means of extending US influence.

Due to extensive unconventional warfare (UW) training, SOF are well-suited to conduct various peacetime operations and provide various types of support. SOF should be considered the force of choice for peacetime missions. General-purpose forces may also be called for their particular specialties or when the scope of operations is so vast that conventional forces are required.

ARMY SERVICE COMPONENT COMMANDER

The operational-level functions discussed here are used as a starting point to discuss the ASCC in peacetime. Some systems, such as operational fires, may not have extensive peacetime applications. Still, the operational-level commander and his staff need to analyze each function and its corresponding subfunctions, augmenting or deleting as necessary to ensure the proper integration and synchronization of all peacetime operations and activities.

Movement and Maneuver

The CINC may use armored, light, or special operations Army forces and their corresponding CS or CSS structures available within the region. Some situations require deployment of additional units via strategic lift. The MCA provides for the orderly flow of these forces and resources. The ASCC receives and prepares incoming units for operations. Since peacetime operations are normally conducted in a permissive environment, CS or CSS units may be the predominant elements and deploy early to prepare to support the arrival of other units.

The CINC may assign operating forces a JOA, but he generally uses few boundaries or other special control measures. Normally, the ASCC, a subordinate Army commander, or a JFC employs these forces to execute a specific MOOTW mission. Each operation is discrete in response to a specific situation, though it may be sequenced with past and future operations. Execution focuses on near-term operations. Peacetime operations often require special

engineer, legal, CA, PSYOP, and PA considerations. Once the operating force completes its mission, it redeploys to its home station or continues peacetime activities in theater with little requirement for consolidation operations or other transition efforts.

Protection

Protecting forces and resources from a wide range of threats is an important responsibility for all senior commanders. In force-projection contingency operations, the threat of the use of WMD must be continually tracked to preclude unacceptable risk to the force. Options for protection from these weapons encompass the politico-military range and include diplomatic defusing and deterrence through NBC readiness, active and passive defense, air defense, and WMD reduction. The ASCC directs measures in peacetime to conserve military potential so that it can be applied at a decisive place and time.

Protecting the force depends on current, accurate intelligence for I&W of possible obstacles or threats. Protection includes conducting antiterrorism measures, maintaining discipline and order, and providing limited deception measures. As part of protecting the force, the ASCC issues the peacetime ROE established by the regional commander in coordination with JCS, the host nation, and the ambassador. Through an operational risk assessment, the ASCC ensures the conservation and safety of the force. Providing air defense of the force and selected geopolitical assets has a deterrent value. It also has an advantage that it is seen as a nonescalatory measure.

Conducting Antiterrorism Measures

Terrorist acts overseas are a constant threat to US armed forces, civilians, and facilities. The ASCC presumes civil authorities and host governments will implement counterterrorism procedures to protect people within their territory. The CINC ensures coordination of all local antiterrorist policies and measures for protecting DOD facilities, equipment, personnel, and family members abroad. The ASCC may assist in implementing specific antiterrorist actions called for by terrorist threat conditions (THREATCONs) discussed later in this chapter. The theater commander's peacetime ROE provide a flexible

self-defense and deterrent posture. These rules deal with terrorist and other threats.

Maintaining Discipline and Order

Good order and discipline are instrumental for conserving military potential. The ASCC establishes a command climate conducive to this end. He ensures the maintenance of proper liaison with DOD police organizations as well as with local or host nation, allied, and interagency police agencies. Within Army organizations, the ASCC facilitates Army MP and Criminal Investigation Command elements investigating offenses. In addition, the ASCC enforces the policies of the senior army commanders. The ASCC may provide prisoner confinement facilities for those who violate good order and discipline.

Providing Limited Deception Measures

Peacetime operations usually require little deception beyond normal OPSEC. OPSEC, or the information measures the ASCC uses, must be consistent with established guidelines and may require interagency coordination.

Fires

A major challenge for any force taking part in peacetime operations is to be organized to accomplish the goals of the sponsoring authority and provide sufficient capability to protect the force. The committed ARFOR must be sufficiently lethal and survivable to protect itself, deter possible aggression, and accomplish its mission. This specialized force must be capable of performing both hostile and nonhostile actions simultaneously throughout its AO. The ASCC must always have available and continuously plan for the employment of a joint or multinational force suite of fire support systems. A credible operational fires capability deters aggression and increases the options available to the commander to accomplish his mission and protect the force.

Fire support units provide more than lethal and nonlethal fires during MOOTW. Fire support coordinators and operational-level planners must establish liaison early to start planning and coordinating targeting functions (operational IPB, high-payoff target selection, target acquisition and attack system selection/tasking, and BDA planning) should fires be needed. The organization and equipment of fire

support units can augment the C³I collection and other capabilities of the joint or multinational force.

Doctrine for fires and the basic tasks of fire support do not change during MOOTW. Still, the MOOTW environment presents unique challenges that affect tactics, techniques, and procedures for fires and require the meticulous attention of planners. Planners must consider the characteristics of the MOOTW threat and their impact on both operational fires and fire support.

The MOOTW AO typically presents threats that do not conform to linear operations. Threats are diverse and may manifest themselves anywhere at any time, making them difficult to predict. Threat personnel and activities may be indistinguishable from friendly until hostilities are initiated. The prevalent threat in MOOTW is from hostile terrorist, guerilla, or partisan activities. Additionally, environmental factors (weather, disease) pose a serious threat. In some scenarios, they will be the prevalent threat. Normally, MOOTW threats do not involve a sophisticated military force unless hostilities have escalated to the realm of conflict or the threat is capable of rapidly massing and dispersing military or paramilitary force to achieve its objectives. MOOTW threat activities include hit and run harassing tactics such as attacks and raids, mining and booby traps, sabotage, deception, and psychological warfare designed to embarrass and demoralize friendly governments and forces.

External support from other nations for the indigenous MOOTW threat and adaptation of friendly operations to the local geography compound the problem. External support of the threat extends the problem to the international diplomatic arena, usually increasing the restrictions and constraints on military options. The extremes in geography require organizations to prepare for and adapt to variations in terrain and vegetation and the impact of seasonal weather changes.

All of these aspects of the MOOTW threat impact planning and execution of operational fires. The range of threats in an MOOTW environment impact both operational fires and fire support. First, all friendly forces are vulnerable. No rear area enjoys relative security. This vulnerability requires establishment of integrated base defenses with a mutually supporting fires capability. Fires

must first support the increased security requirements for both position defense and movement. Second, planners must recognize the restrictions and constraints of ROE on the application of force. Planners must then consider indirect and nonlethal fires, in addition to direct fire systems, when they write ROE. ROE should address appropriate responses to various expected threat actions and force protection. The diversity of available fire support systems, including those of coalition forces, requires that ROE include weapon system and munition selection as well. At all echelons of command, ROE significantly impact all aspects of fire planning, target acquisition, and attack. Finally, the nonspecific nature of MOOTW threats requires continuous planning. Consideration must be given to mutual support between adjacent units or bases and even AOs.

The fleeting nature of the threat requires near real-time target acquisition and sensor-to-shooter links. Target acquisition systems must be capable of distinguishing between friendly and threat activity. This capability increases the importance of HUMINT and IMINT sources, which provide real time *eyes on targets* such as patrols, police, SOF, UAV/RPV (remotely piloted vehicle), and J-STARS (joint surveillance target and attack radar system). Ground surveillance, countermortar, and counterbattery radars are equally important and have special employment considerations in the MOOTW environment. Electronic intelligence (ELINT) systems may provide valuable situation development information, but the need to verify target descriptions limits ELINT responsiveness and utility as a target acquisition system for triggering target attack.

These considerations highlight the need for close coordination among joint, multinational, and coalition force operations; intelligence; and fires representatives at the ASCC headquarters. Although these considerations are not all-inclusive, they may appear to focus fire support at lower echelons rather than operational fires. Still, the MOOTW environment forces the ASCC/ARFOR to plan meticulously, coordinate, and execute application of force.

To expedite fire support coordination, fire planning, and clearance of fires, special arrangements are required with the host nation military, allied nations, joint services, and national and local civilian authorities. These arrangements include determining

communication requirements, identifying liaison personnel, and establishing procedures—all focused on the interoperability of the multinational force effort to support peacekeeping objectives.

Within NATO and the ABCA (American, British, Canadian, Australian) quadripartite working group, special agreements exist which facilitate fire support operations. These are NATO standardization agreements (STANAGs) and quadripartite standardization agreements (QSTAGs). Many countries that the US may support have no bilateral fire support agreements. Action may be required, based on the situation, to establish agreements. Support in these efforts may be arranged through the appropriate DOS agencies and country teams. This increase in centralized C² of fires is needed for civil-military cooperation, developing and adhering to ROE, establishing appropriate procedures for clearance of fires, and establishing an appropriate joint/multinational force staff structure to plan, coordinate, and, when necessary, control operational fires.

Command and Control

Peacetime operations contribute to stability and conflict prevention in order to complement diplomatic initiatives. The ASCC may conduct a wide range of peacetime operations that directly or indirectly stabilize a situation or contribute to the general welfare. Contingency force-projection operations develop through CAP (see Chapter 6). These actions may evolve into longer-term commitments such as regional peacekeeping operations. Other peacetime operations may begin as long-term commitments that may require deliberate planning. Examples include overt PSYOP programs, nation assistance, and security assistance.

Command relationships in peacetime are normally based on the in-place theater structure that conducts routine peacetime activities. These peacetime relationships require special sensitivity to and coordination with nonmilitary organizations. As a result, operational-level command relationships and unity of command may be clouded.

The Ambassador

The ambassador is responsible for the direction, coordination, and supervision of all US Government interagency activities within a particular country. The ASCC's staff, under the

direction of the unified commander's diplomatic-military staff element, may integrate ARFOR to support the ambassador. Military commanders must work closely with the ambassador and his country team to assure effective exchange of information and coordination. Sometimes, the military commander may be a part of the country team and directly advise the ambassador.

The Commander in Chief

The CINC may use forward-deployed Army units in theater when the NCA directs. In such a case, command relationships change little from routine peacetime activities. The ASCC controls ARFOR operations and recommends and coordinates the use of contingency forces and mobilization of reserve forces from outside the theater. In such a case, the CINC may use existing command relationships, or, if the mission requires forces of multiple services, he may establish a JTF. The ASCC may advise the CINC to integrate reserve component forces either in a training status or brought to active duty for an extended period to assist in executing operations.

Intelligence

The ASCC needs high-quality, timely intelligence to conduct peacetime operations. The ACE serves as the clearinghouse for all-source intelligence. The ACE maintains lists of I&W that the ASCC uses to anticipate peacetime operations. The ACE produces intelligence information and disseminates it to commanders and staff agencies for use. This intelligence effort must address diplomatic and economic information as well as information related to potential natural disasters. Based on these indicators and CINC guidance, the ASCC focuses the collection and processing of information on specific peacetime operations.

Intelligence provides a basis for all US plans and operations in MOOTW. The nature of MOOTW is one of heavy involvement with the host nation populace, government, and military. Due to this heavy involvement with the host nation, most activities in MOOTW are HUMINT-intensive. HUMINT operations provide valuable intelligence, as well as I&W on threat activities and operations. HUMINT provides timely information on threat capabilities and intentions. HUMINT collects information by interrogation, observation, elicitation of personnel, and exploitation of documents and material. HUMINT is also the

most effective intelligence discipline available to the threat. Consequently, counter-HUMINT operations are the key to the success of any activity in MOOTW. Counter-HUMINT operations are used to degrade or neutralize threat espionage, sabotage, and subversion capabilities.

Close liaison with a variety of US and host nation military and civil organizations is critical to the success of any MOOTW activity. This liaison is imperative for coordination, intelligence collecting, and information sharing. CI personnel are uniquely suited to this task. As a minimum, CI personnel must coordinate with members of the US country team, US MI units, US MP units, CA units, PSYOP units, HN regional and urban area coordination centers, HN intelligence and security forces, and HN military, paramilitary, and police.

Battle Space

In MOOTW, commanders seek to counter the threat's effects in a given battle space. The threats in MOOTW will vary between each MOOTW activity. Battle space is a physical volume that expands or contracts in relation to the ability to influence and counter the threat. A higher commander does not assign battle space, which extends beyond the limits of the commander's AO. Battle space is based on the premise that the commander's thinking expands to develop a vision for countering the threat before any mental constraints are emplaced, such as boundaries, legal mandates, or terms of reference (TOR).

Battle space includes all friendly assets available to counter the threat. In MOOTW, pure combat power is only a small portion of the true battle space. Other assets may include the diplomatic efforts of embassy officials, liaisons with host nation governments and military agencies, as well as the efforts of NGOs, PVOs, and IOs.

Unity of effort is essential to operations within a given battle space. Ownership of assets is less important than application of their effects toward countering the threat. An understanding of battle space allows commanders to keep their options open, synchronize all friendly assets, and counter the threat. As the commander considers the mission, as well as any perceived *mission creep*, he can visualize his battle space throughout the operation and how the battle space may change as he moves to counter the threat.

Area studies provide host nation weather and geographical information, as well as *basic intelligence* (seaports, airports, transportation systems, water storage, POL storage, building materials availability) helpful in preparing for natural disasters and other contingency-type operations. Forward presence, both through permanent stationing and periodic deployment of CONUS-based HUMINT resources, is essential to this effort.

The theater-level MI organization continuously develops and refines indicator lists. These lists allow the ASCC to monitor diplomatic, military, and economic conditions in the area. Army intelligence sources provide the necessary information and intelligence to identify and predict potential threats. All-source intelligence analysis provides the ASCC with the necessary information to protect his forces, noncombatants, and resources. It also allows him to prepare for future operations while minimizing the probability of surprise from a potential threat.

Logistics

The ASCC is responsible for developing and providing the elements of sustainment for ARFOR within a region and for other services, based on executive agent responsibilities for common servicing. Unless directed by national authority, NGOs and PVOs will provide their respective support. Strategic logistics support is projected from CONUS and other OCONUS sites, using all national resources, including USAMC, DLA, other services, and commercial sources. The ASCC provides logistics, direction, and prioritization. The ASCC staff monitors all support activities to ensure smooth, daily sustainment of the force. The ASCC seeks to conserve Army resources whenever possible by using contractors, the host nation, or other viable sources of support. In peacetime, the CONUS support base continues to project logistics support from national resources. The ASCC monitors the support of the soldier as well.

The Army personnel system and training base provide a supply of qualified soldiers into forward-deployed/forward-presence theaters or to units that may deploy into any region. The following agencies provide daily support to soldiers and their family members:

- Defense Finance and Accounting Service.
- Legal Services Agency.
- Chaplaincy Service Support Agency.

- Community and Family Support Center.
- Other Army staff field operating agencies.

The ASCC may coordinate augmentation of this support through other services or allies.

Combat health support (CHS) of soldiers includes all services performed, provided, or arranged by the Army Medical Department to promote, conserve, or restore the mental or physical well-being of personnel in the Army and, as directed, in other services, agencies, and organizations. The surgeon general has overall worldwide responsibility for Army health care. Senior army commanders and service components must ensure their soldiers and their soldiers' family members receive these services effectively. In theater, the CHS system provides care in Echelons I through IV, ultimately leading to treatment in the US. Senior commanders ensure that the Army health care system provides preventive measures, progressive treatment, hospitalization, and evacuation of service members and their families. In developed theaters the support structure is available to support peacetime operations. This structure includes host nation, contract, and interservice support agreements. Forces conducting peacetime operations integrate their operations into this structure.

When operating forces require support not present in theater or operate in an austere theater, the ASCC plans and coordinates support arrangements either unilaterally or with joint support agencies. Army commanders develop tailored support packages to provide essential support for the ARFOR. This could include functional and area army commands to provide large-scale or long-term support. These considerations provide operational-level commanders with general synchronization requirements applicable to most peacetime operations.

Training

Training for war is the Army's top priority. The ASCC provides the direction, purpose, and necessary motivation to his subordinates to successfully accomplish the training mission. The ASCC outlines his intent and then ensures that his subordinates focus on mission-essential task lists (METLs). Most missions during peacetime can be accomplished by a disciplined force proficient in METL tasks. Subordinate METLs must support the CINC's theater strategy.

Historical Perspective

On 5 April 1991, President Bush announced the beginning of a humanitarian assistance mission in northern Iraq to provide relief to Kurdish refugees who had fled into the mountains to avoid persecution by the Iraqi Government and military. Operation Provide Comfort was a joint and multinational operation executed with no formal agreements among agencies and countries.

The threat to be countered was truly a multifaceted one. The immediate threat to the Kurdish people involved their living conditions in the mountains of northern Iraq. Temperatures day and night were below freezing. Food, water, and shelter were unavailable, and disease was running rampant through the refugee population. The secondary threat involved the continued presence of the Iraqi military and secret police. Since Iraqi military units were present in the area, the Kurds were unwilling to leave the perceived safety of the rugged mountains to receive the assistance available in the northern Iraqi cities.

Under the umbrella and battle space of Combined Task Force (CTF) Provide Comfort, two distinctly different JTFs were formed. JTF-A was involved with countering the immediate physical threat to the Kurds. This JTF set up and administered the actual humanitarian assistance operation. Battle space for JTF-A was far-reaching and included the supplies and personnel from many NGOs, PVOs, and IOs; logistical assistance and personnel from units that were already in-theater for Operation Desert Storm; and logistics and personnel from Europe and CONUS.

JTF-B was involved with countering the secondary threat, which was the continued presence of the Iraqi military and their effects on the Kurds. This JTF opened a security zone in northern Iraq that facilitated the return of the Kurdish people to northern cities, such as Zakho, where they could be given humanitarian assistance. The battle space for JTF-B included combat power that was in theater for Operation Desert Storm, units and equipment from all branches of service stationed in Europe and CONUS, and units from multiple nations that had volunteered to participate in the operation. Battle space for CTF Provide Comfort also included the diplomatic efforts of the US and UN to counter the threats to the region.

The ASCC goes beyond these fundamental training considerations. Since much of the operational-level EAC support structure resides in the reserve components, the ASCC must be involved with active and reserve component training as well as with joint requirements and potentially multinational training. Training during peacetime must prepare ARFOR for missions across the range of military operations and support the national

defense policy of strategic deterrence. Training for leaders may be much broader than the subordinate METL indicate to ensure the leader flexibility required for conducting both warfighting and MOOTW missions. Peacetime operations take advantage of the established support structure and capabilities of the support and service support elements that sustain the routine peacetime activities.

OPERATIONS IN PEACETIME

ASCC peacetime operations include, but are not limited to, security assistance, nation assistance, search and rescue, CA, NEO, peacekeeping, shows of force, support to counterdrug operations, and humanitarian assistance and disaster relief.

SECURITY ASSISTANCE

The Army conducts security assistance operations to provide military articles, training, and defense-related services authorized by statute law. Security assistance is a key element of US foreign policy, with DOS as the lead agent supported by DOD. These operations are strictly controlled by the *Foreign Assistance Act of 1961*, which deals with international military education and training (IMET), or the *Arms Export Control Act of 1976*, which deals with foreign military sales. The US Government provides security assistance on a credit or cash basis to the host nation. Senior army commanders must be careful not to commit the US Government to providing any assistance that could be construed as security assistance without following the statutory requirements.

The in-country security assistance office (SAO) is the military focal point for formulating, planning, and executing these programs. Theater CINCs make significant contributions, to include supervision, support, selection, and command of SAOs. The ASCC contributes to developing assistance requirements. CONUS-based units are usually called on to provide security assistance training teams. Still, in-theater or OCONUS-based units could also provide the training. Training provides the most lasting military contribution for security assistance efforts. Security assistance officials, in rare circumstances, may direct the Army to transfer military hardware or materiel to foreign

nations in response to a crisis requiring a surge of military support.

NATION ASSISTANCE

Nation assistance programs promote stability and orderly progress, thus contributing to the prevention of conflict. If internal conflict has begun, the goal of nation assistance is to aid in removing its root causes. Nation assistance becomes a primary means of bringing the conflict to a successful resolution according to the internal defense and development strategy. Nation assistance consists of general missions such as assisting with development-related infrastructure projects, training health care workers, and improving the professionalism of national military forces. Nation assistance missions can generate useful good will toward the US and assist friendly governments.

SEARCH AND RESCUE

Search and rescue operations are sophisticated actions requiring precise execution. They may be clandestine or overt. They may include the rescue of US or foreign nationals or items critical to US national security. Rescue operations require timely intelligence and detailed planning. They usually involve highly trained special units but may be supported by general-purpose forces. Search and rescue operations may be required in peacetime as well as in conflict and war.

NONCOMBATANT EVACUATION

NEOs are normally conducted to evacuate US civilian noncombatants and nonessential US military personnel from locations in a foreign (host) nation to a safe haven, preferably the US. An NEO is normally conducted to evacuate US citizens whose lives are in danger

from a hostile environment or natural disaster. NEOs may also include the selective evacuation of citizens of the host nation and third-country nationals.

NEOs involve swift, temporary occupancy of an objective, perhaps using temporarily disabling technologies to minimize casualties and end with planned withdrawals. They may include the use of force. Under ideal circumstances, little or no opposition to the operation exists. Still, commanders must anticipate and plan for possible hostilities. If military forces are employed in an NEO, they usually comprise units from more than one service. The regional CINC, on being ordered to support an NEO, designates a JFC to exercise overall control of the operations involved in the NEO.

Evacuation operations differ from other military operations, since direction of the operation may remain with the American ambassador at the time of the evacuation. Further, the order to evacuate is a diplomatic—rather than a military—decision, with extensive ramifications. FM 90-29 provides details on NEO operations.

PEACEKEEPING

Military peacekeeping operations support diplomatic efforts to achieve or maintain peace in areas of potential or actual conflict. The single, most important requirement of a peacekeeping operation is consent to the operation by all the parties to the dispute. Such consent represents an explicit agreement, permitting the introduction of a neutral third party.

The US may participate in peacekeeping operations under the sponsorship of the UN or other IOs, such as the Organization of American States, or in cooperation with other countries. The UN has been the most frequent sponsor of peacekeeping operations. Peacekeeping often involves ambiguous situations that require the peacekeeping force to deal with extreme tension and violence without becoming a participant. Based on the peacekeeping mandate and the stationing agreement, specific TOR, follow-on command directives, and ROE are established.

SHOWS OF FORCE

Shows of force lend credibility to the nation's promises and commitments, increase its regional influence, and demonstrate resolve.

These operations can influence other governments or politico-military organizations to respect US interests and international law. These operations can take the form of aircraft and ship visits, multinational training exercises, forward deployment of military forces, and introduction or buildup of military forces in a region. The appearance of a credible, trained military force underscores national policy interests and commitment, improves host-nation military readiness and morale, and provides an insight into US values.

COUNTERDRUG OPERATIONS

Support to counterdrug operations complies with the national drug control strategy, complements the efforts of law enforcement agencies, and supports foreign governments. At the level of national strategy, the NCA places increasing importance on the role of DOD in controlling the flow of drugs across US borders. The objective of military counterdrug efforts is to reduce the flow of illegal drugs into the US. Military support is therefore a balanced effort to attack the flow of illegal drugs at the source, while in transit, and during distribution in the US. Military counterdrug activities may also be used to support insurgencies and counterinsurgencies and to combat terrorism.

HUMANITARIAN ASSISTANCE AND DISASTER RELIEF

Humanitarian assistance and disaster relief operations are unique peacetime operations because they could be conducted within CONUS. Recent examples in the US have included assistance rendered in the northwest states to contain forest fires and relief operations following Hurricanes Hugo in 1989 and Andrew in 1992. These operations fall within the category of support to domestic civil authorities. Examples of in-theater operations include famine relief efforts in Somalia and hurricane relief operations in Hawaii following Hurricane Iniki.

Humanitarian assistance and disaster relief operations provide emergency relief to victims of natural or man-made disasters. These operations may include refugee assistance, food preparation and distribution programs, medical treatment and care, damage assessment and control, forensic identification, maintenance of law and order, reestablishment

of communications networks, and sanitation/water facilities.

ARFOR are committed to these operations when localities become overwhelmed by the extent of the situation and can no longer provide basic human needs and protection. The ability to respond on short notice with a wide array of capabilities is a unique attribute of the Army. The length of commitment is normally limited to the time that communities and other government and private agencies can handle continued operations by themselves. When properly executed, military participation in humanitarian assistance and disaster relief operations has long-term positive effects. Overseas, such participation demonstrates good will and engenders mutual respect. At home, it provides soldiers the opportunity to demonstrate their skills while helping their fellow citizens.

CIVIL AFFAIRS AND PSYCHOLOGICAL OPERATIONS

Although not a peacetime operation, CA and PSYOP are critical operations that aid commanders in accomplishing their peacetime objectives. Commanders at all levels must understand the depth and capabilities of CA and psychological support found throughout any given command. Commanders must understand the CA and PSYOP ability to support US and allied armed forces.

Civil Affairs

ARFOR execute CA programs to support the unified commander. During peacetime, CA support is often provided as an ancillary benefit to deployments for training. CA units

are suited to both short-term and longer-term involvement. To be effective in short-term operations, these programs require continuous preparation, regional expertise, and consistent coordination between civil and military authorities. This preparation is best achieved through peacetime involvement in the theater.

Psychological Operations

ARFOR PSYOP forces execute PSYOP to support the unified commander and US national interests. Throughout the range of military operations, PSYOP is a vital force employed to optimize the influence of US national policy on foreign target audiences, whether neutral, hostile, or friendly. In MOOTW, PSYOP provides the commander with the capability to project the purpose and mission of US forces and to influence target audience behavior to support the commander's mission.

PSYOP is a force multiplier, providing long-range, mid- to long-term support of the unified commander's intent. While classified as SOF, PSYOP is a general force multiplier. This support exists at all levels of command and operations—from strategic to tactical. PSYOP units are regionally focused and maintain extensive historical research and expertise on the sociological, economical, and religious practices and on the languages of a given AO. ARFOR PSYOP support US Army, Navy, Marine Corps, Air Force, and allied forces. Except for PSYOP-unique equipment and military occupational specialties (MOS), the unit of attachment sustains PSYOP elements. For PSYOP to achieve maximum effectiveness, planners must include it in the planning process early.

TRANSITION TO HOSTILITIES

Operations conducted in peacetime are designed to preclude the onset of conflict. Due to factors that may not be controlled, conflict may evolve. Because the transition to conflict may occur in a gradual or abrupt manner, the ARFOR commander must prepare for either eventuality. The operational METT-T assessment provides the mental process for the continuing reevaluation of the operational environment. That reevaluation aids the identification of needed Army capabilities in the event of conflict. Such identification assists national-level decision makers in determining mobilization requirements.

The theater CINC organizes his AOR for orderly and rapid transition from a peacetime posture to different levels of hostility. This process is sequential and sufficiently flexible to respond to any situation. The transition process must be responsive enough to diplomatic initiatives to be halted or reversed once it has begun. The CINC must be sensitive to the fact that a prolonged state of heightened readiness for combat without action may drain resources and adversely affect morale.

The ASCC translates mission orders from the CINC into plans and military operations. If

mobilization is required, AMOPES—the Army system that supports JOPES—provides a disciplined planning procedure for conducting Army mobilization, deployment, planning, and execution (see also FM 100-17). The ASCC and appropriate Army commanders review the mobilization requirements established in AMOPES, CONPLANs, and OPLANs to meet the situation. C² relationships are likely to change as levels of hostility and military involvement increase.

Commanders participate in joint and multinational planning efforts and coordinate and prepare ARFOR for deployment and employment. Finally, commanders contribute ARFOR ready to meet joint and multinational operational requirements and to establish a logistical base to support fielded Army units.

RESPONSIBILITIES IN CONFLICT

The theater CINC, with concurrence from the NCA, determines when all or part of his AOR is in a state of conflict. Conflict is a state of hostile opposition among organized parties or groups within a nation, or between or among nations, and usually involves irregular forces to achieve limited diplomatic or military objectives. Conflict is often protracted, and irregular forces often dominate.

Military actions may be confined to geographic areas. When US Army units are directly engaged in conflict, they can expect guidelines on weaponry and the degree of force authorized. Diplomatic leaders will likely limit objectives to those achievable with short, focused, and direct application of military force. Even though limited in scope, these short applications of force may be part of a campaign or major operation phased over an extended period. The NCA or the CINC may further limit the conduct of military operations to a specific geographic area.

The Army's Role

The Army's role in conflict is to assist a JFC in gaining control, deterring escalation, and restoring order. Conflict operations are challenging because they require a measured application of military force sufficient to accomplish the designated objectives. Typically, conflict occurs in diplomatically—charged situations within specific legal boundaries. ARFOR operate in a hostile environment with a high probability of physical

confrontation; though sometimes, combat operations may not occur. Army leaders may conduct operations very similar to operations during war but execute them with both restraints and constraints placed on the use of firepower and maneuver.

Factors

Senior army commanders must keep four factors in mind when considering operations in conflict: *coordination, balance, planning for uncertainty, and identification of risk.*

Coordination

Coordination is critical to establishing the basis for the operations being conducted. The Army must cooperate with other government agencies, services, and nations to deal effectively with the diplomatically sensitive situations present in conflict.

Balance

Commanders must balance the combat posture and readiness of their soldiers against the volatile environment in which they function. A balance must also be struck between diplomatic goals and the scale, intensity, and nature of Army operations supporting those goals.

Planning for Uncertainty

Commanders must build flexibility into their plans and operations. Conflict situations are full of uncertainty as presented by both the threat and the diplomatic conditions that limit Army options.

Identification of Risk

Commanders must seek to increase their options while limiting the enemy's options. Successful commanders do not run out of options. Risks and gambles are part of option decisions. The decision to take risks is weighed against the mission, probability of success, available intelligence, and as many other factors as are available to the commander in his decision cycle.

ARMY SERVICE COMPONENT FUNCTIONS IN CONFLICT

Operations during conflict present a challenge to Army leadership. The military, as one of four elements of national power, may not dominate events but may adapt its operations to fit those of other lead agencies. In coalition

and interagency operations, the ASCC must achieve unity of effort through cooperation, liaison, negotiation, and compromise. Where practicable, agreements should be formalized in writing as TOR, memorandums of understanding (MOUs), or similar instruments. Tasks required of the ARFOR will vary relative to the success of returning the area in conflict to a state of peace. ARFOR must be flexible enough to meet a wide range of operational requirements. The conflict environment will challenge the versatility of the force.

Movement and Maneuver

Movement and maneuver in conflict are characterized by planning that reflects the restrictions and constraints placed on military operations. These restrictions and constraints form a set of requirements and prohibitions imposed by the NCA. They usually have a diplomatic basis that outweighs militarily preferred alternatives. The NCA articulates these restrictions and constraints in different manners.

ROE are the translation of circumstances and limitations for the initiation and conduct of engagements with hostile forces. Personnel ceiling caps restrict the level of forces that can become involved in a conflict within prescribed geographical boundaries. Designated AOs define restrictions on the commander's battle space. These factors combine to influence the movement of forces into the AO. After that movement, maneuver is influenced by these same factors.

Army Force

In conflict, the Army force needed is a key consideration. Often the presence of overwhelming force in the conflict area discourages enemy actions. Senior army commanders must forthrightly articulate the resources required to achieve quick and decisive victory with minimum casualties. Based upon the diplomatic situation and other competing priorities, the Army commander may have to achieve his goals with considerably fewer resources than he desires. The sequencing of major operations in this environment requires patience and a clear understanding of the diplomatic realities that apply to the particular conflict.

Forcible Entry

Conditions may require a forcible entry. This capability requires the staging of forces

over time and space. Chapter 6 addresses some considerations for forcible entry. Among the key considerations is the element of force mix. Combat forces are key to seizing the lodgment area, but support forces become immediately critical thereafter. Strategic planners and force commanders must ensure that logistics forces and sustainment resources are deployed in theater as soon as possible to enable combat forces to conduct continuous operations.

Reception and Onward Movement

The mission of reception and onward movement is to integrate rapidly arriving forces and supplies into the theater without disrupting the operation's tempo. This mission must be balanced against support to current operations, as both are logistically intensive. Accordingly, the ASCC must carefully plan and execute reception and onward movement to maintain the proper balance to support arriving forces and the operation's tempo. Early base development efforts are key considerations for the Army commander. Units and facilities for the reception of forces are critical, especially in the initial phase and in an undeveloped theater.

Disposition of Forces

The final consideration for maneuver during conflict is the disposition of forces. Deployment of forces into their initial positions is critical. This positioning must support both current and subsequent operations as envisioned by the Army commanders. ARFOR may operate from noncontiguous bases that require the Army commander to develop lines of operation and support with a minimum amount of protection. To be able to rapidly mass his forces and prevent the enemy from gaining the initiative, the commander must have a finely tuned intelligence capability, a detailed understanding of the physical disposition of friendly forces, and a high degree of operational-level mobility.

Fires

Operational-level fires during conflict revolve around two key considerations: *ROE* and *coordination of joint fires*. The types of fires permitted are likely to be limited, and the fires used will require a higher level of precision and greater reliance on temporary disabling techniques and technology. Collateral damage is less tolerable in conflict. Failure to control

and limit collateral damage can endanger the long-term effects supporting stability.

The Army may find itself in a supported role in the area of operational fires. For instance, the precision and depth of the fires required may dictate a predominant Air Force role. To achieve his operational objectives and complement the JFC's plan, the Army commander selects targets for Army resources to attack and nominates targets for other resources to attack. The joint coordination process is critical to ensuring that resources are not wasted and that fires create a synergistic effect.

The Army operational-level commander must have an organic staff capability to plan and coordinate operational-level fires. This staff element is the DOCC. His staff must also have the capability to augment the joint staff for planning and coordinating joint operational fires. Because of potential restraints and constraints caused by concerns over collateral damages, other systems may take on a role of greater utility. Other systems' fires are designed to impair, disrupt, or delay the performance of enemy operational forces, functions, and facilities. PSYOP, SOF, EW (jamming), and other C² countermeasures are all disabling fire options.

Protection

Protection of the force requires heightened awareness as conditions move toward direct confrontation. As the likelihood of confrontation increases, so does the vulnerability of the force, unless additional protection measures are implemented. Protection conserves the fighting potential of a force and is every soldier's responsibility. Protection has four components.

- The first component includes OPSEC and deception operations. Successful execution of this component prevents the enemy from locating and causing harm to friendly forces.
- The second component supports keeping soldiers healthy and maintaining their fighting morale. It includes protecting their equipment and supplies and taking care of their basic needs.
- The third component is safety. It is a principal element and must be an integral part of all military operations. Soldiers conducting military operations are placed at risk; still, commanders must ensure that

soldiers are not placed in an undue risk situation. Strong command and levels of discipline and training lessen those risks. Training in peacetime must be realistic and equate to requirements for fighting in war.

- The fourth component is avoiding *fratricide*— the unintentional killing or wounding of friendly personnel by fire. Commanders must maintain situational awareness of the enemy and their personnel. This situational awareness, along with strong command presence, disciplined operations, and anticipation of future operations helps limit probability and occurrences of fratricide.

Commanders implement the THREATCON system. Table 8-1 briefly describes THREATCONs Normal, Alpha, Bravo, Charlie, and Delta. The implementation decision is based upon—

- The threat assessment.
- Personnel and facility criticality and vulnerabilities.
- Resource availability.
- Operations and morale impacts.
- Damage control considerations.
- International relations.
- Possible terrorist retaliatory responses.

The commander must recognize that information on the threat is difficult to obtain prior to an incident. Army Regulation 525-13 discusses the combatting terrorism program in detail. The identification of friendly force vulnerabilities and geopolitical assets are key steps in protection. Essential facilities must be identified. Communications must be protected from interference and interception. While the basic principles for deception hold true during conflict, they are often more difficult to apply.

OPSEC is significantly harder to sustain in an open society where national survival is not at stake. Deception is more difficult to achieve when the operational-level objectives have more diplomatic content than military significance. The Army commander must ensure that his deception plans support the unified command's plans and are not compromised by information leaks. The environment of conflict often appears peaceful, requiring commanders to remain vigilant to

Table 8-1. THREATCON Levels

THREATCON Level	Threat
Normal	No credible threat of terrorist activity
Alpha	Low - general terrorist threat
Bravo	Medium - increased and more predictable threat
Charlie	High - when an incident occurs or when intelligence indicates an imminent terrorist action
Delta	Imminent - when an incident occurs in the immediate area after a terrorist attack or when intelligence indicates a threat against a specific person or location

guard against complacency. Terrorism is most effective when the threat is not highly visible and surprise is likely to be achieved.

Command and Control

During conflict, the ASCC contributes to the CINC's theater strategy of limiting hostilities. These efforts often involve direct use of military power to complement diplomatic initiatives. The principal C² problem is how to integrate US military actions with lead agencies of our own or foreign governments. The Army has a variety of operations to select from in supporting conflict situations, all of which have some common C² considerations.

Structure

Military leaders conduct conflict operations without a declaration of war. The absence of this declaration restricts the structuring of the theater for operations. In MOOTW, the CINC does not establish a theater of war or theaters of operation unless it is a major conflict. Normally, he establishes smaller areas, such as a JOA, for conducting operations. Diplomatic considerations predominate over purely military requirements and constrain C². The senior military leader has a greater level of freedom than in peacetime but must coordinate closely with nonmilitary agencies. Whatever the geographic organization, the ASCC must establish clear C² structures for conducting operations in conflict.

Command Relationships

Command relationships and structure usually begin with existing peacetime arrangements that require a degree of

transition to a state of conflict footing. Conflict planners may have to consider combined relationships. The level of international integration will affect C². The unified command structure serves as the C² structure to build upon. C² may emanate straight from the national level if operations include actions of direct strategic importance.

As operations in theater transition to conflict, in-theater forces and existing C² relationships may be adequate to accomplish the mission. ARFOR from CONUS or other theaters could increase the complexity, scope, and level of forces executing operations beyond the capabilities of the normal theater structure. This would thereby require augmentation or restructuring. In austere theaters, an Army force may have to arrive in theater prepared to support itself and execute operations unassisted. Later, the theater ASCC may control all operations, or the CINC could task the ASCC to support operations while he directly controls the execution of operations through a separate operational chain of command.

Planning

Army operational-level commanders are active participants in the development of all conflict plans. They may participate in deliberate planning (*JOPEs*, Volume VI) to prepare for anticipated or potential actions. Unanticipated or rapidly developing situations may require operational-level commanders to conduct CAP. Planning for conflict, especially at the operational level, is a continuous process. Rapidly changing diplomatic

conditions may change the desired objective, composition, and sequencing of conflict operations. Planners must prepare multiple branches and sequels to enhance their ability to provide timely support. Senior army commanders require a flexible force structure to enable their organization to achieve the desired strategic end.

Intelligence

Early establishment of an ACE is critical for successful operations. ACE operations should commence within the theater of operations before hostilities. Intelligence communications established between the theater intelligence center and the national systems provide the critical intelligence that US military forces require immediately upon arrival and until tactical intelligence flow is established.

Operational intelligence must support the targeting effort of operational fires and/or set the stage for operational-level maneuver. Success requires sound IPB. In conflict, IPB may follow the process used for a conventional battlefield or a modified process that focuses on nonmilitary information. Civilian trends are often as important as operational information. Weather analysis remains an important part of IPB. Doctrinal templates for guerrillas, surrogates, and narcotics traffickers do not exist.

Intelligence personnel need different collection techniques and background information, which may require continuous updating. The process must react to the dynamics of the specific situation it supports, as well as to the worldwide situation. Intelligence agencies must exploit the full range of both US and host nation intelligence and counterintelligence production capabilities. This includes the collection and analysis of SIGINT, IMINT, and HUMINT, which are particularly valuable in determining hostile intentions.

The ASCC provides theater-specific intelligence integration for the Army operational-level commander. The Army commander develops his picture of the operational area, based upon the threat he faces and the information gathered by the intelligence system. Intelligence should be the basis for all action.

During foreign internal defense operations, the Army's intelligence organization works

closely with the host government to develop and improve the intelligence capabilities of all security forces. During counterinsurgency operations, intelligence provides the basis for all US and host nation plans. Prior to commitment, US military forces provide specific intelligence requirements to the US national intelligence community. This ensures that national-level collection focuses on force requirements. Cooperative or multinational MI activities at the operational level are integral to effective intelligence collection and production. Army intelligence units provide technical expertise, management, and advice to develop host nation intelligence capabilities. They help establish objectives and, where desirable and feasible, develop common procedures.

The Army can provide tactical intelligence support in conflict situations. ARFOR can contribute experience and expertise to establish and manage all-source intelligence operations and enhance overall management of the intelligence effort. This management of intelligence information includes data on internal unrest, on external support for insurgencies, and on host nation military capabilities, including intelligence and counterintelligence.

The threat of sabotage, terrorism, and subversion requires MI staffs to focus their counterintelligence collection efforts. These efforts require close coordination with host nation police and legal officials. In countries where cooperative or multinational intelligence systems already exist, newly arrived Army tactical units normally work with the area intelligence elements on a mutual support basis. When the situation forces Army units to move frequently, they should not assume responsibility for long-term, area-oriented intelligence programs. Still, they may contribute significantly to short-term collection and production efforts. All Army personnel during conflict provide information which, when tied into the data-gathering system, can produce useful intelligence.

Logistics

In conflict, the ASCC tailors logistics to provide basic requirements in an austere situation. He stages logistics and uses intermediate support bases, leading to full base development if necessary. He does this with the use of HNS. Early deployment of the LSE from USAMC ensures a positive link from the

deploying units to the national logistics system and may be required to fill gaps in the TOE logistics infrastructure or projected selected elements of the national/industrial base into theater. The LSE could provide an initial C² structure to orchestrate USAMC resources and the logistics efforts of contractors and HNS. The degree of development of the host nation's infrastructure has a significant influence upon the Army commander's long-range logistics operations. In an austere environment, logistics operations can take precedence over near-term combat operations.

The Army commander takes a long-range view of the conflict situation and plans his logistics for the anticipated duration of combat operations, plus a transition period. He is responsible for providing HSS to ARFOR and, as directed, to other services, agencies, and

organizations. These logistics responsibilities include—

- Patient evacuation and medical regulation.
- Hospitalization.
- Health service Logistics/blood management.
- Preventive medicine, dental, veterinary, medical laboratory, and combat stress control services.
- Area medical support.
- Command, control, and communications (C³).

Logistics operations may become the primary Army weapon in conflict. Critical logistical skills supplied by the Army may allow the host nation to focus on combat requirements in the particular conflict, with little or no US Army participation.

OPERATIONS IN CONFLICT

In conflict, the ASCC executes a variety of operations that contribute to the achievement of theater-strategic goals. These may include the continuation and expansion of the full range of previously discussed operations begun in peacetime, as well as attacks, raids, UW, support of insurgencies and counterinsurgencies, peacemaking, security assistance surges, and operations to combat terrorism. Sometimes operations are in response to a crisis or other rapidly developing situation. At other times operations may call for long-term planning and sequenced execution to support theater goals. Chapter 4 provides Army planning and deployment considerations for crisis situations. FM 100-17 addresses Army planning and deployment considerations across the range of military operations.

TERRORISM

Terrorism is the calculated use of violence or the threat of violence to inculcate fear. Terrorism is intended to coerce or intimidate governments or societies pursuing goals that are generally diplomatic, religious, or ideological. Combatting terrorism consists of defensive (antiterrorism) and offensive (counterterrorism) actions.

Antiterrorism

Antiterrorism includes all measures that installations, units, and individuals take to reduce the probability of their falling victim to

a terrorist act. Antiterrorism includes those defensive measures that reduce the vulnerability of individuals and property. The extent of these defensive measures varies based on assessment of the local threat. These measures include—

- Being personally aware and knowledgeable of personal protection techniques.
- Implementing crime and physical security programs to harden the target.
- Making installations and personnel less appealing as terrorist targets.

Counterterrorism

Counterterrorism includes the full range of offensive measures to prevent, deter, and respond to terrorism. These measures are normally carried out by SOF under the direction of the NCA. Local measures include only those actions taken to terminate an incident or apprehend individuals responsible for terrorist acts. Other countermeasures—preemption, intervention, or retaliation with specialized forces operating under the direction of the NCA—have the characteristics of attacks or raids.

The Army commander may conduct actions before, during, or after a terrorist incident. Although DOS has the lead in combatting OCONUS terrorism, the Army commander and his staff must understand the threat and its

tactics, as well as current US policies, when dealing with terrorists. The Army may be the lead or a supporting force in an effort to combat terrorism during a specific operation.

ATTACKS AND RAIDS

Attacks and raids can support rescue or recovery operations to destroy or seize equipment or facilities that demonstrably threaten national collective security interests. They can also support counterdrug operations by destroying narcotics production or transshipment facilities (if authorized by the NCA) or by supporting a host government's actions in this regard. The principles of combat operations directly apply.

Attacks by ground, air, and naval forces damage or destroy high-value targets or demonstrate the capability to do so. *Raids* are usually small-scale operations involving swift penetration of hostile territory to secure information, seize an objective, or destroy targets. Attacks and raids end with a withdrawal. Successful attacks and raids can create situations that permit seizing and maintaining the diplomatic initiative. To be successful, they require the proper focus of planning, organization, training, and equipment. Attacks and raids may involve conventional forces and SOF. The JFC usually plays a larger role than the Army operational-level commander in planning and executing these types of operations.

UNCONVENTIONAL WARFARE

UW is a series of military and paramilitary operations conducted in enemy-held, enemy-controlled, or diplomatically sensitive territory. UW includes, but is not limited to, guerrilla warfare, evasion and escape, subversion, sabotage, and other operations of a low visibility, covert, or clandestine nature. US military support to UW operations can include the use of both conventional forces and SOF. UW is usually a long-term effort.

Techniques and tactics for certain UW operations are similar to those employed in support of insurgencies. However, support for insurgency differs from that for UW. Insurgency accomplishes strategic goals directly, whereas UW typically supports conventional operations. The difference affects the operational and strategic design of the operation. For example, operations in support of insurgencies give priority to infrastructure

and diplomatic development, while UW emphasizes military actions.

INSURGENCY AND COUNTERINSURGENCY OPERATIONS

Insurgency and counterinsurgency are two aspects of the same process. However, they differ in execution. Insurgents assume that appropriate change within the existing system is not possible or likely. Insurgency therefore focuses on radical change in diplomatic control and requires extensive use of covert instruments and methods. Counterinsurgency uses principally overt methods and assumes appropriate change within the existing system is possible and likely. The US supports selected insurgencies that oppose oppressive regimes which work against US interests. Since support for insurgencies is often covert, many operations connected with them are special activities. Because of their extensive UW training, SOF are well-suited to provide such support.

Conventional forces may be called on when the situation requires their functional specialties. Their tasks may include support and advice. The CINC may direct the ASCC to provide equipment, training, and services to insurgent forces. In the following types of operations, ARFOR can assist insurgents:

- Recruiting, organizing, training, and equipping forces to perform unconventional or guerrilla warfare.
- PSYOP.
- Institutional and infrastructure development.
- Intelligence-gathering.
- Surreptitious insertion.
- Linkups.
- Evasion and escape of combatants.
- Subversion.
- Sabotage.
- Resupply.

The US uses its military resources to provide support to a host nation's counterinsurgency operations in the context of foreign internal defense (FID). FID is the participation by civilian and military agencies in any of the action programs another government takes to free its society from

subversion, lawlessness, and insurgency. The US ambassador, through his country team, provides the focal point for interagency coordination and supervision of FID.

Military support to FID is provided through the unified CINC. Military resources provide materiel, advisors, trainers, and security assistance forces to support the host nation government's counterinsurgency operations through SAOs. ARFOR operations that support a host nation conducting a counterinsurgency may include, but are not limited to, intelligence-gathering, joint and combined exercises, civil-military operations, humanitarian or civic assistance, logistical support operations, populace and resource control operations, drug-interdiction operations, and tactical operations.

PEACE ENFORCEMENT (OPERATIONS TO RESTORE ORDER)

When in the national interest to stop a violent conflict and force a return to diplomatic methods, the US conducts peace enforcement (PE) operations with its military forces. The US typically undertakes PE operations at the request of appropriate national authorities in a foreign state or to protect US citizens as part of an international multilateral or unilateral operation. The PE force does not represent a wholly disinterested power or such a drastic commitment would not be made. However, the interests of the country or countries that provide forces for these operations are served best by a cessation of violence and a negotiated settlement.

Conflict within a given area eventually affects adjacent areas. These effects are seldom desirable and can include refugee movements, arms marketing, proliferation of weapons, and environmental contamination. A further potential exists for the expansion of the conflict beyond its original boundaries.

TRANSITION TO PEACETIME OR WAR

The successful termination of conflict operations leads to a return to peacetime. The unsuccessful termination of conflict endangers US interests or threatens a possible transition to war. In either case, the ASCC must be prepared for these outcomes. The ASCC plans consolidation operations to terminate combat

The long-range goals of a PE operation are two-fold. The first goal is to contain the conflict to prevent the destabilization of adjacent areas. The second goal is the agreement to a negotiated settlement by the parties to the conflict. This settlement must resolve the basis for the conflict and establish the foundation for the transition to peacekeeping operations and peacetime operations. The diplomatic complexities of operations to restore order require that available force be sufficient but its use be applied with discretion. The operation also requires that the forces be appropriate to the environment.

The senior army commander must understand the constraints and diplomatic sensitivities of this environment and recognize that local law and customs often influence his actions. PE operations require continuous mission analysis, clear C relationships, effective communications facilities, joint and multinational force liaison, and effective public diplomacy and PSYOP.

SECURITY ASSISTANCE SURGES

The US accelerates security assistance when a friendly or allied nation faces imminent threat. In these surges, operations usually focus on logistical support. Geography, the magnitude of the logistics effort, and time limitations determine airlift and sealift requirements. US support to Israel during the 1973 Arab-Israeli War illustrates this kind of operation. The Yom Kippur War demonstrates the importance of airlift in the initial stages of conflict and the follow-on strength of sealift. The CINC may direct the senior army commander to provide equipment from his command as part of security assistance surges. The senior army commander may also provide some of the logistical support (port operation and line haul units) needed to transfer surge equipment to the friendly nation.

operations and prepare the way for the use of diplomatic, informational, and economic elements of power in a peacetime environment. As the level of hostility lessens, the ASCC changes the composition of his force. He replaces those combat arms forces—essential during combat operations—with CS and CSS

forces as hostilities subside. Finally, he positions nation-assistance forces to complete the transition to peacetime operations.

The ASCC plans an orderly redeployment of forces. This redeployment includes recovery

and reconstitution of forces, which facilitates a return to peacetime activities. As a part of postoperation reporting, the commander develops lessons learned for incorporation into training during peacetime activities.

Appendix A

Army Service Component Command Responsibilities and Organization

This appendix focuses on the functions, responsibilities, and capabilities of those operational-level organizations formerly known as echelons above corps. It addresses the dynamic nature of the theater strategic and operational requirements in the states of peacetime, conflict, and war. It contains requirements for establishing and designing a theater. It describes responsibilities, functions, and organizations required to conduct major operations and provide logistical support. It pinpoints the functional, operational, and support responsibilities of the Army service component commander (formerly known as the *theater army commander*) in the theater.

The Army service component serves as the senior Army echelon in a theater and is the Army service component command of a unified command. It includes the service component commander and all Army personnel, organizations, units, and installations that have been assigned to the unified command. The Army's operational-level organizations assist and augment tactical (corps and division) organizations.

THEATER ARCHITECTURE

During periods of peacetime deployments and training where Army forces pass through the area or operate within a CINC's AOR, but are not assigned to that CINC, the ASCC coordinates with the ASCC of the appropriate CINC to ensure those forces are supported. However, except as the NCA directs, all forces operating within the geographic area assigned to a combatant command shall be assigned or attached to and under the command of that combatant commander. The architecture of the Army in a theater is flexible enough to meet the needs of combatant commanders. The ASCC has a number of capabilities and options for organization and provides the capabilities that support a force-projection concept—from an austere to a fully developed theater.

The total capabilities the ASCC provides may not be initially required in theater for the early stages of a force-projection operation. Rather, the ASCC structure represents capabilities that would be task-organized into a selected force based upon the mission, assessment of the operational environment, constraints, restraints, and the commander's risk assessment. Each theater is unique. The functional requirements of a theater organization remain somewhat constant. The variable is the level of capability required. The ASCC tailors units to provide the specific capabilities the CINC requires and echelons those capabilities as required into the theater.

ECHELONS OF COMMAND

Historically, echelons of command at the operational level of war (EAC) have gone through an evolutionary process. During the Civil War, the Army began evolving toward larger, Army-level units with a single commander directing large forces dispersed in multiple locations. Then, during World War I, the theater commander used an intermediate

headquarters—the field army—to control multiple corps. The World War II structure expanded this, using army groups and field armies between the theater and corps commanders. These Army groups were formed to control two to five field armies. In turn, the field army could control a like number of corps. Essentially, an army group could control a maximum of 25 corps.

With the structuring of the Army around a four-corps base, the requirement for the army group and field army was eliminated. However, the functions performed by the army group and field army were not eliminated, resulting in those functions (Title 10) being performed by a forward-deployed theater army and its requisite subordinate organizations performing specific functions. Additionally, the requirement for a multiple corps operation required the capability to constitute at least an operational-level headquarters (a numbered army) for C² of the operations.

Should multinational forces be added to a conflict, as we anticipate to be the case, larger formations are possible. The issue then becomes one of span of control for the theater CINC. Modern forces have a significant mobility advantage over their World War II counterparts, where the US Army last formed army groups. That mobility advantage permits smaller formations to operate over larger AOs. Army echelons reflect the unified command structure, increased span of control capabilities, and improved weapons technology. Corps serve as the Army centerpiece for structure and are normally the building blocks upon which the Army organizes. The ASCC, formerly called the *theater army commander*, carries out the Title 10 responsibilities within the theater.

Subordinate JFCs may control multiple US Army corps without an intermediate Army headquarters. Then, the ASCC carries out the Title 10 responsibilities in lieu of the theater army. However, the ASCC may choose to organize a numbered army as an intermediate headquarters between the corps and the JFC to command and control operations when required by METT-T. Army organizations are structured to enable them to perform the missions to which they are assigned. At corps and below, those missions are primarily tactical. Corps and below units must be augmented to perform at the operational level. Still, units that normally operate at the tactical level may not have the operational perspective necessary to skillfully link tactical operations to strategic objectives.

When a corps or division is fully engaged at the tactical level, it cannot be expected to assume responsibility for the additional functions and command responsibilities that correspond to the operational level. It has neither the personnel nor materiel resources to perform both responsibilities. Chapter 6 discusses these additional requirements in detail. Under the force-projection concept, a tactical-level unit may conduct operational-level operations. In principle, these operations should be performed by an echelon not directly responsible for commanding tactical operations. The tactical force commander must be free to concentrate resources on the tactical mission. Whereas, the operational-level commander must be free to concentrate resources on the performance of the three operational-level tasks—joint, multinational, and interagency linkage; conduct of Army operations; and support of Army operations.

The Army contributes operational-level organizations to support joint and multinational operations. Operational-level units fight and support, as well as make up a support base. Operational-level forces may be part of a forward presence that serves as a symbol of US national resolve. Other forces remain in the US to provide rapid force projection to forward-deployed units or to execute contingency operations. Whatever the case, Army leaders need to be familiar with those Army operational-level forces that contribute capabilities to joint and multinational operations. US Army levels of command include—

- Army service component command.
- Numbered army.
- Corps.
- Division.
- Brigade, regiment, or group.
- Battalion or squadron.
- Company, battery, or troop.

These echelons of command provide a means for commanders to achieve operational- and tactical-level objectives. Each of these echelons has its own set of capabilities and considerations.

THEATER REQUIREMENTS

The Chief of Staff of the Army, with the CJCS and unified command authorities, configures the Army service component to the

unified commands to meet theater requirements.

PEACETIME

In peacetime, the CINC normally exercises COCOM through the ASCC. The ASCC must have a strategic and operational perspective while executing his responsibilities. He serves as the principal advisor to the CINC for supporting and employing ARFOR in theater. The ASCC participates in mid- and long-range planning to support the CINC's theater strategy and campaign plan, conducts major operations that support the CINC's campaign plan, and provides sustainment and support of all ARFOR assigned or attached to the theater. The ASCC may exercise OPCON of selected forces. He may command forces executing combat operations or MOOTW.

The ASCC performs three strategic and operational-level tasks—

- Establish linkages and coordinate with the joint force head quarters and other service component commanders.
- Conduct operations.
- Conduct support operations to sustain the ARFOR assigned to the theater.

The ASCC's strategic task in peacetime is to carry out the strategic logistics tasks and priorities for the CINC. The ASCC's operational role in peacetime is to plan and conduct operations and exercises to execute the CINC's theater strategy and plans. The ASCC is responsible for sustaining all forces in theater and maintaining the capability to expand to accommodate ARFOR required for theater operations plans. For a complete discussion of service component responsibilities, see Joint Pub 0-2, Chapter 3.

CONFLICT AND WAR

As the theater transitions to conflict or war, the CINC may choose one of several options to exercise COCOM. Each of these options has different impacts on the employment of ARFOR. The CINC may choose to continue to exercise COCOM through the ASCC. The ASCC would conduct major operations and continue to provide sustainment and support of all ARFOR assigned or attached to the theater. The CINC may assign the ASCC support-related tasks solely or a combination of both support and operational tasks.

The CINC may choose to exercise COCOM through a JTF for a limited duration mission. The ASCC would place ARFOR under OPCON of the CJTF for the conduct of operations. The

CINC also could designate the ASCC as the CJTF. The ASCC would focus on all three operational-level tasks. The CJTF may choose to organize his command by service element, functional component, subordinate JTF, or any combination of these. The ASCC, if not the GJTF, would continue to focus on sustainment and support of all ARFOR assigned or attached to the theater.

The CINC may choose to exercise COCOM directly over specific forces. The ASCC would place ARFOR under the direct OPCON of the CINC for the conduct of operations. The ASCC would continue to focus on sustainment and support of all ARFOR assigned or attached to the theater. If the CINC chooses to exercise COCOM through functional component commanders, three scenarios are possible.

- The functional component commander might also be the ASCC. The ASCC would conduct major combat operations and support operations for the theater.
- The functional component commander might also be an Army commander—but not the ASCC. In this scenario, the ASCC could establish a numbered army, and the numbered army commander could be the functional component commander. The ASCC would place ARFOR under OPCON of the numbered army commander for the conduct of operations. Within the functional organization, the numbered army commander would perform the three operational-level tasks. However, the ASCC would continue to focus on sustainment and support of all ARFOR assigned or attached to the theater.
- The functions component commander might also be a commander from another service such as the Marine Corps. In this scenario, the ASCC would place ARFOR under rider OPCON of the functional component commander for the conduct of operations. Within the functional organization, the ARFOR commander would perform the three operational-level tasks. The ASCC would continue to focus on sustainment and support of all ARFOR assigned or attached to the theater.

As the theater transitions to conflict or war, the probability increases that the CINC will separate the ASCC's operational

responsibilities from its support role. The CINC may designate another commander to focus on conducting combat operations, while

the ASCC concentrates on conducting support operations.

SUPPORT AND OPERATIONS FUNCTIONS

The ASCC provides to the CINC a collection of capabilities, functions, and C² elements to accomplish the mission. With the initial deployment of forces, the ASCC, based on METT-T, tailors his organization to provide the required support to conduct major operations, battles, and engagements. The ASCC's support function has a major impact on the design and conduct of campaigns and major operations. The ASCC must get the right

ARFOR to the right place at the right time to enable the CINC to strategically concentrate forces and logistics to generate decisive combat power. Figure A-1 illustrates the capabilities and functions the ASCC provides.

The ASCC becomes intimately involved with decisions concerning competing demands for limited resources. He assists the theater CINC in the development of support priorities,

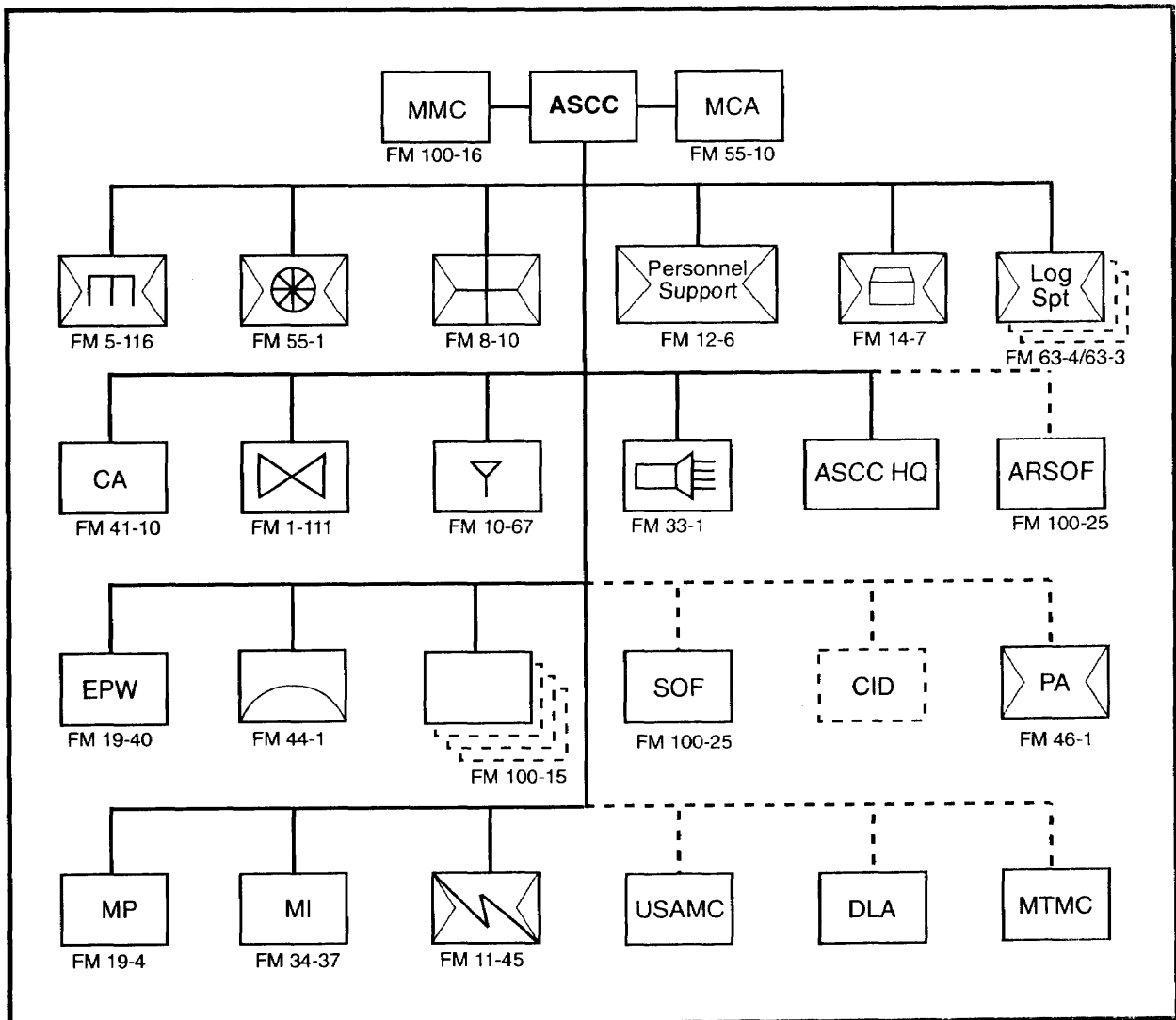

Figure A-1. Army Service Component Command Capabilities and Functions

particularly those affecting other services. To support the force-projection concept and in addition to projecting forces and support, the ASCC must also coordinate the projection of additional required support from CONUS, another theater, or an intermediate support base, using air lines of communication (ALOCs) and sea lines of communication (SLOCs). Figure A-2 illustrates this situation.

In contingency operations, upon entry into the AO, US forces may be either opposed or unopposed. Each type entails a different mix of forces and capabilities. The existence of little or no in-theater support base may require that a large logistics organization, with augmentation from strategic and operational-level logistics organizations, accompany the deploying tactical unit. The synchronization of the deployment of CSS units, supplies, and C² with the increase in combat capabilities is critical.

Theater logistics support requires a seamless logistics profile, from strategic logistics—DLA, USAMC, and General Services Administration—to logistics field units. The historical C² and support structure provided in a mature theater may not be in place. Units must rely on a logistics system that operates on the basis of projecting and supporting force capability instead of supporting units and echelons. Implementation of concepts, such as split-based operations, total asset visibility, in-

transit visibility, real-time communications, and pre-positioned materiel (on land and afloat), along with improved strategic lift capability, ensures sustainment of the projected force. FM 100-16 describes these concepts in detail.

Because of the changing nature of the force size, necessary time frame, and resource constraints, units must be capable of providing mission-essential support before the arrival of doctrinal logistics units or when deployment of logistics units would exceed what is required to support the force's mission. Mission- and capability-oriented modular elements are designed to support combat-essential requirements through sequencing capabilities into the AO. The capability projection of logistics support must focus on two critical areas: essential requirements and the strategic end state. Decisions made early in the process affect the end result. If a developed support infrastructure is absent or eliminated in an area, an ASCC headquarters could serve as the nucleus for a theater base development process. One example of a possible ASCC headquarters organization is shown in Figure A-3. For other examples refer to FM 101-5.

The ASCC headquarters conducts planning and coordinates major operations and support through flexible combinations of area and

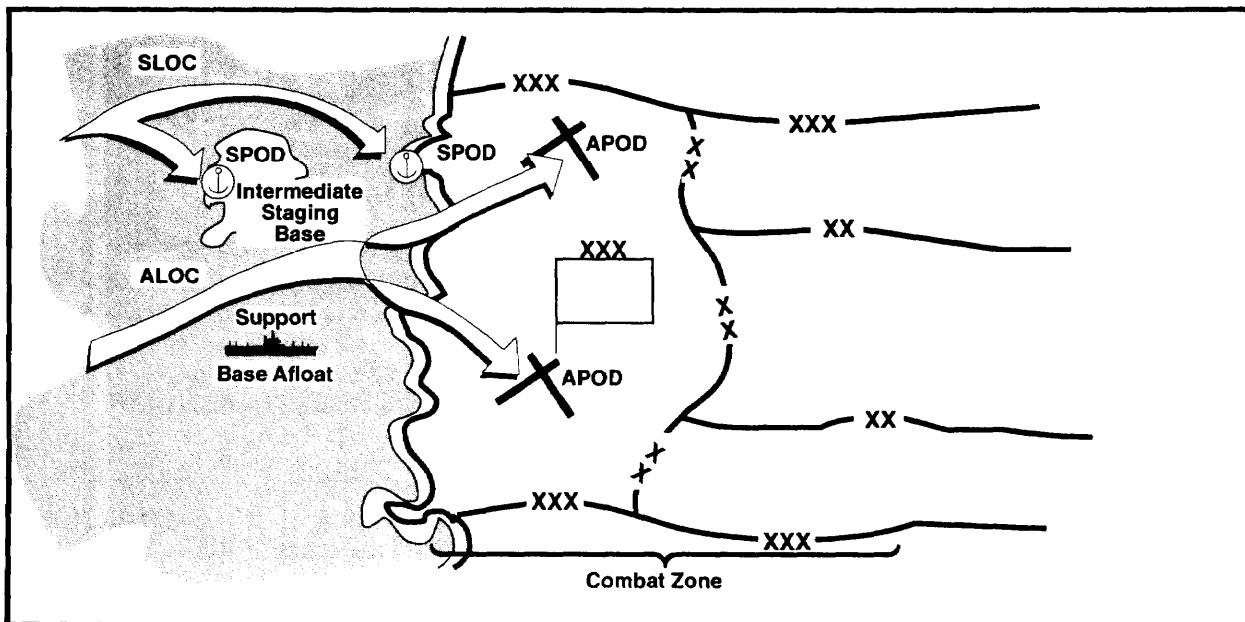

Figure A-2. Contingency Operation Without a Communications Zone

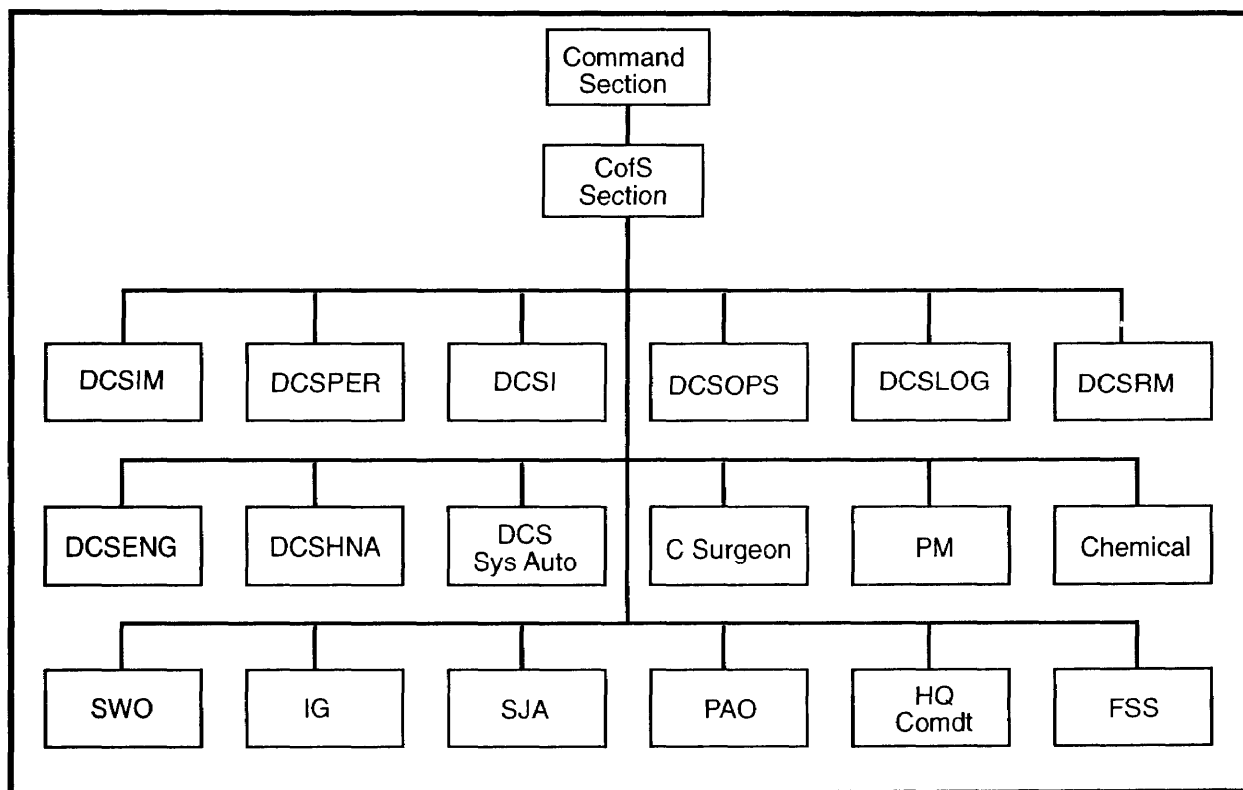

Figure A-3. Army Service Component Command Headquarters Echelonment

functionally oriented organizations. Headquarters management involves managing the organization and administration of the headquarters, including—

- Coordinating and supervising movement, internal arrangement, space allocation, and administrative support.
- Supervising agencies that service the command, such as the American Red Cross; civilian safety personnel; morale, welfare, and recreation personnel.
- Recommending manpower allocation, especially in the use of personnel authorized in large numbers to the headquarters.
- Allocating shelter in the headquarters area for troops, in coordination with the G3 for area organizations and the G4 for provision of shelter.
- Providing control and standardization of procedures within the headquarters. All staff officers are responsible for proper administrative activities within their own staff sections.

The ASCC is responsible for managing the Army's support base in a developed theater. Besides managing the Army's support base, the unified commander may designate the ASCC as the JRAC responsible for surface security of the entire JRA, organization and operation of the theater support base, and conduct of rear operations for all land component services (Joint Pub 3-10.1).

SUPPORT FUNCTIONS

A developed theater consists of forward-deployed resources and forces with some level of installation and HNS. In war, this theater support base, or JRAC, would be located in the intratheater COMMZ or in a dispersal area. The ASCC operates within the theater's developed infrastructure and CINC's strategic priorities to receive forces and resources through seaports of debarkation (SPOD) and aerial ports of debarkation (APOD). The ASCC establishes the logistics infrastructure for the theater of operations and assists in establishing and adjusting theater LOCs. The ASCC receives, equips, marshals, stages, and moves units forward to the tactical assembly

areas for employment. The ASCC continues to support and reconstitute these deployed ARFOR. Upon termination of conflict, the ASCC continues to provide support to the ARFOR to allow redeployment and reconstitution of the force. The theater organization with a COMMZ is depicted in Figure A-4.

Multifunctional Logistics Support

The CINC, with advice from the ASCC, may organize logistical support in his AOR with single, subordinate commanders responsible for large geographic areas. Normally, the ASCC places these areas under the command of a logistics C² headquarters. The ASCC may further divide the support areas into smaller areas assigned to a logistics task-organized support element. The ASCC establishes as many logistics headquarters and logistics task organization elements as needed to efficiently support his force in theater. Figure A-5 illustrates this area command structure.

Logistics Command and Control Headquarters

The ASCC must provide total support to all ARFOR in theater. If the ASCC chooses to focus on operations and streamline his span of C², he may establish a deputy commander for support and make him responsible for oversight of the total support mission. Or, he may choose to retain control of the support function and orchestrate it through his deputy chief of staff for support or appropriate coordinating staff office—that is, DCSPER, deputy chief of staff for logistics (DCSLOG), or deputy chief of staff for resource management (DCSRM).

To orchestrate the many supply and service missions, the ASCC establishes a logistics C² headquarters in the COMMZ. It provides reception and operation staging to units located in or passing through the COMMZ. This reception and operation staging includes personnel and administration support, direct support (DS) maintenance, and supply, field services, and local transportation provision.

The logistics C² headquarters provides backup logistical support to corps or other subordinate units and performs general

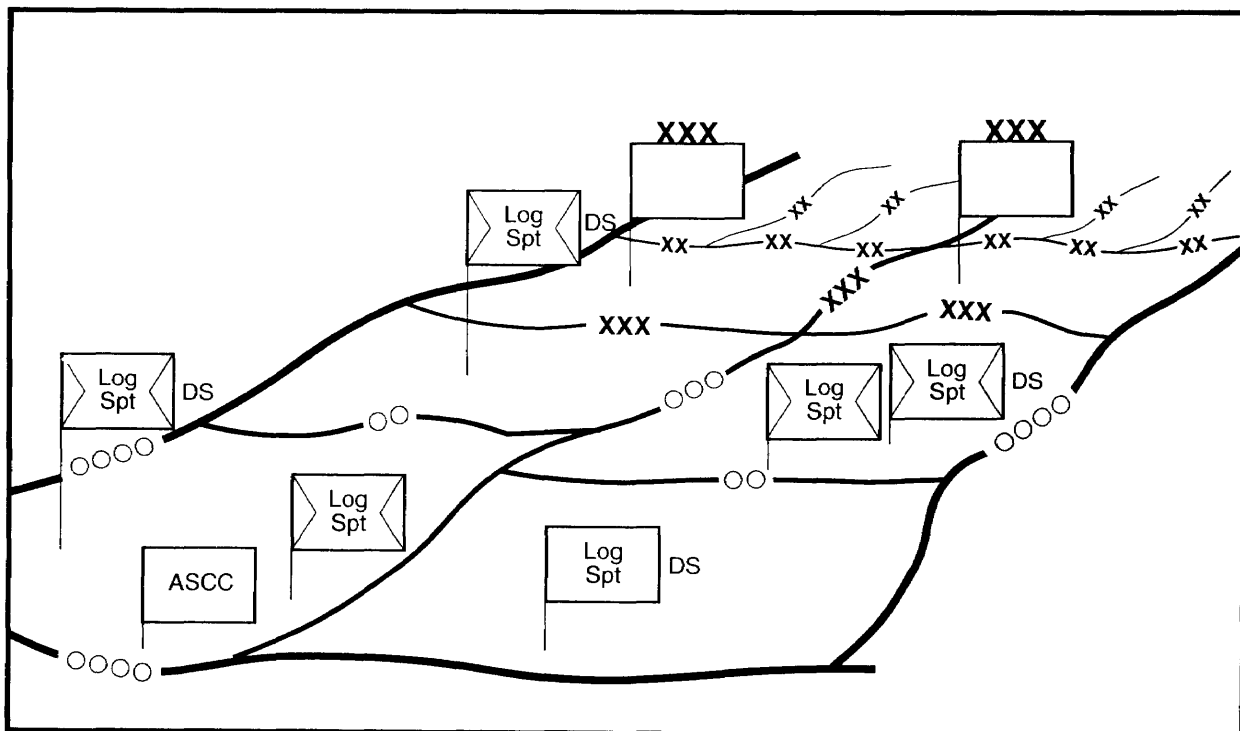

Figure A-4. Support in Intratheater Communications Zone

support (GS) maintenance to support the Joint Theater Logistics System (JTLS) under work load direction of its materiel management center (MMC). The logistics headquarters coordinates area functions, such as traffic circulation and population control, with host nation agencies and MPs and coordinates property maintenance activities with the engineers. This headquarters provides an organization for centralized control of all Army EOD efforts in the theater. This provision allows the ordnance organization commander, with direction from the ASCC's staff, to quickly focus EOD assets to critical locations or operations. FM 9-15 covers EOD structure and operations.

Working with the deputy chief of staff for engineers (DCSENG), the ordnance organization plans and coordinates counterunexploded ordnance operations. Either in the corps or in logistical bases, EOD units can be quickly reassigned to meet any battlefield requirement. When EOD detachments are not readily available, the ASCC may direct engineer units to conduct counterunexploded ordnance operations. Additionally, unit level organizations must train to identify unexploded ordnance (UXO) and perform self-extraction from submunitions and scatterable mines on the battlefield. The ordnance unit (EOD) within the logistics C² headquarters acts as the information flow manager for technical intelligence dealing with

UXOs. It is responsible for channeling this information out of the theater and back down to each detachment.

Additionally, the ASCC, through the logistics C² headquarters, plans and executes rear security operations in the COMMZ. The ASCC may task the logistics headquarters to provide out-of-sector support. Figure A-6 shows a typical logistics C² organization that the ASCC could design to provide the logistics C² functions (less provision for Class VIII and classified maps). The attached organizations are METT-T dependent.

Area Support

The ASCC tailors LSE organization to provide area support based on its subordinate organizations, unit missions, and services required by the forces within the specific AOR. The most common situation requires an element to command and control a mix of DS and GS units, though emphasis is on DS to the units in or passing through its servicing area.

Functions normally provided on an area basis include maintenance, supply and services, and petroleum supply. Strategic logistics organizations (DLA, USAMC), as determined by memorandum of agreement (MOA) or MOU with appropriate commands, also provide support on an area basis. Additionally, medical units provide HSS on an area basis but maintain a separate C² element.

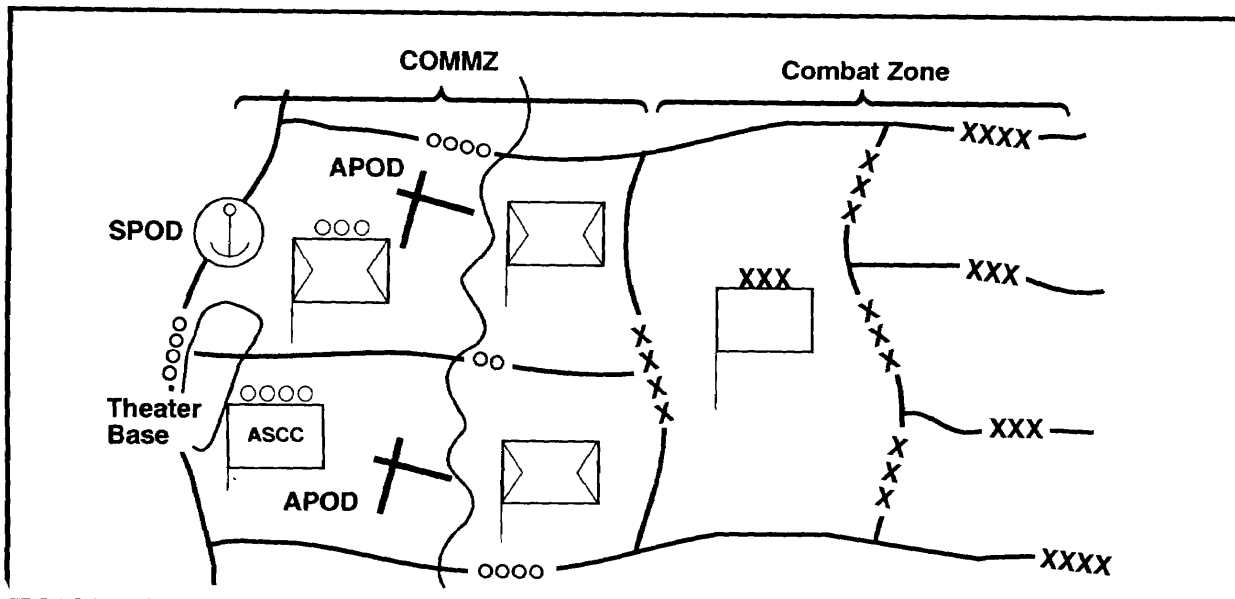

Figure A-5. Communications Zone Area Support Structure

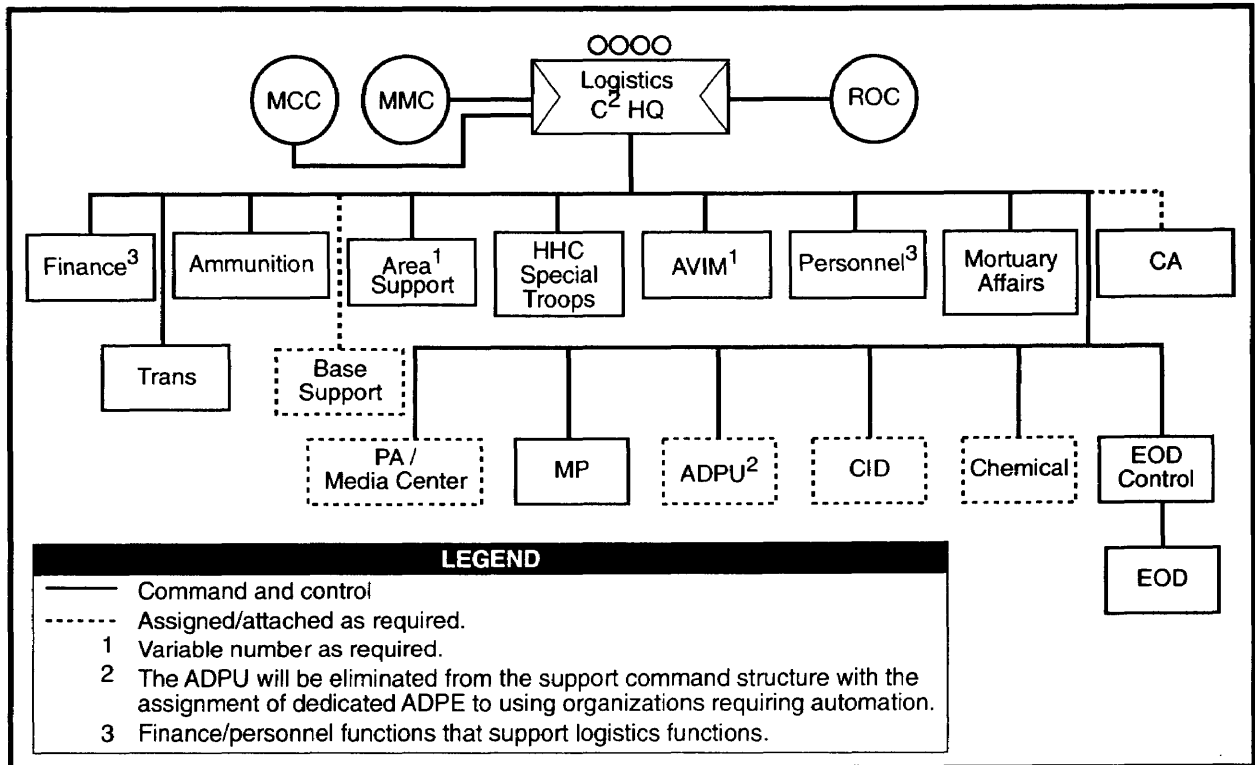

Figure A-6. ASCC Operational-Level Subordinate Logistics Organizations

The C² element may also coordinate and execute rear security operations. An area support C² organization is shown in Figure A-7.

Specific Functions

The ASCC must provide special functions to provide GS in both the COMMZ and CZ. A deputy commander for operations, a deputy commander for logistics, or someone reporting directly to the ASCC may provide the functions to the command. If the theater matures for a long-standing mission with forward-deployed troops, then functional commands, based on METT-T, could be established for the areas of—

- Signal.
- Personnel service support.
- Public affairs and news media.
- Finance.
- Engineer.
- Transportation.
- Combat health service support.
- Air defense.
- Special operations support.

- Civil affairs.
- Aviation support.
- Intelligence structures.
- Petroleum functions.
- Ammunition supply and storage.
- Movement control
- Materiel management

Signal

The ASCC, through his G6, provides information system support to all US Army elements within the theater. The ASCC signal function requires an integrated communication network within the COMMZ, out-of-theater access, and interface with the CZ systems. During the planning phase of any operation, planners must consider initial deployment through a fully mature theater, sustained operations, contingency plans, phased reduction of signal support as units redeploy, and signal support requirements supporting posthostility activities.

The ASCC tailors the organizational-level signal organization to meet his requirements for C⁴ support. This support includes communication, automation, visual

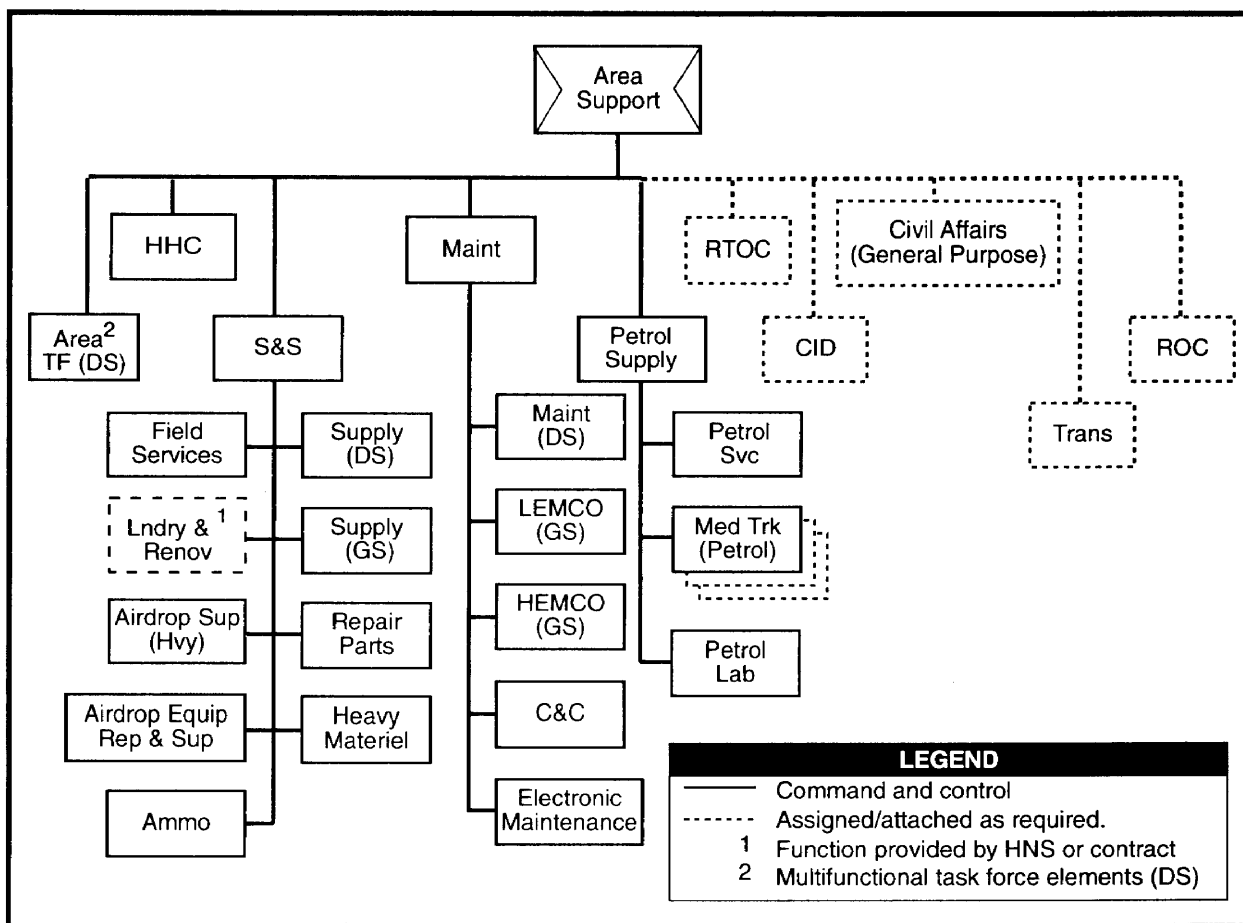

Figure A-7. Operational-Level Logistics Area Support Function

information, printing and publications, and records management. Specific signal capabilities employed from initial entry into the theater to a mature theater are dependent upon the operational environment of the particular theater. The CINC acquires DCS access primarily through TACSAT, DSN, and MILNET/DISNET trunks. The CINC takes maximum advantage of the host nation communication infrastructure. FM 11-45 discusses the operations of operational-level signal organizations and details the information mission area (IMA) support provided by the various organizations. If required, the ASCC may establish an operational-level signal C² organization as depicted in Figure A-8.

To support the force-projection army, operational-level information services mesh seamlessly with those of the sustaining base, which may be located within CONUS or another theater. This connectivity and reach-back capability allows for split-based

operations and is achieved using means such as military or commercial satellite communications, high frequency radios, or commercial fiber optic links. Interoperable gateways provide the means to interface between tactical and strategic systems via DCS entry points. These gateways also provide connectivity with joint and allied forces. The net effect is to allow forces to deploy worldwide without sacrificing their ability to exchange securely and reliably information in theater and with CONUS-base information resources. See Figure A-9.

Personnel Service Support

The ASCC, through the deputy chief of staff for personnel (DCAPER), is responsible for all GS personnel operations. The theater DCSPER manages critical personnel systems and synchronizes personnel network operations throughout the theater. The operational-level personnel C² organization must be flexible and able to adjust to specific

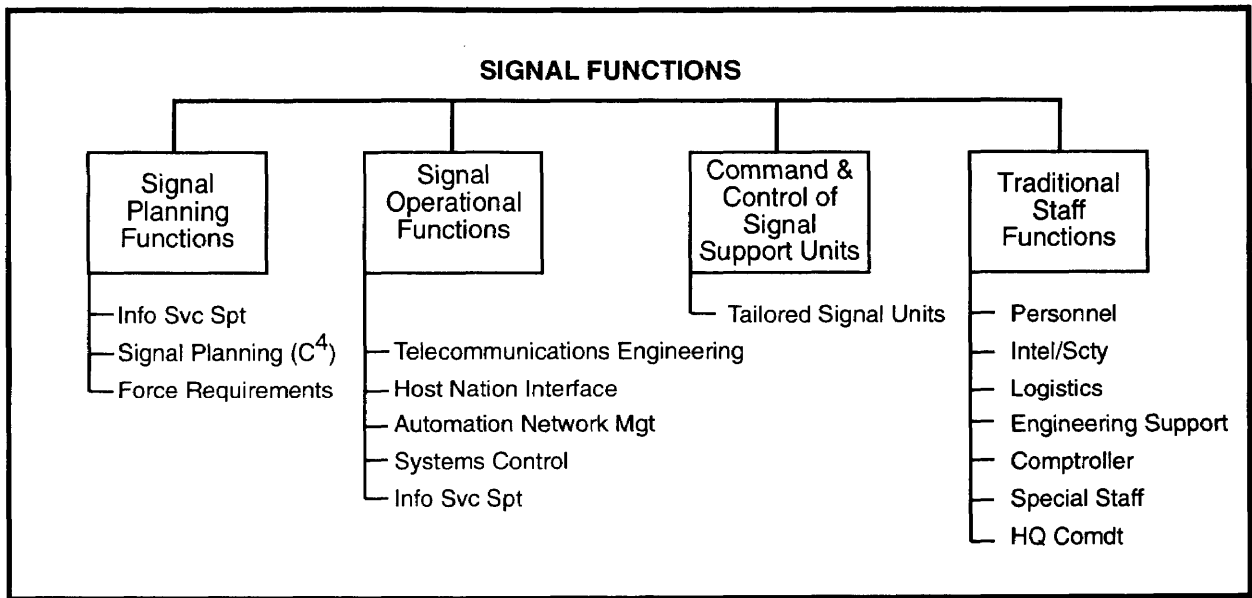

Figure A-8. Operational-Level Signal Functions

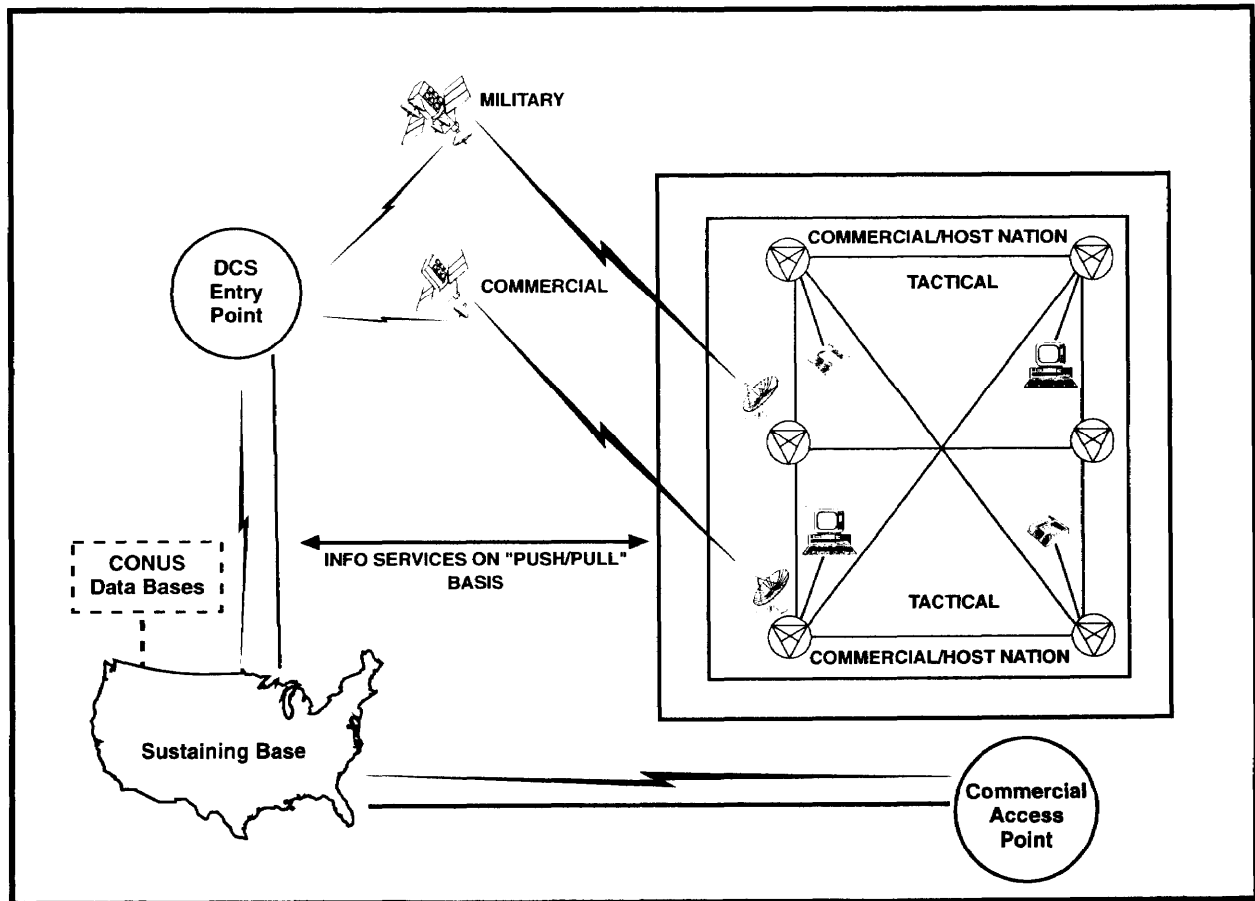

Figure A-9. The Army Information System Network

theater support requirements. The ASCC may initially deploy elements to perform the personnel management function. This element would be comprised of key sections from each functional personnel area and a C² section. Additional elements deploy in follow-on echelons according to conditions dictated by METT-T. Further adjustments take place through changes in subordinate unit number and type.

Operational-level major personnel functions are strength accounting, replacement operations, postal operations, casualty operations, personnel information systems, and personnel readiness. FM 12-6 provides detailed discussions of operational-level personnel functions. An operational-level personnel organization is illustrated at Figure A-10.

When established, the operational-level personnel functional command organization is under the staff supervision of the theater DCSPER. In fulfilling its responsibilities to synchronize the tactical functions of manning and the personnel services the personnel organization exercises C² and provides technical guidance on personnel management to the subordinate personnel organizations.

The personnel organization can task-organize a functional area staff element. This element sustains personnel readiness, directs theaterwide personnel systems, synchronizes personnel network operations, directs GS postal

and replacement activities, and manages essential personnel services. When established, the element draws personnel from personnel operations and replacement, postal, and personnel service areas within the personnel C² organization. HQDA, US Total Army Personnel Command (USTAPERSCOM), DCSPER, provides a civilian support cell, which does not include the C² elements.

The operational-level personnel organization uses the theater communications network to transmit reports and statistics in theater and to CONUS. It must have access to voice and digital communications capabilities with USTAPERSCOM to exchange information and data on personnel strengths, casualty operations, and replacement operations. The information exchange priority between these organizations demands direct, real-time electronic communication, both voice and digital. The personnel community must also maintain close coordination with medical, mortuary affairs, provost marshal, and other communities that provide replacements (such as hospital or straggler returnees) or casualty information. The total theater personnel community, comprised of personnel units and personnel staff elements, including the theater DCSPER and the G1-S1 staffs, is responsible for the support of personnel operations. Its primary mission at the operational level is to sustain theater personnel strength and manage theater personnel support systems. As such, it enhances soldier combat capability

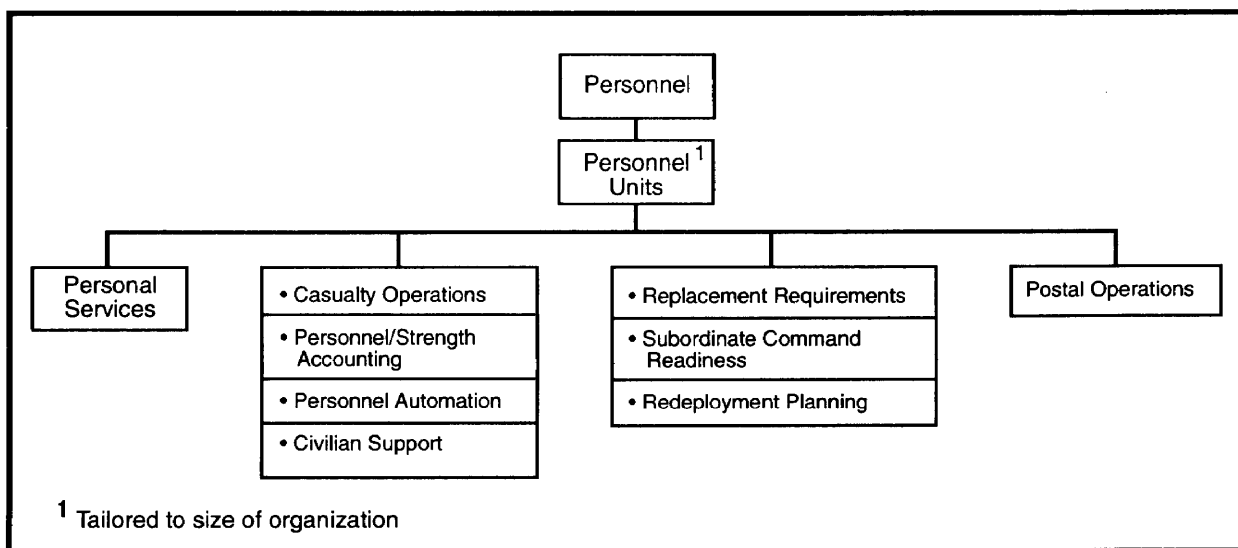

Figure A-10. Operational-Level Personnel Function

Appendix A

through a full range of sustainment activities and thereby increases combat power. The theater personnel community must perform the following functions:

- Report total Army theater strength to Army PERSCOM and HQDA.
- Integrate all personnel support activities within the theater.
- Establish general theater-unique personnel policies and manage services to soldiers, civilians, and joint or allied personnel.
- Assist the ASCC in evaluating and influencing the theater command climate.
- Direct morale, welfare, and recreation activities; alcohol and drug abuse prevention and control; equal opportunity; and safety programs.
- Prepare the personnel estimate.
- Recommend theater replacement priorities to the DCSPER HQDA.
- Prepare personnel service support plans and orders to support the theater campaign plan and its branches and sequels and ensure subordinate plans support the commander's desired end state.
- Direct GS activities within the postal and replacement management systems.
- Track the force, project replacement needs, and ensure subordinate unit personnel plans support branches and sequels of the campaign plan.
- Prepare to function as the J1, if designated by the theater CINC and augmented by additional joint personnel.

Whether committed to MOOTW or war, personnel service support organizations are tailored to satisfy the operational requirement of the theater independently or with allied forces. To ensure unity of effort, joint personnel services require formal agreements, MOUs, and exchanges of liaison officers.

Public Affairs and News Media

A key factor that must be considered at the strategic, operational, and tactical levels is the presence of national and international media representatives and the effects of global visibility on the planning and execution of operations. Leaders must understand that the perception of an operation can be as important

to success as the actual execution of the operation. Leaders must recognize that the global visibility of today's media is bridging the gap between the strategic and tactical levels, so that a tactical victory can be an operational or strategic loss and vice versa. The media's ability to provide detailed, graphic, and live coverage of events from anywhere in the world has made military operations into spectator events watched in real time by the American public, allies, and adversaries. This allows media personalities, politicians, pundits, critics, and academics to become active participants in the debate about the way the operation is being executed.

Also, the American people have a right to know about Army operations. More importantly, the Army has a vital interest in ensuring an expedited flow of complete, accurate, and timely information about Army operations. Doing so fulfills the Army's obligation to keep the American people informed. It also helps to establish the conditions that lead to confidence in America's Army and its conduct of operations in peacetime, conflict, and war. When soldiers, their families, the nation's political leaders, and the general public perceive that the Army is conducting operations competently, professionally, and ethically, the morale, esprit, and effectiveness of the Army force is enhanced. This is critical to successful mission accomplishment.

The key to achieving an expedited flow of complete, accurate, and timely information about Army operations is the integration of PA estimates and recommendations into the planning and decision-making process. PA elements must assess internal and external information needs and expectations and analyze what is being published by the media. They must develop strategies that support open and independent reporting. They must ensure that their strategies are synchronized with the PA guidance of higher headquarters. They need to carefully coordinate their effort with related information communication functions, such as combat camera, as well as CA and PSYOP. PA success comes from open, honest, proactive information communication. PA personnel serve as the interface between the military and the media. They work to communicate the Army perspective and to ensure that reporting is fair and balanced. They try to educate media representatives on the military and the operation, and they

Finance

prepare military personnel to interact with the media. Although the commander and the PAO are the organization's official spokespersons, all soldiers are potential spokespersons. The media often perceive junior soldiers as especially candid, honest, insightful, credible. PA personnel play a key role in facilitating media-soldier interaction.

Besides serving as the interface between the military and the media, PA supports the commander's program to ensure that the information needs of soldiers and their families are met. PA personnel develop a strategy based upon the critical information soldiers and their families need to understand the operation and the mission and the information they need to maintain their morale and esprit. This strategy identifies the product requirements for communicating information within the theater and between the theater and home station. It synchronizes commercial contract services and Army production capabilities to most effectively and efficiently provide those products.

The ASCC provides finance support to the force through his operational-level finance unit commander, who also serves as the staff finance officer. Separately, the DCSRSM provides the operational-level resource management support to the ASCC. The operational-level finance function is to sustain Army, joint, and multinational operations by providing timely commercial vendor and contractor payments, various pay and disbursing services, and essential accounting. Military pay, travel, and disbursing are missions that impact morale support and, as such, provide an additional combat multiplier. If established, the operational-level finance organization provides finance support to all joint and multinational commands, as ordered, and provides policy and technical guidance to finance units. FM 14-7 covers finance activities. A possible operational-level finance function is shown in Figure A-11.

The finance function includes centralized theater support missions such as currency funding, commercial accounts, foreign national

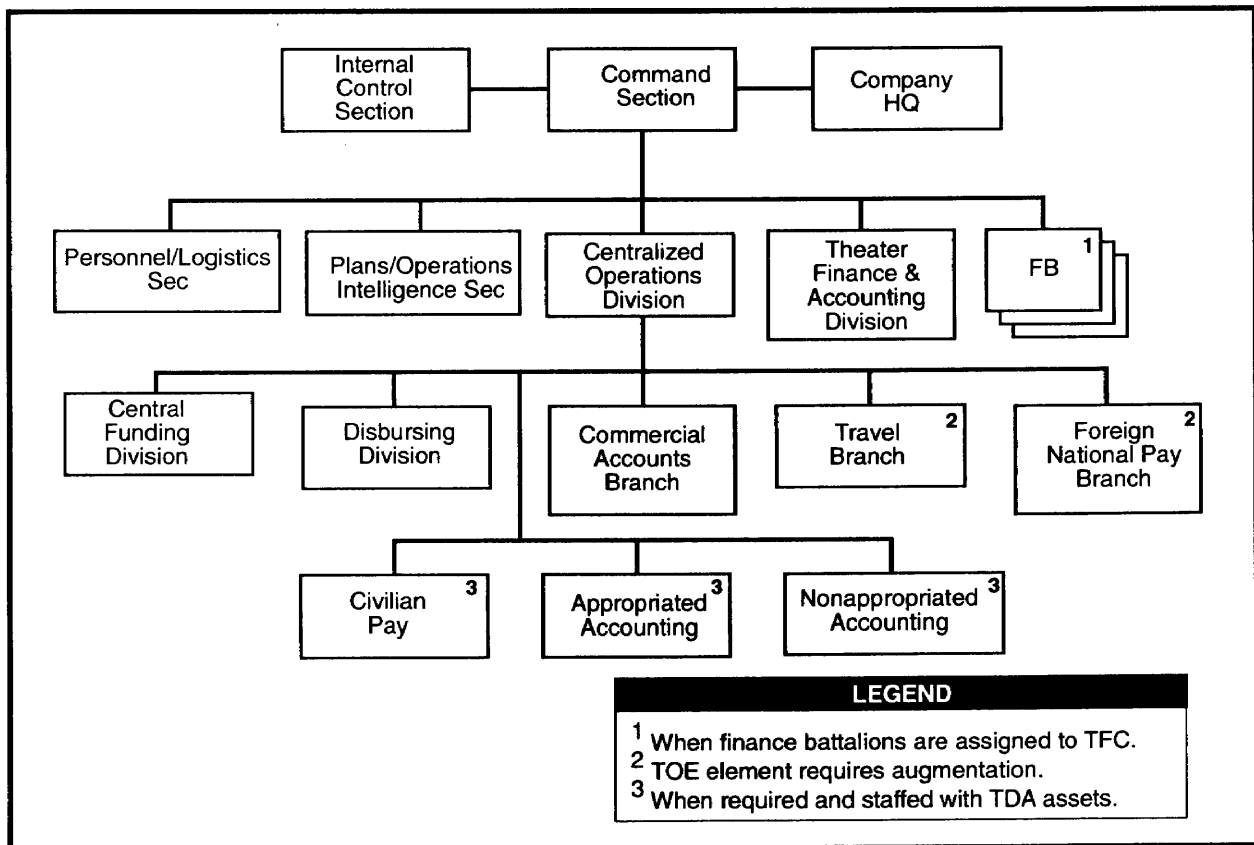

Figure A-11. Operational-Level Finance Function

Appendix A

pay, and appropriated and nonappropriated fund accounting. When designated by DOD, it also provides currency funding support to other US and allied organizations in the theater. The operational-level finance command—

- Establishes theater financial policy to ensure consistent application of DOD finance and accounting policy.
- Coordinates finance support requirements within the theater.
- Recommends allocations of finance units in theater.
- Reviews theater operations plans and prepare annexes to ensure proper support of operations.
- Coordinates HNS for finance and accounting requirements.
- Supports NEO.
- Performs/coordinates logistical, operational, and administrative actions for assigned finance units.
- Ensures operational readiness of assigned finance units.

Finance units provide the full range of finance and accounting services to all soldiers and units in the theater. These units formulate command financial policy, establish finance procedures, and provide finance support for the AOR within the theater, to include—

- Preparing and paying commercial vouchers.
- Cashing negotiable instruments.
- Preparing and paying foreign national payrolls.
- Funding tactical exchange facilities and other nonappropriated fund instrumentalities (NAFIs).
- Preparing and paying travel vouchers.
- Accounting for pay to EPWs and civilian internees.
- Providing currencies for local procurement payments, foreign national payrolls, imprest funds, combat payments, day laborer payments, intelligence and counterintelligence operations, and claims.

During operations, the level of formal accounting services that finance elements perform in the theater depends on the intensity, duration, and location of the

operation. Following coordination by the CINC or CJTF with the Assistant Secretary of the Army for Financial Management (ASA-FM), the ASCC may approve the transfer of accounting functions to a designated finance support activity (DFSA) in CONUS. The finance element continues to ensure that necessary documentation and data are provided to the DFSA to accomplish the accounting function. The ASCC establishes the amounts of monthly cash payments made to individual soldiers. Finance support teams (FSTs) pay soldiers when and where their commanders desire. FSTs are able to make contract payments, commercial vendor payments, and combat payments and process pay inquiries.

Engineer

The ASCC tailors the engineer structure to the theater requirements with the staff advice from his DCSENG. The operational-level engineer commander provides C² and a central organizational framework for the engineer effort. Engineer forces outside corps focus on reinforcing and augmenting corps engineer efforts, developing the theater support base, and maintaining an infrastructure for sustainment. This focus involves—

- Planning.
- Ensuring operational mobility.
- Coordinating all theater engineer assets.
- Providing direction of construction, real property maintenance activities, LOC sustainment, rear area damage control, engineer logistics management, and base development.

The ASCC tailors the engineer structure to his theater requirements. Engineers must be closely tied into current and future operations. Engineer units provide versatility to the operational commander. All engineer units (combat, construction, or topographic) focus on operations in the CZ. In addition, they support the theater by providing general engineering support at the operational level. The engineer's operational-level topography unit and a variety of specialized engineer teams support or augment engineer forces throughout the theater. Combat heavy engineers weight the main effort and provide sea, air, and land operational and strategic mobility. A typical operational-level engineer C² organization is shown in Figure A-12. FM 5-116 discusses the operational-level engineer function.

Theater construction management often spans multiservice requirements. The CINC may direct the establishment of a regional contingency engineering manager (RCEM) to control all theater-level engineering. The operational-level engineer commander can perform this role if the CINC designates the ASCC as the RCEM and the ASCC designates the operational-level engineer commander as his agent. To support force-projection requirements for early deploying engineer units, an engineer element may deploy by sections to meet highly variable work loads and situations. The US Army Corps of Engineers (USACE) may establish field offices that specialize in contract construction, real property management, and host nation construction support.

Transportation

The ASCC provides theaterwide transportation support. This operational-level transportation function includes mode

operations that involve inland waterways, rail, motor, and air and terminal services, to include water, beach, air, motor transport, and rail. The operational-level transportation units move personnel, mail, and materiel, except bulk fuel, from point of arrival in theater to the CZ. The operational-level transportation units must coordinate with the MCA and interact with joint and allied transportation managers. The transportation function requires flexible organizations that the ASCC configures to meet theater needs. FM 55-1 discusses the operational-level transportation function. A typical operational-level transportation organization is shown in Figure A-13.

Combat Health Support

In the theater, CHS encompasses ten functional areas to meet the needs of the service member. These functional areas are—

- Patient evacuation and medical regulation.
- Hospitalization.

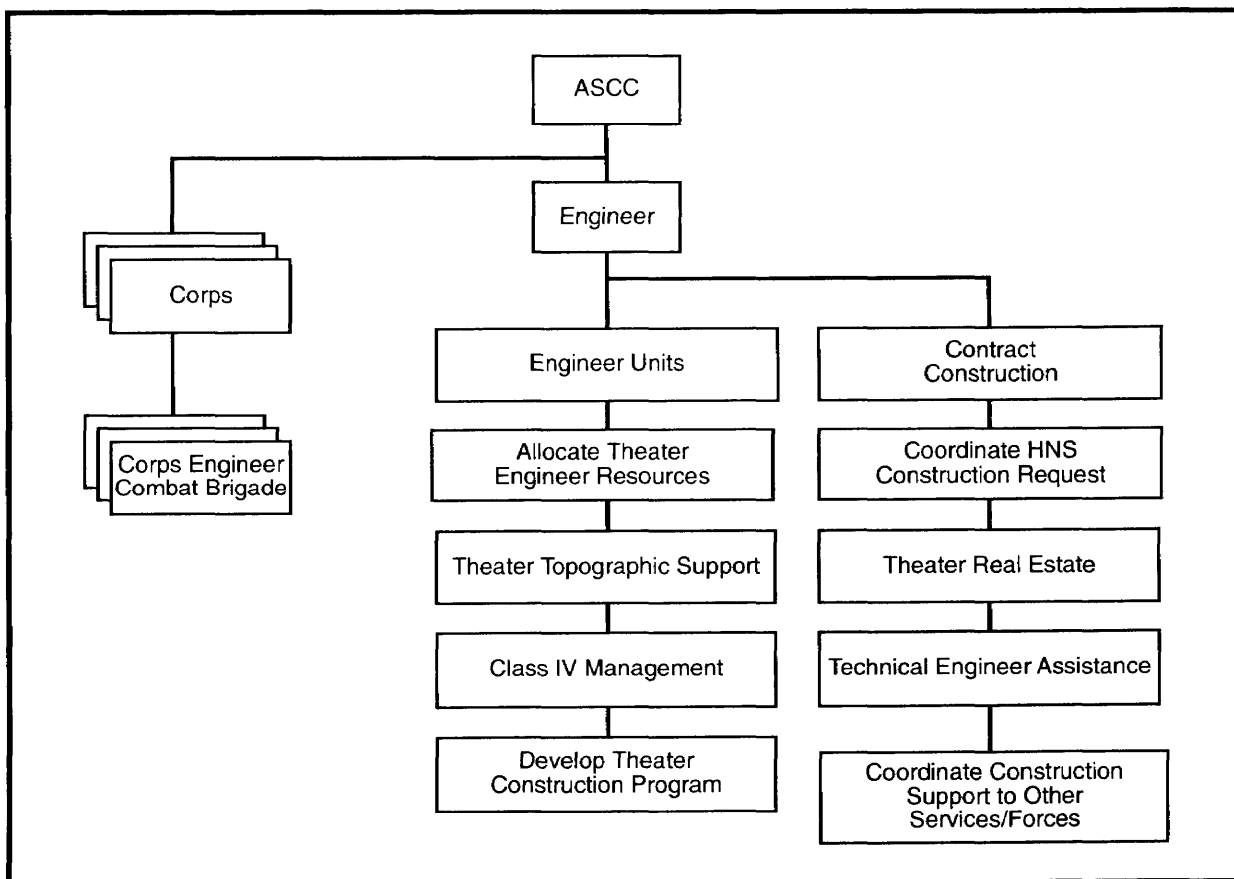

Figure A-12. Operational-Level General Engineer Function

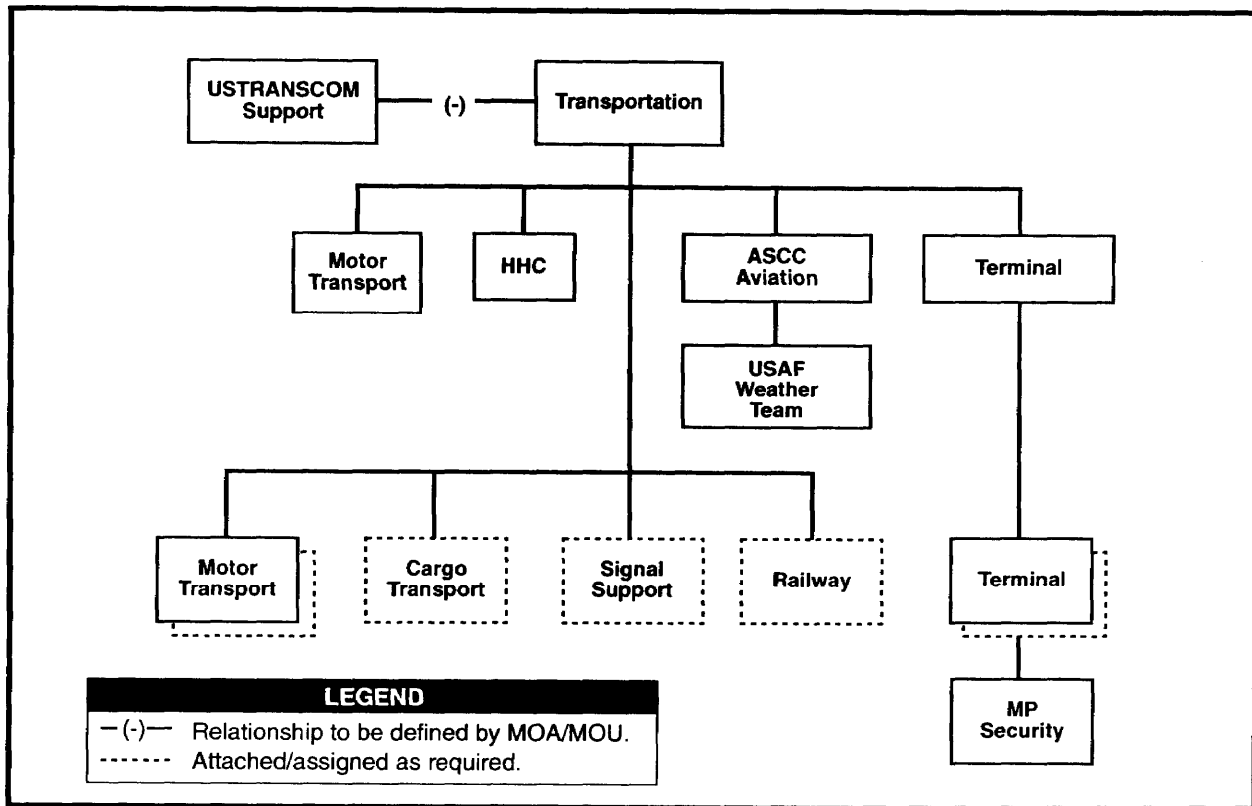

Figure A-13. Operational-Level Transportation Function

- Health service logistics/blood management.
- Dental services.
- Combat stress control services.
- Preventive medicine services.
- Veterinary services.
- Area medical support
- C⁴I.
- Medical laboratory services.

The senior command surgeon and CHS C⁴I organization in theater provide centralized C² of all Army medical department (AMEDD) units assigned to the ASCC and located in the COMMZ. The operational-level army medical force structure under the CHS C⁴I organization provides support to both forward-deployed and nonforward-deployed ARFOR. This C² organization provides the capability and flexibility to shift assets to support additional numbered army or corps buildups, to reallocate medical assets to accommodate patient work loads, and to reconstitute tactical-level CHS units.

Since all CHS units in the COMMZ are under the senior CHS C⁴I organization, units without organic CHS receive CHS on an area basis. This is the most efficient and economical way to provide support to all COMMZ units. The senior CHS unit commander located within the geographical boundaries of a major unit normally provides CHS staff advice to the unit commander. The senior CHS C⁴I commander and ASCC develop standing operating procedures to govern the relationship between each unit commander and the senior CHS unit commander in his area. CHS units are not subordinate to the logistics area support units but do provide CHS on an area basis.

The senior CHS C⁴I organization provides advice on CHS matters to adjacent and subordinate commanders. When directed by the ASCC, the CHS commander may provide CHS to other US and allied forces. FM 8-10 discusses the operational-level CHS function. A typical CHS C⁴I functional structure is displayed in Figure A-14.

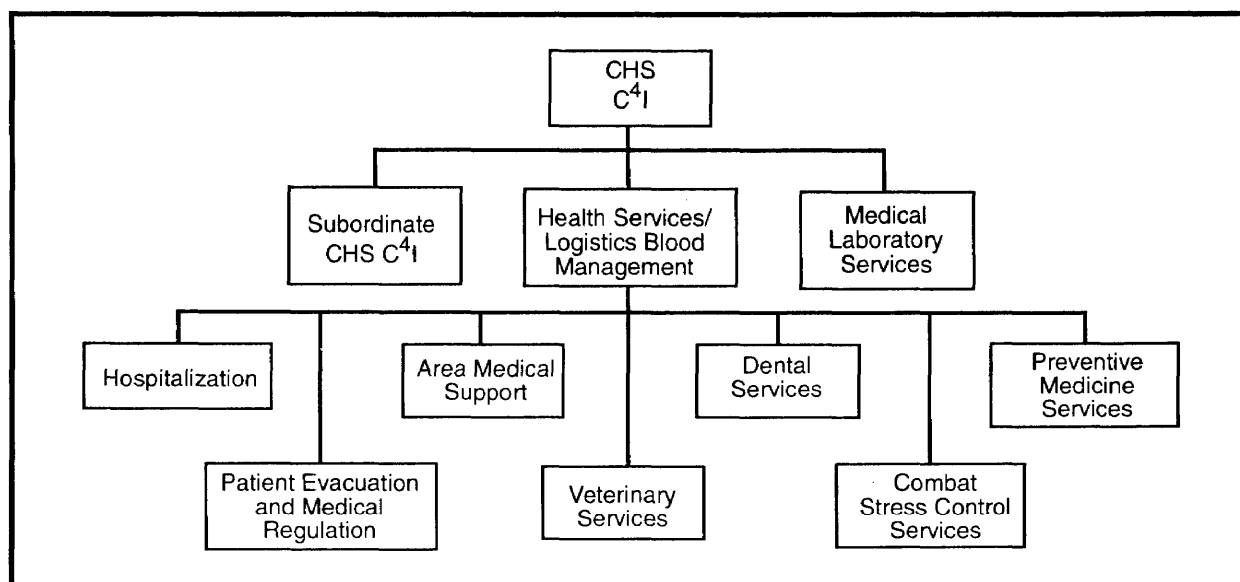

Figure A-14. Operational-Level Combat Health Support Function

Air Defense

The Army air defense function is required for each theater. Air defense organizations provide the Army's contribution to theater air and missile defense in joint and multinational operations. The air defense commander ensures that—

- Army air defense is integrated into joint and multinational counterair and TMD operations and plans.
- Theater force projection, protection, and sustainment requirements are achieved.
- The air defense mission is to—
- Execute and coordinate integrated theater air and missile defense operations throughout the theater of operations.
- Provide theater air and missile defense expertise for campaign planning to the joint land, sea, and air component commanders.
- Recommend air and missile defense priorities for protection of the force and geopolitical assets, to include force allocation.
- Execute active and passive air and missile defense measures to deny enemy surveillance.
- Centralize command (less engagement control) of all operational-level air defense organizations through all phases of force projection in peacetime, conflict, or war.

All air defense operations are joint. FM 44-100 discusses the operational-level Army air defense function. The relationships of air defense in a theater are shown in Figure A-15.

The senior Army air defense commander is the operational-level ADA commander and the Army ADA coordinator (ADCOORD) to the ASCC and JFACC (see Figure A-16). The senior Army air defense commander provides the majority of Army rear area (theater air defense) DCA and active missile defense forces. He is the theater ADA integrator, which ensures that Army air defense elements provide optimum force and geopolitical asset protection throughout the theater. He integrates corps air defense brigade requirements during counterair planning and assists in developing Army OCA and DCA input to the air campaign plan.

The operational-level air defense unit commander performs the following functions:

- Plans theater air and missile defense force projection and sustainment operations.
- Integrates the air defense communications systems with the AADC and operational-level ADA brigades, corps, AOC (BCE), control and reporting center (CRC), and AWACS (airborne warning and control system).
- Coordinates the theater air and missile defense linkages with the ACC, NCC, and

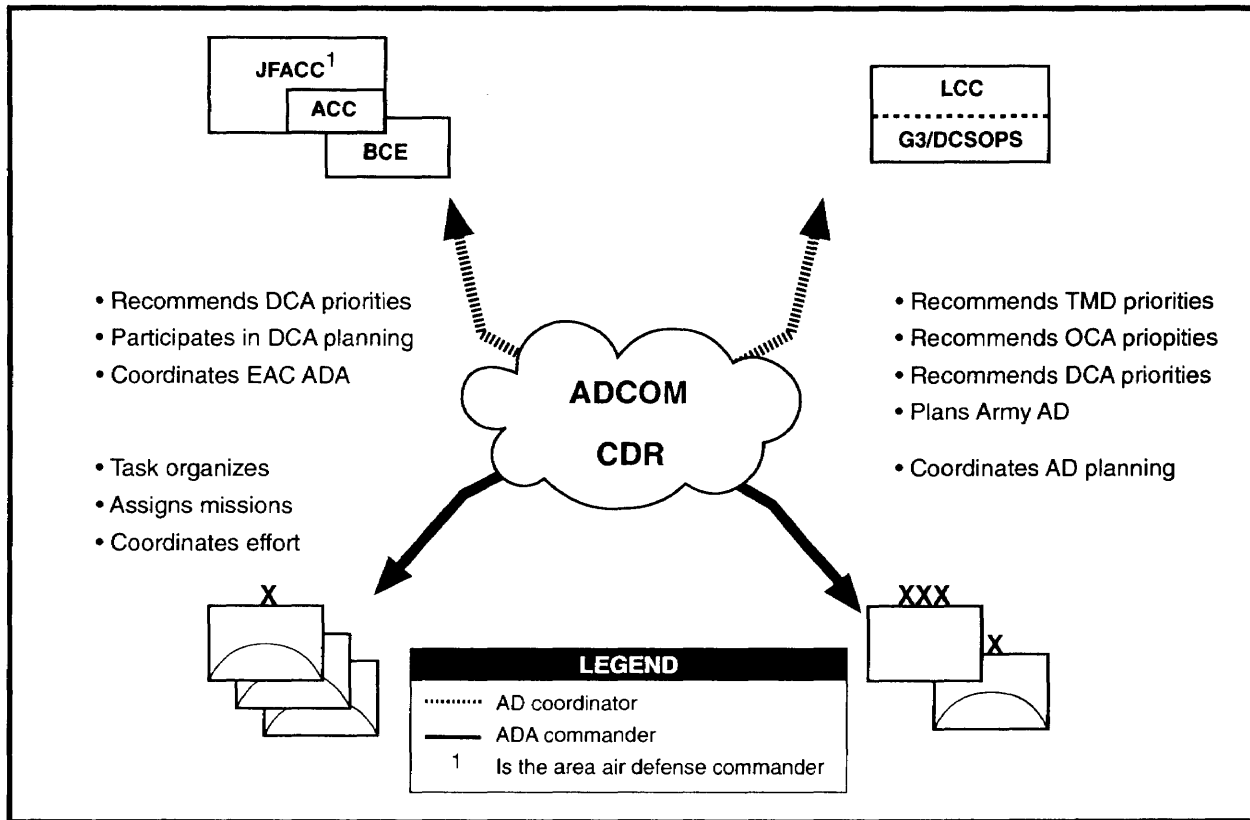

Figure A-15. Relationships of Air Defense in a Theater.

allied ADA forces. These linkages include interface with intelligence sources, OCA, TMD attack operations, space operations, logistics, and so forth.

- Trains and evaluates all Army ADA organizations assigned to operational-level air defense C² according to FM 25-100.
- Transitions all Army ADA organizations assigned to the theater from peacetime, to conflict, to war.
- Recommends priorities for allocation of logistics requirements (manning, arming, fixing/maintaining, moving, fueling, and sustainment of the soldier) for all ADA organizations within the theater.
- Identifies and recommends pre-positioning of war reserve materiel stocks related to air defense missions.

Special Operations Support

Each regional CINC establishes a subordinate unified special operations command (SOC) to exercise OPCON of theater-

level SOF. These SOF normally fight as joint entities. The ASCC, in his service component role, must sustain ARSOF in theater. The ASCC, in coordination with the US Army Special Operations Command (USASOC), identifies the support organization to serve as the link between ARSOF in theater, Army and other service support resources, and the CONUS-based USASOC. This support structure is responsible for planning, coordinating, and monitoring the reception, onward movement, basing, and sustainment of ARSOF in a theater of operations. Note that CA and PSYOP units not assigned to the SOC/ JSOTF (joint special operations task force) receive sustainment from the conventional force unit of assignment or attachment.

The SOF support element does not normally support and sustain ARSOF since it has no dedicated support infrastructure that duplicates the capabilities of other ASCC functions. The ARSOF support element mission is ARSOF sustainment, not the conduct of special operations and therefore does not layer itself as a warfighting headquarters between operating forces and

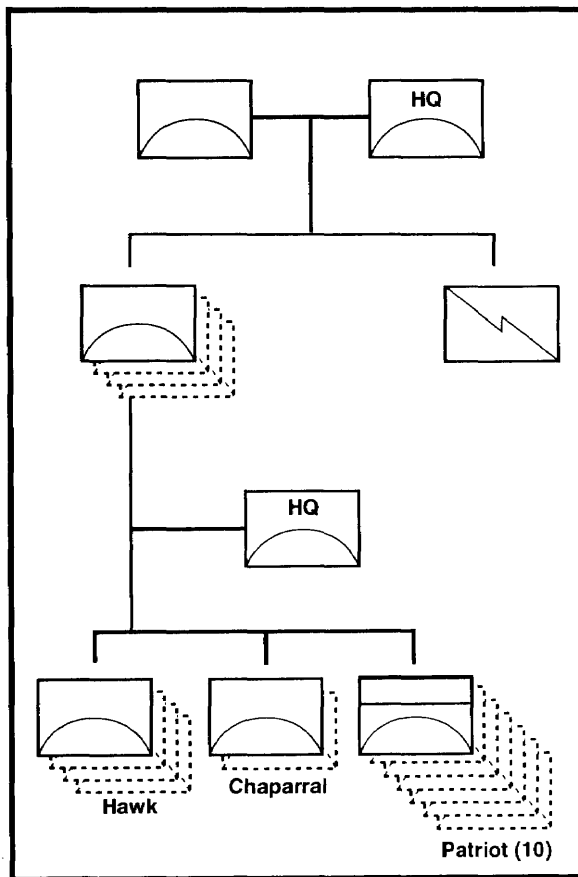

Figure A-16. The Air Defense Function

other higher commands. FM 100-25 discusses ARSOF in detail.

Civil Affairs

The senior CA unit in a theater is normally regionally aligned to the ASCC. A CA organization commands attached CA units and provides staff support to an SOC, other component services, and the joint theater staff, as required. The CA organization has organic language team and government economic public facilities in special function teams that coordinate the following CA functions:

- Civil defense.
- Civilian labor.
- Legal services.
- Public administration, education, finance, health, safety, and welfare.
- Civilian supply.
- Economics and food aid.

- Agricultural assistance.
- Property control.
- Public communications and transportation.
- Public works and utilities.
- Civil information.
- Dislocated civilian control.
- Arts, monuments, archives, and cultural affairs.

FM 41-10 describes CA doctrine. The CA function is illustrated in Figure A-17.

Aviation Support

Operational-level army aviation support, normally an aviation brigade, provides C and air movement support for the ASCC. SOF rely heavily on this brigade for in-theater support. The brigade has the capability to conduct joint or multinational air maneuver to support theater campaigns and major operations. Aviation support provides combat capabilities to assist in COMMZ rear security operations.

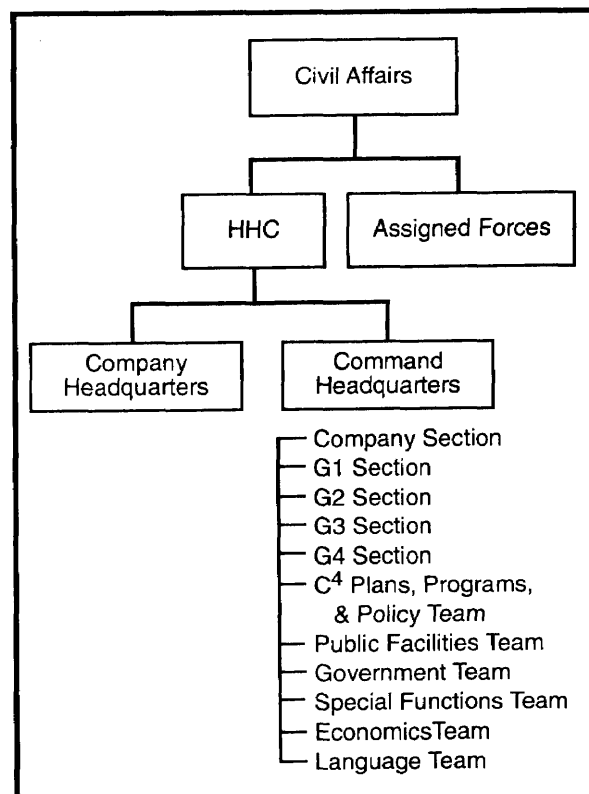

Figure A-17. Operational-Level Civil Affairs Function

The ASCC tailors the aviation support to provide maximum flexibility for his particular theater. However, support normally has a limited organic maintenance capability.

In instances where the ASCC does not have an assigned aviation unit, he may choose to establish that capability using resources and assets available in theater. Once mobilized, Army National Guard maintenance units can be used to provide the required maintenance capability that would not otherwise be available. FM 1-111 provides detailed doctrine for the operational-level army aviation function. Figure A-18 illustrates the operational-level army aviation function.

Intelligence Structures

The intelligence battlefield operating system architecture provides specific intelligence and communications structures at each echelon, from the national level through the tactical level. These structures include intelligence organizations, systems, and procedures for collecting, analyzing, processing, and delivering intelligence to warfighters.

The intelligence function is a seamless, unified system that anticipates and satisfies the intelligence needs of commanders. Commanders drive intelligence and ensure its proper employment by clearly articulating intent, decisively designating PIR, and boldly prioritizing the types of targets they want engaged. Commanders exploiting the full potential of the intelligence system realize the total effect of this combat multiplier.

The intelligence system simultaneously supports multiple commanders at multiple echelons. Each echelon has organic intelligence capabilities and staffs to meet the planning and

execution needs of the commander at that echelon. Each echelon also supports the intelligence needs of commanders at other echelons.

Organizational Tailoring. The IEW organization at the operational level is a deployable, scalable MI organization designed specifically to support the theater or major region in which it operates. It can conduct split-based operations in force-projection missions by early deployment with a force of small, highly technical elements. The DISE is a flexible, scalable support package that acts as a conduit for theater and national intelligence. Its size and capability can be expanded as the scope of operations expands. The operational-level MI organization serves as a C² headquarters for subordinate and attached MI elements. The operational-level analysis and control element (ACE) is the principal organization for producing all-source intelligence. It controls, manages, tasks, processes, analyzes, synthesizes, and disseminates intelligence. The ACE supports OPSEC and deception, sensor cueing, target development, situation development, and force projection. It also coordinates with and provides connectivity to national, joint, allied, and multinational intelligence sources.

The operational-level MI organization supports unified, joint, allied, and multinational commands; other US Army operational-level commands within the theater; and CONUS major Army commands (MACOMs). Operational-level MI organizations are under the command of the US Army Intelligence and Security Command (INSCOM) and are under OPCON of the respective theater commander during peacetime. During conflict, they revert to the

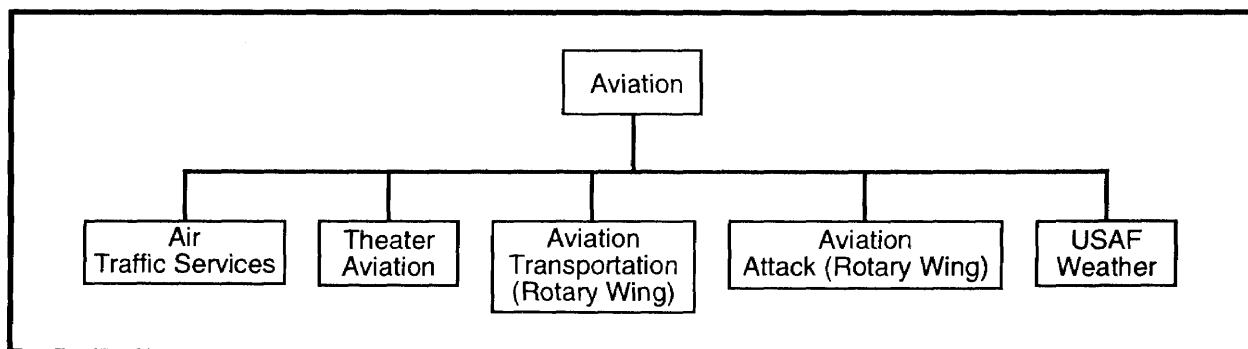

Figure A-18. Operational-Level Army Aviation Function

command of the ASCC. FM 34-37 discusses the operational-level MI organization in detail. Figure A-19 shows an operational-level MI organization.

The Army technical control and analysis element (TCAE) serves as the single focal point between the NSA and forward-deployed operational- and tactical-level forces for providing technical support to SIGINT operations. Collocated with the NSA, the TCAE is positioned uniquely to provide tailored products to support operational- and tactical-level MI units operating worldwide. It also serves as the Trojan system and network manager for all Army Trojan system users.

The DISE is a new and integral part of the concept for MI support to force-projection operations. It is a tactically tailored organization that brings together communications capabilities, automated intelligence fusion systems, and broadcast downlinks in a small package able to deploy with the early entry forces of a force-projection operation. It is not a specific piece of equipment or a particular configuration of equipment. The DISE is a flexible organization able to support any type of ground force whether from army, joint, or allied/coalition forces. Through split-based operations, the DISE provides tactical commanders a link from their forward-based C² element to an intelligence support base

located in CONUS or outside the AO. This link provides commanders access to multisource corps, theater, and national intelligence assets and data bases. The intelligence support base is normally a division, corps, or operational-level ACE.

The mission of the DISE is to provide the deployed commander accurate, detailed, continuous, and timely intelligence during the rapid introduction of US forces across the range of military operations. It is tailored tactically from MI units according to the factors of METT-T, lift, and pre-positioned assets. The two types of tailorable DISE configurations are mini-DISE (manpack) and DISE (vehicular).

Basic tactics and techniques call for the DISE to deploy with the initial assault forces. The DISE works closely with the organic intelligence element of the supported unit. This unit could be anything from an airborne battalion S2 to the G2 of a MEF, depending on the operation. The DISE works with the supported force during both planning and execution of operations to ensure corps, theater, and national intelligence is synchronized with the ground commander's scheme of maneuver and intent. The supporting ACE stays abreast of changes in the friendly situation through close coordination with the DISE. Together, they ensure assets stay focused on the needs of the commander

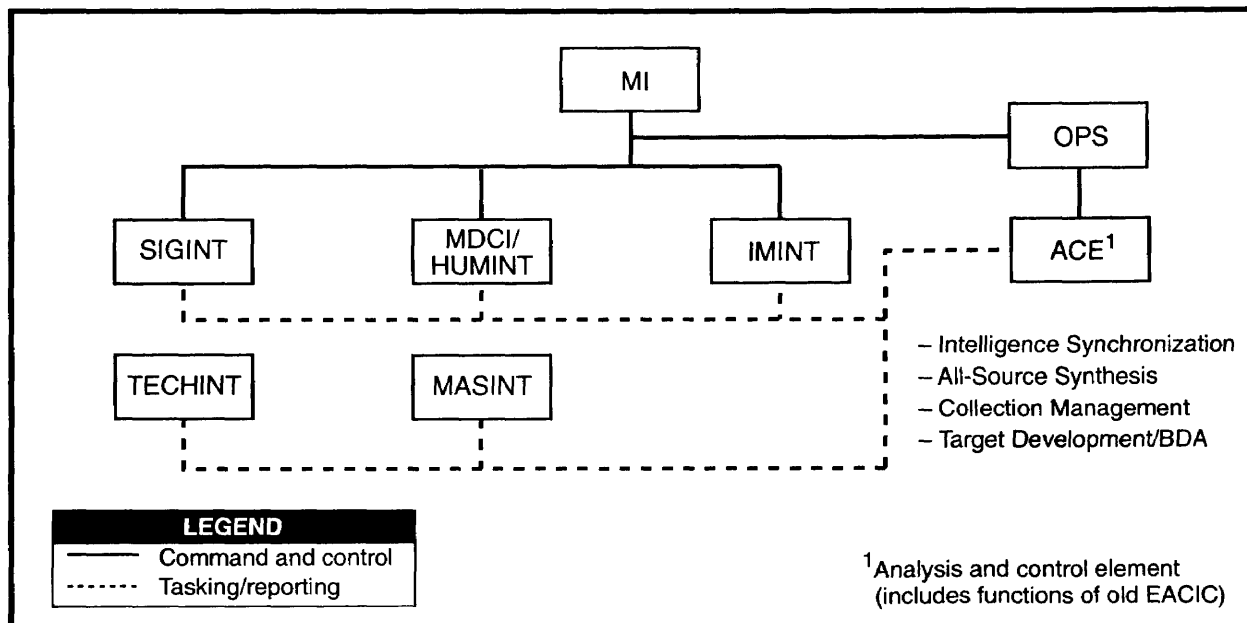

Figure A-19. Operational-Level Army Military Intelligence Organization

and allow the commander and his staff to *pull intelligence* based on actual need.

Depending on the size of the deployed force, the DISE may be the only intelligence asset actually deployed in country receiving processed intelligence from its supporting ACE located outside the AO. In large-scale deployments, the DISE is deployed with the forward-deployed assault element until the main or tactical CP arrives with the complete processing capability of the all-source analysis system (ASAS) and the ACE. In that case, after the main CP arrives and is functioning, the DISE could move forward to support the tactical CP, remain in the rear area, or move wherever its capability is required, based on METT-T.

Intelligence Tasks. MI accomplishes its mission through six primary tasks. These tasks generate intelligence products tailored to the mission for warfighters and other consumers. The products derived assist the combat commander in focusing and leveraging his combat power. The six tasks can be thought of as the METL for intelligence. As such, in a broad sense, these tasks should serve as a framework for training (see TRADOC Pam 11-9). The six intelligence tasks provide information to aid a commander in decision making and include—

- Providing I&W.
- Performing IPB.
- Developing the situation.
- Supporting target development and targeting.
- Developing force protection intelligence.
- Performing BDA.

The operational-level MI organization focuses on providing multidiscipline IEW support to the JTF, ASCC, and ARFOR (see Figure A-20). Army operational-level MI organizations provide—

- Deployable, scalable, high-frequency, intercept, direction-finding, and jamming support (Trackwolf, AN/TLQ-17A Sandcrab, Army High-Frequency Electronic Warfare System [AHFEWS], and single-source processor [SIGINT]).
- Overt HUMINT collection, interrogation, document exploitation, and CI support.
- Battlefield technical intelligence.

- Operational intelligence products such as graphic templates, annotated imagery, and tailored weather forecasts.
- Ground component intelligence support to the JICs.
- Reinforcement to corps intelligence operations in the form of a corps military intelligence support element (CMISE). The CMISE and operational-level MI organization in each theater create *smart* bridges between echelons to ensure a truly seamless system of intelligence systems focused on supporting the warfighter.

Petroleum

The ASCC must provide centralized distribution of bulk petroleum products for all US forces in theater. The ASCC establishes an operational-level army petroleum organization to receive petroleum products in theater and distribute them throughout the COMMZ and rear of the CZ. If the theater uses pipeline systems for bulk distribution, other transportation assets distribute the products from the pipeline terminal to the user. The operational-level petroleum organization interfaces with the MMC for product distribution and coordinates with host nations for additional product and distribution support. FM 10-67 details the operational-level petroleum function. Figure A-21.

Ammunition Supply and Storage

The ASCC is responsible for in-theater receipt, accountability, management, and establishment of storage sites; coordination of distribution between storage sites and between storage sites and forward transfer points; and direct issue to using units from storage sites on an area support basis. This responsibility will most likely be a joint service/multinational forces mission in the theater of operation.

The operational-level ammunition organization interfaces with the MMC for Class V distribution, coordination with joint service and multinational force support, and requirements determination. The ASCC's responsibility continues throughout the conduct of operations in the theater, with emphasis directed to the critical Class V functions of retrograde, management of captured and recovered ammunition, and

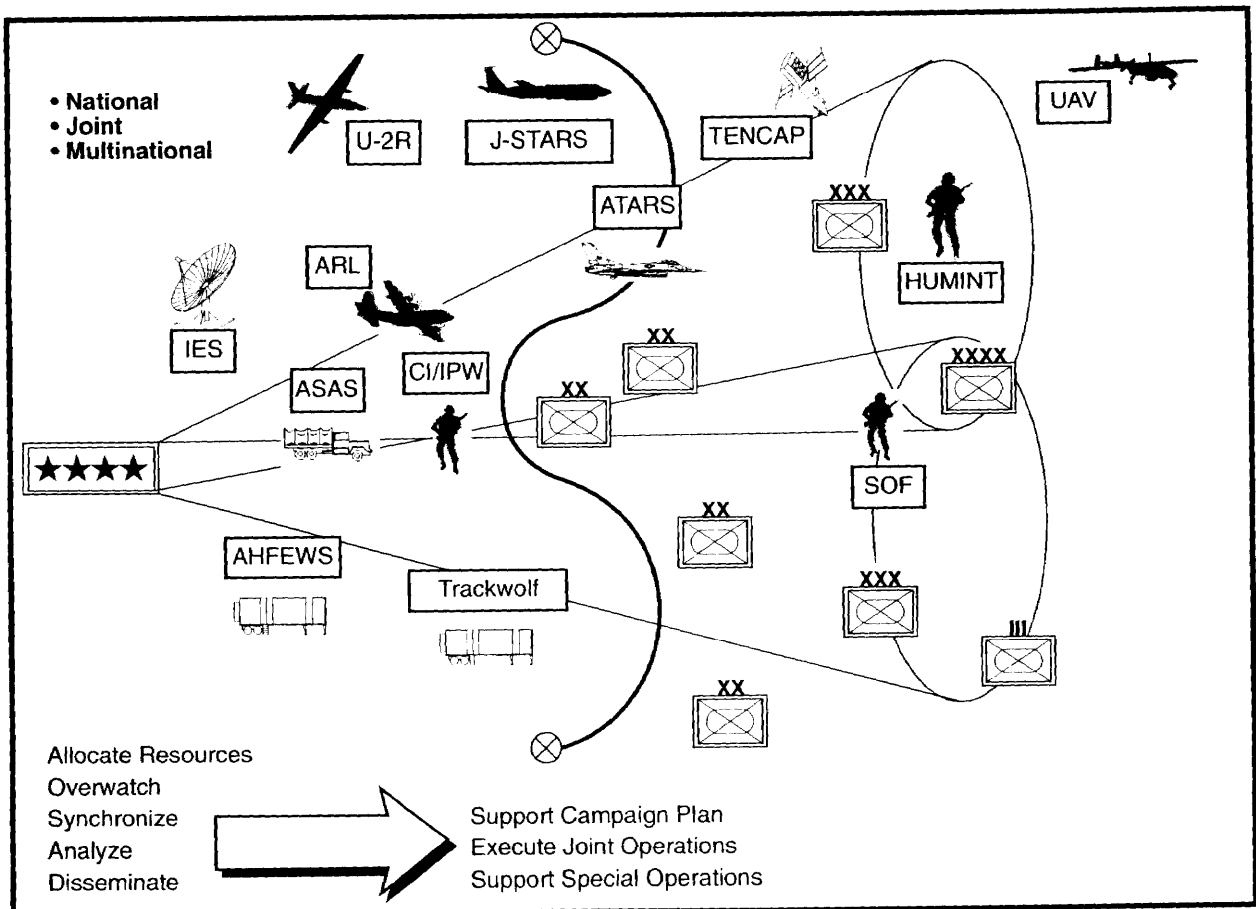

Figure A-20. Operational-Level Intelligence Network Integration

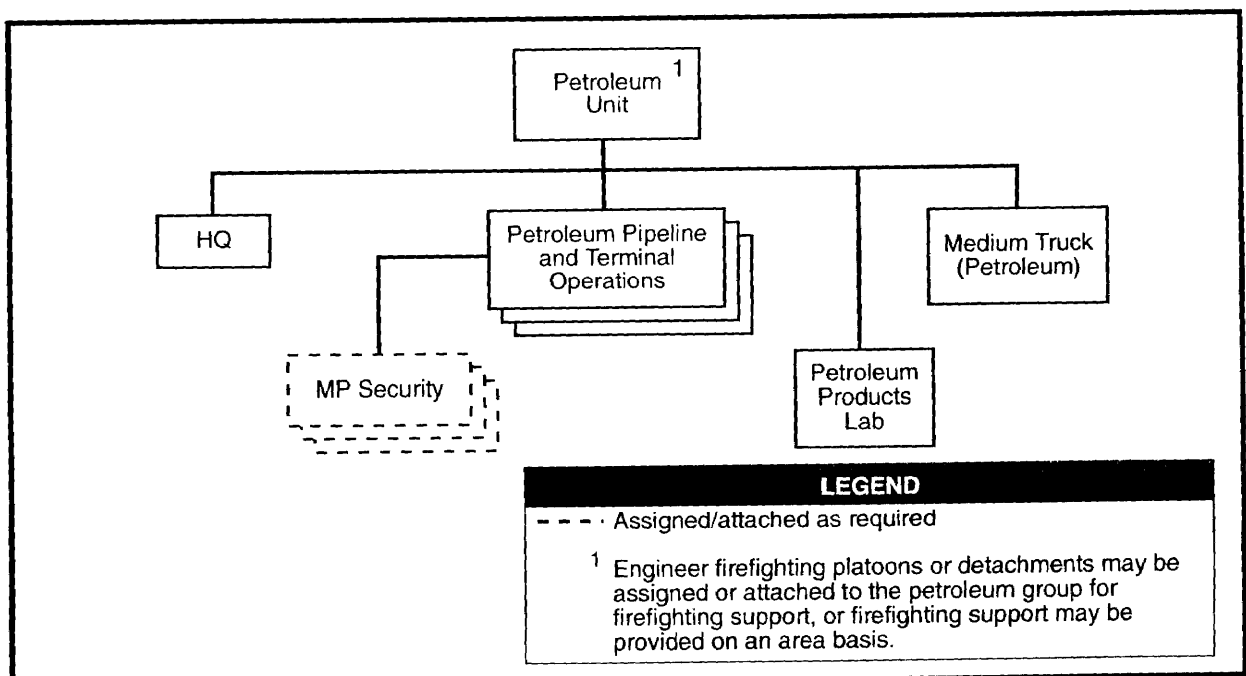

Figure A-21. Operational-Level Army Petroleum Supply Function

recovery and redeployment of stocks following mission completion.

Support is provided within theater from a sequentially deployed ammunition logistics support structure initially consisting of ammunition accountability detachments (port) and modular, platoon-sized container handling and noncontainer ammunition units. As the theater matures and the number of modular units increase, a conventional C² structure is templated over these modular units, creating company-sized units for large volume/area mission capability. Specialized ammunition surveillance and quality assurance support throughout the ammunition system from the CONUS base to the forward ammunition support units is provided by quality assurance specialist ammunition surveillance (QASAS) teams of trained Department of the Army (DA) civilians.

Movement Control

The operational-level Army MCA is responsible for coordinating and administering transportation policy, managing strategic and operational-level movement responsibilities, and managing theaterwide transportation assets. The MCA prepares movement and port clearance plans, conducts liaison with higher and lower movement control elements, and

commands and controls transportation battalions and movement control teams. The MCA may be designated as the validation authority for Army theater airlift requests. This organization often coordinates with allied and host nation MCAs and coordinates and validates theater airlift for Army units. FM 55-10 discusses MCA activities in detail. Figure A-22 illustrates an operational-level Army MCA.

Material Management

The operational-level MMC manages the theater's supply and maintenance operations. Management involves balancing maintenance efforts and ensuring visibility of critical item shortages. The MMC centrally manages the supply and maintenance activities of the area logistics C² organizations, coordinates with subordinate organizations in the CZ, and serves as the primary interface with the CONUS-sustaining base. The MMC is connected electronically with the MCA, appropriate supply and service organizations, and the COSCOM MMC to coordinate distribution of GS supply and maintenance requirements. It may coordinate with joint or multinational agencies. FM 100-16 discusses MMC operations. An operational-level Army MMC is depicted in Figure A-23.

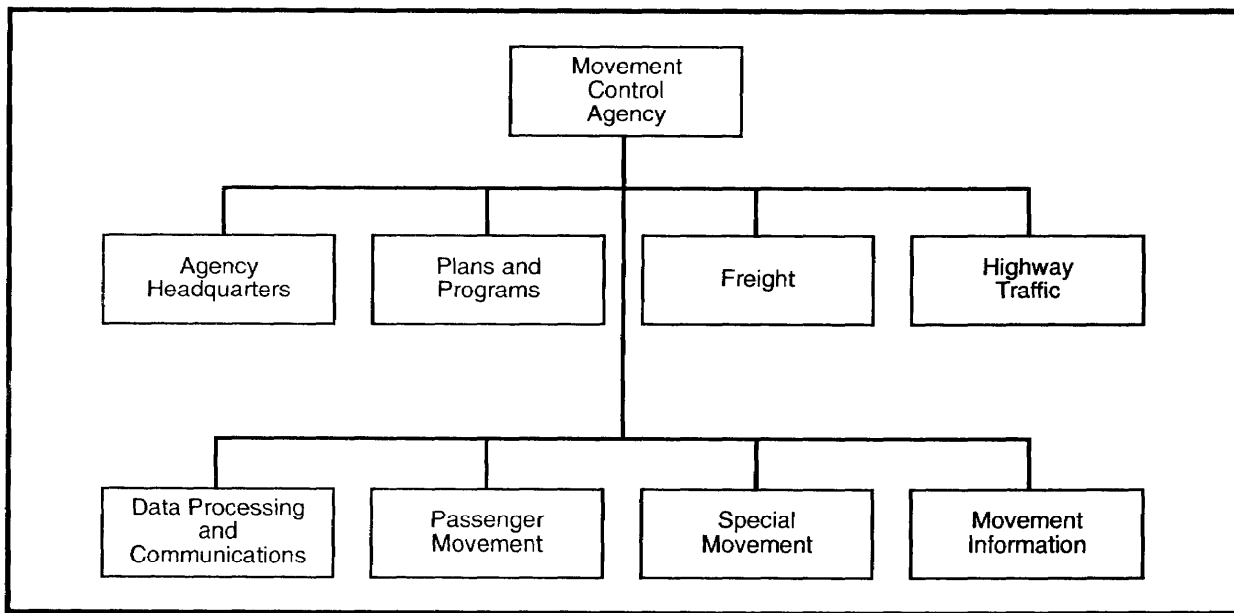

Figure A-22. Operational-Level Army Movement Control Agency

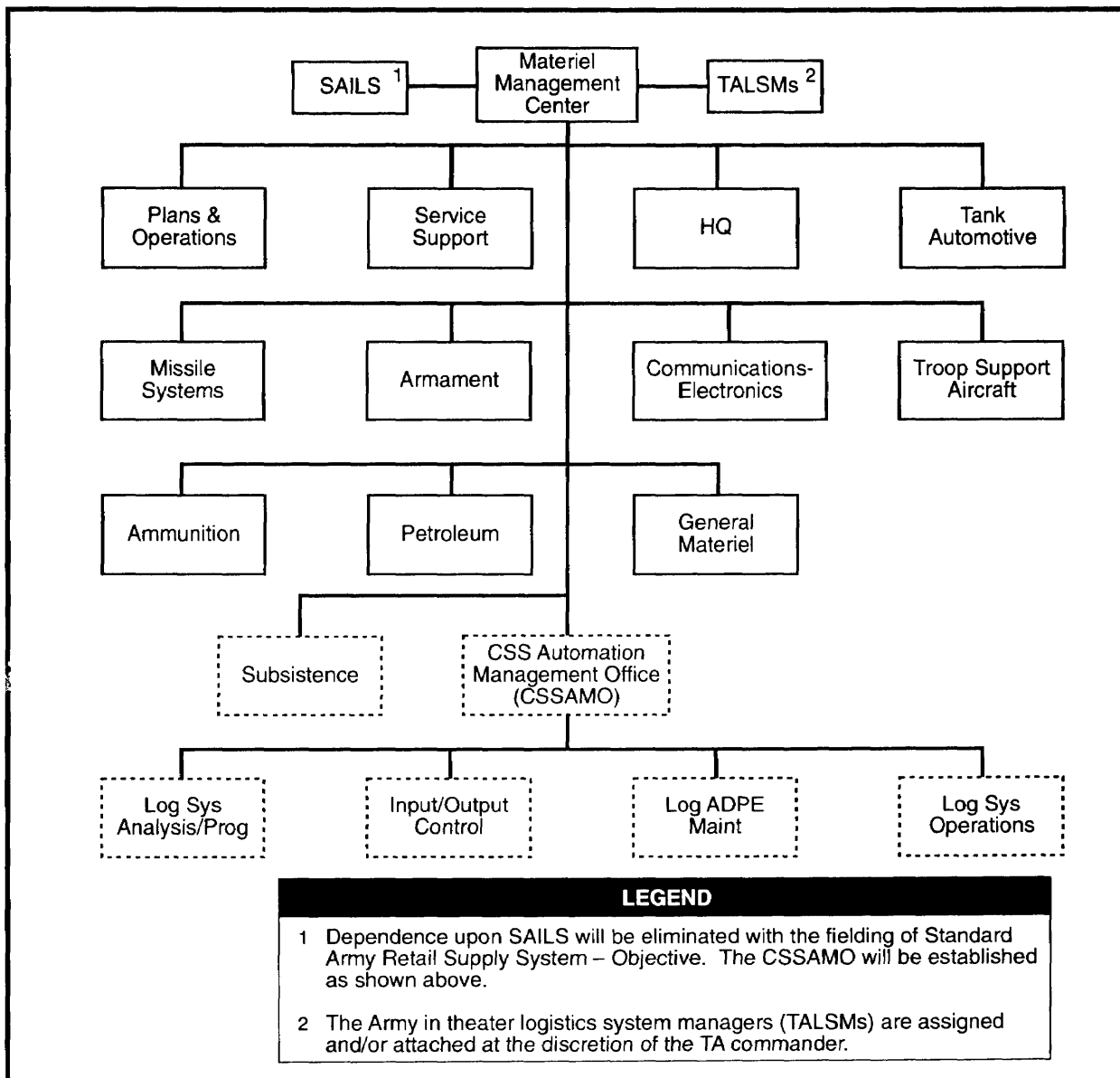

Figure A-23. Operational-Level Army Materiel Management Center

OPERATIONS FUNCTIONS

In peacetime, the ASCC must conduct the three operational-level tasks while continuously supporting all ARFOR in theater. As the situation changes from peacetime to conflict or war, the theater may develop in complexity and scope, requiring the expansion of combat, combat support (CS) and CSS forces. On transition to conflict or war, the CINC may choose one of six options to exercise COCOM. Refer to Chapter 2 for detailed discussion of each option. Each of these options has different impacts on the employment of the ARFOR in theater.

The CINC may exercise COCOM through a subunified commander for operations on a continuing basis. The subunified commander exercises functions, authority, and responsibilities similar to those of a unified command CINC, except for COCOM. The subunified commander exercises OPCON of assigned commands and forces within the assigned AOR or functional area. ASCCs of subunified commands operate in the chain of command within the subunified command. They normally communicate directly with the unified command ASCC on specific Army

Appendix A

matters and inform the subunified commander as required.

The CINC may choose to continue to exercise COCOM through the ASCC or a JFC. If the requirement to conduct major operations becomes severely complex, the ASCC, with the CINC's approval, might choose to create a numbered army to direct the major operation. If he does establish the numbered army, the ASCC would continue to focus on sustainment and support of all ARFOR assigned or attached to the theater. Figure A-24 shows the functions provided by a numbered army organization.

The CINC may choose to exercise COCOM through a JTF. The ASCC would establish the ARFOR (numbered army, corps, division, and so forth) and place it under OPCON of the CJTF for the conduct of operations. As the senior army command in a JTF, the numbered army could serve as the ARFOR, the JFLCC headquarters, or the nucleus around which a subordinate JTF could be built. The numbered army commander would conduct the three operational-level tasks within the JTF. The ASCC would continue to focus on sustainment and support of all ARFOR assigned or attached to the theater.

The CINC may choose to exercise COCOM directly over specific forces. The roles of the numbered army in these situations are similar to those in the JTF discussion. Generally, the CINC does not employ ARFOR in a single-service operation. The CINC usually exercises

COCOM in these situations through the ASCC. The CINC establishes a numbered army in coordination with the ASCC. He does this usually when the span of control becomes too great for the theater army commander or JFC. He may also establish a numbered army when forces are widely dispersed geographically. Establishment may occur when operations require more than one large formation composed of multiple corps to execute distinct, simultaneous campaigns or focus on different major threats. This situation would likely include the division of a theater of war into separate theaters of operation.

The CINC may establish a numbered army when a political situation requires a US operational headquarters as a counterpart to an allied headquarters or to ensure satisfactory distribution of multinational responsibilities. Intermediate headquarters of this nature exist within combined organizations such as a NATO army group. If the CINC chooses to exercise COCOM through functional component commanders, three different scenarios are possible.

- The functional component commander might also be the ASCC. In such a case, the numbered army would be employed in a similar manner as COCOM through the ASCC.
- The functional component commander might also be an Army commander—but not

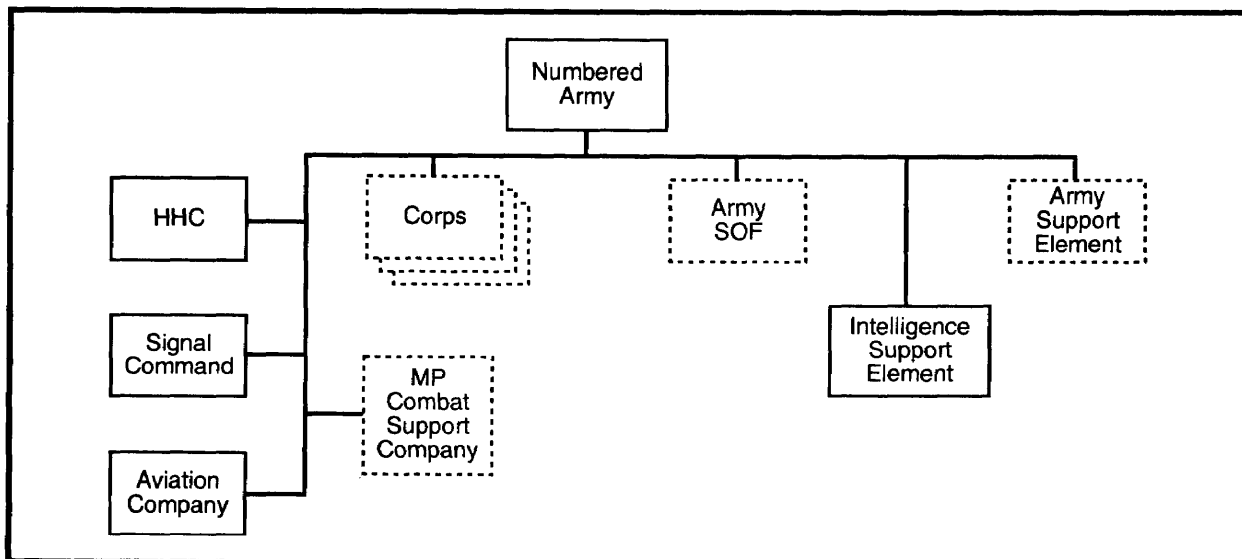

Figure A-24. Numbered Army

the ASCC. In this scenario, the numbered army commander could be the functional component commander. The ASCC would place ARFOR under OPCON of the numbered army commander for the conduct of operations. The ASCC would continue to focus on sustainment and support of all ARFOR assigned or attached to the theater.

- The functional component commander might also be from another service. In this scenario, the numbered army is not likely to be deployed because of the size of the units, and operations would not require an additional level of control.

Structure

The ASCC would normally form a numbered army from existing assets and structure it to meet specific operations requirements. The numbered army is primarily

an operational (as opposed to support) headquarters designed to control from two to five corps. Its commander must have an operational-level perspective. The administrative and support activities of the numbered army are much less than those of the ASCC. As a result, the numbered army staff is austere. The staff focuses on situation assessment, estimate formulation, planning, and functional area coordination. The numbered army probably would make extensive use of liaison representatives to enhance its effectiveness. In conducting operations, the numbered army may direct assigned or attached forces to gain and control terrain, populations, and resources. These operations often involve directing deployment and fires, as well as directing movement and maneuver of large formations over great distances. Figure A-25 illustrates a typical numbered army headquarters.

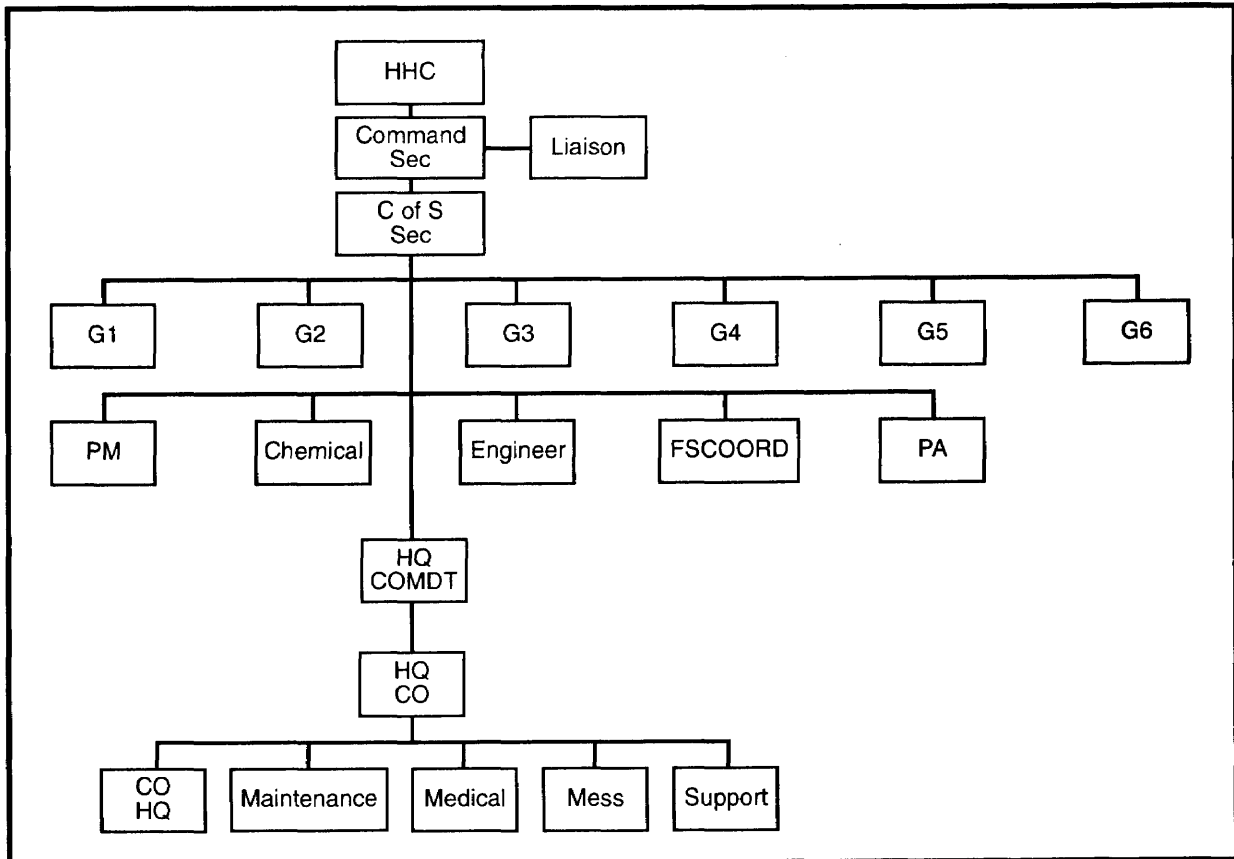

Figure A-25. Typical Numbered Army Headquarters

Support

The numbered army rarely executes support operations. It provides requirements and priorities to the ASCC, which provides logistical support. The headquarters itself receives support from a nearby area support organization in the COMMZ. Assigned ARFOR are normally self-sufficient and rely on the normal theater functional command support network or contingency support arrangement. The ASCC could allocate support forces to the numbered army if independent operations are required. This could occur if the numbered army executes a deep operational maneuver or deploys to a geographically separate area. The ASCC would provide a tailored support package—an Army support element (ASE)—for the duration of the requirement.

The numbered army usually operates from a main and an alternate CP. These headquarters may be located in the COMMZ or CZ. The main CP controls current operations, collates information, integrates all-source intelligence (ASI), and coordinates logistical support. The main CP also develops plans for future operations.

The numbered army commander designates an alternate CP to ensure continuity of operations. The alternate CP may

be a subordinate headquarters. In the event that a numbered army executes support operations, the numbered army commander could establish a rear CP to control logistical support assets as well as coordinate rear security operations.

In addition to the headquarters element, the numbered army consists of a signal unit, an Army aviation element, an MP company, an intelligence support element, and a variable number of maneuver elements. The numbered army is a flexible organization that is task-organized to accomplish assigned missions.

The Army will not likely configure any two numbered armies with the same types of units. The signal unit provides dedicated C³ interface with other systems in theater. The aviation element provides C² aircraft and intratheater mobility for the headquarters. The MP element provides CP security. The intelligence element supports the commander's ASI needs.

The ASCC may allocate SOF to provide HUMINT, PSYOP, or CA capabilities. In rare circumstances, SOF units could execute long-range reconnaissance or strike missions. Engineer support would likely be provided on an area basis or, in an unusual situation, be attached to the ASE.

OTHER MAJOR ARMY COMMANDS

Other MACOMs influence operational-level army units. The US Army Information Systems Command commands the operational-level signal organization during peacetime and conflict. The US Army Intelligence and Security Command commands the operational-level MI organization at theater level during peacetime and conflict. The Criminal Investigations Command commands the criminal investigation division (CID) organization and subordinate detachments during peacetime, conflict, and war. CID elements conduct sensitive investigations, support logistics security operations, manage criminal and terrorist-related intelligence, and conduct criminal investigations.

USACE operates civil works divisions and resident offices within theater to design and execute major construction projects during peacetime. The Military Traffic Management Command (MTMC) serves as the USTRANSCOM executive agent for moving and sustaining unit equipment by surface from CONUS into theater for all services. USAMC is the Army's provider of Army-unique logistical support. USAMC may establish elements of the LSE in the theater to enhance communications between the Army in theater and CONUS-based, USAMC-supporting organizations, as well as USAMC operations in theater.

SPECIAL OPERATIONS FORCES

The vast majority of special operations in a theater of operations are joint special operations. Since the SOC evaluates the SOF support requirements in terms of the total SOF capability, SOF from other services may

support Army operations. It is therefore appropriate to briefly discuss the inherently joint SOF organizations available to support theater operations.

THEATER SPECIAL OPERATIONS FUNCTIONS

Special operations require centralized, responsive, and unambiguous C², which is achieved through a joint operational headquarters exercising OPCON of SOF. Since special operations are conducted continuously (peacetime, conflict, and war), a permanent structure is necessary. To provide the necessary unity of command, each theater combatant commander has elected to establish a subordinate unified command for SOF (see Figure A-26).

These commands—the theater SOCs—are the principal joint headquarters through which the theater CINC's exercise COCOM or OPCON of SOF within their theaters. The commander of the SOC (COMSOC) is also the permanent theater JFSOCC since the SOC has a functional basis. His duties include those of a subunified commander (joint SOF) and a functional component commander (SOF component of a joint operation). These basic duties, as described in Joint Pubs 0-2 and 3-0, are subject to modification by the theater CINC. They include—

- Exercising OPCON over forces assigned or attached.
- Conducting continuing operations.
- Advising the proper employment of SOF.
- Coordinating special operations planning, conduct, and support.

To perform his four basic duties, the JFSOCC organizes the special operations units to—

- Perform deliberate and time-sensitive planning.
- Conduct special operations as directed.
- Organize assigned and attached forces.
- Coordinate special operations with conventional operations.
- Participate in the joint targeting process.
- Obtain special operations intelligence support.
- Establish and maintain effective liaison.
- Plan and conduct joint and multinational special operations training exercises.
- Allocate SOF resources and establish SOF sustainment priorities.
- Coordinate and monitor sustainment of SOF.
- Coordinate and monitor establishment and sustainment of SOF operational project stocks.
- Exercise technical control over SOF communications.
- Identify and articulate theater SOF requirements to the theater CINC for transmission to USCINCSOC.

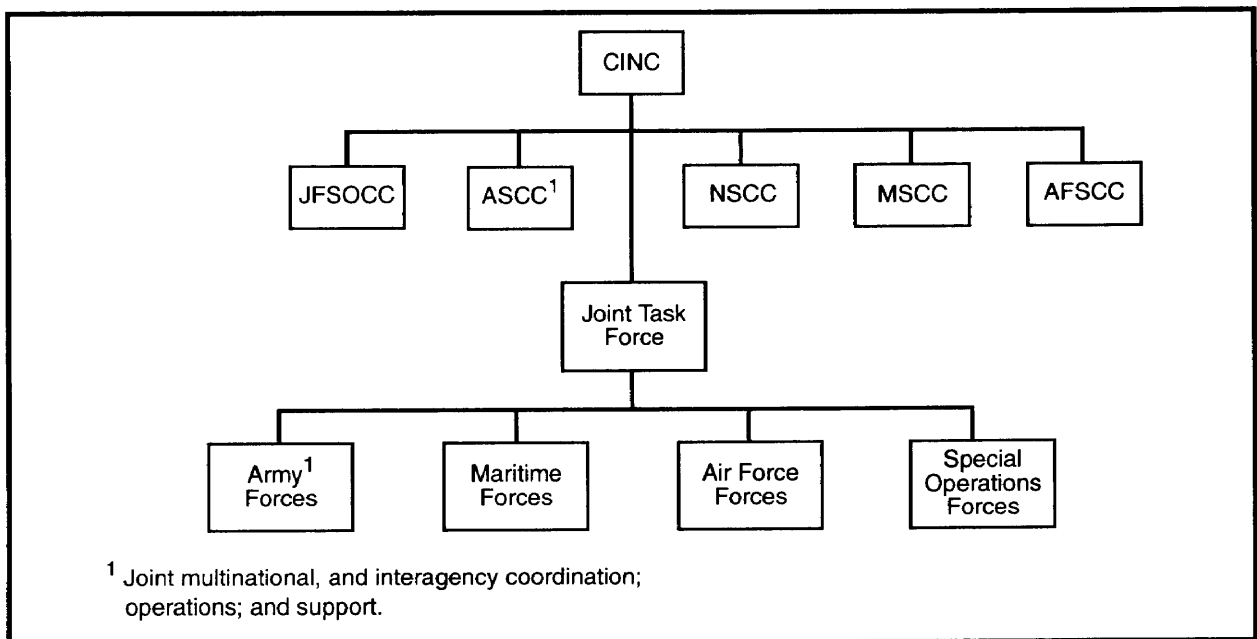

Figure A-26 Special Operations Location

The COMSOC is the JFSOCC for the theater combatant commander. He commands the SOC and is the principal special operations advisor in theater. As COMSOC, he reports directly to the theater combatant commander and exercises OPCON of theater SOF. He may form subordinate headquarters as required. This may include the formation of a JSOTF. JSOTFs may remain OPCON to COMSOC or be placed OPCON to other subordinate commanders (normally a JFC) to perform missions of limited scope or duration. Figure A-27 illustrates a theater with a joint special operations aviation component command (JSOACC).

COMSOC must be familiar with the day-to-day issues working within the theater combatant command. The COMSOC may also serve as a special staff officer. In this situation, he may appoint a deputy to represent him permanently on the staff. A typical SOC is based upon standard joint staff functions. Ideally, each theater should have adequate, experienced SOF personnel to staff the SOC. If the JFSOCC lacks the manpower to fill these positions, he must coordinate for external support or extend his resources to cover all required functions (for example, a combined J3/5).

SUBORDINATE C² ORGANIZATIONS

Organization of SOF subordinate to the JFSOCC—ARSOF, Air Force special operations forces (AFSOF), and Navy special operations forces (NAVSOF)—differ, depending upon the situation, theater of employment, and requirements of applicable OPLANs and CONPLANs. Below the SOC, organization normally takes place along service or functional lines but also may take the form of independent JSOTFs tasked to complete specific missions (see Figure A-27).

FUNCTIONAL C² ORGANIZATION

The COMSOC may choose to organize subordinate forces along functional lines. Functional components may be used in lieu of or in combination with service components. One of the most commonly used special operations functional organizations is the JSOACC. The JSOACC is the subordinate commander within a SOC or JSOTF responsible for planning and executing joint special operations aviation missions and for

coordinating and deconflicting special operations aviation and conventional air operations. (SOC includes Air Force and Army platforms.) The JSOACC is normally the commander of the special operations aviation (SOA) component providing the preponderance of SOA forces, or the one most capable of conducting, commanding, and controlling special operations missions. Depending upon the mission, the JFC may assign OPCON or TACON of conventional air assets to the JFSOCC, who may exercise the authority through the JSOACC.

JOINT SPECIAL OPERATIONS TASK FORCE

The NCA, theater CINC, or COMSOC may form a JSOTF. JSOTFs may be small and temporary or large and enduring, depending upon the national or theater objective. They may be formed from theater SOF, theater SOF augmented by or augmenting headquarters assigned or attached for a specific mission, or SOF external to the theater. They may be formed around an existing service force structure. For example, to accomplish a series of related DA missions, the COMSOC may designate a Naval special warfare task group

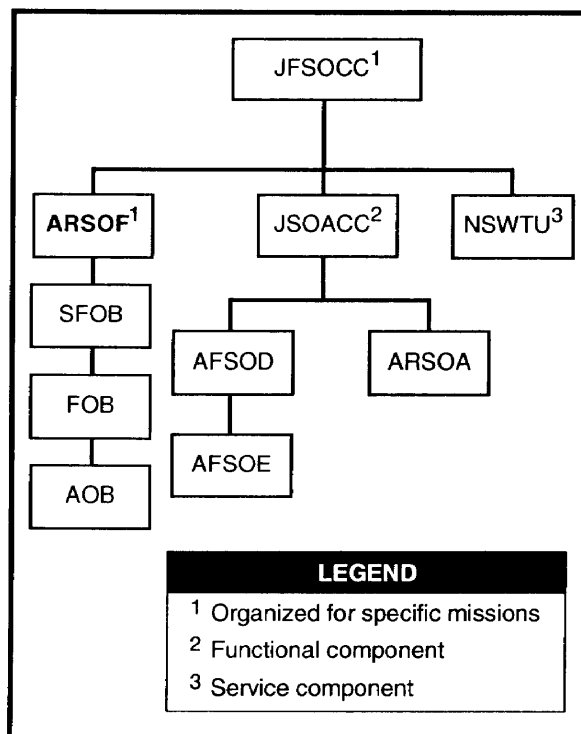

Figure A-27. Theater Arrangement with a JSOACC

(NSWTG) as the nucleus of a JSOTF headquarters. The NSWTG would require ARSOF and AFOSF augmentation to function effectively in this situation. The JSOTF is normally dissolved after its mission is completed.

PSYCHOLOGICAL OPERATIONS FUNCTION

The operational-level PSYOP organization plans and conducts authorized PSYOP activities and implements worldwide support of all nonmobilization contingencies during crises and open hostilities short of declared war. This organization also develops, coordinates, and executes peacetime PSYOP activities. In addition, should war be declared, the operational-level PSYOP organization assists in planning and executing strategic and operational PSYOP for the theater CINC. Figure A-28 depicts the operational-level PSYOP function.

In MOOTW and conflict, the active component PSYOP organization deploys to the theater to provide a planning cell and assume the duties of the senior PSYOP headquarters. This mission is continued until US Army Reserve (USAR) units are mobilized and the appropriate reserve component PSYOP organization arrives and assumes those duties. As these units arrive, they are placed under OPCON of the senior PSYOP headquarters and assigned to their predetermined subordinate commands. OPCON is normally retained at the senior PSYOP headquarters with TACON being passed to the appropriate unit. Examples of PSYOP support to conventional operations include—

- Assessing the psychological impact of military operations.

- Analyzing target audiences in the objective area.
- Advising the commander or mission director of possible PSYOP COAs.
- Developing and conducting PSYOP to support military operations.
- Countering hostile propaganda.
- Supporting commander's information and awareness programs.
- Supporting, planning, or conducting deception operations.
- Providing target audience intelligence, regional and language expertise, and a means for disseminating information and products that describe the intent of military operations.
- Supporting commander's handling of EPW and civilian internees.

THEATER CHEMICAL FORCE FUNCTION

Chemical forces perform combat functions in wartime and offer a variety of mission capabilities in MOOTW. The focus at the functional level allows task organizations of the correct mix of forces to accomplish the mission. Chemical mission areas fall into the following categories:

- NBC defense.
- Smoke and obscurants.
- Temporarily disabling techniques and technologies.
- Flame.

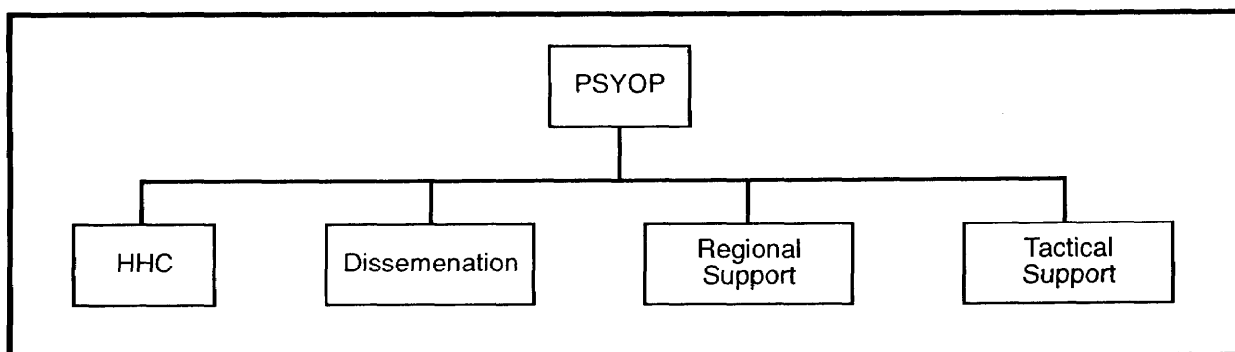

Figure A-28. Operational-Level PSYOP Function

Chemical units are indispensable to operations. They offer a range of capabilities necessary to a versatile force. They can support operations as individuals, teams, or units. A mix of different units (decontamination units, NBC reconnaissance elements, smoke units, and biological identification/detection [BIDS] units) is often necessary to achieve the proper balance of capabilities—force protection and mission accomplishment. Forces deployed in countries with WMD or chemical industrial complexes require support from both NBC battle staffs and units.

A chemical C² organization can provide battle command for a variety of supporting units. It can provide training support and technological and consultative operations for nuclear accident- and incident-response operations and chemical accident- and incident-response operations that involve NBC material, flammable and combustible substances, and industrial chemical hazards. NBC reconnaissance units are equipped to conduct surveys and determine the type and extent of toxic contamination with mobile, real-time analysis. NBC reconnaissance and decontamination units perform chemical and

nuclear hazard surveying, detection, identification, monitoring, and personnel and equipment decontamination.

Smoke units, both mechanized and motorized, provide large-area smoke and obscurant support. Additional capabilities include providing local security, vector control, limited water transfer, spray, storage, limited personnel showers, and limited firefighting. Chemical units can provide training and consultation in—

- Use of defoliants.
- Employment of riot control agents.
- Use of smoke and obscurants.
- Construction and employment of flame field expedient devices and commercial chemical threats.
- Collection, packaging, storage, disposal, and cleanup of hazardous materials and wastes.

FMs 3-100 and 3-101 provide details on missions and mission requirements.

(SECURITY CLASSIFICATION)

Appendix B

Subordinate Campaign Plan Model¹

Copy No. _____

Issuing Headquarters

Place of Issue

Date/Time Group of Signature

CAMPAIGN PLAN: (Number or code name)

References: Maps, charts, time zones (zulu), and other relevant documents

COMMAND RELATIONSHIPS. Briefly describe the command organization (composition and relationships) for the campaign/subordinate campaign. Include detailed information in the command relationships annex (see also paragraph 5a).

1. Situation. Briefly describe the politico-military situation that the plan addresses (see commander's estimate).

a. **Theater Guidance.** Provide a summary of directives, letters of instruction, memorandums, or theater war plans that apply to the plan, including a theater campaign plan received from the theater commander.

- (1) Relate the theater commander's strategic intent to operational requirements in the theater of operation or joint operations area, including its subregional space and multinational elements.
- (2) List the theater commander's strategic and operational objectives and tasks assigned to the subordinate command.
- (3) List actions that are prohibited or required by higher authority (ROE and so forth).
- (4) Include predeployment (C-Day) actions as necessary.

b. **Enemy Forces.** Provide a summary of pertinent intelligence data, including information on the following:

- (1) Composition, location, disposition, movements, and strengths of major enemy forces that can influence action in the theater of operations or joint operations area.

¹Joint Pub 5-0 describes how campaign logic and principles fit into OPLAN format and the JOPES process. Joint Pub 5-03-series further explains the process, including models of planning, messages, estimates, and OPLANs/CONPLANs.

(SECURITY CLASSIFICATION)

(SECURITY CLASSIFICATION)

- (2) Operational concept (if known), to include the enemy's perception of friendly vulnerabilities and the enemy's intentions regarding those vulnerabilities.
- (3) Major operational objectives.
- (4) Commander's idiosyncrasies and doctrinal patterns.
- (5) Operational and sustainment capabilities.
- (6) Vulnerabilities related to the enemy's center of gravity.

NOTE: Assumed information should be identified as such. Reference may be made to the intelligence annex for detailed information.

- c. **Friendly Forces.** State information on friendly forces not assigned that may directly affect the command.
 - (1) Mission of higher, adjacent, and supporting US commands.
 - (2) Mission of higher, adjacent, and supporting allied or other coalition forces.
 - (3) Protection of own operational center of gravity or other critical elements.
 - d. **Assumptions.** State assumptions applicable to the plan as a whole. Include both specified and implied assumptions.
 - e. **Legal Considerations.** State laws or agreements binding on the plan.
 - f. **Public Affairs Considerations.** Identify impact of global visibility, public interest, and media presence on the plan.
- 2. Mission.** Integrate the operational objectives and tasks of the command and their purposes and relationships to achieve the theater strategic objectives (who, what, when, where, and why).
- 3. Joint Operations.**
- a. **Operational Concept.** Integrate the fundamentals of the campaign into a who, what, where, and how statement of operational intent. Restate the assigned operational concept for each phase of the theater strategic concept. Include the phased sustainment of major forces in the command. Include other concepts such as deception and psychological warfare during the subordinate campaign. State how the joint operations are a part of the CINC's unified operations. Include all aspects of operational design. State how operational advantage is to be achieved.
 - (1) Subordinate organization.
 - (2) Operational objectives.
 - (3) Maneuver (operational).
 - (4) Fires (operational).
 - (5) Phases of campaign, major operation, or battle.
 - (6) Timing.

(SECURITY CLASSIFICATION)

(SECURITY CLASSIFICATION)

b. Phase 1.

- (1) Operational or tactical concept. Include operational or tactical objectives, scheme of maneuver, and timing for this phase.
- (2) Forces required by function or capability. Consider Army, Navy, Air Force, Marine Corps, Coast Guard, and special operations and space forces.
- (3) Tasks of subordinate commands and adjacent components.
- (4) Reserve forces location and composition. State "be prepared" missions.
- (5) Fires. Include general missions and guidance to subordinates and components. Ensure that fires are complementary.
- (6) Mobility. Consider transportation; ports; lines of communication; transit and overflight rights; reinforcement, reception, and onward movement; and host nation support arrangements.
- (7) Annexes. Reference all annexes relating to each phase of the concept of operation. Such references show how activities such as deception, psychological operations, nuclear operations, special operations, rules of engagement, airspace management, interdiction operations, mine warfare operations, and so forth, relate to the overall concept.
- (8) Deployment. State briefly how deployments of units, replacements, and supplies into the theater affect the sequencing of operations. Include the details of such deployments in paragraph 4 and/or a logistics annex.

c. **Phases II through IV.** Cite information as stated in each subsequent phase. Provide a separate phase for each step in the subordinate campaign, at the end of which a major reorganization of forces may be required and another significant action initiated.

d. **Coordinating Instructions.** If desired, place instructions here that apply to two or more phases or multiple elements of the command. The execution checklist may be placed in an annex.

4. **Logistics.** Give a brief, broad statement of the sustainment concept for the campaign, with information and instructions applicable to the campaign by phase. The concentration of logistics in phases must be concurrent with operational phases. This information may be issued separately and referenced here. At a minimum, this paragraph should address the following:

- a. Assumptions (including coalition requirements).
- b. Supply aspects.
- c. Maintenance and modifications.
- d. Medical service.
- e. Transportation.
- f. Base development.
- g. Personnel service support.

(SECURITY CLASSIFICATION)

(SECURITY CLASSIFICATION)

- h. Foreign military assistance.
- i. Administrative management.
- j. Lines of communication.
- k. Reconstitution of forces.
- l. Joint and multinational responsibilities.
- m. Sustainment priorities and resources.
- n. Interservice responsibilities.
- o. Host nation considerations.

5. Command and Signal.

a. Command.

- (1) Command relationships. State generally the command relationships for portions of the campaign or the entire campaign. Indicate any shifts of command contemplated during the campaign, indicating the time of the expected shift. These changes should be consistent with the operational phasing in paragraph 3. Give the location of the commander, command posts, and succession to command.
- (2) Delegation of authority.

b. Signal.

- (1) Communications. Plans of communications may refer to a standard plan or be attached in an annex. Include the time zone to be used; rendezvous, recognition, and identification instructions; code; liaison instructions; and axis of signal communications as appropriate.
- (2) Electronics. Plans of electronic systems may refer to a standard plan or be attached in an annex. Include electronic policy and other information as appropriate.

(Signed) _____
(Commander)

ANNEXES: As required (see Joint Strategic Capabilities Plan and theater campaign plan)

DISTRIBUTION:

(SECURITY CLASSIFICATION)

(SECURITY CLASSIFICATION)

Appendix C
Major Operations Plan Model
Operational-Level¹

Copy No _____
Issuing Headquarters
Place of Issue
Date/Time Group of Signature

MAJOR OPERATION PLAN: (Number or code name)

References: Maps, charts, and other documents

TASK ORGANIZATION/COMMAND RELATIONSHIPS: Briefly describe the organization of the Army in theater to support the CINC's long-range strategy and campaign plan, specifically identifying the command conducting the operation. In a plan for a major operation composed of several phases, put the task organization in a separate annex (Annex A) that also outlines command relationships and their changes, if any, as the operation progresses from one phase to the next. Include task organizations for Army component support to contingencies in the annexes referring to the plans for those operations. The structure of Annex A deals with the following factors:

- a. **Civil-Political Relationships.** Embassies, country teams, non-DOD US Government agencies (CIA, Drug Enforcement Agency [DEA], Agency for International Development [AID]).
- b. **Multinational Force Relationships.** Host nations, allies, forces from regional/treaty organizations.
- c. **Joint Relationships.** DOD agencies (DIA, National Security Agency), unified and specified commands (subunified commands and JTFs when appropriate), other services in uniservice roles.
- d. **Relationships with Other Army Commands.** HQDA, USAMC, US Army Training and Doctrine Command (TRADOC), other CONUS MACOMs, and their stovepipe organizations in the theater and army components of other unified commands.
- e. **Army in Theater Relationships.** The structure that reflects unity of command within the ASCC or ARFOR.
 - (1) Army components of subunified commands and JTFs.
 - (2) Functional commands.

1. This OPLAN format conforms to the format delineated in Joint Pub 5-03.2, as amended by CJCS Instruction 3122.03 *JOPES*, Volumes I and II (draft) and FM 101-5, *Command and Control for Commanders and Staffs* (final draft), August 1993.

(SECURITY CLASSIFICATION)

(SECURITY CLASSIFICATION)

- (3) Area commands.
- (4) Major combat and combat support organizations directly under ASCC command in peacetime.
- (5) Army organizations providing operational-level support to the BCE and ACEs.
- (6) ARSOF, especially the theater army special operations support center.

1. **Situation.** Thoroughly describe the operational environment as well as appropriate aspects of the strategic environment in which the major operation will be conducted. Include tactical information for the early phases of the operation. Refer to command and staff estimates, country studies, or OPLANs. Designate the *trigger event* that signals execution of the OPORD.

- a. **Intelligence.** Use this subparagraph to refer to a separate intelligence annex (Annex B) or the intelligence estimate. The two main components should include the following:
 - (1) A summary of information concerning the area of operations, which consists of—
 - (a) A strategic overview of the area, to include its climate, politics, geography, topography, demography, economics, and social/cultural factors.
 - (b) Specific, localized information about conditions affecting the early phases of the operation, especially if a forced entry is anticipated. Include weather, key terrain, observation, cover and concealment, obstacles, avenues of approach, drop zones, landing zones, and beach and hydrographic data.
 - (2) A description of the enemy, which consists of—
 - (a) Strategic and operational factors such as the political roots and objectives of enemy activity, personalities, outside support, sanctuaries, logistics capabilities, levels of training and combat experience, morale, strategic and operational centers of gravity, and vulnerabilities to PSYOP.
 - (b) Factors of immediate concern during the early phases of the operation such as locations, strengths, weapons systems, tactical capabilities, reserves, mobility.
 - (c) Information about the military strengths of nations not allied or affiliated with US forces. Include order-of-battle information, numbers of major weapons systems, personalities of leaders, levels of training, or combat experience and affiliation with major hostile powers.
- b. **Friendly Forces.** Provide information on friendly forces that may affect the execution of the plan being put forth. These effects may impact directly on the command or on the organizations subordinate to that command.
 - (1) Task organizations/command relationships. State the mission and applicable parts of the concept of operation of the joint or

(SECURITY CLASSIFICATION)

(SECURITY CLASSIFICATION)

multinational command to which the ARFOR is subordinate. They will normally be as stated in the theater campaign plan. Provide sufficient detail so that key individuals know and understand the higher, joint, or multinational commander's intent, the *end state* desired at the conclusion of the campaign, and how their actions mesh to attain joint or multinational goals.

- (2) Higher headquarters. Include the mission, concept, and intent of the unified/joint theater CINC. His charter is to further US interests in the theater and should be stated so that the ASCC/ARFOR, his staff, and subordinates know and understand the part they play in achieving the CINC's strategic aim.
 - (3) HQDA. Describe the missions, concepts, and intents of HQDA as they pertain to the theater. In peacetime, the ASCC is a MACOM responding to CINC direction as well as to HQDA for Title 10 responsibilities. Include references to Army regulations or other service authorities.
 - (4) Other service components. Highlight the roles of the Navy, Air Force, and Marine Corps components of the unified command.
 - (5) Joint, unified, and specified commands and DOD agencies. Highlight the roles of other commands that affect the operations in this theater.
 - (6) Multinational forces. Highlight the organization, capabilities, and activities of friendly nations in the theater, with emphasis on their military forces. State their roles and missions in support of the CINC's objectives to further US policies.
 - (7) Special operations forces. Describe the activities of SOF in the region that affect the operation.
 - (8) US Coast Guard. Describe the role of the Coast Guard in the theater, especially its counternarcotics role.
 - (9) Department of State. Highlight the contributions of US embassies and country teams in the theater as they affect and interface with elements of the ASCC/ARFOR.
 - (10) Other non-DOD US agencies. Describe the activities of US Government agencies not included in country teams, such as DEA and AID, as they affect Army operations.
- c. **Attachments and Detachments.** Highlight critical elements of the Task Organization/Command Relationship section (Annex A).
- d. **Assumptions.** Provide a summary of the conditions and situations that must exist when the OPLAN becomes an OPORD. They include predictions and presumptions concerning the following:
- (1) Conditions within host countries and other nations in the region.
 - (2) Consistency of US policy for the region such as the application of the *War Powers Act*.
 - (3) Involvement by hostile powers, both from outside and within the region, in the internal affairs of nations in the theater.

(SECURITY CLASSIFICATION)

(SECURITY CLASSIFICATION)

- (4) Effects of US actions in the theater on relations with nations outside the theater.
- (5) Adequacy of interagency support.
- (6) Bilateral and multilateral consensus on the degree or extent of common threats, for example, the narcotics trade, and required actions.
- (7) Availability of resources.
- (8) Warning times.
- (9) Times and locations of anticipated hostile actions.
- (10) Anticipated political situations in the host nation and neighboring nations.
- (11) The timing of political decisions in friendly nations.
- (12) The timing of the release of the use of special weapons.

2. **Mission.** Provide a clear, concise statement of the tasks to be achieved in all phases of the major operation. Include the commander's visualization of the end state to be achieved. Examples are restoration of an international boundary, defeat of enemy armed forces, or clearing of hostile armed forces from a given geographical area. If for an MOOTW, provide a clear statement of the long-range, continuing aim of the theater army. Summarize tasks assigned by the CINC, tasks directed by HQDA, and tasks derived from the commander's analysis of the environment and his understanding of his superiors' intent. Unlike the single-paragraph narrative common to the mission statement for a wartime operation, the MOOTW mission statement is usually a list of tasks. These tasks may include the following:

- a. Plan and organize for transition to war.
- b. Support and sustain ARFOR and other designated forces.
- c. Protect the force, its personnel, and family members.
- d. Train ARFOR to maintain readiness.
- e. Participate in security assistance efforts.
- f. Conduct Army intelligence activities in conjunction with joint and multinational intelligence efforts.
- g. Plan for, rehearse, and participate in contingency operations and responses to crises. Plans for such operations may be included as annexes and generally conform to the format for an OPORD for an ARFOR in a conflict situation. Such peacetime operations include the following:
 - (1) Security assistance.
 - (2) Nation assistance.
 - (3) Search and rescue.
 - (4) Humanitarian assistance.
 - (5) CA.
 - (6) NEO.

(SECURITY CLASSIFICATION)

(SECURITY CLASSIFICATION)

- (7) Peacekeeping.
- (8) Show of force.

3. Execution.

- a. **Commander's Intent.** Provide a statement, in general terms, of the commander's visualization (from start to finish) of the mission accomplishment by his command. This subparagraph links the mission to the concept of operations. It binds all subordinate activities to the overall objective.
- b. **Concept of Operations.** Describe the commander's visualization of how the mission will be accomplished, to include his intent for the employment of the command as a whole. At the operational level, divide the concept into phases; the commander will specify the *end state* for each phase so that subordinates know his intent for each phase. The *trigger event* for the transition between phases is the achievement of some intermediate goal. This knowledge will permit subordinates to plan *branches* within their own plans. The subordinate commanders are empowered to demonstrate initiative in supporting the achievement of the commander's stated end state. The commander and his subordinates can also execute *sequels* within and at the conclusion of phases, depending on the outcome of battles and engagements. Include an operations overlay (Annex C) and the deception plan (Annex D) in the concept.
 - (1) Phase I. The first operational phase of a contingency is usually the detailed preparation of the command to execute the operation. In a highly charged, time-sensitive environment characterized by political maneuvers from a diplomatic posture, the commander prepares his concept by—
 - (a) Organizing his staff to conduct the proposed operation and integrating those augmentation cells from other components and agencies and subordinate Army units.
 - (b) Establishing liaison with the host nation, with the unified command responsible for the target area, with other unified and specified commands (especially those involved in deployment), with SOF already in the target area, and with appropriate US Government agencies.
 - (c) Negotiating status of forces agreements, constraints (Annex E), and ROE (Annex F) for the proposed operation with the host nation, in coordination with DOS and appropriate embassies and country teams.
 - (d) Establishing or preparing to establish intermediate staging bases in the target region and directing the repositioning of supplies and equipment.
 - (e) Conducting necessary operations to support political and diplomatic initiatives or to rehearse for the planned major operation.

(SECURITY CLASSIFICATION)

(SECURITY CLASSIFICATION)

- (f) Ordering his subordinate organizations to prepare to execute the major operation.
 - (g) Stating the commander's concept to attain the end state for this phase by the command as a whole.
 - (h) Setting forth the commander's scheme of operational maneuver, including close battle, deep battle, and rear operations when appropriate.
 - (i) Describing how operational fires will be employed. Include a phased fire support annex (Annex G) to show complex arrangements for fire support, including priorities of fires and targeting. Augment the annex with appendixes for air support, chemical support, field artillery support, naval gunfire support, and nuclear fires.
 - (j) Including air defense (Annex H), electronic warfare (Annex I), engineer support (Annex J), and PSYOP (Annex K), rear operations (Annex L), protection of forces and means (Annex M), provost marshal functions (Annex N), public affairs (Annex O), and space operations (Annex P).
 - (k) Using the subsequent subparagraphs to direct tasks for subordinate units not already covered in the concept for this phase.
 - (l) Stating the initial location and tasks for the reserve. Propose the employment of the reserve in taking advantage of branches and sequels.
 - (m) Providing coordinating instructions applicable to two or more subordinate elements. If reinforcements from outside the theater will impact on operations, include that impact here. Also include instructions for linkups with SOF or ground units involved in the deep battle.
- (2) Phase II. The second operational phase is the execution of the operation itself. It can be composed of several phases (deployment, force entry, force buildup and combat operations, decisive combat operations and achievement of end state). In this phase, the commander—
- (a) States his concept in detail to attain the phase's end state by the command as a whole. In his narration of the step-by-step execution of the phase, he specifies exactly which subordinate and supporting units will accomplish each operational or tactical task.
 - (b) Sets forth the scheme of maneuver, as well as the deployment scheme, to attain initial objectives. Where appropriate, the scheme should include the forcible insertion of combat elements and necessary C² elements and their accompanying support.
 - 1. Changes in the form of maneuver.
 - 2. Changes in the nature of the operation.

(SECURITY CLASSIFICATION)

(SECURITY CLASSIFICATION)

- 3. Major regrouping of forces.
- 4. Significant changes in enemy capabilities.
- (c) Prescribes the employment of fires necessary to attain initial objectives according to the fire support Annex (Annex G). The annex includes targeting priorities and priorities of fire and may be augmented by appendixes for air support, field artillery support, and naval gunfire support. In this subparagraph or its annex, also include joint interfaces such as the joint targeting board (JTB) and the BCE.
- (d) Includes provisions for air defense (Annex H), electronic warfare (Annex I), engineer support (Annex J), PSYOP (Annex K), rear operations (Annex L), protection of forces and means (Annex M), provost marshal functions (Annex N), public affairs (Annex O), and space operations (Annex P).
- (e) In subparagraphs subsequent to (d) above, includes direct tasks for subordinate units not already covered in the phase concept.
- (f) If appropriate, states the location and tasks for the reserve. This subparagraph proposes the employment of the reserve in taking advantage of *branches* and *sequels*.
- (g) Includes coordinating instructions that apply to two or more subordinate elements. Also includes link-up procedures between the force and forces already in the operation, if appropriate.
- (3) Phase III. The third operational phase is the consolidation of the results of a successful end state for this phase. It does not contain the detail of the preceding phases. In this phase, the commander includes instructions for the—
 - (a) Redeployment of combat forces to their original locations.
 - (b) Deployment of CA, MP, engineer, medical, or other types of units necessary to restore peacetime stability to the target region in case a continuing US military presence is required.
 - (c) Modification of the residual force's relations with US Government agencies and the host nation to aid in the transition to peacetime stability.
- c. **Tasks for Major Subordinate Commands.** Set forth tasks that encompass two or more phases of the major operation in a subparagraph for each major subordinate command.
- d. **Coordinating Instructions.** Provide instructions appropriate to two or more phases of the operation. Coordinating instructions may include—
 - (1) Airspace management procedures. Include the formation of an A²C² cell and its relation with the theater airspace control authority.
 - (2) Operational fires planning guidance. Refer to a separate annex (Annex G).
 - (3) Force-protection guidance. Refer to a separate annex (Annex M). Include the mission-oriented protection posture (MOPP) levels.

(SECURITY CLASSIFICATION)

(SECURITY CLASSIFICATION)

- (4) Times, events, or situations that signal the transition between phases.
- (5) Constraints (Annex E). Operations in situations short of general war are usually constrained significantly by factors other than military ones. Describe such limitations on military actions in an annex detailing the provisions of treaties, agreements, and conventions governing the political, humanitarian, and informational limits on the military effort.
- (6) Rules of engagement (Annex F). In addition to constraints imposed by international agreements, certain self-imposed ROE govern the use of military forces and certain weapons effects during the major operation.
- (7) Times, events, or situations that signal the transition between phases.
- (8) Resource management guidance.
- (9) Training guidance. Refer to a separate annex (Annex Q).
- (10) Operational planning guidance.
- (11) Space operations planning guidance (Annex P).
- (12) Public affairs operations (Annex O).

4. **Support.** Provide operational support instructions that are of primary interest to the elements being supported. An ARFOR without its own inherent logistical organization will refer to the administrative/logistical plan of the ASCC for detailed procedures on how operational-level support elements and other subordinate elements may receive support from operational-level support organizations. In this paragraph or in a support annex (Annex R), the ARFOR commander describes those support matters necessary to accomplish the combat mission of his force. He must ensure that support plan phases coincide with OPLAN phases.

- a. Even without an integral support organization, the ARFOR commander may choose to include the following subjects in his plan's support paragraph or annex.
 - (1) Priorities of supply and maintenance.
 - (2) Submission of materiel status reports.
 - (3) Controlled supply rate for Class V.
 - (4) Prescribed nuclear load.
 - (5) Chemical munitions allocations.
 - (6) Designations of LOCs.
 - (7) Labor policies (use of EPW, civilian labor).
 - (8) Medical evacuation policies.
 - (9) Personnel strength reports.
 - (10) Replacement policies and priorities.
 - (11) Reconstitution.

(SECURITY CLASSIFICATION)

(SECURITY CLASSIFICATION)

- (12) Reception and onward movement of reinforcements.
 - (13) NEO.
 - (14) CA.
 - (15) Host nation considerations.
 - (16) Public affairs.
- b. If a support organization is placed under command of an ARFOR, include the detailed information normally found in the ASCC plan.
 - c. Identify support, such as labor, transportation, and facilities from host nations and friendly third countries. Set forth in detail the procedures for making use of these resources.
 - d. Include procedures for ASCC support of contingency forces from CONUS or other theaters.
 - e. Highlight routine daily force sustainment, to include the operation of installations and military communities.
- 5. Command and Signal.**
- a. **Command.** Provide information concerning command post locations, succession of command, and liaison requirements.
 - b. **Signal.** In this subparagraph or its supporting annex (Annex S), describe communications procedures and priorities such as radio silence, CEOI, codes, and interface with joint or multinational communications nets.

(Signed) _____
(Commander)

ANNEXES:

A - Task Organization/Command Relationships. This annex is presented in phases. For each phase, list commands directly subordinate to the headquarters issuing the OPLAN as major headings. Indent, under the title of each direct subordinate command, the direct subordinates of that command in the order prescribed in FM 101-5, Appendix G. In a numbered army, include corps and maneuver organizations smaller than corps directly under army control, army field artillery air defense units, and other EAC organizations. Additionally, this annex—

- Describes the relationships of the headquarters issuing the order with its higher headquarters/authority and its special relationships with non-DOD US Government agencies (embassies, country teams, DEA, CIA).
- Describes relationships with host nations and with forces from regional/treaty organizations, to include their integration into the overall force structure.
- Unambiguously sets forth the relationships discussed in FM 100-7. The commander issuing this order may be the JFC whose existing army headquarters is the nucleus of the headquarters of the JTF. The

(SECURITY CLASSIFICATION)

(SECURITY CLASSIFICATION)

commander may be the commander of ARFOR as discussed in Chapters 2 and 6 of FM 100-7, with the responsibility for the operational and tactical employment of ground forces. The commander may be the CJTF's Army component commander, with command less OPCON of ARFOR. Separate headquarters may be designated to perform each of the three functions, or a single headquarters may perform two, or even all three, functions: JTF headquarters, ARFOR headquarters, and Army component headquarters.

B - Intelligence. This annex includes the following information:

- Analysis of the AO. Climate, geography, political matters, aspects of economics, and social/cultural affairs affecting the operation.
 - Strategic factors.
 - Operational/tactical factors.
- Enemy situation. Strengths, vulnerabilities, capabilities, dispositions, personalities.
 - Strategic factors.
 - Operational/tactical factors.
- Essential elements of information.
- IPB, to include acquisition tasks.
- Counterintelligence.
- Intelligence administration. Handling of prisoners of war, documents, materiel, and intelligence reports.
- Joint/multinational intelligence links. Interface with the ASCC's ACE to provide for the collection, analysis, and dissemination of information by allies, US strategic means, and joint sources.

C - Operations Overlay. A graphic representation of the concept of operations.

D - Deception. This annex includes a description of the deception objective, the deception story, resources available, excerpts of higher headquarters deception plans, and the active and passive deception measures to be taken by subordinate organizations.

E - Constraints. This annex contains those political, humanitarian, economic, and social/cultural limitations on the application of military power during the operation. It references US laws and treaties, conventions, and international agreements. This annex includes restrictions on the use of certain weapons, limitations on tactical methods, or entry into certain areas. It may prescribe the seizure and retention of certain objectives for political and psychological reasons or the mandatory use of allied or multinational forces in certain situations. This annex includes policies of nations in or near the target area that may inhibit military actions.

F - Rules of Engagement. This annex contains those guidelines to subordinate and supporting organizations regarding the rules for the control of forces and their weapons systems. The security of the force and its personnel is balanced against the need to prevent the employment of undue or excessive military force.

(SECURITY CLASSIFICATION)

(SECURITY CLASSIFICATION)

G - Fire Support. This annex describes the concept for synchronizing operational fires with operational movement and maneuver. It includes priorities of fires, targeting considerations, and control measures. Its phases coincide with those of the OPLAN. It is augmented by appendixes.

- Air Support.** This appendix outlines the major roles and tasks to be carried out by air elements, priorities of allocations for CAS and battlefield air interdiction, specific control arrangements, and procedures for the operational SEAD.
- Field Artillery.** This appendix describes the organization for combat, missions for field artillery formations providing operational fires, and timing of attachments and detachments or changes in artillery unit missions.
- Naval Gunfire.** This appendix describes the concept for employment of naval gunfire, allocation of observers or spotters, allocations or missions of ships, and limitations and control measures peculiar to naval gunfire.
- Chemical Support.** This appendix includes the concept of employment for chemical weapons and the prescribed chemical load.
- Nuclear Support.** This appendix includes the concept of employment for nonstrategic nuclear weapons (NSNW), to include coordinating instructions for nominating NSNW targets, controls, and constraints; preclusion data for collateral damage and troop safety; arrangements for the initiation of nuclear operations; and procedures for integrating conventional weapons with NSNW.

H - Air Defense. This annex includes the joint or multinational air defense organization, organic and supporting air defense capabilities, ROE, weapons control procedures, and enemy air capabilities.

I - Electronic Warfare. This annex includes the EW mission, enemy EW capabilities, defensive and offensive EW measures, and coordination with other parts of the OPLAN (deception, communications, PSYOP, operational fires).

J - Engineer. This annex includes priorities of engineer work to mobility, countermobility, and survival tasks. It also includes planning and execution of operational obstacles and barriers, engineer organization for combat, and engineer tasks for subordinate organizations.

K - Psychological Operations. This annex refers to the intelligence annex, designates PSYOP targets, and describes the PSYOP plan, to include its integration into higher headquarters plans and deception plan operations or related tasks for subordinate units.

L - Rear Operations. This annex contains instructions for the protection of the designated rear area in the host country and neighboring friendly countries from all levels of threats. It designates a joint/multinational rear area coordinator, usually the ASCC, and outlines provisions for the defense of bases, base clusters, and other facilities, using assigned and attached units, host country resources, and, if necessary, tactical combat forces.

(SECURITY CLASSIFICATION)

(SECURITY CLASSIFICATION)

M - Protection. This annex contains instructions for the protection of bases, installations, military personnel, family members, and other US nationals in the theater from terrorism, natural disasters, and other dangers.

N - Provost Marshal. This annex prioritizes the four MP battlefield missions for employed MP forces: area security, battlefield circulation control, EPW operations, and law enforcement. It should correlate with Annex M (Protection) and Annex F (Rules of Engagement).

O - Public Affairs. This annex contains guidance for facilitating the media effort to cover the operation and for supporting the information needs of the soldiers and their families.

P - Space Operations. This annex describes planned and available space support to the OPLAN. It explains how to obtain and coordinate space support, in addition to listing operational constraints and shortfalls.

Q - Training. This annex contains guidance for the multinational, joint, and service training of individuals and units assigned or attached to the theater army.

R - Support. This annex spells out in detail the necessary support for subordinate formations to accomplish their missions. The information is keyed to the phases of the OPORD when appropriate. The annex prescribes priorities of supply and maintenance, requirements for submission of reports, and sources of support (units in the force itself, the host nation, or the Army component of the unified command in the region). This annex is organized in categories and may be presented in separate appendixes if necessary.

- Supply. Levels for each class of supply at organizational, direct support, and general support echelons. Location of MMC, map, and water supply.
- Transportation and Movements.
 - Strategic movements. Coordination with TRANSCOM and other services for airlift and sealift.
 - Establishment of intermediate staging bases.
 - Movements in operational area. Ports, airfields, railroads, airlift, LOCs.
 - Location and functions of the MCC.
- Services.
 - Construction.
 - Graves registration.
 - Field services.
 - Explosive ordnance disposal.
 - Local procurement and contracting.
 - Postal.
- Labor.
- Maintenance.
- Medical evacuation and hospitalization. Evacuation policies.

(SECURITY CLASSIFICATION)

(SECURITY CLASSIFICATION)

- Personnel Service Support.
 - Strengths. Casualty reports and replacement policies.
 - Morale, welfare, and recreation.
 - Finance.
 - Religious support.
 - Discipline, law, and order.
- CA.
- Reconstitution.
- NEO.
- EPW.

S - Communications-Electronics. This annex includes items contained in subparagraph 5b when its contents are too voluminous to put in the body of the OPLAN. It describes the link provided by the force headquarters between the Army tactical command and control system, which exists among its subordinate units, and the joint and multinational C systems, as well as those of the sustaining base. A joint communications support element can be attached to the force headquarters to provide joint interface.

- This annex provides for employment of three communications conduits: area common user (ACU), data distribution system (DDS), and combat net radio (CNR). These systems are automated, with provisions for parts of the force (allies, other services, reserve components) not possessing the degree of automation capability possessed by the bulk of the force.
- This annex describes dealing with the possible degradation of communications, with provisions for redundancy, electronic countermeasures, OPSEC, and hardening and the use of radio silence and messengers.

DISTRIBUTION:**(SECURITY CLASSIFICATION)**

Appendix D

Digitization of the Battlefield

The concept for information operations describes the explosion in information technology and the effects on Army operations. It relates the importance of information and how to win the information war in military operations, now and into the twenty-first century. The ability to manipulate, isolate, or negate portions of information infrastructure systems (electromagnetic spectrum, computers, and so forth) will be key element of future military operations—in war and MOOTW. Disrupting an opponent's ability to effectively use these systems, while protecting our own, will prove crucial in the future.

INFORMATION AGE TECHNOLOGY

Information Age technology will provide the means to control and dominate the battle space in any situation. The Army of today and into the twenty-first century will meet the challenges of the Information Age by achieving force coherence through shared knowledge, instead of through traditional means such as graphic control measures or geographical demarcations. Joint Pub 3-13 and FM 100-6 establish doctrine for this new domain. Information operations provide commanders the METT-T-specific knowledge, coupled with a rapid and precise vision of the battlefield, to gain dominance in a battle space and control the tempo of operations.

Rapid advances in automated C² systems require commanders and soldiers to operate highly sophisticated equipment to function effectively on the battlefield. Information about the adversary and friendly formations will be

distributed among all committed forces—land, sea, air, and space—to create a common view of the battle space and a shared situational awareness across the force. This shared situational awareness, coupled with the ability to conduct continuous operations, will allow Force XXI armies to observe, decide, and act faster, more correctly, and more precisely than their adversaries.

Soldiers do not gain advantage over the enemy by simply using automated equipment. Soldiers achieve and exploit the advantage when they optimize information presented by digital systems. Optimizing the use of automated information begins with discretion in the use of digital reporting. Digital reporting and the digital display are not substitutes for hard copy reports or maps; they are aids in managing and presenting information for the purpose of decision making.

THE DIGITIZED FORCE

Future information technology will provide the means to collect, process, disseminate, and display information in unparalleled volume, speed, and accuracy. Digitization of the battlefield provides common formats, rapid processing, and timely transmission of data. The ASCC/ARFOR commander must be concerned with asymmetrical capabilities within the force. While modernizing the force, he must be cognizant of units that are maintaining current capabilities—not only ARFOR but also joint and multinational as well. The digitized force has capabilities and limitations distinctly separate from its

conventionally-equipped predecessor. The digitized force has an improved capability to achieve the agility, depth, and synchronization that characterize successful Army operations through the use of shared collective unit images.

Collective unit images form a battle space framework. This framework is based on shared real-time awareness of the arrangement of forces in the battle space, instead of a rigid framework of battlefield geometry such as phase lines, objectives, and battle positions. Digitization of the force permits commanders

at every level to share a common, relevant picture of the battlefield scaled to their level of interest and tailored to their specific needs. Commanders of digitized units at the same echelon share a perspective (situational awareness) of their position in relation to adjacent units. Combat, CS, and CSS leaders, horizontally linked by common information, visualize how they will conduct and support major operations, battles, and engagements. Their execution is integrated by a shared vision of the battle space.

The commander of a digitized force has significant advantages over commanders of conventionally-equipped forces. The most significant advantages are-

- An increased situational awareness.
- Enhancement of the planning and preparation of orders and the distribution process.
- Digital aids that enhance the timeliness and accuracy of the reporting process and employment of assets.
- An improved capability to achieve mass at the decisive point. (This includes the achievement of mass of CS and CSS assets as well).
- Digitization and automation of reports,

which provide the capability to share information at each level of the chain of command. The recipient of a report can look at the location of the reported enemy element and compare it to his operational graphics and friendly unit locations. This comparison allows the recipient to determine potential problems with the disposition or orientation of friendly units and adjust accordingly.

In offensive operations, automated reporting is useful in synchronizing the scheme of maneuver during unexpected contingencies such as identifying enemy obstacles. This exchange of automated combat information provides the commander and his staff critical information necessary to maintain and exploit the initiative during offensive operations. In defensive operations, automated reports enable commanders of digital units to transmit all information on enemy activity in sector in one digital spot report, instead of in many separate spot reports. With the increased reliance on digital technology comes the limitations of the hardware and software associated with the systems. Limitations in computer memory and communications capabilities address the requirement to maintain conventional control methods for units.

NONDIGITAL UNIT INTEGRATION

The integration of digitally-equipped elements with conventionally-equipped (nondigital) elements into the force presents special challenges for the commander and staff. The commander must ensure that both digital and nondigital procedures are available for communicating and supporting. The ASCC/ARFOR commander must establish provisions to receive automated information from digital units. Control measures used by digital units are identical to hard-copy overlays.

The ASCC/ARFOR commander must use liaison officers or establish other positive control measures to ensure proper coordination between digital and nondigital units. The ASCC/ARFOR commander must establish procedures that specify which reports will be communicated digitally, by voice, or in hard copy. Digital information will be processed for distribution to nondigital units.

SUPPORTING THE FORCE

Application of information operations (electronic management and information systems) necessitates the formation of strategic alliances between Army logistics mechanisms in theater and civilian industry. This forged linkage between the sustainment base and the ASCC/ARFOR commander will negate the

requirement for Army-managed, in-theater stockpiles and incorporate split-based operations. Because of situational awareness (the shared knowledge on the digitized battlefield between combat, CS, and CSS units), CSS units can maintain an *on-time inventory* of supplies and deliver the supplies

Appendix D

more efficiently. CSS units will push required support forward—to the right units at the right time.

Digitization of the battlefield will increase awareness and coordination over a wide area, enabling the commander to obtain the near real-time information he needs in the most efficient and effective format. This digitization provides the commander with—

- A common view of the battlefield.
- Situational awareness.
- Battlefield synchronization.

- C² on the move.
- Horizontal integration.
- Combat identification.
- Fratricide prevention.

To effectively plan the application and employment of these new technologies within the force, the ASCC/ARFOR commander must be aware of their advantages and disadvantages. Synchronizing digitized and nondigitized units will be a major task.

Glossary

A²C²	Army airspace command and control
AADC	area air defense commander
AAGS	Army Air-Ground System
AAWC	antiair warfare commander
AAWS	antiair warfare section
ABCA	American, British, Canadian, Australian
ABCCC	airborne battlefield command and control center
ACC	air component commander
ACCS	Army Command and Control System
ACE	analysis and control element (Army); aviation combat element (Air Force)
ACOM	United States Atlantic Command—a unified, maritime command
ACR	armored cavalry regiment
ACSIM	assistant chief of staff for installation management
active missile defense	measures taken to intercept, destroy, or negate the effects of an enemy missile launch
ACU	area common user
AD	air defense
ADA	air defense artillery
ADC	area damage control
ADCOM	air defense command
ADCON	administrative control
ADCOORD	air defense artillery coordinator
admin	administration
ADPE	automatic data processing equipment
ADPU	automatic data processing unit
AET	assessment and evaluation team
AFAC	airborne forward air controller
AFCC	Air Force component commander
AFCENT	Allied Forces Central Europe
AFSCC	Air Force service component command
AFSOC	Air Force special operations component
AFSOD	Air Force special operations detachments
AFSOE	Air Force special operations elements

Glossary

AFSOF	Air Force special operations forces
AGCCS	Army Global Command and Control System
AHFEWS	Army High-Frequency Electronic Warfare System
AID	United States Agency for International Development
ALCOM	Alaskan Command
allocation	the translation of apportionment into total numbers of resources
all-source analysis system	a system that collects and fuses intelligence data to support the commander's decision-making process
ALOC	air lines of communication
AME	air mobility element
AMEDD	Army medical department
AMOPES	Army Mobilization and Operations Planning and Execution System
amphibious objective area	a geographical area—delineated in the initiating directive for command and control—within which the objectives to be secured by the amphibious task force are located
ANGLICO	air and naval gunfire liaison company
AO	area of operations
AOA	amphibious objective area
AOB	alternate operating base
AOC	air operations center
Aofi	area of interest
AOR	area of responsibility
APA	Army pre-positioned afloat
APOD	aerial port of debarkation
apportionment	the determination and assignment of the total expected effort by percentage and/or by priority that should be devoted to the various air operations and/or geographic areas for a given period of time
area of assistance	area of land, sea, and air designated for the conduct of peacetime military operations other than war
area of conflict	area of land, sea, and air designated for the conduct of hostile military operations other than war
area of operations	a geographical area assigned to an army commander by a higher commander; the AO has lateral, forward, and rear boundaries that usually define it within a larger joint geographical area
area of responsibility	a defined area of land or sea in which responsibility is specifically assigned to the combatant commander of the theater for the development and maintenance of installations, control of movement, and conduct of joint operations involving troops under his control, along with parallel authority to exercise these functions

AREC	air resource element coordinator
ARL	aerial reconnaissance low
ARLO	Army liaison officer
ARFOR	Army forces; the headquarters and mission forces assigned to an Army service component command, subordinate joint force command, or multinational command
ARFOR commander	the senior army commander
Army Command and Control System	a system that encompasses the command and control systems, communications, and hardware and software required to implement the Army's portion of the Joint Operations Planning and Execution System and execute full-dimensional operations doctrine
Army service component commander	the senior army commander of an Army service component command assigned to a unified command; referred to as the <i>ASCC</i> : the <i>ASCC</i> performs service functions assigned by the UNAAF for the Army forces within the command and performs three strategic and operational-level tasks—establishes linkages, conducts operations, and conducts support operations; the <i>ASCC</i> functions in both the operational and service chain of command
ARSOA	Army special operations aviation
ARSOC	Army special operations component
ARSOCC	Army special operations component commander
ARSOF	Army special operations forces
ASA-FM	Assistant Secretary of the Army for Financial Management
ASAS	all-source analysis system
ASCC	Army service component commander
ASCS	air support control section
ASE	Army support element
ASG	area support group
ASI	all-source intelligence
ASM	air-to-surface missile
ASMB	area support medical battalion
ASMP	Army Strategic Mobility Program
ASOC	air support operations center
assign	to place units or personnel in an organization where such placement is relatively permanent and the organization controls and administers the units or personnel for the primary function, or greater portion of the functions, of the unit or personnel
ASUWC	antisurface warfare commander
ASWC	antisubmarine warfare command

ATACMS	Army Tactical Missile System
ATARS	Advanced Tactical Air Reconnaissance System
ATCS	air traffic control section
ATF	amphibious task force
ATO	air tasking order
attack operations	actions taken to neutralize or destroy an adversary's ability to produce, deploy, and employ theater missiles
ATTN	attention
auto	automation
AUTODIN	automatic digital network
AVIM	aviation intermediate maintenance
AVUM	aviation unit maintenance
AWACS	Airborne Warning and Control System
battle	a series of related tactical engagements
battle command	the art of motivating and directing soldiers and their organizations into action to accomplish missions; includes visualizing a future state and formulating concepts of operations to achieve that state, assigning missions, prioritizing and allocating resources, and selecting the critical time and place to act
battle management and command, control, communications, and intelligence	the process of coordinating and integrating joint and service capabilities to conduct passive defense, active missile defense, and attack operations
battlefield coordination element	an Army fire support coordination element located at an Air Force air operations center whose function is to monitor and interpret the land battle situation and provide land force needs for tactical air support to the air operations center and the Air Force component commander
battle space	components determined by the maximum capabilities of a unit to acquire and dominate the enemy; includes areas beyond the AO; varies over time according to how the commander positions his assets
BCE	battlefield coordination element
BCOC	base cluster operations center
BDA	battle damage assessment
BDCT	base defense coordination team
bde	brigade
BDOC	base defense operations center
BIDS	biological identification/detection system

bn	battalion
branches	options for changing dispositions, orientation, or direction of movement and accepting or declining battle; branches preserve the commander's freedom of action
C²	command and control
C²W	command and control warfare
C³	command, control, and communications
C³CM	command, control, and communications countermeasures
C³I	command, control, communications, and intelligence
C³IC	coalition coordination, communications, and integration center
C⁴	command, control, communications, and computers
C⁴I	command, control, communications, computers, and intelligence
C⁴IS	Command, Control, Communications, and Computers Information System
CA	civil affairs
C&C	collection and classification
CALL	Center for Army Lessons Learned
CAD	combat arms division
campaign	a series of related military operations designed to achieve one or more strategic or operational objectives within a given time and space
campaign plan	a plan for a series of related military operations aimed to achieve one or more strategic and operational objectives within a given time and space
CAP	crisis action planning
CAS	close air support
CATF	commander, amphibious task force
CCT	combat control team
C-Day	the unnamed day deployment operations commence
CDC	combat direction center
CENTCOM	United States Central Command
CFC	Combined Forces Command (Korea)
CHS	combat health support
CI	counterintelligence
CIA	Central Intelligence Agency
CID	criminal investigation division
CINC	the commander in chief of a unified or specified command

Glossary

CINCPAC	Commander in Chief, Pacific
CJCS	Chairman of the Joint Chiefs of Staff
CJTF	commander of the joint task force
CM	cruise missile
CMISE	corps military intelligence support element
CNR	combat net radio
co	company
COA	course of action
COCOM	combatant command
CofS	chief of staff
COID	combat operations intelligence division
combatant command	one of the unified or specified commands established by the President; nontransferable authority established by Title 10, United States Code, Section 134, exercised by combatant commanders; COCOM provides full authority to organize and employ commands and forces as the CINC considers necessary to accomplish assigned missions; the authority to perform those functions of command over assigned forces involving organizing and employing commands and forces, assigning tasks, designating objectives, and giving authoritative direction over all aspects of military operations, joint training, and logistics necessary to accomplish the missions assigned to the command
combatant commander	a commander in chief of a combatant command
combat power	the four primary elements—maneuver, firepower, protection, and leadership—combine to create combat power—the ability to fight; through effective application and sustainment, in concert with one another, these elements will decide the outcome of campaigns, major operations, battles, and engagements
combat zone	that area required by combat forces for the conduct of operations forward of the ARFOR rear area boundary
COMCARGRU	commander, carrier battle group
comdt	commandant
commander's intent	a concise expression of the purpose of the operation, a description of the desired end state and how the posture of units at the current operation end state facilitates transition to future operations; may include the commander's vision of how operations will progress toward that end
communications zone	the rear part of the theater that is contiguous to the combat zone; contains those theater installations and organizations required to support combat and combat support forces; has a three-dimensional aspect and reaches back to the CONUS base

COMMZ	communications zone
compt	comptroller
COMSEC	communications security
COMSOC	commander of the special operations command
CONPLAN	operation plan in concept format
constraint	actions the commander must take or methods that must be employed
CONUS	continental United States
coordinating authority	the authority granted to a commander or individual assigned responsibility for coordinating specific functions or activities involving forces of two or more countries or commands, two or more services, or two or more forces of the same service; this authority can require consultation among involved agencies or their representatives but cannot compel agreement; unresolved disagreements are referred to the appropriate authority
CORDS	Civil Operations Revolutionary Development Support
COSCOM	corps support command
countermobility	to delay, channel, or stop offensive movement by the enemy in order to destroy enemy forces directly or indirectly by enhancing the effectiveness of friendly direct- and indirect-fire weapon systems
CP	command post
CRC	control and reporting center
crisis action planning	the JOPES process involving the time-sensitive development of joint operation plans and orders in response to an imminent crisis; follows prescribed crisis-action planning to formulate and implement an effective response within the time frame permitted by the crisis
CS	combat support
CSCE	communications system control element
CSD	combat support division
CSG	cryptologic support group
CSR	controlled supply rate
CSS	combat service support
CSSAMO	combat service support automation management office
CSSD	combat service support division
CSSE	combat service support element
CTF	combined task force
CVBG	carrier battle group
CWC	composite warfare commander
CZ	combat zone

Glossary

D³	decide, detect, and deliver
D³A	decide, detect, deliver, and assess
DA	Department of the Army
DASC	direct air support center
DASC-A	direct air support center (airborne)
DCA	defensive counterair
DCS	defense communications system
DCSENG	deputy chief of staff for engineers
DCSHNA	deputy chief of staff for host nation activity
DCSI	deputy chief of staff for intelligence
DCSIM	deputy chief of staff for information management
DCSLOG	deputy chief of staff for logistics
DCSOPS	deputy chief of staff for operations
DCSPER	deputy chief of staff for personnel
DCSRM	deputy chief of staff for resource management
DCS Sys Auto	deputy chief of staff for systems automation
DDN	Defense Data Network
DDS	data distribution system
DEA	Drug Enforcement Agency
deception	those measures designed to mislead the enemy by manipulating, distorting, or falsifying evidence to induce the enemy to react in a manner prejudicial to its interests
decide, detect, deliver	targeting process that identifies enemy targets for possible engagement and determines the appropriate system to be used to capture, destroy, degrade, or neutralize the target in question
decisive engagement	an engagement in which a unit is considered fully committed and cannot maneuver or extricate itself; in the absence of outside assistance, the action must be fought to a conclusion and either won or lost with the forces at hand
Defense Logistics Agency	provides logistics support to the Army in areas of supply support, logistics services, and defense contract administrative support
deliberate planning	the JOPES process involving the development of joint operations plans for contingencies identified in joint strategic planning documents; conducted principally in peacetime; accomplished in prescribed cycles that complement other DOD planning cycles and in accordance with the formally established Joint Strategic Planning System
DEPCJTF	deputy commander of the joint task force
det	detachment

DFSA	designated finance support activity
DIA	Defense Intelligence Agency
direct support	a mission requiring a force to support another specific force and authorizing it to answer the supported force's request for assistance directly
DIRLAUTH	direct liaison authorized
DISA	Defense Information System Agency
DISE	Deployable Intelligence Support Element
DISNET	Defense Information Systems Network
div	division
DLA	Defense Logistics Agency
DMA	Defense Mapping Agency
DOCC	deep operations coordination center
DOD	Department of Defense
DOS	Department of State
DS	direct support
DSE	deception staff element
DSN	Defense Switched Network
EAC	echelons above corps
EEI	essential elements of information
ELINT	electronic intelligence
EMP	electromagnetic pulse
engagement	small, tactical conflicts, usually between opposing maneuver forces
EOD	explosive ordnance disposal
EPW	enemy prisoner of war
EUCOM	United States European Command—a unified command
EUSA	Eighth United States Army—the Army component to Combined Forces Command, Korea
EW	electronic warfare
EW/C	early warning/control
FAC	forward air controller
FAC(A)	forward air controller (airborne)
FACP	forward air control post
FB	finance battalion
FC	finance command
FFA	free-fire area

FID	foreign internal defense
FLOT	forward line of own troops
FM	field manual
FOB	forward operating base
FORSCOM	United States Army Forces Command—the Army component of US Atlantic Command (a unified command)
FSCC	fire support coordination center
FSCL	fire support coordination line
FSE	fire support element
FSS	fire support section
FST	finance support team
G1	assistance chief of staff, personnel
G2	assistant chief of staff, intelligence
G3	assistant chief of staff, operations and plans
G4	assistant chief of staff, logistics
G5	assistant chief of staff, civil affairs
G6	assistant chief of staff, signal
GCCS	Global Command and Control System
GCE	ground combat element
GDP	general defense plan
GIE	global information environment
GLO	ground liaison officer
GP	general purpose
GS	general support
HCS	helicopter control section
helo	helicopter
HEMCO	heavy equipment maintenance company
HHB	headquarters and headquarters battery
HHC	headquarters and headquarters company
HHD	headquarters and headquarters detachment
HNS	host nation support
HQ	headquarters
HQDA	Headquarters, Department of the Army
HSS	health service support
HUMINT	human intelligence
hvy	heavy

I&W	indications and warnings
ICAC²	Integrated Combat Airspace Command and Control
IES	imagery exploitation system
IEW	intelligence and electronic warfare
IG	inspector general
IGSM	intermediate general support maintenance
IMA	information mission area
IMET	international military education and training
IMINT	imagery intelligence
infrastructure	a term generally applicable to all fixed and permanent installations, fabrications, or facilities for the support or control of military forces
INSCOM	United States Army Intelligence and Security Command
intel	intelligence
interdiction	an action to divert, disrupt, delay, or destroy the enemy's surface military potential before it can be effectively used against friendly forces
in-transit visibility	the immediate access to data pertaining to the location of materiel in transit from the provider to the requester
IO	international organizations
IPB	intelligence-preparation-of-the-battlefield
IPW	interrogation prisoner of war
IR	information requirements
ISB	intermediate support basing
ISC	integrated systems control
ISE	intelligence support element
ITO	integrated tasking order
J1	personnel directorate at a joint headquarters
J2	intelligence directorate at a joint headquarters
J3	operations directorate at a joint headquarters
J4	logistics directorate at a joint headquarters
J5	plans and policy directorate at a joint headquarters
J6	communications-electronics directorate at a joint headquarters
JCCC	joint communications control center
JCGRO	joint central graves registration office
JCIOC	joint counterintelligence operations center
JCMEB	joint civil-military engineering board

Glossary

JCMEC	joint captured materiel exploitation center
JCS	Joint Chiefs of Staff
JCSE	joint communications support element
JDC	joint deployment community
JDEC	joint documents exploitation center
JFACC	joint force air component commander; a COCOM functional option
JFC	joint force commander
JFLCC	joint force land component commander; a COCOM functional option
JFMCC	joint force maritime component commander; a COCOM functional option
JFSOCC	joint force special operations component commander
JFUB	joint facilities utilization board
JIC	joint intelligence center
JIF	joint interrogation facility
JIPC	joint imagery processing center
JMAO	joint mortuary affairs office
JMBPO	joint military blood program office
JMC	joint movement center
JMCC	joint movement control center
JMEC	joint materiel exploitation center
JMFU	joint meteorological forecasting unit
JMRO	joint medical regulating office
JOA	joint operations area
JOC	joint operations center
joint command	a subordinate command of a unified command composed of joint forces and commanded by a subordinate joint force commander exercising operational control over the joint force
joint force	a general term applied to a force that is composed of significant elements of the Army, Navy, Marine Corps, and Air Force or two or more of these services operating under a subordinate joint force commander authorized to exercise operational control over joint forces or service components operating under a unified commander
joint operations area	that portion of an area of conflict in which a joint force commander conducts military operations pursuant to an assigned mission and the administration incident to such military operations

joint rear area	a specific land area within a joint force commander's area of operations that is designated to facilitate protection and operation of installations and forces supporting the joint force
joint rear area coordinator	the officer given responsibility for the overall securing of the JRA and for furnishing a secure environment to facilitate sustainment, host nation support, infrastructure development, and movements of the joint force
joint zone	an area established for the purpose of permitting friendly surface, air, and subsurface forces to operate simultaneously
JOPES	Joint Operations Planning and Execution System
JPO	joint petroleum office
JPOTF	joint psychological operations task force
JPOTG	joint psychological operations task group
JRA	joint rear area
JRAC	joint rear area coordinator
JRCC	joint rescue coordination center
JSCP	Joint Strategic Capabilities Plan
J-SEAD	joint suppression of enemy air defenses
JSOA	joint special operations area
JSOACC	joint special operations aviation component command
JSOCC	joint special operations component commander
JSOTF	joint special operations task force
JSPS	Joint Strategic Planning System
J-STARS	joint surveillance target and attack radar system
JTB	joint targeting board
JTCB	joint targeting coordination board
JTF	joint task force; a COCOM option
JTL	joint target list
JTLS	Joint Theater Logistics System
JTTP	joint tactics, techniques, and procedures
JULLS	Joint Universal Lessons Learned System
JZ	joint zone
LAAD	low altitude air defense
LAAM	light antiaircraft missile
lab	laboratory
LANDCENT	land component of Allied Forces Central Europe, subordinate to Allied Command Europe

Glossary

LCC	land component commander
LEMCO	light equipment maintenance company
letter of instruction	a means for defining interagency linkages at the operational level
light forces	units from an Army light, airborne, or air assault division or ranger regiment
line of communications	all the routes—land, water and air—that connect an operating military force with a base of operations and along which supplies and military forces move
lines of operation	the directional orientation of a force in relation to the enemy; lines of operation connect the force with a base of operations and its objective
linkage	a relationship between two or more parties, elements, or commands in any form that formulates a mutual understanding, agreement, or exchange of information
littoral theater	a theater established on a shore or coastal region where major actions between land, sea, and air operations are combined and must be synchronized
Indry	laundry
LNO	liaison officer
LOC	line of communication
LOGCAP	Logistics Civil Augmentation Program
logistics	the process of planning and executing the movement and sustainment of operating forces to execute military strategy and operations; includes the design, development, acquisition, storage, movement, distribution, maintenance, evacuation, and disposition of materiel; the movement, evacuation, and hospitalization of personnel; the acquisition or construction, maintenance, operations, and disposition of facilities; and the acquisition or furnishing of services
logistics support element	a multifaceted logistical organization with a work force of DA civilians, military, and contractors that is easily tailored to meet theater logistics requirements; the LSE can control the interface among strategic, operational, and tactical logistics
LOI	letter of instruction
LPT	logistics-preparation- of-the-theater
LSE	logistics support element
MACOM	major Army command
MAGTF	Marine air-ground task force
main battle area	the portion of the battlefield in which the decisive battle is fought to defeat the enemy
maint	maintenance

major operation	the coordinated actions of large forces in a single phase of either a theater or subordinate campaign; a major operation could contain a number of battles or could be a single critical battle
MARLO	Marine liaison officer
MASINT	measurement and signatures intelligence
MATCS	Marine air traffic control squadron
MBA	main battle area
MCA	movement control agency
MCC	movement control center
MCCC	Marine Corps component commander
MCSF	mobile cryptological support facility
MDCI	multidiscipline counterintelligence
MEDCOM	medical command
MEF	Marine expeditionary force
METL	mission-essential task list
METT-T	mission, enemy, terrain, troops, and time available
MI	military intelligence
MIA	missing in action
military end state	the required military conditions determined by the theater commander and integrated into the campaign plan that, when achieved, attains the strategic objectives or allows the main effort to be assumed by other instruments of national power to achieve the final strategic end state
MILNET	military network
mission forces	Army forces assigned, attached, apportioned, or allocated with an ARFOR commander to an Army service component command, a subordinate joint force command, or a multinational command to conduct missions as assigned by these commands
MLRS	Multiple Launch Rocket System
MMC	materiel management center
MOA	memorandum of agreement
MOE	measures of effectiveness
MOOTW	military operations other than war
MOPP	mission-oriented protection posture
MOS	military occupational specialty
MOU	memorandum of understanding
MP	military police
MRS	Mobility Requirement Study
MSCC	Marine service component command

MTMC	Military Traffic Management Command
MWRO	morale, welfare, recreation office
multinational operations	diplomatic-military actions between two or more agencies, with armed forces of two or more nations, to achieve the strategic end state; alliances or coalitions can be formed to carry out these actions
NAF	Naval air facility
NAFI	nonappropriated fund instrumentalities
NALE	naval and amphibious liaison element
NATO	North Atlantic Treaty Organization
NAVSOF	naval special operations forces
NBC	nuclear, biological, chemical
NCA	National Command Authorities
NCC	Naval component commander
NEO	noncombatant evacuation operations
NFA	no-fire area
NGO	nongovernmental organization
NICP	national inventory control point
NIST	national intelligence support teams
NSA	National Security Agency
NSCC	Navy service component command
NSNW	nonstrategic nuclear weapons
NSOC	Navy special operations component
NSS	<i>National Security Strategy</i>
NSWTG	Naval special warfare task group
NSWTU	Naval special warfare task unit
NTACS	Navy Tactical Air Control System
obj	objective
OCONUS	outside the continental United States
OCA	offensive counterair
ODA	Special Forces Operational A Team
OP	operational projects
OPCOM	operational command
OPCON	operational control
operational art	the skillful employment of military forces to attain strategic and/or operational objectives through the design, organization, integration, and conduct of theater strategies, campaigns, major operations, and battles;

	operational art translates combatant command strategy and theater design into operational design and, ultimately, tactical action by integrating the key activities of all levels of war within the theater
operational design	the design element of Army operational art; the application of operational art includes the design, organization, and execution of subordinate campaigns and major operations.
operational firepower	to apply the amount of fire that may be delivered by operational forces through all available means and systems; the application of firepower and nonlethal means to achieve a decisive impact on the conduct of a campaign or major operation
operational-level logistics	military operations other than war activities during peacetime and conflict that do not necessarily involve armed clashes between organized forces
OPLAN	operations plan
opns	operations
OPORD	operations order
opposed entry	combat operations required to land deploying forces
OPSEC	operations security
OTC	officer in tactical command
PA	public affairs
PACOM	United States Pacific Command
PAO	public affairs officer
passive missile defense	those individual and collective measures taken to posture the force to minimize the effects of a missile attack
PE	peace enforcement
peacekeeping operations	operations using military forces and/or civilian personnel at the request of the parties to a dispute to help supervise a cease-fire agreement and/or separate the parties
PERSCOM	personnel command
PIR	priority intelligence requirements
plt	platoon
PM	provost marshal
POTF	psychological operations task force
PRC	population and resource control
PSD	personnel service directorate
PSS	personnel service support
PSYOP	psychological operations
PVO	private voluntary organization

Glossary

QASAS	quality assurance specialist - ammunition surveillance
QSTAG	quadripartite standardization agreement
RAOC	rear area operations center
RCCM	regional contingency construction manager
RCEM	regional contingency engineering manager
RDTE	research, development, test, and evaluation
REAT	reconstitution assessment and evaluation team
recce	reconnaissance
renov	renovation
restrictions	prohibitions on specific actions or categories of actions
RFA	restricted fire area
RGFC	Republican Guard Forces Command
RISTA	reconnaissance, intelligence, surveillance, and target acquisition
ROC	rear operations center
ROE	rules of engagement
RPMA	real property maintenance activities
RPV	remotely piloted vehicle
RSI	rationalization, standardization, and interoperability
rules of engagement	directives issued by competent military authority that delineate the circumstances and limitations under which US forces will initiate and/or continue combat engagement with other encountered forces
RWCM	regional wartime construction manager
S1	personnel officer
S2	intelligence officer
S3	operations and training officer
S4	supply officer
S5	civil affairs officer
S&S	supply and services
SACC	supporting arms coordination center
SAILS	Standard Army Intermediate Level Supply System
SALT	supporting arms liaison team
Sandcrab	AN/TLQ-17A; a jamming/direction-finding system
SAO	security assistance office
SAPO	subarea petroleum office
SEAD	suppression of enemy air defenses

SECDEF	Secretary of Defense
sequels	actions after operations; sequels are an important means of anticipating the course of action and accelerating the decision cycle; they are based on the possible outcomes of operations—victory/success, defeat/failure, or stalemate; they establish general dispositions, objectives, and missions for subsequent subordinate operations; they can be amended as necessary and ordered into effect
SF	Special Forces
SFOB	Special Forces operating base
SIGINT	signals intelligence
SIGSEC	signal security
SJA	staff judge advocate
SLOC	sea lines of communication
SOA	special operations aviation
SOC	special operations command
SOCCE	special operations command and control element
SOCOM	United States Special Operations Command
SOCOORD	special operations coordination element
SOF	special operations forces
SOFA	status of forces agreement
SOFSCC	special operations forces component command
SOI	signal operating instructions
SOSC	special operations support command
SOTSE	special operations theater support element
SOUTHCOM	United States Southern Command
SPACECOM	United States Space Command
split-based operations	dividing logistics management functions so that only those functions absolutely necessary are deployed, allowing some management functions to be accomplished from CONUS or another theater
SPO	security, plans, and operations
SPOD	seaports of debarkation
sqdns	squadrons
SRA	separated reporting activities
STRATCOM	United States Strategic Command
strategic advantage	the overall relative power relationship of opponents that enables one nation or group of nations to effectively control the course of a military/diplomatic situation
strategic concentration	the assembly of a designated force in areas from which intended operations shall begin so that the force is best disposed to initiate the plan of campaign

Glossary

strategic end state	the set of required diplomatic, economic, informational, and military conditions integrated by the NCA in national security policy to achieve a desired strategic outcome or national security objectives in a crisis situation
sup	supply
supported CINC	the CINC for the theater of focus; <i>see also</i> supporting CINC
supporting CINC	a CINC for an economy-of-force theater or deferred theater; theater resources may be reallocated/reoriented toward support for the theater of focus; <i>see also</i> supported CINC
SVS	Secure Voice System
SWC	strike warfare commander
SWO	staff weather officer
sys auto	systems automation
TAACOM	theater army area command
TAADCOM	theater army air defense command
TAC	tactical air coordinator
TAC(A)	tactical air coordinator (airborne)
TACAIR	tactical air
TACC	tactical air command center (USMC); tactical air control center (USN)
TACOM	tactical command
TACON	tactical control
TACP	tactical air control party
TACS	theater air control system
TACSAT	tactical satellite
TADC	tactical air direction center
TAI	target area of interest
TALCE	theater airlift control element
TALSM	theater army logistics system manager
TAMCA	theater army movement control agency
TAML	theater army medical laboratory
TAMMC	theater army materiel management center
TAOC	tactical air operations center
TAPOC	theater army personnel operations center
TBM	tactical ballistic missile
TCAE	technical control and analysis element
TCF	tactical combat force
TDA	table of distribution and allowances

TECHINT	technical intelligence
TENCAP	tactical exploitation of national capabilities
TF	task force
TFC	theater finance command
THAAD	theater high-altitude air defense
theater	the geographical area outside the continental United States for which a commander of a unified or specified command has been assigned military responsibility
theater base	a sizable portion of the joint rear area containing logistics facilities, such as ports of debarkation, marshalling areas, logistics stockage areas, movement control points, logistics headquarters and units, and the rear portion of the intratheater communications zone, together with airfields and air bases, transitioning land forces, theater missile defense forces, the theater rear headquarters, and strategic reserves
theater design	the theater commander's strategic intent to be derived by a strategic estimate and translated into his theater strategy and campaign plans, which provide strategic direction and operational focus to the principal subordinates
theater missile defense	protection against theater missile attack through an integrated and coordinated mix of mutually supporting measures; all service components participate in TMD; TMD for force projection, forward presence, reinforcing forces, and designated theater strategic assets, such as ports, airfields, or civilian population centers, must be considered; supporting measures are called TMD pillars and entail passive missile defense, active missile defense, attack operations, and battle management and C ³ I
theater of operations	that portion of a theater of war necessary for military operations to achieve an assigned mission and for the support incident to the operations
theater of war	that area of air, land, sea, and space that is or may become directly involved in the operations of war
theater strategic environment	a composite of the conditions, circumstances, and influences in the theater that describe the diplomatic-military situation, affect the employment of military forces, and affect the decisions of the operational chain of command
theater strategic maneuver	the employment of unified and joint forces from positions of strategic concentration against the strategic center of gravity to achieve the military end states within the strategic end state
THREATCON	terrorist threat conditions
threat conditions	a system that provides procedures for terrorism analysts to assess the terrorist threat and for commanders to determine appropriate security measures based on the assessed threat of terrorist attack

Glossary

TOC	tactical operations center
TOE	table of organization and equipment
total asset visibility	the immediate access to data pertaining to the location of aircraft, ships, trucks, and trains moving equipment and supplies from the provider to the requestor
TOR	terms of reference
TPFDD	time-phased force and deployment data
TPFDL	time-phased force and deployment list
TRADOC	United States Army Training and Doctrine Command
trans	transportation
Trackwolf	AN/TSQ-152(V); operational-level, high frequency skywave communications-intelligence collection and direction-finding system used to support the operational-level commander
TRANSCOM	United States Transportation Command
Trojan	AN/TSQ-190(V); intelligence dissemination satellite terminal that provides access for intelligence processing and dissemination systems
U-2R	variant of U-2 aircraft sensing platform
UAV	unmanned aerial vehicle
UCP	Unified Command Plan
UN	United Nations
UNAAF	Unified Action Armed Forces
unified force	a general term applied to a force composed of joint, service, special, and supporting forces operating under the command of a unified commander and in conjunction with or for interagency, United Nations, or multinational forces
Unified Command Plan	the document, approved by the President, which sets forth basic guidance to all unified combatant commanders, establishes their missions, responsibilities, and force structure; delineates the general geographical area of responsibility for geographic combatant commanders; and specifies functional responsibilities for functional combatant commanders
unified operations	a strategic operation encompassing the wide scope of subordinate actions taking place within theater unified commands under the overall direction of the commanders of those commands; a unified operation integrates joint, single-service, special, and supporting operations in conjunction with interagency, nongovernmental, private voluntary, multinational, or United Nations operations into a unity of effort in the theater
US	United States
USA	United States Army

USACOM	United States Atlantic Command
USACE	United States Army Corps of Engineers
USAF	United States Air Force
USAID	United States Agency for International Development
USAF	United States Air Force
USAMC	United States Army Materiel Command
USAR-J	United States Army, Japan
USARPAC	United States Army, Pacific
USASOC	United States Army Special Operations Command
USC	United States Code
USFJ	United States Forces, Japan
USFK	United States Forces, Korea
USIA	United States Information Agency
USMC	United States Marine Corps
USN	United States Navy
USPW	United States prisoner of war
USSOCOM	United States Special Operations Command
USTAPERSCOM	United States Total Army Personnel Command
USTRANSCOM	United States Transportation Command
UW	unconventional warfare
UXO	unexploded ordnance
WMD	weapons of mass destruction
WOC	wing operations center
WWMCCS	Worldwide Military Command and Control System

References

SOURCES USED

These are the sources quoted or paraphrased in this publication.

STATUTES

- Public Law 94-329. *Arms Export Control Act of 1976*. 30 June 1976.
Public Law 87-195. *Foreign Assistance Act of 1961*. 4 September 1961.
Public Law 61-253. *National Security Act (NSA) of 1947*. 26 July 1947.
Public Law 433. *The Goldwater Nichols Department of Defense Reorganization Act of 1986*. 1 October 1986.

STRATEGIC PUBLICATIONS

- Joint Strategic Capability Plan*.
National Military Strategy. February 1995.
National Security Strategy. January 1994.
National Security Strategy. January 1995.

JOINT AND MULTISERVICE PUBLICATIONS

- FM 90-12/FMFRP 2-73/TACP 50-50/PACAF 50-50/USAFEP 50-50/AACP 50-50. *Base Defense - Multiservice Procedures for Defense of a Joint Base*. 2 October 1989.
- FM 90-23/TACP 50-49/USAFEP 50-49/PACAF 50-49/AACP 50-49. *Rear Security Operations - Army-Tactical Air Forces Procedures for Rear Security Operations at Echelons Above Corps*. 14 November 1989.
- FM 100-103-1/FMFRP 5-61/NDC TACNOTE 3-52.1/ACCP 50-38/USAFEP 50-38/PACAF 50-38. *Multiservice Procedures for Integrated Combat Airspace Command and Control (ICAC²)*. 3 October 1994.
- Joint Pub 0-2. *Unified Action Armed Forces*. 11 August 1994.
- Joint Pub 1-02. *DOD Dictionary of Military and Associated Terms*. 24 March 1994.
- Joint Pub 3-0. *Doctrine for Unified and Joint Operations*. 9 September 1993.
- Joint Pub 3-05.5. *Joint Special Operations Targeting and Mission Planning Procedures*. August 1993.
- Joint Pub 3-07. *Joint Doctrine for Military Operations Other Than War*. 18 July 1994.
- Joint Pub 3-09. *Doctrine for Joint Fire Support*. February 1995 (second draft).
- Joint Pub 3-10. *Doctrine for Joint Rear Area Operations*. 26 February 1993.
- Joint Pub 3-10.1. *Joint Tactics, Techniques, and Procedures for Base Defense*. 15 March 1993.
- Joint Pub 3-56.1. *Command and Control for Joint Air Operations*. 15 August 1993.

- Joint Pub 5-O. *Doctrine for Planning Joint Operations*. 15 August 1994.
- Joint Pub 5-00.1. *Joint Tactics, Techniques, and Procedures for Campaign Planning*. 1 July 1994 (first draft).
- Joint Pub 5-00.2. *Joint Task Force Planning Guidance and Procedures*. September 1991.
- Joint Pub 6-O. *Doctrine for Command, Control, Communications, and Computer (C³) Systems Support to Joint Operations*. 3 June 1992.
- Joint Pub 6-05.1. *Employment of Joint Tactical Communications Systems*. 24 April 1992.

ARMY PUBLICATIONS

- AR 500-5. *Army Mobilization, Operations, and Planning Execution System*. May 1992.
- FM 3-3. *Chemical and Biological Contamination Avoidance*. 16 November 1992.
- FM 3-4. *NBC Protection*. 29 May 1992.
- FM 1-111. *Aviation Brigades*. August 1990.
- FM 3-4. *NBC Protection*. 29 March 1992.
- FM 3-100. *NBC Defense, Chemical Warfare, Smoke and Flame Operations*. 23 May 1991.
- FM 3-101. *Chemical Staff and Units*. September 1993 (final draft).
- FM 5-116. *Engineer Operations: Echelons Above Corps*. March 1989.
- FM 6-20. *Fire Support in the AirLand Battle*. May 1988
- FM 6-20-10. *Tactics, Techniques, and Procedures for the Targeting Process* (to be published).
- FM 7-85. *Ranger Unit Operations*. June 1987.
- FM 8-10. *Health Service Support in a Theater of Operations*. March 1991.
- FM 9-15. *Explosive Ordnance Disposal Service and Unit Operations*. 20 March 1989.
- FM 10-67. *Petroleum Supply in Theaters of Operations*. February 1983.
- FM 11-45. *Signal Support: Echelons Above Corps (EAC)*. April 1993.
- FM 11-75. *Battlefield Information Services*. October 1993.
- FM 12-6. *Personnel Doctrine*. September 1994.
- FM 14-7. *Finance Operations*. August 1994.
- FM 22-103. *Leadership and Command at Senior Levels*. 21 June 1987.
- FM 24-1. *Signal Support and the Information Mission Area*. May 1993.
- FM 25-100. *Training The Force*. 15 November 1988.
- FM 27-100. *Legal Operations*. 3 September 1991.
- FM 31-12. *Army Forces in Amphibious Operations (The Army Landing Forces)*. 28 March 1991.
- FM 31-20. *Doctrine for Special Forces Operations*. April 1990.
- FM 33-1. *Psychological Operations*. February 1993.

References

- FM 33-1-1. *Psychological Operations Tactics, Techniques, and Procedures*. November 1992 (coordinating draft).
- FM 34-1. *IEW Operations*. 27 September 1994.
- FM 34-37. *Echelons Above Corps Intelligence and Electronic Warfare Operations*. January 1991.
- FM 41-10. *Civil Affairs Operations*. December 1985.
- FM 44-1. *US Army Air Defense Artillery Employment*. 21 September 1984.
- FM 44-100. *US Army Air Defense Operations*. December 1994 (final draft).
- FM 46-1. *Public Affairs Operations*. July 1992.
- FM 54-40. *Area Support Group*. July 1987.
- FM 55-1. *Army Transportation Operations* (to be published).
- FM 55-10. *Movement Control in a Theater of Operations*. December 1992.
- FM 63-3. *Corps Support Command*. September 1993.
- FM 63-4. *Combat Service Support Operations - Theater Army Area Command*. September 1984.
- FM 71-100. *Division Operations*. July 1994 (coordinating draft).
- FM 90-29. *Noncombatant Evacuation Operations (NEO)*. 1 November 1993 (final draft).
- FM 100-1. *The Army*. December 1991.
- FM 100-5. *Operations*. 14 June 1993.
- FM 100-6. *Information Operations*. 22 July 1994 (coordinating draft).
- FM 100-8. *The Army in Multinational Operations*. December 1994 (revised draft).
- FM 100-9. *Reconstitution*. 13 January 1992.
- FM 100-10. *Combat Service Support*. 18 February 1988.
- FM 100-15. *Corps Operations*. September 1989.
- FM 100-16. *Army Operational Support*. 31 May 1995.
- FM 100-19. *Domestic Support Operations*. 1 July 1993.
- FM 100-20. *Military Operations in Low Intensity Conflict*. December 1990.
- FM 100-23. *Peace Operations*. 30 December 1994
- FM 100-25. *Doctrine for Army Special Operations Forces*. 1 January 1991.
- FM 100-103. *Army Airspace Command and Control in a Combat Zone*. 7 October 1987.
- FM 101-5. *Command and Control for Commanders and Staffs*. August 1993.
- TRADOC Pamphlet 11-9. *Blueprint of the Battlefield* (to be published).
- TRADOC Pamphlet 525-5. *Force XXI Operations*. 1 August 1994.

OTHER PUBLICATIONS

- AFM 1-1. *Basic Aerospace Doctrine*. 16 March 1984.
- FMFM 1. *Campaigning*. 25 January 1990.

- FMFM 1-1. *Warfighting*. 6 March 1989.
- Certain Victory: The US Army in the Gulf War*. Washington, DC: Headquarters, Department of the Army. August 1990.
- “Elimination of the Field Army.” *Military Review*. October 1973.
- Conduct of the Persian Gulf Conflict: An Interim Report to Congress*. Washington, DC: United States Department of Defense. July 1991.
- Foss, John W. “Command.” *Military Review*. May 1990.
- Holder, L.D. “Training for the Operational Level.” *Parameters*, Vol 16, No 1. Spring 1986.
- Large Units: Theater Army—Army Group—Field Army*. Combat Studies Institute Report No 6. January 1985.
- Luvass, Jay. “Thinking at the Operational Level.” *Parameters*, Vol 16, No 1. Spring 1986.
- Naval Doctrine Publication 1. *Naval Warfare*. 28 March 1994.
- Operational Art in Low-Intensity Conflict*. Center for Low Intensity Conflict Papers. September 1985.
- Strategic Studies Institute, US Army War College. *The Operational Art of Warfare Across the Spectrum of Conflict*. 1 February 1987.
- After-Action Report Executive Summary*. US Army Forces, Somalia, 10th Mountain Division (L). May 1993.
- Von Clausewitz, Carl. *On War*. Edited and translated by Michael Howard and Peter Paret, Princeton University Press, 1976.
- Yeosock, John J. “Army Operations in the Gulf Theater.” *Military Review*. September 1991.
- Yeosock, John J. “H+100: An Army Comes of Age in the Persian Gulf.” *Military Review*. October 1991.

DOCUMENTS NEEDED

- These documents must be available to the intended user of this publication.
- AR 523-13. *The Army Combatting Terrorism Program*. 26 June 1992.
- FM 3-100. *NBC Defense, Chemical Warfare, Smoke, and Flame Operations*. 23 May 1991.
- FM 3-101. *Chemical Staffs and Units*. September 1993 (draft).
- FM 63-4. *Combat Service Support Operations, Theater Army Area Command*. December 1989.
- FM 100-5. *Operations*. 14 June 1993.
- FM 100-6. *Information Operations*. 22 July 1994 (coordination draft).
- FM 100-8. *Combined Army Operations*. 1 November 1993 (revised final draft).
- FM 100-10. *Logistics*. April 1994 (initial draft).
- FM 100-15. *Corps Operations*. September 1989.
- FM 100-16. *Army Operational Support*. (to be published).

References

- FM 100-17. *Mobilization, Deployment, Redeployment, Demobilization*. 28 October 1992.
- FM 100-20. *Military Operations in Low-Intensity Conflict*. December 1990.
- FM 100-25. *Doctrine for Army Special Operations Forces*. 1 January 1991.
- FM 101-5. *Command and Control for Commanders and Staffs*. August 1993 (final draft).
- Joint Pub 0-2. *Unified Action Armed Forces*. 11 August 1994.
- Joint Pub 1. *Joint Warfare for the US Armed Forces*. 11 November 1991.
- Joint Pub 1-01. *Joint Publications System (Joint Tactics, Techniques, and Procedures Development Program)*. 14 September 1993.
- Joint Pub 2-0. *Doctrine for Intelligence Support to Joint Operations*. 12 October 1993.
- Joint Pub 3-0. *Doctrine for Joint Operations*. 9 September 1993.
- Joint Pub 3-00.1. *Joint Doctrine for Contingency Operations* (to be published).
- Joint Pub 3-01.2. *Joint Doctrine for Theater Counterair Operations*. 15 March 1993.
- Joint Pub 3-01.4. *Joint Tactics, Techniques, and Procedures for Joint Suppression of Enemy Air Defenses*. June 1990.
- Joint Pub 3-03. *Doctrine for Joint Interdiction Operations*. 11 December 1990.
- Joint Pub 3-04. *Doctrine for Joint Maritime Operations (Air)*. 31 July 1991.
- Joint Pub 3-05. *Doctrine for Joint Special Operations*. 17 October 1990.
- Joint Pub 3-07. *Doctrine for Joint Operations in Low-Intensity Operations*. 18 October 1990.
- Joint Pub 3-08. *Doctrine for Joint Ballistic Missile Defense* (to be published).
- Joint Pub 3-10. *Doctrine for Joint Rear Area Operations*. 26 February 1993.
- Joint Pub 3-10.1. *Joint Tactics, Techniques, and Procedures for Base Defense*. 15 March 1993.
- Joint Pub 3-11. *Joint Doctrine for Nuclear, Biological, and Chemical (NBC) Defense* (to be published).
- Joint Pub 3-12. *Doctrine for Joint Nuclear Operations*. 29 April 1993.
- Joint Pub 3-13. *C³CM in Joint Military Operations*. 10 September 1987.
- Joint Pub 3-14. *Joint Doctrine for Space Operations*. 15 November 1990.
- Joint Pub 3-15. *Joint Doctrine for Barriers, Obstacles, and Mines*. 20 June 1993.
- Joint Pub 3-17. *Joint Tactics, Techniques, and Procedures for Theater Airlift Operations* (to be published).
- Joint Pub 3-51. *Electronic Warfare in Joint Military Operations*. 30 June 1991.
- Joint Pub 3-52. *Doctrine for Joint Airspace Control in a Combat Zone*. 3 December 1993.
- Joint Pub 3-53. *Joint Psychological Operations Doctrine*. 30 July 1993.
- Joint Pub 3-54. *Joint Doctrine for Operations Security*. 21 August 1991.

- Joint Pub 3-55. *Doctrine for Joint Reconnaissance, Surveillance, and Target Acquisition*. 15 November 1990.
- Joint Pub 3-56. *Tactical Command and Control Planning Guidance and Procedures for Joint Operations*. 16 May 1979.
- Joint Pub 3-57. *Doctrine for Joint Civil Affairs*. May 1990.
- Joint Pub 3-58. *Joint Doctrine for Operational Deception* (to be published).
- Joint Pub 3-59. *Joint Doctrine for Meteorological and Oceanographic Support*. 1 June 1990.
- Joint Pub 4-0. *Doctrine for logistics Support of Joint Operations*. 25 September 1992.
- Joint Pub 4-01. *Mobility System Policies, Procedures, and Considerations*. 15 September 1983.
- Joint Pub 4-01.3. *Joint Tactics, Techniques, and Procedures for Movement Control*. 26 January 1994.
- Joint Pub 5-00.2. *Joint Task Force Planning Guidance and Procedures*. 3 September 1991.
- Joint Pub 5-03 Series. *Joint Operations Planning and Execution System* (to be published).
- Joint Pub 5-03.1. *Joint Operations Planning and Execution System (Execution)*. August 1993.
- Joint Pub 6-02. *Joint Doctrine for Operational/Tactical C³ Systems*. 7 March 1978.
- Joint Pub 6-04 Series. *United States Message Text Formatting*. October 1991.
- Joint Pub 6-05.1. *Employment of Joint Tactical Communications Systems*. 24 April 1992.
- Joint Pub 6-05.2. *Manual for Employing Joint Tactical Communications Systems Joint Voice Communication Systems*. 1 March 1989.
- Joint Pub 6-05.3. *Manual for Employing Joint Tactical Communications Systems Joint Record Data Communication*. 15 November 1990.
- Joint Pub 6-05.4. *Manual for Employing Joint Tactical Communications Systems Joint Transmissions Systems*. 1 July 1990.
- Joint Pub 6-05.5. *Manual for Employing Joint Tactical Communications Systems Joint Communications Security (C)*. November 1989.
- Joint Pub 6-05.6. *Manual for Employing Joint Tactical Communications Systems Joint Tactical Technical Controls Procedures/Systems*. 15 October 1987 (in revision).
- Joint Pub 6-05.7. *Manual for Employing Joint Tactical Communications Systems Joint Network Management and Control Systems*. 31 August 1992.
- Joint Pub 6-05.2. *Manual for Employing Joint Tactical Communications Systems Joint Voice Communication Systems*. 1 March 1989.
- Joint Pub 6-05.3. *Manual for Employing Joint Tactical Communications Systems Joint Record Data Communication*. 15 November 1990.
- Joint Pub 6-05.4. *Manual for Employing Joint Tactical Communications Systems Joint Transmission Systems*. 1 July 1990.

References

- Joint Pub 6-05.5. *Manual for Employing Joint Tactical Communications Systems Joint Communications Security (C)*. November 1989.
- Joint Pub 6-05.6. *Manual for Employing Joint Tactical Communications Systems Joint Tactical Technical Controls Procedures/Systems*. 15 October 1987 (in revision).
- Joint Pub 6-05.7. *Manual for Employing Joint Tactical Communications Systems Joint Network Management and Control Systems*. 31 August 1992.

READINGS RECOMMENDED

These readings contain relevant supplemental information.

- AFM 1-1. *Basic Aerospace Doctrine of the US Air Force*. March 1992.
- FM 22-103. *Leadership and Command at Senior Levels*. June 1987.
- FM 25-100. *Training the Force*. November 1988.
- FM 100-19. *Domestic Support Operations*. July 1993.
- National Military Strategy*. February 1995
- TRADOC Pamphlet 525-5. *Force XXI Operations*. 1 August 1994.

Index

A

A²C² 4-11, 5-3, 5-4
AAGS 5-5
ACC 5-4, 5-9, 7-8
acceptability, of force 8-1
ACE A-20, A-22
actions to restore order 1-9
ad hoc coalition 2-14
ADA
 and force protection 5-10
 Patriot, 5-11
ADCON v, 2-9, 2-24
 authority 2-7
 of forces apportioned to
 combatant commands 2-6
administrative control.
 See ADCON
administrative support 2-6
aerial ports of debarkation A-5
AFCC 5-5
after-action report, US Army
 Forces, Somalia, 10th Mountain
 Division 6-6
agricultural assistance A-19
AHFEWS A-22
air commanders 5-4, 5-8
air component commander.
 See ACC
air defense 6-17, A-8
 artillery. *See* ADA
 C² A-18
 function A-19
 relationships A-18
air elements 5-11
Air Force component commander.
 See AFCC
Air Force special operations
 forces A-30
air interdiction 1-9, 4-11, 5-3

air lines of communication.
 See ALOCs
air operations 1-9, 5-2
air operations center. *See* AOC
airborne warning and control
 system. *See* AWACS
aircraft
 fixed-wing 7-8
 rotary-wing 7-8
airlift 5-3
Alaskan Command 2-13
alcohol and drug abuse
 prevention and control A-12
alliances
 and agreements v, 2-14, 2-15,
 2-27
 integrated command structure
 2-16
 lead nation command
 structure 2-16
 multinational army command
 structure 2-16
 operations 1-12
allocation
 of forces 2-4
 of resources 1-5, 2-18
all-source analysis system.
 See ASAS
ALOCs A-4
ambassadors 4-14, 8-5
America's national security
 interests iv
American Red Cross 1-9, A-5
ammunition
 management 4-10
 supply and storage A-8
AMOPES 6-15, 8-11.
 See also JOPES
amphibious capabilities 1-7
analysis and control element.
 See ACE

anticipation 1-3, 1-5, 1-6, 5-21
antiterrorism 8-16
AOC 5-9
AOR 1-5
APA 6-2
Apache attack helicopter 5-5
area damage control 7-11
area defense 5-2
area of assistance 2-22
area of conflict 2-21
area of responsibility. *See* AOR
area support A-7
ARFOR iii, iv, v, 6-16, 8-2, 8-3,
 8-12
 headquarters 4-11
 and postconflict operations
 1-9
 protection of 8-3
ARFOR commander iii, v, 2-24,
 4-11, 6-15, 6-17, 7-8, 8-4
 assigned to JTF 2-23, 6-15
 as JFC's primary advisor on
 Army matters 6-19
armed helicopters 2-28
arming, as a characteristic of CSS
 5-21
armor 7-6
Arms Export Control Act of 1976
 8-8
Army
 aviation 5-11, A-20
 corps 2-26
 doctrine iii
 echelons. *See* echelons of
 command
 groups A-1
 operations in war 7-1–7-18
Army Air-Ground System.
 See AAGS

Index

- Army airspace command and control. *See* A²C²
- Army Chief of Staff v, 2-24
- Army commander 3-4
- as the CJTF 6-9
 - as a JFLCC 6-8
 - and operational fires 5-5
 - as a subordinate joint force commander 2-27
- Army component operations 6-1–6-20
- Army forces. *See* ARFOR
- Army Global Command and Control System. *See* AGCCS
- Army High-Frequency Electronic Warfare System. *See* AHFEWS
- Army Information System Network A-10
- Army JFC 2-27, 6-9. *See also* JFC
- Army Mobilization and Operations Planning and Execution System. *See* AMOPES
- Army National Guard maintenance units A-20
- Army operational-level commander 2-22–2-24
- as central integrator of a joint and multinational team 1-9
 - in war 7-3, 7-4, 7-5, 7-13, 7-14, 7-16
- Army pre-positioned afloat. *See* APA
- Army service chain 2-24
- Army service component iii, A-0
- configurations A-1
 - functions during war 7-2
 - functions in conflict 8-11
- Army service component command 2-25, A-1
- BCE 5-9
 - capabilities and functions A-3
 - deputy chief of staff for operations 6-11
 - headquarters echelons A-5
 - organizational options A-0
 - responsibilities and organization A-0–A-32
 - structure of 5-20
- Army service component commander. *See* ASCC
- Army special operations forces. *See* ARSOF
- Army staff planners, and JTF and ARFOR plans 6-11
- Army Strategic Mobility Program. *See* ASMP
- Army support element A-28
- Army tactical missile system. *See* ATACMS
- ARSOF 6-11, A-18
- artillery 7-6
- arts, monuments, archives, and cultural affairs A-19
- ASAS A-22
- ASCC commander iii, v, 1-1, 2-7, 2-13, 2-22, 2-25, 2-26, 8-3, A-27
- and authority 2-6, 2-7
 - as the CJTF A-2
 - and development of supporting plans 4-11
 - as the JFLCC 2-27
 - and logistics 5-20, A-5
 - and mid- and long-range planning A-2
 - operational-level tasks A-2
 - in operations in war 7-3
 - in peacetime 8-2
 - planning and conduct of major operations 4-12
 - planning to terminate combat operations 8-18
 - as the principal advisor 2-12
 - and reception and onward movement 7-17
 - and redeployment of forces 8-19
 - responsibilities of 2-23–2-26
 - responsibilities in contingency operations 6-3
 - support to ARFOR in a JTF 2-25
 - support and reconstitution responsibilities A-6
 - and support operations A-3
 - of subunified commands, 2-13
 - strategic peacetime tasks A-2
 - of the unified or subunified command 2-23
- ASCC/ARFOR commander D-1
- ASMP Action Plan 6-2
- assessment
- factors 2-4
 - of the operational environment 2-25
 - of the situation 1-3
- ATACMS 5-5
- attacks 5-1, 8-17
- attacks, frontal 5-2
- augmentation
- of forces 6-8, 6-9, 2-23
 - modular concept 6-9
 - of staff sections 6-5
- AUTODIN 6-12
- automated information D-0
- Automatic Digital Network. *See* AUTODIN
- automation of reports D-1
- aviation
- support A-8
 - support, Army A-19, A-20
- AWACS A-17
- ## B
- balance, and force mix 1-6
- ballistic missiles 1-8, 2-28
- base cluster commander 7-12
- base cluster operations center. *See* BCOC
- base defense coordination team. *See* BDCT
- base defense operations center. *See* BDOC
- base defense plans 7-12
- base security 6-5
- base/base cluster defense plan 5-13
- battle command 1-5, 1-7
- battle command organizations, logistical 5-20
- battle damage assessment. *See* BDA
- battle dynamics 1-5, 1-7
- battle space 1-3, 1-4, 1-5, 1-7, 8-6, D-1
- continuous estimate of 7-4
 - extending 5-5
 - and offensive operations 5-2
- battlefield coordination element. *See* BCE

battlefield framework 5-15
 battles 1-5
 BCE 5-9, 7-9
 BCE/tactical air control interface
 5-10
 BCOC 7-12
 BDA 5-17, 7-9, A-22
 BDA planning 8-3
 BDCT 7-12
 biological weapons 5-14. *See also*
 WMD
 Boy Scouts of America, and
 MOOTW 1-9
 branches and sequels to
 deployment and combat
 operations 1-9, 3-3, 6-2
 buildup of force capability 6-17

C

C² 2-10, 2-25, 7-2, 8-5
 during conflict 8-14
 within multinational
 operations 2-17
 operations A-1
 relationships 2-17
 responsibilities 7-11
 unified 2-22
 C³ 8-16
 C³ interface A-28
 C³CM plan 7-9
 C³I 5-14, 8-4
 C³IC 2-14
 C⁴ 4-9
 control centers 6-12
 network 4-14
 C⁴I 5-11
 CA 6-9, 6-18, 6-19, 8-3, 8-8, 8-10,
 A-8, A-12, A-19, A-28
 functions A-19
 G5 A-5
 operations 4-11
 organization A-19
 CALL 6-15
 campaign plan iii, 1-1, 1-2, 2-4,
 3-0, 4-0, 4-1, 4-3, 5-19
 approval of 4-2
 CINC's 2-11
 development of 7-14
 and employment of forces 1-2

requirements for supporting
 plans 4-8
 sample of B-1-B-4
 subordinate plan 4-0, 4-3
 and theater strategy 1-2
 for unified theater 2-2
 campaign planning 4-4
 campaigns 3-3, 4-13
 design, organization, and
 conduct of 4-0, 5-0
 fundamentals of 4-3
 in maritime theaters 2-18
 in multinational operations
 1-12
 CAP 4-1, 4-7, 6-11, 6-15, 8-14
 CAS 1-9, 5-3, 5-8, 7-4, 7-5
 casualty operations 6-5
 Center for Army Lessons Learned.
See CALL
 center of gravity 1-5, 3-2, 4-3,
 3-0—3-1
 Central Intelligence Agency.
See CIA
 chain of command v, 2-5, 7-10
 development of 7-14
 for the military departments
 2-6
 illustration of 2-6
 Chairman of the Joint Chiefs of
 Staff. *See* CJCS
 chemical
 forces A-31
 smoke 5-11
 units A-32
 chemical weapons. *See also*
 WMD 5-15
 chiefs of the service forces, and
 chain of command 2-4, 2-5
 CHS A-8, A-15, A-16, A-17
 CI 5-17
 CIA 4-9, 7-16
 CINC iii, v, 1-1, 1-5, 2-2, 2-4, 2-24
 COCOM responsibilities 2-11,
 2-13
 coordination responsibilities
 1-8
 deliberate planning process
 6-11
 delineation of JSOA 2-21
 development of supporting
 plans 4-8

integration of joint operations
 1-9
 management of critical
 shortages 4-9
 military strategy 2-2
 rear operations
 responsibilities of 2-5, 7-11
 responsibilities during
 contingency operations 6-3
 responsibilities in crisis 6-1
 span of control A-1
 theater organization 2-19
 theater strategy 2-1
 CINC's
 AOR A-0
 campaign plan 1-2
 staff 2-4
 civil affairs. *See* CA
 Civil Air Patrol 1-9
 civil defense A-19
 civil information A-19
 civilian labor A-19
 civilian supply A-19
 civil-military construction 6-13
 CJCS v, 2-4, 2-5, 2-9, 2-10, 2-11,
 4-10, 4-14
 CJTF 2-13, 2-23, 2-27, A-26
 ASCC as A-2
 in contingency operations 6-4
 and logistics 6-13
 and OPCON 2-13
 climatology 2-28, 2-29
 close air support. *See* CAS
 close combat 5-7
 close support 2-9
 CMISE A-22
 coalition v
 forces 4-13
 guidance 1-2
 lead nation command
 structure 2-15
 operation 1-12
 parallel command structure
 2-14, 2-15
 coalition, coordination,
 communications, and
 integration center. *See* C³IC
 COAs, development of 1-3, 4-1,
 5-16, A-3

Index

- COCOM v, 2-5, 4-8, A-0, A-2, A-25, A-26
 - of ARFOR 2-25
 - authority 2-7, 2-11
 - options 2-9, 2-13, 4-12
 - organizational options 6-4
 - in peacetime A-2
- combat arms forces 8-18
- combat health support 8-7
- combat net radios 7-11
- combat operations A-2
- combat operations, branches and sequels to 1-9
- combat power iv, 1-5
- combat service support. *See* CSS
- combat support forces. *See* CS forces
- combat units 8-1
- combat zones. *See* CZs
- combatant CINC, and rear operations 5-12
- combatant command authority. *See* COCOM
- combatant commanders iii, 2-5, 2-11, 2-18, 4-12
- combatant commands v, 1-1, 2-2, 2-9
- combined arms 5-11
- command and control. *See* C²
- command authorities 2-7—2-9
- command lines 2-1
- command relationships 2-9, 2-11, 4-8, 5-16, 8-14
 - and campaign plan 4-4
 - establishment of 7-14
 - illustration of 2-12
 - in war 7-14
- command, control, and communications. *See* C³
- command, control, communications, and computers. *See* C4
- command, control, communications, and intelligence. *See* C³i
- commander in chief. *See* CINC
- commander of a joint task force. *See* CJTF
- commander of the special operations command. *See* COMSOC
- commander's estimate 4-7
- commander's intent 1-3, 4-7, 5-16
 - and major operations 1-3
 - strategic intent iv
- commanders of combatant commands. *See* combatant commanders *and* CINC
- commanders of digitized units D-1
- communications 6-12
 - capabilities D-1
 - electronics 6-11
 - networks 6-12
- communications security. *See* COMSEC
- communications zones. *See* COMMZ
- COMMZ 2-19, 2-21, 2-22, 5-12, 6-13, 7-17, A-16
 - area support structure A-7
 - intratheater A-5
 - logistics C² headquarters A-6
 - and rear operations 5-12
- component commanders, responsibilities in contingency operations 6-3
- COMSEC 4-14, 7-15
- COMSOC A-30
- concentration of forces and materiel 4-9
- concept
 - plans. *See* CONPLANS
 - revision of 1-3
 - summaries 4-1
 - sustainment 4-4
- concept of operations 1-2, 1-3, 1-4
- conflict 1-1, 5-7, 8-1
 - responsibilities in 8-11
 - termination of 8-18
- conflict and war configurations A-2
- conflict
 - resolution of iv
 - operations in 8-16—8-18
- CONPLANS 4-1, 6-3, 6-15, A-30 *See also* OPLANS
- constraints 1-11, 3-4
- construction hardening 5-12
- contamination avoidance 5-14
- continental theaters 2-17
- contingencies
 - important characteristics of 6-3
 - unique requirements for 6-3
- contingency force-projection operations iv, 8-5
- contingency forces, and air transport 6-2
- contingency operations 5-9, 6-2—6-14, A-1, A-4
 - Army responsibilities 6-3
 - stages. *See* force-projection stages
 - without a COMMZ A-4
- contingency OPODs 6-15
- continuity 5-21
- contract administration services 4-10
- conventional forces 1-6, 8-17
- cooperation, establishing 1-11
- coordinating authority 2-7, 2-9, 2-17
- coordination 5-16
 - with allies, coalition forces, and host nations 4-9
 - of fires 7-8
 - for interagency operations 4-14
 - relationships 2-9
- corps 6-5, 6-14, A-1. *See also* divisions
 - and below units A-1
 - commander as the CJTF 6-8
- corps military intelligence support element. *See* CMISE
- corps support command. *See* COSCOM
- counterair operations 5-10, 5-11
- counterdrug operations 8-9
- counterinsurgency operations 8-16, 8-17, 8-18
- counterintelligence. *See* CI
- countermobility 5-3
- counterterrorism 5-10, 8-16
- counterterrorism procedures 8-3
- country team 4-9
- course of action. *See* COA

criminal investigations A-28
 Criminal Investigations Command 8-3, A-28
 crisis 6-1–6-2
 crisis action planning. *See* planning, CAP
 crisis-response force 6-2
 critical assets, control of 4-9
 critical enemy functions and facilities, destruction of 5-8
 cruise missiles 2-28
 cryptologic support group. *See* CSG
 CS 6-14
 CS forces 8-1, 8-18, A-25
 CSG 6-12
 CSS 1-5, 1-7, 1-8, 6-14
 forces 8-1, 8-18, A-25, D-1
 characteristics 5-21
 system 1-8
 culminating point 1-5, 3-1, 3-2
 CZ 2-19, 2-21, 7-10, A-24

D

DCA 5-11, A-17
 DCG for Operations 2-26
 DCG for Support 2-26
 DCS 4-9, A-9
 deployment 3-3
 DDN 6-12
 deception 1-5, 3-2, 5-9, 5-11, 5-12, 7-2, 7-13, 7-17, 8-3, 8-13
 deception plan 7-13
 deception staff element 7-13
 decide, detect, deliver, and assess. *See* D³A methodology
 decision-making 2-23, 3-5
 decisive
 force 1-2
 operations 6-14, 6-17–6-18
 points 1-5, 3-1, 7-4
 terrain, securing 5-1
 victory 1-6
 decontamination units A-32
 deep operations 1-7, 5-5
 deep operations coordination cell. *See* DOCC

defense, air 5-1
 defense communication system. *See* DCS
 Defense Data Network. *See* DDN
 Defense Information System Agency. *See* DISA
 Defense Intelligence Agency. *See* DIA
 Defense Logistics Agency. *See* DLA
 Defense Mapping Agency. *See* DMA
 Defense Switched Network. *See* DSN
 defensive counterair operations. *See* DCA
 defensive operations 5-1, 5-2, D-1
 deferred theater 2-18
 deliberate planning 2-4, 2-11, 4-1, 6-11
 demining operations 6-18
 demobilization 4-10, 6-14, 6-20, 7-18
 Department of Agriculture 1-9
 Department of Defense 2-2
 Department of State. *See* DOS
 Department of the Army v, 2-24
 deployable intelligence support element. *See* DISE
 deployability iv
 deployment 3-4, 4-3, 4-10, 6-14, 6-16
 decisions 1-6
 deployed force 1-8
 deploying forces 5-13
 process 6-1
 to home stations 1-9
 depth and simultaneous attack 1-8, 7-4
 deputy chief of staff for engineers. *See* engineers
 deputy chief of staff for logistics A-6
 deputy chief of staff for personnel A-9

deputy chief of staff for resource management A-6
 derived mission 4-6
 design, campaign 4-3—4-5
 design, operational 3-2—3-4
 design, organization, and conduct of campaigns 5-0
 desired end state of war 7-2
 destruction of critical enemy functions and facilities 5-8
 deterrent actions 6-2, 8-3
 DIA 4-9, 7-16
 digital
 reporting D-0
 technology D-1
 digitization
 of the battlefield D-0–D-2
 technology 5-16
 diplomatic advisor, to CINC 4-9
 direct command 2-14
 direct liaison authorized. *See* DIRLAUTH
 direct support. *See* DS
 direct support maintenance. *See* DS maintenance
 DIRLAUTH 2-7, 2-9
 DISA 4-9
 disaster relief 3-1, 8-2, 8-8, 8-9
 DISE 6-5, A-20, A-21, A-22
 dislocated civilian control A-19
 disposal of obsolete materiel 4-10
 disposition of forces 8-12
 divisions 6-14, A-1. *See also* corps
 DLA, and theater logistics support 4-10, 8-6, A-4, A-7
 DMA 4-9
 DOCC 5-8, 5-9, 7-6, 7-7, 7-8, 8-13
 DOD 4-9, 4-14
 DOS 4-9
 coordination during contingency operations 6-3
 interagency operations 4-14
 responsibilities in postconflict operations 6-18
 drug-interdiction operations 8-18
 DS 2-9, A-6
 DS maintenance A-6
 DSN 6-12

Index

E

early entry 1-7, 1-8
echelons above corps 5-16,
8-19. *See also* operational-level
organizations
echelons above corps analysis
and control element 7-9
echelons of command A-0, A-1
during Civil War A-0
during World War I A-0
during World War II A-0
economy of force 7-3
economy-of-force theater 2-18
education, as a CA function A-19
electromagnetic pulse. *See* EMP
electromagnetic spectrum 5-12,
D-0
electronic intelligence. *See* ELINT
8-4
electronic management and
information systems D-1
electronic warfare. *See* EW
ELINT 8-4
EMP 5-14
employment planning 4-13
end state 3-5
desired 1-2
desired end state of war 7-2
ends 2-2, 2-4, 3-0
enemy
attack, disruption of 5-2
capabilities of 1-2, 5-7, 7-16
center of gravity 3-1, 7-4
dominance of 1-3
exploitation of 1-2
prisoners of war. *See* EPW
engagements 1-5
engineer A-7, A-8
entry stage 6-14
forces A-14
general engineer function 6-5
A-15
structure A-14
support 7-17
entry force, C² structure 6-17
entry operations 4-10, 6-14, 6-17

environmental
assessment 6-13
pollution standards 7-1
protection and cleanup 6-5
EOD 6-18, 7-11, A-7
EPW 7-2, A-31
equal opportunity functions A-12
espionage 5-12
EW 4-13, 5-5, 5-11, 7-2, 7-6
EW (jamming) 8-13
EW guidance 7-9
execution of major operations
5-0-5-22
expansibility iv
explosive ordnance disposal.
See EOD

F

fast sealift shipping 6-2
Federal Emergency Management
Agency 1-9
FFAs 7-8
fiber optic links A-9
FID 8-17, 8-18
field armies A-0, A-1
finance support 6-5, A-8, A-13,
A-14, A-19
finance support teams A-14
fire control measures 7-7
fire support coordination line.
See FSCL
fire support element. *See* FSE
firepower. *See* fires
fires 1-5, 7-2, 7-4, 7-5, 8-3, 8-12
fixing, as a CSS function 5-21
fleet ballistic missiles 1-7
fleet operations 2-18
flexibility 1-10
force capability 8-1
force composition for MOOTW 8-1
force projection iii, 1-5, 1-6, 1-8,
6-1
contingency operations 6-14
and logistics 5-19
stages 6-14-6-20
force protection 6-17
force tailoring 8-1
force tracking 1-6

forces, disposition of 8-12
forcible entry operations 1-8, 6-17,
8-12
foreign internal defense. *See* FID
foreign nation support 2-29
forward presence 2-28
forward-presence forces 1-7, 4-3
fratricide 8-13
free-fire areas. *See* FFAs
friendly force vulnerabilities 8-13
frontal attacks 5-2
FSCL 5-8, 7-7, 7-8
FSE 7-9
fueling, as a CSS function 5-21
full mobilization 6-15
functional C² organizations A-30
functional component command
2-4, 2-12, 2-13, 4-13, A-2, A-26,
A-27

G

G2. *See* intelligence
G3. *See* operations and plans
G4. *See* logistics
G5. *See* CA
G6. *See* signal
GCCS. *See also* WWMCCS 6-12
General Services Administration
1-9, A-4
general support. *See* GS
geography 2-28, 2-29
geopolitical assets 8-13
Global Command and Control
System. *See* GCCS
global commands. *See* unified
commands
global conflict, and METT-T 7-2
Goldwater Nichols DOD
Reorganization Act of 1986 2-4,
2-5
ground and air operational fires,
synchronization of 5-5
ground combat operations 5-1,
5-8
ground forces commander 5-8
GS
activities A-12
maintenance A-7, A-8
guerrilla warfare 8-17

H

health, safety, and welfare A-19
 health service support. *See* HSS
 helicopter, Apache attack 5-5
 helicopters, armed 2-28
 hierarchy for Army support 2-24
 hierarchy of guidance and implementing operations 4-2
 higher commander's intent 1-4
 historical perspectives
 commander's intent
 Hurricane Andrew 1-10
 Operation Desert Shield 5-22
 Operation Desert Storm/CTF Provide Comfort 8-7
 Operation Just Cause 1-6
 HNS 1-2, 2-21, 3-4, 4-12, 7-10, 7-12, 8-15, 8-16, A-5, A-14
 acquiring 4-13
 agreements 7-10
 host nation
 forces 7-13
 nation support. *See* HNS
 responsibilities of 7-12
 host nations forces 8-1
 HSS A-7, 7-18
 human intelligence. *See* HUMINT
 humanitarian assistance 1-9, 3-1, 8-2, 8-8, 8-9
 HUMINT 5-17, 8-4, 8-5, 8-15, A-22, A-28
 Hurricane Hugo 2-14

I

IEW 4-1, 5-18, 6-12, 6-13, 7-15-7-17, A-20
 imagery intelligence. *See* IMINT
 IMINT 5-17, 8-4, 8-15
 improvisation 5-21
 indirect approach 3-1
 industrial base
 and DLA 4-10
 expansion of 4-9
 infiltrations 5-2
 information, gaining 5-1
Information Age technology D-0
 information mission area support A-9

information operations 4-14, D-0, D-1
 information system support A-8
 information technology D-0
 infrastructure 2-29
 competition for 4-13
 to deploy forces from their location through CONUS ports 6-2
 ingenuity 1-10
 initial response forces 6-16
 initiative 1-10
 instabilities 2-28
 insurgency operations 8-16, 8-17
 integrated JCCC/ASCC communications management center 7-15
 integration
 of complementary capabilities 1-11
 of digitally-equipped elements with conventionally-equipped (nondigital) elements D-1
 forces 3-4
 intelligence 1-3, 1-5, 5-13, 6-12, 8-5, 8-15
 all-source intelligence 8-15, A-28
 battlefield operating system architecture A-20
 buildup 4-1
 CI operations 7-17
 direction and coordination of 7-16
 dissemination of 5-19
 elements 2-23, 5-14
 function A-20
 integration of 5-18
 integrating and sharing in a multinational command 4-13
 J2 6-11
 MI organization A-20, A-21
 MI units 6-5
 for MOOTW 1-10
 in multinational operations 4-13
 national-level intelligence organizations 4-9
 network integration A-23
 and operational protection 7-16
 planning for MOOTW 1-11

problems 5-19
 and rear area operations 7-17
 readiness 4-1
 staff 4-1
 support for campaigns 4-9
 support elements 7-16
 structures A-8
 sources of 7-16
 split-based 7-15
 synchronization of 7-15
 targets A-20
 tasks A-22
 intelligence collection personnel, deployment of 5-18
 intelligence and electronic warfare. *See* IEW
 intelligence-preparation-of-the-battlefield. *See* IPB
 intelligence-preparation-of-the-theater 1-6
 intent. *See* commander's intent
 interagency cooperation
 in crises 6-1
 for MOOTW 1-10
 interagency operations 2-1, 4-14-4-15, 8-12
 interagency organizations 2-26
 interdiction 1-5, 5-7, 5-8, 7-5, 7-8
 of logistical support system 5-8
 operations 5-2, 7-4
 planning 5-8
 interference 5-12
 intermediate staging basing 6-18
 internal security 6-19
 internal theater organization 2-18
 international community 1-11
 international integration 8-14
 international military education and training 8-8
 international organizations.
 See IOs
 international security agreements 2-4
 interoperability 2-27
 interservice support agreements 8-7
 in-transit visibility A-4
 intratheater COMMZ, support in A-6

Index

intratheater deployment, planning for 4-10
intratheater movement 4-9, 7-3
IOs 8-1, 8-6
IPB 5-17, 7-16, 8-3, 8-15, A-22
isolating the battlefield 5-8

J

J1. *See* personnel function
J2. *See* intelligence
J3. *See* operations 6-11
J4. *See* logistics
J5. *See* plans and policy
J6. *See* communications-electronics
JCCC 6-12, 7-15
JCGRO 6-13
JCMEB 6-13
JCMEC 6-12
JCS 2-2, 8-3
JDEC 6-12
JFACC 2-13, 5-4, 4-11
JFC v, 3-3, 3-4, 6-15
 campaign objectives 5-8
 concept of operations 7-4
 joint targeting process 5-5
 and major operations 4-11
 and maneuver operations 5-1
 operational firepower 5-3
 and synchronization of operational fires 5-9
 subordinate 2-9, 2-11
 transition responsibilities 1-9
JFLCC v, 2-13, 2-27, 5-8, 6-8
JFMCC 2-13
JFSOCC 2-13, 2-20, 6-11, A-29, A-30
JFUB 6-13
JIC 4-9, 5-17, 6-12, 7-16
JIF 6-12
JIPC 6-12
JMBPO 6-13
JMC 6-13
JMRO 6-13
JOA 2-20, 4-0, 4-9, 8-2, 8-14
job training exercises 8-2
JOC 6-11

joint
 C³CM cell 7-9
 capabilities, integration of 1-8
 coordination 6-9
 doctrine iii
 electronic warfare assets 1-9
 environment v
 force iv
 force commands 2-9
 information systems interface 7-2, 7-15
 operations v, 2-1
joint captured materiel exploitation center. *See* JCMEC
joint central graves registration office. *See* JCGRO
Joint Chiefs of Staff. *See* JCS
joint civil-military engineering board. *See* JCMEB
joint communications control center. *See* JCCC
joint documents exploitation center. *See* JDEC
joint facilities utilization board. *See* JFUB
joint force air component commander. *See* JFACC
joint force commander. *See* JFC
joint force land component commander. *See* JFLCC
joint force maritime component commander. *See* JFMCC
joint force special operations component commander. *See* JFSOCC
joint imagery processing center. *See* JIPC
joint intelligence center. *See* JIC
joint interrogation facility. *See* JIF
joint medical regulating office. *See* JMRO
joint military blood program office. *See* JMBPO
joint movement center. *See* JMC
joint operations area. *See* JOA
Joint Operations Planning and Execution System. *See* JOPES
joint petroleum office. *See* JPO
joint rear area coordinator. *See* JRAC

joint rear area. *See* JRA
joint rescue coordination center. *See* JRCC
joint special operations area. *See* JSOA
joint special operations aviation component command. *See* JSOACC
joint special operations task force. *See* JSOTF
Joint Strategic Capabilities Plan. *See* JSCP
Joint Strategic Planning System. *See* JSPS
joint suppression of enemy air defenses 5-7
joint surveillance target and attack radar system. *See* J-STARS
Joint Theater Logistics System. *See* JTLS
Joint Universal Lessons Learned System. *See* JULLS
joint zone. *See* JZ
joint, multinational, and interagency environment iii
JOPES 2-4, 4-5, 6-5, 6-11, 6-15, 8-11, 8-14. *See also* AMOPES
JPO 6-13
JRA 2-20, 2-21, 2-22, 5-12, 7-10, A-5
JRAC 2-21, 5-12, 7-11, A-5
JRCC 6-11
JSCP 2-4, 2-5, 2-11
JSOA 2-20
JSOACC A-30
JSOTF A-30
JSPS 2-4, 4-5
J-STARS 8-4
JTCB 5-5, 6-10, 6-11, 7-9
JTF 2-25, 4-11, 4-13
 Andrew 1-9
 ARFOR commander 6-15
 augmentation of 2-26
 establishing authority 6-10
 establishment of 2-13
 headquarters of an Army JFC 6-8, 6-10
 with two or more Army forces 6-6
JTL 7-9

JULLS 6-15

JZ 2-20

L

land force commander 7-8

large-scale operations 7-3

laws and treaties 3-4

legal services A-19

legal support 5-22

legitimacy 8-1lessons learned for incorporation
into training during peacetime
activities 8-19

lethal force

projection of 1-6

 to support early entry
 operations 1-7*lethality* iv, 1-8

levels of command A-1

levels of threat 7-13

leverage 1-5

liaison 8-6

among forces 2-16

in contingency operations 6-4

 with joint, multinational, NGO,
 PVO, and interagency
 organizations in theater 2-23

teams, exchange of 2-23

light armored forces 6-16

lines of communication.

See LOCs

lines of operation 3-1, 1-5

linkages 1-2, 2-23, 6-17, A-18

 between national and theater
 strategic direction 1-2 with foreign counterpart
 organizations 4-9 joint, multinational, and
 interagency 2-27

littoral theaters 2-17, 2-18

LOCs 1-8, 2-19, 4-13, 5-13, 7-17,
A-5

designation of 6-13

interdiction of 7-13

lodgments, initial 6-17

logistical

 battle command
 organizations 5-20

support 2-7, 4-12

logisticians, responsibilities of 1-8,
5-20

logistics 3-4, 6-13, 8-6

anticipatory 6-16

in conflict 8-15

 C² element 4-10 C² headquarters A-6

multifunctional A-6

 in a multinational environment
 4-13

planners 6-13

support 4-10, 6-18

 support for joint and/or
 multinational forces in the
 theater 2-26Logistics Assistance Program
4-10

logistics support element.

See LSE

logistics units, modular design of
6-14logistics-preparation-of-the-
theater. See LPT processlong-range ballistic missile
systems 5-14

LPT process 4-12, 5-19

LSE 4-10, 5-20, 6-19, 8-15, 8-16,
A-7, A-28**M**

main battle area. See MBA

maintenance support 4-10

major operations iii, 1-3, 1-5, 1-12,
4-11-4-14, A-2

execution of 5-0-5-22

plan model C-1-C-13

plan, sample of C-1-C-13

planning 4-12

requiring decisive force v

 that support joint campaigns
 4-11maneuver 5-8. See also
movement through attack helicopter
 operations 5-3

facilitating 5-7

operations 5-1

of subordinate forces 7-3

manning 5-21

manpower allocation A-5

Marine Corps commander, as
functional component
commander A-2

maritime

air capabilities 1-7

operations 1-9

theaters 2-17, 2-18

MASINT 5-17

mass destruction environment
5-14

massing of effects 5-2

materiel

acquisition 4-10

management A-8, A-24

materiel management center.

See MMC

MBA 2-21

MCA 7-12, A-24

MCSF 6-12

means 2-4, 3-0, 3-4measurement and signatures
intelligence. See MASINTmeasures of effectiveness.
See MOEs

METL A-22

METT-T 1-3, 1-5, 2-4, 2-24, 2-27,
4-10, 6-5, 7-2, 7-13, 7-14, 8-1,
A-1, A-3, A-8, A-11, A-21

MI. See intelligence 5-17

military departments v

military end state 1-3, 1-4, 1-11

military intelligence. See MI

military operations other than war.
See MOOTW

military police 7-11

Military Traffic Management
Command A-28

MILNET/DISNET trunks A-9

minefields, clearing 1-9

mines 7-5

missile defense measures A-17

missiles 7-5

mission analysis 1-3, 1-4

mission creep 8-6

mission statement, 1-3

mission, enemy, terrain, troops-
time available. See METT-T

mission-essential task lists 8-7

MLRS 5-5

Index

- MMC A-7, A-24, A-25
 - mobile cryptological support facility. *See* MCSF
 - mobile defense 5-2
 - mobility and
 - countermobility 5-2
 - and flexibility of US forces 2-28
 - planning 5-0
 - Mobility Requirement Study
 - mobilization iv, 4-3, 4-10, 6-14, 6-15
 - levels of 6-15
 - full 6-15
 - partial 6-15
 - phases of 6-15
 - modern warfare 7-1
 - modular elements A-4
 - MOEs 1-11
 - MOOTW iii, iv, 1-1, 1-9, 1-9-1-12, 2-11, 2-12, 3-1, 3-5, 5-5, 5-7, 6-1, 6-14, 7-1, 8-1-8-19, A-2
 - fundamentals of 8-1
 - and interagency operations 4-14
 - and personnel service support A-12
 - principles of 6-18, 8-1
 - objectives 8-1
 - and theater strategy 1-2
 - and US support to civil authorities 4-9
 - morale, welfare, and recreation A-5, A-12
 - mortuary affairs 6-5, 6-13
 - motivating and influencing the force 5-17
 - movement and maneuver 1-5, 7-2, 8-2, 8-12
 - movement, of intertheater or intratheater forces into the operations area 6-17
 - movement control, for Army assets into the AO 6-18, 7-3, A-8, A-24
 - movement control agency A-24
 - moving the force 5-21
 - MPs A-7
 - MRS 6-2
 - multinational
 - chain of command 4-13
 - commands 2-14
 - force commander 2-17, 4-13
 - force cultures 4-13
 - forces iv, A-1
 - formations 2-16
 - intelligence center 4-13
 - interagency coordination 6-8, 6-9
 - operational-level planning 4-12
 - operations v, 1-2, 1-6, 1-12, 2-1
 - theater structure 2-18
 - multiple launch rocket system. *See* MLRS
 - munitions 7-5
 - mutual support 2-9, 8-4
- N**
- nation assistance 8-2, 8-8, 8-19
 - National Command Authorities. *See* NCA
 - national interests iv
 - National Military Strategy iii, 2-1, 2-2, 2-3, 2-4, 6-1
 - national military-level planning 4-5
 - national mobilization of forces 4-11
 - national resources and military forces. *See* means
 - National Security Act of 1947 2-2, 2-5
 - National Security Agency. *See* NSA
 - national security and military objectives. *See* ends
 - national security policies and military concepts. *See* ways
 - National Security Strategy iii, 1-6, 2-1, 2-2, 2-3, 6-1
 - national security-level planning 4-5
 - national-level support 4-9
 - NATO 2-7
 - agreements 8-5
 - and cooperation 2-16
 - operational and tactical command 2-8
 - terms 2-8
 - natural disasters, response to 6-2
 - naval gunfire 1-7, 1-8, 7-4, 7-6
 - Naval special warfare task group A-30
 - Navy special operations forces A-30
 - NBC
 - decontamination 6-5
 - defense A-31
 - and multinational operations 5-14
 - principles of avoidance 5-13
 - protection 5-15
 - protective postures 5-14
 - readiness 8-3
 - reconnaissance units A-32
 - NCA 1-1, 1-3, 2-4, 2-9, 2-13, 2-25, 4-1, 4-3, 8-11, 8-16
 - and Army operations in war 7-1
 - and control of military forces 2-1
 - and establishment of combatant commands 2-10
 - exercise and control of the armed forces 2-5
 - and postconflict operations 1-9
 - responsibilities in contingency operations 6-3
 - and use of strategic forces or reserves 4-10
 - NEOs 4-14, 8-8, 8-9, A-14
 - NGOs iv, 1-1, 1-2, 4-3, 4-7, 6-10, 8-1, 8-6
 - nongovernment organizations. *See* NGOs
 - nonlinear operations 7-1
 - nonmilitary elements of national power 3-5
 - North Atlantic Treaty Organization. *See* NATO
 - notional joint fires command and control structure 5-4
 - NSA 4-9, 7-16, A-21
 - nuclear weapons 5-13, 5-14. *See also* WMD
 - nuclear, biological, chemical. *See* NBC

numbered armies 7-14, A-1, A-26, A-28

O

objective 2-28, 3-2
 observation 5-12
 obstacles 5-3
 obsolete materiel, disposal of 4-10
 OCA 5-11, A-17
 offensive counterair operations.
See OCA
 offensive operations 1-6, 1-7, 5-1, 5-2
 onward movement 7-17
 OPCOM 2-8, 2-17
 OPCON v, 2-7, 2-17, 2-25, 4-8, 6-15
 Operation Desert Shield 2-18, 5-22
 Operation Desert Storm 2-14, 5-7, 7-2
 Operation Just Cause 1-7, 2-13
 operations plan. *See* OPLAN
 Operation Provide Comfort 8-7
 operational
 air defense 5-9, 5-10
 art iii, v, 1-1, 1-4, 1-9, 2-24, 3-0
 battle command 5-0, 5-15–5-17
 boundaries 7-6
 considerations 2-23
 countermobility 5-2
 design 1-1, 1-7, 3-0
 environment, cumulative assessment of 2-29
 envelopments 5-2
 firepower 7-4, 7-5. *See also* operational fires
 intelligence 5-0, 5-17–5-19
 land commander 7-6
 level of war iii
 logistics 5-0, 5-19–5-22
 maneuver 5-1, 5-3
 mobility 5-2
 movement 5-0, 5-1
 protection 5-0, 5-9
 replenishment 6-13
 reserves 5-2
 support of the force 5-20

tasks/environment 2-28
 tempo 5-16
 theater design 2-11
 operational concept. *See* concept of operations
 operational control. *See* OPCON
 operational fires 5-0, 5-3, 8-3, 8-13. *See also* operational firepower
 coordination of 5-9
 organization of 5-9
 operational-level army
 logistics commanders 7-17
 planners 4-0
 operational-level
 Army 1-11
 and campaign planning 1-3
 command 3-5
 commanders iv, 1-6, 4-12, 5-16
 commander's intent 1-4
 concept of operations 1-4
 conduct of operations in theater 2-24
 and deception 5-12
 during decisive land operations 1-8
 environment 2-27
 headquarters 2-25, formation and deployment of 2-26
 and integration 1-9, 1-11
 link 2-2
 mobility 8-12
 and offensive operations 5-2
 operating systems 1-5, 5-0–5-22
 organizations A-0, A-1
 perspective 3-0, 6-15, 6-19
 planners 1-3, 4-11, 8-3
 planning for major operations 1-3, 4-11
 responsibilities in theater 2-26
 responsibilities in war 1-5
 role in MOOTW 1-9
 tasks 6-7, A-1, A-2
 and terrain 5-2
 and timing 1-7
 unifying participants 1-10
 units A-1
 operations
 area 6-17

functions A-25
 J3 6-11
 officer 5-9
 and plans, director of 6-11
 to reestablish precisis readiness levels 1-9
 to restore order. *See* PE operations
 sequence of 3-2
 tasks, components of 2-28
 and training, in joint force headquarters 6-11
 in war 2-11, 6-1
 Operations Desert Shield/Desert Storm 2-8, 2-18
 operations order. *See* OPORD
 operations security. *See* OPSEC
 OPLANS 1-4, 3-5, 4-1, 4-12, A-30.
See also CONPLANS
 integration of 2-4
 updating 6-3
 OPORD 3-5, 4-1
 OPSEC 4-11, 5-10, 5-14, 6-16, 6-18, 7-17, 8-3, 8-13, A-20
 during contingency operations 6-3
 employment of 5-12
 options
 for Army structure in a JTF 6-4–6-14
 for conduct of MOOTW 2-21–2-22
 ordnance organization A-7
 organization of the Army
 operational-level component 2-26
 organizational options
 Army commander as a joint force functional component commander 6-8
 Army commander as the CJTF 6-8
 separate support and Army forces headquarters 6-7
 single Army headquarters to a JTF 6-4
 two or more Army forces to a JTF 6-6
 organizational tailoring A-20
 organizing fires 5-9
 overseas presence 2-3

Index

P

PA 5-22, 8-3, A-8, A-12, A-13
PA assets 6-4
PAO, responsibilities of 6-6
parallel planning. *See* planning
Patriot 5-11
patrolling 5-13
peace enforcement operations 8-18
peace support operations 8-2
peacekeeping 4-14, 8-8
 forces 7-2
 operations 8-18
peacemaking 8-16
peacetime 1-1, 8-1
 configurations A-2
 deployments A-0
 operations 8-2, 8-18
 responsibilities in 8-1
 stationing requirements 5-2
 transition to 1-9
penetrations 5-2
permissive environment 8-2
perseverance 8-1
personnel function A-1, A-11, A-12
personnel service support 5-22, A-8, A-9, A-11, A-12
petroleum A-8, A-22
petroleum supply function A-23
phases of the campaign 3-3
phasing plans 5-16
PIR 5-17, 5-19, 7-15, 7-16, A-20
plan development process 5-16
planning 4-0
 adaptive 6-1
 CAP 6-8
 conduct of major operations 4-12
 deliberate planning 2-4, 2-11, 4-1, 6-11
 framework 4-0
 for MOOTW 1-10
 operational fires 5-5
 and organizing 5-16
 parallel 3-5
 process
 strategic deployment planning 4-10

 to terminate combat operations 8-18
 in wartime 7-14
plans and policy 6-11
plans for conflict termination 1-9
positional advantage 3-2, 6-17, 7-3
postal operations 6-5
postconflict
 considerations 6-19
 operations 1-6, 1-9, 4-10, 6-18, 6-19
 postcrisis operations 6-14
postoperation reporting 8-19
postwar operations 7-2
power projection 1-5, 2-3
predeployment 4-10
 activities 6-14, 6-15
 considerations 6-16
 decisions 1-6
pre-positioned materiel. *See* APA
pre-positioning of forces 2-28
pre-positioning of war reserve materiel stocks A-18
President, responsibilities of 2-5
Presidential selected reserve call-up 6-15
priority intelligence requirements. *See* PIR
prisoners 6-18
 confinement facilities 8-3
 of war, control of 1-9
private voluntary organizations. *See* PVOs
property control A-19
protection 1-5, 7-2, 7-9, 8-3, 8-13
 of operational forces and means 5-12
 from surprise 5-12
 of LOCs 7-10
protective clothing 5-14
psychological operations. *See* PSYOP
PSYOP 4-11, 5-2, 5-5, 6-9, 6-19, 8-3, 8-10, 8-13, A-12, A-28
 and PE operations 8-18
 organization functions A-31
public administration A-19
public affairs. *See* PA
public affairs officer. *See* PAO

public communications and transportation A-19
Public Health Service, and MOOTW 1-9
public works and utilities A-19
PVOs iv, 1-1, 1-2, 4-3, 4-7, 6-10, 8-1, 8-6

Q

quadripartite standardization agreements.
See standardization agreements
QASAS A-24
QSTAGs. *See* standardization agreements
quality assurance specialist ammunition surveillance.
See QASAS

R

raids 8-17
range of military operations iii, 2-1, 2-20, 4-1, 7-2
RAOC 7-10
rationalization, standardization, and interoperability. *See* RSI
RDTE 4-10
real estate and contract support 6-5
real property maintenance activities. *See* RPMA
real-time communications A-4
rear area operations center. *See* RAOC
rear area protection 6-5
rear operations 5-12–5-13, 7-10
rear operations centers. *See* ROCs
rear security operations, in the COMMZ A-7
reception and onward movement 8-12
reception operations 7-17, 7-18
reconnaissance 6-18
reconnaissance, intelligence surveillance, and target acquisition. *See* RISTA

reconstitution 5-2, 6-19, 7-18
 assessment and evaluation
 team 7-18
 planning cell 7-18
 redeployment 3-3, 4-10, 6-14,
 6-19, 7-18
 and reconstitution
 considerations 6-19
 and reconstitution of the force
 A-6
 of forces 8-19
 refugees, handling of 1-9, 6-8
 regional contingency engineering
 manager A-15
 regional factions 2-28
 regionally oriented unified
 commands. *See* theater
 combatant commands
 reinforcement plans 4-12
 religious support 5-22
 replacement training 7-17
 Republican Guard Forces
 Command. *See* RGFC
 research, development, test, and
 evaluation. *See* RDTE
 residual radiation, effects of 5-14
 resources 3-4
 prioritizing and allocating 1-7
 use of 3-2
 responsiveness 5-21
 restraints 1-11, 8-1
 restrictions 3-4
 restrictive fire areas. *See* RFAs
 retrograde operations 5-1, 5-2
 revised theater strategy and
 estimate 4-7
 RFAs 7-8
 riot control agents A-32
 risk assessments 5-10, 5-13
 risk management 7-10
 RISTA 4-11
 rockets 7-5
 ROCs 7-11
 ROE 4-3, 4-13, 5-16, 6-9, 8-3, 8-4,
 8-12
 and predeployment 6-15
 peacetime 8-3
 planning considerations for
 MOOTW 1-11

RPMA 6-5
 RSI 4-13
 rules of engagement. *See* ROE

S

S2 6-12
 sabotage 5-12
 safety 8-13, A-12
 Salvation Army, and MOOTW 1-9
 SAPO 6-13
 satellite communications A-9
 sea lines of communication.
See SLOCs
 SEAD 5-3, 5-13
 seaports of debarkation A-5
 search and rescue 8-8
 SECDEF v, 2-2, 2-5, 2-11, 2-13,
 6-1
 secretaries of the military
 departments, responsibilities of
 2-5
 Secretary of Defense. *See*
 SECDEF
 Secretary of the Army v, 2-11, 2-24
 Secure Voice System. *See* SVS
 security 5-19, 8-1
 assistance 8-2, 8-8
 assistance surges 8-16, 8-18
 of bases 7-10
 for deploying theater forces
 4-10
 and protection of facilities
 7-10
 security, plans, and operations
 officer. *See* SPO
 selective mobilization 6-15
 senior Army air defense
 commander A-17
 senior army command in a JTF
 A-26
 senior army commander iii, v,
 2-23, 2-24, 2-26, 3-2, 4-11, 5-0,
 5-1, 5-5, 5-9, 5-15, 5-16, 5-17,
 5-18, 5-19, 7-13, 8-2
 in contingency operations 6-3
 and defensive operations 5-2
 and logistical support 8-18
 and major operations 4-11
 and maneuver operations 5-1

and operations to restore
 order 8-18
 and strategic deployment 5-1
 three tasks of iv
 senior army leaders 2-22
 separate support and Army
 combat force headquarters 6-7
 separated reporting activities.
See SRAs
 sequels 1-9, 3-3
 sequencing flow into the theater
 7-2
 sequential and simultaneous
 warfare 3-3
 service component command
 2-12, 4-13
 service component commander
 2-4, 2-6, 2-12
 shows of force 6-2, 8-2, 8-8, 8-9
 SIGINT 5-17, 6-12, 8-15, A-21,
 A-22
 signal A-8
 capabilities in contingency
 functions A-10
 G6 A-8
 operations 6-3
 organization A-8
 signal security. *See* SIGSEC
 signal support 4-4, 6-5, 6-10
 signals intelligence. *See* SIGINT
 SIGSEC 5-12
 simultaneity and depth 1-5
 single Army headquarters in a JTF
 6-4
 single-service force command
 2-13
 situational awareness D-1
 smoke and obscurants A-31
 smoke units A-32
 SOCOORD 6-11
 SOF 1-8, 1-9, 5-5, 7-5, 8-13, A-18,
 A-28, A-29
 commanders 8-2
 and direct command 2-14
 operations 2-18
 and unconventional warfare
 8-17
 SOF target nominations 6-11

Index

- SOFA 6-9, 7-10
 - soft-skinned vehicles 7-6
 - SOTSE 6-11
 - space-based satellite systems 7-6
 - span of control 7-14
 - special deception 5-2
 - special operations 5-3
 - special operations aviation component A-30
 - special operations command A-18
 - special operations coordination element. *See* SOCOORD
 - special operations forces 6-16
 - special operations functions in theater A-29
 - special operations location A-29
 - special operations support A-8, A-18
 - special operations theater support element. *See* SOTSE
 - special reconnaissance 5-5
 - specified commands 1-1, 2-9, 2-10
 - split-based operations 1-7, A-4, A-21
 - SPO 7-11
 - spoiling 5-2
 - SRAs 4-10
 - staging 7-17
 - standardization agreements 8-5
 - statement of intent 1-4
 - status of forces agreements. *See* SOFA
 - statutory authority. *See* combatant command
 - strategic- and operational-level tasks A-2
 - strategic
 - advantage 2-11
 - center of gravity 2-11
 - concept of operations 2-11, 4-10
 - deployment 5-1
 - end state, and campaign planning 1-3
 - environment, assessment of 2-27
 - estimates 2-4
 - firepower 7-5
 - hierarchy 2-1–2-4
 - intent iv
 - maneuver 2-11
 - military objectives 2-3
 - reserves, planning for 4-7
 - tasks 2-3
 - structuring to focus effort 5-16
 - subarea petroleum office. *See* SAPO
 - subareas of responsibility 2-20, 2-22
 - subordinate and supporting operations 4-0
 - subordinate Army combat force commanders 6-9
 - subordinate Army commanders 1-7, 2-21
 - subordinate C² organizations A-30
 - subordinate
 - campaign iii, iv, 3-2
 - campaign model B-1–B-4
 - campaign plans 4-12
 - subordinate commanders 5-16, 6-8
 - and concept of operations 1-4
 - guidance for 2-1
 - responsibilities of 4-9
 - subordinate force commanders 2-9, 4-0, 4-1, 4-5, 4-8, A-1
 - ARFOR commander as 2-27
 - and operational art 1-4
 - subordinate
 - logistics organizations A-8
 - planning at the operational level 4-0
 - theaters 2-20
 - subordinate unified commands. *See* subunified commands
 - subunified
 - command ASCC 2-25
 - commander 2-24, A-29
 - commands v, 2-13, 4-13
 - suitability*, of a force's capability 8-1
 - supplies 4-10
 - support 4-10, 7-2
 - engineering 7-17
 - in Army operation in war 7-17
 - support agreements 4-11
 - support authority 2-7, 2-17
 - support to counterdrug operations 8-2, 8-8
 - support operations, conduct of 2-23
 - support to domestic civil authorities 8-9
 - support
 - close 2-9
 - direct 2-9
 - general 2-8
 - mutual 2-9
 - supported CINC 5-3, and planning 4-1
 - supported commander 4-3
 - supporting campaign plans 4-5
 - supporting commander 4-3, 4-8, 4-9
 - suppression of enemy air defenses. *See* SEAD
 - surveillance and reconnaissance 5-3
 - survivability 1-8
 - sustained land operations iv
 - sustaining soldiers and their systems 5-21
 - sustainment 3-3
 - base 1-8
 - of forces 4-10
 - plans 4-12
 - SVS 6-12
 - synchronization 1-4, 5-18, A-4
 - with diplomatic, informational, and economic efforts 2-1
 - of operational movement 7-3
 - of peacetime operations 8-2
 - of the operational functions 2-29
 - synchronized maneuver and interdiction 7-6
 - synergy 1-5
- T**
- 10th Mountain Division 1-10, 1-12
 - TACAIR resources 5-9
 - TACOM 2-8, 2-17
 - TACON 2-7
 - TACS 5-4, 5-5, 5-6
 - TACSAT 6-12, A-9
 - tactical air resources. *See* TACAIR resources

tactical air support 5-4
 tactical combat forces 7-13
 tactical combat service support functions 5-21–5-22
 tactical command. *See* TACOM
 tactical control. *See* TACON
 tactical CSS 5-20
 tactical execution v, 7-3
 tactical firepower 7-4
 tactical force commander A-1
 tactical level commanders 1-3
 tactical maneuver 7-4
 tactical objectives 1-7
 tactical operations 1-1, 8-18
 tactical organizations. *See* corps and division
 tactical satellites. *See* TACSAT
 tactics iii
 targeting 7-9
 and attacking land and sea targets 5-3, 7-4
 process 7-6
 TCAE A-21
 TECHINT 5-17
 technical and logistics services 4-10
 technical control and analysis element. *See* TCAE
 technical intelligence. *See* TECHINT
 tempo 1-5, 5-0
 termination 1-5
 of combat operations 7-18
 of conflict A-6
 terrain 7-16
 and mobility 5-2
 securing 5-1
 terrorism 8-14
 terrorists 6-2
 THAAD 5-11
 theater 1-1
 architecture A-0
 arrangement with a JSOACC A-30
 campaign 1-2, 2-11
 campaign plan 4-4, 4-7
 campaign planning 4-6
 communications network A-11

deferred 2-18
 design of A-0
 distribution plans 4-11
 forward-deployed forces 1-2
 geography 2-1
 and operational design 3-2
 theater air control system. *See* TACS
 theater army commander. *See* ASCC
 theater CINC 2-21
 theater combatant commander 2-10, 2-18
 theater combatant commands 2-10
 theater command. *See* unified command, regionally oriented
 theater commander. *See* CINC
 theater high-altitude air defense. *See* THAAD
 theater missile defense forces 2-21, 5-11, A-17
 theater of focus 2-18
 theater of operations 2-19, 2-20
 theater of war 2-19
 theater organization
 functional requirements A-0
 internal 2-18
 options for conduct of war 2-19
 for MOOTW 2-20
 during war 2-19
 theater requirements A-1
 theater strategic
 end state 2-11
 environment 1-1, 2-4
 objectives v
 planners 4-0
 theater strategy iii, 2-1, 2-4, 3-0
 theater strategy and campaign plan 2-1
 theater-level planning 4-5
 theaters, types of 2-17
 threat 2-28
 assessment 8-13
 capabilities 5-18
 conditions 8-2, 8-14
 forces, Level II and III 7-12
 levels 7-12, 8-14
 three operational tasks 6-14

time constraints 1-7
 time-phased force deployment list. *See* TPFDL
 timing 1-7
 Title 10 responsibilities A-1, 2-26
 topography 2-28, 2-29
 total asset visibility 1-6, A-4
 total mobilization 6-15
 TPFDD 6-1, 6-5, 6-14, 7-2
 TPFDL 5-1
 training
 war 1-10, 8-7
 replacements 7-17
 transition
 to conflict 8-14
 to conflict or war A-2
 of RC personnel iv
 to hostilities 8-10–8-16
 from peacetime to wartime 7-1
 to peacetime or war 8-18
 to war 7-1, 7-2
 from warfighting to other operations 1-12
 transportation A-8
 and distribution of Class I, III, V, and VIII supplies 6-5
 assets A-24
 function A-16
 support A-15
 Trojan system A-21
 turning movements 5-2

U

UAVs 2-28
 UCP 2-1, 2-4, 2-7, 2-10, 4-6
 UN 1-1
 UN forces 1-2, 4-0
 unconventional warfare. *See* UW
 unexploded ordnance A-7
 unified action. *See* synchronization
 unified command v, 1-1, A-0
 unified command ASCC A-25
 unified command CINC, and operation functions A-25
 Unified Command Plan. *See* UCP

Index

unified commanders,
responsibilities in peacetime 8-2

unified commands 2-9, 2-10
functionally oriented 2-10
regionally oriented 2-10

unified operation 1-1, 2-19, 4-10,
4-12

unified structure 1-1

United Nations. *See* UN

United States. *See* US

unity of command 1-12, 2-7, 5-16

unity of effort 2-10, 5-9, 7-1, 8-1,
8-6
in multinational operations
1-12, 4-12
in the theater 4-1
and theater of operations 2-20
through leadership 1-11

unity of effort, and integration of
joint capabilities 1-8

unmanned aerial vehicles.
See UAVs

US ambassador 4-9

US Army Corps of Engineers A-15

US Army divisions, and
operational-level missions 6-5

US Army Information Systems
Command A-28

US Army Intelligence and Security
Command A-20, A-28

US Army levels of command A-1

US Army Materiel Command.
See USAMC

US Army Special Operations
Command A-18

US Atlantic Command 2-10

US Central Command 2-10

US contingent of a multinational
command 2-17

US European Command 2-10

US forces in a multinational force
2-17

US Forces Japan 2-13

US Forces Korea 2-13

US forces to a multinational force
2-17

US foreign policy 4-10

US interests and objectives 2-3

US Pacific Command 2-10

US Southern Command 2-10

US Space Command 2-10

US Special Operations Command
2-10

US Strategic Command 2-10

US Transportation Command
2-10

USAMC 4-10, 8-6, A-4, A-7, A-28

USN-USMC naval aviation C²
system 5-5

US-only joint force iv

USTRANSCOM 6-1, 6-13, 6-17,
A-28

UW 8-2, 8-16, 8-17

V

versatility iv, 1-10

visualization 7-3

vulnerabilities of friendly forces
8-13

W

war iii, 1-1, 2-12

operations in 1-5

and personnel service support
A-12

transition to 1-9, 1-12

warning orders 6-15, 6-16

ways 2-2, 2-4, 3-0, 3-4

weapons of mass destruction.
See WMD

weapons systems' parts 4-10

weather 5-3, 7-16, 8-15

weather and geographical
information 8-6

WMD 5-3, 5-10, 5-13, 5-17, 7-5,
7-10, 8-3, A-32

WMD target analysts 7-9.
See also nuclear weapons,
biological weapons, *and*
chemical weapons

Worldwide Military Command and
Control System 6-12

X

XVIII Airborne Corps, historical
perspective 1-6