

ENGINEERING DESIGN HANDBOOK

**ELEMENTS OF ARMAMENT ENGINEERING**  
**PART ONE**  
**SOURCES OF ENERGY**



HEADQUARTERS  
UNITED STATES ARMY MATERIEL COMMAND  
WASHINGTON, D.C. 20315

31 August 1964

AMCP 706-106, Elements of Armament Engineering, Part One, Sources of Energy, forming part of the Army Materiel Command Engineering Design Handbook Series, is published for the information and guidance of all concerned.

(AMCRD)

FOR THE COMMANDER:

SELWYN D. SMITH, JR.  
Major General, USA  
Chief of Staff

OFFICIAL:

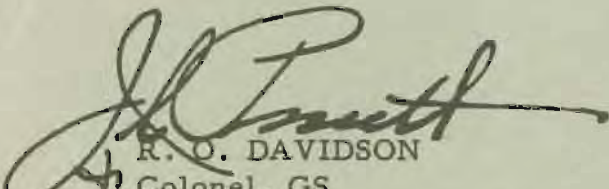
  
R. O. DAVIDSON  
Colonel, GS  
Chief, Administrative Office

DISTRIBUTION: Special

## FOREWORD

This handbook is one of a series of three comprising Elements of Armament Engineering and forms part of the Engineering Design Handbook Series of the Army Materiel Command.

The three Parts of Elements of Armament Engineering were produced from text material prepared for use at the United States Military Academy. They are published as a part of the Handbook Series to make generally available the wealth of fundamental information contained in the text material, which is of value to those concerned with military design, particularly to new engineers and to contractors' personnel.

Arrangements for publication of the handbooks comprising Elements of Armament Engineering were made under the direction of the Engineering Handbook Office of Duke University, prime contractor to the Army Research Office-Durham.

Agencies of the Department of Defense, having need for Handbooks, may submit requisitions or official requests directly to Publications and Reproduction Agency, Letterkenny Army Depot, Chambersburg, Pennsylvania 17201. Contractors should submit such requisitions or requests to their contracting officers.

Comments and suggestions on this handbook are welcome and should be addressed to Army Research Office-Durham, Box CM, Duke Station, Durham, North Carolina 27706.

## FOREWORD TO ORIGINAL TEXT MATERIAL

This text has been prepared to meet a specific requirement as a reference for instruction in "Elements of Armament Engineering," a one-semester course in applied engineering analysis conducted by the Department of Ordnance at the United States Military Academy, for members of the First (Senior) Class. It represents the application of military, scientific, and engineering fundamentals to the analysis, design and operation of weapons systems, including nuclear components. It is not intended to fully orient or familiarize the student in weapons employment or nomenclature.

Of necessity, the large volume of classified data used in presentation of this course has been omitted; hence the text is intended to serve as a point of departure for classroom discussions. The text is revised annually by instructors of the Department of Ordnance in an effort to assure that subject presentation will keep pace with

development and changes in the field of weapons design.

References cited are those available to the student as the result of study in previous courses at the United States Military Academy. Advanced references are available at the Department of Ordnance Reference Room.

Contributing authors for 1958-59 revision are:

Maj. W. E. Rafert, Ord Corps	Asst. Professor
Capt. A. W. Jank, Ord Corps	Instructor
Capt. C. M. Jaco, Jr., Ord Corps	Instructor
Capt. J. M. Cragin, Ord Corps	Instructor
Capt. G. K. Patterson, USAF	Instructor

JOHN D. BILLINGSLEY  
Colonel, U. S. Army  
Professor of Ordnance  
August 1958

## PREFACE

The usefulness and dependability of systems which serve man are contingent upon the effective performance of the components which make up those systems. So it is with the weapon systems of war. In centuries past, vast effort has been expended in improving the performance of war machines. Improvements of this century have included rigorous application of scientific principles to warfare in an effort to optimize the performance of mechanisms of war. As the laws and rules of mathematics, physics, and chemistry have been applied to war and its machines, war has become more complex and more deadly.

Perhaps no component of weapon systems has been studied more thoroughly than sources from which energy can be conveniently and quickly liberated in great quantity. From the days of Crecy in 1346, when guns began competition with sharp-edged weapons, until the end of World War II, when 85% of the casualties were attributed to conventional explosives, the trend toward more and improved explosive has continued. Since 1945, the use of atomic energy has opened a vast new magnitude of effectiveness from a new source of energy, the atom and its parts.

In this portion of the text those fundamental facts which must be known to permit the student to understand how energy is stored, liberated, and applied in military devices will be discussed. Those facts include a discussion of the theory of the release of chemical and nuclear energy, thermochemistry, explosives classification, and the properties of representative explosives.

A reasonable knowledge of all these fundamental facts is required if the military leader is to understand the performance, as well as the capabilities, of his increasingly complex weapons.

The study begins with a review of the theory of basic chemical energy reactions as they apply to explosives.



# TABLE OF CONTENTS

<i>Paragraph</i>		<i>Page</i>
<b>CHAPTER 1</b>		
<b>THE THEORY OF CHEMICAL EXPLOSIVE REACTIONS</b>		
1-1	INTRODUCTION .....	1-1
1-2	HISTORICAL NOTES .....	1-1
1-3	DEFINITION .....	1-2
1-3.1	Formation of Gas .....	1-2
1-3.2	Evolution of Heat .....	1-2
1-3.3	Rapidity of Reaction .....	1-2
1-3.4	Initiation of Reaction .....	1-2
1-4	CATEGORIZATION .....	1-3
1-4.1	Low Explosives .....	1-3
1-4.2	High Explosives .....	1-3
1-5	CHEMICAL KINETICS .....	1-5
1-6	PROPERTIES OF MILITARY CHEMICAL EXPLOSIVES ....	1-7
1-6.1	Load Density (High Explosives) .....	1-7
1-6.2	Hygroscopicity .....	1-7
1-6.3	Sensitivity .....	1-7
1-6.4	Velocity of Detonation .....	1-7
1-6.5	Strength .....	1-8
1-6.6	Brisance .....	1-8
1-6.7	Power .....	1-8
1-6.8	High Order of Detonation .....	1-8
1-6.9	Low Order of Detonation .....	1-8
1-6.10	Stability .....	1-9
1-7	EXPLOSIVE TRAINS .....	1-9
1-7.1	Propelling Charge Explosive Train .....	1-9
1-7.2	Bursting Charge Explosive Trains .....	1-11
<b>CHAPTER 2</b>		
<b>THE THERMOCHEMISTRY OF CHEMICAL EXPLOSIVES</b>		
2-1	CHEMICAL REACTIONS OF EXPLOSIVES .....	2-1

## TABLE OF CONTENTS (cont)

<i>Paragraph</i>		<i>Page</i>
	<b>Chapter 2 (cont)</b>	
2-2	REVIEW OF BASIC DEFINITIONS AND CHEMICAL FUNDAMENTALS .....	2-1
2-2.1	Gram Molecule .....	2-2
2-2.2	Gram Formula Weight .....	2-2
2-2.3	Specific Heat .....	2-2
2-2.4	Molecular Specific Heat .....	2-2
2-2.5	Specific Volume .....	2-2
2-2.6	Molecular Volume .....	2-2
2-2.7	Co-volume .....	2-2
2-2.8	Specific Gravity .....	2-2
2-2.9	Density .....	2-2
2-2.10	Density of Loading .....	2-2
2-2.11	Calorie .....	2-3
2-2.12	Kilocalorie .....	2-3
2-2.13	Heat of Formation .....	2-3
2-2.14	Principle of Initial and Final State .....	2-3
2-2.15	Heat of Reaction .....	2-3
2-2.16	Potential of an Explosive .....	2-3
2-3	POTENTIAL .....	2-4
2-4	QUANTITY OF HEAT LIBERATED AT CONSTANT PRESSURE .....	2-4
2-5	VOLUME OF GAS LIBERATED .....	2-6
2-6	EXTERNAL WORK PERFORMED IN EXPANSION .....	2-7
2-7	QUANTITY OF HEAT LIBERATED AT CONSTANT VOLUME .....	2-7
2-8	POTENTIAL OR WORK .....	2-8
2-9	SUMMARY OF CALCULATIONS .....	2-8
2-10	TEMPERATURE OF EXPLOSION .....	2-9
2-10.1	Temperature When Solid Products Are Formed .....	2-12
2-11	DETERMINATION OF PRESSURE IN A CONSTANT VOLUME CHAMBER .....	2-12
2-11.1	Basic Equations .....	2-12
2-11.2	Pressure in a Gun Propellant Chamber .....	2-13



## TABLE OF CONTENTS (cont)

<i>Paragraph</i>		<i>Page</i>
<b>Chapter 2 (cont)</b>		
2-11.3	Pressure When Solid Products Are Formed .....	2-14
2-11.4	Actual Chamber Pressure .....	2-15
2-12	DETERMINATION OF WORK IN A SYSTEM OF CHANGING VOLUME AND PRESSURE .....	2-15
<b>CHAPTER 3</b>		
<b>MILITARY EXPLOSIVE CHARACTERISTICS</b>		
3-1	INTRODUCTION .....	3-1
3-2	HIGH EXPLOSIVES .....	3-1
3-2.1	Greater Potential .....	3-1
3-3	HIGH EXPLOSIVE CLASSES .....	3-3
3-3.1	Primary High Explosive .....	3-3
3-3.2	Secondary High Explosive .....	3-4
3-3.3	Comparison of Explosives .....	3-4
3-4	PRIMARY HIGH EXPLOSIVES .....	3-5
3-4.1	Mercury Fulminate .....	3-5
3-4.2	Lead Azide .....	3-6
3-4.3	Lead Styphnate .....	3-6
3-5	SECONDARY HIGH EXPLOSIVES .....	3-7
3-5.1	Tetryl .....	3-7
3-5.2	Trinitrotoluene (TNT) .....	3-7
3-5.3	Tetrytol .....	3-8
3-5.4	Amatol .....	3-8
3-5.5	Explosive D .....	3-8
3-5.6	RDX .....	3-9
3-5.7	PETN .....	3-10
3-5.8	Pentolite .....	3-10
3-5.9	HMX .....	3-10
3-5.10	Dynamites .....	3-11
3-6	LIQUID HIGH EXPLOSIVES .....	3-11
3-7	METAL-HIGH EXPLOSIVE MIXTURES .....	3-12
3-7.1	Explosive Manufacturing Considerations .....	3-13

# TABLE OF CONTENTS (cont)

<i>Paragraph</i>		<i>Page</i>
	<b>Chapter 3 (cont)</b>	
3-8	LOW EXPLOSIVES OR PROPELLANTS .....	3-13
3-8.1	Controlled Burning .....	3-14
3-8.2	Sensitivity .....	3-14
3-8.3	Stability .....	3-14
3-8.4	Residue .....	3-14
3-8.5	Manufacture .....	3-14
3-8.6	Erosive Action .....	3-14
3-8.7	Flash .....	3-14
3-8.8	Detonation .....	3-14
3-8.9	Smoke .....	3-14
3-9	BLACK POWDER .....	3-14
3-10	SMOKELESS POWDERS .....	3-15
3-10.1	Burning Time .....	3-15
3-10.2	Burning Action .....	3-17
3-10.3	Degressive Burning .....	3-17
3-10.4	Neutral Burning .....	3-17
3-10.5	Progressive Burning .....	3-17
3-10.6	Web Thickness .....	3-17
3-10.7	Single-Base Propellants .....	3-18
3-10.8	Double-Base Propellants .....	3-19
<del>3-10.9</del>	<del>Ball Powder</del> .....	<del>3-19</del>
<del>3-10.10</del>	<del>Nitroguanidine Propellants</del> .....	<del>3-19</del>
3-11	LIQUID GUN PROPELLANTS .....	3-20
3-12	GUN PROPELLANT IMPROVEMENTS .....	3-21
3-12.1	Flash .....	3-21
3-12.2	Smoke .....	3-21
3-12.3	Higher Potential .....	3-22
3-12.4	Erosion .....	3-23
3-12.5	Greater Stability .....	3-23
3-13	PROPELLANTS FOR ROCKETS .....	3-23
3-13.1	Current Solid Propellants .....	3-24
3-13.2	Current Liquid Propellants .....	3-25

## TABLE OF CONTENTS (cont)

<i>Paragraph</i>		<i>Page</i>
<b>Chapter 3 (cont)</b>		
3-14	EXOTIC PROPELLANTS .....	3-26
3-14.1	Metal Additives .....	3-27
3-14.2	Fluoro Compounds .....	3-27
3-14.3	Free Radicals .....	3-27
3-14.4	Ionic Fuels .....	3-27
<b>CHAPTER 4</b>		
<b>FISSION-FUSION REACTIONS</b>		
4-1	INTRODUCTION .....	4-1
4-2	ATOMIC STRUCTURE .....	4-2
4-2.1	Elements and Atoms .....	4-2
4-2.2	Nuclear Composition .....	4-2
4-2.3	Isotopes .....	4-3
4-2.4	Symbols .....	4-3
4-2.5	Mass of Nuclear Particles .....	4-3
4-2.6	Charge of Nuclear Particles .....	4-4
4-3	RADIOACTIVITY .....	4-4
4-3.1	Nuclear Instability .....	4-4
4-3.2	Alpha Decay .....	4-4
4-3.3	Beta Decay .....	4-4
4-3.4	Gamma Rays .....	4-4
4-3.5	Induced Reactions .....	4-5
4-3.6	Radioactive Series .....	4-5
4-4	ENERGY, FISSION, AND FUSION .....	4-5
4-4.1	Equivalence of Mass and Energy .....	4-5
4-4.2	Fission .....	4-7
4-4.3	Fusion .....	4-7
4-4.4	Nuclear Energy .....	4-8
4-5	CROSS SECTION, THE CHAIN REACTION, AND CRITICALITY .....	4-9
4-5.1	Cross Section .....	4-9
4-5.2	Chain Reaction .....	4-10

## TABLE OF CONTENTS (cont)

<i>Paragraph</i>		<i>Page</i>
<b>Chapter 4 (cont)</b>		
4-5.3	Neutron Reactions .....	4-10
4-5.4	Classes of Chain Reactions and Criticality .....	4-10
4-5.5	Means of Increasing Criticality .....	4-11
<b>EXPLOSIVES ANNEX</b>		
<b>EXPLOSIVES MANUFACTURE AND TESTING</b>		
A-1	INTRODUCTION .....	A-1
A-2	MANUFACTURE OF TRINITROTOLUENE .....	A-1
A-3	MANUFACTURE OF SINGLE-BASE PROPELLANT .....	A-2
A-4	MANUFACTURE OF PERCHLORATE PROPELLANT .....	A-3
A-5	PHYSICAL TESTING OF EXPLOSIVES .....	A-4
A-5.1	Sensitivity to Shock .....	A-4
A-5.2	Trauzl Lead Blocks .....	A-4
A-5.3	Ballistic Mortar .....	A-4
A-5.4	Velocity of Detonation .....	A-4
A-5.5	Relative Brisance .....	A-4
A-5.6	Additional Tests .....	A-8
A-6	PHYSICAL TESTING OF ROCKET PROPELLANTS .....	A-8
A-6.1	Solid Propellant Testing .....	A-8
A-6.2	Measurement of Burning Rates .....	A-8
	APPENDIX .....	A-11
	INDEX .....	I-1

## LIST OF ILLUSTRATIONS

<i>Fig. No.</i>	<i>Title</i>	<i>Page</i>
1-1	Schematic drawing of detonation showing progress through a column of explosive .....	1-4
1-2	Nitroglycerin .....	1-5
1-3	Toluene and trinitrotoluene .....	1-6
1-4	Mercury fulminate and lead azide .....	1-6
1-5	Explosive trains .....	1-10
1-6	Schematic representation of explosive trains .....	1-11
2-1	Curves showing variation of mol specific heat with temperature for several gaseous explosive products .....	2-10
3-1	Effect of oxygen balance on strength of explosives (compared with TNT) in the lead block expansion test .....	3-2
3-2	Schematic representation of mercury fulminate .....	3-5
3-3	Lead azide .....	3-6
3-4	Lead trinitrorescorcinatate .....	3-6
3-5	Tetryl .....	3-7
3-6	Trinitrotoluene (TNT) .....	3-8
3-7	Ammonium picrate (Explosive D) .....	3-8
3-8	Cyclotrimethylenetrinitramine (RDX) .....	3-9
3-9	Pentaerythritetranitrate (PETN) .....	3-10
3-10	Cyclotetramethylene tetranitramine (HMX) .....	3-10
3-11	Typical shapes of powder grains .....	3-16
3-12	Sizes of some typical grains .....	3-16
3-13	Web thickness and route of burning progress through a progressively burning grain .....	3-16
3-14	Relative areas of burning as a function of percent of individual grain consumed, for several typical grain shapes .....	3-17
3-15	Flash suppressor on 75-mm gun tube .....	3-22
4-1	Isotopes of hydrogen .....	4-3
4-2	Uranium ( $4N + 2$ ) series .....	4-6
4-3	Pseudo-continuous plot of average mass per nucleon versus atomic number .....	4-7
4-4	Particles entering a slab of material .....	4-9

## LIST OF ILLUSTRATIONS (cont)

<i>Fig. No.</i>	<i>Title</i>	<i>Page</i>
4-5	Idealized neutron population growth .....	4-11
A-1	Tri-nitration equation showing some typical polynitrotoluenes ..	A-2
A-2	Trauzl lead block after test, with section showing expansion of cavity by explosive .....	A-7
A-3	Ballistic mortar .....	A-7
A-4	Pressure vessel for measuring burning rates of propellant as a function of pressure .....	A-9
A-5	The effect of pressure on burning rate of a rocket solid propellant ..	A-10

## CHAPTER 1

# THE THEORY OF CHEMICAL EXPLOSIVE REACTIONS

### 1-1 INTRODUCTION

In explosive chemistry the energy released by rapid chemical reaction is used to provide heat, expand gas, create blast and shock, provide fragmentation and fragmentation velocity, and to create forces for propulsion.

How this energy is best contained and controlled is left to later chapters on exterior ballistics, principles of propulsion, and gun barrel design. This chapter discusses how such energy is stored and liberated, and how this can be done efficiently, safely, and conveniently.

### 1-2 HISTORICAL NOTES

Great strides forward have been made in explosives since their inception. The earliest known explosive, called gunpowder or black powder, is generally conceded to have been the mixture of saltpeter, sulfur, and charcoal, first described by the English friar, Roger Bacon, in the year 1242. This mixture, at that time, was not thought of as a propellant, but rather as an explosive which would cause terror among the enemy with its bright flash and thundering noise. To Berthold Schwartz, a German monk, is given the credit for having invented, about 1313, a firearm using gunpowder as the propellant. The first organized use of guns in open battle was by the English at the Battle of Crecy in 1346.

Prior to the military use of explosives, which was as early as the seventh century, there were recorded uses of chemicals in forms such as "Greek fire" and Chinese rocket-propelled "fire arrows." The principal ingredient of Greek fire was probably naphtha, mixed with sulfur and pitch. Chinese rockets were propelled by a combination of sodium chlorate or sodium nitrate and some combustible material. These chemical mixtures were the forerunners of gunpowder.

The discovery of gunpowder was followed in 1838 by the preparation of nitrocellulose by

T. J. Pelonze, a Frenchman, and later the development, in 1846, of nitroglycerin by an Italian, Ascanio Sobrero. It remained for Alfred Nobel (1833-1896) of Sweden, a man of practical as well as scientific bent, to develop explosives of usable physical properties from nitroglycerin. Nobel included among his many accomplishments (1) the method of initiating high explosives by detonation to secure their full power; (2) the theory of explosive action; (3) the production of dynamite; and (4) design of double-base propellants.

The great number of achievements in the science of explosives accelerated by two great world wars, make necessary a second look at the basic changes which have taken place in the field of military explosives. World War I was fought with only a few standard high explosives, together with some inferior substitutes necessitated by material shortages. These shortages permitted little choice of explosives for special application or specific requirements. Today the field has been greatly enlarged with many types as well as large numbers of explosives together with new ranges and increased scope of application.

# SOURCES OF ENERGY

---

## 1-3 DEFINITION

An explosive is a chemical compound or mixture which upon the application of heat or shock decomposes or rearranges with extreme rapidity, yielding much gas and heat. Many substances not ordinarily classed as explosives may do one, or even two, of these things. A mixture of nitrogen and oxygen, for example, can be made to react with great rapidity to yield the gaseous product nitric oxide, yet the mixture is

not an explosive since it does not evolve heat but rather absorbs heat during the reaction. To be an explosive a substance must exhibit all of the phenomena mentioned: formation of gases; evolution of heat; rapidity of reaction; and initiation of reaction by shock or heat. To be a military explosive, an explosive must also be suitable for and used for military purposes.

### 1-3.1 FORMATION OF GAS

The student is familiar with the burning of wood or coal in the atmosphere. In this reaction the carbon and hydrogen in the wood or coal combine with the oxygen in the atmosphere to form carbon dioxide and steam, together with flame and smoke. If the wood or coal is pulverized so that the total surface in contact with oxygen is increased, and it is burned in a furnace or forge where more air can be supplied, the burning can be made more rapid and the combustion more complete. If the wood or coal is immersed in liquid oxygen or suspended in air in the form of dust, the burning takes place with explosive violence. In each case the action is the same; the burning of a combustible to form a gas. The difference is the speed with which the reaction takes place. Thus, materials which will burn can be made to explode if sufficient oxygen is made available rapidly. This fact is demonstrated by the explosion within internal combustion engines where combustible mixtures of gasoline and air explode to operate the engine. In coal mines methane gas and coal dust combine with air to produce explosive mixtures, and in grain elevators minute particles of dust form explosive mixtures with air. Most explosives utilize this principle except for the fact that they usually contain their own oxygen integrally and so are independent of oxygen supplied from the air.

### 1-3.2 EVOLUTION OF HEAT

The evolution of heat during the reaction causes a large increase in the temperature of the gases. This increase results in the rapid expansion of the gases and the generation of a very high pressure. A reaction which fails to produce this high pressure will not fill the requirements of an explosion.

### 1-3.3 RAPIDITY OF REACTION

Unless the reaction occurs rapidly the thermally expanded gases will be dissipated in the atmosphere and there will be no explosion. Again consider a wood or coal fire; in the fire there is evolution of heat and formation of gases but these are not liberated rapidly enough to cause an explosion.

### 1-3.4 INITIATION OF REACTION

The fourth factor is the requirement that to qualify as an explosive the material must readily undergo rapid reaction upon the application of a certain amount of energy, in the form of shock or heat, to a small portion of its mass. A material in which the first three factors exist is not suitable as an explosive unless the reaction can be made to occur at will.



## 1-4 CATEGORIZATION

The chemical decomposition of an explosive may take years, days, hours, or a fraction of a second. The slower forms of decomposition take place in storage and are of interest only from a stability standpoint. Of more interest are the two rapid forms of decomposition, burning and detonation. The term "detonation" is used to describe an explosive phenomenon of almost instantaneous decomposition. Explosives are

classified as low or high explosives according to their rates of decomposition. Low explosives burn rapidly. High explosives ordinarily detonate. There is no sharp line of demarcation between low and high explosives. The properties of the explosive indicate the class into which it falls. In some cases explosives may be made to fall into either class by the conditions under which they are initiated.

### 1-4.1 LOW EXPLOSIVES

Low explosives are those materials which undergo rapid decomposition by burning from the surface inward. They are usually manufactured in the form of "grains" and used as propellants. Consider that a number of grains of powder have been placed in the breech of a gun. Sufficient heat is applied so that the powder will ignite. Ignition occurs when a temperature is attained which will cause the combustibles to react with the self-contained oxygen to form gas and liberate heat. Since this heat cannot escape because of the confinement of the breech, it will heat the next inner layer of powder exposed by the burning away of the original surface layer, ignite it, further increasing and expanding the gases. This continues until the grain is completely consumed; concurrently, each grain ignites adjacent grains until the entire charge is consumed. While confined these individual grains burn from the outside toward the center at the rate of about 5 feet per second. In open air where the pressure will not rise appreciably the rate of combustion would be about 0.01 feet per second. As the burning continues through the charge, the pressure and temperature rise and the burning becomes more and more rapid. The rate of burning is approximately doubled for every 10°C rise in temperature. This form of decomposition results in the liberation of large quantities of gas which yield high pressures making the explosive valuable as a propellant. In the barrel of a gun, the shell will begin to move before expansion is complete, leaving room for more expansion and thus preventing the barrel from bursting.

### 1-4.2 HIGH EXPLOSIVES

High or detonating explosives decompose almost instantaneously by a rupture or splitting of the molecule and the rearrangement of the atoms into other molecules, mostly gaseous. Present day explosive molecules are comprised of atoms, most of which are carbon, hydrogen, nitrogen, and oxygen. While carbon and hydrogen tend to unite with oxygen, nitrogen usually returns to its elemental form. The explosive molecule should be considered an unstable molecule which tends to revert to a more stable state. There are several theories as to the mechanics of detonation; the following is one.

(a) First phase. The first phase is initiated by supplying enough energy to an explosive, usually in the form of shock, so that the disruptive forces set up within the molecule exceed the attractive forces between some of the atoms, and decomposition is started. The tendency toward disruption is caused by the instability of the high explosive molecule. The molecular and atomic attractive forces are the normal bonds tying the molecule together. When they are broken, and the molecule is rearranged, concentrated energy is released, which disrupts adjacent molecules. If the initial shock wave energy is sufficient, this wave will proceed through the entire mass of explosive until it has completely detonated, provided the energy released by the splitting of one molecule is sufficient to detonate more than one adjacent molecule.

(b) Second phase. The second phase of detonation consists of the formation and expansion of gas molecules. When the original molecule is

## SOURCES OF ENERGY

split, the heat of the detonating wave causes the carbon and hydrogen atoms to oxidize thus expanding their volume greatly. The entire process of detonation takes place almost instantaneously. Explosives with extreme rates of detonation are no usefull as propellants as the pressure developed would burst the barrel of a gun before it overcame the inertia of the shell.

The mechanism of detonation may be visualized by referring to Figure 1-1. This figure was developed from facts resulting from hydrodynamic studies which showed that after the detonator functioned, a detonation zone which includes a zone of chemical reaction, travels extremely rapidly through the column of the explosive. This detonation zone is generally considered to include a very thin ( $10^{-5}$  cm) shock zone or shock wave. Little or no chemical reaction occurs in this shock zone, but here pressure reaches its peak. The detonation zone includes

not only this shock front, but also the chemical reaction zone (0.1-1.0 cm). Behind this detonation zone are the detonation products. In front of the shock zone is the unreacted explosive in its original state of density, pressure, and temperature. At or near the beginning of the chemical reaction zone, the high temperature to which the material is raised by compression in the shock zone initiates chemical reaction. Maximum density and pressure occur at the beginning of the reaction zone, while the temperature and velocity reach their peak at the completion of the chemical reaction. The detonation products flow with great velocity (but with less velocity than does the detonation zone) through the undetonated explosive. This is characteristic of detonation in contradistinction to deflagration, in which case the reaction products flow away from the unreacted material. The velocity of advance of the detonation zone is termed the detonation rate, or velocity.

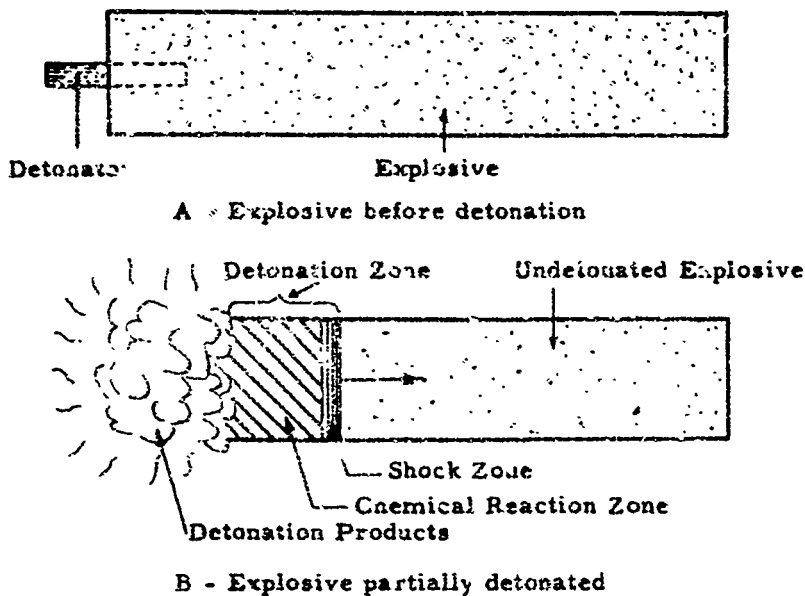

Fig. 1-1 Schematic drawing of detonation showing progress through a column of explosive.

# CHEMICAL EXPLOSIVE REACTIONS

## 1-5 CHEMICAL KINETICS

Explosives are chemical compounds or mixtures of chemical compounds, and like different chemical compounds and mixtures have different physical properties. Their melting points, freezing points, density, and chemical stability may vary widely. Of particular interest to the explosives user is the stability of the explosive, for upon this property depends the power, sensitivity, and ease of handling of the ammunition item in which the explosive is used.

Explosives and propellants generally are organic compounds made up of varying amounts of nitrogen, oxygen, hydrogen, carbon, and metallic atoms. Some of the newer propellants, low explosives, contain boron, lithium, and fluorine. The arrangement and proportion of these various basic constituents determine, in large measure, the physical behavior of the explosive.

As an integral part of nearly all explosives and of fundamental importance to the family of explosive organic compounds is the intractable element nitrogen. Unlike its behavior in air, which is four-fifths nitrogen, as a part of an organic compound, nitrogen is not an unreactive bystander, but is combined with difficulty and in relatively loose union with its neighboring elements. Its bonds are easily broken. When these bonds are broken they rupture suddenly and violently with the accompanying liberation of relatively large amounts of energy.

Also present in most explosives is the element oxygen. Oxygen is relatively easily, but loosely, bound in union with other elements. It may be joined with nitrogen but can be caused to break away easily in order to join elements such as H, C, S, or itself. A union of greater stability results. Fluorine when present is, like oxygen, an oxidizer. It too removes electrons. Hence, in terms of the reactivity of N and O the explosion of gunpowder can be explained. In the pulverized mixture of charcoal (C), sulfur (S), and saltpeter ( $\text{KNO}_3$ , potassium nitrate) are seen the requirements of unstable union of nitrogen, mixed so that excess S and C are readily available for a more stable union once an initiating impetus, such as flame, is applied. The N breaks away, reuniting with either the sulfur, carbon, or itself.

Heat and large quantities of gas are liberated. The reaction is represented by the equation:

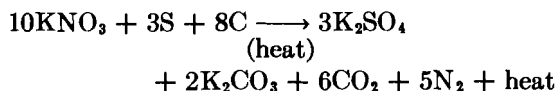

Application over the years of these ideas to more complex organic compounds, containing within themselves all the required ingredients for reaction, has yielded a variety of explosives with a wide range of physical and reactive properties. For example, the addition of nitrogen and oxygen in the form of  $-\text{NO}_2$  groups to glycerin yields nitroglycerin.

The structural formula (schematic) of this unstable, reactive explosive is:

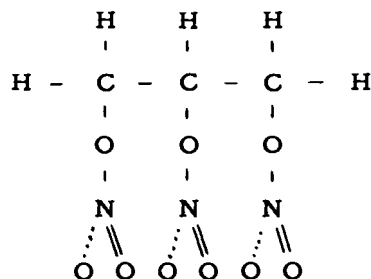

Note: One of the oxygens in the nitrate groups is bound weakly to the N. This linkage is shown by the dashed line.

Fig. 1-2 Nitroglycerin.

The joining of additional nitrogen and oxygen (nitrating) with toluene gives trinitrotoluene, TNT.

Compare nitroglycerin and trinitrotoluene: Both contain unstable nitrogen; both give off appreciable energy when they rearrange. In the nitroglycerin the nitrogen is linked only with oxygen. Nitrogen would be in a more stable state if linked with itself; oxygen more stable if

## SOURCES OF ENERGY

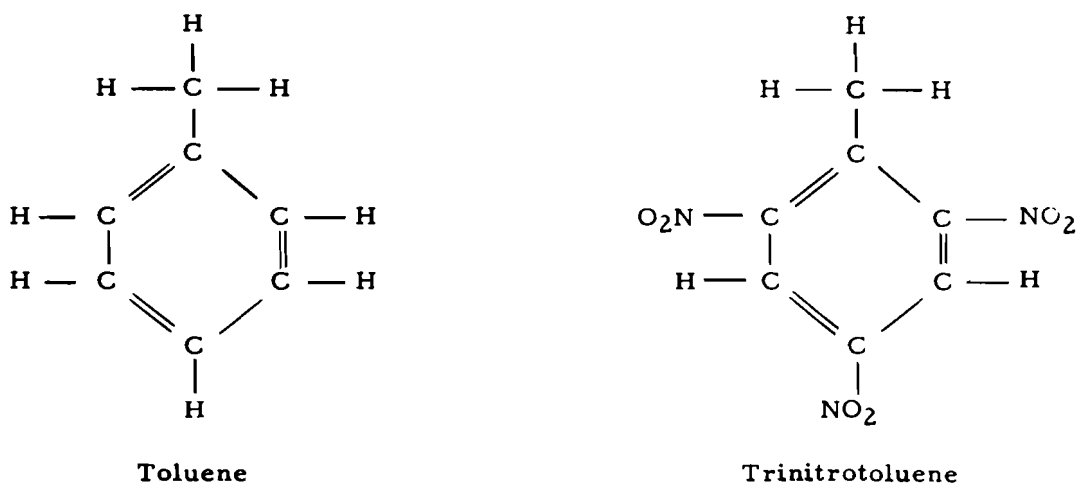
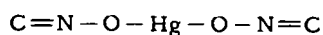
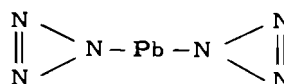

Fig. 1-3 Toluene and trinitrotoluene.



Mercury Fulminate



Lead Azide

Fig. 1-4 Mercury fulminate and lead azide.

joined with carbon or hydrogen; carbon and hydrogen more stable if bonded to oxygen. Thus great instability exists and, as is well known, the compound is very sensitive or reactive and will explode when subject to even a jar. On the other hand, the TNT molecule also contains nitrogen in unstable union, but here the link is with carbon. Also all carbon atoms are joined into a ring of carbon atoms, some bound by reactive double bonds. The ring (or cyclic) configuration serves also to hold the reaction prone "arms" of the molecule farther apart, whereas in the nitroglycerin the "arms" of the  $\text{NO}_2$  groups were closer together. Hence, TNT, although rapidly liberating large amounts of energy and gas when once detonated, does not fracture easily and may be handled without excessive danger.

In summary, it may be said then that the presence of unstable nitrogen and other reactive elements such as oxygen, carbon, hydrogen, and active metals is essential to explosive compounds. The relative amounts of these elements, their arrangement within the compound, and the nature of their bonding all affect the stability and thus

the reactivity or sensitivity of the compound.

The degree of ease of exploding unstable chemical compounds may be an advantage or a disadvantage in the usefulness of an explosive. The instability of the  $-\text{C}-\text{O}-\text{N}=\text{O}$  linkage in nitroglycerin makes it easy to detonate, but difficult to transport. Thus, the end use of the explosive compound often prescribes its constituency. In uses where extremely sensitive but easily detonated compounds are desired, more unstable linkages and arrangements are prescribed.

In mercury fulminate for example, not only is the  $\text{O}-\text{N}$  bond easily broken, but mercury, a noble metal, is only loosely joined with oxygen. In lead azide the nitrogen atoms are mostly joined only with themselves. They are in only a weak union with the lead, a metal of low activity. These compounds are very unstable and extremely sensitive. These easily exploded compounds are useful in small amounts to set off larger amounts of less sensitive explosives, as will be seen in later lessons.

## 1-6 PROPERTIES OF MILITARY CHEMICAL EXPLOSIVES

Almost all physical properties of an explosive substance must be investigated to determine its suitability for military use. Before an explosive's usefulness can be fully appreciated these properties and the factors which affect them should

be thoroughly understood. The more important characteristics are the load density, hygroscopicity, sensitivity, velocity of detonation, strength, brisance, power, order of detonation, and stability.

### 1-6.1 LOAD DENSITY (HIGH EXPLOSIVES)

The final step in the manufacture of artillery projectiles and bombs involves filling them with a high explosive. Depending on the characteristics of the particular high explosive several methods may be employed, i.e., cast, pellet, or press loading. Shells loaded with TNT require an average load density of not less than 1.52 (weight of explosive per unit volume in cgs units) with pellet loading, and an average load density of not less than 1.55 with the casting method of loading. Armor piercing shells are press loaded with Explosive D resulting in an average load density which varies from 1.45 to 1.55. An increase in the load density of the charge is highly desirable. Hence, by pressing, an average density of the loaded charge is obtained which is greater than the actual density of the particular explosive as listed in Table A-1 in the Annex to Part 1. High load density reduces sensitivity by making the mass more resistant to internal friction and to the creation of hot spots. By increasing the continuity of the explosive mass, velocity of detonation is increased, the load is made more dense, and the tendency for cavities to form is decreased. Cavities may cause misfires or premature detonations. In addition, increased load density permits the use of more explosive in the space provided, thereby increasing the strength of the ammunition. Given two explosives of equal power per pound, if one has an average density of 1.0 and the other 2.0 after loading, twice the weight of the second explosive can be carried in the same space. Thus, essentially twice the energy to do work is available.

### 1-6.2 HYGROSCOPICITY

Hygroscopicity is the tendency of a material to absorb moisture. It affects explosives by the introduction of an inert material which when vaporized absorbs heat, and by providing a

solvent medium which promotes undesirable chemical reactions. Since inert materials reduce the continuity of the explosive mass and since cooling reduces the temperature of reaction, moisture reduces sensitivity, strength, and velocity of detonation. In the case of ammonium nitrate explosives, it may even cause the explosives to become so insensitive that they will not detonate. In addition, the presence of moisture promotes decomposition, thereby affecting stability. Still another effect may be the corrosion of the metal containing the explosive.

### 1-6.3 SENSITIVITY

The term "sensitivity" as applied to explosives means the ease with which they may be ignited or detonated or, in other words, the amount and intensity of shock, friction, or heat required for ignition or detonation. Whether an explosive is sensitive or not depends in part upon the molecular make-up of the explosive, and also upon the crystal size and distortion, coating of crystals, density, moisture, and temperature. High density, increased moisture, and coating of crystals with wax or a similar substance will tend to reduce sensitivity. Increased temperature and distortion of the crystalline structure will increase sensitivity. The size of the crystals may increase or decrease the sensitivity depending on the explosive considered and the amount of internal strain within, or between crystals.

### 1-6.4 VELOCITY OF DETONATION

When a high explosive detonates, the action proceeds in a wave through the column of explosive. The speed with which this wave progresses is termed the "velocity of detonation" and is usually expressed in meters per second. Under identical conditions, different explosives detonate at different velocities (see Table A-1 in the Annex to Part 1). The factors which materially affect the velocity of detonation are

## SOURCES OF ENERGY

---

reactivity, diameter of the column of explosive, amount of confinement, crystal size, crystal coating, density, and moisture. Increasing the explosive column diameter, the amount of confinement, or the density will increase the velocity. Moisture, coating of crystals, or decreasing the crystal size will decrease the velocity.

### 1-6.5 STRENGTH

The strength of an explosive is its ability to do work. It may be defined and measured in two ways. From the user or testing standpoint, it is defined as the ability of the explosive to displace the medium which confines it. From the engineering point of view it is the amount of energy liberated by the explosion or detonation. The constituent atoms and their arrangement determines the energy available in an explosive. The degree of rearrangement, the rate of decomposition, and the quantity of gas liberated determines the amount of work done by the explosive.

### 1-6.6 BRISANCE

When a force displaces a mass through a distance, the result is work done. The amount of work done by a given amount of explosive is determined by the strength of the explosive. The speed of the reaction, or the rate of doing work is called power. Explosives have both strength and power. They also possess a third characteristic which is their shattering effect or brisance (from the French, meaning "to break"). Brisance is a unique characteristic of explosives. There is no universally accepted precise meaning of brisance as applied to explosives. Brisance describes the extremely disruptive effect resulting from the almost instantaneous decomposition of a high explosive. The causes of this effect are fairly well understood. Decomposition proceeds in a self-sustaining wave called the detonation wave. This wave traveling at a high velocity is surrounded by extreme pressures (of the order of 2,000,000 lb/sq in.) capable of producing momentary shocks of terrific intensity on contiguous material. It is known that the foregoing qualities are critically affected by load density. Brisance is therefore proportional to the product of load density, reaction zone pressure, and detonation velocity. An explosive with great strength and a high detonation velocity will have high brisance. Brisance is sometimes expressed as the ability

of an explosive to do damage in the close vicinity, or its ability to shatter its confining medium.

### 1-6.7 POWER

Power is defined as the rate of doing work. This definition applies to an explosive as well as to a machine. In explosives power is dependent upon strength and detonation velocity, i.e., the amount of energy released and the speed with which it is released. Strength, brisance, and power are closely related. Generally speaking, given two explosives of equal strength, the one detonating at the highest velocity will not only have the greatest brisance but will be more powerful. It will be more brisant because of the sharpness of the blow and more powerful because of the speed with which the energy is delivered.

Of two explosives of equal velocity, the stronger will be more brisant because there is more force back of the blow. The stronger explosive will also be more powerful, because more energy is delivered in the same time. It is possible to increase velocity and reduce strength, thereby increasing both brisance and power. It is also possible to slightly reduce velocity and greatly increase strength to increase both brisance and power. In the first case, brisance is increased by the sharpness of the blow, and power is increased by the increased speed with which the blow is delivered. In the second case, both power and brisance are increased by the weight of the blow, in spite of the fact that time of delivery is increased. Power sometimes is expressed as the ability of an explosive to do damage at a distance.

### 1-6.8 HIGH ORDER OF DETONATION

This is the detonation of nearly all of the explosive at the highest velocity possible under existing conditions. In detonations, a high order of detonation is desirable in order to produce the maximum shock wave effect and hence blast damage in the proximity of the explosive.

### 1-6.9 LOW ORDER OF DETONATION

This is incomplete detonation in which all the explosive is not detonated. It is inefficient and undesirable. Low order detonations may be caused by:

## CHEMICAL EXPLOSIVE REACTIONS

---

- (a) Initiator of inadequate power.
- (b) Deterioration of the explosive.
- (c) Poor contact with the initiator or lack of continuity in the charge.

### 1-6.10 STABILITY

In non-technical language the term "stability" often is used to mean the opposite of sensitivity, but from a military standpoint, it is used correctly to indicate stability in storage or the ability of the explosive to stand storage under all conditions without deterioration. The fact that a material is very sensitive does not imply that it is unstable in storage, nor does the fact that it is insensitive mean that it will be stable in storage. A substance may be extremely reactive chemically, but at the same time may be stable in the absence of anything with which to react. For example, lead azide may explode from a slight shock, although it is stable if properly stored. It is repeated that by stability is meant ability to be stored, not sensitivity. The following factors affect the stability of an explosive:

(a) Chemical constitution. Certain explosives, nitrates, for example, will decompose at ordinary temperatures. This is caused by a change in the molecular structure at these temperatures, and the reaction can only be minimized by the addition of stabilizing substances which lower the rate of reaction.

(b) Temperature of decomposition. If the decomposition in storage evolves heat, the reaction will be accelerated and a rate of reaction sufficient to cause spontaneous combustion may result.

(c) Temperature of storage. Certain explosives, such as mercury fulminate, are stable at ordinary temperatures but will decompose at elevated temperatures. The rate of decomposition of explosives increases at higher temperatures.

(d) Reaction of decomposition products. The products of decomposition may accelerate the reaction or they may start a different reaction. For example, ammonium nitrate will hydrolyze to ammonia, which will then react with TNT.

(e) Presence of impurities. Impurities may make aromatic compounds unstable. For example, certain impurities such as dinitrotoluene (DNT) lower the melting point of TNT, causing a sensitive eutectic mixture which may liquefy at storage temperatures and exude from the solid TNT.

(f) Presence of moisture. This will affect some explosives by promoting decomposition at storage temperatures.

(g) Exposure to sun. Explosives, many of which contain nitro compounds, are rapidly decomposed by the ultraviolet rays of the sun. This decomposition may increase their sensitivity.

## 1-7 EXPLOSIVE TRAINS

A designed arrangement of a single series of explosives beginning with a small quantity of sensitive explosive and terminating with a relatively large quantity of comparatively insensitive though powerful explosive, is termed an "explosive train." A high explosive artillery round has both a propelling charge explosive train and a

bursting charge explosive train. A round of small-arms ball ammunition has an explosive train only for the propelling charge. A bomb has no propelling charge but may have one or two bursting charge explosive trains, depending on the number of fuzes used.

### 1-7.1 PROPELLING CHARGE EXPLOSIVE TRAIN

The propelling charge explosive train ejects the projectile from the weapon. This train usually consists of a primer, an igniter or igniting charge, and a propelling charge. Thus a spit of fire from a small quantity of sensitive explosive, the primer,

initiated by a blow from the firing pin, is transmitted and intensified by the igniter so that the large, relatively insensitive propelling charge burns in the proper manner and ejects the projectile from the bore.

In small arms cartridges, where the propelling charge is small enough to be ignited by the

# SOURCES OF ENERGY

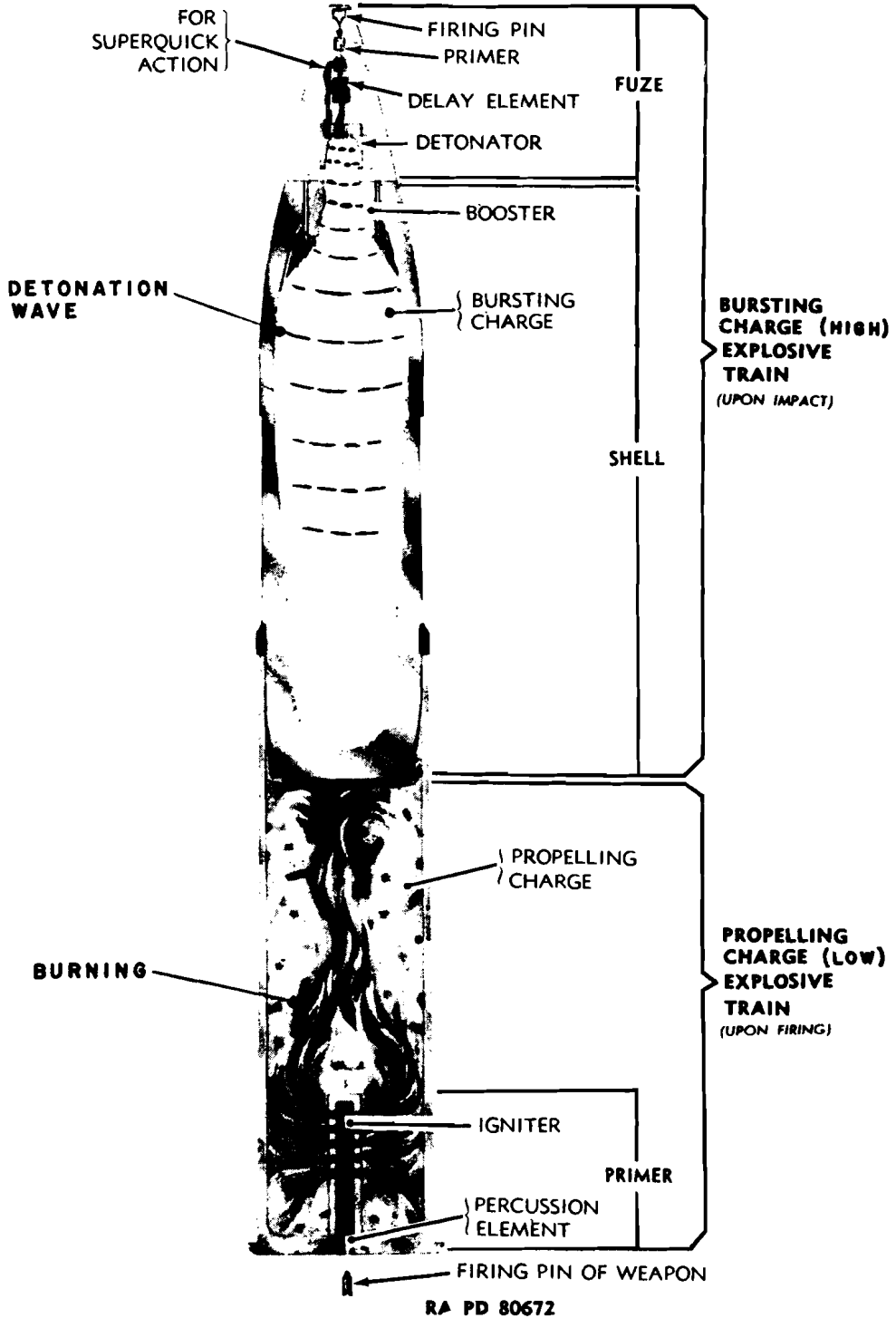

Fig. 1-5 Explosive trains.



# CHEMICAL EXPLOSIVE REACTIONS

primer, an igniter is not required. The components in this train are a percussion primer and a propelling charge. The firing pin explodes the primer, and the flame passes through a vent leading to the powder and ignites the propelling charge. Pressure of the resultant gases then accelerates the bullet through the bore.

The propelling charge of a round of artillery ammunition acts somewhat differently from small arms ammunition. In artillery ammunition it is necessary to place an auxiliary charge of black powder, called the igniter, between the primer and the propelling charge. The addition of the igniter charge is necessary because the small flame produced by the primer composition is not of sufficient magnitude to initiate properly the large quantity of propellant powder. The igniter charge may be contained in the body of the primer, making one assembly of the percussion element of the primer and the igniter charge as in fixed ammunition, or it may be divided between the primer body and the igniter pad of separate-loading propelling charges.

## 1-7.2 BURSTING CHARGE EXPLOSIVE TRAINS

Although there are two explosive trains, the

propelling charge explosive train and the bursting charge explosive train, the term "explosive train," as commonly used, often refers to the bursting charge explosive train.

Upon impact, or at some point at which the missile is desired to function, a series of explosive elements known as the bursting charge train or the high explosive train detonates the missile. Basic components which must be present in practically all high explosive trains are: primer, detonator, booster, and bursting charge. Other elements are sometimes required, but these four charges are basic.

The detonator sets up a detonation wave when initiated by the primer, but this detonation is so small and weak that it will not properly initiate a high order detonation in the bursting charge unless a booster is placed between the two. The booster does detonate from the small explosive wave of the detonator and in turn detonates the bursting charge with a high order detonation (Figures 1-5 and 1-6).

In order to obtain a particular kind of functioning of the missile it may be necessary to incorporate other components in the high explosive train. The desired action may be an air burst, an instantaneous burst upon impact with the target,

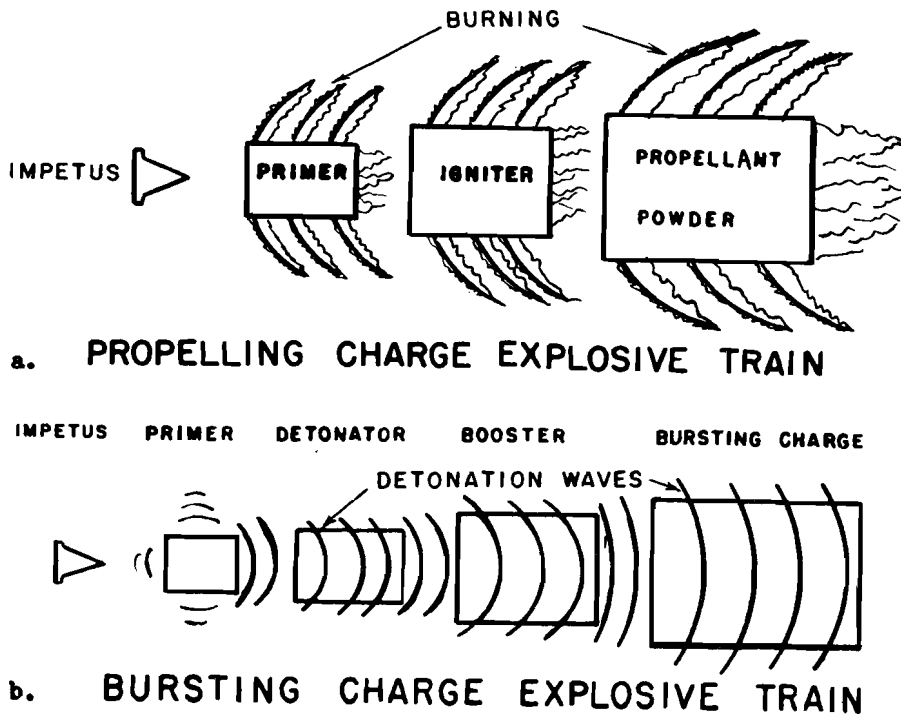

Fig. 1-6 Schematic representation of explosive trains.

## SOURCES OF ENERGY

---

or a delayed burst shortly after the projectile has penetrated the target. The components which may be used to produce these various actions are: primer, black powder delay pellet or train, upper detonator, lower detonator, or some combination of these components. Regardless of the arrangement of the components, the basic chain of events must be provided.

The action which causes a projectile to burst in the air may be obtained by placing a primer (which is fired when the projectile leaves the weapon or when the bomb is dropped) and a black powder time train in front of the basic chain. The primer ignites the time train rings, which burn for the length of time for which the fuze is set, and then in turn initiate the action of the detonator, booster, and bursting charge. Other methods for accomplishing the same end result will be discussed under "Fuzes" later in the text.

To burst the projectile promptly upon impact with the target, a superquick or instantaneous fuze action is necessary. Such action is usually obtained by placing an upper detonator in the extreme front of the fuze and a lower detonator

in the body near the booster charge. In this manner the detonating wave is transmitted instantly to the bursting charge.

The upper detonator is an assembly which contains the primer and detonator. The lower detonator is an assembly which contains the detonator and some booster explosive to lead into the booster.

In order to permit penetration of the target by the projectile before bursting, a delay action is necessary. This is obtained by placing a primer and delay element ahead of the detonator. In some cases this combination of primer and delay is inserted between an upper and lower detonator.

A variation of the high explosive train is found in chemical shells. In this train there is no large bursting charge such as is found in high explosive projectiles, as it is often desirable to only rupture the shell case and allow the chemical contents to escape, not to diffuse the chemical filler. The actual bursting of the case is accomplished by an enlarged booster, known as a burster charge, contained in a tube running the length of the shell along its axis.

## REFERENCES

- 1 T. L. Davis, *The Chemistry of Powder and Explosives*, John Wiley and Sons, Inc., N. Y., 1942, Chapter 1.
- 2 P. R. Frey, *Chemistry*, Prentice-Hall, Inc., N. Y., 1952, Chapter 2.
- 3 M. Meyer, *The Science of Explosives*, T. Y. Crowell Co., N. Y., 1943, Chapter 2.
- 4 Richardson and Scarlett, *Brief College Chemistry*, Henry Holt, N. Y., 1942, Paragraph 52.

## CHAPTER 2

# THE THERMOCHEMISTRY OF CHEMICAL EXPLOSIVES

### 2-1 CHEMICAL REACTIONS OF EXPLOSIVES

The development of new and improved types of ammunition requires a continuous program of research and development. Adoption of an explosive for a particular use is based upon both proving ground and service tests. Before these tests, however, preliminary estimates of the characteristics of the explosive should be made by theoretical calculations and comparisons with laboratory and smaller scale experimental tests. Such calculations are made using the principles of thermochemistry.

Thermochemistry is concerned with the changes in internal energy, principally as heat, in chemical reactions. An explosion consists of a series of reactions, highly exothermic in their summation, involving decomposition of the ingredients and recombination to form the products of explosion. Energy changes in explosive reactions are calculated either from known chemical laws or by analysis of the products.

For most common reactions, tables based on previous investigations permit rapid calculation of energy changes. Products of an explosion remaining in a closed calorimetric bomb (a constant volume explosion) after cooling the bomb back to room temperature are rarely those present at the instant of maximum temperature and pressure. Since only the final products may be analyzed conveniently, indirect or theoretical methods often are used to determine the maximum temperature and pressure values.

Some of the important characteristics of an explosive which can be determined by such theoretical computations and which are discussed in this chapter are:

- (a) Heat of explosion.
- (b) Volume of products of explosion.
- (c) Potential of the explosive.
- (d) Maximum temperature of reaction.
- (e) Maximum pressure developed in a closed chamber.

### 2-2 REVIEW OF BASIC DEFINITIONS AND CHEMICAL FUNDAMENTALS

An explanation of the chemical (stoichiometric) terms used in the discussion follows. The metric system of weights and measures is used in explosives calculations and all tabulations of values of factors and constants are given

in metric units. Problem solutions are simplified accordingly by using metric units in calculation and then, if desirable, by transforming the results into engineering units.

## SOURCES OF ENERGY

### 2-2.1 GRAM MOLECULE

A gram molecule of a compound is a precise weight of that compound: it is the gram-molecular weight, or the weight in grams, numerically equal to its molecular weight. The molecular weight of mercury fulminate,  $\text{Hg}(\text{CNO})_2$ , is 284.8, and one gram molecule of this explosive is 284.8 grams (see Table A-5, Appendix). This term is usually written gm mol.

### 2-2.2 GRAM FORMULA WEIGHT

When the explosive is a mixture instead of a compound, the term gram formula weight is used in lieu of gram molecular weight. It indicates a weight in grams equal to the sum of the molecular weights of as many molecules of each ingredient as appear in the formula of the mixture. Thus, a gram formula weight of black powder,  $10\text{KNO}_3 + 3\text{S} + 8\text{C}$ , is  $(10 \times 101.1 + 3 \times 32 + 8 \times 12)$  grams, or 1203 grams. Similarly, a gram formula weight of a mixture of TNT and ammonium nitrate represented by the formula  $\text{C}_6\text{H}_2(\text{NO}_2)_3\text{CH}_3 + 3\text{NH}_4\text{NO}_3$  is  $(227.1 + 3 \times 80)$  grams, or 467.1 grams.

### 2-2.3 SPECIFIC HEAT

The specific heat of a substance is the quantity of heat required to produce a unit change in temperature in a unit of mass of the substance.

Only small error results if the specific heat of solids is assumed to be constant through wide ranges in temperature, provided temperatures not too near their melting or their dissociation temperatures are approached. A similar assumption may be made as to the specific heats of liquids, except in ranges close to their freezing, boiling, or dissociation temperatures. The specific heats of gases vary with the temperature, and the specific heat of any gas at constant pressure  $C_p$ , is always greater than that at constant volume  $C_v$ , since in the former case the work of expansion is involved.

### 2-2.4 MOLECULAR SPECIFIC HEAT

The molecular specific heat of a gas is the quantity of heat necessary to raise the temperature of a gram molecule of the gas  $1^\circ\text{C}$ . It varies with the temperature, and can be defined for constant pressure or constant volume. The ratio of the specific heat at constant pressure to that

at constant volume is termed  $k$ . It is typically larger than 1, actually about 1.2-1.5. Its value is a function of the gas.

### 2-2.5 SPECIFIC VOLUME

The specific volume of a gas is the volume of a unit weight of a gas at  $0^\circ\text{C}$  and normal atmospheric pressure ( $103.33 \text{ kg/dm}^2$ ).

### 2-2.6 MOLECULAR VOLUME

The molecular volume is the volume of a gram molecule of the gas at  $0^\circ\text{C}$  and normal atmospheric pressure.

### 2-2.7 CO-VOLUME

The co-volume of a gas is defined as the smallest volume into which a unit weight of the gas can be compressed. In this course for the gaseous products of explosion, the co-volume will be assumed to be  $1/1000$  of the specific volume. This is of course not precisely true, but little error results.

### 2-2.8 SPECIFIC GRAVITY

The specific gravity of an explosive is the ratio of its weight to the weight of an equal volume of water at  $4^\circ\text{C}$ .

### 2-2.9 DENSITY

The density of an explosive may be expressed in grams per cubic centimeter. In the metric system, since one cubic centimeter of water weighs one gram, the numerical expressions for density and specific gravity are the same. In engineering units specific gravity and density are not identical values. The term load density refers to density (or specific gravity in cgs units) of the explosive when loaded. This value is often slightly larger than explosive density before loading since explosives are sometimes compressed during loading.

### 2-2.10 DENSITY OF LOADING

The density of loading, as used in calculating pressure in a closed chamber, is the ratio of the weight of the explosive charge to the weight of the volume of water which would fill the total chamber in which the charge is to be burned. Note that this is not the same as load density.

## THERMOCHEMISTRY

### 2-2.11 CALORIE

A calorie is the quantity of heat required to raise the temperature of one gram of water (one cubic centimeter) from 14 to 15°C. This quantity of heat is sometimes called a small calorie.

### 2-2.12 KILOCALORIE

A kilocalorie is 1000 small calories. In explosive technology a kilocalorie (kcal) is called also a large calorie and is abbreviated L.C.

The mechanical equivalent of a large calorie unit of heat, that is, the corresponding amount of work, is approximately 4270 kilogram-decimeters. This value is a conversion factor useful in converting heat energy to work energy. In explosive calculations, work is expressed in kg-decimeters (kg-dm) because it is convenient.

### 2-2.13 HEAT OF FORMATION

When a chemical compound is formed from its constituents, the reaction may either absorb or give off heat. The quantity of heat absorbed or given off during transformation is called the heat of formation. The heats of formations for solids and gases found in explosive reactions have been determined for a temperature of 15°C and atmospheric pressure, and are tabulated in units of kilocalories per gram molecule. They are listed in the Appendix of Part I. Where a negative value is given, it indicates that heat is absorbed during the formation of the compound from its elements. Such a reaction is called an endothermic reaction. The convention usually employed in simple thermochemical calculations is arbitrarily to take the heat contents of all elements as zero in their standard states\* at all temperatures. Since the heat of formation of a compound is the net difference between the heat content of the compound and that of its elements, and since the latter are taken as zero by convention, it follows that the heat content of a compound is equal to its heat of formation in such nonrigorous calculations.

### 2-2.14 PRINCIPLE OF INITIAL AND FINAL STATE

The principle of the initial and final state may be expressed as follows: The net quantity of

\* The standard state being defined as the state at which the elements are found under natural or ambient conditions. The standard state temperature in this text is taken as 15°C.

heat liberated or absorbed in any chemical modification of a system depends solely upon the initial and final states of the system, provided the transformation takes place at constant volume or at constant pressure. It is completely independent of the intermediate transformations and of the time required for the reactions. From this it follows that the heat liberated in any transformation accomplished through successive reactions, is the algebraic sum of the heats liberated or absorbed in the different reactions. Consider the formation of the original explosive from its elements as an intermediate reaction in the formation of the products of explosion. The net amount of heat liberated during an explosion is the sum of the heats of formation of the products of explosion, minus the heat of formation of the original explosive. The effect of this principle will be first observed in the calculation of the quantity of heat liberated at constant pressure.

### 2-2.15 HEAT OF REACTION

The net heat difference between heats of formations of the reactants and products in a chemical reaction is termed the heat of reaction. For oxidations this heat of reaction may be termed heat of combustion. In explosive technology only materials which are exothermic, that is, have a heat of reaction which causes net liberation of heat, are of interest. Hence, in this text heats of reaction are virtually all positive.

Since reactions may occur either under conditions of constant pressure or constant volume, the heat of reaction can be expressed at constant pressure or at constant volume. As will be seen in Par. 2-4, the heat of reaction at constant pressure is equivalent to a change in enthalpy of the constituents of the reaction.

### 2-2.16 POTENTIAL OF AN EXPLOSIVE

The potential of an explosive is the total work that can be performed by the gas resulting from its explosion, when expanded adiabatically from its original volume until its pressure is reduced to atmospheric pressure and its temperature to 15°C. The potential is therefore the total quantity of heat given off at constant volume when expressed in equivalent work units and is a measure of the strength of the explosive.

## SOURCES OF ENERGY

### 2-3 POTENTIAL

The potential, or the total work that is available as a result of explosion under conditions of constant volume from a given weight of an explosive, is a useful term in describing the effectiveness of an explosive.

Using the principles of the initial and final state, and heat of formation tables (resulting from experimental data), the heat released at constant pressure may be readily calculated.

This quantity of heat is different from the amount of useful heat actually released by an explosive in a gun chamber, since in a gun conditions approaching constant volume not constant pressure are met in practice. Thus, an explosion may occur under two general conditions: the first, unconfined, as in the open air where the pressure (atmospheric) is constant; the second, confined, as in a closed chamber where the volume is constant. The same amount of heat energy is liberated in each case, but in the unconfined explosion a certain amount is used as work energy in pushing back the surrounding air, and therefore is lost as heat. In a confined explosion where the explosive volume is small, however (such as occurs in the powder chamber of a firearm) practically all the heat of explosion is conserved as useful energy. If the quantity of heat liberated at constant volume

from a weight of explosive under adiabatic conditions is calculated and converted from heat into equivalent work units, the potential or capacity for work of that weight of the explosive results.

Hence, if:

$Q_{mp}$  represents the total quantity of heat given off by a gram molecule of explosive at 15°C and constant pressure (atmospheric);

$Q_{mv}$  represents the total heat given off by a gram molecule of explosive at 15°C and constant volume;

$W$  represents the work energy expended in pushing back the surrounding air in an unconfined explosion and thus is not available as net theoretical heat;

$E$  represents the mechanical equivalent of heat (4270 kilogram-decimeters per kilocalorie, or large calorie):

Then, because of the conversion of energy to work in the constant pressure case,

$$Q_{mv} = Q_{mp} + W/E \quad (2-1)$$

from which the value of  $Q_{mv}$  may be determined. Subsequently, the potential,  $EQ_{mv}$ , of a gram mol of an explosive may be calculated. Using this value, the potential for any other weight of explosive may be determined by simple proportion.

### 2-4 QUANTITY OF HEAT LIBERATED AT CONSTANT PRESSURE

If the energy change in a reaction is known this change can be used as a basis for calculation of work (and pressure) effects. However, the absolute heat contents of explosive compounds are difficult to calculate, so the quantity of heat liberated in any given reaction may be calculated only from the reactants' net change in energy. Such a technique is used in determining heat of formation of explosive reactions. As a further simplification in such calculations, the heat contents of the elements in their uncombined, "standard" or elemental state, are assumed to be zero. As a result of this assumption, the total change in heat of the reaction may be assumed to be the net change of heat between the explosive and its (nonelemental, or compound) end products. For example, in the equation

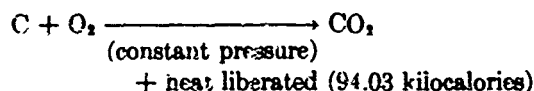

There are 94.03 kilocalories "given off" by this reaction, or a net gain of this amount of heat energy if the end product,  $\text{CO}_2$ , is cooled back to the original room temperature (15°C) of the reactants. Looking at this change thermodynamically, if this  $\text{CO}_2$  reaction is carried to completion in the atmosphere, i.e., at constant pressure, the heat change is a change in enthalpy of the system (enthalpy decreases). It will be recalled by the student that heat change of a system at constant pressure is a change of enthalpy. Enthalpy is defined as:

$$H = U + PV \quad (2-2)$$

## THERMOCHEMISTRY

or

$$\begin{aligned} (\text{enthalpy}) &= (\text{internal energy}) \\ &+ (\text{energy in pressure-volume terms of system}) \end{aligned}$$

Enthalpy is not heat. It has the dimensions of energy, but while both of its terms are "energy" terms it may not represent wholly available energy. It is merely the sum of  $U$  (internal energy) and  $PV$  (pressure-volume energy). Substituting into (2-2) the value of  $U$  in the first law of thermodynamics (conservation of energy law), which is:

$$Q = U + W \quad (2-3)$$

(heat energy)    (internal energy)    (work energy)

then

$$U = Q - W$$

and (2-2) becomes:

$$H = (Q - W) + PV$$

or, differentiating,

$$dH = dQ - dW + PdV + VdP,$$

and if only the constant pressure case is considered, then, since  $dW = PdV$ ,

$$dH = dQ - PdV + PdV + VdP$$

or, since  $VdP = 0$ ,

$$dH = dQ \quad (2-4)$$

Hence, under conditions of constant pressure, a change in heat energy is equivalent to a change in enthalpy.

Since enthalpy decreases when heat is given off or lost, heats of formation of exothermic reactions are given negative signs in many engineering texts. However, in this text in order to simplify calculations (since only explosions which "give off" heat are of interest) for any change where heat is "given off" the heat of formation will be given a positive sign: The tables and illustrative examples in this book are so arranged. The  $\text{CO}_2$  reaction previously described, would thus have a heat of formation of +94.03 kcal. For many reactions it is very difficult to form compounds from their elements and subsequently to determine the heat of formation. Hence, for these reactions the heat of formation must be arrived at by indirect means such as algebraic addition of simple combustion equations. For example, the heat of formation of carbon monoxide is calculated as follows:

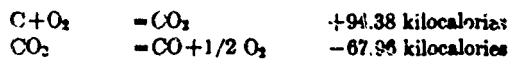

adding:



Or, cancelling  $\text{CO}_2$ 's on each side of the equation gives:



This is the heat of formation per mol of carbon monoxide formed.

Using similar reasoning on equations describing the formation of simple products, and by actually measuring the heat evolved, tables for the heat of formation (or enthalpy change) have been compiled (see Table A-5, in the Appendix). Such heats of formation are for conditions of constant pressure and must be adjusted if constant volume conditions are to be met. Thus, to calculate the quantity of heat liberated at constant pressure, the net heat difference between the sums of the individual heats of reaction of the reactants and the products must be determined. For example, the chemical reaction representing the explosion of nitroglycerin, with the total molecular weights and heats of formation of the explosive (assuming that the products of explosion will be as indicated) will be:

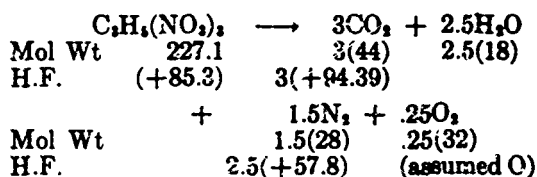

This reaction can be expressed in words by saying that 1 gram molecule (or 227.1 grams) of nitroglycerin produces upon explosion 3 gram molecules (or 132 grams) of  $\text{CO}_2$ ; 2.5 gram molecules (or 45 grams) of  $\text{H}_2\text{O}$  (gaseous); 1.5 gram molecules (or 42 grams) of  $\text{N}_2$ ; and .25 gram molecule (or 8 grams) of  $\text{O}_2$ . The heats of formation in large calories per gram molecule are: nitroglycerin, 35.3;  $\text{CO}_2$ , 94.39; water (gaseous), 57.81. The nitrogen and molecular oxygen have not combined with other elements in the reaction and hence do not give off heat. Therefore, to calculate  $Q_m$ ,

$$\begin{aligned} Q_m &= [3 (+94.39) + 2.5 (+57.8)] \\ &\quad - [+85.3] = +342.4 \text{ L.C.} \end{aligned}$$

## SOURCES OF ENERGY

which is the number of large calories evolved by the explosion of 1 gram molecule (or 227.1 grams) of nitroglycerin at constant pressure.

Observe that in calculating this quantity of heat at constant pressure conditions, the assumption was made that the products of combustion had been reduced to atmospheric pressure and to a temperature of 15°C.

It should be noted that the heat of formation of water has been taken as that for water in a gaseous state. At 15°C and atmospheric pressure water is liquid, but at the moment of maximum pressure and temperature during explosion, and at all working temperatures, the products of explosion, including water, are gaseous. Accordingly, in all thermochemical calculations in this text, water is considered to exist as a gas. Actually, to be consistent with the thermochemical reaction in the explosion of nitroglycerin, using heats of formation calculated at 15°C and 760 mm pressure, the heat of formation of H<sub>2</sub>O should be considered for the liquid rather than

the gaseous state. However, by considering H<sub>2</sub>O as a gas in all phases of these calculations the results theoretically obtained are nearer to the actual observed results. Thus, H<sub>2</sub>O will be considered to exist as a gaseous product at 15°C in calculations in this text.

To convert the quantity of heat liberated per mol, to the heat which would be liberated by other weight of explosive such as a kilogram, the procedure is as follows:

Since

$$Q_{kp} = \text{the total quantity of heat given off by a kilogram of explosive at 15°C and constant pressure (atmospheric);}$$

Then, using a simple proportion:

$$\frac{Q_{kp}}{Q_{mp}} = \frac{1000}{\text{mol wt}}$$

Thus, for nitroglycerin:

$$Q_{kp} = 342.4 (1000/227.1) = 1507.7 \text{ kcal/kg}$$

## 2-5 VOLUME OF GAS LIBERATED

The law of Avogadro, verified experimentally, states that equal volumes of all gases under the same conditions of temperature and pressure contain the same number of molecules. From this law it follows that the molecular volume of one gas is equal to the molecular volume of any other gas. The molecular volume of any gas at 0°C and under normal atmospheric pressure is very nearly 22.4 liters or 22.4 cubic decimeters. Thus, again considering the nitroglycerin reaction,

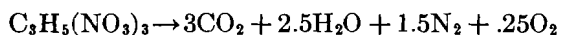

the explosion of one gram molecule of nitroglycerin produces in the gaseous state: 3 gram molecules of CO<sub>2</sub>; 2.5 gram molecules of H<sub>2</sub>O; 1.5 gram molecules of N<sub>2</sub>; and .25 gram molecule of O<sub>2</sub>. Since a molecular volume is the volume of one gram molecule of gas, one gram molecule of nitroglycerin produces 3 + 2.5 + 1.5 + .25 = 7.25 molecular volumes of gas; and these molecular volumes at 0°C and atmospheric pressure form an actual volume of 7.25 × 22.4 = 162.4 liters of gas. Hence, representative symbols can be assigned where:

$n_m$  = the number of molecular volumes of gas resulting from the explosion of one gram molecule of explosive;

$n_k$  = the number of molecular volumes resulting from the explosion of one kilogram of explosive;

$V_m$  = the volume of gas in liters resulting from one gram molecule of the explosive at any stated temperature;

$V_k$  = the volume of gas in liters resulting from one kilogram, at any stated temperature.

Then:

$n_m \times 22.4 = V_{m0}$ , for 0°C and normal atmospheric pressure; and if

$n_m = 7.25$  molecular volumes then

$V_{m0} = 7.25 \times 22.4 = 162.4$  liters since one molecular of any gas at 0°C and atmospheric pressure always equals 22.4 liters.

$n_k = 7.25 \times 1000/227.1 = 31.92$  molecular volumes.

$V_{k0} = 162.4 \times 1000/227.1 = 715.1$  liters/kg.

The above value of  $V_m = 162.4$  liters is the volume of gaseous products from one gram



molecule of nitroglycerin at atmospheric pressure and 0°C. To determine the value of  $V_m$  at 15°C, which is the temperature for which the heats of formation were calculated and tabulated, use must be made of the law of Gay-Lussac for perfect gases. This law states that at a constant pressure a perfect gas expands 1/273 of its volume at 0°C, for each degree of rise in

temperature.

Therefore, at 15°C the volume of gas from one gram molecule of any explosive becomes

$$V_{m15} = 22.4 (1 + 15/273) \times n_m = 23.63 \times n_m \quad (2-5)$$

or

$$V_{m15} = V_{m0} (1 + 15/273)$$

## 2-6 EXTERNAL WORK PERFORMED IN EXPANSION

Immediately upon explosion in the open air, the volume of an explosive substance is greatly increased. If the quantity of heat consumed in the work of pushing back the surrounding air is calculated and added to  $Q_{mp}$ , the resulting quantity is  $Q_{mv}$ . The external work performed in the expansion of the gas may be determined as follows:

Let

- $p$  = pressure;
- $V$  = the volume of any given weight of gas at any pressure  $p$  and any temperature;
- $s$  = the surface area of the envelope enclosing the gas; and
- $u$  = the travel of the surface  $s$ , as the gas expands.

The work of expansion is given by

$$W = \int psdu = \int pdV \quad (2-6)$$

In this case  $p$  is the constant normal atmospheric pressure of 103.33 kilograms per square decimeter, and for the work performed in expansion,

(2-6) becomes

$$W = \int_{V_1}^{V_2} pdV = p \int_{V_1}^{V_2} dV = p (V_2 - V_1) \quad (2-7)$$

in which  $V_1$  represents the volume of the solid explosive and  $V_2$  the volume of the gaseous products. Here  $V_1$  is negligible compared with  $V_2$  and may be disregarded. Therefore,

$$W = pV_2 \quad (2-8)$$

From (2-5) and (2-8),  $W = 2441.69 n_m$  (kg-dm), for the work of expansion of the gaseous products from one gram molecule of the explosive at atmospheric pressure and 15°C. This is derived as follows:

$$\begin{aligned} W \text{ (kg-dm)} &= pV_{m15} = 103.33 \left( \frac{\text{kg}}{\text{dm}^2} \right) \\ &\times 23.63 \left( \frac{\text{dm}^3}{\text{mol}} \right) \times n_m \text{ (mol)} \\ &= 2441.69 n_m \text{ (kg-dm)} \end{aligned} \quad (2-9)$$

## 2-7 QUANTITY OF HEAT LIBERATED AT CONSTANT VOLUME

The equivalent quantity of heat consumed in expansion at 15°C and under constant atmospheric pressure, but available in confined explosion, is then

$$\begin{aligned} W/E &= 2441.69 n_m / 4270 \\ &= 0.572 n_m \text{ L.C. (kilocalories)} \end{aligned} \quad (2-10)$$

Substituting this value in (2-1)

$$Q_{mv} = Q_{mp} + 0.572 n_m \quad (2-11)$$

For the nitroglycerin reaction, for example:

$$\begin{aligned} Q_{mv} &= 342.4 + (0.572 \times 7.25) \\ &= 346.5 \text{ L.C./gm mol} \end{aligned}$$

And

$$Q_{kv} = 346.5 \times 1000 / 227.1 = 1525.8 \text{ L.C./kg}$$

## SOURCES OF ENERGY

### 2-8 POTENTIAL OR WORK

It has been shown how the quantity of heat given off at constant volume by the explosion of any substance whose chemical reaction is known may be calculated. These calculations are made on a basis of cooling the products of explosion to 15°C. Practically, the determination is accomplished by the use of the bomb calorimeter immersed in a known quantity of water at a known temperature.

Having determined  $Q_{mv}$ , the potential of any weight of the explosive can now be found. For

one gram molecule of nitroglycerin,

$$P_m = Q_{mv} \times E = 346.5 \times 4270 \\ = 1,479,555 \text{ kg-dm/gm mol}$$

Similarly, the potential of one kilogram is

$$P_k = 346.5 \times 4270 \times 1000/227.1 \\ = 6,514,993 \text{ kg-dm/kilogram}$$

Potential represents the quantity of work that a given weight of the explosive can do.

### 2-9 SUMMARY OF CALCULATIONS

The nitroglycerin reaction, in which all products are gaseous, will now be examined as a resume of the foregoing work.

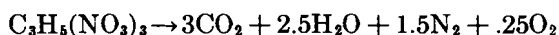

- (a) The total heat given off per gram molecule at constant pressure:

$$Q_{mp} = 3(94.39) + 2.5(57.8) - 85.3 \\ = 342.4 \text{ L.C./gm mol}$$

- (b) The number of molecular volumes per gram molecule:

$$n_m = 3 + 2.5 + 1.5 + .25 \\ = 7.25 \text{ mol-volume/gm mol}$$

- (c) The total heat liberated per gram molecule at constant volume:

$$Q_{mv} = Q_{mp} + 0.572 n_m \\ = 342.4 + (0.572 \times 7.25) \\ = 346.5 \text{ L.C./gm mol}$$

- (d) The volume of the gas produced per gram molecule at 0°C:

$$V_{m0} = 7.25 \times 22.4 \\ = 162.4 \text{ liters/gm mol at } 0^\circ\text{C}$$

- (e) The volume of gas produced per kilogram at 0°C:

$$V_{k0} = 162.4 \times 1000/227.1 \\ = 715.1 \text{ liters/kg at } 0^\circ\text{C}$$

- (f) The volume of gas produced per kilogram at 15°C:

$$V_{k15} = V_{k0} (1 + 15/273) \\ = 715.1 (1 + 15/273) \\ = 754.4 \text{ liters/kg at } 15^\circ\text{C}$$

- (g) The potential (or capacity for work) of one gram molecule at constant volume:

$$\frac{\text{potential}}{\text{gram molecule}} = Q_{mv} \times 4270$$

$$P_m = 346.5 \times 4270 \\ P_m = 1,479,555 \text{ kg-dm/gm mol}$$

- (h) The potential of one kilogram

$$\frac{\text{potential}}{\text{kg}} = \frac{\text{potential}}{\text{gram molecule}} \times \frac{1000}{227.1}$$

$$P_k = 1,479,555 \times \frac{1000}{227.1}$$

$$P_k = 6,514,993 \text{ kg-dm/kg}$$

- (i) The potential of one pound of nitroglycerin in foot-pounds:

$$\frac{\text{potential}}{\text{lb}} = \frac{\text{kg-dm}}{\text{kg}} \times \frac{\text{kg}}{\text{lb}} \times \frac{\text{ft-lb}}{\text{kg-dm}}$$

$$P_{\text{one lb}} = 6,514,993 \times \frac{1}{2.205} \times .7233$$

$$P_{\text{one lb}} = 2,137,095 \frac{\text{ft-lb}}{\text{lb}}$$

Note that potential has been calculated for assumed constant pressure adiabatic conditions. This does not mean to infer that explosives liberate their energy only under constant pressure conditions. They do not. Actually, neither the gun chamber nor the rocket motor are constant pressure adiabatic systems. Rather the use

of the potential concept gives an easy and convenient method of comparing two or more explosives under similar assumed conditions.

For rocket propellants as well as for gun propellants, potential is a measure of energy. For rocket fuels however, the term "specific impulse" (defined as the pounds of thrust delivered per pound of fuel per second) is in more common usage as a measure of performance. The magnitude of specific impulse is not only a function of propellant characteristics, but also is dependent upon the characteristics of the system in which reaction occurs. Rocket propulsion will be discussed more fully in Part 2.

Similarly, for rocket chamber temperature and

pressure calculations, the fact that in the rocket motor, combustion of the propellant occurs during a flow process, alters the method in that the reaction occurs during motion of the reactants and may not be complete before the products are ejected from the nozzle. Further, in a rocket nozzle chamber the ambient pressure characteristics influence chamber pressure and therefore temperature.

In a similar way, pressure in a rocket motor, although calculated using the gas laws, is a function of the rate of flow, nozzle characteristics, and thermodynamic properties of the propellant gas mixture, and thus not a simple, constant volume system.

## 2-10 TEMPERATURE OF EXPLOSION

In the analysis of an explosive, in addition to an evaluation of the potential which it will deliver, it is important to know to what maximum temperatures the heat liberated will raise the products of explosion, since these products subject the containing system to temperatures related to these heats. For example, gun tube erosion is related to the temperature of explosion. Explosion products are essentially a mixture of gases, each of which has a unique specific heat. It should be noted that our calculations thus far have assumed that reactions give off the same products each time an explosion takes place.

Explosions do not always yield similar products. For example, when propellants are burned in a rocket motor, combustion products consisting of varying sizes of molecules may be formed. Discussion of temperature calculations in this text assume constancy of groups of products as shown. In such mixtures, the collective specific heat of the mixture is a weighted sum of the individual specific heats of the mixture components.

Also, since some component gases may have different molecular configurations the specific heat of each component may vary differently with temperature. The curve for one such component's specific heat variation, as a function of temperature is shown in Figure 2-1. Note that

the area beneath each curve represents heat; hence, for a given mixture, if the heat for each component can be determined between the limits of temperature  $t_0$  and  $t_1$  then the heat of the mixture can be determined by calculation of the weighted sum of the heats of all products. For specific heats measured at constant pressure, as in Figure 2-1, the derivation in total heat between two temperature limits,  $t_0$  and  $t_1$ , is arrived at either by rigorous integration, or by more simple approximation.

For example, in Figure 2-1, the area beneath the curve is:

$$Q_{mp} = \int_{t_0}^{T_x} C_{mp} dt \quad (2-12)$$

The expression for  $C_{mp}$  as a function of temperature is not known. However, a close approximation may be attained by the series:

$$C_p = \alpha + \beta t + \gamma t^2 + \dots xt^n \quad (2-13)$$

For use as constants of each term in this series, values in Table 2-1 have been obtained for some specific products of chemical explosives.

Using this specific heat-temperature relationship, a general equation may be drafted which can be solved for  $T_x$ , the explosion temperature. First, a general heat balance equation can be written as follows:

## SOURCES OF ENERGY

$$\left[ \text{Heat liberated by explosion under constant pressure conditions between } 15^{\circ}\text{C and } T_x \right] + \left[ \text{Heat liberated between } 0^{\circ}\text{C and } 15^{\circ}\text{C} \right] = \left[ \text{Heat available from explosive under constant pressure conditions between } 0^{\circ}\text{C and } T_x \text{ on a mol basis. This is approximately equal to } Q_{mp} \text{ as previously calculated.} \right] \quad (2-14)$$

Substituting, keeping in mind that the specific heat for all products is given by the expression:

$$C'_p = \alpha' + \beta'T + \gamma'T^2 \quad (2-15)$$

where  $C'_p$  is the weighted sum mol specific heat of all explosive products, and  $\alpha'$ ,  $\beta'$ , and  $\gamma'$  are weighted sum constants of (2-13) for all explosive products. Then substitution in (2-14) gives:

$$\int_{15^{\circ}}^{T_x} C'_{mp} dt + \int_{0^{\circ}}^{15^{\circ}} C'_{mp} dt \cong Q_{mp} \quad (2-16)$$

Simplifying and substituting values of (2-15) and (2-16):

$$\int_0^{T_x} (\alpha' + \beta't + \gamma't^2 + \dots) \cong Q_{mp} \quad (2-17)$$

Integrating and simplifying:

$$\gamma'T_x + \frac{\beta'}{2} T_x^2 + \frac{\gamma'}{3} T_x^3 \cong Q_{mp} \quad (2-18)$$

This can be solved for  $T_x$ , the approximate explo-

sion temperature. The fact that the equation is expressed as a cubic of temperature complicates its solution; however, as an approximate solution

since the term  $\frac{\gamma'}{3} T_x^3$  is a relatively small percentage of  $Q_{mp}$ , this term may be ignored in order to obtain an approximate solution for  $T_x$  so that a trial-and-error technique subsequently may be used to give a more accurate value for  $T_x$ . Once the cubic term is dropped the equation becomes a quadratic which can be solved using:

$$T_x = \frac{-b \pm \sqrt{b^2 - 4ac}}{2a} \quad (2-19)$$

where

$$a = +\frac{\beta'}{2}$$

$$b = +\alpha'$$

$$c = -1000 Q_{mp} \text{ (since } Q_{mp} \text{ is expressed in kilocalories and the constants in Table 2-1 are expressed in units of cal/}^{\circ}\text{C mol)}$$

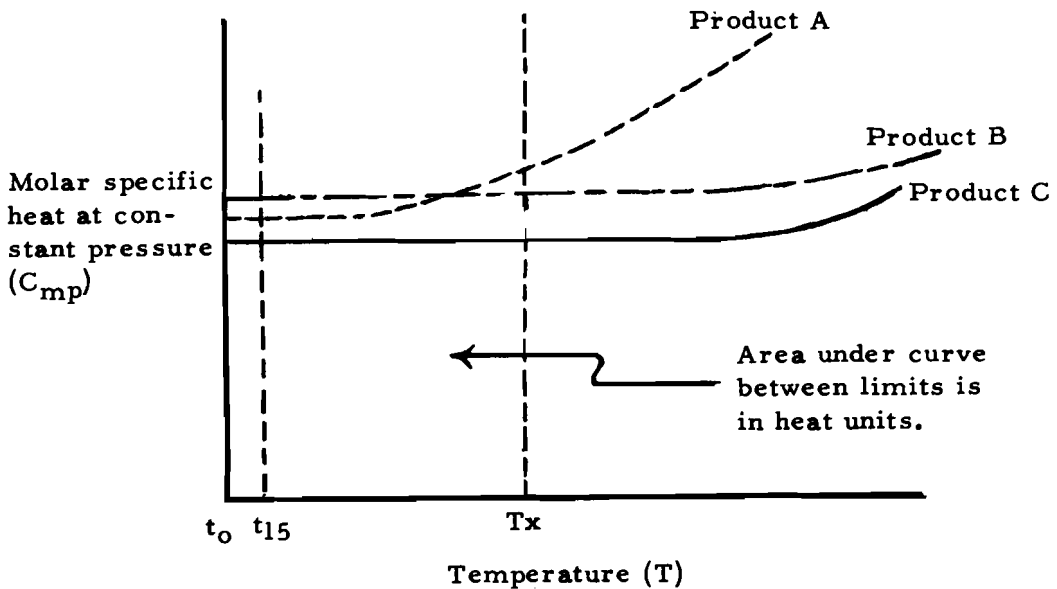

Fig. 2-1 Curves showing variation of mol specific heat with temperature for several gaseous explosive products.

## THERMOCHEMISTRY

Substituting these values into (2-18) yields:

$$T_x = \frac{-\alpha' + \sqrt{\alpha'^2 + 2000 \beta' Q_{mp}}}{\beta'} \quad (2-20)$$

This relationship gives an approximate  $T_x$  which can be used in a trial-and-error solution of (2-18) by trying temperatures in the left side of (2-18) until this side is identical in magnitude to  $Q_{mp}$  of the right side of the equation.

For a specific explosive, since  $Q_{mv} = Q_{mp} + .572n_m$ , a similar equation for the approximate value of  $T_x$  expressed as a function of the constant volume enthalpy change is:

$$T_x = \frac{-\alpha' + \sqrt{\alpha'^2 + 2000\beta' (Q_{mv} - .572n_m)}}{\beta'} \quad (2-21)$$

Note, that to be correct,  $\alpha'$  and  $\beta'$  are the weighted sum of all the product gases'  $\alpha$ 's and  $\beta$ 's (weighted for the mol amounts of the products liberated). Observe also that  $T_x$  is a function only of  $\alpha'$ ,  $\beta'$ , and  $Q_{mp}$  (or  $Q_{mv}$  and  $n_m$ ) and is independent of such other factors as the density of loading and the quantity of explosive.

Consider a typical example:

**EXAMPLE:** The temperature of the explosion of nitroglycerin is:

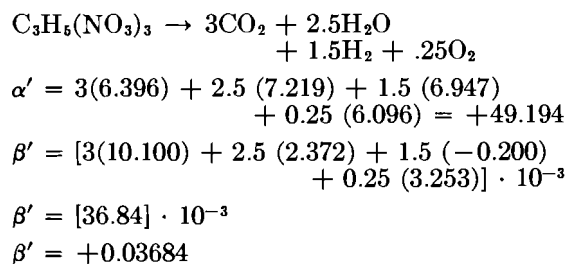

$$\gamma' = [3(-3.405) + 2.5(0.267) + 1.5(0.4808) + 0.25(-1.017)] \cdot 10^{-6}$$

$$\gamma' = -.000009051 \equiv -9.051 \cdot 10^{-6}$$

$$Q_{mp} = 342.4 \frac{\text{kcal}}{\text{mol}}$$

Hence, substituting these value into (2-20):

$$T_x = \frac{-(49.194) + \sqrt{(49.194)^2 + 2000(.03684)(342.4)}}{(.03684)}$$

$$T_x \cong 3170^\circ\text{C}$$

Solving (2-18) by trial-and-error using this value as the first trial temperature a value of  $T_x = 3240^\circ\text{C}$  ( $\equiv T_x = 3513^\circ\text{K}$ ) is obtained by successive approximation as shown in Table 2-2.

**TABLE 2-1 HEAT CAPACITY ( $C_p$ ) CONSTANTS FOR EXPLOSIVE PRODUCTS AT ONE ATMOSPHERE PRESSURE EXPRESSED IN CALORIES PER DEGREE CENTIGRADE PER GRAM MOLECULE**

Product	$\alpha$	$\beta$ ( $\times 10^{-3}$ )	$\gamma$ ( $\times 10^{-6}$ )
H <sub>2</sub>	6.947	-0.200	0.4808
O <sub>2</sub>	6.095	3.253	-1.017
N <sub>2</sub>	6.449	1.413	-0.0807
H <sub>2</sub> O	7.219	2.374	0.267
CO	6.342	1.836	-0.2801
CO <sub>2</sub>	6.396	10.100	-3.405
NH <sub>3</sub>	6.189	7.787	-0.728
CH <sub>4</sub>	3.381	14.450	0.267

Note: Data from *Thermodynamics for Chemists*, Samuel Glasstone, Van Nostrand, Inc., N. Y., 1947

**TABLE 2-2 TRIAL-AND-ERROR METHOD FOR OBTAINING APPROXIMATE EXPLOSION TEMPERATURE**

$T_x$ tried ( $^\circ\text{C}$ )	Value of		Value of $Q_{mp}$ (cal/gm mol)
	$49.194 T_x + \frac{3.684 \cdot 10^{-2}}{2} T_x^2 - \frac{9.051 \cdot 10^{-6}}{3} T_x^3$	(calories/gm mol)	
3170		331,390	342,400
3360		358,100	342,400
3290		349,450	342,400
3240		342,400	342,400

## SOURCES OF ENERGY

It should be noted that the temperature of explosion calculated above neglects heat lost to the confining vessel, energy lost in expanding the container, and the heat content of products between 15°C and absolute zero.

### 2-10.1 TEMPERATURE WHEN SOLID PRODUCTS ARE FORMED

In those explosives which are not entirely converted to gas, the heat absorbed by the solid products must be considered in determining the temperature of explosion. Equation (2-18) was derived on the basis of all the products of explosion being gaseous. Assume that in addition to the gases there are  $x$  gram molecules of a solid product having a molecular specific heat of all the products, and the value of  $\alpha'$  for the mixture of gases must be increased by a quantity representing the heat content of the solid product.

As in the case of all gaseous products, (2-17) may be used to determine the temperature of explosion when solid products are formed, it being necessary only to use a value of  $\alpha'$  and  $\beta''$  for all the products, both solid and gaseous.

EXAMPLE: The explosion of ammonium picrate can be represented by the following reaction:

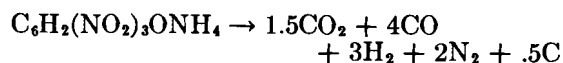

$$Q_{mp} = 1.5(94.39) + 4(26.43) - (78) = 169.3 \text{ L.C.}$$

Considering carbon as a solid product with a constant specific heat of 1.98 calories per gram molecule, then

$$\alpha'' = 1.5(6.396) + 4(6.342) + 3(6.947) + 2(6.449) + .5(1.98) = +69.591$$

$$\beta'' = \beta' = 1.5(10.100) + 4(1.836) + 3(-0.200) + 2(1.413) + (0) \cdot 10^{-3} = +.02472$$

which gives an approximate value of  $T_x$  of

$$T_x = \frac{(-69.591) = \sqrt{(69.591)^2 + 2000(.02472)(169.3)}}{+.02472}$$

$$T_x = \frac{+46.5}{+.02472} = 1879^\circ\text{C (or } 2152^\circ\text{K)}$$

Or by trial-and-error using (2-17) where

$$69.591 T_x + .02472 T_x^2 - 4.95 \cdot 10^{-6} T_x^3 = 169,300$$

$$T_x \cong 1740^\circ\text{C (2013}^\circ\text{K)}$$

## 2-11 DETERMINATION OF PRESSURE IN A CONSTANT VOLUME CHAMBER

The pressure developed by an explosive on being fired in a closed chamber will now be

### 2-11.1 BASIC EQUATIONS

From thermodynamic characteristics of all perfect gases for any gas  $PV = nRT$  (where  $n$  is the number of mols). For a unit weight of a specific gas

$$pv = RT \quad (2-22)$$

Equation (2-22) is called the perfect specific gas equation and states that the product of the pressure and volume of a unit weight of one known specific gas (or mixture) varies directly with the absolute temperature of that gas. Thus, written for a specific gas,  $R$ , the gas constant, must be a specific and unique constant for that gas. Thus, for a given gas,  $R$  becomes

considered. Its value determines the strength, and thus the thickness of the container wall.

$$R = \frac{PV}{T} \text{ or for standard conditions at } 0^\circ \text{ centigrade absolute}$$

$$R = \frac{P_0 V_0}{273} \quad (2-23)$$

The arbitrary "unit" amount for a given gas (or mixture of gases) used in this text is one kilogram. Thus defined,  $R$  is measured in kilogram-decimeters per degree kelvin for one kilogram, and actually is the amount of external work performed when a unit weight (kilogram) of gas (or mixture of gases), expands against atmospheric pressure owing to a unit increase of temperature.  $R$  varies from gas to gas. Use of the

phrase "a unit weight of gas (or a mixture of gases)," stems from Avogadro's law which states: At identical temperature and pressure, equal volumes of all gases contain the same number of molecules; and to Dalton's law which states: If two or more different gases exist as a mixture in a closed vessel, the total pressure exerted by the mixture on the walls of the vessels will be equal to the sum of the individual pressures exerted by the gases making up the mixture. Therefore, in accordance with these laws, the assumption that each constituent of a mixture of gases has the same volume and temperature as the entire mixture, is a valid one.

For real gases (2-22) is only approximately correct and must be corrected for the behavior of actual gases which are not frictionless in their behavior and are composed of particles of finite (though small) volume.

In this text this correction is handled as a co-volume correction in which the calculated ideal volume is reduced by a correction volume  $\alpha$ .  $\alpha$  is defined as the smallest volume to which a unit weight of the gas can be compressed whatever the amount of pressure used. It represents the space occupied by the gas molecules when all the space between them is gone. Equation (2-22) then becomes:

$$P(v - \alpha) = RT \quad (2-24)$$

Such a correction, though accurate enough for the purposes of this text, is a crude method of adjusting the ideal gas law for real gas behavior. Van der Waals, Berthelot, or Virial coefficient equation techniques provide more accurate methods for corrections of this type. For example, Corner, in his book *Internal Ballistics*, uses the relationship

$$PV = nRT \left( 1 + \frac{B}{V} + \frac{nC}{V^2} \right)$$

where  $B$  and  $C$  are constants which are functions of the gas under consideration.

For weights of gas ( $\omega$ ) greater than unity, (2-22) becomes

$$PV = \omega RT \quad (2-25)$$

or,

$$P(V - \omega\alpha) = \omega RT$$

or,

$$P = \frac{\omega RT}{V - \alpha\omega} \quad (2-26)$$

Since the co-volume is the limiting volume beyond which a unit weight of gas cannot be compressed, the expression  $(v - \alpha)$  is sometimes called the effective volume of the gas.

For powder gases the co-volume is generally taken as 1/1000 of the specific volume of the gas, that is, 1/1000 of the volume of a kilogram of the gas at 0°C and atmospheric pressure, a kilogram being the weight on which all calculations in the analysis are based. Thus,  $\alpha$  becomes

$$\alpha = \frac{V_{k0}}{1000} \quad (2-27)$$

### 2-11.2 PRESSURE IN A GUN PROPELLANT CHAMBER

The calculations above provide a means of determining the pressure in a closed chamber where the explosive itself fills the entire volume. A method of determining pressures developed in the chamber of a gun, capable of variations in charge size, will now be considered.

The density of loading, designated by  $\Delta$ , has been defined as the ratio between the weight of the explosive charge and the weight of water which would fill the entire explosive chamber. The term should not be confused with the density of the explosive,  $\rho$ .

If the weight of explosive,  $\omega$ , is given in kilograms and the weight of water ( $W$ ) to fill the chamber is given in kilograms, then

$$\Delta = \frac{\omega}{W} \text{ or } W = \frac{\omega}{\Delta} \quad (2-28)$$

Numerically, the chamber volume in cubic decimeters is equal to the weight in kilograms of an equal volume of water, thus  $W$  represents not only the weight of water to fill the chamber but also (in metric units) the volume of the chamber in liters (or cubic decimeters). Thus, substituting this value of  $W$  for  $V$  in (2-26):

$$P = \frac{\Delta RT}{1 - \alpha\Delta} \quad (2-29)$$

Equation (2-29) gives the expression for maximum pressure to be expected in a chamber of fixed volume.

## SOURCES OF ENERGY

It must be borne in mind that the derivation of (2-29) is based upon the characteristic behavior of perfect gases only grossly corrected. The actual gases evolved in an explosion are not perfect gases, and for this reason the use of (2-29) must be restricted even with the correction to values of  $\Delta$  which in general are less than one. It should also be noted that (2-29) was derived using the metric system in which the density of water is 1.

Consider an example:

**EXAMPLE:** The explosion of nitrocellulose smokeless powder may be represented by the following equation:

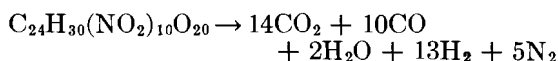

Calculations previously carried out with the method used for nitroglycerin gave  $V_{k_0} = 896$  liters and  $T = 2733^\circ\text{K}$  (centigrade, absolute). Assuming a  $\Delta$  of 0.12, then, since

$$P = \frac{\Delta RT}{1 \alpha \Delta}$$

$$P = \frac{0.12 \times \frac{103.33 \times 896}{273} \times 2733}{1 - (.896) (0.12)}$$

where

$$R = \frac{P_0 V_{k_0}}{273}$$

and

$$P_0 = 103.33 \text{ kg/sq dm or atmospheric pressure}$$

Therefore:

$$P = \frac{0.12 \times 339 \times 2733}{.8926}$$

$$P = 124,200 \text{ kg/sq dm}$$

or

$$P = 17,420 \text{ psia.}$$

### 2-11.3 PRESSURE WHEN SOLID PRODUCTS ARE FORMED

Some explosives, upon combustion, are not entirely converted into gas. Consider the reaction for black powder:

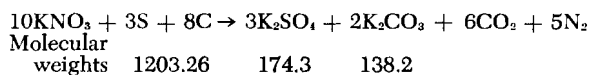

The potassium sulfate and potassium carbonate are solid products. In such instances the solid products occupy space and must be included in the co-volume. Equation (2-29) so adjusted then becomes:

$$P = \frac{\Delta RT}{[1 - (\alpha + \alpha') \Delta]} \quad (2-30)$$

in which  $\alpha'$  represents the volume occupied by the solid products of a unit weight of the explosive.

**EXAMPLE:** Consider the reaction for black powder given above and assume that previous calculations have been made giving  $V_{k_0} = 204.8$  liters and  $t_x = 2800^\circ\text{C}$ . For a density of loading of  $\Delta = 0.6$  find the pressure in a closed chamber.

The solid products of explosion are  $\text{K}_2\text{SO}_4$  and  $\text{K}_2\text{CO}_3$  and the computation of  $\alpha'$  is as follows:

1. Weight of  $\text{K}_2\text{SO}_4$  based on a kilogram of explosive

$$= \frac{1000}{1203.26} \times 3(174.3) = 434.52 \text{ gm}$$

$$\text{Similarly, weight of } \text{K}_2\text{CO}_3 = \frac{1000}{1203.26} \times 2(138.2) = 229.68 \text{ gm}$$

2. The specific gravity of  $\text{K}_2\text{SO}_4 = 2.66$  and that of  $\text{K}_2\text{CO}_3 = 2.29$ . Since in the metric system specific gravity and density are numerically equal, then the volume of

$$\begin{aligned} \text{K}_2\text{SO}_4 &= \frac{434.52}{2.66} \\ &= 163.35 \text{ cc, and the volume of } \text{K}_2\text{CO}_3 \\ &= \frac{229.68}{2.29} = 100.29 \text{ cc.} \end{aligned}$$

3. From 2. above, the total volume of solid products in liters

$$= (163.35 + 100.29) \times \frac{1}{1000} = .2636 = \alpha'$$

4. Then using (2-29)

$$P = \frac{.6 \times \frac{103.33 \times 204.8}{273} \times 3073}{1 - (.2048 + .2636) .6}$$

$$P = 198,794 \text{ kg/dm}^2$$



## 2-11.4 ACTUAL CHAMBER PRESSURE

This simplified method of pressure determination gives the maximum pressure that might be encountered in a weapon if the projectile did

not move. Actually, the projectile does move which increases the size of the closed chamber before the propellant is completely burned. Now consider briefly the general case where volume changes during burning.

## 2-12 DETERMINATION OF WORK IN A SYSTEM OF CHANGING VOLUME AND PRESSURE

The calculations thus far considered have been for systems such as artillery propellant chambers, in which it was assumed that the volume has remained constant during the progress of the explosive reaction. For propulsion devices such as rocket motors, the energy released during the explosive chemical reaction is released into an unsealed chamber in which the pressure is not constant. Nor is the system purely adiabatic since hot gases are lost in the jet out the nozzle. In addition, the quantity of explosive may be changing since the fuel is in motion during its reaction and some may be lost through the nozzle. For rocket motors, the amount of energy liberated per unit weight of explosive is only one variable affecting the changes in chamber pressure and temperature. Also of importance in rockets are:

(a) Rate at which the gases are produced.

(b) Rate at which gases are discharged (area of throat of nozzle and discharge coefficient).

(c) Thermodynamic properties of the exhaust gases.

(d) Conditions on either side of, and shape of the exit section.

It is repeated that in spite of these differences in use, however, the basic calculations of potential, temperature, and pressure are applicable to rockets as well as to guns. For rockets, a steady state flow adiabatic condition must be assumed, and in addition, a solution of several simultaneous equations (required as a result of differing exhaust products) must be solved by trial-and-error methods.

A more detailed discussion of propulsion is included later in the text.

## REFERENCES

- 1 J. Corner, *Internal Ballistics*, Philosophical Library, N.Y., 1951, Chapter II.
- 2 Durham, *Thermodynamics*, Prentice-Hall, N.Y., 1954, Chapter II.
- 3 P. R. Frey, *College Chemistry*, Prentice-Hall, N.Y., 1952, Chapter 8, Paragraphs 9-3 through 9-10.
- 4 Samuel Glasstone, *The Elements of Physical Chemistry*, D. Van Nostrand Co., N.Y., 1946, Chapter 7.
- 5 Samuel Glasstone, *Thermodynamics for Chemists*, D. Van Nostrand Co., N.Y., 1947, Chapters I, III, and V.
- 6 Hausman and Slack, *Physics*, Van Nostrand, N.Y., 3rd Ed., 1948, Paragraphs 137, 139-40, 167-68, 181-3.
- 7 James Kendall, *Smith's College Chemistry*, D. Appleton, Century Co., N.Y., 1935, p. 206.



## CHAPTER 3

# MILITARY EXPLOSIVE CHARACTERISTICS

### 3-1 INTRODUCTION

In Chapter 1 it was pointed out that explosive compounds or mixtures decompose at differing rates. When this rate is sufficiently rapid to cause nearly instantaneous decomposition, the explosion is called a detonation and the explosive is termed a high explosive. On the other hand, compounds or mixtures with lesser rates of decomposition, which burn beginning at the surface of the explosive and progressing inwards,

are termed low explosives and are used principally as propellants.

This chapter deals with the physical property and military requirements for each of these explosive classes. It should be noted that the characteristics of low explosives used as gun propellants and rocket propellants differ somewhat, and therefore are discussed separately.

### 3-2 HIGH EXPLOSIVES

In all military applications of high explosives, the requirement has been to increase effects such as fragmenting power, blast, and fragment velocity. This increase requires improvement of the two major characteristics, strength and brisance, without changing the uniformity of functioning and ability to withstand adverse

conditions of storage. This requirement in ammunition improvement has tended to the utilization of the more potent compounds such as RDX and PETN. Their application to ammunition may be considered the most important development in the high explosives field during World War II.

#### 3-2.1 GREATER POTENTIAL

There is a definite correlation between the potential of an explosive and the degree to which the explosive has been oxidized. To express the latter the term oxygen balance is useful. Oxygen balance is defined as the ratio (converted to a percentage) of oxygen surplus or lack, to that amount required for complete conversion of the end products, carbon and hydrogen, to carbon dioxide and water. A zero oxygen balance means that oxygen present corresponds exactly to the amount needed for complete oxidation of all products. If there is an excess of oxygen, this percentage over is used and given a positive sign. If there is a shortage of oxygen, the percentage short is used and given

a negative sign. Thus, an explosive having perfect balance to yield carbon dioxide and water has zero balance; one lacking sufficient oxygen has a negative balance; and one containing excess oxygen has a positive balance. An oxygen balance of  $-20\%$  indicates that there is only  $80\%$  enough oxygen to fully oxidize the carbon and hydrogen present in the explosive. This means that other, not fully oxidized products, such as  $H_2$ , C, CO, and  $CH_4$ , would be formed with less liberation of heat. The following simple reactions illustrate this reduction in heat.

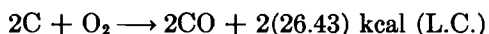

whereas:



## SOURCES OF ENERGY

The volume of gas liberated in each reaction is the same, but in the latter case 67.96 L.C. of additional heat are liberated. On a weight basis,

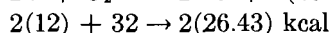

28 grams of the reacting substance would yield 26.43 kcal, or we would derive .944 kcal/gram of explosive.

whereas:

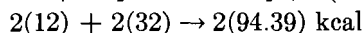

44 grams of the reacting substance would yield 94.39 L.C., or we would derive 2.143 kcal/gram. Thus the complete oxidation of C to  $CO_2$ , not CO, yields (on a weight basis) some 128% more heat.

In Figure 3-1, groups of compounds are graphically compared in strength and oxygen balance. Considering that all the data available have been used without regard to quality of source, and that some of them have been interpolated

from ballistic mortar results by the use of calculated factors, the family of curves which results is remarkably consistent. The conclusion is inescapable: Strength is directly related to oxygen balance for these compounds; It is at a maximum in compounds whose balance is close to zero; The four types of explosives are roughly equal to each other at a given balance, although their indicated maxima may not exactly coincide. It can also be demonstrated that the sensitivity, power, and brisance of these compounds increase rapidly with increasing oxygen balance, to reach a maximum at the zero balance point. However, there appears to be a less rapid falling off of sensitivity in the region of positive balance than in the case of strength. It should be noted that with very few exceptions, explosives are of a decidedly negative balance.

TNT,  $CH_3C_6H_2(NO_2)_3$ , may react as follows and in so doing has an oxygen balance of  $-63.6\%$ :

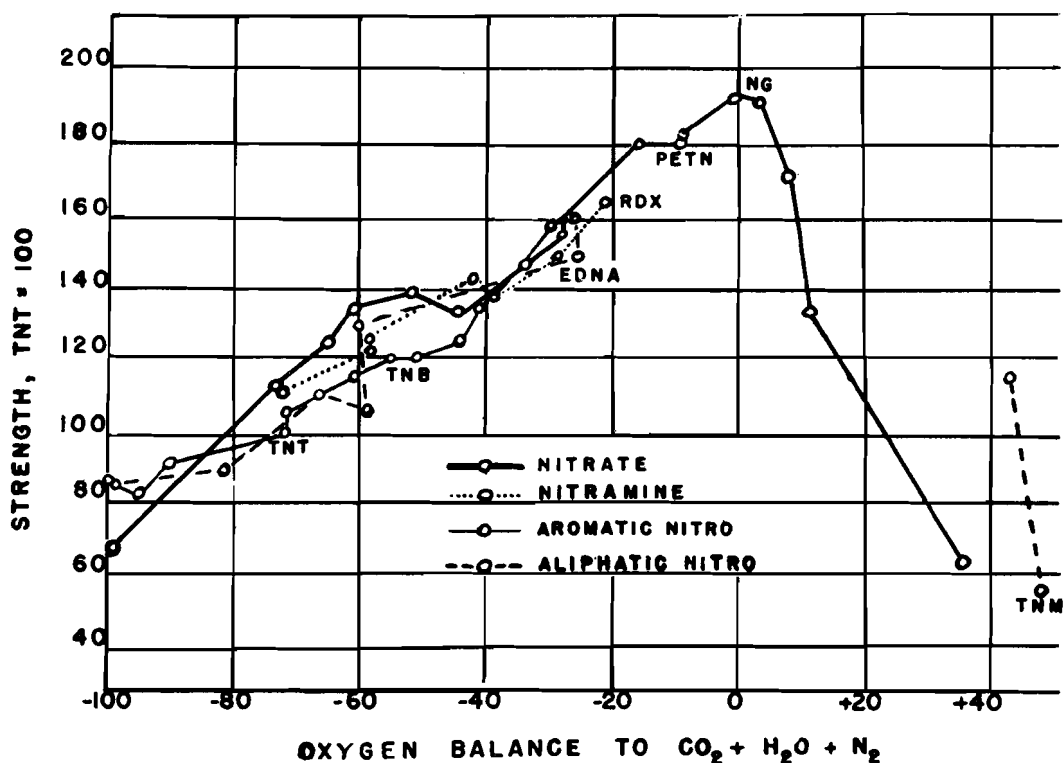

Fig. 3-1 Effect of oxygen balance on strength of explosives (compared with TNT) in the lead block expansion test.

## MILITARY EXPLOSIVE CHARACTERISTICS

### CALCULATION:



Oxygen available:

$$\text{In 12 mols of CO there are } 1/2(12) = \frac{6 \text{ mols O}_2}{2 \text{ mols TNT}}$$

or 3 mols O<sub>2</sub> are available in TNT per mol of TNT

Oxygen needed:

For 14 C's are needed: 14 mols O<sub>2</sub>

For 10 H's are needed:  $\frac{2.5 \text{ mols O}_2}{10 \text{ mols TNT}}$

Total O<sub>2</sub> needed: 16.5 mols O<sub>2</sub>

or

$$\frac{16.5}{2} = 8.25 \frac{\text{mols O}_2}{\text{mol TNT}} \text{ are needed for complete}$$

oxidation of TNT.

Hence there is a shortage of:

$$8.25 - 3 = 5.25 \frac{\text{mols O}_2}{\text{mol TNT}}$$

Or there is a negative O<sub>2</sub> balance of:

$$\frac{-5.25}{8.25} \times 100 = -63.6\%$$

If a sample of TNT is exploded in a calorimeter bomb, containing in addition to the TNT a sufficient quantity of TNM (tetranitromethane, an organic compound readily affording oxygen to the reaction) to make the oxygen balance more nearly perfect, the explosive power is greatly increased.

The relationship between oxygen balance and potential is a tool in the hands of the explosives research worker. It is not the complete answer in the search for stronger explosives. It is quite conceivable that future work will show that certain new arrangements of atoms may give enhanced performance beyond that which would be expected from oxygen balance or from calculated heats of explosion. Such increased performance might result, for example, as a result of the arrangement as well as the constituency of the explosion.

### 3-3 HIGH EXPLOSIVE CLASSES

High explosives are divided into two classes distinguished according to their sensitivity. These classes are primary high explosives and secondary high explosives. Primary high explosives are extremely sensitive to shock, friction, and heat. They will not burn, but will detonate if ignited. Their strength and brisance are inferior, but are sufficient to detonate secondary high explosives.

#### 3-3.1 PRIMARY HIGH EXPLOSIVE

The following requirements are considered in selecting an explosive substance as a primary high explosive:

(a) Sensitivity. The explosive must be quite sensitive, compatible with an acceptable degree of safety in manufacture, transportation, storage, and use.

(b) Velocity of detonation. The explosive must attain maximum velocity of detonation in a very short column since very small amounts of

the explosives are used. A moderately high velocity of detonation is acceptable for primary high explosives used as booster or bursting charges. They will usually burn rather than detonate when ignited in small unconfined quantities. They are used for boosters and bursting charges.

the explosives are used. A moderately high velocity of detonation is acceptable for primary high explosives used as booster or bursting charges.

(c) Stability. Good stability is important in primary high explosives. Deterioration in storage may result in a low order of detonation for a primer or detonator which would render an entire ammunition item ineffective.

(d) Hygroscopicity. Absorption of moisture affects stability, sensitivity, and velocity. Thus, hygroscopicity is to be avoided, particularly in

## SOURCES OF ENERGY

---

this class of sensitive explosives.

Since only small amounts of primary high explosive are used, neither the cost of manufacture nor the availability of raw materials are important factors. Their melting points are not a consideration except as they affect storage characteristics, and any tendency to react with metals can be readily avoided. Strength is not always a factor for, in many cases, a long hot flame, not strength, is the principal requirement.

### 3-3.2 SECONDARY HIGH EXPLOSIVE

The following requirements must be considered in selecting an explosive substance as a secondary high explosive for use in components of ammunition.

(a) Velocity of detonation. A pound of coal has five times the energy of a pound of explosive. Thus it is easy to see that the rate with which energy is released is important to explosives. This is of special importance from a military standpoint since military high explosives must often be detonated without tamping. They must detonate rapidly in order that they may attain a maximum gas pressure before the gases are appreciably dissipated in the atmosphere. For example, in a 2000-pound bomb detonated by a nose fuze, if the explosive detonates slowly, the expanding gases from the nose will start toward the objective before the tail part has detonated. If a fast-acting explosive is used, the pressure build-up is faster, and a larger amount of energy will be delivered at one time. Therefore, the faster the explosive velocity the more violent the action of the explosive mass.

(b) Strength and power. The total capacity of an explosive is a function of the total available heat liberated during detonation. The ability of an explosive to deliver this work energy is a measure of its strength. Strength is of particular importance when the explosive is confined. In an underwater detonation, water "tamps" the gases and permits a high pressure to be built up before the energy is dissipated throughout a great volume. An explosion in water is thus four and one-half times more effective at the point of explosion than in air. If the explosive detonates adequately, the more energy liberated, the greater is its strength.

Power is determined not only by the strength

of the explosive, i.e., its ability to liberate much energy, but also by the rate at which this energy is liberated. An explosive can conceivably be strong but not very powerful, if it liberates energy slowly. This is not usually the case since, if detonation occurs, it provides for very rapid liberation of energy.

(c) Sensitivity. The explosive must be safe to manufacture, transport, store, load, and use. It must withstand the force of setback when used in shells, and must be safe to jettison in the case of bombs. At the same time, it must be readily detonated by the action of a suitable explosive train.

(d) Stability. Explosives must be able to remain unchanged after long periods of storage in any climate.

(e) Hygroscopicity. Absorption of moisture must be low because of its effect on stability, sensitivity, velocity, and strength.

(f) Melting point. This is important particularly for those explosives which are cast (melt) loaded. The melting point should be between 80 and 100°C. If it is much higher than 100°C, the explosive cannot be melted by low pressure steam and the use of other forms of heat for melting has been found to be more hazardous.

(g) Reaction with metals. The tendency to react with metals is undesirable but is not a controlling factor in the selection of an explosive. Metal containers can now be insulated from their fillers with unreactive substances.

(h) Availability and cost. The best explosive known could not be used if its raw materials were not plentiful. For this reason, in the past, many reserve explosives such as the Amatols, became first-line explosives during wars: Cost is not critical in time of war. However, if other factors were equal, it would be the deciding factor.

### 3-3.3 COMPARISON OF EXPLOSIVES

The important characteristics of the more commonly used explosives may be studied on Table A-1 in the Annex of Part 1. Explosives are listed in the order of their sensitivity and are compared to TNT, the characteristics of which are well known. The methods of conducting the tests, from which the table was compiled, are discussed in the Part 1 Annex.

## 3-4 PRIMARY HIGH EXPLOSIVES

Primary high explosives are used principally as initiating agents in items of ammunition. As such, they are used in both priming compositions and as initial detonating agents.

Priming compositions are mixtures of compounds or materials which by their chemical and/or physical nature are very sensitive to impact or percussion. When set off, they undergo very rapid decomposition. This decomposition is generally auto-combustion, and not detonation. When initiated, they give off hot gases and incandescent solid particles. Initial detonating agents likewise are sensitive to heat, friction, or impact, but detonate rather than burn when set off.

Materials such as lead azide, mercury fulminate, or lead styphnate are used as initiating

agents. These compounds may be used as priming compositions which burn only if they are combined with less active ingredients such as ground glass, sulfur, lead thiocyanate, or antimony sulfide. Mercury fulminate will burn if its particles are only one crystal in thickness or when desensitized by pressing to 25,000 psi or more (dead pressing).

For initial detonating agents, azides, fulminate, diazo, nitro, and nitroso compounds are often used. These compounds will detonate. Many compounds that have good initiating characteristics are too sensitive or unstable to be used in ammunition. Most initiating agents have a distinctly lower velocity of detonation and brisance than do the high explosives which they initiate.

### 3-4.1 MERCURY FULMINATE

Mercury fulminate is the oldest primer and detonator. It is extremely sensitive to shock, friction, and heat. It produces a strong, hot flame.

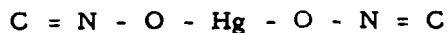

Fig. 3-2 Schematic representation of mercury fulminate.

Because of its sensitivity to flame and percussion, it was for many years the most important material used in primer composition and detonators. Since 1930, it has been replaced in most military ammunition by lead azide.

Mercury fulminate is a crystalline solid, white when pure, but in actual use usually grayish-yellow. It discolors with deterioration. As mercury fulminate explodes before it melts, it is press-loaded.

Its sensitivity increases with the crystal size due to increase in internal stress. The presence of any foreign material, such as sand, will increase its sensitivity to friction. It detonates at

145 to 215°C under normal conditions. However, it can be dead-pressed at 28,500 psi. In this condition, hot gases will not penetrate into the interior portion of the explosive, and it will burn without detonating although it will detonate from a mercury fulminate priming charge.

Mercury fulminate is unstable. Decomposition begins after storage for 10 months at 50°C, or for 3 years at 35°C after which it will not detonate from impact or flame. After 17 months at 50°C, the brisance decreases by over 50%. This characteristic makes it unsuitable for use in the tropics. The fact that moisture will prevent functioning is usually immaterial as it is loaded into a sealed container.

Mercury fulminate is used in primer compositions and detonators in the explosive train. As a primer, about 30% mercury fulminate is usually combined with potassium chlorate, antimony sulfide, and quite often with an abrasive. The chlorate will oxidize the carbon in the compound to carbon dioxide, increasing the completeness of combustion and the efficiency of the explosive. An 80:20 (potassium chlorate: antimony sulfide) mixture is considered most efficient.

Mercury is a semistrategic short supply metal in time of war in the U.S. Mercury fulminate will not detonate cast TNT and Explosive D (unless an unsafe quantity is used).

**3-4.2 LEAD AZIDE**

Lead azide is perhaps the most important primer-detonator explosive now in general use. Although less sensitive than mercury fulminate, lead azide is extremely sensitive to shock, heat, and friction. Lead azide is one of the few explosives that contain no oxygen. The azide breaks down into lead and nitrogen with the evolution of much heat.

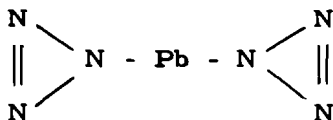

Fig. 3-3 Lead azide.

It is white to buff in color, but will become gray-brown if exposed to light. Since it explodes before melting it is pressed into its container to a specific gravity of about 3.8. It cannot be dead-pressed. It is transported and stored in, or under water to reduce danger of ignition. Its sensitivity to impact depends on the crystal size. If the largest dimension of each crystal is over 1 millimeter, it may detonate spontaneously. This is due to an increase in crystalline internal stresses with increased crystal size. It requires a heat of 245 to 330°C to detonate and will always detonate if ignited. Lead azide is inferior in strength (40% of TNT) but this is not important to its use as a primary explosive. Lead azide is stable under the most adverse storage conditions. It will detonate with as much as 50% moisture present. After hot storage, it becomes slightly more sensitive to shock. It reacts with copper to form super-sensitive copper azides and, for this reason, is pressed into aluminum containers.

Lead azide is used both as a primer and a detonator. As it is not sufficiently sensitive either to stab action or flame to insure 100% operating efficiency, about 30% lead azide is usually used with other ingredients such as antimony sulfide, potassium chlorate, and an abrasive. As a detonator, it is generally sensitized by the addition of lead styphnate to lower the ignition temperature.

Lead azide overcomes most of the disadvantages of mercury fulminate. Although brisance figures show mercury fulminate to be slightly superior to lead azide, the latter is a much more efficient detonator. This efficiency is due to the

fact that lead azide attains its maximum velocity of detonation in a shorter column than mercury fulminate. This permits a one-third reduction in the amount of the detonator, and the use of a longer column of tetryl booster.

The disadvantages of lead azide are its lack of sensitivity to stab action and flame, and the fact that it does not produce an intense flame. The first two objections are easily eliminated but mercury fulminate is generally used when flame is desired, as with delays.

**3-4.3 LEAD STYPHNATE**

This primary high explosive whose basic chemical designation is lead trinitrorescorcinatate, has largely replaced mercury fulminate in priming compositions. It is very sensitive, stable, and produces a strong flame. It has limited use as a detonator except as a sensitizing agent, although its power and velocity of detonation is good. It cannot detonate TNT, tetryl, PETN, or RDX. It is used to lower the ignition temperature of lead azide.

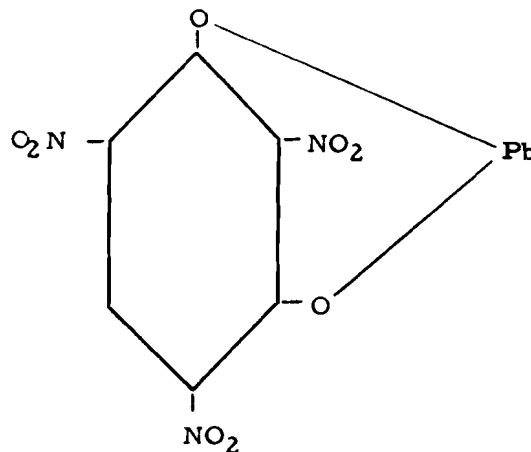

Fig. 3-4 Lead trinitrorescorcinatate.

Lead styphnate varies in color and may be a light straw to red-brown. It is press-loaded. Lead styphnate is very slightly less sensitive than mercury fulminate. Its sensitivity is increased considerably after two months' storage at 75°C. It detonates at temperatures from 200 to 300°C. It has about the same strength as lead azide. When properly primed, it detonates with a brisance of 21.4, compared with 20.3 for mercury fulminate. However, when ignited by flame its brisance is only 9.5 compared with 17.0 for mercury fulminate. It can be made from nonstrategic materials.



## 3-5 SECONDARY HIGH EXPLOSIVES

This class of high explosives, though less sensitive than primary high explosives, might be thought of as noninitiating high explosives. They are used as boosters, bursting charges, or demolition charges. They require initiation to detonation by a primary high explosive. Secondary high explosives may be divided into the following types: single-compound, binary, plastics, and

dynamites. Chemically, these explosives are most often aliphatic, aromatic, and heterocyclic compounds which include nitro compounds, nitrates, and nitramines. Of the many hundreds of compounds which have secondary high explosive characteristics, only a few meet the tough sensitivity, stability, brisance, hygroscopicity, and availability requirements.

## 3-5.1 TETRYL

Tetryl (2, 4, 6-trinitrophenylmethylnitramine) is the standard booster explosive. It is also used as an ingredient in binary explosives and in detonators and blasting caps. Its violence of detonation insures a high-order detonation. Brisance tests show tetryl to have a very high shattering power. It has brisance superior to picric acid or TNT, and its brisance is exceeded only by PETN and some of the newer military explosives such as RDX.

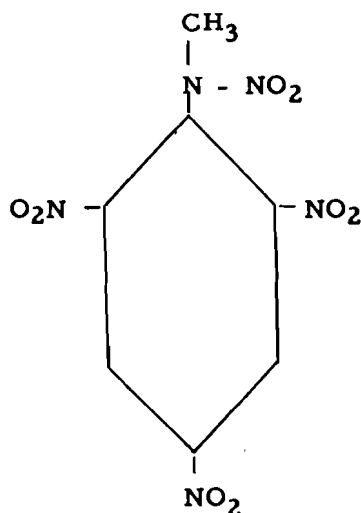

Fig. 3-5 Tetryl.

Tetryl is sufficiently insensitive when compressed to be used safely as a booster explosive. It is used in the form of pressed cylinders (called pellets). Tetryl is the standard bursting charge for 20-mm and 37-mm projectiles. It produces

appreciably better fragmentation of these shells than TNT. It is also more readily detonated, yet in small caliber shells better withstands the force of setback in the weapon. It is also a component of tetrytol (75/25, tetryl/TNT), a demolition.

Tetryl, when pure and freshly prepared, is colorless but will yellow when exposed to light. It melts at 129.45°C (265°F). When heated, tetryl first melts and then decomposes and detonates. It is quite sensitive, can be detonated in storage, and is very nearly nonhygroscopic.

## 3-5.2 TRINITROTOLUENE (TNT)

This secondary explosive, the most widely used bursting charge explosive, commonly known as TNT, is also a constituent of many explosives, such as amatol, pentolite, tetrytol, torpex, tritonal, picratol, cyclotol (Composition B), and ednatol. It is known by such nicknames as triton, trotyl, trilit, trinol, and tritolo.

TNT is relatively insensitive to blows or friction. It is slow to detonate when ignited by a flame. If unconfined it burns slowly, without explosion, giving off a heavy oily smoke. However, burning or rapid heating of large quantities of TNT, especially in closed vessels, may cause violent detonation. TNT in crystalline form can be detonated readily by a blasting cap, but when cast it is necessary to use a booster charge of pressed tetryl or an explosive of similar brisance to insure complete detonation. Although it does not form sensitive compounds with metals, TNT is readily acted upon by unstable compounds which are very sensitive to heat and impact. When stored in warm climates or during warm summer months, some ammunition loaded with TNT may exude an oily brown liquid. This

exudate oozes out around the threads at the nose of the shell and may form a pool on the floor. The exudate is a mixture of TNT and impurities (such as DNT), and is highly explosive.

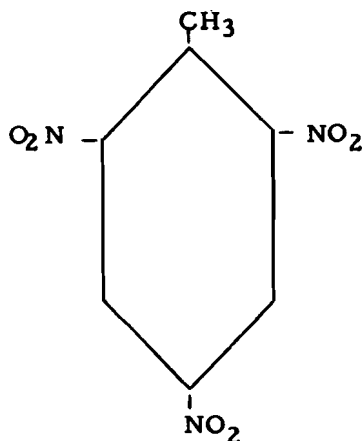

Fig. 3-6 Trinitrotoluene (TNT).

TNT is used as a bursting charge for high explosive shells and bombs, either alone or mixed with ammonium nitrate to form 50/50 or 80/20 amatol. Flake TNT is used in 37-mm shells and in fragmentation hand grenades. Other military uses of TNT are in mines and for parts of certain shell and bomb bursters.

TNT is used for demolition of bridges, railroads, fortifications and other structures, and for land mines. For such purposes TNT is formed into a large-shaped charge or a small, highly compressed block and enclosed in a fiber container which makes it waterproof and protects it from crumbling in handling.

TNT is suitable for all types of blasting. It produces approximately the same effect as the same weight of dynamite of 50% to 60% grade. It is manufactured from toluene and nitric acid. In the prime state it is crystalline and nearly white, but usually it resembles a light brown sugar. Pure TNT has a freezing point of about 177°F. The freezing point is more reproducible than the boiling point. Unlike some high explosives, TNT does not undergo partial decomposition when melted and can be remelted and solidified without significant change in its freezing point.

### 3-5.3 TETRYTOL

Tetrytol is a mixture of 75% tetryl and 25% TNT. It has higher brisance than TNT and is more effective in cutting through steel and in demolition

work. It is less sensitive to shock and friction than tetryl and only slightly more sensitive than TNT. Tetrytol is nonhygroscopic and is suitable for underwater demolition since submergence for 24 hours does not appreciably affect its characteristics. Tetrytol is used as a burster charge in chemical and smoke shells, and demolition blocks.

### 3-5.4 AMATOL

This explosive is a mechanical mixture of ammonium nitrate and TNT, and has approximately the same general characteristics as TNT. It is crystalline, yellow to brownish, and insensitive to friction; but it may be detonated by severe impact. It is less likely to exude than TNT. It is hygroscopic and in the presence of moisture attacks copper, brass, and bronze, forming dangerously sensitive compounds.

Amatol 50/50 consists of 50% ammonium nitrate and 50% TNT by weight. When hot, it is sufficiently fluid to be poured or cast like TNT. Amatol 80/20 consists of 80% ammonium nitrate and 20% TNT. It resembles wet brown sugar. When hot, it becomes plastic, and in that state is pressed into shells and bombs. Amatol is a substitute for TNT in bangalore torpedoes. Amatol 50/50 is used for 3-inch and larger shells, and amatol 80/20 is used for 155-mm (and larger) shells. Amatol is also used in large bombs.

### 3-5.5 EXPLOSIVE D

Ammonium picrate, or Explosive D, is the least sensitive to shock and friction of military explosives. Hence it is well suited as a bursting charge in armor-piercing projectiles. It also is used as an ingredient of picratol and some propellants.

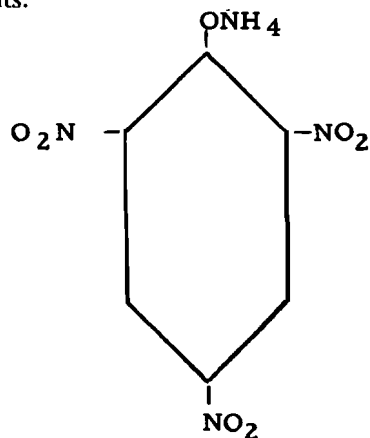

Fig. 3-7 Ammonium picrate (Explosive D).

## MILITARY EXPLOSIVE CHARACTERISTICS

It is slightly weaker in explosive strength than TNT. When heated it does not melt but decomposes. It is nonhygroscopic in humid air, but moisture has a marked effect on its sensitivity making it more sensitive. Explosive D is yellow to orange in color and is not very reactive.

### 3-5.6 RDX

This explosive (cyclotrimethylenetrinitramine) was patented in Germany in 1899, as a medicine. The British patented it as an explosive in 1920, and termed it Research Department EXplosive, RDX. It achieved prominence during World War II as a "super" explosive. In recent years it has become widely used as a base for many explosive mixtures of which Composition B and Composition C are examples. Note that this a heterocyclic, not a benzene ring compound. In addition to its true chemical name, it is also called:

Cyclonite or RDX—	United States
RDX (Research Dept. Explosive)—	Great Britain
T4—	Italy
Hexogen (H)—	Germany
Tanoyaku—	Japan

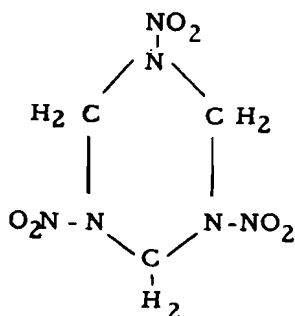

Fig. 3-8 Cyclotrimethylene-trinitramine (RDX).

RDX is manufactured synthetically using formaldehyde, ammonia, and nitric acid. Formaldehyde and ammonia are condensed to form hexamethylenetetramine (hexamine) which is nitrated to RDX. Earlier use of RDX was prevented by the large methyl alcohol requirements, and the fact that eleven pounds of nitric acid are required to produce one pound of RDX. It is difficult to recover the nitric acid after manufacture, due to the reaction between liberated formaldehyde and the spent acid. The first obstacle has been overcome by the production of synthetic methyl alcohol, and the second

partially overcome by improved manufacturing processes.

All nations are interested in devising means of utilizing RDX in a desensitized form. It is being combined with nitro hydrocarbons, which will permit cast loading, or with waxes or oils in press loading. At present the chief advantages of RDX are its tremendous power, good stability, and the fact that it uses nonstrategic raw materials. Its disadvantages are its high melting point, its sensitivity, and its low yield with resulting high cost in manufacture.

(a) RDX wax mixtures. Composition A is the U.S. name for the RDX mixture which uses wax as a desensitizer. The original mixture, which included beeswax, was not a particularly good explosive as the wax did not enter into the detonation, and therefore, reduced the detonation velocity. In burning, it also took some of the oxygen from the explosive, reducing its strength. This mixture was used by the U.S. for press loading 20-mm, 37-mm, and 40-mm shells. It has been used in foreign countries as a booster, bursting charge for grenades, and for armor piercing shells.

The composition of prime interest at present is A-3. This uses a hydrocarbon wax as the desensitizer and gives excellent performance compared to Composition A. It is used in 5-inch naval shells and in high explosive rounds.

(b) Cyclotol. This was the most popular RDX derivative in use during World War II. In this country it is called Composition B, and consists of 60% RDX and 40% TNT with 1% hydrocarbon wax added. Foreign nations use other percentages, 50:50 being the most popular. The Italians call it tritolite.

Composition B is cast-loaded, with a pouring temperature between 85 and 100°C and a density of 1.65. It is entirely stable but corrodes steel, magnesium, copper, and copper alloys very slightly. Its main disadvantage is its sensitivity. Table 3-1 compares its efficiency with that of TNT.

TABLE 3-1 EFFICIENCY COMPARISON OF TNT AND CYCLOTOL

Explosive	Peak Pressure	Impulse	Water Shock	Shaped Charge Efficiency
TNT	100	100	100	100
Cyclotol (Comp B)	110	110	123	169

### 3-5.7 PETN

Pentaerythritetranitrate (or its acronym, PETN) is restricted in its use because of its sensitivity. It is one of the strongest known explosives, being 66% stronger than TNT. Its primary use originally was for boosters and bursting charges in small caliber ammunition; later it was used very extensively as a TNT diluent. Specific uses by the U.S. are for the upper detonator in some land mines and shells, and in primacord (velocity 6200 meters per sec).

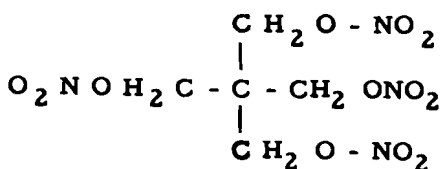

Fig. 3-9 Pentaerythritetranitrate (PETN).

This material was patented in Germany in 1894. Although it has been used commercially since 1937, little or no use was made of it for military purposes until World War II. In this country interest was awakened by reports that the Germans had replaced TNT with a more brisant explosive, believed to be PETN mixed with TNT, in charges to be detonated under water. The effectiveness of the new filler was demonstrated in World War II when the British battleship "Royal Oak" was sunk with a single torpedo. When used alone it is pressed, as its melting point of 138 to 141°C prevents casting. PETN is the most sensitive of the secondary high explosives in general use. It will always detonate from the impact of a rifle bullet, and it has an ignition temperature of 172 to 210°C. It is a white to light-buff crystalline solid, and the military grade must be about 99% pure because it is quite sensitive, particularly to gritty impurities.

### 3-5.8 PENTOLITE

This has been the most widely used PETN-base explosive. It is also known as pentol (German) and pentritol. The usual mixture is PETN and TNT (50:50), with wax added as a desensitizer.

Because PETN is so sensitive, pentolite is prepared by coating the PETN grains with TNT, thus reducing the overall sensitivity. Pentolite is not entirely stable in storage. The TNT, acting as a solvent for PETN, accelerates the natural tendency of the PETN to decompose. Storage at high temperatures may actually result in separation of the two explosives.

Pentolite is a very effective explosive and is 49% more efficient in shaped charges than TNT. Its high sensitivity precludes its use in ammunition, which should not detonate from shock impact. Pentolite has been used for bursting charges in small caliber shells (e.g., 20-mm); shaped charge ammunition of all types (e.g., AT, rifle grenade and bazooka); and shaped demolition charges. Currently, Composition B is replacing pentolite for use in shaped charge ammunition.

### 3-5.9 HMX

Cyclotetramethylene tetranitramine, like RDX, is a nitrated cyclic (heterocyclic) compound. As would be expected from its configuration and constituency, its properties are similar to those of RDX, being nearly equal in sensitivity, 91% as brisant, and 90% as powerful.

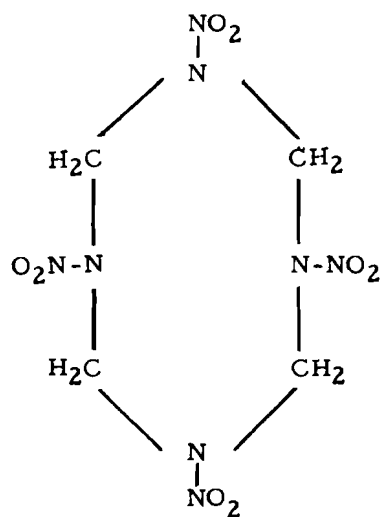

Fig. 3-10 Cyclotetramethylene tetranitramine (HMX).

HMX, a hard, dense, white solid is a by-product in the RDX manufacturing cycle. As a result of the rupture and degradation of hexamethylene tetramine, HMX is produced in very

## MILITARY EXPLOSIVE CHARACTERISTICS

small quantities. If acetic anhydride is added to the nitration vat, yield is approximately 10 percent.

Since separation and vigorous purification are subsequently required, this explosive is quite expensive and has not met general purpose use as a high explosive, but does enjoy increasing special purpose use.

### 3-5.10 DYNAMITES

Nobel gave the name dynamite to a mixture of nitroglycerin and kieselguhr. The strength of dynamite was indicated by the percentage of nitroglycerin in the mixture. Later it was discovered that stronger dynamites could be made using either sodium or ammonium nitrate and a combustible binder (such as wood pulp). These have been called gelignite or "active dope" dynamites. By including nitrocellulose with "active dope" dynamites the gelatin dynamites were formulated.

Dynamites have been the chief commercial blasting explosive for years. They have little military application except for demolition purposes, because of their sensitivity. Dynamites are usually brownish in color. In form they may be either a powder or a plastic, putty-like material. The two types in general military use are 50% nitroglycerin dynamite and gelignites.

Dynamites are all very sensitive to shock, friction, and heat, and will definitely detonate from the impact of a bullet unless they are desensitized by addition of inert materials, which in turn would reduce explosive power. When frozen they become extremely sensitive due to segregation of the nitroglycerin. For the same reason they are less efficient and may give a low order detonation. Dynamites are approximately equal to TNT in strength, but in velocity and brisance they are inferior to TNT, having a rate of detonation of about 6000 meters per second and a brisance figure of about 35. They are considered unstable due to the hygroscopicity of certain ingredients, and the tendency of nitroglycerin to segregate after prolonged storage.

The United States Engineers use 50% dynamite for demolitions in this country. The British use gelignites under the names of Nobel's 803, 808, 823. The Germans used gelignites for a variety of purposes, particularly in grenades. Dynamites are used for military purposes primarily for their economy. Also, they do not require a booster and are very sensitive to detonation by propagation. Their main disadvantages are their sensitivity and lack of stability. The British use one pound of gelignite to detonate bombs up to 250 kilograms and five pounds for bombs over 250 kilograms.

## 3-6 LIQUID HIGH EXPLOSIVES

Periodically, there are reports of new liquid superexplosives, many times more powerful than the standard high explosives. Such reports should be studied with care. From the previous discussions concerning the nature of explosions and the example of nitroglycerin which, even with complete oxidation, is only 60% stronger than TNT, it would not seem very probable that this figure could be exceeded by very much unless nuclear energy is utilized.

The following is a list of typical liquid high explosives. They are compared with picric acid in strength and sensitivity.

Explosive	Strength	Sensitivity
Picric acid	100	100
Methyl nitrate	174	29
Ethyl nitrate	128	—
Ethylene glycol dinitrate	170	13 plus
Diethylene glycol dinitrate	130	127
Nitroglycerin	160	13
Chlorhydrindinitrate	125	120 plus
Nitromethane	127	100
Anilite (nitrogen peroxide/butane)	161	sensitive
Dithekite (nitric acid/nitrobenzene/water)	110	100
Liquid oxygen/lampblack	100	50

## SOURCES OF ENERGY

Most of the presently proposed liquid high explosives are too sensitive for general military use. Some are unstable in storage. Others, such as anilite, must have their components in separate compartments with the mixing taking place just before detonation. Some, such as liquid oxygen, must be used shortly after manufacture or they evaporate. If high vapor pressure liquids are sealed in a thin-walled container, the evaporation and condensation can rupture or collapse the container. While some liquid explosives are

stronger than standard explosives, this advantage often is offset by low density. Since liquid high explosives present many problems and few advantages much development remains to be done upon them before they become generally useful, except possibly to circumvent material shortages. However, if further research yielded a stable, high energy, explosive, temperature-insensitive liquid, it would be of great interest as a high explosive.

### 3-7 METAL-HIGH EXPLOSIVE MIXTURES

In recent years the effect of the addition of metals such as boron, zinc, beryllium, lithium, silicon, magnesium, and aluminum to explosives has been studied extensively, because of the excellent results predicted by theoretical thermodynamic computations. These predictions proved inadequate, in that reactions were not as expected and the metal was not oxidized appreciably in the detonation reaction. High detonation rates were not observed; in fact, rates were lowered and brisance characteristics reduced. Surprisingly enough, however, it was found that in the case of aluminum that the oxidation of the aluminum did occur after detonation was complete, and that the energy so released contributed markedly to the power and blast effects of the aluminized products. The nature of the expanding flame-gas surface provided a mechanism by which external oxygen reached the aluminum. The oxygen thus utilized, effectively increased the performance of the filler weight of the component. Expanding products have been observed to occupy about thirty times the volume that would be predicted on the assumption that the expanding products merely push the surrounding atmosphere ahead of them. This discovery led to the development of several castable aluminized materials for bomb filling, e.g., Minol, Torpex, Tritonal, DBX, etc. It was found after considerable testing that aluminized explosives had significantly greater blast effects, or damage radii, than their nonaluminized counterparts. Particularly strong effects resulted from

underwater, and underground explosion. HBX (70% Comp B/12% TNT/18% Al/5% waxes, nitrocellulose, lecithin) has been developed to fill the need for an aluminized explosive with high resistance to impact. As indicated previously it achieves this by the addition of wax to the composition.

To illustrate how the aluminum can increase the blast effect of an explosive consider the detonation of Torpex. Torpex is composed of 40% TNT, 42% RDX, and 18% powdered aluminum. (Proportions may vary slightly from this general formulation.) When pure TNT or RDX react, one of the products of the explosion is  $\text{CO}_2$ , according to the following thermochemical reaction.

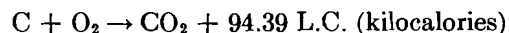

Powdered aluminum at the temperatures prevailing in the explosion is a more powerful reducing agent than carbon. As a result, instead of  $\text{CO}_2$  being formed, the products are CO and  $\text{Al}_2\text{O}_3$ , according to this reaction:

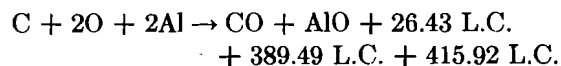

The weight of the reactants in the first instance is  $12 + 32 = 44$ . In the second case the weight of the reactants is  $12 + 2(32) + 2(26.97) = 129.94$ . The heat liberated in the first case is:

$$\frac{94.39}{44} = 2.143 \text{ L.C. per gram}$$

## MILITARY EXPLOSIVE CHARACTERISTICS

---

The heat liberated in the second case is:

$$\frac{415.92}{129.94} = 3.2 \text{ L.C. per gram}$$

Thus, the reaction involving aluminum is about 150% more efficient as a heat producing reaction, while at the same time an equal volume of gas is evolved. In addition the aluminum is oxidized by the oxygen in the air, which in effect allows the explosive-contained oxygen to be used more effectively.

Composition B consists of a mixture of 60% RDX and 40% TNT. A comparison between Torpex and Composition B shows that Torpex produces an area of blast damage about 30% greater than the same volume of Composition B.

The addition of metals to low explosives provides comparable increases in propellant performance, but since slower rates of energy liberation are desirable in a propellant, the energy per unit weight improvement is generally lower, and thus, this technique has not enjoyed wide acceptance for propellants.

### 3-7.1 EXPLOSIVE MANUFACTURING CONSIDERATIONS

Since funds (in time of peace) are not available to maintain large establishments for the preparation of explosives, it is highly desirable that any standard military explosive be capable of being made in existing chemical plant facilities. Preparation should not introduce extreme

safety or corrosion problems, nor should it require excessively large quantities of strategic raw materials. Of course, no explosive which would require an imported raw material would be considered. The considerations have led to an extensive examination of the field of synthetics for use as raw materials in military explosives. The development of improved manufacturing techniques to obtain greater yield, safety, and more stable explosives is a continuing problem. For example, Tetryl of acceptably good quality can be produced from dimethylaniline by a two-stage, continuous process. Current research is being directed so as to determine whether equally good results can be obtained with a single-stage, continuous process which would appear to offer advantages with respect to design and operation of equipment and savings in manufacturing costs. It would also be safer since less Tetryl would be in process at any time.

Efforts are constantly being made to improve the storage life of explosives. In World War I a considerable quantity of TNA (tetranitroaniline) was manufactured as an experimental shell filler. After being stored for several years it underwent an autocatalytic reaction with the formation of highly sensitive compounds which led to explosions in storage. TNA therefore is not used today by the United States as a shell filler. This type of failure points out that it sometimes takes ten or fifteen years to uncover stability flaws in an otherwise acceptable explosive. Ammunition must be capable of long storage, sometimes as long as twenty-five years, with no loss in ballistic efficiency or safety.

## 3-8 LOW EXPLOSIVES OR PROPELLANTS

The second family of explosives, called propellants or low explosives, differs from high explosives in that their rate of decomposition is slower. They burn rather than detonate.

The general properties of low explosives which distinguish them from high explosives were covered in Chapter 1. The major use of low explosives is as a propelling charge. A propelling

charge is defined as a powder charge used in a weapon which when ignited produces large volumes of gas which rapidly force the projectile out the barrel. Although for several hundred years black powder was the only practicable propellant, it has many undesirable features. Consequently, it has been replaced in most uses as a low explosive. (It is still used as an igniter

## SOURCES OF ENERGY

---

compound.) All explosives currently in use as gun propellants have a nitrocellulose base and are commonly known as "smokeless powders." These substances are not powders in the true sense of the word nor are they smokeless. Rather they are manufactured as flakes, strips, pellets, spheres, or cylinders. The last type of grain is by far the most common, especially in this country. Continuous effort has been expended to design a smokeless, flashless powder. However, as will be explained later, the complete absence of smoke or flash can be accomplished only by accepting other unfavorable characteristics.

The qualities desirable in a good gun propellant will now be considered.

### 3-8.1 CONTROLLED BURNING

Any good propellant should produce a large volume of hot gas and should burn at a controlled rate. Guns are designed to withstand a maximum gas pressure which occurs when the projectile has moved only a short distance in the bore. It is desirable for the propellant to attain this maximum gas pressure by a gradual and progressive rise in pressure. Control of this pressure lies in the composition of the powder, the form or shape of the individual grains, and the dimensions of any particular form of grain. Granulation determines the area of the burning surface of the grain. This, in turn, partly controls the rate of combustion and pressure.

### 3-8.2 SENSITIVITY

The propellant should be readily ignited but safe to manufacture, transport, load, and store. It should not burn or detonate under the shock of being struck by a nonexplosive bullet or a shell fragment.

### 3-8.3 STABILITY

The propellant must be able to withstand long storage under all climatic conditions without deterioration. This means lack of hygroscopicity

as well as freedom from changes in chemical composition.

### 3-8.4 RESIDUE

The exploded propellant should leave little or no residue. Unexploded powder and unoxidized residue will corrode gun barrels, create smoke, and reduce efficiency.

### 3-8.5 MANUFACTURE

The propellant should be easy to produce in quantity from plentiful raw materials.

### 3-8.6 EROSIIVE ACTION

The burning temperature should be kept at a minimum to prevent erosion of the gun barrel.

### 3-8.7 FLASH

The explosive gases must be as cool as possible to prevent muzzle flash which will indicate the position of a gun fired at night.

### 3-8.8 DETONATION

The propellant should be incapable of detonation as this will burst the barrel of the gun. This implies no tendency for the grains to break up under stress of firing.

### 3-8.9 SMOKE

The explosion should be smokeless, or the position of a gun fired during the day will be revealed.

Whether ammunition upon firing is flashless, smokeless, or both, depends upon the weapons in which used, the type of ignition used, weapon wear, the temperature of the tube of the weapon, as well as the quantity and design of the propellant powder. "Flashless" and "smokeless" are relative terms and have been defined as follows: flashless ammunition does not flash more than 5% of the time in weapons of average life under standard conditions; smokeless ammunition produces less than half the amount of smoke produced by ammunition not so designated. A complete round having both these characteristics is designated "flashless-smokeless."

## 3-9 BLACK POWDER

Black powder is manufactured in small shiny black grains. The ingredients are usually finely pulverized potassium or sodium nitrate, charcoal, and sulfur which are incorporated into an inti-

mate mechanical mixture. The charge is pressed into a cake and pressed or extruded to the desired grain size and shape. The grains are glazed with graphite to prevent caking and accumula-



## MILITARY EXPLOSIVE CHARACTERISTICS

tion of static electricity. The potassium or sodium nitrate (about 75%) acts as an oxidizing agent, while charcoal (about 15%), and sulfur (about 10%) are combustibles. Sulfur also lowers the ignition temperature of the mixture from 340 to 300°C. The sulfur ignites first and communicates the flame throughout the mass. Sulfur has colloidal qualities and fills the spaces between other components. It also acts as a catalyst and reduces the solid residue. Potassium nitrate is expensive but only slightly hygroscopic, so it is used in fuze powders, while sodium nitrate, being cheap but very hygroscopic, is used in blanks and spotting charges.

Black powder is no longer considered suitable as a propellant because of its many objectionable features and because of the development of newer powders in which the undesirable qualities have been overcome or improved. It is difficult to control accurately the burning speed of black powder. Consequently, the range of a projectile propelled by it may vary. Black powder is too easily ignited, being extremely sensitive

to heat and friction, and therefore, must be handled very carefully. It is hygroscopic which requires that sealing precautions be taken to retain stability. Its strength is relatively low and the large amount of solid residue which it leaves makes smoke reduction difficult. Flash reduction is also a problem with black powder.

The manufacturing process is both easy and cheap. The required raw materials are plentiful. An advantage for certain uses is that black powder, in small quantities (such as those used in military applications), does not detonate.

Black powder, in its several grades, is still used for the following military purposes:

- (a) Igniters in artillery shell.
- (b) Delay elements in fuzes.
- (c) Saluting and blank charges.
- (d) Spotting charges for practice ammunition.
- (e) Safety fuse (burning rate, 1 ft in 30-40 seconds).
- (f) Quickmatch (burning rate, 9-120 ft per second).

### 3-10 SMOKELESS POWDERS

Smokeless powders are forms of nitrocellulose explosives with various organic and inorganic additives and are used as propellants. They may be divided by composition into classes of which two, the single-base and double-base, are the most common. Both classes are manufactured in quantity in a variety of shapes including flakes, strips, sheets, pellets, or perforated cylindrical grains (Figure 3-11). The cylindrical grains are made in various diameters and lengths depending on the size of the gun. Figure 3-12 shows

how size of grain varies for the various calibers of gun. The grains for a cal. .30 cartridge are 0.032 inches in diameter and 0.085 inches long, while those for a 16-inch round are 0.947 inches in diameter and 2-7/16 inches long. The perforations shown in Figure 3-11 are for the purpose of controlling the rate of gas liberation as well as burning time. The single perforated grain is used in small arms, while those with seven perforations are used in large caliber weapons.

#### 3-10.1 BURNING TIME

The burning time can be controlled by the following means:

(a) The size and shape of the grains including the number of perforations (Figure 3-11).

(b) The web thickness or amount of solid powder between burning surfaces; the thicker

the web, the longer the burning time (Figure 3-13).

(c) The quickness or rate of burning of the powder.

(d) The percentages of volatile materials, inert materials, and moisture present. A 1% change in volatiles in a low volatile content propellant may cause as much as a 10% change in burning rate.

# SOURCES OF ENERGY

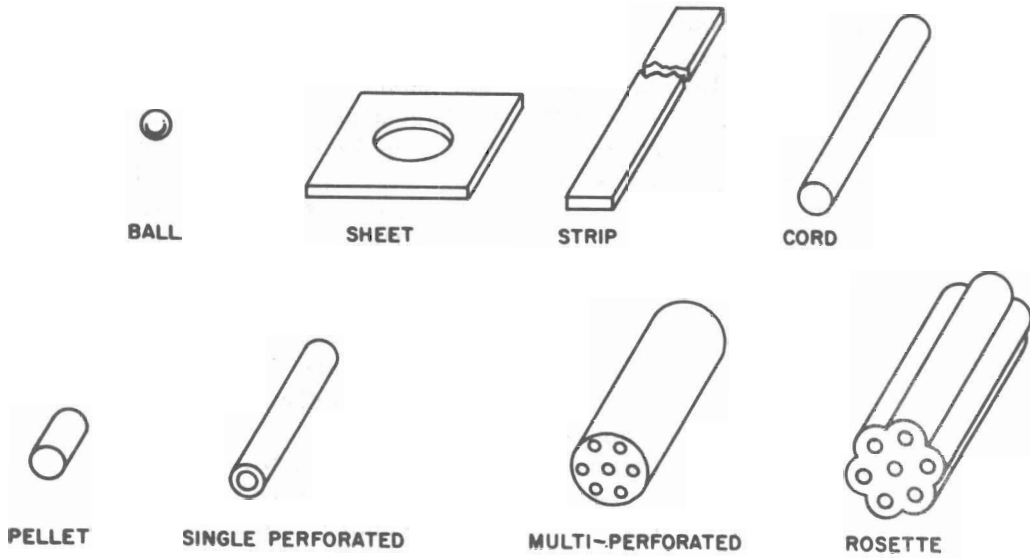

Fig. 3-11 Typical shapes of powder grains.

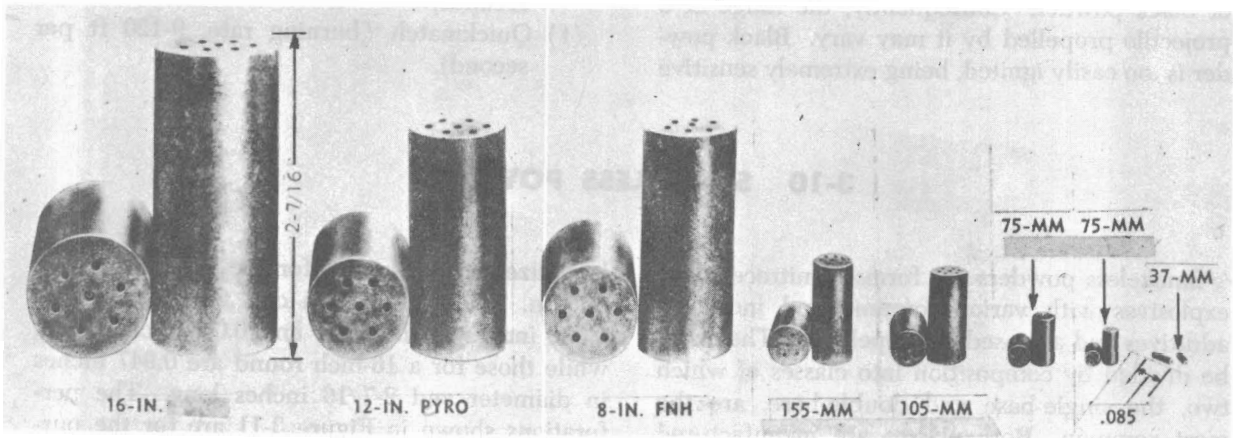

Fig. 3-12 Sizes of some typical grains.

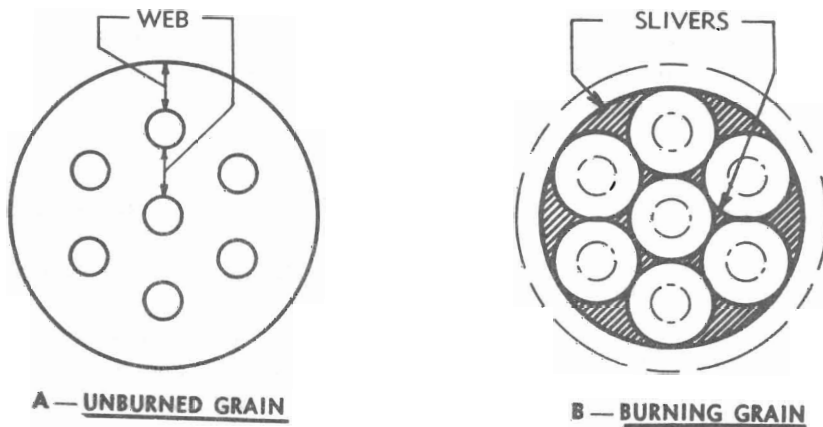

Fig. 3-13 Web thickness and route of burning progress through a progressively burning grain.

## 3-10.2 BURNING ACTION

Unconfined smokeless powder burns with little ash or smoke. When confined, its rate of burning increases with temperature and pressure. In order not to exceed the permissible chamber pressure of the weapon, the time of burning of the propellant is controlled. At constant pressure the time of burning is proportional to the amount of exposed powder surface. Therefore, powder is made into accurately sized grains of selected shapes.

Since powder burns only on its exposed surfaces, the rate of gas evolution for a given powder will depend upon the area of the burning surface. For a given weight of powder the initial burning surface will depend upon the form and dimensions of the grains. As burning continues, the rate of combustion and of pressure variation will depend upon how the area of surface changes, that is, upon the rate of area increase or decrease.

The rapidity with which a powder will burn depends upon the chemical composition, pressure, and area exposed to burning. The quickness

of a powder is a relative term only, expressing its rate of burning compared with other powders. A quick powder will burn more rapidly and produce a higher pressure in a given gun than a slow powder. Powders of fixed weight, chemical composition, and grain geometry may be made quicker by decreasing size, thus increasing burning area.

## 3-10.3 DEGRESSIVE BURNING

As the total surface of smokeless powder changes with burning, on cord and strip forms the surface area of the grain decreases. The burning action of these grains is classified as degressive.

## 3-10.4 NEUTRAL BURNING

As a single-perforated grain burns, the outer surface decreases and the inner surface increases. The result of the two actions is that the net burning surface remains approximately the same. The burning of this type of grain is known as neutral.

## 3-10.5 PROGRESSIVE BURNING

When the multiperforated grain burns, the total surface area increases since the perforated grain burns from the inside and outside at the same time. This type of burning is called progressive (Figure 3-13). When a multiperforated grain is not completely consumed, portions of the grain remain in the form of slivers and may be ejected as such from the weapon.

## 3-10.6 WEB THICKNESS

Web thicknesses for most rocket propellant grains are considerably larger than for gun propellant grains, making burning time longer. For thick-webbed propellant it is difficult and expensive to remove solvent from a solvent-type extruded grain. To avoid this problem, dry extrusion, lamination, and casting are used. The added expense, and often unpredictable performance of large grains formed by these techniques has limited the popularity of nitrocellulose-base propellant in large rocket motor applications.

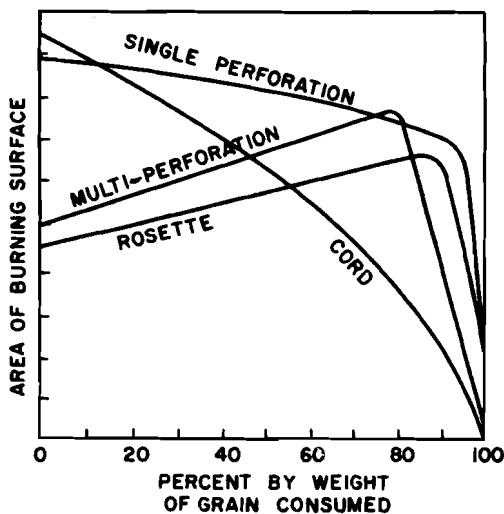

Fig. 3-14 Relative areas of burning as a function of percent of individual grain consumed, for several typical grain shapes.

### 3-10.7 SINGLE-BASE PROPELLANTS

Single-base propellants are essentially gelatinized nitrocellulose to which various organic substances are added either to produce improved qualities or for special purposes. Single-base propellants are amber, brown, or black in color, depending on the additives present.

Single-base powder is rather insensitive. In fact, it is difficult to ignite, requiring a powerful primer and additionally, in large ammunition, a black powder igniter. It ignites at 315°C. In the open, single-base powder burns very much like celluloid. Seemingly, this explosive is very safe but the fact should not be overlooked that, although it is used as a low explosive, single-base powder is an organic nitrate and may detonate if burned in large quantities. (Single-base powder detonates with a velocity of 4600 meters per second.) It may also detonate sympathetically from the detonation of other explosives, although in actual practice this rarely occurs. Single-base powder is stronger than black powder, giving off 1000 calories and 900 cubic centimeters of gas per gram, compared with 700 calories and 300 cubic centimeters per gram of black powder. It has a burning speed of 0.1 to 18 centimeters per second at pressures up to 60,000 pounds per square inch.

Single-base powder is unstable and decomposes in hot moist storage. It is hygroscopic, although not as hygroscopic as black powder. Nitrocellulose in the presence of moisture hydrolyzes to free acid, which takes the form of oxides of nitrogen. These oxides accelerate the decomposition, building up heat to an ignition temperature, and spontaneous combustion may result.

Nitrocellulose is one of several nitrated cellulose compounds useful as explosive compounds. The nitration effect of nitric acid on cotton was first observed in 1838. Nitroglycerin was produced in 1846, and guncotton in 1848. Around 1880, the gelatinizing effect of combining nitroglycerin and nitrocellulose was discovered and led to the production of blasting gelatin, which is still one of the strongest explosives known. Smokeless powder (nitrocellulose) was first used for blasting, but was gradually developed as a propellant to overcome the objectionable features of black powder. About 1886, pyro-cotton, cordite, and ballistite were all developed

and gradually replaced black powder. At present, all nations use some form of gelatinized nitrocotton as a propellant. This type of explosive is referred to by various names as follows:

(a) Nitrocellulose: A highly purified compound produced from a combination of cellulose and nitric acid.

(b) Nitrocotton: Nitrated cotton.

(c) Pyroxylin: Nitrocellulose containing less than 12% nitrogen.

(d) Collodion cotton: That type of nitro-cotton which dissolves most readily in a solvent. It usually contains about 12.1% nitrogen.

(e) Pyrocotton (Pyrocellulose): Nitrocellulose containing about 12.6% nitrogen.

(f) Guncotton: Nitrocellulose containing 13.35% or more nitrogen.

To summarize, the characteristics of single-base propellants are:

(a) Controlled burning. The burning time of single-base powder can be controlled to a point where the maximum propelling effect is obtained.

(b) Sensitivity. Ignition is difficult, and the powder is reasonably safe.

(c) Stability. The powder is unstable, but this can be controlled to within acceptable limits.

(d) Residue. There is some residue and smoke.

(e) Manufacture. This is complicated but safe. Raw materials are plentiful.

(f) Erosive action. Single-base powder erodes the bore, but not quite as much as black powder. Its combustion temperature is 2700 to 3500°C.

(g) Flash. This is caused by hot gases which ignite when they come into contact with oxygen at the muzzle. It can be controlled by adding cooling materials to the powder.

Single-base powder can be produced in a form lacking most of the objectionable features. For this reason, it has been adopted as the standard U.S. propellant for small arms and artillery weapons.

The powder for small arms is usually glazed with graphite to facilitate machine loading and to prevent the accumulation of large charges of static electricity, and thus presents a black, polished appearance. Since the powder grains are small, they ignite more readily and burn more freely than cannon powder. When moisture is present or abnormal temperatures prevail,

they are subject to more rapid deterioration than the larger grains.

### 3-10.8 DOUBLE-BASE PROPELLANTS

This form of smokeless powder is known as ballistite in the U.S., and as cordite in Britain. It is essentially a combination of nitroglycerin and nitrocellulose with certain additives to give special properties. The nitroglycerin, usually 30 to 40% by weight, serves to increase the potential and reduces hygroscopicity, the latter improving stability of the powder. The color of the grains is gray-green to black, and the forms are the same as for single-base powders.

Double-base gun powders are more sensitive than single-base powders, igniting at 150 to 160°C. They detonate more readily than do single-base powders, and can be made to yield a higher potential and liberate more heat, but produce a smaller volume of gas. The burning rate, generally faster than that of single-base powder, can be controlled similarly.

The desired characteristics of these propellants are, in summary:

(a) Controlled burning. Burning can be controlled, as with single-base powders.

(b) Sensitivity. This is greater than for single-base powder, and slightly more hazardous.

(c) Stability. Double-base powders can be made stable by the addition of stabilizing ingredients.

(d) Residue. Since there is not so much inert material, there is little solid residue. Smoke can be controlled.

(e) Manufacture. Not as safe as single-base powder due to presence of nitroglycerin. Raw materials are readily available.

(f) Erosive action. High temperature and heat of explosion from the higher potential double-base powders cause more erosion than single-base powders.

(g) Flash. As is the case with single-base propellants, flash can be controlled to a certain extent by the use of additives. The presence of nitroglycerin accentuates the tendency to flash by increasing the flame temperature.

Double-base powders have limited use in artillery weapons in the U.S. However, they are used as the standard propellants in most other countries. The U.S. Army and Navy both evaluated single-base and double-base powders prior

to World War I and decided in favor of the former due to the great erosive effect of ballistite on the guns. In various forms and compositions, double-base powders are used in the U.S. in mortar propellants, small rocket engines, shotgun shells, and the new T65 cal. .30 NATO rifle cartridge.

### 3-10.9 BALL POWDER

With the standardization of the caliber .30 carbine by this nation, another form of double-base propellant became standard. This configuration of ballistite in the form of spheres 0.02–0.03 inch in diameter is called ball powder. It is produced by dissolving wet nitrocellulose in a solvent (ethyl acetate) with additives. When a protective colloid is added and the solution is agitated, small globules are formed. When the volatile solvent is removed by evaporation the globules solidify, and when coated, dried, and graphited, become balls or spheres. A wide variety of double-base (and single-base as well) compositions may be produced by this technique. Because of the economy and speed with which ball powder can be manufactured, this propellant has promise in future applications not limited to small arms.

### 3-10.10 NITROGUANIDINE PROPELLANTS

A double-base propellant containing nitroguanidine in addition to nitroglycerin and nitrocellulose as principal ingredient, is sometimes referred to as "double-base" propellant, although it is more specifically a "poly-base" propellant. This type of propellant was developed by Great Britain as a result of research for a powder with desirable properties such as cool burning, low erosion, and flashlessness, without decrease in stability or potential. The British have designated their nitroguanidine propellant as Cordite N. The nitroguanidine propellant, designated M-15, developed by the United States, represents an interim solution for selected rounds of ammunition where the obscuration problem is critical and where its special properties are particularly needed.

The M-15 propellant has a ballistic potential comparable to single-base powders currently in use but with a lower erosive effect and less tendency to flash.

The major drawback to the use of this new propellant is the small number of domestic

## SOURCES OF ENERGY

---

facilities for the manufacture of the principal ingredient, nitroguanidine. Our major supplier of this item is Canada. Even if facilities are expanded, production would be limited in that the basic raw material, cyanamide, must be imported and was in short supply during World War II. The current method of producing nitroguanidine has two undesirable features: the large amount

of electrical power required and the inability to recover the sulphuric acid which must be used. One production advantage is that M-15 propellant can be manufactured by any facility which is equipped to make double-base powder.

Nitroguanidine propellants are currently used in this country for a 90-mm round and the M-35 bazooka round.

### 3-11 LIQUID GUN PROPELLANTS

For a number of years the feasibility of employing liquid propellants for high pressure projectile launchers has been considered. A vigorous program to investigate this possibility has been initiated. Numerous improvements over conventional solid propellants are conceivable if such an application can be successfully reduced to practice. Among these may be mentioned the following:

- (a) Elimination of the cartridge case.
- (b) Shaped propellant tanks in remote (safer) location in aircraft, ships, and tanks, with pipeline transfer to gun or launcher.
- (c) Reduced gun length and weight.
- (d) Higher velocities by reason of higher propellant potential of some liquid propellants.
- (e) Control over chamber pressure-time curves by control of rate of propellant injection, employing hypergolic bi-propellant systems such as hydrazine-hydrogen peroxide or hydrazine-nitric acid. This in turn would give higher velocities at lower peak chamber pressures.

The work thus far performed on the project indicates that several of the above advances may be realized in a weapon of practical design. Initial experiments employed a caliber .50 tube attached to a block incorporating a combustion chamber and piston injectors for introducing  $N_2H_4$  and  $H_2O_2$  over a very short time interval. Pressure for liquid propellant injection was supplied by igniting a charge of powder in a sub-chamber behind the injection system. With such a gun system, muzzle velocities above 8000 ft/sec were obtained at lower peak chamber pressures than have been observed with solid propellants for corresponding performance.

Two additional types of systems were subsequently investigated. The first, a "preloaded chamber" gun utilized separate containers of  $N_2H_4$  and  $H_2O_2$  initially located in the gun chamber, with firing initiated by container rupture and propellant mixing through mechanical means. Velocities in the 11,000 ft/sec range could be reached with this launcher. Second, it was considered desirable to revise the earlier "externally pressurized" injection gun to provide for propellant introduction at a controlled rate without the use of auxiliary sources of high pressure. Consequently, several systems were built and successfully operated on a "regenerative injection" principle, in which the injection pressure was derived from the chamber pressure through the use of differential area pistons. Experimental models of both caliber .50 and 37-mm launchers were employed in tests of this principle.

In the course of the exploratory work performed during the contract, a number of engineering problems were uncovered, practical solutions to which are necessary before prototype models of any conceivable field weapons can be designed. For injection launchers, improved methods of sealing liquid propellants at high pressures are required. Correspondingly, methods for absorbing the high impact loads at the end of the injection stroke must be improved or developed, if a reasonable launcher life is to be achieved. For both preloaded chamber and injection launchers, a more thorough understanding of the propellant mixing and combustion process is necessary in order to eliminate pressure fluctuations of considerable magnitude. These problems are under current investigation.

## 3-14.1 METAL ADDITIVES

Metal additives such as boron are increasingly popular. Most typical forms of boron fuels now in use (or study) are the boranes, such as diborane ( $B_2H_6$ ) a poisonous gas, pentaborane ( $B_5H_9$ ) a volatile liquid, and decaborane ( $B_{10}H_{14}$ ) a solid. In liquid propellants, such as hydrocarbons, these can be premixed with the liquid petroleum base. They may be used alone as fuel, or they can be combined with polymeric binders and used as a solid fuel constituent. Toxicity, and the fact that combustion of fuels with some borane additives often produces a readily depositing crust or syrup on adjacent parts, has deferred their popularity.

## 3-14.2 FLUORO COMPOUNDS

Compounds containing fluorine show promise as oxidizers for propellants. Some fluorine compounds presently under investigation include elemental fluorine, halogen fluorides, nitrogen trifluoride, and oxygen difluoride. Fluorides are corrosive and often unstable. Hence, some emphasis is placed on compound stability. In rockets fluoride fuels offer a good balance between low molecular weight combustion products and high flame temperature.

Lithium fuels, such as  $LiNF_2$ , which utilize fluorine, are also of current interest.

## 3-14.3 FREE RADICALS

Potentially more powerful rocket propellants than the newer chemical energy fuels discussed

above are the "free radicals," or unstable molecule fragments. These particles are of interest in rocket propulsion since their presence gives a rocket much higher thrust (through increased momentum discharge) than do chemical fuels. These pieces of fuel are at present difficult to create, have a lifetime of only a few millionths of a second. They recombine readily. The fact that they are present in flames and in common chemical reactions does, however, give promise of their use as efficient fuels if economical ways can be found to generate and use them, before they recombine.

## 3-14.4 IONIC FUELS

Still further in the future lies the use of ionic propellants. These fuels, as exemplified by the metal cesium, would owe their use to their ability to be readily ionized and discharged as charged ionic particles.

As a rocket fuel, such materials would yield efficient thrust by a contribution to rocket momentum since their discharge velocities would be very high ( $1.4 \cdot 10^7$  ft/sec), and would be subject to magnetic acceleration.

The use of ionic fuels would be limited to space where drag is negligible since the total thrust produced by the ion discharge motor would be very small (about .01 pounds of force, for example, for a 150 kw motor) even though the particle velocities are very high ( $13.0 \cdot 10^7$  ft/sec) since mass rate of discharge is so low.

## REFERENCES

- 1 J. Corner, *The Theory of Internal Ballistics of Guns*, Philosophical Library, N. Y., 1951, Chapter 2.
- 2 T. L. Davis, *The Chemistry of Powder and Explosives*, John Wiley and Sons, N. Y., 1941, Vol. I, Chapters I, IV; Vol. II, Chapters VI, VII, and IX.
- 3 P. R. Frey, *College Chemistry*, Prentice-Hall, N. Y., 1954, Chapters 26 and 27.
- 4 Hausman and Slack, *Physics*, Van Nostrand, N. Y., 3rd Ed., 1948, Paragraphs 173, 174, 176, and 346.

## 3-12 GUN PROPELLANT IMPROVEMENTS

The principal aim in low explosives research for guns has been to find the ideal propellant. This propellant would have to meet many requirements, the foremost of which are the elimination of flash while still retaining the property of being substantially smokeless; high stability to

permit peacetime storage; and high potential with minimum erosion effect on the weapon. Although work is underway to find new compositions based on nitrocellulose powder, the most extensive effort is directed toward the development of new double-base combinations.

### 3-12.1 FLASH

True muzzle flash is a secondary explosion phenomenon as distinguished from the muzzle glow caused by incandescent gas or powder particles that have not, up to that point, been burned. The emerging powder-gas mixture contains hot combustible gases, such as CO and H<sub>2</sub>. These gases react with the atmospheric oxygen outside the muzzle and even though they are so diluted, they are above their ignition temperature (750°C), and subsequently may explode. The resulting muzzle flash appears from a distance as a ball of fire. Flash effects are promoted by moderate humidity. They will increase with rapid firing of the gun due to heating of the barrel. On the other hand, high humidity, fog, dew, formation of drops, and low air temperature hinder muzzle flash but increase formation of smoke. Both chemical and mechanical means have been developed for reduction of muzzle flash. Both methods have the same basic objectives; to completely oxidize the gases within the tube, or to reduce the temperature of the gases below ignition temperature prior to their leaving the tube.

The chemical method introduces an additive to the propellant. Most flash reducing agents simply evolve considerable gas. This gas in heating to explosion temperature cools the combustible gases below their ignition points. This, of course, reduces the energy of the explosion; however, the loss can be partly overcome by use of additives, such as DNT, which are partially combustible themselves. The increase in gas volume keeps up pressure and work done by gas, while permitting lower temperature. The potassium salts which are used extensively are thought to suppress re-ignition by their anticatalytic action. They somehow interrupt the reaction between powder gases and oxygen.

Mechanical methods of suppressing flash include increasing tube length and use of flash hiders and flash suppressors. Increasing the length of the tube will cause a lowering of the temperature of the gases as they are discharged into the atmosphere. This has practical limitations. A flash hider is a conical shaped nozzle attached to the muzzle and acts mainly to conceal the flash from observers not in the direct line of fire. Flash hiders do not actually reduce the volume of flame although they may cause it to become narrower and longer. The flash suppressor (Figure 3-15) now in use is a three pronged elongation of the barrel. The reason as to why this suppressor reduces flash is not completely understood. However, firings indicate excellent results in eliminating flash, probably because of the suppression of intermediate, high-energy, luminescent, chemical-reaction radicals in the hot gas envelope as a result of the presence of a metallic surface in the envelope.

### 3-12.2 SMOKE

Frequently a promising development from one point of view has disadvantages when viewed from another. So it is with chemical flash reducers, the use of which leads to an unacceptable amount of smoke. For daytime use the smoke is nearly as objectionable as the night-time flash. For this reason some weapons have flash elimination pads only for night firing, flash being accepted in day firing in preference to smoke.

Research organizations presently are working to determine the nature of the smoke from weapons. The smoke from actual gun firings is collected and analyzed for composition. At the same time optical measurements are made for the computation of distances at which the smoke is visible. It has been determined that the visible smoke from artillery powder is due principally



## SOURCES OF ENERGY

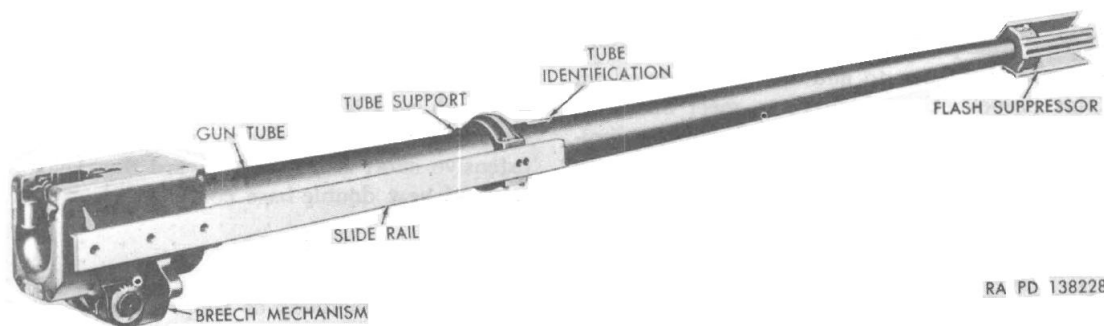

RA PD 138228

Fig. 3-15 Flash suppressor on 75-mm gun tube.

to unburned carbon, inorganic noncombustible constituents, and metallic vapors from the rotating band of the projectile. Recommendations which have been made to minimize smoke include the elimination of hygroscopic salts from the products of combustion and the use of unsulfated powder.

Another method of reducing smoke is to lessen the quantity of black powder used in ignition of the propellant. Beyond a certain point, however, such reduction of black powder is undesirable because it is accompanied by an increased tendency to flash and unfavorable ballistic uniformity.

While a truly smokeless powder has not yet been attained, propellants which are practically free of smoke have been developed for specific weapons. It has become obvious that more can be accomplished in fitting powders, if the overall weapons system is considered from the beginning. Previously the weapon dimensions, projectile weight, and velocity requirements were set and then the propellant was designed to make them function efficiently. Now consideration is given to designing weapons systems, including ballistics, as well as performance parameters. Such design is termed "weapons system" design and differs from the old "component" design.

### 3-12.3 HIGHER POTENTIAL

The current trend in weapons development is toward higher muzzle velocities. Such velocities make possible longer ranges for artillery, greater penetration depth for armor-piercing projectiles,

and a shorter time of flight for antiaircraft projectiles. In addition, higher-potential propellants make possible lighter-weight ammunition and smaller weapons, provided no increase in performance is sought. For example, a rifle propellant has been developed using nitroglycerin as one of the ingredients. Use of this propellant makes possible a smaller cartridge case and hence a lighter weight of the complete round.

Once again, however, a gain in one direction may cause losses in another. Generally speaking, the propellants of increased potential cause more erosion and greater flash. This requires that efforts be directed towards the development of propellant compositions which will provide minimum flame temperatures (low erosion) at maximum performance (a combination which implies high gas volume and low heat of combustion). The M-15 (nitroguanidine) propellant was developed as a result of the search for high potential and low erosion and flash.

In developing powders of higher potential the search has led to double-base propellants. In past years the undesirable features of nitroglycerin have restricted their use in this country. Explosives chemists have been searching for many years for a material which imparts to a powder the same desirable properties as does nitroglycerin, with superior waterproofing properties, superior igniting properties, and excellent ballistic uniformity, and which does not have the manufacturing hazards of nitroglycerin. A number of substances show promise for use as nitroglycerin replacements but none have been developed to the point where a new double-base

## MILITARY EXPLOSIVE CHARACTERISTICS

---

powder can be standardized.

It has been the policy of the Ordnance Corps to use nitroglycerin in the propellant powder only when a definite improvement in the specific weapon which fires the round is needed. Such has been the case of the rifle propellant or when ease of ignition is required to give acceptable velocity uniformity. In mortar ammunition, especially in the lower zones, the double-base roll sheet powders show vast improvement over granular powders. In this case higher production costs of roll sheets and greater hazards of nitroglycerin manufacture are justifiable to obtain ballistic requirements.

Although foreign powers have tended (in general) to use nitroglycerin in double-base artillery propellants, early in World War II the Germans showed a tendency to drift away from the use of nitroglycerin propellants. The main reason was the difficulty and danger of manufacturing nitroglycerin, as well as shortage of raw materials. Contributing factors included the storage difficulties of nitroglycerin powder in hot climates such as Africa where the high temperatures caused shorter storage life, as well as great erosion of gun bores. The Germans made use of a propellant having nitrocellulose and diethylene-glycol-dinitrate as its principal explosive ingredients and called this "Diglykol." It was used in 88-mm ammunition, and rockets.

The British developed Cordite N for many of the same reasons that the Germans developed

"Diglykol," as the result of a search, started years before, for the ideal propellant. The U.S. Army also took part in this search and developed its Nitroguanidine Propellant (similar to Cordite N).

### 3-12.4 EROSION

This is a three-fold problem inasmuch as the extent of the erosion can be minimized by characteristics of the propellant, the projectile, and the physical properties and compositions of the alloys used in the gun tube.

Considering propellant requirements only, the problem is to achieve high potential (which gives high muzzle velocities) and yet have low temperatures of combustion. The use of additives has helped a great deal in this requirement.

### 3-12.5 GREATER STABILITY

A major recurring expense to the armed services is the necessity for maintaining continual surveillance of ammunition. In order to help keep this expense low it is essential that propellants have as long a storage life as possible. For example, a large number of 90-mm H.E. rounds were loaded during World War II. Post-war surveillance tests showed that the propellant in these rounds had deteriorated to such an extent that the original ballistic performance could no longer be expected. As a result, these rounds had to be opened and the propellant charges adjusted.

## 3-13 PROPELLANTS FOR ROCKETS

A propellant is a compound or mixture which contains in the correct proportions a fuel and an oxidizer which will support high-performance combustion. While oxygen is the most common oxidizer, fluorine, chlorine and other elements will likewise oxidize fuels.

Such propellants may be solid, liquid, or gaseous. In gun propellants solids have been in favor up until recent years; in rockets both solid and liquid propellants have found wide-spread use. Gases are too bulky per unit weight to be efficient propellants. The type of propellant most

suitable for use depends upon the demands placed upon the rocket. In general, small, smaller thrust, quick-burning, but high pressure motors, use solid propellants while large, high-thrust, long-burning, low-pressure motors use liquid propellants.

An ideal rocket propellant should possess the following characteristics:

- (a) Uniform ignition and burning.
- (b) Reproducible composition with constant heat of explosion.
- (c) Smokelessness.

- (d) Flashlessness.
- (e) Stability in storage.
- (f) Low sensitivity to temperature variation and high resistance to fracture or deformation at extremes of temperature.
- (g) Availability, cheapness, and safety in manufacture.

In addition to these, solid propellants should possess:

- (a) Well-defined, reproducible, and near constant rate of burning.
- (b) Nonhygroscopicity.
- (c) Ability to be worked into grains of widely varying sizes, shapes, and burning times.
- (d) Adequate mechanical and physical properties to allow it to be "cycled" through extremes of temperature without cracking and have sufficient strength to prevent "sagging" at higher temperatures, or imbrittlement at low temperatures.

Liquid propellants should additionally possess:

- (a) Low toxicity.
- (b) Low corrosiveness.
- (c) Ease of handling.

Of all propellants yet considered, no single propellant possesses all of these characteristics, for some are obtained at the expense of others.

Propellants particularly must be rated or compared from a performance standpoint, because a logistically perfect propellant might have such a low performance rating as to render it useless from strictly military considerations. The two most important rocket performance parameters are the constancy of burning rate over the required temperature range and specific impulse. It should be remembered that rocket motors are thrust-producing power plants and that the greater the thrust per pound of motor weight, the more desirable the unit. Specific impulse  $I_{sp}$  is the ratio between the thrust and the number of pounds of propellant consumed per second. In other words, it is the thrust that would be delivered if the propellant were consumed at the rate of one pound per second. The equation for specific impulse is:

$$I_{sp} = \frac{\text{pounds force of thrust}}{\text{pounds of propellant consumed per second}}$$

(with units of  $\frac{\text{lb}}{\text{lb}} \text{ sec}$ )

Application of this concept to rocket propulsion theory will be discussed in Part 2 of the text.

### 3-13.1 CURRENT SOLID PROPELLANTS

Solid rocket propellants may be classed into three general groups: double-base propellants; cast perchlorate propellants; and composite propellants.

(a) Double-base propellants. These propellants usually are known under the trade name "Ballistite." Ballistite as used in rockets is a solid solution of nitrocellulose and nitroglycerin in roughly equal proportions with usually about 5 to 15% additives. It has good performance, an  $I_{sp}$  of over 200 seconds, and produces negligible smoke. It is limited by its temperature sensitivity (almost 1% per °F). It is fairly difficult and dangerous to manufacture.

(b) Cast perchlorate propellants. This type comprises our largest tonnage of solid rocket propellants. Two of the better known ones are Galcitol and Thiokol. Galcitol is a heterogeneous mixture of about ¼ asphalt-oil fuel with about ¾ perchlorate oxidizer, having a specific impulse around 185 seconds. It was developed at California Institute of Technology during World War II. Thiokol propellants incorporate the perchlorate oxidizers in a matrix of polysulfide rubber. They have a specific impulse of about 180-215 seconds, good temperature limits, and reduced temperature sensitivity.

(c) Composite propellants. These propellants contain ammonium picrate, potassium or sodium nitrate, and a plastic binder. They tend to be brittle at low temperatures.

Small (6-8 inch diameter of motor and smaller) solid propellant rockets have in recent years enjoyed a wide variety of uses because of their outstanding thrust-to-weight ratio and relative simplicity. However, because of limited web thicknesses in double-base propellant motors (difficult solvent evaporation limits web), and because of slump (sag due to cantilever loading by its own weight) and nozzle burn-out in single-base propellants, only today are large solid propellant rockets enjoying wide acceptance. Also, the lack of ability for precise fuel shut-off has deterred the use of large solid propellant rocket motors in missiles. This deficiency too, has been recently

## MILITARY EXPLOSIVE CHARACTERISTICS

overcome. To overcome initially these undesirable features, liquid propellant rockets were developed.

### 3-13.2 CURRENT LIQUID PROPELLANTS

Liquid propellants for rockets usually consist of two liquid elements, an oxidizing agent such as liquid oxygen, and a reducing agent, often a hydrocarbon fuel. Both the oxidizer and the reducer may, however, be an integral part of the same compound. Nitromethane (in Table 3-2) is an example of such a monopropellant. Such single compound propellants, however, are often unstable and have low specific impulse. Many propellant combinations are feasible. In recent years many new ones have been tested. Liquid propellants which ignite spontaneously when mixed are termed "hypergols" and their self-

ignition, "hypergolic." Table 3-2 gives the important characteristics of some common liquid rocket propellants. The oxidizer-to-fuel weight ratio is the ratio of the weight of the oxidizer to the weight of the fuel.

In addition to burning requirements (of differing duration), which have made liquid propellants popular for weapons requiring long duration of thrust, solids are most useful for short duration high total impulse requirements.

With liquid fuels, tremendous numbers of potential fuel combinations are available and have been tested. The German B. M. W. concern alone tested more than 3000 differing combinations during World War II. Liquids which have a high heat of combustion per pound of propellant and give both a high chamber temperature and reaction products of low mean molecular weights

**TABLE 3-2 REPRESENTATIVE LIQUID PROPELLANTS**

Oxidizer	Fuel	Oxidizer-Fuel Ratio	$I_{sp}$ (sec)	Remarks
Liquid Oxygen O <sub>2</sub>	Gasoline C <sub>8</sub> H <sub>18</sub>	2.5/1	248	Low boiling point of liquid oxygen, -298°F, makes it difficult to handle and impossible to store.
Liquid Oxygen	Alcohol C <sub>2</sub> H <sub>5</sub> OH	1.5/1	244	Alcohol requires less oxygen for its burning than gasoline does. Both gasoline and alcohol are satisfactory.
Liquid Oxygen	Hydrazine (CH <sub>3</sub> ) <sub>2</sub> NNH <sub>2</sub>	0.5/1	259	Hydrazine is flammable, toxic, a strong solute with a high vapor pressure.
Liquid Oxygen O <sub>2</sub>	Liquid Hydrogen H <sub>2</sub>	3.8/1	353	Has highest $I_{sp}$ of any known fuel. Impractical because of low temperatures, -424°F, and density, .07, of liquid hydrogen.
Red-fuming Nitric Acid HNO <sub>3</sub> -NO <sub>2</sub>	Aniline C <sub>6</sub> H <sub>5</sub> NH <sub>2</sub>	3/1	221	Hypergolic (self-igniting). Nitric acid is highly corrosive and requires special handling technique. Aniline is toxic.
Fluorine	Hydrazine	1.9/1	299	Fluorine is extremely corrosive, poisonous, reactive, and expensive.
Hydrogen Peroxide H <sub>2</sub> O <sub>2</sub>	Alcohol C <sub>2</sub> H <sub>5</sub> OH	3.66/1	225	Hydrogen peroxide is quite unstable and requires special handling technique.
(O <sub>2</sub> contained within fuel)	Nitromethane CH <sub>3</sub> NO <sub>2</sub>	—	218	This is a monopropellant, that is, only one chemical is needed. It is unstable and requires special handling techniques.

are best. Generally, propellants having a large weight percent of hydrogen in preference to carbon meet these conditions best because of the higher heat of combustion of hydrogen and because the products of the hydrogen reaction ( $H_2$  and  $H_2O$ ) are lighter than the carbon end products ( $CO$  and  $CO_2$ ).

Liquid propellant rockets currently are most useful where long thrust durations are typical. Hence large quantities of propellant usually are required. For this reason what apparently at first glance appears to be a small difference in density of the propellant may be, on closer scrutiny, of interest. Thus, liquid propellants are judged in part by their density impulse. This parameter is obtained by multiplying the specific impulse by the propellant's specific gravity. The resulting "density impulse" is a measure of the propellant impulse as a function of its density. Many of the propellant combinations which the German rocket scientists used rated well on this evaluation. Nitric acid-aniline has a density impulse of 290 seconds. Surprisingly, liquid oxygen-hydrogen is very poor in this regard yielding only 85 seconds in density impulse.

In liquid propellants too, due to the highly

oxidizing (and hypergolic) nature of some, scrupulous care of handling is required. Concentrated hydrogen peroxide, for example, if contaminated with organic matter such as wood, rags, gasket bits, etc., may ignite. This hazard has probably been overemphasized in test situations, but will require considerable work in future years if liquid rockets are to be truly mobile and easily serviced.

Present work on liquid propellants is directed in large measure today to combustion problems and handling considerations. Handling difficulties of some liquid propellants are one reason that solid propellants for intermediate size rocket engines are increasing in the favor of the services.

The previous discussion of rocket propellants makes it clear that solid propellants are not ideal rocket propellants. While some of the disadvantages can be minimized by careful choice of the ingredients and proportions, as yet no new materials have been found which, when used in conventional propellants, produce large scale improvements in ballistic properties; nor are the potentials (in rocketry specific impulse) for either solid or liquid propellants high enough. Consequently, in the hope of producing new propellants with few disadvantages and greater strength, considerable work has been directed towards entirely new rocket propellants.

### 3-14 EXOTIC PROPELLANTS

The conventional fuels of the future are the exotic fuels of today. In the popular press the word "exotic" has been applied in recent years, not to foreign or outlandish fuels, but only to unusual ones. A few years ago JP-4 and chemical additive (commonly boron) fuels ("zip" fuels) were not in common usage. In a few years perhaps lithium, fluorine, and even ion fuels (such as cesium) will be as commonplace as JP-4 is today. A more proper name for the new fuels would be new or novel rather than "exotic."

Chemical fuels liberate energy of association by decomposition and reassociation. Oxidation (removal of electrons) is most frequently used as the mechanism for such a change. Fuels most commonly used in past years were predominantly

of the hydrocarbon petroleum base variety. Oxidation of these fuels caused oxidation of mostly hydrogen and carbon by rupture of C-H and C-C linkages.

Propellants which have different common linkages such as B-H and C-F can theoretically liberate greater energy by oxidation than can the common hydrocarbon propellants since greater net energy is available after oxidation of such linkages. Note that fluorine is the oxidizer and boron is the reducing agent in such arrangements. It is also important to remember that boron, used as a fuel alone liberates some 29,000 BTU's per pound when oxidized which compares with some 19,000 BTU's per pound liberated by hydrocarbons, a 40% increase.



## FISSION-FUSION REACTIONS

## 4-1 INTRODUCTION

Thus far the text material has been confined to a discussion of the liberation of energy from chemical reactions. In this chapter attention will be focused on another source of energy, that which holds together the particles of atomic nuclei. Such energy might be thought of as that which binds together the sub-atomic particles of matter, nuclear energy.

There is a vast difference in the magnitude of energy available from nuclear, as opposed to chemical reactions. Chemical explosives, such as TNT, can be made to release on the order of 84,000 foot-pounds of work per pound, whereas plutonium, a nuclear explosive, may deliver about  $3.0 \times 10^{15}$  foot-pounds, per pound. This vast potential of work is of interest to the military engineer because of its application to the weapons of war.

Man's successful exploitation of atomic energy in the form of an explosive device took only five years to accomplish. Behind that "bomb," however, there stand thousands of years of study and research, theory and experiment. It was only after decades of effort that investigators by the thousands in every civilized country of the world have built up, bit by bit, today's broad understanding of how nuclear energy is liberated and how the different elements are constructed (see Table 4-1).

The first step was the discovery that all matter, whether in the liquid, solid, or gaseous state, is composed of extremely tiny particles, atoms, and that all the millions of different substances on the face of the earth are only different combinations of the atoms of 98 different elements. With this discovery came the development of chemistry and all its subsequent contributions to man's

comfort and convenience.

The next big step forward did not take as long to achieve, but it has resulted in even more exciting applications. This was the discovery that the atom is not a single solid unit, but contains particles much smaller yet, electrons, which through their application in electricity and electronics, enable man to develop and efficiently handle far greater amounts of power than before.

**TABLE 4-1 PROGRESS OF NUCLEAR PHYSICS**

1811—Avogadro's Law
1831—Faraday's Law
1881—Helmholtz "Element of Charge"
1895—Discovery of X-rays
1896—Discovery of natural radioactivity
1897—Discovery of the electron
1902—Theory of radioactive decay
1905—Special theory of relativity
1911—Theory of the atomic nucleus and Millikan oil drop experiment
1912—Theory of isotopes of the elements
1913—Theory of atomic structure
1913—Atomic numbers of the elements
1915—General theory of relativity
1919—First experimental nuclear reaction
1920—Discovery of the proton
1928—Theory of alpha particle emission
1932—Discovery of the neutron
1933—Discovery of artificial radioactivity
1939—Discovery of nuclear fission
1942—First successful atomic pile
1945—First atomic (fission) device
1953—First fusion device

## SOURCES OF ENERGY

The third, and to date, the most spectacular step, has been the discovery that the heart of the atom, the nucleus, is also composed of small individual particles; that one element differs from another only in the number of these particles in its nucleus; that one element can be converted into another by changing the number of these particles; and that such changes can be utilized to produce millions of times as much energy as any electrical or chemical process known.

Until 1945, only the comparatively tiny amounts of energy stored in the outermost fringes of the atom could be utilized. In every type of

chemical reaction for securing power, such as the burning of coal, wood, or gasoline, the power produced comes only from the rearrangement of the atoms in the substance. In a typical molecule of coal, wood, or gasoline, the atoms are arranged in one way, and in the products of combustion, the atoms are arranged in a different way. There is no change in the number or character of the atoms, only in their arrangement, and in this change, the energy holding them together is released. This is true whether the energy comes from the burning of coal, wood, or gasoline; from the explosion of TNT; or from chemical reaction in storage batteries.

## 4-2 ATOMIC STRUCTURE

### 4-2.1 ELEMENTS AND ATOMS

An element may be defined as a substance which cannot be separated by chemical means into substances different from itself. The properties of an element originate in the atoms that make up the element; consequently, the atoms of different elements are not the same. An atom then is the smallest part of an element that still retains the properties of the element.

Although atoms of one element differ from those of another, all atoms have the same general structure and often are described by comparing them with our solar system. At the center of every atom is a nucleus with positive electrical charge. Moving about the nucleus in orbits, much like planets move around the sun, are a number of particles called electrons. The electrons have a negative charge and are held within the atom by the attraction of the positive nucleus. For convenience, the charge of an electron is assigned the unit  $-1$ .

### 4-2.2 NUCLEAR COMPOSITION

Physicists now recognize at least ten different nuclear particles. This text discusses, however, just two of these particles, the proton and neutron. The positive charge of a nucleus is attributed to component particles called protons. The charge of a proton is  $+1$ . A second type of particle, called a neutron, also exists within the

nucleus. The neutron has a neutral charge. Protons and neutrons often are referred to as nucleons because both exist within nuclei. A nucleon is much heavier than an electron. It takes about 1840 electrons to weigh as much as one nucleon. Therefore, most of the weight of an atom is concentrated within its nucleus (see Table 4-2).

The number of protons in an uncharged atom is equal to the number of electrons. There can be from 1 to 100 or more protons in an atom. The number of protons in an atom determines its characteristics as an element. For example, all atoms of hydrogen have 1 proton; all atoms of helium have 2 protons; all atoms of oxygen have 8 protons; and all atoms of uranium have 92 protons. The number of protons in an atom is the atomic number of the atom, while the total number of nucleons (number of protons plus the number of neutrons) in an atom is the atomic mass number.

TABLE 4-2 ATOMIC PARTICLES

Particle	Charge	Mass (amu)*
Proton	+1	1.00758
Neutron	0	1.00894
Electron	-1	0.00055

\* An amu (atomic mass unit) is equivalent to  $1.6603 \times 10^{-24}$  grams  $\equiv \frac{1}{16}$  mass of  ${}^8\text{O}^{16}$  atom.



### 4-2.3 ISOTOPES

Since atoms were thought of as the smallest divisible particles of matter for many years, and it was known that the number and arrangement of atoms gave elements their properties, the possibility that atoms with slightly differing masses might possess identical chemical properties was delayed until after the discovery of radioactivity. In an effort to logically support the arrangement of the periodic table, the possibility of isotopes, atoms with different masses but identical chemical properties, was suggested by Frederick Soddy, an English physicist, in 1912. The number of isotopes now known totals several hundred. Among them are many artificially produced isotopes, including at least 1 radioactive isotope for every known element. Isotopes are atoms with the same atomic number (number of protons) but different total numbers of nucleons. For instance,  ${}_{92}\text{U}^{234}$ , and  ${}_{92}\text{U}^{238}$ , are different varieties or isotopes of the same element, uranium. The element hydrogen has three known isotopes indicated schematically in Figure 4-1.

### 4-2.4 SYMBOLS

Chemists many years ago prescribed a shorthand system for describing elements. Instead of the full name of an element, a brief symbol is used, e.g., the symbol for hydrogen is the letter H; the symbol for helium is He.

In nuclear physics a subscript is added to the symbol to show the atomic number of the element and superscript is used to show which isotope of the element is being considered. This superscript is the atomic mass number of the isotope.

Thus, the three isotopes of hydrogen are written:

${}^1_1\text{H}$	${}^2_1\text{H}$	${}^3_1\text{H}$
Common Hydrogen (Hydrogen-1)	Deuterium (Hydrogen-2)	Tritium (Hydrogen-3)

The four isotopes of helium are written:

${}^3_2\text{He}$	${}^4_2\text{He}$	${}^5_2\text{He}$	${}^6_2\text{He}$
Helium-3	Helium-4	Helium-5	Helium-6

The general symbol for any atom is then:

$${}_Z X^A$$

where,

$X$  = symbol of the element.\*

$Z$  = the atomic number (number of protons).

$A$  = the atomic mass number (the sum of the number of protons and the number of neutrons, i.e., the number of nucleons).

Thus,  $A - Z$  = the number of neutrons.

### 4-2.5 MASS OF NUCLEAR PARTICLES

The mass of nuclei and nuclear particles is based on a system in which the mass of the  ${}^1_8\text{O}^{16}$  atom is 16.00000. The unit of mass is called a mass unit; it is 1/16 of the mass of this isotope of oxygen, and equals  $1.6603 \times 10^{-24}$  gram. The atomic weight  $M$ , of an atom is its mass written in mass units. The mass of an atom to the nearest whole number is called its mass number,  $A$ .

\* Those sub-atomic particles with no chemical element symbols are given a letter abbreviation. Thus, the electron, with a charge of  $-1$  and negligible mass is written  ${}_{-1}e^0$ ; the neutron is written  $n^1$ ; the proton (hydrogen nucleus) is written  ${}^1p^1$ .

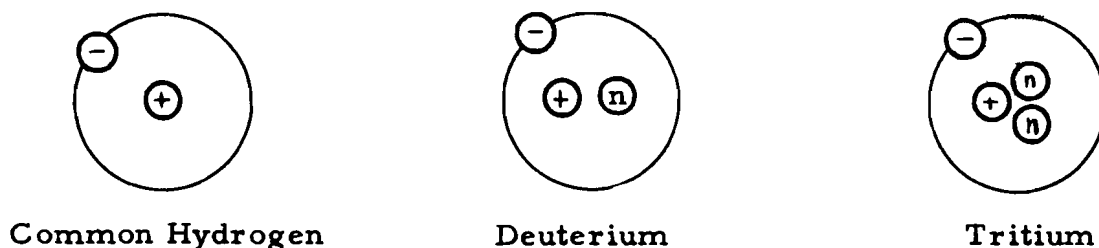

Fig. 4-1 Isotopes of hydrogen.

### 4-2.6 CHARGE OF NUCLEAR PARTICLES

In nuclear physics, the unit of electric charge is the positive charge of the proton. This charge is often called the electronic charge, or the electronic unit of charge, because the electron

has a charge of the same magnitude (but of opposite sign). By various ingenious experiments the magnitude of the electronic charge has been accurately determined to be  $4.8024 \times 10^{-10}$  electrostatic units (esu), or about  $1.60 \times 10^{-19}$  coulomb.

## 4-3 RADIOACTIVITY

### 4-3.1 NUCLEAR INSTABILITY

Negative electrons are bound to the atom by the attraction of the positive protons. Within the nucleus, however, only positive charges exist, and these charges should repel each other. Therefore, other forces strong enough to overcome the repelling forces of the protons, must exist between nucleons. Since these forces are of very short range, acting only between nucleons close to one another, it is possible in isotopes of heavier elements for the electrostatic forces between protons to overcome the strong nuclear forces. If this happens, part of the nucleus actually may break off and escape. In other cases, rearrangements may take place which lead to more stable configurations within the nucleus. Nuclei in which this happens are said to be unstable or radioactive. All isotopes with atomic number greater than 83 are naturally radioactive and many more isotopes can be made artificially radioactive by adding neutrons, protons, or groups of these to a normally stable configuration. The time that it takes for the product to be half-transformed into the succeeding product is called its half-life. It is a measure of the relative stability of the radioactive element. In most cases an atom always breaks up in the same way, giving a second atom and an  $\alpha$  or  $\beta$  particle. In certain cases, some atoms break up in two distinct ways, giving rise to what are called branch products.

### 4-3.2 ALPHA DECAY

Natural radioactivity occurs in three basic ways. Many unstable nuclei emit a particle composed of 2 protons and 2 neutrons, called an alpha particle (symbol  $\alpha$ ). This configuration is also the nucleus of a helium ( ${}_2\text{He}^4$ ) atom and is very stable. To evaluate what results from alpha

particle emission, consider the isotope of uranium with 146 neutrons and 92 protons ( ${}_{92}\text{U}^{238}$ ). This is a naturally occurring isotope but is radioactive and an alpha particle emitter. Since the alpha particles take away two protons, the uranium changes to an entirely new element, thorium, with 90 protons and 234 nucleons.

### 4-3.3 BETA DECAY

It often happens that unstable nuclei emit high-speed electrons called beta particles (symbol  $\beta$ ), to indicate that they originate in the nucleus instead of outside the nucleus. The source of  $\beta$  particles is interesting since there are no electrons in a nucleus. The paradox is explained by breakdown of a neutron into a proton and an electron. When this happens, the electron ( $\beta$  particle) is ejected from the nucleus while the proton is left behind.

### 4-3.4 GAMMA RAYS

Previously it was said that an unstable configuration of neutrons and protons in a nucleus is sometimes made more stable by a rearrangement of the components with no particles emitted. Such changes are accompanied by radioactivity in the form of energy. With different configurations of the nucleus the components are bound with different energies, and so upon rearrangement energy is often released in the form of electromagnetic waves called gamma rays (symbol  $\gamma$ ). They come from the nucleus rather than from the excitation of planetary electrons, as in the case of X-rays. No change in atomic structure accompanies  $\gamma$  emission ( $A$  and  $Z$  numbers remain the same); the only effect upon the nucleus involved is to leave it with less energy and usually with less tendency for further decay.

# FISSION-FUSION REACTIONS

## 4-3.5 INDUCED REACTIONS

While only three radioactive particles are emitted from naturally occurring radioisotopes, there are a great many more types of decay from artificial isotopes. In addition to alpha and beta particles and gamma rays, certain nuclei may emit neutrons, positive electrons, or other particles. The neutrons are especially important in applications of atomic energy for they can cause nuclear fission, a reaction fundamental to atomic explosions and sources of atomic power. The surplus neutrons from atomic explosions which impinge on atoms of the earth, induce sufficient radioactivity in some elements found in the earth in the vicinity of ground zero to be of military importance.

## 4-3.6 RADIOACTIVE SERIES

The step-by-step process by which radioactive elements emit radiations and change into other elements and finally reach a more stable state is called a decay series. The steps from  ${}_{92}\text{U}^{238}$  to  ${}_{90}\text{Th}^{234}$  to  ${}_{91}\text{Pa}^{234}$  described above, represent two steps in what is called the natural radioactive uranium series,  ${}_{92}\text{U}^{238}$  being the original element in the series. Several other steps, not described here, occur in this uranium series before stability is reached and radioactivity no longer exists. The last step in this process occurs when the element polonium ( ${}_{84}\text{Po}^{210}$ ) emits an alpha particle and becomes the element lead ( ${}_{82}\text{Pb}^{206}$ ), which is stable. This terminates the uranium series. There are four radioactive decay series (see Figure 4-2).

## 4-4 ENERGY, FISSION, AND FUSION

Until a few decades ago two separate laws described the conservation of mass and the conservation of energy. These laws were: In any reaction or system, the amount of mass existing prior to a given reaction must be equal to the amount of mass present after the reaction; and, The amount of energy inherent in the system before a reaction must be equal to the amount of energy present after the reaction. These laws of conservation were used for many years without disproof until deviations were detected by research scientists using refined techniques of measurement. One such deviation was a loss in mass within the atomic nucleus. For example, it was known that a free neutron mass is 1.00894 amu; and a free proton, 1.00758 amu. When 79 protons are combined with 118 neutrons to form a

gold nucleus for example, a mass of  $79 \times 1.00758$  plus  $118 \times 1.00894 = 198.654$  amu would be expected if the law of conservation of mass held. It was found by experiment, however, that a gold nucleus has a mass of only 196.996 amu; a loss of 1.657 amu. Similar discrepancies have since been found for every type of nucleus. These disturbing violations of hitherto accepted laws of physics were resolved in a brilliant work in 1905, by Albert Einstein, in which he showed that mass of all matter and energy are equivalent, and that it is possible for one to be changed into the other. Although this would seem to negate the laws of conservation, it did not. Rather, energy and mass are conserved as a sum, that is:

$$(\text{mass} + \text{energy})_{\text{before}} = (\text{mass} + \text{energy})_{\text{after}}$$

### 4-4.1 EQUIVALENCE OF MASS AND ENERGY

A major result of Einstein's theory was that if a quantity of matter of mass  $m$ , is converted completely into energy, the amount of energy created is given by the equation:

$$E(\text{ergs}) = m(\text{grams}) \cdot c^2$$

where  $c$  is the velocity of light ( $3 \times 10^{10}$  cm/sec). For example, if 1 gram is converted into energy, the result is  $9 \times 10^{20}$  ergs of energy.

$$E = mc^2 = (1 \text{ gm}) (3 \times 10^{10} \text{ cm/sec})^2 \\ = 9 \times 10^{20} \text{ ergs}$$

A conception of the tremendous amount of energy thus liberated can be judged better if it is

# SOURCES OF ENERGY

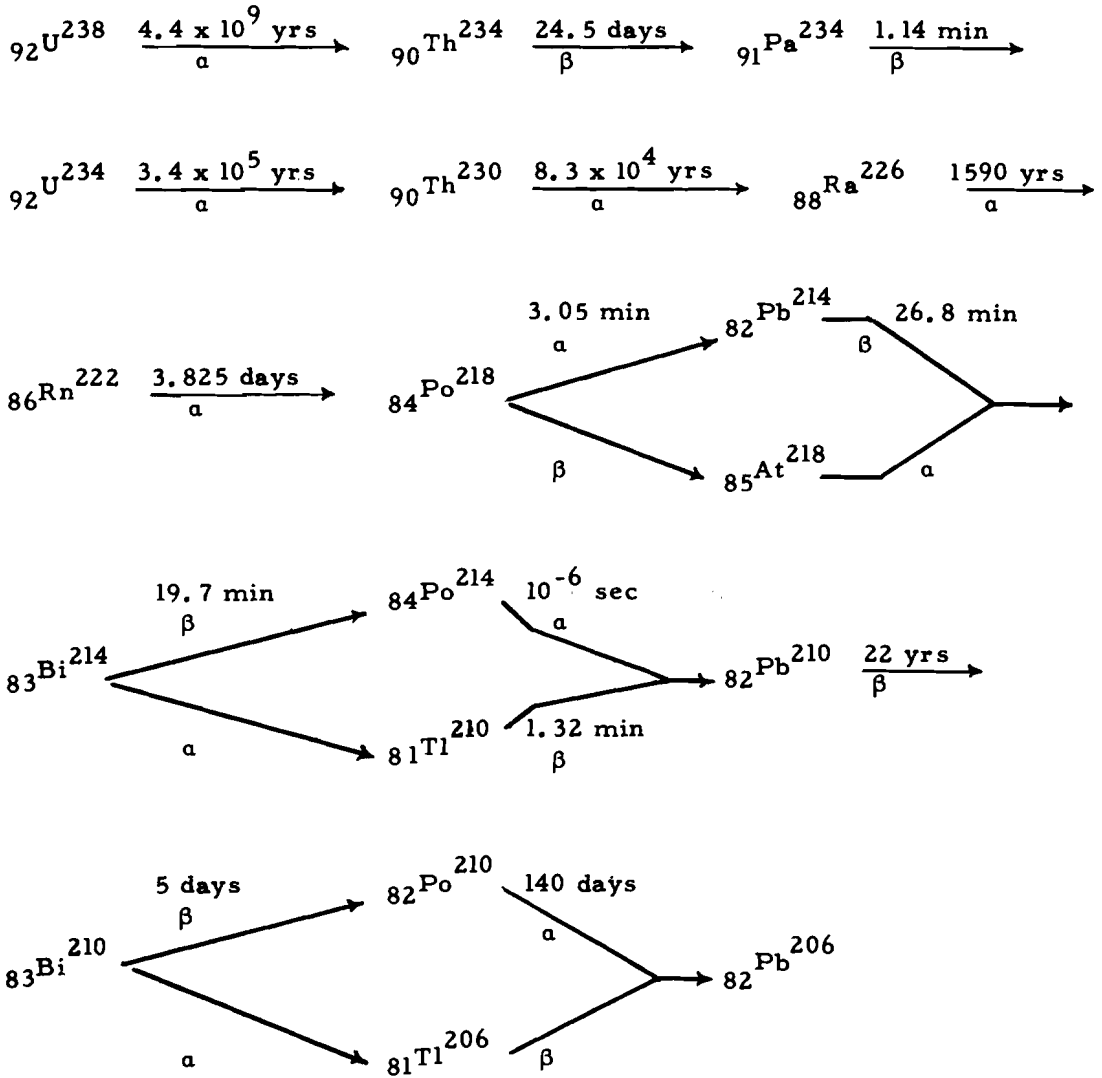

Note:  $N =$  an integer between 52 and 59, thus the  $(4N + 2)$  Series is the  $4 \times 59 + 2 = 238$  or Uranium Series. Other Series are Thorium  $(4N)$ , Neptunium  $(4N + 1)$ , and Actinium  $(4N + 3)$ .

Fig. 4-2 Uranium  $(4N + 2)$  series.

conceived that it would take about 20,000 tons of TNT to release the same energy by chemical means.

Consider the example of gold again. The mass of 1.657 amu lost by the neutrons and protons

when they were combined into a nucleus must have gone into energy. Consequently, this amount of energy must be supplied to the gold nucleus in order to completely separate all of the component particles. Energy of this type is called the binding energy, of the nucleus.

## FISSION-FUSION REACTIONS

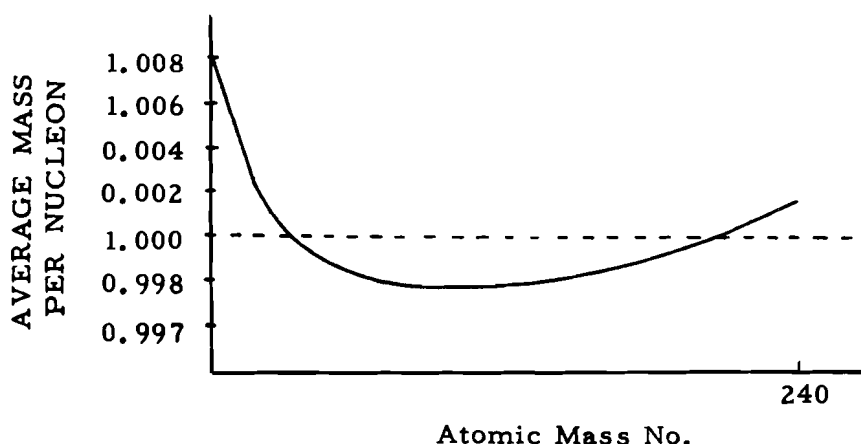
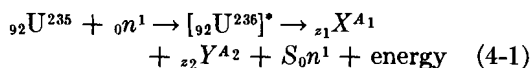

Fig. 4-3 Pseudo-continuous plot of average mass per nucleon versus atomic number.

### 4-4.2 FISSION

If a nucleus has a mass greater than the sum of masses of the particles into which it may be subdivided, then such subdivision would yield energy. Our problem then is to cause subdivisions of large nuclei. It has been found that certain large nuclei, notably  $U^{235}$  and  $Pu^{239}$ , will subdivide or fission when struck by a neutron. The nuclear reaction equations are:



where  $X$  and  $Y$  are fission fragments with a binodal frequency distribution such that

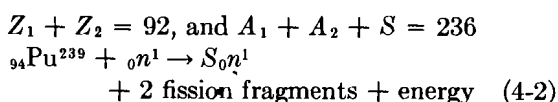

The energy results from a conversion of mass, i.e., the mass of the right side of the equation is less than the mass of the left side:

$$E = (m_{\text{left}} - m_{\text{right}})c^2 = \Delta mc^2$$

Hence, new "structures" have been created which have less mass but the same number of nucleons. Thus, the average mass per nucleon is less for the fission fragments than for the heavy atoms. Figure 4-3 is a plot of the average mass per nucleon versus atomic number. The variation is explained by the difference in energy required to hold the various configurations.

\* The brackets around the  ${}_{92}U^{236}$  indicate a compound nucleus which is short lived.

To completely dismember an atom of atomic number about 80 into its constituent sub-atomic particles would require the addition of mass (initially in the form of energy) to bring the average mass per nucleon up from about .998 to about 1.008 amu.

Of the fission energy released in the reactions described by (4-1) and (4-2) about 80% takes the form of kinetic energy of fission fragments; about 2% kinetic energy of prompt neutrons; about 2% gamma radiation; about 12%  $\beta$ -decay of fission fragments; and about 4% is lost to delayed neutrons. The delay of a portion of the neutrons allows time to control (by neutron capture in control rods) an atomic reactor which may be operating at too high an energy level.

### 4-4.3 FUSION

Since nucleons in the very light nuclei are heavier than those in nuclei of intermediate mass (see Figure 4-3), the fusing together of light nuclei to form a larger nucleus should result in the release of energy. It has been found that extremely high temperatures are required to produce a fusion reaction. Hence, the name thermonuclear is often applied to fusion reactions.

Some examples of fusion reactions follow:

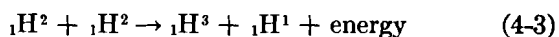

In each case the mass on the right side is less than the initial mass, thus:

$$\text{Energy} = (m_{\text{l.h.s.}} - m_{\text{r.h.s.}})c^2 = \Delta mc^2$$

# SOURCES OF ENERGY

## 4-4.4 NUCLEAR ENERGY

Since nuclear masses are ordinarily given in amu (1/16 the mass of an  ${}^8\text{O}^{16}$  atom), it will be instructive to compute the energy which is equivalent to 1 amu.

$$\begin{aligned}
 E &= mc^2, \quad 1 \text{ amu} = 1.66 \times 10^{-24} \text{ gm} \\
 E \text{ (ergs)} &= 1.66 \times 10^{-24} \times 3^2 \times (10^{10})^2 \\
 &= 14.92 \times 10^{-4} \text{ ergs} \\
 &= 9.31 \times 10^8 \text{ ev} \approx 931 \text{ Mev}
 \end{aligned}$$

Assuming the mass of right side of (4-1) is .215 amu less than the mass of the left side, the energy released by this fission is:

$$931 \times .215 = 200 \text{ Mev}$$

Table 4-3 gives the masses of several different isotopes. With the aid of this table, the  $\Delta m$  for several promising fusion reactions can be computed.

**TABLE 4-3 ATOMIC MASSES OF SOME PARTICLES AND LIGHT ISOTOPES**

Z	Element	A	Mass (amu)
0	Electron	0	0.00055
0	Neutron	1	1.00894
1	Proton	1	1.00758
1	Hydrogen	1	1.00813
	(Deuterium)	2	2.01471
	(Tritium)	3	3.01702
2	Helium	3	3.01700
		4	4.00390
		6	6.02090
3	Lithium	6	6.01697
		7	7.01822
		8	8.02502

To find the energy released by the deuterium-deuterium reactions (4-3) and (4-4), the following simple calculations can be carried out.

$$\begin{array}{rcl}
 & \text{very} & \\
 & \text{hi} & \\
 {}_1\text{H}^2 + {}_1\text{H}^2 & \xrightarrow{\text{temp}} & {}_1\text{H}^3 + {}_1\text{H}^1 \quad (4-5) \\
 & & \\
 2.01471 & & 3.01702 \\
 2.01471 & & \underline{1.00813} \\
 4.02942 & & 4.02515 \\
 & & \\
 & & 4.02942 \\
 & & \underline{-4.02515} \\
 \Delta m = & & .00427
 \end{array}$$

$$\begin{array}{rcl}
 E = .00427 \times 931 & = & 3.98 \text{ Mev} \\
 {}_1\text{H}^2 + {}_1\text{H}^2 & \rightarrow & {}_2\text{He}^3 + {}_0n^1 \quad (4-6) \\
 4.02942 & & 3.01700 \\
 & & \underline{1.00894} \\
 & & 4.02594
 \end{array}$$

$$\begin{array}{r}
 4.02942 \\
 -4.02594 \\
 \hline
 \Delta m = .00348 \\
 E = .00348 \times 931 = 3.24 \text{ Mev}
 \end{array}$$

Other fusion reactions might prove useful. Consider, for example, a lithium (4-6) tritium reaction.

$$\begin{array}{rcl}
 & \text{very hi} & \\
 {}_3\text{Li}^6 + {}_1\text{H}^3 & \xrightarrow{\text{temp}} & {}_0n^1 + 2{}_2\text{He}^4 \\
 & & \text{temp} \\
 & & 1.00894 \\
 6.01697 & & 4.00390 \\
 3.01702 & & \underline{4.00390} \\
 9.03399 & & 9.01674 \\
 & & \\
 & & 9.03399 \\
 & & \underline{-9.01674} \\
 \Delta m = & & .01725 \\
 E = .01725 \text{ amu} \times 931 \text{ Mev/amu} \\
 & & = 16 \text{ Mev}
 \end{array}$$

Note that besides 16 Mev of energy we have also gained, by this reaction, a neutron which might be useful to produce fission.

The possible use of deuterium, tritium, and lithium in fusion reactions of commercial or military importance would be influenced by certain of their characteristics. Deuterium occurs naturally (about .015% of all hydrogen is  ${}_1\text{H}^2$ ); it can be separated (at considerable expense) from water. It is useful since it can be made to fuse more easily than  ${}_1\text{H}^1$ .

Tritium does not occur naturally and must therefore be produced in an atomic reactor (at tremendous expense). Further, tritium is radioactive and has a short half-life (or the order of 12 years). This means that it is dangerous and has a limited shelf-life. However, it can be made to fuse more easily than deuterium.

Lithium occurs naturally and is, relatively speaking, cheap.

The tremendously high temperatures required to produce fusion reactions can be attained most simply by fission reactions. Fission reactions are controllable. It is desirable, therefore, to go to a more detailed examination of these reactions.

4-5 CROSS SECTION, THE CHAIN REACTION, AND CRITICALITY

4-5.1 CROSS SECTION

Consider an incident beam of particles ( $I_0$ ) entering a slab of material within which interactions will occur (see Figure 4-4).

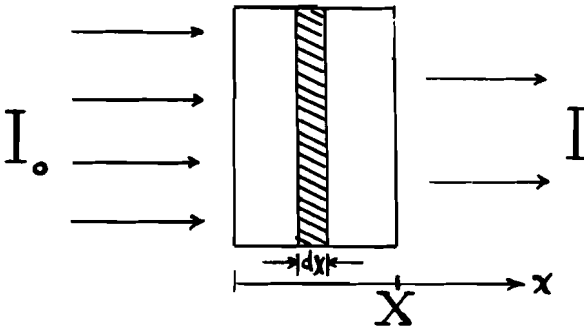

Fig. 4-4 Particles entering a slab of material.

Let  $N$  = number of nuclei/cc  
 $\sigma$  = microscopic cross section or the effective area of an individual nucleus of the slab (or target) material

The decrease in intensity ( $-dI$ ) of the beam as it travels the infinitesimal distance  $dx$ , will be  $I\sigma Ndx$ . The intensity ( $I$ ) at any point ( $x$ ) in the slab is a function of the distance the beam has traveled.

$$-dI = I\sigma Ndx$$

Solve by separation of variables.

$$-\int_{I_0}^I \frac{dI}{I} = \sigma N \int_0^x dx$$

$$-1 \ln I \Big|_{I_0}^I = \sigma NX$$

or

$$I = I_0 e^{-\sigma NX} \tag{4-7}$$

This general type of equation may be described as an exponential attenuation.\*

\* The same form of equation describes radioactive decay. Thus,  $N = N_0 e^{-\lambda t}$  where  $N$ , the number of undecayed nuclei, is a function of the number with which we start ( $N_0$ ), the time ( $t$ ), and a decay constant ( $\lambda$ ) which is a property of the particular material. Elsewhere,  $\lambda$  denotes mean free path; the different uses of the symbol should be noted to avoid confusion.

The greater  $\sigma$ , the greater the probability of interaction. Hence  $\sigma$  gives an indication of the probability of a given interaction. The unit in which  $\sigma$  is usually given is the barn (1 barn =  $10^{-24}$  cm<sup>2</sup>). Since heavy nuclei have a diameter of the order  $10^{-12}$  cm,  $10^{-24}$  cm<sup>2</sup> is relatively "big as a barn."\*\*

We are interested in neutron interactions, particularly that one which fissions  ${}_{92}\text{U}^{235}$ . The fission cross section  $\sigma_f$ , gives a measure of the probability that a neutron incident on  ${}_{92}\text{U}^{235}$  will produce a fission. But there are other possible interactions, e.g., scattering and capture. The total cross section,  $\sigma_t$ , which is a measure of the likelihood of some interaction, is given by

$$\sigma_t = \sigma_s + \sigma_c + \sigma_f + \dots$$

The microscopic (very small scale) cross section  $\sigma$  can be converted to a macroscopic (large scale) cross section  $\Sigma$ , by multiplying it by the number of nuclei per cc ( $N$ ).

$$\Sigma = N\sigma = \frac{\text{nuclei}}{\text{cm}^3} \times \frac{\text{cm}^2}{\text{nucleus}} = \text{cm}^{-1}$$

$$\text{Since } N = \frac{\text{Avogadro's No.}}{\text{atomic wt.}} \times \text{density}$$

$$= \frac{N_0}{A} \rho, \text{ it follows:}$$

$$\Sigma = \frac{\sigma N_0 \rho}{A} \tag{4-8}$$

The reciprocal of  $\Sigma$  has the units of length and is called mean free path:

$$\lambda = \frac{1}{\Sigma} = \text{average distance a particle goes before interaction.***}$$

It will be remembered that moderators are used in some atomic reactors to slow down neutrons because slow neutrons cause fissions of

\*\* Improbable interactions have cross sections given in "sheds" or even "out-houses."

\*\*\* By setting  $X$  in (4-1) equal to  $\lambda$ , we find  $I_0$  is reduced by a factor  $\frac{1}{e}$ ; thus  $\lambda$  is sometimes called the "e-folding thickness."

$U^{235}$  better than fast neutrons. This fact is more properly stated: The fission cross section for  $U^{235}$  is greater when the velocity (and thus kinetic energy) of the incident neutrons has a certain range of values. In general we may say that cross sections are highly energy dependent.\*

The idea that only  $U^{235}$  and plutonium are fissionable is erroneous. With neutrons of sufficient energy  $U^{238}$ , protactinium, and thorium can be fissioned. The reason these reactions are not more important is that neutrons of required energy are hard to obtain.

### 4-5.2 CHAIN REACTION

When it was discovered that the fission of a nucleus, caused by a neutron, results in the emission of 2 to 3 neutrons, a startling possibility was suggested. If most of the neutrons emitted could each be made to cause another fission resulting in the emission of more neutrons, in a few generations the number of free neutrons present could be made to increase astronomically. The fission process then would proceed at an exponentially increasing rate until all of the fissionable material had been disintegrated. Due to the high speeds of these fission neutrons and due to the negligible time required for a fission to be completed, it might be possible for a tremendous amount of energy to be released in a small fraction of a second. The process could result in an explosion; or if the process could be controlled, it could serve as a nuclear source of usable power. This process, where the product neutrons of an initial fission produce additional fissions, as described above, is called a chain reaction.

### 4-5.3 NEUTRON REACTIONS

Several possibilities, which tend to impede the occurrence of a chain reaction, exist for fission neutrons. Often, neutrons are captured by a nucleus without producing a fission: they may be captured by a nonfissioning impurity; they may

escape from the mass of fissionable material without having entered into a fission; or, many are merely scattered and slowed down to impotent velocity by "billiard ball"-type impacts with nuclei.

### 4-5.4 CLASSES OF CHAIN REACTIONS AND CRITICALITY

Depending upon the relative frequency of these events, chain reactions have been classified in three types that may occur in a mass containing fissionable material: (1) nonsustaining or convergent; (2) sustaining; and (3) multiplying or divergent. In a nonsustaining reaction, the chance that a neutron will escape or become captured is much larger than the chance that it will cause fission; therefore, the chain reaction dies out quickly if started. In a sustaining reaction the chances of neutron capture or escape are less, such that on the average, 1 of the 2 or 3 neutrons produced per fission in turn will produce a fission itself, and the number of free neutrons remains fairly constant with time. This is the desired condition for a source of nuclear power since a constant energy output results. Finally, in a multiplying chain reaction, an average of more than one neutron per fission will go on to produce additional fissions with a rapid increase in neutron population and fissions occurring per unit time. This type of reaction is essential to a nuclear weapon.

One thing that must be done to achieve a multiplying chain reaction is to minimize escape and capture, for these effects result in an unproductive loss of neutrons. Studies of capture effects have been made and, briefly, it has been found that capture varies with the energy (or speed) of the neutrons which strike a nucleus. Fortunately, for pure samples of some materials, there are fairly wide ranges of energy for which fission processes dominate over capture. However, the loss of neutrons through the surface can retard a chain reaction even in the best materials, if the mass is small. By increasing the amount of material, the probability that a neutron will escape can be reduced because a larger volume contains more nuclei with which a neutron can interact before reaching the surface, or, in other words, increasing the diameter of a sphere, for example, will add more volume, but the volume increases at a faster rate than the surface area. Therefore,

---

\* This fact can be explained qualitatively by realizing that there is a wave length associated with a moving particle which depends on its velocity. When the velocity (and thus the wave length) of the particle attains a resonant value, the probability of interaction is dramatically increased.



## FISSION-FUSION REACTIONS

it is found that there is a certain volume, or, in weight, a specific mass necessary to sustain a chain reaction. This amount is called a critical mass. Similarly, a mass is said to be subcritical or supercritical if it is capable of a nonsustaining or a multiplying chain reaction, respectively.

The multiplying chain reaction can be understood qualitatively as a population growth. Assume, for example, that each free neutron produces a fission which, in turn, produces 2 more neutrons (these conditions are optimistically over-simplified). Figure 4-5 shows the growth schematically.

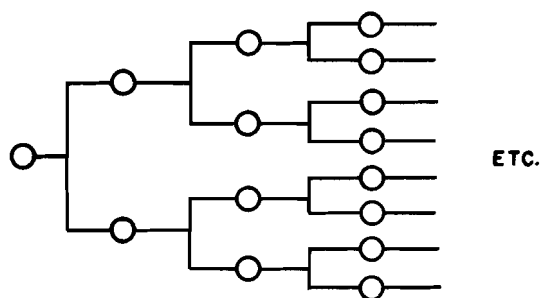

Fig. 4-5 Idealized neutron population growth.

At the end of 20 generations, each initial neutron will have produced  $2^{20} = 1,048,576$  neutrons; at the end of 4 generations over 1,000,000,000,000 will have been produced. Generations are in the order of  $10^{-14}$  sec, hence, after 1 sec,  $2^{100,000,000,000,000}$  neutrons will have descended from one neutron.

### 4-5.5 MEANS OF INCREASING CRITICALITY

Many things can affect the size of a critical mass. It is possible to reduce this size by operation such as the following:

(a) Enrichment. Purify the material so that the number of nuclei capable of capture, but not fission (i.e., impurities), is minimized.

(b) Compression. Increase the amount of fissionable material in a given volume by compression. This increases the density of the fissionable material, and thus [by (4-2)]  $\Sigma$ .

(c) Reflect neutrons. Surround the active material with a material that will scatter the escaping neutrons back into the fissionable material.

(d) Best shape. Use shapes with low surface-to-volume ratios to reduce escape, and to increase volume within which interactions take place.

(e) Moderate. Surround the active material with material that will slow the velocity of the liberated neutrons thereby increasing the fission cross section.

This last method is used especially in nuclear power plants. The materials used for slowing down neutrons are called moderators. Nearly all light elements are good moderators, especially those with small tendencies for neutron capture. Moderators have little value in weapon use, however, because there is no time for significant slowing down of neutrons during explosion. The other four means are applicable to weapons.

Application of these principles to an ordnance device was accomplished in strictest secrecy by members of the Manhattan Project during World War II. The project's success introduced a new era in warfare when in August of 1945, the first atomic bombs were dropped on Hiroshima and Nagasaki. This was the first time that nuclear energy had been used in military operations against an enemy. The devastating effects of these weapons have been adequately reported. At these two locations approximately 10 square miles were destroyed and more than 100,000 casualties resulted. The energy released by each of these bombs was roughly equivalent to that produced by the explosion of 20,000 tons (20 KT) of high explosive (TNT).

The research and testing of nuclear reactions and their application to atomic weapons have continued up to the present time. Military nuclear weapons in our stockpile now include the use of fusion as well as fission type reactions, and include artillery projectiles, missile warheads, demolitions, and bombs. In post-war tests, yields equivalent to approximately 10–20 million tons of TNT (20 MT) have been attained.

### REFERENCES

- 1 Samuel Glasstone, *Sourcebook on Atomic Energy*, D. Van Nostrand Co., Inc., N.Y., 1950.
- 2 Otto Oldenberg, *Introduction to Atomic Physics*, McGraw-Hill Book Co., Inc., N. Y., 1954, 2nd Edition.



## EXPLOSIVES ANNEX

# EXPLOSIVES MANUFACTURE AND TESTING

### A-1 INTRODUCTION

As has been learned in earlier chapters, within the family of explosives, different chemical explosive molecules have different make-up and configurations. Such characteristics determine, to a large degree, the explosive behavior of such compounds. As might be expected, such unique characteristics mean a dissimilarity of problems in the manufacture of these compounds. In order to better understand the problems, consider these typical examples:

(a) The manufacture of TNT, the most used high explosive compound.

(b) The manufacture of the single-base propellant, nitrocellulose, a typical cannon powder.

(c) The manufacture of one type of rocket propellant, the polymer-perchlorate type, frequently used in booster units and aircraft rockets.

Following the discussion of these examples, typical tests to which high explosives and propellants are subjected are discussed.

### A-2 MANUFACTURE OF TRINITROTOLUENE

Of various high explosives expended during World War II, TNT was the greatest in tonnage. For this reason it was essential that national sources of raw materials, particularly toluene, were readily available for TNT production. During World War I and until about 1939, toluene was procurable from two sources. Primarily it was available as a by-product of coke. A lesser amount was found to occur naturally in certain petroleum deposits, but these two sources together were unable to satisfy the U.S. requirements in World War I. Consequently, vigorous measures were taken to increase the supply of toluene. City gas mains were stripped of their small quantities of toluene but still there was an insufficient amount. The dilution of TNT with ammonium nitrate was tried; however, the resulting product, amatol, lacked the brisance and blast effects of TNT. Ammunition loaded with amatol was not as effective as desired.

It is doubtful that the United States Army could have conducted the vast operations of World War II, consuming millions of tons of TNT, if their sources of toluene had been those of World War I. Fortunately, a process was developed in 1939 by which toluene could be

synthesized from fractionated or cracked petroleum. Facilities for the manufacture of toluene were established so that approximately twice as much toluene was available as was required for the manufacture of TNT. This manufacture of toluene actually consumed about 0.5 to 1% of the amount of crude petroleum that was used in the manufacture of gasoline during the same years. This had little effect on the supply of motor fuel. As exemplified by this case of toluene, and in the more recent synthesis of some rocket fuels, the petrochemicals industry has become one of the most important industries which support the manufacture of explosives.

The other raw material required in the manufacture of TNT, nitric acid, is obtained by nitrogen fixation. In peacetime, nitrogen is mainly used in the manufacture of fertilizer. Today, the nitrogen fixation facilities which were built and expanded during the war are for the most part busily engaged in supplying the great domestic and foreign demand for fertilizers, chiefly ammonium nitrate and anhydrous ammonia. As a result of World War II expansion, these facilities are sufficient to rapidly and quickly supply large quantities of explosives raw materials. Using

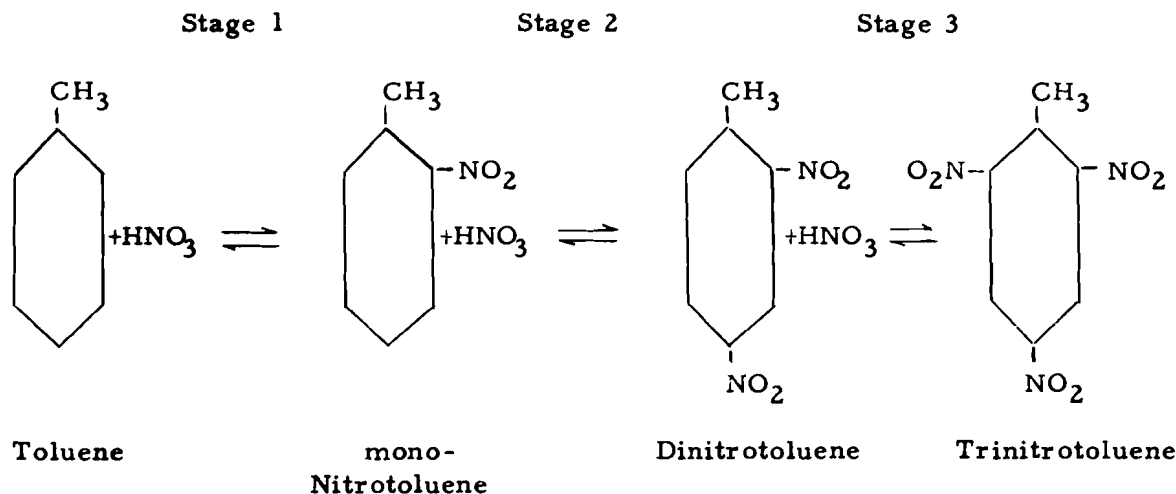
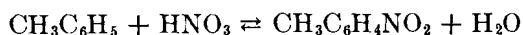

Fig. A-1 Tri-nitration equation showing some typical polynitrotoluenes.

toluene, the manufacture of TNT involves the following processes:

- (a) Three stages of nitration: toluene to mono-nitrotoluene, to dinitrotoluene, to trinitrotoluene.
- (b) Washing finished product in water until free of acid.
- (c) Purification by remelting and chemical treatment.
- (d) Drying and flaking.

Since so many present day explosives must be nitrated, a summary of nitration fundamentals is of interest. When the organic compound toluene (cold), is treated with concentrated nitric acid, the following reaction occurs:



The end products are water and mononitrotoluene, one of the hydrogens on the toluene having been replaced by the  $-\text{NO}_2$  group, giving the toluene explosive characteristics. However, as soon as the concentration of the nitric acid drops below a certain lower limit, the reaction

stops and an equilibrium condition is reached due to the presence of excess  $\text{H}_2\text{O}$ . Thus, in order to tri-nitrate, or replace three hydrogens with three  $-\text{NO}_2$  groups, water must be removed, the temperature raised, and the concentration of the nitric acid increased. Since chemically it is easier to substitute the first  $-\text{NO}_2$  group than the second, and easier to replace the second than the third, the strength and temperature of the nitrating mixture should be highest for tri-nitration, and lowest for mono-nitration. Thus, tri-nitration of toluene is carried out in three stages.

A three-stage process, in which heated toluene was passed successively through a series of vats provided with agitators, and with acid flowing countercurrently, was used extensively before and during World War II. Sulfuric acid, an inexpensive and effective dehydrating agent, was used throughout the process to remove the  $\text{H}_2\text{O}$ . The resulting TNT was collected, washed, purified by remelting, and dried into a finished form.

### A-3 MANUFACTURE OF SINGLE-BASE PROPELLANT

Single-base powder consists mainly of nitrocellulose into which various additives are incorporated to give improved qualities. These additives are frequently inert materials which absorb heat, increase stability, or reduce smoke.

These inert materials, of course, decrease the potential of the powder. However, the resulting product is improved in certain useful qualities. The additives generally found in single-base powders are:

## EXPLOSIVES MANUFACTURE AND TESTING

---

Diphenylamine as a stabilizer;  
Dibutylphthalate as a coolant;  
Dinitrotoluene or trinitrotoluene to control  
burning rate and reduce hygroscopicity;  
Triacetin as a gelatinizing agent;  
Centrolite as a stabilizer and coolant;  
Vaseline as a stabilizer and coolant.

In the preparation of nitrocellulose, cotton linters (cellulose) are digested by caustic soda under pressure in order to eliminate oils and resinous materials, and then are washed and bleached. After drying, nitration is done at 30°C (86°F) with a mixture of nitric and sulfuric acids. After nitration, the acid and most of the water are removed. Alcohol under pressure is then forced into the block of nitrocellulose to displace the remainder of the water; ether is used to help the alcohol disperse the disintegrated nitrocellulose into a colloidal state; then additives are

mixed in. Next, the powder is forced through extrusion dies to give it the desired shape. The long tubes of extruded powder are then chopped into grains of the proper length and allowed to dry until they contain about 0.3% to 0.4% of the volatile alcohol-ether solvent.

After a considerable quantity of powder has been prepared as described, it is passed through a blending tower where each batch is thoroughly mixed with each other batch so that the final powder lot will be as homogeneous as possible. (A blending tower may have a capacity of 1,000,000 lb of powder which represents on the order of two weeks production.) The ballistic properties of the lot are then tested and analyzed so that the proper amount of each lot of powder can be loaded into the cartridge cases or powder bags to secure uniformity of ballistic performance to meet specifications.

### A-4 MANUFACTURE OF PERCHLORATE PROPELLANT

As was mentioned in an earlier chapter, propellants formulated of organic fuel, such as an asphalt-oil mixture and an oxidizer (potassium or ammonium perchlorate), offer the advantages of high specific impulse (about 185 seconds), a wide range of desirable physical characteristics, and competitive cost. Such propellants have the advantages of a very wide range of temperature limits, rugged handling characteristics, ease of loading, and simplicity of manufacture. They were originally thought of as useful for only small rocket motors and jets carrying not more than a few hundred pounds of propellant. Future years will see the use of very large rocket motors loaded with this type of propellant.

Thiokol, one popular propellant of this type, is made using a polymerizable rubber base as the fuel, to which carefully sized granular perchlorate is added. The general scheme is to create a carefully blended slurry of the polymer, and

while mixing, blend in the perchlorate.

Mixing is done in a slurry tank or kettle. Viscosity control is critical; into the viscous liquid polymer, only particles of great purity and controlled size (or size distribution) are blended. This mix is used to fill the rocket motors by pouring around a removable mandrel. The rocket motors are then cured, i.e., the rubber polymer is polymerized by resting the filled motors in a heated, constant high-temperature chamber. After several hours the mandrel is removed from each motor and the motor is ready for inspection (often radiographic) and shipment, or assembly.

Manufactured in this way the propellant is extremely sensitive to curing (i.e., heat transfer) rates during polymerization. In addition, homogeneity is of considerable importance. The distribution, size, and size distribution of the oxidizer influence the rate of burning. Engineering advances in this method of manufacture have been great in the last decade.

## A-5 PHYSICAL TESTING OF EXPLOSIVES

The present standard military explosives have been tested by actual use over a long period of time and their points of superiority and weaknesses are known. When a new explosive is proposed to meet a particular use, it is compared with the explosive it is intended to replace. It is impossible to obtain a satisfactory comparison by subjecting the new explosive to the test of actual use, because the period of time in which the old explosive has been so tested comprises many years. A new explosive, therefore, is compared with the old, or accepted explosive, by subjecting both to certain arbitrary tests, and in the interests of economy, rapidity of examination, and safety, the preliminary comparison tests are made on a small scale in the laboratory. If the laboratory results seem promising, further tests are conducted on a larger scale.

Practically all tests of high explosives (both small and large scale) are empirical because the

very nature of high explosives sometimes prevents the use of highly refined or delicate apparatus. Because of such limitations, it is difficult to devise tests of a rigidly scientific type. The results obtained by standard tests on high explosives usually consist of the measurement of that specific characteristic for which the test was developed. Often such tests are so encumbered with partial measurements of several other characteristics that it is difficult to estimate or separate their relative magnitudes. For this reason it is necessary to consider the results of the entire series of tests before a verdict is rendered on the relative merits of two different high explosives.

The chart of high explosives (Table A-1) contains the results of some important physical tests. The methods employed to obtain the information listed on this table are as follows:

### A-5.1 SENSITIVITY TO SHOCK (COLUMN 5)

This test is conducted by loading 0.02 gram of the explosive in a cup and dropping a 2-kilogram weight on it. By this method the distance through which it is necessary to drop the weight in order to secure one detonation in ten drops, is determined in inches and given as the sensitivity of the explosive. The higher the value, the lower the sensitivity. The figures given in column 5 are the averages of many figures and are calculated to show the sensitivity of the various explosives as compared with TNT.

### A-5.2 TRAUZL LEAD BLOCKS (COLUMN 6)

The trauzl lead block test measures the comparative disruptive effect of an explosive when fired in a lead block. The volume of the bore hole is measured before and after the explosion and the expansion caused by the explosion is computed to the nearest cubic centimeter. This gives a measure of the strength of the explosive (Figure A-2).

### A-5.3 BALLISTIC MORTAR (COLUMN 7)

The ballistic mortar tests the strength of an explosive. The mortar is suspended by a pendulum supported on knife edges. The explosive

to be tested is placed in the mortar and detonated. The deflection of the mortar resulting from the explosion is measured and compared with that resulting from a standard explosive, usually TNT (Figure A-3).

### A-5.4 VELOCITY OF DETONATION (COLUMN 8)

This test is usually conducted by detonating an unconfined tube of explosive of a given length and one inch in diameter. The time for the detonating wave to pass from one end of the tube to the other is recorded and the velocity in meters per second computed.

### A-5.5 RELATIVE BRISANCE (COLUMN 9)

The figures are grams of a unique sand which will be crushed by 0.4 gram of the explosive. The test is conducted by loading 0.4 gram of the explosive into a gilding metal shell. The shell is placed in a bomb containing 200 grams of Ottawa silica sand which will pass through a twenty-mesh screen and still be retained by a thirty-mesh screen. After firing, the number of grams of sand that will be sifted by a shaker through the thirty-mesh screen in three minutes is measured and listed as the brisance of the explosive.

**TABLE A-1 PROPERTIES O**

Explosive*	Formula or Proportions	Color
(1)	(2)	(3)
1. Mercury Fulminate	$\text{Hg}(\text{ONC})_2$	White - Grayish Yellow
2. Nitroglycerin	$\text{C}_3\text{H}_5(\text{ONO}_2)_3$	Pale Yellow Liquid
3. Lead Styphnate	$\text{C}_6\text{H}(\text{NO}_2)_3(\text{O}_2\text{Pb})$	Deep Yellow
4. Lead Azide	$\text{PbN}_6$	White - Buff
5. PETN	$\text{C}(\text{CH}_2\text{ONO}_2)_4$	White
6. Cyclonite (RDX)	$(\text{CH}_2)_3\text{N}_3(\text{NO}_2)_3$	White
7. Tetryl	$\text{C}_6\text{H}_2(\text{NO}_2)_3(\text{NCH}_3\text{NO}_2)$	Buff - Lemon Yellow
8. Nitrostarch	40/37.7/20/0.8/1.5, NS/SodNit/ BarNit/Oil/Stabilizer	Gray
9. Pentolite	50/50, PETN/TNT	Dirty White - Buff
10. Torpex	42/40/18, RDX/TNT/AL	Gray
11. Tetrytol	75/25, Tetryl/TNT	Light Yellow
12. Minol II	40/40/20, $\text{NH}_4\text{NO}_3$ /TNT/AL	Gray
13. Cyclotol (Comp B)	60/40, RDX/TNT	Dirty White - Buff
14. Tritonal	80/20, TNT/AL	Gray
15. Composition C <sub>2</sub>	80.1/4/10/4/1/.9, RDX/MNT/DNT/TNT/ Collodion Cotton/Dimethyl Formamide	Yellow Brown
16. Picric Acid	$\text{C}_6\text{H}_2\text{OH}(\text{NO}_2)_3$	Light Cream
17. TNT	$\text{C}_6\text{H}_2\text{CH}_3(\text{NO}_2)_3$	Buff - Light Brown
18. Composition C	88/12, RDX/Oil	Brown
19. Amatol 50/50	50/50, Ammonium Nitrate/TNT	Buff - Dark Brown
20. Composition A-3	91/9, RDX/Wax	White - Buff
21. Amatol 80/20	80/20, Ammonium Nitrate/TNT	Buff - Dark Brown
22. Picratol	52/48, ExD/TNT	Brownish Yellow
23. Explosive D	$\text{C}_6\text{H}_2(\text{ONH}_4)(\text{NO}_2)_3$	Lemon Yellow Orange - Reddish Brow

\* Listed in order of their sensitivity.

Explosives 1 thru 4 are primary high explosives.  
Explosives 5 thru 23 are secondary high explosives.

# EXPLOSIVES MANUFACTURE AND TESTING

## OF SOME TYPICAL MILITARY HIGH EXPLOSIVES

Density (4)	Sensitivity to Shock (Drop Test) Inches (5)	Trauzl Block Test (Strength) Cubic Centimeters (6)	Ballistic Mortar (Strength) % of TNT (7)	Detonation Velocity Meters per Second (8)	Brisance Grams of Sand (9)	Melting Point °C (Castability) (10)	Use (11)
3.55	2	150	—	4700 - 5400	15.5 - 22.4	Explodes	Primers and Detonators
1.60	2 - 3	515 - 600	156	8400	60.0	13	Double-Base Powder, Dynamite
3.1	2 - 3	120	—	4900 - 5200	9.5 - 21.4	Explodes	Primers, Sensitizer for Primers and Detonators
3.8	3 - 4	115	—	4000 - 5000	13.9 - 18	Explodes	Detonators and Primers
1.63	6	500 - 560	166	8300	61.9	138 - 141	Booster Mixtures, Primacord
1.65	7	525	162	8400	61.0	200 - 203.5	Booster Mixtures
1.57	8	375	120 - 125	7500	53.5	128.5 - 130	Booster Mixtures
1.6	8	275	96	6100	37.7	Explodes	Demolitions
1.56 - 1.63	9	345	130	7500	53.0	80 - 90	Bursting Charge
1.73	9	475	140 - 170	7300	57.9	88 - 95	Bursting Charge
1.60	10	350	120	7300	50.0	65 - 90	Burster, Chemical Shell Demolitions
1.65	10 - 11	465	143	5400 - 5700	40 - 41	80 - 90	Bursting Charge
1.65	11	375	135	7800	51.8	85 - 100	Bursting Charge
1.7	12	360	118	5500	42.0	80 - 90	Bursting Charge
1.57	12.5	450	135	8000	55.0	67	Bursting Charge, Demolitions
1.6	12 - 13	300	106	7200	45.0	120.3 - 122.5	Mixtures
1.55	14	285	100	6900	43.0	80.2	Bursting Charge
1.50	14	360	125	7400	46.5	200 - 203.5	Demolitions, Bursting Charges
1.54	14	330	109	6500	38.0	80 - 85	Bursting Charge
1.62	14	410	130	7500	49.6	200 - 203.5	Bursting Charge
1.38	15	360	117	5400	32.0	76 (Softens)	Bursting Charge
1.61	18	280 (?)	100	6972	43.0 (?)	Castable	Bursting Charge
1.48	18	275	96	6500	35.0	Decomposes 265	Bursting Charge



## EXPLOSIVES MANUFACTURE AND TESTING

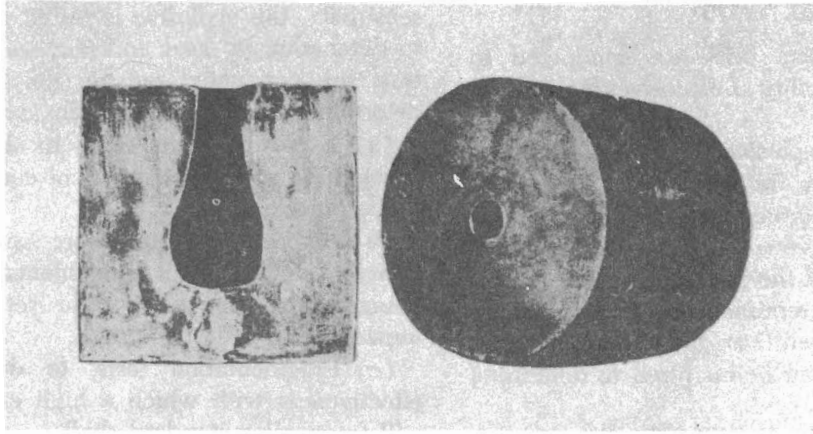

*Fig. A-2 Trauzl lead block after test, with section showing expansion of cavity by explosive.*

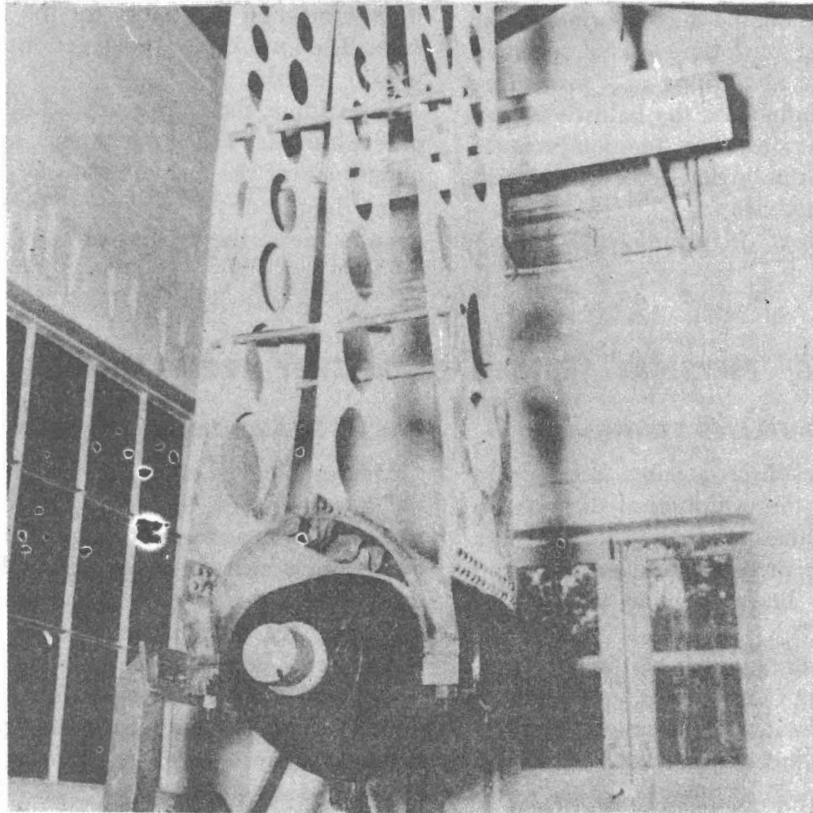

*Fig. A-3 Ballistic mortar.*

### A-5.6 ADDITIONAL TESTS

Still other physical tests are conducted to determine the suitability of explosives for military purposes.

For all types of explosives, the bomb calorimeter is used to obtain the quantity of heat given off in a closed chamber, the volume of gases produced, and the pressure developed. From this data the potential of the explosive or its capacity for doing work is determined. For low explosives the products obtained from the explosion in the bomb calorimeter can be analyzed to determine smokiness.

The rate of combustion of propellants varies with the specific rate of burning and the pressure, and may be computed by empirical formulas based upon experimentally determined values. The specific rate of burning is the depth or thickness of the layer burned, measured normal to the burning surface, per unit time under specified conditions. The rate of burning of a propelling charge profoundly influences the ballistic effects produced in a weapon. The temperatures of flames or explosions can be determined by optical or spectroscopic methods.

For high explosives, in addition to impact

sensitivity, the explosive is tested for sensitivity to detonation by heat and friction. Large scale tests are conducted outside the laboratory to determine other qualities such as:

(a) Explosive train tests, to determine the functioning and effectiveness of each element in the explosive train.

(b) Setback tests, to insure safety and certainty of action of all components after undergoing setback in the gun or set forward on impact.

(c) Fragmentation tests, to determine the effectiveness with which a high explosive filler will fragment a standard shell.

For primers the tests include the comparative effect of a black powder flame on the form, volume, and duration of the primer blast. The duration of primer flames is measured in order to determine their suitability for the low explosive train. The impulse (or shock action) at the primer is also tested.

In addition, there are many other physical tests of explosives. The student can appreciate the magnitude of the test program by recalling that many hundreds of explosive compounds have been or are in the process of being tested.

## A-6 PHYSICAL TESTING OF ROCKET PROPELLANTS

### A-6.1 SOLID PROPELLANT TESTING

Evaluation of rocket propellants depends in large measure upon the evaluation of their chemical kinetics. Problems of principal interest are:

(a) The effect of pressure, temperature, and composition on the linear burning rate of the propellants.

(b) The temperature gradients in the propellant while burning in the motor.

(c) The determination of intermediate chemical reactions, their mechanisms, and effects on the burning reaction.

(d) Final products at reaction temperature.

(e) Effects of composition changes on the above parameters.

In recent years each of the above problems has received much investigation, but by far the most effort has been devoted to those characteristics enumerated in (a), above.

### A-6.2 MEASUREMENT OF BURNING RATES

Measurement of rates of burning of solid propellants requires specialized equipment and experience. Measurements should be made under conditions which approach as closely as possible those which the propellant is to meet in actual use, since the combustion reaction is influenced by a large, and not individually predictable, number of factors. During tests the propellant is immersed in its own propellant gases at high pressures. Since rates of burning are on the order of 1 to 2 inches per second, very good resolution in time is required in order to obtain acceptable experimental accuracy. Since scaling up of results on small lots of propellant introduces errors, a number of separate propellant tests must be made. This introduces a safety requirement for small lot manufacturing and calls for specialized facilities. To illustrate measurement

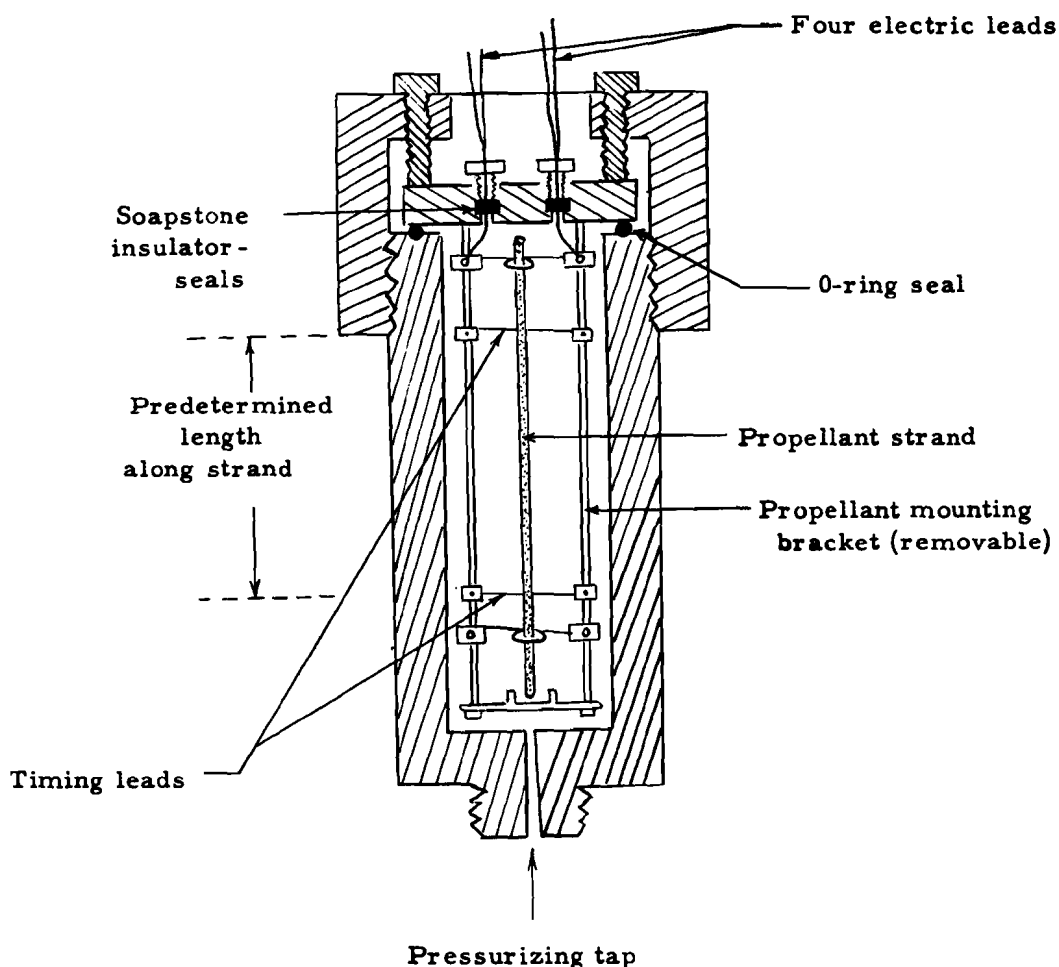

**Fig. A-4** Pressure vessel for measuring burning rates of propellant as a function of pressure.

of burning rates consider two typical methods:

(a) Strand burning. A strand of the test propellant about  $\frac{1}{8}$  inch in diameter and 6-8 inches long, coated with some inert plastic to restrict burning to the ends only, is supported by a wire bracket in a heavy-walled bomb pressurized to the desired value with inert gas. Through the strand are passed two electric leads of fine wires located a known distance apart along the strand. The strand is ignited and as the strand burns an electrical impulse passes into a recording device, through each wire in turn, as the combustion consumes the strand. Thus, a measurement can be taken of the effect of pressure on

the time taken for the burning to travel between the accurately known distance along the strand. This method is well suited to laboratory investigation in that only small quantities of propellant are required for each test. However, the strands must be carefully formulated and extruded. Properties of propellants of differing compositions may be checked in this way. In this method results must be adjusted using empirical data in order to correct them to actual burning rates of propellants immersed in their own propellant gases. A drawing of a typical strand burning apparatus is shown in Figure A-4.

## SOURCES OF ENERGY

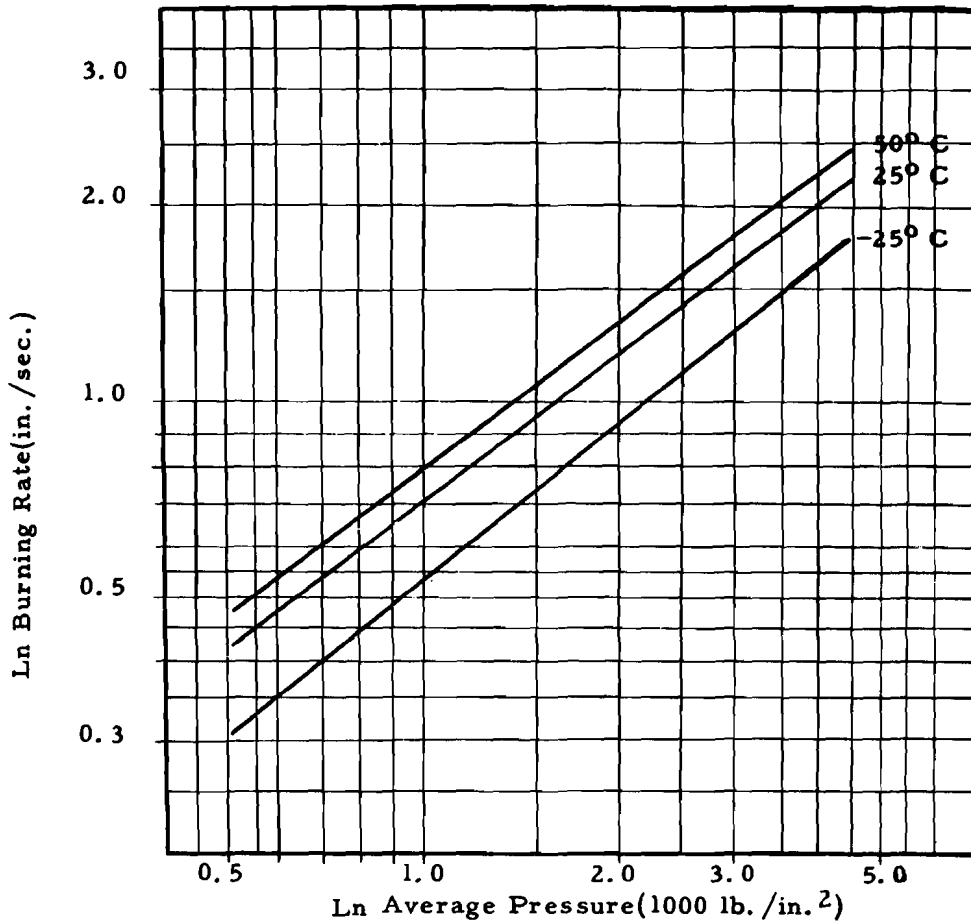

### PROPELLANT COMPOSITION

Nitrocellulose	57.55
(including 13.21% N)	
Nitroglycerin	39.96
Potassium Sulfate	1.48
Ethyl Centralite	1.01
Volatiles	1.00
Carbon Black	.10

Fig. A-5 The effect of pressure on burning rate of a rocket solid propellant.

(b) Vented-vessel techniques. In this equipment the propellant is burned in a simple rocket motor provided with a variety of nozzles, the purpose of which is to provide a means of varying the pressure. The test motor and propellant are kept under controlled (and predetermined) temperature conditions until needed. The pressure-time curve of the burning charge is measured with a strain gauge which is part of a wheatstone bridge. The unbalanced emf of the bridge is amplified, applied to an oscilloscope,

and recorded on film using a drum camera. In this apparatus the effect of time on burning rate may be measured by suddenly dunking the vessel containing the burning propellant into water during burning. Analysis of the pressure-time curve, coupled with a knowledge of the rate of burning, gives data which is the linear rate of burning in a particular pressure region. A number of tests permit construction of a family of curves of burning rate as a function of pressure. Typical curves so arrived at are shown in Figure A-5.

## APPENDIX

**TABLE A-2 INTERNATIONAL ATOMIC WEIGHTS, 1937**

	Symbol	Atomic Number	Atomic Weight		Symbol	Atomic Number	Atomic Weight
Aluminum.....	Al	13	26.97	Mercury.....	Hg	80	200.61
Antimony.....	Sb	51	121.76	Molybdenum....	Mo	42	96.0
Argon.....	A	18	39.944	Neodymium....	Nd	60	144.27
Arsenic.....	As	33	74.91	Neon.....	Ne	10	20.183
Barium.....	Ba	56	137.36	Nickel.....	Ni	28	58.69
Beryllium.....	Be	4	9.02	Nitrogen.....	N	7	14.008
Bismuth.....	Bi	83	209.00	Osmium.....	Os	76	191.5
Boron.....	B	5	10.82	Oxygen.....	O	8	16.0000
Bromine.....	Br	35	79.916	Palladium.....	Pd	46	106.7
Cadmium.....	Cd	48	112.41	Phosphorus.....	P	15	31.02
Calcium.....	Ca	20	40.08	Platinum.....	Pt	78	195.23
Carbon.....	C	6	12.01	Potassium.....	K	19	39.096
Cerium.....	Ce	58	140.13	Praseodymium..	Pr	59	140.92
Cesium.....	Cs	55	132.81	Radium.....	Ra	88	226.05
Chlorine.....	Cl	17	35.457	Radon.....	Rn	86	222.
Chromium.....	Cr	24	52.01	Rhodium.....	Rh	45	102.91
Cobalt.....	Co	27	58.94	Rubidium.....	Rb	37	85.48
Columbium.....	Cb	41	92.91	Ruthenium.....	Ru	44	101.7
Copper.....	Cu	29	63.57	Samarium.....	Sm	62	150.43
Dysprosium.....	Dy	66	162.46	Scandium.....	Sc	21	45.10
Erbium.....	Er	68	167.64	Selenium.....	Se	34	78.96
Europium.....	Eu	63	152.0	Silicon.....	Si	14	28.06
Fluorine.....	F	9	19.00	Silver.....	Ag	47	107.880
Gadolinium.....	Gd	64	156.9	Sodium.....	Na	11	22.997
Gallium.....	Ga	31	69.72	Strontium.....	Sr	38	87.63
Germanium.....	Ge	32	72.60	Sulphur.....	S	16	32.06
Gold.....	Au	79	197.2	Tantalum.....	Ta	73	180.88
Hafnium.....	Hf	72	178.6	Tellurium.....	Te	52	127.61
Helium.....	He	2	4.002	Terbium.....	Tb	65	159.2
Holmium.....	Ho	67	163.5	Thallium.....	Tl	81	204.39
Hydrogen.....	H	1	1.0078	Thorium.....	Th	90	232.12
Indium.....	In	49	114.76	Thulium.....	Tm	69	169.4
Iodine.....	I	53	126.92	Tin.....	Sn	50	118.70
Iridium.....	Ir	77	193.1	Titanium.....	Ti	22	47.90
Iron.....	Fe	26	55.84	Tungsten.....	W	74	184.0
Krypton.....	Kr	36	83.7	Uranium.....	U	92	238.07
Lanthanum.....	La	57	138.92	Vanadium.....	V	23	50.95
Lead.....	Pb	82	207.21	Xenon.....	Xe	54	131.3
Lithium.....	Li	3	6.940	Ytterbium.....	Yb	70	173.04
Lutecium.....	Lu	71	175.0	Yttrium.....	Y	39	88.92
Magnesium.....	Mg	12	24.32	Zinc.....	Zn	30	65.38
Manganese.....	Mn	25	54.93	Zirconium.....	Zr	40	91.22

Data for this Table furnished by Picatinny Arsenal,

## SOURCES OF ENERGY

**TABLE A-3 DENSITIES OF CERTAIN GASES AT 0°C AND 760 MM PRESSURE**

Gas	Formula	Density Air = 1	lb per cu ft	cu ft per lb
Acetylene.....	C <sub>2</sub> H <sub>2</sub>	0.9073	.07324	13.654
Air <sup>1</sup> .....	—	1.0000	.08072	12.390
Ammonia.....	NH <sub>3</sub>	0.5963	.04813	20.777
Bromine <sup>2</sup> .....	Br <sub>2</sub>	5.516	.44525	2.246
Carbon dioxide.....	CO <sub>2</sub>	1.5290	.12342	8.102
Carbon monoxide.....	CO	0.9671	.07806	12.810
Chlorine.....	Cl <sub>2</sub>	2.49	.20099	4.975
Coal gas.....	—	0.504	.04068	24.58
Cyanogen.....	C <sub>2</sub> N <sub>2</sub>	1.804	.14562	6.867
Ethane.....	C <sub>2</sub> H <sub>6</sub>	1.0493	.08470	11.806
Ethylene.....	C <sub>2</sub> H <sub>4</sub>	0.9710	.07838	12.758
Fluorine.....	F <sub>2</sub>	1.312	.1059	9.443
Helium.....	He	0.1381	.01115	89.69
Hydrogen.....	H <sub>2</sub>	0.06952	.005612	178.19
Hydrogen bromide.....	HBr	2.8189	.22754	4.395
Hydrogen chloride.....	HCl	1.2678	.10234	9.771
Hydrogen fluoride.....	HF	0.713	.0576	17.361
Hydrogen iodide.....	HI	4.4776	.3614	2.767
Hydrogen sulphide.....	H <sub>2</sub> S	1.190	.09606	10.411
Methane.....	CH <sub>4</sub>	0.5544	.0448	22.32
Nitric oxide.....	NO	1.0366	.08367	11.953
Nitrogen.....	N <sub>2</sub>	0.9673	.07808	12.807
Nitrogen dioxide <sup>2</sup> .....	NO <sub>2</sub>	1.588	.1282	7.800
Nitrogen tetroxide <sup>2</sup> .....	N <sub>2</sub> O <sub>4</sub>	3.176	.2564	3.900
Nitrous oxide.....	N <sub>2</sub> O	1.530	.12350	8.097
Oxygen.....	O <sub>2</sub>	1.1053	.08922	11.208
Steam (at 100°C.).....	H <sub>2</sub> O	0.4618 <sup>3</sup>	.03728	26.824
Sulphur dioxide.....	SO <sub>2</sub>	2.2638	.18273	5.473
Water gas.....	—	0.684	.05521	18.11

<sup>1</sup> Dry atmospheric air at sea level has approximately the following composition by volume:

	Per Cent		Per Cent
N <sub>2</sub> .....	78.03	CO <sub>2</sub> .....	0.03
O <sub>2</sub> .....	20.99	H <sub>2</sub> .....	0.01
A .....	0.94	Rare gases .....	0.002

<sup>2</sup> Not gaseous under standard conditions. Density is calculated assuming molecular volume equal to 22.411 liters.

<sup>3</sup> Compared to air at 0°C.

Data for this Table furnished by Picatinny Arsenal.

## APPENDIX

**TABLE A-4 SPECIFIC HEATS AT ROOM TEMPERATURES, SOLIDS AND LIQUIDS**

Name	Formula	Molecular Weight	Specific Heats	
			Calories per Gram	Calories per Gram Molecule or Gram Atom
Alcohol (liquid).....	C <sub>2</sub> H <sub>5</sub> OH	46.1	0.581	26.8
Aluminum oxide.....	Al <sub>2</sub> O <sub>3</sub>	101.9	0.188	19.2
Ammonium chloride.....	NH <sub>4</sub> CL	53.5	0.376	20.1
Ammonium nitrate.....	NH <sub>4</sub> NO <sub>3</sub>	80.0	0.407	32.6
Antimony.....	Sb	121.76	0.0503	6.12
Antimonous oxide.....	Sb <sub>2</sub> O <sub>3</sub>	291.5	0.0829	24.2
Arsenic (metallic).....	As	74.91	0.0822	6.16
Barium carbonate.....	BaCO <sub>3</sub>	197.4	0.1030	20.3
Barium chloride.....	BaCl <sub>2</sub>	208.3	0.0875	18.2
Barium nitrate.....	Ba(NO <sub>3</sub> ) <sub>2</sub>	261.4	0.1523	39.8
Benzene (liquid).....	C <sub>6</sub> H <sub>6</sub>	78.1	0.406	31.7
Calcium carbonate.....	CaCO <sub>3</sub>	100.1	0.206	20.6
Calcium chloride.....	CaCl <sub>2</sub>	111.0	0.1642	18.2
Calcium sulphate (cryst. anhyd.)...	CaSO <sub>4</sub>	136.1	0.169	23.0
Carbon (graphite).....	C	12.01	0.165	1.98
Chromium trioxide.....	Cr <sub>2</sub> O <sub>3</sub>	152.0	0.178	27.1
Copper sulphate (anhydrous).....	CuSO <sub>4</sub>	159.6	0.157	25.1
Glycerin (liquid).....	C <sub>3</sub> H <sub>5</sub> (OH) <sub>3</sub>	92.1	0.580	53.4
Iron sulphide.....	FeS	87.9	0.139	12.2
Lead.....	Pb	207.21	0.0305	6.32
Lead carbonate.....	PbCO <sub>3</sub>	267.2	0.0971	26.0
Lead nitrate.....	Pb(NO <sub>3</sub> ) <sub>2</sub>	331.2	0.1173	38.8
Magnesia.....	MgO	40.3	0.235	9.46
Mercury (liquid).....	Hg	200.61	0.03325	6.67
Nitric acid (liquid).....	HNO <sub>3</sub>	63.02	0.476	30.00
Phosphorus (Red).....	P <sub>4</sub>	124.08	0.1829	22.7
Potassium dichromate.....	K <sub>2</sub> CR <sub>2</sub> O <sub>7</sub>	294.2	0.182	53.5
Potassium carbonate.....	K <sub>2</sub> CO <sub>3</sub>	138.2	0.2162	29.9
Potassium chlorate.....	KClO <sub>3</sub>	122.6	0.196	24.00
Potassium chloride.....	KCl	74.6	0.164	12.2
Potassium ferrocyanide.....	K <sub>4</sub> Fe(CN) <sub>6</sub>	368.3	0.218	80.3
Potassium nitrate.....	KNO <sub>3</sub>	101.1	0.220	22.2
Potassium perchlorate.....	KClO <sub>4</sub>	138.6	0.191	26.5
Potassium sulphate (cryst.).....	K <sub>2</sub> SO <sub>4</sub>	174.3	0.182	31.7
Potassium sulphide.....	K <sub>2</sub> S	110.3	0.091	10.0
Silica (quartz).....	SiO <sub>2</sub>	60.1	0.188	11.3
Silver.....	Ag	107.880	0.05625	6.07
Silver chloride (cryst.).....	AgCl	143.3	0.0878	12.6
Silver nitrate (fused).....	AgNO <sub>3</sub>	169.9	0.144	24.5
Sodium carbonate.....	Na <sub>2</sub> CO <sub>3</sub>	106.0	0.2728	28.9
Sodium chloride.....	NaCl	58.5	0.208	12.2
Sodium nitrate.....	NaNO <sub>3</sub>	85.0	0.259	22.0

## SOURCES OF ENERGY

**TABLE A-4 (CONTINUED) SPECIFIC HEATS AT ROOM TEMPERATURES,  
SOLIDS AND LIQUIDS**

Name	Formula	Molecular Weight	Specific Heats	
			Calories per Gram	Calories per Gram Molecule or Gram Atom
Sodium sulphate . . . . .	Na <sub>2</sub> SO <sub>4</sub>	142.1	0.207	29.4
Sodium sulphide . . . . .	Na <sub>2</sub> S	78.1	0.091	7.11
Strontium nitrate . . . . .	Sr(NO <sub>3</sub> ) <sub>2</sub>	211.6	0.182	38.5
Strontium sulphate . . . . .	SrSO <sub>4</sub>	183.7	0.1428	26.2
Sulphur (Rhombic) . . . . .	S <sub>2</sub>	64.12	0.1728	11.1
Sulphuric acid (liquid) . . . . .	H <sub>2</sub> SO <sub>4</sub>	98.1	0.345	33.8
Water . . . . .	H <sub>2</sub> O	18.0	1.000	18.0



## APPENDIX

**TABLE A-5 HEATS OF FORMATION FROM THE ELEMENTS AT 15°C AND 760 MM PRESSURE**

Name	Formula	Molec- ular Weight	Heats of Formation in Large Calories per Gram Molecule			
			Gas	Liquid	Solid	Dis- solved
Acetone . . . . .	CH <sub>3</sub> COCH <sub>3</sub>	58.1	53.4	61.5	—	64.0
Acetylene . . . . .	C <sub>2</sub> H <sub>2</sub>	26.0	-54.86	—	—	—
Ammonia . . . . .	NH <sub>3</sub>	17.0	10.9	15.8	—	19.1
Ammonium bicarbonate . .	NH <sub>4</sub> HCO <sub>3</sub>	79.1	—	—	208.6	—
Ammonium chloride . . . .	NH <sub>4</sub> Cl	53.5	38.9	—	76.8	72.8
Ammonium dichromate . . .	(NH <sub>4</sub> ) <sub>2</sub> Cr <sub>2</sub> O <sub>7</sub>	252.1	—	—	420.1	407.4
Ammonium nitrate . . . . .	NH <sub>4</sub> NO <sub>3</sub>	80.0	—	—	88.1	82.8
Ammonium picrate . . . . .	C <sub>6</sub> H <sub>2</sub> (NO <sub>2</sub> ) <sub>3</sub> O·NH <sub>4</sub>	246.1	—	—	78.0	69.3
Aniline . . . . .	C <sub>6</sub> H <sub>5</sub> NH <sub>2</sub>	93.1	—	-6.4	-4.3	-6.6
Antimonic oxide . . . . .	Sb <sub>2</sub> O <sub>5</sub>	323.5	—	—	230.9	—
Antimonous oxide . . . . .	Sb <sub>2</sub> O <sub>3</sub>	291.5	—	—	166.9	—
Antimony sulphide . . . . .	Sb <sub>2</sub> S <sub>3</sub>	339.7	—	—	34.4	—
Barium chlorate . . . . .	Ba(ClO <sub>3</sub> ) <sub>2</sub>	304.3	—	—	171.2	167.2
Barium oxide . . . . .	BaO	153.4	—	—	133.1	169.1
Barium nitrate . . . . .	Ba(NO <sub>3</sub> ) <sub>2</sub>	261.4	—	—	238.3	180.0
Barium peroxide . . . . .	BaO <sub>2</sub>	169.4	—	—	151.7	—
Benzene . . . . .	C <sub>6</sub> H <sub>6</sub>	78.1	-16.8	-12.0	-9.7	—
Calcium picrate . . . . .	[C <sub>6</sub> H <sub>2</sub> (NO <sub>2</sub> ) <sub>3</sub> O] <sub>2</sub> Ca	496.3	—	—	185.4	187.6
Camphor . . . . .	C <sub>10</sub> H <sub>16</sub> O	152.2	—	—	79.8	—
Cane sugar . . . . .	C <sub>12</sub> H <sub>22</sub> O <sub>11</sub>	342.3	—	—	535.0	—
Carbon dioxide . . . . .	CO <sub>2</sub>	44.0	94.39	—	100.3	99.1
Carbon disulphide . . . . .	CS <sub>2</sub>	76.1	-25.4	-19.0	—	—
Carbon monoxide . . . . .	CO	28.0	26.43	—	—	—
Cellulose . . . . .	C <sub>24</sub> H <sub>40</sub> O <sub>20</sub>	648.6	—	—	920.9	—
Cellulose acetate (penta) . .	C <sub>6</sub> H <sub>5</sub> (O <sub>2</sub> CCH <sub>3</sub> ) <sub>5</sub>	372.3	—	—	520.0	—
Copper picrate . . . . .	[C <sub>6</sub> H <sub>2</sub> (NO <sub>2</sub> ) <sub>3</sub> O] <sub>2</sub> Cu	519.8	—	—	60.4	63.7
Cyanogen . . . . .	C <sub>2</sub> N <sub>2</sub>	52.0	-66.7	-65.5	—	-64.0
Dextrine . . . . .	C <sub>6</sub> H <sub>10</sub> O <sub>5</sub>	162.1	—	—	242.0	—
Dibutylphthalate . . . . .	C <sub>6</sub> H <sub>4</sub> (CO <sub>2</sub> C <sub>4</sub> H <sub>9</sub> ) <sub>2</sub>	278.3	—	—	199.8	—
Diethylphthalate . . . . .	C <sub>6</sub> H <sub>4</sub> (CO <sub>2</sub> C <sub>2</sub> H <sub>5</sub> ) <sub>2</sub>	222.2	—	—	180.3	—
Dinitrobenzene (ortho) . . .	C <sub>6</sub> H <sub>4</sub> (NO <sub>2</sub> ) <sub>2</sub>	168.1	—	—	-0.2	—
Dinitrobenzene (meta) . . . .	C <sub>6</sub> H <sub>4</sub> (NO <sub>2</sub> ) <sub>2</sub>	168.1	—	—	6.0	—
Dinitrobenzene (para) . . . .	C <sub>6</sub> H <sub>4</sub> (NO <sub>2</sub> ) <sub>2</sub>	168.1	—	—	8.0	—
Dinitronaphthalene (1 : 8)	C <sub>10</sub> H <sub>6</sub> (NO <sub>2</sub> ) <sub>2</sub>	218.2	—	—	-2.7	—
Dinitrophenol (2 : 3) . . . . .	C <sub>6</sub> H <sub>3</sub> OH(NO <sub>2</sub> ) <sub>2</sub>	184.1	—	—	14.0	—
Dinitrophenol (2 : 4) . . . . .	C <sub>6</sub> H <sub>3</sub> OH(NO <sub>2</sub> ) <sub>2</sub>	184.1	—	—	55.6	—
Dinitrophenol (2 : 6) . . . . .	C <sub>6</sub> H <sub>3</sub> OH(NO <sub>2</sub> ) <sub>2</sub>	184.1	—	—	17.0	—
Dinitrotoluol (2 : 4) . . . . .	C <sub>6</sub> H <sub>3</sub> CH <sub>3</sub> (NO <sub>2</sub> ) <sub>2</sub>	182.1	—	—	12.2	—
Dinitrotoluol (3 : 4) . . . . .	C <sub>6</sub> H <sub>3</sub> CH <sub>3</sub> (NO <sub>2</sub> ) <sub>2</sub>	182.1	—	—	5.1	—
Dinitrotoluol (3 : 5) . . . . .	C <sub>6</sub> H <sub>3</sub> CH <sub>3</sub> (NO <sub>2</sub> ) <sub>2</sub>	182.1	—	—	12.0	—
Diphenylamine . . . . .	C <sub>6</sub> H <sub>5</sub> NH·C <sub>6</sub> H <sub>5</sub>	169.2	—	-22.2	-27.6	—
Ethane . . . . .	C <sub>2</sub> H <sub>6</sub>	30.1	25.5	—	—	—
Ethyl alcohol . . . . .	C <sub>2</sub> H <sub>5</sub> OH	46.1	56.0	66.3	—	69.2

## SOURCES OF ENERGY

**TABLE A-5 (CONTINUED) HEATS OF FORMATION FROM THE ELEMENTS AT  
15°C AND 760 MM PRESSURE**

Name	Formula	Molecular Weight	Heats of Formation in Large Calories per Gram Molecule			
			Gas	Liquid	Solid	Dis-solved
Ethyl ether . . . . .	(C <sub>2</sub> H <sub>5</sub> ) <sub>2</sub> O	74.1	39.1	46.8	—	—
Ethylene . . . . .	C <sub>2</sub> H <sub>4</sub>	28.1	-6.5	—	—	—
Formaldehyde . . . . .	CH <sub>2</sub> O	30.0	28.8	—	—	40.4
Glucose . . . . .	CH <sub>2</sub> OH(CHOH) <sub>4</sub> CH·O	180.2	—	—	303.6	276.
Glycerin (glycerol) . . . . .	CH <sub>2</sub> OH·CHOH·CH <sub>2</sub> OH	92.1	—	159.7	163.6	165.1
Glycol . . . . .	(CH <sub>2</sub> OH) <sub>2</sub>	62.1	99.9	112.0	—	99.9
Glycol dinitrate . . . . .	C <sub>2</sub> H <sub>4</sub> (NO <sub>3</sub> ) <sub>2</sub>	152.1	—	58.7	—	—
Guanidine . . . . .	C(NH)(NH <sub>2</sub> ) <sub>2</sub>	59.1	—	—	19.2	28.4
Guanidine nitrate . . . . .	CH <sub>5</sub> N <sub>3</sub> NO <sub>3</sub> H	122.1	—	—	79.3	89.2
Hydrocellulose . . . . .	C <sub>12</sub> H <sub>22</sub> O <sub>11</sub>	342.3	—	—	453.8	—
Hydrogen peroxide . . . . .	H <sub>2</sub> O <sub>2</sub>	34.0	—	46.84	56.0	45.3
Hydrogen sulphide . . . . .	H <sub>2</sub> S	34.1	5.26	9.26	—	9.32
Lead azide . . . . .	PbN <sub>6</sub>	291.3	—	—	-105.9	—
Lead oxide . . . . .	PbO	223.2	—	—	52.47	—
Lead nitrate . . . . .	Pb(NO <sub>3</sub> ) <sub>2</sub>	331.2	—	—	108.3	101.7
Lead picrate . . . . .	[C <sub>6</sub> H <sub>2</sub> (NO <sub>2</sub> ) <sub>3</sub> O] <sub>2</sub> Pb	663.4	—	—	82.2	75.1
Magnesium picrate . . . . .	[C <sub>6</sub> H <sub>2</sub> (NO <sub>2</sub> ) <sub>3</sub> O] <sub>2</sub> Mg	480.5	—	—	172.6	187.3
Mannite . . . . .	(CH <sub>2</sub> OH) <sub>2</sub> (CHOH) <sub>4</sub>	182.2	—	—	317.9	282.4
Mannitol hexanitrate . . . . .	C <sub>6</sub> H <sub>8</sub> (NO <sub>3</sub> ) <sub>6</sub>	452.2	—	179.1	—	—
Mercuric oxide . . . . .	HgO	216.6	—	—	21.7	—
Mercury fulminate . . . . .	Hg(CNO) <sub>2</sub>	284.6	—	—	-64.5	—
Mercury picrate . . . . .	[C <sub>6</sub> H <sub>2</sub> (NO <sub>2</sub> ) <sub>3</sub> O] <sub>2</sub> Hg	656.3	—	—	42.8	38.1
Methane . . . . .	CH <sub>4</sub>	16.0	20.3	—	—	—
Methyl nitrate . . . . .	CH <sub>3</sub> O·NO <sub>2</sub>	77.0	39.9	—	—	—
Mononitrobenzene . . . . .	C <sub>6</sub> H <sub>5</sub> NO <sub>2</sub>	123.1	-11.7	-2.0	0.7	—
Nitric acid . . . . .	HNO <sub>3</sub>	63.0	35.3	42.4	43.0	49.8
Nitric oxide . . . . .	NO	30.0	-21.6	—	—	—
Nitroacetanilide (ortho) . . . . .	C <sub>8</sub> H <sub>8</sub> N <sub>2</sub> O <sub>3</sub>	180.2	—	—	52.6	—
Nitroacetanilide (meta) . . . . .	C <sub>8</sub> H <sub>8</sub> N <sub>2</sub> O <sub>3</sub>	180.2	—	—	54.6	—
Nitroacetanilide (para) . . . . .	C <sub>8</sub> H <sub>8</sub> N <sub>2</sub> O <sub>3</sub>	180.2	—	—	60.6	—
Nitrobenzaldehyde (ortho) . . . . .	C <sub>6</sub> H <sub>4</sub> CHONO <sub>2</sub>	151.1	—	19.9	—	—
Nitrobenzaldehyde (meta) . . . . .	C <sub>6</sub> H <sub>4</sub> CHONO <sub>2</sub>	151.1	—	19.9	31.6	—
Nitrobenzaldehyde (para) . . . . .	C <sub>6</sub> H <sub>4</sub> CHONO <sub>2</sub>	151.1	—	19.9	44.1	—
Nitrocamphor (alpha) . . . . .	C <sub>10</sub> H <sub>15</sub> (NO <sub>2</sub> )O	197.2	—	—	85.4	—
Nitrocamphor (phenol) . . . . .	C <sub>10</sub> H <sub>15</sub> (NO <sub>2</sub> )O	197.2	—	—	125.2	—
Nitrocellulose (12.6% N) . . . . .	C <sub>24</sub> H <sub>30.19</sub> O <sub>10.19</sub> (NO <sub>3</sub> ) <sub>9.81</sub>	1090.0	—	—	665.5	—
Nitrocellulose (12.75% N) . . . . .	C <sub>24</sub> H <sub>30</sub> O <sub>10</sub> (NO <sub>3</sub> ) <sub>10</sub>	1098.6	—	—	659.3	—
Nitrocellulose (13.15% N) . . . . .	C <sub>24</sub> H <sub>29.45</sub> O <sub>9.45</sub> (NO <sub>3</sub> ) <sub>10.55</sub>	1123.3	—	—	643.1	—
Nitrocellulose (13.75% N) . . . . .	C <sub>24</sub> H <sub>29.32</sub> O <sub>9.31</sub> (NO <sub>3</sub> ) <sub>10.69</sub>	1129.6	—	—	639.9	—
Nitroethane . . . . .	C <sub>2</sub> H <sub>5</sub> NO <sub>2</sub>	75.1	30.6	37.5	—	—
Nitrogen chloride . . . . .	NCl <sub>3</sub>	120.4	—	-38.5	—	-54.8 in CCl <sub>4</sub>
Nitrogen pentoxide . . . . .	N <sub>2</sub> O <sub>5</sub>	108.0	-1.2	3.6	14.6	28.6

## APPENDIX

**TABLE A-5 (CONTINUED) HEATS OF FORMATION FROM THE ELEMENTS AT  
15°C AND 760 MM PRESSURE**

Name	Formula	Molec- ular Weight	Heats of Formation in Large Calories per Gram Molecule			
			Gas	Liquid	Solid	Dis- solved
Nitrogen peroxide.....	NO <sub>2</sub>	46.0	-7.4	-12.6	—	25.6
Nitrogen sulphide.....	N <sub>4</sub> S <sub>4</sub>	184.3	-19.0	—	-31.9	—
Nitrogen trioxide.....	N <sub>2</sub> O <sub>3</sub>	76.0	-21.4	—	—	-14.7
Nitroglycerin.....	C <sub>3</sub> H <sub>5</sub> (NO <sub>3</sub> ) <sub>3</sub>	227.1	—	85.3	—	—
Nitroguanidine.....	C·NH NH <sub>2</sub> ·NHNO <sub>2</sub>	104.1	—	—	12.6	—
Nitromethane.....	CH <sub>3</sub> NO <sub>2</sub>	61.0	14.0	27.6	—	—
Nitronaphthalene (alpha).....	C <sub>10</sub> H <sub>7</sub> NO <sub>2</sub>	173.2	—	-2.2	-7.1	—
Nitrophenol (ortho).....	C <sub>6</sub> H <sub>4</sub> NO <sub>2</sub> OH	139.1	—	-56.1	47.2	—
Nitrophenol (para).....	C <sub>6</sub> H <sub>4</sub> NO <sub>2</sub> OH	139.1	—	-57.0	50.1	—
Nitrous oxide.....	N <sub>2</sub> O	44.0	-17.0	-18.7	—	-14.4
Ozone.....	O <sub>3</sub>	48.0	-34.4	—	—	-32.5
Picric acid.....	C <sub>6</sub> H <sub>2</sub> (NO <sub>2</sub> ) <sub>3</sub> OH	229.1	—	—	56.0	—
Potassium carbonate.....	K <sub>2</sub> CO <sub>3</sub>	138.2	—	—	275.0	281.5
Potassium chlorate.....	KClO <sub>3</sub>	122.6	—	—	89.9	79.5
Potassium chloride.....	KCl	74.6	—	—	104.3	99.9
Potassium dichromate.....	K <sub>2</sub> Cr <sub>2</sub> O <sub>7</sub>	294.2	—	—	481.7	—
Potassium nitrate.....	KNO <sub>3</sub>	101.1	—	114.2	119.0	110.14
Potassium perchlorate.....	KClO <sub>4</sub>	138.6	—	—	113.5	100.2
Potassium picrate.....	C <sub>6</sub> H <sub>2</sub> (NO <sub>2</sub> ) <sub>3</sub> OK	267.2	—	—	110.1	100.1
Potassium sulphate.....	K <sub>2</sub> SO <sub>4</sub>	174.3	—	—	338.5	—
Silver nitrate.....	AgNO <sub>3</sub>	169.9	—	16.0	30.11	24.66
Sodium carbonate.....	Na <sub>2</sub> CO <sub>3</sub>	106.0	—	—	272.6	276.2
Sodium chlorate.....	NaClO <sub>3</sub>	106.5	—	79.6	82.34	77.06
Sodium chloride.....	NaCl	58.5	—	90.7	98.4	97.1
Sodium nitrate.....	NaNO <sub>3</sub>	85.0	—	106.0	112.5	107.4
Sodium perchlorate.....	NaClO <sub>4</sub>	122.5	—	—	100.3	97.25
Sodium picrate.....	C <sub>6</sub> H <sub>2</sub> (NO <sub>2</sub> ) <sub>3</sub> ONa	251.1	—	—	103.4	97.1
Sodium sulphide.....	Na <sub>2</sub> S	78.1	—	—	89.7	105.5
Starch.....	(C <sub>6</sub> H <sub>10</sub> O <sub>5</sub> ) <sub>x</sub>	162.1	—	—	230.8	—
Strontium nitrate.....	Sr(NO <sub>3</sub> ) <sub>2</sub>	211.6	—	—	234.4	230.6
Strontium oxide.....	SrO	103.6	—	—	140.7	237.1
Strontium picrate.....	[C <sub>6</sub> H <sub>2</sub> (NO <sub>2</sub> ) <sub>3</sub> O] <sub>2</sub> Sr	543.8	—	—	196.0	196.8
Sulphur dioxide.....	SO <sub>2</sub>	64.1	69.3	75.3	—	77.9
Sulphuric acid.....	H <sub>2</sub> SO <sub>4</sub>	98.1	188.4	189.8	192.2	208.8
Sulphur trioxide.....	SO <sub>3</sub>	80.1	91.5	101.1	103.2	139.0
Tetryl.....	C <sub>7</sub> H <sub>5</sub> N(NO <sub>2</sub> ) <sub>4</sub>	287.1	—	—	-10.4	—
Toluene (toluol).....	C <sub>6</sub> H <sub>5</sub> CH <sub>3</sub>	92.1	-9.0	0	—	—
Triacetin.....	C <sub>3</sub> H <sub>5</sub> (CH <sub>3</sub> COO) <sub>3</sub>	218.2	—	307.3	—	—
Trinitrobenzene (1 : 2 : 4).....	C <sub>6</sub> H <sub>3</sub> (NO <sub>2</sub> ) <sub>3</sub>	213.1	—	—	-5.4	—
Trinitrobenzene (1 : 3 : 5).....	C <sub>6</sub> H <sub>3</sub> (NO <sub>2</sub> ) <sub>3</sub>	213.1	—	—	4.9	—
Trinitronaphthalene (1 : 3 : 8).....	C <sub>10</sub> H <sub>5</sub> (NO <sub>2</sub> ) <sub>3</sub>	263.2	—	—	5.7	—
Trinitrophenol.....	(Same as Picric Acid)					

## SOURCES OF ENERGY

**TABLE A-5 (CONTINUED) HEATS OF FORMATION FROM THE ELEMENTS AT  
15°C AND 760 MM PRESSURE**

Name	Formula	Molec- ular Weight	Heats of Formation in Large Calories per Gram Molecule			
			Gas	Liquid	Solid	Dis- solved
Trinitrotoluene (2 : 4 : 6)..	$C_6H_2(NO_2)_3CH_3$	227.1	—	—	16.5	—
Urea .....	$CO(NH_2)_2$	60.1	—	—	79.1	77.2
Urea nitrate.....	$CO(NH_2)_2HNO_3$	123.1	—	—	136.8	126.0
Water.....	$H_2O$	18.0	57.81	68.38	69.7	—
Wood meal (hardened) corresponding to.....	$C_{50}H_{72}O_{33}$	1201.1	—	—	1494.	—
Zinc picrate.....	$[C_6H_2(NO_2)_3O]_2Zn$	521.6	—	—	102.8	114.3

Data for this Table furnished by Picatinny Arsenal.

## INDEX

- Alpha decay, 4-4
- Aluminized explosives, 3-12
- Amatol, 3-8
- Ammonium picrate, 3-8
  - explosion of, 2-12
- Atomic mass number, 4-2
  - structure, 4-2
  - weight, A-11
- Average density, 1-7
- Avogadro's law, 2-6, 2-13
  
- Bangalore torpedoes, 3-8
- Beta decay, 4-4
- Black powder, 3-14
- Booster, 3-3
- Brisance, 1-8
  - relative, A-4
- Burning action of smokeless powder, 3-17
- Burning, controlled, 3-14
  - degressive, 3-17
  - neutral, 3-17
  - progressive, 3-17
  - relative areas, 3-17
- Burning rates, measurement, A-8
- Burning time of smokeless powder, 3-15
- Ballistic potential, 3-19
- Ballistite, 3-24
- Bursting charge explosive train, 1-11
  
- Calorie, 2-3
- Categorization of explosives, 1-3
- Chain reaction, 4-10
- Chamber pressure, actual, 2-15
- Charge of nuclear particles, 4-4
- Chemical explosive reactions, 1-1
- Chemical explosives, properties, 1-7
  - thermochemistry, 2-1
- Chemical kinetics, 1-5
- Chemical reactions of explosives, 2-1
  
- Composition A, 3-9
- Composition B, 3-9
- Cordite N, 3-23
- Co-volume, 2-2
- Criticality, 4-10
  - increase of, 4-11
- Critical mass, 4-11
- Cross section, fission, 4-9
- Cyclotetramethylenetetranitramine  
(*see* HMX)
- Cyclotol, 3-9
- Cyclotrimethylenetrinitramine  
(*see* RDX)
  
- Decomposition of explosives, 3-5
  - lead azide, 3-6
  - mercury fulminate, 3-5
  - trinitrotoluene, 3-7
- Density, 2-2
  - average, 1-7
  - impulse, 3-26
  - load, 1-7
  - of loading, 2-2
- Detonation, 1-4
  - high order of, 1-8
  - low order of, 1-8
  - velocity of, 1-7
  - test for, A-4
- Diglycol, 3-23
- Dynamites, 3-11
  
- Electron charge, 4-2
- Elements, symbols, 4-3
- Energy, equivalence with mass, 4-5
  - nuclear, 4-8
- Enthalpy, 2-4
- Erosion of gun tube, 2-9
- Expansion, work performed in, 2-7
- Explosion, ammonium picrate, 2-12
  - smokeless powder, 2-14
  - temperature, 2-9, 2-11

Explosive D, 3-8  
*(see also Ammonium picrate)*

Explosives, 3-1  
 aluminized, 3-12  
 categorization, 1-3  
 characteristics, 3-1  
 chemical, 1-7  
 comparison, 3-4  
 decomposition of  
*(see Decomposition of explosives)*  
 definition, 1-2  
 high  
*(see High explosives)*  
 low  
*(see Low explosives)*  
 manufacture, A-1  
 military, 3-1  
 mixtures with metals, 3-12  
 potential of, 2-3  
 primary high, 3-3, 3-5  
 properties of, A-5, A-6  
 reactions of  
*(see Reactions of explosives)*  
 secondary high, 3-3, 3-7  
 testing  
*(see Testing of explosives)*

Explosive trains, 1-9

Fission, 4-7  
 Fission cross section, 4-9  
 Fission-fusion reactions, 4-1  
 Flash, 3-21  
 Flash hider, 3-21  
 Flash suppressor, 3-22  
 Fusion, 4-7

Gamma rays, 4-4  
 Gases, densities, A-12  
 formation, 1-2  
 Gas liberated, volume, 2-6  
 Gelignite, 3-11  
 Gram formula weight, 2-2  
 Gram molecule, 2-2  
 Gunpowder, 1-1  
 Half life, 4-8

Heat, evolution of, 1-2  
 of formation, 2-3  
 at STP, A-15  
 of carbon monoxide, 2-5  
 of nitroglycerin, 2-5  
 of reaction, 2-3  
 Heat capacity constants, 2-11  
 High explosives, 1-3, 3-1  
 classes, 3-3  
 primary, 3-3, 3-5  
 secondary, 3-3, 3-7  
 liquid, 3-11  
 load density of, 1-7  
 High order of detonation, 1-8  
 HMX, 3-10  
 Hygroscopicity, 1-7

Impulse, specific, 2-9  
 Initial and final state, principle of, 2-3  
 Isotopes, 4-3  
 masses of, 4-8

Kilocalorie, 2-3  
 Kinetics, chemical, 1-5

Law of Avogadro, 2-6, 2-13  
 of Gay-Lussac, 2-7  
 Lead azide, 1-6, 3-6  
 Lead styphnate, 3-6  
 Lead trinitrorescorcinatate, 3-6  
 Liquid high explosives, 3-11  
 Load density, 1-7  
 Loading, density of, 2-2  
 Low explosives, 1-3, 3-13  
 sensitivity, 3-14  
 stability, 3-14  
 Low order of detonation, 1-8

Mass, critical, 4-11  
 equivalence of with energy, 4-5  
 of isotopes, 4-8  
 of nuclear particles, 4-3, 4-7, 4-8  
 Mean free path, 4-9  
 Melting point, 3-4

Mercury fulminate, 1-6, 3-5  
 Metal-explosive mixtures, 3-12  
 Military explosives, 3-1  
 Molecular specific heat, 2-2  
     volume, 2-2  
  
 Neutron reaction, 4-10  
 Nitration, A-2  
 Nitrocellulose, 3-18  
 Nitroglycerin, 1-5  
 Nobel, Alfred, 1-1  
 Nuclear energy, 4-8  
     particle charge, 4-4  
  
 Pentolite, 3-10  
 Perchlorate propellant, A-3  
 Perfect gas law, 2-7  
 PETN, 3-10  
 Poly-base propellants, 3-19  
     (*see also* Propellants, double-base)  
 Potential, 2-4, 2-8  
     of an explosive, 2-3, 3-1  
 Powder, ball, 3-19  
     black, 3-14  
     gun, 1-1  
     smokeless, 3-15  
 Powder grains, sizes, 3-16  
     shapes, 3-16  
 Power of an explosive, 1-8  
 Pressure, basic equations of, 2-12  
     chamber, 2-15  
 Pressure determination at constant volume, 2-12  
 Pressure in propellant chamber, 2-13  
 Pressure of solid product formation, 2-14  
 Primer, 1-9  
 Propellant chamber pressure, 2-13  
 Propellants, 3-19  
     composite, 3-24  
     double-base, 3-19  
     exotic, 3-26  
     fluoro, 3-27  
     free radical, 3-27  
     high-potential, 3-22  
     hypergolic, 3-25  
     improvements in, 3-21  
     ionic, 3-27  
     liquid, 3-25  
     liquid gun, 3-20  
     metal-additive, 3-27  
     nitroguanidine, 3-19  
     perchlorate, A-3  
     rocket, 3-23  
         testing, A-8  
     single-base, 3-18  
         (*see also* Single-base propellants)  
     solid, 3-24  
         testing, A-8  
  
 Propelling charge explosive train, 1-9  
 Properties of explosives, 1-7, A-5  
 Proton charge, 4-2  
  
 Radioactive series, 4-5  
 Radioactivity, 4-4  
 RDX, 3-9  
 Reaction, heat of, 2-3  
 Reactions, fission-fusion, 4-1  
     induced nuclear, 4-5  
     neutron, 4-10  
     reactions of explosives, chemical, 1-1  
         decomposition products, 1-9  
         initiation of, 1-2  
         rapidity of, 1-2  
         with metals, 3-4  
 Rocket propellants, 3-23  
     physical testing, A-8  
 Rockets, liquid propellant, 3-26  
  
 Sensitivity of explosives, 1-7  
     low explosives, 3-14  
     to shock, A-4  
 Single-base propellants, 3-18  
     additives, A-3  
     manufacture, A-2  
 Smoke, 3-21  
 Smokeless powder, burning action, 3-17  
     burning time, 3-15  
 Solid propellants, testing, A-8  
 Specific gravity, 2-2

Specific heat, 2-2  
  molecular, 2-2  
  variation with temperature, 2-10  
  of solids and liquids, A-13

Specific impulse, 2-9, 3-24

Specific volume, 2-2

Stability of explosive, 1-9  
  low explosive, 3-14

Standard state, 2-3

Strength, 1-8

Structure, atomic, 4-2

Temperature of decomposition, 1-9  
  of explosion, 2-9, 2-11  
  of solid product formation, 2-12  
  of storage, 1-9

Testing of explosives, A-1, A-4  
  ballistic mortar, A-7  
  explosive train tests, A-8  
  fragmentation tests, A-8  
  relative brisance, A-4  
  sensitivity to shock, A-4  
  setback tests, A-8  
  trauzl lead blocks, A-4, A-7  
  velocity of detonation, A-4

Tetranitroaniline, 3-13

Tetryl, 3-7

Tetrytol, 3-8

Thermochemistry of chemical explosives, 2-1

TNT, 3-7  
  efficiency, 3-9

Toluene, 1-6

Torpedoes, bangalore, 3-8

Trinitrotoluene, 1-6, 3-7, 3-8  
  manufacture, A-1

Uranium series, 4-6

Velocity of detonation, 1-7  
  test for, A-4

Volume, molecular, 2-2  
  specific, 2-2

Web thickness, 3-16, 3-17

Weight, atomic, A-11

Work, 2-8  
  (*see also* Potential)

Work determination in dynamic system, 2-15

Work performed in expansion, 2-7



# ENGINEERING DESIGN HANDBOOK SERIES

Listed below are the Handbooks which have been published or submitted for publication. Handbooks with publication dates prior to 1 August 1962 were published as 20-series Ordnance Corps pamphlets. AMC Circular 310-38, 19 July 1963, redesignated those publications as 706-series AMC pamphlets (i.e., ORDP 20-138 was redesignated AMCP 706-138). All new, reprinted, or revised Handbooks are being published as 706-series AMC pamphlets.

## General and Miscellaneous Subjects

No.	Title
106	Elements of Armament Engineering, Part One, Sources of Energy
107	Elements of Armament Engineering, Part Two, Ballistics
108	Elements of Armament Engineering, Part Three, Weapon Systems and Components
110	Experimental Statistics, Section 1, Basic Concepts and Analysis of Measurement Data
111	Experimental Statistics, Section 2, Analysis of Enumerative and Classificatory Data
112	Experimental Statistics, Section 3, Planning and Analysis of Comparative Experiments
113	Experimental Statistics, Section 4, Special Topics
114	Experimental Statistics, Section 5, Tables
121	Packaging and Pack Engineering
134	Maintenance Engineering Guide for Ordnance Design
135	Inventions, Patents, and Related Matters (Revised)
136	Servomechanisms, Section 1, Theory
137	Servomechanisms, Section 2, Measurement and Signal Converters
138	Servomechanisms, Section 3, Amplification
139	Servomechanisms, Section 4, Power Elements and System Design
170(C)	Armor and Its Application to Vehicles (U)
250	Guns--General (Guns Series)
252	Gun Tubes (Guns Series)
270	Propellant Actuated Devices
290(C)	Warheads--General (U)
331	Compensating Elements (Fire Control Series)
355	The Automotive Assembly (Automotive Series) (Revised)

## Ammunition and Explosives Series

175	Solid Propellants, Part One
176(C)	Solid Propellants, Part Two (U)
177	Properties of Explosives of Military Interest, Section 1
178(C)	Properties of Explosives of Military Interest, Section 2 (U)
179	Explosive Trains
210	Fuzes, General and Mechanical
211(C)	Fuzes, Proximity, Electrical, Part One (U)
212(S)	Fuzes, Proximity, Electrical, Part Two (U)
213(S)	Fuzes, Proximity, Electrical, Part Three (U)
214(S)	Fuzes, Proximity, Electrical, Part Four (U)
215(C)	Fuzes, Proximity, Electrical, Part Five (U)
244	Section 1, Artillery Ammunition--General, with Table of Contents, Glossary and Index for Series
245(C)	Section 2, Design for Terminal Effects (U)
246	Section 3, Design for Control of Flight Characteristics
247	Section 4, Design for Projection
248	Section 5, Inspection Aspects of Artillery Ammunition Design
249	Section 6, Manufacture of Metallic Components of Artillery Ammunition

## Ballistic Missile Series

No.	Title
281(S-RD)	Weapon System Effectiveness (U)
282	Propulsion and Propellants
283	Aerodynamics
284(C)	Trajectories (U)
286	Structures
<u>Ballistics Series</u>	
140	Trajectories, Differential Effects, and Data for Projectiles
150	Interior Ballistics of Guns
160(S)	Elements of Terminal Ballistics, Part One, Introduction, Kill Mechanisms, and Vulnerability (U)
161(S)	Elements of Terminal Ballistics, Part Two, Collection and Analysis of Data Concerning Targets (U)
162(S-RD)	Elements of Terminal Ballistics, Part Three, Application to Missile and Space Targets (U)

## Carriages and Mounts Series

340	Carriages and Mounts--General
341	Cradles
342	Recoil Systems
343	Top Carriages
344	Bottom Carriages
345	Equilibrators
346	Elevating Mechanisms
347	Traversing Mechanisms

## Military Pyrotechnics Series

186	Part Two, Safety, Procedures and Glossary
187	Part Three, Properties of Materials Used in Pyrotechnic Compositions

## Surface-to-Air Missile Series

291	Part One, System Integration
292	Part Two, Weapon Control
293	Part Three, Computers
294(S)	Part Four, Missile Armament (U)
295(S)	Part Five, Countermeasures (U)
296	Part Six, Structures and Power Sources
297(S)	Part Seven, Sample Problem (U)

## Materials Series\*

149	Rubber and Rubber-Like Materials
212	Gasket Materials (Nonmetallic)
691	Adhesives
692	Guide to Selection of Rubber O-Rings
693	Magnesium and Magnesium Alloys
694	Aluminum and Aluminum Alloys
697	Titanium and Titanium Alloys
698	Copper and Copper Alloys
699	Guide to Specifications for Flexible Rubber Products
700	Plastics
721	Corrosion and Corrosion Protection of Metals
722	Glass

\*The Materials Series is being published as Military Handbooks (MIL-HDBK-) which are available to Department of Defense Agencies from the Naval Supply Depot, 5801 Tabor Avenue, Philadelphia, Pennsylvania 19120.