



National
Defence

Défense
nationale

B-GL-321-006/FP-001

LAND FORCE

COMBAT TEAM OPERATIONS (INTERIM) (ENGLISH)

(This publication is active on receipt.)

WARNING

ALTHOUGH NOT CLASSIFIED, THIS PUBLICATION, OR ANY PART OF IT, MAY BE EXEMPT FROM DISCLOSURE TO THE PUBLIC UNDER THE ACCESS TO INFORMATION ACT. ALL ELEMENTS OF INFORMATION CONTAINED HEREIN MUST BE CLOSELY SCRUTINIZED TO ASCERTAIN WHETHER OR NOT THE PUBLICATION OR ANY PART OF IT MAY BE RELEASED.

Issued on the Authority of the Chief of Land Staff

Canada



National
Defence

Défense
nationale

B-GL-321-006/FP-001

LAND FORCE

COMBAT TEAM OPERATIONS (INTERIM)

(ENGLISH)

(This publication is active on receipt.)

WARNING

ALTHOUGH NOT CLASSIFIED, THIS PUBLICATION, OR ANY PART OF IT, MAY BE EXEMPT FROM DISCLOSURE TO THE PUBLIC UNDER THE ACCESS TO INFORMATION ACT. ALL ELEMENTS OF INFORMATION CONTAINED HEREIN MUST BE CLOSELY SCRUTINIZED TO ASCERTAIN WHETHER OR NOT THE PUBLICATION OR ANY PART OF IT MAY BE RELEASED.

Issued on the Authority of the Chief of Land Staff

OPI: DAD 4

2003-10-28

Canada

FOREWORD

1. B-GL-321-006/FP-001, *Combat Team Operations (Interim)*, is issued on authority of the Chief of the Land Staff.
2. This publication is effective upon receipt.
3. The French version of this publication is B-GL-391-006/FP-002, *Les opérations de l'équipe de combat*.
4. Unless otherwise noted, masculine pronouns contained herein refer to both genders.
5. Suggestions for amendment and/or improvement shall be forwarded through normal channels to the Army Lessons Learned Centre or to the Directorate of Army Doctrine as appropriate.
6. This publication is available electronically on both the Defence Information Network (DIN) and the World Wide Web in the Army Electronic Library. Keyword—Army Electronic Library.

©DND/MDN 2003

PREFACE

GENERAL

1. This interim edition of B-GL-321-006/FP-001 *Combat Team Operations (Interim)* builds upon the previous drafts of the Tactics School's Combat Team TTPs, and also incorporates lessons learned from the Mobile Automated Instrumentation Suite (MAIS) Trial conducted in CFB Gagetown. This interim edition supersedes all earlier drafts, and is the principal reference for LF units conducting combat team training and operations.

PURPOSE

2. The purpose of B-GL-321-006/FP-001, *Combat Team Operations (Interim)*, is to provide LAV III and Leopard C2 equipped units with the low level tactical knowledge that will maximize their effectiveness.

DOCTRINAL RELEVANCE

3. *Combat Team Operations*, along with its complementary manual, B-GL-321-007/FP-001, *LAV Company Tactics*, are being produced as interim editions. While the fielding, integration, training and level of experience with the LAV III and Leopard C2 continues across the field force, there are many issues yet to be resolved. In the meantime, these units are to use *Combat Team Operations* and *LAV Company Tactics* as primary doctrinal guidance for training and operations. Only through application of this doctrine will we be able to effectively gauge the precision and relevance of these manuals.

4. In the near future, LFDTS will coordinate an Army-wide review of these manuals to include your feedback regarding all aspects of integrating and fighting the LAV III and Leopard C2. Following the review process, the manuals will be improved, perhaps integrated into one publication, and will then be produced as final editions. Your assistance in this process is critical to the success of the review and to the standard of our combat team doctrine.

5. Feedback on the information contained in these manuals is encouraged and it need not wait until the execution of the formal review process. In this regard, units are asked to submit observations to the Army Lessons Learned Centre or to the Directorate of Army

B-GL-321-006/FP-001

Doctrine as appropriate, which they consider would improve the doctrine contained in either manual.

TABLE OF CONTENTS

FOREWORD I

PREFACE iii

 General iii

 Purpose iii

 Doctrinal Relevance iii

CHAPTER 1 INTRODUCTION

SECTION 1 COMBAT TEAM DEFINITION AND STRUCTURE..... 1

 Definition..... 1

 Structure 1

SECTION 2 COMBAT TEAM FREQUENCIES..... 1

 Combat Team Frequencies 1

SECTION 3 THE COMBAT ESTIMATE..... 3

 General 3

CHAPTER 2 OFFENSIVE OPERATIONS

SECTION 1 HASTY ATTACK 5

 Warning, Security, Recce and Plan 5

 Hasty Attack with One Tank Troop in Fire Base 9

 Hasty Attack with Two Tank Troops in Fire Base 15

 Hasty Attack from the Line of March..... 20

 Hasty Attack on Converging Axes 21

 Hasty Attack with Armour in Fire Base While Infantry Assaults 23

 Hasty Attack Assault and Fight Through 24

 Consolidation..... 30

 Pursuit Operations 35

 Radio Warning Order for Hasty Attack..... 38

 Radio Orders for Hasty Attack 39

SECTION 2 OBSTACLE BREACHING 40

 Action on Mine Contact 40

 Hasty Minefield Breach..... 43

 Composite Obstacle Breach 47

CHAPTER 3 DEFENSIVE OPERATIONS

SECTION 1 DEFENCE..... 57

 Area and Mobile Defence..... 57

 Defence in a Built-up Area..... 70

 Reserved Demolition Guard 78

CHAPTER 4 DELAYING OPERATIONS

 Delaying Operations..... 85

CHAPTER 5 TRANSITIONAL PHASES

SECTION 1 THE ADVANCE..... 89

 Advance to Contact 89

 Crest Drill..... 93

 Gap Drill..... 94

 Short Defile Drill..... 96

 Long Defile Drill 99

 Blind Corner Drill 102

 Blind Corner / T-Junction Drill 104

 Point Obstacle Drill 105

SECTION 2 MEETING ENGAGEMENT 107

 Meeting Engagement..... 107

SECTION 3 LINK-UP..... 109

 Link-up..... 109

SECTION 4 BREAKOUT 114

 Breakout 114

SECTION 5 WITHDRAWAL..... 117

Withdrawal	117
SECTION 6 RELIEF	123
Relief	123
Passage of Lines	129
CHAPTER 6 COMBAT SERVICE SUPPORT	
SECTION 1 COMMAND AND CONTROL OF THE COMBAT TEAM ECHELON	132
Command and Control of the Combat Team Echelon	133
SECTION 2 A COMPARISON OF THE ECHELONS	137
A Comparison of the Echelons	133
SECTION 3 HIDE/HARBOUR, LEAGUER, AND RUNNING REPLENISHMENT DRILLS	141
Hide/Harbour, Leaguer, and Running Replenishment Drills	139
LIST OF ABBREVIATIONS.....	145

LIST OF FIGURES

Figure 2-1: Illustrates Warning, Security, Recce and Plan for
 Hasty Atk..... 6

Figure 2-2: Illustrates Right Flank Hasty Atk..... 7

Figure 2-3: Illustrates Right Flank Hasty Atk – One Troop in Fire
 Base 10

Figure 2-4: Two Lanes—One Troop in Fire Base 11

Figure 2-5: One Lane—One Troop in Fire Base..... 13

Figure 2-6: Illustrates Right Flank Hasty Atk—wo Troops in Fire
 Base 16

Figure 2-7: Two Lanes—Two Troops in Fire Base 17

Figure 2-8: One Lane—Two Troops in Fire Base 18

Figure 2-9: Atk from the Line of March 21

Figure 2-10: Hasty Atk Armour/Inf on Converging Axes 22

Figure 2-11: Armour in Fire Base While Inf Assaults 24

Figure 2-12: Break-in, Initial Approach..... 25

Figure 2-13: Break-in, the Edge of Enemy Position 26

Figure 2-14: Break-in of a Trench System..... 27

Figure 2-15: Break-in of a Trench System, One Lane 28

Figure 2-16: Fight-through..... 28

Figure 2-17: Hasty Atk Consolidation 31

Figure 2-18: Combat Team Pursuit Operations 35

Figure 2-19: Action on Mine Contact 41

Figure 2-20: Hasty Minefield Breach, Initial 44

Figure 2-21: Hasty Minefield Breach..... 46

Figure 2-22: Composite Obstacle Breach, Initial 48

Figure 2-23: Composite Obstacle Breach, Step 1 48

Figure 2-24: Composite Obstacle Breach, Step 2 50

Figure 2-25: Composite Obstacle Breach, Step 3 50

Figure 2-26: Composite Obstacle Breach, Step 4 51

Figure 2-27: Composite Obstacle Breach, Step 5 51

Figure 2-28: Composite Obstacle Breach, Step 6 52

Figure 2-29: Composite Obstacle Breach, Step 7 53

Figure 2-30: Composite Obstacle Breach, Assault Force Entry..... 53

Figure 3-1: Illustrates an Area Defence 58

Figure 3-2: Illustrates a Mobile Defence..... 59

Figure 3-3: Dividing a Killing Zone 60

Figure 3-4: Disrupt..... 67

Figure 3-5: Turn 67

Figure 3-6: Fix 68

Figure 3-7: Block 68

Figure 3-8: Defence in a Built-up Area..... 71

Figure 3-9: Bridge Demolition Guard..... 79

Figure 4-1: The Delay 87

Figure 5-1: Combat Team Advance—Sqn Box, Coy Column..... 89

Figure 5-2: Combat Team Advance—Sqn 3-Up Line,
Coy 2-Up Column 91

Figure 5-3: Crest Drill..... 94

Figure 5-4: Gap Drill 95

Figure 5-5: Short Defile Drill, Recce..... 97

Figure 5-6: Short Defile Drill, Clearance..... 98

Figure 5-7: Short Defile Drill, Crossing 99

Figure 5-8: Long Defile Drill, Recce 100

Figure 5-9: Long Defile Drill, Clearance..... 101

Figure 5-10: Long Defile Drill, Crossing..... 102

Figure 5-11: Blind Corner Drill, Left..... 103

Figure 5-12: Blind Corner Drill, T-Junction 104

Figure 5-13: Point Obstacle Drill..... 106

Figure 5-14: Tactical Options for a Meeting Engagement..... 108

Figure 5-15: Link-up of Moving Force with a Stationary Force.... 110

Figure 5-16: Link-up of Two Moving Forces 111

Figure 5-17: The Withdrawal..... 119

Figure 5-18: Combat Team Relief in Place..... 125

Figure 5-19: Forward Passage of Lines 129

Figure 5-20: Rearward Passage of Lines, Responsibilities 131

Figure 5-21: Rearward Passage of Lines 132

Figure 6-1: LAV Inf Coy A1 Ech 137

Figure 6-2: Armd Sqn A1 Ech 137

Figure 6-3: LAV Rifle Coy A2 Ech..... 138

Figure 6-4: Armd Sqn A2 Ech 138

Figure 6-5: Example of a Perimeter Hide/Harbour Layout..... 141

Figure 6-6: Example Layout of a Combat Team Leaguer..... 143

Figure 6-7: Example of a Running Replenishment..... 144

CHAPTER 1 INTRODUCTION

SECTION 1 COMBAT TEAM DEFINITION AND STRUCTURE

DEFINITION

1. A combat team is defined as: “A tactical grouping based on either a mechanized infantry company or a tank squadron, with at least a platoon or troop of the other arm and additional support as required” (ATB approved 2002-01-23).

STRUCTURE

2. The table of organization and equipment of 20 Canadian Mechanized Brigade Group (the Land Force doctrinal warfighting order of battle) was the basis for the establishment of the structure of the combat team that is used throughout this document. Specifically, the combat team is structured as follows (these composite elements include their A echelons as applicable):

- a. 19-tank squadron;
- b. 15-light armoured vehicle (LAV III) mechanized company;
- c. an engineer troop, in the close support role; and
- d. one forward observation officer (FOO) party.

3. The combat team can be task organized with the addition of battle group (BG) assets such as Tube-launched, Optically-tracked, Wire-guided missile (TOW) under armour, recce, etc. and other supporting assets such as air defence (AD). These will not be discussed further within the context of the tactics, techniques and procedures (TTP).

SECTION 2 COMBAT TEAM FREQUENCIES

COMBAT TEAM FREQUENCIES

4. The following chart depicts which frequencies commanders, at all levels within a combat team, should monitor on their “A” and

Combat Team Operations (Interim)

“C” sets. The basic premise is that the combat team commander’s “domestic net” is the combat team net.

SER	APPOINTMENT	INFANTRY COY CBT TM	ARMED SQUADRON CBT TM
(a)	(b)	(c)	(d)
1.	Cbt Tm Commander	A—Cbt Tm Freq C—BG Freq	A—Cbt Tm Freq C—BG Freq
2.	Cbt Tm 2IC	A—Cbt Tm Freq C—BG Freq	A—Cbt Tm Freq C—BG Freq
3.	Altn Arm Commander	A—Cbt Tm Freq C—Squadron Freq	A—Cbt Tm Freq C—Coy Freq
4.	Altn Arm 2IC	A—Cbt Tm Freq C—BG Freq	A—Cbt Tm Freq C—BG Freq
5.	Sub-Sub-Unit (Troop/Platoon) Comds	Platoon: A—Cbt Tm Freq C—Nil or Coy Altn Freq Troop: A—Cbt Tm Freq C—Squadron Freq	Platoon: A—Cbt Tm Freq C—Nil or Sqn Altn Freq Troop: A—Cbt Tm Freq C—Coy Freq
6.	Engineer Troop Commander	A—Cbt Tm Freq C—Fd Sqn Freq	A—Cbt Tm Freq C—Fd Squadron Freq
7.	FOO	A—Cbt Tm Freq C—Bty Freq	A—Cbt Tm C—Bty Freq
8.	Coy/Sqn Sergeant- Major	A—Cbt Tm Freq C—Coy Freq	A—Cbt Tm Freq C—Sqn Freq
NOTE			
During the assault stage of an attack, intimate support tanks “flick” to the assault company’s frequency for assault force tasks until released by the assault force company commander.			

SECTION 3 THE COMBAT ESTIMATE

GENERAL

5. The 15 steps of battle procedure, as outlined in B-GL-300-003/FP-000 *Command*, apply at the combat team level. The aim of this TTP is to outline the combat estimate, which is as follows:

SER	STEP	FACTOR	CONSIDERATIONS
(a)	(b)	(c)	(d)
1.	One	Mission Analysis	<ol style="list-style-type: none"> 1 Superior commander's intent two up and concept of operations one up. 2. Assigned/IMPLIED tasks. 3. Constraints. 4. Changed situation. 5. Mission statement.
2.	Two	Enemy	<ol style="list-style-type: none"> 1. Intentions: <ol style="list-style-type: none"> a. Two up—intent. b. One up—enemy concept of operations. c. Courses open to the enemy facing you. 2. Capabilities (armoured fighting vehicles, weapons, air, NBC, etc.) to include strengths and weaknesses. 3. Objectives (offence). 4. Dispositions (defence).
3.	Three	Ground	<ol style="list-style-type: none"> 1. FLOCARK if time available. 2. Ground LEFT—COPPED. 3. Ground CENTRE—COPPED. 4. Ground RIGHT—COPPED. 5. Key terrain/vital ground.
4.	Four	Own Troops	<ol style="list-style-type: none"> 1. Effect that friendly troops (flanks, front, rear) will have on our mission/tasks. 2. What effect will deficiencies to our combat strength (casualties) have on our ability to execute mission/tasks, i.e., need to regroup or fight with under strength elements.
5.	Five	Meteorology (Met)	<ol style="list-style-type: none"> 1. Hours of daylight available. 2. Weather impact on air threat, NBCE, etc.
6.	Six	Time and Space	Time and space constraints.

Combat Team Operations (Interim)

SER	STEP	FACTOR	CONSIDERATIONS
(a)	(b)	(c)	(d)
7.	Seven	Assessment of Tasks: a. Examine two down. b. Order one down.	<ol style="list-style-type: none"> 1. Summarize tasks. 2. Prioritize tasks. 3. Options for grouping and/or phasing. 4. Combine tasks or forces. 5. Additional support required. 6. Eliminate tasks (risk management).
8.	Eight	Courses Open	<ol style="list-style-type: none"> 1. Identify courses open. 2. Advantages/disadvantages (risks). 3. Compare to enemy most likely and most dangerous course open. 4. Select best course of action. 5. Review against principles of war and applicable fundamentals.
9.	Nine	Plan/orders	Style of orders, i.e., radio/overlay, etc.

6. Only relevant portions of the estimate may be discussed within the TTP during a review of the process when expanded discussion occurs for the applicable combat functions.

CHAPTER 2 OFFENSIVE OPERATIONS

SECTION 1 HASTY ATTACK

WARNING, SECURITY, RECCE AND PLAN

1. **General.** This TTP covers the actions of the combat team from initial contact to the arrival of the assault force in the attack position.
2. **Warning.** The following actions will be taken upon initial contact:
 - a. the first element of the combat team that comes into contact with the enemy (normally the leading tank troops) will send a contact report and tries to win the direct firefight;
 - b. the combat team will send a contact report to battle group HQ (infantry combat team—2IC and armoured combat team—battle captain (BC)); and
 - c. the FOO will move to a position of observation, which could be at the fire base or other location (Note 1 on Figure 2-1), and will start adjusting and recording the enemy position.
3. **Security.** Normally, armour elements will be involved in winning the initial firefight. Elements of the combat team not involved in the direct firefight will move into a position concealed from enemy observation (air and ground) under the control of the company 2IC (Note 2 on Figure 2-1). This may be the potential rendezvous (RV).
4. **Recce.** The following actions will be taken in order to conduct the recce:
 - a. the combat team commander and the supporting arm officer commanding (OC) will move into a position of observation (Note 3 on Figure 2-1);
 - b. if necessary, the engineer assets integral to the combat team will try to define the obstacle and identify which engineer assets will be required for the breach (Note 4 on Figure 2-1);

Combat Team Operations (Interim)

- c. on completion of the recce, the combat team commander will send a warning order (see “Hasty Attack Radio Warning Order”, page 38 for format);
- d. locations for fire base, attack position, line of departure (LD), limit of exploitation, and cut-off will be determined and RVs and routes will be designated as required; and
- e. possible bypass route(s) will be located.

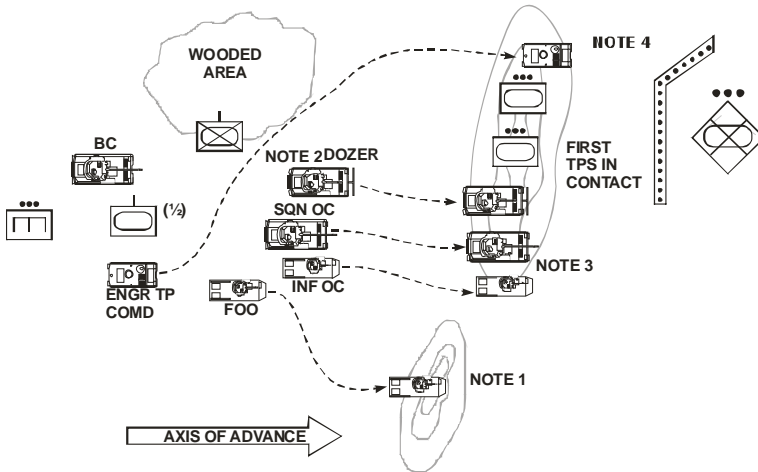

Figure 2-1: Illustrates Warning, Security, Recce and Plan for a Hasty Atk

5. **Plan.** The following preliminary moves and orders will occur:
 - a. if required, designated elements will move to secure the attack position, LD and fire base;
 - b. the fire base and cut-off force will move to designated location;
 - c. the assault force will move to RV location (RV optional) under the control of the company 2IC;
 - d. the combat team commander will issue orders (see “Hasty Attack Radio Orders”, page 39 for format) and the battle group HQ will be informed;

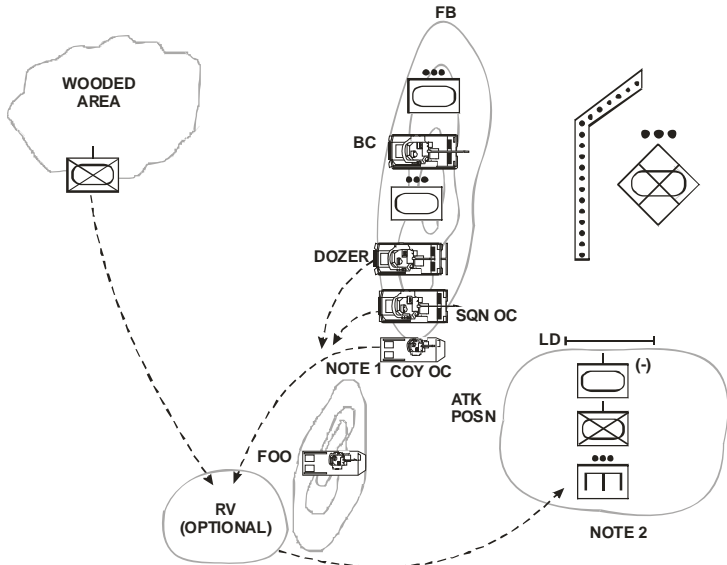

Figure 2-2: Illustrates Right Flank Hasty Atk

- e. the squadron OC, the company OC, (Note 1 of Figure 2-2) and assault force will move to attack position (Note 2 on Figure 2-2); and
 - f. upon arrival in the attack position, intimate support tanks will elevate their barrels for ease of identification and the troop leader will operate on company radio frequency while monitoring combat team frequency, which may be the same (see Chapter 1, Section 2).
6. **Combat Functions:**
- a. **Command.** The first decision a combat team commander has to make is based on a quick analysis of the tactical situation he is facing; i.e., he has to conduct a Combat Estimate. Generally, he has to consider three options: bypass, conduct a hasty attack or becoming a fixing force for a battle group attack. His decision will be based on his mission analysis.
 - b. **Protection.** Location for consolidation will be determined by the protection available on the enemy

Combat Team Operations (Interim)

position compared to the threat of enemy indirect fire and/or counter-moves.

c. **Firepower:**

- (1) The enemy should be suppressed with direct fire and neutralized with indirect fire prior to crossing the LD. As a minimum, the enemy should be neutralized by indirect fire.
- (2) For a combat team hasty attack, the fire base will normally be controlled by the squadron BC. As a fixing force for a battle group or higher formation attack, the fire base will likely be controlled by the combat team commander.
- (3) Cutting off or blocking the enemy may be done by manoeuvre, direct fire and/or indirect fire.

d. **Manoeuvre:**

- (1) If bypassing the enemy is an option, the enemy must be picketed to maintain contact. The picket will pass the enemy over to follow-on battle group elements. The picket must have the battle group frequency. Flank and rear security will have to be increased.
- (2) Fire base or assault forces may be used to cut off or block the enemy.
- (3) Limit of exploitation and arcs must be identified for consolidation.
- (4) On completion of the attack, the combat team should be oriented to continue the advance and exploit success or act as a force-in-place for the forward passage of lines of follow-on forces.

HASTY ATTACK WITH ONE TANK TROOP IN FIRE BASE

7. **Mounting** (Figure 2-3). For warning, security, recce and plan, see “Warning, Security, Recce and Plan”, page 5. The hasty attack with one tank troop in fire base will be mounted as follows:
- a. The first tank troop in contact will normally become the fire base. The squadron BC will move to fire base location.
 - b. Upon arrival in the attack position (unless otherwise stated in the warning order), the three tank troops will adopt the following positions:
 - (1) the first troop to arrive will be left forward (assault troop);
 - (2) the second troop to arrive will be right forward (assault troop); and
 - (3) the third troop to arrive will take position behind the assault troops and become the intimate support troop, elevating their barrels for identification.
 - c. Two breaching teams, one from each assault troop, will be formed in attack position. A team is comprised of one tank with plough and one engineer section (barrels of breaching tank will be at the 9 o'clock position).
 - d. Breaching reserve will be the plough tank of the intimate support troop, which is normally situated centrally so that the plough tank can be sent to either lane if required. Refer to “Obstacle Breaching Hasty Minefield Breach”, page 43 for breaching drill.
 - e. Unless otherwise ordered, the infantry platoons will organize first platoon left, second platoon right and third platoon depth.

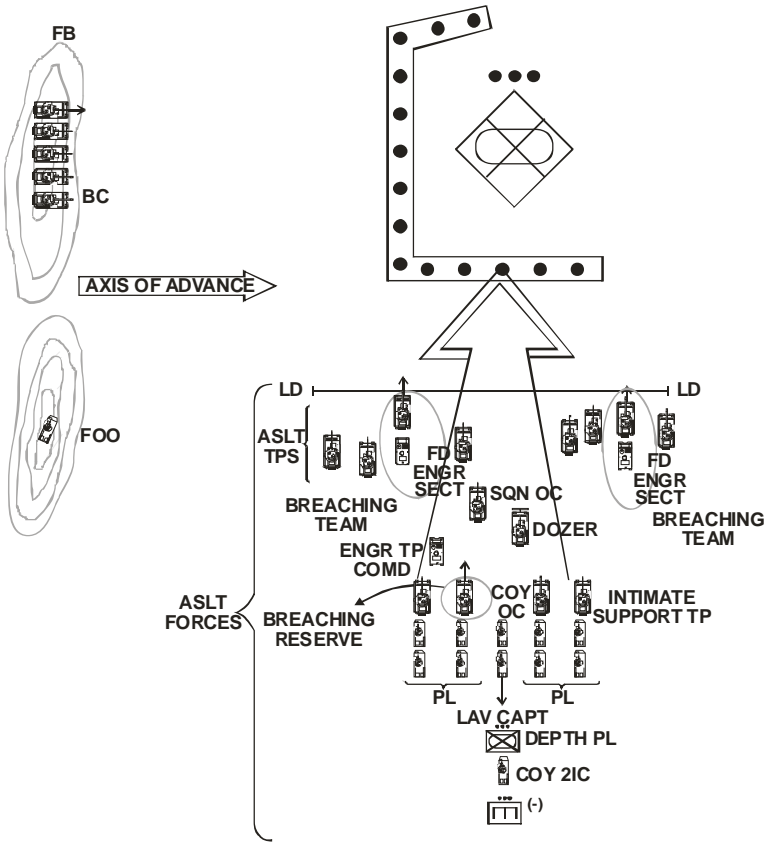

Figure 2-3: Illustrates Right Flank Hasty Atk—One Troop in Fire Base

8. **Assault.** The assault will be conducted as follows:
 - a. the breaching teams will cross LD at H hour;
 - b. the rest of assault force will remain in the attack position until committed by the combat team commander;
 - c. elements not required during the assault (such as armoured engineer section) will stay in attack position under cover unless called forward;

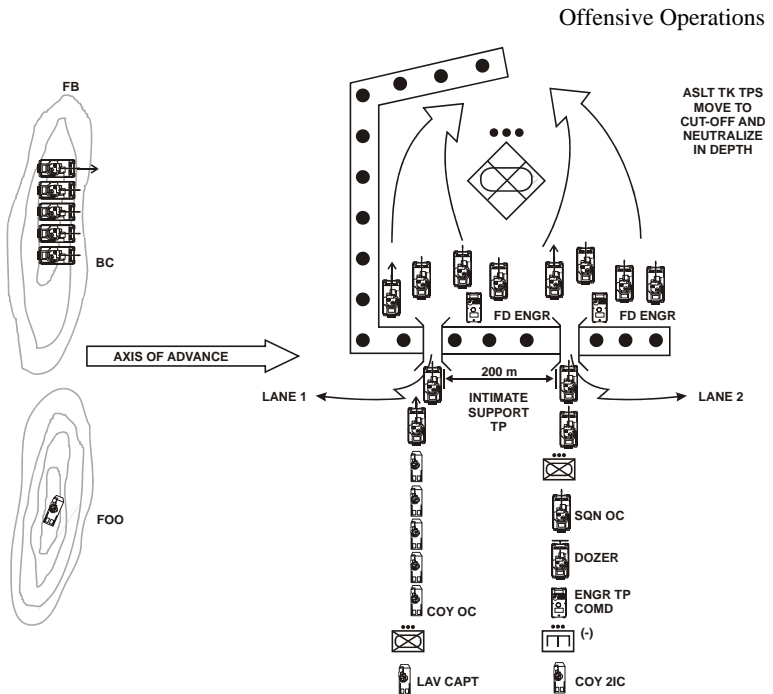

Figure 2-4: Two Lanes—One Troop in Fire Base

NOTES

1. Lanes will always be numbered from left to right.
2. Minimum 200 m between lanes.
3. If no obstacles are detected or suspected, the assault force will move to the attack position, cross the LD at H hour and move at best possible speed to the objective.

- d. order of march if two lanes available (Figure 2-4):
 - (1) lane one:
 - (a) breaching team;
 - (b) assault tanks (the troop will pick up the plough tank as troop arrives on enemy side of obstacle);

Combat Team Operations (Interim)

- (c) two tanks of intimate support troop;
- (d) infantry platoon;
- (e) infantry company OC;
- (f) infantry platoon; and
- (g) LAV Capt; and
- (2) lane two:
 - (a) breaching team;
 - (b) assault tanks (the troop will pick up the plough tank as troop arrives on enemy side of obstacle);
 - (c) two tanks of intimate support troop;
 - (d) squadron OC and dozer tank; and
 - (e) infantry platoon.
- e. order of march if one lane available (Figure 2-5):
 - (1) breaching team;
 - (2) assault tanks;
 - (3) intimate support tanks;
 - (4) infantry platoon;
 - (5) squadron OC and dozer tank;
 - (6) infantry company OC;
 - (7) two remaining infantry platoons; and
 - (8) LAV Capt.

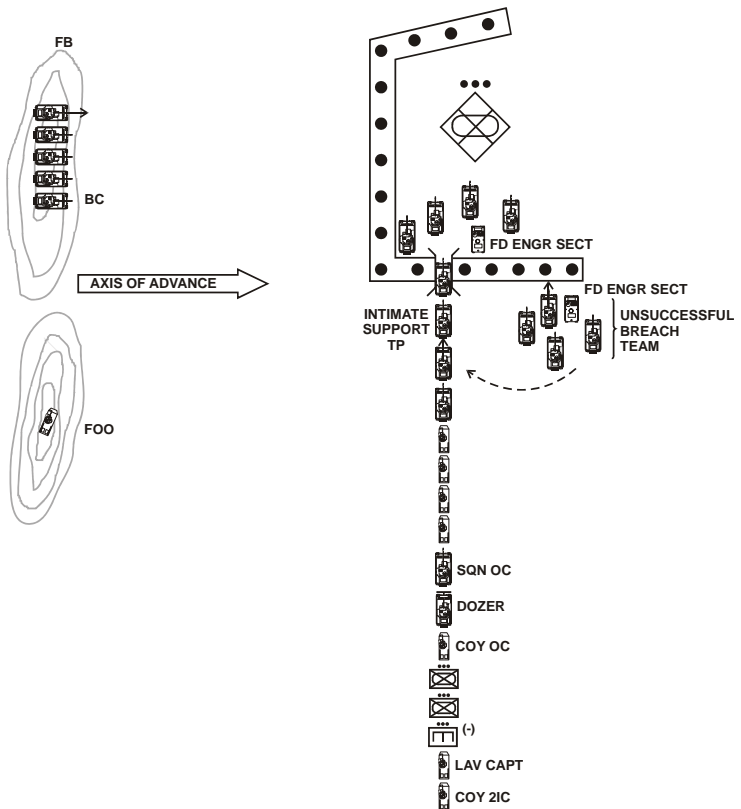

Figure 2-5: One Lane—One Troop in Fire Base

9. **Other Considerations—Combat Functions:**

a. **Command:**

- (1) The combat team commander will have to make the decision of committing the assault force to one lane only or two lanes when one of the lanes is 75 percent cleared. Once the first lane reports, the second lane will immediately send a SITREP. His decision will be based on the progression in the other attempted lane.

Combat Team Operations (Interim)

- (2) The company 2IC could be with the assault force or remain in the attack position.

NOTE

Refer to “Hasty Attack Assault and Fight Through”, page 24 for fighting through and “Hasty Attack Consolidation”, page 30 for consolidation.

b. Manoeuvre:

- (1) Field engineers will clear wire obstacles and be prepared to support dismounted infantry on the objective.
- (2) Reserve options will be tank troop(s) (normally from fire base after the arrival of the assault force on the objective), engineer section(s), infantry platoon and LAVs once infantry has dismounted.

c. Firepower:

- (1) The fire base and indirect fire resources will concentrate their fires on objective while the breaching takes place.
- (2) LAVs could be used for tasks such as secure attack position/LD, cut-off or flank protection after infantry has dismounted, etc.
- (3) Fire support must be concentrated on those targets that it is vital to neutralize for the success of the attack.
- (4) As the combat team approaches the enemy position, indirect fire will have to be maintained until last safe moment.
- (5) Once on the objective, fire support will target in depth to disrupt a possible enemy counter-attack.

d. Protection:

- (1) **Dispersion.** Vehicles should be no closer than 50 m from one another in attack position. Vehicles will go to hatches down on arrival in attack position.
- (2) Flank protection normally will be provided from within troops/platoons.
- (3) Once the breaching teams are on the enemy side of the obstacle, they will move to fire positions.
- (4) Follow on forces need to use confirmed track plan, i.e., those tracks that friendly vehicles have travelled and that are clear of mines.

HASTY ATTACK WITH TWO TANK TROOPS IN FIRE BASE

10. **Mounting** (Figure 2-6). For warning, security, recce and plan, see “Warning, Security, Recce and Plan”, page 5. The hasty attack with two tank troops in fire base will be conducted as follows:

- a. The first troop in contact will become fire base. The squadron BC and another tank troop will move to fire base location. The plough tank from the fire base will move to the attack position.
- b. The breaching force will consist of:
 - (1) one troop of tanks, augmented with one of the ploughs coming from the troops in the fire base, and two engineer sections; and
 - (2) the plough from the intimate support troop, which will be the breaching reserve.

Combat Team Operations (Interim)

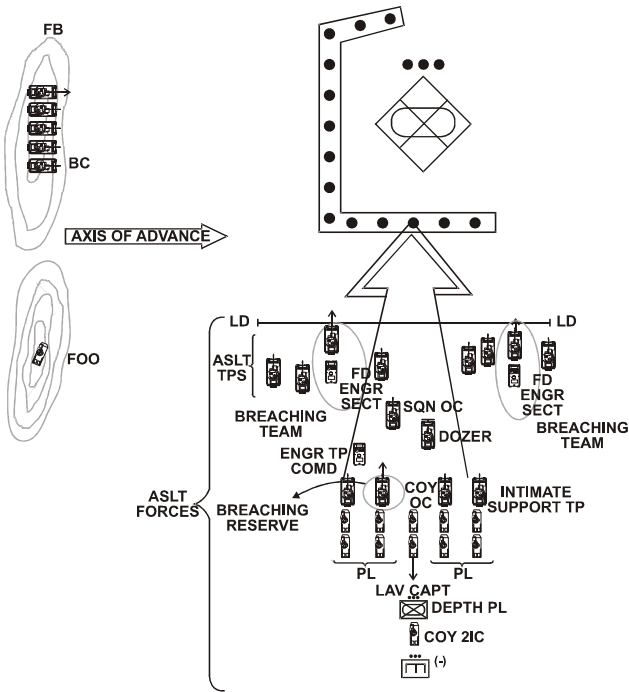

Figure 2-6: Illustrates Right Flank Hasty Atk—Two Troops in Fire Base

11. **Assault.** The assault will be conducted as follows:
 - a. the assault troop with the breaching force of combat team will cross LD at H hour;
 - b. the rest of assault force will remain in attack position, to avoid congestion, until committed by the combat team commander;
 - c. elements not required during the assault (such as armoured engineer section) will stay in attack position unless called forward;

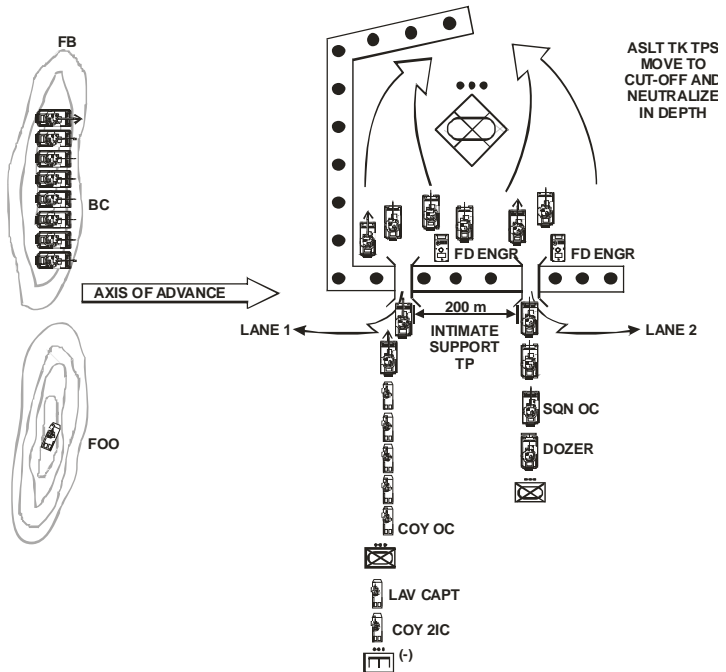

Figure 2-7: Two Lanes—Two Troops in Fire Base

- d. order of march if two lanes available (Figure 2-7):
- (1) lane one:
 - (a) breaching team;
 - (b) assault tanks (the troop will pick up the plough tank as troop arrives on the enemy side of the obstacle);
 - (c) two tanks of intimate support troop;
 - (d) infantry platoon;
 - (e) infantry company OC;
 - (f) infantry platoon; and
 - (g) LAV Capt.
 - (2) lane two:
 - (a) breaching team;

Combat Team Operations (Interim)

- (b) assault tanks;
- (c) two tanks of intimate support troop;
- (d) squadron OC and dozer tank; and
- (e) infantry platoon.

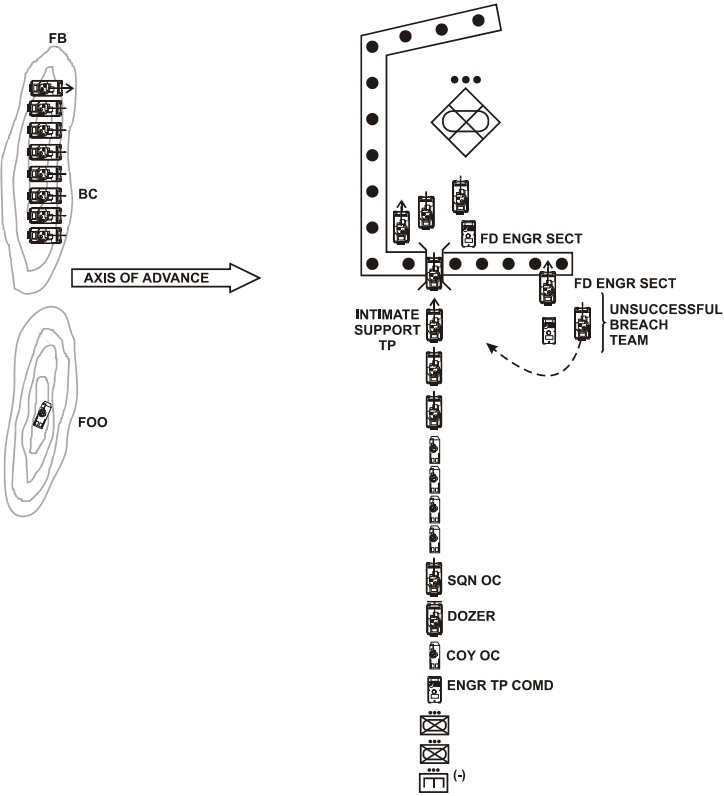

Figure 2-8: One Lane—Two Troops in Fire Base

NOTE

If one lane is unsuccessful, the breaching team from that lane has little chance to reorganize and achieve the lane in time to be used by part of the assault force. It should be redirected to use open lane in order to participate in assault (Note 1 on Figure 2-8). Refer to “Hasty Attack Assault and Fight Through”, page 24 for fighting through and “Hasty Attack Consolidation”, page 30 for consolidation.

- e. order of march if one lane available Figure 2-8):
 - (1) breaching team;
 - (2) assault tanks (the troop will pick up the plough tank as troop arrives on the enemy side of the obstacle);
 - (3) intimate support troop;
 - (4) infantry platoon;
 - (5) squadron OC and dozer tank;
 - (6) company OC;
 - (7) two remaining infantry platoons; and
 - (8) LAV Capt.
12. **Combat Functions:**
- a. **Command.** Combat team commander will have to make the decision of committing the assault force to one lane only or two lanes when one of the lanes is cleared at 75 percent. This decision will be based on the progression in the other attempted lane.
 - b. **Manoeuvre:**
 - (1) Field engineers will have to clear wire obstacles and be prepared to support dismounted infantry on the objective.
 - (2) Reserve options will be tank troop(s) (normally from fire base after arrival of the assault force on the objective), engineer

Combat Team Operations (Interim)

section(s), infantry platoon and LAVs once infantry has dismounted.

c. **Firepower:**

- (1) The fire base and indirect fire resources will concentrate their fires while the breaching takes place.
- (2) LAVs could be used for tasks such as secure attack position/LD, cut-off or flank protection after infantry has dismounted, etc.

d. **Protection:**

- (1) **Dispersion.** Vehicles should be no closer than 50 m from one another in attack position. Vehicles should go to hatches down on arrival in attack position.
- (2) Once the breaching elements are on the enemy side of the obstacle, if possible, they will position themselves to be concealed from enemy fire/observation.

HASTY ATTACK FROM THE LINE OF MARCH

13. **General.** A hasty attack will normally follow “Hasty Attack with One or Two Tank Troops in Fire Base”, pages 9 and 15 respectively. However, given the limitations, such an attack may be executed directly through fire and movement (versus the establishment of a “conventional” fire base). The conditions in which an attack from the line of march would be warranted are:

- a. the ground may not allow for a “conventional” fire base; and
- b. the enemy position is weak and could be overrun easily, particularly if speed and violence are employed.

14. As soon as the combat team commander has given orders, the combat team will adopt the formation illustrated in the following figure:

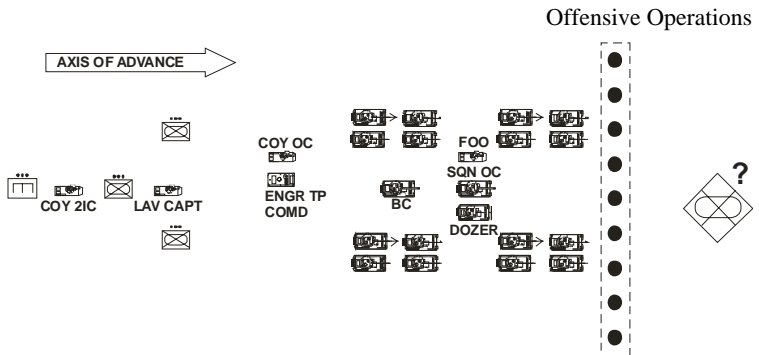

Figure 2-9: Atk from the Line of March

15. **Combat Functions:**

- a. **Command.** Speed of execution is paramount. The combat team commander must maintain momentum by executing the attack as soon as possible.
- b. **Firepower.** Indirect fire might not be adjusted if the attack is launched before the FOO has adjusted fire on targets. That should not stop the combat team commander from launching the attack as soon as possible. Because of limited time, it is unlikely that an elaborate fire plan could be developed; it is likely that the fire plan would consist of a series of predicted targets as in a continuous fire support plan (CFSP), i.e., on call. The employment of indirect tank smoke should be considered. Consideration should also be given to using the LAV for intimate support to the company.

HASTY ATTACK ON CONVERGING AXES

16. **General.** The conditions in which an attack on converging axes would be warranted are:

- a. the objective can be easily split into two distinctive parts that could be attacked simultaneously; and
- b. deception of the enemy is of particular importance.

17. **Conduct.** The hasty attack on converging axes will be conducted as follows:

Combat Team Operations (Interim)

- a. upon receiving orders from the combat team commander, the combat team will split into two assault forces;
- b. armoured, infantry and engineer assets would likely be grouped in each of the assault forces; and
- c. the fire base must be in a position to observe both approaches.

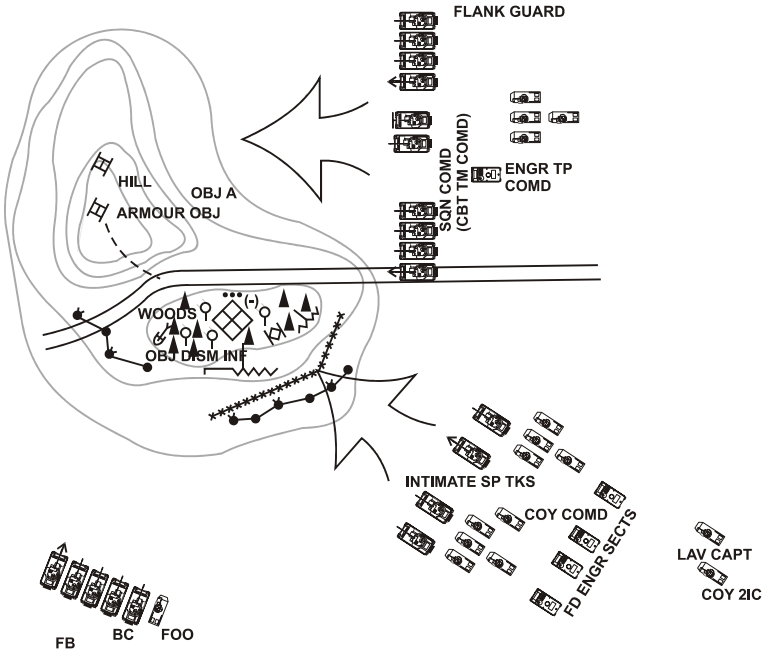

Figure 2-10: Armour/Inf Hasty Atk on Converging Axes

18. Combat Functions:

- a. **Command.** During his estimate, the combat team commander will have to assess whether the advantages of executing an attack on converging axes—deception and confusion imposed upon the enemy—outweigh the disadvantages. For example, command and control of two assault forces will likely present significant challenges such as coordination of H hour and control of fire during the fight through to avoid fratricide. Additional time required for coordination of attack may also present

some risks, e.g., loss of momentum, added exposure to enemy direct and indirect fire, etc.

- b. **Firepower.** Synchronization of the direct and indirect fire plans will necessitate special consideration. Priority of fire must be determined by the combat team commander.

HASTY ATTACK WITH ARMOUR IN FIRE BASE WHILE INFANTRY ASSAULTS

19. **General.** The conditions for conducting a hasty attack with the armour remaining in the fire base while the infantry assaults are as follows:

- a. the ground does not allow armour to move through the enemy position but tanks are on the objective;
- b. the momentum of advance by armour is maintained; and
- c. assist transit to pursuit.

20. **Conduct.** A hasty attack with armour remaining in the fire base while infantry assaults will be conducted as follows:

- a. the squadron will move to the fire base;
- b. the infantry company will move to the attack position with an engineer troop minus; and
- c. part of the squadron could be launched to conduct an envelopment shortly after H hour.

Combat Team Operations (Interim)

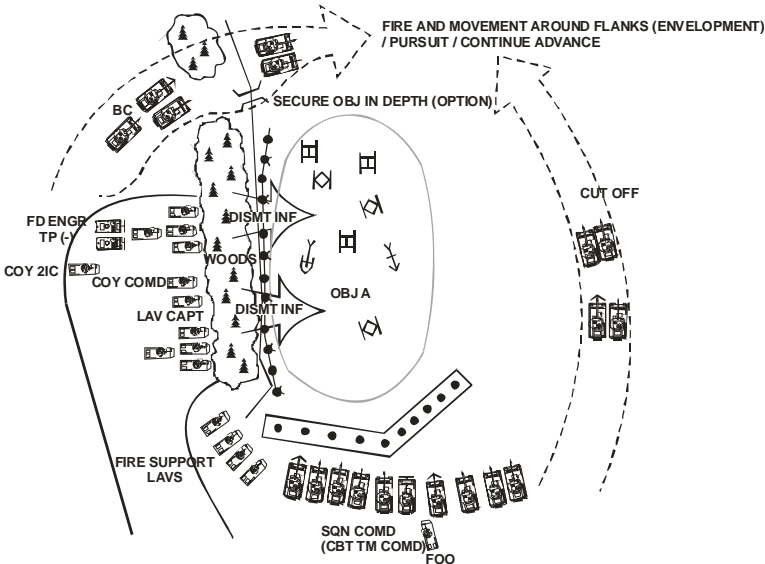

Figure 2-11: Armour in Fire Base While Inf Assaults

21. **Combat Functions:**

- a. **Protection.** Artillery/mortar danger close limitations and orders for fire base check firing must be carefully considered in relation to dismounted infantry.

HASTY ATTACK ASSAULT AND FIGHT THROUGH

22. **General.** This TTP details the actions of a combat team during the assault/break-in/fight through of a hastily prepared enemy position *after* the breach of an obstacle.

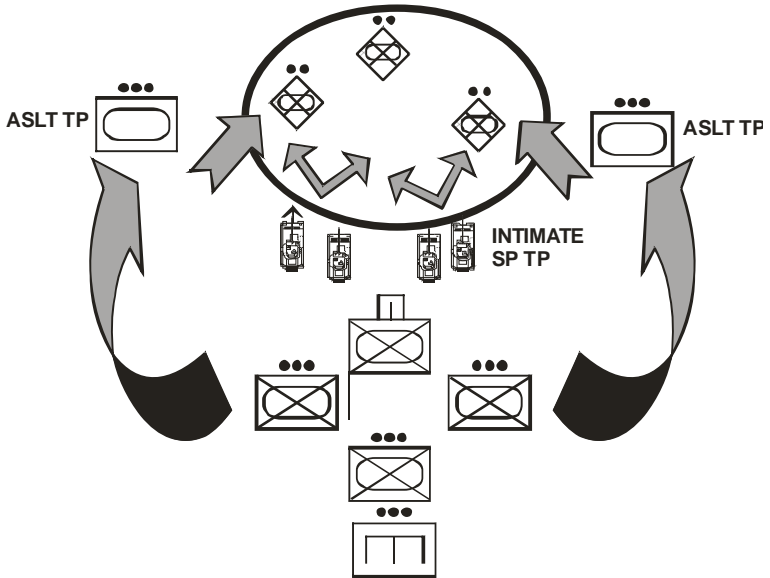

Figure 2-12: Break-in, Initial Approach

23. **Break-in (Figure 2-12).** Actions of the combat team after it is beyond the obstacle are:

- a. The assault force closes rapidly to the objective. Speed is critical.
- b. The assault tank troops manoeuvre along the flanks of the position to neutralize the initial platoon objectives and to suppress any depth positions.
- c. The intimate support troop and the LAVs concentrate on the initial platoon objectives and try to suppress any enemy fire. All known and suspected enemy trenches must be neutralized.
- d. Intimate support tanks guide platoons to gaps and objectives.
- e. Infantry platoons must remain close to intimate support tanks.

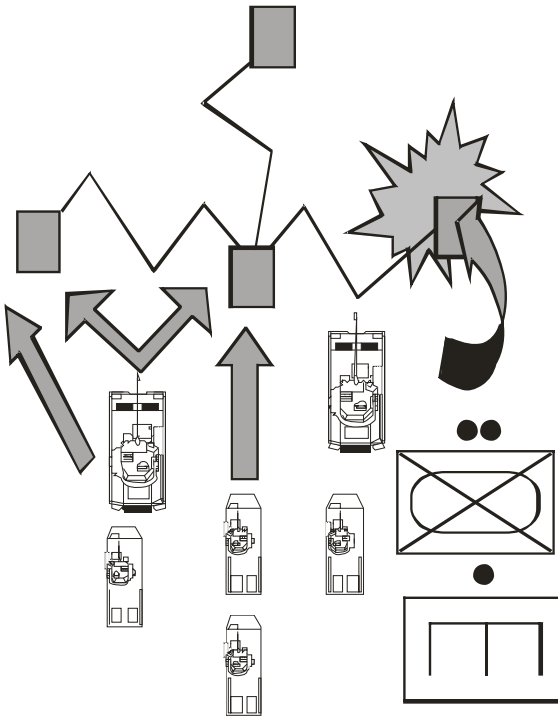

Figure 2-13: Break-in, the Edge of Enemy Position

24. **Break-in (Figure 2-13).** Actions of the combat team once the intimate support tanks and the platoons are on the edge of the trenches are:

- a. Intimate support tanks and LAVs continue to neutralize lead trenches.
- b. Infantry dismounts on order behind intimate support tanks and maintain communications with tanks through tank phone or radio. Options include dismounting short, on or plus of the objective.
- c. Intimate support tanks and LAVs continue neutralizing fire at the point of attack for the break-in by the dismounted infantry into the enemy trenches.
- d. Infantry section commanders report to tank crew commanders when ready for break-in.

- e. Intimate support tanks shift fire to depth targets.
- f. Infantry sections break into the enemy trenches.
- g. Field engineer sections clear wire obstacles as well as support infantry in trench clearance.

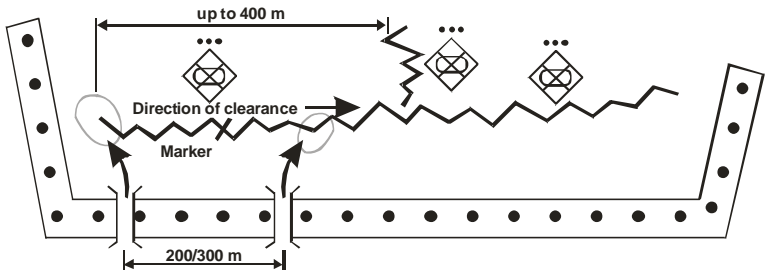

Figure 2-14: Break-in of a Trench System

25. Break-in of a Trench System:

a. Two Lanes:

(1) Break-in Point and Trench Clearance.

Should the combat team use two lanes through the enemy obstacles, the combat team will then enter the trench system through two break-in points. The second break-in point (the one along the direction of clearance) must mark its position inside the trench system to indicate that friendly forces are around the next bend or corner.

(2) Order of March Through Lanes. See Section 1 for hasty attack with obstacles (two lanes), pages 11 and 17.

b. One Lane:

(1) Break-in Point and Trench Clearance.

Should the combat team use only one lane through the enemy obstacles, the combat team will then enter the trench system through one break-in point. Looking at the enemy position, if it is the right edge of the enemy position, the infantry will clear the trench system to the left using the normal

trench clearance drills. Likewise, if it is the left edge of the enemy position, the infantry will clear to the right.

- (2) **Order of March Through Lane.** See Section 1 for hasty attack with obstacles (one lane), pages 13 and 18.

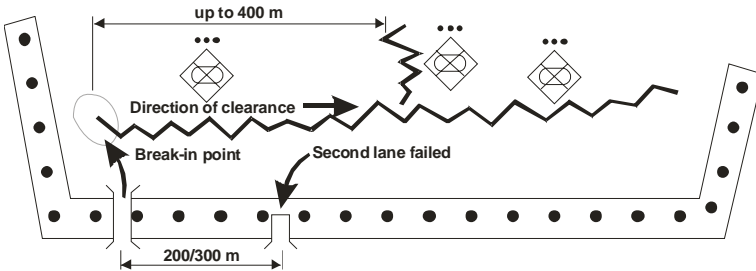

Figure 2-15: Break-in of Trench System—One Lane

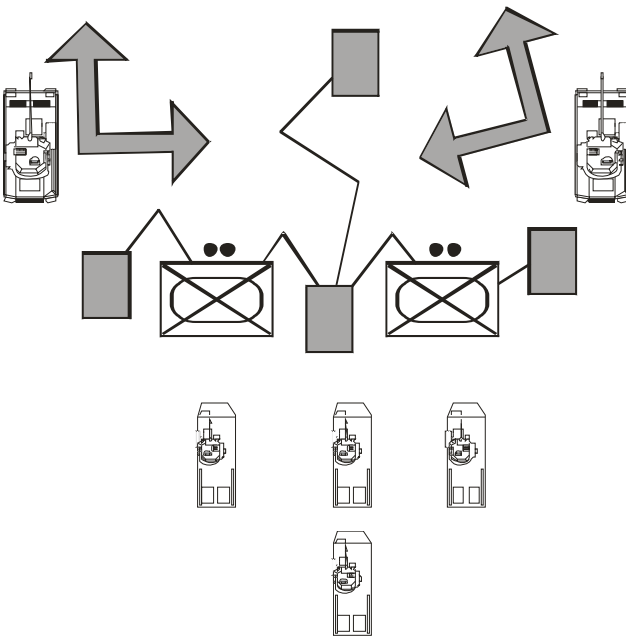

Figure 2-16: Fight-through

26. **Fighting Through** (Figure 2-16). Actions of the combat team after the infantry has broken into the enemy trenches are:

- a. The infantry fights through and clears the trench system.
- b. LAVs continue to provide intimate support, however, LAVs may be employed in flank security.
- c. Intimate support tanks move along flanks to neutralize depth positions and prevent enemy reinforcements from moving forward. Intimate support tanks remain until released by the dismounted company commander using the codeword **PUNCH**.
- d. The depth platoon can remain mounted if not committed.
- e. The infantry clears through to the depth and consolidates on or off the position. See “Hasty Attack Consolidation”, page 30.
- f. Tanks move to position to secure the objective and push on as detailed to limit of exploitation.

27. **Combat Functions:**

- a. **Command:**
 - (1) Company OC fights dismounted the battle.
 - (2) Squadron OC focuses on the area surrounding the objective to isolate the position and destroy counter-attacks. Control options for the tanks and Zulu LAVs, which are under the control of the LAV Capt, are as follows:
 - (a) squadron commander commands all, i.e., controls Zulu LAVs through LAV Capt;
 - (b) LAV Capt and LAVs remains under control of infantry company commander; and
 - (c) LAV Capt acts independently.
 - (3) The plan must consider the orientation of the enemy position in reference to the direction of attack.

Combat Team Operations (Interim)

- (4) The combat team commander must decide if objectives will be taken in succession or simultaneously. This will determine the degree of depth and the need for mounted or dismounted platoons.
 - (5) Control measures for consolidation and limits of exploitation must be given.
 - (6) Troop leader(s) of intimate support troop(s) will operate on company radio frequency—after implementation of Tactical Command, Control, and Communications System (TCCCS), radio frequency will be the “dismounted frequency”—until released by the company OC.
- b. **Protection.** If depth platoon remains mounted, it should focus on all-arms air defence (AAAD) by observing likely attack helicopter fire positions around the objective.
- c. **Firepower:**
- (1) The fire plan (direct and indirect) remains simple and focuses on neutralizing targets during the approach to the objective and isolating the position from supporting enemy locations. This should also include likely attack helicopter fire positions.
 - (2) Indirect and direct fires should be shifted in depth to prevent enemy vehicles from reinforcing the position or enemy withdrawal and disrupt any possible enemy counter-attack.
- d. **Sustainment.** The A1 echelon remains concealed until the position is secured and it is called forward.

CONSOLIDATION

28. **General.** This TTP covers the actions of a combat team after the fight through (see “Hasty Attack Assault and Fight Through”, page 24 for details on fighting through).

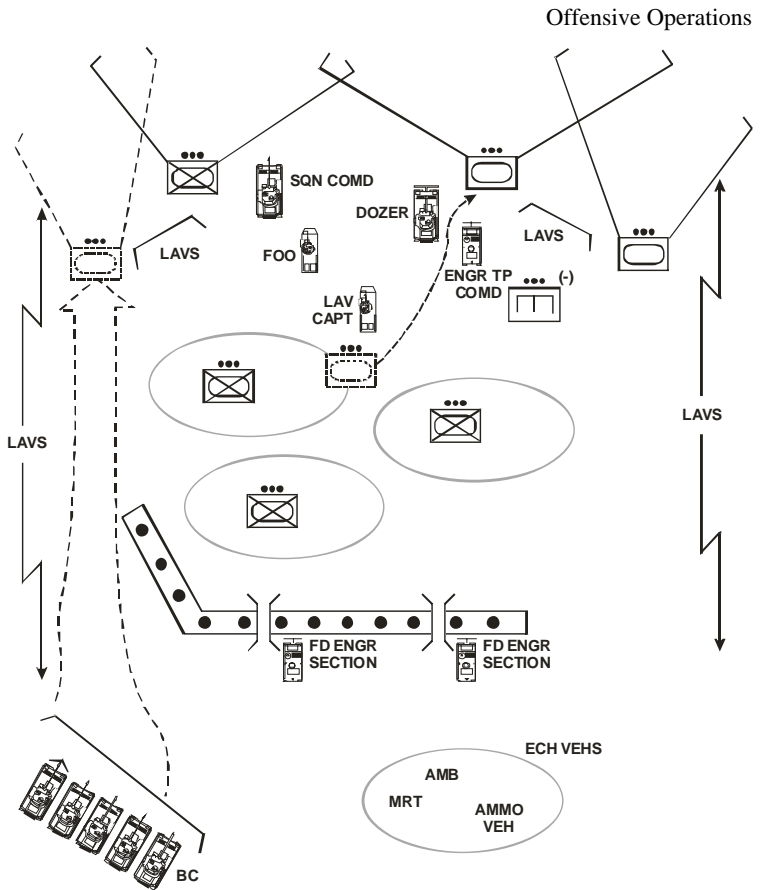

Figure 2-17: Hasty Atk Consolidation

NOTE

Possible LAVS tasks: remain on obj; flank protection; block possible counter-attack routes.

29. **Conduct.** The hasty attack will be consolidated as follows:
 - a. Consolidation could either take place on the objective, as shown on figure 2-17, or beyond it. The decision will be based on:
 - (1) what is the best ground in relation to the follow-on task;
 - (2) the exploitation policy; and

Combat Team Operations (Interim)

- (3) the importance given to protection provided by enemy defensive positions.
- b. The combat team needs to quickly adopt a hasty defence posture.
- c. Assault tanks and LAVs will move forward and secure flanks, cover possible enemy counter-attack approaches and engage withdrawing enemy. Consideration should be given to the limit of exploitation before launching into a pursuit (see “Hasty Attack Pursuit Operations”, page 35 for details on conduct of pursuit).
- d. Infantry crew-served weapons will be dismounted and sited by the company OC to cover most likely enemy counter-attack approaches. Once this is done, the infantry company OC will order a sweep of the objective in order to destroy or capture all remaining enemy and collect casualties.
- e. The fire base can either stay in location or move forward. Decision will be based on best location available to cover approaches on flanks and beyond objective area.
- f. Once situation is stabilized, casualty and prisoner of war (PW) evacuation will take place. A1 echelon will move forward under the control of the squadron sergeant-major (SSM) to conduct replenishment of combat supplies.

30. **Combat Functions:**

- a. **Command:**
 - (1) During the consolidation stage, the combat team commander should be focused on the following:
 - (a) regaining control over his organization;
 - (b) defeating a possible enemy counter-attack; and
 - (c) any remaining task(s), with the main possibilities being:

- i. hasty defence;
 - ii. resuming the advance(maintaining momentum is then important);
 - iii. supporting forward passage of lines; and
 - iv. exploiting any tactical opportunity, e.g., pursuit.
- (2) Frequent SITREPs must be sent to BG HQ during this critical stage of the battle. A consolidated SITREP including combat strength remaining and number of wounded, missing and killed in action are of particular importance along with ammunition status such as MASH (for tanks) and emergency ADREPs, etc.
- (3) The combat team commander should consider replacing key losses by doing the following:
 - (a) utilizing personnel from disabled vehicles;
 - (b) ensuring all command positions are filled; and
 - (c) ensuring key weapons systems are manned.
- b. **Information Operations.** All around defence and observation (including AAAD) is critical to avoid being surprised by an enemy counter-attack coming from an unexpected direction. Observation posts (OP) to cover unobserved/concealed approaches have to be deployed soonest.
- c. **Manoeuvre.** Marking of all obstacles is to be done if follow-on forces are to move through the objective area.
- d. **Firepower.** Indirect fire assets will focus on defensive fire (DF) in depth. DFs should be sited on

Combat Team Operations (Interim)

possible enemy counter-attack approaches and withdrawal routes.

e. **Protection:**

- (1) If consolidation is conducted in the immediate vicinity of the objective, enemy trenches should be used by dismounted infantry and for casualty collection points.
- (2) If time and resources are available, consideration should be given to the siting of a protective obstacle and the development of the position if it is considered that the combat team will remain.
- (3) Possible tasks for field engineers include the following:
 - (a) clear booby-traps in trenches;
 - (b) lay point obstacles such as nuisance minefields (surface laid) to increase flank protection;
 - (c) clear wire obstacles that impede the movement of combat team elements on or around the objective; and
 - (d) improve the breached lanes to facilitate the movement of A echelon vehicles.
- (4) Possible tasks for LAVs include the following:
 - (a) blocking possible counter-attack routes;
 - (b) flank protection; and
 - (c) mounted protection against enemy volumetric munitions.

f. **Sustainment.** The focus will be on resupply and medical evacuation. If not enough combat supplies are available from the A1 echelon to fully replenish

the combat team, redistribution must be considered. Emergency repairs could be necessary in order to carry on with any follow on task. The company sergeant-major (CSM) will establish casualty collection point and coordinate casualty evacuation. PW evacuation will be conducted if necessary.

PURSUIT OPERATIONS

31. **General.** This TTP covers the action of the combat team in the pursuit.

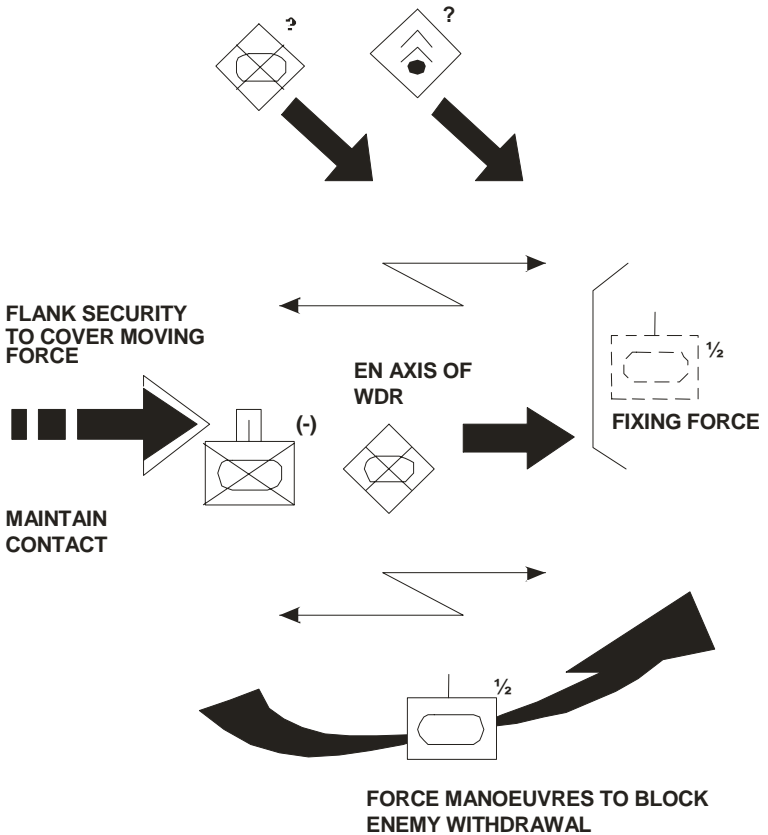

Figure 2-18: Combat Team Pursuit Operations

32. **Concept:**

- a. Pursuit operations are normally conducted following successful offensive or defensive operations. They are mounted to exploit tactical opportunities and prohibit the enemy from being able to withdraw in an orderly fashion and establish a cohesive defence. The pursuit seeks to destroy enemy cohesion through force destruction.
- b. Pursuits usually develop quickly and will require maximum use of radio orders. Regrouping is unlikely and battle procedure will be compressed. Pursuing units must be committed in time to ensure pressure is maintained on the withdrawing enemy force.
- c. Bold action is required during pursuits. Risks must be accepted by the force commander. In order to destroy an enemy, a pursuit force must first fix the enemy. A fixing force can seize ground of tactical importance in depth in order to accomplish this task. The striking force maintains pressure to ensure the enemy does not establish a defensive posture. Once the fixing force blocks the withdrawal of the enemy units, the striking force will then manoeuvre to destroy enemy.

33. **Combat Functions:**

a. **Command:**

- (1) Combat estimates must be rapid with a constant review of the mission analysis to ensure the pursuit conforms to the superior commander's intent.
- (2) The commander must be flexible to deal with unexpected events. The commander must also be well forward to deal with a rapidly changing tactical situation.
- (3) Plans must be clear, simple and flexible to allow subordinate commanders freedom of action.

- (4) The need for alternate means of communications over long distances (e.g., radio rebroadcast) should be considered.
 - (5) If time and authorization permits (requested through BG HQ), scatterable mines should be considered to fix the enemy or provide flank security.
- b. **Information Operations.** Little opportunity will be available for a detailed recce during a pursuit. The commander must rely on forces in contact for combat intelligence.
- c. **Protection:**
- (1) Consider whether the Nuclear, Biological and Chemical Defence (NBCD) posture and measures should be changed prior to commencing the pursuit.
 - (2) A pursuing force must establish security elements sufficient to prevent surprise of the force while retaining combat power. In other words, risk versus concentration should be considered. A force will cover its flanks by detaching an element or by adopting a tactical formation suited to the threat.
 - (3) AAAD policy must receive a high consideration due to likelihood of operating outside of friendly AD coverage (e.g., anti-helicopter sentries).
- d. **Manoeuvre.** Momentum is maintained by rapid and bold movement into the depth of the enemy area of operations. Strong points should be bypassed and gaps exploited. There will be a high probability of meeting engagements. The need for armoured engineers for mobility should be considered.

Combat Team Operations (Interim)

e. **Firepower:**

- (1) Firepower should be coordinated with the FOO to determine limitations to fire support.
- (2) Depth fire should be used to fire into retreating enemy columns to keep them off balance and to prevent reorganization, reinforcement or respite from pressure.

RADIO WARNING ORDER (WNG O)

CHARLIE CHARLIE _____ THIS IS _____ WNG O IN _____ MINS ...
OVER.

CHARLIE CHARLIE _____ THIS IS _____ WNG O:

SIT: EN (Strength) _____

LOC AT GR _____ FACING _____

MSN _____

EXEC LEFT FLANKING FRONTAL RIGHT FLANKING
_____ UP _____ PHASES

ASSAULT FORCE C/S _____ WITH C/S _____ COMMANDING

FIRE BASE C/Ss _____ AT GR _____ C/S _____ COMMANDING

C/S _____ TO PROVIDE INTIMATE SUPPORT

BREAK-IN TMS WITH C/S _____ AND C/S _____

FOO LOC GR: _____

CUT OFF C/S _____ FROM GR _____

RV AT GR _____

RTE TO RV _____

C/S _____ TO SECURE RV ASAP

ORDER OF MARCH IS _____

ATTACK POSITION GR _____ FACING _____

FIRE PLAN _____

H-HOUR NOT BEFORE _____

ORDERS IN _____ MINS IN RV ATTACK POSITION

ACKNOWLEDGE...OVER.

NOTE

Info given in the Wng O does not have to be repeated but can be confirmed in the orders.

RADIO ORDERS

CHARLIE CHARLIE _____ THIS IS _____ ORDERS IN ONE MIN...OVER.

CHARLIE CHARLIE _____ THIS IS _____ ORDERS:

SIT NO CHANGE.

MSN CONFIRMED.

EXECUTION CONFIRMED LEFT FLANKING FRONTAL
RIGHT FLANKING

ASSAULT FORCE:

C/S _____ LEFT, C/S _____ CENTRE, C/S _____ RIGHT
AND INDIA _____

BREACHING TEAMS WITH C/S _____ AND C/S _____

C/S _____ TO PROVIDE INTIMATE
SUPPORT

FIRE BASE CONFIRMED C/S. _____ FM GR _____

C/S _____ IS AUTH TO CHECK FIRE

CUT OFF CONFIRMED C/S _____ FROM GR _____

RESERVE C/S _____

FLANK SECURITY C/S _____

ATTACK POSITION CONFIRMED AT GR _____ SECURED BY
C/S _____

ROUTE TO ATTACK POSITION _____

LD _____ SECURED BY C/S _____

Combat Team Operations (Interim)

ROUTE TO OBJECTIVE _____

H-HOUR IS AT _____ HRS

DISMOUNT _____

CONSOLIDATION _____

LIMIT OF EXPLOITATION _____

FIRE PLAN (TARGETS, TIMINGS AND EFFECT) _____

DF TARGET GR: _____

C/S _____ AUTH TO CHECK FIRE _____

ORDERS FROM TANGO INDIA IN _____ MINS

SECTION 2 OBSTACLE BREACHING

ACTION ON MINE CONTACT

34. **General.** This TTP details the actions of the combat team when one of the lead vehicles strikes a mine during the advance to contact.

35. In the event of a mine strike during the advance to contact, the following action is to be taken:

- a. the contact is reported;
- b. vehicles forward or adjacent to strike immediately adopt fire positions with minimal movement (see “Warning, Security, Recce and Plan”, page 5);
- c. depth vehicles adopt positions of fire covering the forward vehicles;
- d. the combat team commander assesses the situation;
- e. if no enemy direct fire into the obstacle area:

- (1) and the mined area cannot be bypassed, the combat team will conduct a hasty minefield

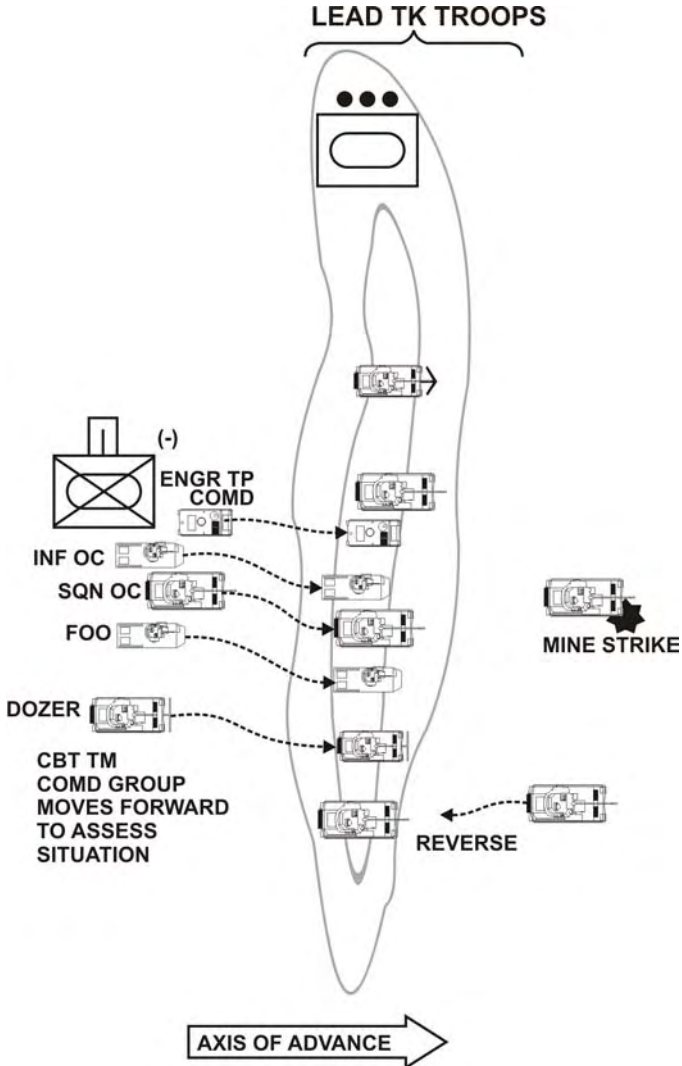

breach in the effort to clear two lanes (see “Obstacle Breaching Hasty Minefield Breach”, page 43); or

Figure 2-19: Action on Mine Contact

Combat Team Operations (Interim)

- (2) and the mined area can be bypassed, the combat team will continue the advance and the following drill will be conducted:
 - (a) forward and adjacent vehicles will reverse out of the mined area;
 - (b) the crew of the vehicle that struck the mine will either remain with the vehicle or extract themselves from the vehicle and minefield depending on the tactical situation; and
 - (c) the combat team will inform BG HQ of the vehicle casualty status and location for recovery; or
- f. if enemy direct fire into the obstacle area, the following drill will be conducted:
 - (1) the enemy will be suppressed immediately using the most expedient combination of direct and indirect fire and smoke;
 - (2) the situation will be assessed (i.e., mission analysis) by the combat team commander to determine the appropriate course of action, e.g., attack, fix or bypass the enemy; and
 - (3) when the enemy has been suppressed, the vehicle and personnel casualties will be extracted as described above—an engineer field section supported by an appropriate protection party should be deployed to clear a path to the vehicle that sustained the mine strike.

36. **Combat Functions:**

- a. **Information Operations.** As soon as a mine is struck, the combat team commander should focus his efforts on defining the obstacle and identifying a way around. The “far target indicator” of the LAV can be used to confirm the exact grid of the mine strike.

- b. **Manoeuvre.** If lanes through the obstacle are to be attempted, refer to “Obstacle Breaching Hasty Minefield Breach”, page 43.
- c. **Protection.** The portion of combat team not involved in suppressing the enemy will remain in a position concealed from enemy observation and fire. Safe distances must be considered in the employment of indirect fire.
- d. **Sustainment.** It is likely that the combat team will not have the maintenance resources to repair a vehicle that has struck a mine. Casualties will have to be left in location and recovered by BG/brigade resources. However, the vehicle should be extracted from a minefield area if possible. If A1 echelon vehicles are sent forward to recover vehicle or personnel casualties, the lane created by the vehicle that struck the mine will be used. If the area is secure, obstacle breaching resources integral to the combat team (ploughs, field engineer, etc.) will be used to improve the lane.

HASTY MINEFIELD BREACH

37. **General.** This TTP contains a description of the combat team executing a hasty minefield breach as part of a hasty attack. The description will cover actions from attack position to completion of the breach. The breach of two lanes should be attempted for every lane required. At the combat team level, the norm is to attempt two lanes. Normally, tank rollers will only be used for a deliberate breach as rollers are normally held in the squadron A2 echelon.

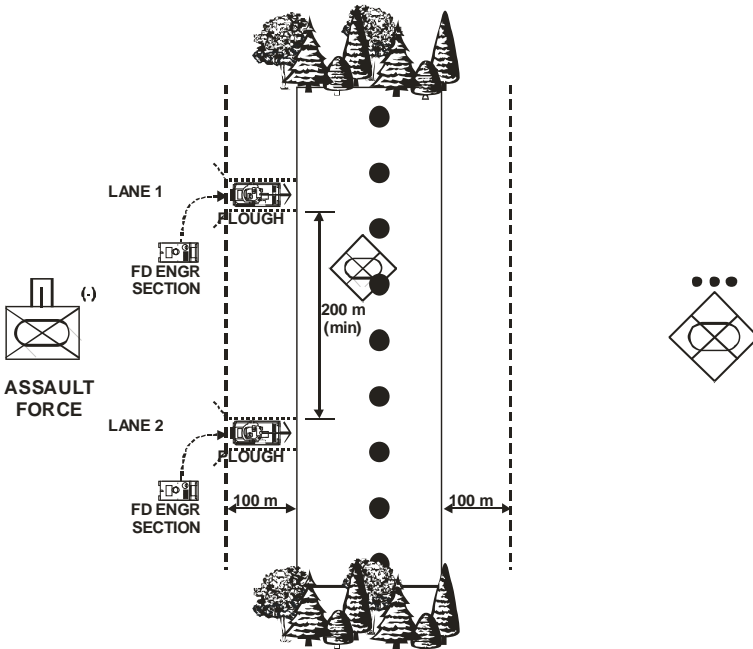

Figure 2-20: Hasty Minefield Breach, Initial

38. **Sequence of Events.** A hasty minefield breach will be conducted as follows:

- a. If possible, the forward edge of minefield along with lanes to be cleared (plough lanes) will be identified by engineers and marked to include the direction of the breach.
- b. The breaching teams, composed of field engineers set and plough tanks, will form in the attack position.
- c. Plough tanks mounted with Safe Lane Under armour Marking Systems (SLUMS) will begin ploughing 100 m short of the known/suspected edge of minefield at the area indicated by the engineers.
- d. If the threat of direct and indirect fire is low:
 - (1) the engineer section following the plough tank will pull off to the right-hand side of the entrance (positioning the section vehicle

to the right of the plough scar so as to not block the lane) and start constructing a funnel (See Figure 2-20); and

- (2) the engineer section will mark and prove the lane by doing the following:
 - (a) marking the funnel entrance;
 - (b) removing the mines that have fallen into the track (the mines on the berm will be dealt with by the engineers if required);
 - (c) once the lead plough is approximately 50 m into the minefield, commencing to mark the right-hand side of the lane (lane marking personnel move mounted, standing on the open APC ramp, throwing the lane placing markers from the vehicle ramp or dismounting personnel only as necessary to place markers); and
 - (d) ensuring markers are a minimum of one metre high to enable crews to see them while driving hatches down.
- e. The engineer section will report when approximately 75 percent of the minefield is clear. Immediately, the second engineer section will report on their progress.
- f. If the lead plough tank becomes a casualty, the engineer section will close with the tank, and the plough tank from the breaching reserve, on order, will continue to breach, bypassing the casualty to the left.
- g. The plough tanks will seek fire positions on the far side of the minefield (see Figure 2-21).
- h. The engineer section vehicle will stop at the end of the minefield and park at the right-hand side

Combat Team Operations (Interim)

identifying the end of the lane. A funnel will be created as part of lane improvement.

- i. The lane will be reported “open” by the engineer section to the combat team commander.

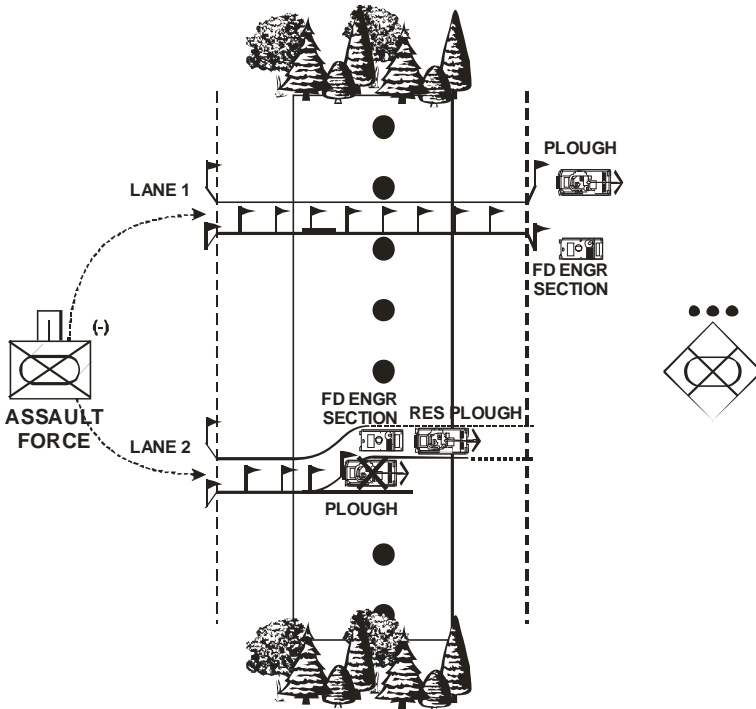

Figure 2-21: Hasty Minefield Breach

39. Combat Functions:

a. Command:

- (1) The combat team commander will have to make the decision of committing the assault force to one lane only or to two lanes when one of the lanes is 75 percent cleared. His decision will be based on progression in the other attempted lane.
- (2) H hour is when the breaching team crosses the LD.

- b. **Firepower.** Suppression and/or neutralizing of the enemy with direct and indirect fire while the breaching is conducted will be critical to the success of the operation.
- c. **Protection.** Lanes will be a minimum of 200 m apart but can be up to 300 m depending upon the tactical plan and dispersion desired. This is established on a dispersion requirement of 200 m for 122 mm and 300 m for 152 mm artillery. The advantages/disadvantages of separation must be weighed by the commander. They include the factors of command and control, concentration of force/dispersion and enemy layout.

COMPOSITE OBSTACLE BREACH

40. **General.** This section covers the actions of a combat team executing a breach of a composite obstacle—an obstacle that necessitates the commitment of more than one type of breaching resource (ploughs, rollers, armoured engineer vehicle (AEV), armoured vehicle-launched bridge (AVLB), etc.)—from the attack position to the completion of the breach. The following guidelines apply to executing a breach of a typical composite obstacle as shown in the figure below:

- a. a combat team can execute a breach of a composite obstacle as an independent task or when tasked as the breaching force of a BG deliberate breach;
- b. the breach of two lanes should be attempted for every lane required; and
- c. the following gaps can be crossed:
 - (1) AEV with fascine—8 m; and
 - (2) AVLB—20 m.

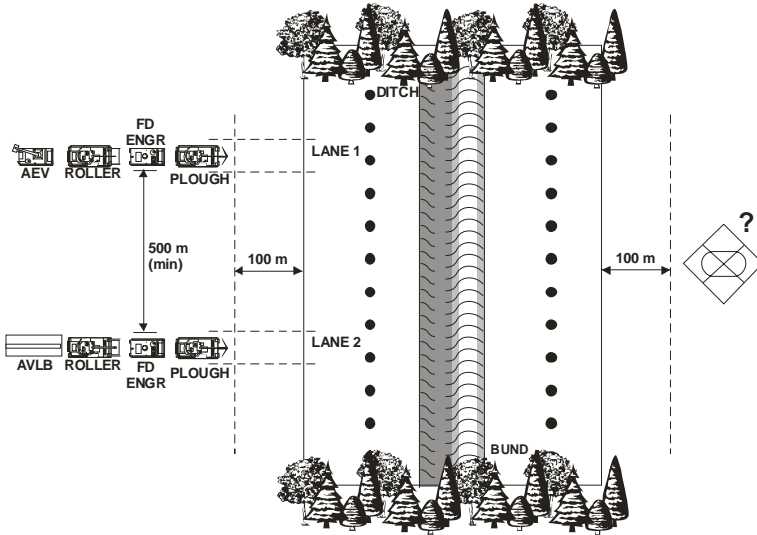

Figure 2-22: Composite Obstacle Breach, Initial

41. **Sequence of Events.** A breach of composite obstacle will be executed as follows:

- a. **Figure 2-22:**
 - (1) If possible, forward edge of minefield will be identified by engineer recce (not illustrated).
 - (2) The breaching teams will form up in the attack position under the control of the engineer section commander with the plough tank leading followed by the engineer section vehicle followed by the roller (if available) followed by the AEV or AVLB.

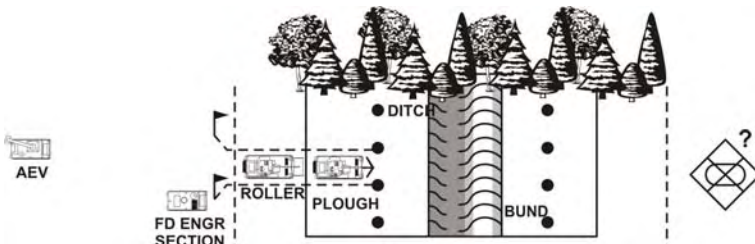

Figure 2-23: Composite Obstacle Breach, Step 1

b. Figure 2-23:

- (1) A plough tank mounted with SLUMS will begin ploughing 100 m short of the known/suspected edge of minefield and start ploughing towards the near side of the gap requiring breaching by the AEV or AVLB.
- (2) If the threat of direct and indirect fire is low, the engineer section following the plough tank will pull off to the right-hand side of the entrance (positioning the section vehicle to the right of the plough scar so as to not block the lane) and start constructing a funnel.
- (3) A roller tank (if employed) will prove the lane.
- (4) If the threat of direct and indirect fire is low and the roller is not employed, engineers will prove the lane by doing the following:
 - (a) marking the funnel entrance;
 - (b) removing mines that have fallen into the track (mines found on the berm will only be dealt with by the engineers if required);
 - (c) once the lead plough is approximately 50 m into the minefield, commencing marking the right-hand side of the lane (lane marking personnel moved mounted, standing on the open APC ramp, through the lane placing markers from the vehicle ramp or dismounting personnel only as necessary to place markers); and
 - (d) markers are a minimum of one meter high to enable crews to see them while driving hatches down.

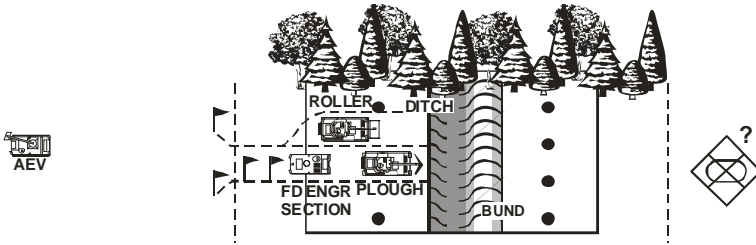

Figure 2-24: Composite Obstacle Breach, Step 2

c. **Figure 2-24:**

- (1) The engineer section will commence marking the right hand side of the lane. Lane marking personnel move mounted through the lane placing markers from the vehicle ramp or dismounting personnel are used only as necessary to place markers.
- (2) The roller will drive left of the lane before the ditch, park parallel to the lane and adopts a fire position.
- (3) The engineer section vehicle will stop to the rear of the plough tank leaving sufficient room for the tank to reverse.

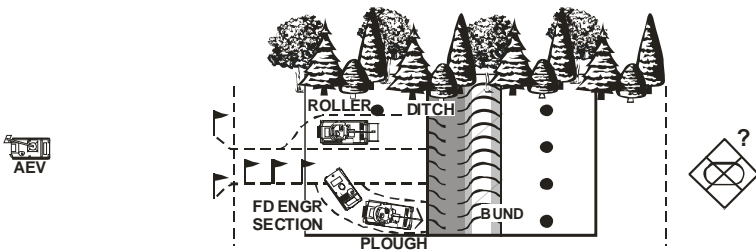

Figure 2-25: Composite Obstacle Breach, Step 3

d. **Figure 2-25:**

- (1) The plough will clear up to the ditch then reverse and plough a “cushion area” on the right hand side and adopt a fire position. The engineer section commander will ensure that the lane is proven for mines that

may have rolled back in behind the plough and guide the plough on the radio as it reverses.

- (2) The engineer section vehicle will follow the plough into the cushion area.
- (3) If the threat of direct and indirect fire is low, the engineer section will dismount and prepare the ditch as follows:
 - (a) **AEV/fascine:** clear bund, mark cleared area; and
 - (b) **AVLB:** clear bund and 5 m on far side, mark launch point for bridge on home side.

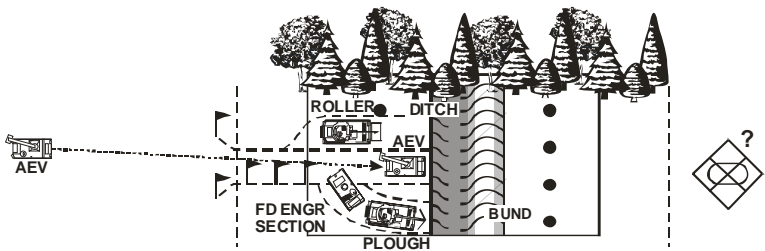

Figure 2-26: Composite Obstacle Breach, Step 4

- e. **Figure 2-26.** On order of the engineer section, the AEV/AVLB will move forward from the attack position and breach the obstacle.

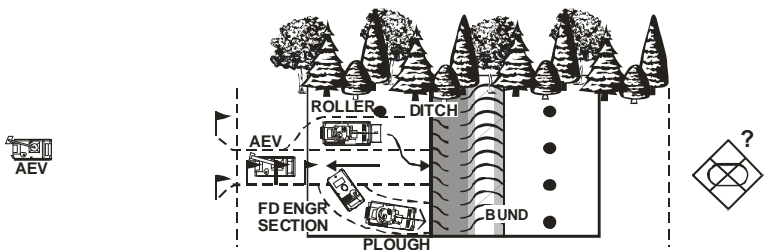

Figure 2-27: Composite Obstacle Breach, Step 5

- f. **Figure 2-27.** Guided over the radio by the engineer section commander, the AEV/AVLB will reverse 50 m to allow the roller sufficient room for the breach to continue. Once the AEV is clear of the roller, the roller will advance onto the lane.

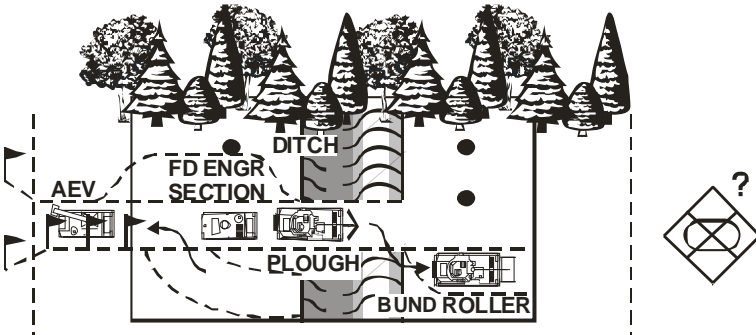

Figure 2-28: Composite Obstacle Breach, Step 6

- g. **Figure 2-28:**
- (1) Guided over the radio by the AEV/AVLB crew commander, the engineer section vehicle will back up on the lane.
 - (2) Guided by the engineer section commander, the plough will back up out of the cushion area and on to the lane.
 - (3) The roller will cross the gap first to prove it and then pull off on the right-hand side.
Note: the roller will deploy before plough because there is less of a “skip zone” as the roller moves off the fascine/bridge as compared to the plough.

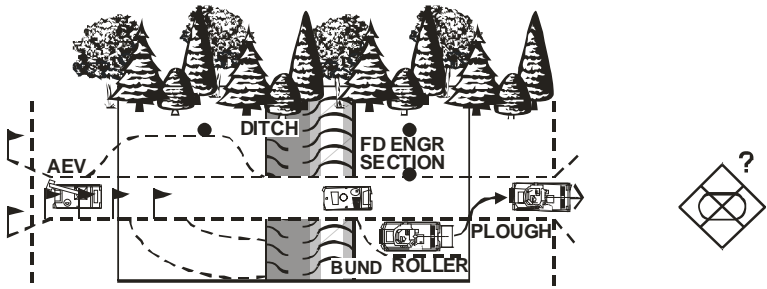

Figure 2-29: Composite Obstacle Breach, Step 7

h. Figure 2-29:

- (1) The plough will continue over the ditch and commence ploughing as soon as possible.
- (2) The roller will advance and follow the plough proving the lane.
- (3) The engineer section commander will report to the combat team commander that the ditch is breached and the section will follow behind the roller marking the lane. Immediately, the section commander of the second lane will send a SITREP.
- (4) The breach of the ditch will be a likely decision point for the combat team to commit.

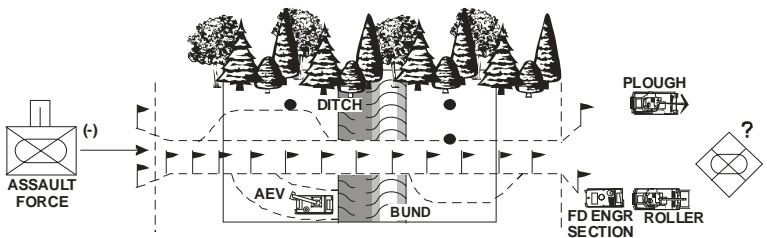

Figure 2-30: Composite Obstacle Breach, Assault Force Entry

i. Figure 2-30:

- (1) The AEV/AVLB will move into the cushion area vacated by the plough and remain at the ditch to maintain the crossing.

Combat Team Operations (Interim)

- (2) The plough and roller will exit the minefield and adopt fire positions.
- (3) The engineer section vehicle will stop at the end of the minefield and park to the right-hand side of the end of the lane identifying the end of the lane.
- (4) The assault forces will move through the lane and pass the engineer vehicle on the left side (for order of march refer to “Hasty Attack with One or Two Tank Troops in Fire Base” [Two Lanes, pages 11 and 17, One Lane, pages 13 and 18]).
- (5) Engineers will improve the safe lane as required.

42. **Combat Functions:**

a. **Command:**

- (1) Control of each lane during the breach is given to the engineer section commander operating on that lane. All breaching assets will be on the combat team net.
- (2) The relative complexity and the deliberate nature of a composite breach imply that it is a high risk operation.
- (3) The combat team commander has to make the decision to commit the assault force to one or two lanes based on the progression of the breaching.

b. **Firepower.** Suppression and/or neutralization of the enemy with direct and indirect fire while the breaching is conducted is critical to the success of the operation.

c. **Protection.** As a minimum lanes will be 200 m apart but can be up to 300 m depending upon the tactical plan and dispersion desired. This guideline is based on the dispersion requirement of 200 m for 122 mm and 300 m for 152 mm artillery. The advantages/disadvantages of separation must be

weighed by the commander. They include the factors of command and control, concentration of force/dispersion and enemy layout. There may be a requirement to expand the distance between the lanes subject to the commander's assessment for a BG operation.

CHAPTER 3 DEFENSIVE OPERATIONS

SECTION 1 DEFENCE

AREA AND MOBILE DEFENCE

1. **General.** This TTP covers the actions of the combat team in the defence.
2. **Area Defence:**
 - a. focuses on retention of terrain in accordance with commander's intent;
 - b. absorbs enemy into an interlocked series of arcs of fire upon which indirect fire is superimposed;
 - c. normally requires a relatively small reserve; and
 - d. emphasis is placed on depth within the position to break up enemy momentum.

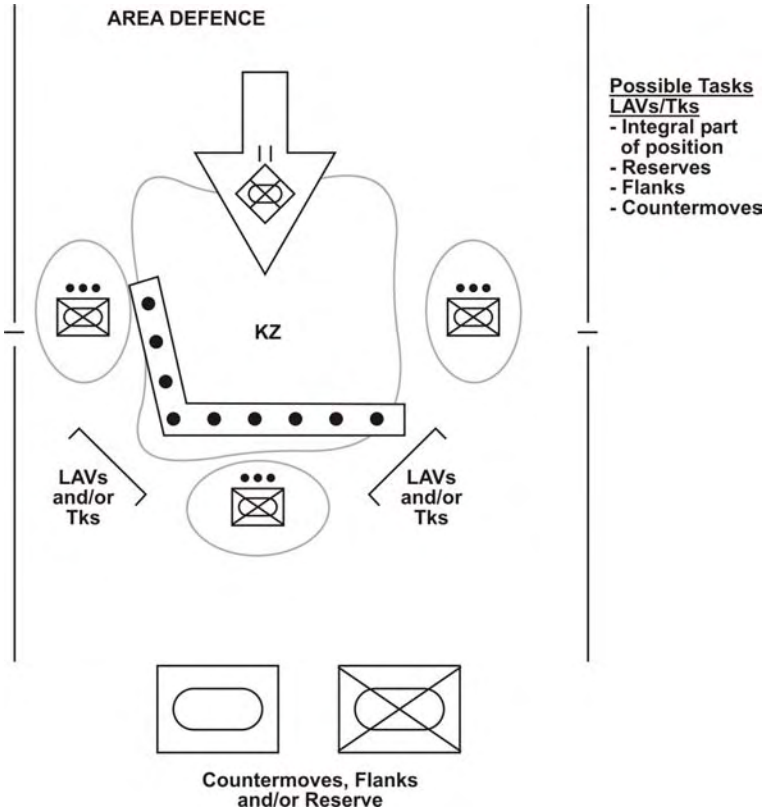

Figure 3-1: Illustrates an Area Defence

3. Mobile Defence:

- a. focuses on destruction of enemy in accordance with commander's intent;
- b. permits enemy to advance to a position(s) which exposes it to offensive operations;
- c. forward positions identify, shape, delay, and/or attrit enemy advance;
- d. canalizes enemy into killing zones (KZ);
- e. fixes enemy using depth elements; and
- f. striking force completes the destruction of the enemy by counter-attack.

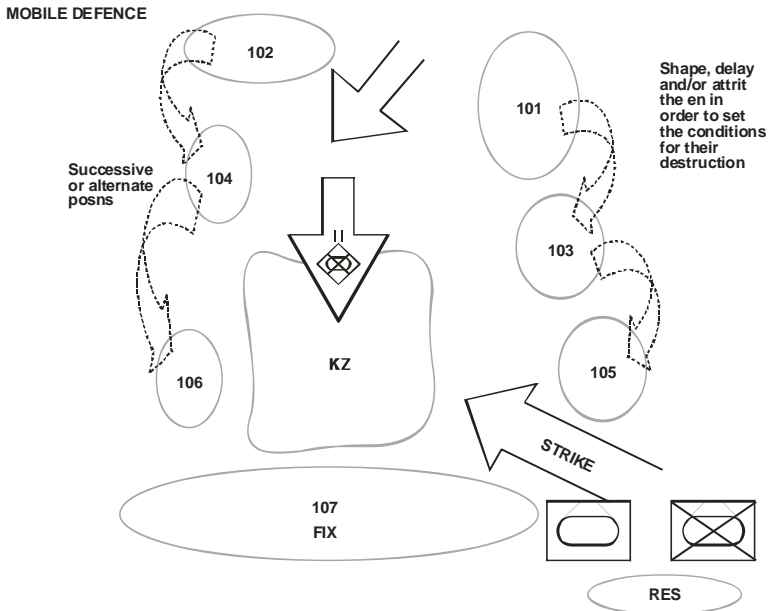

Figure 3-2: Illustrates an Area Defence

4. **Combat Functions:**

a. **Command:**

- (1) The locating of the commander requires special consideration to allow him to be in a position that best influences the battle.
- (2) **Division of a KZ.** A KZ is divided by engagement band, desired weapon effect, and for direct and indirect fire control. Control measures for KZ management are assigned using a matrix that includes the following information for each segment of the KZ:
 - (a) responsibilities by weapons system and call sign;
 - (b) open fire policy;
 - (c) description of the enemy to be destroyed;

Combat Team Operations (Interim)

- (d) location, arcs and method of identification (day and night);
- (e) mutually supporting call signs or weapons systems; and
- (f) alternate responsibilities.

DIVIDING A KILLING ZONE

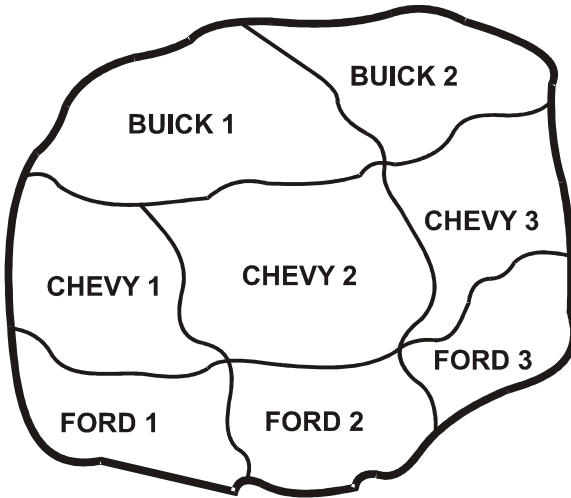

KZ HAWK

Figure 3-3: Dividing A Killing Zone

- (3) **Combat Estimate** (see Chapter 1, Section 3).
 - (a) **Enemy.** In the defence, commanders must focus on enemy intentions, capabilities and objectives within and through the combat team area of operations.
 - (b) **Ground.** A ground analysis must be done identifying the ground of tactical importance; possible enemy approaches (to, through and beyond own position(s)/

troops); and for each approach, identify the following:

- i. size of the enemy force in accordance with frontage of the approach;
 - ii. possible KZs;
 - iii. positions dominating KZs;
 - iv. possible obstacles;
 - v. positions of observation; and
 - vi. possible arty targets for DF and final protective fire (FPF).
- (c) **Own Troops.** Determine the impact of friendly troops on own flanks, moving into or through own area.
- (d) **Meteorology.** Analysis to determine the following:
- i. the time and additional resources required because of specific conditions (e.g., frozen ground will require engineer assets to dig); and
 - ii. the influence conditions (fog, rain, etc.) will have on enemy and friendly fire support in relation to visibility and enemy air threat (close air support and heliborne operations).
- (e) **Time and Space.** Clearly identify the following:

Combat Team Operations (Interim)

- i. the time necessary to prepare positions;
- ii. counter-move timings (if possible, conduct rehearsals by day and night); and
- iii. the time left for other activities such as emplacing protective obstacles, rehearsals, rest, etc.

(f) **Assessment of Tasks.** Possible tasks include the following:

- i. preparing and occupying positions (primary and alternate if required) to include clearing fields of fire (identify any additional resources required to clear);
- ii. covering KZs and secondary approaches with observation and fire;
- iii. conducting DF and FPF;
- iv. occupying positions for indirect fire observers;
- v. conducting surveillance and target acquisition (STA) tasks including OPs, listening posts, patrols, standing patrols, and observation and arcs of fire of all major weapons systems;
- vi. siting and emplacement of obstacles in accordance with barrier plan intent;

Defensive Operations

- vii. siting and emplacement of protective obstacles;
- viii. conducting counter-move tasks;
- ix. reserve (separate from counter-move force if possible);
- x. flank protection; and
- xi. rear area security.

(g) **Courses Open.** Reconcile courses open to assessment of tasks. Check best course against fundamentals of defence and principles of war:

- i. information gathering,
- ii. use of terrain,
- iii. coordination,
- iv. mutual support,
- v. depth,
- vi. manoeuvre,
- vii. firepower, and
- viii. reserves.

(h) **Plan.** Formulate plan in accordance with factors considered and the information derived from the combat estimate.

b. **Information Operations:**

- (1) As part of the BG intelligence, surveillance, target acquisition and reconnaissance (ISTAR) plan, develop the combat team STA plan. This plan will take into consideration 24/7 all weather coverage and all warning/observation devices such as night observation device long range

Combat Team Operations (Interim)

(NODLR), ground sensors, trip flares, LAV and Leopard C2 sight sensors, etc. (the STA trace to the BG HQ will also include arcs of observation, dead zones and areas of intelligence responsibility not covered).

- (2) Request additional intelligence from flanks and higher.
 - (3) Consider tactical deception, i.e.:
 - (a) use of dummy positions;
 - (b) track plan; and
 - (c) fire plan.
 - (4) Consider conducting counter-moves under radio silence until point of contact regardless of emission control (EMCON) policy.
- c. **Manoeuvre.** Counter-moves planning is conducted as follows:
- (1) develop counter-move plan (trace, including matrix, submitted to higher);
 - (2) possible tasks for counter-move elements are (consider all counter-moves as combined arms operations):
 - (a) reinforcing;
 - (b) counter-attack; and
 - (c) blocking;
 - (3) develop counter-move matrix with following headings: serial, loc, task, size, time by day, time by night, commander, route, decision points, liaison and other tasks;
 - (4) develop counter-move trace with following information: routes (primary and alternate) and blocking/fire positions;

- (5) consider navigation aids/markings and confirm counter-move routes are clear of obstacles; and
- (6) determine control measures, e.g., limit of exploitation and liaison.

d. **Firepower:**

- (1) **General.** Articulate and synchronize fire support and barriers with the anti-armour plan to achieve the desired effects. The anti-armour plan should include machine guns (MGs). All applicable firepower overlays are to be submitted to BG HQ.
- (2) **KZs—Divide KZ(s)** (see Figure 3-3). Site weapons to achieve desired weapons effects and site complementary weapons, e.g., for each anti-armour weapon, site an anti-personnel weapon. As well, set the open fire policy and set priority of targets by weapons system.
- (3) **MGs.** Consider dismounted approaches, and site MGs to cover possible dismounting areas and areas where enemy troop carriers could be hit by armour weapons causing the enemy to dismount.
- (4) **Fire Support Plan.** Fire support planning is conducted as follows:
 - (a) fire support plan is developed to include counter-moves;
 - (b) priority of effort is identified;
 - (c) observation to cover DF targets (three/four per combat team) to include one possible FPF (normally only one FPF per BG);
 - (d) effects of types of ammunition are selected, i.e., improved conventional munitions (ICM),

smoke on friendly and enemy plans is considered; and

- (e) consider danger close if targets are closer than 600 m. Fire unit footprints:
 - i. 155 mm battery is 200 m;
 - ii. 155 mm regiment is 300 m; and
 - iii. 81 mm mortar platoon is 150–200 m.

(5) **Siting Considerations:**

- (a) A ratio of 1 to 3 is used as a minimum (use combat multipliers to increase).
- (b) One infantry half section is required per crew served weapon.

e. **Protection:**

(1) **Barrier Planning**—synchronize fire plan and obstacles to meet the following intents:

- (a) **Disrupt**—cause the enemy to break up its formation and tempo. A disrupt group in a BG barrier plan—the location of the symbol is the general location of the obstacle group—provides the following information:
 - i. width of symbol—width of enemy approach;
 - ii. short arrows—general location where enemy is to be slowed; and
 - iii. long arrows—general location where enemy is to be shaped.

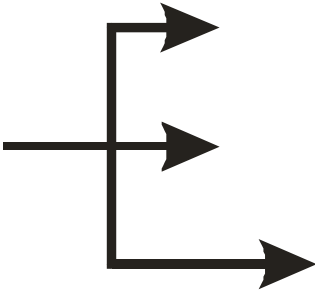

Figure 3-4: Disrupt

- (b) **Turn**—divert the enemy formation from one approach to another or into a KZ. The heel of the arrow is tied into impassable terrain.



Figure 3-5: Turn

- (c) **Fix**—slow an attack within a specified area, normally a KZ. A fix group in BG barrier plan represents the length and width of area in which enemy is slowed.

Combat Team Operations (Interim)

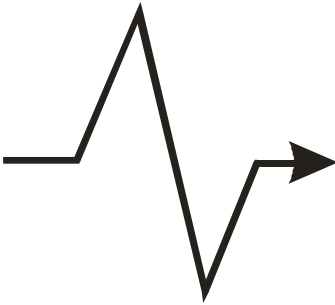

Figure 3-6: Fix

- (d) **Block**—halt the enemy along a specific approach or prevent him from exiting a KZ. A block obstacle group in a BG barrier plan provides the following information:
 - i. vertical line—where enemy is to be blocked; and
 - ii. ends of vertical line—tied into impassable obstacles.



Figure 3-7: Block

- (2) Enforce the AAAD policy.
- (3) **Defensive Stores.** The specifics of the company pack will be determined by resource availability. The stores in a company defensive pack should be sufficient for the construction of 34 two-man battle trenches, 17 crew served weapons trenches, a company command

post (CP) and a medical aid post. This means the digging-in of four C6 MGs, nine Eryx, four Carl Gustav, three platoon CP trenches, a company CP trench and all of the two-man trenches for the remainder of the company.

- (4) **Protective Obstacles.** Protective obstacles are emplaced by using combat team resources, i.e., not by the engineers, and must be documented. The company pack has enough concertina wire and pickets to emplace 300 m of type three cat wire fence. The remaining resources for protective obstacles, e.g., antitank mines, are controlled by BG and pushed down based on requirements. Combat team commanders must ensure that the request for these resources, based on their estimates, is sent to BG. Protective obstacles are not part of the barrier plan; however, they must still be covered by fire and observation. Principles for siting obstacles are:
- (a) obstacles should be covered with fire and observation;
 - (b) obstacles should deny covered approach to enemy;
 - (c) obstacles should mask the position;
 - (d) obstacles should be tied into natural features;
 - (e) obstacles should be concealed from the enemy; and
 - (f) obstacles should be sited in enough strength to achieve the desired effect.
- (5) **NBCD.** Confirm the mission oriented protective posture (MOPP) level to be adopted.

Combat Team Operations (Interim)

- f. **Sustainment.** The following sustainment actions are developed:
- (1) establish administrative plan;
 - (2) select locations for:
 - (a) echelons; and
 - (b) dumping of defensive stores.
 - (3) organize echelons to include composition of combat loads;
 - (4) develop a feeding plan;
 - (5) organize casualty evacuation (casualty collection point, placement of medical resources, etc.); and
 - (6) organize PW evacuation.

DEFENCE IN A BUILT-UP AREA

5. **General.** This TTP covers the actions of the combat team in the defence of a built-up area. The purpose of defending in a built-up area is normally to deny the enemy use of the routes through the built-up area. It is important to note that the TTP on defence (Area and Mobile Defence, page 57) is still applicable, and only the issues unique to the defence within this environment are discussed in this TTP.

6. **Concept:**

- a. Higher formation and BG covering force will provide early warning and information on enemy strength and approaches and will likely impose delay.
- b. The combat team perimeter guard is deployed, based on mutually supporting positions, to provide early warning, destroy enemy recce, separate infantry from armour and force the enemy to deploy. This force will cover obstacles, deceive the enemy as to the location of the main force and canalize the enemy. It will also be used as a disruption force. Upon completion of tasks, the perimeter guard may withdraw to the main position.

- c. The main defence area is based on strongpoints and the use of alternate positions to canalize the enemy into a KZ and complete the enemy's destruction through counter-moves. A centrally located reserve is imperative.

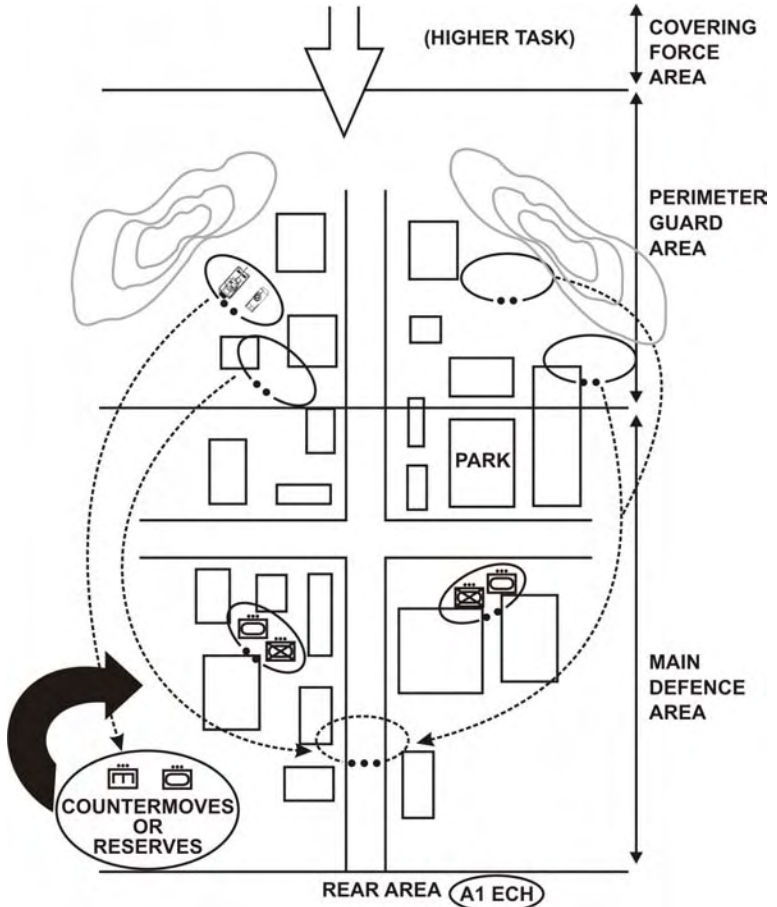

Figure 3-8: Defence in a Built-up Area

7. **Combat Functions:**

- a. **Command:**

(1) Commanders must:

Combat Team Operations (Interim)

- (a) clearly articulate the end state down to individual positions;
 - (b) have a centralized plan but decentralize execution;
 - (c) liaise with local authorities civil-military cooperation (CIMIC) as required;
 - (d) be located in a position to influence the battle and maintain presence in the area of stated main effort and/or where they can influence the battle;
 - (e) coordinate/establish sectors, report lines, boundaries and coordination points;
 - (f) communicate by land line, radio and established contingency plans; and
 - (g) establish a clear open fire policy and detail the conditions in which deployed troops may move.
- (2) Combat Estimate (see Chapter 1, Section 3).
- (a) **Enemy:**
 - i. An intensive recce effort will likely be conducted by the enemy to determine the combat team defence layout.
 - ii. The enemy formation will likely re-organize to attack the built-up area. In accordance with GENFORCE doctrine, the reinforced motorized rifle battalion will likely be formed into a “storm

detachment.” This basic organization will be reinforced with a tank company, an artillery battalion, an engineer company, anti-tank weapons, flame-throwers and air defence weapons and formed into two or three “storm groups.” These storm groups will likely utilize three dimensional avenues of approach, (e.g., subterranean approaches such as sewers).

(b) **Ground:**

- i. Do FLOCARK (Features, Lanes, Objectives, Canalizing ground, Approaches, Rate, and Key terrain and vital ground), taking into account the ground of tactical importance may be a building, and possible enemy approaches in order to look for a route through the built-up area or around it.
- ii. The KZ may be small. Look for parks or parking lots. If none are available, a KZ may have to be cleared.

(c) **Own Troops:**

- i. Aviation assets will conduct air reces, control indirect fire,

Combat Team Operations (Interim)

- reposition forces, casualty evacuation or delivery of CSS (combat service support).
 - ii. Engineers will be used for counter mobility tasks, obstacles, and preparation of the defence area, i.e., survivability and mobility tasks.
 - iii. Artillery may be used in the direct fire role depending on the effects of fire.
 - iv. Tanks will be used as an integral part of the strongpoint and for counter-moves, reserves, and anti-tank fire from prepared positions. Lack of mobility increases vulnerability (engineer mobility tasks).
- (d) **Time and Space.** Clearly identify the following:
 - i. the time necessary to prepare positions and a series of alternate positions, strengthen buildings, clear counter-move routes, and prepare withdrawal routes for forward positions; and
 - ii. the counter-move timings (if possible, conduct rehearsals by day and night).

- (e) **Assessment of Tasks.** Possible tasks include the following:
- i. prepare and occupy position to include clearing fields of fire, KZs, covered movement routes between positions, etc.;
 - ii. maintain a reserve of infantry separate from the counter-move force;
 - iii. locate sniper and marksmen forward for disruption and destruction of enemy command and control;
 - iv. task perimeter guard based on armour, anti-armour tank hunting teams, and indirect fire to shape, disrupt, canalize and attrit;
 - v. secure counter-move and withdrawal routes;
 - vi. locate and occupy positions for indirect fire observes well forward and on main effort;
 - vii. task air sentries and roof top surveillance; and
 - viii. block underground approaches such as sewers, basements, etc.
- b. **Information Operations.** See “Area and Mobile Defence”, page 57.

Combat Team Operations (Interim)

- c. **Manoeuvre.** Barrier planning lanes and gaps may be required for counter-moves forces. In order to conduct a counter-move:
- (1) contingency plans identified by code word must be put in place;
 - (2) develop counter-move plan for all levels including infantry counter-moves;
 - (3) possible tasks for counter-moves are:
 - (a) reinforcing strongpoints;
 - (b) counter-attack to recapture buildings; and
 - (c) blocking of routes.
 - (4) control measures must be clearly identified and routes marked.
- d. **Firepower:**
- (1) **General.** Fire support and barriers must be articulated and synchronized with the anti-armour plan to achieve the desired effects down to individual posts. Also, the best anti-armour weapon should be selected for use inside buildings.
 - (2) **KZs.** The following considerations should be taken into account when siting KZs:
 - (a) site weapons for most effective engagement ranges, as fields of fire will be limited;
 - (b) if sited in buildings, set weapons systems back from windows;
 - (c) siting of KZs and weapons systems must include sighting of all weapons systems; and
 - (d) open fire policies and priority of targets must be established for each weapons system.

- (3) **MGs.** The following considerations should be taken into account when siting MGs:
 - (a) dismantled approaches through alleys, parks, etc; and
 - (b) site MGs to fire on narrow arcs.
 - (4) **Fire Support Plan.** The fire support plan should include counter-moves and identify priority of effort. The following should also be considered:
 - (a) the effects (fire, creation of rubble, etc.) of certain types of ammunition; and
 - (b) the danger of collateral damage close to all targets:
 - i. artillery is normally fired with flat trajectory and therefore may hit tops of buildings, i.e., ensure targets are fired in depth; and
 - ii. 81 mm mortar provides high angle fire and therefore can more easily hit targets in defilade, i.e., over buildings.
- e. **Protection:**
- (1) **General.** The defensive stores list must include materials for the strengthening and reinforcing of buildings, controlling access to buildings and the building of set back positions. The use of normal trench systems beside buildings should be considered for the initial enemy artillery barrage (once finished, own troops then move into building positions).
 - (2) **Protective Obstacles.** Protective obstacles include:

Combat Team Operations (Interim)

- (a) minefields, rubble, roadblocks, etc.;
 - (b) anti-grenade obstacles around buildings; and
 - (c) roof top obstacles such as spikes or glass as a deterrent against that avenue of approach.
- (3) **Rear Area Security.** The use of LAVs for casualty evacuation and pushing of ammunition forward should be considered.
- f. **Sustainment.** Sustainment should take into account the following considerations:
- (1) a high consumption of combat supplies, therefore administrative plan must be clear;
 - (2) a high casualty rate can be expected including stress casualties;
 - (3) resupply and evacuation routes may be very restricted, therefore great care must be taken in coordination;
 - (4) local facilities (water supply, hospital, etc.) may be useful; and
 - (5) a CIMIC plan must be put in place.

RESERVED DEMOLITION GUARD

8. **General.** This TTP covers the generic layout and considerations for a demolition guard on a reserved bridge demolition. Basic fundamentals of the defence, as stated in “Area and Mobile Defence”, page 57, apply to the demolition guard with the following special considerations (the principles are applicable to all reserved obstacles):

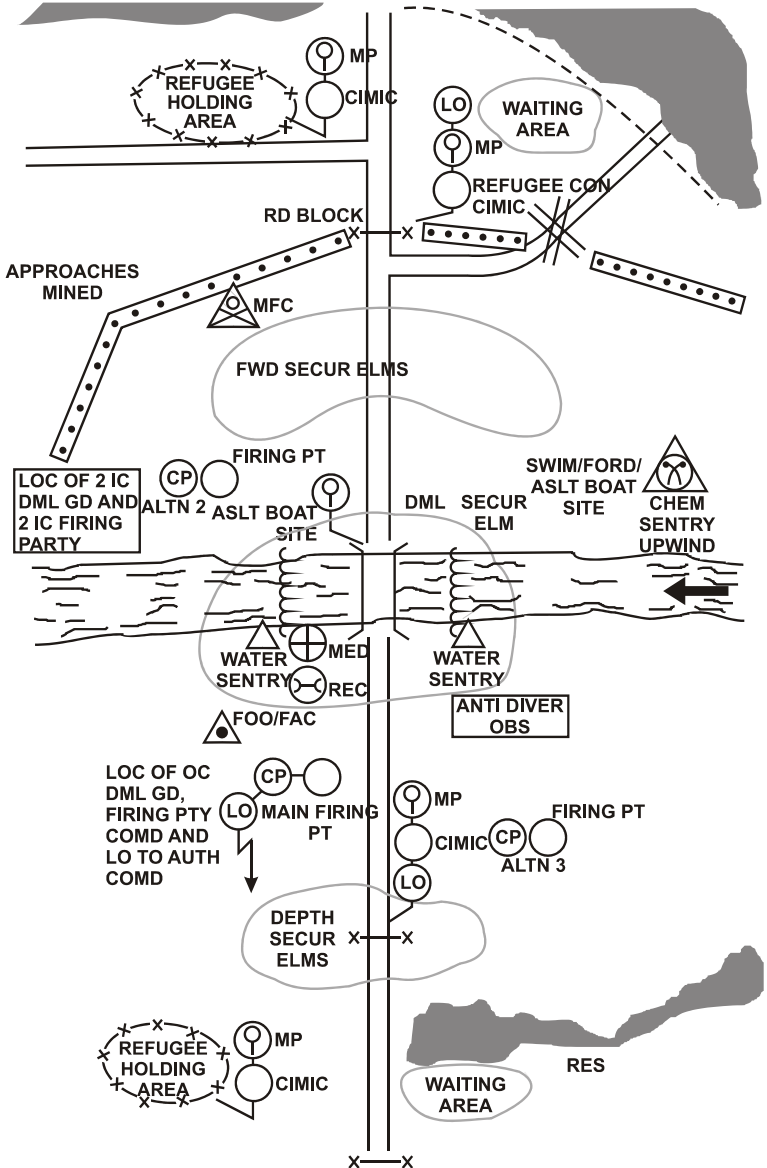

Figure 3-9: Bridge Demolition Guard

9. **Diagram Details:**

- a. Approaches to the demolition are covered with observation, fire and obstacles, including potential

Combat Team Operations (Interim)

airborne/airmobile approaches and above or below water approaches.

- b. The guard is divided into three security elements: forward, demolition and depth.
- c. The CP and firing points are co-located.
- d. Firing points should be no more than 200 m from the target due to the resistance in the firing cable as well as the requirement to quickly check and repair the cable while under attack. The connected circuit must be one meter from field radios and 100 m from radar.
- e. A minimum of one alternate CP and firing point is required. A second alternate CP and firing point is an option depending on the enemy threat and the manning resources available. The location of the CPs and firing points will be determined by the enemy threat and ground.

10. Unique tasks include the following:

- a. refugee control;
- b. traffic control;
- c. water sentries;
- d. refugee protection;
- e. road block security;
- f. demolition patrols;
- g. escorts; and
- h. in-situ vehicle repair and recovery.

11. **Combat Functions:**

- a. **Command:**
 - (1) **Mission Analysis:**
 - (a) The demolition guard commander is responsive to the authorized commander on the DND 913 Demolition Order and must meet this commander's intent. The

methods of communication for the execution of the order are detailed in the DND 913.

- (b) The main effort will be focussed on ensuring the demolition will be successfully executed on order of the authorized commander or as otherwise directed by the DND 913. Restrictions and freedoms will be outlined in the DND 913, para 6, Emergency Firing Procedures.

(2) **Enemy/Ground:**

- (a) Airborne/airmobile and water approaches, including divers, are considered. Saboteurs and partisans are considered.
- (b) Determine possible swimming, fording and/or assault boat crossing sites to withdraw friendly troops and to deny to enemy on execution of the demolition (considerations for other reserved demolitions would include minefield gaps, tracks through woods, etc.).

- (3) **Refugees.** Refugees should be considered as a separate factor. MPs and CIMIC resources, including local police, should be utilized to deal with refugees. Rules of engagement (ROE) should be reviewed to determine the appropriate action if refugees are on the demolition site when the order is given to execute. Refugee control—including holding areas, escorts and protection—needs to be considered.

- (4) **Friendly.** Identify forces likely to withdraw through the demolition and confirm liaison officers from units utilizing the bridge have reported to the main CP

(refer to Chapter 5, Section 6 “Rearward Passage of Lines”). The movement of administration elements supporting forward elements will have to be controlled.

- (5) **Time and Space.** It is critical that the engineer troop commander determine the time required to prepare the demolition to State One and provide an estimate of time to change to State Two. The engineer firing party commander will confirm the time to prepare from State One to State Two (these timings must be rehearsed) and the time to complete the obstacle after it has been fired. Consideration should also be given to the appropriate defensive posture when the demolition is at State Two.

- b. **Information Operations.** Early warning is required around the defended demolition to ensure adequate time for the execution of counter-moves and fire plan (decision points).
- c. **Manoeuvre.** The risk of vehicles on the enemy side of the obstacle should be considered. Arrangements are required for the withdrawal of friendly forces after the demolition is executed and for the destruction of vehicles that may remain. Rehearsals are required for the movement of forces from the enemy side of the demolition.
- d. **Firepower.** Maintain observation and indirect fire support well forward to support withdrawing forces.
- e. **Protection:**
- (1) The charges and firing circuit must be protected from indirect fire. Regular patrols/inspections are required.
 - (2) The NBC threat, AD and AAAD must be considered.
 - (3) Friendly forces require sufficient distance and cover from the effects of the

demolition. Confirm safety distances according to the type of demolition.

- (4) Once the target is destroyed, DND 913, Part III Demolition Report para 14 must be completed and the DND 913 returned to the authorized commander in order to report the effectiveness of the obstacle and update the barrier plan and Brown situational awareness. If mines are laid, they are to be reported and recorded on the E121B Bridge Demolition Recce Report.

f. **Sustainment:**

- (1) As the task may be significantly removed from the location of the parent unit and occur over a prolonged period of time, logistical support must be confirmed.
- (2) The demolition must remain open to traffic throughout the operation. As a minimum, recovery and medical resources will be located on the near bank.
- (3) Logistical support to assist in the passage of lines of forward elements must be considered.
- (4) The traffic policy on the bridge must be confirmed. Limitations on one or two way traffic, density of flow and priority for use must be considered.

CHAPTER 4 DELAYING OPERATIONS

DELAYING OPERATIONS

1. **General.** This TTP covers the actions of the combat team in the delay. The combat team trades space for time without becoming decisively engaged.
2. **Warning.** BG recce normally provides warning of enemy approach, and forward troops and the FOO take over the battle. Contact must be maintained throughout the operation.
3. **Security.** The following considerations apply to establishing tactical security:
 - a. AFVs not engaged should remain concealed until called forward into a battle position.
 - b. Engineers provide counter mobility support to shape the enemy.
 - c. Flank security must be maintained.
4. **Recce.** Initial plan from map. Thereafter, extensive recce essential for combat team commander, down to crew commander level.
5. **Plan.** The delay plan must be simple and flexible: find, fix, strike and withdraw to a subsequent battle position.
6. **Combat Functions:**
 - a. **Command.** The combat team commander will be positioned well forward and will have to address a number of command issues:
 - (1) The combat team commander will have to consider span of command across forward positions and having an alternate commander on a less threatened axis in order to ensure the battle group commander is made aware if the combat team commander becomes decisively engaged.
 - (2) The combat team commander will have to constantly determine whether the time to be gained justifies the reduction of combat

Combat Team Operations (Interim)

power. To make these decisions, he will have to be told either the minimum length of time that he must delay the enemy or the percentage of his force he must preserve based on his subsequent tasks because he cannot do both.

- (3) The combat team commander will also have to determine whether he has sufficient resources (time, engineers, integral assets, etc.) to action the planned delay framework.

- b. **Information Operations.** Consideration must be given to the employment of forces for early warning and should be given to tactical deception against the enemy's lead elements in order to draw him forward. Flank security is a particular concern in the delay.

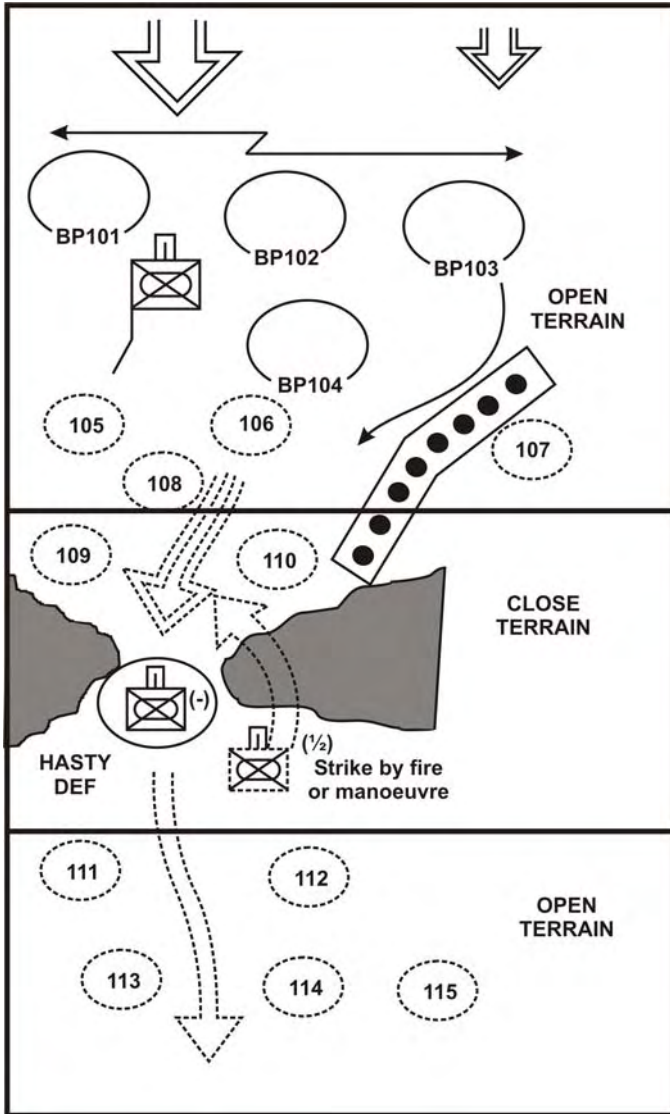

Figure 4-1: The Delay

c. **Manoeuvre:**

- (1) The combat team commander should consider delaying on alternate or successive

Combat Team Operations (Interim)

- bounds with combined arms elements and be prepared to occupy any battle position.
- (2) The combat team commander must consider all mobility/counter-mobility assets (engineers, ploughs, dozers, scatterable mines, etc.).
 - (3) Consideration must be given to the loss of mobility if LAVs are used separate from dismounted infantry.
 - (4) The combat team commander must consider the employment of a counter-move/reserve to quickly regain the initiative. For deliberate positions, consideration should be given to a dedicated counter-move force. The reconstitution of a reserve is particularly relevant during the delay.
 - (5) During the planning/execution of the delay, the commander must consider re-occupying forward positions to retain the initiative or attack the enemy in depth while assessing the risks associated with either alternative.
- d. **Firepower.** The combat team commander should consider the use of a CFSP (in the delay to fix, disrupt and destroy the enemy. Additionally, he should consider the use of fire support assets to separate the enemy and the use of tank hunting teams in close terrain.
- e. **Protection.** Consideration should be given to the AAAD requirements, as enemy air superiority is likely.
- f. **Sustainment.** The commander should give special consideration to ammo, medical and maintenance requirements (including confirmation of the denial/destruction of equipment policy) during the delay.

CHAPTER 5 TRANSITIONAL PHASES

SECTION 1 THE ADVANCE

ADVANCE TO CONTACT

1. **General.** This TTP is limited to the actions of a combat team in the advance without covering the actions to be taken when contact with the enemy occurs. “Warning, Security, Recce and Plan”, page 5 gives the details on this technique.

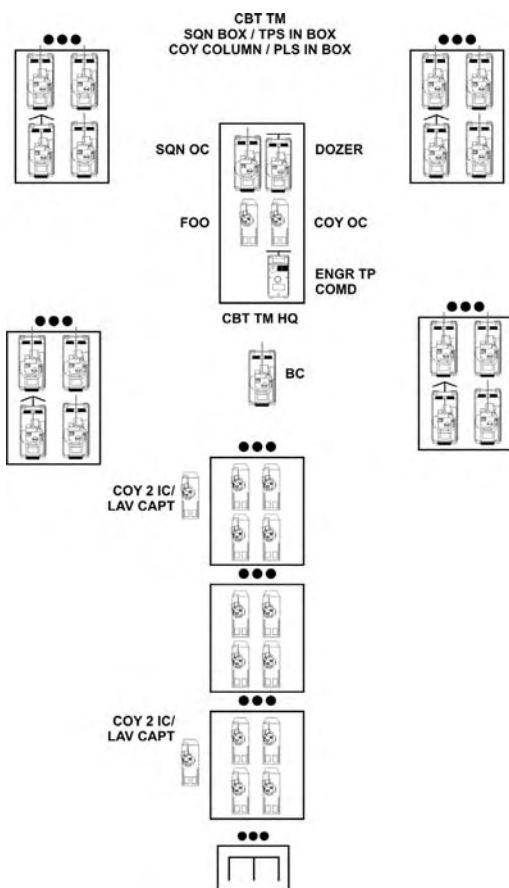

Figure 5-1: Combat Team Advance—Sqn Box, Coy Column

Combat Team Operations (Interim)

2. **Conduct.** The advance to contact should be conducted as follows:

- a. Infantry should not lead mounted. In close ground, infantry lead when dismounted.
- b. Common formations at the combat team level are two tank troops up or three tank troops up (see Figures 5-1 and 5-2 respectively).
- c. The combat team commander should keep at least one quarter of his forces as a “foot on the ground” as the combat team advances using fire and movement.
- d. LAVs may move from fire position to fire position close enough behind the tanks to supplement their firepower. Careful consideration must be given to exposing a non-armour vehicle forward in a position in which it could become the first target of enemy tank fire.

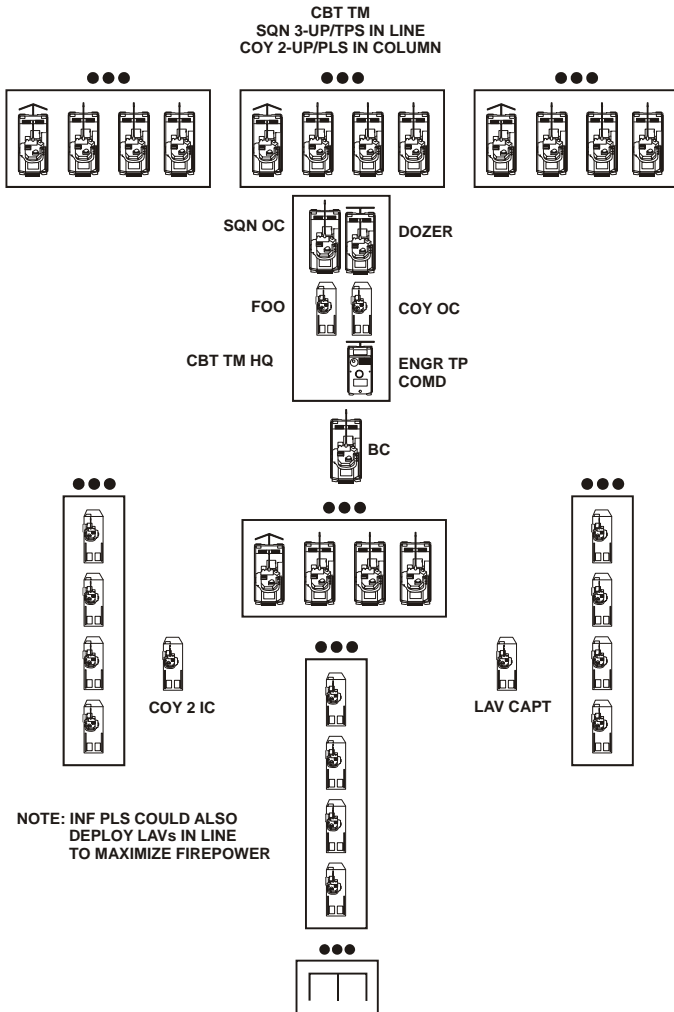

Figure 5-2: Combat Team Advance—Sqn 3-Up Line, Coy 2-Up Column

3. **Combat Functions:**

a. **Command:**

- (1) The combat team commander must be clear at the conclusion of his mission analysis on what is expected from him in terms of the following:

Combat Team Operations (Interim)

- (a) Must the area within boundaries be totally clear of enemy?
 - (b) Is the intent of his superiors to clear only an access route through the area for follow on forces or, for example, to clear the entire area/axis of enemy?
- (2) The combat team commander time estimate will be a key factor in the determination of the following:
 - (a) acceptable level of risk;
 - (b) formations adopted during the advance; and
 - (c) method of movement used, e.g., successive vs alternate bounds.
- (3) To avoid the possible loss of five key commanders, the combat HQ will be organized as follows:
 - (a) the squadron OC, company OC and engineer troop commander will be co-located (the FOO will move between positions of observation while remaining accessible to the combat team commander);
 - (b) the squadron BC will travel with depth tank troop(s); and
 - (c) the company 2IC and LAV Capt travel with the infantry company.
- b. **Manoeuvre.** Control of key terrain should be considered when planning/executing tactical bounds. Assessment of enemy threat in a specific location will be a key factor in determining which formation the combat team will use to cover the surrounding area. Engineer assets should be moved forward when obstacles are anticipated in order to maintain momentum.

- c. **Firepower.** The FOO should be given some freedom of action in order to move from one OP to another. If two indirect fire observers are available (e.g., FOO and mortar fire controller [MFC]), they should alternate from one position to another. Selection of DF targets should be part of CFSP.
- d. **Protection.** If no forces have been specifically designated for flank protection, an option is to adjust formations within the combat team (e.g., use echelon formation within tank troop located on the flanks). Protection from the air threat should be considered with respect to selection of waiting areas and should also be a concern for any forces that become static for a period of time.

CREST DRILL

- 4. **General.** This TTP describes the actions of the combat team when lead elements, generally leading tank troops, have to cross a ridge/crest during an advance to contact with no possibility of observation forward.
- 5. **Warning.** The lead tank troop reports **HELD UP CREST.**
- 6. **Security.** Combat team takes a position of cover and concealment.
- 7. **Rece.** The crest drill rece is conducted as follows:
 - a. lead tanks move into positions of observation (versus positions of fire);
 - b. tanks in positions of observation look for enemy and plan next movement; and
 - c. FOO moves forward to observe beyond the crest.
- 8. **Plan/Execution.** The crest drill is conducted as follows:
 - a. the lead troops jockey off the crest and cross it at the same time (Note 1) supported by the remainder of the squadron that has moved to a position of fire (Note 2);
 - b. alternate bounds may provide for the best security; and

Combat Team Operations (Interim)

- c. the infantry company adopts the same drill.

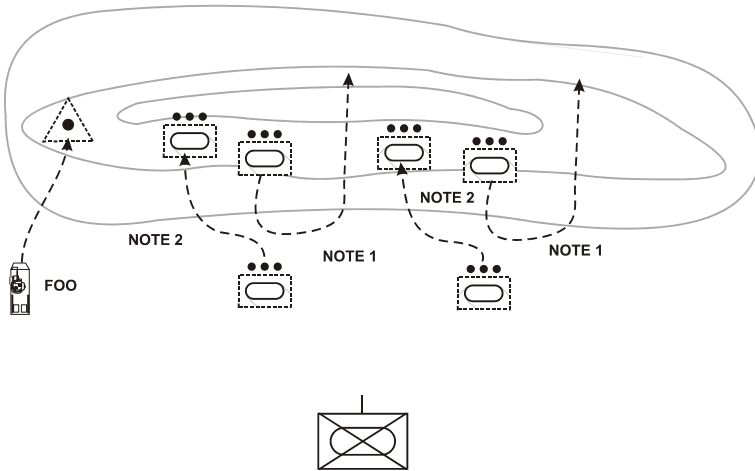

Figure 5-3: Crest Drill

GAP DRILL

9. **General.** This TTP covers the action of the combat team from identification of a gap that presents a threat to a flank until the whole combat team has moved beyond the gap.
10. **Warning.** The first element of combat team that comes into contact with the gap (normally the leading tank troops) sends a contact report—**HELD UP GAP RIGHT/LEFT**—identifying the gap and moves into a position of observation/fire.
11. **Security.** Tank troops and LAVs located on the flank opposite the gap provide flank protection and observe forward, in the direction of the advance. The remainder of combat team moves into a position concealed from enemy observation (air and ground). Elements opposite the gap orient fire into the gap.
12. **Rece.** The combat team commander, the supporting arm OC and the FOO move into a position of observation.
13. **Plan/Execution.** The gap drill will be executed as follows:
 - a. the company OC will order a platoon to move forward and link-up with one of the tanks closest to the gap;

- b. the infantry platoon will send a section (the rest of the platoon will cover the rear) mounted or dismounted to Position A (dismounted section illustrated in figure) while one tank moves to the edge of the gap to provide observation and possibly speculative direct fire (see note in “Firepower”);
- c. the section will recce the gap and report **GAP CLEAR;**
- d. the combat team will then cross the gap using fire and movement; and
- e. the infantry section will be picked up as the remainder of the combat team resumes the advance.

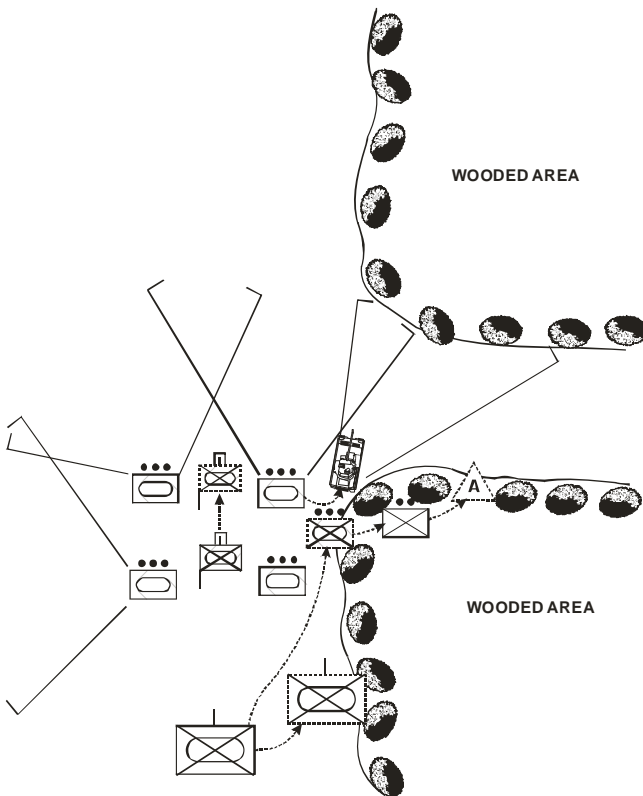

Figure 5-4 : Gap Drill

14. **Combat Functions:**

Combat Team Operations (Interim)

- a. **Command.** Before initiating a gap drill, the combat team commander must assess the possibility of bypassing the gap. When faced with a gap drill, the combat team commander has the option of using smoke in the gap area and carrying on with the advance without engaging in the drill described above.
- b. **Information Operations.** The section that is sent to clear the gap must try to provide observation and fire as far as possible into the gap.
- c. **Firepower.** Tank speculative direct fire may be used to suppress enemy that could be located in the gap. The combat team commander must take into consideration the amount of ammunition available to the combat team. If the section sent to clear the gap is dismounted, it should carry a hand held anti-armour weapon.

SHORT DEFILE DRILL

15. **General.** This TTP covers the action of the combat team from identification of the short defile to the arrival of the whole combat team on the far side of the defile. For the purposes of this TTP, a short defile (versus a long defile) is defined as a defile for which the far side (i.e., exit) can be covered by direct fire by the forces located at the near side.
16. **Warning.** The first element of combat team that comes into contact with the short defile (normally the leading tank troops) sends a contact report—**HELD UP SHORT DEFILE**—identifying the defile and moves into a position of observation.
17. **Security.** The combat team will move into a position concealed from enemy observation (air and ground).
18. **Recce.** The combat team commander, the supporting arm OC, the FOO and the engineer troop commander move into a position of observation (Figure 5-5).

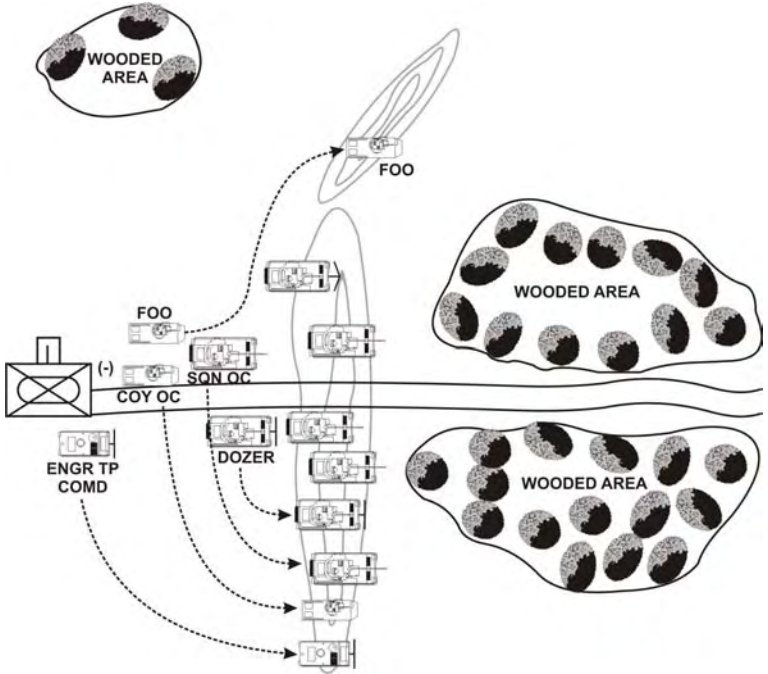

Figure 5-5: Short Defile Drill, Recce

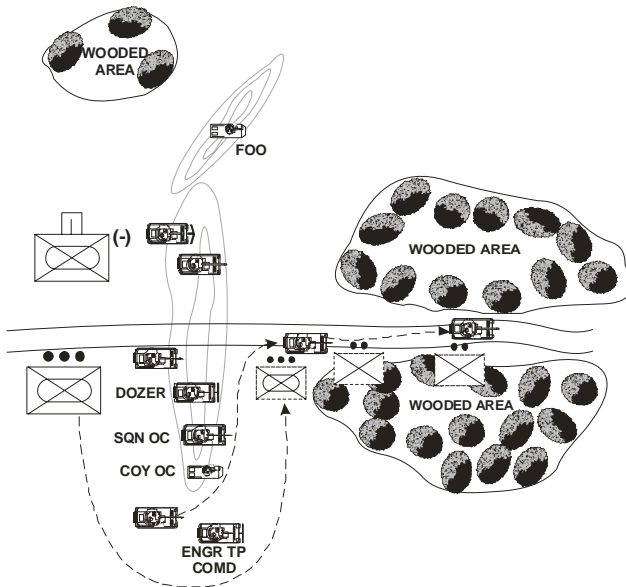

Figure 5-6: Short Defile Drill, Clearance

19. **Plan/Execution.** The short defile drill will be executed as follows:

- a. the company OC will order a platoon to move forward and link-up with a tank at the entrance of the defile;
- b. the platoon and tank will move to the mouth of the defile;
- c. the platoon or section will dismount (Figure 5-6 illustrates platoon dismounting) and start clearing both sides of the defile, keeping in line with the second road wheel of the tank as it advances;
- d. once the dismounted infantry platoon (or section) and the tank are on the far side of the defile (Figure 5-7), the remaining tanks of the lead tank troop will cross, followed by the remainder of the combat team (normally the dismounted platoon will be mounted last and move to the depth of the infantry company); and

- e. the rest of the combat team will cross the defile one sub-sub-unit at a time.

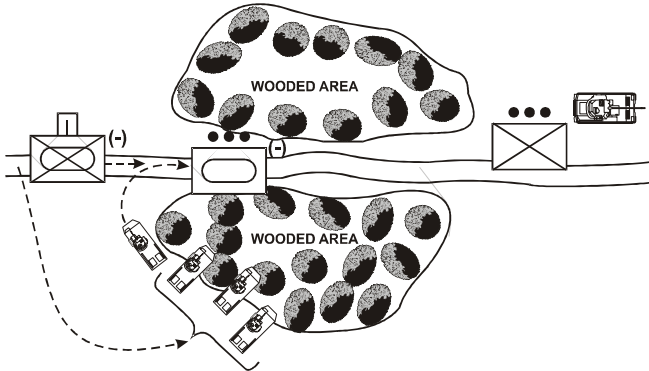

Figure 5-7: Short Defile Drill, Crossing

20. Combat Functions:

a. Protection:

- (1) Tanks and LAVs not involved in clearing the defile will move into a position of fire/observation in order to cover flanks and the area beyond the defile. Other elements of the combat team will move into a position concealed from enemy observation (air and ground).
- (2) The combat team must keep spacing adequate at the entrance of the defile and as it moves through it one sub-sub-unit at a time.

LONG DEFILE DRILL

21. **General.** This TTP covers the actions of the combat team from identification of a long defile to the arrival of the whole combat team on the far side of that defile. For the purposes of this TTP, a long defile (versus a short defile) is defined as a defile for which the far side (or exit) cannot be covered by direct fire by the forces located at the near side. The combat team commander will determine if the risk is sufficient to conduct the drill, otherwise the TTP on the “Short Defile Drill” can be applied.

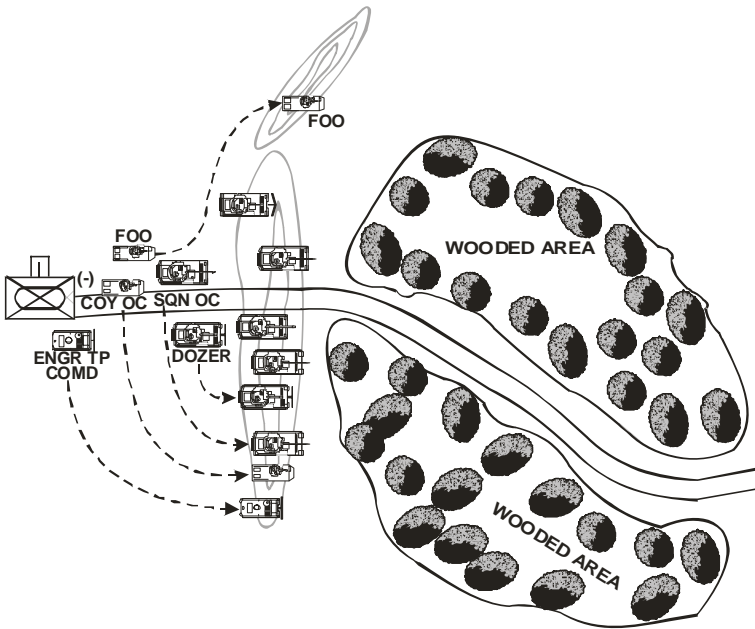

Figure 5-8: Long Defile Drill, Recce

22. **Warning.** The first element of the combat team that comes into contact with the long defile (normally the leading tank troops) sends a contact report—**HELD UP LONG DEFILE**—identifying the defile and moves into a position of observation.
23. **Security.** The combat team will move into a position concealed from enemy observation (air and ground).
24. **Recce.** The combat team commander, the supporting arm OC, the FOO and the engineer troop commander move into a position of observation (Figure 5-8).

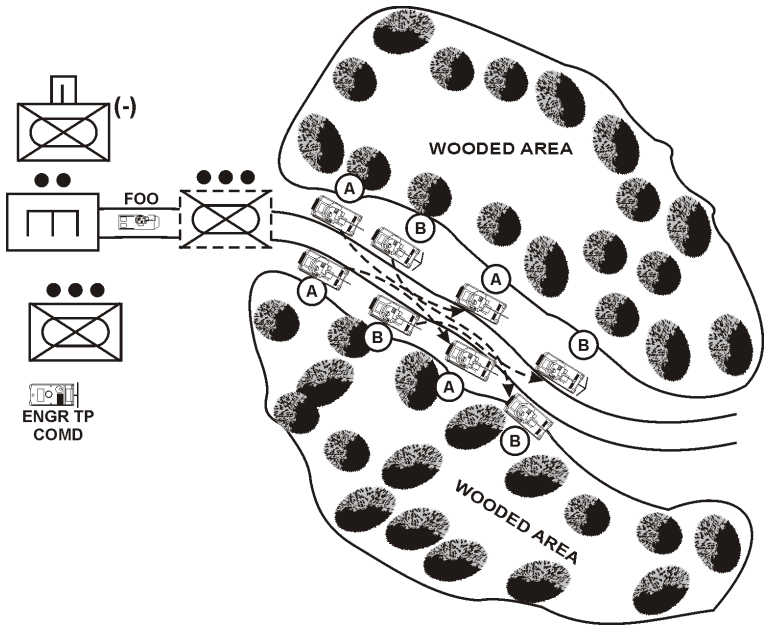

Figure 5-9: Long Defile Drill, Clearance

25. **Plan/Execution.** The long defile drill will be executed as follows:

- a. the infantry company OC will order a platoon to move forward and link-up with one of the tanks at the entrance of the defile. The engineer troop commander will also order an engineer section to link-up with this lead element;
- b. the tank troop will start to clear the defile by using successive or alternate bounds (Figure 5-9);
- c. the infantry platoon, FOO and engineer section will follow the tank troop mounted; and
- d. once the tank troop, the infantry platoon, FOO and the engineer section are on the far side of the defile, the rest of the combat team will cross the defile one sub-sub-unit at a time (Figure 5-10).

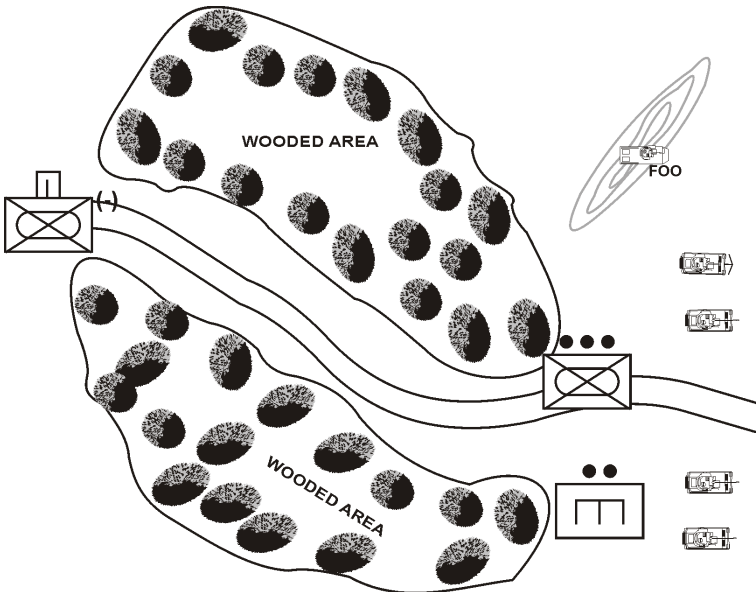

Figure 5-10: Long Defile Drill, Crossing

26. **Combat Functions:**

- a. **Protection.** Tanks and LAVs not involved in clearing the defile will move into a position of fire/observation in order to cover flanks and the area beyond the defile. Other elements of the combat team will move into a position concealed from enemy observation (air and ground). The combat team must keep spacing adequate at the entrance of the defile and as it moves through it (one sub-sub-unit at a time).
- b. **Manoeuvre.** The engineer section will be brought forward in preparation of an obstacle breach in the defile.

BLIND CORNER DRILL

27. **General.** The blind corner drill is executed at the troop/platoon level.

28. **Warning.** T11A (see Figure 5-11) will send a **HELD UP BLIND CORNER LEFT** report. Both T11A and T11C will edge forward not exposing themselves to the open corner.

29. **Security.** The combat team will move in a position of security.

30. **Recce.** T11A and T11C will observe, conduct a thermal sweep of the defile, and report information on the combat team net.

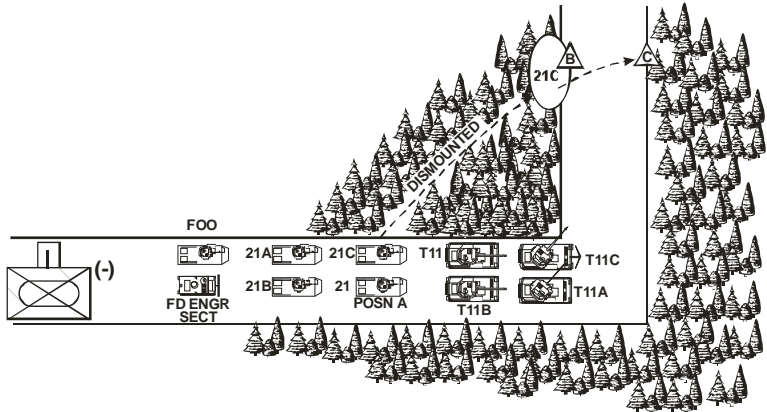

Figure 5-11: Blind Corner Drill, Left

31. **Plan/Execution.** The blind corner drill will be executed as follows:

- a. with C/S 21 in Position A, the platoon commander will order a section (C/S 21C) to dismount and move to an OP at Position B;
- b. the 21C will send a fire team to an OP at Position C to establish visual contact with T11C;
- c. the fire team tasked by the 21C will signal **CORNER CLEAR** to T11C (visual signal);
- d. T11 will order T11A and T11C around the corner together, supporting each other followed by the remaining tanks;
- e. the **CORNER CLEAR** will be reported to the combat team commander; and
- f. the combat team will resume its movement.

32. **Combat Functions: Firepower.** Dismounted infantry section (21C) should bring an anti-armour weapon.

BLIND CORNER / T-JUNCTION DRILL

33. **General.** This TTP is a variant of “Blind Corner Drill” on page 104. In this example, the combat team plans to turn left at the junction.

34. **Warning.** T11A or T11C will send **HELD UP BLIND CORNER T-JUNCTION**. Both T11A and T11C will edge forward, ensuring not to expose themselves to the open corner.

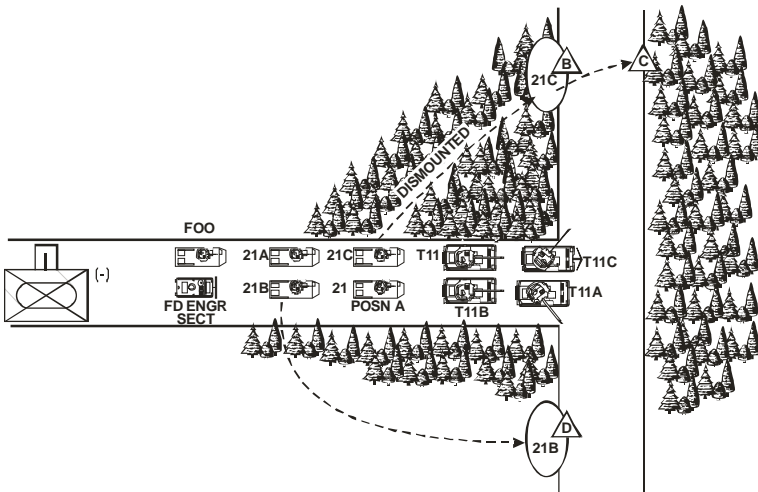

Figure 5-12: Blind Corner Drill, T-Junction

35. **Security.** The combat team will move to a position of security.

36. **Rece.** T11A and T11C will observe and report information on the combat team net.

37. **Plan/Execution.** The blind corner / T-junction drill will be conducted as follows:

- a. the company C/S 21 will be in Position A;
- b. the platoon commander will order two sections (C/S 21C and 21B) to dismount and to move to Positions B and D respectively;

- c. 21C will send a fire team to Position C;
- d. 21B will set up a hasty blocking position at Position D;
- e. the fire team from 21C will signal **CORNER CLEAR** to T11C (visual signal);
- f. T11 will order T11A and T11C around the corner together supporting each other and followed by the remaining tanks;
- g. if it is clear, the blind corner will be reported **CLEAR** to combat team commander; and
- h. the combat team will resume its movement (in doing so, the combat team commander must decide whether to bypass the lead infantry platoon to maintain security at Position D or accept risk and remount C/S 21).

38. **Combat Functions: Firepower.** The dismounted infantry section (21C and 21B) should bring anti-armour weapons.

POINT OBSTACLE DRILL

39. **General.** This TTP covers the action of the combat team from identification of a point obstacle to the arrival of the whole combat team on the far side of that obstacle. A prime example of a point obstacle is a road block.

40. **Warning.** The first element of the combat team that comes into contact with the point obstacle (normally the leading tank troops) will send a contact report and move into a position of observation.

41. **Security.** The combat team will move into a position concealed from enemy observation (air and ground).

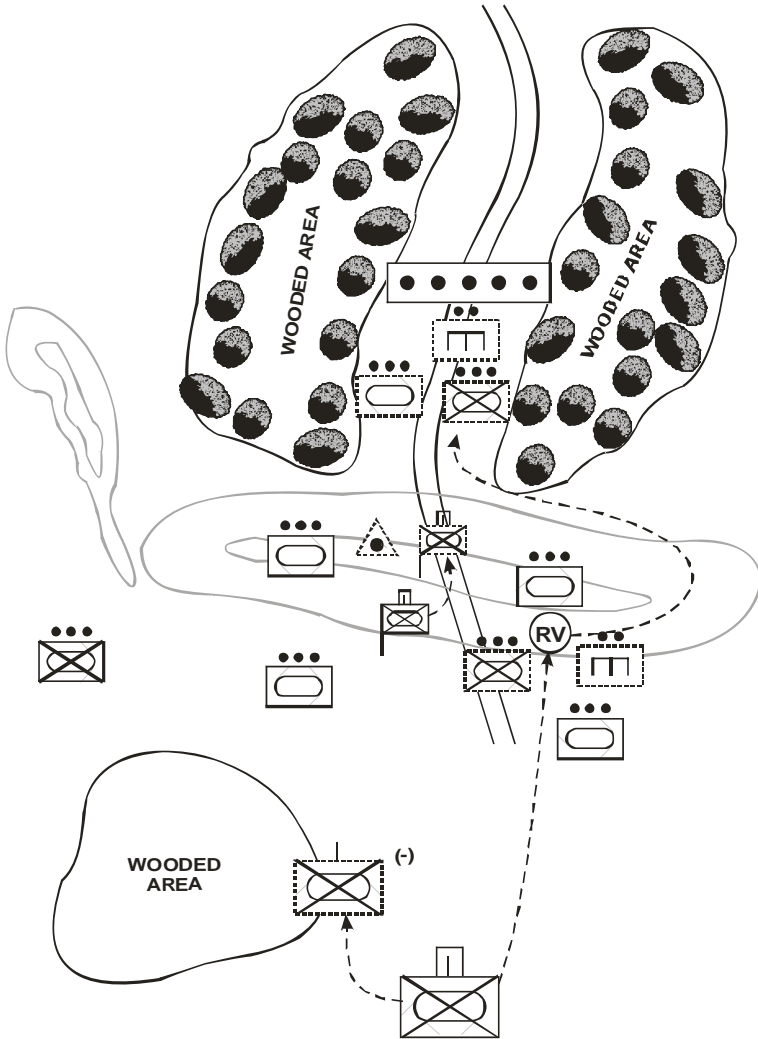

Figure 5-13: Point Obstacle Drill

42. **Recce.** The combat team commander, the supporting arm OC and the FOO will move into a position of observation overlooking the obstacle, and the engineers will move forward to recce the obstacle and prepare for its reduction.

43. **Plan/Execution.** The point obstacle drill will be conducted as follows:

- a. a location for an RV will be sent by the lead tank troop;
 - b. an infantry platoon and engineers (without AVLB) will move to the RV;
 - c. the infantry platoon, the troop and engineer recce will move forward to recce the obstacle;
 - d. the engineer recce will determine the resource requirement to breach the obstacle;
 - e. the required engineer resources will move forward and breach the obstacle;
 - f. lead elements will establish a position of fire supporting the move forward of the infantry platoon, tank troop and engineer recce; and
 - g. once the obstacle has been breached, the forward tank troop and platoon will cross followed by the remainder of the combat team, which will cross one sub-sub-unit at a time.
44. **Combat Functions:**
- a. **Command.** Before initiating this drill, the combat team commander must assess the possibility of bypassing the obstacle.
 - b. **Firepower.** Tank fire high explosive squash head (HESH) may be used to destroy the obstacle; however, this may hinder a deliberate breach as it may spread, not destroy, anti-tank mines.
 - c. **Protection.** The combat team must keep spacing adequate during the breaching of the obstacle and as it moves through it (one sub-sub-unit at a time).

SECTION 2 MEETING ENGAGEMENT

MEETING ENGAGEMENT

45. **General.** This TTP covers the action of a combat team that is moving and encounters an enemy moving force normally head-on.
46. **Sequence of Events:**

Combat Team Operations (Interim)

- a. upon contact with the enemy, the combat team must win the firefight to regain freedom of action; and
- b. the combat team commander has various options:
 - (1) bypass the enemy;

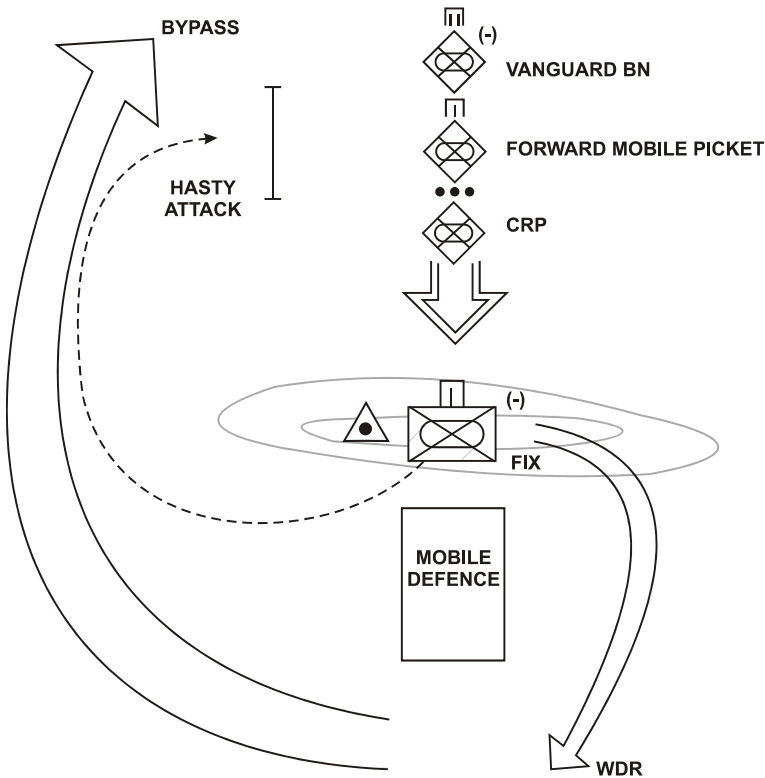

Figure 5-14: Tactical Options for a Meeting Engagement

- (2) conduct a hasty attack (see Chapter 2, Section 1 for various options of hasty attack);
- (3) conduct a mobile defence, i.e., disrupt the enemy's momentum, fix (see Chapter 3, Section 1);
- (4) become the fixing force for a BG hasty attack; or

- (5) conduct a hasty withdrawal (see Chapter 5, Section 5).

SECTION 3 LINK-UP

LINK-UP

47. **General.** This TTP covers the action of the combat team tasked to link-up with another force under the following conditions:
- a. a link-up of a moving force (see Figure 5-15) with a stationary force; and
 - b. a link-up of two moving forces (see Figure 5-16), which is normally undertaken to complete the encirclement of an enemy force as an independent operation or as a preliminary phase to subsequent operations.
48. **Conduct:**
- a. **One Moving Force, One Stationary Force.** A link-up of a moving force with a stationary force will be conducted as follows:
 - (1) the combat team will be the moving force, as the stationary force will usually be one that is encircled or cut-off;
 - (2) the stationary force, unless mission tasked (e.g., to seize a vital point in enemy depth) may attempt to breakout (see Section 4—“Breakout”);
 - (3) should a breakout not be possible or inappropriate due to mission task, the stationary force will adopt a defensive posture to facilitate the link-up;
 - (4) ground link-up points must be established at locations where the axis of advance of the moving force intersects with the security elements of the stationary force; and

Combat Team Operations (Interim)

- (5) link-up will be deemed complete when the main bodies of the moving and stationary forces consolidate for further operations.

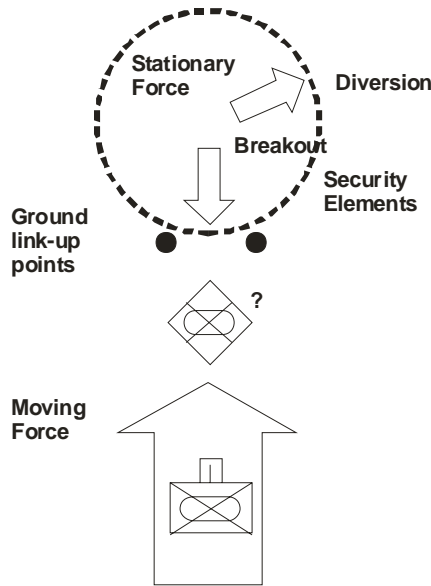

Figure 5-15: Link-up of Moving Force with a Stationary Force

- b. **Two Moving Forces.** A link-up of two moving forces will be conducted as follows:
- (1) primary and alternate link-up points will be established along the boundary where the two forces will be expected to converge;
 - (2) friendly recce elements from the two forces will establish contact with each other as early as possible, and information passed and plans adjusted as necessary;
 - (3) a combined ISTAR plan will be established as soon as possible to ensure that no enemy slip between the combat team and the other friendly converging force; and

- (4) the subsequent operation will determine the level of marrying up and integration of the converging forces.

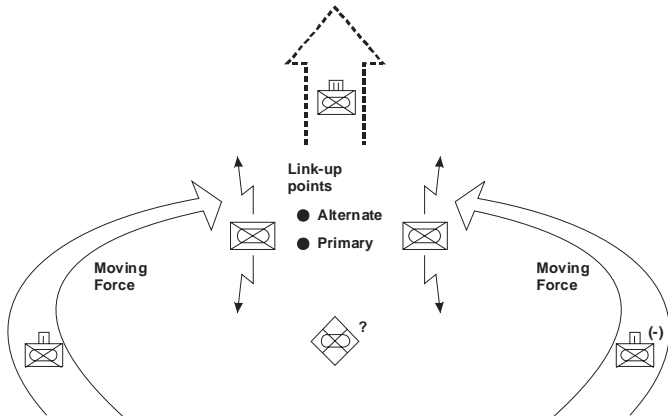

Figure 5-16 : Link-up of Two Moving Forces

49. **Combat Functions:**

- a. **Command.** The combat team commander will:
- (1) develop a scheme of manoeuvre and establish control measures (coord points, phase lines, routes, etc.);
 - (2) develop the fire plan in concert with the FOO;
 - (3) develop actions at the link-up point and tasks for subordinate commanders;
 - (4) develop contingency plans in the event of enemy contact before, during and/or after link-up;
 - (5) identify tentative primary and alternate link-up sites by map recce if the link-up sites have not been designated by the higher HQ (sites should be easy to recognize, provide cover and concealment and be defensible/securable);

Combat Team Operations (Interim)

- (6) verify frequencies, call signs, codes, visual signals and alternate recognition signals;
- (7) confirm fire coordination measures;
- (8) confirm the command relationship with the link-up force (who is in charge if the enemy attacks during/after link-up?);
- (9) coordinate action following link-up;
- (10) establish control measures and a restrictive fire line as required;
- (11) establish how long the link-up site will be occupied (either in terms of time or percentage of unit that has arrived);
- (12) establish and clarify the chain of command; and
- (13) send to higher HQ a report when link-up is complete.

b. **Manoeuvre:**

- (1) The force establishing the link-up point will send a security element to locate and secure the link-up point.
- (2) The security element will conduct the following tasks:
 - (a) it will occupy the link-up point by the time stated in the order;
 - (b) it will establish security for the link-up point;
 - (c) it will take up covered and concealed positions to observe the link-up point and await the moving force; and
 - (d) it will mark the link-up point with pre-arranged recognition signals.
- (3) The moving force will establish comms with the stationary force, if not under radio silence.

- (4) The moving force commander will issue final instructions and contingency plans to his recce element.
 - (5) The recce element commander will conduct the following:
 - (a) he will verify the link-up point and positions the security elm in covered and concealed positions that dominate the link-up point;
 - (b) he will signal the stationary force; and
 - (c) he will conduct final coordination with the stationary force.
 - (6) The moving force recce element commander will guide the stationary force guides to the moving force.
 - (7) The stationary force guides will alert the main body before guiding the moving force to the stationary force.
 - (8) The stationary force guides will direct the moving force into its assigned sector of the defensive perimeter.
 - (9) The moving force commander will coordinate with the stationary unit commander and assigns tasks and sectors to his platoons/troops based on that coordination.
- c. **Firepower.** A restrictive fire line (RFL) will be required to control fire.
- d. **Protection.** The combat team commander must ensure that his soldiers are aware of the type of force they will be linking-up with and that they can readily identify the vehicles of that force. The importance of control measures (panel marking, smoke identification, etc.) will be increasingly significant.

Combat Team Operations (Interim)

- e. **Sustainment.** The moving force must be prepared to assist an encircled or cut-off force with administrative support.

SECTION 4 BREAKOUT

BREAKOUT

50. **General.** This TTP covers the action for a combat team when cut off or encircled by the enemy and a breakout is required. The combat team has become encircled either unintentionally or deliberately as part of the defensive plan. Other friendly elements may also be in the encircled area. The enemy has the capability to attack by air, ground and indirect fire. Breaking out by stealth is not feasible. The combat team provides its own security.

51. **Conduct.** The combat team will move its personnel and primary weapons systems out from the encirclement. Where the combat team has become encircled unintentionally, the breakout will be initiated as soon as possible and before the enemy has time to prepare his defences. Where the combat team has become encircled deliberately and is breaking out on order, the breakout starts no later than the time ordered. The combat team will effectively employ control measures and recognition signals to prevent or minimize casualties due to friendly fire. Where the combat team has become depleted and lacks cohesion, the breakout will be conducted in small groups in a multi-directional effort in order to increase the likelihood of escaping.

52. **Combat Functions:**

- a. **Command:**
 - (1) During the breakout, the combat team commander will:
 - (a) assume control of all friendly forces in the encirclement and initiates re-establishment of a chain of command as soon as practical;
 - (b) initiate the deployment of all elements for all-round defence;

- (c) establish a reserve;
- (d) obtain status of elements (personnel, weapons, equipment, ammo and other supplies) and reorganizes logistics;
- (e) report status of units and tactical situation;
- (f) request authorization to conduct a breakout;
- (g) direct recce of the enemy to determine weak points and gaps;
- (h) decide on the breakout point(s);
- (i) designate an assault element to create and maintain the opening and security elements to provide protection and deception on the perimeter and to cover the front, flanks and rear of the main body while it is moving;
- (j) organize all available direct and indirect fire support and develops an offensive fire plan;
- (k) conduct link-up (see Section 3, “Link-up”) and planning and coordination for rearward passage of lines if necessary (see Section 6, “Passage of Lines”);
- (l) prepare to destroy equipment that cannot be moved;
- (m) make provisions for personnel who cannot accompany the breakout (e.g., leaving behind medical support for wounded who cannot be moved);
- (n) use deception to cover the breakout; and

Combat Team Operations (Interim)

- (o) pass primary and alternate link-up points, recognition signals, radio frequencies and other control measures between the encircled combat team and the friendly forces it will link-up with (see Section 3, “Link-up”).
- b. **Manoeuvre.** The combat team will execute the attack as follows:
- (1) the attack will be executed rapidly before the enemy can organize his defences or, in the case of a deliberate encirclement, on order;
 - (2) the attack will be aimed at any gaps or weakness in the enemy’s defences;
 - (3) the combat team will fix the enemy in other areas where possible and maintains all-around security;
 - (4) tactical deception activities will be employed to surprise the enemy as to the time and location of the breakout attack;
 - (5) the attack will exploit limited visibility if possible;
 - (6) the attack will be coordinated with supporting attacks by friendly units outside the encirclement when possible;
 - (7) on order, the defending elements will disengage and follow the breakout attack;
 - (8) the commander, IAW the destruction policy, will order equipment and supplies (except medical which will likely be left behind) destroyed;
 - (9) the combat team will effectively employ control measures and recognition signals to prevent or minimize casualties due to friendly fire; and

- (10) the combat team will report breakout status to higher HQ.
- c. **Firepower.** A RFL will be required to control fire.

SECTION 5 WITHDRAWAL

WITHDRAWAL

53. **General.** This TTP covers the action of the combat team in the withdrawal.

54. **Warning.** Combat team commander will issue a warning order via radio, line or by runner. The warning order must include:

- a. an outline of the new combat team task (if known);
- b. the time until which the position must be denied to the enemy;
- c. the time rearward move may start;
- d. the time rearward recce may start;
- e. the locations of the combat team and BG RVs and check points; and
- f. the route from the combat team RV to the BG RV (unless combat team is operating independently).

55. **Security.** Tactical deception is critical to maintain the security of the withdrawal. The position must be denied until the designated time.

56. **Recce.** On hearing the warning order (and limited by recce timings given in the warning order):

- a. the combat team 2IC will liaise with combat team commander for details of new combat team tasks and locations then take the liaison officer (LO) to the combat team RV to meet recce/harbour parties;
- b. the infantry company sergeant-major will go to and man the company/combat team RV;
- c. platoons/troops will send recce and harbour parties to combat team RV;

Combat Team Operations (Interim)

- d. the artillery tactical group will check validity of current fire plan;
- e. the combat team 2IC will arrive at the combat team RV, check all harbour/recce parties present, brief them and take them to BG RV (or new location if independent); and
- f. on arrival at new location, the combat team 2IC and recce parties will recce the new position and brief harbour parties who will RV at battle group release point in time to meet main bodies to guide them to new positions.

57. **Plan.** The plan must be simple and rehearsed if possible.

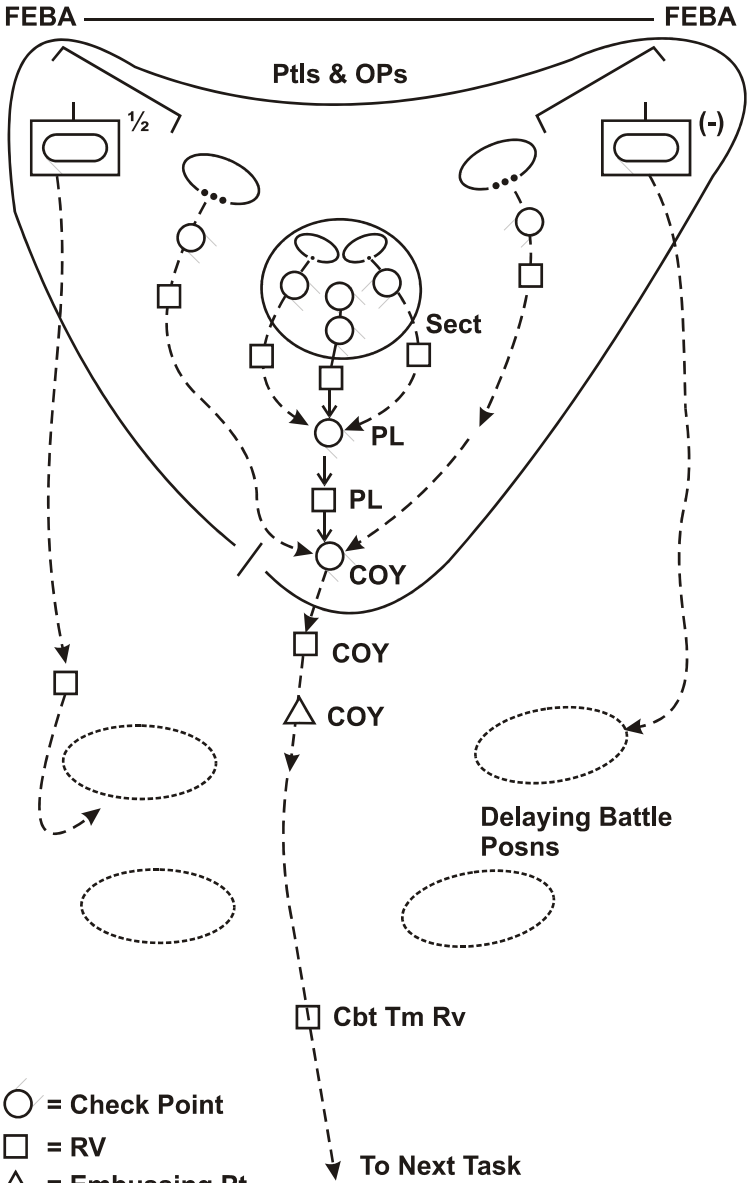

Figure 5-17: The Withdrawal

58. **Conduct/Sequence.** The withdrawal will take place either in or out of contact with the enemy.

Combat Team Operations (Interim)

- a. Whichever the case, the commander's primary concerns will be:
 - (1) to disengage;
 - (2) to retain an intact front by the deployment of strong covering troops;
 - (3) to safeguard withdrawal routes; and
 - (4) to maintain balance throughout the operation.

- b. The sequence of withdrawal from the position will be as follows:
 - (1) Recce parties will move back, and all non-essential vehicles and equipment will be cleared from the position.
 - (2) Covering troops will take up station behind the position, and reserves will move to their appropriate locations.
 - (3) Troops on the position will withdraw through the covering troops. By night, where surprise is easier to achieve and a commander considers a disengagement possible, rear elements should pull out first leaving those forces deployed forward until later. Where disengagement is not possible, forward troops will move first covered by those in depth.
 - (4) As soon as the main body has disengaged and is at a safe distance, the protective elements will start their disengagement, although they could remain in their original position until the enemy attacks in force so as to achieve the maximum deception and delay. If the enemy launches a strong attack, they will continue their protective task with a delaying operation. If the distance to be moved is great and the enemy is expected to react quickly, a portion of the protective force may occupy a number of intermediate defensive

positions in the rear of the main position being abandoned before the withdrawal of the main body.

- (5) If the protective element is not able to disengage or to prevent the enemy from closing in on the main body, it must either be reinforced by elements from the main body or the commander must commit the majority or all of this force. In this event, the withdrawal must be resumed at the earliest possible time. If the protective element has disengaged, it will follow the main body and continue to provide security. In this case, it will maintain surveillance of the enemy until ordered to disengage or until this task is taken over by another force.
- (6) This sequence is repeated at each intermediate position. The withdrawal is terminated when a force is ready to assume the next task.

59. **Combat Functions:**

a. **Command:**

- (1) The combat team commander remains in position to influence the battle.

(2) **Combat Estimate:**

- (a) **Enemy.** Consider requirements for early warning. Once contact is made, it must be maintained until successful disengagement.
- (b) **Ground.** Select well covered routes and consider control measures, easily recognizable RVs, covered embussing areas and possible employment of LAVs. Consider embussing on position depending on enemy situation. Consider obstacles including plan for closing minefield safe lanes.

Consider route marking and traffic control requirements.

- (c) **Time and Space.** Time available for rear recce and time between thinning out and “position denied until” are critical.
 - (d) The combat team commander should consider the following unique tasks for the withdrawal:
 - i. LOs; and
 - ii. route marking/traffic control if not done by the battle group.
- b. **Information Operations.** The following should be considered:
- (1) the appropriate EMCON state to ensure security;
 - (2) the illumination policy to reinforce tactical deception and/or maintain security;
 - (3) the alternate means of communications (i.e., to initiate withdrawal);
 - (4) the fact that clear recognition signals are essential; and
 - (5) the counter-recce battle (i.e., patrols) should be conducted.
- c. **Manoeuvre.** Keep vehicle and foot routes well clear of each other. Consider separate routes for wheeled and tracked vehicles. The combat team commander should consider maintaining mobility assets forward to counter scatterable mines. Once off the position, a series of alternate or successive bounds through subsequent positions may be required to disengage (see Chapter 4).
- d. **Firepower.** Tanks and FOOs will normally remain forward to cover the withdrawal. LAVs may cover the withdrawal of dismounted infantry but must

leave before tanks to allow embussing. Use indirect fire and smoke, harassing fire and/or a deception fire plan to blind and confuse enemy.

- e. **Protection.** Security is key throughout the operation. Withdraw under conditions of reduced visibility and out of contact if possible. Continue normal activity as long as possible. Conform to deception measures (e.g., electronic warfare) in force. Consider AAAD. Consider requirement for flank protection, especially during protective/delaying action. The reserve is likely to change through the operation and must be prepared to counter-attack at all levels until position denied time.
- f. **Sustainment.** The following should be considered:
 - (1) replenishment before commencement of operation;
 - (2) the backloading of excess stores and ammo;
 - (3) consider maintaining repair, recovery and medical assets forward, as long as possible;
 - (4) the denial of equipment and supplies policy;
 - (5) the ability to evacuate personnel casualties; and
 - (6) replenishment on arrival in new position.

SECTION 6 RELIEF

RELIEF

- 60. **General.** The types of relief are defined as:
 - a. **Relief in Place.** A relief in which all or part of a force is replaced in a sector by an incoming force.
 - b. **Forward Passage of Lines** (see page 131). A relief in which a force advances or attacks through another that is in contact with the enemy.

Combat Team Operations (Interim)

- c. **Rearward Passage of Lines** (see page 131). A relief where a force effecting a movement to the rear passes through the sector of a unit occupying a defensive position.
- d. **Retirement.** A retirement is different from a withdrawal in that it is a movement away from the enemy by a force out of contact.

NOTE

This TTP covers the actions of the combat team in a relief in place operation.

- 61. **Warning.** A timely warning order will commence the relief operation. The warning order will give the time the relief is to be completed as well as the timings for planning, movement and co-location of command elements, movement of recce, advance and combat support elements and movement of the main body.
- 62. **Security.** Tactical security for the current operation must be maintained by the in-place force.
- 63. **Recce.** Advance parties—combat team commander and his recce group including commanders down to section level if possible.
- 64. **Plan.** The plan must achieve surprise, security and good cooperation.

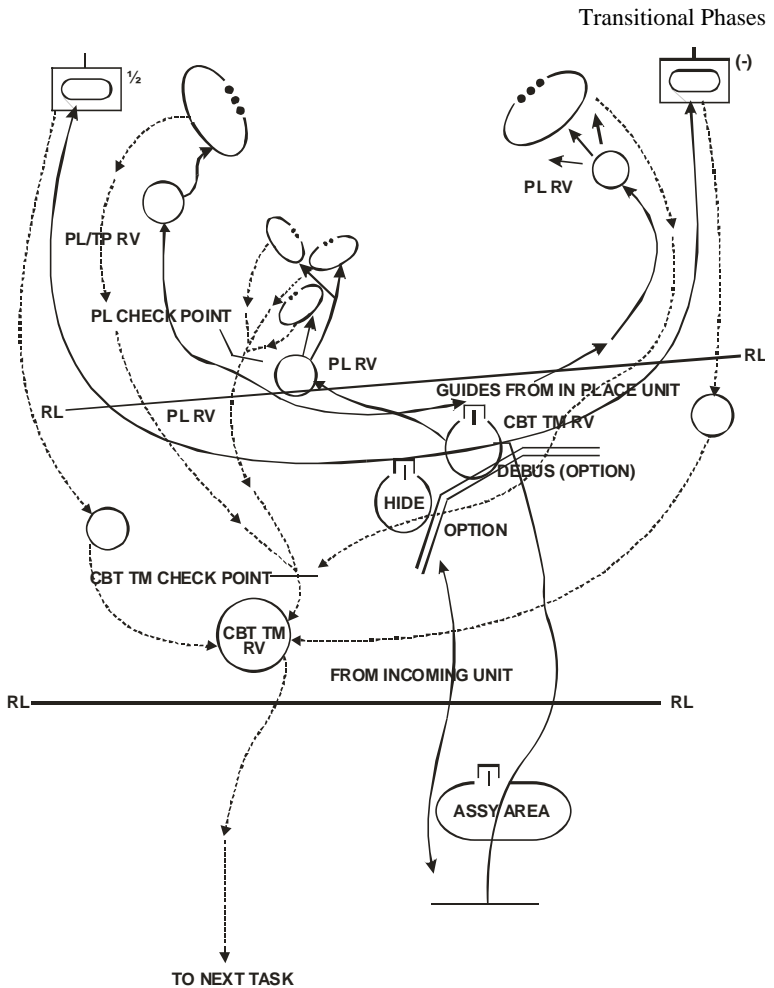

Figure 5-18: Combat Team Relief in Place

65. **Conduct.** The relief in place will be conducted as follows:
- a. The moving force will:
 - (1) establish liaison with the force in place early;
 - (2) ensure recce is done in detail and at as many levels as possible;
 - (3) ensure advance parties are deployed;

Combat Team Operations (Interim)

- (4) ensure plans are prepared in conjunction with the in-place force;
- (5) ensure orders are prepared and delivered and troops are briefed;
- (6) move from the assembly area to the de-bussing point (optional);
- (7) ensure guides from the in-place force lead relieving elements through battle group, combat team and sub-sub-unit control points to RVs;
- (8) ensure the incoming force is met at the RV by an advance party, briefed and directed to new locations;
- (9) ensure troops occupy positions, take on stores, equipment, barriers and assume new tasks including patrols and surveillance; and
- (10) adopt the grouping, disposition and support plans of the in-place force.

b. The in-place force will:

- (1) brief the advance parties of the relieving force;
- (2) plan for subsequent tasks and those required to support the moving force;
- (3) ensure orders are prepared and delivered and troops are briefed;
- (4) ensure elements of the moving force are guided forward from de-bussing points to RVs;
- (5) ensure responsibilities are handed over; and
- (6) conduct withdrawal (see Section 5)

66. **Combat Functions:**

a. **Command:**

- (1) Establish liaison with the force in place at an early stage. Commanders should co-locate to effect hand-over. The change of command should occur when more than 50% of the combat team has been relieved, communication has been established and it is mutually agreed by commanders.
- (2) All control measures must be coordinated with the battle group HQ.
- (3) **Combat Estimate:**
 - (a) **Enemy.** Consider enemy threat in relation to routes, waiting areas, de-bussing points and RVs.
 - (b) **Ground.** Select well covered and easily identified control measures, routes and de-bussing areas. Ensure separate routes are designated for the moving force and the in-place force. Consider what route marking and traffic control is required and the time and space available for forward recce.
 - (c) **Assessment of Tasks.** Ensure personnel tasked to relieve OPs, patrols and any forward elements are identified early and are put in place prior to the main body. Commander should consider that forces tasked for reserve or counter-moves are placed in first and in daylight (if possible) in order to conduct recce of possible tasks.
 - (d) **Courses Open.** Options for relief are to relieve sequentially by sub-sub-unit or relieve simultaneously by percentage of each sub-sub-unit. The incoming force must

adopt the plan of the in-place force.

- b. **Information Operations.** Counter surveillance measures (e.g., EMCON) must be strictly enforced. Radio silence should be imposed on the moving force alternate means of communications to initiate relief should be considered. Clear recognition signals are essential. It is also essential that the in-place force observation posts and patrol activities be maintained.
- c. **Manoeuvre.** Ensure separate routes are designated for the moving force and the in-place force. Separate routes for vehicles and dismounted forces may also be required. The order of march must be clear.
- d. **Firepower.** Consider the sequence of relieving tanks and infantry to ensure a foot on the ground is maintained. As well, consider the use of harassing fire or a deception fire plan to cover the relief operation. FOO/MFCs should consider relief early, and any fire plan must remain unchanged.
- e. **Protection.** Security is key throughout the operation. Conduct relief at night if possible, and continue normal activity throughout. Conform to deception measures in force (e.g., electronic warfare). Consider the use of all-arms air defence for the move forward and the requirement for flank protection especially during initial moves.
- f. **Sustainment.** Replenishment should be conducted before commencement of the operation. Commanders should consider a possible exchange of equipment and supplies including mortar base plates, defensive stores, line communications, combat supplies, tri-pods and equipment that is difficult to move.

PASSAGE OF LINES

67. **General.** This TTP covers the action of the combat team during a passage of lines. A passage of lines is a type of relief operation.

68. **Forward Passage of Lines** (Figure 5-19). A forward passage of lines involves a force advancing or attacking through a force that is in contact. The plan of the force making the passage of lines takes priority. The force in place must provide the moving force as much assistance as possible, including tactical and logistical support. Coordination is key. Comds and HQs must establish and maintain liaison as soon as possible.

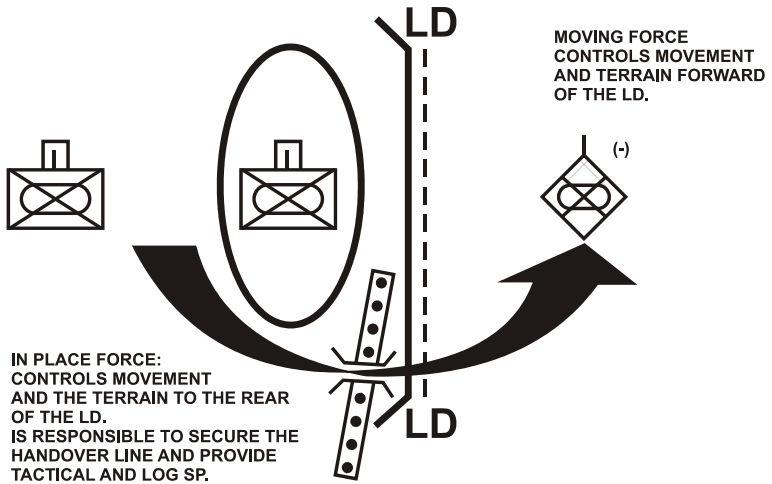

Figure 5-19: Forward Passage of Lines

69. **Rearward Passage of Lines** (Figures 5-20 and 5-21). Rearward passage of lines entails a force effecting a move to the rear that passes through the sector of a unit occupying a defensive position. The passage may occur in or out of contact. The rearward passage of lines differs from the withdrawal in that one force passes through another. In a withdrawal, this does not occur. As with the forward passage of lines, planning and liaison is critical. The major difference is that a force moving to the rear has likely been in contact, may have suffered casualties and is probably disorganized. The enemy may also

be pressing hard, which will add to the control problem. Blue-on-blue considerations are critical.

70. **Combat Functions:**

- a. **Command.** Consider co-locating HQs and early liaison with the in-place force HQ—this may include the provision of liaison officers from the moving force. It is critical to clearly delineate command and control relationships between HQs. A controlling HQ must be established. Plans are exchanged and understood by both forces during battle procedure. Timings and fire support must be clear. The force in place is responsible for terrain allocation and movement control within boundary. A moving force must report to the in-place force HQ when all units have passed through.
- b. **Information Operations.** The in-place force provides combat intelligence during forward passage to include topographical data. Recces are coordinated.
- c. **Protection.** AD and AAAD will be provided by the in-place force up to the LD (and beyond if possible) and to the rear of the handover line. Recognition signals must be agreed upon for day and night. The in-place force remains responsible for security within boundaries.
- d. **Manoeuvre.** The force in place is responsible to secure the LD and handover line(s). The moving force normally controls all actions forward of these lines. The in-place force provides information, traffic control and guides around and through any obstacles and the area of operation.
- e. **Firepower.** Fire support is provided by the in-place force and must be coordinated. After H hour during the forward passage of lines, the in-place force provides fire support as long as possible.
- f. **Sustainment.** The in-place force provides as much combat service support as possible to the moving force. The moving force combat team commander should consider deploying the A1 echelon to the in-

place force to allow the in-place plan to conduct running replenishment.

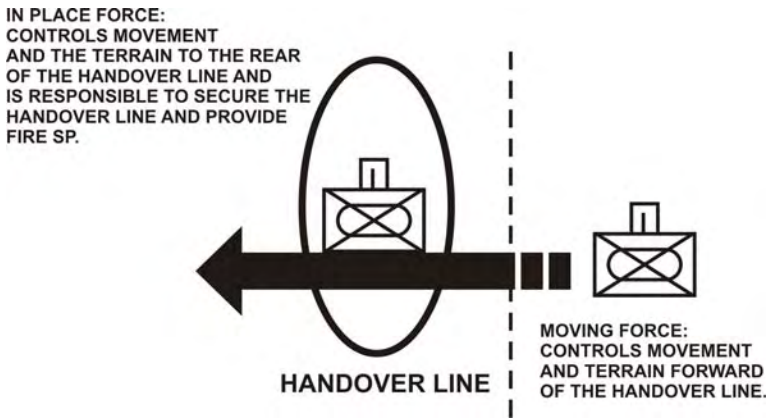

Figure 5-20: Rearward Passage of Lines, Responsibilities

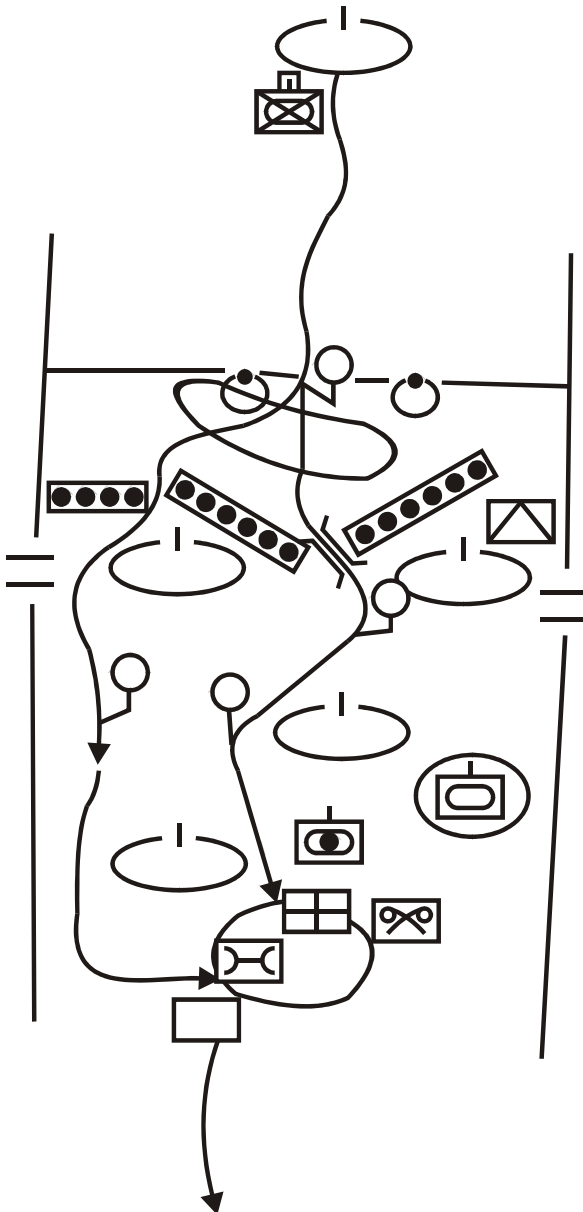

Figure 5-21: Rearward Passage of Lines

CHAPTER 6 COMBAT SERVICE SUPPORT

SECTION 1 COMMAND AND CONTROL OF THE COMBAT TEAM ECHELON

1. **General.** This TTP covers the various factors, regarding the administrative echelons at rifle company / armored squadron level that should be considered when a combat team is formed. A brief examination of the company/squadron administrative echelons will be covered, and finally the combat team administrative echelon will be examined.
2. All the combat units have their own integral level of support. Forming a combat team requires some regrouping of assets to ensure the essential assets are in the right place to provide the desired level of support. As well, the replenishment process must be reorganized to meet the challenges made by the regrouping process. This is not an overly difficult process, but it is one that requires careful consideration and training to ensure the combat team echelon gets seamlessly plugged into the sustainment system.
3. **Regrouping of Echelons and Administrative Responsibilities.** The orders given to form the combat team explain the changes in command and control and in administrative responsibilities. The gaining unit usually gets the elements of the other arms under OPCOM or under OPCON if the element is likely to be regrouped later in the operation. Normally the gaining unit (in command of the combat team) is given the additional task of providing daily maintenance (daily maintenance refers to the provision of common combat supplies such as ammunition, fuel and rations) to all the attachments placed under its command or control. The losing units retain responsibility for administration less daily maintenance, and each combat team element must continue to draw certain support from its home unit including personnel administration, maintenance for specific equipment, replacement technical stores, repair parts, equipment, etc. The gaining unit CO will require additional resources to carry out the daily maintenance task, and he will negotiate assets from the losing units as required. The administration company/HQ squadron OCs, quarter masters and maintenance officers will sort this out for the CO and coordinate the regrouping activity in terms of where, when and how.

Combat Team Operations (Interim)

4. **Command of the Combat Team Echelon.** Due to the robustness and complexity of the armoured squadron's echelon, its command structure is the basis for all square combat teams, regardless of which sub-unit is joining which unit. In the A1, the infantry sergeant (transport sergeant) should be commanded by the armoured master warrant officer (SSM), and in the A2 the infantry warrant officer (company quarter master sergeant [CQMS]) should be commanded by the armoured captain (squadron 2IC).

5. For example, an infantry led combat team may have the following structure:

a. **F Echelon:**

- (1) 1 x infantry company;
- (2) 1 x tank squadron;
- (3) 1 x field engineer troop; and
- (4) FOO;

b. **A1 Echelon:**

- (1) infantry company A1;
- (2) the tank squadron echelon and elements of the armoured regiment's HQ squadron as required (this includes refuelling vehicles, ammo vehicles, tank mobile repair team, armoured recovery vehicle (ARV), armoured ambulances); and
- (3) elements of the losing engineer squadron's A1 if required (normally the combined infantry and tank A1s are sufficient to support the engineer troop without significant problems, particularly if the engineer share the same LAV platform); and

c. the addition of an artillery FOO party would pose no problem to the combat team as his requirements for combat supplies are minimal.

SECTION 2 A COMPARISON OF THE ECHELONS

6. **General.** The infantry echelon is smaller than the armoured echelon and is organized differently.
- a. **The Infantry Echelon.** An infantry battalion is supported under a centralized system based on an administration company. The company deploys A1's OPCON to the infantry companies and retains the remainder. The administration company is normally grouped into three groups on the battlefield:
 - (1) **B Echelon.** The non-critical support to the unit, located normally in the brigade support area (BSA). It is normally composed of the battalion orderly room with the adjutant or chief clerk commanding. It is OPCON to the close support service battalion for movement and defence, and the service battalion may be directed to provide daily maintenance. This echelon should control the personnel records and the flow of replacements to the unit. It may also house personnel left out of battle for any reason.
 - (2) **A1 Echelon.** Each infantry company is given a slice of the administration company to meet its immediate support requirements. These elements are detached OPCON from the administration company to the sub-unit.
 - (3) **A2 Echelon.** The remainder of the administration company. The A2 is required for the sustainment of operations but is of less immediacy than the A1.
 - b. **The Armoured Echelon.** An armoured regiment is supported under a decentralized system, meaning that every tank squadron has an echelon under its full command. There is also an HQ squadron providing the remainder of the unit integral support. These are normally organized into four groups on the battlefield:

Combat Team Operations (Interim)

- (1) **Regiment Orderly Room.** The non-critical support to the unit, located normally in the BSA. It is composed normally of the regiment orderly room with the adjutant or chief clerk commanding. It is OPCON to the close support service battalion for movement and defence, and the service battalion may be directed to provide daily maintenance. This echelon should control the personnel records and the flow of replacements to the unit. It may also house personnel left out of battle for any reason.
 - (2) **Squadron A1 Echelon.** The slice of the squadron echelon immediately behind the squadron, commanded by the SSM. The A1 contains vehicles carrying ammunition and petroleum, oil and lubricants (POL), maintenance and medical vehicles and the OC's rover.
 - (3) **Squadron A2 Echelon.** The slice of the squadron echelon behind the A1, providing the link to the HQ squadron. The A2 echelon would typically be commanded by the squadron 2IC, a captain. The A2 may include back-up assets to the A1, including medical, ammunition, POL and cargo carrying vehicles.
 - (4) **B Echelon.** This is HQ squadron less the regiment orderly room.
- c. Figures 6-1 and 6-2 depict a typical LAV infantry company A1 echelon and an armoured squadron A1 echelon:

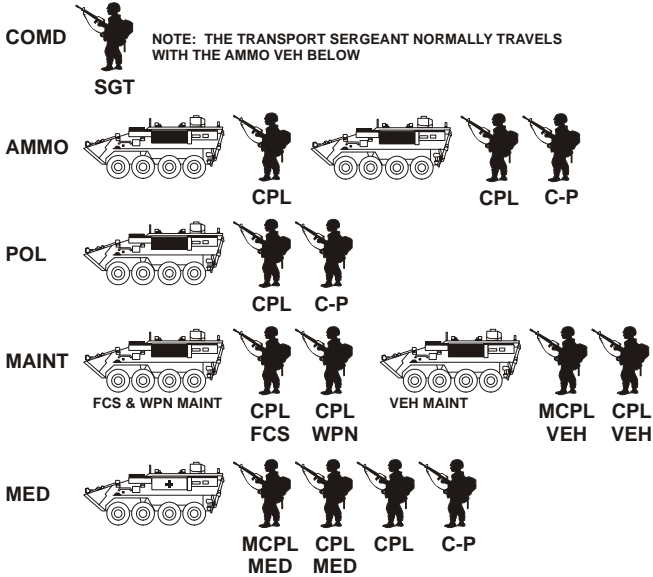

Figure 6-1: LAV Inf Coy A1 Ech

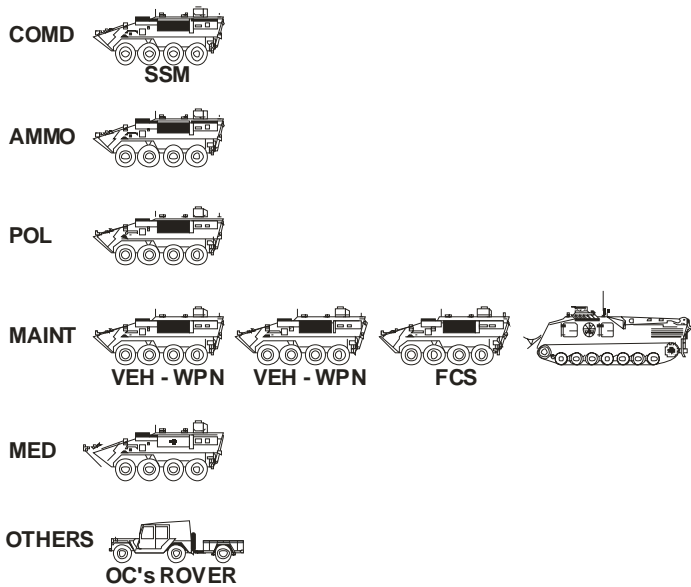

Figure 6-2: Armd Sqn A1 Ech

Combat Team Operations (Interim)

- d. Figures 6-3 and 6-4 depict a typical LAV infantry company A2 echelon and an armoured squadron A2 echelon:

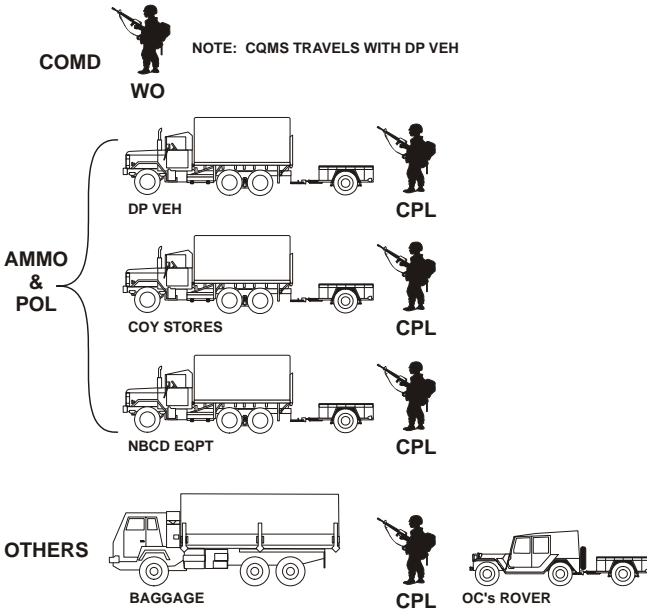

Figure 6-3: LAV Inf Coy A2 Ech

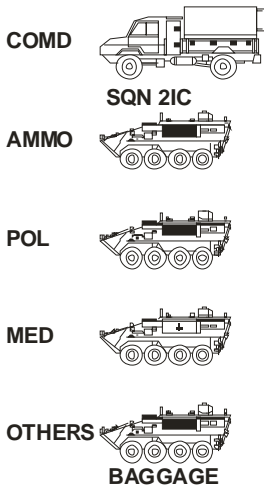

Figure 6-4: Armd Sqn A2 Ech

SECTION 3 HIDE/HARBOUR, LEAGUER, AND RUNNING REPLENISHMENT DRILLS

7. **Definitions:**
- a. **Leaguer.** A leaguer is a defensive formation adopted by armoured or mechanized forces while they replenish, maintain and rest. A leaguer is sometimes concealed and is a posture adopted by a force for administration convenience and protection.
 - b. **Hide.** A hide is a location that troops occupy before moving to battle or fire positions. A hide is simply an area offering concealment where a force waits before operations or a move into battle positions.
 - c. **Harbour.** A harbour is a temporary area that permits dispersal and concealment during rest, maintenance, replenishment or other administrative activities. It is an area where enemy interference is considered unlikely and where the emphasis is on administrative convenience.
 - d. **Running Replenishment.** An efficient way of conducting replenishment is the running replenishment point. This procedure works well on narrow forested tracks, in villages or at the entrance to a hide/waiting area. Ideally, it is done at night using filtered light indicators.
8. **Drill 1—Combat Team Harbour Area:**
- a. **Orders.** Orders for a move to and occupation of a combat team harbour/hidden area will include the following (if not already included in standard operating procedures):
 - (1) centre of mass (six figure grid—encoded);
 - (2) direction of approach (if appropriate);
 - (3) RV (six-figure grid, encoded if appropriate);
 - (4) order of march to RV;
 - (5) notice to move once in harbour area;

Combat Team Operations (Interim)

- (6) platoon/troop locations (if dispersed hide);
 - (7) crash RV; and
 - (8) replenishment and recovery plans.
- b. **Action on Arrival.** Actions to be taken on arrival at the combat team harbour area are as follows:
- (1) sub-units meet guides at RV;
 - (2) guides lead their troop/platoon into position using the in-route and follow the track plan;
 - (3) vehicles are individually positioned to allow a forward exit;
 - (4) vehicles switch off individually;
 - (5) after the last vehicle has switched off, the combat team stand-to for a two-minute period;
 - (6) troops/platoons deploy sentries to establish security;
 - (7) stand-to continues until sentries report their area clear;
 - (8) tank troop leaders coordinate troop arcs with the troop on their right;
 - (9) arcs of responsibility, locations of security elements and crash RVs are coordinated by combat team HQ;
 - (10) sub-unit commanders report to combat team HQ with administrative requirements and their personnel and vehicle states 20 minutes after the stand-to ends; and
 - (11) the combat team commander issues orders.
- c. **Layout.** A suggested layout is below:

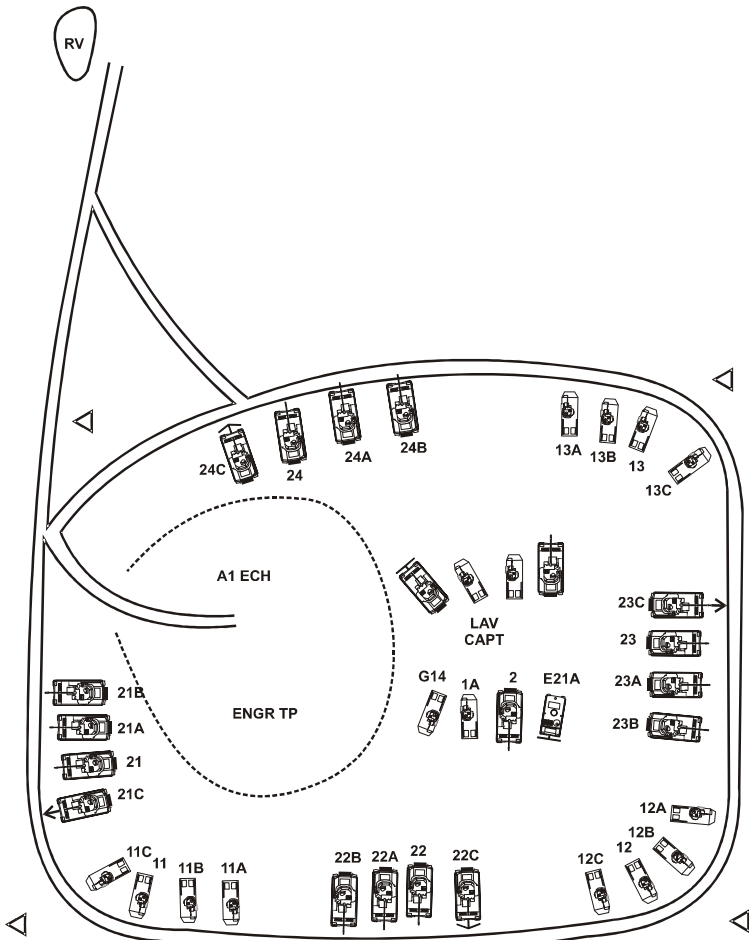

Figure 6-5: Example of a Perimeter Hide/Harbour Layout

9. **Drill 2—Combat Team Leaguer:**

a. **Orders.** Orders for a move to and occupation of a combat team leaguer will include the following:

- (1) centre of mass (six-figure grid);
- (2) direction (e.g., facing NORTH);
- (3) direction from which leaguer is to be entered;
- (4) order of march;

Combat Team Operations (Interim)

- (5) timings; and
 - (6) resupply.
- b. **Action on Arrival.** Actions to be taken on arrival at the combat team leaguer are as follows:
- (1) troops/platoons shake out well to the rear of the leaguer to get into position (tanks normally move into the leaguer first);
 - (2) tanks face out, first troop entering the leaguer forms front, second troop left, third troop right, fourth troop rear;
 - (3) combat team HQ and infantry platoons join leaguer using same drill;
 - (4) vehicles switch off individually;
 - (5) tanks and LAVs main armament traverse to cover arcs;
 - (6) sentries from “C” call signs deploy with radios forward, rear and on both sides of the leaguer;
 - (7) after the last vehicle has switched off, the combat team stands-to for a two-minute period;
 - (8) the stand-to continues until sentries report their areas clear;
 - (9) tank troop leaders coordinate troop arcs with the troop on their right;
 - (10) arcs of responsibility, location of security elements and crash RVs are coordinated by combat team HQ;
 - (11) sub-unit commanders report to combat team HQ with administrative requirements and the personnel and vehicle states 10 minutes after the stand-to ends; and
 - (12) the combat team commander issues orders.
- c. **Layout.** A suggested layout is below.

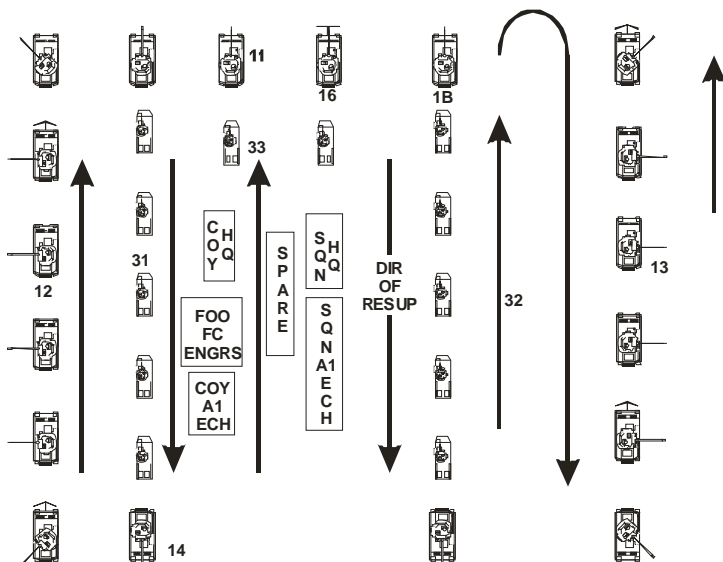

Figure 6-6: Example Layout of a Combat Team Leaguer

10. **Drill 3—Running Replenishment:**

- a. The procedure for running replenishment will be as follows:
 - (1) each troop/platoon will be called forward individually;
 - (2) before being called, each crew will determine its requirements—POL, ammo, rations, medical, etc.—and prepare to fuel the vehicle by positioning funnel, etc.;
 - (3) the vehicles in the running replenishment point will be parked in order according to their requirements:
 - (a) fuel (either jerry cans or pumps);
 - (b) oil and lubricant;
 - (c) ammo; and
 - (d) rations and other commodities.
 - (4) at the fuel vehicle, the crew will collect the required number of jerry cans, moves

immediately to the next vehicle to collect oil and lubricants and then proceeds to the ammo vehicle (thus more than one vehicle is serviced at once); and

- (5) beyond the ration vehicles, the crew will empty the jerry cans and drop them at the jerry can collecting point before moving on.

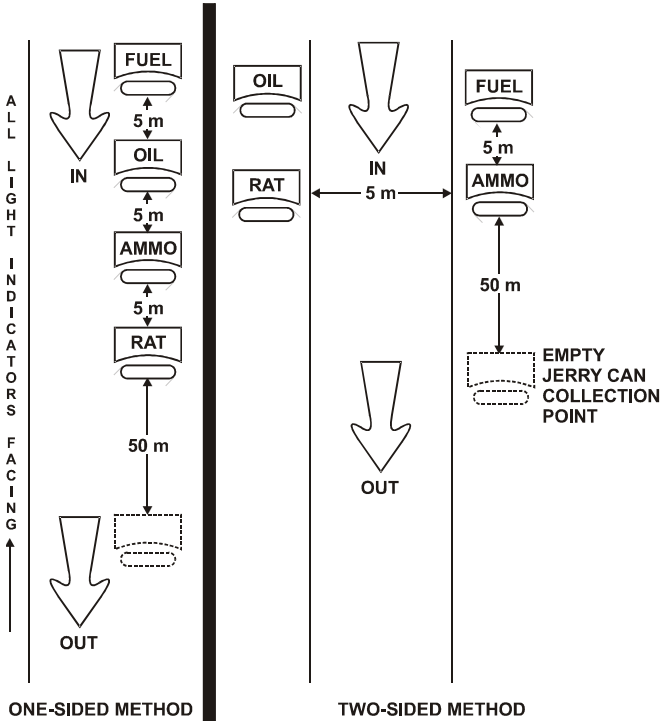

Figure 6-7: Example of a Running Replenishment

LIST OF ABBREVIATIONS

A

ADREP	administrative report
AD	air defence
AAAD	all-arms air defence
armd	armour
AEV	armoured engineer vehicle
AFV	armoured fighting vehicle
altn	alternate
arty	artillery
atk	attack
atk posn	attack position
aslt	assault
ARV	armoured recovered vehicle

B

bty	battery
BC	battle captain
BG	battle group
BSA	brigade support area

C

Capt	captain
CIMIC	civil-military cooperation
CSS	combat service support
cbt tm	combat team
comd	commander
CP	command post
coy	company
CSM	company sergeant-major

Combat Team Operations (Interim)

CFSP continuous fire support plan

COPPED Cover, Obstacles, Positions of fire, Positions of observation, Enemy, and Distance

D

DF defensive fire

E

EMCON emission control

en enemy

enr engineer

F

FASCAM field artillery scatterable mines

fd field

FPF final protective fire

FB fire base

FLOCARK Features, Lanes, Objectives, Canalizing ground, Approaches, Rate, and Key terrain and vital ground

FOO forward observation officer

H

HQ headquarters

HESH High explosive squash head (tank ammunition type)

ICM improved conventional munitions

inf infantry

K

KZ killing zone

L

LAV light armoured vehicle

LD line of departure

loc location

M

MASH Machine gun, Armour-piercing, Smoke, High explosive squash head (tank ammunition status)

m metre

mm millimetre

MG machine gun

MOPP mission oriented protective posture

MFC mortar fire controller

N

NBCD nuclear, biological and chemical defence

O

obj objective

OC officer commanding

OP observation post

OPCOM operational command

OPCON operational control

P

POL petroleum, oil and lubricants

pl platoon

posn position

PW prisoner of war

R

recce reconnaissance

RFL Restrictive Fire Line

RV rendezvous

ROE rules of engagement

S

SLUMS Safe Lane Under armour Marking Systems

Combat Team Operations (Interim)

SITREP situation report

sqn squadron

SSM squadron sergeant-major

sp support

T

TTP Tactics, techniques and procedures

TCCCS Tactical Command, Control and Communications system

tk tank

TOW Tube-launched, Optically-tracked, Wire-guided

TUA TOW Under Armour

tp troop

W

wng O warning order