

**FM 3-5**  
**MCWP 3-37.3**

***NBC***  
***Decontamination***

**Headquarters,  
Department  
of the  
Army**

**Commandant,  
US Marine Corps**

**DISTRIBUTION RESTRICTION:** Distribution is authorized to US Government agencies only to protect technical or operational information from automatic dissemination under the International Exchange Program or by other means. This determination was made on 31 March 2000. Other requests for this document will be referred to Commandant, US Army Chemical School, ATTN: ATSN-CMZ, Fort Leonard Wood, Missouri 65473

**DESTRUCTION NOTICE:** Destroy by any method that will prevent disclosure of contents or reconstruction of the document.

# FOREWORD

This publication may be used by the US Army and US Marine Corps during training, exercises, and contingency operations.

**JOHN N. ABRAMS**  
General, United States Army  
Commanding  
Training and Doctrine Command

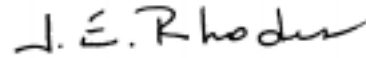

**J. E. RHODES**  
Lieutenant General, US Marine Corps  
Commanding General  
Marine Corps Combat Development  
Command

Field Manual  
No. 3-5

Headquarters,  
Department of the Army

Marine Corps Warfighting Publication (MCWP)  
3-37.3

Commandant,  
US Marine Corps

Washington, DC, 28 July 2000

# NBC DECONTAMINATION

## Contents

	<b>Page</b>
<b>PREFACE</b> .....	<b>vi</b>
<b>Chapter 1 INTRODUCTION</b> .....	<b>1-1</b>
Contamination Forms.....	1-1
Contamination-Hazards Transmission.....	1-1
Agent Classification .....	1-2
Decontaminants .....	1-2
Decon Concepts.....	1-2
Decon Decisions .....	1-2
Decon Principles .....	1-3
Decon Levels .....	1-4
Immediate.....	1-4
Operational.....	1-4
Thorough .....	1-4
Chemical-Agent-Resistant Coating (CARC) .....	1-5
Weather Effects .....	1-5
Temperature.....	1-5
Wind .....	1-5
Humidity and Rain .....	1-5
Sunlight.....	1-5
Time.....	1-5
Decon in Combat .....	1-5
<b>Chapter 2 IMMEDIATE DECON</b> .....	<b>2-1</b>
Skin Decon .....	2-1
Chemical.....	2-1

**DISTRIBUTION RESTRICTIONS:** Distribution is authorized to US Government agencies only to protect technical or operational information from automatic dissemination under the International Exchange Program or by other means. This determination was made on 31 March 2000. Other requests for this document will be referred to Commandant, US Army Chemical School, ATTN: ATSN-CMZ, Fort Leonard Wood, Missouri 65473

**DESTRUCTION NOTICE:** Destroy by any method that will prevent disclosure of contents or reconstruction of the document.

\* This publication supersedes Field Manual (FM) 305/Fleet Marine Force Manual (FMFM) 11-10, 17 November 1993.

	<b>Page</b>
Biological .....	2-1
Radiological .....	2-2
Personal Wipe Down .....	2-2
Chemical.....	2-2
Biological .....	2-2
Radiological .....	2-2
Operator's Spray Down .....	2-2
Chemical.....	2-2
Biological .....	2-3
Radiological .....	2-4
<b>Chapter 3 OPERATIONAL DECON .....</b>	<b>3-1</b>
Techniques .....	3-1
Phases .....	3-1
Preparation .....	3-1
Execution.....	3-2
Site Clearance .....	3-2
Vehicle Washdown .....	3-3
MOPP-Gear Exchange .....	3-3
Buddy-Team Method.....	3-6
Triple Buddy-Team Method.....	3-6
Individual (Emergency) Method.....	3-6
<b>Chapter 4 THOROUGH DECON .....</b>	<b>4-1</b>
Planning .....	4-1
Preparation .....	4-2
Execution .....	4-3
Predecon Staging Area .....	4-4
DED and DTD Areas .....	4-6
Postdecon AA .....	4-6
Detailed Troop Decon .....	4-6
Station 1 - Individual-Gear Decon .....	4-7
Station 2 - Overboot and Hood Decon .....	4-10
Station 3 - Overgarment Removal .....	4-11
Station 4 - Overboot and Glove Removal.....	4-12
Station 5 - Monitor .....	4-15
Station 6 - Mask Removal .....	4-15
Station 7 - Mask Decon Point.....	4-16
Station 8 - Reissue Point .....	4-17
Resupply Support Responsibilities .....	4-17
Detailed Equipment Decon .....	4-18
Decon Stations .....	4-18
Recycle Criteria .....	4-22
Reconstitution Criteria .....	4-22
DED Layouts .....	4-22
Alternate-Layout Planning Considerations .....	4-23
Decon Platoon .....	4-23
Smoke/Decon Platoon.....	4-23
Thorough-Decon-Site Closure .....	4-29
Closing the DED Area .....	4-30
Closing the DTD Area.....	4-32

	<b>Page</b>
Thorough Decon Under Unusual Conditions .....	4-33
<b>Chapter 5 SPECIAL DECON OPERATIONS .....</b>	<b>5-1</b>
Terrain Decon .....	5-1
Weathering .....	5-2
Removing/Covering .....	5-2
Neutralizing .....	5-2
Burning .....	5-3
Exploding .....	5-3
Flushing .....	5-4
Clearing .....	5-5
Fixed-Site Decon .....	5-5
Airfield .....	5-6
Helipad .....	5-6
POMCUS/Motor Park .....	5-7
Vulnerable Equipment Decon .....	5-7
Electronics .....	5-8
Optics .....	5-8
Ammunition .....	5-9
Canvas Items .....	5-9
Food and Water .....	5-9
Chemical Munitions Disposal and Decon .....	5-10
Handling .....	5-10
Contamination Control .....	5-11
Depleted Uranium (DU) Decon .....	5-11
Contaminated Remains Decon .....	5-12
Radiological Decon .....	5-12
Cesium .....	5-12
Cobalt .....	5-13
Plutonium .....	5-13
Strontium .....	5-13
Tritium .....	5-14
Uranium .....	5-14
<b>Chapter 6 EFFECTS OF ENVIRONMENTAL CONDITIONS .....</b>	<b>6-1</b>
Cold- and Arctic-Weather Areas .....	6-1
Decontaminants .....	6-1
Equipment-Decon Devices .....	6-3
Detection and Warning Devices .....	6-3
Equipment-Decon Stations .....	6-4
Warmed Areas .....	6-4
Urban Areas .....	6-5
Streets and Structures .....	6-5
Civilians .....	6-5
Supplies and Ammunition .....	6-5
Sanitation Systems .....	6-5
Mountains .....	6-5
Mobility .....	6-6
Wind .....	6-6
Temperature .....	6-6
Sunlight .....	6-6

	<b>Page</b>
Jungle .....	6-6
Temperature and Humidity .....	6-7
Time.....	6-7
Security.....	6-8
Resupply.....	6-8
Persistency .....	6-8
Desert .....	6-8
Water .....	6-8
Heat Stress.....	6-8
Weathering .....	6-8
Bearings and Other Critical Moving Parts .....	6-9
<b>Chapter 7 AVIATION .....</b>	<b>7-1</b>
Contamination Avoidance .....	7-1
Decontaminants .....	7-2
Aircraft Decon .....	7-2
Decon Types .....	7-3
Decon Stations .....	7-9
Recycle Criteria .....	7-14
Aircraft Decon-Site Selection .....	7-14
Decon-Site Layout .....	7-15
<b>Chapter 8 PATIENT EVACUATION AND DECON .....</b>	<b>8-1</b>
Evacuation Considerations .....	8-1
Patient Decon .....	8-2
Patient Decon at an MTF .....	8-2
Battalion Aid Station (BAS).....	8-3
Medical Company's Clearing Station.....	8-3
Hospital.....	8-3
Chlorine-Solution Preparation for Patient Decon .....	8-4
Chemical-Agent Patient Decon Procedures .....	8-4
Litter Patient .....	8-4
Ambulatory Patient .....	8-10
Biological-Agent Patient Decon Procedures .....	8-15
Litter Patient .....	8-15
Ambulatory Patient .....	8-19
Radiological-Agent Patient Decon Procedures .....	8-22
Litter Patient .....	8-22
Ambulatory Patient .....	8-25
<b>Chapter 9 LOGISTICS.....</b>	<b>9-1</b>
Skin Decon and Personal Wipe Down .....	9-1
Individual-Gear Decon .....	9-1
Operator's Spray Down .....	9-1
MOPP-Gear Exchange.....	9-1
Vehicle Washdown .....	9-2
Detailed Troop Decon .....	9-2
Detailed Equipment Decon .....	9-2

---

	<b>Page</b>
<b>Chapter 10 DECON PROCEDURES FOR INDIVIDUAL AND CREW-SERVED WEAPONS</b> .....	<b>10-1</b>
Operational-Decon Procedures Using the IEDK .....	10-1
M60 Machine Gun .....	10-1
M249 Squad Automatic Weapon .....	10-2
M203 Grenade Launcher.....	10-2
M47 Dragon.....	10-2
Tow Missile (M220 Series) .....	10-3
AT4 Light Antitank Weapon .....	10-4
66-Millimeter Rocket Launcher .....	10-4
81-Millimeter Mortar .....	10-4
60-Millimeter Mortar .....	10-4
Javelin.....	10-5
Thorough-Decon Procedures Using the HTH Solution .....	10-5
Materials .....	10-7
Procedures .....	10-8
<b>Appendix A CONVERSIONS AND MEASUREMENTS</b> .....	<b>A-1</b>
<b>Appendix B DECONTAMINANTS</b> .....	<b>B-1</b>
<b>Appendix C DECON OF SPECIFIC SURFACES AND MATERIALS</b> .....	<b>C-1</b>
<b>Appendix D DECON KITS, APPARATUSES, AND EQUIPMENT</b> .....	<b>D-1</b>
<b>Appendix E DTD STATION CHARTS FOR CHEMICAL UNIT LEADERS AND NBC NCOS</b> ....	<b>E-1</b>
<b>GLOSSARY</b> .....	<b>Glossary-1</b>
<b>BIBLIOGRAPHY</b> .....	<b>Bibliography-1</b>
<b>INDEX</b> .....	<b>Index-1</b>

## Preface

FM 3-5 integrates the nuclear, biological, and chemical (NBC) fundamentals published in FM 3-100 and implements Standardized North Atlantic Treaty Organization Agreement (STANAG) 2426.

The extent and timing of decon depends on the tactical situation, the mission, the area of contamination, and the decon resources available. Survivability and reducing the effect of any chemical threat are the ultimate goals of decon. This manual provides detailed guidance on conducting decon operations performed by chemical and nonchemical personnel. Individual soldiers and leaders must be familiar with the basic procedures and concepts in this manual.

Appendix A contains an English to metric measurement conversion chart.

The proponent of this publication is Headquarters TRADOC. To submit changes for improving this publication use Department of the Army (DA) Form 2028 (Recommended Changes to Publications and Blank Forms) and forward to Commandant, US Army Chemical School, ATTN: ATSN-CMZ, Fort Leonard Wood, Missouri 65473-8926.

*Unless this publication states otherwise, nouns and pronouns do not refer exclusively to men.*



## Chapter 1

# Introduction

The use of NBC weapons creates unique residual hazards that may require decon. In addition to the deliberate use of these weapons, collateral damage, natural disasters, and industrial emitters may require decon. The presence of contamination generally reduces the effectiveness of our combat power. Contamination forces us into protective equipment that degrades our ability to perform individual and collective tasks.

### CONTAMINATION FORMS

1-1. The following are the different forms of contamination:

- Solids – radioactive particles, biological spores, or dusty agents that could appear as a fine dust.
- Liquids – liquid droplets that fall like rain. Droplets can range from thick and sticky to the consistency of water.
- Vapors or gases – created by bursting munitions or generators. These clouds are affected by the weather and can cover large areas.
- Aerosols – fine liquids or solid particles suspended in the air. They behave much like vapors.

### CONTAMINATION-HAZARDS TRANSMISSION

1-2. Contamination hazards can be transmitted in the following manner:

- **Transfer.** Anything that touches a surface covered with liquid or solid contamination will tend to pick up that contamination and move it from one surface to another.
- **Spread.** Touching a surface covered with liquid chemical agent can spread contamination on the same surface, thereby, increasing the size of the contaminated area.
- **Vapor.** Vapors can be carried through the air in the form of a dust, atomized liquids (aerosols), or true gases. Vapors in an open/outdoor area disperse rapidly, so there is no need to decon.
- **Desorption.** Liquid-chemical contamination absorbs into porous surfaces. Once absorbed, it begins to desorb or give off gas; that is, low levels of vapor pass out of the contaminated surface into the air and can be transferred to any surface that contacts it, including bare skin.
- **Radiation.** Radiation is given off by radioactive dust or dirt, most of which appears as fallout. For decon purposes, radiation can be thought of as a solid.

## AGENT CLASSIFICATION

1-3. Depending on the length of time agents will be a hazard, they are classified as—

- Nonpersistent – an immediate threat that lasts a few minutes. They rarely require decon.
- Persistent – takes a longer time to act and may last for days. In a protected environment, these agents can last for long periods of time. All agents are affected to some extent by the weather. Even radiological particles can “rain out” of the air and form hot spots on the ground. Biological organisms are greatly affected by sunlight. Chemical agents can be decontaminated by the weather. The duration of a hazard is a complex estimation that is based on numerous factors which include the—
  - Type of contamination.
  - Contamination density and droplet size.
  - Temperature.
  - Wind speed.
  - Sunlight.
  - Humidity and rain.
  - Composition of the contaminated surface.
  - Type of soil and terrain.

## DECONTAMINANTS

1-4. Decontaminants are described as follows:

- Natural – weather (rain, wind, and humidity).
- Standard – supertropical bleach (STB) and decontaminating solution number 2 (DS2).
- Nonstandard – soaps and detergents.

1-5. For more information on the types of decontaminants, see Appendix B.

## DECON CONCEPTS

1-6. Whenever soldiers are unable to avoid contamination and have to use protective measures, decon is necessary to allow them to remove their protective gear and resume normal operations. Weathering is the most desirable means of decon; however, time and operational needs may not permit that option.

1-7. This chapter describes when, where, and how much to decon. Protective clothing (mission-oriented protective posture [MOPP] gear), protective equipment, and collective protective shelters (CPSs) offer only a temporary solution. Decon is the removal, destruction, or naturalization of contamination. If you become contaminated, some decon must occur as soon as possible.

## DECON DECISIONS

1-8. The decision to decon is a risk assessment and is made within the context of the mission, enemy, terrain, troops, time available, and civilian

consideration (METT-TC) and the resources available. Decon must be considered if the contamination levels exceed the negligible risk levels as follows:

- Chemical and biological contamination causes mild incapacitation in 5 percent or less of unprotected soldiers operating for 12 continuous hours within 1 meter of contamination. For the chemical-agent monitor (CAM), this equates to a one-bar reading at a distance of 1 inch from the surface.
- Radiological contamination can cause mild incapacitation in 2.5 percent or less of unprotected, nonpreviously exposed soldiers. This equates to a reading of no more than 0.33 centigray per hour (cGy/hr).

1-9. MOPP-gear exchange provides excellent protection against field concentrations of agents; however, wearing the gear causes performance degradation. Decon is performed to restore the normal operating tempo, but the logistical support that is required to keep soldiers in MOPP gear impacts operations. Therefore, decon should be conducted as soon as practical. Table 1-1 provides comparison data for decon levels/techniques.

**Table 1-1. Comparison Data for Decon Levels/Techniques**

Levels	Techniques <sup>1</sup>	Best Start Time	Performed by	Advantages
Immediate	Skin decon	Before 1 minute	Individual	Stops agent from penetrating.
	Personal wipe down	Within 15 minutes	Individual or crew	
	Operator's spray down			
Operational	MOPP-gear exchange <sup>2</sup>	Within 6 hours	Unit	Provides possible temporary relief from MOPP <sup>4</sup> . Limits liquid agent spread.
	Vehicle washdown <sup>3</sup>		Battalion crew or decon platoon (-)	
Thorough	DED and DAD	When mission allows reconstitution	Decon platoon	Provides probable long-term MOPP reduction with minimum risk.
	DTD		Unit	

<sup>1</sup>The techniques become less effective the longer they are delayed.  
<sup>2</sup>Performance degradation and risk assessment must be considered when exceeding 6 hours. See FM 3-4 for battle-dress overgarment (BDO) risk assessment.  
<sup>3</sup>Vehicle washdown is most effective if started within 1 hour.

## DECON PRINCIPLES

1-10. Decon immediately for a chemical agent on the skin. Perform higher levels of decon as a result of the risk assessment. Personnel should—

- Decon as soon as possible. The sooner the contamination is removed, the sooner MOPP levels can be reduced and combat power can be restored.
- Decon only what is necessary. Weathering is the least costly method of decon. Expend resources where they count.
- Decon as far forward as possible. While METT-TC dependent, performing decon as close to the point as possible reduces the spread of contamination and minimizes any transfer hazard.
- Decon by priority. The commander identifies which items are most critical to the mission. Restoring combat power and reestablishing operating tempo are key.

## **DECON LEVELS**

1-11. The three levels of decon operations are immediate, operational, and thorough (see Table 1-1, page 1-3).

### **IMMEDIATE**

1-12. Skin decon is a soldier's basic survival skill and should be performed within 1 minute of being contaminated using the skin decontaminating kit (SDK).

1-13. Personal wipe down should be performed within 15 minutes. This is done to remove contamination from individual equipment by using an individual equipment decon kit (IEDK). Use detector paper or a CAM to locate the agent. For radiological contamination, use a radiac set to locate it and then brush, wipe, or shake it off.

1-14. Operators' spray down should be done within 15 minutes. Operators use the on-board decon apparatus to decon surfaces that they must touch or contact to operate the equipment. Radiological contamination in the form of dust particles may be wiped, scraped, or brushed off.

### **OPERATIONAL**

1-15. A MOPP-gear exchange should be performed within 6 hours of being contaminated when thorough decon cannot be done. Soldiers will continue to wear MOPP gear and the operating tempo will be reduced.

1-16. Vehicle washdown should be performed within 6 hour of being contaminated when the mission does not permit a thorough decon. This process removes gross contamination and limits the spread of it.

### **THOROUGH**

1-17. Detailed equipment decon (DED) and detailed aircraft decon (DAD) restore items so that they can be used without MOPP gear. Normally, the DED and the DAD are conducted as part of a reconstitution or during breaks in combat operations. These operations require support from a chemical decon unit.

1-18. Detailed troop decon (DTD) normally takes place in conjunction with DED/DAD. The contaminated unit conducts this process and supports the DED/DAD operations.

---

## **CHEMICAL-AGENT-RESISTANT COATING (CARC)**

1-19. Army equipment is painted with CARC, which precludes the absorption of chemical agents and, thus, facilitates decon. By preventing penetration of an agent, contamination is easier to remove. Thickened agents are still a problem, but detergent and water should remove them.

1-20. The proper CARC paint colors should be used to paint bumper numbers, spot painting, and so forth. Do not use other paints in lieu of CARC.

## **WEATHER EFFECTS**

1-21. If METT-TC allows, leaving the contamination alone is the easiest method of decon. However, marking, reporting, and periodically rechecking the contamination are required.

### **TEMPERATURE**

1-22. The higher the temperature, the faster the rate of evaporation. Contamination persistency decreases as the temperature rises. It has no effect on radiological contamination.

### **WIND**

1-23. Aeration aids in decon. Agents are dispersed by the wind, thus reducing the concentration.

### **HUMIDITY AND RAIN**

1-24. Moisture tends to break down chemical agents but does so slowly. Heavy rain physically removes contamination; however, contaminated runoff may build up in drainage areas. Biological agents dehydrate (dry out) in low humidity, thus reducing their persistency. Rain may prevent the desorption of aerosols and leach contamination into the soil.

### **SUNLIGHT**

1-25. Sunlight hastens the evaporation and decomposition of agents. Ultraviolet and infrared radiation in sunlight rapidly kills most biological agents.

### **TIME**

1-26. Only time will neutralize and destroy radiological contamination. Other techniques merely shield or remove the problem.

## **DECON IN COMBAT**

1-27. Combat effectiveness is degraded by MOPP. Decon can remove the contamination and restore combat power. The detection and warning network is vital to ensure that soldiers and equipment are protected when contamination is encountered. Considerations of decon in combat are—

- Immediate decon. It saves lives and permits the use of individual equipment and key systems.
- Operational decon. It reduces the spread and the level of contamination. In some cases, when combined with weathering, MOPP levels may be reduced without further decon.
- Thorough decon. It removes the unit from the fight but allows it to return with restored effectiveness.

1-28. Figure 1-1 depicts the drop in effectiveness as the affected unit and soldiers react.

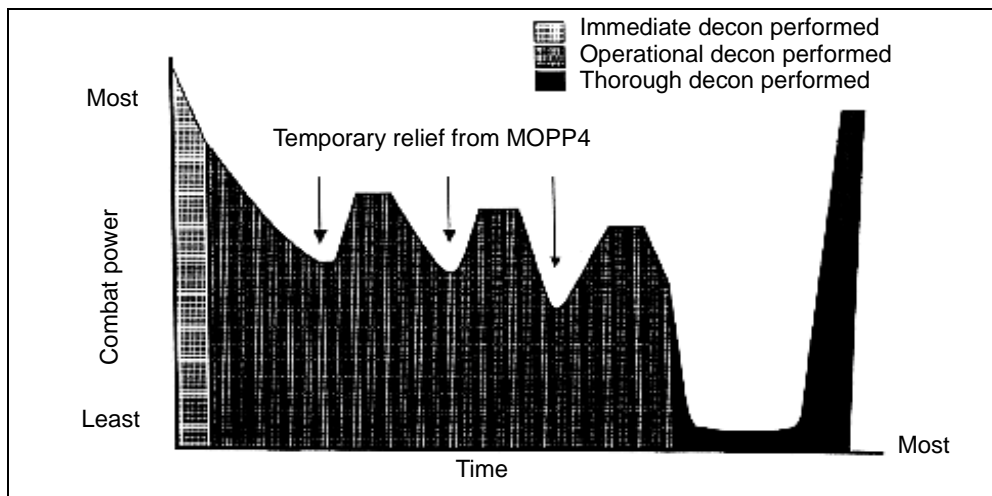

Figure 1-1. How Decon Affects Combat Effectiveness

## Decon-Operation Scenario

*You are the commander of the 155-millimeter Self-Propelled Howitzer Battery. Your unit is hit by a persistent nerve agent. Soldiers react by taking cover and going to MOPP4. The warning system provided sufficient alert and only a few have to conduct skin decon; most contamination is on the outside of your howitzers and vehicles.*

*The ongoing fire mission continues with minimal disruption, and the enemy is being detected. Your well-trained soldiers complete a personal wipe down and an operator's spray down as soon as possible. During this period, you are capable of providing fire support and moving, as necessary.*

*The temperature is 55°F, and humidity is low. While the work rate is strenuous, your troops drink water and suffer no heat casualties. However, after several hours, your response times to the fire mission are getting longer and soldiers have not eaten in more than 12 hours.*

*Upon making a decision to decon, you request support from your battalion. Coordination is made for an operational decon en route to an alternate position. You have 2 ½ hours to complete the movement and be in a firing position. The alternate position is 20 minutes away, with the decon site about halfway.*

*You send the advance party to meet the supporting power-driven decon-equipment (PDDE) crew and organize the site. The crew sets up and runs the vehicle washdown while the advance party, with battery supply personnel, prepares the MOPP-gear exchange.*

*The battalion chemical noncommissioned officer (NCO) directs the vehicle washdown as you rotate one platoon at a time through the site. The firing platoons go quickly as it is critical to have the artillery firing tables available. You complete the operation and are in position to fire at the prescribed time. Your soldiers are in MOPP4 because a vapor hazard still exists from the residual contamination. The advance party found the new area clear of contamination, and ammo resupply commences.*

*As sections begin improving their positions, gun crews one and two leave one soldier on each gun and move the rest of the soldiers 65 feet upwind. After a check on contamination proves negative, the battery NBC NCO directs unmasking procedures using two crew members. When no symptoms show up, the crews eat and get relief from the masks. The wind direction is monitored to ensure that the soldiers stay upwind of any vapors desorbing from their equipment.*

*Soldiers on the guns rotate into the clean area for rest and relief. Those returning to the guns assume MOPP4.*

## Chapter 2

# Immediate Decon

Once a soldier is aware of chemical or biological contamination on his bare skin, he initiates immediate decon techniques, without command, by using his personal SDK. He decontaminates his hood, mask, gloves, and weapon using the IEDK or an additional SDK. To remove radiological contamination from equipment and personnel, brush it off and/or use soap and water.

**NOTE: Throughout this manual, SDK refers to the M291 kit and IEDK refers to the M295 kit.**

### SKIN DECON

2-1. Start the skin-decon techniques within 1 minute of becoming contaminated. Some toxic chemical agents, especially nerve agents, kill in minutes.

### CHEMICAL

2-2. Use the SDKs within 1 minute of contamination (see Figure 2-1). Instructions for use are listed on the outside of the kit itself, on the individual packet within the kit, and in STP 21-1-SMCT.

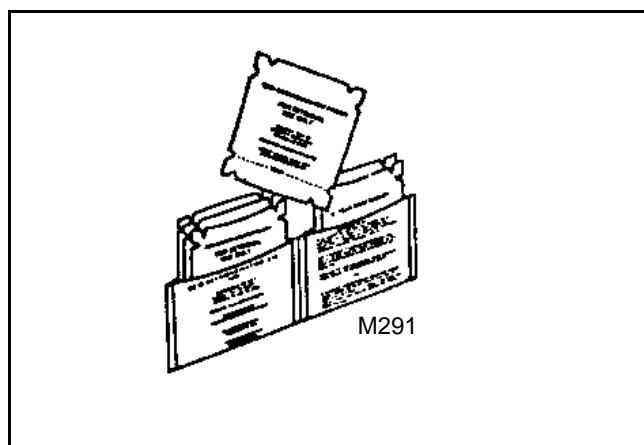

Figure 2-1. M291 SDK

2-3. If an SDK is not available, chemical contamination may be pinch-blotted from the skin with a cloth and flushed with water from a canteen. Soap, if available, can also be used to wash the agent from the skin. Washing with soap and water (or hot water) is the next best method for toxic-agent decon if SDKs are not available, but this method is not as effective as using the decon kits.



## **BIOLOGICAL**

2-4. Washing with soap and water removes nearly all biological agents from the skin. A 0.5 percent chlorine (calcium hypochlorite [HTH] or household bleach) solution is an effective biological decontaminant. See Appendix B for details on how to make this solution.

## **RADIOLOGICAL**

2-5. To remove radiological dust particles, brush, wash, or wipe them off.

## **PERSONAL WIPE DOWN**

2-6. The personal wipe-down techniques are most effective when done within 15 minutes of being contaminated. The CAM and/or M8/M9 detector paper is used to detect and monitor equipment.

**NOTE: Very high concentrations of DS2 can cause a CAM response in the G mode.**

2-7. Wipe down your mask, hood, gloves, and other essential gear. Do not attempt to remove chemical contamination from your protective overgarment unless there are obvious clumps of the agent. In this case, scrape off the material. Brush off radiological or frozen chemical-agent contamination. See FM 3-4 for detailed information on your overgarment's protective qualities.

## **CHEMICAL**

2-8. Decon individual equipment using the IEDKs. Wearing your Kevlar® helmet protective cover will prevent or reduce the adsorption of any liquid chemical agent. Washing with soap and water and bleach solutions is partially effective (see Appendix B).

## **BIOLOGICAL**

2-9. Wash with soap and water. If water is not available, use SDKs in the same manner as described for chemical-agent decon.

## **RADIOLOGICAL**

2-10. Locate radiological contamination with monitoring equipment and remove by brushing and shaking it off. Wash exposed areas of your skin and pay particular attention to your hair and fingernails. Avoid breathing the dust particles you shake off by wearing your protective mask or a piece of cloth over your nose and mouth. If wet, conduct a MOPP-gear exchange as soon as possible because brushing or shaking will not remove the contamination. Wipe off your equipment with warm, soapy water using rags or damp paper towels.

## **OPERATOR'S SPRAY DOWN**

2-11. Decon other mission-essential portions of your equipment before continuing your mission. The CAM and/or M8/M9 detector paper is used to determine what surfaces require decon.

2-12. Operator's spray down is most effective when done within 15 minutes of contamination.

**CHEMICAL**

2-13. Decon those surfaces that you must touch on the exterior of the vehicle or equipment you must use to do your job with the on-board portable decon apparatus (such as the M11 or M13) (see Figure 2-2). The IEDK may be used on equipment that DS2 may cause damage to by corrosive action (see Figure 2-3).

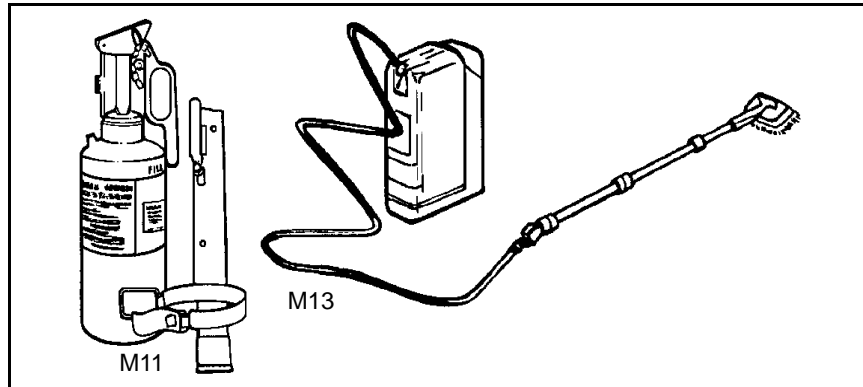

Figure 2-2. Portable Decon Apparatuses

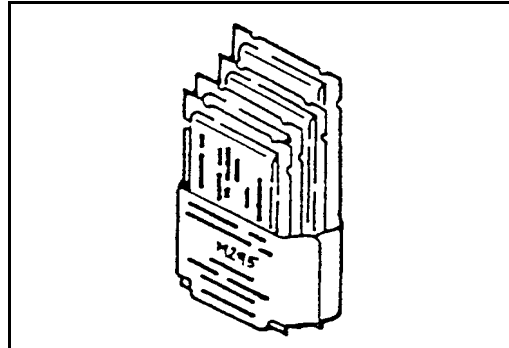

Figure 2-3. M295 IEDK

**WARNING**

Use extreme caution at all times when handling DS2. Do not mix DS2 and STB because it will cause a fire. Do not allow DS2 to be sprayed on personnel or protective clothing. DS2 is a combustible solution. Do not spray DS2 on hot engine blocks. Severe chemical burns can result if personnel fail to observe all safety precautions. DS2 can severely injure eyes and skin and, if inhaled, can cause illness. DS2 can damage the NBC protective overgarment. Long-term contact with DS2 can damage the NBC protective gloves, hood, and overboots.

2-14. Scrub the DS2 into the exterior surface with brushes. Wait 30 minutes, then wash off. If a decon apparatus is not available, use the field-expedient resources that are available to apply DS2 or STB from bulk containers. If necessary, use the nonstandard decontaminants that are discussed in Appendix B.

#### **BIOLOGICAL**

2-15. Use a bleach solution for biological contamination; however, if bleach is not available, use hot, soapy water. Apply with brushes and scrub the surface well. Rinse the surface after scrubbing (no wait is required). DS2 and STB are also effective against most known biological contamination, but because of their caustic nature, they are not preferred. Other nonstandard biological decontaminants are described in Appendix B.

#### **RADIOLOGICAL**

2-16. If you are contaminated by fallout, rain out, neutron-induced contamination, or any type of radiological agent, use your monitoring equipment to help locate it and decon as required. If detection equipment is not available and you suspect that you are contaminated, decon. Radiological contamination can usually be removed by brushing or scraping. Water is effective for flushing away radiological contamination; however, the runoff should be controlled by using drainage ditches that flow into a sump. Remember, you have not destroyed the contamination, it has just been moved. The runoff will still be hazardous. If you have time, brush or scoop away the top inch of soil from your fighting position to lower the amount of radiological contamination affecting you.

## Chapter 3

# Operational Decon

An operational decon limits the spread of contamination, allows temporary relief from MOPP4, and facilitates additional decon requirements. By speeding up the weathering process, the need for a thorough decon may be eliminated. This process requires about a 120-square-yard area and, depending on the number of contaminated vehicles, may not require a nearby water source. An operational decon consists of a vehicle washdown and a MOPP-gear exchange. The techniques that may be used to conduct an operational decon are decentralized company control, centralized battalion control, or centralized brigade control.

### TECHNIQUES

3-1. Decentralized company control is provided by the unit commander. The commander requests PDDE support, selects the decon site, links up with the PDDE crew, and executes the operational decon.

3-2. Centralized battalion control is similar to the above except that the battalion chemical NCO controls the decon. The site is selected by the battalion commander, and the battalion chemical NCO directs site setup and security and provides command and control (C<sup>2</sup>). The battalion chemical NCO travels with the PDDE and communicates via the radio.

3-3. Centralized brigade control is done when decon assets within the brigade have been consolidated. In this technique, the brigade chemical NCO performs those functions described for the battalion chemical NCO. The advantages and disadvantages of operational-decon techniques are listed in Table 3-1, page 3-2.

### PHASES

3-4. The three phases for an operational decon are preparation, execution, and site clearance.

### PREPARATION

3-5. The preparation phase starts with the decision to conduct an operational decon and ends with a site that is set up and ready for operation. (The decision to decon was described in Chapter 1.) The CAM is used to identify which vehicles need decontaminating, and PDDE support is requested. Coordination with higher headquarters (HQ) includes identifying the linkup point and the unit that will provide the PDDE support. Signal operating instructions (SOI) information is exchanged and the technique (decentralized company control, centralized battalion control, or centralized brigade control) is selected. The number and type of vehicles and the number of personnel for a MOPP-gear exchange are provided.

**Table 3-1. Advantages and Disadvantages of Operational-Decon Techniques**

	<b>Decentralized Company Control</b>	<b>Centralized Battalion Control</b>	<b>Centralized Brigade Control</b>
Advantages	Flexibility Dispersion	C <sup>2</sup> Flexibility Dispersion Planning Sustained operations	C <sup>2</sup> Synchronized support assets Rehearsal Time Planning Sustained operations
Disadvantages	C <sup>2</sup> Synchronized support assets Rehearsal Time Planning Sustained operations	Synchronized support assets Rehearsal Time	Flexibility Dispersion

3-6. Site selection is done by the controlling HQ. The site may have been designated in the operation order (OPORD) or selected based on the current METT-TC. For site characteristics, see Table 3-2.

3-7. Linkup at the designated point includes establishing security, positioning any necessary marshalling areas, camouflaging removal points, designating the direction of flow into and out of the site, and ensuring that unit supply has sufficient replacement MOPP gear.

3-8. Site setup requires the PDDE crew to position itself upwind from the entrance. Set up the MOPP-gear exchange about 164 feet upwind from the vehicle washdown at a 45° angle. Notify the contaminated unit when the site is ready.

**EXECUTION**

3-9. The execution phase starts with establishing positive control over the site and ends with processing the last contaminated vehicle and soldier through the site. Vehicles move from the predecon area to the site either on order or by watching the vehicle ahead. Contaminated soldiers leave the vehicle and proceed to the MOPP-gear-exchange point. The contaminated unit provides security.

3-10. Each vehicle receives a 2- to 3-minute washdown with hot, soapy water and moves to a point near the MOPP-gear exchange. Any remaining soldiers requiring MOPP-gear exchange will do so then. When the squad or crew has finished, it remounts its vehicles and moves into an after-decon assembly area (AA) to await further instructions or moves to its next battle position.

**SITE CLEARANCE**

3-11. The site-clearance phase includes cleanup, marking, and reporting. METT-TC will dictate the cleanup requirements. The PDDE crew buries or double bags and removes contaminated MOPP gear and other expendables. Standard NBC contamination markers are posted, and the PDDE crew submits an NBC 5 report.

**Table 3-2. Operational-Decon Phases**

<b>Preparation</b>	
Decon assessment	Identify soldiers and equipment to be decontaminated.
Coordination	Request PDDE support. The chemical section conducts coordination with the contaminated unit on the linkup point. Decon operations should be done between 1 and 6 hours after becoming contaminated.
Site selection	Is selected by the controlling HQ. Is off the main route but has easy access. Is a large enough area (120 square yards per site for a squad-size element). Has good overhead concealment. Has a good water source (plan for 100 gallons per vehicle). Has good drainage.
Linkup	Ensure that the noncommissioned officer in charge (NCOIC) knows where to link up with the contaminated unit and the location for site setup. Radio communication is essential for operations.
Site setup	Ensure that the PDDE is positioned properly and ready to dispense hot, soapy water. Ensure that the contaminated unit sets up and operates the MOPP-gear exchange at the same time as the vehicle washdown. Consider contamination runoff when positioning the PDDE.
<b>Execution</b>	
Site control and security	Ensure that the drivers of the contaminated vehicles know when to move into position at the washdown location. Ensure that the contaminated unit has provided site security.
Processing	Ensure that the decon site NCOIC is processing vehicles at a rate of 2 to 3 minutes per vehicle. Also, ensure that soldiers are going through the MOPP-gear exchange at the rate of 30 minutes per squad/crew.
<b>Site Clearance</b>	
Cleanup	Decon site NCOIC ensures that the MOPP-gear-exchange area is cleaned up.
Marking and reporting	Decon site NCOIC ensures that his team properly marks the decon site and sends the NBC 5 report forward.

## VEHICLE WASHDOWN

3-12. A vehicle washdown may be conducted with or without PDDE and in either a one- or two-lane configuration. An unsupported washdown requires the contaminated unit to have washing equipment that can produce 60 to 120 pounds per square inch (psi) of water pressure. The capacity to heat water and inject soap increases effectiveness. A supported washdown requires PDDE organic to the unit or from a supporting chemical decon or dual-purpose company. A two-lane washdown is simply a one-lane washdown parallel with another (see Figure 3-1, page 3-4).

3-13. Other configurations are limited only by the constraints of the METT-TC. Figure 3-2, page 3-5, illustrates a dispersed operational-decon setup. Table 3-3, page 3-5, describes the vehicle-washdown process.

## MOPP-GEAR EXCHANGE

3-14. A MOPP-gear exchange can be done with a buddy team, a triple buddy team, or an individual (emergency). For planning purposes, estimate about 60

minutes for a squad or a platoon to complete the exchange. Since individual performance is severely degraded after 6 hours at MOPP4, the MOPP-gear exchange should be scheduled before that time.

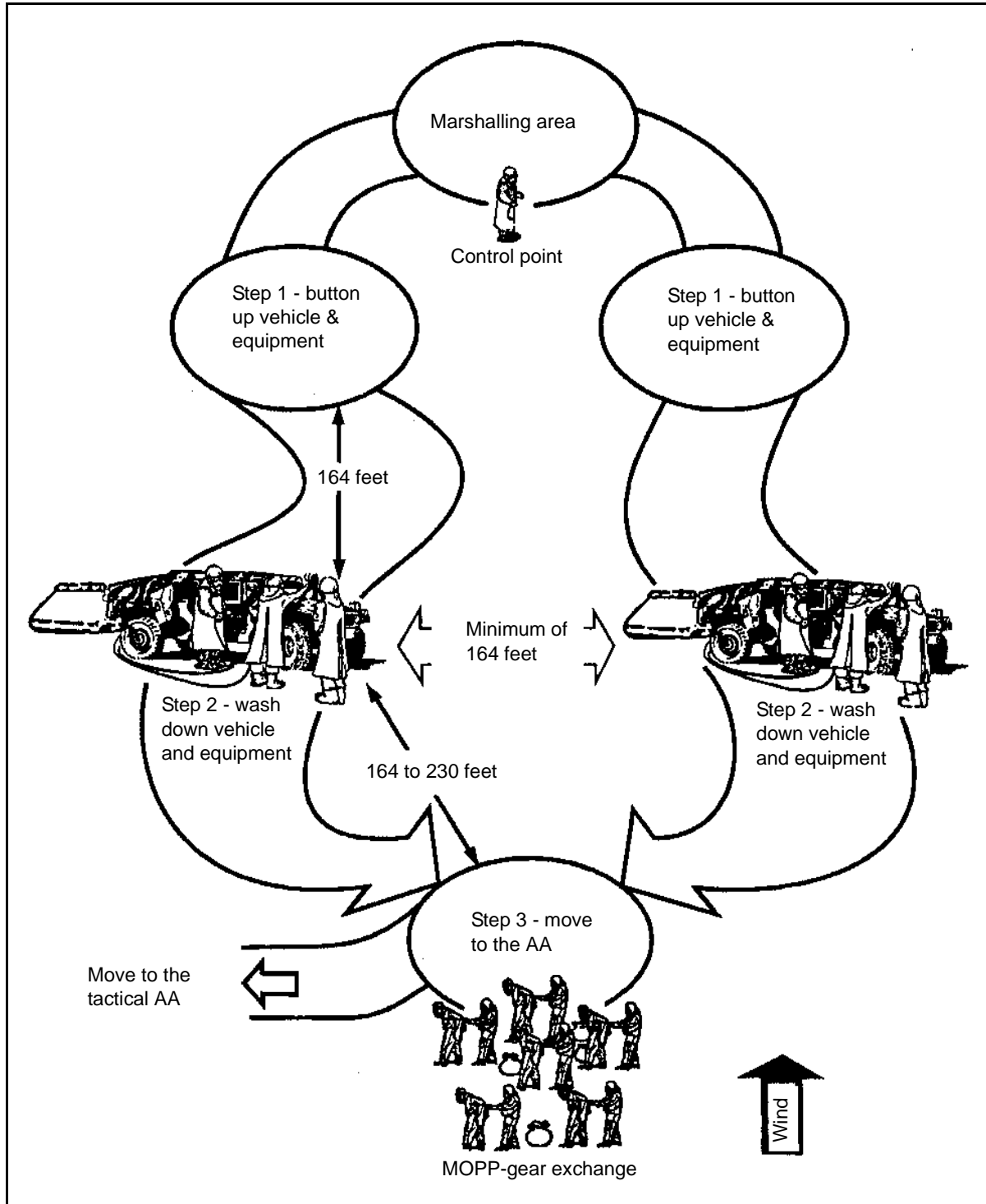

Figure 3-1. Two-Lane Washdown

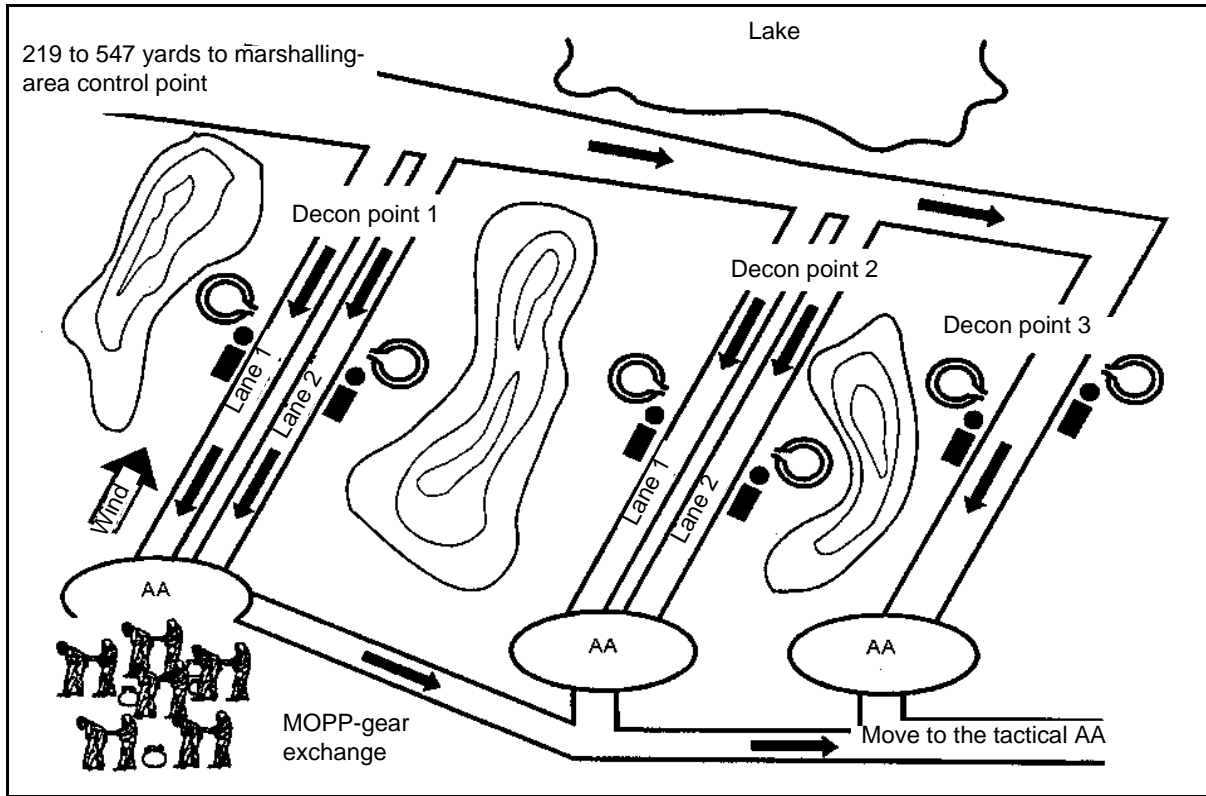

Figure 3-2. Dispersed Operational-Decon Setup

Table 3-3. Vehicle-Washdown Process

Steps	Equipment	Procedures
1. Assemble vehicles. Unit is tactically dispersed. Personnel at the control point direct movement.	Watch	Personnel at the control point supervise preparing vehicles and directing movement out of the AA.
2. Prepare vehicles.	None	Individual/crew closes all access doors, hatches, windows, and other openings. Remove camouflage and cover muzzles. If required, crews (less drivers) move to the MOPP-gear-exchange area. Move to the wash area on order.
3. Perform washdown.	Delivery system (such as the M12 and M17, 65-gallon-per-minute [GPM] pump, fire-fighting equipment, and so forth) that delivers hot, soapy water at 60 to 120 psi. Also sufficient water, fuel, and detergent for vehicles.	Soldiers/personnel wash equipment from top to bottom. Decon crew wears a toxicological apron, protective (TAP) or wet-weather gear over MOPP gear.
4. Move out to the next position.	None	Vehicles move to the MOPP-gear-exchange area (if required) or the next battle position.



### **BUDDY-TEAM METHOD**

3-15. This method uses pairs of soldiers under the supervision of their squad/team leader to conduct the buddy-team MOPP-gear exchange. See Table 3-4, pages 3-7 through 3-17, for detailed step-by-step procedures for this method. For units equipped with the combat vehicle crewman uniform system (CVCUS)/chemical protective undergarment (CPU), see Table 3-5, pages 3-18 through 3-21.

### **TRIPLE BUDDY-TEAM METHOD**

3-16. This method is used by soldiers equipped with the M40A1, M42, or M43 mask with the quick-doff hood. A third soldier is needed to hold the filter canister and hose to prevent the transfer of contamination. See Table 3-6, pages 3-22 through 3-27, for detailed step-by-step procedures for this method. For units equipped with the CVCUS/CPU, see Table 3-7, pages 3-28 through 3-30.

### **INDIVIDUAL (EMERGENCY) METHOD**

3-17. This method is used only when a soldier does not have buddy to help him and the risk of MOPP-gear failure demands that an exchange occur. See Table 3-8, pages 3-31 through 3-33, for detailed step-by-step procedures for this method. For units equipped with the CVCUS/CPU, see Table 3-9, pages 3-34 through 3-37.

**Table 3-4. Steps for the Buddy-Team Method MOPP-Gear Exchange**

Steps	Contamination Type	Required Equipment	Procedures
1. Decon gear—removes gross contamination from individual gear (weapons, helmet, load-bearing equipment, and mask carrier).	All contamination	Four long-handled brushes A large piece of plastic (poncho or similar material)	The soldier mixes three parts earth to two parts STB.
	Chemical/biological	One 30-gallon container, STB dry mix, and one IEDK	The soldier removes and discards the chemical protective helmet cover if worn. He brushes or rubs STB onto his individual gear (helmet and mask carrier) and the hose of the M42 or M43 mask if worn. He gently shakes off any excess STB and sets aside his gear on an uncontaminated surface.
	Radiological	Hot, soapy water	The soldier brushes or wipes radiological contamination from his individual gear. He washes it with hot, soapy water (if available) then sets it aside to dry on an uncontaminated surface (plastic, poncho, or similar material).
2. Prepare to decon—facilitates later removal of overgarment trousers and overboots.	All contamination	Cutting tool	Buddy #1 unfastens the shoulder straps on Buddy #2's hood and pulls them over his shoulder and reattaches them to the Velcro® fasteners. He loosens the drawcord on Buddy #2's hood (see Figure 3-3, page 3-8). He removes the M9 detector paper from Buddy #2's overgarment. He unties the drawcords on the trouser legs of Buddy #2's overgarment. He unzips Buddy #2's trouser legs and rolls a cuff in each trouser leg, ensuring that the cuffs do not come above the tops of his overboots (see Figure 3-4, page 3-8). He unfastens or cuts the fasteners on Buddy #2's overboots. <b>NOTE: A soldier can do this step by himself or with the help of his buddy. When wearing overboots, unsnap both quick releases on the overboots. The M40 voice amplifier (M7) and the M42A2 detachable microphone cannot be decontaminated and will be disposed of as contaminated waste; however, ensure that these items are contaminated before disposing of them.</b>
3. Decon mask and hood—removes gross contamination.	Chemical/biological	Two IEDKs per person	Buddy #1 uses an IEDK to wipe Buddy #2's eye-lens outserts from the top down. <b>(NOTE: Do not press so hard that you break Buddy #2's face-mask seal.)</b> He then wipes the rest of Buddy #2's hood from the top of the head to the bottom of the hood (see Figure 3-5, page 3-9). After he has finished wiping Buddy #2's mask, he must wipe his own gloves in preparation for rolling Buddy #2's hood. He starts from the rear and rolls Buddy #2's hood, using 2-inch tucks, until it reaches the center of his head (see Figure 3-6, page 3-9). He rolls the front of Buddy #2's hood tightly under the outlet valve and filter. He ensures that the hood is off of Buddy #2's garment (see Figure 3-7, page 3-10).



Figure 3-3. Loosening the Drawcord on the Hood



Figure 3-4. Rolling the Cuff in the Trouser



Figure 3-5. Wiping From the Head to the Bottom of the Hood



**Figure 3-6. Rolling the Hood to the Center of the Head**



**Figure 3-7. Ensuring That the Hood is off the Garment**

Table 3-4. Steps for the Buddy-Team Method MOPP-Gear Exchange (Continued)

Steps	Contamination Type	Required Equipment	Procedures
3. Decon mask and hood (continued).	Radiological	Three containers (about 3-gallon capacity) Two sponges Soapy water Rinse water Paper towels or similar drying material	Buddy #1 wipes Buddy #2's mask and hood with a sponge dipped in hot, soapy water and rinses them with a sponge dipped in clean water. He dries Buddy #2's mask and hood with paper towels or rags. Buddy #2 wipes his own gloves. <b>NOTE: Cool, soapy water is not as effective for removing contamination, but it can be used if you scrub longer.</b> If the water supply is limited, use drinking water from your canteen with a wet sponge or cloth. If water is not available, brush and dust off the radioactive dust particles. <b>Do not reverse roles.</b> Only Buddy #2's hood will be decontaminated and rolled at this time.
4. Remove overgarments and overboots—limits the spread of agents and helps prevent agents from penetrating through to the undergarments or the skin.	All contamination	Two discard containers (for example, plastic bags)	Buddy #1 grasps Buddy #2's overgarment jacket, unsnaps the snaps individually, and unties the drawcord at the bottom of the jacket (see Figure 3-8, page 3-12). He unfastens the Velcro at the wrist of Buddy #2's jacket and then refastens it. He unfastens the Velcro closure over the zippered front of Buddy #2's jacket and unzips the jacket. He grasps Buddy #2's jacket at the shoulders and instructs him to make a fist. He then pulls Buddy #2's jacket down and away from him, ensuring that the black part of the jacket is not touched (see Figure 3-9, page 3-12). He lays Buddy #2's overgarment jacket on the ground, black side up. (It will be used to stand on later.) He carefully unfastens and unzips Buddy #2's trousers. <b>NOTE: Do not loosen Buddy #2's waist tabs.</b> He instructs Buddy #2 to loosen his overboots by alternately stepping on each heel and pulling up on his foot (see Figure 3-10, page 3-13). He grasps Buddy #2's trousers and pulls them down to his knees. He instructs Buddy #2 to walk out of his trousers/overboots simultaneously and step onto the black side of the jacket (see Figure 3-11, page 3-13). Buddy #2 should step onto the jacket wearing his mask, battle-dress uniform (BDU), combat boots, and gloves.
5. Remove gloves.	All contamination	Two discard containers (from step 4)	The soldier holds the fingertips of his gloves and partially slides his hand out. When the fingers of both hands are free, he holds his arms away from his body and lets the gloves drop (see Figure 3-12, page 3-14).



**Figure 3-8. Unsnapping the Trousers From the Jacket**



**Figure 3-9. Pulling the Jacket Down and Away**



Figure 3-10. Loosening the Overboots



Figure 3-11. Stepping on the Black Lining of the Jacket





Figure 3-12. Removing the Gloves

**Table 3-4. Steps for the Buddy-Team Method MOPP-Gear Exchange (Continued)**

Steps	Contamination Type	Required Equipment	Procedures
6. Put on overgarment.	All contamination	One set of chemical protective overgarments per person	Buddy #1 opens the package containing the new overgarment without touching the inside of the package. Buddy #2 pulls out the overgarment without touching the outside of the package. He puts on the overgarment and fastens it, leaving the trouser legs open (see Figure 3-13, page 3-16). <b>Do not reverse roles.</b> Only Buddy #2 will put on the clean overgarment at this time.
7. Put on overboots and gloves.	All contamination	One set of chemical protective overboots per person One set of chemical protective gloves per person (correct size) M9 detector paper	Buddy #1 opens the package of clean overboots without touching the inside of the package. Buddy #2 removes the overboots from the package without touching the outside of the package, puts them on, and fastens his trouser legs. Buddy #1 opens the package of clean gloves without touching the inside of the package. Buddy #2 removes the gloves from the package without touching the outside of the package and puts them on. Buddy #2 puts on the M9 detector paper (see Figure 3-14, page 3-16). <b>Do not reverse roles.</b> Only Buddy #2 will put on the clean overboots and gloves at this time.



Figure 3-13. Putting on the New Overgarment



Figure 3-14. Putting on the M9 Detector Paper

**Table 3-4. Steps for the Buddy-Team Method MOPP-Gear Exchange (Continued)**

Steps	Contamination Type	Required Equipment	Procedures
8. Secure hood.	All contamination	One IEDK	Buddy #1 uses an IEDK to wipe Buddy #2's gloves. He unrolls Buddy #2's hood and attaches the straps and tightens the neck cord. Buddy #1 and Buddy #2 reverse roles and repeat steps 2 through 8.
9. Secure gear.	All contamination	One chemical protective helmet cover per person	The soldier secures his individual gear and puts it back on (see Figure 3-15). He puts on a new chemical protective helmet cover and moves to the AA. He uses the buddy system to check the fit of all secured gear.



**Figure 3-15. Securing the Hood**

Table 3-5. Steps for the CVCUS/CPU (Buddy-Team Method) MOPP-Gear Exchange

Steps	Contamination Type	Required Equipment	Procedures
1. Decon gear—removes gross contamination from individual gear (weapons, helmet, load-bearing equipment, and mask carrier).	All contamination	Four long-handled brushes A large piece of plastic (poncho or similar material)	The soldier mixes three parts earth to two parts STB.
	Chemical/ biological	One 30-gallon container, STB dry mix, and one IEDK	The soldier removes and discards the chemical protective helmet cover if worn. He brushes or rubs the STB onto his individual gear and the hose of the M42 mask if worn. He gently shakes off any excess STB and sets aside his gear on an uncontaminated surface.
	Radiological	Hot, soapy water	The soldier brushes or wipes radiological contamination from his individual gear. He washes it with hot, soapy water (if available) then sets it aside to dry on an uncontaminated surface (plastic, poncho, or similar material).
2. Prepare for decon—facilitates MOPP-gear removal.	All contamination	Cutting tool	Buddy #1 unfastens the shoulder straps on Buddy #2's hood and pulls them over his shoulder and reattaches them to the Velcro fastener. He loosens the drawcord on Buddy #2's hood. He removes the M9 detector paper from Buddy #2's CVCUS. He unzips the ankles on both legs of Buddy #2's CVCUS. He unfastens or cuts the fasteners on Buddy #2's overboots. <b>NOTE: A soldier can do this step by himself or with the help of his buddy.</b>
3. Decon mask and hood—removes gross contamination.	Chemical/ biological	Two IEDKs per person	Buddy #1 uses an IEDK to wipe Buddy #2's eye-lens outserts from the top down. <b>(NOTE: Do not press so hard that you break Buddy #2's face-mask seal.)</b> He then wipes the rest of Buddy #2's hood from the top of the head to the bottom of the hood (see Figure 3-5, page 3-9). After he has finished wiping Buddy #2's mask, he must wipe his own gloves in preparation for rolling Buddy #2's hood. He starts from the rear and rolls Buddy #2's hood, using 2-inch tucks, until it reaches the center of his head (see Figure 3-6, page 3-9). He rolls the front of Buddy #2's hood tightly under the outlet valve and filter. He ensures that the hood is off of Buddy #2's garment (see Figure 3-7, page 3-10).

**Table 3-5. Steps for the CVCUS/CPU (Buddy-Team Method) MOPP-Gear Exchange (Continued)**

Steps	Contamination Type	Required Equipment	Procedures
3. Decon mask and hood (continued).	Radiological	Three containers (about 3-gallon capacity) Two sponges Soapy water Rinse water Paper towels or similar drying material	Buddy #1 wipes Buddy #2's mask and hood with a sponge dipped in hot, soapy water and rinses them with a sponge dipped in clean water. He dries Buddy #2's mask and hood with paper towels or rags. Buddy #2 wipes down his own gloves. <b>NOTE: Cool, soapy water is not as effective for removing contamination, but it can be used if you scrub longer.</b> If the water supply is limited, use drinking water from your canteen with a wet sponge or cloth. Only Buddy #2's mask and hood will be decontaminated and rolled at this time.
4. Remove CVCUS/overboots—limits the spread of contamination.	All contamination	Two discard containers (for example, plastic bags)	Buddy #1 opens all the zippers on Buddy #2's CVCUS in the following order: wrist, ankles, and front. While standing behind Buddy #2 and adjacent to the clean area, Buddy #1 grasps the shoulders of Buddy #2's CVCUS and instructs him to make a fist to ensure that his gloves do not come off. He then pulls Buddy #2's CVCUS down below his knees, turning it inside out. He has Buddy #2 to partially remove his overboots by alternately stepping on each heel and pulling up on his foot. While kneeling, Buddy #1 grasps one leg of Buddy #2's CVCUS and his overboot and instructs him to remove his leg and foot simultaneously (see Figure 3-16, page 3-20). As Buddy #2 removes each leg and foot, he steps directly onto the clean area.
5. Remove CPU jacket/gloves.	All contamination	Two discard containers	Buddy #2 holds the fingertips of his gloves and partially slides his hand out. When the fingers of both hands are free, he holds his arms away from his body and lets the gloves drop. Buddy #1 unzips and removes Buddy #2's CPU jacket by grasping it at the shoulders and pulling down, turning it inside out (see Figure 3-17, page 3-20). He places it on the clean area with the clean side up. He removes Buddy #2's protective glove inserts.



Figure 3-16. Removing Leg and Foot From the Garment



Figure 3-17. Removing the Garment and Turning it Inside Out

**Table 3-5. Steps for the CVCUS/CPU (Buddy-Team Method) MOPP-Gear Exchange (Continued)**

Steps	Contamination Type	Required Equipment	Procedures
6. Remove combat boots/ CPU pants.	All contamination	Two discard containers	Buddy #1 instructs Buddy #2 to stand on the clean area (but not on the CPU jacket) and unlace his combat boots. Buddy #2 partially removes his boots by alternately stepping on each heel and pulling up on his foot. Buddy #1 grasps one of Buddy #2's boots and instructs him to remove his foot. As Buddy #2 removes his foot, he will step directly onto the clean side of the CPU jacket. Repeat the procedure for the other foot. Next, Buddy #1 removes Buddy #2's CPU drawers by pulling down on the sides and turning them inside out. Buddy #2 is now stripped to his underwear and mask and is ready to put on new clothing. <b>NOTE: If Buddy #2's feet come in contact with the contaminated pants of the CPU, decon them.</b>
7. Put on CPU/ CVCUS.	All contamination	One CPU/CVCUS per soldier	Buddy #1 opens the package containing the new undergarment without touching the inside of the package. Buddy #2 pulls out the undergarment without touching the outside of the package. He puts on the new clothing in the following order: CPU drawers, CPU jacket, combat boots, and CVCUS (over the CPU drawers).
8. Put on overboots and gloves.	All contamination	One set of chemical protective overboots per soldier One set of chemical protective gloves per soldier M9 detector paper	Buddy #1 opens the package of clean overboots without touching the inside of the package. Buddy #2 removes the overboots without touching the outside of the package and puts them on. Buddy #1 opens the package of clean gloves without touching the inside. Buddy #2 removes the gloves without touching the outside of the package and puts them on. Buddy #2 puts on the M9 detector paper (see Figure 3-18, page 3-23).
9. Secure hood.	Chemical/ biological	One IEDK	Buddy #1 wipes his rubber gloves with an IEDK. He unrolls Buddy #2's hood and attaches the straps and tightens the neck cord. Buddy #1 and Buddy #2 reverse rolls and repeat steps 2 through 9.
10. Secure gear.	All contamination	One chemical protective helmet cover per person	The soldier secures his individual gear and puts it back on. He puts on a new chemical protective helmet cover and moves to the AA. He uses the buddy system to check the fit of all secured gear.



Table 3-6. Steps for the Triple-Buddy Method MOPP-Gear Exchange With the M40A1 and M42

Steps	Contamination Type	Required Equipment	Procedures
1. Decon gear—removes gross contamination from individual gear (weapons, helmet, load-bearing equipment, and mask carrier).	All contamination	Four long-handled brushes A large piece of plastic (poncho or similar material)	The soldier mixes three parts earth to two parts STB.
	Chemical/ biological	One 30-gallon container, STB dry mix, and one IEDK	The soldier removes and discards the chemical protective helmet cover if worn. He brushes or rubs STB onto his individual gear (helmet and mask carrier) and the hose of the M42 or M43 mask if worn. He gently shakes off any excess STB and sets aside his gear on an uncontaminated surface.
	Radiological	Hot, soapy water	The soldier brushes or wipes radiological contamination from his individual gear. He washes it with hot, soapy water (if available) then sets it aside to dry on an uncontaminated surface (plastic, poncho, or similar material).
2. Prepare to decon—facilitates later removal of overgarment trousers and overboots.	All contamination	Cutting tool	Buddy #1 unfastens the shoulder straps on Buddy #2's hood and pulls them over his shoulder and reattaches them to the Velcro fastener. He loosens the drawcord on Buddy #2's hood and ties off the microphone cord to the hose of his mask (see Figure 3-19). He removes the M9 detector paper from Buddy #2's overgarment. He unzips Buddy #2's trouser legs and rolls a cuff in each trouser leg, ensuring that the cuffs do not come above the tops of his overboots. He unfastens or cuts the fasteners on Buddy #2's overboots. <b>NOTE: A soldier can do this step by himself or with the help of his buddy.</b>



Figure 3-18. Reapplying the M9 Detector Paper



Figure 3-19. Tying the Microphone Cord to the Hose of the Mask

Table 3-6. Steps for the Triple-Buddy Method MOPP-Gear Exchange With the M40A1 and M42 (Continued)

Steps	Contamination Type	Required Equipment	Procedures
3. Decon mask and hood—removes gross contamination.	Chemical/ biological	Two IEDKs per person	Buddy #1 uses an IEDK to wipe Buddy #2's eye-lens outserts from the top down. <b>(NOTE: Do not press so hard that you break Buddy #2's face-mask seal.)</b> He then wipes the rest of Buddy #2's hood from the top of the head to the bottom of the hood (see Figure 3-5, page 3-9). After he has finished wiping Buddy #2's mask, he must wipe his own gloves in preparation for rolling Buddy #2's hood. He starts from the rear and rolls Buddy #2's hood, using 2-inch tucks, until it reaches the center of his head (see Figure 3-6, page 3-9). He rolls the front of Buddy #2's hood tightly under the outlet valve and filter. He ensures that the hood is off of Buddy #2's garment (see Figure 3-7, page 3-10).
	Radiological	Three containers (about 3-gallon capacity) Two sponges Soapy water Rinse water Paper towels or similar drying material	Buddy #1 wipes Buddy #2's mask and hood with a sponge dipped in hot, soapy water and rinses them with a sponge dipped in clean water. He dries Buddy #2's mask and hood with paper towels or rags. Buddy #2 wipes down his own gloves. <b>NOTE: Cool, soapy water is not as effective for removing contamination, but it can be used if you scrub longer.</b> If the water supply is limited, use drinking water from your canteen with a wet sponge or cloth. Only Buddy #2's mask and hood will be decontaminated and rolled at this time.
4. Remove overgarment overboots—limits the spread of agents and helps prevent agents from penetrating through to the undergarments or the skin.	All contamination	Two discard containers (for example, plastic bags)	Buddy #1 grasps Buddy #2's outside overgarment jacket, unsnaps the snaps individually, and unties the drawcord at the bottom of the jacket. He unfastens the Velcro at the wrist of Buddy #2's jacket and then refastens it. He unfastens the Velcro closure over the zippered front of Buddy #2's jacket and unzips the jacket. Buddy #1 grasps Buddy #2's jacket by the shoulders and instructs him to make a fist. He then pulls the jacket down and away from Buddy #2, ensuring that the black part of the jacket is not touched (see Figure 3-20, page 3-26). He lays Buddy #2's overgarment jacket on the ground, black side up. (It will be used to stand on later.) Buddy #1 carefully unfastens and unzips Buddy #2's trousers. <b>NOTE: Do not loosen Buddy #2's waist tabs.</b> He instructs Buddy #2 to break the seals on his overboots by alternately stepping on each heel and pulling up on his foot. He grasps Buddy #2's trousers and pulls them down to his knees. Buddy #1 instructs Buddy #2 to walk out of his trousers/overboots, taking care not to step on the contaminated side of the overgarment. If Buddy #2 is wearing overboots, Buddy #1 removes Buddy #2's trousers first then helps him step out of his overboots onto the black side of the jacket. Buddy #2 should step onto the jacket wearing his mask, BDU, combat boots, and gloves.

**Table 3-6. Steps for the Triple-Buddy Method MOPP-Gear Exchange With the M40A1 and M42 (Continued)**

Steps	Contamination Type	Required Equipment	Procedures
5. Remove gloves.	All contamination	Discard container (from Step 4)	The soldier holds the fingertips of his gloves and partially slides his hand out. When the fingers of both hands are free, he holds his arms away from his body and lets the gloves drop.
6. Put on overgarment.	All contamination	One set of chemical protective overgarments per person	Buddy #1 opens the package containing the new overgarment without touching the inside of the package. Buddy #2 pulls out the overgarment without touching the outside of the package. He puts on the overgarment and fastens it, leaving the trouser legs open. <b>Do not reverse roles.</b> Only Buddy #2 will put on the clean overgarments at this time.



**Figure 3-20. Removing the Outer Garment**

**Table 3-6. Steps for the Triple-Buddy Method MOPP-Gear Exchange With the M40A1 and M42 (Continued)**

Steps	Contamination Type	Required Equipment	Procedures
7. Put on overboots and gloves.	All contamination	One set of chemical protective overboots per person One set of chemical protective gloves per person M9 detector paper	Buddy #1 opens the package of clean overboots without touching the inside of the package. Buddy #2 removes the overboots without touching the outside of the package, puts them on, and fastens his trouser legs. Buddy #1 opens the package of clean gloves without touching the inside of the package. Buddy #2 removes the gloves without touching the outside of the package and puts them on. Buddy #2 puts on the M9 detector paper. <b>Do not reverse roles.</b> Only Buddy #2 will put on clean overboots and gloves at this time. <b>NOTE: The gloves and overboots will have a light powdery coating. This is normal. It is not necessary to remove it. It will not affect the protective qualities.</b>
8. Secure hood.	All contamination	One IEDK	Buddy #1 wipes his rubber gloves with an IEDK. He unrolls Buddy #2's hood and attaches the straps and tightens the neck cord. He checks the clips and neck cord on Buddy #2's hood. Buddy #1 and Buddy #2 reverse roles and repeat steps 2 through 8.
9. Secure gear.	All contamination	One chemical protective helmet cover per person	The soldier secures his individual gear and puts it back on. He puts on a new chemical protective helmet cover and moves to the AA. He uses the buddy system to check the fit of all secured gear.

**Table 3-7. Steps for the CVCUS/CPU (Triple-Buddy Method) MOPP-Gear Exchange With the M40A1, M42, and M43 (Aviation and Armor)**

Steps	Contamination Type	Required Equipment	Procedures
1. Decon gear—removes gross contamination from individual gear (weapons, helmet, load-bearing equipment, and mask carrier).	All contamination	Four long-handled brushes A large piece of plastic (poncho or similar material)	The soldier mixes three parts earth to two parts STB.
	Chemical/ biological	One 30-gallon container, STB dry mix, and one IEDK	The soldier removes and discards the chemical protective helmet cover if worn. He brushes or rubs STB onto his individual gear (helmet and mask carrier) and the hose of the M43 mask if worn. He gently shakes off any excess STB and sets aside his gear on an uncontaminated surface.
	Radiological	Hot, soapy water	The soldier brushes or wipes radiological contamination from his individual gear. He washes it with hot, soapy water (if available) and sets it aside to dry on an uncontaminated surface (plastic, poncho, or similar material).
2. Prepare to decon—facilitates later removal of overgarment trousers and overboots.	All contamination	Cutting tool	Buddy #1 unfastens the shoulder straps on Buddy #2's hood, pulls them over his shoulder, and reattaches them to the Velcro fastener. He loosens the drawcord on Buddy #2's hood and ties off the microphone cord to the hose of his mask. He removes the M9 detector paper from Buddy #2's overgarment. He unzips Buddy #2's trouser legs and rolls a cuff in each trouser leg, ensuring that the cuffs do not come above the top of his overboots. He unfastens or cuts the fasteners on Buddy #2's overboots. <b>NOTE: A soldier can do this step by himself or with the help of his buddy.</b>

**Table 3-7. Steps for the CVCUS/CPU (Triple-Buddy Method) MOPP-Gear Exchange With the M40A1, M42, and M43 (Aviation and Armor) (Continued)**

Steps	Contamination Type	Required Equipment	Procedures
3. Decon mask and hood—removes gross contamination.	Chemical/biological	Two IEDKs per person	If wearing the M42 or M43 mask, use the buddy-team method (three buddies). Buddy #1 uses an IEDK to wipe Buddy #2's hood, mask, canister, and hose of the M42 or M43 mask. <b>NOTE: Do not press so hard that you break Buddy #2's face-mask seal.</b> He uses as many wipes as necessary. Buddy #3 wipes off his gloves and holds Buddy #1's hose and canister away from his contaminated overgarment. After Buddy #1 wipes Buddy #2's mask and then his own gloves, he rolls Buddy #2's hood. He starts from the rear and rolls Buddy #2's hood, using 2-inch tucks, until it reaches the center of his head (see Figure 3-6, page 3-9). He rolls the front of Buddy #2's hood tightly under the outlet valve and filter. He ensures that the hood is off of Buddy #2's garment (see Figure 3-7, page 3-10).
	Radiological	Three containers (about 3-gallon capacity) Two sponges Soapy water Rinse water Paper towels or similar drying material	Buddy #1 wipes Buddy #2's mask and hood with a sponge dipped in hot, soapy water and rinses them with a sponge dipped in clean water. He dries Buddy #2's mask and hood with paper towels or rags. Buddy #2 wipes his own gloves. <b>NOTE: Cool, soapy water is not as effective for removing contamination, but it can be used if you scrub longer.</b> If the water supply is limited, use drinking water from you canteen with a wet sponge or cloth. If water is not available, brush and dust off the radioactive dust particles. <b>Do not reverse roles.</b> Only Buddy #2's hood will be decontaminated and rolled at this time.
4. Remove CVCUS overboots—limits the spread of contamination.	All contamination	Two discard containers (for example, plastic bags)	Buddy #1 opens all the zippers on Buddy #2's CVCUS in the following order: wrist, ankles, and front. While standing behind Buddy #2 and adjacent to the clean area, Buddy #1 grasps the shoulders of Buddy #2's CVCUS and instructs him to make a fist to ensure that his gloves do not come off. He then pulls Buddy #2's CVCUS down below his knees, turning it inside out. He has Buddy #2 to partially remove his overboots by alternately stepping on each heel and pulling up on his foot. While kneeling, Buddy #1 grasps one leg of Buddy #2's CVCUS and his overboot and instructs him to remove his leg and foot simultaneously. As Buddy #2 removes each leg and foot, he steps directly onto the clean area. Buddy #1 decons his gloves again.



**Table 3-7. Steps for the CVCUS/CPU (Triple-Buddy Method) MOPP-Gear Exchange With the M40A1, M42, and M43 (Aviation and Armor) (Continued)**

Steps	Contamination Type	Required Equipment	Procedures
5. Remove CPU jacket/gloves.	All contamination	Two discard containers	Buddy #2 holds the fingertips of his gloves and partially slides his hand out. When the fingers of both hands are free, he holds his arms away from his body and lets the gloves drop. Buddy #1 unzips and removes Buddy #2's CPU jacket by grasping it at the shoulders and pulling down, turning it inside out. He places it on the clean area with the clean side up. He removes Buddy #2's protective glove inserts.
6. Remove combat boots/CPU pants.	All contamination	Two discard containers	Buddy #1 instructs Buddy #2 to stand on the clean area (but not on the CPU jacket) and unlace his combat boots. Buddy #2 partially removes his boots by alternately stepping on each heel and pulling up on his foot. Buddy #1 grasps one of Buddy #2's boots and instructs him to remove his foot. As Buddy #2 removes his foot, he steps directly onto the clean side of the CPU jacket. Repeat the procedure on the other foot. Next, Buddy #1 removes Buddy #2's CPU drawers by pulling down on the sides and turning them inside out. Buddy #2 is now stripped to his underwear and mask and is ready to put on new clothing. <b>NOTE: If Buddy #2's feet come in contact with the contaminated pants of the CPU, decon them.</b>
7. Put on CPU/CVCUS.	All contamination	One CPU/CVCUS per person	Buddy #1 opens the package containing the new undergarment without touching the inside. Buddy #2 pulls out the undergarment without touching the outside of the package. He puts on the new clothing in the following order: CPU drawers, CPU jacket, combat boots, and CVCUS (over the CPU drawers).
8. Put on overboots and gloves.	All contamination	One set of chemical protective overboots per person One set of chemical protective gloves per person M9 detector paper	Buddy #1 opens the package of clean overboots without touching the inside of the package. Buddy #2 removes the overboots without touching the outside of the package and puts them on. Buddy #1 opens the package of clean gloves without touching the inside of the package. Buddy #2 removes the gloves without touching the outside of the package and puts them on. Buddy #2 puts on the M9 detector paper.
9. Secure hood.	Chemical/biological	One IEDK	Buddy #1 wipes his rubber gloves with an IEDK. He unrolls Buddy #2 hood and attaches the straps and tightens the neck cord. He checks the snaps and neck cord on Buddy #2's hood to ensure that they are closed. Buddy #1 and Buddy #2 reverse rolls and repeat steps 2 through 9.
10. Secure gear.	All contamination	One chemical protective helmet cover per person	The soldier secures his individual gear and puts it back on. He puts on a new chemical protective helmet cover and moves to the AA. He uses the buddy system to check the fit of all secured gear.

**Table 3-8. Steps for the Individual (Emergency Method) MOPP-Gear Exchange**

Steps	Contamination Type	Required Equipment	Procedures
1. Decon gear—removes gross contamination from individual gear (weapon, helmet, load-bearing equipment, and mask carrier).	Chemical/ biological	One IEDK	The soldier uses M8 detector paper to determine the areas of gross contamination and field-expedient absorbents (sand, dirt, or rags) to remove gross liquid contamination. He should take special care to avoid touching these areas during overgarment removal. He uses an IEDK to decon his individual gear (helmet, load-carrying equipment (LCE), weapon, and mask carrier).
	Radiological	Hot, soapy water	The soldier brushes or wipes radiological contamination from his individual gear. He washes it with hot, soapy water (if available) then sets it aside to dry on an uncontaminated surface (plastic, poncho, or similar material).
2. Prepare to decon—facilities removal of overgarment trousers and overboots.	All contamination	Cutting tool	The soldier unfastens the shoulder straps on his hood, pulls them over his shoulders, and reattaches them. He loosens the drawcord on the hood of his protective mask. <b>NOTE: If wearing the M43 protective mask, tie off the microphone cord to the hose of the mask.</b> He removes the M9 detector paper from his overgarment and unties/cuts the drawcords on the trouser legs of his overgarment. He unzips the trouser legs and rolls a cuff in each trouser leg, ensuring that the cuffs do not come above the top of his overboots. He unfastens or cuts the fasteners on the overboots.
3. Decon mask and hood—removes gross contamination from the mask and hood.	Chemical/ biological	One IEDK	<p>The soldier wipes the eye-lens outserts on his mask from the top down. He wipes his mask and gloves and rolls his hood. He grasps the straps of the hood and lifts the hood off his shoulders and partially over his head until most of the back of his head is exposed. He rolls the hood, starting at the chin, and works around the entire mask until the rolled hood will stay up and off of his shoulders. He tucks the straps and neck cord into the roll. He rolls the hood tightly against his mask without pulling the hood off the back of his head. He tucks the tail between the upper part of the canister and the mask. (Tie the tail over and under the hose for the M42 mask.)</p> <p>The soldier removes the applicator mitt from the package with his nondominant hand. Making a "V", he wipes down his hand, paying particular attention to the areas between his fingers. Once he has thoroughly wiped down his dominant hand, he must insert it into the applicator mitt and thoroughly wipe down his other hand. He gently pats the voicemitter with black powder until it is covered.</p>

Table 3-8. Steps for the Individual (Emergency Method) MOPP-Gear Exchange (Continued)

Steps	Contamination Type	Required Equipment	Procedures
3. Decon mask and hood (continued).			<p>The soldier starts at the top of his hood and wipes down and away, patting until the surface of the hood is covered by the black powder. He rewipes his gloves, starting with his nondominant hand.</p> <p>The soldier lifts the hood off of his shoulders by grasping the shoulder straps in one hand and placing the other hand on top of the head and pulling the hood over his head until the elastic band is over his knuckles and most of the back of his head is exposed. He should not expose his ears or pull the hood completely over his face or mask. He tucks his shoulder straps, underarm straps, and the rolled portion of his hood under the elastic band.</p> <p>Follow these procedures when using the M40A1 mask with the quick-doff hood: The soldier removes the underarm straps from the front of his hood and places them over his shoulders. He refastens them on the front of his hood. <b>NOTE: Anytime you decon your mask or roll your hood, place two fingers on the voicemitter of the mask to prevent accidental breakage of the seal.</b></p>
	Radiological	Three containers (about 3-gallon capacity) Two sponges Soapy water Rinse water Paper towels or similar drying material	<p>The soldier wipes his mask and hood with a sponge dipped in hot, soapy water and rinses them with a sponge dipped in clean water. He dries the mask and hood with paper towels or rags. <b>NOTE: Cool, soapy water is not as effective for removing contamination, but it can be used if you scrub longer.</b> If water is not available, soldier should brush and dust off the radioactive dust particles.</p>
4. Remove overgarment/overboots—prevents agent from penetrating through to the undergarments or the skin.	All contamination	Two discard containers (recommend plastic bags). Chemical protective suit with protective gloves and overboots	<p>The soldier grasps his overgarment jacket and unsnaps the snaps individually. He unties the drawcord at the bottom of the jacket. He unfastens the Velcro at the waist and then refastens it. He unfastens the Velcro closure over the zippered front of the jacket and unzips the jacket. He grasps the front of the jacket and pulls the jacket back until it is off his shoulders. He puts his arms behind his back and works his arms out of the sleeves. He should not let the outside of the jacket touch his body. When the jacket is off, he lays it on the ground with the black side up. He unfastens and unzips his trousers. He should not loosen his waist tabs. He loosens his overboots by alternately stepping on each heel and pulling up on his foot. He grasps his trousers and pushes them down to his knees. He walks out of his trousers/overboots simultaneously and steps onto the black side of the jacket. He steps onto the jacket wearing his mask, BDU, combat boots, and gloves.</p>

**Table 3-8. Steps for the Individual (Emergency Method) MOPP-Gear Exchange (Continued)**

Steps	Contamination Type	Required Equipment	Procedures
5. Remove gloves.	All contamination	Two discard containers (from step 4) One IEDK	The soldier wipes around the edges of the packages containing the new items (gloves, overgarments, and overboots) with an IEDK. He opens the new packages. He holds the fingertips of his gloves and partially slides his hands out. When the fingers of both hands are free, he holds his arms away from his body and lets his gloves drop.
6. Put on overgarment.	All contamination	One set of chemical protective overgarments per person One IEDK	The soldier removes the overgarment from its package without touching the outside. He puts on the overgarment and fastens it, leaving the trouser legs open until he puts on the new overboots.
7. Put on overboots and gloves.	All contamination	One set of chemical protective overboots per person One set of chemical protective gloves per person	The soldier removes the overboots (one at a time) from their package without touching the outside and puts them on. He removes the gloves from their package without touching the outside, puts them on, and fastens his trouser legs. <b>NOTE: The gloves and overboots will have a light powdery coating. This is normal. Do not remove it. It will not affect the protective qualities.</b>
8. Secure hood.	All contamination	One chemical protective helmet cover per person	The soldier secures his individual gear and puts it back on. He puts on a new chemical protective helmet cover and moves to the AA.

Table 3-9. Steps for the CVCUS/CPU, Individual (Emergency Method) MOPP-Gear Exchange

Steps	Contamination Type	Required Equipment	Procedures
1. Decon gear—removes gross contamination from individual gear (weapon, helmet, load-bearing equipment, and mask carrier).	Chemical/ biological	One IEDK	The soldier uses M8 detector paper to determine the areas of gross contamination and field-expedient absorbents (sand, dirt, or rags) to remove gross liquid contamination. He should take special care to avoid touching these areas during overgarment removal. He uses an IEDK to decon his individual gear (helmet LCE, weapon, and mask carrier).
	Radiological	Hot, soapy water	The soldier brushes or wipes radiological contamination from his individual gear. He washes it with hot, soapy water (if available) then sets it aside to dry on an uncontaminated surface (plastic, poncho, or similar material).
2. Prepare to decon—facilitates removal of overgarment trousers and overboots.	All contamination	Cutting tool	The soldier unfastens the shoulder straps on his hood, pulls them over his shoulders, and reattaches them to the front of the hood. He loosens the drawcord on the hood of his protective mask. <b>NOTE: If wearing the M43 protective mask, tie off the microphone cord to the hose of the mask.</b> He removes the M9 detector paper from his overgarment and unties/cuts the drawcords on the trouser legs of his overgarment. He unzips the trouser legs and rolls a cuff in each trouser leg, ensuring that the cuffs do not come above the top of his overboots. He unfastens or cuts the fasteners on the overboots.
3. Decon mask and hood—removes gross contamination from the mask and hood.	Chemical/ biological	One IEDK	<p>The soldier wipes the eye-lens outserts on his mask from the top down. He wipes his mask and gloves and rolls his hood. He grasps the straps of the hood and lifts the hood off his shoulders and partially over his head until most of the back of his head is exposed. He rolls the hood, starting at the chin, and works around the entire mask until the rolled hood will stay up and off of his shoulders. He tucks the straps and neck cord into the roll. He rolls the hood tightly against his mask without pulling the hood off the back of his head. He tucks the tail between the upper part of the canister and the mask. (Tie the tail over and under the hose for the M42 mask.)</p> <p>The soldier removes the applicator mitt from the package with his nondominant hand. Making a "V", he wipes down his hand, paying particular attention to the areas between his fingers. Once he has thoroughly wiped down his dominant hand, he must insert it into the applicator mitt and thoroughly wipe down his other hand.</p>

**Table 3-9. Steps for the CVCUS/CPU, Individual (Emergency Method) MOPP-Gear Exchange (Continued)**

Steps	Contamination Type	Required Equipment	Procedures
3. Decon mask and hood (continued).			<p>The soldier gently pats the voicemitter with black powder until it has been covered. He starts at the top of his hood and wipes down and away, patting until the surface of the hood is covered by the black powder. He rewipes his gloves, starting with his nondominant hand.</p> <p>The soldier lifts the hood off of his shoulders by grasping the shoulder straps in one hand and placing the other hand on top of the head and pulling the hood over his head until the elastic band is over his knuckles and most of the back of his head is exposed. He should not expose his ears or pull the hood completely over his face or mask. He tucks his shoulder straps, underarm straps, and the rolled portion of his hood under the elastic band.</p> <p>Follow these procedures when using the M40A1 mask with the quick-doff hood: The soldier removes the underarm straps from the front of his hood and places them over his shoulders. He refastens them on the front of his hood. <b>NOTE: Anytime you decon your mask or roll your hood, place two fingers on the voicemitter of the mask to prevent accidental breakage of the seal.</b></p>
	Radiological	Three containers (about 3-gallon capacity) Two sponges Soapy water Rinse water Paper towels or similar drying material	<p>The soldier wipes his mask and hood with a sponge dipped in hot, soapy water and rinses them with a sponge dipped in clean water. He dries the mask and hood with paper towels or rags. <b>NOTE: Cool, soapy water is not as effective for removing contamination, but it can be used if you scrub longer.</b> If water is not available, the soldier should brush and dust off the radioactive dust particles.</p>
4. Remove CVCUS/overboots.	All contamination	Two discard containers (plastic bags)	<p>The soldier opens all the zippers on his CVCUS in the following order: wrists, ankles, and front. While standing adjacent to the clean area, he grasps the front of his CVCUS and pulls it off of his shoulders. He makes a fist to ensure that his gloves do not come off when removing his CVCUS. He puts his arms behind his back and works his arms out of the sleeves. He loosens his overboots by alternately stepping on each heel and pulling up on his foot. He pulls his CVCUS down below his knees, turning it inside out. He should not let the outside of his CVCUS touch his body. He walks out of his CVCUS/overboots simultaneously and steps onto the clean area.</p>

Table 3-9. Steps for the CVCUS/CPU, Individual (Emergency Method) MOPP-Gear Exchange (Continued)

Steps	Contamination Type	Required Equipment	Procedures
5. Remove jacket/gloves.	All contamination	Two discard containers	<p>The soldier wipes his gloves and around the edges of the packages containing the new items (gloves, undergarments, and overboots) with an IEDK. He opens the new packages. He holds the fingertips of the gloves and partially slides his hands out. When the fingers of both hands are free, he holds his arms away from his body and lets the gloves drop.</p> <p>The soldier opens all Velcro wrist fasteners and unzips his CPU jacket. He removes the CPU jacket by grasping it at the shoulders and pulling down, turning it inside out. He places the jacket on a clean area with the clean side up. He removes the protective glove inserts.</p>
6. Remove combat boot/CPU pants.	All contamination	Two discard containers	<p>The soldier unlaces his combat boots, removes them, and steps directly onto his CPU jacket. He takes off his CPU drawers by placing his hands beneath the waistband and removing them, turning them inside out. The soldier is now stripped to his underwear and mask and is ready to put on his new clothing.</p> <p>The soldier follows these procedures if wearing the BDU. He stands on the clean area (but not on the CPU jacket) and unlaces his combat boots. He partially removes his boots by alternately stepping on each heel and pulling up on his foot. He removes each trouser leg and combat boot simultaneously and steps directly onto the clean side of the CPU jacket.</p>
7. Put on CPU.	All contamination	One set of chemical protective undergarments per soldier	The soldier removes the undergarment from the package without touching the outside. He puts on the undergarment in the following order: CPU drawers, CPU jacket, combat boots, and CVCUS (over the CPU drawers).
8. Put on overboots and gloves.	Chemical/biological	One set of chemical protective overboots per soldier One set of chemical protective gloves per soldier M9 detector paper	The soldier removes the overboots from their package without touching the outside and puts them on. He removes the gloves from their package without touching the outside and puts them on. He puts on the M9 detector paper.

**Table 3-9. Steps for the CVCUS/CPU, Individual (Emergency Method) MOPP-Gear Exchange (Continued)**

Steps	Contamination Type	Required Equipment	Procedures
9. Secure hood.	Chemical/ biological	One IEDK	The soldier wipes his rubber gloves with an IEDK. He unrolls his hood, attaches the straps, and tightens the neck cord.
10. Secure gear.	All contamination	One chemical protective helmet cover per soldier	The soldier secures his individual gear and puts it back on. He puts on a new chemical protective helmet cover and moves to the AA.



## Chapter 4

# Thorough Decon

Thorough-decon operations reduce and sometimes eliminate contamination. They restore combat power by removing nearly all contamination from unit and individual equipment so that troops can operate it safely for extended periods at reduced MOPP levels. Since a small risk of contamination remains, periodic checks with the CAM, the M8/M9 detector paper, or the M256A1 detector kit must be performed after each operation. A thorough decon can be done as part of reconstitution, or it can be done to support operations throughout the battlefield. After a thorough decon, the unit moves out of the decon site into a tactical AA. The unit, while in this tactical assembly, may undergo reconstitution or prepare for future operations. Combat-service-support (CSS) elements replenish combat stocks, refit equipment, and replace personnel and equipment, as required. The contaminated unit, with some assistance from a chemical unit, does the DTD. A supporting chemical unit does the DED or DAD. The planning considerations that are required to conduct thorough-decon operations and the methods that various chemical units (decon and smoke/decon) use to conduct DTD/DED are discussed in this chapter. The exact layout of a thorough-decon site is determined by METT-TC.

## PLANNING

4-1. A thorough decon is the most effective type of decon but is the most resource intensive. A combination of weather conditions, agent used, mission requirements, time, troops, and supplies available may make weathering the decon option of choice. Commanders decide which type of decon is required based on the recommendation of the chemical personnel.

4-2. Generally, thorough-decon operations are conducted beyond the range of enemy direct-fire systems. If a contaminated unit requires a thorough decon as part of reconstitution operations, the decon site is established near the reconstitution area or the brigade's rear area. Usually, company-sized units are reconstituted in their brigade's rear area while battalion-level units are reconstituted in their division's rear area. Organizations larger than a battalion will be reconstituted in the corps's rear area. Further information about reconstitution can be found in FMs 100-5 and 100-9.

4-3. All echelons prepare for thorough-decon operations as part of the overall planning process. From the commander's general guidance, the chemical staff can begin to develop the decon plan. Coordination with higher HQ is required to determine the availability of engineer support for site preparation and closure. Engineers can provide support for sump preparation, drainage ditches, and sumps. Coordinate with the civil-affairs office for host-nation

support (personnel, equipment, and supplies) and for environmental requirements and restrictions.

4-4. The chemical staff selects possible decon sites throughout the unit's area of operation (AO) based on such factors as decon type, terrain, mission, threat, road network, and availability of water. After the decon sites are selected, linkup points are chosen to support each site. A site may have more than one linkup point.

4-5. Since decon assets are limited, the commander must establish a priority of decon support. The priority of support lists the units in the order they will receive decon support. This can change from phase to phase during an operation. The chemical staff develops the priority of support based on an understanding of the commander's intent.

4-6. To give priority of support to the lead task force during the assault phase may not be the best choice since any contaminated elements will most likely not stop for decon until after the assault is completed. The commander should establish a priority of work that specifies the order in which equipment will be decontaminated. For example, a priority of work may be in this order: engineer equipment, artillery pieces, main battle tank, and long-haul vehicles. A limiting factor is the availability of water. A typical vehicle requires 500 gallons of water during the DED. The actual amount of water required varies by the vehicle and its contamination level. The supported unit's chemical staff must develop a water resupply plan for thorough-decon operations.

4-7. A water resupply plan can be as simple as selecting a series of linkup points along a route where the chemical unit can link up with a bulk water truck. More complex water resupply plans include caching water throughout the AO, coordinating for the movement of water bladders by aircraft, and identifying water sources in the unit's AO. The use of nonpotable, salt, and brackish waters should be considered.

## **PREPARATION**

4-8. Subordinate units review their higher HQ decon plan. If additional decon sites or assets are required, request them from the higher HQ. The supporting decon-platoon leader conducts a leader's recon of the designated decon sites. Since the decon sites are initially selected by map recon, the actual site may not be suitable. If the selected site cannot support decon operations, the chemical unit leader attempts to find another site close to the original site and notifies the supported unit and his higher HQ of the change.

4-9. The decon-platoon unit leader determines the support requirements that are needed to operate the decon site. Engineers are required to dig sumps, improve access to the site, and dig ditches for runoff. Air defense (AD) and military police (MP) are required to provide security. Medical support is also required. Depending on the operational situation and the threat, some DED sites may be prepared in advance. Routes must be established and published in the OPORD, leading the contaminated unit to the linkup point.

**NOTE: Units must be informed not to proceed directly to the decon site.**

## EXECUTION

4-10. The actual decon operation begins once a unit requests decon support. The unit leader must assess his situation and accurately report it to his HQ. This situation report should include the type and extent of contamination, the current location, his assessment of the unit's ability to perform the current mission while contaminated, and the time he expects the unit to become combat ineffective. The contaminated unit should perform immediate-decon techniques to increase its survivability and to limit the spread of contamination. An operational decon should also be considered and performed, as appropriate. The request for decon support must contain several essential elements of information to assist the chemical staff and the decon-platoon leader in coordinating the decon operation. These essential elements of information are the—

- Designation of the contaminated unit.
- Location of the contaminated unit.
- Time the unit became contaminated.
- Earliest possible time the unit can move/begin decon.
- Type of contamination.
- Number and type of vehicles contaminated.
- Special requirements (patient-decon station, recovery assets, unit decon team, and so forth).
- Supported unit's frequency and call sign to facilitate initial linkup.

4-11. The supporting chemical unit is given a warning order (WO) to conduct a decon operation. Subsequent WOs provide more detailed information. After requesting decon support, the supported unit issues an OPORD/fragmentary order (FRAGO) to the chemical unit.

4-12. The supported unit must coordinate the movement of the contaminated unit to the linkup point. If the contaminated unit is out of the supported unit's AO, the move must be coordinated with the higher HQ.

4-13. Once the chemical unit is set up, the decon-platoon leader moves to the linkup point. Other elements may provide assets to support the decon operations, such as medical, engineer, AD, and MP. These elements linkup with the chemical unit before the arrival of the contaminated unit (see Table 4-1, page 4-4).

4-14. The supported unit is responsible for site security and overall control. The decon-platoon leader is responsible for operating the predecon area and processing vehicles.

4-15. After linkup is achieved and all support assets are in position, the actual decon operation begins. The decon-platoon leader, with help from the commander of the contaminated unit or the supported unit's command and control cell, supervises the decon operation. All equipment not necessary for decon operations should be located in a clear area to limit the spread of contamination.

**Table 4-1. Thorough-Decon Support Matrix**

Tasks	Units							
	Division CMO	Division	Brigade	DISCOM	FSB	Chemical Unit	Contaminated Unit	Battalion
<b>Preparation-Phase Tasks</b>								
Request	S						P	S
Coordination	S		S					P
Site selection		S OR S				P		
Advance-party linkup						S	P	S
Site setup				S	S	P		
<b>Execution-Phase Tasks</b>								
Site control/security						S	P	
Predecon actions						P	S	
Processing						P	S	
<b>Site-Clearance-Phase Tasks</b>								
Cleanup						P	P	
Marking and reporting						P		
S - supporting responsibility P - primary responsibility								

4-16. A thorough-decon site consists of the following areas: predecon staging area, DED and DTD areas, and postdecon AA (see Figure 4-1). The chemical unit leader selects these areas based on operational guidance, road network, available cover and concealment, and water supply. The contaminated unit uses the predecon staging area to ready itself. The postdecon AA is the location where the vehicles and soldiers exiting the DED and DTD areas are linked up before moving from the decon site.

**PREDECON STAGING AREA**

4-17. The contaminated unit moves to the predecon staging area about 274 to 547 yards downwind of the thorough-decon site. The contaminated unit performs predecon actions to include segregating vehicles by checking for contamination.

4-18. For chemical contamination, use the CAM and the M8/M9 detector paper. The contamination level can be estimated by comparing the M8/M9 detector paper to Figure 4-2. When monitoring vehicles for contamination, there should be about 33 to 49 feet between each vehicle to prevent false positive readings with the CAM. For radiological contamination, use the AN/PDR-77 or AN/VDR-2 radiac detector. If the vehicle only has isolated areas of contamination, use the M11 or M13 to decon those areas.

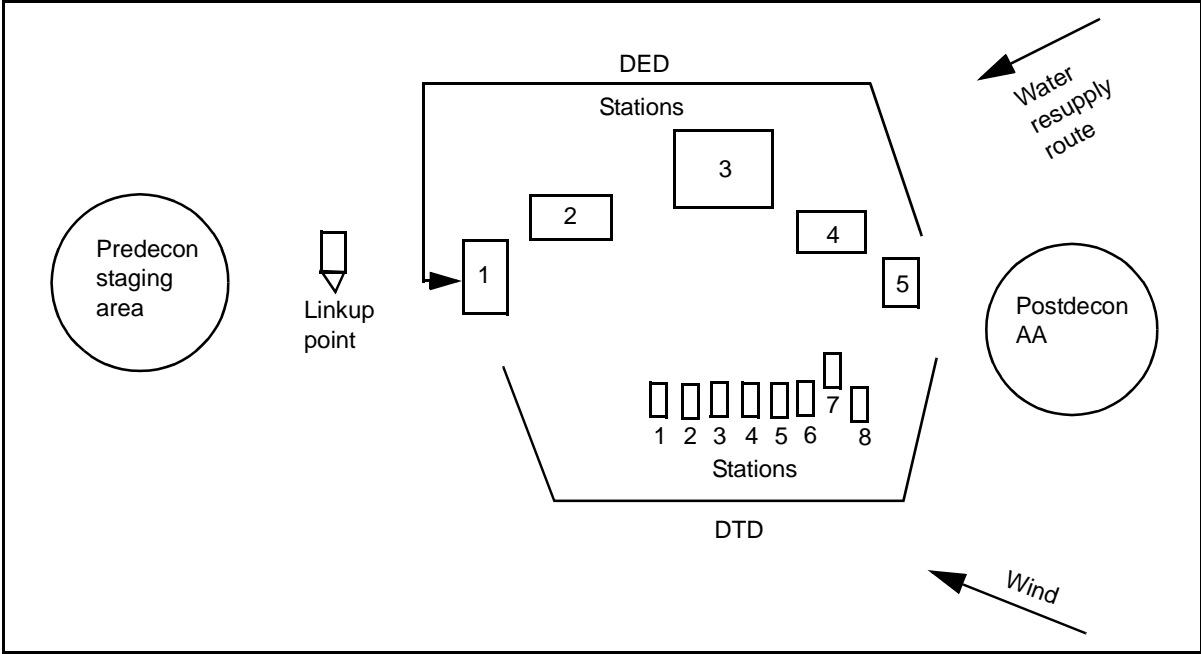

Figure 4-1. Thorough-Decon Site

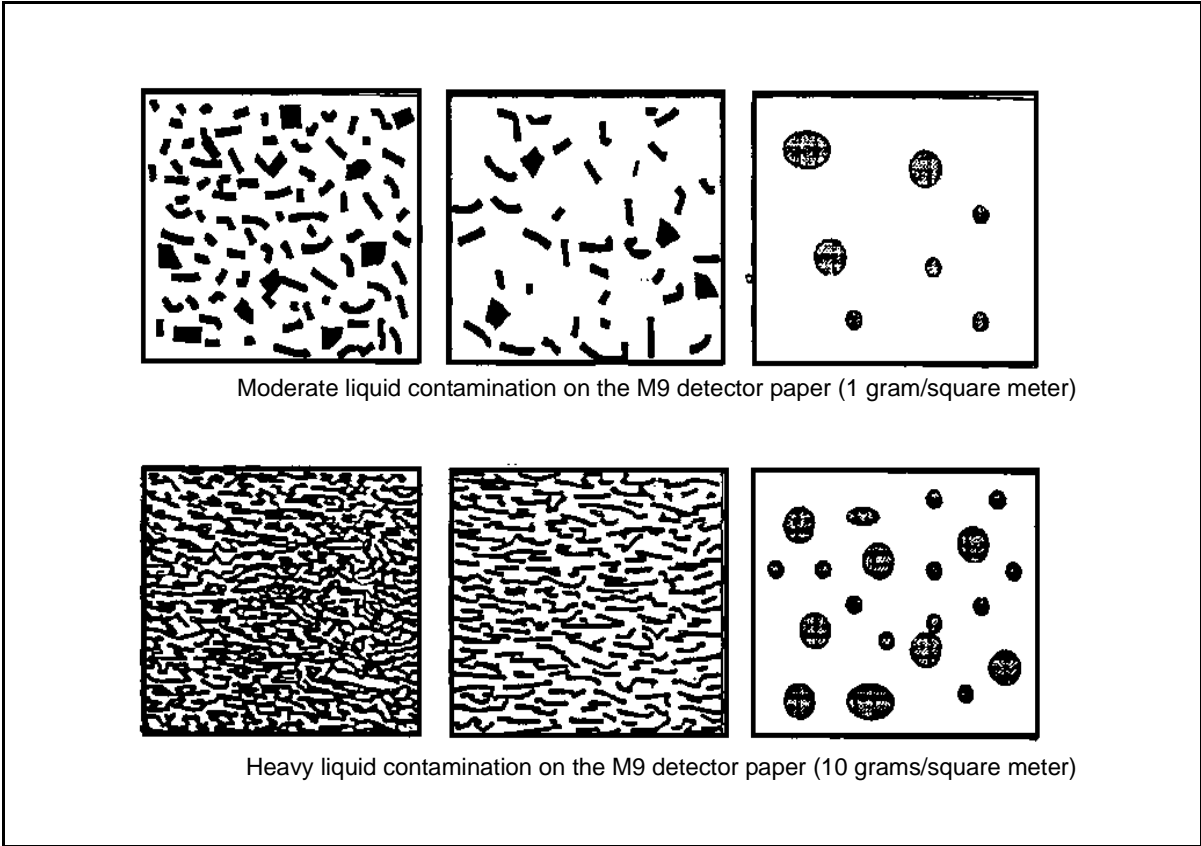

Figure 4-2. Contamination Levels

**Vehicle Crews**

4-19. The vehicle crews, except for the drivers, dismount. As the crews dismount, they remove all contaminated equipment, to include electro-optical systems from the top and sides of the vehicles. Once the crews have exited the vehicle, they will not reenter. This prevents contamination from being spread into the vehicle interior.

**Vehicle Preparation**

4-20. Using the pioneer tools from the contaminated vehicles, the crews remove all heavy mud and debris. They concentrate on the vehicle's undercarriage, which is the most likely place for contamination to collect and the hardest place to decon. Once the crews are finished with the pioneer tools, they are placed back on the vehicle. Initial removal of the mud and debris makes it more likely that the decon wash will remove any remaining contamination.

4-21. Seat covers (when applicable), canvas items, camouflage netting, and any other materials that can absorb liquid contamination are removed. These items create a potential transfer hazard and are not easily decontaminated. Left untreated, absorbed chemical agents will desorb after being decontaminated and will create a vapor hazard. Remove items that cannot be decontaminated by the standard methods used in the DTD, and place them at the collection point. Chemical-unit personnel provide advice concerning the decon or disposal of these items.

4-22. Design vehicle-loading plans to minimize the amount of equipment carried on the outside of the vehicle that cannot be readily decontaminated. Whenever possible, NBC covers should be used when a chemical attack is expected (see FM 3-4). All NBC covers are removed and disposed of as contaminated waste during the predecon actions.

**DED AND DTD AREAS**

4-23. In coordination with the chemical unit leader operating the decon site, the contaminated unit begins sending contaminated vehicles by priority for processing. Communication is maintained between the predecon staging area and the chemical unit leaders. All assistant vehicle drivers are the first individuals sent through the DTD to ensure that there is a driver exchange at station 3 (see paragraph 4-94).

**POSTDECON AA**

4-24. The chemical unit leader selects the general location for the postdecon AA. It must be big enough to hold the entire unit undergoing the thorough decon with proper cover and concealment. The postdecon AA is located about 0.62-mile upwind from the DED and DTD areas. The unit assembles in the postdecon AA after completing DTD and DED operations. The unit occupies the postdecon AA before moving to a reconstitution location or a tactical AA to prepare for future operations.

**DETAILED TROOP DECON**

4-25. The contaminated unit or its higher HQ is responsible for setting up, operating, manning, and closing the DTD area at the thorough-decon site. The chemical unit leader determines the general location of the DTD within the decon site and provides technical advice on setting up, operating, and closing the DTD area. The supervisor of the DTD must establish a work/rest cycle.

4-26. There are eight stations for a DTD. Spacing between the stations is 10 to 16 feet (see Figure 4-3, page 4-8). Recapitulation of personnel and equipment for a DTD is provided at Table 4-2, page 4-9.

### **STATION 1 - INDIVIDUAL-GEAR DECON**

4-27. At this station, contamination is removed from individual gear (LCE, mask carrier, helmet, and weapon) to a negligible risk level (see Chapter 1 of this manual).

#### **Preparation**

4-28. At this station, the following equipment and supplies are needed:

- Four 30-gallon containers for each two decon lanes used.
- 2 long-handled brushes for each two decon lanes used.
- Sufficient STB slurry mix for chemical contamination.
- Hot, soapy water and a sponge for radiological contamination.
- Rinse water.
- 2 ponchos or plastic sheets.
- Engineer tape.

4-29. Dig a sump that is 6 feet long, 6 feet wide, and 4 feet deep (minimum). Place three 30-gallon containers near the sump for ease of changing. Fill two containers with an STB slurry mix. Fill the other two containers with clean water for rinsing and place it about 3 feet forward of the STB cans. Place two long-handled scrub brushes at each can of STB slurry.

4-30. To prepare the slurry, mix 100 pounds of STB with 20 gallons of hot water. The chemical unit provides the hot water. Change the mixture after 20 soldiers have decontaminated their gear. The rinse water should be changed after every 10 soldiers or when it appears dirty (place the waste mixture in the sump).

4-31. Place a poncho or a plastic sheet on the ground at the checkpoint. Divide the poncho or the sheet in half using engineer tape. This is the contamination control line. The checkpoint will be a minimum of 10 feet from all other stations in order to get a true reading on the detection equipment. Place the following chemical detection/identification equipment at the checkpoint for an average company-sized unit:

- 1 CAM.
- 8 books of M8 detector paper.
- 4 M256A1 detector kits.
- 100 plastic trash bags.
- 1 AN/VDR-2 for radiological contamination.

4-32. Three soldiers are required to operate this station. One soldier supervises the decon of the individual gear and takes the decontaminated equipment to the checkpoint. He also prepares a new slurry mixture as necessary. One soldier remains at the checkpoint and checks all the gear using the detection equipment to ensure that it is decontaminated. One soldier transports the decontaminated gear to the reissue point.

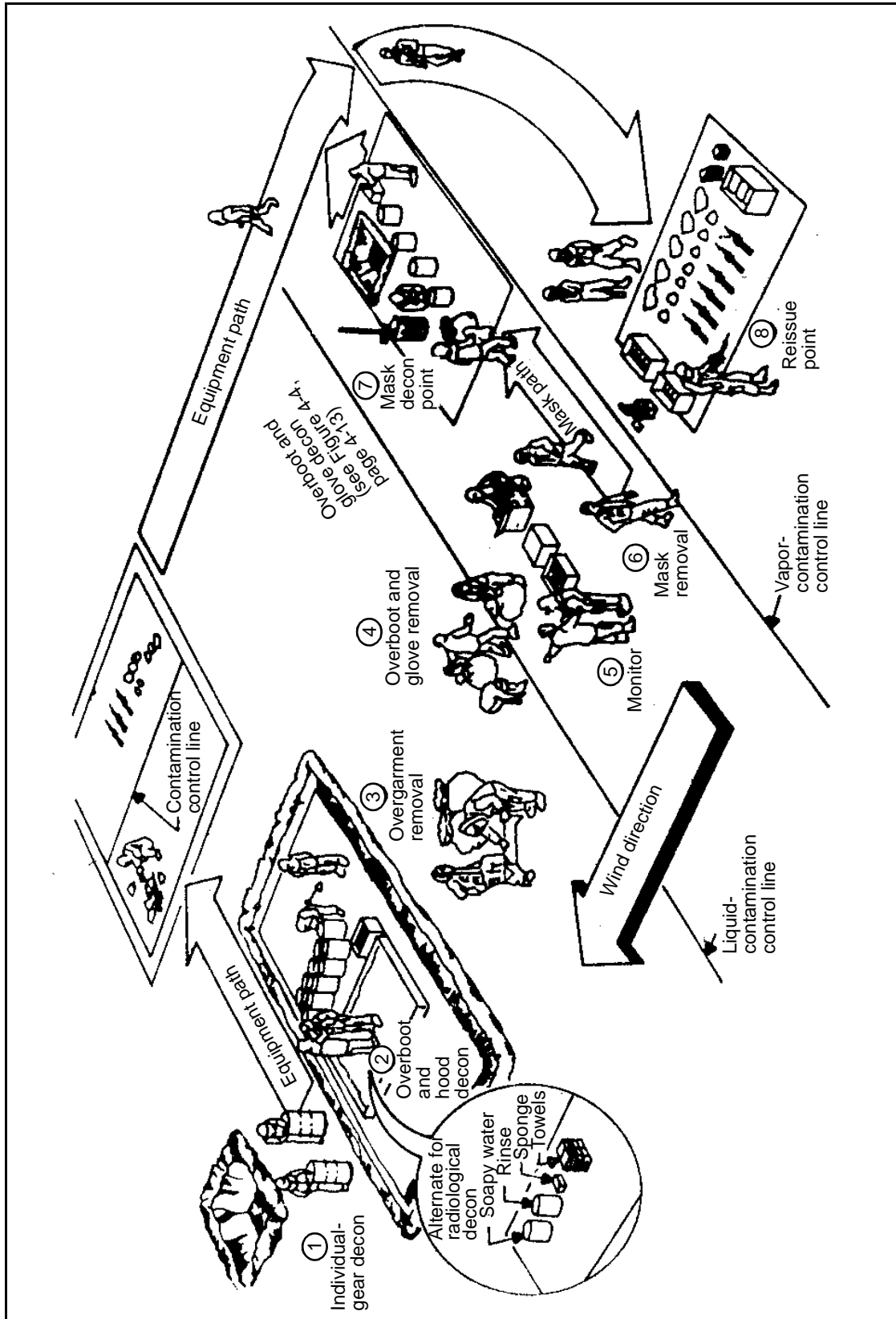

Figure 4-3. DTD Layout



Table 4-2. DTD Personnel and Equipment Recapitulation

Stations	Personnel	Equipment/Supplies
Station 1 - individual-gear decon	2 attendants 1 monitor (CAM operator)	4 30-gallon containers 2 long-handled brushes 2 ponchos or plastic sheets 1 CAM 8 books of M8 detector paper 4 M256A1 detector kits 100 plastic trash bags Sufficient STB slurry mix Rinse water *Hot, soapy water *AN/VDR-2 *Sponge
Station 2 - overboots and hood decon	1 attendant	Cutting tool One SKD or IEDK per person Large plastic sheet Plastic trash bags (as required) 10 drums of STB 1 shovel
Station 3 - overgarment removal	1 attendant	2 30-gallon containers 100 plastic trash bags 10 boxes of SDKs
Station 4 - overboot and glove removal	3 attendants	8 30-gallon containers 2 long-handled brushes M8 detector paper (as required) 1 immersion heater 100 plastic trash bags 1 CAM Engineer tape 1 cutting tool 2 ponchos or large plastic sheets 10 percent STB/HTH solution Hot, soapy water Cold rinse water
Station 5 - monitor	1 attendant (CAM operator) 1 aidman (or combat lifesaver)	1 CAM First aid supplies 5 books of M8 detector papers 1 case of SDKs
Station 6 - mask removal	2 attendants	1 M8A1 or M22 ACAA Engineer tape
Station 7 - mask decon point	2 attendants 1 monitor	1 30-gallon container 4 3-gallon containers 1 CAM 2 sponges One case of paper towels 1 immersion heater Mask sanitizing solution Hot, soapy water Rinse water
Station 8 - reissue point	Unit NBC NCO/supply sergeant	Mask PLL
* Denotes the equipment needed for radiological contamination. <b>NOTE: Assume that an operational decon was done before the thorough decon.</b>		

**Execution**

4-33. The soldier decontaminates his gear by washing and scrubbing it for 6 minutes in a decontaminant container with hot, soapy water or an STB slurry mix. If he is wearing the M42 mask, he should use hot, soapy water and a sponge or an STB slurry mix to decon the hose and canister.

4-34. The soldier dips his gear into the clean water and rinses it for 4 minutes then hands it to the attendant and proceeds to the next station. The attendant takes the gear to the equipment checkpoint and places the decontaminated gear on the "dirty" side of the contamination control line and returns to the containers to pick up more gear. The monitor at the checkpoint checks the gear using the appropriate detection device and the procedures associated with that device. If the residual contamination exceeds negligible risks, recycle the gear and decon it again (see Chapter 1 of this manual). If the gear passes the check, place it on the clean side of the contamination control line. The attendant will carry the equipment to the reissue point.

4-35. Depending on the time available, more extensive washing and checking procedures may be used. The longer the gear is washed or left out in the air after washing, the lower the contamination level. The gear may be put in closed areas or plastic bags and checked for hazardous vapors with the M256A1 detector kit or the CAM. The CAM only detects the G-series nerve-agent vapors and the H-series blister-agent vapors.

**Risk**

4-36. If this step is not done properly, contamination may remain on the equipment. The resulting vapor hazard could cause casualties to unmasked personnel, particularly in closed areas (vehicle interiors) or heavily wooded areas where air circulation is poor.

**STATION 2 - OVERBOOT AND HOOD DECON**

4-37. At this station, gross contamination on overboots, trouser legs, mask, and hood is neutralized. If ample hoods are available at the reissue point, the hood should be cut away.

**Preparation**

4-38. Prepare a shuffle pit by digging a shallow pit about 3 feet long, 3 feet wide, and 6 inches deep. Fill the shuffle pit with an STB dry mix or an STB slurry, depending on water availability. Prepare the STB dry mix by mixing three parts of earth to two parts of STB. Prepare the STB slurry in the same manner as at station 1 (see paragraph 4-30). Add more STB to the mix after 10 soldiers have processed through the shuffle pit. The chemical unit will provide 10 drums of STB for every company-sized unit that goes through the station.

4-39. At this station, the following equipment and supplies are needed for the mask and the shuffle pit: 1 cutting tool for each decon lane used, 1 SDK or IEDK per person, plastic trash bags (as required), 10 drums of STB, and 1 shovel (to mix).

4-40. One soldier is required to operate this station. The attendant directs and "observes" the soldiers as they decon their overboots and hoods.

**Execution**

4-41. The soldier walks into the shuffle pit and spreads his legs apart (double-shoulder width), bends at the waist, and uses his hands to thoroughly rub the STB dry mix or the STB slurry on his overboots and lower trousers legs. He should take special care to rub the rear of his overboots. He should also remove any excess decontaminant from his gloves.

4-42. If a replacement hood is available, remove the hood as follows. Buddy #1 cuts the shoulder straps and drawcord on Buddy #2's hood. Buddy #1 pulls Buddy #2's hood inside out over the front of the mask, being careful not to touch the exposed neck or head. Buddy #1 gathers Buddy #2's hood in one hand and using a cutting tool, cuts away the hood as close as possible to the eye-lens outsert, voicemitter, and inlet-valve covers. Make sure nothing is left dangling below the bottom of the mask.

4-43. If a replacement hood is not available, Buddy #1 decontaminates and rolls Buddy #2's hood in the same manner as for a MOPP-gear exchange. When the task is completed, Buddy #1 and Buddy #2 reverse roles.

**NOTE: Soldiers should check their overboots, rubber gloves, and overgarment for damage. Any rips, tears, or punctures in these items should be reported to the monitor at station 5. This allows the monitor at station 5 to check the soldiers for chemical-agent symptoms and their clothing for possible contamination.**

**Risk**

4-44. If this step is not done properly, contamination can be transferred to the combat boots and the head and neck area from the hood.

**STATION 3 - OVERGARMENT REMOVAL**

4-45. At this station, contaminated overgarments are removed before the agent penetrates the overgarment material and touches the undergarments or the skin.

**Preparation**

4-46. At this station, the following equipment and supplies are needed:

- Two 30-gallon containers for each two decon lanes used.
- 100 plastic trash bags (or about one per soldier).
- 10 boxes of SDKs.

4-47. One soldier is required to operate this station. He directs and "monitors" the soldiers as they remove their overgarments in the same manner as a MOPP-gear exchange.

**Execution**

4-48. The attendant assists the soldier in removing his overgarment. The attendant cuts and removes the M9 detector paper from around the soldier's wrist. He unfastens the Velcro closure over the jacket zipper, waist cord, and wrist Velcro straps on the soldier's jacket. He unfastens the back snaps and instructs the soldier to make a fist. He then pulls the soldier's jacket down and away from him.

4-49. The attendant cuts and removes the M9 detector paper from the soldier's trousers. He unfastens the Velcro straps and zippers on the cuffs of the soldier's trousers. He also unfastens the front waist snaps and unzips the front zipper. He has the soldier lift one leg and point that foot down and bend slightly at the knees for stability. The attendant grasps the cuff of the elevated foot with a hand on each side and pulls the cuff in an alternating, jerking motion until the soldier can step out of the trouser leg. The process is repeated on the other leg.

**NOTE: The attendant ensures that the soldier steps wide enough so as not to rub his clean leg against the contaminated boot and overgarment.**

### **Risk**

4-50. If this step is not done properly, the agent may be transferred to the undergarment or the skin.

### **STATION 4 - OVERBOOT AND GLOVE REMOVAL**

4-51. At this station, contaminated overboots and gloves are removed to limit the spread of contamination. The overboots and gloves may also be decontaminated for reissue (if serviceable).

### **Preparation**

4-52. At this station, the following equipment and supplies are needed for every two lanes used:

- Engineer tape.
- 1 cutting tool for each lane used.
- 100 plastic trash bags (or about one per soldier).

4-53. If the overboots and gloves are not being decontaminated, two 30-gallon containers are needed.

4-54. If the overboots and gloves are being decontaminated, the following are needed:

- Eight 30-gallon containers.
- 2 long-handled brushes.
- 2 ponchos or large plastic sheets.
- 1 CAM.
- 1 AN/VDR-2 for radiological contamination.
- 4 M256A1 detection kits.
- 1 immersion heater.
- 100 plastic trash bags.
- M8 detector paper, as required.
- 10 percent STB/HTH solution.
- Hot, soapy water.
- Cold rinse water.

4-55. If replacement overboots and gloves are available, set up the station as follows (see Figure 4-4). Establish a liquid-contamination control line and set

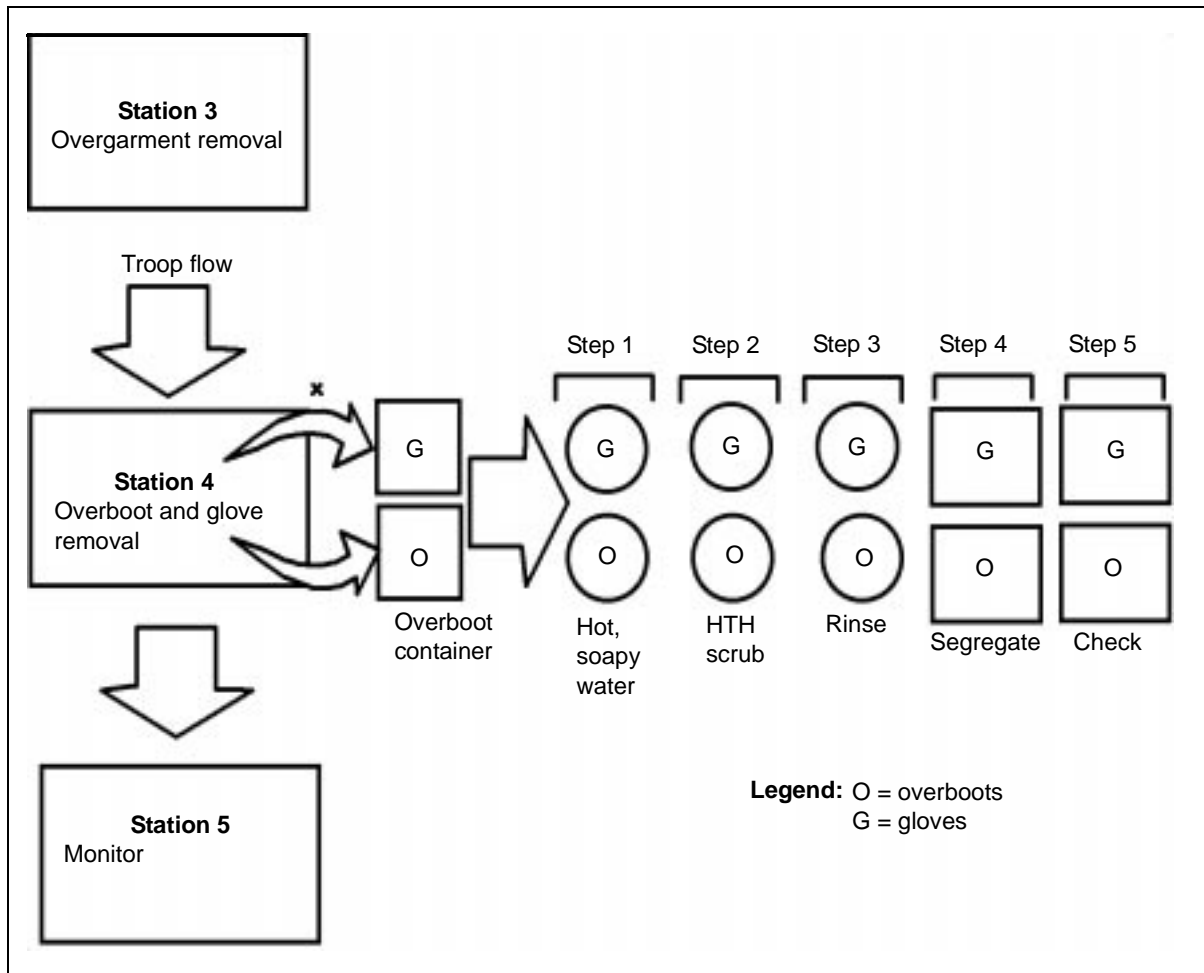

Figure 4-4. Station 4 Layout

two 30-gallon containers 1 foot back from the line. Soldiers support themselves using the containers and discard their overgarments into the containers. An attendant directs and monitors the soldiers as they remove their overboots and gloves in the same manner as a MOPP-gear exchange; however, the soldiers step over the control line instead of onto a jacket.

4-56. If replacement overboots and gloves are not available, set up the station as follows: Fill two 30-gallon containers with hot, soapy water and two 30-gallon containers with a 10 percent STB/HTH solution, placing two scrub brushes near the containers. Then fill two 30-gallon containers with cold rinse water. One attendant supervises and assists the soldiers wearing the M42 mask. The other two attendants decon the overboots and the gloves; one processes the overboots, while the other processes the gloves.

**NOTE: Replace the water in the container once 20 items have been processed. When available, the decon platoon will assist with the water requirements.**

4-57. For both situations, use engineer tape to mark the liquid-contamination control line on the ground. Place the cutting tools, two containers, and plastic

bags on the "dirty" side of the liquid-contamination control line. The liquid-contamination control line separates the "dirty" and "clean" areas. No liquid agent should be tracked on the ground beyond the liquid-contamination control line.

### Execution

4-58. The liquid-contamination control line separates the "dirty" and "clean" areas. The attendant unfastens or cuts the elastic closures on the soldier's overboots. The soldier faces the liquid-contamination control line and steps back from it about 12 inches. The attendant steps on the back of the soldier's overboot and instructs him to lift his heel and work his foot out of the overboot and step across the liquid-contamination control line. Repeat the process on the other foot. If the overboot cannot be removed by this process, the attendant cuts it off and discards it in the designated container. The soldier holds the fingertips of his gloves and partially slides his hands out. The attendant remove the soldier's gloves.

4-59. If the soldier is wearing the M42 protective mask, the attendant from station 6 carries the soldier's filter canister until it is removed.

**NOTE: The attendant at station 4 performs his duty from the "dirty" side of the liquid-contamination control line.**

4-60. The overboots and gloves are decontaminated using the following steps:

**NOTE: Check all items for holes, tears, and punctures and discard any item with this defect. Do not decon any item that is unserviceable.**

- Step 1. Submerge the gloves and overboots in their respective container of hot, soapy water. Some of the contamination is removed during this step. When the overboots and gloves are removed from the container, ensure that no water remains inside them.
- Step 2. Submerge the gloves and overboots in their respective containers of STB/HTH solution. Thoroughly scrub the items until no visible contamination remains. After scrubbing, submerge each item once more before moving to the rinse container.
- Step 3. Thoroughly rinse the scrubbed items, making sure that they are rinsed inside as well as out.
- Step 4. Place usable items on a poncho or a plastic sheet to air dry and weather.
- Step 5. Place usable items in plastic trash bags along with an M256A1 detector kit. If the detector kit shows contamination remaining, the attendants can recycle the items or discard them. However, if the kit show no contamination, the items can be reused.

### Risk

4-61. If the overboots are not properly removed, the combat boots may become contaminated and contamination may be spread to clean areas. If the gloves are not properly removed, the undergarments and skin may become contaminated.

**STATION 5 - MONITOR**

4-62. At this station, contamination on personnel is identified, spot-decon capabilities are provided, and medical aid is provided, as required.

**Preparation**

4-63. At this station, the following equipment and supplies are needed:

- First aid supplies.
- 1 CAM.
- 1 AN/VDR-2 for radiological contamination.
- 5 books of M8 detector paper per 100 soldiers.
- 1 case of SDKs.

4-64. An aidman should be present to treat any soldiers suffering from chemical-agent symptoms. If an aidman is unavailable, a combat lifesaver should be present.

**Execution**

4-65. The attendant checks the soldiers for contamination using the CAM. Liquid agents can be detected with M8 detector paper. Small quantities of agent vapor can be detected with the CAM. Symptoms of agent poisoning are the most obvious indication of skin contamination. At this station, the medic checks each soldier for symptoms of agent poisoning and treats, as required. Soldiers should report any damage to their MOPP gear that was identified at stations 2, 3, and 4. The attendant can decon any areas identified as contaminated with an SDK. Soldiers are remonitored after decon. It is possible that all liquid-chemical contamination is absorbed into the clothing. If so, M8/M9 detector paper will indicate negative, even though there is a hazard.

**Risk**

4-66. If this station is omitted, the soldier could become a casualty. After this station, the soldier is not checked for contamination or decontaminated again. Commanders can choose to conduct more extensive contamination checks here if medical assistance and time are available. This decreases the risk of casualties.

**STATION 6 - MASK REMOVAL**

4-67. At this station, the mask is removed without contaminating the soldier. The mask is taken to a mask decon point, limiting agent transfer at the station.

**Preparation**

4-68. At this station, the M8A1 or M22 automatic chemical-agent alarm (ACAA) and engineer tape are needed. Two soldiers are needed to operate this station. They remove and carry the masks to station 7.

**Execution**

4-69. If the hood is still attached to the mask, the attendant pulls the hood over the front of the mask, grabs the mask by the voicemitter cover, and pulls the mask off the soldier. The soldier holds his breath as the mask is removed. If the mask has optical inserts, the attendant holds the mask open so that the

soldier can remove the inserts without touching the outside of the mask. The soldier walks upwind 16 feet, crosses the vapor-contamination control line, and then resumes breathing. The attendant brings the mask to station 7.

4-70. If the wind direction remains constant, no chemical vapor hazard is expected beyond the vapor-contamination control line. Position the M8A1 or the M22 ACAA upwind of the station to warn of vapor hazards. The soldier getting decontaminated moves straight ahead while his mask, which may still give off vapors, is held on the vapor dirty side of the line and taken to station 7 where it is decontaminated.

### **Risk**

4-71. If the step is not done properly, the soldier could breathe toxic vapors. There is a high probability that the vapor hazard is still present on the mask and the hood. The soldier must not touch the outside of the mask because it could contaminate his bare hands. The soldier proceeds to station 8.

### **STATION 7 - MASK DECON POINT**

4-72. At this station, all the contamination is removed from the mask.

**NOTE: Once 20 items have been processed in the wash containers, replace the water. Once 10 items have been processed in the rinse water, replace it. Place the contaminated waste into the sump.**

### **Preparation**

4-73. At this station, the following materials and equipment are needed:

- 4 containers (about a 3-gallon capacity).
- 1 CAM (for chemical only).
- Hot, soapy water.
- Rinse water.
- Mask sanitizing solution.
- Immersion heater.
- One 30-gallon container.
- 2 sponges.
- 1 case of paper towels per company.

4-74. Dig a sump that is 4 feet long, 4 feet wide, and 4 feet deep in which to discard used filters and canisters. Place the equipment and materials as shown in Figure 4-3, page 4-8. Three soldiers are needed to operate this station. Two soldiers strip, wash, rinse, sanitize, and dry masks. The other soldier checks the masks and carries them to the reissue point.

### **Execution**

4-75. Remove the eye-lens outserts and the hood if the hood was not cut off at station 2. Remove and discard the filters or canisters. Put the items into the properly marked containers. Wash the mask, hood, eye-lens outserts, and the hoses on the M42 and M43 masks in hot, soapy water. Rinse these items in clean water, dip them into the sanitizing solution, agitate them for 5 minutes, and then rinse them again in clean water. Add one tube of mask sanitizing solution (calcium hypochlorite) to each quart of water. Wipe the masks with rags until they are almost dry. Discard each container of mask sanitizing



solution into a sump after every 10 masks. The attendant checks the masks for contamination with a CAM. If the masks are still contaminated, the attendant recycles them for more decon and then decons his rubber gloves. If the masks are not contaminated, the attendant takes the masks to the reissue point. The attendant must take care not to contaminate the reissue point or himself.

### **Risk**

4-76. If this step is not done properly, the soldiers may become contaminated when the masks are reissued to them at the reissue point. Even though the step is done correctly, there is still a possible danger when many masks are stacked together. Small amounts of residual vapor from each mask can become potentially dangerous.

**NOTE: Runners between stations 7 and 8 are in MOPP2 and are prepared to go into MOPP4.**

### **STATION 8 - REISSUE POINT**

4-77. At this station, the mask with its components is provided to the soldier for reassembly.

### **Preparation**

4-78. At this station, the protective-mask prescribed load-list (PLL) parts are needed. The unit NBC NCO/supply sergeant sets up the reissue point to provide the soldiers with replacement parts for all types of protective masks and assist in mask maintenance.

### **Execution**

4-79. The mask with its components is reissued to the soldier who assembles it in the AA. The unit chemical NCO affixes canisters to the cleaned M42 and M43 hoses. The soldier picks up individual gear and moves to the postdecon AA.

### **Risk**

4-80. If this step is not done properly, the soldier may be inadequately equipped for future operations.

**NOTE: If time is not available, the NBC NCO will have replacement chemical suits, overboots, and gloves at this station for reissue. If time is available, personnel will receive this equipment at the postdecon AA.**

## **RESUPPLY SUPPORT RESPONSIBILITIES**

4-81. The supporting chemical unit (decon or smoke/decon) must supply the majority of the equipment and supplies that are required to operate the DTD. This does not relieve the supported unit of the requirement to maintain adequate supplies to conduct DTD procedures.

4-82. A chemical unit's operational control continues to receive support from its parent organization. The supported unit provides the chemical unit with replacements, supplies, and material at the end of the DED. This shortens the time the chemical unit is nonmission capable following the DED. The supported unit must coordinate for the supplies and equipment necessary to operate the DTD.

4-83. Typical nonchemical units do not have more than two CAMs per company-sized unit. However, the DTD requires a minimum of three CAMs. The supported HQ may need to provide additional CAMs. The division support command (DISCOM) sustains the division's chemical units. A chemical unit attached to a maneuver force identifies the resources that are needed to accomplish the mission and passes these requirements to the maneuver staff's Supply Officer (S4)/Logistics Staff at Corps and Division (G4). The S4/G4 then coordinates with the supporting CSS element to fill the requirement. The supply units that operate the Class II points issue the protective masks and overgarments. They normally package protective clothing as complete sets of MOPP equipment to support a predetermined number of soldiers. Decon supplies may be issued in preconfigured "push" packages.

## **DETAILED EQUIPMENT DECON**

4-84. Chemical units (decon and smoke/decon platoons) are responsible for setting up, operating, and closing the DED portion of the thorough-decon operation. The DED for chemical and biological contamination is comprised of five stations. For radiological contamination, the DED uses all but station 2. Stations are normally 98 to 164 feet apart; however, spacing is METT-TC dependent.

### **DECON STATIONS**

4-85. The actions that are taken at each of the stations are as follows:

#### **Station 1 - Primary Wash**

4-86. At this station, the gross contamination and dirt are removed from the vehicle. The vehicle is sprayed for 2 to 3 minutes with hot, soapy water. The vehicle is then scrubbed to help remove caked-on dirt. The mechanical action of scrubbing also helps remove thickened chemical agents. Although the undersurfaces are difficult to reach, try to remove as much dirt as possible. After scrubbing the vehicle, spray it again for 2 to 3 minutes to remove loosened dirt and contamination. This station uses about 250 gallons of water per vehicle. Larger vehicles with large quantities of dirt use more water. The runoff from this station is contaminated and must be treated as hazardous. The contaminated runoff must be controlled; if available, engineer support may be used. This station requires high water-pressure systems (M12A1 power-driven decon apparatus [PDDA] and M17 Lightweight Decontaminating System [LDS]) rather than low water-volume systems (65-GPM pumps).

**NOTE: Thirty-five cubic feet of space per 250 gallons of liquid runoff should be used when calculating the size for the drainage pump.**

4-87. The effectiveness of the wash depends on the type of wash (hot, soapy water; hot water; cold water; or steam). The relative effectiveness rankings for selected surfaces are listed in Table 4-3, page 4-20. Hot, soapy water is water heated to about 120° to 140° F to which a detergent has been added to reduce its surface tension. The detergent removes the agent by emulsification, which is followed by the mechanical displacement of the suspension. Hot water alone is less effective than hot, soapy water. Because of the high temperature, some

agents are best removed by steam through vaporization. Finally, for some chemical agents, cold water exhibits better solvent characteristics.

### **Station 2 - DS2 Application**

4-88. At this station, a decontaminant is applied to the entire vehicle. The vehicle is divided into four parts, and a member of the scrubbing team is assigned that part of the vehicle. This limits the workload of each member of the scrubbing team and avoids duplication of work. DS2 is applied starting at the top of the vehicle and working towards the undercarriage. Every effort is made to apply DS2 to the undercarriage, especially if the vehicle has crossed a contaminated area. The mop is the least tiring method of applying DS2. Using a mop to apply DS2 creates a large amount of spillage. However, continual use of the M13 decontaminating apparatus, portable (DAP) requires the scrubbing team to exert more energy than with using the mop. The M13 DAP can be used to apply DS2 to hard-to-reach areas. Planning factors for DS2 application are provided at Table 4-4, page 4-20.

4-89. Before starting the decon operation, the scrubbing team pours 5-gallon cans of DS2 into 30-gallon containers if mops are going to be used instead of M13 DAPs. Each member of the scrubbing team wears a TAP apron or wet-weather gear to protect himself from the DS2.

4-90. Water adversely affects the DS2's ability to react with chemical agents. If there is excess water remaining on the vehicle from station 1, the scrubbing team can—

- Wait for the majority of the water to evaporate.
- Remove the excess water.
- Increase the amount of DS2 applied.

4-91. There must be sufficient DS2 on the item being decontaminated for complete neutralization to occur. The DS2-to-agent ratio needs to be 55 to 1 for H agents and 25 to 1 for G agents. For a vehicle the size of an M1A1 tank, this corresponds to 15 and 7 gallons, respectively.

### **Station 3 - Contact Time/Interior Decon**

4-92. At this station, the DS2 is allowed to completely neutralize the chemical agent and the interior of the vehicle is decontaminated. Vehicles are moved to a concealed position. Vehicles will remain in station 3 for no less than 30 minutes. DS2 reacts with most chemical agents within 5 minutes. However, by allowing the DS2 to remain on the contaminated surface for 30 minutes, the amount of agent that will later desorb (off gas) will be significantly reduced. When there is a 30-minute contact time, there will be no desorption after decon operations for most chemical agents. However, studies indicate that distilled-mustard (HD) vapors desorb after decon even if DS2 is allowed to remain for 30 minutes.

4-93. While the vehicle is held at this station for the DS2 to completely react, the driver inspects the interior of the vehicle for liquid contamination. He is given M8 detector paper to check for chemical contamination. If he identifies chemical contamination, he is given decon supplies to decon the interior of the vehicle. The best decon solution for use in the interior of vehicles is a 5 percent solution of HTH or STB. The driver wipes all reasonably accessible

**Table 4-3. Effectiveness of Types of Wash**

Agents/Surfaces	Relative Effectiveness <sup>1</sup>
TGD on alkyd-painted metal	Hot water and/or steam; hot, soapy water; cold, soapy water
TGD on CARC-painted metal	Hot, soapy water; hot water and/or steam; cold water
THD on alkyd-painted metal	Hot water and/or steam; hot, soapy water; cold water
THD on CARC-painted metal	Hot, soapy water; hot water and/or steam; cold water
HD on alkyd-painted metal	Hot, soapy water; hot water and or steam; cold water
HD on CARC-painted metal	Hot, soapy water and/or steam; cold water; hot water
VX on alkyd-painted metal	Steam; cold water; hot water and/or hot, soapy water
TGD on canvas/webbing	Steam; hot water and/or hot, soapy water; cold water
GD on canvas/webbing	Steam; hot, soapy water and/or hot water; cold water
THD on canvas/webbing	Steam; hot, soapy water; cold water; hot water
HD on canvas/webbing	Steam; hot water; hot, soapy water; cold water
VX on canvas/webbing	Steam; hot water and/or hot, soapy water; cold water
Overall	Steam; hot water and/or hot, soapy water; cold water

<sup>1</sup>The types of wash are listed in the order of effectiveness, starting with the most effective to the least effective.

**Table 4-4. Planning Factors for DS2 Application**

Planning Categories	Tank	Truck	APC
Gallons of DS2 applied	15	8	7
Minutes to apply solution	35	29	18

surfaces with a rag or sponge soaked in the HTH or STB solution. He should not attempt to decon areas where there is little likelihood of contamination (electrical assemblies, area beneath the turret floor, and so forth).

**CAUTION**  
Do not mix HTH or STB with DS2. If mixed, a violent reaction will occur.

4-94. Once the interior decon is completed, the driver places a cover over the seat and floor of the vehicle. Then he dismounts from the vehicle and proceeds to the start of the DTD. The assistant driver, having completed the DTD, mounts the vehicle and moves it to the next station. Drivers must exercise caution when entering or exiting the vehicle. A DS2-coated surface is slippery, and the DS2 may react with chemical protective footwear. Personnel should avoid stepping in DS2 and tracking it into the vehicle.

4-95. For radiological contamination, use an AN/PDR-77 or AN/VDR-2 radiac detector to determine the extent and location of contamination inside the vehicle. If there is contamination, determine the intensity of the

contamination inside the vehicle. If the contamination has an intensity greater than 0.33cGy, the interior of the vehicle must be decontaminated. Use a sponge to wipe the interior of the vehicle.

**Station 4 - Rinse**

4-96. At this station, the DS2 is removed from the vehicle. The vehicle is sprayed with water from top to bottom. Take care to rinse the undercarriage. This station uses about 200 gallons of water per vehicle. Failure to remove all DS2 from the vehicle may cause a false-positive reading at station 5. If high water-pressure systems (M12A1 PDDA and M17 LDS) are not available, large-volume water pumps (65-GPM pumps) should be used at this station. The driver removes plastic or other material (if present) covering the seats and floor and disposes of it as hazardous waste. See Table 4-5 for the planning factors for the rinse station.

**Table 4-5. Planning Factors for the Rinse Station**

Planning Categories	M1 Tank	M2 BFV	M113 APC	M109A PALADIN	HEMTT	5-Ton Truck	HMMWV
M12A1 PDDA rinse (gallons applied)	325	325	203	325	180	158	90
M12A1 PDDA rinse (minutes applied)	12	12	9	12	8	7	4
M17 LDS rinse <sup>1</sup> (gallons applied)	57	57	38	57	30	42	23
M17 LDS rinse <sup>1</sup> (minutes applied)	14	14	10	14	12	11	6
<sup>1</sup> Rinse is done with a spray wand.							

**Station 5 - Check**

4-97. At this station, the vehicle is checked to see if it has a negligible contamination level or if it still has significant contamination remaining. Detection procedures will vary depending on the type of contamination. If significant contamination is found on the vehicle, the vehicle will be recycled to station 2 for chemical contamination or station 1 for radiological contamination. An assistant driver takes the vehicle to the AA.

4-98. **Chemical.** The CAM is used to check for the presence of vapor from residual liquid contamination. A one bar or lower reading on the CAM indicates a negligible contamination level. Once the CAM indicates the presence of vapor contamination, M8 detector paper is used to verify the presence of liquid contamination. If it is suspected that both the CAM and M8 detector paper are producing a false positive, use an M256A1 detector kit to confirm or deny the presence of contamination. See Table 4-6, page 4-22, for a list of common interferences that can cause false-positive readings on the CAM. If the vehicle has significant contamination remaining, recycle it. The commander may modify the recycle criteria based on mission requirements.

4-99. There will be desorption of chemical agents from the surfaces after decon. The desorption of vapors on surfaces painted with the CARC will stop sooner than those surfaces painted with alkyd. Consider this when checking decontaminated items for overall decon effectiveness.

Table 4-6. Common Interferences of the CAM

Interferences	G-Bar Response	H-Bar Response
DS2	Low	
Insect repellent	Low to very high	
Brake fluid	High to very high	Very high
General-purpose cleaner	High	
Burning kerosene		High
Breath mints	High	
Gasoline vapors	Low	Low
Burning grass	Low to high	Low
Burning gas	Low	
Green smoke	Low	Low to high
Break-free oil	Low	
Ammonia	Very high	

4-100. **Radiological.** Use the AN/PDR-77 or AN/VDR-2 to determine if any contamination remains. If there is contamination remaining, determine the intensity of the contamination inside and outside of the vehicle. If the contamination has an intensity greater than 0.33cGy/hr, the vehicle is recycled to station 1.

#### RECYCLE CRITERIA

4-101. The commander, with the chemical unit leader's help, establishes the recycle criteria before starting decon operations. The recycle criteria determines which vehicles will return to station 1 after contamination is detected at station 5. If the unit has sufficient time and resources, any vehicle having more contamination than the acceptable level should be recycled. However, time and resources are usually limited, and not all vehicles can be recycled. The recycle criteria is based on the weathering effects.

#### RECONSTITUTION CRITERIA

4-102. The operational- and thorough-decon operations that are performed on vehicles or major equipment will be recorded on DA Form 2404 (Army) or NAVMC 10245 (Marine). This information will become a permanent record for these vehicles or major equipment. The entries that are required on these forms are the type of decon performed, decontaminant used, date/time group completed, location of decon site, and type of monitoring equipment used to verify decon completeness. These forms will remain a permanent part of the unit's, vehicle's, and equipment's records. This information will assist with reconstitution operations once the conflict or war has ended.

#### DED LAYOUTS

4-103. Dual-purpose and decon platoons establish thorough decon sites differently because of organization and equipment differences. The optimum layout for each type of platoon is described in the following paragraphs (see

Figures 4-5 through 4-8, pages 4-24 through 4-27). This layout provides the maximum output for platoons at 100 percent personnel and equipment. The equipment and personnel requirements for the optimum layout are identified for both the chemical unit (decon platoon) and supported unit (augments) (see Tables 4-7 through 4-10, pages 4-28 through 4-31).

4-104. Since it is likely that all platoons will not be at 100 percent strength, alternate layouts are discussed. For each alternate layout, chemical-unit equipment requirements are identified. However, personnel requirements are not identified by chemical unit and supported unit. The total number of personnel that are needed is identified, with a minimum number of chemical unit personnel.

### **ALTERNATE-LAYOUT PLANNING CONSIDERATIONS**

4-105. Chemical unit leaders use METT-TC to determine the best possible DED layout to execute their mission. When determining alternate DED layouts, use the following guidelines:

- The ability to spray hot, soapy water or steam under pressure must be retained at station 1.
- The largest number of people is required at station 2.
- Experienced and qualified CAM operators are required at station 5.
- Water does not have to be hot to rinse off the DS2; however, the lower the water pressure the more water that is required for the rinse.

### **DECON PLATOON**

4-106. The optimum DED layout for an M12A1 PDDA-equipped platoon requires the use of all authorized equipment and personnel (see Figure 4-5, page 4-24). While this DED layout is manpower and equipment intensive, it provides for the rapid decon of vehicles and equipment (eight vehicles processed per hour). This layout uses dual lanes at stations 1, 4, and 5 to process two vehicles at one time. Since the most time- and labor-intensive work takes place at station 3, this station is designed to process three vehicles at a time. The processing rate of this layout will be affected by any work/rest cycle (see Table 4-11, page 4-32).

### **SMOKE/DECON PLATOON**

4-107. Smoke/decon platoons equipped with the M17 LDS will set up the DED differently than the decon units equipped with the M12A1 PDDA. While the optimum DED layout is manpower and equipment intensive, it provides for the rapid decon of vehicles and equipment (eight vehicles processed per hour). The layout uses a dual lane at stations 1, 4, and 5 to process two vehicles at a time. Since the most time- and labor-intensive work takes place at station 3, this station is designed to process three vehicles at a time. The processing rate of this layout will be affected by any work/rest cycle (see Table 4-11, page 4-32).

4-108. It may not be possible, for a variety of reasons, for an M17 LDS-equipped decon platoon to use the optimum DED layout. Figure 4-7, page 4-26, shows an example of an optimum DED layout. Limited personnel or equipment will affect the DED layout. Figure 4-8, page 4-27, shows an example of an alternate DED layout.

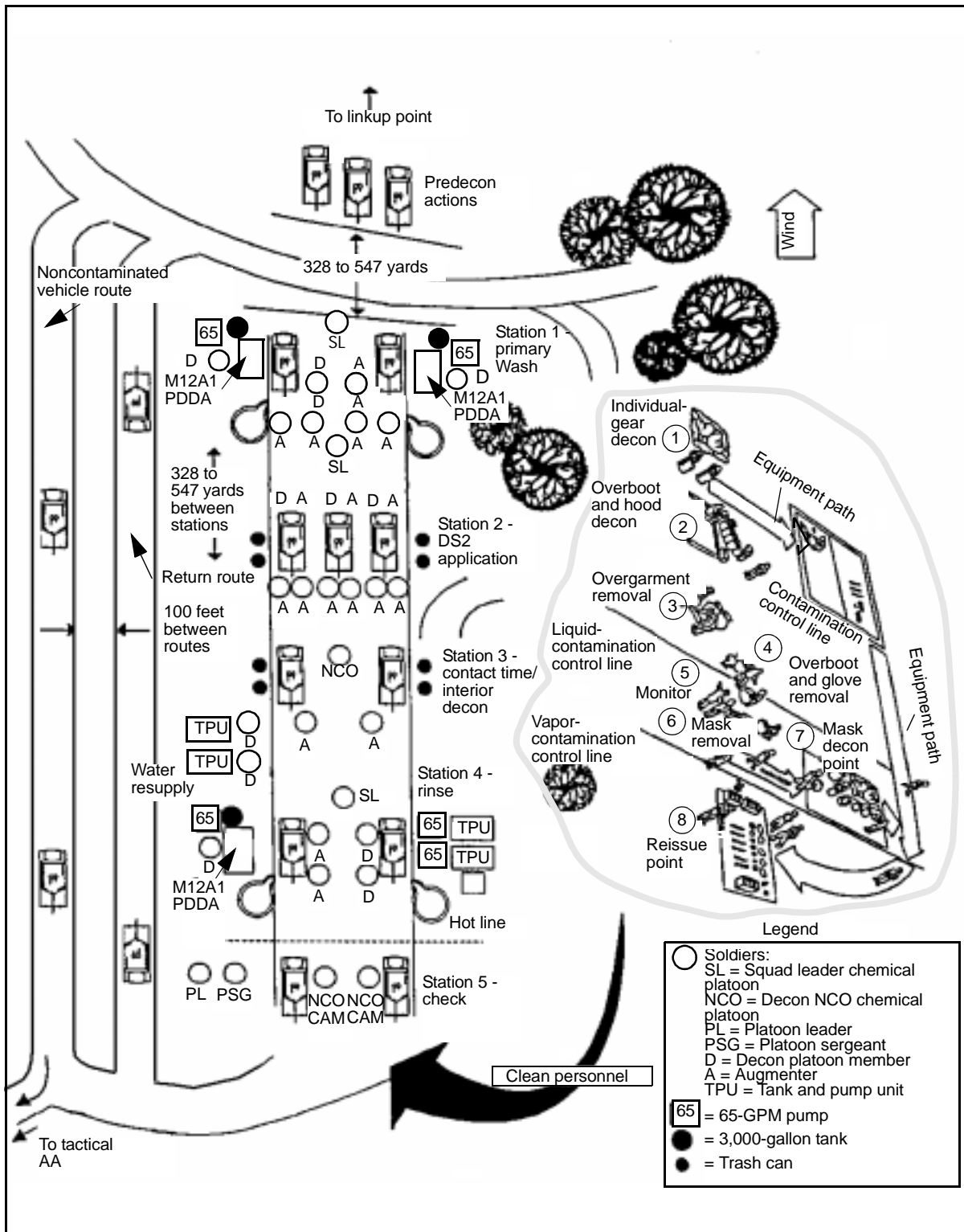

Figure 4-5. Optimum DED Layout for the M12A1 PDDA-Equipped Unit



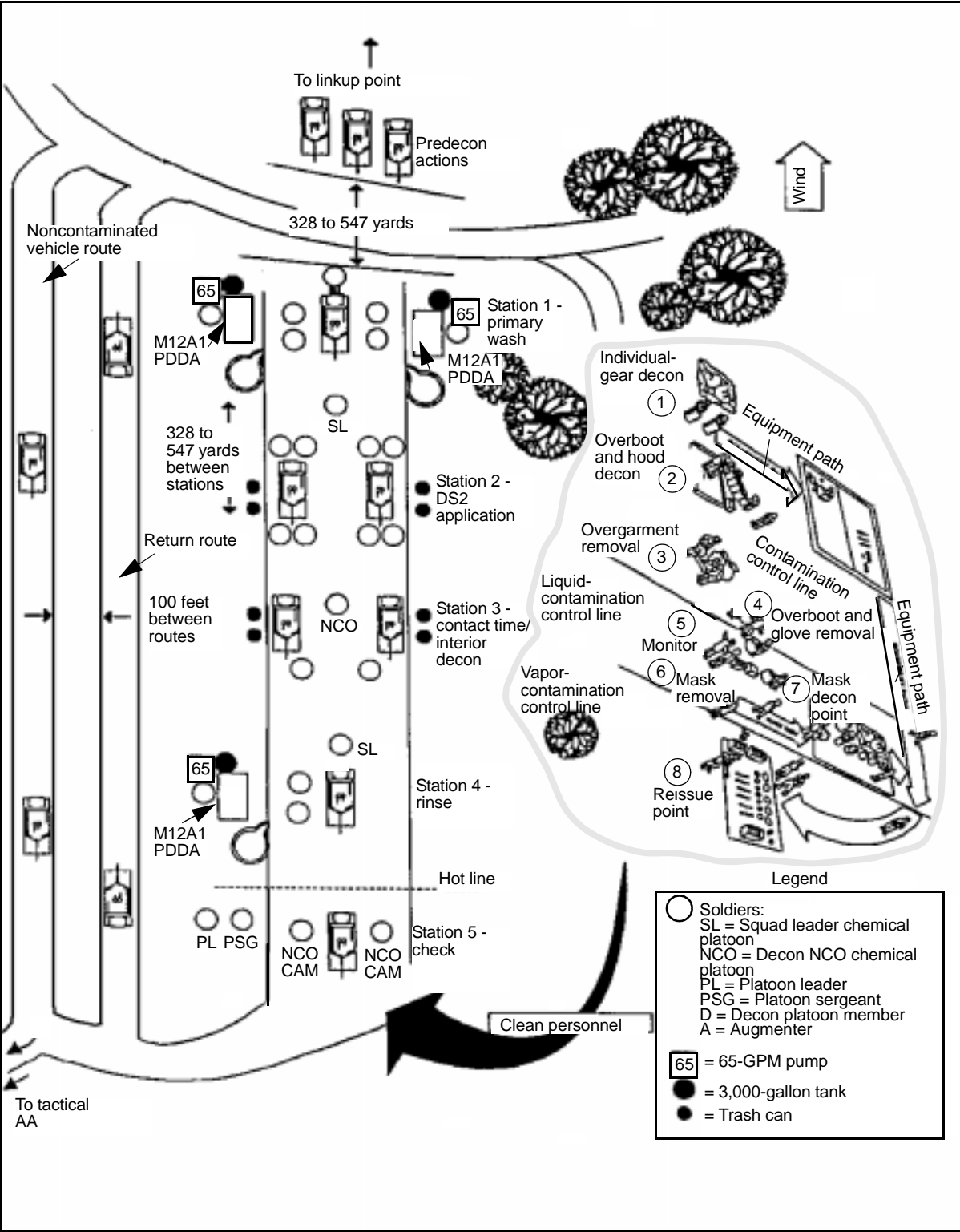

Figure 4-6. Alternate DED Layout for the M12A1 PDDA-Equipped Unit

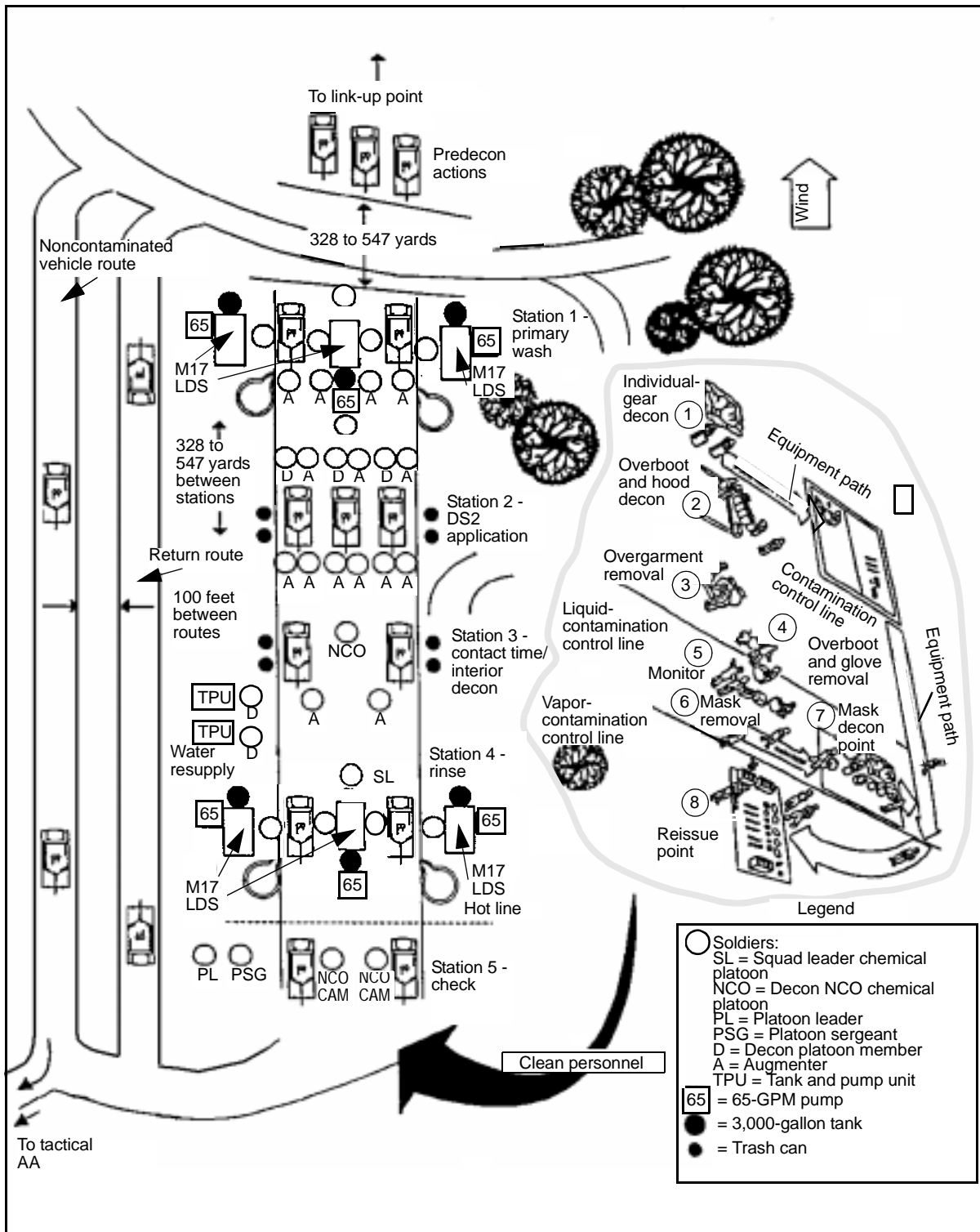

Figure 4-7. Optimum DED Layout for the M17 LDS-Equipped Unit

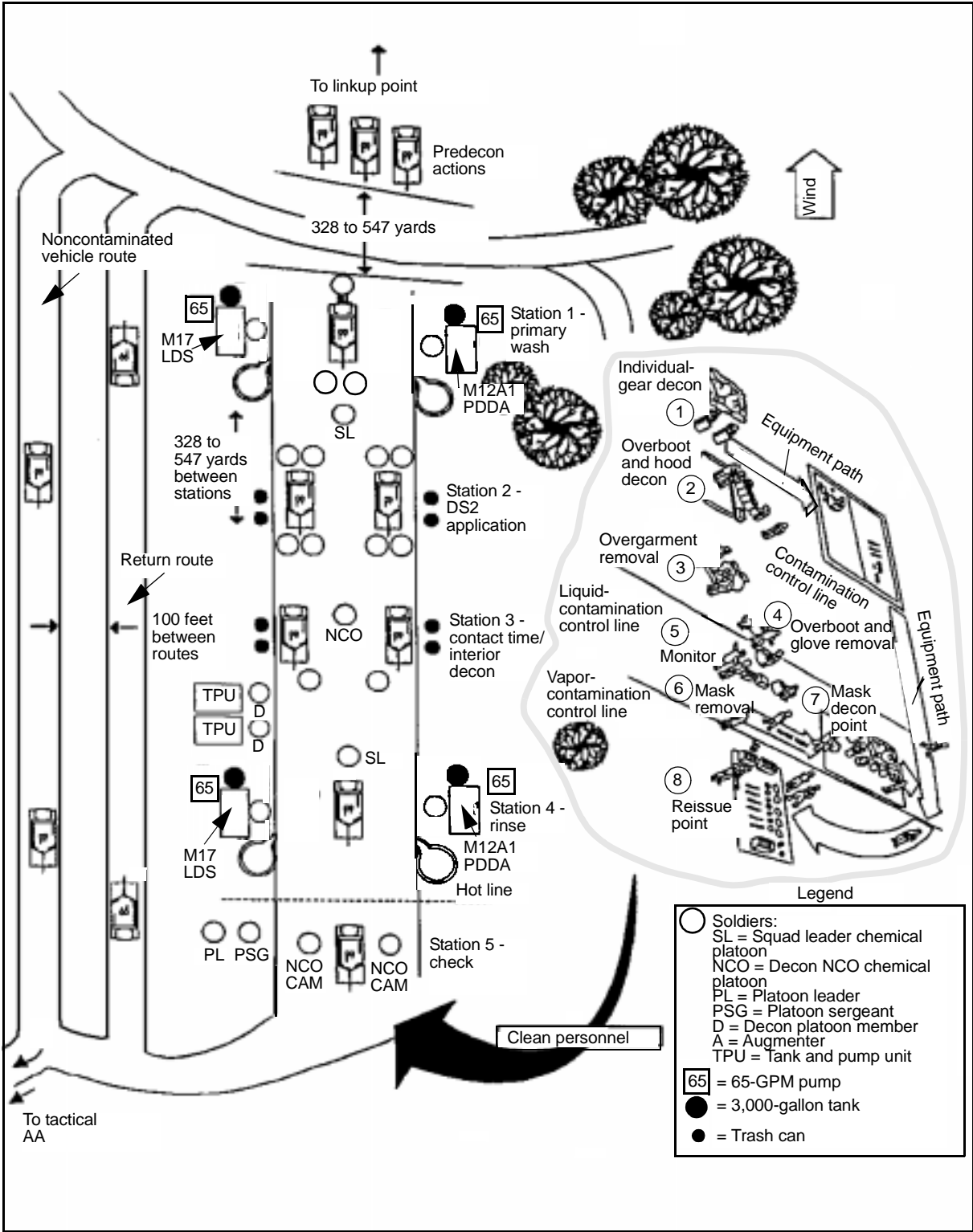

Figure 4-8. Alternate DED Layout for the M17 LDS-Equipped Unit

**Table 4-7. Personnel and Equipment Requirements for the Optimum DED Layout of the M12A1 PDDA-Equipped Unit**

Stations	Personnel		Equipment/Supplies
	Decon Platoon	Augmenter	
Station 1 - primary wash	1 squad leader 2 PDDE operators 4 sprayers	4 scrubbers	2 M12A1 PDDAs 2 3,000-gallon tanks 2 65-GPM pumps 6 long-handled brushes 8 TAP aprons Liquid detergent
Station 2 - DS2 application	1 squad leader 3 applicators	9 applicators	18 long-handled brushes 9 mops with extra mop heads 3 30-gallon containers 9 M13 DAPs Sufficient DS2
Station 3 - contact time/ interior decon	1 NCO	2 interior decon assistants	2 AN/VDR-2 3 TAP aprons 6 30-gallon containers 10 books of M8 detector paper 30 sponges 8 M256A1 detector kits 50 trash bags 1 clipboard with a pen 1 stopwatch
Station 4 - rinse	1 squad leader 1 PDDE operator 2 pump operators	2 sprayers	1 M12A1 PDDA 1 3,000-gallon tank 3 65-GPM pumps 2 TPUs 2 TAP aprons
Station 5 - check	2 NCO/CAM operators		2 CAMs 10 M256A1 detector kits 20 books of M8 detector paper 2 AN/VDR-2 2 M8A1 or M22 ACAAs
C <sup>2</sup>	1 PL 1 PSG		1 HMMWV with a radio 3 NBC marking kits
Total personnel	20	17	

**WARNING**

**Chemical-unit leaders must consider the impact of the work/rest cycle on their unit's ability to process vehicles through the DED. Failure to initiate a work/rest cycle could result in heat casualties and mission failure.**

4-109. It may not be possible, for a variety of reasons, for an M12A1 PDDA-equipped decon platoon to use the optimum DED layout. Limited personnel or equipment will affect the DED layout. Figure 4-6, page 4-25, shows an example of an alternate DED layout.

**Table 4-8. Personnel and Equipment Requirements for the Alternate DED Layout of the M12A1 PDDA-Equipped Unit**

Stations	Personnel	Equipment/Supplies
Station 1 - primary wash	1 NCOIC* 2 PDDE operators* 4 sprayers 2 scrubbers	2 M12A1 PDDAs 2 3,000-gallon tanks 2 65-GPM pumps 4 long-handled brushes 6 TAP aprons Liquid detergent
Station 2 - DS2 application	1 NCOIC* 8 appliers	14 long-handled brushes 8 mops with extra mop heads 3 30-gallon containers 8 M13 DAPs Sufficient DS2
Station 3 - contact time/ interior decon	1 NCO* 2 interior decon assistants	2 AN/VDR-2 3 TAP aprons 6 30-gallon containers 10 books of M8 detector paper 30 sponges 8 M256A1 detector kits 50 trash bags 1 clipboard with a pen 1 stopwatch
Station 4 - rinse	1 NCOIC* 1 PDDE operator* 2 sprayers	1 M12A1 PDDA 1 3,000-gallon tank 3 65-GPM pumps 2 TPUs 2 TAP aprons
Station 5 - check	2 NCO/CAM operators*	2 CAMs 10 M256A1 detector kits 20 books of M8 detector paper 2 AN/VDR-2 2 M8A1 or M22 ACAAs
C <sup>2</sup>	1 PL* 1 PSG*	1 HMMWV with a radio 3 NBC marking kits
Total personnel	29 (Minimum of 11 soldiers from the decon platoon)	
<b>* These individuals should be from the decon platoon.</b>		

## THOROUGH-DECON-SITE CLOSURE

4-110. Once all vehicles and soldiers from the contaminated unit have processed through the thorough-decon site, the site can be closed. Coordination with the supported unit is necessary before actually closing the site to ensure that all contaminated elements have been processed.

4-111. The chemical unit (decon or smoke/decon platoons) closes the DED first. Once the DED is closed, the chemical unit processes through the DTD. After the chemical unit has processed through the DTD, the DTD is closed. At that point, the chemical unit marks the area as a contaminated area and reports its exact location to the supported unit, using an NBC-5 report. The exact procedures for closing the DED and DTD are described as follows:

**Table 4-9. Personnel and Equipment Requirements for the Optimum DED Layout of the M17 LDS-Equipped Unit**

Stations	Personnel		Equipment/Supplies
	Decon Platoon	Augmenter	
Station 1 - primary wash	1 squad leader 4 sprayers 2 scrubbers	2 scrubbers	3 M12A1 PDDAs 3 1,500-gallon tanks 3 65-GPM pumps 6 long-handled brushes 8 TAP aprons Liquid detergent
Station 2 - DS2 application	1 squad leader 3 applicers	9 applicers	18 long-handled brushes 9 mops with extra mop heads 3 30-gallon containers 9 M13 DAPs Sufficient DS2
Station 3 - contact time/ interior decon	1 NCO 2 interior decon assistants		2 AN/VDR-2 3 TAP aprons 6 30-gallon containers 10 books of M8 detector paper 30 sponges 8 M256A1 detector kits 50 trash bags 1 clipboard with a pen 1 stopwatch
Station 4 - rinse	1 squad leader 4 sprayers		3 M17 LDSs 3 3,000-gallon tanks 3 65-GPM pumps 2 TPUs 4 TAP aprons
Station 5 - check	2 NCO/CAM operators		2 CAMs 10 M256A1 detector kits 20 books of M8 detector paper 2 AN/VDR-2 2 M8A1 or M22 ACAAs
C <sup>2</sup>	1 PL 1 PSG		1 HMMWV with a radio 3 NBC marking kits
Total personnel	23	11	

**CLOSING THE DED AREA**

4-112. The DED is closed in sequence, starting at station 1. All vehicles, equipment, and nonexpendable supplies are inspected for contamination. If contamination is found on an item, it is decontaminated. The actions at each station are described as follows:

**Station 1 - Primary Wash**

4-113. Spray all vehicles and equipment with hot, soapy water to remove any contamination that could have been transferred during the primary wash operations. Drain the water billets or fabric tanks of water. Inspect all equipment and vehicles for contamination using the appropriate detection equipment.

**Table 4-10. Personnel and Equipment Requirements for the Alternate DED Layout of the M17 LDS-Equipped Unit**

Stations	Personnel	Equipment/Supplies
Station 1 - primary wash	1 NCOIC* 4 sprayers 4 scrubbers	3 M17 LDSs 3 3,000-gallon tanks 3 65-GPM pumps 4 long-handled brushes 8 TAP aprons Liquid detergent
Station 2 - DS2 application	1 NCOIC* 8 applicers	14 long-handled brushes 8 mops with extra mop heads 3 30-gallon containers 8 M13 DAPs Sufficient DS2
Station 3 - contact time/ interior decon	1 NCO* 2 interior decon assistants	2 AN/VDR-2 3 TAP aprons 6 30-gallon containers 10 books of M8 detector paper 30 sponges 8 M256A1 detector kits 50 trash bags 1 clipboard with a pen 1 stopwatch
Station 4 - rinse	1 NCOIC* 4 sprayers	2 M17 LDS 2 3,000-gallon tanks 2 65-GPM pumps 4 TAP aprons
Station 5 - check	2 NCO/CAM operators*	2 CAMs 10 M256A1 detector kits 20 books of M8 detector paper 2 AN/VDR-2 2 M8A1 or M22 ACAAs
C <sup>2</sup>	1 PL* 1 PSG*	1 HMMWV with a radio 3 NBC marking kits
Water resupply	2 drivers*	2 TPUs
Total personnel	32 (Minimum of 10 soldiers from the smoke/decon platoon)	
* These individuals should be from the smoke/decon platoon.		

### Station 2 - DS2 Application

4-114. Throw the mops and brushes that were used in applying the DS2 into a sump or bury them. Load the unused cans of the DS2 and the M13 DAPs on a vehicle.

### Station 3 - Contact Time/Interior Decon

4-115. Inspect any unused supplies and equipment for contamination. If no contamination is detected, load the equipment and supplies on a vehicle. Throw all contaminated supplies into the nearest sump. In calculating sump requirements, 35 cubic feet of space is required for 250 gallons of liquid drain off. Once a sump is 2/3 full, prepare a new sump.

**Table 4-11. Work/Rest Table**

Temperatures	Stations and Workload				
	Station 1 – Primary Wash	Station 2- DS2 Application	Station 3 – Contact Time/Interior Decon	Station 4 - Rinse	Station 5 - Check
	Physical Exertion				
	Moderate	Heavy	Moderate	Moderate	Light
Cool (<68°F)	60 work 15 rest	30 work 30 rest	60 work 15 rest	60 work 15 rest	60 work 15 rest
Warm (68° - 74°F)	45 work 45 rest	20 work 20 rest	45 work 45 rest	45 work 45 rest	50 work 50 rest
Hot (74° - 84°F)	30 work 60 rest	15 work 30 rest	30 work 60 rest	30 work 60 rest	40 work 80 rest
Very Hot (>84°F)	20 work 60 rest	10 work 30 rest	20 work 60 rest	20 work 60 rest	25 work 75 rest
<p><b>NOTE: When operating in temperatures above 75°F, consider the ability of the soldiers to accomplish the mission. Once the soldiers have reached their maximum workload for heat stress, they cannot recover quickly enough to accomplish the decon mission. A viable option is to postpone the decon operation until a cooler part of the day or evening. This will reduce the heat-stress load on the soldiers and increase the probability of mission success. For further information, see FM 3-4.</b></p>					

**Station 4 – Rinse**

4-116. Spray all vehicles and equipment with hot, soapy water to remove any contamination that could have been transferred during the rinse operations. Drain the water billets or fabric tanks of water. Inspect all equipment and vehicles for contamination using the appropriate detection equipment. If no contamination is detected, load the equipment on the vehicles. Spread one can of STB dry mix into each of the sumps and then cover them. Ensure that DS2 is not present in the sumps. Post NBC hazard markers near the covered sumps. **(NOTE: DS2 destroys chemical agents; however, some of the by-products created from it are toxic.)**

**Station 5 – Check**

4-117. Ensure that all equipment has been checked for contamination. If it is not contaminated, load it on a vehicle. If it is contaminated, decon it according to the appropriate technical manual (TM). Throw any contaminated supplies into the nearest sump. Move all vehicles upwind of station 5 and inspect them again for contamination. If any contamination is detected, the crew will use either the M11 or M13 DAP to decon the identified areas. Once the vehicles are staged, all the soldiers will proceed to the DTD.

**CLOSING THE DTD AREA**

4-118. Once all the soldiers from the DED have processed through the DTD, it may be closed. After the last person has exited the DTD—



- Pick up all the used supplies from station 7 and put them in station 7's sump. Take up the contamination control line. If engineer tape was used, dispose of it in station 7's sump.
- Move all usable supplies and equipment from all the stations to station 1. Discard all unusable supplies from stations 3, 4, and 5 in station 1's sump.
- Decon all supplies and equipment collected at station 1 using the decon and rinse water at station 1. Empty the decon and rinse water from the station into the sump and decontaminant the containers.
- Mark the entire decon area. Remove your overgarment using the MOPP-gear-exchange technique and dispose of it in the sump at station 1.
- Move any equipment used to fill the sump upwind of the decon area. Decon your rubber gloves and move all equipment and supplies in station 1 upwind of the decon area. Keep this equipment and supplies separate from that used to fill the sump.

## **THOROUGH DECON UNDER UNUSUAL CONDITIONS**

4-119. Decon operations are not restricted to daylight hours. The enemy may employ chemical and biological weapons at night, since weather conditions are usually more favorable for their employment at that time. Consequently, NBC contamination encountered at night may require decon before daylight.

4-120. Conducting decon operations at night is a challenge. "White light" cannot be used without possibly revealing your location. However, decon personnel must have illumination to perform such essential decon tasks as spraying water, applying decontaminants, using detection equipment, and taking off the MOPP gear.

4-121. Use M8/M9 detector paper to check for chemical contamination and to see how well the chemical decon was performed. If contamination is present, the paper color changes to red and cannot be seen if red-filtered light is used. The CAM and M256A1 detector kit can be used to identify and detect chemical agents but will require a light source in order to obtain a reading.

4-122. Several vehicles awaiting or undergoing decon present a significant infrared "signature" due to the hot engines. To enter, exit, and move within the decon site is difficult under blackout conditions.

4-123. Night-decon operations are difficult but can be accomplished. Whenever possible, conduct thorough-decon operations in built-up areas. Use a building for DTD operations and a warehouse for DED operations. This allows for the use of white light. Soldiers can see what they are decontaminating, see where they are going, and read the color changes of the M8/M9 detector paper.

4-124. There will be a need for additional soldiers to act as ground guides in the DED area. The NCOICs of stations 1, 2, and 4 will inspect each vehicle with a flashlight or chemical light before the vehicle proceeds to the next station. There should be at least two flashlights at each station in both the DED and DTD areas.

## Chapter 5

# Special Decon Operations

The decon of terrain or structures allows personnel to increase their stay time in an area and facilitates their passage through an area. Large-scale terrain decon requires extensive amounts of equipment, material, and time. Thus, terrain decon is limited to areas of critical importance. Contaminated areas and structures that can be avoided do not need to be decontaminated except by weathering. If they must be used, decon may be necessary. When decon is not practical, use protection to deal with the hazard. Most terrain and structural surfaces (excluding unpainted metal and glass) absorb the agent. Therefore, the agent may be transferred to clothing by physical contact. The agent may also be transferred through vaporization and subsequent inhalation or diffusion into the eyes and the clothing. The decon of equipment containing vulnerable components presents certain challenges. Electronics and optics are especially vulnerable to damage if not carefully decontaminated. Some materials, such as canvas, absorb chemical agents and may not be decontaminated and reused.

### TERRAIN DECON

5-1. A terrain decon provides more long-term rather than short-term benefits. Generally, you cannot decon occupied terrain well enough to allow you to reduce your MOPP level right away. At best, all you can do is speed up the weathering process. This may allow you to reduce your MOPP level a little sooner, for example, in 2 days instead of 4 or 5. Terrain decon can be so expensive and so ineffective that you should consider relocating.

5-2. If you decide on a terrain decon, limit the amount you do. Build a causeway or breach a path through the contamination for entry/exit into a major facility. Restrict your efforts to areas where you must work or move. No matter what you do, you will probably have to remain in MOPP; but you can reduce the danger of picking up liquid contamination and spreading it to other areas.

5-3. The most effective techniques for a terrain decon are the natural methods (weathering or aging). Using standard decontaminants will quickly exhaust your resources (see Appendix B). Usually the most practical method is to scrap off contaminated surfaces. Fire is a terrain-decon method; however, consideration must be given to the potential downwind vapor hazard. If possible, a contaminated area should be evacuated until time and weather remove the hazard. An STB slurry can be used for vital areas. To determine the persistency of chemicals at various temperatures, refer to FM 3-9.

5-4. A terrain decon may be accomplished using several methods. These methods are listed in the order of decreasing effectiveness. Although they

reduce the contact hazard, none will prevent hazardous vapors desorbing from contaminated surfaces. Therefore, appropriate protective measures must still be taken.

## **WEATHERING**

5-5. Weathering is the simplest and easiest form of decon.

### **Chemical and Biological Contamination**

5-6. Warm, windy weather can significantly reduce terrain contamination. In some cases, this occurs in a few hours or it may take a few days. Many variables affect the persistency of chemical and biological hazards, so it is impossible to accurately predict how long it takes such contamination to weather. Sunlight is especially effective against most biological agents.

### **Radiological Contamination**

5-7. Although the term “weathering” is used to describe the decon process, weather has little effect on radiological hazards. Heavy rain and wind may remove some contamination, but only time will reduce the radiation emanating from the contamination.

## **REMOVING/COVERING**

5-8. Removing or covering contamination does not destroy it, but it does keep the hazards away from you temporarily.

### **Chemical and Biological Contamination**

5-9. Contamination can be removed from paths and unpaved roadways by scraping off a layer of earth using heavy earthmoving equipment (bulldozers and road graders). Contaminated paths and paved surfaces can be covered with a 4-inch layer of earth, roofing paper, plastic sheets, and wood mats. This is a temporary measure because the agents may penetrate the covering. When the contamination penetrates the covering or when the covering is removed, the hazards will reappear. The coverings may also extend the life of the contamination hazard by reducing its exposure to air and sunlight.

### **Radiological Contamination**

5-10. Radiological contamination must be covered by thick layers of dense material, like earth. Three inches of earth will decrease radiation dose rates by half because of the shielding provided by the soil. However, 12 inches is more effective. The job will be easier with earthmoving equipment, but the equipment and operators probably will have to undergo decon.

## **NEUTRALIZING**

5-11. The STB dry mix or STB slurry may be used effectively against chemical or biological contamination, but not against radiological contamination. Trained chemical troops and equipment are required when using the STB slurry, which is costly both in time and material.

### **Chemical and Biological Contamination**

5-12. The STB dry mix is spread on solid surfaces and raked into soft surfaces like sand or earth.

5-13. The STB slurry is applied to terrain by using a spray hose that is attached to an M12A1 decon apparatus. Operators wear TAP aprons over their MOPP gear and sit on the front fenders of a vehicle to spray the STB slurry. The speed of the vehicle should be adjusted according to the terrain; this is normally 2 to 4 miles per hour. The operators spray a fan pattern 3 to 5 feet ahead of the vehicle. The pattern overlaps on the center and extends past both sides of the vehicle. The STB slurry forms a seal over the surface and must be renewed periodically due to deterioration from traffic or weathering. One load of STB slurry will decon a concrete surface about 328 feet long by 33 feet wide. Other surfaces may require more decontaminants. It takes about an hour to load and mix one load of SBT slurry.

#### **Radiological Contamination**

5-14. The STB dry mix and STB slurry have no effect on radiological contamination or its hazards.

#### **BURNING**

5-15. Burning works well against chemically or biologically contaminated vegetation; but it is of no value against radiological contamination.

#### **Chemical and Biological Contamination**

5-16. Fuel may be used to burn grass or short undergrowth. Burning also works on dirt surfaces. Soak the area with diesel fuel, kerosene, or fuel oil and ignite remotely. Do not use gasoline; it burns too quickly. Burning will cause vapor hazards downwind, and protective measures will have to be used by downwind units. Area commanders must warn these units of the vapor hazards.

#### **Radiological Contamination**

5-17. Radiologically contaminated surfaces should not be burned. Burning will not destroy radiological contamination or its hazards. It may spread contamination if radioactive particles become suspended in smoke spread by the wind.

#### **EXPLODING**

5-18. Explosives can be used to blow up areas that are chemically and biologically contaminated; however they are of no value against radiological contamination.

#### **Chemical and Biological Contamination**

5-19. Detonating cord, bangalore torpedoes, or mine-clearing line charges may be used with the STB dry mix to clear small paths through a contaminated area. The two methods that are used follow:

- First method. Remove the holding band and loosen the lid of the bleach drum. Set the drum with the lid in place upside down over about 3 feet of looped detonation cord. Remove the drum and leave the bleach piled on the lid as shown in Figure 5-1, A, page 5-4. Lids may be fired in a series with a single strand of detonation cord connecting the loops.

- Second method. Remove the holding band and loosen the lid of the bleach drum. Set the drum in a shallow hole as shown in Figure 5-1, B. Make sure the lid is loose. Use 5 feet of looped detonating cord (7 feet in soft ground) for each drum. The drums may be fired individually or in a series. For gross contamination, additional firings may be necessary.

5-20. For either emplacement method, the suggested spacing for charges is 33 feet apart for a 100-foot-front contaminated area. The charges should be placed along the upwind edge of the contaminated area (see Figure 5-1, C).

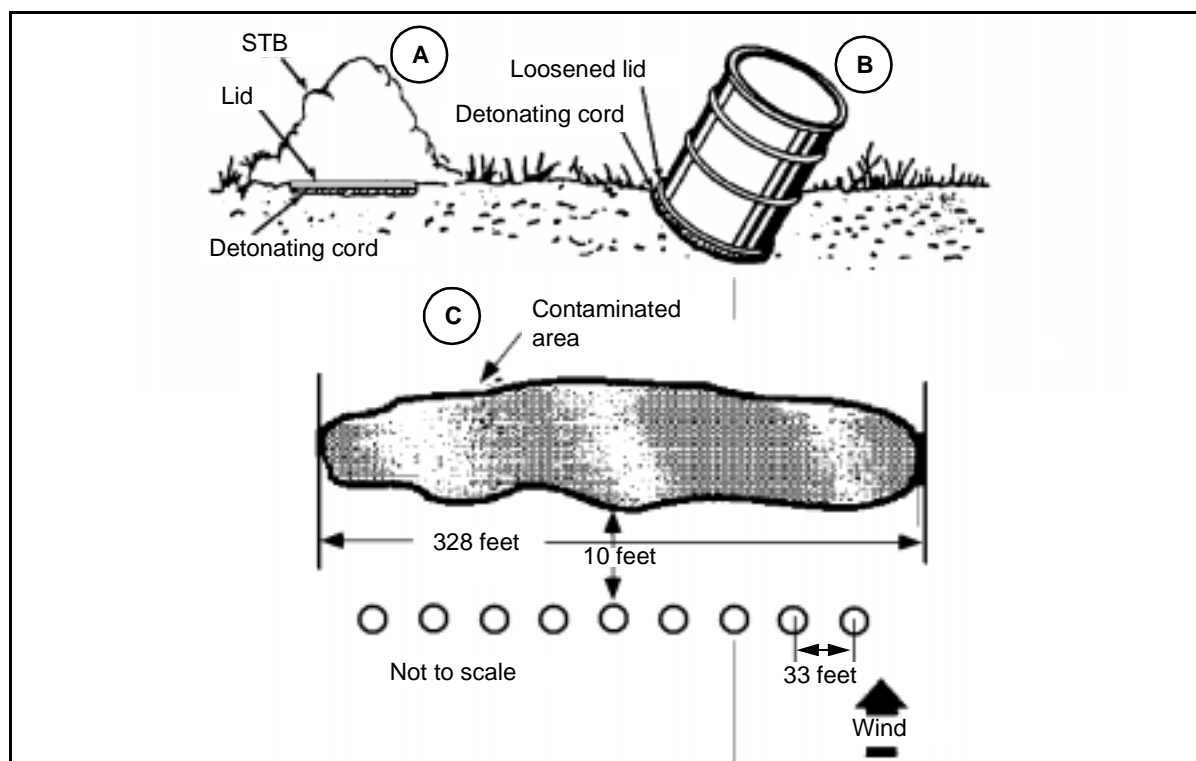

Figure 5-1. Two Methods of Emplacing Dry STB for Distribution by Detonation

### Radiological Contamination

5-21. Explosives will not destroy radiological contamination or its hazards.

### FLUSHING

5-22. Flushing with large quantities of water removes contamination. A pressurized stream of hot, soapy water delivered by the PDDA, M17 LDS, or fire trucks can remove significant amounts of an agent. Scrubbing removes even more.

### Chemical and Biological Contamination

5-23. Flushing is not very effective against some kinds of agents, especially thickened agents. However, flushing may speed up the weathering process.

**Radiological Contamination**

5-24. Flushing is very effective for removing loose radioactive contamination such as fallout. Rain out, however, can coat surfaces with a film that resists flushing. Such films must be scrubbed. Any contamination removed by flushing and scrubbing will remain radioactive, so control the runoff.

**CLEARING**

5-25. To clear passageways, remove the contaminated layers covering the terrain.

**Chemical and Biological Contamination**

5-26. Most liquid chemical agents will not penetrate the soil more than 2 inches, and biological agents penetrate even less. Earthmoving equipment or hand tools can be used to scrap aside contamination. By scraping off 2 to 4 inches of earth, a passageway can be created that is free of transfer hazards. However, contamination on either side of the passageway will continue to present a vapor hazard.

**Radiological Contamination**

5-27. Fallout does not penetrate the top layer of soil unless it is followed by rain. It can be scraped aside. Move contaminated soil as far away as possible; the piles tend to concentrate radiation. Immediately below a nuclear blast area, the soil may be radioactive to a depth of 5 feet. In most cases, decon of this much earth is not practical.

**FIXED-SITE DECON**

5-28. Personnel and equipment need to be decontaminated to reduce the hazard and the spread of contamination, limit casualties, and minimize operational degradation. The goal is to restore the unit to an acceptable level of operational effectiveness. The inability of a fixed site to move away from contamination makes decon more critical. Decon is necessary when protective items cannot be worn in performing the mission or when long-term occupancy is anticipated.

5-29. Decon capabilities may be designed and built into a facility and used if the facility becomes contaminated. Mobile decon equipment may also be available at a fixed site to decon equipment, roads, and buildings. Interior decon may be accomplished with large commercial heaters. Loading docks, entries and exits, and building exteriors can be decontaminated with more conventional methods, such as using an STB dry mix or STB slurry, soap and water, or an M13 DAP. Commanders should identify all systems that are capable of contributing to the decon effort (for example, fire trucks, steam cleaners, and water pumps).

5-30. Decon equipment can be retrofitted to accommodate the process in each area. For instance, rest and relief shelters need rapid, personnel decon systems, and supply operations need a decon system that can handle moderate size pieces of equipment, but at a high volume. Light maintenance needs a system that can decon equipment sensitive to harsh decontaminants or water, and heavy maintenance needs a system that can clean large equipment.

5-31. The commander should designate and train teams that can perform decon for fixed-site operations. The following are fixed-site decon techniques that the teams could apply:

**AIRFIELD**

5-32. Decon the area required to sustain the mission (see Figure 5-2). Figure 5-3 illustrates the STB application on the entrance/exit of the airfield hangers. Note that the STB application includes 10 feet on each side of the runway between the entrance and the exit. A transfer hazard will remain a problem until all parts of the airfield have weathered. Buildings' or hangers' entrance/exit and doors must be decontaminated accordingly. Figure 5-3 illustrates a field-expedient method that could be employed at any fixed site to cover the major entry/exit toward the site.

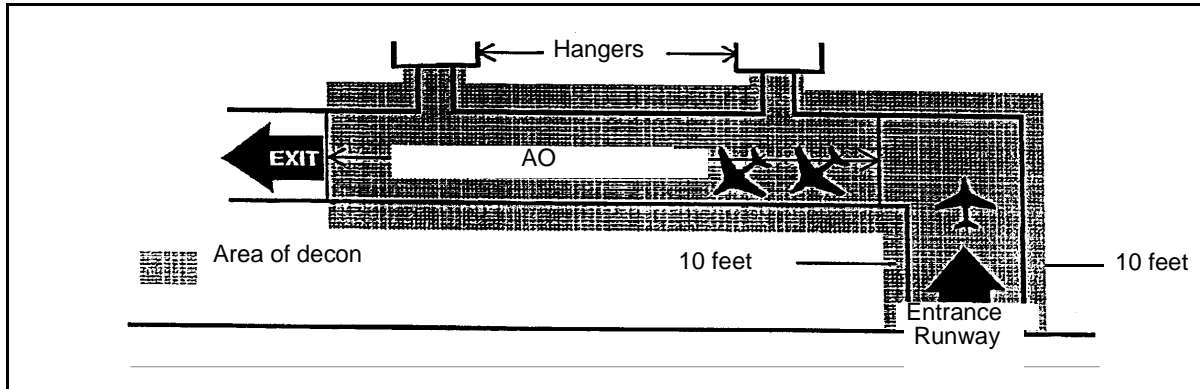

Figure 5-2. Airfield-Area Decon

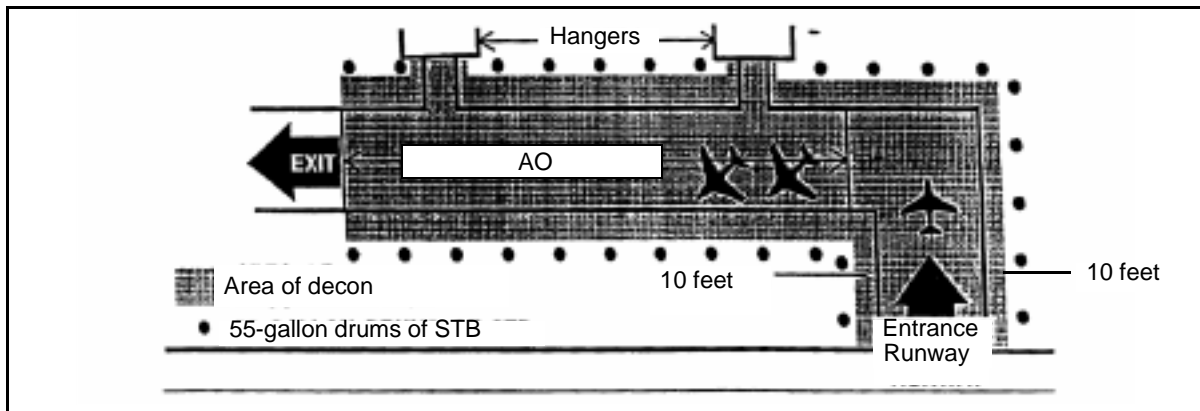

Figure 5-3. Field-Expedient Airfield Decon

**HELIPAD**

5-33. To decon a helipad site, spray the STB slurry on the entrance/exit approach or the path (see Figure 5-4). Since airborne STB particles can damage sensitive aircraft components, the decontaminated area should be washed with water before landing helicopters.

**POMCUS/MOTOR PARK**

5-34. At a repositioning of material configured to unit sets (POMCUS)/motor-park site, decon entrance/exit approaches to limit contamination. Exposed vehicles in a POMCUS/motor park will become contaminated but most likely there will not be enough personnel to drive the vehicles to a decon station. Decon parked equipment by spraying it with an STB slurry or with hot, soapy water (see Figure 5-5). The M12A1 PDDA crew drives around the parked vehicles and performs vehicle washdown to accelerate the weathering process.

**NOTE: For more detailed guidance on the decon procedures of fixed sites, ports, and airfields, refer to FM 3-4-1.**

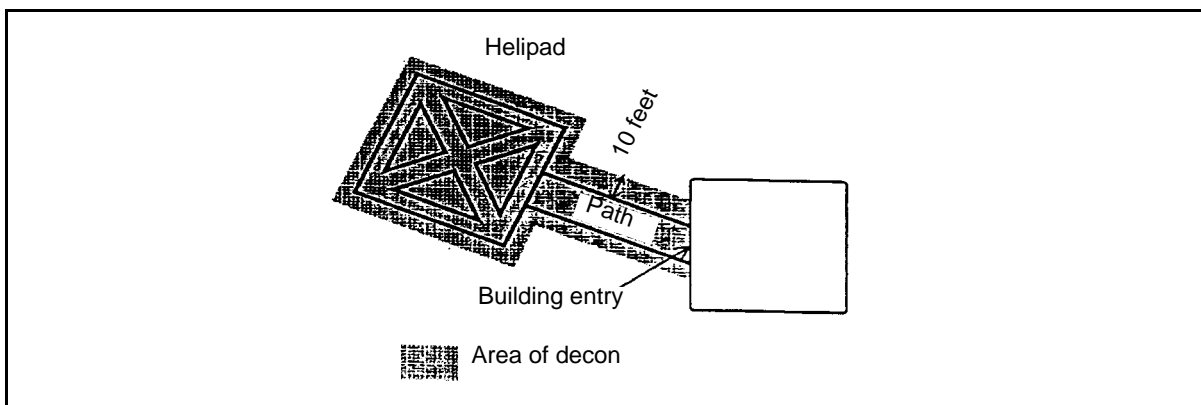

**Figure 5-4. Helipad-Area Decon**

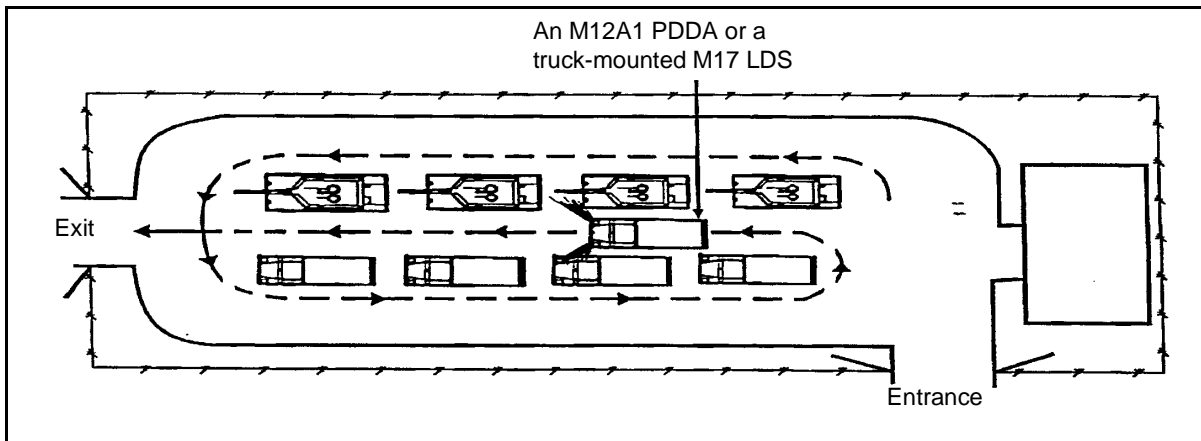

**Figure 5-5. POMCUS/Motor-Park-Site Decon**

**VULNERABLE EQUIPMENT DECON**

5-35. Most military equipment has not been critically assessed for its ability to withstand decon operations. As more testing is done, specific decon instructions will be included in the TM for all types of equipment. Some equipment is extremely vulnerable to damage when subjected to decon operations. Electronics and optic equipment are especially vulnerable. Some



materials (such as canvas and rubber) tend to absorb chemical agents, and decontaminating absorbent surfaces is extremely difficult, if not impossible. Most decontaminants are highly corrosive and cannot be used on certain materials. They may also render ammunition unserviceable. Do not subject vulnerable equipment to unnecessary decon operations. Radiac meters may measure low levels of radiation that are not dangerous. The commander's operational exposure guidance (OEG) determines the maximum permissible radiation dose rate (usually 0.33 cGy per hour). If this dose rate is exceeded, you must decon.

## **ELECTRONICS**

5-36. Nonsealed electronic-equipment circuitry can be damaged by corrosive decon materials. Most field electronic equipment is watertight for environmental protection. This also provides good protection against NBC contamination. Contamination probably will not penetrate gasket-equipped protective covers and sealed components on electronic equipment; but if exposed, the contaminants may be present on the outside of cases containing the electronic equipment. Wipe down the outside portions of the equipment case with a designated decontaminant. After decontaminating the outside, wipe down the equipment with either water or an approved solvent to remove traces of the decon solution. If equipment seals appear damaged or if penetration of NBC contamination into the inside of the equipment is suspected, then the unit should be treated as if it was nonsealed. Under no circumstances should electronic equipment be immersed in a decon solution or subjected to a high-pressure application of decon solutions.

5-37. For chemical contamination, wipe all metal electronic cases with DS2. If a chemical agent is identified as HD, allow 30 minutes contact time. Next, wipe the case down thoroughly with a damp cloth, dry it off, and wipe it down with a designated oil (for biological agents, wait 10 minutes). If DS2 is not available or the case is of some material other than metal, wipe the equipment's exterior with a cloth and hot, soapy water or use a nonstandard decontaminant (see Appendix B). If contamination is not extensive, use an IEDK.

5-38. Corrosive decontaminants, such as DS2, should never be used on nonsealed electronic equipment. This type of equipment is often found inside shelter assemblies and helicopters. Refer to the appropriate TMs or to Appendix C for acceptable decon procedures for nonsealed electronic equipment.

5-39. For radiological contamination, brush, wipe, or vacuum contamination from the equipment. Since contamination is not destroyed but just moved from one place to another, control the runoff and treat it as a hazardous substance.

## **OPTICS**

5-40. Optic systems are extremely vulnerable to decon materials that might scratch or adversely affect the lenses. Wipe optic systems with a soft, nonabrasive material such as lens-cleaning tissue, cotton wadding, or soft cloth dipped in hot, soapy water. Wipe the optic system with decontaminants. Do not immerse it.

5-41. Hot, soapy water is the preferred decontaminant for chemical and biological contamination. When DS2 is applied to coated lenses, it causes some damage. Likewise, exposing lenses to an STB slurry removes some of the magnesium from the coating. Small optic surfaces can be decontaminated with the IEDK.

5-42. Radiological contamination should be blown off with a stream of air or wiped off with hot, soapy water. Rinse by wiping with a sponge dipped in clean water.

## **AMMUNITION**

5-43. Decon contaminated ammunition with cool, soapy water. Apply the soapy water with the PDDA or with brushes, mops, rags, or brooms. Cool, soapy water is the preferred decontaminant for all types of contamination.

### **WARNING**

**Do not use DS2 or an STB powder on ammunition. It removes critical markings from the ammunition. The STB powder may cause a fire when it comes in contact with a blister agent or DS2. It may also corrode and render the ammunition unserviceable. Do not use nonstandard decontaminants that are corrosive. They also may remove critical markings from the ammunition.**

## **CANVAS ITEMS**

5-44. These items include load-carrying equipment and web gear. It may be necessary to burn or bury them if they are heavily contaminated. Either an STB dry mix or an STB slurry may be used to decon them. The STB slurry is more effective. In many cases, weathering may be the preferred decon technique because scrubbing canvas frequently imbeds the contamination further and worsens the situation. If the item must be decontaminated, boil it for 1 hour in soapy water. This is the preferred method for chemical and biological decon. Radiological contamination can be removed by brushing it off, then washing. It may also be vacuumed off a surface.

5-45. Salvage of contaminated canvas requires a great amount of logistic and manpower requirements. Other options for disposing of contaminated canvas should be considered against METT-TC. NBC covers protect vulnerable items, but these covers must be buried or destroyed after use.

## **FOOD AND WATER**

5-46. Most units cannot test the purity of food and water even if they can decon it. Food and water decon usually takes special handling by trained technicians. If your water becomes contaminated, contact medical personnel. Water-treatment specialists test and treat the water in an NBC environment. Direct contaminated-food questions to supporting veterinary personnel.

5-47. Food and water should be kept in sealed containers and protective packaging. Leave food in wrappers. Keep wrapped food in boxes, tins, or other containers. Store these containers in closed refrigerators or vans. See FM 3-3 for further discussion on avoiding contamination.

5-48. Contaminated food should be placed into three groups for handling.

### **Group I**

5-49. Group I consists of canned and unopened items that have been exposed only to the vapors of an agent. Generally, the items in this group will be safe for issue to personnel after a brief period of outdoor airing to remove clinging vapors.

### **Group II**

5-50. Group II consists of canned and unopened items that have been contaminated with a liquid chemical agent. Attempts to decon porous packaging materials, such as cardboard or wood, are likely to be unsuccessful and may result in spreading the contamination. To handle such items, strip off the outer contaminated coverings and examine the inner layer to determine if agent penetration has occurred. If it has, continue stripping off layers until an uncontaminated layer is reached. Items packaged for military operations are usually packed in boxes, so this procedure is feasible. When the inner uncontaminated package is reached, place it in group I. If the agent has penetrated to the food, place it in group III.

### **Group III**

5-51. Group III consists of unpackaged or poorly packaged items that have been exposed to an agent in either a vapor or liquid form. Foodstuffs in this group should be decontaminated only when absolutely necessary.

5-52. If you do not know if the food is contaminated, do not use it. Do not decon items in group III without the help of veterinary personnel.

## **CHEMICAL MUNITIONS DISPOSAL AND DECON**

5-53. In combat, chemical munitions may be encountered. Captured enemy chemical munitions may have sustained damage or have deteriorated to where they are leaking. Leaking munitions must be decontaminated, evacuated, and disposed of safely by specialized units with properly trained soldiers performing this task. All soldiers must use protective clothing and masks when there is a possibility of exposure to a toxic chemical agent. The MOPP level will be specified by the unit commander. Use detection equipment (CAM, M256A1 detector kit, M8A1 or M22 ACAA, and M8/M9 detector paper) to monitor chemical munitions.

5-54. Unexploded leaking munitions should be treated in the same manner as conventional ordnance. A spot report must be submitted to an explosive ordnance disposal (EOD) unit.

5-55. When disposing of and decontaminating chemical munitions, see Army regulation (AR) 385-10 and TM 10-277 for additional safety guidance.

## **HANDLING**

5-56. Chemical projectiles should not be handled. A good rule of thumb is to treat them as you would a fused high-explosive (HE) round. Security and protective measures must match those given to conventional munitions. Notify an EOD unit for disposal and decon of chemical munitions. EOD units have the responsibility for sealing, packaging, and disposing of chemical munitions.

## CONTAMINATION CONTROL

5-57. Whenever a chemical projectile is damaged and starts to leak, the round presents the same hazards to personnel in the area as an enemy chemical attack. Only munitions that have not completely detonated or have been severely damaged may exude liquid agent. It is the vapor hazard created when the chemical leakage occurs that poses the greatest threat to personnel. When a leaking chemical munition is discovered, react as if you are under chemical attack.

## DEPLETED URANIUM (DU) DECON

5-58. DU is an extremely dense metal used in munitions to penetrate heavy armor or as a protective shielding (armor packages). DU is also used as equipment components. All components containing radioactive isotopes are listed in TB 43-0116.

5-59. DU exposure and incidents may occur anytime there is damage to the DU armor package, a vehicle is hit with DU munitions, DU munitions are damaged, or equipment components containing DU are damaged. The DU armor package can be damaged during vehicle maneuvers, on-board fires, maintenance activities, or ballistic impacts. DU munition problems may occur during storage, transportation, combat, testing, or manufacturing. DU contamination may be present on the ground in areas where equipment was destroyed or damaged.

5-60. DU contamination may include DU oxides (dust), contaminated shrapnel, munition components, or armor components. DU emits primarily alpha particles; however, beta, gamma, and x-ray ionizing radiation are also emitted. DU contamination can be inhaled, ingested, or injected. DU contamination does not pose an immediate health risk. Consequently, contamination should be removed from personnel or vehicle surfaces when directed by the unit commander based on METT-TC.

5-61. Visual signs that DU contamination is present include heavy, dull-black dust or small round holes. DU contamination can only be verified with a radiac meter. An AN/VDR-2 or AN/PDR-77 with an alpha or beta probe (flat-pancake surface) is used to detect and measure DU contamination. These probes are within the radiological protection officer (RPO) kit.

5-62. When working on or within DU contaminated equipment, soldiers should wear their protective mask. Depending on temperature, protective-clothing availability, DU contamination levels, and tasks to be performed, soldiers can wear the BDO or coveralls or they can roll down their sleeves and blouse their trousers as directed by the unit's chemical or medical personnel.

5-63. General decon procedures follow:

- Use a radiac meter to determine if DU contamination is present.
- Provide protection, including appropriate clothing, for workers as directed by the unit's chemical or medical personnel.
- Identify what is to be decontaminated.
- Obtain necessary equipment and materials (Appendix D).

- Brush, wash, or wipe off contamination with a damp cloth. Use a high-efficiency particulate air filter (HEPA) vacuum cleaner, if available.
- Work from the outside of the contaminated area to the inside.
- Cover fixed contamination with tape, paint, paper, plastic, or other disposable material.
- Use the standard double-bag-and-tag process for hazardous waste. The only contaminated waste generated by DU will be the vacuum-cleaner bags after use on multiple vehicles.
- Continue the decontaminating process until contamination levels are reduced to the appropriate level (see AR 11-9).
- Decon personnel and equipment according to Chapter 4 of this manual.

## **CONTAMINATED REMAINS DECON**

5-64. Mortuary affairs personnel establish and operate the mortuary affairs decontamination collection point (MADCP). When an NBC event has occurred on the battlefield, there is a very high probability that many deceased personnel were exposed to contaminating agents. If the situation does not lend itself to the determination of a hazard on an individual basis, all remains within the affected area will be treated as if contaminated. If the theater surgeon or his staff determines that biological agents have been employed, all remains will be treated as if contaminated.

5-65. Whenever the threat of NBC warfare exists in a theater of operations, the unified commander will direct the Joint Mortuary Affairs Office (JMAO) to be prepared to handle contaminated remains. The JMAO will serve as the theater central point of coordination for the operation. Joint operations of contaminated remains are described in Joint Publication 4-06.

5-66. Personnel support is required after completing the evacuation mission to the MADCP. A DTD takes about 1 hour. The MADCP site will require a complete detailed decon by a chemical decon unit.

## **RADIOLOGICAL DECON**

5-67. Radiological contamination may occur in the form of one element. In the following paragraphs, the decon of six specific, commonly found radioactive elements is discussed. The discussion is applicable not only to these elements but also to other elements having similar chemical properties.

### **CESIUM**

5-68. The common radioisotope of cesium is cesium-137. It emits beta and gamma radiation, decaying to stable barium-137. Cesium-137 is widely used in gamma sources. It occurs in these sources as cesium-chloride pellets. Cesium chloride is a soluble salt. The contamination from a sealed-source leak absorbs water, becomes damp, and creeps. Contamination from a sealed cesium source is best decontaminated by wet procedures unless the contamination is on a porous surface, in which case wet procedures should be preceded by vacuuming. Cesium is known to adsorb from a solution onto glass surfaces. Decontaminating a cesium liquid-contaminated surface is best

accomplished by wetting the surface, absorbing the solution with a rag or other absorbent material, and rinsing the area several times with water. If the contamination persists, use a detergent solution and scrub with a brush. A cesium-contaminated solution that has been standing for some time is best decontaminated by absorbing any remaining liquid, treating the surface several times with water (allowing the water to stand on the surface for about 1 minute each time), and then absorbing the liquid from the surface. If the contamination remains, further treatment depends on the surface. Metallic surfaces are treated with strong mineral or oxidizing acids. Waxed surfaces are removed. If contamination still persists, abrasives or other removal techniques are used.

## **COBALT**

5-69. The common radioisotope of cobalt is cobalt-60, a beta gamma emitter. Metallic cobalt-60 is commonly used in sealed gamma sources. Particles of cobalt dust adhering to small articles are readily removed by ultrasonic cleaners or by dipping the article in a dilute solution of nitric, hydrochloric, or sulfuric acid. Cobalt-dust contamination that exists over a large area is best removed by vacuuming. Sealed cobalt sources may leak as a result of electrolytic action between the cobalt and the container. The result is often a soluble cobalt salt, which creeps and spreads. This is best decontaminated with a detergent or an ethylene diamine tetra acetic acid (EDTA) solution, followed by a treatment with mineral acids. Contamination from solutions containing cobalt may be treated with water.

## **PLUTONIUM**

5-70. The most common isotope in which plutonium may be present as a contaminant is plutonium-239, an alpha emitter. This isotope is present in the AN/UDM-6 calibration source. Plutonium contamination may be the result of a nuclear weapon's accident, in which case, the plutonium will be scattered as a metal or oxide in a dust form. Both forms of plutonium are insoluble. Aging of plutonium-239 contamination is impractical since it has a 24,000-year half-life. Plutonium contamination that covers a small area is best decontaminated by vacuuming. If contamination remains, the area should be washed with a detergent solution. Any contamination that remains can be sealed in a protective coating of paint, varnish, or plastic. Plutonium oxide or metal dust spread over a large area, such as a field, is best decontaminated by removing the top layer of soil and disposing of it as radioactive waste. Personnel should wear respiratory protection when decontaminating or moving the soil.

## **STRONTIUM**

5-71. The most common radioisotope of a strontium is strontium-90, a beta emitter. The daughter particle of strontium-90 is yttrium-90, which is also a beta emitter. Strontium-90-yttrium-90 is commonly used in sealed beta sources such as the M6 source. Generally, it is present as chlorine or carbonate. The chlorine is hygroscopic; it absorbs water and creeps out of the container. This contamination is best decontaminated by vacuuming, followed by a treatment with water, a complexing-agent solution, and a mineral acid, in that order. Contamination resulting from a dilution containing strontium is best decontaminated by absorbing the solution and washing the area with a detergent solution. If strontium contamination persists, the top layer of the

surface should be removed by abrasives or other removal procedures and a sealing coat should be placed over the surface.

### **TRITIUM**

5-72. Tritium is the radioisotope of hydrogen and is a weak beta emitter. If it is released to an area as a gas, the best decon method is to flush the area with air. Since inhalation of tritium can present an internal hazard, personnel entering an area containing tritium gas should wear an appropriate self-contained type of breathing apparatus. Objects in an area exposed to tritium for a length of time may absorb the gas and should be disposed of, if possible. They may be degassed, under a vacuum, by flushing with helium or hydrogen. A surface which monitors clean may become contaminated again in a matter of hours by percolation. There is no practical way of removing tritium oxide (T<sub>2</sub>O) from water due to its similarity to natural water.

### **URANIUM**

5-73. The most probable source of uranium contamination is a nuclear weapon accident in which the fissionable uranium is spread as a metal or oxide dust. The common isotopes of uranium contamination are uranium-235 and uranium-238. This metal or oxide is insoluble and is best removed from a contaminated surface by brushing or vacuuming, followed by a treatment with mineral acids or oxidizing acids and then sealed. Large-area uranium contamination is best decontaminated by removing the top layer of the surface or by sealing it.

## Chapter 6

### Effects of Environmental Conditions

US forces may find themselves anywhere in the world and subjected to the conditions in that region. Weather and terrain conditions will dictate how to fight and what equipment is most effective to support the fighting force under NBC conditions. The conditions in cold- and arctic-weather areas, warmed areas, urban areas, mountains, jungles, and deserts impact how decon operations are performed.

#### **COLD- AND ARCTIC-WEATHER AREAS**

6-1. These regions comprise about 45 percent of the North American continent and about 65 percent of the Eurasian land mass. They are characterized by extreme cold weather and deep snow during winter months. Spring breakup and mud restrict mobility. Whiteout and grayout cause loss of depth perception, making vehicle movement hazardous. Ice fog (clouds of ice crystals) covers troops, vehicles, bivouac areas, and permanent facilities, marking their location. Chemical agents become more persistent in low temperatures (see Table 6-1, page 6-2). As a result, some normally nonpersistent chemicals, such as sarin (GB), become persistent; this nerve agent could remain a transfer hazard for up to 30 days in arctic climates. Normally, persistent agents become more persistent. Although frozen agents do not present a significant problem in solid state, they become hazards when they warm up. Decon is a problem because low temperatures also reduce the effect of decontaminants.

6-2. The freezing points of decontaminants are as follows:

- Water, 32°F.
- STB slurry with antiset, 0°F.
- DS2, -25°F.
- SKD, -50°F.
- IEDK, -50°F.

#### **DECONTAMINANTS**

6-3. When temperatures reach 32°F, water can no longer be used as a decon. In such situations, use DS2. DS2 is effective down to -25°F. For temperatures below -25°F, use STB or HTH as a dry mix (two parts of STB to three parts of earth or snow) for decon. Apply the dry mix by shoveling it on contaminated surfaces or by filling sandbags with the mix and dusting it on the surfaces. Remove the dry mix by brushing, scraping, or using uncontaminated earth or snow to "wash" it off. Other decontaminating methods using nonstandard solvents and fuels may be used, but observe fire safety, protect personnel from corrosives, and take precautions against super-cooling effects. Because of



their low freezing points, solvents such as aviation fuel (JP8), diesel fuel, and kerosene may be used to physically remove contamination. These solvents only flush the agent from the surfaces. They generally do not neutralize agents nor do they eliminate agents that soak into surfaces. Nonstandard solvents generally are very flammable and must be handled with care. See Appendix B for specific nonstandard solvents.

**Table 6-1. Freezing Points of Selected Chemical Agents**

Agents	Symbols	Contact Hazard	Vapor Hazard	Freezing Point
<b>Nerve</b>				
Tabun	GA	Extreme	Low-moderate	+23°F
Sarin	GB	Extreme	Extreme	-69°F
Soman	GD	Extreme	Probable	-44°F
	GF	Extreme	Probable	-22°F
	VX	Extreme	Negligible	-60°F
	VR-55	Extreme	Probable	Unknown
	TGD	Extreme	Probable	Depends on the percent of thickener
<b>Blister</b>				
Distilled mustard	HD	Extreme	Negligible	+57°F
Mustard-lewisite	HL	Extreme	Low	-14°F (Pure) -44°F (Plant purity)
Nitrogen mustard	HN-1	Extreme	Low	-29°F
Nitrogen mustard	HN-2	Extreme	Low	-76°F
Lewisite	L	Extreme	Negligible	0°F
Nitrogen mustard	HN-3	Extreme	Low	+25°F
Phosgene oxime	CX	Extreme	Low	+95°F
<b>Blood</b>				
Hydrogen cyanide	AC	Low	Extreme	+8°F
Cyanogen chloride	CK	Low	Extreme	+20°F
Arsine	SA	Low	Extreme	-177°F
<b>Choking</b>				
Phosgene	CG	Slight	Extreme	-198°F
Diphosgene	DP	Slight	Extreme	-71°F

---

## **EQUIPMENT-DECON DEVICES**

6-4. Discussed in the following paragraphs are the different types of equipment decon devices:

### **M11 Decon Apparatus**

6-5. This apparatus is designed to dispense DS2 at temperatures as low as  $-15^{\circ}\text{F}$ . DS2 is effective down to  $-25^{\circ}\text{F}$ , but it becomes thicker as the temperature drops. Normally, one nitrogen cylinder is used to charge the M11. In cold weather, a second nitrogen cylinder may be used if inadequate pressure is developed with one. Never use more than two nitrogen cylinders.

### **M13 Decon Apparatus**

6-6. This apparatus is designed to dispense DS2 at temperatures as low as  $-15^{\circ}\text{F}$ . As the temperature drops, the flow of decontaminants through the hose and wand becomes degraded.

### **M17 Lightweight Decon System and M12A1 Decon Apparatus**

6-7. Both apparatuses have problems in the cold similar to any other water pump. Normal engine "cold-soaking" problems that cause starting difficulties and brittle metal parts have been observed. Also, internal pumps and lines will crack and break when water freezes within these systems. To avoid freeze-up problems, use the shutdown procedures described in TMs 3-4230-228-10 and 3-4230-209-20&P.

## **DETECTION AND WARNING DEVICES**

6-8. In the following paragraphs, the different types of detection and warning devices are discussed:

### **M8/M9 Detector Paper**

6-9. M8/M9 detector paper is limited in the cold because only agents in a liquid form can be detected. If the substance is thickened or solidified, collect a sample with a stick or scraper and wipe it onto a sheet of M8/M9 detector paper. Place the sample on a heated surface, such as an operating vehicle or a power generator, to thaw the suspected agent. Because of off gassing, do not do this in a heated vehicle or tent. Put a box or can over the paper to concentrate any vapors. Put an M256A1 detector kit inside the box or can. Heat the suspected agent enough to enable detection and allow agent identification.

### **M256A1 Detector Kit**

6-10. As temperatures drop toward  $32^{\circ}\text{F}$ , the M256A1 detector kit takes longer to give a positive or negative indication. When temperatures reach freezing, carry the liquid components in the breast pockets of the chemical protective clothing. It may also be necessary to put the test sampler back into the shipping bag after sampling and place it on a heated surface to hasten the reaction. The kit will not work at temperatures below  $-25^{\circ}\text{F}$ .

### **Chemical-Agent Monitor**

6-11. The CAM will have difficulty in detecting agents at low temperatures. Contaminated personnel entering a building or a collective protection shelter will desorb agents as they warm up. Use the CAM in a vestibule or an air lock where the temperature has been raised to that of the building's or shelter's

interior. Likewise, check aircraft and vehicles requiring maintenance as they pass through a warmed-up site before entry into a hanger or maintenance bay.

#### **M8A1 Automatic Chemical-Agent Alarm**

6-12. When operating an M8A1 ACAA at temperatures below 20°F, use the M253 winterization kit. Warm-up time with this kit is 50 minutes.

#### **EQUIPMENT-DECON STATIONS**

6-13. Place decon sites in built-up areas and near road junctions and intersections of forest lanes to facilitate access. Divide the decon sites and approach routes into sectors, and assign units to keep them open in spite of mud or heavy snow. With present technology, equipment decon problems in the field are difficult to overcome in an arctic climate. Commanders should consider fighting dirty in arctic regions. Fresh units can be rotated into the field so that dirty units can be moved back to built-up areas to decon.

6-14. Decon apparatuses and water trucks may have to be deployed with empty tanks instead of full ones as in temperate climates. To prevent freezing, it may be necessary to preheat water when loading the water trucks and the tanks of the decon apparatuses and keep it heated until it is used. These vehicles may have to be enclosed and warmed so that the engines will start. Decon apparatuses and water trucks must be drained immediately after use to prevent damage from freezing. Commanders may choose to conduct minimum decon until they can get back to fixed facilities and conduct a more thorough decon.

6-15. Vehicles and personnel covered with contaminated snow must be decontaminated before the snow has a chance to melt and freeze. Such snow forms layers of ice that make contamination difficult to remove. Radioactive fallout that is mixed with snowfall must be removed as soon as possible. Use tree branches (if available) to remove contaminated snow.

6-16. Snow can be used to cover contamination; however, the snow can blow away or the contamination can resurface when tracked vehicles, troop movement, or digging disturbs it. Snow cover provides some protection if left undisturbed, but this protection is too uncertain to rely on.

#### **WARMED AREAS**

6-17. Preventing contamination from entering warmed areas is a challenging problem. For example, if soldiers get frozen agents on their clothing, it will be hard to detect because low temperatures have slowed its effects. However, if the temperature warms or if the soldiers enter a warmed area, the agents become dangerous. Because of this, it may be necessary to set up a warming station for each warmed area to isolate the agents. Otherwise, all occupants may be subjected to hazardous liquids and vapors.

6-18. Additional soldiers and equipment are needed for these warming stations. Therefore, in cold-weather operations, the decon and detection priority must be heated support facilities. FM 3-4 discusses individual and collective protection in detail.

---

## **URBAN AREAS**

6-19. The need for decon operations in urban areas may also exist, and it may be easier to support. Water sources are generally available and commercial chemicals may be used as decontaminants. Site security may be simplified because of limited observation and poor fields of fire. Decon operations in urban areas will not differ significantly from similar operations in the field; however, keep the following considerations in mind:

### **STREETS AND STRUCTURES**

6-20. When buildings are contaminated with persistent chemicals, their value for cover, concealment, and shelter is reduced. Wood and concrete tend to absorb liquid agents, and they may give off toxic vapors for days or weeks. Building decon is very difficult and requires large quantities of decontaminants. The hazard can be reduced by covering the contamination with plastic sheets, STB slurry, sodium silicate, or other substances that cover or absorb the agent. Even though a particular part of a building is not intended for occupation, it may still need to be decontaminated to prevent the contamination from spreading.

6-21. Streets and sidewalks also absorb liquid agents, then give off toxic vapors when heated by the sun. These surfaces may need to be decontaminated several times to reduce hazards. Streets, sidewalks, or other porous surfaces are best decontaminated by weathering if the time and the situation permit.

### **CIVILIANS**

6-22. Try to locate decon operations away from civilians because they may injure themselves or interfere with the work. Civilians must not be forced to prepare decon sites or to help with decon operations. However, volunteers who have been cleared by the Assistant Chief of Staff, G5 (Civil Affairs) (G5) may be used.

### **SUPPLIES AND AMMUNITION**

6-23. Store ammunition, as well as other supplies, under cover to protect it from NBC contamination. FM 3-4 explains contamination covers in detail.

### **SANITATION SYSTEMS**

6-24. Urban areas may have sophisticated sanitation systems. When those systems are destroyed, sanitary conditions become far worse than those in areas where sanitation systems have never existed. Sanitation systems must be maintained to avoid epidemics and to avoid overloading biological-decon capabilities. Contaminated water and residue must be controlled so that they will not create a hazard to the civilian population or interfere with sanitation systems. Engineer support may be necessary to construct controlled runoff areas.

### **MOUNTAINS**

6-25. Excluding the extremely high, alpine-type mountains, most mountain systems are characterized by heavy woods or jungle, compartments and ridge systems, limited routes, and highly variable weather conditions. All these factors will affect decon operations.

**MOBILITY**

6-26. The terrain and the disruption of existing routes may dictate that mountain operations be decentralized. Additional water-carrying vehicles may be needed to support these operations. Forces must be organized to be self-sufficient and should have decon elements attached to them initially. Decon platoons are attached to brigades and decon squads are attached to battalions. When decon elements operate independently, their parent chemical companies may not be able to provide support. Decon elements must be equipped with greater hauling capabilities, especially for water. Administrative and logistical support to the decon element will have to come from the support unit.

**WIND**

6-27. Mountains have changing weather and constant winds that promote weathering at a faster rate. In high mountains, calm winds in the ridges and passes are seldom; whereas, in protected valleys, strong winds are rare. Normally, wind velocity increases with altitude. Generally, downwind contamination will be greater because high winds are more frequent. However, variable winds will make predictions unreliable.

**TEMPERATURE**

6-28. Cool or cold temperatures have an adverse effect on decon operations. With every 328-foot gain in elevation, the temperature will normally drop 3° to 5°F. The drier the air, the more pronounced this drop will be. At high altitudes, there may be differences of 40° to 50°F between the temperature in the sun and that in the shade. Consequently, the temperature rises swiftly after sunrise and drops quickly after sunset. Low temperatures that normally exist at extremely high altitudes may demand decon procedures and precautions similar to those used in cold-weather operations. Daytime operations can be scheduled to avoid some low-temperature problems.

**SUNLIGHT**

6-29. Sunlight destroys most biological agents. Above the timberline, there is little protection from the sun, so the effectiveness of a biological attack is reduced.

**JUNGLE**

6-30. Jungle climates vary with the location. Close to the equator, all seasons are nearly alike, with rains throughout the year. Farther from the equator, especially in India and Southeast Asia, jungles have distinct wet (monsoon) and dry seasons. Both zones have high temperatures (averaging 78° to 98°F), heavy rainfall (as much as 400 inches annually), and high humidity (90 percent) throughout the year.

6-31. Transportation is extremely difficult due to natural obstacles; therefore, decon operations will be decentralized as much as possible. Because of high humidity and temperatures, MOPP gear should not be worn for long periods. Since decon crews will be more susceptible to heat stress, staffs should plan for frequent crew rotations and provide enough decon personnel to conduct decon operations.

6-32. Contamination will be retained temporarily in the jungle canopy, reducing the immediate hazard. Later, rains will wash these particles to the ground and concentrate them in low areas. These areas are likely to become contamination "hot spots." Decon sites should be put on high ground during the rainy season.

6-33. Tropical rainstorms will flood decon sites unless the sites are adequately drained. Ground that appears firm may become impassable when it rains. Rain and intense heat will speed the deterioration of many supplies. Do not break the seals on packing material until it is absolutely necessary.

6-34. Rain and high humidity (wetness) degrade the protective abilities of the overgarment. Take care to ensure the maximum length of time of the overgarment's usefulness. Additional quantities of overgarments must be maintained to replace those that have gotten wet. Rain helps the decon process by washing away contamination on exposed surfaces. Rain can also hydrolyze some agents. However, runoff may contaminate the soil.

#### **TEMPERATURE AND HUMIDITY**

6-35. When temperatures rise to the 85<sup>o</sup> to 100<sup>o</sup>F range, troops can only continue medium or heavy workloads by reducing their MOPP level. More soldiers will be needed to make up for extra rest periods and more frequent rotation periods during decon operations.

6-36. Frequently oil exposed metal parts and grease wheel bearings to protect them from moisture. Since petroleum, oils, and lubricants (POL) tend to absorb chemical agents, additional decon may be needed. Measures taken to protect electronic communications equipment from moisture will reduce the need for decon since these measures provide good NBC protection. Seal radios with silicone compound and pack them in waterproof containers when they are not in use (remove batteries). Protect handsets and microphones with plastic bags and check the bags frequently for moisture buildup.

6-37. The jungle's high humidity and temperature increase the need for maintenance. Contact teams must operate independently as they move from site to site doing repairs. There may be no decon specialists to help them.

6-38. Biological agents thrive in the heat, humidity, and shade, which are characteristics of the jungle. Therefore, weathering is not a practical means of biological decon.

6-39. Solid decontaminants, such as STB powder, tend to cake and decompose at a faster rate than in temperate climates. Caking is no problem, but the decomposition eventually makes STB powder ineffective.

#### **TIME**

6-40. Many tasks in the jungle take more time than in other environments. More time for movement and security must be allowed, which may leave less time for planning and preparation. In the jungle, more decon personnel will be required to perform decon operations.

**SECURITY**

6-41. Decon stations are lucrative targets; therefore, security must be a prime consideration. Relocating a decon site may require a small security force, thus additional personnel will be required.

**RESUPPLY**

6-42. Because of the terrain, aerial resupply usually will be common practice. Keep this in mind when determining the amounts of decontaminants to keep on hand since they will compete with ammunition, POL, medical supplies, food, and water for priority of delivery.

**PERSISTENCY**

6-43. Sunlight and wind are reduced within thick jungles due to the vegetation. As a result, chemical and biological agents are less likely to disperse and will remain a hazard for an extended time.

**DESERT**

6-44. Desert regions are characterized by extreme temperatures with ranges varying between 30<sup>0</sup> to 130<sup>0</sup>F over a 24-hour period. These regions have long drought periods, which are interrupted by sudden rains that bring flash floods. There are shortages of suitable groundwater. Large areas suitable for tracked-vehicle maneuvers may sometime have impassable ravines; wet, spongy grounds; and sand areas.

**WATER**

6-45. The principal problem for decon in the desert is the lack of water. The use of STB slurry and DS2 will burden the logistical system because of the water required for mixing and rinsing. Nonwater-based decontaminants (natural solvents) may be required (see Appendix B of this manual). Contamination avoidance becomes increasingly important in desert operations because of limited water sources. Therefore, maximum use should be made of field-expedient covers, especially at night when an attack by chemical or biological agents is most likely.

**HEAT STRESS**

6-46. Heat stress is a critical problem for soldiers working in the desert environment in full MOPP. Operating decon stations in daytime temperatures may require short periods of work followed by long periods of rest. Performing operations at night to avoid heat stress may create light discipline problems.

**WEATHERING**

6-47. Weathering is a viable decon option. High daytime temperatures can increase evaporation of liquid contamination. As a result, vapor concentrations will be high but may not last long. Refer to FM 3-4 for MOPP opening/unmasking guidance to estimate the chemical hazards resulting from enemy attacks. If liquid contamination soaks into soft, porous soil (such as loose sand), evaporation is not as quick. Strong winds also increase the evaporation rate. Low temperatures during the night have a reverse effect and tend to increase the persistency of chemical and biological contamination. The sandblasting effect of sandstorms may remove contamination from

surfaces facing the storm. Desert sunlight and high temperatures will destroy many chemical and biological agents without additional decon measures.

#### **BEARINGS AND OTHER CRITICAL MOVING PARTS**

6-48. Bearings and other critical moving parts need extra lubrication in the desert. This complicates decon because lubricants tend to absorb chemical agents. After a sandstorm, maintenance must be conducted regardless of the last scheduled maintenance. Therefore, perform decon first and if time is critical, decon only those surfaces that will be touched during maintenance. This will not eliminate vapor hazards.



## Chapter 7

# Aviation

Contamination in the battle space causes a unique problem for aviation. Since an aircraft uses its high mobility to maneuver across the entire battle space, avoiding contamination can be very difficult. Once an aircraft is contaminated, it is very difficult to decon. Therefore, aviation units need to prepare effective standing operating procedures (SOPs) that emphasize contamination avoidance, protection, and methods to decon each type of aircraft using an immediate, an operational, and a thorough decon.

### CONTAMINATION AVOIDANCE

7-1. Contamination avoidance is critical due to the difficulty in decon. Aircrews must be aware of NBC hazards. For instance, an aircraft that hovers or lands in a contaminated area could splash contamination onto itself. Likewise, contaminated passengers or ground crews pose a danger of transferring contaminants into the aircraft where they are difficult to remove. Aircraft could also possibly pick up some contamination by flying through an invisible vapor cloud. Hazards that will only incapacitate ground personnel for a short time can be fatal in the air.

7-2. Some things that can be done to limit contamination are as follows:

- Know what areas are contaminated and avoid these, if possible.
- Pick landing zones that will have a reduced splash effect if an aircraft must land in a contaminated area.
- Limit the spread of contamination into the aircraft from the outside. For example, ground crews at the forward arming and refueling point (FARP) could conduct arming and refueling without requiring the aircrew to exit the aircraft.
- Conduct inspections without touching or shaking items. The contaminated crews should perform this task. Many inspection points can be inspected visually.
- Increase the use of covers when not flying. Use engine covers, flyaway gear, and hatches. If possible, provide overhead cover for parked aircraft.
- Limit the number of aircraft that must operate in a contaminated area or use aircraft already contaminated.
- Line the troop compartment with plastic (a field expedient way to limit the spread of contamination) when carrying contaminated personnel or casualties. A plastic curtain can be fastened between the troop compartment and the flight compartment with tape or Velcro to limit contamination transfer. The aircraft's heater can be used with

the curtain to create an overpressure in the pilot's compartment. This will limit vapors from entering the compartment.

- Apply M9 detector paper to the landing gear of the aircraft. FARP personnel should always check the M9 detector paper before servicing the aircraft. Another piece of M9 detector paper can be placed on the windscreen where the aircrew can see it.

**CAUTION**

M9 detector paper will show false positives if exposed to petroleum products.

## DECONTAMINANTS

7-3. Only approved cleaning compounds may be used to decon aircraft. Caustic decontaminants such as DS2, STB, bleaches, and sodium hypochlorite are not considered safe. STB corrodes metal components and the aircraft's skin, and DS2 corrodes rubber, plastic, and acrylic-plastic windows.

7-4. Soap and water, kerosene, JP8, and diesel fuels are approved as decontaminants on selected parts of the aircraft. JP8 is effective in removing some agents from the aircraft's skin and components; however, it does not neutralize the agents. Personnel must use care when handling JP8. When using a cloth soaked in JP8, personnel must avoid wiping internal components near the exhaust. If water is available, use it to rinse off the JP8. Many portions of the aircraft are delicate and cannot stand high-pressure water or extreme hot air.

7-5. Sodium carbonate is a fair decontaminant against G nerve agents, but it is not effective against V nerve and blister agents. The chemical reaction of the V nerve agent and sodium carbonate is extremely slow and produces a product that is very toxic. Most of the field-expedient decontaminants are corrosive and could cause damage to the aircraft's skin or acrylic-plastic windows.

## AIRCRAFT DECON

7-6. When an aircraft becomes contaminated, the aircrew must fly in MOPP gear. However, wearing MOPP gear degrades the aircrew's ability to perform its jobs over time.

7-7. If air and ground crews are careful when operating in a contaminated environment, contamination can be contained on the exterior of the aircraft. The increased airflow over the aircraft's skin increases the rate of evaporation. Still, some agents will remain and continue to be a hazard. Thickened agents evaporate more slowly and may remain a hazard even after prolonged flights. If the interior is contaminated, flying the aircraft with the doors open can help reduce the hazard. The heat from the running engine decontaminates the interior of the engine compartment. However, more active methods of decon may be needed. Use the immediate-, operational-, or thorough-decon method with modifications to perform an aircrew spot decon, an aircraft washdown, and the DAD.

**DECON TYPES**

7-8. Table 7-1 shows the types of aircraft decon. The crew of a contaminated aircraft will use the techniques described in previous chapters to decon. Unit personnel conduct the aircrew spot decon and aircraft washdown, but a chemical decon unit usually conducts the DAD.

**Aircrew Spot Decon**

7-9. After personal wipe down, aviators may conduct a spot decon on their aircraft (see Table 7-1). The aircrew spot decon provides the same benefits as the operator’s spray down. It limits the transfer and spread of contamination by decontaminating the surfaces that must be touched during operations. Spot decon applies to the first six functional activities. The goal is to limit the transfer and spread of contamination while sustaining flight operations.

**Table 7-1. Aircraft Decon Types**

Decon Types	When, Why, Who Performs Decon	Areas to Decon	Types of Decon Agents
Aircrew spot decon	The crew decontaminates after the immediate decon to allow continued operations	Essential operating surfaces on the aircraft	IEDK, JP8 <sup>1</sup>
Aircraft washdown	The unit decon PDDE crew or decon unit performs decon within 6-24 hours to reduce contact hazards <sup>2</sup>	The entire exterior surface of the aircraft <sup>3</sup>	Hot, soapy water
DAD	The decon units decon when the mission allows to reduce the hazard to negligible risk levels	The entire exterior surface and selected interior surfaces of the aircraft	10 percent sodium-carbonate solution (10 pounds of sodium carbonate to 12 gallons of water)
<sup>1</sup> JP8 should not be used inside the aircraft. <sup>2</sup> An aircraft washdown is most effective if conducted within 1 hour of contamination. <sup>3</sup> An aircrew spot decon is performed to reduce contact hazards inside the aircraft. Do not spray water inside the aircraft.			

7-10. Air or ground crews may perform the aircrew spot decon. Wash exterior surfaces with decontaminants to flush off contamination. Fuel, soap, and water are most commonly used. Exact procedures and areas to decon are identified in the aircraft’s maintenance manual. See Table 7-2, pages 7-4 through 7-6, for guidance on the aircrew spot decon.

**Aircraft Washdown**

7-11. An aircraft washdown site consists of a single station; with other decon sites, there may be several stations. Before arriving at the site, the aircrew should fly its aircraft at high speeds to help evaporate exterior contamination. If the aircraft’s interior has been contaminated, open the doors; however, before arriving at the washdown site, close the doors. At the washdown site, the aircraft will land and reduce its speed to an idle. If the aircrew is contaminated, it should exit the aircraft and perform a MOPP-gear exchange.

Table 7-2. Aircraft Spot Decon

Actions and Locations	Areas to Decon	Personnel Responsible	Decontaminants	Procedures	Remarks
Refueling at FARP	Fuel ports, hatches, and all areas that FARP personnel touch	POL handler	Diesel fuel; JP8; or hot, soapy water	Wipe fuel ports and hatches with a sponge dipped in the decontaminant. Do not allow the decontaminant to enter the fuel system. Control runoff because the agent will not be neutralized. This method simply flushes contamination from the surface.	FARP personnel should conduct an operational decon before servicing aircraft if they are contaminated.
Arming at FARP	Armament system	Ammo handler	JP8 or hot, soapy water	Wipe the armament system with a sponge dipped in the decontaminant. Control runoff because the agent will not be neutralized. This method simply flushes contamination from the surface.	<div style="border: 1px solid black; padding: 5px; margin-bottom: 5px;"> <p style="text-align: center;"><b>CAUTION</b></p> <p><b>Take care to prevent certain areas of the armament system from being exposed to the decontaminants.</b></p> </div> <p>The TM on the armament system should be checked to know what areas to avoid.</p>
Entering and exiting aircraft anywhere	Door handles, steps, ladders, handholds, and all other areas that the aircraft crew is likely to touch	Crew members and FARP personnel	JP8 or hot, soapy water	Apply the decontaminant. Take care to prevent the spread of liquid contamination from the outside of the aircraft to the inside. This includes controlling the contaminated runoff. This method simply flushes contamination from the surface. Precautions might include having the crew chief do the decon, which reduces the chance of contamination spreading into the pilot and copilot compartment. All crew members should diligently practice NBC avoidance.	Procedures should be developed for each type of aircraft. Before entering the aircraft, use an IEDK on boots and gloves. FARP personnel can decon the area for exiting aircrew members.

**Table 7-2. Aircraft Spot Decon (Continued)**

Actions and Locations	Areas to Decon	Personnel Responsible	Decontaminants	Procedures	Remarks
Preflight and postflight checks anywhere. Maintenance inspections at aviation intermediate maintenance (AVIM) facilities	Areas that must be touched as part of the inspection	Aircrew	Diesel fuel; JP8; or hot, soapy water on exterior surfaces. Use hot air on interiors or areas that are not compatible with decontaminants or liquids.	Wipe areas that are required to be touched for preflight and postflight checks with a sponge dipped in the decontaminant. Wash gloves in a decontaminant before touching uncontaminated surfaces. Decon gloves with an IEDK after the inspection is completed. Control runoff because the agent will not be neutralized. This method simply flushes contamination from the surface.	Overheated air should not be used directly on instrumentation. Crews may want to wear wet-weather gear to keep most of the contamination off overgarments.
Repair and recovery anywhere	Parts or areas that will need to be decontaminated depending on the situation	Battle-damage repair team	Diesel fuel; JP8; or hot, soapy water on exterior surfaces. Use hot air on interiors or areas that are not compatible with liquid decontaminants.	Decon only those parts that need to be touched during repair.	Contaminated aircraft should not be brought into an uncontaminated area.
Cannibalization anywhere on the battle space	Parts or assemblies being cannibalized	Maintenance personnel (someone who knows what assembly or parts are needed)	DS2; diesel fuel; 5 percent chlorine solution; or hot, soapy water on exterior parts or surfaces. Use hot air on interior parts that are not compatible with liquids or corrosive decontaminants.	Decon only those parts or assemblies that need to be touched during cannibalization.	Caustic decontaminants should be used only on those areas that have been removed from the aircraft. Assemblies must be rinsed thoroughly before replacing.

Table 7-2. Aircraft Spot Decon (Continued)

Actions and Locations	Areas to Decon	Personnel Responsible	Decontaminants	Procedures	Remarks
Overhaul at AVIM facilities	All areas and equipment required to be worked on during the overhaul	Maintenance personnel and/or a chemical decon platoon from division or corps	DS2; diesel fuel; 5 percent chlorine solution; or hot, soapy water. Surfaces that are easily destroyed by liquid or corrosion should be decontaminated using hot air.	Wash with diesel fuel and then hot, soapy water. Then rinse. Check for contamination with the M8 detector paper or the CAM. If time permits, allow the equipment to weather to reduce chemical contamination to negligible risk levels.	Caustic decontaminants should be used only on those assemblies that have been removed from the aircraft. Assemblies must be rinsed thoroughly before replacing. This process has the same results as a deliberate decon.

If the aircrew must perform a MOPP-gear exchange, the aircraft will be shut down. After the MOPP-gear exchange, the aircrew should use a shuffle pit before reboarding the aircraft. The M12A1 PDDE or M17 LDS is used to spray down the aircraft with hot, soapy water and then to rinse it. Spray the aircraft from the top to the bottom, working from the front to the rear. Sprayers must avoid the tail rotor when the aircraft is running. Aviation personnel should follow the guidelines in the aircraft's maintenance manual during aircraft washdown operations.

**CAUTION**

The aircraft's skin and components can be damaged when spraying aircraft with pressurized water.

7-12. The aviation unit must provide a C<sup>2</sup> element to control the flow of aircraft into the washdown site. Figure 7-1 shows a typical layout for an aircraft washdown site. The support aviation must assist the chemical unit in selecting the site to ensure that it has a suitable landing zone for the type of aircraft contaminated.

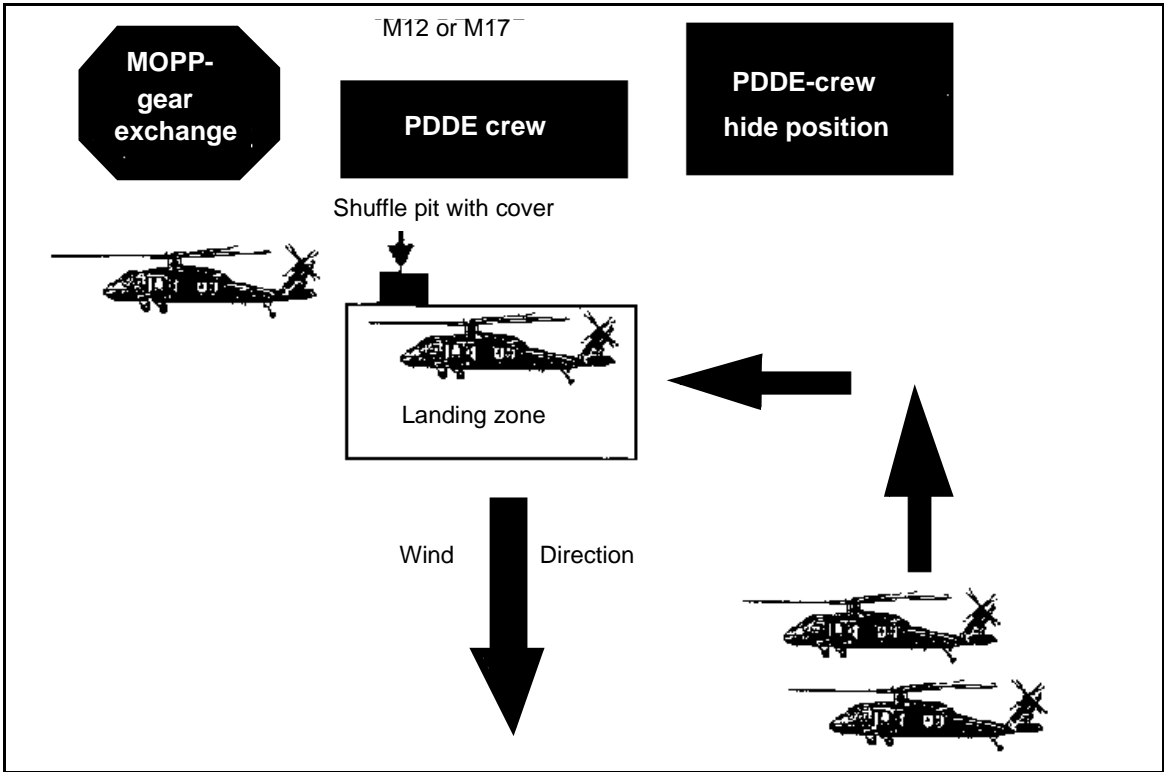

Figure 7-1. Aircraft Washdown Site

7-13. An aircraft washdown is important when operating an aircraft contaminated by gross amounts of chemical agent. It limits the absorption of the chemical agent into the paint, plastic, and rubber portions of the aircraft

where it will pose a vapor hazard and be difficult, if not impossible, to decon later.

**NOTE: Many (but not all) aircraft have been painted with CARC paint. Aircraft will be painted with CARC paint when sent to the appropriate maintenance shop. Contamination stays on top of CARC surfaces where it can be more easily neutralized or removed.**

7-14. An aircraft washdown should be conducted within 6 hours and is most effective if conducted within 1 hour. Some amounts of chemical contamination may remain after the aircraft washdown. The aircrew should continue to wear, as a minimum, its protective masks and rubber gloves for protection until a deliberate decon can be conducted.

7-15. Presently, there is no timely detection method to check the effectiveness of decon for biological contamination. Medical personnel will monitor the aircrew's disposition if biological contamination is suspected.

### **Detailed Aircraft Decon**

7-16. The goal of a DAD is to reduce contamination hazards to a negligible risk level so that air and ground crews can operate the aircraft without protective measures. The DTD can be conducted at the same time. The decon site should be set up in a similar fashion to the thorough-decon site (see Chapter 4). The decon site consists of the following areas: a predecon staging area, DAD and DTD areas, and a postdecon AA. For safety reasons, it is not possible to decon aircraft and ground vehicles at the same site. A separate DED site can be established in the vicinity to support the contaminated aviation unit's ground vehicles.

7-17. Aviation units must be supported by a chemical unit to set up and operate the DAD site. The chemical unit, assisted by the supported aviation unit, operates the DAD site while the aviation unit sets up and operates the DTD. See Chapter 4 for DTD operations.

7-18. Typically, a DAD is either performed as part of a reconstitution effort or before maintenance operations (after every 25 hours of flight time). When the aircraft is either overhauled or grounded for scheduled maintenance, contamination hazards should be reduced to negligible risk levels by going through a DAD. When components are removed from the aircraft for repair, care must be taken because of residual contamination. Decon these components either before cannibalization or overhaul.

7-19. Chemical units (decon and smoke/decon) are responsible for setting up, operating, and closing the DAD portion of the thorough-decon operation. The site setup is the same for all types of contamination (chemical, biological, and radiological). The DAD area is composed of the following five stations: primary wash, decon-solution application, contact time/interior decon, rinse, and check (see Figure 7-2).

### **DECON STATIONS**

7-20. The actions that are taken at each of the stations are as follows:

#### **Station 1 - Primary Wash**

7-21. At this station, gross contamination is removed from the aircraft. Spray the aircraft for 2 to 3 minutes with hot, soapy water. Avoid hitting the



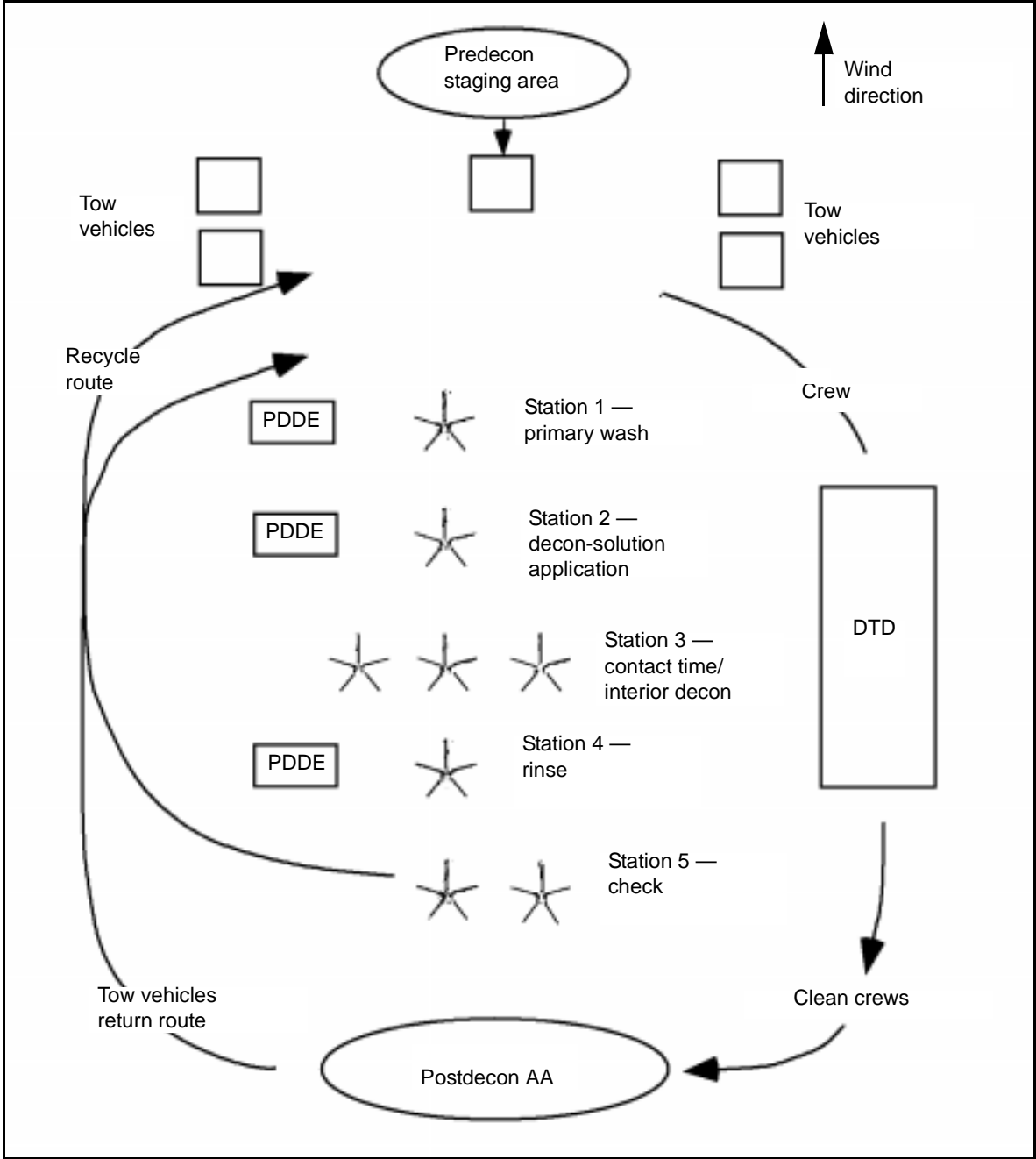
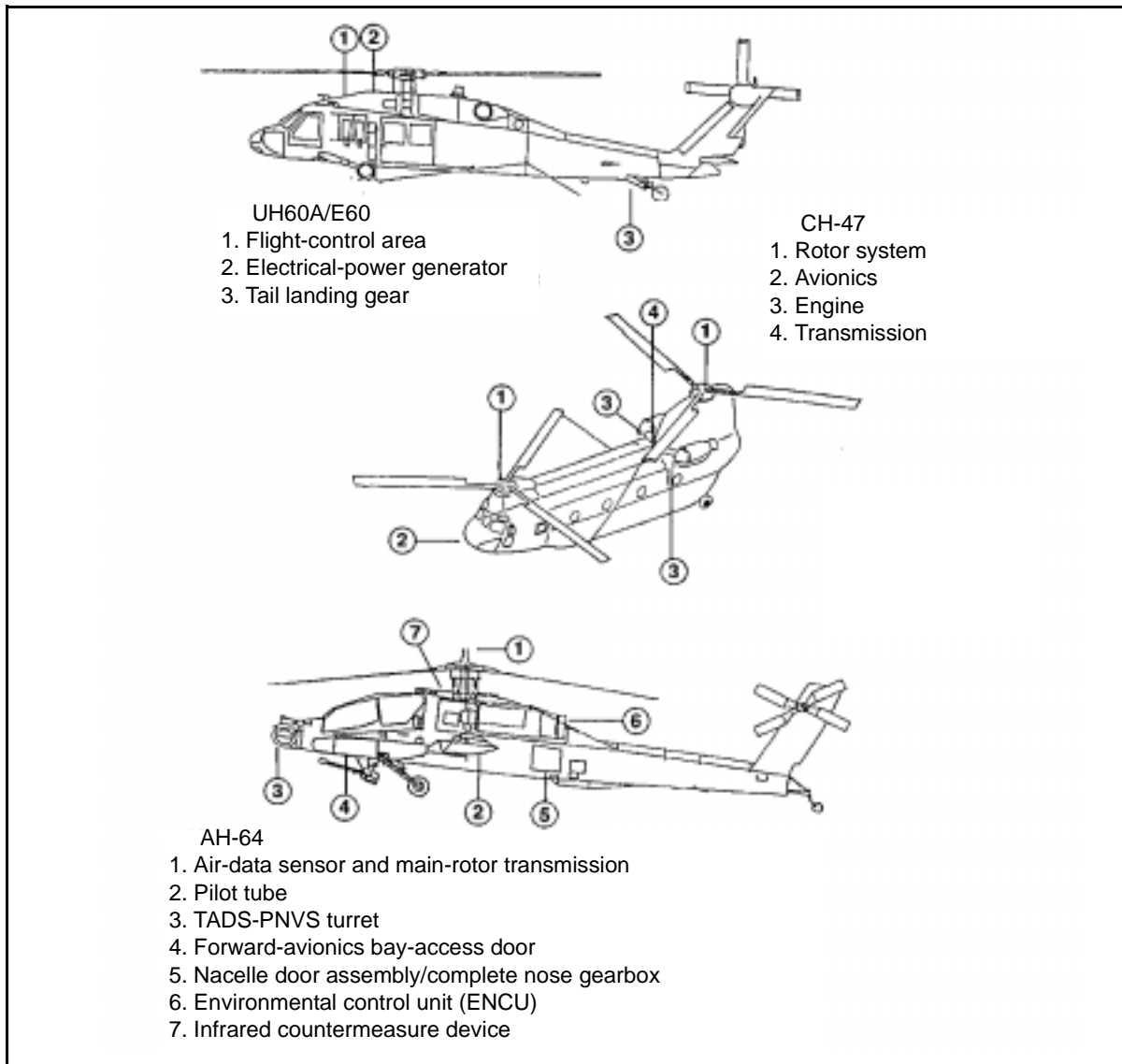

Figure 7-2. Optimum Layout for a DAD Station

aircraft's skin at a 90° angle to prevent damage. Also avoid the sensitive areas shown in Figures 7-3 through 7-6, pages 7-10 through 7-13.

**Station 2 - Decon-Solution Application**

7-22. At this station, a decon solution is applied using the M12A1 PDDE or the M17 LDS (in the siphinjector mode). After the solution is applied, a member of the scrubbing team scrubs the aircraft's skin. This allows the chemical agent

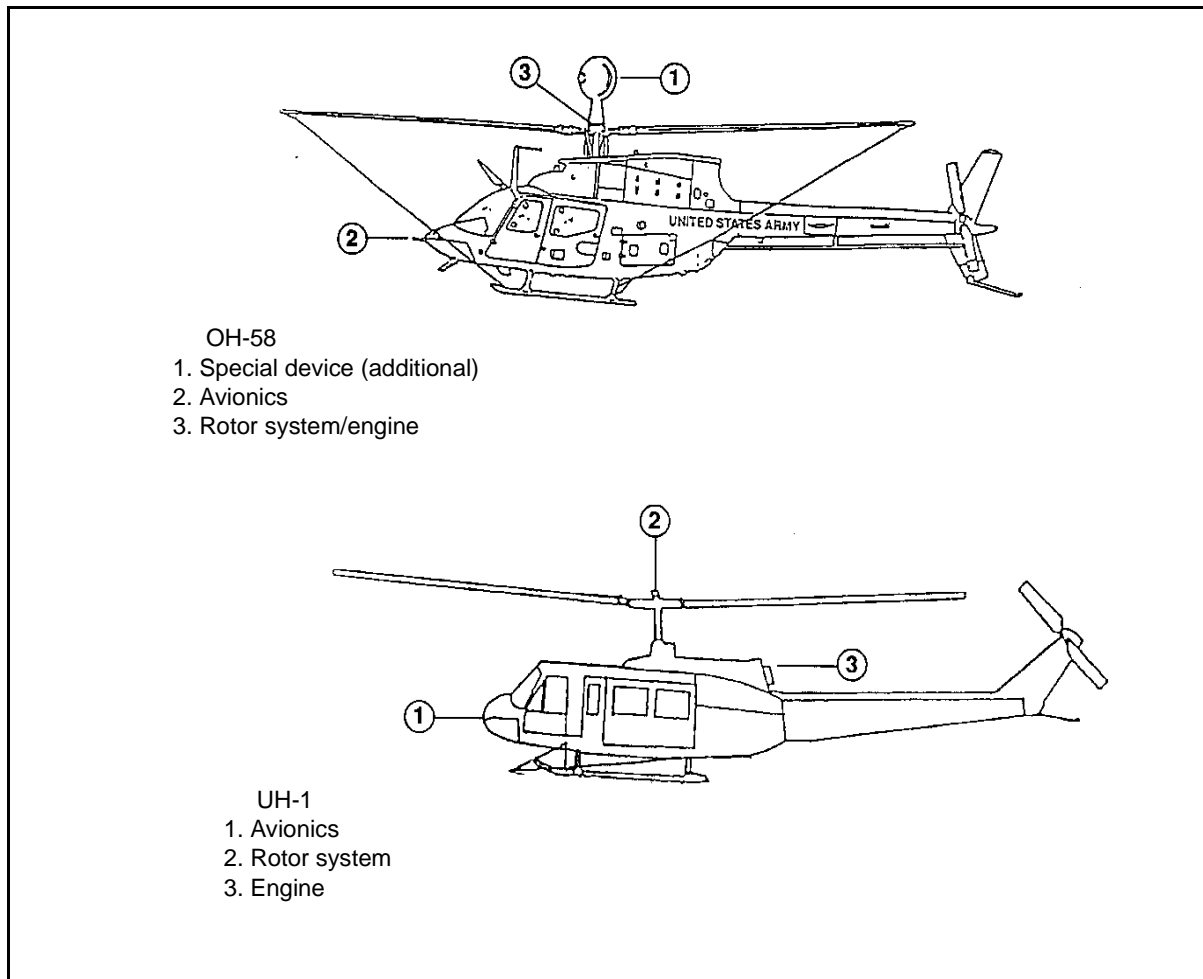

**Figure 7-3. No Direct Water-Pressure Areas for the UH60A/E60, CH-47, and AH-64 Helicopters**

to mix with the decon solution, especially when thickened chemical agents are present. For decontaminants, refer to Appendix B. STB and HTH should not be used because of their corrosive nature.

**Station 3 - Contact Time/Interior Decon**

7-23. At this station, the decon solution is allowed to completely neutralize the chemical agent; also, the interior of the aircraft is decontaminated, if necessary. The aircraft will remain in station 3 for no less than 30 minutes. The decon solution reacts with most chemical agents within 5 minutes. However, allowing the decon solution to remain on the contaminated surface for 30 minutes ensures a complete neutralization.



**Figure 7-4. No Direct Water-Pressure Areas for the OH-58 and UH-1 Helicopters**

7-24. While the aircraft is in this station, an attendant inspects the interior of the aircraft for liquid contamination using the CAM and M8 detector paper. If liquid-chemical contamination is identified, he will decon the interior of the aircraft.

**WARNING**

**Personnel should not be in the aircraft during this operation.**

7-25. Decon the aircraft's interior with hot, soapy water as long as maintenance personnel approve the use of it on certain pieces of equipment. Use IEDKs or damp, soapy washcloths to decon optical and electrical equipment and instruments.

**NOTE: The IEDK leaves a charcoal residue on surfaces.**

7-26. Field studies show the Herman-Nelson portable duct heaters to be effective in decontaminating chemically contaminated vehicle and aircraft

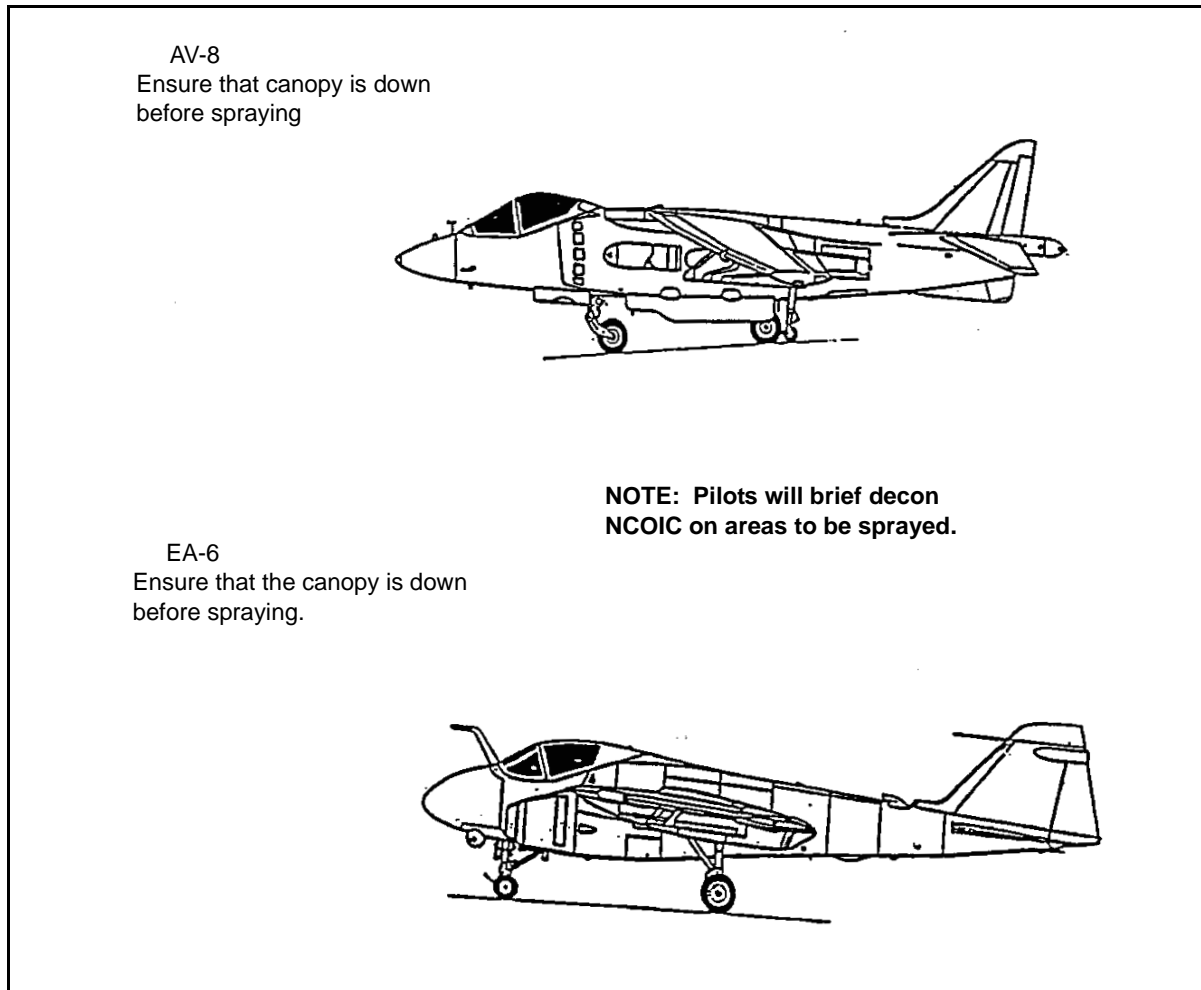

**Figure 7-5. No Direct Water-Pressure Areas for the AV-8 and EA-6**

interiors. However, using a hot-air decon has the following drawbacks: time required, heat damage, and downwind vapor hazards. A hot-air decon for a helicopter or light aircraft requires about 30 to 120 minutes to remove all of the contamination. Times are based on the amount of contamination and interior surface materials. Enough time must be provided to get the contaminated surface hot enough to vaporize the agent. The Herman-Nelson heaters discharge air at a temperature between 150<sup>o</sup> and 280<sup>o</sup>F. Pressurized containers, such as fire extinguishers, must be removed before starting a hot-air decon. These items will fail catastrophically and could cause severe damage. The heat will also damage sensitive electronic equipment. Additionally, chemical agents irreversibly bind to many materials, particularly gaskets, vinyl coatings, seat belts, and seat cushions. These items should be removed since they cannot be decontaminated. A hot-air decon does not destroy chemical agents. The air exiting the aircraft may contain hazardous levels of the agent. A downwind exclusion area of about 164 yards must be maintained to prevent unwanted casualties.

7-27. While a hot-air decon is an alternate to using hot, soapy water or an IEDK, the technique has many drawbacks. Maintenance personnel must be

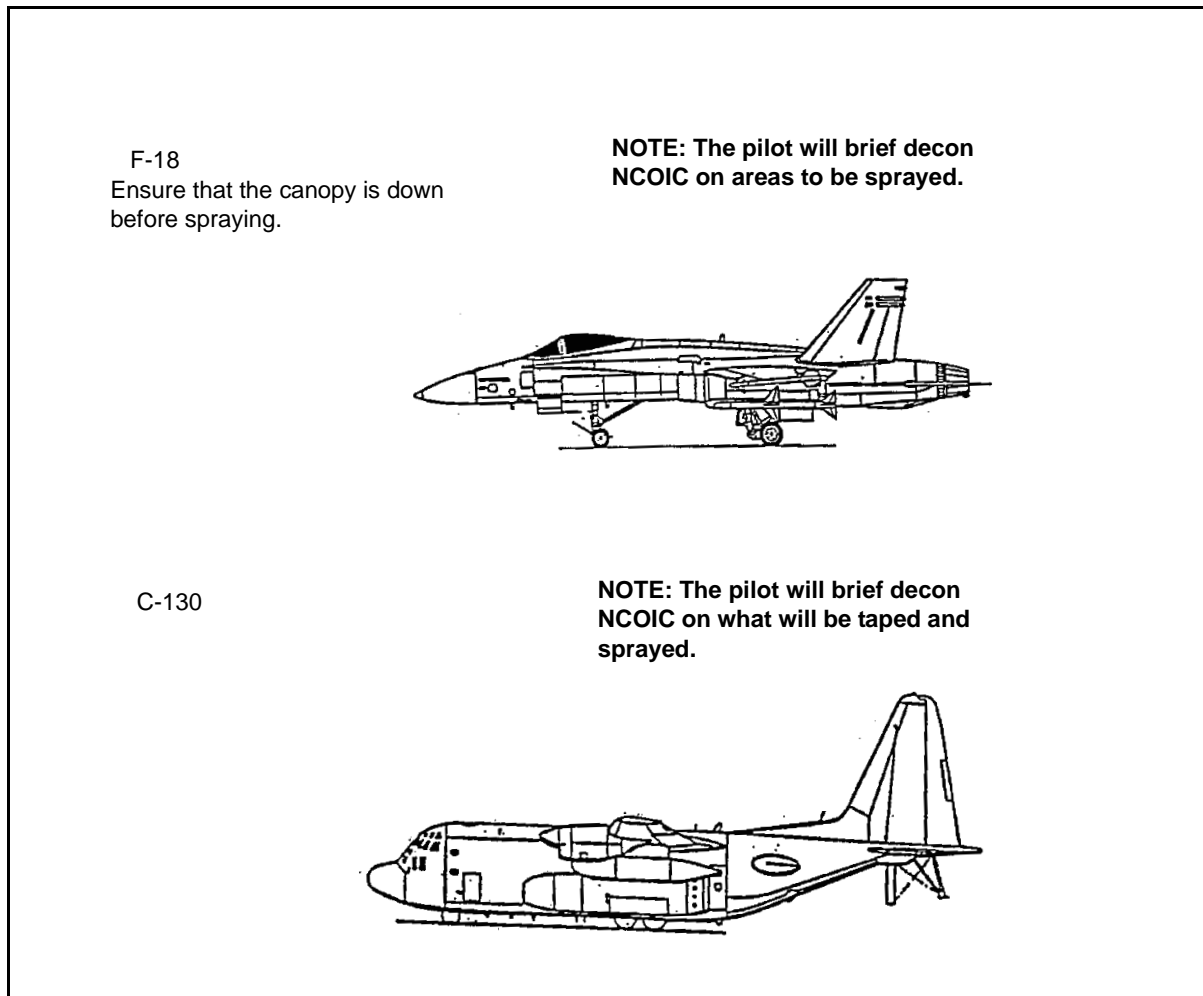

**Figure 7-6. No Direct Water-Pressure Areas for the F-18 and C-130**

consulted before using this technique to ensure that the aircraft is not damaged by the heat.

7-28. For radiological contamination, use a radiac meter to determine the extent and location of contamination inside the aircraft. If there is contamination, determine the intensity of the contamination. If the contamination has an intensity greater than 0.33 cGy, the interior of the aircraft must be decontaminated. Use hot, soapy water to wash the contaminated areas and a sponge to mop up the water and the contamination.

#### **Station 4 - Rinse**

7-29. At this station, the decon solution is removed from the aircraft. Spray the aircraft with water from top to bottom. Take care not to damage the aircraft's skin. This station will use about 250 gallons of water. Failure to remove all decon solution from the aircraft's skin may cause corrosion.

### Station 5 - Check

7-30. At this station, the completeness of the decon is checked. Determine if the aircraft has a negligible risk or if it still has significant contamination remaining. Detection procedures vary depending on the type of contamination. If significant contamination is found on the aircraft, it will be recycled to station 2 for chemical contamination or station 1 for radiological contamination.

7-31. **Chemical.** Use the CAM to check for the presence of vapors. A one bar or lower reading on the CAM indicates a negligible risk. If the CAM indicates the presence of vapors, use M8 detector paper to check for liquid contamination. If it is suspected that these are producing a false positive, use an M256A1 detector kit to confirm or deny the presence of contamination. If the aircraft has significant contamination remaining, recycle it. Desorption of chemical agents may occur after the decon. On CARC-painted surfaces, the desorption of vapors will stop sooner than on alkyd-painted surfaces.

7-32. **Radiological.** Use the radiac meter to determine if any contamination remains. If so, determine the intensity of the contamination. If the contamination is greater than 0.33 cGy, recycle the aircraft to station 1.

### RECYCLE CRITERIA

7-33. The commander, with the chemical unit leader's help, establishes the recycle criteria before starting a decon operation. If contamination is detected at station 5, the recycle criteria is used to determine which aircraft are returned to station 2 or, if radiologically contaminated, station 1. If the unit has sufficient time and resources available, any aircraft having more contamination than a negligible risk should be recycled. However, time and resources are usually limited and not all aircraft can be recycled.

### AIRCRAFT DECON-SITE SELECTION

7-34. Operational- and thorough-decon sites for aircraft must be selected with care. The decon area must be big enough for the required number of aircraft, have a readily available water source, and allow for adequate drainage. The site should be relatively secure; however, it should be close enough to the AOs and FARP to allow for a reasonably quick turnaround of aircraft. The site must not have less than a 5 percent slope. Decon sites should be integrated into the tactical plan.

### DECON-SITE LAYOUT

7-35. The equipment and personnel requirements for a DAD layout are identified in Table 7-3, page 7-16. Chemical units can establish other layouts based on METT-TC.

7-36. It may not be possible, for a variety of reasons, for a chemical platoon to use the optimum layout. Limited personnel or equipment will affect the layout of the thorough aircraft decon site. The platoon leader will use METT-TC and the concepts outlined in this chapter to establish a DAD station within his capabilities.

**WARNING**

Chemical unit leaders must consider the impact of the work/rest cycle on their operation to process aircraft. Failure to initiate a work/rest cycle could result in heat casualties and mission failure.

**Table 7-3. Personnel and Equipment Requirements for an Optimum DAD Layout**

Stations	Personnel		Equipment/Supplies
	Decon Platoon	Augmenter	
Station 1 - primary wash	1 squad leader 1 PDDE operator 2 sprayers	2 scrubbers	1 PDDE 1 3,000-gallon tank 2 65-GPM pumps 6 long-handled brushes 5 TAP aprons Liquid detergent
Station 2 - decon-solution application	1 squad leader 2 appliers 2 sprayers 1 PDDE operator	4 appliers	1 PDDE 18 long-handled brushes 9 mops with extra heads Liquid detergent
Station 3 - contact time/interior decon	1 NCO (CAM operator)	2 interior decon assistants	2 AN/VDR-2 or AN/PDR-77 3 TAP aprons 6 30-gallon containers 10 books of M8 detector paper 30 sponges 8 M256A1 detector kits 50 plastic trash bags 1 clipboard with a pen 1 stopwatch 1 CAM
Station 4 - rinse	1 squad leader 1 PDDE operator 2 sprayers		1 PDDE 1 3,000-gallon tank 3 65-GPM pumps 1 TPU 2 TAP aprons
Station 5 - check	1 NCO 2 CAM operators		1 CAM 10 M256A1 detector kits 20 books of M8 detector paper 2 AN/VDR-2 or AN/PDR-77 2 M8A1 or M22 ACAA
C <sup>2</sup>	1 platoon leader 1 platoon sergeant		1 HMMWV 3 marking kits
Aircraft moving team		6 drivers 18 ground guides	
Total personnel	20	32	

## Chapter 8

# Patient Evacuation and Decon

Evacuating patients under NBC conditions forces the unit commander to consider to what extent he will commit evacuation assets to enter the contaminated area. Generally, if most or all of a supported force is operating in a contaminated area, most or all of the medical-evacuation assets will operate there also. If it is possible to keep some ambulances free from contamination, every effort should be made to do so.

### EVACUATION CONSIDERATIONS

8-1. On the modern battle space, there are three basic modes of evacuating patients (personnel, ground vehicles, and aircraft). Personnel who physically carry the patients incur a great deal of inherent stress. Cumbersome MOPP gear, climate, increased workloads, and fatigue will greatly reduce the effectiveness of unit personnel.

8-2. If evacuation personnel are to be sent into an area that is contaminated with radiation, an OEG must be established. Radiation-exposure records must be maintained by the supported unit chemical NCO and made available to the commander, staff, and medical leader. Based on the OEG, the commander or medical leader decides which evacuation elements to send into the contaminated environment. Every effort is made to limit the number of evacuation assets that are contaminated; however, a number of these assets will become contaminated in the course of a battle. Therefore, optimize the use of resources, medical and nonmedical, which are already contaminated before employing uncontaminated resources.

8-3. Once a vehicle has entered a contaminated area, it is highly unlikely that it can be spared long enough to undergo a complete decon. This will depend on the contaminant, the tempo of the battle, and the resources available for casualty evacuation. Normally, contaminated vehicles (air and ground) will be confined to dirty environments.

8-4. Ground ambulances should be used instead of air ambulances in contaminated areas. They are more plentiful, are easier to decon, and can be replaced more easily. However, this does not preclude the use of aircraft, if required.

8-5. The patient's medical condition and the relative positions of the contaminated area, the forward line of troops (FLOT), and the threat's air-defense systems determine if and where air ambulances may be used in the evacuation process. One or more air ambulances may be restricted to the contaminated areas. To the greatest extent possible, use ground vehicles to cross the line separating the contaminated and clean areas.



8-6. After the patients are loaded, the medical-evacuation vehicles proceed to a medical-treatment facility (MTF) with a patient-decon station. (For the setup of a patient-decon station, see FM 8-10-7.) The patients are decontaminated and treated at this station. If further evacuation is required, transfer the patients to a clean ground or air ambulance. The routes that the ground vehicles use to cross between contaminated and clean areas should be considered dirty routes and should not be crossed by clean vehicles. The effects of the wind and time on the contaminants must be considered.

8-7. The rotor wash of the helicopters must always be kept in mind when evacuating patients. The intense winds will disturb the contaminants, increasing vapor hazards.

8-8. The helicopter should be allowed to land and reduce to a flat pitch before the patients are brought near. Additionally, the helicopter must not land too close to a decon station because any trace of contaminants in the rotor wash may be spread into the clean treatment area.

8-9. Evacuating patients must continue even under NBC conditions. The medical leader must recognize the constraints that NBC operations place on him, and he must plan and train to overcome these constraints.

## **PATIENT DECON**

8-10. Patient decon presents special problems for units and combat-health-support (CHS) personnel. Under NBC conditions, contaminated wounded soldiers create increased hazards to rescuers and CHS personnel. In the following paragraph, decon procedures at unit level are discussed:

8-11. On the NBC battle space, two classifications of patients will be encountered—contaminated and uncontaminated. Those contaminated may suffer from the effects of an NBC agent, a conventional wound, or both. For more information on the treatment of NBC patients, see FM 8-9. Some may suffer battle fatigue or heat injuries induced by the stress of NBC conditions and the extended time spent in MOPP4. It is important to follow proper decon procedures to limit the spread of contamination. The most important decon is performed at the contamination site. Later decon may be too late to prevent injury. All agents should be promptly removed from the skin.

8-12. Patient decon must begin at the platoon and company level with the individual soldier. The soldier himself or members of his team must perform immediate decon and administer nerve-agent antidotes and convulsant antidotes, if required. Tag the patient with a DD Form 1380 or a field-expedient tag, noting the time and type of contamination (see Figure 8-1). If available, use the CAM or M8/M9 detector paper to determine the type and concentration of contamination. When the patient's condition and the battle permits, the patient may go through a MOPP-gear exchange (see Chapter 3 of this manual). The MOPP-gear exchange must not cause further injury to the patient.

## **PATIENT DECON AT AN MTF**

8-13. In the following paragraphs, the types of MTFs are discussed:

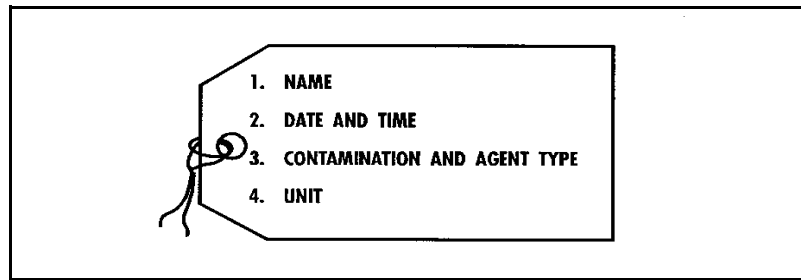

Figure 8-1. Field-Expedient NBC Patient Tag

### **BATTALION AID STATION (BAS)**

8-14. When battle conditions prevent decon procedures forward, the patient may have to be evacuated to the BAS before decon. Contaminated patients arriving at the MTF must be decontaminated before admission into the clean treatment area.

8-15. Patient decon is the systematic removal of clothing and contaminants from a patient who is unable to decon himself. Patient decon is done by an 8-man, patient-decon team consisting of nonmedical personnel from the supported unit at the BAS. The team operates under the supervision of medical personnel to ensure that no further injury is caused to the patient by the decon process.

### **MEDICAL COMPANY'S CLEARING STATION**

8-16. The medical company's clearing station may receive patients from the BAS or directly from other areas who may be contaminated. The clearing station must also have a patient-decon area. For more information on BAS operations under NBC conditions, see FMs 8-10-4 and 8-10-7. As with the BAS, the clearing station must have at least an 8-man, patient-decon team consisting of nonmedical personnel from the supported units to perform the decon. Procedures for patient decon at the clearing station are the same as for the BAS.

### **HOSPITAL**

8-17. To the maximum extent possible, hospitals are located away from tactical or logistical targets. Patients evacuated from forward areas should already be decontaminated; however, contaminated patients may arrive from forward MTFs and units located within the geographical area of the hospital and require decon. Patient decon is done by 20 nonmedical personnel from units located in the geographical area/base cluster of the hospital.

8-18. If the hospital does not have CPSs and becomes contaminated with a persistent agent, patients are rerouted to other hospitals. All inpatients are evacuated, if possible, and the hospital is decontaminated. On completion of the decon, the hospital will return to normal operations.

8-19. A hospital with CPSs will decon the areas around the entry to these facilities, then continue receiving and caring for patients. Forward medical facilities and hospitals use the same patient-decon procedures. Several patient-decon stations can be operated at a hospital decon site. All patients arriving at the hospital will be considered contaminated. They must be

decontaminated before being admitted into the clean areas. Perform decon as required.

**CHLORINE-SOLUTION PREPARATION FOR PATIENT DECON**

8-20. To decon a patient, use an SDK; however, if an SDK is not available, use a chlorine solution. If the chlorine solution is used, two concentrations of it are required. A 5 percent chlorine solution is required to decon gloves, aprons, litters, scissors, patient's hood, and other nonskin contact areas. A 0.5 (1/2) percent chlorine solution is required to decon the patient's mask, skin, and splints and to irrigate his wounds. To prepare the solutions, use calcium hypochlorite granules or sodium hypochlorite (household bleach) (see Table 8-1).

**Table 8-1. Preparation of Chlorine Solution for Patient Decon**

HTH Ounces	HTH Spoonfuls*	Household Bleach	Solution Percent- age in 5 Gallons of Water
6	5	2 quarts	0.5
48	40	**	5
<p>*These measurements are used when bulk HTH is used. To measure this preparation, use the plastic spoon supplied with your meal, ready-to-eat (MRE). Use a heaping spoonful of chlorine (all that the spoon will hold). Do not shake any granules off the spoon before adding to the water.</p> <p>**Do not dilute in water because household bleach is about a 5 percent solution.</p> <p><b>NOTE: HTH is supplied in a 6-ounce jar in the chemical-agent patient's treatment and decon medical-equipment set.</b></p>			

**CAUTION**

Only use a 0.5 percent chlorine solution on the patient's skin. Avoid vigorous scrubbing because it can force the agent into the skin.

**CHEMICAL-AGENT PATIENT DECON PROCEDURES**

8-21. Decon procedures for chemical-agent patients are discussed in the following paragraphs:

**LITTER PATIENT**

8-22. Before patients receive medical treatment in the clean treatment area, the 8-man patient-decon team decontaminates them. Figure 8-2 shows one way to establish the patient-decon station. Place the bandage scissors in a container of 5 percent chlorine solution between each use. The team members decon their gloves and aprons with a 5 percent chlorine solution.

**NOTE: Litter patients requiring emergency medical treatment (EMT) or ambulatory medical treatment (AMT) in the clean area of the MTF will be completely decontaminated. However, a patient requiring immediate evacuation should have only his wound area and MOPP gear spot decontaminated to remove any gross contamination (for example, a stable patient with a partial amputation of a lower extremity). The patient should be evacuated in his MOPP gear.**

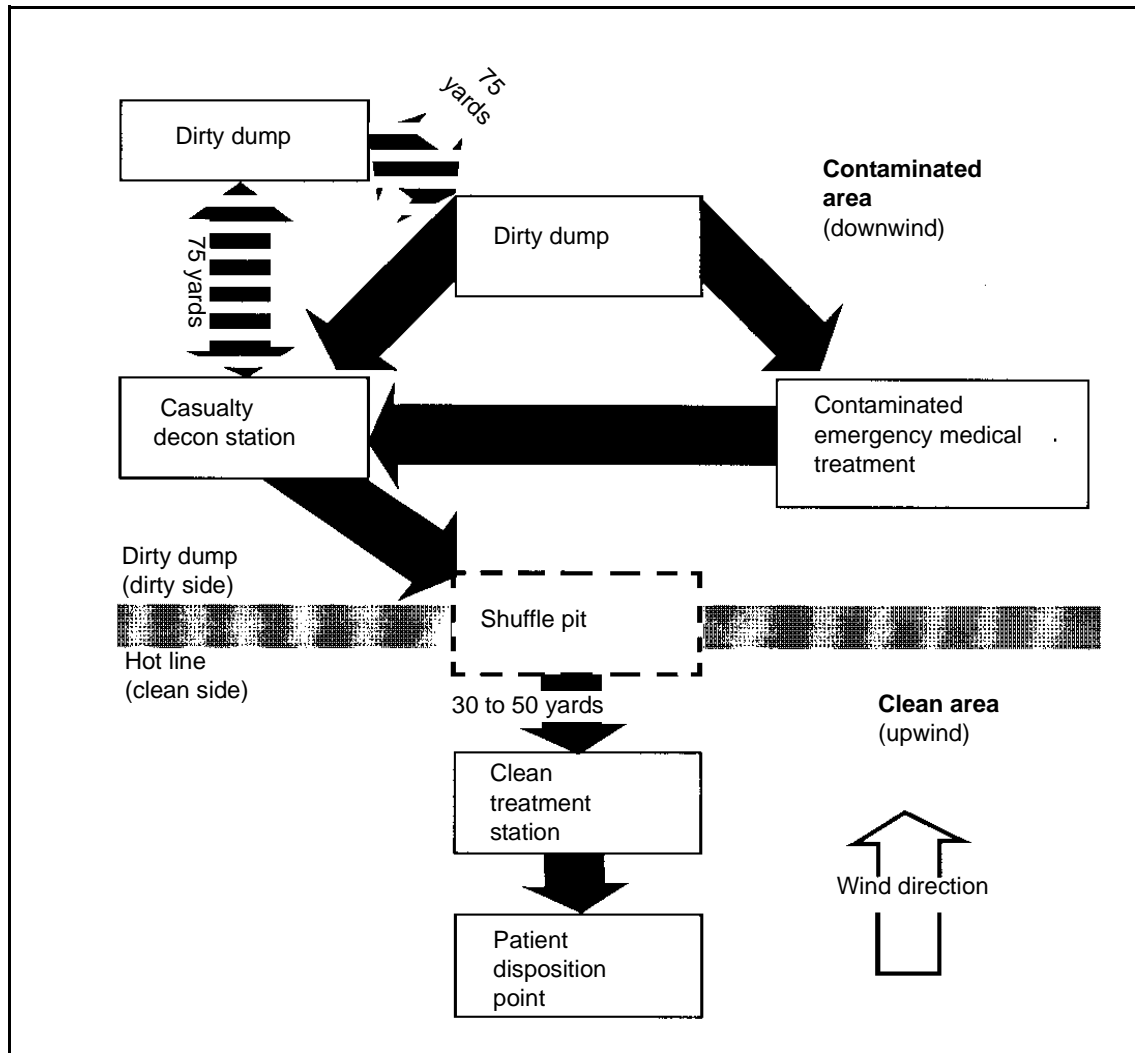

Figure 8-2. Layout for a Patient-Decon Station and a Clean Treatment Area Without a CPS

8-23. Decon the patient's skin, bandages, wounds, mask, identification tags with chain, and splints by wiping them with a 0.5 percent chlorine solution. For treatment procedures, refer to FMs 8-9, 8-33, and 8-285.

8-24. Some procedures in the following steps can be done with one soldier, while others require more than one soldier.

### Step 1 - Decon the Patient's Mask and Hood

8-25. **Move the patient to the clothing removal station.** After the patient has been triaged and stabilized (if necessary) by the senior medic in the patient-decon area, move him to the litter stands at the clothing removal station.

8-26. **Decon the hood.** Use either an IEDK or a 5 percent chlorine solution (or household bleach) to wipe down the front, sides, and top of the hood.

**8-27. Remove the hood.** Remove the hood by cutting it with scissors or by loosening it from the mask attachment points for the quick-doff hood or other similar hoods (see Figure 8-3). Before cutting the hood, dip the scissors in a 5 percent chlorine solution. Cut the neck cord and the small string under the voicemitter. Release or cut the hood shoulder straps and unzip the hood zipper. Cut the hood upward to the top of the eye-lens outsert, staying close to the filter-inlet cover and eye-lens outsert, then across the forehead to the outer edge of the other eye-lens outsert. Proceed downward toward the patient's shoulder, staying close to the eye lens outsert and filter-inlet cover, then across the lower part of the voicemitter to the zipper. After dipping the scissors in the 5 percent chlorine solution, cut the hood from the center of the forehead over the top of the head. Fold the left and right sides of the hood to the side of the patient's head, laying the sides of the hood on the litter.

**8-28. Decon the protective mask and exposed skin.** Use an SDK or a 0.5 percent chlorine solution to wipe the external parts of the mask. Cover the mask's air inlets with gauze or your hand to keep the mask filter dry. Continue by wiping the exposed areas of the patient's face, to include the neck and behind the ears. Do not remove the protective mask.

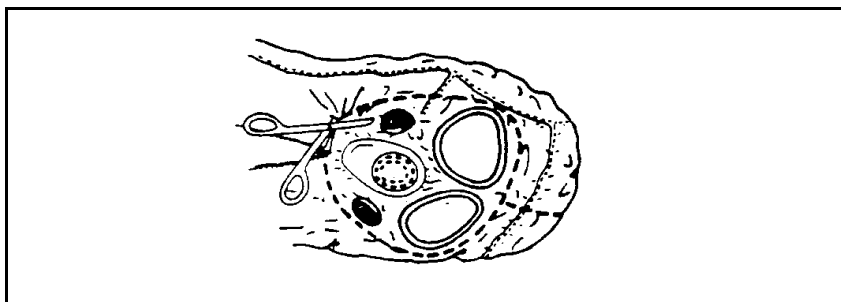

**Figure 8-3. Cutting the Protective Mask Hood**

**8-29. Remove the field medical card (FMC).** Cut the patient's FMC tie wire, allowing the FMC to fall into a plastic bag. Seal the plastic bag and rinse the outside of the bag with a 5 percent chlorine solution. Place the plastic bag under the back of the protective mask's head straps. The FMC will remain with the patient in the contaminated area and a clean copy will be made before the patient is moved to the clean area.

### **Step 2 - Remove Gross Contamination From the Patient's Protective Overgarment**

**8-30.** Remove all visible contamination spots from the overgarment with an SDK or a 5 percent chlorine solution.

### **Step 3 - Remove the Patient's Personal Effects and Protective Overgarment**

**8-31. Remove the patient's personal effects.** Remove the patient's personal effects from his protective overgarment and BDU pockets. Place the articles in a plastic bag, label the bag with the patient's identification, and seal the bag. If the articles are not contaminated, they are returned to the patient. If the articles are contaminated, place them in the contaminated holding area until they can be decontaminated, then return them to the patient.

**CAUTION**

Bandages may have been applied to control severe bleeding; therefore, they are treated like tourniquets. Only medical personnel will remove bandages, tourniquets, and splints.

**NOTE: The overgarment jacket and trousers will be cut simultaneously. One soldier cuts the jacket, while another soldier cuts the trousers.**

**8-32. Cut and remove the overgarment jacket.** Before cutting the overgarment jacket and trousers, dip the scissors in a 5 percent chlorine solution to prevent contamination of the patient's BDU or undergarments. Make two cuts, one up each sleeve from the wrist up to the shoulder and then across the shoulder through the collar (Figure 8-4). Cut around bandages, tourniquets, and splints, leaving them in place. Do not allow your gloves to touch the patient along the cut line. Keep the cuts close to the inside of the arms so that most of the sleeve material can be folded outward. Unzip the jacket and roll the chest sections to the respective sides, with the inner surface outward. Continue by tucking the clothing between the arm and chest. Roll the cut sleeves away from the arms, exposing the black liner.

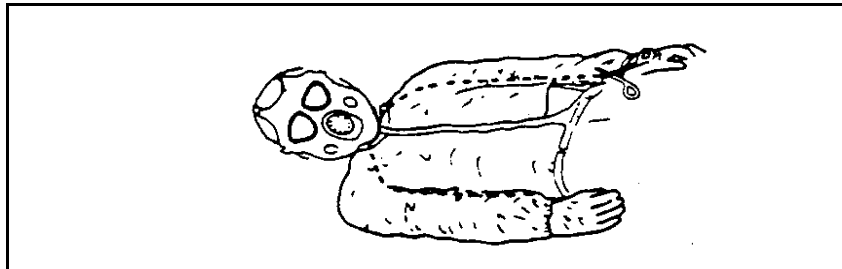

**Figure 8-4. Cutting the Overgarment Jacket**

**8-33. Cut and remove the overgarment trousers.** Cut both trousers legs starting at the ankle as shown in Figure 8-5, page 8-8. Keep the cuts near the inside of the legs, along the inseam, to the crotch. With the left leg, cut all the way to the waist, avoiding the pockets. With the right leg, cut across at the crotch to the left leg cut. Cut around bandages, tourniquets, and splints, leaving them in place. Place the scissors in a 5 percent chlorine solution. Fold the cut trouser halves away from the patient and allow the halves to drop to the litter with the contaminated (green) side down. Roll the inner leg portion under and between the legs.

**8-34. Remove the outer gloves.** Before touching the patient, the patient-decon team decontaminates its gloves with a 5 percent chlorine solution. Lift the patient's arms up and out of the cutaway sleeves unless detrimental to his condition. Grasp the fingers of the gloves, roll the cuffs over the fingers, and turn the gloves inside out. Do not remove the inner cotton gloves at this time. Carefully lower the patient's arms across the chest after the outer gloves have been removed (Figure 8-6, page 8-8). Do not allow the patient's arms to come into contact with the exterior of his overgarment. Drop his gloves into the

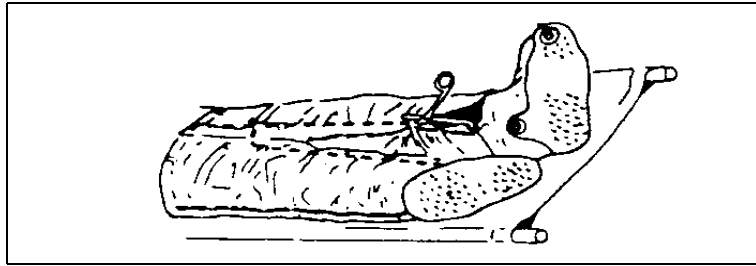

Figure 8-5. Remove the Overgarment Trousers

contaminated-waste bag. The team members decon their gloves with the 5 percent chlorine solution.

**8-35. Remove the overboots.** Cut the overboot laces and fold the lacing eyelets flat outward. While standing at the foot of the litter, hold the patient's heel with one hand. Pull the overboot downward, then toward you to remove it. Remove the two overboots simultaneously. This reduces the likelihood of contaminating one of the combat boots.

**8-36.** While holding the patient's heels off the litter, have a team member wipe the end of the litter with a 5 percent chlorine solution to neutralize any contamination that was transferred to the litter from the overboots. Lower the patient's heels onto the decontaminated litter. Place the overboots in the contaminated-waste bag. The team members decon their gloves with the 5 percent chlorine solution.

#### Step 4 - Remove the Patient's BDU and Undergarments

**8-37. Cut and remove the BDU.** To cut and remove the BDU jacket and trousers, follow the procedures for removing the protective overgarment as described in paragraph 8-32 and 8-33.

**8-38. Remove the combat boots.** Cut the bootlaces along the tongue. Remove the boots by pulling them toward you. Place the boots in the contaminated-waste bag. Do not touch the patient's skin with your contaminated gloves when removing his boots.

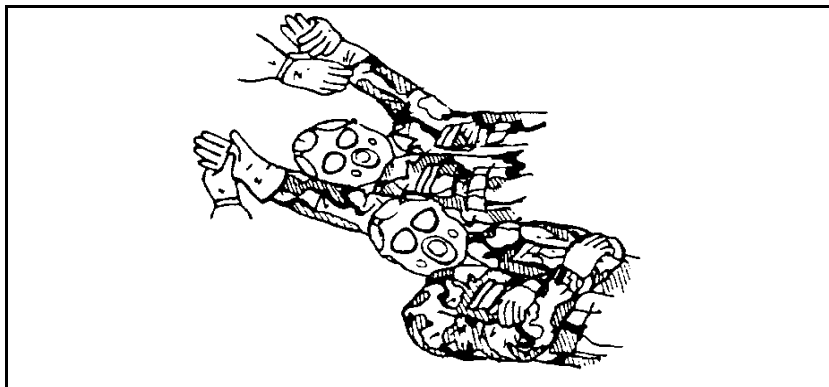

Figure 8-6. Removing the Outer Gloves and Positioning the Arms After the Glove Removal

8-39. **Cut and remove the undergarments.** Follow the procedures for cutting away the protective overgarment and rolling it away from the patient (see paragraph 8-32 and 8-33). If the patient is wearing a brassiere, cut it between the cups. Cut both shoulder straps where they attach to the cups and lay them back off of the shoulders. Remove the socks and cotton gloves. Do not remove the identification tags.

#### **Step 5 - Transfer the Patient to a Decon Litter**

8-40. After the patient's clothing has been cut away, transfer him to a decon litter or a canvas litter with a plastic-sheeting cover. Three decon team members decon their gloves and aprons with a 5 percent chlorine solution. One member places his hands under the patient's legs at the thighs and Achilles tendons, a second member places his arms under the patient's back and buttocks, and a third member places his arms under the patient's shoulders and supports the head and neck. They carefully lift the patient using their knees (not their backs) to minimize back strain. While the patient is elevated, another decon team member removes the litter from the litter stands and replaces it with a decontaminated (clean) litter. The team members carefully lower the patient onto the clean litter. The clothing and overgarments are placed in a contaminated-waste bag and moved to the contaminated-waste dump. The dirty litter is rinsed with the 5 percent chlorine solution and placed in the litter storage area.

#### **Step 6 - Decon the Patient's Skin**

8-41. **Spot decon.** With the patient in a supine position, spot decon the skin by using an SDK or a 0.5 percent chlorine solution. Decon areas of potential contamination, to include areas around the neck, wrists, and lower parts of the face. Decon the patient's identification tags and chain, if necessary.

**NOTE: A complete body wash is not appropriate and may be harmful to the patient. During a complete body wash, the patient would have to be rolled over to reach all areas of the skin. This is not necessary for an adequate decon.**

8-42. **Combat medic care.** The combat medic gently cuts away the bandage. He decontaminates the area around the wound and irrigates it with a 0.5 percent chlorine solution. If bleeding begins, he replaces the bandage with a clean one. He replaces the old tourniquet by placing a new one ½ to 1 inch above the old one. He then removes the old tourniquet and decontaminates the patient's skin with an SDK or a 0.5 percent chlorine solution. He does not remove a splint. He decontaminates the splint by thoroughly rinsing it, to include the padding and cravats, with a 0.5 percent chlorine solution.

#### **WARNING**

**Do not use an SKD around any wounds. Do not remove splints. Splints will not be removed until the patient has been evacuated to a forward MTF or hospital.**

8-43. **Completeness of decon check.** Check the patient with M8 detector paper or the CAM for completeness of decon.

**NOTE: Other monitoring devices may be used, if available.**



8-44. **Contaminated-waste disposal.** Dispose of contaminated bandages and coverings by placing them in a contaminated-waste bag. Seal the bag and place it in the contaminated-waste dump.

#### **Step 7 - Transfer the Patient Across the Shuffle Pit**

8-45. The patient's clothing has been cut away and his skin, bandages, and splints have been decontaminated. Transfer the patient to the shuffle pit and place the litter on the litter stands. The shuffle pit is wide enough to prevent the decon team members from straddling it while carrying the litter. A third team member will assist with transferring the patient to a clean treatment litter in the shuffle pit. Decon personnel rinse or wipe down their aprons and gloves with a 5 percent chlorine solution.

8-46. The three team members lift the patient off the decon litter (see step 5 for lifting procedures). While the patient is elevated, another team member removes the litter from the stands and returns it to the decon area. A medic from the clean side of the shuffle pit replaces the litter with a clean one. The patient is lowered onto the clean litter. Two medics from the clean side of the shuffle pit move the patient to the clean treatment area. The patient is treated in this area or awaits processing into the CPS. The litter is wiped down with a 5 percent chlorine solution in preparation for reuse. Once the patient is in the air lock of the CPS and the air lock has been purged, his protective mask is removed. Place the mask in a plastic bag and seal it.

**NOTE: Before decontaminating another patient, each decon team member drinks about half a quart of water. The exact amount of water consumed is increased or decreased according to the work level and temperature (see Table 8-2).**

#### **AMBULATORY PATIENT**

8-47. All ambulatory patients requiring EMT or AMT in the clean treatment area of the BAS will be decontaminated. Stable patients not requiring treatment at the BAS, but requiring evacuation to the medical company's clearing station or a corps hospital for treatment (for example, a patient with a broken arm), should be evacuated in their protective overgarments and masks by any available transportation. However, before evacuation, spot remove all thickened agents from their protective clothing.

**NOTE: Place the bandage scissors that are used in this procedure in a container of 5 percent chlorine solution when not in use. Most ambulatory patients will be treated in the contaminated treatment area and returned to duty. Upon removal of an ambulatory patient's clothing, he becomes a litter patient. The BAS and clearing station do not have clothing to replace those that are cut off during the decon process. The patient must be placed in a patient protective wrap (PPW) for protection during evacuation (Figure 8-7, page 8-12).**

8-48. The ambulatory patient is decontaminated and undressed as follows. Some procedures in the following steps can be done with one soldier, while others require more than one.

Table 8-2. Heat-Injury Prevention and Water Consumption

Criteria			Controls	
Heat		Water Intake Quart/Hour	Physical Activity for Soldiers/Trainees	
Condition	WBGT Index °F*		Acclimatized to Work/Rest**	Not Acclimatized to Work/Rest
White	78-81.9	At least ½	Continuous	
Green	82-84.9	At least ½	50/10 minutes	Use discretion in planning heavy exercise.
Yellow	85-87.9	At least 1	45/15 minutes	Suspend strenuous exercise during the first 3 weeks of training. Training activities may be continued on a reduced scale after the second week of training. Avoid activity in the direct sun.
Red	88-89.9	At least 1½	30/30 minutes	Curtail strenuous exercise for all personnel with less than 12 weeks of hot-weather training.
White	78-81.9	At least ½	Continuous	
Green	82-84.9	At least ½	50/10 minutes	Use discretion in planning heavy exercise.
Black	90 and up	More than 2	20/40 minutes	Suspend physical training and strenuous exercise. Essential operational commitments (not for training), where the risk of heat casualties may be warranted, are excluded from suspension. Enforce water intake to minimize expected heat injuries.

\*MOPP gear or body armor adds 10°F to the wet-bulb gradient-temperature (WBGT) index.  
\*\*An acclimatized soldier is one who has worked in the given heat condition for 10 to 14 days.

**NOTE: "Rest" means minimal physical activity. Rest should be accomplished in the shade, if possible. Any activity requiring only minimal physical activity can be performed during rest periods (for examples, training by lecture or demonstration, minor maintenance procedures on vehicles or weapons, and personal-hygiene activities such as skin and foot care).**

### Step 1 - Remove the LCE

8-49. Remove the LCE by unfastening/unbuttoning all connectors or tie straps and then place the equipment in a plastic bag. Place the plastic bag in the designated storage area for later decon.

### Step 2 - Decon the Patient's Mask and Hood

8-50. **Begin the clothing removal process.** After the patient has been triaged and treated (if necessary) by the senior medic in the patient-decon station, the clothing removal process begins.

8-51. **Decon the hood.** Use either an IEDK or a 5 percent chlorine solution (or household bleach) to wipe down the front, sides, and top of the hood.

8-52. **Remove the hood.** Remove the hood by cutting it with scissors or by loosening it from the mask attachment points for the quick-doff hood or other similar hoods (see Figure 8-3, page 8-6). Before cutting the hood, dip the scissors in a 5 percent chlorine solution. Cut the neck cord and the small

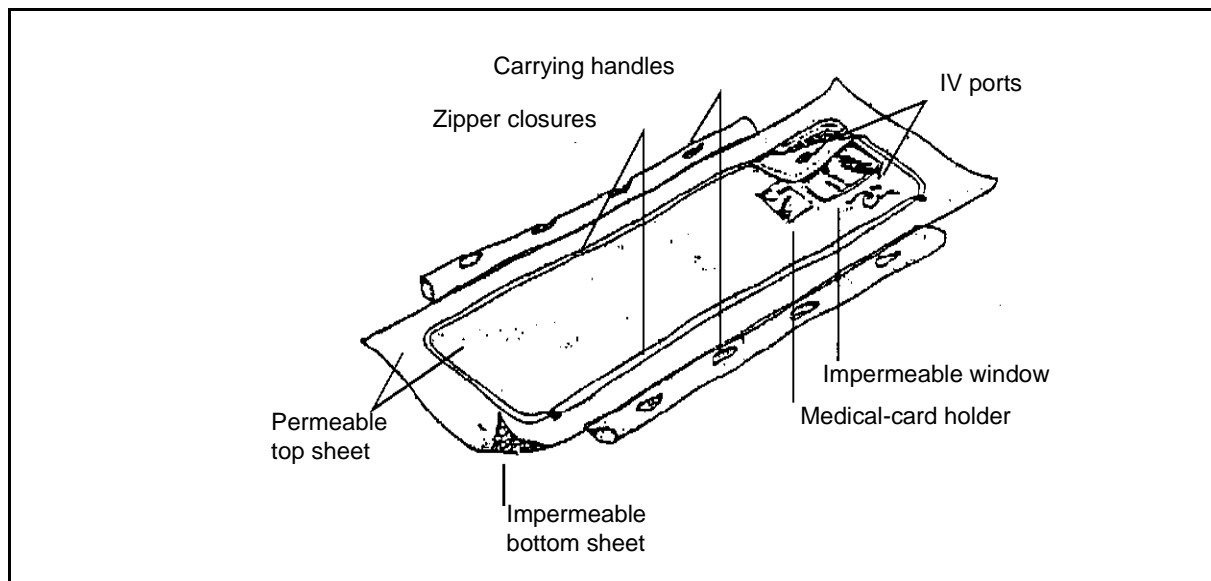

**Figure 8-7. Chemical-Agent Patient Protective Wrap**

string under the voicemitter. Release or cut the hood shoulder straps and unzip the hood zipper. Cut the hood upward to the top of the eye-lens outsert, staying close to the filter-inlet cover and eye-lens outsert, then across the forehead to the outer edge of the other eye-lens outsert. Proceed downward toward the patient's shoulder, staying close to the eye-lens outsert and filter-inlet cover, then across the lower part of the voicemitter to the zipper. After dipping the scissors in the 5 percent chlorine solution, cut the hood from the center of the forehead over the top of the head. Fold the left and right sides of the hood away from the patient's head and remove the hood.

**8-53. Decon the protective mask and exposed skin.** Decon the mask and the patient's face by using an SDK or a 0.5 percent chlorine solution. Cover the mask's air inlets with gauze or your hands to keep the mask filters dry. Continue by wiping the exposed areas of the patient's face, to include the neck and behind the ears. Do not remove the protective mask.

**8-54. Remove the FMC.** Cut the patient's FMC tie wire, allowing the FMC to fall into a plastic bag. Seal the plastic bag and rinse the outside of the bag with a 5 percent chlorine solution. Place the plastic bag under the back of the protective mask's head straps. The FMC will remain with the patient in the contaminated area and a clean copy will be made before the patient is moved to the clean area.

### **Step 3 - Remove Gross Contamination From the Patient's Protective Overgarment**

8-55. Remove all visible contamination spots from the overgarment by using an SDK (preferred method) or a 0.5 percent chlorine solution.

### **Step 4 - Remove the Patients Personal Effects and Protective Overgarment**

8-56. **Remove the patient's personal effects.** Remove the patient's personal effects from his protective overgarment and BDU pockets. Place the

articles in a plastic bag, label the bag with the patient's identification, and seal the bag. If the articles are not contaminated, they are returned to the patient. If the articles are contaminated, place them in the contaminated holding area until they can be decontaminated, then return them to the patient.

**8-57. Remove the overgarment jacket.** Have the patient stand with his feet spread apart at shoulder width. Unsnap the front flap of the jacket and unzip the jacket. If the patient can extend his arms, have him clinch his fist and extend his arms backward at about a 30° angle. Move behind the patient, grasp his jacket collar at the sides of the neck, and peel the jacket off the shoulders at a 30° angle down and away from the patient. Avoid any rapid or sharp jerks, which spread contamination. Gently pull the inside sleeves over the patient's wrists and hands.

**8-58.** If the patient cannot extend his arms, you must cut the jacket to aid in its removal. Before cutting the overgarment jacket, dip the scissors in a 5 percent chlorine solution to prevent contamination of the patient's BDU or underclothing. As with the litter patient, make two cuts, one up each sleeve from the wrist up to the shoulder and then across the shoulder through the collar. Cut around bandages, tourniquets, and splints, leaving them in place. Do not allow your gloves to touch the patient along the cut line. Peel the jacket back and downward to avoid spreading contamination. Ensure that the outside of the jacket does not touch the patient or his inner clothing.

**8-59. Cut and remove the overgarment trousers.** Unfasten or cut all ties, buttons, or zippers before grasping the trousers at the waist and peeling them down over the patient's combat boots. Again, the trousers are cut to aid in removal. If necessary, cut both trouser legs starting at the ankle. Keep the cuts near the inside of the legs, along the inseam, to the crotch. Cut around all bandages, tourniquets, and splints. Continue to cut up both sides of the zipper to the waist and allow the narrow strip with the zipper to drop between the legs. Peel or allow the trouser halves to drop to the ground. Have the patient step out of the trouser legs one at a time. Place the trousers in the contaminated-waste bag. Place the scissors in a 5 percent chlorine solution.

**8-60. Remove the outer gloves.** Grasp the fingers of the gloves, roll the cuffs over the fingers, and turn the gloves inside out. Do not remove the inner cotton gloves at this time. Drop the gloves into the contaminated-waste bag. Do not allow the patient to touch his clothing or other contaminated objects with his hands.

**8-61. Remove the overboots.** Cut the overboot laces and fold the lacing eyelets flat on the ground. Step on the toe and heel eyelets to hold the overboot on the ground and have the patient step out of it. Repeat this procedure for the other overboot. If the overboots are in good condition, they can be decontaminated and reissued.

**8-62. Remove the patient's cotton glove liners.** Instruct the patient to remove his cotton glove liners to reduce the possibility of spreading contamination. Have the patient grasp the heel of one glove liner with the other gloved hand, peeling it off of his hand. Hold the removed glove by the inside and grasp the heel of the other glove, peeling it off of his hand. Place both gloves in the contaminated-waste bag.

### Step 5 - Check the Patient for Contamination

8-63. After the patient's overgarment has been removed, check his BDU by using M8 detector paper or the CAM. Carefully survey the patient, paying particular attention to discolored areas, damp spots, and tears on the uniform; areas around the neck, wrists, and ears; and bandages, tourniquets, and splints. Remove contaminated spots by using an SDK or a 0.5 percent chlorine solution or, if possible, by cutting away the contaminated area. Always dip the scissors in a 5 percent chlorine solution after each cut. Recheck the area with the detection equipment. If significant contamination is found on the BDU, then remove it and spot decon the skin. To remove the BDU, follow the procedures for removing the overgarment as described in paragraphs 8-57 through 8-59. Do not remove the patient's identification tags.

### Step 6 - Decon the Patient's Skin

8-64. **Spot decon.** Use an SDK or a 0.5 percent chlorine solution to spot decon the skin and areas of potential contamination, to include areas around the neck, wrists, and lower parts of the face. Decon the patient's identification tags and chain, if necessary.

8-65. Have the patient hold his breath, close his eyes, and lift, or assist him with lifting, his mask at the chin. Wipe his face and exposed areas of the skin with an SDK or a 0.5 percent chlorine solution. Starting at the top of the ear and quickly wiping downward, wipe all folds in the skin, ear lobes, upper lip, chin, dimples, and nose. Continue up the other side of the face to the top of the other ear. Wipe the inside of the mask where it touches the face. Have the patient reseal and check his mask.

<p style="text-align: center;"><b>CAUTION</b></p>
---

<p style="text-align: center;">Keep the decon solution out of the patient's eyes.</p>
---

8-66. **Combat medic care.** The combat medic gently cuts away the bandage. He decontaminates the area around the wound and irrigates it with a 0.5 percent chlorine solution. If bleeding begins, he replaces the bandage with a clean one. He replaces the old tourniquet by placing a new one ½ to 1 inch above the old one. He then removes the old tourniquet and decontaminates the patient's skin with an SDK or a 0.5 percent chlorine solution. He does not remove a splint. He decontaminates the splint by thoroughly rinsing it, to include the padding and cravats, with a 0.5 percent chlorine solution.

8-67. **Contaminated-waste disposal.** Dispose of contaminated bandages and coverings by placing them in a contaminated-waste bag. Seal the bag and place it in the contaminated-waste dump.

### Step 7 - Proceed Through the Shuffle Pit to the Clean Treatment Area

8-68. Have the decontaminated patient proceed through the shuffle pit to the clean treatment area. To ensure that the patient's boots are well decontaminated, have him stir the contents of the shuffle pit with his boots as he crosses it. The patient's combat boots and protective mask will be removed at the entrance of the CPS or clean treatment area.

---

## **BIOLOGICAL-AGENT PATIENT DECON PROCEDURES**

8-69. The decon station as established for chemical-agent patients is also used for biologically contaminated patients. The 8-man, patient-decon team is required for biologically contaminated patient-decon procedures.

### **LITTER PATIENT**

8-70. The decon procedures for a litter patient that is contaminated with a biological agent are described in the following paragraphs. Some procedures can be done with one soldier, while others require more than one.

#### **Step 1 - Decon the Patient's Mask and Hood**

8-71. **Move the patient to the clothing removal station.** After the patient has been triaged and stabilized (if necessary) by the senior medic in the patient-decon area, move him to the litter stands at the clothing removal station.

8-72. **Decon the hood.** Use a 0.5 percent chlorine solution to wipe down the front, sides, and top of the hood.

8-73. **Remove the hood.** Remove the hood by cutting it with scissors or by loosening it from the mask attachment points for the quick-doff hood or other similar hoods (see Figure 8-3, page 8-6). Before cutting the hood, dip the scissors in a 5 percent chlorine solution. Cut the neck cord and the small string under the voicemitter. Release or cut the hood shoulder straps and unzip the hood zipper. Cut the hood upward to the top of the eye-lens outsert, staying close to the filter-inlet cover and eye-lens outsert, then across the forehead to the outer edge of the other eye-lens outsert. Proceed downward toward the patient's shoulder, staying close to the eye-lens outsert and filter-inlet cover, then across the lower part of the voicemitter to the zipper. After dipping the scissors in the 5 percent chlorine solution, cut the hood from the center of the forehead over the top of the head. Fold the left and right sides of the hood to the side of the patient's head, laying the sides of the hood on the litter.

8-74. **Decon the protective mask and exposed skin.** Use a 0.5 percent chlorine solution to wipe the external parts of the mask. Cover the mask's air inlets with gauze or your hand to keep the mask filter dry. Wash the exposed areas of the patient's face, to include the neck and behind the ears, with soap and warm water or wipe them with a 0.5 percent chlorine solution. Do not remove the protective mask.

8-75. **Remove the FMC.** Cut the patient's FMC tie wire, allowing the FMC to fall into a plastic bag. Seal the plastic bag and rinse the outside of the bag with a 0.5 percent chlorine solution. Place the plastic bag under the back of the protective mask's head straps. The FMC will remain with the patient in the contaminated area and a clean copy will be made before the patient is moved to the clean area.

#### **Step 2 - Remove Gross Contamination From the Patient's Protective Overgarment**

8-76. Remove all visible contamination spots from the overgarment by using a 0.5 percent chlorine solution.

**Step 3 - Remove the Patient's Personal Effects and Protective Overgarment**

**8-77. Remove the patient's personal effects.** Remove the patient's personal effects from his protective overgarment and BDU pockets. Place the articles in a plastic bag, label the bag with the patient's identification, and seal the bag. If the articles are not contaminated, they are returned to the patient. If the articles are contaminated, place them in the contaminated holding area until they can be decontaminated, then return them to the patient.

**CAUTION**

Bandages may have been applied to control severe bleeding; therefore, they are treated like tourniquets. Only medical personnel will remove bandages, tourniquets, and splints.

**NOTE: The overgarment jacket and trousers will be cut simultaneously. One soldier cuts the jacket, while another soldier cuts the trousers.**

**8-78. Cut and remove the overgarment jacket.** Before cutting the overgarment jacket and trouser, dip the scissors in a 5 percent chlorine solution to prevent contamination of the patient's BDU or undergarments. Make two cuts, one up each sleeve from the wrist up to the shoulder and then across the shoulder through the collar (Figure 8-4, page 8-7). Cut around bandages, tourniquets, and splints, leaving them in place. Do not allow your gloves to touch the patient along the cut line. Keep the cuts close to the inside of the arms so that most of the sleeve material can be folded outward. Unzip the jacket and roll the chest sections to the respective sides, with the inner surface outward. Continue by tucking the clothing between the arm and chest. Roll the cut sleeves away from the arms, exposing the black liner.

**8-79. Cut and remove the overgarment trousers.** Cut both trousers legs starting at the ankle as shown in Figure 8-5, page 8-8. Keep the cuts near the inside of the legs, along the inseam, to the crotch. Cut the left leg all the way to the waist, avoiding the pockets. Cut the right leg across at the crotch to the left leg cut. Cut around bandages, tourniquets, and splints, leaving them in place. Place the scissors in a 5 percent chlorine solution. Fold the cut trouser halves away from the patient and allow the halves to drop to the litter with the contaminated (green) side down. Roll the inner leg portion under and between the legs.

**8-80. Remove the outer gloves.** Before touching the patient, the patient-decon team decontaminates its gloves with a 5 percent chlorine solution. Lift the patient's arms up and out of the cutaway sleeves unless detrimental to his condition. Grasp the fingers of the gloves, roll the cuffs over the fingers, and turn the gloves inside out. Do not remove the inner cotton gloves at this time. Carefully lower the patient's arms across the chest after the outer gloves have been removed (Figure 8-6, page 8-8). Do not allow the patient's arms to come into contact with the exterior of his overgarment. Drop his gloves into the contaminated-waste bag. The team members decon their gloves with the 5 percent chlorine solution.

8-81. **Remove the overboots.** Cut the overboot laces and fold the lacing eyelets flat outward. While standing at the foot of the litter, hold the patient's heel with one hand. Pull the overboot downward, then toward you to remove it. Remove the two overboots simultaneously. This reduces the likelihood of contaminating one of the combat boots.

8-82. While holding the patient's heels off the litter, have a team member wipe the end of the litter with a 0.5 percent chlorine solution to neutralize any contamination that was transferred to the litter from the overboots. Lower the patient's heels onto the decontaminated litter. Place the overboots in the contaminated-waste bag. The team members decontaminate their gloves with the 5 percent chlorine solution.

#### **Step 4 - Remove the Patient's BDU and Undergarments**

8-83. **Cut and remove the BDU.** To cut and remove the BDU jacket and trousers, follow the procedures (described in paragraphs 8-78 and 8-79) for removing the protective overgarment.

8-84. **Remove the combat boots.** Cut the bootlaces along the tongue. Remove the boots by pulling them toward you. Place the boots in the contaminated-waste bag. Do not touch the patient's skin with your contaminated gloves when removing his boots.

8-85. **Cut and remove the undergarments.** Follow the procedures for cutting away the protective overgarment and rolling it away from the patient (see paragraphs 8-78 and 8-79). If the patient is wearing a brassiere, cut it between the cups. Cut both shoulder straps where they attach to the cups and lay them back off of the shoulders. Remove the socks and cotton gloves. Do not remove the identification tags.

#### **Step 5 - Transfer the Patient to a Decon Litter**

8-86. After the patient's clothing has been cut away, transfer him to a decon litter or a canvas litter with a plastic-sheeting cover. Three decon team members decon their gloves and aprons with a 5 percent chlorine solution. One member places his hands under the patient's legs at the thighs and Achilles tendons, a second member places his arms under the patient's back and buttocks, and a third member places his arms under the patient's shoulders and supports the head and neck. They carefully lift the patient using their knees (not their backs) to minimize back strain. While the patient is elevated, another decon team member removes the litter from the litter stands and replaces it with a decontaminated (clean) litter. The patient is carefully lowered onto the clean litter. The clothing and overgarments are placed in a contaminated-waste bag and moved to the contaminated-waste dump. The dirty litter is rinsed with the 0.5 percent chlorine solution and placed in the litter storage area.

#### **Step 6 - Decon the Patient's Skin**

8-87. **Spot decon.** With the patient in a supine position, spot decon the skin by washing it with soap and warm water or by wiping it with a 0.5 percent chlorine solution. Decon areas of potential contamination, to include areas around the neck, wrists, and lower parts of the face. Decon the patient's identification tags and chain, if necessary.



**NOTES:**

**1. Use a 0.5 percent chlorine solution to decon patients suspected of being contaminated with mycotoxins.**

**2. A complete body wash is not appropriate and may be harmful to the patient. During a complete body wash, the patient would have to be rolled over to reach all areas of the skin. This is not necessary for an adequate decon.**

**8-88. Combat medic care.** The combat medic gently cuts away the bandage. He decontaminates the area around the wound and irrigates it with a 0.5 percent chlorine solution. If bleeding begins, he replaces the bandage with a clean one. He replaces the old tourniquet by placing a new one ½ to 1 inch above the old one. He then removes the old tourniquet and decontaminates the patient's skin with a 0.5 percent chlorine solution. He does not remove a splint. He decontaminates the splint by thoroughly rinsing it, to include the padding and cravats, with a 0.5 percent chlorine solution.

**WARNING**

**Do not use an SDK around any wounds. Do not remove splints. The splint will not be removed until the patient has been evacuated to a forward MTF or hospital.**

**8-89. Completeness of decon check.** Check the patient with M8 detector paper or the CAM for completeness of decon.

**NOTE: Other monitoring devices may be used, if available.**

**8-90. Contaminated-waste disposal.** Dispose of contaminated bandages and coverings by placing them in a contaminated-waste bag. Seal the bag and place it in the contaminated-waste dump.

**Step 7 - Transfer the Patient to the Hot Line**

**8-91.** The patient's clothing has been cut away and his skin, bandages, and splints have been decontaminated. Transfer the patient to the hot line and place the litter on the litter stands. A third team member will assist with transferring the patient to a clean treatment litter at the hot line. Decon personnel rinse or wipe down their aprons and gloves with a 5 percent chlorine solution.

**8-92.** Three team members lift the patient off the decon litter (see step 5 for lifting procedures). While the patient is elevated, another team member removes the litter from the stands and returns it to the decon area. A medic from the clean side of the hot line replaces the litter with a clean one. The patient is lowered onto the clean litter. Two medics from the clean side of the hot line move the patient to the clean treatment area. The patient is treated in this area or awaits processing into the CPS. The litter is wiped down with a 0.5 percent chlorine solution in preparation for reuse. Once the patient is in the air lock of the CPS and the air lock has been purged, his protective mask is removed. Place the mask in a plastic bag and seal it.

**NOTE: Before decontaminating another patient, each decon team member drinks about half a quart of water. The exact amount of water consumed is increased or decreased according to the work level and temperature (see Table 8-2, page 8-11).**

### **AMBULATORY PATIENT**

8-93. The decon procedures for an ambulatory patient that is contaminated with a biological agent are described in the following paragraphs. Some procedures can be done with one soldier, while others require more than one.

8-94. All ambulatory patients requiring EMT or AMT in the clean treatment area of the BAS will be decontaminated. Stable patients not requiring treatment at the BAS, but requiring evacuation to the medical company's clearing station or a corps hospital for treatment (for example, a patient with a broken arm), should be evacuated in their protective overgarments and masks by any available transportation. However, before evacuation, spot remove all thickened agents from their protective overgarment.

**NOTE: Place the bandage scissors that are used in this procedure in a container of 5 percent chlorine solution when not in use. Most ambulatory patients will be treated in the contaminated treatment area and returned to duty. Upon removal of an ambulatory patient's clothing, he becomes a litter patient. The BAS and clearing station do not have clothing to replace those that are cut off during the decon process. The patient must be placed in a PPW for protection during evacuation (Figure 8-7, page 8-12).**

#### **Step 1 - Remove the LCE**

8-95. Remove the LCE by unfastening/unbuttoning all connectors or tie straps and then place the equipment in a plastic bag. Place the plastic bag in the designated storage area for later decon.

#### **Step 2 - Decon the Patient's Mask and Hood**

8-96. **Begin the clothing removal process.** After the patient has been triaged and treated (if necessary) by the senior medic in the patient-decon station, the clothing removal process begins.

8-97. **Decon the hood.** Use a 0.5 percent chlorine solution to wipe down the front, sides, and top of the hood.

8-98. **Remove the hood.** Remove the hood by cutting it with scissors or by loosening it from the mask attachment points for the quick-doff hood or other similar hoods (Figure 8-3, page 8-6). Before cutting the hood, dip the scissors in a 5 percent chlorine solution. Cut the neck cord and the small string under the voicemitter. Release or cut the hood shoulder straps and unzip the hood zipper. Cut the hood upward to the top of the eye-lens outsert, staying close to the filter-inlet cover and eye-lens outsert, then across the forehead to the outer edge of the other eye-lens outsert. Proceed downward toward the patient's shoulder, staying close to the eye-lens outsert and filter-inlet cover, then across the lower part of the voicemitter to the zipper. After dipping the scissors in the 5 percent chlorine solution, cut the hood from the center of the forehead over the top of the head. Fold the left and right sides of the hood away from the patient's head and remove the hood.

8-99. **Decon the protective mask and exposed skin.** Use a 0.5 percent chlorine solution to decon the external parts of the mask. Cover the mask's air inlets with gauze or your hands to keep the mask filters dry. Wash the exposed areas of the patient's face, to include the neck and behind the ears, with soap and warm water or wipe them with a 0.5 percent chlorine solution. Do not remove the protective mask.

8-100. **Remove the FMC.** Cut the patient's FMC tie wire, allowing the FMC to fall into a plastic bag. Seal the plastic bag and rinse the outside of the bag with a 5 percent chlorine solution. Place the plastic bag under the back of the protective mask's head straps. The FMC will remain with the patient in the contaminated area and a clean copy will be made before the patient is moved to the clean area.

### **Step 3 - Remove Gross Contamination From the Patient's Protective Overgarment**

8-101. Remove all visible contamination spots from the overgarment by using a 0.5 percent chlorine solution.

### **Step 4 - Remove the Patient's Personal Effects and Protective Overgarment**

8-102. **Remove the patient's personal effects.** Remove the patient's personal effects from his protective overgarment and BDU pockets. Place the articles in a plastic bag, label the bag with the patient's identification, and seal the bag. If the articles are not contaminated, they are returned to the patient. If the articles are contaminated, place them in the contaminated holding area until they can be decontaminated, then return them to the patient.

8-103. **Remove the overgarment jacket.** Have the patient stand with his feet spread apart at shoulder width. Unsnap the front flap of the jacket and unzip the jacket. If the patient can extend his arms, have him clinch his fist and extend his arms backward at about a 30° angle. Move behind the patient, grasp his jacket collar at the sides of the neck, and peel the jacket off the shoulders at a 30° angle down and away from the patient. Avoid any rapid or sharp jerks, which spread contamination. Gently pull the inside sleeves over the patient's wrists and hands.

8-104. If the patient cannot extend his arms, you must cut the jacket to aid in its removal. Before cutting the overgarment jacket, dip the scissors in a 5 percent chlorine solution to prevent contamination of the patient's BDU or undergarment. As with the litter patient, make two cuts, one up each sleeve from the wrist up to the shoulder and then across the shoulder through the collar. Cut around bandages, tourniquets, and splints, leaving them in place. Do not allow your gloves to touch the patient along the cut line. Peel the jacket back and downward to avoid spreading contamination. Ensure that the outside of the jacket does not touch the patient or his inner clothing.

8-105. **Cut and remove the overgarment trousers.** Unfasten or cut all ties, buttons, or zippers before grasping the trousers at the waist and peeling them down over the patient's combat boots. Again, the trousers are cut to aid in removal. If necessary, cut both trouser legs starting at the ankle. Keep the cuts near the inside of the legs, along the inseam, to the crotch. Cut around all bandages, tourniquets, and splints. Continue to cut up both sides of the zipper to the waist and allow the narrow strip with the zipper to drop between the legs.

Peel or allow the trouser halves to drop to the ground. Have the patient step out of the trouser legs one at a time. Place the trousers in the contaminated-waste bag. Place the scissors in a 5 percent chlorine solution.

**8-106. Remove the outer gloves.** Grasp the fingers of the gloves, roll the cuffs over the fingers, and turn the gloves inside out. Do not remove the inner cotton gloves at this time. Drop the gloves into the contaminated-waste bag. Do not allow the patient to touch his clothing or other contaminated objects with his hands.

**8-107. Remove the overboots.** Cut the overboot laces and fold the lacing eyelets flat on the ground. Step on the toe and heel eyelets to hold the overboot on the ground and have the patient step out of it. Repeat this procedure for the other overboot. If the overboots are in good condition, they can be decontaminated and reissued.

**8-108. Remove the patient's cotton glove liners.** Instruct the patient to remove his cotton glove liners to reduce the possibility of spreading contamination. Have the patient grasp the heel of one glove liner with the other gloved hand, peeling it off of his hand. Hold the removed glove by the inside and grasp the heel of the other glove, peeling it off of his hand. Place both gloves in the contaminated-waste bag.

#### **Step 5 - Check the Patient for Contamination**

**8-109.** After the patient's overgarment has been removed, check his BDU by using M8 detector paper or the CAM. Carefully survey the patient, paying particular attention to discolored areas, damp spots, and tears on the uniform; areas around the neck, wrists, and ears; and bandages, tourniquets, and splints. Remove contaminated spots by washing with soap and water, by wiping with a 0.5 percent chlorine solution or, if possible, by cutting away the contaminated area. Always dip the scissors in a 5 percent chlorine solution after each cut. Recheck the area with the detection equipment. If significant contamination is found on the BDU, then remove it and spot decon the skin. To remove the BDU, follow the procedures for removing the protective overgarment as described in paragraphs 8-103 through 8-105. Do not remove the patient's identification tags.

#### **Step 6 - Decon the Patient's Skin**

**8-110. Spot decon.** Use soap and water or a 0.5 percent chlorine solution to spot decon the skin and areas of potential contamination, to include areas around the neck, wrists, and lower parts of the face. Decon the patient's identification tags and chain, if necessary.

**8-111.** Have the patient hold his breath, close his eyes, and lift, or assist him with lifting, his mask at the chin. Wash his face and exposed areas of the skin with soap and water or wipe them with a 0.5 percent chlorine solution. Starting at the top of the ear and quickly wiping downward, wipe all folds in the skin, ear lobes, upper lip, chin, dimples, and nose. Continue up the other side of the face to the top of the other ear. Wipe the inside of the mask where it touches the face. Have the patient reseal and check his mask.

#### **CAUTION**

Keep the decon solution out of the patient's eyes.

8-112. **Combat medic care.** The combat medic gently cuts away the bandage. He decontaminates the area around the wound and irrigates it with a 0.5 percent chlorine solution. If bleeding begins, he replaces the bandage with a clean one. He replaces the old tourniquet by placing a new one ½ to 1 inch above the old one. He then removes the old tourniquet and decontaminates the patient's skin with an SDK or a 0.5 percent chlorine solution. He does not remove a splint. He decontaminates the splint by thoroughly rinsing it, to include the padding and cravats, with a 0.5 percent chlorine solution.

**NOTE: Use a 0.5 percent chlorine solution to decon ambulatory patients suspected of being contaminated with mycotoxins.**

8-113. **Contaminated-waste disposal.** Dispose of contaminated bandages and coverings by placing them in a contaminated-waste bag. Seal the bag and place it in the contaminated-waste dump.

#### **Step 7 - Cross the Hot Line to the Clean Treatment Area**

8-114. Have the decontaminated patient cross the hot line to the clean treatment area. The patient's boots must be decontaminated at the hot line before enters the clean area. The patient's combat boots and protective mask will be removed at the entrance of the CPS or clean treatment area.

### **RADIOLOGICAL-AGENT PATIENT DECON PROCEDURES**

8-115. The decon of patients that are contaminated with radiation is easily accomplished without interfering with the required medical care. The 8-man, patient-decon team is required to perform the decon procedures on patients contaminated with radiation.

**NOTE: Patients must be monitored by using a radiac meter before, during, and after each step of the decon procedure.**

#### **LITTER PATIENT**

8-116. The decon procedures for a litter patient that is contaminated with radiation are discussed in the following paragraphs. Some procedures can be done with one soldier, while others require more than one soldier.

#### **Step 1 - Decon the Patient's Mask and Hood**

8-117. **Move the patient to the clothing removal station.** After the patient has been triaged and stabilized (if necessary) by the senior medic in the patient-decon area, move him to the litter stands at the clothing removal station.

8-118. **Decon the hood.** Brush contamination off or use soap and water to wipe down the front, sides, and top of the hood.

8-119. **Remove the hood.** Remove the hood by cutting it with scissors or by loosening it from the mask attachment points for the quick-doff hood or other similar hoods (see Figure 8-3, page 8-6). Before cutting the hood, dip the scissors in a 5 percent chlorine solution. Cut the neck cord and the small string under the voicemitter. Release or cut the hood shoulder straps and unzip the hood zipper. Cut the hood upward to the top of the eye-lens outsert, staying close to the filter-inlet cover and eye-lens outsert, then across the

forehead to the outer edge of the other eye-lens outsert. Proceed downward toward the patient's shoulder, staying close to the eye-lens outsert and filter-inlet cover, then across the lower part of the voicemitter to the zipper. After dipping the scissors in the 5 percent chlorine solution, cut the hood from the center of the forehead over the top of the head. Fold the left and right sides of the hood to the side of the patient's head, laying the sides of the hood on the litter.

**8-120. Decon the protective mask and exposed skin.** Use soap and water to wipe the external parts of the mask. Cover the mask's air inlets with gauze or your hand to keep the mask filter dry. Wash the exposed areas of the patient's face, to include the neck and behind the ears, with soap and warm water. Do not remove the protective mask.

**8-121. Remove the FMC.** Cut the patient's FMC tie wire, allowing the FMC to fall into a plastic bag. Seal the plastic bag and rinse the outside of the bag with soap and water. Place the plastic bag under the back of the protective mask's head straps. The FMC will remain with the patient in the contaminated area and a clean copy will be made before the patient is moved to the clean area.

### **Step 2 - Remove Gross Contamination From the Patient's Protective Overgarment**

**8-122.** Remove all visible contamination spots from the overgarment by brushing off or by washing with soap and water.

### **Step 3 - Remove the Patient's Personal Effects and Protective Overgarment**

**8-123. Remove the patient's personal effects.** Remove the patient's personal effects from his protective overgarment and BDU pockets. Place the articles in a plastic bag, label the bag with the patient's identification, and seal the bag. If the articles are not contaminated, they are returned to the patient. If the articles are contaminated, place them in the contaminated holding area until they can be decontaminated, then return them to the patient.

#### **CAUTION**

Bandages may be applied to control severe bleeding; therefore, they are treated like tourniquets. Only medical personnel will remove bandages.

**NOTE: The overgarment jacket and trousers will be cut simultaneously. One soldier cuts the jacket, while another soldier cuts the trousers.**

**8-124. Cut and remove the overgarment jacket.** Before cutting the overgarment jacket and trousers, dip the scissors in a 5 percent chlorine solution to prevent contamination of the patient's BDU or undergarment. Make two cuts, one up each sleeve from the wrist up to the shoulder and then across the shoulder through the collar (Figure 8-4, page 8-7). Cut around bandages, tourniquets, and splints, leaving them in place. Do not allow your gloves to touch the patient along the cut line. Keep the cuts close to the inside of the arms so that most of the sleeve material can be folded outward. Unzip the jacket and roll the chest sections to the respective sides, with the inner

surface outward. Continue by tucking the clothing between the arm and chest. Roll the cut sleeves away from the arms, exposing the black liner.

**8-125. Cut and remove the overgarment trousers.** Cut both trousers legs starting at the ankle as shown in Figure 8-5, page 8-8. Keep the cuts near the inside of the legs, along the inseam, to the crotch. Cut the left leg all the way to the waist, avoiding the pockets. Cut the right leg across at the crotch to the left leg cut. Cut around bandages, tourniquets, and splints, leaving them in place. Place the scissors in a 5 percent chlorine solution. Fold the cut trouser halves away from the patient and allow the halves to drop to the litter with the contaminated- (green-) side down. Roll the inner leg portion under and between the legs.

**8-126. Remove the outer gloves.** Before touching the patient, the patient-decon team decontaminates its gloves with a 5 percent chlorine solution. Lift the patient's arms up and out of the cutaway sleeves unless detrimental to his condition. Grasp the fingers of the gloves, roll the cuffs over the fingers, and turn the gloves inside out. Do not remove the inner cotton gloves at this time. Carefully lower the patient's arms across the chest after the outer gloves have been removed (Figure 8-6, page 8-8). Do not allow the patient's arms to come into contact with the exterior of his overgarment. Drop his gloves into the contaminated-waste bag. The team members decon their gloves with the 5 percent chlorine solution.

**8-127. Remove the overboots.** Cut the overboot laces and fold the lacing eyelets flat outward. While standing at the foot of the litter, hold the patient's heel with one hand. Pull the overboot downward, then toward you to remove it. Remove the two overboots simultaneously. This reduces the likelihood of contaminating one of the combat boots.

**8-128.** While holding the patient's heels off the litter, have a team member wipe the end of the litter with a 0.5 percent chlorine solution to neutralize any contamination that was transferred to the litter from the overboots. Lower the patient's heels onto the decontaminated litter. Place the overboots in the contaminated-waste bag. The team members decon their gloves with the 5 percent chlorine solution.

**NOTE: Patients arriving at the MTF in MOPP gear will only have their MOPP gear removed. They will remain in their BDUs unless contamination is found on them. If contamination is found, follow the procedures for removing the protective overgarment as described in paragraphs 8-124 and 8-125.**

#### **Step 4 - Check the Patient for Contamination**

**8-129.** After the patient's overgarment has been removed, check his BDU by using M8 detector paper or the CAM. Carefully survey the patient, paying particular attention to discolored areas, damp spots, and tears on the uniform; areas around the neck, wrists, and ears; and bandages, tourniquets, and splints. Remove contaminated spots by washing with soap and water, by wiping with a 0.5 percent chlorine solution or, if possible, by cutting away the contaminated area. Always dip the scissors in a 5 percent chlorine solution after each cut. Recheck the area with the detection equipment. If significant contamination is found on the BDU, then remove it and spot decon the skin.

To remove the BDU, follow the procedures for removing the protective overgarment as described in paragraphs 8-124 and 8-125. Do not remove the patient's identification tags.

#### Step 5 - Decon the Patient's Skin

8-130. **Spot decon.** Wash exposed skin surfaces with soap and warm water, to include areas around the neck, wrists, and lower parts of the face. Decon the patient's identification tags and chain, if necessary.

8-131. **Combat medic care.** The combat medic gently cuts away the bandage. He decontaminates the area around the wound and irrigates it with a 0.5 percent chlorine solution. If bleeding begins, he replaces the bandage with a clean one. He replaces the old tourniquet by placing a new one  $\frac{1}{2}$  to 1 inch above the old one. He then removes the old tourniquet and decontaminates the patient's skin with a 0.5 percent chlorine solution. He does not remove a splint. He decontaminates the splint by thoroughly rinsing it, to include the padding and cravats, with a 0.5 percent chlorine solution.

#### WARNING

Do not use an SDK around any wounds. Do not remove splints. The splint will not be removed until the patient has been evacuated to a forward MTF or hospital.

8-132. **Completeness of decon check.** Check the patient with M8 detector paper or the CAM for completeness of decon.

**NOTE: Other monitoring devices may be used, if available.**

8-133. **Contaminated-waste disposal.** Dispose of contaminated bandages and coverings by placing them in a contaminated-waste bag. Seal the bag and place it in the contaminated-waste dump.

#### Step 6 - Transfer the Patient to the Hot Line

8-134. Move the patient to the hot line. Two medics from the clean side of the hot line move the patient into the clean treatment area.

**NOTE: Before decontaminating another patient, each decon team member drinks about half a quart of water. The exact amount of water consumed is increased or decreased according to the work level and temperature (see Table 8-2, page 8-11).**

#### AMBULATORY PATIENT

8-135. The decon procedures for an ambulatory patient that is contaminated with radiation are discussed in the following paragraphs. Some procedures can be done with one soldier, while others require more than one.

8-136. All ambulatory patients requiring EMT or AMT in the clean area of the BAS will be decontaminated. Stable patients not requiring treatment at the BAS, but requiring evacuation to the medical company's clearing station or a corps hospital for treatment (for example, a patient with a broken arm), should be evacuated in their protective overgarments and masks by any



available transportation. However, before evacuation, spot remove all thickened agents from their protective overgarment.

**NOTE: Place the bandage scissors that are used in this procedure in a container of 5 percent chlorine solution when not in use. Most ambulatory patients will be treated in the contaminated treatment area and returned to duty. Upon removal of an ambulatory patient's clothing, he becomes a litter patient. The BAS and clearing station do not have clothing to replace those that are cut off during the decon process. The patient must be placed in a PPW for protection during evacuation (Figure 8-7, page 8-12).**

### **Step 1 - Remove the LCE**

8-137. Remove the LCE by unfastening/unbuttoning all connectors or tie straps and then place the equipment in a plastic bag. Place the plastic bag in the designated storage area for later decon.

### **Step 2 - Decon the Patient's Mask and Hood**

8-138. **Begin the clothing removal process.** After the patient has been triaged and treated (if necessary) by the senior medic in the patient-decon station, the clothing removal process begins.

8-139. **Decon the hood.** Brush off contamination or use soap and water to wipe down the front, sides, and top of the hood.

8-140. **Remove the hood.** Remove the hood by cutting it with scissors or by loosening it from the mask attachment points for the quick-doff hood or other similar hoods (see Figure 8-3, page 8-6). Before cutting the hood, dip the scissors in a 5 percent chlorine solution. Cut the neck cord and the small string under the voicemitter. Release or cut the hood shoulder straps and unzip the hood zipper. Cut the hood upward to the top of the eye-lens outsert, staying close to the filter-inlet cover and eye-lens outsert, then across the forehead to the outer edge of the other eye-lens outsert. Proceed downward toward the patient's shoulder, staying close to the eye-lens outsert and filter-inlet cover, then across the lower part of the voicemitter to the zipper. After dipping the scissors in the 5 percent chlorine solution, cut the hood from the center of the forehead over the top of the head. Fold the left and right sides of the hood away from the patient's head and remove the hood.

8-141. **Decon the protective mask and exposed skin.** Use soap and water to wipe the external parts of the mask. Cover the mask's air inlets with gauze or your hands to keep the mask filters dry. Wash the exposed areas of the patient's face, to include the neck and behind the ears, with soap and warm water. Do not remove the protective mask.

8-142. **Remove the FMC.** Cut the patient's FMC tie wire, allowing the FMC to fall into a plastic bag. Seal the plastic bag and rinse the outside of the bag with a 5 percent chlorine solution. Place the plastic bag under the back of the protective mask's head straps. The FMC will remain with the patient in the contaminated area and a clean copy will be made before the patient is moved to the clean area.

---

**Step 3 - Remove Gross Contamination From the Patient's Protective Overgarment**

8-143. Remove all visible contamination spots by brushing off or by washing with soap and water.

**Step 4 - Remove the Patient's Personal Effects and Protective Overgarment**

8-144. **Remove the patient's personal effects.** Remove the patient's personal effects from his protective overgarment and BDU pockets. Place the articles in a plastic bag, label the bag with the patient's identification, and seal the bag. If the articles are not contaminated, they are returned to the patient. If the articles are contaminated, place them in the contaminated holding area until they can be decontaminated, then return them to the patient.

8-145. **Remove the overgarment jacket.** Have the patient stand with his feet spread apart at shoulder width. Unsnap the front flap of the jacket and unzip the jacket. If the patient can extend his arms, have him clench his fist and extend his arms backward at about a 30° angle. Move behind the patient, grasp his jacket collar at the sides of the neck, and peel the jacket off the shoulders at a 30° angle down and away from the patient. Avoid any rapid or sharp jerks, which spread contamination. Gently pull the inside sleeves over the patient's wrists and hands.

8-146. If the patient cannot extend his arms, you must cut the jacket to aid in its removal. Before cutting the overgarment jacket, dip the scissors in a 5 percent chlorine solution to prevent contamination of the patient's BDU or undergarment. As with the litter patient, make two cuts, one up each sleeve from the wrist up to the shoulder and then across the shoulder through the collar. Cut around bandages, tourniquets, and splints, leaving them in place. Do not allow your gloves to touch the patient along the cut line. Peel the jacket back and downward to avoid spreading contamination. Ensure that the outside of the jacket does not touch the patient or his inner clothing.

8-147. **Cut and remove the overgarment trousers.** Unfasten or cut all ties, buttons, or zippers before grasping the trousers at the waist and peeling them down over the patient's combat boots. Again, the trousers are cut to aid in removal. If necessary, cut both trouser legs starting at the ankle. Keep the cuts near the inside of the legs, along the inseam, to the crotch. Cut around all bandages, tourniquets, and splints. Continue to cut up both sides of the zipper to the waist and allow the narrow strip with the zipper to drop between the legs. Peel or allow the trouser halves to drop to the ground. Have the patient step out of the trouser legs one at a time. Place the trousers in the contaminated-waste bag. Place the scissors in a 5 percent chlorine solution.

8-148. **Remove the outer gloves.** Grasp the fingers of the gloves, roll the cuffs over the fingers, and turn the gloves inside out. Do not remove the inner cotton gloves at this time. Drop the gloves into the contaminated-waste bag. Do not allow the patient to touch his clothing or other contaminated objects with his hands.

8-149. **Remove the overboots.** Cut the overboot laces and fold the lacing eyelets flat on the ground. Step on the toe and heel eyelets to hold the overboot on the ground and have the patient step out of it. Repeat this

procedure for the other overboot. If the overboots are in good condition, they can be decontaminated and reissued.

8-150. **Remove the patient's cotton glove liners.** Instruct the patient to remove his cotton glove liners to reduce the possibility of spreading contamination. Have the patient grasp the heel of one glove liner with the other gloved hand, peeling it off of his hand. Hold the removed glove by the inside and grasp the heel of the other glove, peeling it off of his hand. Place both gloves in the contaminated-waste bag.

#### **Step 5 - Check the Patient for Contamination**

8-151. After the patient's overgarment has been removed, check his BDU by using M8 detector paper or the CAM. Carefully survey the patient, paying particular attention to discolored areas, damp spots, and tears on the uniform; areas around the neck, wrists, and ears; and bandages, tourniquets, and splints. Remove contaminated spots by washing with soap and water. Always dip the scissors in a 5 percent chlorine solution after each cut. Recheck the area with the detection equipment. If significant contamination is found on the BDU, then remove it and spot decon the skin. To remove the BDU, follow the procedures for removing the protective overgarment as described in paragraphs 8-145 through 8-147. Do not remove the patient's identification tags.

#### **Step 6 - Decon the Patient's Skin**

8-152. **Spot decon.** Wash exposed skin surfaces with soap and warm water, to include areas around the neck, wrists, and lower parts of the face. Decon the patient's identification tags and chain, if necessary.

8-153. Have the patient hold his breath, close his eyes, and lift, or assist him with lifting, his mask at the chin. Wipe his face and exposed areas of the skin with soap and water. Starting at the top of the ear and quickly wiping downward, wipe all folds in the skin, ear lobes, upper lip, chin, dimples, and nose. Continue up the other side of the face to the top of the other ear. Wipe the inside of the mask where it touches the face. Have the patient reseal and check his mask.

8-154. **Combat medic care.** The combat medic gently cuts away the bandage. He decontaminates the area around the wound and irrigates it with a 0.5 percent chlorine solution. If bleeding begins, he replaces the bandage with a clean one. He replaces the old tourniquet by placing a new one ½ to 1 inch above the old one. He then removes the old tourniquet and decontaminates the patient's skin with a 0.5 percent chlorine solution. He does not remove a splint. He decontaminates the splint by thoroughly rinsing it, to include the padding and cravats, with a 0.5 percent chlorine solution.

8-155. **Contaminated-waste disposal.** Dispose of contaminated bandages and coverings by placing them in a contaminated-waste bag. Seal the bag and place it in the contaminated-waste dump.

#### **Step 7 - Transfer the Patient to the Hot Line**

8-156. Have the decontaminated patient cross the hot line to the clean treatment area. The patient's boots must be decontaminated at the hot line

before he enters the clean area. The patient's combat boots and protective mask will be removed at the entrance of the CPS or clean treatment area.

**NOTE: Before decontaminating another patient, each decon team member drinks about half a quart of water. The exact amount of water consumed is increased or decreased according to the work level and temperature (see Table 8-2, page 8-11).**

## Chapter 9

# Logistics

The materials that are needed to conduct decon operations are identified in this chapter.

### **SKIN DECON AND PERSONAL WIPE DOWN**

9-1. Each soldier carries his own skin-decon supplies. The SDK is stored in the right cargo pocket of the overgarment trousers or BDU trousers. The basis of issue per soldier is two SDKs (12 packets). Each kit contains six individual decon packets. The unit maintains at least one SDK per assigned person for resupply. Personal wipe down is also done with these kits.

### **INDIVIDUAL-GEAR DECON**

9-2. The standard decon kit for individual gear is the IEDK. Each soldier carries an IEDK in the right cargo pocket of his overgarment trousers or BDU trousers. The basis of issue per soldier is one IEDK. Each kit contains four individual decon packets, enough to decon two complete sets of individual gear. The unit maintains at least one IEDK per assigned soldier for resupply.

### **OPERATOR'S SPRAY DOWN**

9-3. The M11 or M13 is the decon apparatus used for the operator's spray down. Fill the M11 with a 1 <sup>1</sup>/<sub>3</sub>-quart can of DS2 before use. The IEDK can be used on equipment that the DS2 may cause damage to by corrosive action.

9-4. Four nitrogen cylinders and two 1 <sup>1</sup>/<sub>3</sub>-quart cans of DS2 should be carried in the vehicle with each M11 (two nitrogen cylinders are authorized per can of DS2). Use the nitrogen cylinders to pressurize the M11 during use. Operating the M11 in below-freezing weather (below 32°F) requires two nitrogen cylinders to expend its contents.

9-5. Units maintain limited spare parts and accessories. They are not required to maintain additional stocks of 1 <sup>1</sup>/<sub>3</sub>-quart cans of DS2. The 5-gallon pails that are authorized to each unit can be used to refill empty M11s until a resupply of 1 <sup>1</sup>/<sub>3</sub>-quart cans of DS2 is received from the battalion.

9-6. The M13 comes with a 3.7 gallon DS2 container.

### **MOPP-GEAR EXCHANGE**

9-7. Each soldier wears or carries one complete set of MOPP gear. The unit stocks a second complete set, which is sized and identified for each soldier. When a squad or platoon undergoes a MOPP-gear exchange, the unit sends a supply vehicle with replacement MOPP gear and any decontaminants (STB) to rendezvous with the contaminated element at the operational-decon site. (The procedure on how to prepare the STB dry mix is discussed in Appendix B.) Use about 40 pounds of the STB dry mix per squad-sized element. In

wartime, 5-pound quantities of the STB dry mix can be put in 1-gallon airtight containers and stored in the company's supply section.

**NOTE: Do not leave a 50-pound drum of STB dry mix open because it loses its effectiveness if left open to the air for extended periods. The unit is resupplied with MOPP gear and decontaminants from its battalion.**

9-8. Units maintain a 5 percent overage of MOPP gear based on their personnel strength or authorization (whichever is greater) to ensure a complete range of sizes and replacement gear. All MOPP gear, serviceable and unserviceable, is handled as organizational clothing and equipment (Class II supplies). The higher HQ is responsible for resupply of these items.

### **VEHICLE WASHDOWN**

9-9. Like the MOPP-gear exchange, a vehicle washdown is done in the unit's AO. The battalion's PDDE crew, stationed in the battalion trains, conducts the washdown. The crew moves to the operational-decon site, rendezvous with the contaminated element, and conducts the washdown. The crew uses its PDDE to spray about 100 to 150 gallons of hot, soapy water on each vehicle to wash off the gross contamination. For vehicles such as the M1-series armored fighting vehicles, about 200 gallons of water may be required per vehicle. One hundred gallons of water per vehicle provides a 2- to 3-minute wash. To speed up the operation, the crew should heat the water before arriving at the operational-decon site. See Chapters 2 and 3 and Table 9-1 for the planning and coordination of and the requirements for a vehicle washdown.

9-10. The M12A1 PDDA injects detergent into the water as it operates. It uses 2.5 quarts of detergent for every 1,200 gallons of water (about 1 quart of soap per 450 gallons of water). The battalion decon crew should maintain a basic load of liquid all-purpose detergent, which is sufficient to decon 30 percent of the battalion's organic vehicles.

### **DETAILED TROOP DECON**

9-11. Generally, units conduct DTD in the brigade support area. Battalions conduct it in the division/corps support area. Materials for this technique usually are stocked in the battalion or brigade trains. Reconstitution operations should be closely associated with decon operations. The battalion's assessment and recovery team (ART) ensures that the material and equipment are available for the decon operation as part of the reconstitution effort.

### **DETAILED EQUIPMENT DECON**

9-12. A chemical platoon must have access to large water sources—rivers, ponds, and public water systems—to conduct the DED. The chemical unit leader estimates the amounts of decontaminants that are needed. The platoon sets up the DED site, supplies the decontaminants, and conducts the DED. The platoon should carry enough decontaminants to service one company/team/battery. A decon platoon that is assigned to support a maneuver company (about 16 vehicles per tank company) should carry a minimum of 4 gallons of liquid detergent, 48 5-gallon cans of DS2, and 10 50-pound drums of STB. The chemical platoon is usually resupplied through its parent unit. Command-assignment relationships can change the resupply channels.

**Table 9-1. Estimated Water Consumption for Decon**

Required Equipment	Time	Water Consumption
<b>Operational Decon<sup>1</sup></b>		
M12A1 PDDA or M17 LDS	1-3 minutes	100 to 150 gallons per regular vehicle 150 to 200 gallons per armored or larger vehicle Example: 15 (contaminated vehicles) x 150 (gallons of water) = 2,250 gallons <sup>2</sup>
<b>Detailed Equipment Decon<sup>3</sup></b>		
M12A1 PDDA <sup>4</sup> or M17 LDS <sup>4</sup>	See Chapter 4 for the time allowed during a primary wash and rinse. Use the proper decon method.	Vehicles: Station 1 - primary wash, 250 gallons Station 4 - rinse, 200 gallons Armored or larger vehicle: Station 1 - primary wash, 300 gallons Station 4 - rinse, 200 gallons Example: 6 vehicles x 450 gallons of water = 2,700 gallons 4 tanks x 500 gallons of water = 2,000 gallons Total: 4,700 gallons <sup>2</sup>
<b>Detailed Troop Decon</b>		
30-gallon container		The initial setup requires 258 gallons of water. The water must be exchanged after 10 troops have been decontaminated through the DTD to avoid the transfer of contamination. Station 1 (120 gallons, 4 30-gallon containers).
3-gallon container		Station 2 (6 gallons, 2 3-gallon containers).
30-gallon container		Station 4 (180 gallons, 6 30-gallon containers).
3-gallon container		Station 7 (12 gallons, 4 3-gallon containers). Example: About 150 troops are to be decontaminated through the DTD. You will need 258 gallons of water per every 10 troops. Example: 150 (number of troops) ÷ 10 (required water exchange) = 15 (the amount of times the water will need to be exchanged)  15 x 258 (gallons of water per every 10 troops) = 3,870 gallons of water for 150 troops <sup>2</sup>
<p><sup>1</sup>To reduce contamination, conduct the operator's spray down before the operational decon. This process requires less water consumption during a thorough decon.</p> <p><sup>2</sup>Always include a 10 percent planning factor to the total estimate of the water consumption for the DED and the DTD. Example: 2,250 (gallons of water for the DTD) x 10 percent = 225 (additional gallons of water). A total of 2,250 + 225 = 2,475 (gallons of water required for the DTD).</p> <p><sup>3</sup>The planner should consider vehicle predecon action to estimate water consumption. He should consider vehicles that were processed through operational decon because they will normally increase the weatherization process and may reduce water usage.</p> <p><sup>4</sup>The M17 LDS with two wands uses 14 gallons of water per minute. The M17 LDS with only one wand, which is fitted with an injector, uses 25 gallons per minute. The M12A1 PDDA pumps 25 gallons of water per minute.</p>		

9-13. Chemical platoons attached to division engineers may be resupplied through the division engineer battalion instead of their parent company. See Table 9-2 for the decon resources that are available at each organizational level. For the equipment and supplies that are needed for decon operations, see Table 9-3, pages 9-5 through 9-7.

**Table 9-2. Decon Resources Available at Each Organizational Level**

Organizational Level	Decon Resources
Individual soldiers	2 SDKs 1 canteen of water 2 IEDKs
Operators and crews	2 SDKs 2 IEDKs 1 on-board decon apparatus (M11 or M13) Soap and water 2 50-pound drums STB
Companies	2 5-gallon pails of DS2 2 immersion heaters 2 to 3 30-gallon containers 6 3-gallon containers 6 long-handled brushes 6 sponges 300 plastic trash bags
Battalion PDDE crews	PDDE (M17 LDS) Basic load, liquid detergent
Chemical company decon squad	PDDE (M12A1 PDDA/M17 LDS) Basic load, liquid detergent
Chemical company decon platoon	PDDE (M12A1 PDDA/M17 LDS) Interior decon equipment Sufficient materials to set up a DTD



Table 9-3. Equipment and Supplies Needed for Decon Operations

Minimum Amounts of Equipment and Supplies Needed for Decon Techniques							Nomenclature	NSN	Class of Supply	Unit of Issue	Basis of Issue (See TOE for Actual Authorization)***
SD*	PW*	OS*	MGX**	VW**	DTD**	DED**					
		1				***	Decon apparatus, DS2, ABC-M11 or M13 DAP	4230-00-720-1618 4230-01-113-4124	II II	Each Each	1 per every major equipment
		2					Cylinder, nitrogen filled	4230-00-775-7541	II	Box	2 per can, DS2 5 per box
1	1	1	2		35	2	Decon kit, M291 SDK M295 IEDK	4230-01-0276-1905 6850-01-3577-8456	II II	Each Each	1 per mask 2 per soldier
		1					Fluid-filled container, DS2	4230-01-136-8888	II	Each	1 per M13 DAP
					1		Filter canister, C2, or filter canister, C2A1	4240-01-119-2315 4240-01-361-1319	II	Each	1 per M40-series mask
					1		Hood, M40 mask	4240-01-376-3152	II	Each	1 per mask
			1		2		Shears	5111-00-223-6371	II	Each	As needed
							Knife	5110-00-240-5943	II	Each	As needed
			***			***	Axe, single bit	5110-00-293-2336	II	Each	1 per most vehicles
			***		***	***	Shovel, hand, RD, PT, D handle	5120-00-293-3336	VII	Each	1 each for most vehicles
						***	NAAK, MK1	6505-01-140-6455	VII	Each	3 per individual
						***	CANA	6505-01-274-0951	VII	Each	1 per individual 5 per combat life saver 10 per combat medic
					***	3	Paper, chemical agent, detector, M9	6665-00-049-8982	II	Roll	1 per squad 3 per platoon

Table 9-3. Equipment and Supplies Needed for Decon Operations (Continued)

Minimum Amounts of Equipment and Supplies Needed for Decon Techniques							Nomenclature	NSN	Class of Supply	Unit of Issue	Basis of Issue (See TOE for Actual Authorization)***
SD*	PW*	OS*	MGX**	VW**	DTD**	DED**					
					***	***	Paper, chemical agent, detector, M8	6665-00-050-8529	II	Book	6 books per company
					***	***	Radiac meter, AN/PDR-2	6665-01-222-1425	VII	Each	Per MTOE
					2	***	Radiac meter, IM-93/UD	6665-00-752-7759	VII	Each	Per MTOE
					1	2	Alarm, chemical agent, M8A1 or M22	6665-00-935-6955 6665-01-438-6963	VII VII	Each Each	Per MTOE
					4	2	CAM	6665-01-199-4153	VII	Each	Per MTOE
					4		Detector kit, chemical agent, M256A1	6665-01-016-8399	II	Kit	1 per squad
					1		Mask sanitizing solution	6810-00-266-6979	III	Tube	4 per 10 masks
					**	1	Decontaminating agent, STB	6850-00-297-6653	III	Drum	2 50-pound drums per company
						***	Decontaminating agent, DS2	6850-00-753-4870	II	Can	5 gallons, 25 cans per decon
		1			2	24	Brush, scrub, long-handled	7920-00-141-5452	II	Each	As required
					7		Pail, metal, 14-quart	7240-00-160-0455	II	Each	As required
			1		9	4	Garbage can, galvanized, 30-gallon	7240-00-160-0440	II	Each	2 per company
						6	Mop	7920-00-224-8756		Each	As required
					5		Sponge, cellulose	7920-00-240-2559	II	Each	As required
			2		4	6	Brush, scrub	7920-00-240-7171	II	Each	As required
			2		2		Towels, paper	7920-00-823-6931	II	Box	As required
			1	1	1	1	Detergent, GP, liquid	7930-00-282-9699	II	Gallon	As required

**Table 9-3. Equipment and Supplies Needed for Decon Operations (Continued)**

Minimum Amounts of Equipment and Supplies Needed for the Decon Techniques							Nomenclature	NSN	Class of Supply	Unit of Issue	Basis of Issue (See TOE for Actual Authorization)***	
SD*	PW*	OS*	MGX**	VW**	DTD**	DED**						
			1		1	1	Bag, plastic	8105-00-655-8286	II	Box	125 count	
				**		10	TAP apron	8415-00-281-7813 through 8415-00-281-7816	II	Each	10 per platoon	
			1		1		Suit, clothing, protective, See CTA 50-909 for clothing tariff	8415-01-137-1700 through 8415-01-137-1707	II	Each	2 per soldier	
			1		1		Glove set, CP, See SB 10-523 for clothing tariff	8415-01-033-3517 through 8415-01-033-3520	II	Pair	1 per soldier	
							Cover, helmet, chemical protective	8415-01-111-9028	II	Each	1 per soldier	
			1		1		Overboots	8430-01-048-6305 through 8430-01-049-0887	II	Pair	1 per soldier	
			2	2	2	2	NBC marking kit	9905-12-124-5955	II	Kit	1 per squad	
					2		Immersion heater		II	Each	2 per company	
*Techniques executed by individual soldiers							SD – Skin decon PW – Personal wipe down OS – Operator’s spray down	Amount is consumption rate for 1 soldier				
**Techniques executed by units							MGX – MOPP-gear exchange VW – Vehicle washdown	Amount is consumption rate for 1 platoon (4 vehicles, 40 personnel)				
							DTD – Detailed troop decon DED – Detailed equipment decon	Amount is consumption rate for 1 company (20 vehicles, 150 personnel)				
***Amounts vary, depending on situation												

## Chapter 10

# Decon Procedures for Individual and Crew-Served Weapons

Decon procedures for light infantry crew-served weapons and some individual major weapons that are critical to the unit's mission are discussed in this chapter. For those units that are not authorized decon devices such as the M11 or M13 DAP, alternative measures are described. Decon procedures are specified for the following weapons: M60 machine gun; M249 squad automatic weapon (SAW); M47 Dragon; tube-launched, optically tracked, wire-guided (TOW) missile (M220 series); 81-millimeter mortar; 60-millimeter mortar; M203 grenade launcher; AT4 light antitank weapon (LAW); LAW (M72 series); and 66-millimeter rocket launcher.

### OPERATIONAL-DECON PROCEDURES USING THE IEDK

10-1. Operational decon is conducted to sustain combat operations, remove gross contamination, and reduce the transfer/spread of contamination. Before decon, soldiers should visually inspect the weapon system for contamination. If liquid contamination is present, follow the procedures prescribed for each weapon system. The protection level required for operational-decon operations is MOPP4.

**NOTE: The United States Marine Corp (USMC) does not possess the IEDK; therefore, it will have to use additional SDKs to decon individual and crew-served weapons.**

10-2. The following procedures reduce the spread/transfer of liquid contamination. These procedures are unique to the IEDK. Using other decon equipment with these procedures could result in a malfunction of the weapons/weapon systems. Powder from the IEDK could affect the mechanical parts of the weapons/weapon systems if not used properly. See the maintenance manual for proper lubrication after decon.

#### WARNING

Do not apply an IEDK to any optic lens. The abrasive effect of the charcoal inside the IEDK will damage the lens.

### M60 MACHINE GUN

**NOTE: Ensure that the feed tray of the weapon is closed. This prevents the powder from the IEDK from falling inside the feed tray and jamming the weapon. Do not touch the barrel of the weapon with the chemical protective gloves when it is hot. The heat of the barrel could melt the gloves.**

10-3. To decon the M60 machine gun, follow the steps below:

- Step 1. Decon your gloves using the IEDK.
- Step 2. Use the IEDK to remove all liquid contamination from the bipod, barrel assembly, forearm assembly, and carrying handle. Use a second IEDK if necessary.
- Step 3. Use the IEDK to decon the feed-tray cover, shoulder stock, and trigger assembly.
- Step 4. Repeat step 1.

**NOTE: Do not decon the flash suppressor with the IEDK. Powder debris may fall into the barrel and cause the weapon to malfunction.**

#### **M249 SQUAD AUTOMATIC WEAPON**

**NOTE: Ensure that the feed tray of the weapon is closed. This prevents the powder from the IEDK from falling inside the feed tray and jamming the weapon. Do not touch the barrel of the weapon with chemical protective gloves when it is hot. The heat of the barrel could melt the gloves.**

10-4. To decon the M249 SAW, follow the steps below:

- Step 1. Decon your gloves using the IEDK.
- Step 2. Use the IEDK to remove all liquid contamination from the bipod, barrel assembly, gas regulator, and carrying handle.
- Step 3. Use the IEDK to decon the feed-tray cover, magazine, trigger assembly, and shoulder stock.
- Step 4. Repeat step 1.

**NOTE: Ensure that the weapon is upright when decontaminating the feed-tray cover with the IEDK. This prevents powder from the IEDK from falling into the ammunition feeder. Place the magazine in the well before the decon.**

#### **M203 GRENADE LAUNCHER**

**NOTE: The M203 is not a crew-served weapon; however, this weapon is considered critical for accomplishing the infantry squad's mission. Decon the M16A2 according to STP 21-24-SMCT. Before decontaminating the M203 grenade launcher, ensure that the dust cover is closed and the magazine is stored in the well. Ensure that the barrel assembly is closed.**

10-5. To decon the M203 grenade launcher, follow the steps below:

- Step 1. Decon your gloves using the IEDK.
- Step 2. Use the IEDK to decon the barrel, hand guard, and receiver.
- Step 3. Use the IEDK to decon the lower receiver group and butt stock.
- Step 4. Repeat step 1.

#### **M47 DRAGON**

10-6. Use this procedure only when liquid contamination is present on encased missile or tracker components. If the launcher has been fired and chemical contamination is present, follow the procedures shown in steps 1, 4,

and 5 of paragraph 10-7 to decon the tracker. Gather all the contaminated launching tubes in a single area before departing the contaminated area and mark them properly.

**NOTE: Do not use the IEDK on any optic lens (exclude rubber eyecups), battery connector, electrical connectors, or lubricated components. Using the IEDK could cause corrosion if the powder from it is left on the equipment for an extended period of time. However, if these items are stored in a protective container/box, decon the storage container with the IEDK. Rinse or flush the lens with water only if it becomes contaminated. The rubber eyecups can be rinsed with water or decontaminated with the IEDK.**

10-7. To decon the M47 Dragon, follow the steps below:

- Step 1. Decon your gloves using the IEDK.
- Step 2. Use the IEDK to decon the bipod.
- Step 3. Use the IEDK to decon the exterior of the launcher.
- Step 4. Rinse or flush any liquid contamination off the exterior of the day/night sight with water. Use a rag or any available towelettes to dry the sight but do not touch the lens.
- Step 5. Repeat step 1.

#### **TOW MISSILE (M220 SERIES)**

10-8. Gather all the contaminated launching tubes in a single area before departing the contaminated area and mark them properly.

**NOTE: Do not use the IEDK on any optic lens (exclude rubber eyecups), battery connector, electrical connectors, or lubricated components. However, if these items are stored in a protective container/box, decon the storage container with the IEDK or spray it with the M11 DAP. Do not touch or decon the front lens of the night sight. Rinse or flush the lens with water if it becomes contaminated with liquid chemical agent. The rubber eyecups can be rinsed with water.**

10-9. To decon the TOW missile (M220 series), follow the steps below:

- Step 1. Decon your gloves using the IEDK.
- Step 2. Use an M11 DAP filled with bleach or soapy water to spray down the launch tube, traversing unit, and tripod respectively. Protect or cover the day/night sights when spraying.
- Step 3. Use the IEDK to decon the exterior of the day-sight tracker and night-sight tracker. Avoid touching the lens. Once the sights are decontaminated, brush off any powder residue.
- Step 4. Use the IEDK to decon the collimator.
- Step 5. Use the IEDK to decon the exterior of the missile-guidance set and cable surface. Ensure that the electrical connectors are covered before the decon.
- Step 6. Use the IEDK to decon the power conditioner and its cable for the battery component.
- Step 7. Repeat step 1.

#### **AT4 LIGHT ANTITANK WEAPON**

**NOTE: Ensure that the transport safety pin, the cocked-level safety, and the forward safety on the launcher are engaged.**

10-10. To decon the AT4 LAW, follow the steps below:

- Step 1. Decon your gloves using the IEDK.
- Step 2. Use the IEDK to wipe the exterior of the launcher and the front and rear sights.
- Step 3. Repeat step 1.

#### **66-MILLIMETER ROCKET LAUNCHER**

**NOTE: Ensure that the launcher is in the safe position and is not loaded before decontaminating. Omit step 2 if the launcher has not been fired in a contaminated environment.**

10-11. To decon the 66-millimeter rocket launcher, follow the steps below:

- Step 1. Decon your gloves using the IEDK.
- Step 2. Extend the launcher into the firing position.
- Step 3. Use the IEDK to decon the exterior of the launcher and around the reflecting sight.
- Step 4. Repeat step 3 using the IEDK.
- Step 5. Repeat step 1.

#### **81-MILLIMETER MORTAR**

**NOTE: Following the decon of the mortar with the IEDK, ensure that the mechanical parts of the mortar are dried. Lubricate the mortar when the mission permits. Do not touch the mortar tube with chemical protective gloves when it is hot. The heat of the tube could melt the gloves. Do not apply the IEDK to any optic lens due to the abrasive effect of the charcoal in the IEDK. Rinse or flush the lens with water, when required.**

10-12. To decon the 81-millimeter mortar, follow the steps below:

- Step 1. Decon your gloves using the IEDK.
- Step 2. Use the IEDK to decon from the blast attenuator device to the lower half of the mortar tube.
- Step 3. Use the IEDK to decon the base plate.
- Step 4. Use the IEDK to decon the bipod.
- Step 5. Use the IEDK to decon the elbow telescope and telescope mount. Do not use the IEDK on the optic lens. Flush the lens with water if contamination is present.
- Step 6. Repeat step 1.

#### **60-MILLIMETER MORTAR**

**NOTE: Following the decon of the mortar with the IEDK, ensure that the mechanical parts of the mortar are dried. Lubricate the mortar when the mission permits. Do not touch the mortar tube with chemical protective gloves when it is hot. The heat of the tube could**

**melt the gloves. Do not apply the IEDK to any optic lens due to the abrasive effect of the charcoal in the IEDK. Rinse or flush the lens with water, when required.**

10-13. To decon the 60-millimeter mortar, follow the steps below:

- Step 1. Decon your gloves using the IEDK.
- Step 2. Use the IEDK to decon the mortar tube and handgrip. If the mortar is heavily contaminated, you may need to use another IEDK.
- Step 3. Use the IEDK to decon the bipod and base plate.
- Step 4. Use the IEDK to decon the exterior of the telescope. Do not apply the IEDK to the lens. Flush the lens with water if contamination is present.
- Step 5. Repeat step 1.

## JAVELIN

10-14. The decon procedures for the Javelin and its components are listed in Table 10-1, page 10-6.

### WARNING

The IEDK only removes a liquid hazard. Decontaminated items may still present a vapor hazard. Do not unmask until it has been determined safe to do so.

### CAUTION

Close the lens covers on the Javelin before decontaminating because decon powders on the lens can obscure your vision. Do not use the IEDK on the eyecup because the decon powder entering the eyecup can obscure your vision.

## THOROUGH-DECON PROCEDURES USING THE HTH SOLUTION

10-15. When conducting the DED, the equipment is decontaminated with a 10 percent HTH solution (see Table 10-2, page 10-6) or with pure bleach that is diluted. Use the M256A1 detector kit, CAM, or M8 detector paper to determine the effectiveness of the decon. The crew-served weapons should be decontaminated before the DTD by the individual weapons' crew (the preferred method). Alternatively, the commander could task his own decon team to decon the unit's light weapons. The contaminated unit is responsible for establishing an area about 109 to 164 yards upwind from the DTD and DED sites for decon of the crew-served weapons. Unit leaders supervise this procedure. The unit chemical NCO plans and coordinates the preparation of this area.

10-16. The preferred decontaminant for a thorough decon is a 10 percent HTH solution (see Table 10-2). Use a contact time for the HTH solution of 15 minutes for chemical and biological agents. Prepare the amount of solution required according to the number and size of the weapon systems that need to be decontaminated.



**Table 10-1. Decon Procedures for the Javelin and Its Components**

Immediate Decon	
Round	Command Launch Unit (CLU)
Step 1. Decon your gloves using the IEDK. Step 2. Decon the round by patting it with the IEDK, working from the front to the rear until the entire round is covered. <b>NOTE: When the shoulder strap is grossly contaminated, discard it.</b> Step 3. Repeat step 1. Step 4. Discard the IEDK.	Step 1. Decon your gloves using the IEDK. Step 2. Decon the CLU by patting it with the IEDK. Pay special attention to the handgrips, CLU carrying handle, battery cover, round interface-connector protective cover, and switch boots. Step 3. Use a knife to cut the protective-cover lanyard from the protective cover and remove it. Step 4. Repeat step 1. Step 5. Discard the IEDK.
Thorough Decon	
Predecon Round	Predecon CLU
Step 1. Check for contamination. Step 2. Remove the shoulder strap. Step 3. Use a knife to cut the connector boot. Step 4. Use a knife to cut the protective-cover lanyard from the protective cover and remove it. Step 5. Use a knife to scrape about 1/4 inch of the shoulder pad away from the launcher-tube assembly (LTA). Step 6. Ensure that the protective cover is installed on the round/CLU interface connector.	<b>NOTE: Ensure that the on/off switch is in the off position. If the connector was not covered before contamination, place the protective cover on the connector before decon. After the decon, remove the protective cover and allow the connector to weather. The foam around the connector may be cut away as required.</b> Step 1. Check for contamination. Step 2. Remove the rubber from the handles and remove the lanyards from the CLU. Step 3. Ensure that the protective covers are installed on the connectors.
Decon LTA	Decon CLU
Step 1. Submerge one half of the LTA in the decon solution. Step 2. Submerge the other half of the LTA in the decon solution. Step 3. Rinse one half of the LTA by submerging it in the rinse solution. Step 4. Rinse the other half of the LTA by submerging it in the rinse solution. Step 5. Use the CAM to check the LTA, ensuring that all contaminants have been removed. Step 6. Repeat steps 1 through 5 above if the LTA is still contaminated.	Step 1. Open the lens covers. Step 2. Submerge the CLU in the decon solution. Step 3. Rinse the CLU by submerging it in the rinse solution. Step 4. Use the CAM to check the CLU, ensuring that all contaminants have been removed. Step 5. Repeat steps 1 through 4 above if the CLU is still contaminated. If only the switch boots remain contaminated, remove them by using a knife.

**Table 10-2. HTH Mixture**

HTH Solution	Amount of HTH per 1 Gallon of Water	Amount of HTH per 5 Gallons of Water
5 percent	9.6 ounces	48 ounces
10 percent	12 ounces	60 ounces

**NOTE: Refer to Appendix B for instruction on how to use sodium hypochlorite (household bleach) and HTH, and see Table 10-2 for instructions on how to prepare the 5 and 10 percent HTH solution.**

10-17. Follow the procedures below during the DED and DTD. Always wear chemical gloves when performing these procedures.

- Use the HTH solution to decon up to 10 weapon systems. Use the required number of rags on a weapon system and then dispose of them properly to avoid transferring the contamination.
- Do not apply the HTH solution or bleach on electrical connectors and lens.
- Use bleach or a 10 percent HTH solution on the exterior of the optic systems that are not sensitive to bleach and then rinse them with water.

10-18. Once the HTH solution has been used on the weapon systems, thoroughly dry and lubricant them. Avoid spilling the HTH solution or bleach on the chemical overgarment.

## MATERIALS

10-19. Listed in the following paragraphs are the different types of materials that will be needed to clean the weapon systems:

### Cleaning Rags

10-20. The recommended number of clean rags to use with the HTH solution on each weapon system follows:

- M60 machine gun/M249 SAW (three rags)
  - 1: Bipod and barrel.
  - 1: Forearm, carrying handle, and rear sight.
  - 1: Feed-tray cover, shoulder stock, pistol grip, and trigger assembly.
- M203 grenade launcher (two rags)
  - 1: M16A1/2 barrel, hand guard, receiver group, and butt stock.
  - 1: M203 receiver group, sight, and exterior of the barrel.
- M47 Dragon (three rags)
  - 1: Exterior of the sight.
  - 1: Bipod (if weapon is not fired).
  - 1: Round (canister) (if weapon is not fired).

**NOTE: Keep the electrical connector covered before the decon. The Dragon's rubber eyepiece can be removed and submerged in the decontaminant.**

- TOW missile (M220 series) (seven rags)
  - 1: Exterior of the night sight.
  - 1: Exterior of the day sight.
  - 1: Launch tube.
  - 1: Traversing unit.
  - 1: Tripod assembly.
  - 1: Battery-power conditioner and cable. Ensure that the battery is in a waterproof container or case.
  - 1: Missile-guidance set and its cable.

**NOTE: Lock the bridge clamp after removing the round. Do not get the HTH solution on the electrical connector under the bridge clamp or on the post-amplifier cable.**

- 66-millimeter rocket launcher (one rag)
- AT4 LAW (one rag)
- 81-millimeter mortar (four rags)
  - 1: Blast denature device and tube.
  - 1: Bipod.
  - 1: Base plate.
  - 1: Exterior of the telescope.
- 60-millimeter mortar (three rags)
  - 1: Tube (barrel) and handgrip.
  - 1: Base plate and bipod.
  - 1: Exterior of the telescope.

#### **Water**

3-21. Use five gallons of water (as a minimum) for the HTH mix. Change the solution after 10 weapons are decontaminated.

#### **Buckets**

3-22. Use a minimum of two buckets for the procedures below.

#### **Trash Bags**

3-23. Dispose of the contaminated rags in plastic trash bags.

#### **NBC Marking Kit**

3-24. Mark the contaminated area once the decon procedures are completed.

#### **Lubricants**

3-25. Use the required lubricants for the weapon systems. Follow the procedures specified in the applicable TMs.

#### **PROCEDURES**

3-26. The procedures on how to decon weapons and weapon systems with the HTH solution are described below:

- Step 1. Submerge the rag or cloth in the HTH solution and ensure that the material is completely dampened.
- Step 2. Wipe down the weapons and weapon systems with the rag until the contamination is no longer suspected.
- Step 3. Submerge the rag or cloth into a container of clean water (use hot water when available) and wipe down the weapons and weapon systems once more to remove the HTH or bleach solution.
- Step 4. Completely dry the weapons and weapon systems once step 3 is completed.
- Step 5. Lubricate the weapons and weapon systems.

## Appendix A

### Conversions and Measurements

This appendix contains an English/Metric conversion chart (see Table A-1). It also contains the measurements and weights of decontaminant containers that are replacements for used containers (see Table A-2, page A-2).

**Table A-1. English/Metric Conversion Chart**

To Convert	To	Multiply By	To Convert	To	Multiply By
Feet	Centimeters	30.48	Gallons	Milliliters	3,785
	Miles	0.00019		Cubic meters	0.00379
	Kilometers	0.00003			
	Meters	0.3048			
Cubic yards	Cubic meters	0.76456	Quarts (fluid)	Millimeters	946.358
				Liters	0.946333
Cubic feet	Cubic meters	0.02831702	Ounces	Grains	437.6
	Liters	28.32		Drams	16
				Pounds	0.0625
				Grams	28.34952
				Kilograms	0.02835
Yards	Meters	0.9144	Pounds	Grams	453.6
				Kilograms	0.453592
				Metric tons	0.0004536
Inches	Centimeter	2.54000508	Ounces (fluid)	Milliliters	29.57353
	Kilometers	$2.54000508 \times 10^{-5}$		Liters	0.02957
	Millimeters	25.4000508	Square yards	Square meters	0.836
<b>NOTE: For temperatures, Celsius = <math>5/9 (F^{\circ} - 32^{\circ})</math> and Fahrenheit = <math>9/5 (C^{\circ} + 32^{\circ})</math></b>					

**Table A-2. Measurements and Weights of Decontaminant Containers**

Containers	Measurements	Weights
Drum, 55 gallons, 16 gauge NSN 8110-00-597-2353	Volume—12 cubic feet Length—35 inches Width—27.5 inches	Empty—70 pounds Filled with water—526 pounds Filled with STB (slurry)—620 pounds Filled with DS2—507 pounds
Drum, 55 gallons, 18 gauge NSN 8110-00-292-9783	Volume—12 cubic feet Length—35 inches Width—27.5 inches	Empty—50 pounds Filled with water—506 pounds Filled with STB (slurry)—600 pounds Filled with DS2—487 pounds
Ash and garbage can, 32 gallons (GI can) NSN 7240-00-160-0440	Volume—7 cubic feet Length—26.5 inches Width—20 inches	Empty—33 pounds Filled with water—300 pounds Filled with STB (slurry)—353 pounds Filled with DS2—288 pounds
Gasoline can, 5 gallons NSN 7240-00-178-8286	Volume—1 cubic foot Length—18.50 inches Width—6.75 inches	Empty—10.5 pounds Filled with water—52 pounds Filled with STB (slurry)—66 pounds Filled with DS2—50 pounds
Pail, 5 gallons, DS2 NSN 7240-00-575-2243	Volume—1 cubic foot Length—13.75 inches Width—11.12 inches	Empty—6 pounds Filled with water—48 pounds Filled with STB (slurry)—61 pounds Filled with DS2—46 pounds
Drum, 8 gallons, STB, 16 gauge NSN 6850-00-297-6693	Volume—1.4 cubic feet Length—14 inches Width—14 inches	Empty—11 pounds Filled with water—78 pounds Filled with STB (slurry)—91 pounds Filled with DS2—71 pounds

## Appendix B

### Decontaminants

The decontaminants listed in Tables B-1 through B-3, pages B-1 through B-14, are grouped according to their classification: standard, nonstandard, or natural. Each is identified by name and national stock number (NSN) (where applicable). Also listed are brief directions on preparing the decontaminants and any appropriate cautions and information on application, coverage, substitute solutions, and related effectiveness of the decontaminants.

**Table B-1. Standard Decontaminants Available in the Supply System**

Decontaminants	Use	Remarks	Cautions	Preparation
<p>Decontaminating solution number 2; DS2 in a 1<math>\frac{1}{3}</math>-quart can (NSN 6850-00-753-4827); DS2 in a 14-liter container for the M13 DAP; (NSN 4230-01-136-8888); DS2 in a 5-gallon pail (NSN 6850-00-753-4870)</p>	<p>Bio Chem</p>	<p>Is effective against all known toxic chemical and biological agents (except bacterial spores) if sufficient contact time is allowed.</p> <p>Must remain in contact with contaminated surface for about 30 minutes.</p> <p>Must be rinsed off with water. Recheck the item for contamination.</p> <p>Can be used at temperatures above -15°F.</p> <p>Is used with the M11 or M13 DAP or can be applied with brooms and swabs.</p> <p>Is most effective when the application is accompanied by scrubbing action.</p>	<p>Is extremely irritating to the eyes and skin. Must wear protective mask and rubber gloves. If DS2 contacts skin, wash area with water. Do not inhale vapors. Will cause a green or black color change upon contact with M8 detector paper and cause a false/positive reading with M9 detector paper.</p> <p>Will ignite spontaneously on contact with STB or HTH.</p> <p>Should not be spilled on the chemical protective overgarment.</p> <p>Is a combustible liquid with a flash point of 160°F. Do not confuse it with a fire extinguisher. Spraying DS2 on surfaces above 168°F will ignite it.</p> <p>Must not be used on individual mask (damages Mylar diaphragm in voicemitter assembly).</p>	<p>Mixing is not required. Issued in ready-to-use solutions.</p>

**Table B-1. Standard Decontaminants Available in the Supply System (Continued)**

Decontaminants	Use	Remarks	Cautions	Preparation
Decontaminating solution number 2 (continued)			<p>Will corrode aluminum, cadmium, tin, and zinc; will soften leather. May soften, remove, or discolor paint. Rinse well after use and oil metal surfaces.</p> <p>Is ineffective against bacterial spores.</p>	
Supertropical bleach (NSN 6850-00-297-6653)	Bio Chem	<p>Is effective against lewisite, V and G agents, and biological agents.</p> <p>Must remain in contact with contaminated surface for at least 30 minutes; then, wash off with clear water.</p> <p>Does not effectively decon mustard if it has solidified at low temperatures.</p> <p>Should be applied several times to porous surfaces.</p>	<p>Will ignite spontaneously on contact with liquid blister agent or DS2.</p> <p>Will give off toxic vapors on contact with G agent.</p> <p>Is not recommended for ship use. Store on top deck only.</p> <p>Is corrosive to most metals and damaging to most fabrics (rinse thoroughly and oil metal surfaces).</p> <p>Should not be inhaled or allowed to touch the skin. When preparing a slurry, wear a protective mask or respiratory protective device.</p> <p>Should be stored in an unheated warehouse away from combustibles and metals subject to corrosion.</p>	<p>Slurry paste: mix one 50-pound drum of STB with 6 gallons of water. Slurry paste consists of about equal parts (by weight) of STB and water.</p> <p>Dry mix: mix two shovels of STB to three shovels of earth or inert material (ashes).</p> <p>Slurry mix, chemical: mix will consist of 40 parts of STB to 60 parts of water (by weight). To mix in the M12A1 PDDA, use 1,300 pounds of STB, 225 gallons of water, 12½ pounds of antiset, 24 ounces of antifoam.</p> <p>Slurry mix, biological: mix will consist of 7 parts of STB to 93 parts of water (by weight). To mix in the M12A1 PDDA, use 150 pounds of STB, 225 gallons of water, 12½ pounds of antiset, and 24 ounces of antifoam.</p> <p>Camouflage: lamp-black or dye mixes may be added for camouflage.</p>

Table B-1. Standard Decontaminants Available in the Supply System (Continued)

Decontaminants	Use	Remarks	Cautions	Preparation
Mask sanitizing solution	Bio Chem	<p>Use on a previously cleaned mask with filter elements/canisters removed.</p> <p>Place the mask face up; attach the canteen to the mask at the drinking tube. Drain one canteen full of sanitizing solution through the mask. Rinse the mask with two canteens of clear water. Immerse the mask and outserts in the sanitizing solution. Agitate the mask for 5 minutes. Rinse it twice in clear water, agitating 2 to 3 minutes each time.</p> <p>Dry all parts of the mask and reassemble.</p> <p>Use one gallon of solution for every 10 masks.</p>		<p>Fill a standard plastic canteen to the shoulder with water. Add a 0.5-gram tube of calcium hypochlorite from the water-purification kit (NSN 6810-00-266-6976). Cover the canteen and shake vigorously for 30 seconds.</p> <p>Mix bulk quantities as follows: add 2.0 grams of calcium hypochlorite from a 6-ounce jar (NSN 6810-00-255-0471) to 1 gallon of water.</p> <p>Use a ratio of about 1 pound of soap per gallon of water for smaller amounts of solution. Mix 2 pints of detergent to 450 gallons of water in the M12A1 PDDA.</p>
Soaps and detergents: detergent, GP, liquid (NSN 7930-00-282-9699)	Rad Bio Chem	<p>Scrub or wipe the contaminated surface with a hot, soapy water solution or immerse the item in the solution.</p>	<p>Are effective in physically removing contamination. However, casualty-producing levels of contamination may remain in the runoff water and must be considered contaminated.</p>	<p>Mix 75 pounds of powdered soap in 350 gallons of water. If powdered soap is not available, use bar laundry soap (75 pounds of soap cut into 1-inch pieces and dissolved in 350 gallons of hot water).</p> <p>Use a ratio of about 1 pound of soap per gallon of water for smaller amounts of soap solution. Mix 2 pints of detergent to 450 gallons of water in an M12A1 PDDA.</p>



**Table B-1. Standard Decontaminants Available in the Supply System (Continued)**

Decontaminants	Use	Remarks	Cautions	Preparation
Calcium hypochlorite (high-test hypochlorite [HTH] or high-test bleach [HTB]) (NSN 6810-01-225-2682) (25 pounds), (NSN 6810-00-225-0472) (100 pounds)	Bio Chem	Is effective against mustards, lewisite, V agents, and all biological agents, including bacterial spores. Will react rapidly (within 5 minutes) with mustards and lewisite. Should be allowed a 15-minute contact time for biological agents. Will act faster than STB. Can be used as a dry mix or slurry.	Precautions are the same as for STB. Pure calcium hypochlorite will burn on contact with VX, HD, or DS2. Agent is more corrosive than STB. Will destroy clothing, has a toxic vapor, and will burn the skin. Protective mask and rubber gloves are the minimum protective equipment needed when handling.	Chemical: mix 5 pounds of decontaminant to 6 gallons of water (10 percent solution). Biological: mix 1 pound of decontaminant to 6 gallons of water (2 percent solution). PDDE: mix a slurry of 1 part decontaminant to 2 parts water (any heavier slurry will clog the decon apparatus). HTH should only be used if STB is not available.

**Table B-2. Nonstandard Decontaminants Available in the Supply System**

Decontaminants	Use	Remarks	Cautions	Preparation
Oxidizing agents (nitric acid, aqua regia, sodium dichromate, and potassium permanganate)	Rad	Are effective in dissolving surfaces containing absorbed radioactive contamination. Are applied to a surface or the item is dipped. Exposure must be limited due to the corrosive nature of the solution. Rinse thoroughly with water and detergent and then with clear water.	Are extremely corrosive. Use only under the supervision of a trained individual. Will require the use of a neoprene or rubber protective apron, gloves, boots, and safety glasses when handling. (Rubber offers only limited protection.)	Aqua regia is prepared by mixing 3 parts of concentrated hydrochloric acid and 1 part of concentrated nitric acid. Other oxidizing agents do not require mixing.
Iodine water purification tablets	Bio	Are used when it is impractical to boil drinking water. Two iodine tablets per canteen are effective against most biological agents.	None	None

**Table B-2. Nonstandard Decontaminants Available in the Supply System (Continued)**

Decontaminants	Use	Remarks	Cautions	Preparation
Complexing (chelating) agents (versene, citric acid, sequesterene, sodium citrate, tartanic acid, sodium oxalate, sodium tartralegoxalic acid, orthophosphoric acid, and similar agents)	Rad	Will aid in the physical removal of absorbed contamination on surfaces. Should be applied as a film over the surface using the PDDE, firefighting apparatus, or tree or garden sprayer. Should be allowed a 30-minute contact time and then flushed with water.	Do not neutralize contamination. Runoff will be contaminated.	Mix 3 to 5 percent of the agent (by weight) in water.
Disinfectant chlorine (NSN 6840-00-270-8172)	Bio	Use to decon utensils, mess gear, exteriors of sealed containers, and food products that can withstand soaking. Dispose of any food or vegetables that are damaged and any outer leaves that are bruised or torn. Do not cut or peel fruits and vegetables before disinfecting them. Leave items in the solution for 30 minutes and stir occasionally. Rinse thoroughly in potable water.	None	Dissolve one package of disinfectant in 20 gallons of warm potable water (100°F).

**Table B-2. Nonstandard Decontaminants Available in the Supply System (Continued)**

Decontaminants	Use	Remarks	Cautions	Preparation
Disinfectant chlorine (continued)	Bio	<p>Use the solution only once.</p> <p>Prepare an emergency solution by mixing one level MRE spoonful of calcium hypochlorite (water disinfecting powder) to each 10 gallons of water. If liquid chlorine bleach is available, use about <math>\frac{1}{3}</math>-canteen cup of 5 percent chlorine bleach to each 10 gallons of water.</p> <p>Make fresh solutions for rinsing and disinfecting utensils for each 100 persons.</p>	None	
Ethylene oxide	Bio	<p>Is effective against all microorganisms, to include bacterial spores.</p> <p>Should be applied in the strength of 30 pounds for every 1,000 cubic feet.</p> <p>Should be allowed a 6-hour contact time (contact time must be doubled for each 20°F drop in temperature below 75°F).</p> <p>Should be used in an airtight enclosure.</p>	Is flammable. Not recommended for interior use.	None
Formalin (formaldehyde)	Bio	<p>Agent is effective against all microorganisms, to include bacterial spores.</p> <p>Agent is used for interior decon of relatively close areas.</p> <p>Vapors should remain 16 hours in a closed structure; then, aerate until the odor is no longer objectionable.</p>	<p>Vapors are very toxic. Agent will curl and discolor paper. Leaves a white residue.</p> <p>A self-containing breathing apparatus is required in closed spaces.</p> <p>Personnel handling or spraying the agent should wear impermeable protective clothing.</p>	<p>No mixing is required. However, less residue remains and less aeration is required if the mixture of 5 parts formalin and 3 parts methanol is used. (Use this mixture at a rate of 4/5 quart per 1,000 cubic feet of space).</p>

Table B-2. Nonstandard Decontaminants Available in the Supply System (Continued)

Decontaminants	Use	Remarks	Cautions	Preparation
Formalin (formaldehyde) (continued)	Bio	<p>Optimum conditions for spraying formalin are 70° to 80°F with an 85 percent relative humidity. The minimum effective relative humidity is 70 percent. At 60°F, the exposure should be increased to 24 hours.</p> <p>Agent is applied as a vapor from standard insecticide sprayers or is vaporized by heat or a bubbling steam from a pan.</p>	<p>Personnel entering an area containing formalin vapors should—</p> <ul style="list-style-type: none"> <li>• Wear a protective mask.</li> <li>• Wear washable outer clothing, fastened to prevent vapors from entering at wrists, ankles, or neck.</li> <li>• Remove outer clothing after emerging from vapors.</li> <li>• Shower and put on clean clothing as soon as possible.</li> </ul> <p>Vapors are not flammable; open flame should not be used for vaporizing when methanol has been added to the agent. When steam is used, the source of the steam should be outside the area being decontaminated.</p>	
Detrochlorite	Bio	<p>Agent is a thickened bleach that is very useful on vertical surfaces.</p> <p>Coverage is 1 gallon per 8 square yards. Apply by means of the PDDA. Allow 30 minutes contact time, then rinse with water.</p>	<p>Agent is very corrosive.</p> <p>See <i>Preparation</i> column.</p>	<p>Mix by weight 19.3 percent diatomaceous earth, 0.5 percent anionic wetting agent, 2.9 percent calcium hypochlorite (70 percent available chlorine), and 77.3 percent water.</p> <p>Mix wetting agent and diatomaceous earth with water before adding the calcium hypochlorite. Mixing the wetting agent and calcium hypochlorite in a dry and undiluted state may cause an explosion.</p>

Table B-2. Nonstandard Decontaminants Available in the Supply System (Continued)

Decontaminants	Use	Remarks	Cautions	Preparation
Peracetic acid (PAA)	Bio	<p>Agent is effective against all microorganisms, to include bacterial spores. A contact time of 10 minutes must be allowed. Item should be wiped with a rag or swab. Remove excess acid and aerate for 10 to 15 minutes or until no objectionable odor remains. Small items should be immersed for 10 minutes. Remove excess acid and aerate until no objectionable odor remains.</p>	<p>Fumes are highly irritating. Prolonged exposure will damage most material. A 40 percent solution has a low flash point (105°F); a 3 percent solution is nonflammable. Burns and blistered on the skin will occur. Agent must be stored in original containers under refrigeration to prevent decomposition. Protective mask and clothing are required. A violent explosion may result if heavy metal ions come in contact with the agent. Prolonged exposure will corrode iron and deteriorate rubber, plastic, and leather.</p>	<p>Available as a 40 percent solution. Mix 1 quart of PAA to 3½ gallons of water (add PAA to the water).</p>
Hyamine (benzethonium chloride)	Bio	<p>Agent is effective against all bacteria. A contact time of 5 to 30 minutes should be allowed.</p>	<p>Agent is very toxic. Estimated fatal dose to man is 1 to 3 grams. Care should be taken when mixing to avoid inhalation of powder. Agent is not to be used on aircraft or ships.</p>	<p>Use a 0.1 to 1 percent solution (1 pound of hyamine for every 12 gallons of water yields a 1 percent solution).</p>
Carbon dioxide and ethylene oxide mixture (with more than 87 percent ethylene oxide)	Bio	<p>Should be applied in the strength of 30 pounds for every 1,000 cubic feet. Should be allowed a 12-hour contact time (doubled for each 20°F drop in temperature below 75°F). Is nonflammable and is recommended for interior use. Should be used in an airtight enclosure.</p>	<p>Will blister the skin. Aerate items next to the skin 18 to 24 hours.</p>	<p>None</p>

**Table B-2. Nonstandard Decontaminants Available in the Supply System (Continued)**

Decontaminants	Use	Remarks	Cautions	Preparation
Sodium hypochlorite solution (household bleach)	Bio Chem	Is effective against blister and V agents and all biological agents. Will react rapidly (within 5 minutes) with blister and V agents. Should be allowed a 10- to 15-minute contact time for biological agents. Should be applied undiluted with brooms, brushes, or swabs. Is the preferred decon for ship use. A 5:1 concentration is recommended. Has a limited storage problem.	Is harmful to the skin and clothing if undiluted. Remove from the skin and clothing by flushing with water. Is corrosive to metals unless rinsed, dried, and lubricated after decon. Should be stored in a cool place.	For chemical decon, no mixing is required. For biological decon, dilute by adding 2 parts bleach to 10 parts water. For decon of cotton clothing and utensils, dilute 2 cups of bleach to 1 gallon of water. For application, dilute half and half with water and spray from the PDDE.
2-Propanone (acetone)	Chem	Freezing point is -203°F; boiling point is 133°F (evaporates rapidly). Good decontaminant for use in arctic regions. Commonly obtained as fingernail polish remover or paint thinners. Scrubbing increases its effectiveness.	Is extremely flammable. Does not neutralize agents. Is effective for dissolving and flushing agent by physically removing it.	None
Diethyl ether	Chem	Freezing point is -241°F; boiling point is 93°F. Good decontaminant for use in arctic regions. Available through medical supply facilities. Scrubbing increases its effectiveness.	Is the same as for 2-propanone.	None

**Table B-2. Nonstandard Decontaminants Available in the Supply System (Continued)**

Decontaminants	Use	Remarks	Cautions	Preparation
Ethylene glycol	Chem	Scrub on contaminated surfaces and rinse thoroughly.	Removes contamination, but does not neutralize it. Therefore, runoff residue must be considered contaminated.	Mix equal amounts of solution and water.
Solvents (gasoline, JP-4, diesel fuel, kerosene, and similar solvents)	Chem	Scrub on contaminated surfaces and rinse thoroughly.	Is the same as for ethylene glycol. May damage materials such as rubber and plastic.	None
Sodium hydroxide (caustic soda or lye) (NSN 6810-00-174-6581) (100 pounds)	Bio Chem	Is effective against G agents, lewisite, and all biological agents, including bacterial spores. Will neutralize G agents on contact. Should be allowed to remain in contact with the chemically contaminated surface for about 15 minutes.	Agent will damage the skin, eyes, and clothes and can cause upper respiratory or lung damage if inhaled. Full rubber protective clothing, gloves, boots, and mask are required when using. Affected area must be washed immediately with large amounts of water and flushed with diluted acetic acid or vinegar. Remove affected clothing. If eyes are involved, flush them at once with large amounts of warm water and seek medical attention. Runoff from decon operations is highly corrosive and toxic. Drain runoff into a sump and bury. Equipment must be flushed with large amounts of clear water.	Small amount—10 pounds of lye to 12 gallons of water (10 percent solution). Mix in an iron or steel container (never aluminum, zinc, or tin). Add lye to the water to prevent boiling and splattering due to heat being emitted. Do not handle mixing container with bare hands. Large amount (PDDE use)—Prepare a solution of 227 grams (½ pound) of lye for each gallon of water. Pump 350 gallons of water into the tank unit. Connect the tank unit, pump unit, and heater together. Heat the water to 122°F. Disconnect the heater unit and add 175 pounds of lye to the heated water. Circulate the solution with the pump unit until all the lye is dissolved. The temperature will increase noticeably. Use while hot.

**Table B-2. Nonstandard Decontaminants Available in the Supply System (Continued)**

Decontaminants	Use	Remarks	Cautions	Preparation
Sodium hydroxide (caustic soda or lye) (NSN 6810-00-174-6581) (100 pounds) (continued)			<p>Sodium hydroxide—</p> <ul style="list-style-type: none"> <li>• Is not recommended for ship use. Store on top deck only.</li> <li>• Is corrosive to most metals.</li> <li>• Is not recommended if less toxic caustic decontaminants are available. Will cause a red color change upon contact with M8 detector paper.</li> </ul> <p>Agent's effectiveness is directly proportional to the strength of the solution.</p>	<p>Simultaneous mixing and applying—Sprinkle dry lye on the contaminated area and then dissolve it with a spray of steam or hot water. Do not wash the lye off the surface while applying the steam or hot water.</p> <p>Paint removal—1 pound of lye per 2½ gallons of water is capable of removing an average coat of paint from about 11 square yards of surface. This solution is effective in removing paint on which chemical contamination has absorbed. (Can substitute calcium hydroxide, potassium hydroxide, or trisodium phosphate for sodium hydroxide.)</p>
Sodium carbonate (washing soda, soda ash, sal soda, or laundry soda)	Chem	<p>Is effective against G agents and CN. Will react rapidly with G agents, normally within 5 minutes.</p> <p>Is the preferred decontaminant for ship use. The recommended concentration is 5 percent by weight. There is no storage problem. Should be used with a hot solution to decon CN effectively.</p>	<p>Should not be used for VX. It cannot detoxify VX and creates extremely toxic by-products.</p> <p>Does not dissolve mustard agents or detoxify them.</p>	<p>Mix 10 pounds of washing soda to 12 gallons of water (10 percent solution).</p>
Potassium hydroxide (caustic potash)	Bio Chem	<p>Is the same as for sodium hydroxide.</p>	<p>Is the same as for sodium hydroxide.</p>	<p>Is the same as for sodium hydroxide.</p>
Hexachloramelamine	Chem	<p>Is effective against mustard agents.</p>	<p>May require the use of a protective mask and rubber gloves when used.</p> <p>Is corrosive to metal.</p>	<p>Is not soluble in water but is soluble in organic solvents such as gasoline, kerosene, and paint thinner.</p>



**Table B-2. Nonstandard Decontaminants Available in the Supply System (Continued)**

Decontaminants	Use	Remarks	Cautions	Preparation
Ammonia or ammonium hydroxide (household ammonia)	Chem	Is effective against G agents. Is slower acting than sodium hydroxide or potassium hydroxide.	May require the use of a self-contained breathing apparatus or special purpose mask.	Ammonium hydroxide is a water solution of ammonia. No further mixing is required.
Dichloramine-B and Dichloramine-T	Chem	Is effective against mustard agents.	May require the use of a protective mask and rubber gloves when used. Is corrosive to metal.	Is not soluble in water, but is soluble in certain organic solvents. Is normally mixed as a 10 percent solution in dichloroethane.
Perchloroethylene (tetrachloroethylene)	Chem	Freezing point is -8°F; boiling point is 250°F. Agent— <ul style="list-style-type: none"> <li>• Is good for use in arctic climates.</li> <li>• Is a nonflammable, synthetic solvent widely used in dry cleaning plants.</li> <li>• Dissolves H and V agents but not G.</li> <li>• Has a low toxicity.</li> </ul> Scrubbing increases its effectiveness.	Physically dissolves and removes contamination, but does not neutralize it.	Requires no mixing (practically insoluble in water).
Acids (sulfuric acid, hydrochloric acid, oxalic acid, and similar acids)	Rad	Are effective solvents for rust and mineral deposits holding radioactive material on metal surfaces. Should be allowed a 1-hour contact time. Must be flushed with water, scrubbed with a water-detergent solution, and flushed again with water.	Are difficult to handle and are harmful to the body, especially the eyes. Can produce boiling and splattering of the solution when mixed. May require the use of rubber boots, gloves, aprons, and goggles when used. Will require the use of respiratory protection when used in closed areas. Can cause serious injury when they come in contact with the body. Flush the area immediately with water. Use a 5 percent solution of water and baking soda (sodium bicarbonate).	None

Table B-3. Natural Decontaminants

Decontaminants	Use	Remarks	Cautions	Preparation
Water	Rad Bio Chem	Can be used to flush contamination from surfaces.	Is effective in physically removing contamination, but does not neutralize it. Do not use water on lewisite.	Hot water with soap makes water more effective in removing agents. Boiling for 15 minutes (30 minutes at high altitude) destroys biological agents.
Steam	Rad Bio Chem	Is more effective when accompanied by scrubbing.	Is effective in physically removing contamination, but does not neutralize it.	None
Absorbents (earth, sawdust, ashes, rags, and similar materials)	Chem	Are used to remove gross contamination, physically, from surfaces.	The contamination is transferred from the surface to the absorbent. The absorbent becomes contaminated and must be disposed of accordingly. Sufficient contamination to produce casualties may well remain on surfaces.	
Sealants (concrete, asphalt, earth, paint, and similar materials)	Rad Bio Chem	Sealants are used to physically seal in or shield contamination. They are effective as follows: <ul style="list-style-type: none"> <li>• 12 inches of earth provides a good protection from fallout (3 inches will reduce the dose rate about one half).</li> <li>• 1 inch of asphalt or concrete completely absorbs alpha and beta radiation.</li> </ul>	A break in the surface of the sealant will expose the contamination. Contaminated areas covered with sealants must be marked with appropriate NBC warning signs.	None

**Figure B-3. Natural Decontaminants (Continued)**

Decontaminants	Use	Remarks	Cautions	Preparation
Sealants (concrete, asphalt, earth, paint, and similar materials) (continued)	Rad Bio Chem	<ul style="list-style-type: none"> <li>• 1/4 inch of grout shields alpha and beta radiation.</li> <li>• 4 inches of earth provides good protection from chemical contamination.</li> </ul> <p>Burying items contaminated with biological agents is an effective means of sealing off contamination.</p>	<p>A break in the surface of the sealant will expose the contamination.</p> <p>Contaminated areas covered with sealants must be marked with appropriate NBC warning signs.</p>	None
Weather/time	Rad Bio Chem	UV light kills most bio-organism agents, organisms, and radiation decay overtime.	Should be used when time and the mission permits.	None
Burning	Bio Chem	Must be approved by the first general officer in the chain of command.	<p>Creates downwind hazards.</p> <p>Requires that sentries be posted to keep people out of the danger area.</p>	None

## Appendix C

### Decon of Specific Surfaces and Materials

Table C-1, pages C-1 through C-7, lists specific surfaces or materials and explains briefly how to best decon each for chemical, biological, or radiological contamination.

**Table C-1. Decon Procedures for Specific Surfaces and Materials**

Surface or Material	Types of Contamination and How to Decon		
	Chemical	Biological	Radiological
Asphalt roads (applicable to small vital areas only)	Flush with water. Spray with an STB slurry from the PDDE. Cover with STB (pure form). When liquid contamination is visible and personnel are nearby, use the STB dry mix. Weather. Cover small areas or paths across roads with 4 inches of earth.	Weather (remain masked). Wet with water (will help prevent secondary aerosols but does not decon). Apply 2 percent household-bleach solution. Spray with an STB slurry from the PDDE. Pour, spray, or spread oil on the surface (will help prevent secondary aerosols, but does not decon).	Brush or sweep. Flush with water (this may drive some of the contamination into the surface; waste must be controlled). Clean with a vacuum.
Roofs	Follow the same directions as for asphalt roads.	Follow the same directions as for asphalt roads. Apply detrochlorite; leave on at least 30 minutes, then flush with water.	Follow the same directions as for asphalt roads.
Brick and stone roads (applicable to small vital areas only)	Weather. Spray with an STB slurry from the PDDE or apply with brushes and brooms. Leave on for 24 hours, then flush with water. Wash with soapy water, preferably hot. Cover small areas or paths across roads with 4 inches of earth.	Follow the same directions as for asphalt roads.	Follow the same directions as for asphalt roads. Use abrasion (sand blasting). This provides direct and complete removal of contaminated dust; however, sand and equipment being used becomes contaminated.

**Table C-1. Decon Procedures for Specific Surfaces and Materials (Continued)**

Surface or Material	Types of Contamination and How to Decon		
	Chemical	Biological	Radiological
Brick and stone buildings, bunkers, gun emplacements, and tank obstacles	Spray with an STB slurry from the PDDE or apply with brushes and brooms. Leave on for 24 hours, then flush with water. Use STB (pure form) or an STB dry mix around buildings where waste water runs. Wash with soapy water, preferably hot. Weather.	Follow the same directions as for asphalt roads. Apply an STB slurry to vertical surfaces by manual means or with the PDDE. The slurry may be left on exteriors.	Follow the same directions as for brick and stone roads.
Concrete roads (applicable to small vital areas only)	Spray with an STB slurry from the PDDE. Cover with an STB slurry or STB dry mix. Weather. Cover small areas or paths across roads with 4 inches of earth. Scrape the layer of contaminated earth to the side of the road.	Follow the same directions as for asphalt roads.	Follow the same directions as for brick and stone roads.
Earth (applicable to small vital areas only): roads, gun emplacements, bivouac areas, pathways, and bomb craters	Spray with an STB slurry from the PDDE. Cover with STB (pure form). When liquid contamination is visible and personnel are nearby, use an STB dry mix. Weather. Cover small areas or paths across roads with 4 inches of earth. Scrape the layer of contaminated earth to the side of the road.	Follow the same directions as for asphalt roads. Burn.	Earth moving (removal): Try to control contaminated dust, as equipment may become contaminated. Consider waste disposal. Sealing (with earth): Does not create a waste-disposal problem; however, equipment may be contaminated.
Grass and low vegetation: fields and open terrain	Burn. Spray with an STB slurry from the PDDE. Cover with STB (pure form) or an STB dry mix. Explode drums of STB. Clear paths through area using detonating cord or other detonating devices.	Burn. Follow the same directions as for asphalt roads.	Follow the same directions as for earth.

**Table C-1. Decon Procedures for Specific Surfaces and Materials (Continued)**

Surface or Material	Types of Contamination and How to Decon		
	Chemical	Biological	Radiological
Undergrowth, tall grass (applicable to small vital areas only): meadows, jungles, and forests	Burn (may cause a downwind vapor hazard). Spray slurry with PDDE. Explode drums of STB. Clear a path with detonating cord, bangalore torpedoes, or demolition snakes.	Burn. Follow the same directions as for sand.	Follow the same directions as for earth.
Sand (applicable to small vital areas only): beaches and deserts	Flush with water. Use DS2. Spread STB (pure form) or spray an STB slurry over the surface. Weather. Cover paths with roofing paper. Scrape off 2 to 4 inches of contaminated top layer.	Burn.	Follow the same directions as for earth.
Fabrics: canvas, covers, tarpaulins, tentage, mask carriers, web gear, and clothing	Cotton: <b>NOTE: Not for MOPP gear.</b> Immerse in boiling, soapy water for 1 hour (1 pound of soap to 10 gallons of water) and stir. Use a 5 percent sodium-carbonate solution for G agents. Immerse in boiling water for 1 hour. Launder by standard methods. Use an STB slurry. Weather except for V agents.  Woolen: Do not use DS2, as it is not recommended. Immerse in warm, soapy water (100°F) for 1 hour or longer with light agitation. Dry items slowly because the fabric may shrink.	Cotton: Boil in water for 15 minutes. Autoclave for 45 minutes at 253°F. Immerse in a 2 percent household-bleach solution for 30 minutes and rinse immediately. Launder (destroys or inactivates all but highly resistant spores).  Woolen: Do not use DS2, as it is not recommended. Launder (fabric may shrink).	Cotton and woolen: Using DS2 is not recommended. Brushing removes contamination dust, but it presents a dust hazard to personnel. Laundering is the most practical procedure; however, the fabric may shrink. Try to control waste.

**Table C-1. Decon Procedures for Specific Surfaces and Materials (Continued)**

Surface or Material	Types of Contamination and How to Decon		
	Chemical	Biological	Radiological
Leather: boots, gloves, and other items	Scrub with hot, soapy water and rinse. Immerse in warm, soapy water at 120°F for 4 hours and rinse. Use a 5 percent sodium-carbonate solution for G agents. Air.	Immerse in a 2 percent household-bleach solution and rinse. Immerse in a 2 percent PAA for 10 minutes, rinse, and air 10 to 15 minutes. Wipe with a 2 percent PAA, remove excess agent, and air 10 to 15 minutes.	Brush. Flush with water or soapy water.
Glass, windows	Use an IEDK or DS2. Wash with hot, soapy water. Rinse with clear water or an organic solvent. Blot off surface. Air. Weather.	Use an IEDK. Wash with soap and water. Wipe with a disinfectant solution or a 2 percent PAA (see similar procedures on page C-7 for mess gear).	Use an IEDK. Wash with a detergent. Flush with water. Wipe with solvents.
Glass, lens	Wash with hot, soapy water. Rinse with clear water or an organic solvent. Blot off surface. Air. Weather.	Wash with hot, soapy water. Wipe with alcohol or household bleach.	Brush or wipe (be careful so as not to scratch the lens). Use compressed air to blow contamination from surface.
Metal (unpainted), ammunition	Wipe with soapy water. Wipe with organic solvent and dry. Air.	Wipe with soapy water. Wipe with a 2 percent household-bleach solution. Air.	Brush or wipe.
Metal (unpainted), machinery	Use DS2. Follow the same directions as for ammunition.	Use DS2. Wipe with a 2 percent PAA, rinse, and air 10 to 15 minutes.	Brush or wipe. Wash with a detergent. Flush with water.
Metals (painted): vehicles, weapons, and equipment	Use DS2 (may soften paint). Wash with hot, soapy water and rinse. Spray with an STB slurry from the PDDE then remove it in 1 hour and oil the surface. Weather. Air. Use an IEDK to decon individual gear.	Wash with a detergent and a high-pressure water system. Apply detrochlorite. Leave it on for 30 minutes then remove by washing with a stream of water. Steam clean using a detergent. Use a household-bleach solution. Use a 2 percent PAA.	Brush or wipe. Wash. Use organic solvents, caustic agents (not on aluminum or magnesium surfaces), complexing agents (of small value on weathered surfaces), or abrasives.

**Table C-1. Decon Procedures for Specific Surfaces and Materials (Continued)**

Surface or Material	Types of Contamination and How to Decon		
	Chemical	Biological	Radiological
Wood (unpainted surfaces): buildings, vehicle bodies, boxes, crates, and similar items	Apply an STB slurry with the PDDE, brooms, or swabs. Let the slurry remain 12 to 24 hours then flush with water. Repeat the application and flush again. Scrub with hot, soapy water and rinse. Weather.	Apply detrochlorite. Leave it on for at least 30 minutes then flush with water. Apply an STB slurry to vertical surfaces. The slurry may be left on interiors. Weather (sun and rain eliminate most microorganisms within 1 day). Burn.	Wash the interior with large amounts of water (some contamination may soak into surfaces).
Wood (painted surfaces): buildings and boxes	Apply an STB slurry with the PDDE, brooms, or swabs. Let the slurry remain 12 to 24 hours then flush with water. Scrub with hot, soapy water and rinse. Use DS2 and rinse. DS2 may soften paint. Weather.	Follow the same directions as for wood (unpainted surfaces).	Wash the interior with large amounts of water. Wipe the contamination from the surface.
Plastics (opaque): insulation, telephones, and panel boards	Use DS2 (may soften or damage some plastics). Wash with hot, soapy water and rinse. Weather. Air.	Follow the same directions as for glass lens.	Wash with a detergent. Flush with water. Wipe or brush.
Plastics (transparent): eyepieces and airplane canopies	Use DS2 (may soften or damage some plastics). Wash with hot, soapy water and rinse. Weather. Air.	Follow the same directions as for glass lens.	Wash with a detergent. Flush with water. Wipe or brush.
Nonsealed electronic equipment	Use a mild, evaporative solvent such as alcohol. Use DS2. Use a mild detergent and water. Rinse with distilled water. Keep the solution out of the adjustable switches, connectors, and relays. Use hot-air blowers.	Use a mild, evaporative solvent such as alcohol. Use DS2. Use a mild detergent and water. Rinse with distilled water. Keep the solution out of the adjustable switches, connectors, and relays. Use hot-air blowers.	Use hot-air blowers. Wipe or brush.



**Table C-1. Decon Procedures for Specific Surfaces and Materials (Continued)**

Surface or Material	Types of Contamination and How to Decon		
	Chemical	Biological	Radiological
Rubber (impermeable): aprons, suits, and other items	Spray with DS2 and rinse after 30 minutes. Immerse in soapy water (just below the boiling point) for 1 hour. Do not agitate. Rinse with clear water and hang to dry. Use a 10 percent sodium-carbonate solution for G agents, rinse, and air. Apply hot, soapy water with brushes and rinse. Spray with an STB slurry from the PDDE. Wash off, after a few minutes, with clear water.	Follow the same directions as for leather.	Brush. Scrub or flush with water or soapy water.
Rubber (natural and synthetic): gloves and boots	Spray with a 10 percent mixture of HTH and rinse. Immerse in STB slurry for 4 hours, rinse, and dry. Use an IEDK in emergencies. Air.	Follow the same directions as for leather.	Brush. Scrub or flush with water or soapy water.
Rubber: mask facepieces and other rubber articles coming in direct contact with the skin	Use IEDK in emergencies. Wash with warm, soapy water.	Follow the same directions as for leather.	Brush. Scrub or flush with water or soapy water.
Rubber: tires, hoses, mats, and insulation	Spray with a 10 percent mixture of HTH and rinse. Apply an STB slurry. Allow the slurry to remain at least 30 minutes then flush with clear water (may be left on tires). Apply hot, soapy water. Air. Weather.	Follow the same directions as for leather.	Brush. Scrub or flush with water or soapy water.
Water	Use trained water-purification personnel to decon.	Boil small amounts 15 minutes. Chlorinate using a chlorination kit. Add iodine water-purification tablets to small amounts.	Flocculation (requires special chemicals to remove suspended matter). Ion exchange (removes radions from solution).

Table C-1. Decon Procedures for Specific Surfaces and Materials (Continued)

Surface or Material	Types of Contamination and How to Decon		
	Chemical	Biological	Radiological
Mess gear and canned rations	Immerse in boiling, soapy water for 30 minutes and rinse. Immerse in boiling water for 30 minutes. Spray with DS2. Wash in hot, soapy water; rinse; and air.	Wash with soap and water, then immerse in disinfectant solution (disinfectant, chlorine or $\frac{1}{3}$ cup of household bleach per 10 gallons of water). Boil in water for 15 minutes (not effective on toxins and bacterial spores.) Immerse in a 5 percent sodium-carbonate solution (4 pounds of washing soda to 10 gallons of water) and rinse with potable water. Immerse in a household-bleach solution (2 gallons of bleach to 25 gallons of water) for 30 minutes, rinse, and air for 10 to 15 minutes. Immerse in an HTH solution ( $\frac{1}{2}$ pound to 25 gallons of water) for 30 minutes and rinse. Immerse in a 2 percent PAA for 10 minutes, rinse, and air 10 to 15 minutes.	Wash with soap and water and rinse. Brush and then wipe contamination from surfaces and containers.
Food: not canned or protected by impermeable container	Do not consume food that is suspected to be contaminated with chemical agents until veterinary personnel approve it.	Boil water 15 minutes. Cook food thoroughly. Immerse in or spray with a 2 percent household-bleach solution. (Packaged food or food that is peeled or pared can be immersed or sprayed with the solution.)	Wash or trim contamination from unpackaged food.
Food: canned, bottled, or protected by impermeable container	Follow the same directions as for mess gear and canned rations.	Follow the same directions as for mess gear and canned rations.	Follow the same directions as for mess gear and canned rations.
Paper currency	Destroy by burning. Do not decon.	Destroy by burning. Do not decon.	Destroy by burning. Do not decon.
Coins	Wipe with soapy water. Wipe with an organic solvent.	Use UV rays. Wash with soapy water. Wipe with a 2 percent household-bleach solution. Air.	Brush or wipe. Wash with a detergent. Flush with water.

## Appendix D

# Decon Kits, Apparatuses, and Equipment

Various materials and equipment are used in decon operations. Some are simple to use and are readily available to individual soldiers. Others are very complex to use and are available only to specially trained teams. Table D-1, pages D-1 and D-2, lists the decon equipment and materials for the different use levels; Table D-2, pages D-3 through D-5, lists the detection equipment and materials for the different use levels.

**Table D-1. Decon Equipment and Materials**

Item and Description	Use	Limitations	Reference
<b>Individual</b>			
Decontaminating kit, skin, M291 SDK, (NSN 4230-01-276-1905) (20 kits per box)	To decon your skin, completely, through physical removal, absorption, and neutralization of toxic agent with no long-term effects  <b>NOTE: Use this kit for both actual combat and training purposes.</b>	Is for external use only.  <div style="border: 1px solid black; padding: 5px; text-align: center;"><b>WARNING</b> Keep decon powder out of eyes, cuts, or wounds. It could slightly irritate the skin or eyes.</div>	TM 3-4230-229-10
Decon kit, individual equipment, M295, IEDK, (NSN 6850-01-357-8456)	To decon your chemical protective gloves, mask, hood, overboots, LCE, and weapon.	<div style="border: 1px solid black; padding: 5px; text-align: center;"><b>WARNING</b> Do not use for skin decon. Keep off the skin and out of wounds, eyes, and mouth.</div>	TM 3-4230-235-10
Decontaminating apparatus, portable, M13 DAP, (3.7 gal), (NSN 4230-01-133-4124). It has a 3.7-gallon disposable DS2 container. The apparatus can be mounted to a standard 5-gallon fuel can mount on vehicles and equipment.	To spray DS2 on surfaces of vehicles and equipment.	Cannot refill DS2 container. See Table A-2, page A-2, for a list of replacement containers.	TM 3-4230-214-12&P TM 43-0001-26-1

**Table D-1. Decon Equipment and Materials (Continued)**

Item and Description	Use	Limitations	Reference
<b>Battalion Decon Crew and Chemical Company</b>			
<p>Decontaminating apparatus, power driven, skid mounted, multipurpose, integral, 500 gallon, M12A1 PDDA, (NSN 4230-00-926-9488), LIN F81880. Apparatus includes pump unit, tank unit, and M2 water heater (all mounted on skids).</p>	<p>To spray decon agent, STB slurries, and solutions as well as hot, soapy water rinses during field decon operations. To pump water or foam to fight fires, de-ice items, wash vehicles, and pump various fluids.</p>	<p>Do not use with defoliants, herbicides, or insecticides.</p>	<p>LO 3-4230-209-12 LO 5-2805-259-12 TM 3-4230-209-20&amp;P TM 43-0001-26-1</p>
<p>Decontaminating system, lightweight, M17 LDS, (NSN 4230-01-251-8702). The M17 is a portable pump and water-heating unit for producing hot water and steam. The system incorporates a 1,580- to 3,000-gallon collapsible water tank, two wand assemblies, and connecting hoses.</p>	<p>To perform operational and thorough decon of vehicles and equipment. Can also be used for troop showers, as necessary.</p>		<p>TM 3-4230-228-10</p>

**Table D-2. Detection Equipment and Materials**

Item and Description	Use	Limitations	Reference
<b>Individual</b>			
<p>Paper, chemical agent, detector, VGH, M8, (NSN 6665-00-050-8529). Paper is issued in a book of 25 sheets, perforated for easy removal. A color-comparison bar chart is printed on the inside front cover.</p>	<p>To detect the presence of liquid V, G, and H chemical agents</p>	<p>Cannot be used to detect vapors or chemical agents in water, DS2, or petroleum products. May cause false readings.</p>	<p>TM 3-6665-254-12 TM 3-6665-268-10 TM 3-6665-307-10 TM 43-0001-26-1</p>
<p>Paper, chemical agent, detector, M9, (NSN 6665-01-226-5589). Paper is issued in a 7-ounce dispenser box that contains one 30-foot roll of 2-inch-wide detector paper and plastic storage bags. The paper has an adhesive back for attaching to equipment and clothing.</p>	<p>To detect the presence of liquid V, G, and H chemical agents</p>	<p>Cannot be used to detect vapors or chemical agents in water. Will not stick to dirty, oily, or greasy surfaces. Contamination indications cannot be read under red light or by color-blind soldier. The following can cause false readings:</p> <ul style="list-style-type: none"> <li>• Temperatures above 125°F.</li> <li>• Brake fluid.</li> <li>• Aircraft cleaning compound.</li> <li>• DS2.</li> <li>• Petroleum products.</li> <li>• Insect repellent.</li> </ul>	<p>TM 3-6665-311-10</p>
<b>Company</b>			
<p>Chemical-agent alarm, automatic, M22 ACAA, (NSN 6665-01-438-6983)</p>	<p>To detect chemical nerve agents in the air.</p>	<p><b>WARNING Radiation hazard. Contains beta emitters.</b></p>	<p>TM 3-6665-321-12&amp;P</p>
<p>Chemical-agent alarm, automatic, M8A1 ACAA, (NSN 6665-01-105-5623). It can be vehicle-mounted, back-packed, or ground-emplaced.</p>	<p>To detect chemical nerve agents in the air.</p>	<p><b>WARNING Radiation hazard. Contains Americium (AM241).</b></p>	<p>TM 3-6665-312-12&amp;P</p>

**Table D-2. Detection Equipment and Materials (Continued)**

Item and Description	Use	Limitations	Reference
Chemical-agent monitor system (CAM) (NSN 6665-01-199-4153)	To search out areas; to search and locate contamination on personnel, equipment, ship's structure, aircraft, land vehicles, buildings, and terrain; and to monitor for effectiveness of decon. Can also be used for monitoring collective protection. The CAM responds to nerve- and blister-agent vapors down to the lowest concentration that could affect personnel over a short period.	Cannot be used as a detector. The CAM is a monitor and not a detector. Since it is a monitor, it can become contaminated and overloaded (saturated). The CAM can only report conditions at the front of the inlet probe. It is, therefore, a point monitor only and cannot give a realistic assessment of the vapor hazard over an area from one position. <div style="border: 1px solid black; padding: 5px; margin: 10px auto; width: fit-content;"> <p style="text-align: center;"><b>WARNING</b> Beta radiation hazard.</p> </div>	TM 3-6665-331-10
Detector kit, chemical agent, M256A1 (NSN 6665-01-438-6983). It contains M8 detector paper for liquid agents and samplers/detectors for vapors.	To detect liquid G, V, and H chemical agents using M8 detector paper and to detect and determine the type of vapor (G, V, H, and AC) using samplers/detectors.		TM 3-6665-307-10

**Table D-2. Detection Equipment and Materials (Continued)**

Item and Description	Use	Limitations	Reference
Radiac set, AN/VDR-2 (NSN 6665-01-222-1425)	To measure gamma radiation dose rates from 0.01 uGy/hr to 100 Gy/hr; to detect and display the level of beta particle dose rates from 0.1 uGy/hr to 5 cGy/hr; and to measure, store, and display accumulated dose rates from 0.01 uGy to 9.99 Gy. The instrument consists of a radiac meter with an internal sensor for obtaining dose rates during both mounted and dismounted operations. It has a second sensor housed in a probe and attached to the radiac meter with a cable and input connector. It is used for monitoring personnel, supplies, and equipment. The radiac set uses a presettable, an audible, and a visual warning device integral to the radiac meter. The system is air-transportable and organic to all units.		TM 11-6665-251-10
Computer indicator, radiac, CP696/PDR-75; detector, radiac/DT236/PDR-75; radiac set, AN/PDR-75, (NSN 6665-01-211-4217)	To measure the accumulated neutron and gamma radiation dose recorded by the DT236. A person who may be exposed to radiation from tactical nuclear weapons wears the DT236 on his wrist.		

## **Appendix E**

### **DTD Station Charts for Chemical Unit Leaders and NBC NCOs**

This appendix provides station charts for the DTD. They can be laminated and posted at each station. They provide the station number and on the reverse side, instructions for the station supervisor/attendant. They are not meant to be all-inclusive and do not include setup procedures or equipment requirements. They are an easy guide for soldiers going through a decon and for station supervisors/attendants.



**STATION 1**

**INDIVIDUAL-  
GEAR  
DECON**

---

**TASK: Remove contamination to  
a negligible risk from individual gear  
(LCE, mask carrier, helmet, and weapon)**

- **The soldier—**
  - **Decontaminates his own gloves with hot, soapy water or an STB slurry.**
  - **Decontaminates his hose and canister (if wearing the M42 mask) with either hot, soapy water and a sponge or an STB slurry mix.**
  - **Decontaminates his own gear by washing and scrubbing it for 4 minutes in a decontaminant container with hot, soapy water or an STB slurry mix.**
  
- **The attendant—**
  - **Takes the gear to the equipment checkpoint and places it on the "dirty" side of the contamination control line (engineer tape).**
  - **Waits as the monitor holds the detection device 1 inch from the gear and checks it for residual contamination.**
  - **Recycles any gear that is above one bar.**
  - **Places the gear on the clean side of the contamination control line if it passes the check.**
  - **Carries the gear to the reissue point.**

**NOTE: Change the slurry mix after 20 soldiers have decontaminated their gear and the rinse water after 10 soldiers or when it appears dirty (place the waste in the sump).**

**STATION 2**

**OVERBOOT**

**AND**

**HOOD DECON**

---

**TASK: Neutralize gross contamination on  
overboots, lower trouser legs,  
protective mask, and hood**

- **The soldier walks into the shuffle pit and spreads his legs apart (double-shoulder width), bends at the waist, and uses his hands to thoroughly rub the STB dry mix or the STB slurry on his overboots and lower trouser legs.**
- **Buddy #1 cuts the shoulder straps and drawcord on Buddy #2's hood. He pulls Buddy #2's hood inside out over the front of the mask, being careful not to touch the exposed neck or head. Buddy #1 gathers Buddy #2's hood in one hand and using a cutting tool, cuts away the hood as close as possible to the eye-lens outsert, voicemitter, and inlet-valve cover. Make sure nothing is left dangling below the bottom of the mask. If a replacement hood is not available, decon Buddy #2's hood in the same manner as for a MOPP-gear exchange.**
- **The attendant—**
  - **Instructs Buddy #1 on how to roll Buddy #2's hood to ensure that it is accomplished to standard.**
  - **Will monitor the shuffle pit and add more STB after 10 soldiers have processed through it.**

# **STATION 3**

# **OVERGARMENT REMOVAL**

---

**TASK: Remove contaminated overgarment before the agent penetrates material and touches the undergarments or the skin**

**The attendant—**

- **Assists the soldier in removing his overgarment.**
- **Cuts or removes the M9 detector paper from around the soldier's wrist.**
- **Unfastens the Velcro closure over the jacket zipper.**
- **Unties the waist cord and unfastens the Velcro straps on the soldier's jacket.**
- **Unfastens the back snaps.**
- **Cuts or removes the M9 detector paper from the soldier's trousers, if binding.**
- **Unfastens the Velcro straps and zipper on the cuffs of the soldier's trousers.**
- **Unfastens the front waist snaps and unzips the front zipper. He has the soldier lift one leg and point that foot down and bend slightly at the knees for stability.**
- **Grasps the cuff of the elevated boot with a hand on each side and pulls the cuff in an alternating, jerking motion until the soldier can step out of the trouser leg. The process is repeated on the other leg.**

**STATION 4**

**OVERBOOT  
AND GLOVE  
REMOVAL**

---

**TASK: Remove contaminated overboots and gloves to limit the spread of contamination (the overboots and gloves may also be decontaminated for reissue, if servicable)**

- **Engineer tape is used to mark the liquid-contamination control line.**
- **The attendant unfastens or cuts the elastic closures on the soldier's overboots.**
- **The soldier stands next to and faces the liquid-contamination control line.**
- **The soldier steps back about 12 inches from the liquid-contamination control line.**
- **The attendant steps on the back of the soldier's overboot and instructs him to lift his heel and work his foot out of the overboot and step across the liquid-contamination control line. Repeat the process on the other foot.**
- **The attendant discards the overboots.**
- **The soldier holds the fingertips of his gloves and partially slides his hands out.**
- **The attendant removes the soldier's gloves.**
- **The attendants—**
  - **Put the gloves and overboots into the containers on the "dirty" side of the control line.**
  - **Submerge the gloves and overboots in the container of hot, soapy water, ensuring that no water remains inside when removed from the container.**
  - **Submerge the gloves and overboots in the STB/HTH solution and thoroughly scrub them.**
  - **Rinse the scrubbed items and check for holes, tears, or punctures. If found, discard the items.**
  - **Place the usable items on a poncho or a plastic tarp to air dry.**
  - **Place the air-dried usable items into plastic trash bags along with an M256A1 detector kit. If the kit shows contamination remaining, the attendants can recycle the items or discard them. However, if the kit shows no contamination, they can be reused.**



# **STATION 5**

# **MONITOR**

**TASK: Identify contamination on personnel (spot-decon capability and medical aid are provided, as required)**

- **The monitor checks the soldiers for contamination.**
- **The aidman checks the soldiers for any chemical-agent symptoms and treats as necessary.**
- **The monitor asks the soldiers about any damage to their MOPP gear that was identified at stations 2, 3, or 4.**

**NOTE: If all the liquid contamination is absorbed into the clothing, the M8 detector paper will be negative even though there is a hazard.**

# **STATION 6**

# **MASK REMOVAL**

---

## **TASK: Remove the mask without contaminating the soldier**

- **The attendant pulls the hood over the front of the mask, grabs the mask by the voicemitter cover, and pulls the mask off the soldier while he holds his breath.**
- **The attendant holds the mask open so that the soldier can remove the inserts without touching the outside of the mask if the mask has optical inserts.**
- **The soldier walks upwind 16 feet, crosses the vapor-contamination control line, and then resumes breathing.**
- **The attendant brings the mask to station 7.**

**NOTE: No vapor hazard is expected beyond the vapor-hazard contamination control line.**

- **The chemical unit positions the M8A1 or M22 ACAA upwind of the site.**
- **The soldier moves straight ahead while his mask, which may still be emitting vapors, is held on the "dirty" side of the vapor-contamination control line and taken to the next station.**

# **STATION 7**

# **MASK DECON POINT**

---

## **TASK: Remove all contamination from the protective masks**

### **The attendants—**

- **Discard the winterization kits, if used.**
- **Remove the eye-lens outserts and the hoods if the hoods were not cut off at station 2.**
- **Remove or discard the filters or canisters and dispose of them in the properly marked containers.**
- **Wash the masks, hoods, eye-lens outserts, and hoses on the M42 and M43 masks in hot, soapy water.**
- **Rinse these items in clean water.**
- **Dip them in the sanitizing solution and agitate for 5 minutes.**
- **Rinse them in clean water again.**
- **Add one tube of mask sanitizing solution (calcium hypochlorite) to each quart of water.**
- **Wipe the masks with rags until they are almost dry.**
- **Discard each gallon of mask sanitizing solution into a sump after every 10 masks.**
- **Check for contamination with a CAM.**
- **Recycle the masks if they are still contaminated and then decon their gloves.**
- **Take the unassembled masks to the reissue point if they are not contaminated.**

# **STATION #8**

# **REISSUE POINT**

**TASK: Reissue the masks  
with their components to the soldiers**

- **The unit NBC NCO reissues the masks with their components to the soldiers.**
- **The soldiers will reassemble the masks in the postdecon AA.**
- **The unit NBC NCO provides the soldiers with replacement parts for all types of protective masks.**
- **The soldiers pick up individual gear and move to the postdecon AA.**



## Glossary

<b>AA</b>	assembly area
<b>AC</b>	hydrogen cyanide
<b>ACAA</b>	automatic chemical-agent alarm
<b>AD</b>	air defense
<b>AFM</b>	Air-Force Manual
<b>AFR</b>	Army-Force Regulation
<b>AMT</b>	ambulatory medical treatment
<b>AO</b>	area of operation
<b>APC</b>	armored personnel carrier
<b>AR</b>	Army regulation
<b>ART</b>	assessment and recovery team
<b>attn</b>	attention
<b>AVIM</b>	aviation intermediate maintenance facility
<b>BAS</b>	battalion aid station
<b>BDO</b>	battle-dress overgarment
<b>BDU</b>	battle-dress uniform
<b>BFV</b>	Bradley fighting vehicle
<b>bio</b>	biological
<b>C<sup>2</sup></b>	command and control
<b>CAM</b>	chemical-agent monitor
<b>CANA</b>	convulsant antidote for nerve agent
<b>CARC</b>	chemical-agent-resistant coating
<b>CG</b>	phosgene
<b>cGy/hr</b>	centigray per hour
<b>chem</b>	chemical
<b>CHS</b>	combat health support
<b>CK</b>	cyanogen chloride
<b>Class II Supplies</b>	clothing, individual equipment, tentage, organizational tool sets and kits, hand tools, maps, and administrative and housekeeping supplies and equipment

<b>Classes of Supply</b>	the grouping of supplies by type into 10 categories to facilitate supply management and planning
<b>CLU</b>	command launch unit
<b>CMO</b>	chemical officer
<b>CN</b>	chloroacetophenone
<b>CP</b>	chemical protective
<b>CPS</b>	collective protective shelter
<b>CPU</b>	chemical protective undergarment
<b>CRDEC</b>	Chemical Research Development and Engineering Center
<b>CSS</b>	combat service support
<b>CTA</b>	common table of allowance
<b>CVCUS</b>	combat vehicle crewman uniform system
<b>CX</b>	phosgene oxime
<b>DA</b>	Department of the Army
<b>DAD</b>	detailed aircraft decon
<b>DAP</b>	decontaminating apparatus, portable
<b>DD</b>	Department of Defense
<b>DED</b>	detailed equipment decon
<b>DISCOM</b>	Division-support command
<b>DP</b>	diphosgene
<b>DS2</b>	decontaminating solution number 2
<b>DTD</b>	detailed troop decon
<b>DU</b>	depleted uranium
<b>EDTA</b>	ethylene diamine tetra acetic acid
<b>EIC</b>	end-item code
<b>EMT</b>	emergency medical treatment
<b>ENCU</b>	environmental control unit
<b>EOD</b>	explosive ordnance disposal
<b>F</b>	Fahrenheit
<b>FARP</b>	forward arming and refueling point
<b>FLOT</b>	forward line of troops
<b>FM</b>	field manual
<b>FMC</b>	field medical card
<b>FMFM</b>	Fleet Marine Force Manual

---

<b>FRAGO</b>	fragmentary order
<b>FSB</b>	forward-support battalion
<b>G4</b>	Assistant Chief of Staff, G4 (Logistics)
<b>G5</b>	Assistant Chief of Staff, G5 (Civil Affairs)
<b>GA</b>	tabun
<b>GB</b>	sarin
<b>GD</b>	soman
<b>GF</b>	soman
<b>GI</b>	Government issue
<b>GP</b>	general purpose
<b>GPM</b>	gallons per minute
<b>Gy</b>	gray
<b>HD</b>	distilled mustard
<b>HE</b>	high explosive
<b>HEMTT</b>	heavy expanded-mobility tactical truck
<b>HEPA</b>	high-efficiency particulate air filter
<b>HL</b>	mustard-lewisite
<b>HMMWV</b>	high-mobility multipurpose wheeled vehicle
<b>HN-1</b>	nitrogen mustard
<b>HN-2</b>	nitrogen mustard
<b>HN-3</b>	nitrogen mustard
<b>HP</b>	horsepower
<b>HQ</b>	headquarters
<b>HTB</b>	high-test bleach
<b>HTH</b>	high-test hypochlorite
<b>IEDK</b>	individual equipment decon kit
<b>JMAO</b>	Joint Mortuary Affairs Office
<b>JP8</b>	aviation fuel
<b>L</b>	lewisite
<b>LAW</b>	light antitank weapon
<b>LCE</b>	load-carrying equipment
<b>LDS</b>	Lightweight Decontaminating System
<b>LIN</b>	line-item number
<b>LO</b>	lubrication order

<b>LTA</b>	launcher-tube assembly
<b>MADCP</b>	mortuary affairs decontamination collection point
<b>METT-TC</b>	mission, enemy, terrain, troops, time available, and civilian consideration
<b>MGX</b>	MOPP-gear exchange
<b>MOPP</b>	mission-oriented protective posture
<b>MP</b>	military police
<b>MRE</b>	meals, ready-to-eat
<b>MTF</b>	medical-treatment facility
<b>MTOE</b>	modification table of organization and equipment
<b>NATO</b>	North Atlantic Treaty Organization
<b>NAVMC</b>	Navy/Marine Corp
<b>NBC</b>	nuclear, biological, and chemical
<b>NBC5 report</b>	once the NBC reports are posted on the situation map, an NBC5 report showing the contaminated area is prepared by the division
<b>NCO</b>	noncommissioned officer
<b>NCOIC</b>	noncommissioned officer in charge
<b>NSN</b>	national stock number
<b>OEG</b>	operational exposure guidance
<b>OPORD</b>	operation order
<b>OS</b>	operator's spray down
<b>PAA</b>	peracetic acid
<b>PALADIN</b>	artillery howitzer
<b>PDDA</b>	power-driven decon apparatus
<b>PDDE</b>	power-driven decon equipment
<b>PL</b>	platoon leader
<b>PLL</b>	prescribed load list
<b>PNVS</b>	Pilot Night-Vision System
<b>POL</b>	petroleum, oils, and lubricants
<b>POMCUS</b>	prepositioning of material configured to unit sets
<b>PPW</b>	patient protective wrap
<b>PSG</b>	platoon sergeant
<b>psi</b>	pounds per square inch
<b>PT</b>	pointed
<b>PW</b>	personal wipe down

---

<b>rad</b>	radiological
<b>RD</b>	rounded
<b>RPO</b>	radiological protection officer
<b>S4</b>	Supply Officer (US Army)
<b>SA</b>	arsine
<b>SAW</b>	squad automatic weapon
<b>SB</b>	supply bulletin
<b>SD</b>	skin decon
<b>SDK</b>	skin decontaminating kit
<b>SMCT</b>	soldiers' manual of common tasks
<b>SOI</b>	signal operating instructions
<b>SOP</b>	standing operating procedure
<b>STANAG</b>	Standardized North Atlantic Treaty Organization Agreement
<b>STB</b>	supertropical bleach
<b>STP</b>	soldier training publication
<b>T20</b>	tritium oxide
<b>TADS</b>	Tactical Air-Defense System
<b>TAP</b>	toxicological apron, protective
<b>TB</b>	technical bulletin
<b>TC</b>	training circular
<b>TGD</b>	thickened soman
<b>THD</b>	thickened distilled mustard
<b>TM</b>	technical manual
<b>TO</b>	technical order
<b>TOE</b>	table of organization and equipment
<b>TOW</b>	tube launched, optically tracked, wire guided
<b>TPU</b>	tank and pump unit
<b>TRADOC</b>	United States Army Training and Doctrine Command
<b>uGy</b>	microgray
<b>US</b>	United States
<b>USMC</b>	United States Marine Corp
<b>UV</b>	ultraviolet
<b>VDR-2</b>	radiac meter
<b>VR-55</b>	soman

<b>VW</b>	vehicle washdown
<b>VX</b>	soman
<b>WBGT</b>	wet-bulb gradient temperature
<b>WO</b>	warning order

## Bibliography

- AR 11-9. *The Army Radiation Safety Program*. 28 May 1999.
- AR 385-10. *The Army Safety Program*. 23 May 1988.
- CRDEC Technical Report. CRDEC-CR-87036. *Project VALID Final Comprehensive Report. Herman Nelson Heater Utilization Study*. December 1986. AD-B108506.
- CRDEC Technical Report CRDEC-TR-175. *Decontamination Effectiveness of Water Streams*. March 1991. AD-B154567.
- CTA 50-909. *Field and Garrison Furnishings and Equipment*. 1 August 1993.
- DA Form 2028. *Recommended Changes to Publications and Blank Forms*. 1 February 1974.
- DA Form 2404. *Equipment Inspection and Maintenance Worksheet*. 1 April 1979.
- DD Form 1380. *US Field Medical Card*. December 1991.
- DO49 Technical Report DPB/JOD-91/025. *MOPP Exchange Evaluation, Operational*. September 1991. AB-B158128.
- DO49 Technical Report DPG/TA-86-015. *Standard and Nonstandard Decontaminants, and Decontamination Efficiency (U)*. May 1987. AD-C041660.
- DO49 Technical Report DPG/TA-88/018. *Effects on High Water Pressure on Composite Materials*. June 1988. AD-B124033.
- DO49 Technical Report DPG/TA-88/023. *Commercial and Field Expedient Chemical Warfare Agent Decontamination*. March 1988. AD-B121231.
- DO49 Technical Report DPG/TA-88/030. *Decontamination on Selected Military Equipment: US Army Ammunition Stocks*. September 1988. AD-B128325.
- DO49 Technical Report DPG/TA-89024. *Decontaminative Effects of Soil*. November 1989. AD-B140334.
- DO49 Technical Report DPG/TA-90/007. *Water Quality Requirements for Decontamination*. December 1989. AD-B140336.
- DO49 Technical Report DPG/TA-90/014. *Mission Oriented Protective Posture (MOPP) Exchange Procedures Evaluation*. January 1990. (No DDIC Number Assigned).
- DO49 Technical Report DPG/TA-90/025. *Human Factors Evaluation of the Mission Orientated Protective Posture (MOPP) Exchange Procedures*. July 1990. AD-B148421.
- FM 3-3. *Chemical and Biological Contamination Avoidance (FMFM 11-7)*. 16 November 1992.
- FM 3-3-1. *Nuclear Contamination Avoidance (FMFM 11-18)*. 9 September 1994.

- FM 3-4. *NBC Protection (FMFM 11-9)*. 29 May 1992.
- FM 3-4-1. *Fixed Site Protection*. 16 August 1989.
- FM 3-6. *Field Behavior of NBC Agents (Including Smoke and Incendiaries) (AFM 105-7; FMFM 7-11-H)*. 3 November 1986.
- FM 3-7. *NBC Field Handbook*. 29 September 1994.
- FM 3-9. *Potential Military Chemical/Biological Agents and Compounds (AFR 355-7)*. 12 December 1990.
- FM 3-100. *Chemical Operations Principles and Fundamentals*. 8 May 1996.
- FM 3-101. *Chemical Staffs and Units*. 19 November 1993.
- FM 8-9. *NATO Handbook on the Medical Aspects of NBC Defensive Operations*. 1 February 1996.
- FM 8-10-4. *Medical Platoon Leader's Handbook—Tactics, Techniques, and Procedures*. 16 November 1990.
- FM 8-10-7. *Health Service Support in a Nuclear, Biological, and Chemical Environment*. 22 April 1993.
- FM 8-33. *Control of Communicable Diseases Manual*. 9 April 1996.
- FM 8-285. *Treatment of Chemical Agent Casualties and Conventional Military Chemical Injuries (FMFM 11-11)*. 22 December 1995.
- FM 21-10. *Field Hygiene and Sanitation*. 22 November 1988.
- FM 21-11. *First Aid for Soldiers*. 27 October 1988.
- FM 100-5. *Operations*. 14 June 1993.
- FM 100-9. *Reconstitution*. 13 January 1992.
- FM 100-10. *Combat Service Support*. 3 October 1995.
- Joint Publication 3-11. *Joint Doctrine for Nuclear, Biological, and Chemical (NBC) Defense*. 10 July 1995.
- Joint Publication 3-12. *Doctrine for Joint Nuclear Operations*. 18 December 1995.
- Joint Publication 4-06. *Joint Tactics, Techniques, and Procedures for Mortuary Affairs in Joint Operations*. 28 August 1996.
- LO 3-4230-209-12. *Decontaminating Apparatus, Power-Driven, Skid-Mounted, Multipurpose, Nonintegral, 500 Gallon, ABC-M12A1*. 21 June 1974.
- LO 5-2805-259-12. *Engine, Gasoline, 20 HP, Military Standard Models 4A084-2, 4A084-3, 4A084-4, (LI-03524B-10-1A)*. 30 January 1989.
- SB 10-523. *Size Tariff for Clothing, equipment, and Footwear*. 1 August 1998.
- STANAG 2426 NBC. *NBC Contamination Control Policy for NATO Forces (Edition 1)*. 8 February 1995.
- STP 21-1-SMCT. *Soldier's Manual of Common Tasks Skill Level 1*. 1 October 1994.
- STP 21-24-SMCT. *Soldier's Manual of Common Tasks Skill Levels 2/3/4*. 1 October 1992.



- TB 43-0116. *Identification of Radioactive Items in the Army*. 1 April 1998.
- TC 3-4-1. *Chemical Agent Monitor Employment*. 17 December 1991.
- TM 3-4230-209-20&P. *Unit Maintenance Manual Including Repair Parts and Special Tools List Decontaminating Apparatus: Power-Driven, Skid-Mounted, 500 Gallon, M12A1 (NSN 4230-00-926-9488)*. 28 June 1986.
- TM 3-4230-214-12&P. *Operator's and Unit Maintenance Manual Including Repair Parts and Special Tools List for Decontaminating Apparatus: Decontaminating Apparatus: Portable, 14 Liter, M13 (Practice) (NSN 4230-01-345-5172)*. 15 August 1992.
- TM 3-4230-228-10. *Operator's Manual for Decontaminating Apparatus: Power Driven, Lightweight, M17 (NSN 4230-01-251-8702)*. 15 May 1989.
- TM 3-4230-229-10. *Operator's Manual for Decontaminating Kit, Skin: M291, (NSN 4320-01-251-8702) (SS010-AA-MMO-1-0; TO 11D1-1-131; TM 4230-10/1)*. 2 October 1989.
- TM 3-4230-235-10. *Operator's Manual for Decontamination Kit, Individual Equipment: M295 (NSN 6850-01-357-8456) (EIC: Y67)*. 20 February 1994.
- TM 3-6665-254-12. *Operator's and Organizational Maintenance Manual: Detector Kit, Chemical Agent, ABC-M18A2 (NSN 6665-00-903-4767)*. 16 February 1976.
- TM 3-6665-268-10. *Operator's Manual for Sampling Kit, CBR Agent 34*. 6 September 1968.
- TM 3-6665-307-10. *Operator's Manual for Chemical Agent Detector Kit, M256 (NSN 6665-01-016-8399) and M256A1 (NSN 6665-01-133-4964)*. 1 September 1985.
- TM 3-6665-311-10. *Operator's Manual for Paper, Chemical Agent Detector: M9 (NSN 6665-01-226-5589 (TO 11H2-2-21)*. 31 August 1998.
- TM 3-6665-312-12&P. *Operator's and Organizational Maintenance Manual Including Repair Parts and Special Tools List for M8A1 Automatic Chemical Agent Alarm (NSN 6665-01-105-5623) and Auxiliary Equipment M10 Power Supply (NSN 6665-00-859-2225); M10A1 Power Supply (NSN 6665-00-093-2739); M228 High Profile Mounting Kit (NSN 6665-00-859-2212) and M182 Low Profile Mounting Kit (NSN 6665-00-110-9492) (TO 11H2-17-1)*. 17 March 1985.
- TM 3-6665-321-12&P. *Operator's and Unit Maintenance Manual (including Repair Parts and Special Tools List ) for Alarm, Chemical Agent, Automatic: M22 (NSN 6665-01-438-6963) (EIC: Y14) and Auxiliary Equipment Power Supply, Chemical Agent Automatic Alarm: M28 (6130-01-438-6960) (EIC: Y40) Mounting Kit, Chemical Agent Automatic Alarm: M281 (NSN 6665-01-438-6959) (EIC: Y38) Alarm Unit, Chemical Agent Automatic Alarm: ABCA-M42 (NSN 6665-00-859-2215) (EIC: 399) (TO 11H2-23-1; MC 10434A-12&P; EE168-DB-OMP-010)*. March 98.
- TM 3-6665-331-10. *Operator's Manual for Chemical Agent Monitor (CAM) (TO 11H2-20-1)*. 12 June 1992.

TM 10-277. *Chemical, Toxicological, and Missile Fuel Handlers Protective Clothing.*  
1 November 1980.

TM 11-6665-251-10. *Operator's Manual for Radiac Set AN/VDR-2 (NSN 6665-01-222-1425).* 1 March 1988.

TM 43-0001-26-1. *Army Equipment Data Sheets: Chemical Defense Equipment.*  
12 May 1982.

NAVMC 10245. *Equipment Maintenance Request.* February 1994.

# Index

**A**  
agent classification  
  nonpersistent 1-2  
  persistent, 1-2  
aircraft decon, 7-2

**B**  
battalion aid station, *see* MTFs

**C**  
calcium hypochlorite, *see*  
  *decontaminants, standard, HTH*  
CARC, 1-5, 4-21  
chemical-agent monitor, *see*  
  *detection and warning devices,*  
  *CAM*  
chemical-agent-resistant coating,  
  *see* CARC  
chemical protective undergarment,  
  *see* CPU  
combat vehicle crewman uniform  
  system, *see* CVCUS  
common interferences of the CAM,  
  4-22  
contamination avoidance, 7-1  
contamination forms  
  aerosols, 1-1  
  liquids, 1-1  
  solids, 1-1  
  vapors or gases, 1-1  
contamination levels, 4-5  
CPU, 3-6, 3-19, 3-30, 3-36  
CVCUS, 3-6, 3-19, 3-29, 3-30, 3-35,  
  3-36

**D**  
decon  
  concepts, 1-2  
  decisions, 1-2  
  fixed site, 5-5  
  in combat, 1-5  
  levels  
    immediate, 1-4, 2-1  
    operational, 1-4, 3-1  
    thorough, 1-4, 4-1  
  of contaminated remains, 5-12  
  of depleted uranium, 5-11

  of radiological contamination,  
    5-12  
  of vulnerable equipment, 5-7  
  principles, 1-3  
decon devices for equipment  
  M11 DAP, 2-3, 6-3  
  M12A1 PDDA, 4-18, 6-3, 9-3,  
    D-2  
  M13 DAP, 2-3, 6-3, D-1  
  M17 LDS, 4-18, 6-3, 9-3, D-2  
decon procedures for  
  patient  
    biological agent, 8-15  
    chemical agent, 8-4  
    radiological agent, 8-22  
  specific surfaces and material,  
    C-1–C-7  
  weapons  
    60-millimeter mortar, 10-4  
    66-millimeter rocket  
      launcher, 10-4  
    AT4 light antitank weapon,  
      10-4  
    Javelin, 10-5, 10-6  
    M203 grenade launcher,  
      10-2  
    M249 squad automatic  
      weapon, 10-2  
    M47 Dragon, 10-2  
    M60 machine gun, 10-1  
    tube-launched, optically  
      tracked, wire-guided  
      (TOW) missile (M220  
      series), 10-3

decontaminants  
  natural, 1-2, B-13–B-14  
  soap and water, 7-2  
  nonstandard, 1-2, B-4–B-12  
  diesel fuel, 7-2  
  JP8, 7-2  
  kerosene, 7-2  
  sodium carbonate, 7-2  
  sodium hypochlorite, 7-2  
  standard, 1-2, B-1–B-14  
  DS2, 2-3, 7-2  
  HTH, 2-2, 8-4, B-4  
  STB, 7-2

decontaminating solution number 2,  
  *see* *decontaminants, standard,*  
  *DS2*  
DED, 1-4, 4-18, 9-2  
DED layout, 4-22, 4-24–4-27  
detailed aircraft decon, *see* *types of*  
  *aircraft decon, DAD*  
detailed equipment decon, *see* *DED*  
detailed troop decon, *see* *DTD*  
detection and warning devices  
  CAM, 4-10, 4-21, 6-3, D-4  
  M22 ACAA, D-3  
  M256A1 detector kit, 4-10, 6-3,  
    D-4  
  M8 detector paper, 6-3, D-3  
  M8A1 ACAA, 6-4, D-3  
  M9 detector paper, 6-3, D-3  
DTD, 1-4, 4-6, 9-2  
DTD layout, 4-8  
DTD station charts, E-1

**E**  
effects of environmental conditions  
  on  
    cold- and arctic-weather areas,  
      6-1  
    desert, 6-6  
    jungle, 6-6  
    mountains, 6-5  
    urban areas, 6-5  
    warmed areas, 6-4  
engineer support, 4-1, 4-2  
equipment and supplies needed for  
  decon, 9-5–9-7  
essential information for decon  
  support, 4-3

**F**  
fragmentary order, *see* *FRAGO*  
FRAGO, 4-3  
freezing points of  
  decontaminants, 6-1  
  selected chemical agents, 6-2

**I**  
IEDK, 1-4, 2-1, 2-3, 9-1  
individual equipment decon kit, *see*  
  *IEDK*

**L**

layout of patient-decon station, 8-5  
 layout of thorough decon site, 4-5

**M**

M11 decontaminating apparatus,  
 portable, *see decon devices for  
 equipment, M11 DAP*  
 M12A1 power-driven decon  
 apparatus, *see decon devices for  
 equipment, M12A1 PDDA*  
 M13 decontaminating apparatus,  
 portable, *see decon devices for  
 equipment, M13 DAP*  
 M17 Lightweight Decontaminating  
 System, *see decon devices for  
 equipment, M17 LDS*  
 M22 automatic chemical-agent  
 alarm, *see detection and warning  
 devices, M22 ACAA*  
 M291 kit, 2-1, D-1  
 M295 kit, 2-1, 2-3, D-1  
 M8A1 automatic chemical-agent  
 alarm, *see detection and warning  
 devices, M8A1 ACAA*  
 MADCP, 5-12  
 medical-treatment facilities, *see  
 MTFs*  
 methods of terrain decon  
   burning, 5-3  
   clearing, 5-5  
   exploding, 5-3  
   flushing, 5-4  
   neutralizing, 5-2  
   removing/covering, 5-2  
   weathering, 5-2  
 MOPP-gear exchange, 3-1, 9-1  
   buddy-team method, 3-6, 3-7,

3-11, 3-15, 3-17–3-19, 3-21  
 individual (emergency) method,  
 3-6, 3-31–3-37  
 triple buddy-team method, 3-6,  
 3-22, 3-24, 3-25, 3-27–3-30

mortuary affairs decontamination  
 collection point, *see MADCP*  
 MTFs, 8-2

BAS, 8-3  
 hospital, 8-3  
 medical company's clearing  
 station, 8-3

**N**

negligible risk levels of  
 contamination, 1-3

**O**

operation order, *see OPORD*  
 operational-decon phases  
   execution, 3-2  
   preparation, 3-1  
   site clearance, 3-2  
 operator's spray down, 2-2, 9-1  
 OPORD, 4-3

**P**

personal wipe down, 2-2, 9-1  
 personnel and equipment  
 requirements for  
   DAD layout, 7-15  
   DED layout, 4-28–4-31  
   DTD layout, 4-9  
 planning factors for DS2 application,  
 4-20  
 planning factors for rinse station,  
 4-21

preparation of chlorine-solution for  
 patient decon, 8-4  
 preparing vehicles for decon, 4-6  
 priority of work for equipment decon,  
 4-2

**R**

radiac detector  
   AN/PDR-75, D-5  
   AN/PDR-77, 4-4  
   AN/VDR-2, 4-4, D-5  
 responsibility for DTD setup, 4-6

**S**

SDK, 1-4, 2-1, 9-1  
 skin decon, 1-4, 2-1  
 skin decontaminating kit, *see SDK*  
 supertropical bleach, *see  
 decontaminants, standard, STB*

**T**

types of aircraft decon  
   aircrew spot decon, 7-3  
   aircraft washdown, 7-3  
   DAD, 1-4, 7-8

**V**

vehicle washdown, 3-3, 9-2

**W**

warning order, *see WO*  
 WO, 4-3  
 work/rest cycle, 4-23, 4-32  
 water consumption for  
   DED, 9-3  
   DTD, 9-3  
 operational decon, 9-3

**FM 3-5**  
**28 JULY 2000**

By Order of the Secretary of the Army:

ERIC K. SHINSEKI  
*General, United States Army*  
*Chief of Staff*

Official:

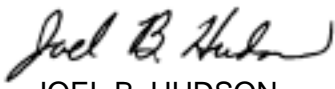
  
JOEL B. HUDSON  
*Administrative Assistant to the*  
*Secretary of the Army*  
0016712

DISTRIBUTION:

*Active Army, Army National Guard, and US Army Reserve:* To be distributed in accordance with the initial distribution number 110737, requirements for FM 3-5.

By Direction of the Commandant of the Marine Corps:

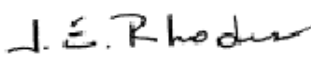
  
J. E. RHODES  
Lieutenant General, US Marine Corps  
Commanding General  
Marine Corps Combat Development Command  
PCN: 14300008000