



NATO Science for Peace and Security Series - C:  
Environmental Security

# Risk Management of Water Supply and Sanitation Systems

Edited by  
Petr Hlavinek  
Cvetanka Popovska  
Jiri Marsalek  
Ivana Mahrikova  
Tamara Kukharchyk



Springer



*This publication  
is supported by:*

The NATO Science for Peace  
and Security Programme

# Risk Management of Water Supply and Sanitation Systems

# NATO Science for Peace and Security Series

This Series presents the results of scientific meetings supported under the NATO Programme: Science for Peace and Security (SPS).

The NATO SPS Programme supports meetings in the following Key Priority areas: (1) Defence Against Terrorism; (2) Countering other Threats to Security and (3) NATO, Partner and Mediterranean Dialogue Country Priorities. The types of meeting supported are generally "Advanced Study Institutes" and "Advanced Research Workshops". The NATO SPS Series collects together the results of these meetings. The meetings are co-organized by scientists from NATO countries and scientists from NATO's "Partner" or "Mediterranean Dialogue" countries. The observations and recommendations made at the meetings, as well as the contents of the volumes in the Series, reflect those of participants and contributors only; they should not necessarily be regarded as reflecting NATO views or policy.

**Advanced Study Institutes (ASI)** are high-level tutorial courses intended to convey the latest developments in a subject to an advanced-level audience

**Advanced Research Workshops (ARW)** are expert meetings where an intense but informal exchange of views at the frontiers of a subject aims at identifying directions for future action

Following a transformation of the programme in 2006 the Series has been re-named and re-organised. Recent volumes on topics not related to security, which result from meetings supported under the programme earlier, may be found in the NATO Science Series.

The Series is published by IOS Press, Amsterdam, and Springer, Dordrecht, in conjunction with the NATO Public Diplomacy Division.

## Sub-Series

A.	Chemistry and Biology	Springer
B.	Physics and Biophysics	Springer
C.	Environmental Security	Springer
D.	Information and Communication Security	IOS Press
E.	Human and Societal Dynamics	IOS Press

<http://www.nato.int/science>

<http://www.springer.com>

<http://www.iospress.nl>



**Series C: Environmental Security**

# Risk Management of Water Supply and Sanitation Systems

edited by

**Petr Hlavinek**

AQUA PROCON Ltd.  
Brno, Czech Republic

**Cvetanka Popovska**

University of St. Cyril and Methodius  
Skopje, Former Yugoslav Republic of Macedonia

**Jiri Marsalek**

National Water Research Institute  
Burlington, Canada

**Ivana Mahrikova**

Slovak University of Technology Bratislava  
Bratislava, Slovak Republic

and

**Tamara Kukharchyk**

National Academy of Sciences of Belarus  
Minsk, Belarus

 Springer

Published in cooperation with NATO Public Diplomacy Division



Proceedings of the NATO Advanced Research Workshop on  
Risk Management of Water Supply and Sanitation Systems Impaired by Operational  
Failures Natural Disasters and War Conflicts  
Ohrid, Macedonia  
22–25 October 2008

Library of Congress Control Number: 2009922611

ISBN 978-90-481-2364-3 (PB)  
ISBN 978-90-481-2363-6 (HB)  
ISBN 978-90-481-2365-0 (e-book)

---

Published by Springer,  
P.O. Box 17, 3300 AA Dordrecht, The Netherlands.

*www.springer.com*

*Printed on acid-free paper*

---

All Rights Reserved

© Springer Science + Business Media B.V. 2009

No part of this work may be reproduced, stored in a retrieval system, or transmitted in any form or by any means, electronic, mechanical, photocopying, microfilming, recording or otherwise, without written permission from the Publisher, with the exception of any material supplied specifically for the purpose of being entered and executed on a computer system, for exclusive use by the purchaser of the work.

# CONTENTS

<b>Preface</b> .....	<b>ix</b>
<b>Acknowledgement</b> .....	<b>xi</b>
<b>List of Contributors</b> .....	<b>xiii</b>
<b>Vulnerability of Wastewater and Sanitations Systems</b>	
Hazards, Vulnerability and Mitigation Measures of Water Supply and Sewerage Systems .....	3
<i>Petr Hlavinek</i>	
Sewer System Management in Extraordinary Events.....	13
<i>Dejan Ljubisavljevic and Anja Randjelovic</i>	
Risk and Uncertainty Assessment of Urban Drainage Networks .....	27
<i>Roumen Arsov and Tanya Igneva-Danova</i>	
Waste Water from Small Urban Areas-Impact of Environment in Slovakia .....	37
<i>Ivana Mahrikova</i>	
Financial Network Reconstruction Plan .....	47
<i>Daniel Moran</i>	
Influence of Sewages from the Industrial Zone of Uranium Production on the State of the Water Objects.....	55
<i>Borys Kornilovych, Larysa Spasonova, Oleksandr Makovetsky and Victoria Tobilko</i>	
Risk Analysis of Sewer System Operational Failures Caused by Unstable Subsoil.....	65
<i>Karel Kříž, Vojtěch Bareš, Jaroslav Pollert Jr., David Stránský and Jaroslav Pollert</i>	
Risk and Vulnerability Assessment (“ROS-Analysis”) of the Bergen Water Supply System – A Source to Tap Approach .....	73
<i>Jon Røstum, Asle Aasen and Bjørnar Eikebrokk</i>	
<b>Vulnerability of Drinking Water Systems</b>	
Drinking Water Security: Municipal Strategies.....	87
<i>Jiri Marsalek</i>	
Flood Risk Assessment of Urban Areas .....	101
<i>Cvetanka Popovska and Dragan Ivanoski</i>	

Economic and Technical Efficiency of Drinking Water Systems: An Empirical Approach for Spain .....	115
<i>F. Hernandez-Sancho, S. Del Saz-Salazar and R. Sala-Garrido</i>	
Occurrence and Consequences of Disinfection By-Products in Drinking Waters as Related to Water Shortage Problems in Istanbul Metropolitan City .....	125
<i>Miray Bekbolet</i>	
Drinking Water System of Chernivtsi: Current Condition, Vulnerability Assessment and Possible Ways of Threat Mitigation.....	135
<i>Igor Winkler and Alla Choban</i>	
<b>Emergency Response Plans</b>	
Water Safety Plans in Disaster Management: Appropriate Risk Management of Water, Sanitation and Hygiene in the Context of Rural and Peri-Urban Communities in Low-Income Countries.....	145
<i>James Webster, Jen Smith, Tim Smith and Francis Okello</i>	
Online Monitoring Technologies for Drinking Water Systems Security .....	153
<i>Andrea G. Capodaglio and Arianna Callegari</i>	
The Use of Data-Driven Methodologies for Prediction of Water and Wastewater Asset Failures .....	181
<i>Dragan A. Savic</i>	
Proactive Crisis Management of Urban Infrastructure Executive Summary of the Cost Action C19.....	191
<i>J. Røstum</i>	
Water Pollution Impact on Immune Status of Human Organism and Typical Epidemic Processes: Mathematic Model, Obtaining Results, Their Analysis and Proposals to Manage Risk Factors .....	199
<i>Borys Skip</i>	
Risk Assessment of Water Pollution Driven by Random Currents .....	205
<i>Jacques Ganoulis</i>	
<b>Case Studies from Regions Affected by Drinking Water Systems, Wastewater and Sanitations System Failures</b>	
Vulnerability of the Drinking Water Supplies of Istanbul Metropolitan City: Current Status and Future Prospects .....	215
<i>Ceyda Senem Uyguner</i>	

Consequences of Non Planned Urban Development During Turbulent Times in Serbia – Case Study of Suburb Kumodraz Watershed in Belgrade.....	225
<i>Jovan Despotović, Jasna Plavšić, Aleksandar Djukić and Nenad Jaćimović</i>	
Reuse of Waste Waters in Slovakia, Water Supply Sustainability.....	233
<i>Štefan Stanko</i>	
Examples of Risk Management in Flanders for Large Scale Groundwater Contamination.....	241
<i>Ilse van Keer, Richard Lookman, Jan Bronders, Kaat Touchant, Johan Patyn, Ingeborg Joris, Danny Wilczek, Johan Vos, Jan Dewilde, Katrien van de Wiele, Pascal Maebe and Filip de Naeyer</i>	
Environmental Benefits of Wastewater Treatment: An Economic Valuation.....	251
<i>F. Hernandez-Sancho, M. Molinos Senante and R. Sala-Garrido</i>	
<b>Poster Section</b>	
Anoxic Granulation of Activated Sludge.....	263
<i>Petra Pagacova, Katarina Galbova and Ivana Jonatova</i>	
Drinking Water Supply in Belarus: Sources, Quality and Safety.....	273
<i>Tamara Kukharchyk and Valery Khomich</i>	
Operation of Household MBR WWTP – Operational Failures.....	283
<i>Tina Pikorova, Zuzana Matulova, Petr Hlavinek and Miloslav Drtil</i>	
Perspective of Decentralized Sanitation Concept for Treatment of Wastewater in the Czech Republic, Otmarov.....	293
<i>Tatiana Sklenarova and Petr Hlavinek</i>	
Xenobiotics in Process of Wastewater Treatment – Web Knowledge Base.....	299
<i>Jiří Kubík and Petr Hlavinek</i>	
Hydraulic and Environmental Reliability Model of Urban Drainage.....	305
<i>Petr Hlavinek, Petr Prax, Vladimíra Šulcová and Jiří Kubík</i>	
<b>Subject Index.....</b>	<b>323</b>

## PREFACE

Each year more than 200 million people are affected by floods, tropical storms, droughts, earthquakes, and also operational failures, wars, terrorism, vandalism, and accidents involving hazardous materials. These are part of the wide variety of events that cause death, injury, and significant economic losses for the countries affected. As demonstrated by recent events, natural and manmade hazards can affect anyone in anyplace. From the tsunami in the Indian Ocean to the earthquake in South Asia, from the devastation caused by hurricanes and cyclones in the United States, the Caribbean, and the Pacific, to the intense rains throughout Europe and Asia, hundreds of thousands of persons have lost their lives and millions their livelihoods because of disasters triggered by natural and manmade hazards.

In an environment where natural hazards are present, local actions are decisive in all stages of risk management: in the work of prevention and mitigation, in rehabilitation and reconstruction, and above all in emergency response and the provision of basic services to the affected population. Commitment to systematic vulnerability reduction is crucial to ensure the resilience of communities and populations to the impact of natural and manmade hazards.

Current challenges for the water and sanitation sector require an increase in sustainable access to water and sanitation services in residential areas, where natural hazards pose the greatest risk. In settlements located on unstable and risk-prone land there is growing environmental degradation coupled with extreme conditions of poverty that increase vulnerability. The development of local capacity and risk management play vital roles in obtaining sustainability of water and sanitation systems as well as for the communities themselves.

Unfortunately water may also represent a potential target for terrorist activity or war conflict and a deliberate contamination of water is a potential public health threat. An approach which considers the needs of communities and institutions is particularly important in urban areas affected by armed conflict. Risk management for large rehabilitation projects has to deal with major changes caused by conflict: damaged or destroyed infrastructure, increased population, corrupt or inefficient water utilities, and impoverished communities.

Water supply and sanitation are amongst the first considerations in disaster response. The greatest water-borne risk to health in most emergencies is the transmission of faecal pathogens, due to inadequate sanitation, hygiene and protection of water sources. Water-borne infectious diseases include diarrhoea, typhoid, cholera, dysentery and infectious hepatitis. However, some disasters, including those involving damage to chemical and nuclear industrial installations, or involving volcanic activity, may create acute problems from chemical or

radiological water pollution. Sanitation includes safe excreta disposal, drainage of wastewater and rainwater, solid waste disposal and vector control.

Natural and manmade hazards and the sustainability of water resources are important issues in Water Resources Management. Moreover, safety is one of the most important aspects of water management. Water Resource Management also seeks to balance environmental, economic, and cultural values. Natural and manmade hazards have far-reaching physical, biological, environmental and socio-economic impacts and usually have their greatest impact on the poor, women and children. While people cannot prevent these occurrences, good planning and proper preparation can limit the devastating effects of these disasters on their lives. So the vital output of this Advanced Research Workshop is multi-hazard risk management, sustainable recovery plans at a community level, and strengthening institutions responsible for sustainability and replication of these efforts.

Petr Hlavinek  
Brno, Czech Republic

Cvetanka Popovska  
Skopje, Former Yugoslav Republic  
of Macedonia\*

Jiri Marsalek  
Burlington, Canada

Ivana Mahrikova  
Bratislava, Slovak Republic

and

Tamara Kukharchyk  
Minsk, Belarus

---

\* Turkey recognizes Republic of Macedonia with its constitutional name

## ACKNOWLEDGEMENT

Prof. Petr Hlavinek, AQUA PROCON Ltd., Czech Republic, and Prof. Cvetanka Popovska, University of St. Cyril & Methodius, Skopje, Former Yugoslav Republic of Macedonia\* directed this Advanced Research Workshop (ARW). They were assisted by three other members of the workshop Organizing Committee, Dr. Jiri Marsalek, National Water Research Institute, Environment Canada, Burlington, Canada, Ivana Mahrikova, Slovak University of Technology Bratislava, Slovak Republic and Tamara Kukharchyk National Academy of Sciences of Belarus, Minsk, Belarus.

The ARW was granted by NATO Science for Peace and Security Programme. Special thanks are due to NATO Science Committee and in particular to Dr. Fausto Pedrazzini, Programme director of NATO's Public Diplomacy Division, who provided liaison between the workshop organizers and NATO.

Compilation of the proceedings typescript was done by Jiri Kubik and Zuzana Jakubcova, Brno University of Technology, Czech Republic. Special thanks to all contributors who make this workshop possible and fruitful.

---

\* Turkey recognizes Republic of Macedonia with its constitutional name

## LIST OF CONTRIBUTORS

Miray Bekbolet

Boğaziçi University, Institute of Environmental Sciences, 34342 Bebek, Istanbul, Turkey, bekbolet@boun.edu.tr

Andrea G. Capodaglio

University of Pavia, Via Ferrata 1 27100 PAVIA, PAVIA, Italy, capo@unipv.it

Jovan Despotovic

University of Belgrade, Faculty of Civil Engineering, P.O. Box 42, Belgrade, Serbia, edespoto@hikom.grf.bg.ac.yu

Aleksandar Djukic

University of Belgrade, Faculty of Civil Engineering, P.O. Box 42, Belgrade, Serbia, djukic@grf.bg.ac.yu

Katarina Galbová

Slovak University of Technology, Department of Environmental Engineering, Radlinskeho 9, 812 37, Bratislava, Slovakia, katarina.galbova@stuba.sk

Jacques Ganoulis

Aristotle University of Thessaloniki, Civil Engineering Department, 54124, Thessaloniki, Greece, iganouli@civil.auth.gr

Francesc Hernandez-Sancho

University of Valencia, Faculty of Economics, Campus dels Tarongers, 46022, Valencia, Spain, Francesc.Hernandez@uv.es

Petr Hlavinec

AQUAPROCON ltd., Palackeho 12, 612 00, Brno, Czech Republic, petr.hlavinec@aquaprocon.cz

Petr Hlustik

Brno University of Technology, Institute of Municipal Water Management, Zizkova 17, 602 00, Brno, Czech Republic, hlustik.p@fce.vutbr.cz

Tanya Igneva-Danova

University of Architecture, Civil Engineering and Geodesy, Mladost 3, bl.332, entrance 1, floor 8, ap.29, Sofia 1712, Bulgaria, igneva@mail.bg

Dragan Ivanoski

Faculty of Civil Engineering, Skopje, Macedonia/Teaching assistant, Bul. Partizanski Odredi 24, Skopje, Macedonia, ivanoski@gf.ukim.edu.mk

Ilse Van Keer

VITO (Flemish Institute for Technological Research), Boeretang 200, Mol, Belgium, Ilse.vankeer@vito.be



Valery Khomich

Institute for Problems of Natural Resources Use & Ecology of National Academy of Belarus, Staroborysovski tract, 10, 220114, Minsk, Belarus, valery\_khomich@mail.ru

Karek Kriz

Czech Technical University, Faculty of Civil Engineering, Thakurova 7, Prague, Czech Republic, karel.kriz@fsv.cvut.cz

Jiri Kubik

Brno University of Technology, Institute of Municipal Water Management, Zizkova 17, 602 00, Brno, Czech Republic, kubik.j@fce.vutbr.cz

Tamara Kukharchyk

Institute for Problems of Natural Resources Use & Ecology of National Academy of Sciences of Belarus, Staroborysovski tract, 10, 220114, Minsk, Belarus, kukharchyk@yahoo.com

Dejan Ljubisavljevic

University of Belgrade, Faculty of Civil Engineering, Belgrade, Serbia, ljubisav@grf.bg.ac.yu

Ivana Mahrikova

Slovak University of Technology, Department of Sanitary Engineering, Radlinského 11, 813 68, Bratislava, Slovakia, mahrikova@svf.stuba.sk

Jiri Marsalek

National Water Research Institute, 867 Lakeshore Road, L7R 4A6, Burlington, ON, Canada, Jiri.Marsalek@ec.gc.ca

Zuzana Matulova

Brno University of Technology, Institute of Municipal Water Management, Zizkova 17, 602 00, Brno, Czech Republic, jakubcova.z@fce.vutbr.cz

Daniel Moran

DHI a.s., Na Vrších 1490/5, 100 00, Prague, Czech Republic, d.moran@dhi.cz

Petra Pagacova

Slovak University of Technology, Department of Environmental Engineering, Radlinskeho 9, 812 37, Bratislava, Slovakia, petra.pagacova@stuba.sk

Tina Pikorova

Slovak University of Technology, Department of Sanitary Engineering, Radlinského 11, 813 68, Bratislava, Slovakia, pikorova@svf.stuba.sk

Cvetanka Popovska

University of Ss. Cyril and Methodius, Dept. of Hydrology and River Engineering, Partizanski odredi 24, P.O. Box 560, 1000, Skopje, Macedonia, popovska@gf.ukim.edu.mk

Anja Randjelovic

Faculty of Civil Engineering, University of Belgrade, Bul Kralja Aleksandra 73, Belgrade, Serbia, anja@hikom.grf.bg.ac.yu

Jon Rostum

SINTEF, Department for water and wastewater, N- 7465, Trondheim, Norway,  
jon.rostum@sintef.no

Dragan Savic

University of Exeter, Department of Engineering, North Park Road, EX4 4QF, Exeter,  
UK, d.savic@exeter.ac.uk

Dimitrija Sekovski

United Nations Development Programme and Ministry of Environmental and Physical  
Planning/Project Manager, 11 oktombri 90, Resen, Macedonia,  
dimitrija.sekovski@undp.org

Maria Molinos Senante

University of Valencia, Faculty of Economics, C/Mariano Aser 35 pta 10, Valencia,  
Spain, senante@alumni.uv.es

Boris Skip

Physical Chemistry and Ecology of Chemical Manufacturing, Vice Dean for Education,  
Chemistry Faculty, Chernivtsi National University, Ukraine, 47500, Berezhany town,  
S.Stril'civ str. 53a, Chernivsti, Ukraine, b.skip@chnu.edu.ua

Tatiana Sklenarova

Brno University of Technology, Institute of Municipal Water Management, Zizkova 17,  
602 00, Brno, Czech Republic, sklenarova.t@fce.vutbr.cz

Larysa Spasonova

National Technical University "KPI", 03056, Kyiv, 37 Peremogy pr., Kyiv, Ukraine,  
L\_Spasonova@kpi.ua

Stefan Stanko

Slovak University of Technology, Department of Sanitary Engineering, Radlinského  
11, 813 68, Bratislava, Slovakia, stefan.stanko@stuba.sk

Vladimir Stavric

SOFRECO, CarlBro, European Agency for Reconstruction, Dimitrija Cupovski 8,  
Skopje, Macedonia, vladimir.stavric@undp.org

Goce Taseski

Faculty of Civil Engineering, Str. Ilindenska N.21 Ohrid, Ohrid, Macedonia,  
go\_taseski@hotmail.com

Sasho Terzioski

Responsible Engineer for water & environment in BUS Factory SANOS, Skopje  
Activities with the association Macedonian Water Center (as Establisher and President),  
Str. "516" No.10, Skopje, Macedonia, terzioski.water@yahoo.com

Nina Trendafilova

Municipal Public Water Utility "MJP Proaqua" Ohrid/Struga, Naum Ohridski bb, 6000,  
Ohrid, Macedonia, proaquapl@yahoo.com

Ceyda Senem Uyguner

Boğaziçi University, Institute of Environmental Sciences, 34342 Bebek, Istanbul,  
Turkey, uygunerc@boun.edu.tr

James Webster

Cranfield University, Centre for Water Science, Building 39, MK43 0AL, Bedfordshire,  
UK, r.j.webster@cranfield.ac.uk

Igor Winkler

Chernivtsy National University, Kotsiubinsky St. 2, Chernivtsi, Ukraine,  
igorw@connect.cv.ua

Zlatko Zafirovski

University of Ss. Cyril and Methodius, Dept. of Hydrology and River Engineering,  
Partizanski odredi 24, P.O. Box 560, 1000, Skopje, Macedonia,  
zafirovski@gf.ukim.edu.mk

# HAZARDS, VULNERABILITY AND MITIGATION MEASURES OF WATER SUPPLY AND SEWERAGE SYSTEMS

PETR HLAVINEK\*

*AQUA PROCON Ltd., Palackého 12, 612 00 Brno, Czech Republic*

**Abstract.** paper deals with hazards, vulnerability and mitigation measures of sewerage systems. Types of hazards pending in central Europe and their consequences on sanitation systems are described. The goal of the paper was to review existing knowledge about risk management and related topics such as disaster planning and management and emergency management as a starting point for the rest of the publication.

**Keywords:** hazards, vulnerability, risk management, water supply, sewerage systems

## 1. Introduction

Water, a life-sustaining element, can become the source of major concerns after a disaster. It is critical to have sufficient clean water in the immediate aftermath of an event in order to treat the ill, provide for human consumption and maintain basic hygiene, support in the work of search and rescue, and to resume normal productive and commercial activities. In the current global situation, characterized by conditions of inequity and extreme poverty, environmental degradation and climate change have caused an increase in the occurrence of natural hazards such as landslides, intense rains, hurricanes, drought, fires, and earthquakes. Furthermore, rapid and unplanned urban growth has increased the number of settlements on unstable, flood-prone, and high-risk land where phenomena such as landslides, rains, and earthquakes have devastating consequences. Socio-economic factors increase the vulnerability of communities as well as existing infrastructure and services (Gomez, 2002).

---

\* To whom correspondence should be addressed. Prof. Petr Hlavinek, AQUA PROCON Ltd., Palackého 12, 612 00 Brno, Czech Republic; e-mail: petr.hlavinek@aquaprocon.cz

IPCC WG 2 Fourth Assessment Report, April 2007: Climate Change Impacts, adaptation and vulnerability documents increases in wind intensity, decline of permafrost coverage, and increases of both drought and heavy precipitation events. Mountain glaciers and snow cover have declined on average in both hemispheres. Losses from the land-based ice sheets of Greenland and Antarctica have very likely (>90%) contributed to sea level rise between 1993 and 2003. Ocean warming causes seawater to expand, which contributes to sea level rising. Sea level rose at an average rate of about 1.8 mm/year during the years 1961–2003. The rise in sea level during 1993–2003 was at an average rate of 3.1 mm/year. Dry regions are projected to get drier, and wet regions are projected to get wetter. By mid-century, annual average river runoff and water availability are projected to increase by 10–40% at high latitudes and in some wet tropical areas, and decrease by 10–30% over some dry regions at mid-latitudes and in the dry tropics. Drought-affected areas will become larger. Heavy precipitation events are very likely to become more common and will increase flood risk. Water supplies stored in glaciers and snow cover will be reduced over the course of the century.

The development of local capacity and risk management therefore play vital roles in obtaining sustainability of water and sanitation systems as well as for the communities themselves. When these factors are not taken into account, there is the danger of designing and constructing unsustainable services that progressively deteriorate and malfunction. Poor design and construction put both the community and infrastructure at risk in disaster situations. The many actors in the water and sanitation sector (the administration, supervisors, providers, consumers, etc.) complicate the definition and assignment of functions and responsibilities. This result in confusion as to who does what regarding specific actions related to disaster prevention, preparedness, mitigation, and response. During each of these phases, each of the actions and actors have one common objective, that is, to ensure that the levels of water and sanitation service, established with local authorities and the community, can be sustained even during disaster situations. The reduction of vulnerabilities entails multi-disciplinary work in a network with other actors in risk management, such as public ministries, disaster management agencies, NGOs, the private sector, and the academic sector fostering the development and exchange of knowledge in matters of protecting water and sanitation systems against natural hazards. On the other hand, the resistance of systems to natural disasters is an important step toward ensuring that the achievements made in increased access to water and sanitation services are strengthened in the long term, thereby realizing the goal of reducing by half, by the year 2015, the percentage of people that lack sustainable access to safe drinking water and basic sanitation. In this sense, the local activities of risk management position themselves as a tool for realizing

the global challenges of providing water and sanitation services for all and at all times.

## 2. Types of Hazards and Their Consequences on Sanitation Systems

In Central Europe mainly floods and strong winds, occasionally earthquakes and landslides are experienced.

### 2.1. FLOODS

Floods are natural phenomena that may be caused by excessive rainfall or the thawing of ice and snow. It is important to be aware of the factors that modify runoff behaviour in a watershed. Some are climatic: variations in rainfall patterns, intersection areas, evaporation and transpiration. Others are physiographic: characteristics of the basin such as geological conditions, topography, the course of riverbeds, absorption capacity, type of soil, and land use. Historical statistics (precipitation levels, river levels, etc.) are a key input for the design of water systems. Special attention must be paid to recurrence periods and variations in the water level over the years and decades. Flood damage can take many forms: the wrenching force of flash floods, the impact of floating debris, landslides in oversaturated areas, rockslides, and so on. Floods are not new phenomenon as can be seen from Figure 1 (floods in centre of city Brno in 1950).

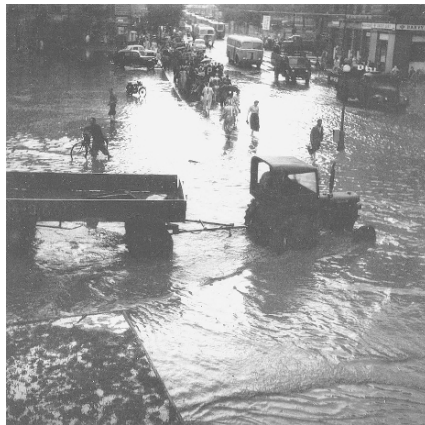

*Figure 1.* Floods in Brno 1950

The amount of damage depends on the levels reached by the water, the violence and speed of its flow, and the geographical area covered. Both too much water and too little can be a problem for water supply and sewerage

systems. In the case of floods, water and sanitation system components are most vulnerable when located where water collects or in the path of flash floods. Most devastating floods in Czech Republic were in 2002 (flooded centre of the city Prague; Fig. 2).



*Figure 2. Floods in Prague 2002*

Some water-supply system components themselves may increase the vulnerability of the systems and that of the population, for instance when a dam or reservoir breaks, ruptures occur in high-pressure pipes, or drinking water is supplied to settlements located in unstable terrain without the necessary drainage, so that runoff saturates the soil causing landslides and other mishaps. During floods, sanitation systems, particularly combined sewers, may become obstructed and fail. Sewerage obstructions and leaks put water-supply systems at risk from faecal and other contamination, particularly when water-distribution and sewage networks follow roughly the same layout and are thus in close proximity. It should be expected that different areas, or of different extension, will become prone to flooding at different times, depending on precipitation and recurrence patterns. When waterworks are designed, it is vital that historical variations in precipitation levels or river overflows be taken into account (Kubik, 2005).

## 2.2. EARTHQUAKES

Earthquakes may have various causes. However, their destructive power will depend in part on the characteristics: maximum probable magnitude, which relates to the quantity of energy released by seismic motion; intensity, which takes into account the effects felt by people, the damage to buildings, and the

changes to the terrain; likelihood of occurrence; background – seismic events in the past as well as currently active faults; quality and types of soil and potential for liquefaction and conditions of groundwater, level and variations over time.

It is important to be aware of potentially unstable areas: soil that is liquefiable or oversaturated, that might be displaced by a seismic event, and so on. The greatest danger is associated with fracture areas, seismic faults, and the former epicentres of destructive earthquakes. Seismic events may lead to underground instabilities, the terrain caving in, landslides, rock slides or mudflows. They can also render oversaturated soil too soft, leading to its collapse and damaging system components in the affected area. The types of damage wrought by earthquakes on water and sanitation systems include the total or partial destruction of the collection, treatment, storage and distribution structure, rupture of the pipes and damage to the joints, leading to a drop in the water supply and alteration of its quality and variations in the volume of surface or groundwater.

### 2.3. LANDSLIDES

This phenomenon may be caused by earthquakes, intense rains, volcanic eruptions, even human activities such as those that lead to deforestation. Regardless of the cause, it occurs in isolated fashion in specific places, hence the need to identify those points in the system that might be affected. In order to forecast landslides, it is essential to know the geology of the region, particularly steep slopes, ravines, drainage and filtration catchment areas, the topography and stability of the soil, areas with concentrated fissures and places where liquefaction has taken place due to earthquakes or precipitation. Vulnerability of water and sanitation systems to landslides is high, particularly in areas where collection facilities are located in mountainous areas and pipes must descend down mountain slopes to reach the areas serviced. In such areas, landslides may cause the total or partial destruction of vital system components, particularly collection and conduction facilities, located on or near the path of landslides in unstable terrain with steep slopes and water contamination in surface catchment areas in mountainous regions.

In many cases, inappropriate sitting, or leaks in water-supply system components, can cause landslides that damage a given component or even render an entire system inoperative. Landslides are generally the result of cumulative changes over weeks, months, even years. Water companies often have enough time to take precautionary measures to prevent damage to the system. However, landslides caused by unpredictable natural phenomena such as earthquakes or heavy rainstorms do not allow for preventive actions – unless these were taken at the time the system was designed. Several measures are available to reduce



vulnerability to landslides; reforestation campaigns; the construction or reinforcement of retaining walls and drainage components; slope stabilization and when pipes have to be laid on slopes, use of materials appropriate to the contours of the terrain.

### **3. Disaster Prevention and Mitigation**

Vulnerability reduction can be achieved through the use of prevention and mitigation measures that help correct deficiencies before disaster strikes and minimize the risk of failure in normal conditions. The purpose of this prevention and mitigation strategy is to counter the weaknesses in the system based on the frequency and intensity of the phenomena that may occur. In most cases, the problems that cause damage to water and sanitation systems are not exclusively related to the disaster itself, but rather reflect insufficient consideration of natural phenomena as a variable in the planning, design, construction, operation and maintenance of such systems. Most hazards can be mitigated by decentralizing water and sanitation systems; for instance, by establishing alternative water sources so as not to disrupt the service.

Vulnerability analysis means to determine the consequences of the hazards affecting the facility or operations of concern. It includes assessment and measurement of risk, meaning the probability of the event happening and how bad it would be. It normally would identify all possible vulnerabilities, present historical data about past disasters, assess future probability and frequency of emergencies and disasters, analyze impacts and effects, and validate data. For vulnerability analysis of water systems six steps are identified:

- Identification of components of system
- Quantifying magnitude of anticipated disasters
- Estimating effects of the anticipated disaster on each system component
- Estimating all water demands during and after the disaster
- Determining capability of the water supply system to meet demands
- Identifying critical components that cause failure

Identification of system components requires an inventory with maps, condition inspections, and data for operations and maintenance scenarios, including emergency actions. Quantifying the magnitude of anticipated disasters determines the scale and magnitude of each potential disaster or contingency. Estimating the effects of each anticipated disaster on each component of the system involves disaggregation of the system to assess the effects of each disaster type on each component. Estimating water demand during and after the disaster for all purposes is an extension to normal water demand estimating

procedures. Determining the capability of the water supply system to meet demands during emergencies requires modeling and analysis to match demands and supplies during the emergency. Finally, identifying critical components that cause failure during emergencies is the result of the vulnerability analysis and pinpoints the components that need strengthening (PAHO, 2006).

During floods in 2002 was necessary to start up damaged WWTP as soon as possible. In Table 1 damage of individual WWTP and start-up time is described.

TABLE 1. WWTP damaged by floods 2002

Name of WWTP	Orientation assessment of damage (Yes x no)			Putting into service	Orientation damage (million CZK)
	Electro	Technology	Civil		
WWTP Praha	Yes	Yes	No	4 months	300
WWTP Roztoky nad Vltavou	Yes	Yes	No	1 month	12.5
WWTP Kralupy nad Vltavou	Yes	Yes	Yes	1 month	
WWTP Znojmo	Yes	No	No	2 weeks	5
WWTP Roudnice	Yes	Yes	No	1 month	0.4
WWTP Bystřany	Yes	Yes	No	3 weeks	0.2
WWTP Litoměřice	Yes	Yes	Yes	2 months	0.75
WWTP Děčín	Yes	Yes	No	2 months	0.75
WWTP Želénky	No	Yes	No	Immediately	0.05
WWTP Žatec	No	Yes	No	Immediately	0.05
WWTP Štětí	Yes	Yes	No	6 weeks	5.7
WWTP SETUZA	Yes	Yes	No	1 week	0.3
WWTP Lovochemie	Yes	Yes	Yes	4 months	6.5
WWTP České Budějovice	Yes	Yes	No	2 months	81
WWTP Kaplice	Yes	No	Yes	1 week	2.5
WWTP Písek	Yes	Yes	Yes	1 month	5
WWTP Prachatice	Yes	Yes	Yes	1 month	2
WWTP Protivín	Yes	No	No	2 months	1.5
WWTP Strakonice	No	No	No	1 week	0.4
WWTP Tábor-Klokoty	Yes	Yes	No	1 month	5
WWTP Veselí nad Lužnicí	Yes	Yes	No	1 week	3
WWTP Plzeň I	No	No	No	Immediately	5
WWTP Plzeň II	Yes	Yes	Yes	2 months	55
WWTP Rokycany	Yes	Yes	Yes	2 weeks	5
WWTP Klatovy	Yes	Yes	Yes	Immediately	2.5
WWTP Beroun	Yes	Yes	Yes	1 month	10

#### 4. Risk Management

Risk analysis is a process by which we learn about and begin to understand how accidents and incidents occur. It answers the basic questions what can go wrong and why, how likely is it, how bad can it be and what can we do about it (Fig. 3).

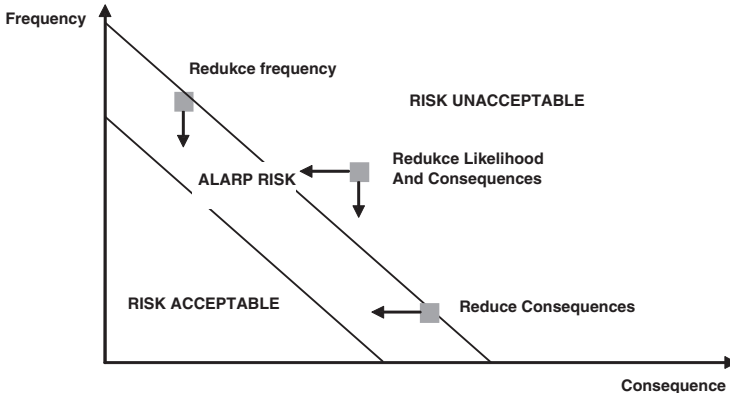

Figure 3. Frequency consequence diagram

The idea is to consider hazards which can threaten vulnerable elements of a system, assess risks and consequences, and develop risk management actions, including mitigation, response, recovery, and communication of risk to constituent groups. These elements form a planning process with five steps, determine, recognize, and appreciate all potential out-of-course events, determine (measure) levels of these risks, reduce levels of risk to as low as reasonably practicable (ALARP) or to acceptable levels, ascertain how and why each out-of-course event can affect people, place, processes, and the consequences of the effects and establish means and mechanisms by which consequences can be counterbalanced in manner acceptable to business and regulators (Simon, 2008).

#### 5. Emergency Management and Planning

Emergency management and disaster preparedness anticipate diverse situations, which threaten security. They involve a high degree of police or military skills, but critical infrastructure systems such as water supply require special expertise. In the water supply sector, the most common type of emergency is short term, caused by main breaks resulting from either natural or man-made hazards such as floods, hurricanes, earthquakes, tsunamis, tornadoes, power failures, landslides, terrorist attacks or similar events. A longer term emergency would result from

drought, contamination, loss of water source, and other causes. A disaster such as war is the worst kind because it combines sudden onset with a long term imbalance between supply and demand. Mitigation, preparation, response, and recovery are the four stages of emergency management.

Mitigation are “Disaster-proofing” activities which eliminate or reduce the probability of a disaster. Includes long-term activities to reduce effects of unavoidable disasters. In the case of water supply, mitigation includes reliable and flexible supply systems, cooperative plans for water-sharing and inter-connections, preparing to conserve, alternative treatment, and removing high-risk components. Preparedness is necessary to extent that mitigation measures cannot prevent damages. Governments, organizations, and individuals develop plans to save lives, minimize damage and enhance response operations. Requires standby equipment and arrangements for mutual assistance. Critical facilities should have water reserves. Response follows an emergency or disaster. Designed to provide emergency assistance for casualties, reduce probability of secondary damage and speed recovery operations. Command and control during an emergency are critical. Requires effective control through decisive actions based on accurate information, with established chain of command, effective decision support, and trained participants who understand chain of command and coordination requirements. Recovery continues until systems return to normal or better. Short-term recovery returns vital life-support systems to minimum operating standards. Long-term recovery may continue for a number of years after a disaster (Mcintre, 2008).

## **6. Conclusions**

This paper presents a background of risk management for water supply and sewerage systems. The goal of the paper was to review existing knowledge about risk management and related topics such as disaster planning and management, and emergency management. It gives overview of hazards, vulnerability and mitigation measures for both wastewater and drinking water systems, and serve as a starting point for the rest of the publication.

## **References**

- Gomez, P., Acquaviva, L.: Disaster mitigation in drinking water and sanitation systems, PAHO/WHO, 2002, Lima, Peru.
- Kubik, J., Hlavinec, P., Prax, P., Šulcová, V., Ugarelli, R.: Modelling hydraulic performance. Conclusive report. CARE-S Report D10, 2005.

- McIntire, P.: Integrated risk management to protect drinking water and sanitation services facing natural disasters, IRC, 2008, ISBN 978-90-6687-065-9.
- Pan American Health Organization, The challenge in disaster reduction for the water and sanitation sector: improving quality of life by reducing vulnerabilities, Washington, DC: PAHO, 2006, ISBN 92 75 12629 1.
- Pan American Health Organization, Natural disaster mitigation in drinking water and sewerage systems: Guidelines for vulnerability analysis, Washington, DC: PAHO, 1998, ISBN 92 75 12250 4.
- Simon, J.T. Pollard: Risk management for water and wastewater utilities, IWA Publishing, 2008, ISBN 1843391376.

# SEWER SYSTEM MANAGEMENT IN EXTRAORDINARY EVENTS

DEJAN LJUBISAVLJEVIC\*

*Faculty of Civil Engineering, University of Belgrade, Bul. Kralja Aleksandra 73, 11200 Belgrade, Serbia*

ANJA RANDJELOVIC

*Faculty of Civil Engineering, University of Belgrade, Bul. Kralja Aleksandra 73, 11200 Belgrade, Serbia*

**Abstract.** This paper deals with the problem of sewer system management in extraordinary conditions – by which are included both non-regular and special events. Extreme precipitation, thick layer of snow and its melting, extreme temperatures, odors, electrical energy shortage in main pumping stations, malfunctions of main pumping stations, obstruction of collecting pipes, discharge of septic tanks' contents in Belgrade Sewer System's (BSS) manholes, etc. belong to the group of non-regular events. As special events are considered damages of BSS's buildings and objects, high water levels of Danube and Sava, earthquakes, fires in main pumping stations, high concentration of pollution in sewer system and recipient water bodies, vandalism, occurrence of torrent streams in the outskirts of BSS, large scale erosion of soil, etc.

**Keywords:** management of sewer system, extraordinary, non-regular, special events

## 1. Introduction

### 1.1. BELGRADE SEWER SYSTEM FACTS

Belgrade sewer system (BSS) occupies an area of 15,000 ha and is spread in regions of central Belgrade, New Belgrade, Zemun, and some neighborhoods on the left Danube bank. A total of 10 districts of the city have a sewer network. There are approximately 1,000,000 people using the system every day. Sewer

---

\* To whom correspondence should be addressed. Prof. Dr. Dejan Ljubisavljevic, Institute for Hydrotechnics and Environmental Eng., Faculty of Civil Eng. University of Belgrade, Bul. Kralja Aleksandra 73, 11200 Belgrade, Serbia; e-mail: ljubisav@grf.bg.ac.yu

system is used to evacuate both domestic and industrial wastewater, atmospheric water (stormwater), partly drainage water and water from natural streams. Sewer system has discharges in rivers Sava, Danube and other city waterways without any treatment. The sewer system is mostly combined (both sanitary and stormwater). Newer parts of the city, though, have separated pipes for sanitary and stormwater.

Total length of the pipe network is close to 1,580 km, that being around 1.2 m per person, with diameters in range from 250 mm to 5.5 m. The sewer system has circa 51,000 connections, 32,000 kennels and 30 pumping stations, with installed capacity of more than 60 m<sup>3</sup>/s (even though, most of them are outdated). In the inner city parts, the degree of coverage by the BSS is close to 80% for wastewater and circa 65% for stormwater.

The design concept of the BSS was influenced in a great manner by the city's relief. According to the design solutions and concepts of the Master plan of the city of Belgrade (valid by the year of 2021), all done in the 1970s, the city's area has been divided in five distinctive catchments (systems): Central, Batajnicky, Banatski, Ostruznicki and Bolecki.

Central sewer system – includes majority of the old city's area between Danube and Sava, up to Kumodraz watershed boundary, the area of Mali Mokri Lug and left Sava bank, New Belgrade and Zemun, all the way to the industrial zone. Wastewater from this area is being discharged, without any pretreatment, directly to Sava and Danube. The key part of this system will be the "Interceptor" – main collecting pipe, which will accept wastewater from both Sava banks, and right Danube bank and conduct them to the wastewater treatment plant – planned in Veliko Selo. Stormwater is also being discharged in Sava and Danube, and other urban waterways (part of the same watershed). Central sewer system has both combined pipes (in the older parts of the city) and separated pipes for wastewater and stormwater (New Belgrade, Zemun and newer neighborhoods of the Sumadija region; Fig. 1). Central system is divided in a total of 21 subsystems – subcatchments, which are illustrated in the Fig. 2.

Batajnicky sewer system – covers area northwest of the neighborhood "Galenika" with neighborhoods: Dobanovci, Ugrinovci, Batajnica, Zemun polje, commercial zone Surcin – Dobanovci, industrial zone Upper Zemun and Surcin. System is planned to have separated pipes for wastewater and stormwater, of which, to the present, only the wastewater pipes exist.

Banatski sewer system – covers the area with neighborhoods on the left Danube bank, in parts of Banat, Padinska skela, Borca, Ovca, industrial zone "Pancevacki rit", Krnjaca and Kotez. System has separated pipes for wastewater and stormwater. This area is characterized by low terrain and high groundwater level. The sewer system has been built only in two neighborhoods: Borca and Kotez.

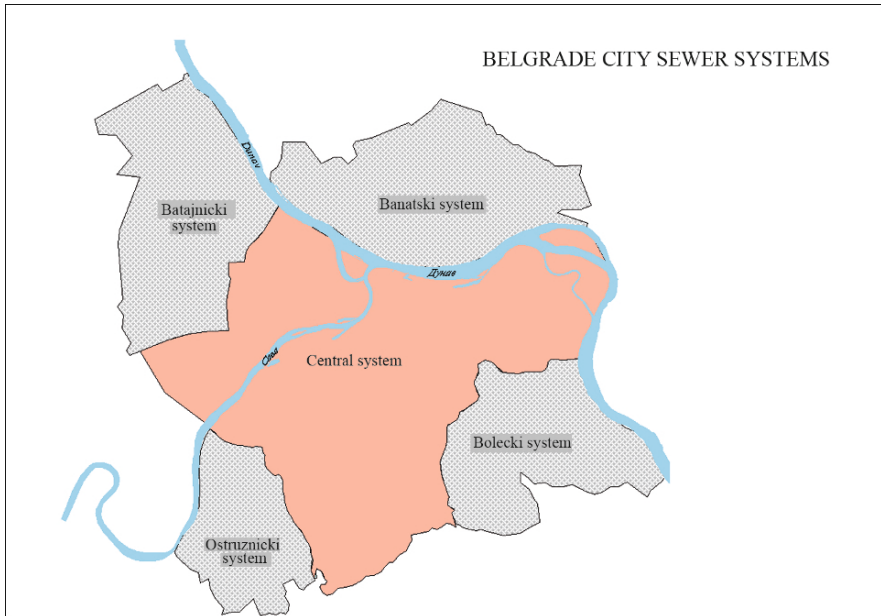

Figure 1. Main sewer systems

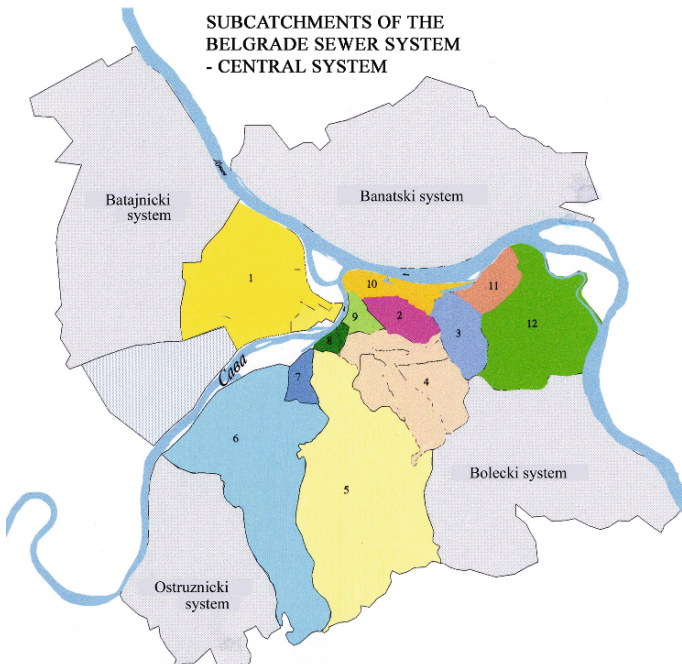

Figure 2. Subsystems of the central sewer system of Belgrade



Ostruznicki and Bolecki sewer systems have not yet been built. There is no public sewerage.

Table 1 shows the number of users of the BSS.

TABLE 1. Number of users and the degree of coverage – Belgrade sewer system

System name	Number of residents (2002)	BSS's users (2002)	Degree of coverage (2002) (%)
Central	1,152,095	843,300	73.2
Batajnicky	51,983	13,000	25
Banatski	60,020	28,200	47
Ostruznicki	21,741	0	0
Bolecki	41,781	0	0
TOTAL :	1,327,620	884,200	67

The area of the city that is covered by the BSS is shown in Fig. 3.

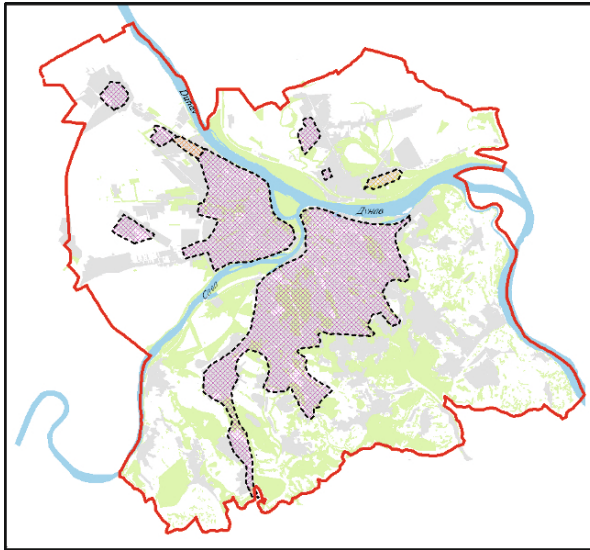

Figure 3. Present coverage by the BSS

BSS has 28 major discharge points to Sava and Danube, without any pre-treatment (Fig. 4). Beside these major discharges, there is a number of smaller direct wastewater discharge points, and a number of individual and group sewers installed to discharge directly to city's waterways and irrigation channels. Some details are presented in Table 2.

TABLE 2. Technical data about BSS

System area (ha)	circa 15,000
Pipe length of the sewer network (km)	1,580
– Total length of collecting pipes – diameters 60/110 cm to 5.5 m × 5.5 m	204
– Total length of pipes – diameters 250 mm to 600 mm	1,376
Number of connections	51,260
Number of pumping stations	30
– Capacity of pumping stations (m <sup>3</sup> /s)	63.5
– Capacity of pumping stations for wastewater (m <sup>3</sup> /s)	16
– Capacity of pumping stations for stormwater (m <sup>3</sup> /s)	37
Number of kennels	32,300
Number of major discharges to rivers	28
Estimated quantity of wastewater (m <sup>3</sup> /year)	circa 140,000,000
Estimated quantity of stormwater (m <sup>3</sup> /year)	circa 63,000,000
Pipe age (%):	
– Below 25 years	49
– Between 25 and 50 years	32
– More than 50 years	19
Type of pipe material	
– Ceramic (%)	51
– Concrete (%)	39
– Asbestos – cement (%)	9
– Plastic, iron and steel (%)	1

Systematic measurement of flow and wastewater quality, in the BSS, is still in its earliest phase. There have been frequent water quality checks, but they were rarely accompanied by flow measurements, making it impossible to get proper data about the mass-flow of contaminants.

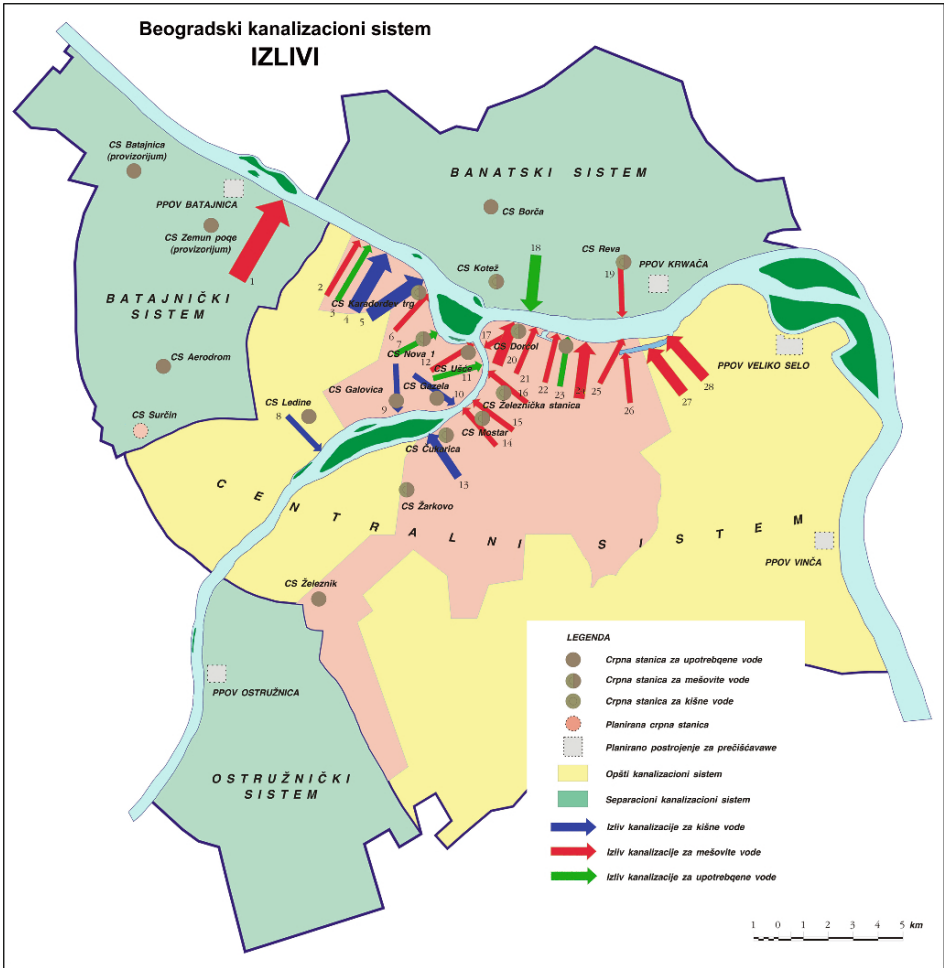

Figure 4. Major sewer system discharges to Sava and Danube

## 2. Procedures in Extraordinary Events

At a time of non-regular events it is necessary to obtain a written consent for urgent activities in the area of BSS from the City’s Department for Public Works and Department for Ecology and Environmental Protection. With these consents, BSS communicates to the State Waterworks Inspection and City’s Public Works Inspection.

Some activities during the non-regular events, like natural disasters (high water levels, floods, earthquakes), are regulated by law.

## 2.1. NON-REGULAR EVENTS

### 2.1.1. *Electrical Energy Shortage in Main Pumping Stations*

Electrical energy shortage causes malfunction of the parts of the system equipped with sewer pumping stations. To avoid this problem, every pumping station has a diesel – electric power unit (DEPU) to serve in time of emergency. Existing capacity of DEPUs is not enough to fulfill power needs of all the pumping stations. Besides, some of the DEPUs need reconstruction and reparation because of age and malfunction.

### 2.1.2. *Large Scale Precipitation (Rain and Downpour)*

Large scale precipitation causes local flooding of the areas located in the region where streams used to be (parts of the highway – former Mokroluski stream, parts of Vozdovac in the vicinity of the former Kumodraski stream, etc.). Some facts need to be emphasized: local flooding is intensified by the fact that stormwater pipe network is not fully developed, compared to the wastewater pipe network; rapid urbanization increases volume and speed of the surface flow, while the rapid urbanization that is done without planning greatly imperils, or, in some cases, completely disables realization of major sewer system objects for stormwater. Besides, there is no clear concept in relation to the needed protection level from inner waters on the city level, nor there is a clear flood risk/protection classification of the areas. It is clear that the only solution to the problem of protection from excessive stormwater is to build adequate stormwater sewer system objects (main collecting pipes, retention basins, etc.) and adequate urban planning.

### 2.1.3. *Thick Layers of Snow and Problems Associated with its Melting*

Melting of the thick layer of snow has very similar consequences to the environment – that is flooding, as does the large scale precipitation. The only difference is that snow adds extra risk by introducing larger quantities of suspended material to the sewer system, causing clogging. This clogging calls for extra cleaning activities of kennels and collecting pipes.

### 2.1.4. *Extreme Temperatures (Low and High)*

High temperatures can cause failure of certain equipment and speed up odor formation. Low temperatures, that are becoming rarer, can cause equipment failure, ice formation in parts of the system and at the discharge points.

### 2.1.5. *Odor*

Causes of odor can be found in wastewater compounds, the way of sewer system exploitation, and atmospheric conditions (air flow currents, to be precise). The most known example is the closed ventilation system with odor treatment facility next to the main railway station in Belgrade. There are many places with odor problem, but it hasn't been treated in systematic manner and therefore it requires detailed analysis.

### 2.1.6. *Malfunctions of Main Pumping Stations*

Most of the pumping stations are in bad condition and need reconstruction. Some stations are not in function because they were never fully equipped. BSS has special teams that deal with malfunctions of pumping stations. Because of the lack of the system for remote monitoring of pumping stations, monitoring is a very time-consuming process.

### 2.1.7. *Obstruction of Main Collecting Pipes*

BSS has special teams that deal with the obstruction of main collecting pipes (that can be noticed and reported by users or BSS's regular inspection teams). Because there are no continuous measurements and remote monitoring of sewer system, monitoring requires a lot of human effort and the detection of obstruction and its repairment are slow.

### 2.1.8. *Discharge of Septic Tanks' Contents in Belgrade Sewer System's Manholes*

This is a problem of illegal behavior of users at the edges of the system and can cause clogging of the sewer system, odor, and disease. This behavior has to be abolished through communication and joint action between BSS and authorities.

## 2.2. SPECIAL EVENTS

### 2.2.1. *Damages to BSS's Buildings and Objects*

Regular inspection or user reports are the main two sources of information about the damages on BSS's objects. Depending on the scale and the importance of the damage, repairments are done by the BSS's teams or companies with whom BSS has contract. Lack of the system for remote monitoring of the sewer system causes slowness in detection of damages, while the constant lack of funding for regular maintenance and improvement worsens the whole situation.

### 2.2.2. High Water Levels of Danube and Sava

Water levels of Danube and Sava are regularly monitored by Republic Hydrometeorological Service of Serbia (RHMSS). If it happens that the levels go above the limit for regular flood protection, a whole procedure for flood protection has to be followed and a coordination center is formed (main roles play the Center for Public Information and Alert and City's Headquarter for Flood Protection). The organization scheme is presented in Fig. 5.

Years 1981 and 2006 have been analyzed and compared as good examples of extreme water levels (Fig. 6). Even though the highest water level of 1981 was lower and lasted shorter than in 2006, flood consequences were worse. Milder impact of floods of 2006 is a result of better coordination between authorities and large scale and everyday activities on stopping the water from getting through sewer system discharge points into the system, relocation of water flow, use of mobile pumping power units and other interventions done by BSS. It must be mentioned that during the flood of 2006 there was little or no precipitation (during the actual flood), so there was no coincidence between extreme rain and high water levels. This coincidence would have led to a potentially very severe flooding by inner waters, for it would be very difficult to evacuate stormwater from the collecting pipes to the streams.

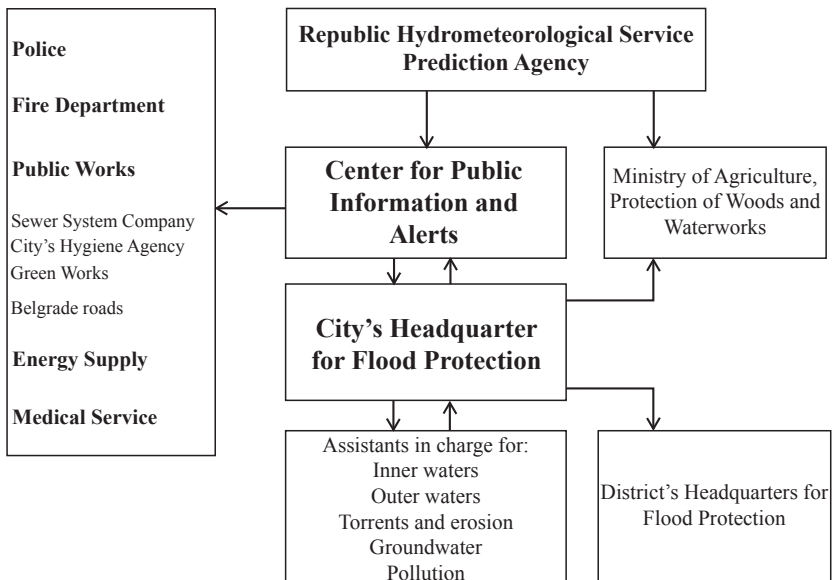

Figure 5. Flood protection – organization scheme

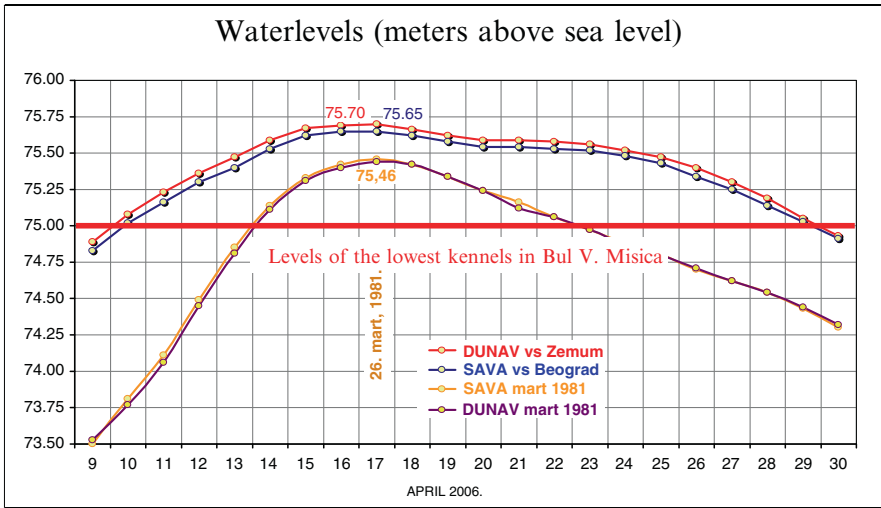

Figure 6. Water level diagram of the floods in 1981 and spring of 2006 on Danube in Zemun and on Sava at the measuring point “Beograd”

### 2.2.3. Earthquake

Additional checks are done to the system and reparations (if necessary) in the case of an earthquake. If the earthquake has significant impact to the environment and sewer system, so that a state of emergency is declared, then by the Law there is a set of procedures that have to be followed.

### 2.2.4. Fire in the Main Pumping Stations

In the case of fire in the main pumping stations, or other BSS’s object, there is a set of procedures that need to be followed by the staff in order to protect themselves and objects. These procedures can be found in Operating Procedures in the Case of Emergency (internal regulations).

### 2.2.5. High Concentration of Pollution in Sewer System and Recipient Water Bodies

High concentration of pollution can:

- Endanger health of employees working in BSS
- Damage sewer objects – dangerous materials that have been spilt to the sewer system can cause abrasion, settling, crust formation, corrosion, fire/explosion, etc.
- Deteriorate water quality of the recipient water bodies or damage processes at the (future) water treatment facilities.

The city of Belgrade has a set of regulations for discharge of wastewater into the city sewer. However, these regulations are very outdated and are not completely followed (i.e. many industries have malfunctioning or completely out of order wastewater treatment plants). Few events of pollution in the river Sava and a large set of pollution detection in other places make it clear that pollution appears often, but is rarely noticed. The type of pollution that gets noticed are usually insoluble or slightly soluble matters that have dominant color, odor, etc. (i.e. oil discharges from the Clinical Centre's heating room to the river Sava through Belgrade city sewer system).

Lack of the system for remote monitoring of the sewer system causes slowness in detection of pollution. On the other hand, users of the sewer system don't have the habit of monitoring the sewer system for pollution, nor they have proper alert and action procedures in the case of accidental pollution spread. This whole theme has to be addressed with utmost importance in order to create a complete and strict system to decrease the amount of pollution that enters the system, to monitor system parameters, and to act in the case of emergency, including procedures for alert and reparation of consequences.

#### *2.2.6. Vandalism*

Security service of the BSS is in charge of protection against vandalism. Action in the case of security breach is regulated by internal operating procedures and includes both security staff and other employees. Lack of the system for remote monitoring of the sewer system causes slowness in detection of vandalism.

#### *2.2.7. Occurrence of Torrent Streams in the Outskirts of BSS*

Peripheral parts of the system are usually in the vicinity of streams that sometimes become torrents. Some of these streams get into the closed system (sewer), like: Mirijeovski stream, Kumodraski stream, Mokroluski stream, etc. In the case of flooding caused by the torrents, a set of procedures very similar to the ones for flood protection in case of extreme water levels has to be followed.

However, BSS's segment that deals with these problems has a lot of technical and organizational problems. The development of the connections between torrential streams and sewer system is not synchronized with city's development. Other than that, objects in the sewer, that serve to accept torrential streams, are not well maintained and are underdimensioned (too small). There is also a lack of retention basins that would lessen the impact of flood waves. Systematic solutions to the problem of responsibility for the torrential streams inflow to the sewer system don't exist. All this leads to conclusion that this problem needs a lot of attention, in both institutional development, and planning and realization of projects.



### 2.2.8. *Large Scale Erosion of Soil (Parks, Construction Sites, etc.)*

All parts of the city have some construction sites and many park areas prone to erosion, with a lot of suspended materials getting to the city's sewer. Construction sites usually are not well organized, so that the material is let loose and is not secured from erosion (with a lot of loose materials getting to the city's stormwater sewer). Additionally, construction technology sometimes speeds up erosion of the soil and construction materials (sand, gravel, cement, etc.). There is no data about the quantity of the material that gets into the sewer system, but it can be estimated that these quantities at some locations are immense. BSS doesn't have jurisdiction over this segment, so this problem has to be addressed through other institutions (Green Works of the city of Belgrade, construction inspection, etc.).

## 3. **Removal of Consequences of Non-Regular Extraordinary Events in BSS**

Procedure of removal of consequences in non-regular extraordinary events has to be followed immediately after the event, without any exceptions (whether it's preparation, action or organization). If BSS has all the necessary resources (workforce, machines, material), all the activities start immediately whether it's maintenance or construction. If there is a significant number of consequences, and there are not enough resources in the BSS, a list of priorities is made, and for the ones that cannot be fixed, BSS secures the area around them.

If consequences go beyond BSS's capacities, then BSS hires other companies, usually the ones with which they have a long term contract. If the value of the hire is no more than 200,000 RSD, then it can be authorized by the Assistant to the General Manager. However, if the value of the hire is more than 200,000 RSD, it must be authorized by Executive Manager. If the price exceeds BSS's financial capacity, then BSS asks for financial help from the Belgrade Land Development Public Agency or City Council.

## 4. **Conclusion**

Several flaws have been noticed in the existing set of regulations about action in non-regular and special events in both BSS and city of Belgrade. There is a Decision about city sewer system (it can be found in the Official Newsletter of Serbia: Sl. glasnik SRS br. 5/75, 1/81, 25/88, 13/90, 15/91, 23/92, 9/93, 25/93, 31/93, 25/93, 31/93, 4/94, 2/95, 6/99, 11/2005) but this decision doesn't define action and rules that need to be followed in the case of non-regular and special events. Two of the solutions are set of internal regulations in the BSS and set of regulations made by the City's Assembly. Until present, there hasn't been a

systematic approach to this theme, and that was very obvious during the flood in the spring of 2006. Another observation has been made: pollution is first detected in the river Sava (by the City's Agency for Public Health) and afterwards an analysis is made to find where is the source (pollution goes through the entire system unnoticed).

Next steps in development of BSS should be defined by General project regarding city sewer system and wastewater treatment, and all future projects should be in accordance to this project. Parallel should be the development of BSS management. Evidence has shown that current way of management and functioning of the BSS during the extraordinary events causes too many hardships and sometimes complete blockade of city's life. Therefore, authors strongly believe that procedures in management of BSS during special events need to be regulated on City level, not only internally in the BSS.

## References

- Official Newsletter of Serbia: Sl. glasnik SRS br. 5/75, 1/81, 25/88, 13/90, 15/91, 23/92, 9/93, 25/93, 31/93, 25/93, 31/93, 4/94, 2/95, 6/99, 11/2005
- Master plan of the city of Belgrade, 1970
- Operating Procedures in the Case of Emergency (internal regulations) – Belgrade Sewer System Regulations Regarding Wastewater Discharge – Council of the City of Belgrade

# RISK AND UNCERTAINTY ASSESSMENT OF URBAN DRAINAGE NETWORKS

ROUMEN ARSOV AND TANYA IGNEVA-DANOVA\*  
*University of Architecture, Civil Engineering and Geodesy  
1 "Chr. Smirnenski" Blvd., 1046 Sofia, Bulgaria*

**Abstract.** The paper demonstrates application of the Fuzzy Set Theory in risk and uncertainty assessment, associated with hydraulic overloading and flooding of urban drainage networks. The case study with the town of Novi Iskar, Bulgaria has been chosen as an example, because it was among the settlements in the country, drastically damaged by the heavy rains and floods in August 2005. Modeling has been performed by means of MOUSE software, based on the available electronic cadastre of the urban drainage network on ArcView platform. Different scenarios and technical measures have been checked for coping with the problem with flood mitigation, which have been assessed on the base of cost analyses. Risk for the sewer networks vulnerabilities of hydraulic overloading and flooding at the relevant scenarios was assessed, based on selected criteria.

**Keywords:** hydraulic overloading, flooding, Fuzzy Set Theory, risk, uncertainty, urban drainage networks

## 1. Introduction

Beginning of the new millennium is characterized with consecutive catastrophic floods in many regions of the planet, which are commented to be unusual and unexpected.

Increasing of intense and long lasting rains during the summer of 2005 in vast parts of Bulgaria's territory is evidence that the country experiences the consequences of the climate change in Balkans. These circumstances are challenge

---

\* To whom correspondence should be addressed. Tanya Igneva-Danova, University of Architecture, Civil Engineering and Geodesy 1 "Chr. Smirnenski" Blvd., 1046 Sofia, Bulgaria

for the population and all local administration authorities as well as for the engineers in the area of urban drainage management and risk analysis.

The town of Novi Iskar was one of the settlements in Bulgaria drastically damaged by the heavy rains and floods in August 2005 and that was the main reason for choosing it as a case study for the present research. The town of Novi Iskar with its area of 358 ha is situated nearby the river Iskar and one of its tributaries. The town is built on extremely steep terrain with considerable displacement between its upper and lower parts. The total number of the population is approximately 12,000 people.

As a first step the modeling of the existing urban drainage network was performed by means of MOUSE software, based on the available electronic cadastre.

Concrete pipes with circular and composite cross-sections have been used for construction of the existing combined sewer network and some design and structural faults have been noticed during the observation which leads to its abnormal (improper) performance.

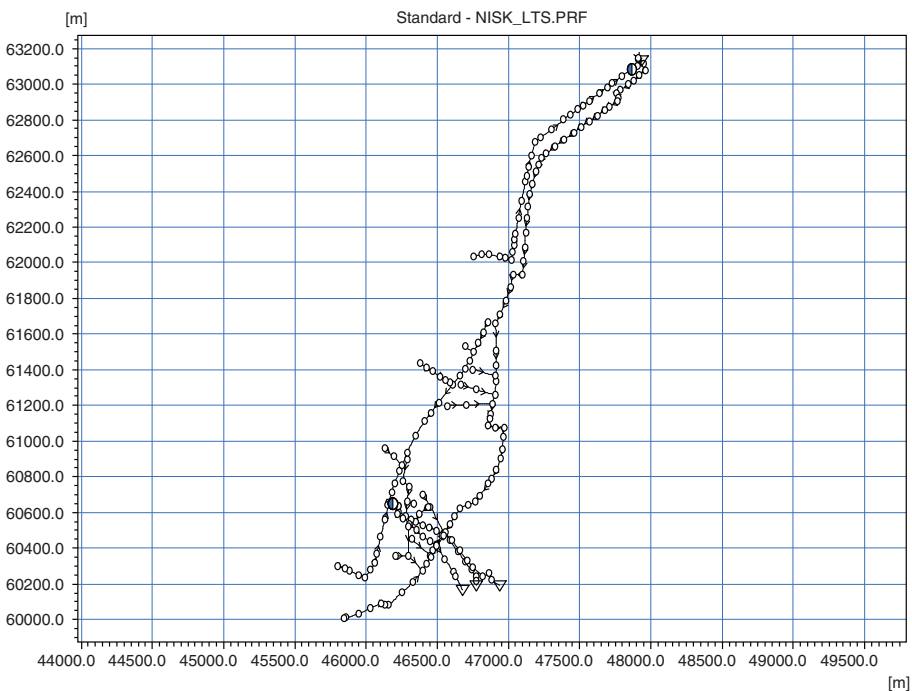

Figure 1. Scheme of combined sewer network of the town of Novi Iskar, Bulgaria

A scheme of the sewer network with manholes and two weirs is shown in Fig. 1 presented in MOUSE software environment.

Simulations are performed with design rain for the latest downstream pipe cross-section of the existing main sewer trunk. Due to lack of hydraulic capacity, errors in design and construction of the sewer network, hydraulic overloading occurs even with the design storm. In some parts of the sewer network the water level reaches the terrain surface and flooding occurs (Fig. 2).

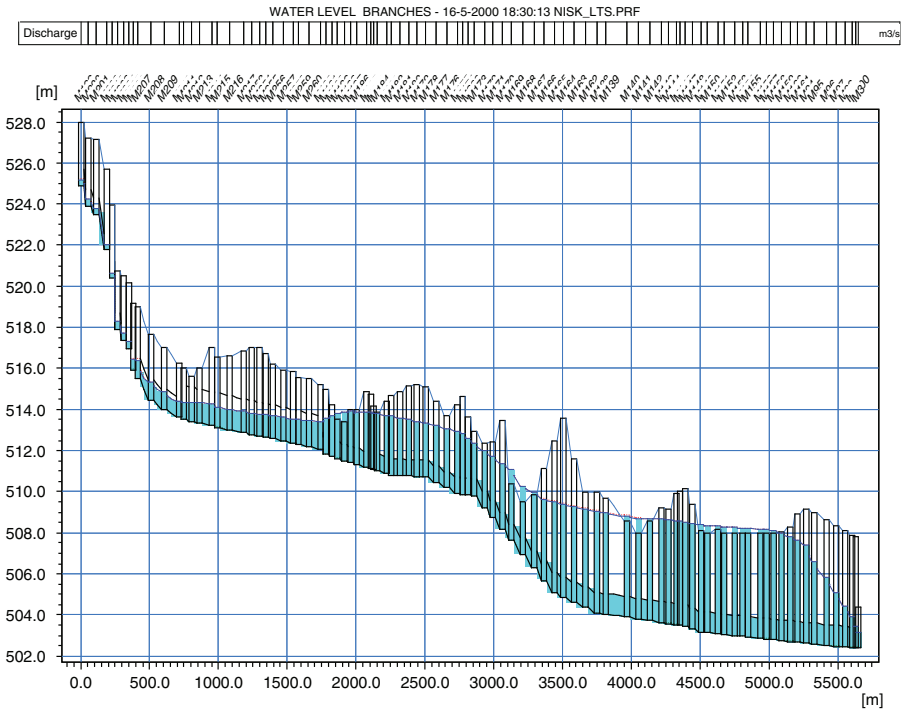

Figure 2. Longitudinal section of the main trunk of the existing sewer network of the town of Novi Iskar with the maximum water levels with the design storm

In relation to the extreme storm event, which occurred in August 2005, the following scenario for the sewer network modeling has been selected:

- First day: rain with relatively small intensity of 10 l/s/ha with duration of 24 h which lead to full saturation of the permeable area and increasing of the surface runoff.
- Second day: dry period.
- Third day: rain with intensity of 25 l/s/ha and duration of 24 h.

The result of modeling, indicating drastic hydraulic overloading and flooding is represented in Fig. 3.

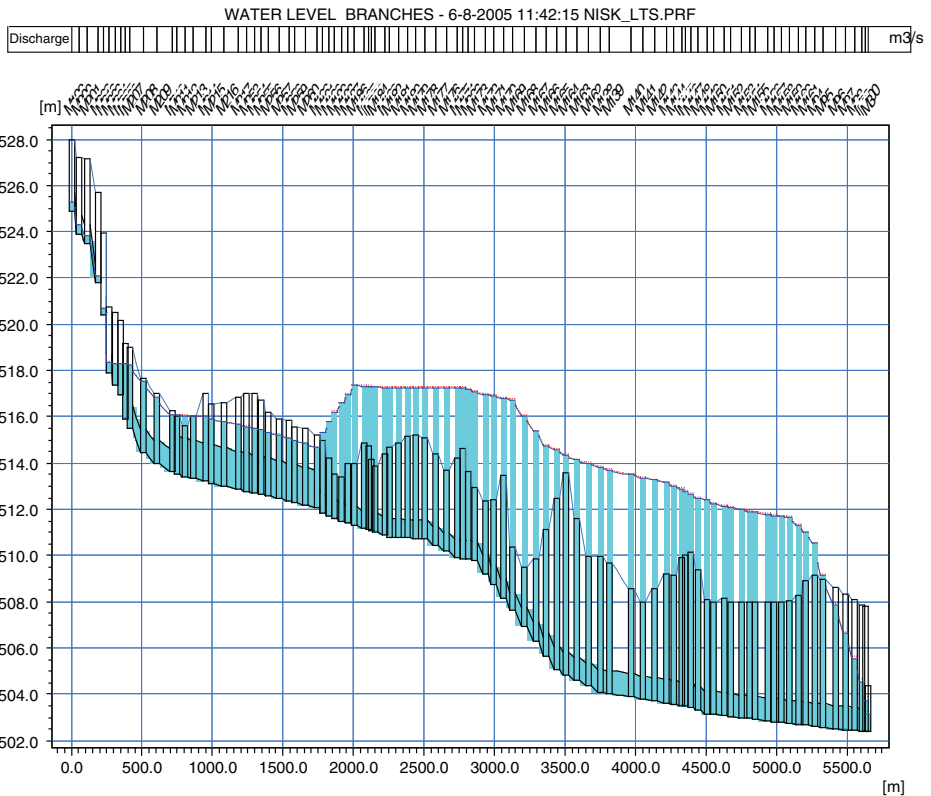

Figure 3. Longitudinal section of the main trunk of the existing sewer network of the town of Novi Iskar with the maximum water levels during the storm event in August 2005

According to the simulations performed, on the first day of that storm the main sewer trunk is overloaded and even some flooding occurs, while in the third day half of the town is flooded as it actually was observed in reality.

Obviously the investigated combined sewer network does not perform properly even during the design rain and needs reconstruction. In this connection the following three options for reconstruction were investigated.

1. Reconstruction by replacing part of the sewer network with pipes with higher hydraulic capacity
2. Reconstruction by implementation of additional collector in a parallel with the main trunk

### 3. Reconstruction by implementation of two retention basins

The economical analysis of those three options shows that the reconstruction with implementation of two retention basins are the most cost-effective solution in a comparison with the rest two ones. The technical analysis shows that the same option is also more effective in hydraulic aspect than the two others and in this case the urban drainage network performs properly with the design storm, nevertheless the existing design and construction faults (Fig. 4).

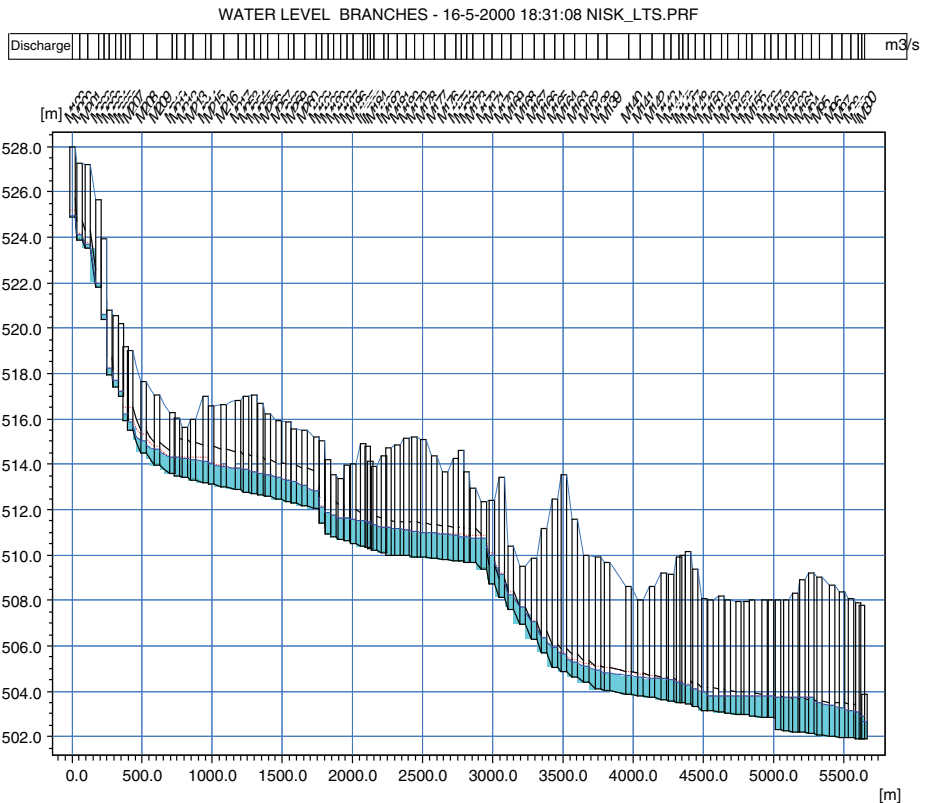

Figure 4. Longitudinal section of the main trunk of the reconstructed sewer network of town of Novi Iskar with two retention basins along with maximum water levels during design rain

Apart from the reconstruction options investigation, in any case it is important the risk for hydraulic overloading and/or flooding of the urban drainage system to be quantitatively assessed. In this respect, beside the availability of a number of methods for different systems performance, it seems the one, based on the Fuzzy Set Theory is the most promising for the case under consideration.

## 2. Methodology for Risk Assessment of Hydraulic Overloading and Flooding of the Urban Drainage System Based on the Fuzzy Set Approach

*Fuzzy Set Theory* [3] is successfully applied in number of different fields. Main areas of application are physically controlled systems, different engineering problems, statistics, medicine, biology, etc. However no information for application of this theory in risk assessment for hydraulic overloading of urban drainage networks is available for our best knowledge.

Considering for instance a sewer trunk with diameter  $D$  of 1,000 mm and depth of the pipe of 3, a number of computer simulations could be performed for storms with return periods  $P = 1, 2, 3, \dots, T$ , where  $T$  is the exploitation period of the urban drainage network. For each storm (each return period) different water levels could be obtained and for some of them overloading/flooding could be observed. According to the water levels when the trunk performs either properly or under pressure with a head lower than the pipe depth, the following fuzzy numbers  $\bar{L}$ ,  $\bar{R}$ ,  $\bar{M}$  and associated areas can be defined (Fig. 5).

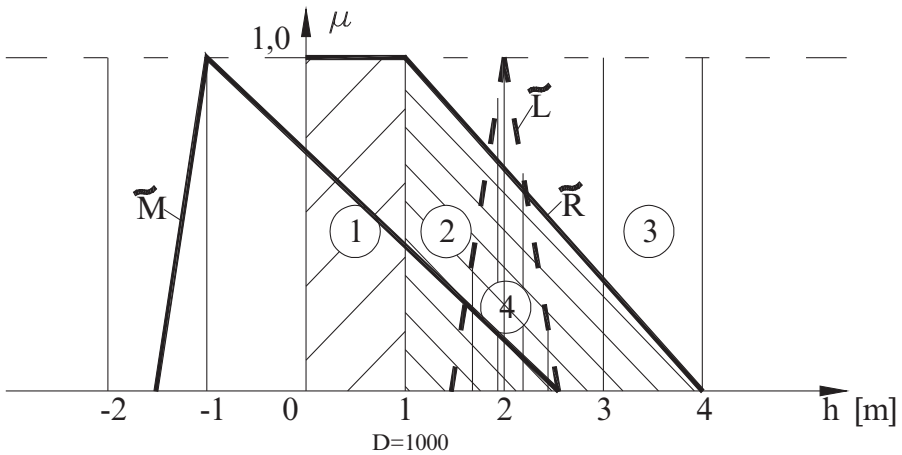

Figure 5. Illustration of the fuzzy numbers  $\bar{L}$ ,  $\bar{R}$ ,  $\bar{M}$ , defining the performance of the urban drainage system

1. Area of absolutely safety (normal performance of the sewer pipe)
2. Area of decreasing safety (increasing risk – the sewer pipe is pressurized)
3. Area of absolute risk (the water level is above the terrain – flooding)



4. Area of external load to the sewer pipe (rain with a definite return period – P, at which in this example the water level rises up to 2 m above the sewer pipe invert)

External Load of the system, expressed as fuzzy number  $\bar{L}$  – defined for return periods, which cause overloading/flooding. For a single rain with a definite return period the respective water level, which was obtained reflects the external load. Its membership function  $m_L$  is changing in the interval (0,1) at maximum  $m_L = 1$  at a head/depth of 2 m, for this example.

Response of the system to the external load/runoff expressed as fuzzy number  $\bar{R}$  -  $m_R$  – increasing the pipe depth from D to terrain surface, the membership function is changing from 1 to 0 linearly. The physical meaning of this number is as follows: the higher the pipe depth  $h$  is, the higher is the reliability for flooding.

The area of absolute safety (left from  $\bar{R}$ ) is characterized with water levels lower than the diameter of the pipe and therefore the sewer trunk is not pressurized.

The area of absolute risk (right from  $\bar{R}$ ) water level increase above the terrain surface and therefore flooding occurs. The areas of absolute safety and absolute risk are not graduated in this investigation (by obvious reason) and therefore were not considered in the following calculation.

The Reliability measure expressed as a fuzzy number of the system can be defined by the difference between the Load  $\bar{L}$  and Response  $\bar{R}$  [1, 2].

$$\bar{M} = \bar{R} - \bar{L}$$

The reliability of the sewer pipe Re can be defined by the following expression:

$$Re = \frac{\int_{h>0} \mu_{\bar{M}}(m) dm}{\int_h \mu_{\bar{M}}(m) dm},$$

The algebraic sum of the reliability – Re and the Risk – Ri is equal to 1:

$$Re + Ri = 1$$

The reliability/risk for all cross-sections of the sewer pipe network of the town of Novi Iskar and for different return periods – P was calculated. The results are given in Fig. 6. It is obvious that the reliability decreases (risk increases) with higher values of P. Such dependence is observed more readily in the lower parts of the town in comparison to the upper one. The reducing of the

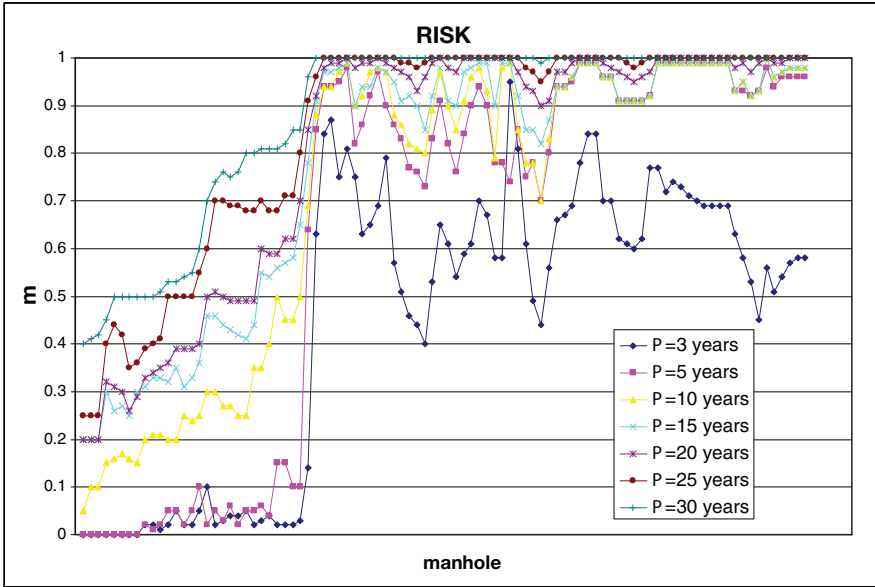

Figure 6. Risk of overloading and flooding of the sewer network depending on P

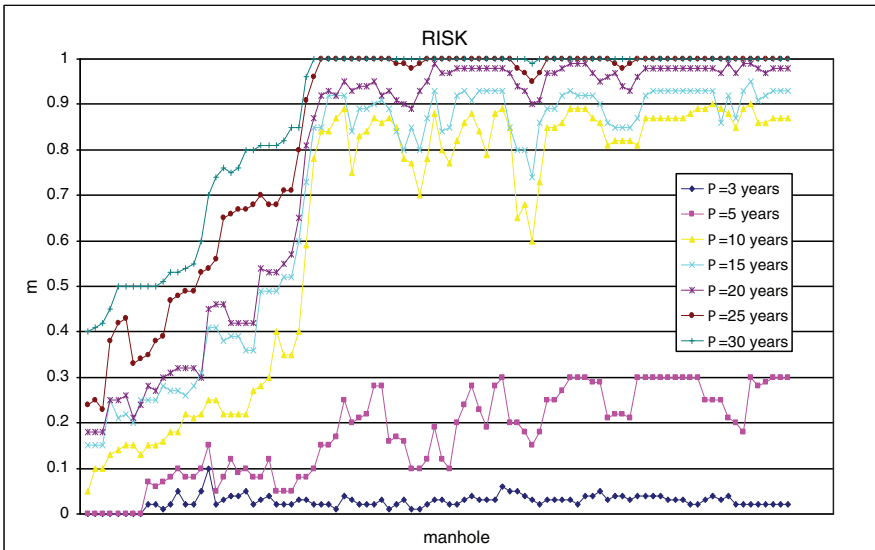

Figure 7. Risk of overloading and flooding of the reconstructed sewer network depending on P

risk associated with the reconstruction option of the sewer network with two retention basins is shown in Fig. 7. As it can be seen in the figure, the risk with this reconstruction option is considerably lower. It can be shown that at this option the risk is minimal in comparison to the other two ones. Conclusions also can be made for the time of exploitation period, namely that the risk increase drastically with the increasing of the exploitation periods up to 30 or 40 years.

The risk assessment approach demonstrated above allows quantitative analysis of the functional adequateness of the sewer network for preservation of flooding the urbanized territory. It is a useful tool not only for assessment existing facilities, but also for different options for their reconstruction.

Spatial distribution of the reliability of hydraulic overloading/flooding over the territory of the town of Novi Iskar is given in Fig. 8 as a *Map of risk*. More precise interpretation can be achieved by 3-D modeling of the terrain. The map of reliability allows assessment the influence of overloading/flooding not only for the main trunk, but also for the adjusted territory. In this case (Fig. 8) the scale in the interval from 0 to 1 is divided into five parts, indicated by different hachure.

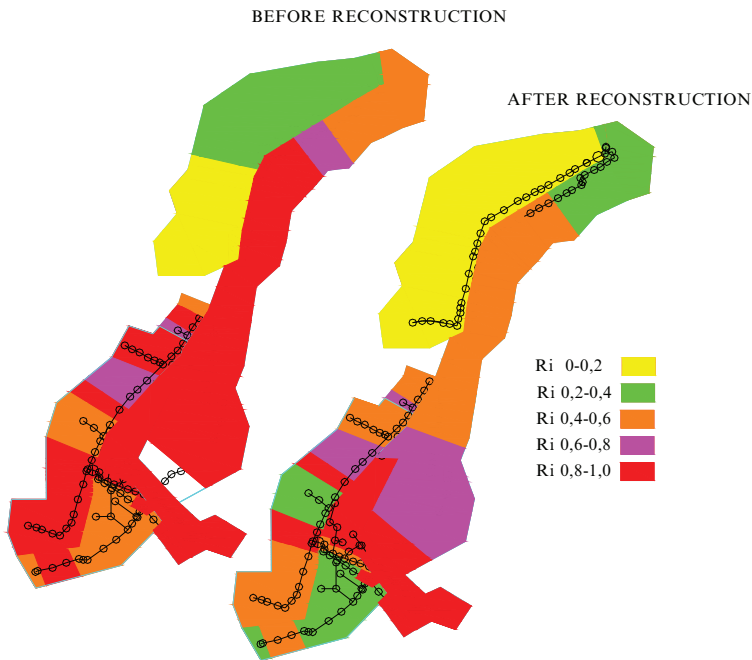

Figure 8. Map of risk – spatial distribution of reliability over the territory of the town of Novi Iskar before and after the reconstruction

### 3. Conclusions

The long lasting and intensive rains upon the territory of Bulgaria in August 2005, lead to catastrophic flooding with high material damages, revealed the problems associated with the status and management of the sewer infrastructure and especially with design, execution and exploitation of sewer networks. Taking into consideration the approaches of risk reliability assessment demonstrated herein and possibility for its future application, the following conclusions could be made:

- Risk/reliability of hydraulic overloading of the urban drainage networks can be adequately assessed only by applying the appropriate approaches, models and software.
- In our view the most appropriate approach for assessment of the hydraulic overloading/flooding of the sewer network should be one, based on the *Fuzzy Set Theory*.

### References

1. Ganoulis, J.G., 1994, Engineering Risk Analysis of Water Pollution.
2. Shrestha et al., 1990, Fuzzy reliability in hydraulics, Proceedings of the First International Symposium on Uncertainty Modelling and Analysis, University of Maryland, College Park.
3. Zadeh, L.A., 1965, Fuzzy sets, Information Control, Vol. 8, pp. 338–353.

# WASTE WATER FROM SMALL URBAN AREAS-IMPACT OF ENVIRONMENT IN SLOVAKIA

IVANA MAHRIKOVA\*

*Department of Sanitary & Environmental Engineering,  
Slovak University of Technology Bratislava, Slovak Republic*

**Abstract.** Slovakia after entering to the EU commits oneself to follow requests of EU Directive Nr. 91/271/EEC. The requirements of this Directive came into force in a new Water Act. The harmonisation of the waste water treatment in Slovakia with the requirements of this Directive will require substantial amount of funding for construction of new and reconstruction of existing WWTP's. This problem concerns especially municipalities with the equivalent population over 2,000 (EO). This paper discusses some possibilities to address this problem. There are some specific aspects and problems, as well as technical design of solutions for sewage systems in small municipalities. Under a small municipality we understand smaller urban units. In terms of water management Slovak Technical Norm (STN) 756402 Small Waste Water Treatment Plans, this group includes municipalities or urban centres, which produce up to 100 m<sup>3</sup>/day of waste water.

**Keywords:** sewage systems, waste water treatment, small urban areas, legislation in Slovakia

## 1. Introduction

Since 1,174 out of a total of 2,891 municipalities in Slovakia belongs in the small municipality category and predominantly they are located in areas with less affected environment, the sewage solution needs to meet the technical and financial requirements, but also the aforementioned dilemma must be reduced to the acceptable degree and the sewage network must be integrated sensitively

---

\* To whom correspondence should be addressed. Ivana Mahrikova, Department of Sanitary & Environmental Engineering, Slovak University of Technology Bratislava, Radlinského 11, 813 68 Bratislava, Slovak Republic; e-mail: ivana.mahrikova@stuba.sk

with the environment. Preferred approach is sewage network – Waste water treatment plant (WWTP), as well as sewage – natural environment – life environment. These links need to be given a priority not only in terms of design planning, execution and operation of the construction, but also in terms of contradiction waste water – surface water. Whereas the waste water, carried off via a sewage network represents progress for the society, mainly in terms of improved health and hygiene, the waste water is detrimental to the surface water and subsequently also to the natural environment [3].

## **2. Connection to Water Supply System and to Sewage System in Slovakia**

There is a great disproportion between connection to water supply system and connection to sewage system in Slovakia. More than 86.3% of population is connected to public water supply system, but only 57.5% of Slovak population is connected to public sewage system. You can find some districts where is the connection lower than 30%. We have to solve this problem in the near future. There is coming great amount of finances for building a new sewage system in Slovakia. But at first we have to find the general idea how to built this system with the view of technical and economical relation [3].

## **3. Sewage, Division and Execution Status**

Sewage is a set of equipment allowing harmless removal of waste water, including its treatment. It consists of two sub-systems – sewage network with construction objects and waste water treatment plant.

There are a number of municipalities, which have addressed waste water treatment partially, or not at all. In terms of the world standard in this area the municipalities can be split into the following categories:

- Ideal status, municipality with sewage network with waste water treatment, located before the receiving water
- Interim status, sewage system prior to expansion, reconstruction
- Interim status, sewage network in place, insufficient effectiveness WWTP
- Unsatisfactory status, sewage system without WWTP in place
- Critical status, no sewage system [1].

### **3.1. SEWAGE SYSTEM IN PLACE**

In this case the whole activity is focussed on operation and maintenance, or fixing of small breakdowns. In case of fully built sewage system we can encounter these

problems: low quality construction (seepage, deficiencies in detail), insufficient and non-qualified operation, low effectiveness of WWTP, difficulties with sludge utilisation [1].

### 3.2. SEWAGE PRIOR TO RECONSTRUCTION

Each expansion or reconstruction even in small municipalities represents certain distinctiveness. In the first place we need to take into account the inspection of existing structure. Expansion can be delayed by application of new trends in sewage management and increased intensity of treatment processes [1].

### 3.3. SEWAGE SYSTEM IN PLACE, INSUFFICIENT EFFECTIVENESS OF WWTP

Solution to this situation is very similar to case no. 2, with the only difference being more focus on WWTP. Again, crucial factor is determining the amount and quality of waste water, hydraulic, technological and operational parameters of WWTP. Over the past decades the development of sewage systems has been the focus also in small municipalities. Considering that the financial and time requirements for the construction of WWTP are lower than the sewage network for the whole municipality, the waste water treatment plant was usually, and also due to legal reasons (waste water without treatment must not be drained in the river system), constructed as the first sewage system element. Following the launch of the operation, the WWTP has, as a result of incomplete sewage system, significant capacity reserves and it is a problem to maintain it in optimal operation regime [1].

### 3.4. SEWAGE SYSTEM IN PLACE, WITHOUT WWTP

When constructing a new WWTP, emphasis needs to be placed on establishing the volume and quality of waste water, treatment effectiveness, technological design, as well as proper operation. Of course, other factors are also important, such as costs, lifespan of materials and incorporation in the environment.

### 3.5. SEWAGE SYSTEM NOT EXISTING

Construction of sewage systems in small housing centres requires the preparation of warranted, prudent and forward looking concept. Formulation of such concept needs to be entrusted with experienced specialists with know-how on the subject. Considering the required distances, sewage cost per person in smaller estates are higher than average. Therefore a great care is necessary when

deciding, which technical solution to apply. Two possible solutions for the treatment of household effluent are available [1]:

- *Central drainage and treatment of waste water*
- *Individual waste water treatment*

#### **4. Central Drainage and Treatment of Waste Water**

This is a case of a construction of new municipal sewage network and its connection to the existing regional waste water treatment facility or a construction of a new local WWTP. From the technical and operational aspect, it is the optimal solution. Currently a Water Act has come into force in Slovakia, stating, that by the year 2015 every municipality with population over 2,000 will have to be connected to the public sewage system and waste water from this sewage must be subsequently treated in WWTP with biological treatment level effectiveness, which will be determined by the respective water management body according to the pollution degree of the receiving waters, which will be receiving the treated water. At the same time however it is necessary to consider the question of financial effectiveness of the given solution. The sewage system construction and its financing will be the responsibility of the municipalities, who find it increasingly difficult to raise the substantial amounts of funds required for such purposes. For example a construction of 1 m of gravity-fed sewage system, outside the road, costs 100–300 Euro, depending on the contractor. Considering the adverse financial position of our municipalities we are encountering more and more often individual solutions for household waste water storage and treatment [7].

#### **5. Individual Waste Water Treatment**

Household effluent can be drained from individual houses into drain-wells, septic tanks or into individual waste water treatment facilities [5].

#### **6. Drain-Wells**

Drain-wells are used as storage tanks for household effluent. In majority of cases they are built as enclosed monolithic concrete tanks in the vicinity of the house. Disadvantage of the drain-wells is that they are used only for storage purposes and not as a separation or stabilisation tanks and therefore the content has to be removed and transported to the WWTP.



## 7. Septic Tanks

These are flow-through tanks used for accumulation, sedimentation and partially stabilisation purposes. They were known and used already towards the end of the last century, when waste water from cities across England was treated in this manner. They work as a small anaerobic filter. The sludge is separated from the water, which is then filtered through a filtration layer. Thus reducing substantially the amount of sludge, which needs to be removed from the septic tank. However this sludge is not sufficiently stabilised and therefore it needs to be further processed. In principle there are three solutions available: removal, stabilisation and final treatment at the municipal WWTP.

Removal – the sludge is taken to agricultural and other lands, sludge lagoons, possibly can be used for composting purposes.

Sludge stabilisation – carried out in the form of wet oxidation or aerobic – thermal processing.

Final treatment in municipal WWTP – currently this is the only realistic method in case of high volume of sludge. However, WWTP must be suitable for sludge processing, since the sludge causes uneven peak loads for the treatment plant and therefore causing the run-off quality deterioration. It is accompanied by a strong odour and at the same time it has detrimental effects on the facility's equipment. When draining the sludge from septic tanks to WWTP, compliance with the following principles is recommended:

- Maximal distance, effective for sludge transportation to WWTP is 20–25 km.
- Minimal size of WWTP, for sludge processing is 10,000 EP.

Sludge drainage represents a technical problem. If the sludge is drained directly, it can disrupt the treatment plant operation and reduce the quality of treated water. Current trend to combat this problem is by building as storage tank for sludge. The size of the tank depends on the number of EP, which the WWTP is capable of handling. From this tank the sludge is evenly fed, even prior to the mechanical treatment. The technology in the processing of sludge prior to treating in WWTP has been addressed also by several domestic companies. The approach adopted abroad was to bring the sludge directly to heated putrefaction tanks. However, the practice has shown that this sludge does not have sufficient sedimentation properties. Therefore it is simpler to introduce the sludge into the waste water feeder at the WWTP. Of course, construction of such tank requires additional funding required for reconstruction of the treatment plant, which needs to be secured by the operator, i.e., the municipality.

## **8. Household Waste Water Treatment Plants**

As a last of the offered solutions are household waste water treatment plants. Over the past several years we have been witnessing their construction with increasing frequency also in Slovakia. In price terms they are comparable with quality septic tanks, without having to deal with the problem of residual sludge. This sludge is aerobically stabilised, which means that it is hygienically harmless. It can be used in agriculture, thickened in concentration tanks or drained in sludge presses. Its thickening or drainage properties are comparable with properties of excess sludge produced in municipal WWPT [6].

## **9. Function of Household Waste Water Treatment Plants**

Treatment plants are designed for treating normal household effluent. They are scaled to accommodate approximately 5–50 population equivalent. Waste water treatment takes place in two steps. In the first step, during the mechanical pre-treatment, mechanical debris is removed from the water. Second step represents biological treatment in the form of fine-bubble aeration activation. At the same time the treatment process is extended by removal of biological elements of nitrogen and phosphorus in the form of denitrification and nitrification, which makes the majority of household treatment plants compliant with the European requirements with respect to effluent treatment. Waste water treatment plant itself comprises of the delivery unit placed on the concrete plate. It is necessary to ensure that the whole unit is watertight, since often it is placed below the water-table level and also to prevent the waste water seepage [6].

## **10. Technological Treatment Line Design**

Household waste water treatment plants are offered on our market by several companies in various technological modifications. They use either bio-filtration or a long-term activation with aerobic sludge activation. In our paper we will focus on the description of household WWTP technology and operation, which was used also by residents of a new housing estate in Bernolákovo. Since it is a new development within the boundaries of municipality, which does not have a public sewage system, it was necessary to conduct a study of effluent management for the area. Following the assessment of investments required for the construction of effluent sewage and related connection to the municipal WWTP, a decision on behalf of about 25 households was made, to construct individual household waste water treatment units to address the household effluent issue. Waste water treatment takes place in a circular tank, in the form

of long-term activation with aerobic sludge activation. The principle of comprehensive waste water treatment in the proposed technological solution is based on biological treatment by heterogeneous biological sludge, maintained in the deposit, with prior denitrification, where the source of carbon for denitrification processes is the introduced organic contamination of waste water. In order to oxidise the biological treatment process and to maintain the concentrate in the deposit, an aerating system of fine-bubble aeration is applied. Air is delivered through fan powered by electric motor. Treated waste water is lead to the collection tank, where tertiary treatment, using disinfectant agent is introduced. Excess, aerobically stabilised sludge, is removed from the treatment process by effluent truck once or twice per year, depending on the sludge production [4].

## 11. Operation of Household WWTP

It is very important to know that well functioning WWTPs, not requiring regular maintenance and audit do not exist. Therefore it is necessary to look after your WWTP and to follow the supplier instructions for maintenance and operation. Biological treatment is based on the biomass growth, which needs for its existence regular supply of nourishment in the form of organic contamination in waste water and also sufficient amount of oxygen, which is supplied to the system through fine-bubble aeration. Any disruption of this system can lead to deterioration of treatment effectiveness. Long-term incorrect operation of WWTP results in dying of the biomass, followed by total disruption of the treatment process. Although the treatment plant operation is automated, it still requires supervision. At least once a week the fan needs to be checked and the treatment process in the reactor, as well as the quality of treated water in the accumulation tank, need to be checked visually.

Household waste water treatment unit is designed for treating normal household effluent, therefore it can be disabled by the introduction of excess amounts of substances, which should not be present in municipal waste water. These are mainly the following:

- Greases in higher concentration (frying oil)
- Household softener solutions
- Paints, varnishes and solvents
- Powerful disinfectants and acids
- Low degradability materials (plastics, rubber, textiles)

Reliable treatment requires daily supply of effluent, in order to facilitate biological processes in the treatment unit. In case of absence over a period of

2 to 4 weeks, without new effluent for the WWTP, the micro-organisms start slowly to die. However, following the re-introduction of regular effluent supply they have the capacity to adapt and recommence their reproduction. However the air supply must be maintained also during the absence of waste water supply, otherwise organisms could start to decompose and rot. Only in case of absence from home for several months it is recommended to shut down the whole unit and remove the content [2].

## **12. Handling of Treated Water**

Treated water can be used for watering of lawns and fruit trees. However it is not to be used for watering of plants for direct consumption, since it can contain substances harmful to human digestive tract.

## **13. Handling of Excess Sludge**

When the separation tank is filled with sludge, it needs to be removed in order to prevent the sludge entering the treated water, hence reducing the quality at the exit point from WWTP. Excess sludge is sufficiently stabilised, i.e., hygienically harmful and it can be used in agriculture or used for further treatment in the municipal WWTP.

In closing, we would like to present several price comparisons, which can assist the consumers in selecting the most suitable solution for the treatment of their household effluent. These are for reference purposes only, since there is a number of suppliers and operators of sewage systems and waste water treatment plants [5].

## **14. Conclusions**

Currently the trend is the preference for individual solution and each home owner has the freedom to select the most suitable equipment. Be it a drain-well, which is more affordable, but the operation requires regular emptying the full content, hence increased cost of removal or more costly septic tank, where only thickened sludge is being removed. However it is not stabilised and therefore a hygienic treatment at the municipal WWTP is necessary. Available is also a third solution, being highly promoted in the past few years – household waste water treatment unit. Although it is more demanding in terms of operation, there are however no problems with excess sludge and treated water.

## Acknowledgement

The Research Grant VEGA 1/0854/08 held by the Department of Sanitary Engineering Faculty of Civil Engineering, Slovak University of Technology Bratislava has supported this paper.

## References

- [1] Rajczyková, a kolektív E.: Základné princípy odvádzania a čistenia odpadových vôd, Bratislava, 2001
- [2] Mahrikova, I., Majdúch, J.: Čistá voda v každej obci, Renovujeme staviame zariaďujeme, jeseň 2002, vydavateľstvo Jaga group, str. 121–124
- [3] Správa o stave vodného hospodárstva v SR 2006, Ministerstvo životného prostredia, Bratislava
- [4] Mahrikova, I.,: Problematika odvádzania a čistenia odpadových vôd z malých územných celkov, Optimalizace návrhu a provozu stokových sítí a ČOV, MĚSTSKÉ VODY 2006, 5.–6.10.2006, Břeclav, s. 129–135
- [5] Mahrikova, I.: Waste Water Treatment from Small Urban Areas. In: Dangerous Pollutants (Xenobiotics) in Urban Water Cycle, ISBN 978-1-4020-6800-3, Published by Springer 2008, The Netherlands. 71–81
- [6] Stanko, S.: Alternatívne využitie jestvujúcich stokových sítí, Zborník z odbornej konferencie./ Banská Bystrica, 11.5.2006, ISBN80-227-2402-5SK / Bratislava: STU, 2006, str 67–72
- [7] Stanko Štefan.: Reconstruction and Rehabilitation of Sewer System in Slovakia. In: Dangerous Pollutants (Xenobiotics) in Urban Water Cycle, ISBN 978-1-4020-6800-3, Published by Springer 2008, The Netherlands. 61–71

# FINANCIAL NETWORK RECONSTRUCTION PLAN

DANIEL MORAN\*

*DHI a.s., Na Vrších 5/1490, 100 00 Praha 10*

**Abstract.** Operational, pipe bursts, and leakage costs in water distribution systems are in most cases significant. In order to get the most out of an agency's reconstruction investment, water managers need a reliable long-term financial reconstruction plan which evaluates pipes with higher failure rate, critical pipes based on their location, diameter, material, aging attributes, pressure zones, and reconstruction difficulty level. A multi-criteria system evaluation pinpoints areas for reconstruction investment vs. benefits. Provides an outlook of the network based on the agency's yearly budget allocations for present and years to come.

**Keywords:** Mike Urban, Network Reconstruction plan, modeling network, long-term financial rehabilitation plan, master planning

## 1. Introduction

The importance of a safe and reliable source of drinking water is beyond question; it is a basic necessity of life. At the present time water uses are normally included in agricultural, industrial, household, recreational and environmental activities. Virtually all of these human uses require fresh water [1].

Operational, pipe bursts, and leakage costs in water distribution systems are in most cases significant. However; cost of not providing basic water for drinking and sanitation will far outweigh the cost of doing so. In order to get the most out of an agency's reconstruction investment, water managers need a reliable long-term financial reconstruction plan which evaluates pipes not just based on their age but based on their failure rate, location, diameter, material, aging attributes, pressure zones, pipe fittings and reconstruction difficulty level. A multi-criteria evaluation pinpoints areas for reconstruction taking in account

---

\* To whom correspondence should be addressed. Daniel Moran, DHI a.s., Na Vrších 5/1490, 100 00 Praha 10, e-mail: d.moran@dhi.cz

investment vs. benefits, provides an outlook of the network based on the agency's yearly budget allocations for present and years to come.

## **2. Why a Network Reconstruction Plan**

Failure to properly evaluate a water distribution system will translate to an ineffective reconstruction campaign, which results won't reflect a decrease on number of pipe breaks and system leaks. Working without a reliable reconstruction plan will be more costly and ineffective since key points which are significant for shaping areas for reconstruction are ignored.

On the other hand, a reliable network reconstruction plan makes it easier to decide which water mains need immediate replacement – so water managers can get the biggest bang for their buck and the most out of their network reconstruction campaign.

## **3. Technical Evaluation**

Lately, a large number of water agencies focus their attention to urban network rehabilitation, due to aging networks, structural failures, high level of leakages, deterioration of water quality, etc. A reliable network reconstruction plan isn't an easy task due to the vast data and parameters that must be considered during the process. Up to now, management planning methods have been relatively poorly developed in comparison to the management of water supply systems development, based on the application of modern information technologies and presented in a form of Water Supply System Master Plans.

Finding an optimal rehabilitation strategy is based on evaluation of many scenarios with different approaches to solving technical needs and resulting technical impacts, prediction of related operational costs and calculation of investments costs, which must be adopted by water agencies to meet their real financial limits.

Technical evaluation of network conditions is core of the simulation process. It is based on multi-criteria evaluation method. The methodologies behind the technical evaluation and possible rehabilitation solutions are carefully evaluated; this process uses pipe's characteristics that can be directly evaluated such as failure rate, age, corrosion, pressure zones, leaks, pipe's importance, etc.

The criteria point classification and significant weights are received based on the initial methodology and as dictated by the agency based on their focus priorities. These combined are the main forces shaping the reconstruction process.

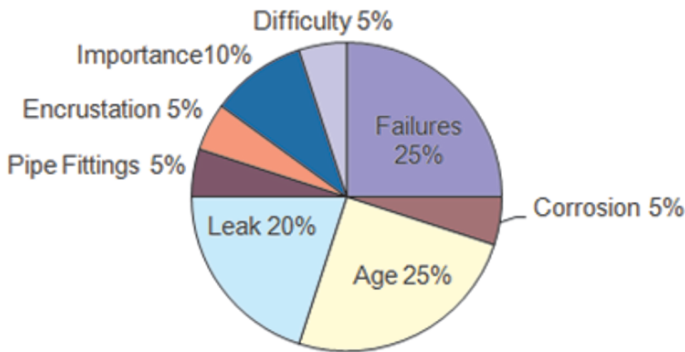

Figure 1. Significant weights by criterion, which defines criteria importance as the original methodology

#### 4. Initial Evaluation

The technical methodology already in place is based on standard multi-criteria evaluation but can be adjusted to meet any technical evaluation as required and/or presented by water agency. The water rehabilitation plan is constructed using available GIS data and the agency's water operations information to build a reliable model of the existing water supply system.

The primary technical evaluation during master rehabilitation plan is usually performed without budget limitations. This first evaluation shows a basic network rehabilitation plan for the chosen time period (such as next 20–30 years) and gives basic information about technical and financial limits for the applied methodology.

After the initial methodology (without budget constrains) is presented, a second methodology with budget constrains will be designed; a methodology with more realistic technical and economical financial facts indicated by the water agency. The revised and budget restricted rehabilitation plan reflects more reasonable investment and operating expenses for present and future network rehabilitation repairs.

#### 5. Methodology and Its Criteria

##### 5.1. AGE FACTOR

Pipe's age is not the only evaluated parameter but indeed is one of the most important physical evidences about a pipe. Pipe's age goes hand by hand with



other important parameters in a multi-criteria methodology, for example, corrosion, failures rate, pipe fittings and leaks are mainly age dependants.

Age can be judge as a form of actions physical and those which cannot be directly evaluated such as the vibrations from cars overhead, tiny leaks that can slowly wash away the ground supporting a pipe, gaskets can deteriorate and weaken pipes critical joints.

## 5.2. FAILURE RATE

Another important parameter in the multi-criteria evaluation is failure rate, here the repair crew's observations becomes concrete evidence in relation to the pipe's conditions. For example; corrosion, incrustation, pipe's fittings, material and other key parameters are recorded and confirm to become the strongest evidence about the pipe's physical conditions. Based on historical records, the agency is able to evaluate the failure rate/km/year which can later be translated to the cost for failures per year.

## 5.3. LEAKS

A leak is the consequence of a pipe's failure; in many distribution systems a significant percentage of water is lost while in transit from the water treatment plant to consumer's service area. Unaccounted losses are in average between 20–30% of production [2].

One of the most complex criteria to evaluate is leak/m<sup>3</sup>/km. Here we must determine the pipe's length in comparison to the overall distance inside its pressure zone, and then a leak is calculated based on the segment (pipe) length. On top of this, the leak gets additional weight points from the resulted failure rate and age factors.

## 5.4. COROSSION

Corrosion in drinking water and sewer infrastructure is the most costly off all the industrial sectors, based on a study, [2] results indicate that corrosion is apparently so overwhelming that often the deterioration of a system is normally ignore by water agencies and the choice is often just wait for the water and sewer systems lines to break.

Corrosion confirmation comes mainly from the field crews working on failure repairs. Corrosion mainly affects steel and iron water mains which represents a large number of the water mains around the world.

### 5.5. PIPE FITTINGS

Pipe fittings include mainly valves, meters, and fire hydrants. Pipe fittings are appraised based on the pipe's age; this can be translated as another weight put onto the pipes age evaluation.

### 5.6. INCRUSTATION

Incrustation is mainly due to rust and the water hardness based on the quantity of calcium carbonated. This process cannot be prevented only delayed [3]. Incrustation can be evaluated differently depending on available data regarding the criterion but in most cases incrustation is based on the pipe's material such as plastic or metallic. Metallic considered as candidate for incrustation development.

### 5.7. PIPE'S IMPORTANCE

The water main importance is for the most part based on the pipe's diameter and its configuration importance in comparison to the rest of the water system. Pipes with larger diameter transport larger quantities of water which in term are essential part of the system. Most likely a large diameter burst will have a greater impact to its service customers, businesses, surrounding infrastructure such as the street and public utilities in the vicinity. On the other hand, small diameters mains which serve water to sensitive customers such as hospitals, public areas are also classified as important to the system.

### 5.8. CONSTRUCTION DIFFICULTY

Diameter is not considered as a difficulty level; here the focused attention is the pipe's location such as downtown areas, boulevards, transportation routes, utility easements, surrounded utilities, pipe's depth etc. Another element is the terrain such as open space, hills, and canyons.

## **6. Present Rehabilitation Tools**

There are a number of software applications which in one way or the other assist water agencies with network reconstruction plans. For example, the rehabilitation tool in Mike Urban provides great advantages and means to generate flexible multi-criteria evaluation of existing water systems based on different conditions and requirements, flexibility, reliability and faster technical and economical evaluation of conditions and requirement.

## 7. Outputs

The first outputs are mainly focus on the overall evaluation of the water system, a detail summary and conditions of the system are carefully appraised in order to provide details about the system's age, identify areas with high failure rate/km/year, leaks in m<sup>3</sup>/km/year, yearly operational cost associated with failures and corresponding leaks, areas for immediate reconstruction needs (initial methodology without budget constrains) and an immediate reconstruction plan without budget constraints. The intent of the first results is mainly to assist water managers with their yearly allocation for reconstruction based on their present and future budget constraints and of course their optimal target goal.

The ultimate output is to locate the optimal investment which meets the agency's financial allocation. Once a budget is determined, and areas for reconstruction are pinpointed the long-term financial and technical reconstruction plan takes form.

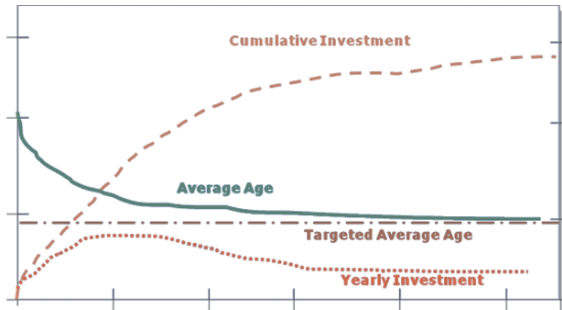

Figure 2. Optimal investment to meet its target goal

## 8. Conclusion

To ensure availability for future generations, the withdrawal of fresh water from an ecosystem should not exceed its natural replacement rate. With this in mind, there are a number of measurements water agencies can take in order to optimize their system to the fullest. Aside from water conservation, educational programs, and pressure optimization, a reliable rehabilitation plan which ultimate results are to locate the optimal investment and goals, is a must have among water agencies.

In order to make the best out of a water distribution system or simply improve its operation, each water agency should have a reliable rehabilitation plan. This will provide a clear evaluation of their system, maximize the system's capacity, decrease pipe burst repairs, leaks, maximize natural resources, and a more

effective reconstruction campaign. It has also been confirmed that financial rehabilitation plans have best results when produced in coordination with water or sewer master plans. Modeling techniques and outputs from such master plan indeed benefit management decision in relation to system optimization, pressure optimization, and system capacity. These observations are often visited during a reconstruction campaign.

## References

1. GreenFacts 2008, scientific facts on water resources website.
2. National Research Council Canada 2/2008, planning the renewal of aging water website.
3. Research on incrustation in a model evaporative cooler 5/2006, Teresa Szymura.

# INFLUENCE OF SEWAGES FROM THE INDUSTRIAL ZONE OF URANIUM PRODUCTION ON THE STATE OF THE WATER OBJECTS

BORYS KORNILOVYCH, LARYSA SPASONOVA\*,  
OLEKSANDR MAKOVETSKYY AND VICTORIA TOBILKO  
*National Technical University of Ukraine "KPI", 03056, Kyiv, 37  
Peremogy pr., Ukraine*

**Abstract.** The situation with waste and disposal remains critical in Ukraine. An overwhelming majority of wastes continues to be accumulated on the territories of enterprises and not meet the requirements for ecological safety. The greatest amount of pollutants to get in the rivers from industrial zone. The surface water quality, even taking into account the total reduction in wastewater discharges, shows no considerable improvement. A level of water pollution of some water bodies, which require urgent water protective measures, has remained unsatisfactory during several years. Almost all rivers and reservoirs are greatly affected by man-made activities.

**Keywords:** water objects, soils, wastes, heavy metals, uranium, electrokinetic remediation, permeable reactive barrier (PRB)

## 1. Introduction

The market of possible applications of up-to-date environment protection technologies has been rapidly developing in recent years. This is related, first of all, not only with further scientific-and-technical progress, but also with ever growing realization by the mankind of the importance of preserving environment in the maximum possible untouched state that is an absolute precondition for future existence of our planet in general. The latter statement implies enhanced

---

\* To whom correspondence should be addressed. Larysa Spasonova, Chemical Technology Department National Technical University of Ukraine "KPI", Ukraine, 03056, Kyiv, 56 Peremogy pr., l\_spasonova@kpi.ua; lar\_spas@yahoo.com, tel. +38 (044) 2417614

ecological requirements not only to newly created technological processes, but also involves the need for significant tightening of existing ecological norms, which, in its turn, implies the need of bringing in compliance with new standards of a great number of earlier polluted territories, dumps of toxic wastes, etc.

The most hazardous pollutants are volatile organic compounds, toxic hydrophilic and hydrophobic organic substances, and also heavy metals and radionuclides. Heavy metals, which most often find their way into the environment, include lead, mercury, arsenic, chromium, cadmium, and copper, while among the natural radionuclides the most hazardous is uranium.<sup>1,2</sup> Tremendous volumes of polluted sediments and soils in Europe and America require now decontamination. Hence, in the USA, in accordance with estimates of the National Environment Protection Agency about 20 million cubic meters of polluted soils and 300 million cubic meters of silts are waiting for appropriate measures to remove heavy metals from these wastes.<sup>1,3</sup> Urgent measures for their neutralization also require the so-called tailing pits formed after processing of uranium ores, which only in the USA constitute about 240 million tons<sup>2</sup>. According to the analysis conducted only within the framework of the US Energy Ministry, about 30 polluted sites where soils are characterized by low permeability (water penetration) can be recommended for decontamination. The similar situation takes place in Europe.

In Ukraine, which is known for its mighty metallurgical and metalworking branches of industry, remediation of soils and silts polluted with heavy metals is a pressing ecological problem.<sup>4,5</sup>

Ukraine belongs to the countries with wide use of radioactive materials in industry, medicine, and science. Only in power engineering about 50% of the entire energy is produced at the nuclear power stations, which is one of the highest indicators in the world. During operation of all NPS in Ukraine more than 25,000 m<sup>3</sup> of solid and 15,000 m<sup>3</sup> of liquid radioactive wastes (LRW) have been accumulated.<sup>6</sup>

A separate issue is the state of environment in the process of extraction and processing of uranium ores. In Ukraine the biggest in Europe deposits of uranium ores are exploited and scheduled for future exploitation. The first projects dealing with exploration and exploitation of uranium ores had begun in the 1950s years of the last century in Dnipropetrovs'k region, where the Eastern mining-and-concentrating integrated works was built. In the 1980s the construction of new ore mines began in Kirovograd region, where vast reserves of uranium ores were also explored. At present, on the basis of the Novo-Konstyantynivsk deposit the construction of a new powerful mining-and-concentrating integrated works is close to completion.<sup>7</sup> Up to date tailing dumps in Ukraine occupy hundreds of hectares of fertile lands, while the total amount of LRW accumulated in them amounts to nearly 65 million tons with the total radioactivity of 120,000 curie.

That is why there is a great demand both in Ukraine and in the world as a whole for applying effective and economically viable technologies aimed at decontamination and reclamation of vast territories that were polluted with toxic chemical substances as a result of industrial activity. However, in the overwhelming majority of cases this does not necessitate the use of costly technological processes of decontamination and reclamation of polluted sites and in this case the choice of one or another technological facility must be preceded with sufficiently long-term and detailed analysis of the nature of pollution and specific ecological-and-geographical situation as a whole.

At present a variety of methods has been proposed for dealing with soils and silts contaminated with hazardous toxic substances. Depending on the kind of pollution, degree of contamination, and the quantity of contaminated soils or silts, in each specific case one or another method is usually proposed.<sup>8,9</sup> One of the most common methods for decontaminating large quantities of wastes with predominantly low toxicity is their isolation in the environment by using barriers. However, in this case, the problem of neutralization of wastes proper is not resolved, but only the term of its solution is put off.

Another approach, which is rather popular in the USA, implies the use of technologies for fixing and stabilization of pollutants in disperse systems.<sup>8,10</sup> Low cost of this method of fixing/stabilization makes it attractive, however its meaningful disadvantage is the possibility of exclusion of sizable quantities of toxic substances owing to modified parameters of the environment (for example, pH). This disadvantage can be avoided by using such method as glazing. However, in this case consumption is very high.

In reviewing the methods designed for handling contaminated soils that imply their partial or complete decontamination should review the methods providing for removal (excavation) of soils or silts from the environment with their subsequent treatment.

Chemical treatment of soils contaminated with heavy metals and radio-nuclides after their excavation includes mostly the use of complexing reagents. Such alternative is quite common, since in this case the reagents are spent in the most purposeful and economic way. A new and rather promising method is also the ultrasound method of soil treatment, which however is still at the stage of experimental-and-laboratory tests.<sup>11</sup>

However, all the methods with excavation of contaminated soils, despite a high level of decontamination are characterized by high costs per unit of soil subjected to treatment. The so-called in situ methods to a certain degree are free of the above disadvantage. They enable us, despite a substantially lower degree of decontamination, to achieve in many cases the results, which are acceptable in terms of the resultant costs and levels of decontamination.

In view of many specialists, a wide variety of biological methods are the most promising and lately they have been rapidly developing. Their absolute advantage is high ecological compatibility and low cost.<sup>12</sup>

The main disadvantage of all biological methods for soils contaminated with heavy metals and radionuclides should be considered the slow speed of processes of microbiological oxidation or reduction of metals that requires much time, and also inability of achieving high levels of decontamination in the majority of cases.

Physicochemical in situ methods, and first of all the so-called “pump and treat” method, are free of these disadvantages.<sup>13</sup> This is the most popular and convenient environmental process based on extraction of toxic admixtures from soils during their washing with disinfection solutions that are introduced into the body of soil by using special wells.

Another in situ method is the use of so-called reaction-capable penetrable barriers that are mounted directly in soil on the way of underground flows.<sup>14,15</sup> Such barriers may ensure decomposition of toxic organic compounds or oxidation or reduction of a number of metals. Powders of iron or various granular media with appropriate biocenoses are used as materials for such filters.

However, the only physicochemical method that allows us to handle contaminated soils, which actually prevent the penetration of water, is the electrokinetic method.

Electrochemical remediation is based on electromigration phenomena using low-level direct current between the electrodes which can be installed in trenches around polluted sites or in batch installation with contaminated soils or wastes.

## 2. Experimental

East Mine Dressing Combine (Vost GOK) develops uranium mines of largest European and one of the largest all over the world uranium ore province. Now 3 of 12 uranium deposits are in exploitation. Potential pollution of the environment also connected with activity of hydrometallurgical plant in Zhovty Vody city. At this plant processing of the uranium ores and chemical concentrates after underground and heap leaching and after stations of mine water purification take place.

The most contaminated sites near tailing dumps, tails of spent material of hydrometallurgical plant and dumping ground in Zhovty Vody city were examined.

The determination of heavy metals and radionuclides content in samples provided by party modified standards methods. For analysis the average specimen of air-dried soils from selected samples were used.



The Cu, Pb, Cd, Zn, Fe, Co, Ni, Cr determination provided by atomic-absorption spectroscopy after the full decomposition of the sample in mixture of different acids. For Cu and Pb determination the samples were treated during heating by HCl+HNO<sub>3</sub> and dry residue was dissolved in diluted HCl. The detection was made by analytical bands 324.7 nm (Cu) and 283.3 nm (Pb). The detection for Cd, Zn, Fe, Co and Ni was made by analytical bands 228.8 nm (Cd), 213.9 nm (Zn), 248.3 nm (Fe), 232.0 nm (Ni) and 240.7 nm (Co). For Cr determination the samples were treated in Pt-vessel by HF and HClO<sub>4</sub> mixture and after the appearance of vapours of HClO<sub>4</sub> decomposition was continued with addition of HF and saturated solution of H<sub>3</sub>BO<sub>3</sub> for fluoride ions immobilization. Wet residue of salts was then dissolute in concentrated HCl and diluted by water. The analytical band for Cr determination is 357.9 nm.

The evaluation of degree of radioactive contamination of soil was made on the basis of  $\Sigma\alpha$ - and  $\Sigma\beta$ -activity determinations with the use of low background equipment UMF-2000. The sensibility of the method was 0.02 Bk/kg for  $\Sigma\alpha$ - and 0.1 Bk/kg  $\Sigma\beta$ -activity. Besides this the determination of the most important individual radionuclides which determine the radioactive hum near East Mine dressing combine – Ra-226, Th-230, Pb-210, Po-210, U<sub>natural</sub> was provided.

The determination of Ra-226 was provided after fusion the sample with H<sub>2</sub>O<sub>2</sub> and Na<sub>2</sub>CO<sub>3</sub> in the presence of BaCl<sub>2</sub>. The received transparent melt was analyzed by emanation method which was based on the detection of  $\alpha$ -activity of Rn and its decomposition products in scintillation chamber of “Alfa-1” radiometer. The determination of Th-230 was also provided after previous heating and fusion the sample with Na<sub>2</sub>O<sub>2</sub>. Then the separation of Th-230 from other  $\alpha$ -emitters in dissolute melt were made chromatographically on cationic exchange resin KU-2p and by sorption on ZnS based luminescent solid. Number determination of Th-230 was provided with radiometer PP-8. The determination of Pb-210 was provided after radionuclides separation on anion exchange resin EDE-10P from retained HCl. Radiometric determination of Pb-210 was made by its decomposition product control – Bi-210 with radiometer UMF-1500M. The determination of Po-210 was provided after treating of the samples by oxidants. The concentration of radioactive element was made and next detection with radiometer PP-8 was performed. The determination of U<sub>natural</sub> was provided after treating of the samples during heating by mixture of acids. U(VI) was reduced to U(IV) by TiCl<sub>3</sub> and then determined titrimetrically by ammonium vanadate NH<sub>4</sub>VO<sub>3</sub> in phosphoric acid medium. The indicator was sodium biphenylaminosulfonate.

The main results of the analysis of different places were presented in Tables 1 and 2.

TABLE 1 The contents of heavy metals in samples from industrial zone

Tests ground	The contents of heavy metals, %							
	Cu	Cr	Pb	Co	Cd	Fe	Zn	Ni
Tailing storage 1	0.010	0.040	0.050	0.090	<0.001	3.66	0.100	0.024
Tailing storage 2	0.003	0.020	<0.010	0.015	<0.001	4.20	0.009	0.020
Tailing storage 3	0.004	0.031	0.028	<0.005	<0.001	2.40	0.011	0.024
Tailing storage 4	0.002	0.020	<0.010	0.005	<0.001	1.20	0.009	0.020
Tailing storage 5	0.003	0.016	0.024	0.009	<0.001	1.55	0.006	0.015
Tailing storage 6	0.006	0.012	0.100	<0.005	<0.001	1.44	0.007	0.007
Tailing storage 7	0.010	0.015	<0.010	0.005	<0.001	3.80	0.010	0.008

TABLE 2. The contents of radionuclides in samples from industrial zone

Tests ground	The contents of radionuclides, Bk/kg						
	$\Sigma \alpha_{\text{aktiv}}$	$\Sigma \beta_{\text{aktive}}$	Ra-226	Th-230	Pb-210	Po-210	$U_{\text{nat.}}, \%$
Tailing storage 1	1,616	1,072	387	381	420	363	0.003
Tailing storage 2	1,077	715	258	254	280	242	0.002
Tailing storage 3	2,700	1,791	647	637	702	607	0.005
Tailing storage 4	808	536	194	191	210	182	0.0015
Tailing storage 5	281	186	67.3	66.3	73.1	63.2	0.0005
Tailing storage 6	1,616	1,072	387	381	421	363	0.003
Tailing storage 7	6,980	2,274	1,157	1,118	1,235	1,059	0.009

The obtained results suggest that the content of the most toxic heavy metals in samples are  $\geq 0.3\%$ . At the same time  $\Sigma\alpha$ -activity is  $2.25 \cdot 10^4 \div 5.00 \cdot 10^2$  Bk/kg and  $\Sigma\beta$ -activity –  $1.39 \cdot 10^4 \div 1.86 \cdot 10^2$  Bk/kg, Ra-226 is  $5.3 \cdot 10^3 \div 6.7 \cdot 10^1$  Bk/kg and  $U_{\text{nat.}}$  0.041  $\div$  0.001%. The aforesaid enable to consider the investigated samples as radioactive wastes with low level of radioactivity.

One of the most polluted places was selected for remediation by electrokinetic method in the Zhovty Vody city at the Vost GOK, the second place which includes contaminated underground waters and which impossible to clean by electrochemical method was chosen for the probable usage of permeable reactive barrier (PRB).

On the basis of the analysis conducted we chose the site located on the territory of the hydrometallurgical works, where pollution occurred due to a spill of the process uranium-containing solution. The contamination was relatively uniformly distributed over the area of several tens of square meters with the average uranium concentration in the top layers of soil of  $\sim(178 \pm 10)$  mg/kg.

Preliminary experiments revealed that essential removal of uranium from soil is possible only after long-term treatment of samples. This is explained by the fact that the complexation elements can be sorbed by clay minerals not only on basal surfaces of plane particles of the latter due to a relatively weak ion-static interaction, but also on lateral faces of these particles with formation of strong surface complexes. Another major cause of slow removal of pollutants is the presence in soil of natural organic complexation substances, the most important of which are humic substances.<sup>16</sup> Complexes of metals with these substances feature high durability and are not destroyed even under severe conditions.<sup>17</sup>

In order to determine the speciation of the uranium in the soil that was sampled on the territory of the hydrometallurgical plant sequential extraction analyses were performed. Generally accepted procedure include determination of the main five fractions of heavy metals and radionuclides in soils and sediments: loosely held cations in porous solution, including the exchangeable forms, that can be readily extracted; tightly adsorbed cations and those associated with carbonates and easily soluble oxides/hydroxides; metals that are associated with Fe-Mn oxides; complexes with natural organic substances (humic acids et al.); practically insoluble substances. According with the received chemical analysis data, ~43% of the uranium contamination in the samples are in loosely held forms but the rest uranium is tightly associated with inorganic and organic parts of the soil and may be removed only by extraction procedure under strong acid conditions. So, the last part of the contaminants is practically immobilized and it is not necessary to remove it during electrokinetic remediation of radioactively contaminated soils.<sup>18</sup>

For conducting decontamination of soil on the polluted site without its excavation, the wells were made in the soil having depth of ~1.2 m and with due regard for the external diameter of the electrode chambers. The electrode chambers were placed in soil at the general area of 10 m<sup>2</sup>. Electrokinetic remediation of the soils uranium production in-situ shown in the Figure 1.

Also it was shown by our investigation that for the approved in construction of the electrode unit (l = 1 m with cathode and anode) the voltage was ~1.0 – 1.4 V/cm, the density of current 5–15 A/m<sup>2</sup>.

Anode electrode – titanium rod, Ø 1.4 cm, covered with more than ten layers of MnO<sub>2</sub>, length 100 cm. Cathode electrode – stainless steel rod, Ø 1.4 cm, length 100 cm. Electrode chamber – perforated PE pipe, inside diameter 7.0 cm, covered with a layer of filter fabric.

To neutralize hydroxyls that formed as a result of electrode reactions, 5 N of HAc solution was introduced automatically into the cathode chamber throughout the experiment. The total duration of stand experiments was 28 days (14 days – first stage and 14 days – second stage).

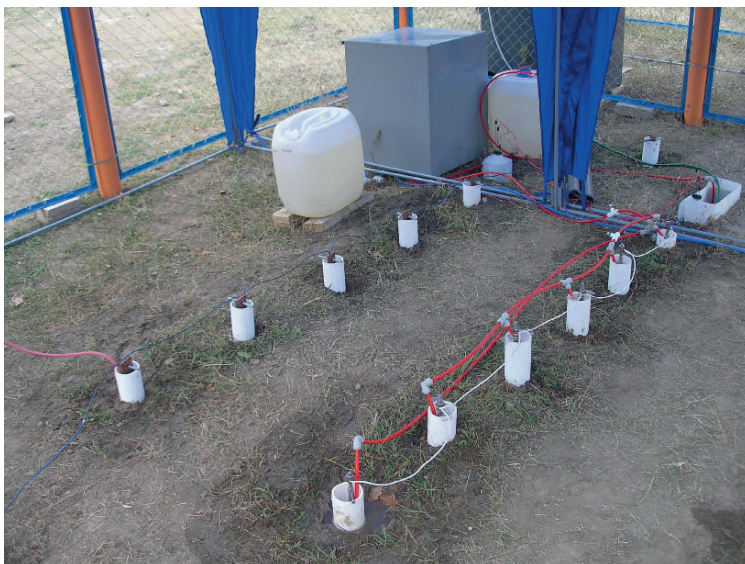

*Figure 1.* Electrokinetic remediation in-situ

The total amounts of pollutants extracted from soil during 2 weeks experiment on the second stage were 798 g of uranium (by the results of chemical analysis of catholyte). This quantity makes up ~22% of the whole uranium contamination or ~52% of the uranium contamination, that are in soil in loosely held forms.

The total amounts of pollutants extracted from soil during 2 weeks next experiment were 497 g of uranium (by the results of chemical analysis of catholyte). This quantity makes up ~14% of the whole uranium contamination or ~32% of the uranium contamination, which is in soil in loosely held forms.

As can be seen from the obtained results comparative quantity of uranium, which were removed from the soil during the final stage, were significantly lower than corresponding value for previous stage (~22%). Such distinction is connected first of all with different forms of uranium which were removed in these two cases. On the first stage the uranium contamination in soil was produced by recent overflow of the technological solution and contained mainly uranium sorbed on surfaces of mineral clay particles or humic acids and uranium, which were in porous space as free uranyl ions or complex carbonate or hydroxyl ions. At the applying of the electric field the contaminated porous solution was removed first of all together with electroosmotic stream. The removing of ion sorbed uranium by ionic exchange reaction between anode generated protons and uranium in ion exchange positions also took place at this time. But the rate of this process is much lower than the rate of electroosmotic

removing of porous solution. During the first stage the main contribution in summary remediation process was by electroosmotic constituent and predominant part of free uranium in porous solution was removed before the end of this stage. During the second stage the removing of the uranium contamination was mainly due to surface exchange reactions and connected with lowering of the soil pH and movement of the strongly marked hydrogen front toward the cathodes. Such change of the character of the remediation process is the reason of it's retarding.

That is why, the results obtained during the testing indicate high efficiency of the electrokinetic technology.

In order to create a closed process cycle for operation of electroremediation installations designed to decontaminate liquid wastes, we carried out a survey of state-of-the-art water treatment methods. The efficiency of decontamination of mineralized waters polluted with uranium was shown in the case of using the complexation – ultrafiltration method. It was established that the best poly-electrolyte for binding uranium ions into durable complexes in waters with enhanced salt content for subsequent separation on ultrafiltration membranes is polyethylene. A process for the membrane wastewater purification after electroremediation was proposed. Industrial testing of the electroremediation installation conducted on wastewaters showed that the concentration of uranium in the purified water constitutes 0.03–0.04 mg/l.

For determining the right place for PRB application the detailed examination of ecological situation of one of the most dangerous contaminated place in Zhovty Vody (near telling storage 1) were provided. The following samples were collected: surface water quality samples, surficial samples, ground water samples. The place for future PRB installation was selected across the ground-water stream near the Zhovta river.

This investigations were executed for the financial support of the Science Technology Center of Ukraine project № 2426 “Electroreclamation systems for the decontamination of radioactively contaminated waters, wastes and soils” and project P-322 “Regional evaluation of mining-related metals contamination, risks, and innovative remediation technologies in Ukraine and Georgia”.

## References

1. R.J. Abumaizaz and E.H. Smith, Heavy metal contaminants by soil washing, *J. Hazard. Mater.* B70, 71–86 (1999).
2. E.R. Landa, Uranium mill tailings: nuclear waste and natural laboratory for geochemical and radioecological investigations, *J. Environ. Radioactivity* 77, 1–27 (2004).

3. C.N. Mulligan, R.N. Yong and B.F. Gibbs, Remediation technologies for metal-contaminated soils and groundwater: an evaluation, *Engineer. Geol.* 60, 193–207 (2001).
4. National report on the state of environment of Ukraine in 1999; <http://file.menr.gov.ua/publ/nreport;/Nd99eng.pdf>
5. National report on the state of environment of Ukraine in 2004; <http://www.menr.gov.ua/img/nd2004.pdf>
6. A.M. Serduk, I.I. Karachov and L.S. Gronska, Radiation hygienical aspects of handling radio-active wastes in Ukraine, *Environ. Health* 4, 24–28 (2002).
7. Mining and processing of uranium ores in Ukraine/Edited by Chernov A.P. (АДЕФ-Україна, Київ, 2001).
8. Environmental restoration of metals contaminated soils/Edited by I.K. Iskandar (Lewis Publishers, Boca Raton, 2001).
9. C.N. Mulligan, R.N. Yong and B.F. Gibbs, An evaluation of technologies for the heavy metal remediation of dredged sediments. *J. Hazard. Mater.* 85, 145–163 (2001).
10. J.R. Conner, *Chemical fixation and solidification of hazardous wastes* (Van Nostrand Reinhold, New York, 1990).
11. A.F. Collings, A.D. Farmer, P.B. Gwan Sosa, A.P. Pintos and C.J. Leo, Processing contaminated soils and sediments by high power ultrasound, *Minerals Engineering* 19, 450–453 (2006).
12. F.Y.C. Huang, P.V. Brady, E.R. Lindgren and P. Guerra, Biodegradation of uranium – citrate complexes: implications for extraction of uranium from soils, *Environ. Sci. Technol.* 32, 379–382 (1998).
13. P. Bayer and M. Finkel, Life cycle assessment of active and passive groundwater remediation technologies, *J. Contamin. Hydrol.* 83, 171–199 (2006).
14. B. Gu et al., Reductive precipitation of uranium (VI) by zero-valent iron, *Environ. Sci. Technol.* 32, 3366–3373 (1998).
15. A.D. Gusmao, T.M.P. Campos, M.M.M. Nobre and E.A. Vargas, Laboratory tests for reactive barrier design, *J. Hazard. Mater.* 110, 105–112 (2004).
16. J. Buffle, *Complexation Reactions in Aquatic Systems: An Analytical Approach* (Wiley, New York, 1988).
17. W. Stumm, *Chemistry of the Solid-Water interface* (Wiley, New York, 1992).
18. K.R. Reddy, C.X. Xu and S. Chinthamreddy, Assessment of electrokinetic removal of heavy metals from soils by sequential extraction analysis, *J. Hazard. Mater.* B84, 279–296 (2001).



# RISK ANALYSIS OF SEWER SYSTEM OPERATIONAL FAILURES CAUSED BY UNSTABLE SUBSOIL

KAREL KRÍŽ\*, VOJTĚCH BAREŠ, JAROSLAV POLLERT JR,  
DAVID STRÁNSKÝ AND JAROSLAV POLLERT  
*Faculty of Civile Engineering, CTU in Prague, Thákurova 7, 166  
29, Prague 6*

**Abstract.** In unstable subsoil areas, all constructions including sewer systems are threatened by non-uniform surface downthrown. Conditions of constructing and operating of sewer systems in these localities differ significantly from standard conditions. Therefore, it is necessary to distinguish criteria applicable to the designs and reconstruction of sewer systems in these types of areas. Ground subsidence causes failures on the sewerage and consequently the hydraulic capacity problems. Sewer system can stops perform major tasks and it would promote the hygienic problems. Usual rainfall-runoff process modelling can be used in this type of catchment; however, there are several specific parameters, which are essential for getting representative results. Only these results are usable for effective operation and reconstruction design and they can help spend a less cost of investments too. Most of experiments were undertaken in experimental undermined area (municipality Horní Suchá in Moravian-Silesian Region, Czech Republic).

**Keywords:** unstable subsoil; sewerage failures; hydrodynamic model; calibration; simulation analysis and modelling

## 1. Introduction

Safely drainage of sewage and stormwater is one of the major tasks of sewerage. Inherited sewer and wastewater systems suffer from insufficient capacity due to continuous urbanization, construction flaws and pipe deterioration. Consequences

---

\* To whom correspondence should be addressed. Karel Kríž, Faculty of Civile Engineering, CTU in Prague, Thákurova 7, 166 29, Prague 6, e-mail: karel.kriz@fsv.cvut.cz

are structural failures, local floods, surface erosion, and hydraulic and chemical stress in receiving water bodies. European cities are spending in the order of 5 billion Euro per year for wastewater network rehabilitation. Especially the localities on the unstable subsoil (undermined area) are endangered. Problems are more severe and the municipalities are encumbered by increased operating costs. The application of standard principles in design and construction of sewer system may cause major problem in these localities, possibly resulting in destruction of these structures.<sup>3</sup> In relation to this, serious operating problems occur and the functionality is limited, and if immediate remediate actions fail to be taken, important elements of the sewerage systems may have to be put out of service. The ongoing as well as terminated mining work very often results in ground movements, above all subsidence, causing changes in the sewer system slopes and local structural failures.<sup>7,8</sup> Behaviour analysis by rainfall-runoff modelling for operation and reconstruction planning can be very helpful, but not sufficient.<sup>2</sup>

The specific approach for rainfall-runoff model design and calibration is necessary. It should be solved in terms of traditional calibration parameters (reduction factor, initial loss, concentration time and time area curve shape<sup>9</sup>) supplemented by other specific calibration parameters for failed sewerage on the unstable subsoil (hydraulic roughness and non-discharge places).

## 2. Methodology

Experimental works were undertaken in Ostrava-Karvina mining region, municipality Horní Suchá with combined sewer system. Experimental sewerage length is 7,900 m. Catchment area is 62.6 ha. Pervious areas are 33%. There was build water-pumping station.

For the purpose of simulating rainfall-runoff processes in experimental catchments, a digital model of the sewer system and related sub-catchments (used DHI software MOUSE 2003<sup>9</sup>) was developed at first. In order to do so, design documentation updated by detailed height surveying of gradients was used. Mid-term monitoring of rainfalls and flow rates (i.e. water levels and velocities) in selected points of the sewer system was made for the model calibration and verification. It was performed generally irrespective of the occurrence of structural faults in the sewer system.

In standard cases, this does not introduce any major uncertainties into the solution; however, in areas affected by unstable subsoil this can lead to incorrect calibration and verification and result in incorrect assessing of the sewer system behaviour.

First model calibration done with reduction factor, initial loss, concentration time a time area curve calibration parameters only was not accurate enough.<sup>6,9</sup>



It was necessary to take into account specific parameters describing damaged sewerage system in order to obtain accurate calibration.

2.1. EFFECTS OF UNSTABLE SUBSOIL ON THE SEWER SYSTEMS STRUCTURAL INTEGRITY

The effects of unstable subsoil on sewer system behaviour were found out primarily. The individual relations and influences of subsidence on the sewerage systems are in the Figure 1.

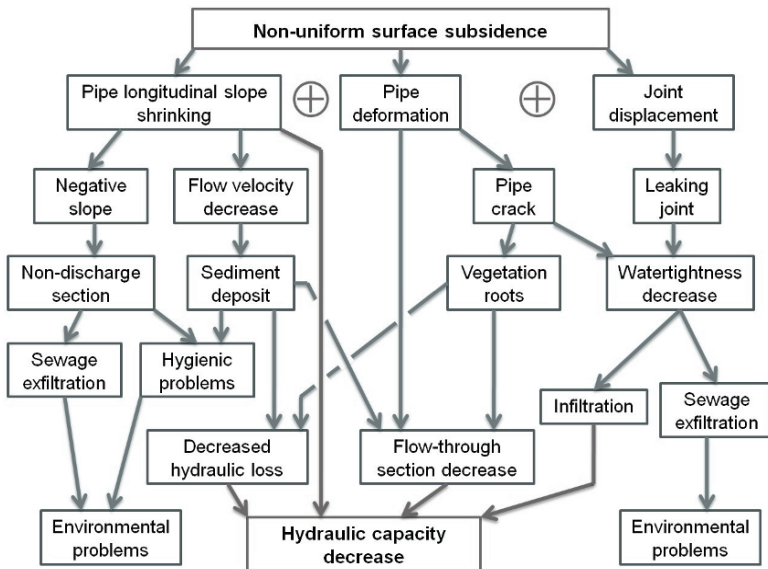

Figure 1. Effects of non-uniform subsoil on the sewer systems

2.2. SPECIFIC CALIBRATION PARAMETERS

2.2.1. Hydraulic Roughness

Three methods describing increased hydraulic loss has been tested. Hydraulic losses influence is substituted by increased Manning coefficient of roughness in all methods.

1. Traditional approach:

All pipe failures within whole sewerage network are described by one increased value of Manning coefficient of roughness. The value was found out according to calibration hydrographs analysis. The manholes influence was solved separately in MOUSE 2003 by the coefficient of head loss.

## 2. CARE-S methodology:

Every pipe failure localized by CCTV is encoded in compliance with standard EN13508.<sup>4</sup> These codes are used as input data into Obstacle program. The program calculates particular Manning coefficients of roughness for every pipe section.<sup>1,5</sup> The manholes influence was solved separately in MOUSE 2003 by the coefficient of head loss again.

## 3. Tracer experiment:

Experiment has been made to find out real losses. Tracer (sodium chloride- cheap, environmental friendly, simple and cheaply in-line detected) was dosed into the first manhole of experimental section and the response was measured in-line by conductivity probes with logger in the two manholes downstream. The value of roughness coefficient was obtained from mixing equation. All hydraulic losses are included in Manning coefficient of roughness (pipe friction head loss and local hydraulic head loss).<sup>2</sup>

### 2.2.2. Non-Discharge Section

The water volume of these “dead zones” is one of specific calibration parameters and it is found out according to calibration hydrograph analysis. A start of the outflow from these places depends on their initial filling. Non-discharge section must be solved before the start of every simulation, especially as to sewer systems with water-pumping station. In these cases are using measured data of water level in the pump sump accordant with calibration rain event for setting. Fictive discharge defined to the manhole upstream of the dead zone on the sewerage in sufficient period before rain event start is the optimal way for solve this problem.

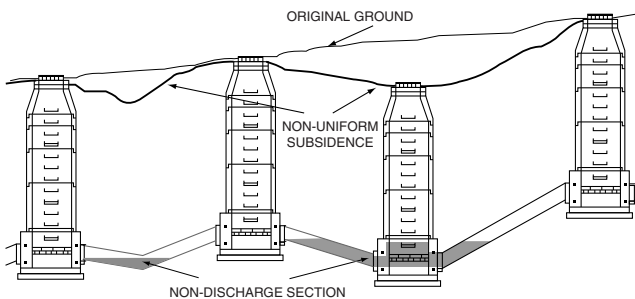

Figure 2. Non-dicharge section

The value of fictive discharge volume must be greater than or equal to dead zone volume. The redundant volume flow downstream out of system. It is possible to find these places according to geodetic surveying in the cases of

manholes subsidence only. Some of these sections can stay latent, if droop the section between the manholes (Figure 2). We can discover these places by CCTV.<sup>2</sup>

### 3. Results

#### 3.1. SPECIFIC CALIBRATION PARAMETERS

##### 3.1.1. Hydraulic Roughness

###### 1. Classic approach:

Original setting value of Manning coefficient of roughness for concrete pipe was according to literature  $n = 0.013$ . For failed sewerage was the value increased to the  $n = 0.016$ . The final value found out according to hydrograph analysis was  $n = 0.020$ .

###### 2. CARE-S methodology:

The input value to the Obstacle program according to last experience was  $n = 0.016$ . The outputs are the individual values of roughness for each pipe section. The average value for whole catchment sewerage resulted  $n = 0.018$ .

###### 3. Tracer experiment:

The values of roughness ascertained by this experimental method are given below in the Table 1. The real losses are significantly higher.

TABLE 1. Hydraulic roughness results<sup>2</sup>

Section ID	Q [l/s]	L <sub>0-1</sub> [m]	L <sub>1-2</sub> [m]	S <sub>0</sub> [%]	D [m <sup>2</sup> s <sup>-1</sup> ]	k <sub>st</sub> [m <sup>1/3</sup> s <sup>-1</sup> ]	n [m.s <sup>1/3</sup> ]
1	4.84	67	200	1.35	0.109	27.8	0.036
2	7.73	67	200	1.35	0.147	32.7	0.031
3	9.18	67	200	1.35	0.153	33.7	0.030
4	12.45	67	200	1.35	0.151	34.3	0.029

Q = discharge; L<sub>0-1</sub> = distance 0-1; L<sub>1-2</sub> = distance 1-2; S<sub>0</sub> = average slope 1-2; D = dispersion coefficient; k<sub>st</sub> = Strickler coefficient of roughness; n = Manning coefficient of roughness.

We can say, that the differences between concrete depths for roughness accordant with individual methods are great, through that the methods are not exactly comparable. It is not possible using literary value  $n = 0.013$  for these failed sewer systems. The results manifesting roughness influence on the depth of flow are in the Table 2.

TABLE 2. Roughness influence on the depth of flow

n \ Q [l/s]	0.013		0.018		0.02		0.03	
	h (m)	h (%)	h (m)	h (%)	h (m)	h (%)	h (m)	h (%)
20	0.09	30	0.1	33	0.11	37	0.13	43
40	0.12	40	0.15	50	0.16	53	0.21	70
50	0.14	47	0.17	57	0.18	60	0.25	83
60	0.16	53	0.19	63	0.21	70	N/A	N/A
$Q_{cap}$	115		81		75		55	

Q = discharge;  $Q_{cap}$  = capacity discharge; n = Manning coefficient of roughness; h = depth of flow

### 3.1.2. Non-Discharge Section

Number of fictive discharge places and their volume are individual.

For example, in the experimental area with total length of sewerage 7,900 m was discovered six non-discharge sections with total volume 230 m<sup>3</sup> (including pipes and manholes). In case the non-discharge places are not filled before the simulation start, the initial loss of rainfall can be incorrectly increased of 0.5 mm, which can be considered as significant (calculated for catchment area 50 ha).

### 3.1.3. Lag Intake Component

In calibration and simulation process, the “lag intake component” was found out (Figure 3). Effect of this component depends on the sewerage conditions, on the pipe laying depth, on the seepage (soil type), and on a time period after last rainfall events (waterlogged).

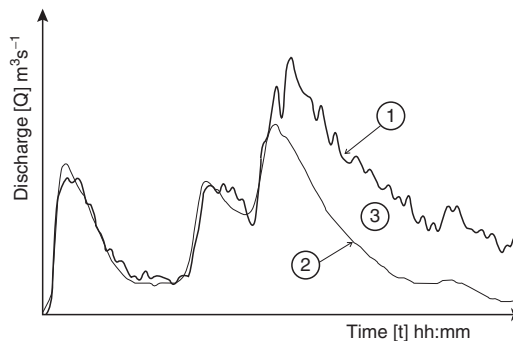

Figure 3. Lag intake component

(1) Flow-meter data, (2) MOUSE simulation curve (n = 0.020), (3) Area indicates lag intake component (LIC) volume infiltrated through the earth into the leaky pipe

During the calibration rainfall (duration 5 h) was the LIC volume approximately 30% of rainfall volume flowed through gauging station. The lag was approximately 150 min in this case.

#### **4. Conclusion**

The classic approach in comparison with CARE-S methodology is more accurate in the case studied, because CCTV was not made complete (we don't know individual failures in unexplored localities). Further, some of pipe failures are substituted by smaller pipe cross section (not as higher roughness) and individual failures are computed separately.

However, classic approach is useful for simulation of whole sewer system only, because it is not detailed. If the complete CCTV is done, CARE-S methodology is advantageous for simulation and assessment particular section of sewerage. The manholes influence must be solved separately.

It should be set real non-discharge volume according to hydrograph analysis and we need to know water level in the pump sump in water-pumping station (measured data) for correct calibration. For sewer systems condition assessment should be always set a worst possibility in order to rain events and fictive discharges cause maximal depth, in point of interest. Some of these sections can be full, some can be empty (due by exfiltration). Actual condition of filling should be located by the sewer inspection/monitoring.

Lag intake component does not need to be important for calibration. In dependence on the geological conditions and on the sewerage watertightness, this symptom can be delayed for several hours. It is considerable for storm stand-by tank, and CSO design.

Operators or municipalities can use these models for more effective decision making about operation, and reconstruction design. Reconstruction works can decrease pipe cross section but the new material roughnesses are decrease too. Therefore, the hydraulic capacity increases in these localities. However, this improvement in this section can to cause deterioration in some places downstream. The global situation in the catchment can be second to original condition. Rainfall-runoff process modelling offers possibility to find the critical sections, choose a reconstruction method and evaluate its effect.

In undermined areas, there usually exist forecast maps of subsidence. However, a significance of sewer pipe subsidence cannot be accurately predicted on the basis of these forecast maps as was found out within the project. The change of sewer manholes elevation is mainly unpredictable and uncontrolled. Therefore, a development of traditional sewer system in new areas endangered by ground subsidence is not recommended. A decentralized system of sanitation should be applied. The same recommendation is valid for reconstructions.

Sewerage on the unstable subsoil is continually developing system (several tens year after mining end). It is a big problem keeps the actual information about sewer system.

How often survey a new sewerage condition, make inspection, and change the model? Should it be regularly or after problem discover?

How to made rekonstruction of sewerage, which is all length in negative slope? How act, if prediction on other subsidence exists?

Is it right build line civil engineering works in these localities?

## Acknowledgments

This works was supported by the Czech Grant Agency project No.103/08/0134.

## References

1. J. Pollert, R. Ugarelli, S. Saegrov, W. Schiling, Di Zederico. Change of the Hydraulic Capacity of sewer systems due to deterioration. UDM – Dresden, Pages 719–727, 2004.
2. K. Kríž, V. Bareš, J. Pollert, D. Stránský. Effect of undermining on the sewer systems (in Czech: Vliv poddolování na hydraulickou funkci stokové sítě). Wastewater 2007, Brno, ISBN 978-80-239-9618-0. Pages 97–104. 2007.
3. J.W. Delleur, S. Reyna, J. Vanegas. Sewerage rehabilitation, Hydroinformatics Tools. ISBN 0-7923-5097-9, Kluwer, 1996.
4. CEN EN 13508-2 Conditions of drain and sewer systems outside buildings – Part 2: Visual inspection coding system. European Committee for Standardization, May 1, 2003.
5. NTNU, SINTEF. Manual for Obstacle program. SINTEF. 2004.
6. Wastewater planning users group. Code of practice for hydraulic modelling of sewer systems, Wastewater planning users group. 2002.
7. K. Neset. Effects of undermining (in Czech: Vlivy poddolování), SNTL, Prague 1984.
8. J. Schenk. Movement and deformation measurement in areas of subsidence (in Czech: Měření pohybů a deformací v poklesové kotlině), VŠB-TU Ostrava, HGF Ostrava 2006.
9. DHI Water & Environment. Mouse 2003 – User guide. DHI Water & Environment. 2003.

# RISK AND VULNERABILITY ASSESSMENT (“ROS-ANALYSIS”) OF THE BERGEN WATER SUPPLY SYSTEM – A SOURCE TO TAP APPROACH

JON RØSTUM\*

*SINTEF Building and infrastructure, Klæbuvegen 153, 7465 Trondheim*

ASLE AASEN

*Bergen Water & Sewage Works, Bergen municipality, Norway*

BJØRNAR EIKEBROKK

*SINTEF Building and infrastructure, Klæbuvegen 153, 7465 Trondheim*

**Abstract.** The paper provides an overview of the application and results of a risk and vulnerability analysis (in Norwegian: ROS-analyse) of Bergen’s water supply system covering all elements from source to tap (i.e. catchment, source, treatment plant, and distribution). The analysis gives an overview of the risk-picture for the water supply system. The main conclusion is that the flexible and redundant water system of Bergen, where five independent waterworks feed water into the same system, reduces the consequences from many of the undesired events which might happen. This puts Bergen in a unique situation compared to many other water companies in Norway. However, resulting from the analysis, we have identified new possible risk reducing measures for all elements in the water supply system which will improve the safety of the system to an even higher level. Within the project a new procedure for assessing the strength of the hygienic barriers represented by the water treatment step and the disinfection step has been developed. By using large datasets from the SCADA-system, long time-series of water quality data has been aggregated into easy understandable risk measures represented by duration curves. The risk analysis is organised and carried out within a database system, making it easy to update and improve the analysis at later stages.

**Keywords:** risk analysis, water supply, Giardia, duration curves

---

\* To whom correspondence should be addressed. Jon Røstum, SINTEF Building and infrastructure, Klæbuvegen 153, 7465 Trondheim, e-mail: jon.rostum@sintef.no

## 1. Introduction

The risk and vulnerability analysis of the Bergen water supply system is a response to the results from the internal and external evaluations after the waterborne *Giardia*- outbreak occurring in Bergen in 2004 where up to 6000 persons were infected (Eikebrokk et al., 2006). The incident was the first documented disease outbreak from waterborne protozoan pathogens in Norway. One of the recommendations from the external evaluation committee was to perform a risk analysis covering all elements from source to tap in the water supply system. After the outbreak the municipality has focused on proactive risk management of the complete water supply system, from source to tap.

Bergen is the second largest city in Norway with a population of approximately 250,000. The water supply system is owned by the municipality and operated by a public water company, Bergen Water KF, which is 100% owned by the municipality. Bergen has five catchment/surface water sources (lakes) and five corresponding major water treatment plants (WTP) Four of the WTPs employ coagulation, filtration, corrosion control, and disinfection by UV and/or chlorination). The fifth WTP has no coagulation because the raw water has good/acceptable microbial quality and very low NOM and turbidity levels. The WTPs feed water into the water distribution system at different locations thus creating a flexible and redundant system. Thus, one of the WTPs can be taken out of service at any time; The remaining WTPs have still sufficient capacity to maintain water supply for the entire city.

In this paper a description of the method for risk and vulnerability analysis is described together with some of the interesting findings from the analysis which can be of interest for a broader audience. For a more detailed overview of the analysis, we refer to the complete report (Røstum and Eikebrokk, 2008) which most likely will be available for download from the homepage of Bergen Water/Bergen municipality.

## 2. Method

The method for carrying out the risk and vulnerability analysis is based on a modification of the existing Norwegian guidelines for risk assessment (RA) in water supply systems (Norwegian Food and Safety Authority, 2006), where also elements from WHO's Water safety plans (WSP) and the HACCP principles are implemented in the analysis. The main focus is on identifying hazardous events, a risk evaluation matrix, and identifying risk reduction options and control points.

Figure 1 illustrates the concept of hygienic (safety) barriers in a water supply system considering all elements from source to tap. Within the project a partly quantitative and qualitative analysis of the strength of these barriers has been carried out.



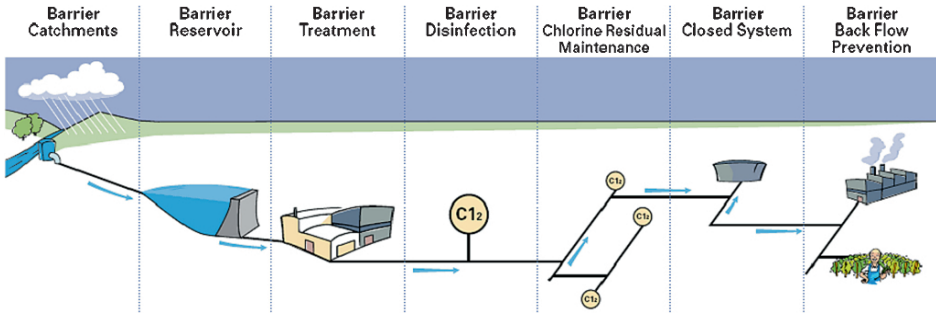

Figure 1. Illustration hygienic barriers in a water supply system from source to tap (Modification of a figure taken from Sydney Water, 2005)

Figure 2, which due to its shape is called a bow-tie diagram, illustrates the concept of risk and vulnerability analysis with identification of threats, undesired event, chain of causes and consequences. Different types of safety barriers (e.g. hygienic barriers) exist for reducing probability of the events and/or reducing the resulting consequences from an event.

Figure 1 also illustrates the systematic way of dealing with hazard identification for the whole water supply system from source to tap. By using updated flowcharts for each specific water work, a more complete list of possible undesired events is identified.

With reference to Figure 2 we asked the following questions for the Bergen water supply system:

- What can go wrong in the water supply system in Bergen?
- How likely are these events to occur?
- What are the resulting consequences?
- Which safety barriers exist? (For both left and right side of Figure 2.)
- How strong are the existing safety barriers?
- What is the corresponding risk for each event?
- Which new safety barriers/risk reducing measures (e.g. control, education, physical) can be implemented?

The resulting risks are presented as standard risk matrixes. The *probabilities* and *consequences* are given in terms of the following categories:

- *Probability Classes*, from  $P1 = \text{Small probability}$  to  $P4 = \text{Very High probability}$
- *Consequence Classes*, from  $C1 = \text{Small consequence}$  to  $C4 = \text{Very High consequence}$

One outcome of the analysis of a specific hazardous event/undesired event is the *risk*, given by probability of occurrence,  $P$ , and consequence,  $C$ . This set

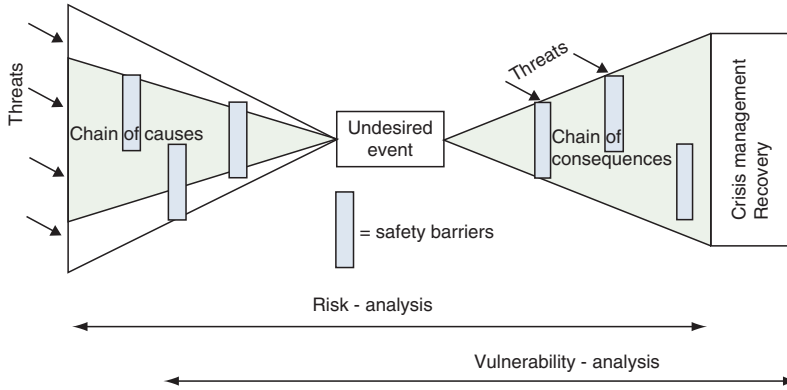

Figure 2. Illustration of risk and vulnerability analysis with identification of threats, undesired event, chain of causes and consequences (Inspiration from Rausand, 2006)

(*P, C*), is to be inserted in a Risk matrix (see Figure 3) where each events are identified through a coding system covering all undesired events. Three different risk matrixes are generated, one for *water quality* issues, one for *quantity/delivery* and one for *loss of reputation/economy*. Separate evaluations are carried out for each of these (see Figure 3). For events in the red area (both high probability and consequences), control measures have to be initiated; for events in the yellow area (medium probability and consequences), it is required to search for cost-effective risk reducing measures.

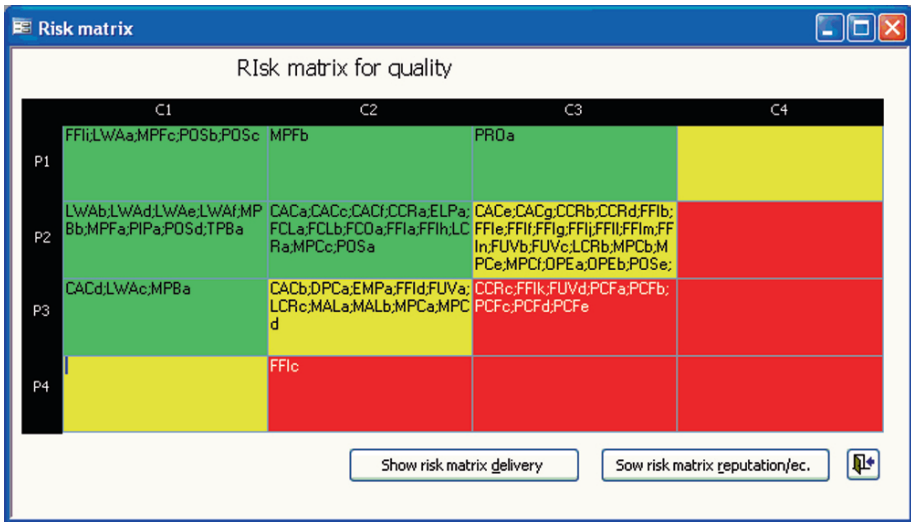

Figure 3. Illustration of risk matrixes for water quality

For organising the risk registering process a database-tool has been developed. The user-interface of the tool is shown in Figure 4. As an integrated part of the tool a coding system for undesired events has been developed covering all elements in the drinking water system. The work with the coding system has been inspired by the hazard database developed in the EU 6FP Techneau project (described in Rosén et al., 2007).

By organizing the risk and vulnerability analysis process and results in a database, we believe will make future updates/modifications of the analysis easier. Hopefully, this will turn the project into something like a *dynamic/living* risk and vulnerability analysis for Bergen Water.

Figure 4. User interface for registering undesired events and for organising the risk assessment process

### 3. Results

Based on the risk and vulnerability analysis a wide variety of results are available, e.g.:

- A database with identified undesired events with corresponding risk assessment. This also includes a coding system registering hazardous events/undesired events. Totally 85 undesired events are identified. In order to limit the number of events in the database, we discarded many events with low probability and low consequences during processing the data.

- In addition to the information recorded in the database the complete report (Røstum and Eikebrokk, 2008) also includes a more thoroughly description of the water supply system possible event.
- New procedures for assessing the strength of hygienic barriers in treatment and disinfection.
- Identification of possible risk reducing measures.

### 3.1. PROCEDURE FOR ASSESSMENT OF THE “STRENGTH” OF THE HYGIENIC BARRIERS IN WATER TREATMENT AND DISINFECTION

Within the project a new procedure for assessing the strength of the hygienic barriers (cf. Figures 1 and 2) represented by the water treatment step and the disinfection step has been developed. By using large datasets from the SCADA-system, long time-series of water quality data has been aggregated into easy understandable *duration curve* which can be used for calculating risk measures such as availability and downtime of the hygienic barrier. The availability has been used as estimate for the probability required in the risk analysis.

The “strength” of the hygienic barriers in the water treatment step and the disinfection step has been calculated based on the requirements given in the guidelines for the Norwegian Drinking water regulations (Norwegian Food and Safety Authority, 2005):

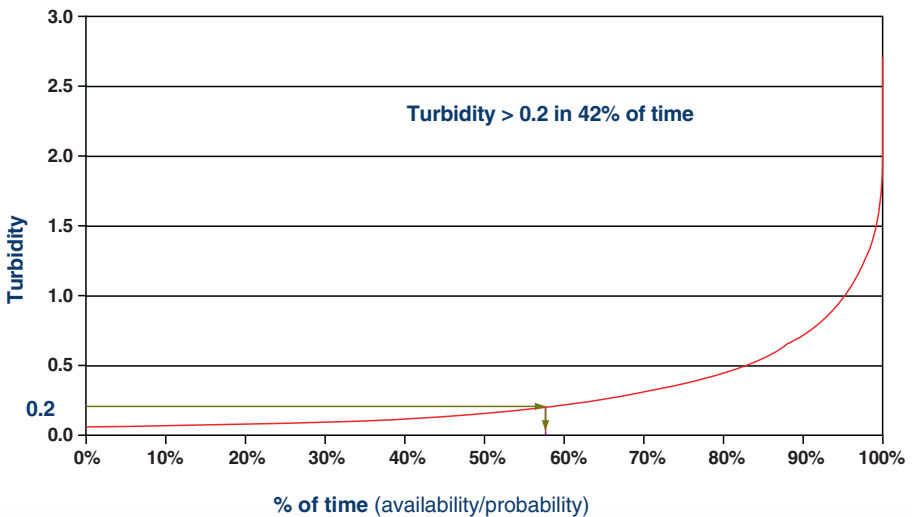

Figure 5. Duration curve for one filter calculated for a period of 1 month in a water treatment plant in Bergen (worst case)

- **Turbidity** (percent of time where turbidity > 0.2 NTU)
- **UV-dose** (percent of delivered water where UV-dose < 40 mJ/cm<sup>2</sup> or percent of time UV-dose < 40 mJ/cm<sup>2</sup>)

Figure 5 shows an example of a duration curve for a specific filter for 1 month analysis period. The turbidity in the outflow from one filter was less than the threshold value in 58% of the time, i.e. not fulfilling the requirements in 42% of the time.

Table 1 shows the complete results for the same water treatment plants in Bergen. The analysis is carried out for four parallel filters and also from the outlet of the clean water tank. The analysis has been carried out for both 1 year and 1 month time intervals. The values given in the table can be interpreted as the “strength” of the hygienic barrier represented by the water-treatment step (i.e. coagulation/filtration). There are large differences between the individual filters and also from the outlet of the clean water tank. This illustrates the need for measuring turbidity after each filter (i.e. a critical control point). The length of the time-interval used in the analyses, also have influence on the results. The shorter period analysed, the more likely high values of downtimes can be observed. It should be noted that the situation shown in Table 1 is not representative for the water treatment plants in Bergen as whole, but represent a worst case.

TABLE 1. Summary data for the strength of the hygienic barrier represented by the treatment-step (i.e. coagulation/filtration)

Period	Percent of time where the treatment barrier does not fulfil the requirements for turbidity removal				
	Filter 1 (%)	Filter 2 (%)	Filter 3 (%)	Filter 4 (%)	Outlet (from clean water tank) (%)
1 year	13	20	13	7	3 (>0.2 NTU)
1 month	24	42	26	14	8 (>0.2 NTU)

Duration curves have also been generated for UV-disinfection for different water treatment plants in Bergen. Figure 6 shows the duration curve for one specific UV-disinfection unit. In the figure the required threshold value 40 mJ/cm<sup>2</sup> is indicated for all the five parallel aggregates. For this water treatment plant water meters are available for each UV-aggregate making it possible to calculate the duration curve as a function of percentage of delivered water volume where the UV-dose has been lower than the required dose (40 mJ/cm<sup>2</sup>). Alternatively the unit “percentage of time” could have been used but “percentage of delivered water” is a better measure.

It should be noted that for the specific time period analysed, the redundant water transport system in Bergen was not fully implemented yet. Due to the

important role of this specific treatment plant, water was delivered from the plant even though the UV-dose was lower than the required values. The observed duration curve for this specific UV-plant is therefore *not* representative for the other UV-plants in Bergen. However it illustrates the power of the analysis.

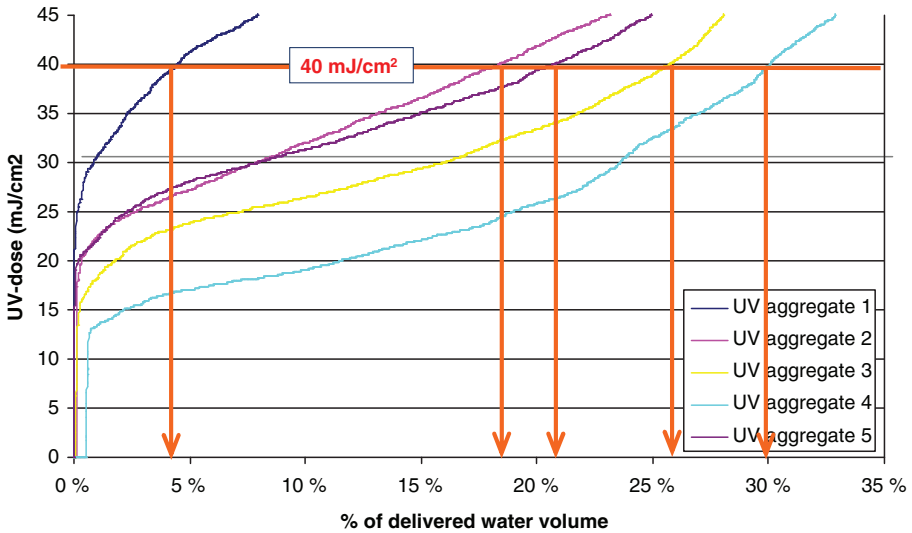

Figure 6. Duration curve (part of) for UV-disinfection in a water treatment plant in Bergen

Similar analysis can be carried out also for other criteria in the drinking water directive, e.g. chlorine residual. An interesting extension of the duration curve concept is also to generate duration curves for failure in water treatment and disinfection at the same time.

Bergen water has after the project implemented the duration curve are now being implemented into the SCADA system making it easy to assess the values. We believe the concept of duration curves and the corresponding risk measure is a powerful tool for all actors involved in safeguarding the water quality (owner, operator and inspectorate). Values from this analysis can also be used for benchmarking, both internal within the water company to improve the performance but also external to be compared with others.

The results from the duration curves can also be used for internal benchmarking in Bergen Water for improving the performance (thereby also the hygienic safety) for each filter/UV-aggregate and for the whole treatment plant.

## 3.2. DISTRIBUTION

A literature review of waterborne outbreaks (Hrudney and Hrudney, 2004) shows that for outbreaks caused by events happening on the distribution system, it is very difficult to identify the cause of the outbreak. However, main contributing factors are poor condition of the network and poor operational/maintenance routines. Contaminants might be transported as a plug-flow in the distribution system, making it difficult to identify by ordinary water sampling programs. Results from the EU project Microrisk (2006) show that 33% of all contamination events are caused by events happening on the distribution system.

### 3.2.1. *Identification of Hazards on the Distribution System and Some Risk Reducing Measures*

Hazard identification (undesired events) in the distribution system has been organised according to failure in the hygienic barrier (water quality) and failure in supplying water (quantity). In the following a summary of the identified undesired events which might take place on the distribution system are given:

#### **I Failure in hygienic barriers** (water quality)/induction of contaminated water into network:

- Contamination in water tanks (water surface)
- Induction due to low pressure/non-pressurised network
  - Operational and maintenance situations (e.g. valve operations)
  - Power failure
  - Work on non-pressurised network (e.g. repair, rehabilitation, construction)
  - Fire (huge water demands might lead to low pressure)
  - Water mains failure (might lead to non-pressurised system)
  - Incorrect operation of valves
  - Failure pumping stations in zones without water tanks
  - Water hammer
  - Pipe fracture valve closes without intention
  - Water tanks emptied due to communication error
  - Extraordinary water demand/tapping
  - In-pipe processes
- Cross-connection/backflow
  - Unintended backflow from building
  - Sabotage (intended backflow from building)

## II Failure water deliverance/quantity:

- Operational and maintenance situations (e.g. valve operations)
- Pipe failures
- Rockslides/rockfall in tunnel
- Water tanks emptied due to communication error
- Failure pumping stations
- Failure equipment (e.g. valves)

Some of the events might lead to consequences with both water quality and water quantity issues. For each of undesired events possible risk reducing measures have been identified.

For failures in the hygienic barrier represented by the distribution system the two following main drivers must be present in order to have contamination:

- Low pressure/non-pressurised system *and*
- Contamination agents nearby/available

Possible risk reducing measures for improving the hygienic barrier in the network can therefore act on both of these aspects.

Some geographical areas are more likely to have induction of contaminated water than others. For identification of these areas systematic analysis like fire flow analysis and network reliability analysis can be carried out. Fire flow analysis identifies areas with low water pressure in case of large fire water outlets. Network reliability analysis identifies pipes, which in case they break/fail, have consequences for the rest of the water network (water quantity). Such pipe failures might also lead to non-pressurised system and possible induction of contaminated water. Analysis like fire flow and reliability analysis can be used as one criterion for assessing the “strength” of the hygienic barriers in the distribution system. However, such analyses should be followed up with physical improvements (rehabilitation, new constructions, change in topology etc.) in order to have effect on the safety of the system.

According to Bergen Water’s existing master plan (2005–2015) for water supply, the annual rehabilitation rate is fixed to 1%. However the city council has indicated that they might increase this up to 2% per year. Even though these numbers are relatively rough for the rehabilitation needs, it illustrates the high level of ambition Bergen Water/Bergen city council have for safeguarding the water supply.

Many undesired events and critical control points have already been identified by Bergen Water and the control routines for operations at the network level is well documented and covers most situations.



## References

- Eikebrokk, B., Gjerstad K.O., Johnson, J., Røstum, J., and Rytter, E. (2006). Giardia-utbruddet i Bergen høsten 2004. Rapport fra det eksterne evalueringsutvalget. Rapporten kan lastes ned fra: <http://www.bergen.kommune.no/info/> (in Norwegian).
- Hrudney, E. and Hrudney, E. (2004). Safe drinking water. Lessons from recent outbreaks in affluent nations. IWA Publishing.
- Microrisk (2006). Microbiological risk assessment: a scientific basis for managing drinking water safety from source to tap. EU project under 5FP. ([http://217.77.141.80/clueadeau/microrisk/publish/cat\\_index\\_6.shtml](http://217.77.141.80/clueadeau/microrisk/publish/cat_index_6.shtml)) (visited 05.12.07).
- Norwegian Food and Safety Authority (2005). Veileder til Drikkevannsforskriften. (Guidelines for the Norwegian Drinking water regulations) (in Norwegian). Can be downloaded from [www.mattilsynet.no](http://www.mattilsynet.no).
- Norwegian Food and Safety Authority (2006). Økt sikkerhet og beredskap i vannforsyningen-veiledning. (Guidelines for risk assessment for drinking water (in Norwegian).
- Rausand M. (2006). System reliability theory. Models and statistical methods.
- Rosén, L., Hokstad, P., Lindhe, A., Sklet, S., and Røstum, J. (2007). Generic Framework and Methods for Integrated Risk Management in Water Safety Plans. Deliverable number D 4.1.3. Report available from [www.techneau.org](http://www.techneau.org).
- Røstum, J. and Eikebrokk, B. (2008). Risiko-og sårbarhetsanalyse for Bergen kommunes vannforsyningssystem. SINTEF report.
- Sydney Water (2005). SA Water – Drinking water quality report 2004–2005.

# DRINKING WATER SECURITY: MUNICIPAL STRATEGIES

JIRI MARSALEK\*

*National Water Research Institute, Burlington, Ontario, Canada  
L7R 4A6*

**Abstract.** Drinking water systems represent one of the critical infrastructures that are essential for the well-being of the general population. Consequently, risk management strategies need to be applied to these systems to strengthen their safety under exposure to various types of hazards. The process of developing management actions, with respect to new technologies and procedures, can be guided by recent advances in this field, and particularly those produced under the U.S. EPA water security program.

**Keywords:** drinking water infrastructure; threats and hazards, vulnerability assessment; risk management, emergency response plan; online monitoring

## 1. Introduction

Water supply systems are exposed to various levels of risk due to such causes as major disasters (e.g., storms, earthquakes, fires, floods, or explosions), accidents, acts of extortion or acts of terrorism (Halliday, 2003). Among these causes, intentional attacks on drinking water infrastructure pose a particularly serious challenge that must be addressed.

The risk management of water infrastructure in Canada and USA is conducted under the public safety and emergency preparedness programs, dealing with critical infrastructure protection, emergency preparedness, response and recovery, and related communication and dissemination of information. While these programs generally consider the whole system of critical infrastructures, the discussion in this paper is limited just to the water supply infrastructure.

Following the attacks of September 11, 2001, new programs on infrastructure security have been initiated in the USA by the Department of Homeland

---

\* To whom correspondence should be addressed. Jiri Marsalek, Environment Canada, National Water Research Institute, 867 Lakeshore Road, Burlington, ON, L7R 4A6, Canada; e-mail: [jiri.marsalek@ec.gc.ca](mailto:jiri.marsalek@ec.gc.ca)

Security (DHS) and in the field of water infrastructure, by the U.S. Environmental Protection Agency (U.S. EPA). The main issues addressed include protecting drinking water systems against physical and cyber threats; identifying drinking water threats, contaminants, and threat scenarios (USEPA, 2006); improving analytical methodologies and monitoring systems for drinking water; containing, treating, decontaminating, and disposing of contaminated water and materials (USEPA, 2006); planning for contingencies and addressing infrastructure interdependencies; determining effects on human health and informing the public about risks; and, protecting wastewater treatment and collection systems. Most of the information produced is readily accessible via the Internet, and used by both US and Canadian municipalities.

The main purpose of this paper is to review the strategies for addressing drinking water security in Canadian and US small-to-medium communities (<100,000 inhabitants), and provide sources of information on these developments.

## **2. Drinking Water Infrastructure**

Water infrastructure, sometimes subdivided into drinking water and wastewater systems, is generally recognized as one of the national critical infrastructures (NCI) to be protected against disasters, terrorism or other hazards. As such, it is covered by the Government of Canada position paper on a National Strategy for Critical Infrastructure Protection (PSEPC, 2004) with respect to developing a national strategy for critical infrastructure protection. This strategy includes a number of guiding principles, such as awareness, integration, participation, accountability, and an all-hazards approach. Within the context of this paper, the discussion focuses just on drinking water, even though it is recognized that various infrastructures are interconnected (PSEPC, 2004).

### **2.1. WATER SUPPLY SYSTEM**

In risk management analysis, the water supply system must be considered in its entirety, consisting of water sources (including an intake and piping), water treatment, and water distribution. While potential threats/attacks concern all the three components, risk levels for individual components differ. The most upstream component is a raw water source, such as a reservoir, lake, river, stream, or groundwater aquifer. Such sources are usually public water bodies, which can be easily targeted for disruption, but an effective attack would require high quantities of harmful agents and this limits the probability of success of such attacks.

The water treatment facility is a plant where raw water is treated to the level required by local regulations. Water treatment plants often employ chemicals (e.g., chlorine-based disinfectants), which could be used to contaminate water or harm employees. Also these plants often employ Supervisory Control and Data Acquisition (SCADA) computer systems which may be vulnerable to cyber attacks. Furthermore, many of these facilities are automated with minimum staff present on site. Consequently, water treatment plants may be vulnerable to attacks, particularly the final distribution tanks.

The last component is the water distribution system, which transports treated water to individual points of consumption. The quality of water entering the distribution system is generally tested, but the results are known with some delay and the tests performed do not target all chemicals that could be used in an attack. Consequently, the distribution system is also considered fairly vulnerable to attacks. It should be also noted that contamination of drinking water could have an impact on wastewater collection and treatment as well, when disposing of contaminated drinking water.

Welter (cited in Halliday, 2003) listed targets of the North American “events” disrupting water infrastructure, in a descending order of frequency, as drinking water systems (31%), storage facilities (27%), surface sources (8%), water treatment plants (7%), distribution systems (6%), dams (4%), SCADAs (3%), and miscellaneous (4%).

## 2.2. TYPES OF THREATS

In addressing drinking water security, it important to deal with all hazards, which may include natural disasters, accidents, computer cyber attacks, and deliberate attacks by extortionists or terrorists; such incidents are also referred to in the literature as “major events”. In a listing of North American major events involving drinking water infrastructure, Welter (cited in Halliday, 2003) analyzed the attacks with respect to the modes of attack and listed them in the order of descending frequencies as contamination (37% of all events), break-in (29%), use of explosives (7%), hacking (6%), vandalism (6%), and information gathering (3%). Such acts were perpetrated by unknown persons (41%), vandals (19%), terrorists (12%, domestic or foreign), employees (8%), disturbed (6%), and others (4%).

Thus, the available information indicates that any component of the water supply system may be vulnerable to some form of failure or attack, and the most common forms are contamination and break-in. It should be also noted that this list does not include disasters, which also pose significant hazards with respect to safety and security of water supply systems. Examples of such hazards include floods (potentially impacting on water sources, intake structures,

and water treatment plants), power failures (impacting on pumping stations and treatment plant operations), and earthquakes impacting on all elements of the drinking water infrastructure.

### **3. Risk Management**

The assurance actions of critical infrastructure owners/operators are based on risk management principles. In this approach, a consistent set of criteria is used to identify and rank critical infrastructures and determine the relative levels of risk of their failure. The relative priority of infrastructures is assessed by identifying the impact of their loss on the operation of the respective sector and on other sectors, and the consequence of their loss. Subsequently, owners and operators make decisions about the appropriate level of infrastructure protection (PSEPC, 2004).

The risk management process includes the following three components: (a) developing an understanding and creating awareness of the critical infrastructure and its interdependencies, (b) assuring the critical infrastructure through threat and vulnerability assessments, and threat mitigation; and, (c) managing response and recovery by facilitating cross-sector coordination, response planning, and education and training (PSEPC, 2004).

#### **3.1. DRINKING WATER INFRASTRUCTURE – VULNERABILITY ASSESSMENT**

The main purpose of vulnerability assessment (VA) is to evaluate the susceptibility of the drinking water infrastructure to potential threats and hazards, and identify corrective actions reducing or mitigating the risk of serious consequences from adverse incidents (e.g., vandalism, sabotage, terrorist attack, etc.). VA takes into account the vulnerability of the whole water supply system (water source, transmission, treatment plant, and distribution components) and the risks posed to the surrounding community (USEPA, 2002; USEPA, 2006). The assessment then serves to guide the agency in prioritizing plans for security upgrades, modifications of operations, and policy changes to mitigate the risks and vulnerabilities to the critical assets. VA should be performance-based, i.e., it should result in evaluation of the risk to the water system for the existing situation and for future measures designed to reduce the existing vulnerabilities. While the U.S. VA procedures emphasize adverse actions (USEPA, 2002), in the Canadian approach, consideration of all threats, including those caused by natural disasters, is emphasized (PSEPC, 2004).

The VA comprises the following elements (USEPA, 2002):

- Characterization of the drinking water system, including its mission and objectives.
- Identification and prioritization of adverse consequences to avoid.
- Determination of critical assets that might be subject to malevolent acts potentially leading to undesired consequences.
- Assessment of the likelihood (qualitative probability) of such malevolent acts from adversaries.
- Evaluation of the existing countermeasures.
- Analysis of current risks and development of a prioritized plan for risk reduction.

Brief comments on individual vulnerability assessment elements follow.

#### 3.1.1. *Drinking Water System Characterization*

The most important steps in this process include identifying the drinking water utility customers (e.g., general public, military, industrial, etc.) and the most important facilities, processes and assets needed to achieve the utility's mission objectives. Specifically, one needs to develop a list of utility facilities, operating procedures, management practices, utility operation (i.e., sources of raw water), treatment processes, storage methods and capacity, chemicals use and storage, and details of the distribution system. In assessing critical assets, important considerations include critical customers, dependence on other infrastructures (e.g., electricity), contractual obligations, points of potential failures (e.g., aqueducts), chemical hazards, and availability of other resources that may affect the criticality of specific facilities (USEPA, 2002).

#### 3.1.2. *Identification and Prioritization of Adverse Consequences to be Avoided*

One needs to list all the impacts that would substantially disrupt the system ability to supply safe water, or would impact on the surrounding community. Examples of typical impacts, including mechanical failures, hydraulic failures, water quality failures and water contamination, were reported by McBean (2006). Ranges of consequences or impacts of each eventuality should be identified and might include magnitude of service disruption, economic impacts (replacement of damaged components, revenue losses), number of illnesses or deaths resulting from an event, loss of public confidence in the water supply system, chronic problems arising from specific events, and other types of impacts. Risk reduction recommendations presented later in the vulnerability assessment should address each of these factors (USEPA, 2002).

### 3.1.3. *Determination of Critical Assets Vulnerable to Malevolent Acts*

The malevolent acts usually considered include physical damage or destruction of critical assets, contamination of water, intentional release of stored chemicals, and interruption of electricity or of other infrastructure interdependencies. The U.S. Bioterrorism Act also specifies the elements that should be included in the review, including: pipes and other conveyance elements; physical barriers; water collection, pre-treatment and treatment facilities; storage and distribution facilities; automated systems utilized in the system operation (SCADAs); the use, storage and handling of chemicals; and, operation and maintenance of such systems (USEPA, 2002).

### 3.1.4. *Likelihood of Malevolent Acts*

The possible modes of attack, which would significantly endanger the critical assets, need to be identified. The threats considered will determine, to a great extent, the risk reduction measures to be considered later in the vulnerability assessment process. Other sources of guidance for estimating the probability of major events include local law enforcement agencies, EPA documents, and incident reports reviewing past breaches of security (USEPA, 2002).

### 3.1.5. *Evaluation of Existing Countermeasures*

Countermeasure considerations deals with capabilities for detection, delay and response, including the existing detection capabilities such as intrusion detection, water quality monitoring, operational alarms, guards, and employee security awareness programs. The current delay mechanisms may include locks and key control, fencing, structure design, and vehicle access checkpoints. Furthermore, the existing policies and procedures dealing with intrusions (both physical or via the cyberspace), system malfunctions, and adverse water quality indications need to be identified and evaluated. This evaluation goes beyond the system identification, it addresses the actual performance. Cyber protection features include protective measures for SCADAs and business related computer information, including firewalls, modem access, Internet and other external connections, and security policies and protocols; and, vendor access rights. Security issues deal with personnel security, physical security, key and access badge control, control of system configuration and operational data, deliveries, and security training and exercise records.

### 3.1.6. *Analysis of Current Risks and Development of a Prioritized Plan for Risk Reduction*

In this step, the above listed information (3.1.1–3.1.5) is analyzed to determine the current levels of risk. The operator should then determine whether the

existing risks are acceptable, or risk reduction measures should be pursued. If the latter option is chosen, the recommended measures should measurably reduce risks or consequences, e.g., by reducing vulnerability or improving deterrence, delay, detection, and/or response capabilities. Both short and long-term solutions should be considered; security improvements should be considered in conjunction with other planned improvements (USEPA, 2002). In the multiple barrier approach (O'Connor, 2002b), some system redundancies may both reduce vulnerabilities and improve water supply system operation.

Strategies for reducing vulnerabilities fall into three categories – (a) Sound business practices, which are the policies, procedures, and training designed to improve the overall security culture; (b) System upgrades including changes in operations, equipment, processes and infrastructure that make the system safer; and, (c) Security upgrades improving capabilities for detection, delay or response (USEPA, 2002).

The vulnerability assessment document is used for preparing Emergency Response Plans (ERP), as demonstrated in the following section for small to medium size communities.

#### **4. Emergency Response Plans (Example for Small to Medium Size Communities)**

An emergency response plan (ERP) describes the actions taken by operators of a municipal water supply system in response to major events, which include credible threats, or indications or acts of terrorism, major disasters or emergencies caused by storms, wind storms, ice storms, fires, floods, earthquakes or explosions, and catastrophic incidents with extraordinary levels of casualties, damage, and disruptions. Before preparing an ERP, vulnerability assessments should be prepared and first responders and ERP partners be identified. Consultations with local and territorial (state or provincial) agencies are recommended to secure their advice and cooperation. ERP has eight core elements, which are briefly described below on the basis of US EPA recommendations for small to medium communities ( $3,300 < \text{population} < 100,000$ ) (USEPA, 2004a).

##### **4.1. WATER SUPPLY SYSTEM SPECIFIC INFORMATION**

During major events, basic technical information for the water supply system should be readily available to staff, first responders, contractors/vendors, the media and others. Thus, such information needs to be assembled during the vulnerability assessment and identified in the ERP. The level of technical documentation reflects the complexity of the water system and typically includes the municipal water supply system identification; administrative contact persons; population



served; service connections; distribution and pressure boundary maps; overall process flow diagrams; site plans and facility “as built” engineering drawings; operating procedures and system descriptions, including those for SCADA systems and process control systems operations; communication system operations; staffing rosters; chemical handling and/or storage facilities; and, release impact analyses (USEPA, 2004a).

#### 4.2. WATER SUPPLY UTILITY ROLES AND RESPONSIBILITIES

To fulfil responsibilities of the water supply utility, an Emergency Response Lead (ER Lead) and Alternate Lead need to be designated, and must be reachable on a 24-h basis. The lead will be responsible for evaluating the incoming information, managing resources and staff, and deciding on appropriate response actions. The lead also coordinates response efforts with first responders (USEPA, 2004a).

#### 4.3. COMMUNICATION PROCEDURES: WHO, WHAT AND WHEN

Good communications are essential during emergencies. Consequently, one needs to maintain internal and external notification lists and provisions should be made for an efficient and fail-safe form of communications during major events. The internal notification list includes the ER Lead and Alternate, ER team members, and utility management. The external list focuses on first responders who may be drawn from local, state and national agencies (police, fire protection, emergency committees, etc.). Finally, one also needs to communicate with the public and media. For this purpose, it is best to name an official spokesman, who may be someone external to the municipal water supply utility. Draft press releases and public water restrictions notices can be prepared in advance. In such communications, emphasis is placed on message clarity, accuracy, and ease of understanding (USEPA, 2004a).

#### 4.4. PERSONNEL SAFETY

Protecting the health and safety of the water supply utility staff as well as of the surrounding community is a key priority during emergencies. In safety considerations, one needs to consider evacuation planning, evacuation routes and exits, assembly areas and shelters, accountability, training and information, emergency equipment and administering first aid. There are many sources of additional information on these procedures (USEPA, 2004a).

#### 4.5. IDENTIFICATION OF ALTERNATE WATER SOURCES

The planning of alternate supplies requires a good understanding of the water supply system and of the available alternate sources. One needs to plan for both short-term and long-term outages, depending on the type of emergency. Where “boil water” notices suffice to address the problem, there is no need for alternate water sources. The next level is a “do not drink” order; in this case, the water may still be suitable for sub-potable uses not involving ingestion. The most restrictive is the order “do not use”, which may eliminate even the use for fire fighting. Possible short-term alternate water supplies include bottled water, bulk water provided by certified water haulers, inter-connections to nearby municipal water systems, and water from unaffected wells (sources). Dealing with long-term outages is much more challenging. Quite often the only solution is a replacement of the entire component of the water supply system, e.g., of the water source, treatment plant, or the distribution system (USEPA, 2004a).

#### 4.6. REPLACEMENT EQUIPMENT AND CHEMICAL SUPPLIES

The ERP should identify equipment that can lessen the impact of a major event on public health and drinking water supply. Towards this end, one should maintain an inventory of replacement equipment, spare parts, chemical supplies, and information on mutual-aid agreements with other municipal water supply utilities (USEPA, 2004a).

#### 4.7. PROPERTY PROTECTION

Protection of municipal water supply facilities, equipment and vital records is important for restoring operations after major events. Thus, the plan must include measures and procedures to be taken, in order to secure and protect the utility property following major events. This may include “lock down” procedures, access control procedures, establishing a security perimeter, evidence protection, and securing building/facilities against forced entry (USEPA, 2004a).

#### 4.8. WATER SAMPLING AND MONITORING

Water sampling and monitoring is needed to determine whether the drinking water is fit for public consumption, following a major event. Typical considerations include identifying sampling procedures, obtaining sample containers, determining the quantity of required samples, identifying who is responsible for collecting and transporting samples, confirming laboratory capabilities and

certifications, and interpreting monitoring or laboratory results (USEPA, 2004a, 2006).

## **5. Addressing Contamination Threats: Contaminant Monitoring**

One of the most common major events experienced by water supply utilities is water contamination by various agents (Halliday, 2003; O'Connor, 2002a, b), and detailed guidance for dealing with contamination can be found elsewhere (USEPA, 2006). One way of detecting water contamination is by online monitoring, which was examined in the recently published 'Interim Voluntary Guidelines for Designing an Online Monitoring System' (ASCE et al., 2004). A brief summary of these guidelines follows and is used to demonstrate the challenge of dealing with drinking water contamination.

When determining whether to use an Online Contaminant Monitoring System (OCMS), the utility should go through the risk assessment procedures outlined earlier under the vulnerability assessment and emergency response planning documents. In this process, one would consider all practical points of contaminant insertion, identify the insertion points of highest criticality (affecting the largest population), choose those which are most readily accessible to attackers, postulate a set of contamination threats, and estimate the consequences. Where the cost of OCMS is justified, one would follow with implementing such a system, which should meet the following objectives: (a) Provide an early warning with sufficient lead times to take corrective measures, (b) indicate the location and travel of the contaminant needed to design appropriate responses, (c) "identify" the contaminant and its conceivable concentration to inform the medical community, (d) provide information on the normal operating characteristics of the system, and (e) support or supplement the existing surveillance activities (ASCE et al., 2004).

There are many lists of potential contaminants of drinking water and their concentrations, which are available on the Internet (e.g., from EPA or Centers for Disease Control and Prevention, CDC), or from proprietary sources. Instrumentation for early detection of drinking water contaminants is rapidly developing, but it is not yet at the state of meeting "ideal" performance parameters (States et al., 2004). Thus, it is required to use one tier of instruments to detect contamination events and provide information on locations of contaminant occurrences, and the second tier involving laboratory techniques is needed to measure specific contaminants (ASCE et al., 2004). Among laboratory techniques, preference is given to rapid analytical techniques, such as rapid immunoassays, rapid enzyme tests, polymerase chain reaction, field-deployable gas chromatograph-mass spectrometry, and acute toxicity screening methods (States et al., 2004). This two-tier strategy assumes that contaminants in water

may change some measurable properties of the water and reveal their presence through these surrogate measurable parameters. The types of changes possibly caused by contaminants include changes in chemical composition of water, including carbon or other elements; changes in pH, reduction-oxidation potential and conductivity; changes in optical properties including UV absorption (van den Broeke et al., 2006; Perfer et al., 2006); changes in biological makeup of water; and, changes in mechanical and acoustic properties of the water.

Potential locations of instruments are in source water, end of water aqueducts, treatment plants, finished water reservoirs, and various locations in distribution systems – early, mid and end points. Each of these sites has advantages and disadvantages, which need to be considered when selecting instrument locations. In general, it is recommended to monitor the following water characteristics: flow/pressure, temperature, pH, conductivity, residual chlorine, turbidity, oxidation-reduction potential (ORP), ammonia, nitrate, chloride, toxic materials (e.g., by a toximeter), and radiation (alpha, beta and gamma) (ASCE et al., 2004). New research indicates potential advantages of also measuring UV absorption (van den Broeke et al., 2006; Perfer et al., 2006).

Data from online instruments need to be analyzed to identify presence and location of contamination, determine the time to tap, eliminate false negatives and minimize false positives, provide timely information to decision makers, and as much as possible, identify the contaminant and its class and concentration profile, and assess public health risk. Towards this end, instrument data are used in conjunction with computer models of the system, automating the process as much as possible. Besides the common water supply, distribution and quality models (Grayman, 2006; Ingeduld, 2006; Samuels and Bahadur, 2006), the analysts also need diagnostic/analytical programs, which address such issues as contamination scenarios with a range of insertion events from short insertion pulses to long-term bleeds and filter out background noise to enable extraction of the contamination signal (Ingeduld, 2006). Furthermore, modellers need to develop a catalogue of pulse characteristics and study signatures of both benign events as well as the historical events, which produced negative impacts. Other uses of modelling analysis include choosing the locations for placing instruments, response planning, design/upgrade of water systems, identification of contamination locations (e.g., by back-tracking contamination to the sources), and confirmation of positive events (Ingeduld, 2006; Samuels and Bahadur, 2006). A number of suitable models are available on the market (ASCE et al., 2004).

After compilation of contamination data at a central facility, alarms are provided to bring such data to the attention of decision-makers, who then evaluate the situation and take appropriate actions, including issuing advisories, contacting officials, directing utility staff and contacting media. For data transmission and

other essential communications, there is a need for a communication system that is reliable, effective and secure.

Next step in this procedure is the response to a contamination event, designed to minimize the exposure of the public while providing additional time to evaluate the nature and severity of contamination. In these actions, water utilities are guided by the EPA Response Tool box (RPTB) (USEPA, 2003) and additional guidance is available from the National Response Plan. The final considerations in designing the OCMS are interfacing with the existing surveillance systems and operations, maintenance, upgrades and exercise of the system (ASCE et al., 2004).

## **6. Water Security Research**

The field of drinking water security is rapidly evolving, with many research projects currently under way. Some key research and technical support issues addressed under the EPA program include identification and characterisation of threats to water systems, development of methods for detecting and monitoring contaminants in water, development of rapid screening technologies for contaminant identification, refinement of detectors and early warning systems for water systems, enhancement of models for contaminant transport in pipes, testing and evaluation of sensors and biomonitors, fate and transport of contaminants in water, treatment or inactivation of water contaminants, improvement of decontamination and disposal techniques, establishing contingency planning and infrastructure backup procedures, improved assessment of risks to the public due to water contamination, enhancing risk communication and information sharing concerning threats or attacks, and providing training and exercises which enhance preparedness and response (USEPA, 2004b, c). Progress on various research projects can be obtained from the National Homeland Security Research Center (NHSRC) at <http://www.epa.gov/nhrc>, or in an Internet-based catalogue with publicly available EPA products at <http://www.epa.gov/watersecurity>.

## **7. Conclusions**

Water infrastructure is critical to the well-being of the society and consequently, the risk of its failure or malfunctioning has to be managed for all forms of hazards and threats, including terrorist attacks. Recognizing high costs of drinking water infrastructure protection and relatively low levels of success of past attacks, a rational plan for water infrastructure protection needs to be developed. The first step is the vulnerability assessment considering all hazards, followed by

evaluating the risks, and developing response measures presented in the Emergency Response Plan. Good guidance for water security enhancement planning can be obtained from various publicly accessible sources, including those provided by the U.S. EPA and the Department of Homeland Security. The ongoing cooperative research involving government agencies, universities, professional associations and the private sector provides development of new technologies and forms of technical support. Implementation of the current expertise in water security in practice should substantially reduce the risk posed to drinking water infrastructure and ensure the well-being of citizens served by these systems.

## References

- American Society of Civil Engineers (ASCE), American Water Works Association (AWWA), and Water Environment Federation (WEF), 2004, Interim Voluntary Guidelines for Designing an Online Contaminant Monitoring System, ASCE, Reston, VA.
- Grayman, W.M., 2006, Use of Distribution System Water Quality Models in Support of Water Security, Security of Water Supply Systems: From Source to Tap, NATO Security Through Science Series C, Springer, Dordrecht, the Netherlands, 39–50.
- Halliday, R.A., 2003, Water, Critical Infrastructure Protection and Emergency Management, Public Safety and Emergency Preparedness Canada, Critical Infrastructure Protection and Emergency Preparedness, R. Halliday and Associates Ltd., pp. 1–48, [cip.gmu.edu/archive/12\\_CanadaWaterCIP.pdf](http://cip.gmu.edu/archive/12_CanadaWaterCIP.pdf).
- Ingeduld, P., 2006, Real Time Analysis for Early Warning Systems, Security of Water Supply Systems: From Source to Tap, NATO Security Through Science Series C, Springer, Dordrecht, the Netherlands, 65–84.
- McBean, E.A., 2006, Failure Mechanisms and Monitoring Methodologies Pertinent for Detection of Exposure Risks in Water Distribution Networks, Security of Water Supply Systems: From Source to Tap, NATO Security Through Science Series C, Springer, Dordrecht, the Netherlands, 9–18.
- O'Connor, D.R., 2002a, Report of the Walkerton Inquiry: Part One. The Events of May 2000 and Related Issues, the Ministry of the Attorney General, Toronto, Ontario.
- O'Connor, D.R., 2002b, Report of the Walkerton Inquiry: Part Two. A Strategy for Safe Drinking Water, The Ministry of the Attorney General, Toronto, Ontario.
- Perfer, R., Langergraber, G., Lettl, W., and Fleischmann, N., 2006, Use of UV-VIS Spectrophotometry for Alarm Parameters in Drinking Water Supply, Security of Water Supply Systems: From Source to Tap, NATO Security Through Science Series C, Springer, Dordrecht, the Netherlands, 85–98.
- Public Safety and Emergency Preparedness Canada (PSEPC), 2004, Government of Canada Position Paper on a National Strategy for Critical Infrastructure Protection, Ottawa, Ontario.

- Samuels, W.B., and Bahadur, R., 2006, An Integrated Water Quality Security System for Emergency Response, Security of Water Supply Systems: From Source to Tap, NATO Security Through Science Series C, Springer, Dordrecht, the Netherlands, 99–112.
- States, S., Newberry, J., Wichterman, J., Kuchta, J., Scheuring, M. and Casson, L., 2004, Rapid analytical techniques for drinking water security investigations. *J. AWWA*, 96(1):52–64.
- U.S. Environmental Protection Agency (USEPA), 2002, Vulnerability Assessment Fact Sheet, U.S. EPA, Office of Water, EPA/816/F-02/025, Washington, DC.
- U.S. Environmental Protection Agency (USEPA), 2003, Response Protocol Toolbox: Planning for and Responding to Drinking Water Contamination Threats and Incidents, U.S. EPA, Office of Ground Water and Drinking Water; <http://www.epa.gov/safewater/security>, Washington, DC.
- U.S. Environmental Protection Agency (USEPA), 2004a, Emergency Response Plan Guidance for Small and Medium Community Water Systems (Final draft, Apr. 7, 2004), U.S. EPA, Office of Water; <http://www.epa.gov/safewater/security>, Washington, DC.
- U.S. Environmental Protection Agency (USEPA), 2004b, EPA's Role in Water Security Research. U.S. EPA, Office of Water, EPA/600/R-04/037, Washington, DC.
- U.S. Environmental Protection Agency (USEPA), 2004c, Water Security Research and Technical Support Action Plan, USEPA, EPA/600/R-04/063, Washington, DC.
- U.S. Environmental Protection Agency (USEPA), 2006, A Water Security Handbook: Planning for and Responding to Drinking Water Contamination Threats and Incidents, USEPA, EPA No. 817-B-06-001, Washington, DC.
- van de Broeke, J., Brandt, A., Weingartner, A., and Hofstaedter, F., 2006, Monitoring of Organic Micro Contaminants in Drinking Water Using a Submersible UV-VIS Spectrophotometer, Security of Water Supply Systems: From Source to Tap, NATO Security Through Science Series C, Springer, Dordrecht, the Netherlands, 19–30.

# FLOOD RISK ASSESSMENT OF URBAN AREAS

CVETANKA POPOVSKA\* AND DRAGAN IVANOSKI  
*University of Ss. Cyril and Methodius, Faculty of Civil  
Engineering, 1000 Skopje, Macedonia*

**Abstract.** The paper deals with assessment of the existing storm sewer system of the Prishtina airport area in Kosovo. Frequent flooding of the airport area occurred recently and the activities in flood assessment and flood protection design were undertaken. First step in achieving flood risk assessment is data collection. Since the region recently was in war conflict it was not an easy task to obtain necessary data. Availability, suitability and quality of hydrological, meteorological, topographic and management data is discussed. Some results obtained by hydrological analysis of the maximum runoff flows with different probability, as well as the results obtained by hydraulic modeling of the existing drainage system are presented. Flood risk maps have been created, flood risk analysis was performed and measures against flooding of the runway were proposed. Furthermore, the importance of applying proper methodologies in flood analysis in storm sewer systems is also discussed. Maintenance of the existing system and establishing early warning, prediction and forecasting is extremely important in evaluating flood risk assessment and flood risk management.

**Keywords:** flood risk assessment, watershed, runoff, storm drainage system, culvert, flood mapping, hydraulic modeling

## 1. Introduction

The flood damage caused by heavy rainfall is one of the most important natural disasters and affects human life and social development. Moreover, the frequency

---

\* To whom correspondence should be addressed. Cvetanka Popovska, Ph.D., Professor, University of Ss. Cyril and Methodius, Faculty of Civil Engineering, Department of Hydraulics, Hydrology and River Engineering, Partizanski podredi bb, P.O. Box 560, 1000 Skopje, Macedonia; e-mail: popovska@gf.ukim.edu.mk



of its occurrence and disaster risk are considered to increase recently with global warming.

Therefore, the study on risk assessment and zoning of flood damage caused by heavy rainfall is very important to make strategies for preventing and mitigating flood damage.

The flood damage caused by heavy rainfall is one of the most important natural disasters and affects human life and social development. Moreover, the frequency of its occurrence and disaster risk are considered to increase recently with global warming. Therefore, the study on risk assessment and zoning of flood damage caused by heavy rainfall is very important to make strategies for preventing and mitigating flood damage.

Risk assessment of natural disasters is defined as the assessment on both the probability of natural disaster occurrence and the degree of danger caused by natural disasters. It can be assumed that natural disasters result from the interaction of both physical impact and human and environmental vulnerability.

The most appropriate procedure in flood risk assessment is: estimating of flood levels, generating flood risk maps, selecting methodology for risk assessment and zoning of flood damage. This paper will present the results from estimation of flood and flood risk mapping for the case study of Prishtina Airport in Kosovo. The main steps in flood risk mapping (Evans et al., 2002) are: (a) identify and prioritize "hotspot areas", (b) produce interception report on availability, suitability and quality of hydrological, meteorological and topographic data and selection of the most appropriate methodology in establishing flood levels, (c) carry out hydrological analysis, including determining design flows and flood hydrographs, (d) carry out hydraulic modeling on steady and unsteady state flow, (e) produce flood risk maps by use of GIS based models, (f) create a flood information database, and (g) dissemination of flood risk information.

Flood risk assessment and mapping is extremely difficult for urban areas. Urban areas can be described by geographical position, climate, morphology, population, social relationship and economic activities. Describing the interactions between the urban system, environment and risk management is a difficult task because of the complex relationships in cities between physical, social and economic variables. In general, the urban systems gather the following five elements: nature, human, community, cores and networks. The nature is represented by the water, air, temperature, precipitation, land use, pollution and protection. The human element is described by space, biological needs, emotional needs and relationships, while the community is represented by the laws, management, education, health, and economical and industrial development. Housing, public service, cultural and recreational centers are sub-elements in cores. Infrastructural systems such as roads, railways, and airports,

then communication and informatics systems are the networks. In the past these five elements were balanced, but nowadays they are not due to the nature destruction, population separation and spreading of the communities. Can we understand the urban systems better than we do now? The answer is yes, we can measure different phenomenon related to natural disasters, war conflicts and other economic and political activities, and immeasurability of some elements is not the reason not to observe and measure the measurable ones. Obtaining measured data makes possible good management including risk assessment and risk management.

In an attempt to assess the state of urban environment urban indicators grouped into urban attributes have to be selected, focusing on urban patterns, urban flows and urban environmental quality (Stanners and Bordeau, 1995). The current analysis shows that knowledge of European urban environment is incomplete. Most often data do not exist, and even when data exist, it is extremely difficult to obtain them. Especially in flood risk analysis, flood control and flood management the activities are not well established, except in the largest cities in Europe. The quality of urban environment depends on both physical and community conditions.

## 2. Case Study

The existing storm water drainage system of the Prishtina Airport area in Kosovo is the case study within this study. The objectives are: watershed and sub-watersheds re-determination, peak runoff flow rates re-definition, hydraulic modeling, and propose technical concept and measures for flood protection of the runway and associate structures. The first step in achieving these goals was to collect basic information about the age and efficiency of the system, present state of the system, review of the existing design project documentation and problem definition. Hydrological, meteorological, geological and topographic data were also collected. Since the region was in war conflicts, the available hydrological and meteorological data were assessed as insufficient. Flooding the runway and other infrastructure in the area was the reason to undertaken the activities in developing hydrological analysis and hydraulic modeling of the existing drainage system. The comparative analysis between the obtained results with this study (Popovska et al., 2008), and those in the existing design (alfa.i, 2006), are presented. Topographic maps and detail ground survey of the storage areas and the structures were provided in electronic version and 3D terrain model (DTM) was created. The software Auto Desk LAND DESKTOP, Auto Desk CIVIL DESIGN and HEC HMS have been used for delineating the watershed. The area mark N2 – 1 and N2 – 2 in Table 1 and Figure 1 are defined as  $N2 - 1 = N2 + \text{runway}$  and  $N2 - 2 = N2 + \text{runway} + A2 + A3 + A4$ .

TABLE 1. Watershed characteristics

Area	Drain point	A (ha)	L (m)	Hmax (m asl)	Hmin (m asl)	S (m/m)
A2	D2	299	2,000	750	560	0.11
A3	D3	186	2,100	840	560	0.23
A4	D4	63	1,100	770	560	0.10
N2	N2	371	1,750	561	542	0.01
N2 – 1	N2	484	1,800	561	542	0.01
N2 – 2	N2	1,032	3,900	840	542	0.08

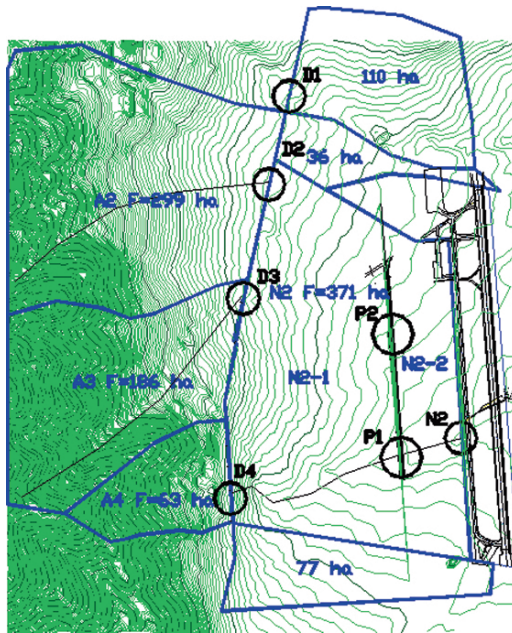

Figure 1. Watersheds map

### 3. Precipitation Analysis

Storm water design systems are based on topographic data and precipitation data from pluviograph recording and development of intensity–duration–frequency (IDF) curves. In the existing design (alfa.i, 2006) have been used short-term rainfall data with short duration (10, 20, 30, 60 min). Regression between Prishtina (Kosovo) and Kukesh (Albania) was established to extend data series. In the present design (Popovska et al., 2008) regression was established between long-term rainfall data observed at meteorological station Skopje (Macedonia) with duration (10, 20, 30, 40, 60, 90, 150, 300 min). The

obtained IDF (intensity–duration–frequency) and HDF (height–duration–frequency) curves for Prishtina region are presented in Figure 2.

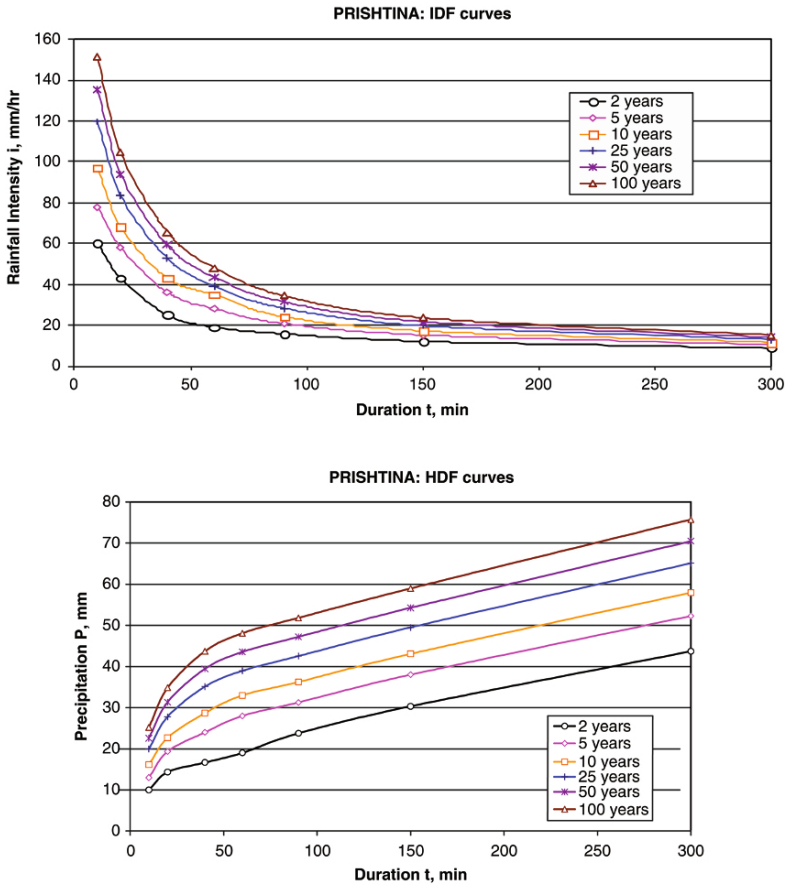

Figure 2. IDF and HDF curves

#### 4. Hydrological Analysis

In designing a storm water conveyance or detention systems, the engineer must obtain information on runoff flow rates. Two basic level of analysis exist. The first level is a peak flow calculation to determine the maximum runoff flow rate at a given point resulting from a storm event. This level of analysis is often sufficient for designing storm sewer and culverts whose only function is to transfer runoff away from areas where it is unwanted. The second level, which

is more complex, consists of the generation of a runoff hydrograph that provides information on flow rates versus time and runoff volume. This type of information is necessary in the analysis of detention and retention facilities where time and volume considerations are critical. In many cases where large watersheds are determined, hydrograph analysis is also required in storm sewer analysis.

In the previous design only the first approach was applied (Rational Method), and the present one both levels were applied (Rational Method and Hydrograph Method). The results are presented in Tables 2 and 3. The differences in obtained peak flows are mainly related to computation of the time of concentration  $T_c$  and runoff coefficient  $C$  estimation. In the previous design Kirpich formula was used for calculating  $T_c$  and in presented study the "Yaroslav Černi" formula was used which is based on experimental investigations and precipitation analysis in the region of Former Yugoslavia including Kosovo. Besides this the runoff coefficient  $C$  was not computed by weighting individual coefficients for each land use by their respective areas as it was done in present study.

TABLE 2. Results obtained by Rational Method (2006)

Watershed parameters				Peak flow $Q$ in $m^3/s$		
Area	Drain point	A (ha)	$T_c$ (min)	Return period in years		
				10	20	50
A2	D2	295	30	18.00	19.20	22.30
A3	D3	166	28	10.60	11.40	13.30
A4	D4	69	16	6.10	7.00	8.10
N2	N2	–	–	–	–	–
N2 – 1	N2	480	53	21.00	21.80	25.40
N2 – 2	N2	–	–	–	–	–

TABLE 3. Results obtained by Rational Method (2008)

Watershed parameters				Peak flow $Q$ in $m^3/s$		
Area	Drain point	A (ha)	$T_c$ (min)	Return period in years		
				10	25	50
A2	D2	299	40	9.50	11.63	13.07
A3	D3	186	26	7.59	9.30	10.50
A4	D4	63	22	2.87	3.52	3.96
N2	N2	371	91	4.24	4.99	5.56
N2 – 1	N2	484	101.3	7.92	9.31	10.35
N2 – 2	N2	1,032	70.4	25.45	30.05	33.59

The Rational Method is a popular choice for storm sewer design because this type of design usually considers only peak flows, and because of the simplicity of the calculations involved. This method assumes that a steady state is attained such that the rainfall inflow rate of water onto a drainage basin is equal to the outflow rate of water from the basin. Also, steady state conditions dictate that the storm intensity be spatially and temporally uniform. It is not reasonable to expect that rainfall will be spatially uniform over a large drainage basin, or that it will be temporally uniform over a duration at least as long as the time of concentration when  $T_c$  (and hence  $A$ ) is large. Therefore, these conditions limit the applicability of the Rational Method to small drainage basins. An upper limit of 200 acres (about 80 ha), but the local characteristics may limit the applicability of the Rational Method to basins smaller than 10 acres (about 4 ha). So, may be concluded that in case of the watersheds of the investigated area which are between  $63 \div 1,032$  ha the Rational Method could not be applied. Therefore, the Synthetic Hydrograph Method was applied to

TABLE 4. Results obtained by Hydrograph Method (2008)

Area	Watershed parameters				Peak flow Q in m <sup>3</sup> /s		
	Drain point	A (ha)	Tc (min)	CN	Return period in years		
					10	25	50
A2	D2	299	40	85	4.69	7.61	9.80
A3	D3	186	26	85	3.06	5.19	6.85
A4	D4	63	22	85	1.07	1.85	2.47
N2	N2	371	91	78	2.18	3.46	4.55
N2 – 1	N2	484	101.3	81	3.81	5.65	7.18
N2 – 2	N2	1,032	70.4	83	11.83	17.49	22.29

TABLE 5. Frequency data obtained by Hydrograph Method (2008)

Return period (years)	Frequency				
	P (%)	P (mm)	Pe (mm)	Qmax (m <sup>3</sup> /s)	qmax (m <sup>3</sup> /s·km <sup>2</sup> )
Watershed N2 – 2 = N2 + runway + A2 + A3 + A4: 1,032 ha					
2	50	19.00	1.23	2.12	0.21
5	20	28.00	4.46	7.69	0.75
10	10	33.00	6.86	11.83	1.15
25	4	39.00	10.14	17.49	1.69
50	2	43.60	12.92	22.29	2.16
100	1	48.10	15.86	27.36	2.65
1,000	0.1	69.50	31.46	54.27	5.26

obtain more reliable data. Extensive literature exists on various ways of calculating the synthetic hydrograph and the most commonly used is the method proposed by Soil Conservation Service (1969). The results obtained by Synthetic Hydrograph Method are presented in Table 4. It is obvious that the differences in obtained peak flow rates with Rational Method and Hydrograph Method are significant. This is very important because the technical concept of flood control, flood risk mapping, flood risk assessment and finally flood risk management will be different by actions, methodologies and costs. The frequency data on total rainfall  $P$ , effective rainfall  $P_e$ , peak flow  $Q_{max}$ , and specific peak flow  $q_{max}$  are shown in Table 5 and Figure 3.

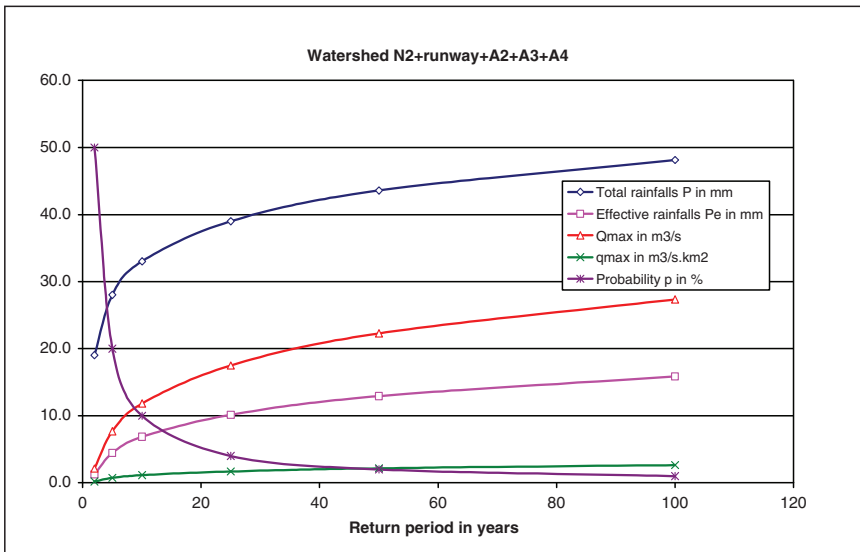

Figure 3. Frequency curves

### 5. Hydraulic Analysis

The capacity of the culverts was obtained by HAESTAD METHODS Software that simulates steady flow. CulvertMaster program was used that enables design and analyze culvert hydraulics. It solves most hydraulics variables, including culvert size, flow, and headwater. It also allows generating and plotting rating tables and graphical output with computed flow characteristics. The software offers a choice of culvert barrel shapes including circular pipes, arches, boxes, and more. Calculations handle free surface flow, pressure and varied flow

situations including backwater and drawdown curves. The capacity of the main culvert N2 is  $6.26 \text{ m}^3/\text{s}$ , Figure 4. The flow regime is supercritical with downstream velocity  $3.13 \text{ m/s}$ . In the previous design (alfa.i, 2006) the capacity of N2 was estimated to  $4.85 \text{ m}^3/\text{s}$ .

Flooding process due to storm event is unsteady flow which describes flow parameters changeable with time. Unsteady flow analysis has been performed by HEC-RAS. When the river/channel is raising water moves laterally away from the channel, inundating the flood plain and filling available storage areas. As the depth increases, the flood plain begins to convey water downstream generally along a shorter path than that of the main channel. Because the primary direction of the flow is oriented along the channel, this two-dimensional flow field can often be accurately approximated by a one-dimensional representation.

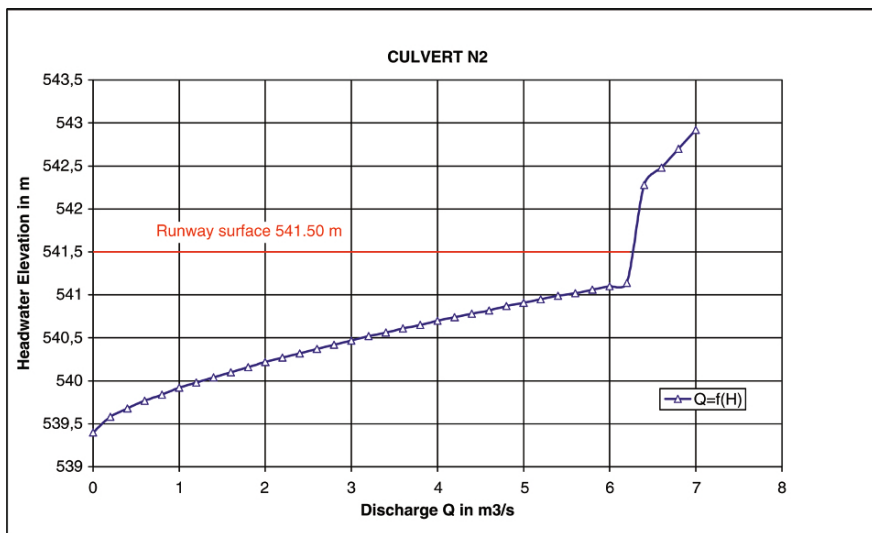

Figure 4. Discharge curve

The boundary conditions upstream and downstream are flow hydrograph  $Q = f(T)$  and rating curve  $Q = f(H)$  respectively. The topographic characteristics of the area were representing by 81 cross sections on distance  $5 \div 20 \text{ m}$  or in total length of about  $1,600 \text{ m}$ . The simulated width of the area was  $500 \text{ m}$  to the left and  $300 \text{ m}$  to the right from the axis of drain point N2. The obtained results are presented in Figures 5 and 6.



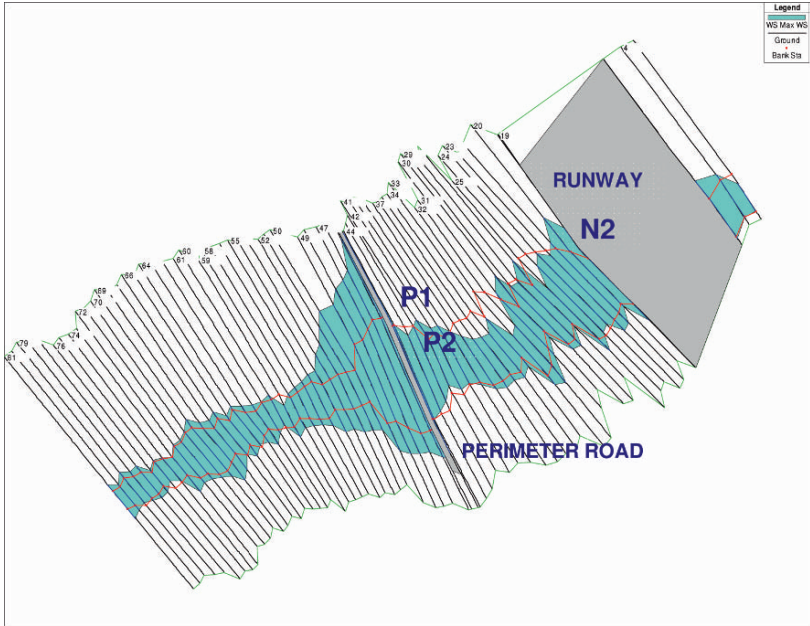

Figure 5. Floodplain map

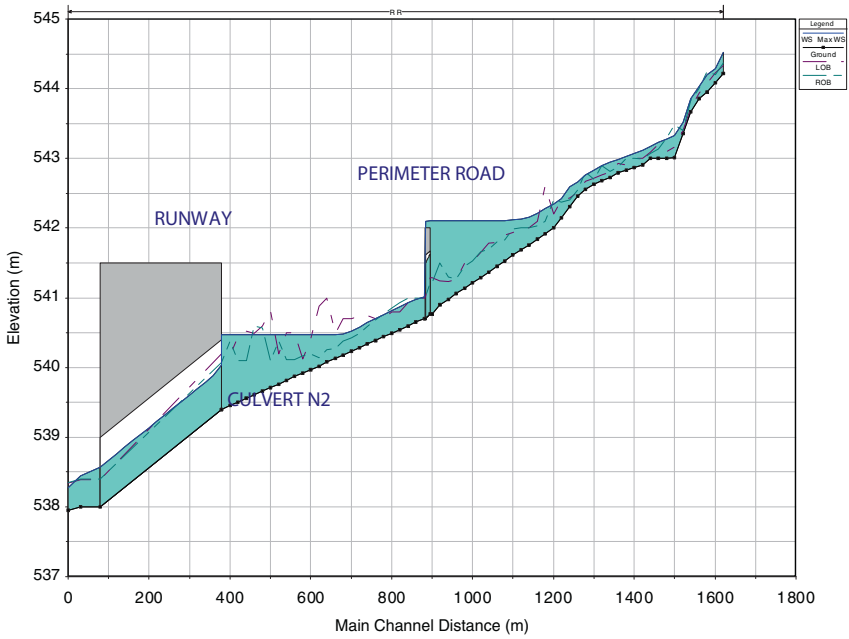

Figure 6. Longitudinal section and water surface profile

## 6. Risk Assessment

The conceptual framework of risk assessment is based on potential threats (flood damage) and direct damage caused by heavy rainfall. A flood damage caused by the heavy rainfall is a phenomenon of composite nature where the natural and social factors overlapped and the grade of the damage changes with the natural and social characteristics of the area. The main indicators of flood risk assessment (Zhang et al., 1998; Zhang et al., 2002) are presented in Table 6. The indicators have variety of units (money, houses, number of people). The theoretical foundation for indicator quantification is based on identifying and evaluating key factors related to the flood damage risk and their contribution to the flood damage. For each indicator there should be established an evaluation formula. For example, the vegetation index can be obtained as a ratio of vegetation cover (forest, grassland etc.) to total land area (%), and similar the population density can be defined as a ratio of total population to total land area (person/km<sup>2</sup>). The evaluation of flood damage index (FDI) is the most important. The larger value of FDI is, the severer loss extent of flood damage caused by heavy rainfall is. This index includes persons damaged number, houses damaged number and economic losses. In addition, the regression analysis of FDI and other factors should be carried out to find the concrete relationships between the respective factors related to the flood damage. Since there were no data on measured potential and direct damages it was not possible

TABLE 6. Risk assessment factors and indicators

Factor	Indicator
Potential danger of flood damage caused by heavy rainfall	Average precipitation
	Maximum rainfall duration/intensity
	Geographical index
	Soil index
	Vegetation index
	Maintenance index
State of flood damage caused by heavy rainfall	Flood damage index (FDI)
	Crop damage area
Change of flood damage caused by heavy rainfall	Heavy rainfall frequency
	Flood damage frequency
Socioeconomic development level of the area	Population density
	GDP per unit area
Resistance capacity against flood damage caused by heavy rainfall	Resistance damage index

to preformed the risk assessment analysis. Based on the presented case study analysis it might be recommended one more indicator as potential danger of flood damage that is “maintenance index” that can be obtained as a ratio of the fully operational length or number of structures in the storm sewer system to the length or number of structures that are out of maintenance.

## 7. Conclusions

The performed flood analysis is based on up-to-date topographic and ground survey data of the Prishtina airport area. The obtained design floods in the previous design are overestimated due to the use of not recommended methodologies. The overestimated flood flows imposed reconstruction and rehabilitation of the existing storm sewer system which include: (a) construction of additional culvert under the runway, (b) construction of pumping station and diversion of pumped water to Magure River, (c) diversion of the drain points D2 and D3 to Henc River. The proposed technical measures are not only high costly, but are not recommended in flood control and flood management of urban areas. Therefore, the achievements of the performed analysis presented in this paper can be summarized as it follows.

Analyzing the inflow and outflow hydrographs it is obvious that there is no significant delay of the peak flows, but there is significant peak flow reduction due to the retention capacity of the topographic area. The obtained results show that there is no need of reconstruction of the existing storm sewer system, and therefore no need of additional culvert construction under the runway. The existing system enables safety transfer of floods with greater probability  $Q_{25} = 17.49 \text{ m}^3/\text{s}$ . The question that arises is why flooding happened frequently? The answer is due to the absence of maintenance and monitoring. This conclusion is based on the site visit assessment: (a) the entire network of canals and culverts is completely out of maintenance, (b) the open canals along the regional road and the railway are filled with all kind of solid waste and are overgrown with middle and high vegetation, (c) some sections of the canals and culverts are completely filled with earth and disconnected from the system. The current state of the drainage system probably causes flooding of the area even at rather small storm event than the design one. Implementing maintenance will improve the operational ability of the system and will prevent operational failures.

Monitoring on hydrological and meteorological data is urgently needed. Hydrological data such as rainfall, stream flow, net radiation and snow are disturbed both temporally and spatially. In practice various ways have been used to transfer data from site to central database. For example, radio, satellite and wire communication may be used to collect rainfall and snow data. Apart from real physical data modeling output also has to be stored and archived.

Satellite images are another important tool. Proper collection and management of such huge amount of data should not be a trivial task.

## References

- alfa.i/CDM Int. Inc., (2006): Assessment of Prishtina Airport-Drainage Project, Project Report on Hydrological Analysis, Prishtina, Kosovo
- Evans, S. Y., Moore, D., Butcher, P., (2002): Flood Risk Mapping and Control of Development in Floodplains in UK, Proceeding of the Second International Symposium on Flood Defense, Volume I, pp. 171–178, Tsinghua University, Beijing, China
- Popovska, C., Ivanoski, D., Jovanovski, M., (2008): Prishtina Airport Drainage System – Hydrological and Hydraulic Analysis, Faculty of Civil Engineering, Skopje, Macedonia
- SCS-Soil Conservation Service, (1969): National Engineering Handbook, Section 4, Chapter 16, National Resources Conservation Service, Washington, USA
- Stanners, D., Bourdeau, Ph., (1995): Europe's Environment, European Environment Agency, Copenhagen, Denmark
- Zhang, J.Q., Hayakawa, S.J., Yamamoto, H.H., Suzuki, K.J., (1998): Assessment and Prediction of the Year of Disaster caused by Heavy Rainfall in Yamaguchi Prefecture, Tenki 45(10), pp. 773–779, Japan
- Zhang, J., Okada, N., Tatano, H., Hayakawa, S., (2002): Risk Assessment and Zoning of Flood Damage Caused by Heavy Rainfall in Yamaguchi Prefecture in Japan, Proceeding of the Second International Symposium on Flood Defense, Volume I, pp. 162–170, Tsinghua University, Beijing, China

# ECONOMIC AND TECHNICAL EFFICIENCY OF DRINKING WATER SYSTEMS: AN EMPIRICAL APPROACH FOR SPAIN

F. HERNANDEZ-SANCHO<sup>\*</sup>, S. DEL SAZ-SALAZAR  
*Department of Applied Economics II: Faculty of Economics*  
*University of Valencia. Campus dels Tarongers*  
*46022 Valencia, Spain*

R. SALA-GARRIDO  
*Department of Maths for Economics: Faculty of Economics.*  
*University of Valencia. Campus dels Tarongers.*  
*46022 Valencia, Spain*

**Abstract.** The objective of this paper is to analyze the efficiency of drinking water systems. Efficient performance, both in technical and economic terms guarantee minimum water losses in the network and reduced tariffs for the users. An analytical benchmarking methodology based on non-radial measures considering water losses as undesirable output gives us an efficiency indicator for each input used in the water supply process. These indicators, obtained by means of mathematical programming techniques, are used to rank suppliers' activity. The relation between the efficiency in the activity of the companies and the establishment of different tariffs is also analyzed. An empirical application is carry out for a sample of 91 municipalities into the Valencia Region in Spain. The results are very useful to the water suppliers and authorities in order to optimize the drinking water management in a geographical area.

**Keywords:** benchmarking methodology, technical efficiency, drinking water systems, DEA-Window Analysis

## 1. Introduction

Urban water demand, with different sides, has been the aim of study for many works in the literature. For example, we can see Arbués et al. (2003),

---

<sup>\*</sup> To whom correspondence should be addressed. F. Hernandez-Sancho, Department of Applied Economics II: Faculty of Economics, University of Valencia. Campus dels Tarongers. 46022 Valencia, Spain; e-mail: Francesc.Hernandez@uv.es

Bhattacharyya et al. (1995), Feigenbaum and Temples (1983), Garcia-Valiñas and Muñiz (2007), Ketler and Goulter (1985), Morgan and Goulter (1985), among others. Usually, the variables considered in the models to analyse domestic water use are the price, the power purchase, socio-economic factors related with the composition of the family unit and its way of life, the climatology and the own management of the supply firms.

In this context, one of the variables that has received the highest interest is the price. Also is emphasized the importance of water rates when promoting a rational use of water resources. In the same way, it is quite usual to consider that the price paid for the water consumed does not reflect its true value (Bartoszczuk and Nakamori, 2003). Following EU-Water Framework Directive, water pricing should aim at full-cost recovery, including environmental and resource costs.

The user's power purchase has also been used as a main factor of urban water demand. It is assumed that there is a positive relationship between income levels and water consumption, with an elasticity value below one.

From this array of variables affecting urban water consumption, we consider of special interest the role played by the supply firms. An efficient management from these firms including a good maintenance of the network and a minimum of water leaks, for example, will have a positive effect not only on a higher quality of the services provided but also on the setting of more favourable water rates. The previous measures will help to rationalize the consumption and saving of water as it is demanded in the different regulations related with this resource.

An important factor when assessing the efficiency in the urban supply of water is to consider the existence and extent of water leaks in the supply net. From the supply firms' point of view, these water leaks represent a fraction of the supply that cannot be sold and, therefore, does not generate revenues.

This possible relationship between the existence of water leaks and the setting of higher rates would be a clear example of inefficient management with evident detrimental effects on consumers. This situation should be avoided by the authorities involved through effective regulation measures. We do not have to forget, that following the EU-Water Framework Directive, the price should be used as an incentive to achieve an efficient use of water and never as a compensation mechanism for situations of inefficiency in the supply side.

In the context of the efficiency analysis, we consider water leaks as a non desirable output that is generated jointly with the supply of drinking water (desirable output) to the users in urban context.

The aim of this research is to analyse the efficiency in the management of a sample of water supply firms considering the existence of water leaks in the network. Once the respective efficiency indexes for each firm are known, we

analyse their possible relationship with the rates charged to the users. An empirical application is carried out for a sample of different municipalities located in Valencia region (Spain).

## 2. Methodology

The vast majority of the methodological approaches that assess the behaviour of producers in terms of productivity or efficiency, consider the output obtained in the production process considering only the desirable outputs and ignoring the undesirable outputs. The works by Pittman (1983) can be considered as pioneer in the treatment of non desirable outputs in this type of analysis. The referred author adapts the methodology of Caves et al. (1982a, b) introducing the non desirable outputs in the calculation of the productivity indexes. Since no market exists for them, he estimates their shadow prices.

In a parallel way, several authors considered to adapt the Farrell's (1957) efficiency measure with the aim of allowing the presence of non desirable outputs. In this case, is worth to mention, among others, the work by Färe et al. (1989). Is in this work where the methodological basis for the efficiency analysis in presence of non desirable outputs is established. Once the reference technology is characterised, these authors set out an optimization model with the aim of increasing the desirable outputs and reducing at the same time the non desirable ones. In this way a global efficiency index is obtained for each one of the production units considered under the presence of undesirable outputs.

Despite of this contribution, it's necessary to admit that assumes a similar behaviour, in terms of efficiency, for the set of inputs that take part in the production process. This fact implies a limitation factor in the analysis. It justified the development of a non radial measure that facilitates obtaining these specific efficiency indexes for each input with the aim of having a higher level of information. So using non radial measures we can know the efficiency level associated to each one of the inputs individually considered. In this way, obtaining specific indexes for each non desirable output turns out to be very relevant. Therefore, in this work we propose a methodology that allows us not only to separate the output vector between desirable and non desirable outputs, but also we can obtain efficiency indexes for each input or output considered in the process.

To carry out our methodological approach, let's assume a production process in which from an input vector  $x \in \mathfrak{R}_+^N$  we can obtain a vector of desirable outputs  $y \in \mathfrak{R}_+^M$  and another one of non desirable  $z \in \mathfrak{R}_+^H$  using the technology T in such a way that,

$$T = \{(x, y, z); x \text{ can produce } y, z\}$$

This T technology can be also expressed in an equivalent way from the point of view of the inputs, i.e.

$$(x, y, z) \in T \Leftrightarrow x \in L(y, z)$$

where,  $L(y, z)$  represents the set of input vectors  $x$  that allows to reach at least a vector of desirable outputs  $y$  along with another of non desirable ones  $z$ .

Let's start from  $k = 1, 2, \dots, K$  producers using each one an input vector  $x^k = (x_1^k, x_2^k, \dots, x_N^k)$  to carry out the joint production of a vector of desirable outputs  $y^k = (y_1^k, y_2^k, \dots, y_M^k)$  and another of non desirable ones  $z^k = (z_1^k, z_2^k, \dots, z_H^k)$ , being  $\lambda = (\lambda_1, \lambda_2, \dots, \lambda_K)$  a vector of intensity of variables. Following to Färe and Lovell (1978), for each firm  $k$  we can obtain the efficiency indexes associated to each one of the non desirable outputs considered solving the next optimization problem with linear programming (see Färe et al., 1994).

$$\begin{aligned}
 \text{Min } E &= \frac{1}{H} \sum_{h=1}^H \theta_h^{k'} \\
 \text{s.t. :} & \\
 \sum_{k=1}^K \lambda^k x^k &\leq x_n^{k'} \quad n = 1, \dots, N \\
 \sum_{k=1}^K \lambda^k y^k &\geq y_m^{k'} \quad m = 1, \dots, M \\
 \sum_{k=1}^K \lambda^k z^k &= \theta_h^{k'} z_h^{k'} \quad h = 1, \dots, H \\
 \lambda^k &\geq 0 \quad k = 1, \dots, K
 \end{aligned} \tag{1}$$

These models have been previously proposed in different works Cooper et al. (2007), being worth to highlight the compilation made by Zhou et al. (2008) in which several scenarios are considered under the methodology *Data Envelopment Analysis* (DEA) and using both constant returns (CRS) as varying returns (VRS). In the model used, we minimize the non desirable output considering a specific level of inputs and desirable output and using a non radial measure Rusell type.

### 3. Sample and Variables

A sample of 91 municipalities of the Valencia region (Spain) has been chosen. The data used correspond to two different years what allows us not only analysing the efficient behaviour of the supply firms in these years, but also their temporal evolution (see Table 1). The outputs considered are:



*Production volume*: represents the total production of water.

*Sales volume*: cubic meters of water sold to the users.

*Leaks*: is the difference between the production volume and the sales volume.

*Revenue level*: represents the revenue volume obtained by the supply firm. Its amount coincides with the global cost of the inputs since the full recovery costs principle is applied.

Regarding the inputs we have considered:

- Workforce cost
- Maintenance and preservation costs
- Water purchased or electricity consumed for pumping water
- Recovery costs (amortization) and canon (tax)
- Other costs

TABLE 1. Sample description

OUTPUTS (m <sup>3</sup> )	2001		2006		Variation % (2001–2006)
Production volume	263,574,235		210,332,527		–20.20
Billed volume	190,913,643		160,530,818		–15.91
Water leaks	72,660,592		49,801,709		–31.46
% Leaks	27.57		23.68		–14.11
Revenues (€)	105,599,993		154,792,024		46.58
INPUTS (€)	2001	%	2006	%	Variation % (2001–2006)
Personnel	33,113,962	31.36	39,603,088	25.58	19.60
Maintenance and preservation	14,065,459	13.32	14,210,988	9.18	1.03
Water purchased	25,326,358	23.98	46,342,754	29.94	82.98
Amortization	14,865,050	14.08	17,875,740	11.55	20.25
Other costs	18,229,163	17.26	36,759,455	23.75	101.65
TOTAL INPUTS	105,599,993	100	154,792,024	100	46.58

#### 4. Results

We consider that in each one of the 91 municipalities considered operates a firm supplying water that uses an input vector  $x^k = (x_1^k, x_2^k, \dots, x_5^k)_{(5 \times 1)}$  (production factors costs) to carry out the supply of an only desirable output  $y^k = (y_1^k)_{(1 \times 1)}$  (drinking water) and another undesirable output  $z^k = (z_1^k)_{(1 \times 1)}$  (water leaks). In

the case of the desirable output, it has been considered two different alternatives, one using the volume of supplied water and the other using the volume of revenues of the firm. From this information it is necessary to solve the next optimization problem for each municipality considered:

$$\begin{aligned}
 & \text{Min } E = \theta^{k'} \\
 & \text{s.t. :} \\
 & \sum_{k=1}^{91} \lambda^k x_n^k \leq x_n^{k'} \quad n = 1, \dots, 5 \\
 & \sum_{k=1}^{91} \lambda^k y^k \geq y^{k'} \\
 & \sum_{k=1}^{91} \lambda^k z^k = \theta^{k'} z^{k'} \\
 & \lambda^k \geq 0 \quad k = 1, \dots, 91
 \end{aligned} \tag{2}$$

This model is similar to (1) with only one undesirable output. The results obtained show a little change on the average value of efficiency between the 2 years considered, taking account the volume of water supplied as a desirable output. When the volume of revenues is used as a desirable output, the behaviour observed is very similar since the average efficiency index is 0.7604 in 2001 and 0.7561 in 2006 (see Table 2).

TABLE 2. Efficiency average values according to the non desirable output considered

Year	Average efficiency index (All the sample)	
	Desirable output: production volume (m <sup>3</sup> )	Desirable output: revenues volume (€)
2001	0.5498	0.7604
2006	0.5401	0.7561

In general, the efficiency indexes obtained are considerably low especially when the volume of water supplied is used as a desirable output. We can say that the possibilities of improving the network and, therefore, of reducing the water leaks are very high. The fact that the efficiency values improve considerably when the volume of revenues is used as an output, suggests the need of analyzing the rates charged to the users and extending the analysis also to the behaviour of the supply firms.

We propose to analyze the efficient behaviour of the firms that supply the different municipalities gathered in our sample with the main aim of identifying the possible existence of ties with the rates charged to the users.

In Table 3 are shown the general characteristics of the supply firms belonging to the sample. The most important companies are nine and the rest are grouped under the name *others*.

TABLE 3. Descriptive data of supply firms

Firms	Number of users		Volume sold (m <sup>3</sup> )		Volume sold per user	
	2001	2006	2001	2006	2001	2006
1	510,826	53,107	92,799,817	7,171,436	181.67	135.04
2	186,443	206,633	26,415,137	27,649,133	141.68	133.81
3	110,019	135,417	13,418,045	15,710,871	121.96	116.02
4	7,358	70,203	754,763	7,349,906	102.58	104.70
5	23,674	51,701	3,916,778	6,391,308	165.45	123.62
6	–	420,130	–	47,450,000	–	112.94
7	80,537	89,104	9,786,325	10,201,073	121.51	114.49
8	53,554	32,842	7,071,365	3,992,863	132.04	121.58
9	16,765	20,899	2,397,411	2,499,874	143.00	119.62
Others	272,224	272,948	34,354,002	32,114,354	126.20	117.66
TOTAL	1,261,400	1,352,984	190,913,643	160,530,818	151.35	118.65

Using the efficiency indexes obtained previously for each municipality, and knowing the supply firm located at each municipality, we are going to construct an efficiency index for each firm as a mean of the municipality indexes. Since the desirable output can be considered in two different ways (revenues or volume of water supplied) we, in fact, could obtain two efficiency indexes for each supplier firm. These results are shown in Table 4.

TABLE 4. Efficiency indexes by supply firm

FIRM	2001			2006		
	IEFFIC. I (Prod. V)	IEFIC. I (Reven. V)	DIFFER.	EFFIC. I (Prod. V)	EFFIC. I (Reven. V)	DIFFER.
1	0.4809	0.7501	0.2692	0.5977	0.6537	0.0560
2	0.5565	0.4369	-0.1195	0.1730	0.2531	0.0801
3	0.5417	0.7670	0.2254	0.5128	0.6956	0.1827
4	0.2294	1.0000	0.7706	0.3504	0.9427	0.5923
5	0.6026	0.8340	0.2315	0.6075	0.7526	0.1451
6	–	–	–	0.1034	1.0000	0.8966
7	0.5476	0.7237	0.1761	0.5354	0.9085	0.3731
8	0.5950	0.8566	0.2617	0.8385	0.8235	-0.0150
9	0.5782	0.6732	0.0950	0.3461	0.5876	0.2415
Others	0.5504	0.7726	0.2222	0.5660	0.7776	0.2116
Mean	0.5202	0.7571	0.2369	0.4631	0.7395	0.2764

In general we can say that all the firms show an improvement in the efficiency levels when the revenues variable is considered as a desirable output (except the firm number 2 in 2001 and the firm number 8 in 2006). Besides, this positive difference in the efficiency levels is more significant in 2006 than in 2001 (0.2764 against 0.2369). This fact reveals a leading role of prices when assessing the higher or lower efficiency of a supplier firm.

When trying to find a possible relationship between the efficiency of the supply firm and the prices charged to the users, it is very important to know the tariffs applied by each firm as well as its evolution.

First, it is necessary to highlight the increase, on average, found in the price charged by cubic meter between 2001 and 2006. More specifically, the rate has increased a 38.9%. In parallel, the average level of efficiency by firm has decreased about 11 points in the same period (see Table 5).

TABLE 5. Average rates by firm and changes in efficiency indexes

FIRM	Average rate (€/m <sup>3</sup> )		Change % (2001–2006)	
	2001	2006	Average rate	Efficiency index <sup>a</sup>
1	0.4056	0.6578	62.18	0.1168
2	0.9705	1.3090	34.89	-0.3835
3	0.6675	0.8443	26.49	-0.0288
4	0.8589	0.8595	0.07	0.1210
5	0.4188	0.6467	54.41	0.0049
6	–	1.1248	–	–
7	0.4434	0.5893	32.91	-0.0122
8	0.4648	0.6468	39.14	0.2435
9	0.4157	0.6707	61.35	-0.2321
Others	0.6537	0.8259	26.34	0.0156
Mean	0.5888	0.8175	38.85	-0.1098

<sup>a</sup>Considering as desirable output the amount of water produced.

Summing up, the notable increase, on average, in the rates during the period 2001–2006 in the 91 municipalities analysed, do not have had a positive effect in the efficiency of supply services in terms of reduction of water leaks in the network, and therefore, a saving of water. The fact that the items “Maintenance and Preservation” have lost more than 4 percentage points in the costs structure during the period 2001–2006 (see Table 1) seems to confirm the result found.

## 5. Conclusions

In the frame of efficiency analysis, we consider water leaks from the network as an undesirable output that is produced in parallel with the supply of drinking

water to urban users. In this study we analyse the efficiency in the management of this resource for a sample of supply firms considering the presence of water leaks. Once the different efficiency indexes have been obtained for each firm, we analyze its possible relationship with the rates charged to the users. The methodology used is based in the models known as *Data Envelopment Analysis (DEA)* in presence of undesirable outputs. In general, our findings suggest that the possibilities of improving the network, and therefore, reducing the water leaks are very high. The fact that the efficiency indexes improve considerably when firms' revenues are used as a desirable output makes us think about the possible influence of rates, and the own behaviour of the supply firms, on efficiency. Our results verify that the notable increase experienced by the rates during the period 2001–2006 in the 91 municipalities considered, has not implied an improvement in the efficiency of the service.

### Acknowledgement

The authors thank the statistical help from the *Generalitat Valenciana* and the financial assistance obtained from the *NOVEDAR Project (CSD2007-00055)*.

### References

- Arbués, F., García-Valiñas, M.A. and Martínez-Espiñeira, R. (2003): "Estimation of residential water demand: a state-of-the-art review", *Journal of Socio-Economics*, 32, 81–102.
- Bartoszczuk, P. and Nakamori, Y. (2003): *Modeling Sustainable Water Prices*, In M Quaddus and A Siddique (Eds): *Handbook of Sustainable Development Planning: Studies in Modelling and Decision Support*, Edward Elgar, Cheltenham, UK/Northampton, MA, USA.
- Bhattacharyya, A., Harris, T.R., Narayanan, R. and Ralfee, K. (1995): Specification and estimation to the effect of ownership on the economic efficiency of the water utilities. *Regional Science and Urban Economics*. 27(6), 759–784.
- Caves, D.W., Christensen, L.R. and Diewert, W.E. (1982a): "Multilateral Comparisons of Output, Input, and Productivity Using Superlative Index Numbers", *Economic Journal* 92(365), 73–86.
- Caves, D.W., Christensen, L.R. and Diewert, W.E. (1982b): "The Economic Theory of Index Numbers and the Measurement of Input, Output and Productivity", *Econometrica* 50(6), 1393–1414.
- Cooper, W.W., Seiford, L.M. and Tone, K. (2007): *Data Envelopment Analysis*. Springer, New York.
- Färe, R. and Lovell, C.A.K. (1978): "Measuring the Technical Efficiency of Production" *Journal of Economic Theory* 19, 150–162.
- Färe, R., Grosskopf, S., Lovell, C.A.K. and Pasurka, C. (1989): "Multilateral Productivity Comparisons when some Outputs are Undesirable: A Nonparametric Approach", *The Review of Economics and Statistics*, 71, 90–98.

- Färe, R., Grosskopf, S. and Lovell, C.A.K. (1994): *Production Frontiers*. Cambridge University Press. New York.
- Farrell, M. (1957): "The Measurement of Productive Efficiency". *Journal of the Royal Statistics Society. Series A*, 120(3), 253–282.
- Feigenbaum, S. and Temples, R. (1983): "Public Versus Private Water: A Hedonic cost approach". *The Review of Economics and Statistics*, 65, 672–676.
- García-Valiñas, M.A. and Muñoz, M.A. (2007): "Is DEA useful in the regulation of water utilities?" *Applied Economics*, 39(2), 245–252.
- Ketler, A.J. and Goulter, I.C. (1985): "Analysis of pipe breakage in urban distribution networks". *Canadian Journal of Civil Engineering*, 12(2), 286–293.
- Morgan, D.R. and Goulter, I.C. (1985): "Optimal urban water distribution design". *Water Resources Research*, 21(5), 642–652.
- Pittman, R.W. (1983): "Multilateral Productivity Comparisons with Undesirable Outputs". *Economic Journal*, 93(372), 883–891.
- Zhou, P., Ang, B.W. and Poh, K.L. (2008): "Measuring environmental performance under different environmental DEA technologies". *Energy Economics*, 30, 1–14.

# OCCURRENCE AND CONSEQUENCES OF DISINFECTION BY-PRODUCTS IN DRINKING WATERS AS RELATED TO WATER SHORTAGE PROBLEMS IN ISTANBUL METROPOLITAN CITY

MIRAY BEKBOLET\*

*Boğaziçi University, Institute of Environmental Sciences, 34342,  
Bebek, Istanbul, Turkey*

**Abstract.** As expected for the majority of South Europe countries, Turkey would also face serious problems related to water shortage conditions particularly for drinking water. Istanbul is one of the mega cities of the world with a population of 13 million. Considering both European and Asian sides, average water demand is  $3 \times 10^6$  m<sup>3</sup>/day. Existing raw water sources display quite different characteristics in relation to raw water quality. Besides basic parameters set by the local as well as the international standards, daily monitoring of pesticides, taste and odor compounds, bromide and bromate levels also followed for all of the finished water samples before being introduced to the distribution system. Considering the major concern as disinfection by-products (DBPs) among all of the chlorinated by-products trihalomethanes (THMs) constitute the main group of interest. The major surrogate parameter of DBPs is mainly the natural organic matter (NOM) content of water either expressed as total organic carbon (TOC) or dissolved organic carbon (DOC). Therefore the control of DBPs primarily relies on the efficiency of DOC removal from drinking waters through the application of conventional treatment methods as well as by the use of disinfection alternatives such as ozonation, chlorine dioxide or UV-irradiation. Preoxidation either by prechlorination or by preozonation is applied to surface water sources of Istanbul. Following a conventional treatment scheme, post chlorination is applied as a final step in all of the treatment plants. Therefore existence of chlorinated DBPs as well as the other DBPs in drinking waters could possibly pose a public health risk. However, as monitored by the local authorities the THM levels are reported to be well below 100 µg/L. Water shortage and drought conditions lead to adverse changes in

---

\* To whom correspondence should be addressed. Prof. Miray Bekbolet, Bogazici University, Institute of Environmental Sciences, 34342, Bebek, Istanbul, Turkey; e-mail: bekbolet@boun.edu.tr

water quality parameters mainly in terms of NOM characteristics. The major consequence of the diverse conditions related to the occurrence and distribution of allochthonous and autochthonous organic matter contents would be observed in the process efficiencies as well as on the DBPs formed via the action of oxidizing agents. This paper addresses the occurrence and consequences of disinfection byproducts in drinking waters as related to the water shortage problems in Istanbul Metropolitan City. Detailed information would be presented regarding the speciation and characteristics of NOM, removal efficiencies, application of conventional and novel treatment schemes in relation to the formation of DBPs and THMs.

**Keywords:** Disinfection byproducts, natural organic matter, Istanbul

## 1. Introduction

Dissolved organic matter (DOM) in natural waters is regarded as one of the most dynamic reservoirs of organic carbon the amount of which is considered to be equal to the CO<sub>2</sub> content of the atmosphere. Considering the importance of DOM in relation to the global carbon and water cycles, growing attention has been paid upon the transportation and transformation of organic carbon within the compartments of the ecosystems. The chemical characteristics and concentration of natural organic matter (NOM) in raw fresh water sources has been demonstrated to change throughout the year, normally reflecting a change in seasonal climatic conditions. NOM increase could be observed mainly resulting from heavy rains after a dry season or spring snow melts in relation to sunlight and temperature conditions. Surface runoff is known to be a significant contributor to variations in NOM concentration and composition as runoff transports allochthonous NOM in surface waters. On the other hand, flood events are particularly important leading to leaching of dissolved organic carbon from upper soil horizons and high fluxes of particulate organic carbon. Autochthonous NOM production primarily changes in relation to the seasonal changes in temperature and sunlight. Drinking water reservoirs could also suffer from eutrophication due to introduction of nutrients in excessive amounts caused by non-point pollution sources such as agricultural area, residential areas, and even industrial complexes resulting in diverse NOM properties. Under dry seasonal circumstances namely drought conditions, water quality of the drinking water sources could be deteriorated by the low level of precipitation or due to excessive evaporation.



NOM is omni present in terrestrial and aquatic ecosystems as well as in marine environments. NOM is essentially an assemblage of heterogeneous mixture of structurally complex compounds composed of nonidentical poly-functional molecules containing diverse ligand types. The main function of NOM in natural systems is its contribution to the photochemical and photo-biological processes. NOM is the source of reactive oxygen species (ROS); via sensitization  $^3\text{NOM}^*$ ,  $^1\text{O}_2^*$ ,  $\cdot\text{OH}$ ,  $\cdot\text{OOR}$ ,  $\cdot\text{OOH}$ ,  $\cdot\text{CO}_3^-$  and  $e^-_{\text{aq}}$  are formed by solar radiation in fresh waters. NOM can be isolated and fractionated into subgroups from water sources in relation to its polarity property as hydrophobic fractions and hydrophilic fractions. Hydrophobic fractions constitute the humic substances (HS) that are mainly composed of humic acids (HA, acid insoluble) fulvic acids (FA, soluble under all pH conditions) and humin fraction (acid and base insoluble). Hydrophilic fractions comprise low molecular weight carbohydrates, proteins and amino acids. NOM can be also fractionated into two main subgroups according to molecular weight (MW), molecular structures and charge density (CD) properties; aquatic humic substances, MW:  $\cong 500\text{--}5,000$  Da and CD (meq/g DOC): a few tenths to a few meq/g, and microbial debris, MW:  $>10,000$  Da and CD (meq/g DOC):  $<0.1$  meq/g. These properties have confounded effect on process efficiencies during drinking water treatment, e.g. coagulation. Although humic substances are regarded as non-toxic these substances should be removed since they are the main precursors of disinfection by-products (DBPs).

Significance of humic substances to water quality in relation to drinking water treatment (DW) could be explained by the following factors; (i) contributions to the olfactory/sensory properties of water as color, taste and odor, (ii) interference with water treatment by a probable increase in the coagulant demand thereby coagulant residuals, reducing the efficiency of membrane microfiltration and irreversible fouling, (iii) precursors of DBPs mainly trihalo-methanes (THMs) and haloacetic acids (HAAs) other haloorganic/other DBPs that are formed by chlorination of the drinking water for disinfection purposes, (iv) their act as corrosion promoters in distribution systems, (v) bacterial regrowth in the distribution system.

## 2. Drinking Water Treatment and Disinfection By-Products Control

Generally, NOM related studies were focused on two aspects; its relationship to formation of DBPs and control prior to disinfection process of drinking water. Realization an effective removal of NOM constitutes the major challenge in drinking water treatment (DWT) plants. Production of potable water from surface water sources is the primary goal of DWT plants due to many factors. The efficiency of NOM removal mainly depends on its characteristics and

composition. Therefore catchment area information is very crucial for proper water management. Moreover, during recent years, water utilities had to face operational difficulties due to the rapid influxes of organic material at certain times of year, depending on the level of excessive precipitation.

As a consequence of more strict regulatory requirements for DBPs in drinking waters and uncontrolled deterioration in water sources, many NOM laden waters have become more difficult to treat using traditional coagulation means in order to comply with current legislations (Eikkebrokk et al., 2004). Alternative and additional treatment stages have been researched and implemented at full scale (Parsons et al., 2007). Recent trends address to the removal of NOM including HS by providing additional unit processes, such as granular activated carbon (GAC), nanofiltration (NF), ozonation or ion exchange.

The most important step in DWT train is the final disinfection step that is applied in order to provide safe drinking water to the consumers in compliance to the public health criteria. In order to guarantee the effectiveness of disinfection, a minimum concentration of  $0.2 \text{ mg L}^{-1}$  of free residual chlorine is recommended. Depending on the size of the distribution system, the safety approach by maintaining a certain amount of residual disinfectant could be difficult to attain.

DBPs are generally classified as halogen substitution by-products (e.g. THMs and/or HAAs) and oxidation by-products e.g. bromate ( $\text{BrO}_3^-$ ). Chlorination DBPs are mainly trihalomethanes, haloacetic acids, haloacetonitriles, chloral hydrate, cyanogen chloride and others. Ozonation DBPs are lower molecular weight, aldehydes, aldoketoacids, carboxylic acids and assimilable organic carbon. DBPs formation could be modeled by the use of raw water models as multiple parameter power functions;  $\text{THMs/HAAs} = k(\text{DOC})^a(\text{Br}^-)^b(\text{T})^c(\text{Cl}_2)^d(\text{pH})^e(t)^f$ , where independent variables are DOC,  $\text{Br}^-$ , temperature (T), chlorine dose ( $\text{Cl}_2$ ), pH and time (t) and k, a, b, c, d, e, f are empirical constants. Since SUVA is organic carbon normalized  $\text{UV}_{254}$ , higher SUVA values reflects as higher DBP formation and TCAA/THM ratio correlates well with SUVA. The presence of algae/algal biomass and their extracellular products (EOM) increase DBP formations in terms of haloacetonitriles through the reactions with amino acids. Application of such raw water models could provide information on the possibility of formation of DBPs in the finished waters subjected to human consumption.

Total THMs were regulated as  $460 \text{ }\mu\text{g L}^{-1}$  by WHO,  $80 \text{ }\mu\text{g L}^{-1}$  by EPA and  $100 \text{ }\mu\text{g L}^{-1}$  by EC however no limit has been set by Turkish Standards. No standard has been set by EU for HAAs. Maximum contaminant level MCL of  $0.06 \text{ mg L}^{-1}$  for the sum of five HAAs (MCAA, DCAA, TCAA, MBAA and DBAA) (EC, 1998, WHO, 1999, USEPA, 2002). Epidemiological studies have

associated the consumption of chlorinated drinking water and cancers of the digestive and urinary tracts and early term miscarriage was reported for a level of  $>75 \mu\text{gL}^{-1}$  THMs.

### 3. Drinking Water Reservoirs and Water Plants of Istanbul

Istanbul drinking water reservoirs are located on both sides of Bosphorus, the main strait dividing the city of Istanbul also to two continents. DW reservoirs on the Asian Side are Omerli, Darlik and Elmali. Omerli water reservoir is the largest of all with an active volume of  $10^6 \text{ m}^3$  providing water to both sides of Bosphorus. DW reservoirs on the European Side are mainly Buyukcekmece, Terkos, and Alibeykoy. Buyukcekmece water reservoir could be considered as important due to the specific location and connection to the Marmara Sea. Seawater intrusion results in elevated  $\text{Br}^-$  levels leading to probable formation of brominated DBPs via the application of pre and post chlorination.

Water quality parameters are strictly controlled and reported by the local authorities (ISKI, 2008). The results are reported monthly in accordance with the EC, USEPA, WHO and TSE standards. Water quality parameters could be classified into four groups outlined as follows:

*Physical Parameters* (Turbidity), *Primary Parameters*: (i) microbiological parameters (Total coliform), (ii) disinfection by-products (TTHMs,  $\text{BrO}_3^-$ ), (iii) inorganic parameters; anions ( $\text{NO}_3^-$ ,  $\text{Br}^-$ ,  $\text{F}^-$ ) and metals (Al, As, Ba, Cd,  $\text{Cr}_{\text{tot}}$ , Pb, Hg, Se, Ag, Sb, Be), (iv) radiological parameters (Gross alfa, Gross beta), *Secondary Parameters*: (i) physical parameters (pH, total dissolved solids) (ii) aesthetic parameters (Color, odorous compounds, Geosmin, MIB), (iii) inorganic parameters; anions ( $\text{Cl}^-$ ,  $\text{SO}_4^{2-}$ ) and metals (Cu, Fe, Mn Zn), *Other parameters* (Hardness, Ca, Mg, K, Na, free chlorine and  $\text{NH}_4^+$ ). However, the surrogate parameters for the formation of DBPs mainly THMs as  $\text{UV}_{254}$  and TOC/DOC are not reported.

### 4. Case Study: Drinking Water Samples and Treatment Scenarios in Relation DBPs Formation Potentials

A comparative study is performed aiming to illustrate the effectiveness of various conventional and novel treatment schemes on the formation of disinfection by-products. Selected water samples are taken from three major drinking water reservoirs representing diverse chemical properties (Table 1).

TABLE 1. Source water characteristics

	Buyukcekmece	Omerli	Elmali
Alkalinity, mg CaCO <sub>3</sub> L <sup>-1</sup>	133	60	70
pH	7.6	7.2	7.7
Turbidity, NTU	3.2	2.8	3.0
Bromide, mg L <sup>-1</sup>	284	94	85
DOC, mg L <sup>-1</sup>	3.98	3.78	5.29
UV <sub>254</sub> , m <sup>-1</sup>	9.4	10.7	22.5
SUVA <sub>254</sub> , m <sup>-1</sup> mg <sup>-1</sup> L	2.14	2.83	4.04

The water quality of Elmali reservoir is already deteriorated both in terms of land and water resources as reflected to its high DOC, UV<sub>254</sub> and color values compared to the other reservoirs of Istanbul. Omerli water reservoir is considered as one of the cleanest water sources whereas Buyukcekmece reservoir displays the risk of high bromide contents.

UV-vis spectra of the water samples exhibited a general trend of decreasing absorbance with respect to the increasing wavelength. UV-vis parameters revealed quite low values in comparison to the humic and fulvic acids. According to the emission scan spectra of the samples, fluorescence spectroscopic properties displayed a maximum fluorescence intensity at 450 nm, being almost the same for Omerli and Buyukcekmece water samples and a quite high value for Elmali water. Spectroscopic profiles display the chemical characteristics of the organic matter that could also be followed through the application of the below mentioned treatment schemes.

#### 4.1. TREATMENT SCHEMES

Following basic characterization analysis, the applied methodology consisted of a sequence of treatment procedures such as, ozonation, coagulation, photocatalytic oxidation and combined treatment schemes covering preozonation and coagulation as well as coagulation and photocatalysis (Bekbolet et al., 2005, Uyguner et al., 2007).

#### 4.2. EVALUATION OF NOM REMOVAL EFFICIENCIES BY THE APPLIED TREATMENT SCHEMES

Operational parameters of Istanbul Drinking Water Treatment Plants were reported as follows: Buyukcekmece water treatment plant: pre-chlorination, coagulation, sedimentation, sand filtration, and post-chlorination (applied Cl<sub>2</sub> dose: 4–7 mg L<sup>-1</sup>, coagulant dose: Alum, 25–50 mg L<sup>-1</sup>) and for Omerli and

Elmali water treatment plants: pre-ozonation, coagulation, sedimentation, sand filtration, and post-chlorination (applied  $\text{Cl}_2$  dose: 3–5  $\text{mg L}^{-1}$  for Omerli and, 3–7  $\text{mg L}^{-1}$  for Elmali, coagulant dose range for ferric chloride was 20–40  $\text{mg L}^{-1}$ . Considering these conditions, ozonation was applied as a preozonation step and photocatalysis was applied as a non-selective oxidation system.

#### 4.2.1. *Effect of Preozonation*

Preozonation affected the removal percentages of  $\text{UV}_{254}$  and DOC ranging from 49% to 54% and 16% to 29% respectively, expressing the highest removal for Elmali water sample for both of the specified parameters.

#### 4.2.2. *Effect of Photocatalytic Oxidation*

Photocatalytic oxidation was applied for 45 min, 30 min and 30 min for Buyukcekmece, Omerli and Elmali, respectively. Under the specified conditions, approximately 52%, 57% and 60% removals were achieved in terms of  $\text{UV}_{254}$ . On the other hand, DOC removal percentages were ordered as Elmali (21%) < Omerli (25%) < Buyukcekmece (38%). The kinetic rate constants for DOC removal indicated comparatively slower degradation efficiencies compared to  $\text{UV}_{254}$  removals (>40%) (Uyguner et al., 2007.)

#### 4.2.3. *Effect of Enhanced Coagulation*

No significant difference was observed in  $\text{UV}_{254}$  removal efficiencies between the samples of Elmali and Omerli but slightly lower removal efficiency for Buyukcekmece sample after enhanced coagulation either with ferric chloride or alum was attained. Application of Fe/Al based coagulants displayed quite similar reactivities towards the organic matter contents of water samples. Buyukcekmece water sample was better removed by alum both in terms of  $\text{UV}_{254}$  and DOM.  $\text{UV}_{254}$  removal efficiencies were found to be greater than DOC removal efficiencies irrespective of the coagulant type and source water.

#### 4.2.4. *Effect of the Combined Systems*

In the case of preozonation prior to enhanced coagulation relatively higher removal efficiencies were attained in terms of both  $\text{UV}_{254}$  and DOC compared to ozonation or enhanced coagulation alone. On the other hand, application of enhanced coagulation followed by photocatalysis revealed distinctly different results in terms of DOC for Elmali water sample in comparison to Buyukcekmece and Omerli water samples.

#### 4.3. EVALUATION OF NOM REMOVAL CHARACTERISTICS IN RELATION TO TREATMENT SCHEMES AND DBPS FORMATION

Since ozonation leads to major alterations in the structure of NOM, through the oxidative cleavage of larger molecular size fractions, significant changes are expected in the spectroscopic features of NOM as observed by UV-vis and fluorescence spectroscopic properties. Selective oxidation via ozonation could also result in an increase in polarity due to the formation of acidic functional groups. Therefore; ozonated NOM structure displays alterations in surface charge, molecular structure and hydrophobicity.

Water treatment using coagulation is a well established process worldwide. Coagulation effectively removes natural organic matter (NOM), particulate matter and microbiological matter. The removal of organic matter is best affected by the addition of trivalent Fe/Al salts which hydrolyses in water and form hydroxocomplexes. The presence of metals (Fe or Al) displays undesired consequences such as presence metal residuals in drinking water and production of a significant amount of sludge. NOM composition displays the major important parameter in coagulation efficiency.

As a special treatment method, photocatalysis was also applied to achieve non selective oxidation of the organic matter content of the water samples. Considering coagulation preferentially removes hydrophobic fraction of NOM, the reactivity of the remaining recalcitrant NOM fractions towards hydroxyl radical attack, would possibly affect the DBPs speciation in the finished waters.

Nature of halogen attack sites could be assessed via the DBPs formation potential of the resultant NOM moieties. Inefficient NOM removal can also lead to the formation of potentially carcinogenic DBPs such as THMs and HAAs. Higher yields of DBPs formation is expected via chlorination of the raw water samples, expressing decreasing trend after ozonation or coagulation. On the other hand preozonated water samples would display different DBPs through the reaction of ozonation followed by chlorination.

The total THMs of water samples were found to be significantly higher with respect to the limits set by USEPA, WHO and EC. Chloroform constitutes the major THM formed under all conditions irrespective of the treatment scheme and source.  $\text{CHBrCl}_2$  and  $\text{CHBr}_2\text{Cl}$  were found to be significantly greater in Buyukcekmece water sample than Omerli and Elmali water samples irrespective of the treatment scheme.  $\text{CHBr}_3$  formation was significantly higher in Buyukcekmece water sample due to the presence of excessive amounts of  $\text{Br}^-$ . Individual THMs distribution with respect to the sources displayed the importance of the presence of bromide in the water matrix. Ratio of  $\text{Br}^-$  to the average free available chlorine controls bromine substitution in relation to a general trend as higher the ratio higher the content of brominated THMs even DBPs as observed for Buyukcekmece water sample. HAAs were selected as

monochloroacetic acid, dichloroacetic acid, trichloroacetic acid and bromochloroacetic (BCAA) acid. BCAA was not detected for Buyukcekmece water sample under all conditions whereas upon the application of photocatalysis, either alone or in combination with coagulation the presence of BCAA in Omerli and Elmali water samples was evident. In general, significant variations in HAAs formation were observed both between the samples and treatment schemes.

## 5. Conclusive Remarks

The applied treatment schemes and the profiles of DBPs mainly THMs and HAAs indicate that the formation and speciation of DBPs mostly depend on the source water characteristics both in terms of NOM and water matrix. Reactivities of the source related NOM moieties towards both the successive introduction of the treatment chemicals as well as the oxidizing agents should be assessed in terms of informative surrogate indices derived through the application of the analytical methods.

Long term temporal changes could be monitored for better elucidation of NOM speciation, concentration and properties revealing possibility to demonstrate the significant changes in NOM. Linkages to the precipitation and snow melt events, or drought conditions could be assessed through the evaluation of surrogate parameters of NOM as content of DOC or specific UV absorption ( $UV_{254}/DOC$ ).

Changes in land management, such as the disturbance of peat or vegetation damage can lead to increased decomposition and the production of loosely bound organic material. Alterations in catchment area management and the respective anthropogenic impacts on waters could lead to drastic changes in NOM contents of surface waters. Speciation and chemical properties of NOM could be changed resulting in diverse reactivities towards the applied treatment processes. Understanding of the linkages between C, N and water cycles in terrestrial and inland aquatic systems and the factors driving the human activities that impact vegetation distribution and water quality would bring valuable information about NOM.

## References

- Bekbolet, M., Uyguner, C.S., Sencuk, H., Rizzo, L., Nikolaou, A.D., Meric, S., Belgiorno, V., 2005 Application of oxidative removal of NOM to drinking water and formation of disinfection by-products, *Desalination*, **176**(1–3), 155–166.

- EC, European Union Drinking Water Directive, 1998 (14.03.2007); [http://europa.eu.int/eur-lex/pri/en/oj/dat/1998/l\\_330/l\\_33019981205en00320054.pdf](http://europa.eu.int/eur-lex/pri/en/oj/dat/1998/l_330/l_33019981205en00320054.pdf)
- Eikkebrokk, B., Vogt, R.D. and Liltved, H., 2004. NOM increase in Northern European Source Waters: discussion of possible causes and impacts on coagulation/contact filtration processes. *Wat. Sci. Technol.*, **4**(4): 47–54.
- ISKI (Istanbul Water and Sewerage Administration) (27.8.2008); [http://www.iski.gov.tr/Web/UserFiles/File/su\\_kalite\\_raporu/swf/sukalite\\_temmuz2008t.swf](http://www.iski.gov.tr/Web/UserFiles/File/su_kalite_raporu/swf/sukalite_temmuz2008t.swf)
- Parsons, S.A., Jefferson, B., Jarvis, P., Sharp, E., Dixon, D., Bolto, B. and Scales, P., 2007. Treatment of elevated content waters. AWWARF Report 2874.
- TS 266, İnsani tüketim amaçlı sular hakkında yönetmelik, *Türk Standartları*, Ankara, 2005.
- USEPA (US Environmental Protection Agency), Drinking water contaminants, 2002. (14.03.2007); <http://www.epa.gov/safewater/contaminants/index.html>
- Uyguner, C.S., Bekbolet, M. and Selcuk, H., 2007. A comparative approach to the application of a physico-chemical and advanced oxidation combined system to natural water samples, *Sep. Sci. Technol.*, **42**(7): 1405–1419.
- WHO (World Health Organization), Guidelines for drinking-water quality, 1999. (16.03.2007); [http://www.who.int/water\\_sanitation\\_health/dwq/gdwq0506.pdf](http://www.who.int/water_sanitation_health/dwq/gdwq0506.pdf)



# DRINKING WATER SYSTEM OF CHERNIVTSI: CURRENT CONDITION, VULNERABILITY ASSESSMENT AND POSSIBLE WAYS OF THREAT MITIGATION

IGOR WINKLER\* AND ALLA CHOBAN

*Yu. Fedkovich Chernivtsi National University, Chernivtsi, Ukraine*

**Abstract.** Water/sewage system is one of the key parts of the municipal economy. It is shown that current operation mode of the Chernivtsi (Ukraine) drinking water system is significantly overproductive. The system output is growing although total water usage is gradually decreasing. Main causes of this situation are identified and analyzed. It is also shown that such situation can potentially cause raise of the ground water level followed by the threat of ground shifts and weakening especially on the slopes. These processes can seriously damage pipelines and other municipal communications causing follow up depressurization and other secondary problems. Current condition and possible risks of the municipal water supply points functioning are also analyzed. Prospects of the gradual switching from current surface water supply to the underground water are discussed. Main problems related to the local wastewater treatment plant operation are also identified and analyzed and some steps to mitigate these problems are proposed.

**Keywords:** Municipal water supply system, analysis of effectiveness and vulnerability, risk analysis, advanced operation

## 1. Introduction

Water/sewage system is one of the key factors governing a policy of the city growing, development and improvement of its infrastructure. It is one of the vital factors ensuring comfort level of the city life. However, malfunctioning or

---

\* To whom correspondence should be addressed. Igor Winkler, Yu. Fedkovich Chernivtsi National University, Chernivtsi, Ukraine; e-mail: igorw@ukrpost.ua

incorrect management in this area can be potentially threatening and may cause negative economical, hygienic, ecological and other effects.

Stable level of the water production is reported for many Ukrainian cities on the background of serious worsening of the municipal water/sewage lines condition.<sup>1</sup> We reckon that serious reconstruction and rethinking of the development strategy is needful for many water/sewage companies in Ukraine now. Below we analyze these aspects for more than 100 years old water/sewage system of Chernivtsi.

## **2. Current Structure of the Drinking Water Consumption and Potential Threats of its Overproduction**

Current water selling in Chernivtsi is reported as 35,000–40,000 m<sup>3</sup>/day<sup>2</sup> with technological water usage and losses of 16,000–20,000 m<sup>3</sup>/day. However, total daily water supply is much higher and reaches 100,000 m<sup>3</sup>/day. This overproduction is constant throughout recent 15 years. Local water supplier doesn't pay attention to changes in the water consumption structure and keeps higher but needless level of the water production.

Many major industrial water consumers have been stopped or transformed since USSR collapsed. Some food processing and agricultural plants do not work or work at partial productive capacity. These consumers used to take up to 60% of the city water supply. Now their consumption is significantly lesser and water is mainly consumed by townspeople, municipal and social facilities and other small entities. Most individual subscribers use water counters, which also decreases amount of the water used. Approximate assessment of the water overproduction gives 40,000–50,000 m<sup>3</sup>/day, which makes up to 90 million cubic meters of excessive water pumped in the system during last 5 years.

This overproduction caused many negative effects. Ground water level has increased for about 2 m. At some spots ground water has reached house footing level, which endangers some buildings in the old historical part of Chernivtsi. New construction is almost impossible without previous intense drainage works.

High ground water level leads to other negative processes such as soils subsidence, slope sliding and worsening of the ground bearing reliability. All these processes also decrease security of the water pumping and transportation system and equipment, cause pipelines displacement and deformation, pipe coupling breaking, etc. Water supply usually interrupts for some night hours and untreated groundwater and even sewage water can be sucked inside the water pipes during such breaks.

On other hand, additional microbe contamination may occur in the stagnant water during such water supply breaks. Therefore, we can conclude that aged

and worn-out pipeline is the main problem of the municipal water supply system in Chernivtsi.

### 3. Possible Ways of the Water Supply Improvement

What steps can be proposed in order to eliminate the above mentioned negative effects and improve the situation?

First: Water supply should be decreased down to the actual level of consumption.

Second: We propose to equip local water supply system with a system of automatic water management and distribution (EPANET)<sup>3,4</sup> ensuring:

- Uniform pressure distribution along all waterlines
- Express diagnostics of the emergency pipe breaks areas
- Advanced distribution of the water supply to various parts of the system

This system would require installation of the electronic manometers and valves network with a computer central management post. Water supply distribution would ensure avoiding of the night water supply minimums – water pressure jumps, which provoke pipelines rupture.

Third: Water supply should be redistributed in order to take into account cross-country relief of Chernivtsi. Current water supply strategy relates to the ‘average’ altitude of the city which results in the water pressure over 6 bars at some lower areas. Advanced water supply system should keep this value below two bars along all pipelines. This step would require renovation and construction of some small local water-supply reservoirs equipped with automatic water boost pumps. This system would ensure avoiding numerous pipe damages by excessive water pressure.

Fourth: New high-duty cast iron pipes should also be used at any repair works or installation of new lines.<sup>5</sup> This material can provide required level of technological durability and ecological safety.

### 4. Current Water Quality and Its Improvement

Chernivtsi drinking water system is fed from both surface and ground water sources. About 70% of the water production is supplied from the surface water intake points located at rivers Dnestr and Prut. Surface water quality is rather insufficient and local water supply company has to use intense treatment trying to meet requirements towards drinking water quality.

First of all, water treatment technology deals with suspended solids, which should be coagulated and removed with  $\text{Al}_2(\text{SO}_4)_3$ -based reagent. Intense use of

this coagulant causes sometimes eight-times excessive concentration of  $\text{Al}^{3+}$  ions over its maximum permissible value (1.6 mg/l) in the municipal drinking water.<sup>6</sup> There are some other coagulating agents, which can ensure better water cleaning at lower coagulant concentration but local surface river water becomes more and more contaminated now. Concentration of oil-products, detergents, nitrates, pesticides, phenols and other pollutants is constantly rising in the water while classic water treatment technology can not ensure required level of its cleaning.

On other hand, Chernivtsi Water Supply Company still uses the cheapest but unsafe method of the chlorine water disinfection. Such water treatment can cause formation of new toxic and carcinogenic compounds from other pollutants.<sup>7,8</sup> Chlorinated hydrocarbons can form after water chlorination and these compounds in fact were identified in the drinking water samples.<sup>6</sup> Concentration of such chlorinated compounds two times exceeded the maximum permissible level. Current chloroform concentration was found at subthreshold level of 60  $\mu\text{g/l}$ ,<sup>9</sup> which is still unsafe at long exposition.

Therefore, we can conclude that most part of Chernivtsi drinking water has insufficient quality and can not meet required standards using present technology of the drinking water treatment and supply.

We propose to pay more attention to development of existing and construction of new ground water supply points. Quality of this water is much higher comparing to the surface river water and it does not require such intense and expensive treatment. Even simple UV-ray irradiation would provide required level of the ground water cleaning.

Current level of the ground water supply covers about 30% of the city needs. Further water supply can easily be covered by new underflow water supply point along riverbed of Prut. This step should also be accompanied by simultaneous lowering of the surface water supply from Dnestr. This water supply should mostly be oriented to the nighttime water pumping in order to use the lowest electricity price time. Amount of the Dnestr water should also be seriously lowered down to the level corresponding to actual drinking water realization. Senseless pumping of the river water to ground water layers of Chernivtsi can be eliminated and funds for new underflow water supply points construction can be released by this strategy.

## **5. Prospects of the Wastewater Treatment Plant Modernization**

Current condition of Chernivtsi municipal sewage water treatment plant also brings numerous risks. Rather significant part of the city is not connected to the city sewage system and untreated wastewater is discharged directly to small

urban rivers.<sup>10</sup> Cesspools are mostly in a poor condition, often overflowed, which also causes wastewater leakage towards small rivers of just in the ground.

Biotreatment equipment at the local wastewater treatment plant is in an unsatisfactory condition. Only one of four aeration basins is currently in operation. This four-chamber basin ensures daily treatment of 70,000 m<sup>3</sup>, which is absolutely insufficient for a 260,000 city. Many other types of important water treatment equipment are absent or out of operation: sediments dehydration system, hard coated areas for excessive active sludge storage equipped with water collection and recycling system, sand bunkers needed for sand catchers operation, etc.

Prospective raise of the wastewater treatment plant capacity up to 150,000 m<sup>3</sup>/day (and up to 200,000 m<sup>3</sup>/day at the second stage) was planned. This project supposed building of new aeration basins, sediment dehydration post, new areas for excessive sludge storage, chlorination plant and additional biotreatment plant. However, this project has not been realized.

Therefore, Chernivtsi wastewater treatment plant can provide required level of the water treatment only if the city population were about 40,000–60,000. Current population is much higher. This situation is even worsened by using of the traditional combined sewage system, which covers most part of the old city and collects wastewater together with rainwater. Local wastewater treatment plant can not meet periodical peak discharges of rainwater, which just overflows its equipment and runs in the river Prut together with wastewater and without any treatment.

Wastewater quality monitoring proved<sup>11</sup> unsatisfactory level of the treatment efficiency (see Table 1). Concentration of many pollutants in wastewater still exceeds the maximum permissible level even after the treatment. For example, concentration of Ammonium (salt) was found at 2.3 mg/l, which exceeds maximum permissible level. Full nitrification should keep this value below 1–2 mg/l. Bio-oxygen demand is eight times over the limit.

Everyday operation of the excessive active sludge storage areas also brings many ecological risks.<sup>12</sup> They were put into operation in 1970s but without any sludge compressing and dehydration equipment. Excessive sludge is being sent to the areas directly from primary and secondary settlers together with all the water collected. There is no any drainage system at the storage areas and this water can be eliminated only through slow evaporation. This operation mode caused fast expansion of the area required for storing the sludge. Previous storage area was 7.5 ha but currently this area has widened to 15 ha and new storage areas are still needed. New areas do not have any hard coating, just clay–sand surface, which can not prevent sludge water seepage to the pure groundwater layers. Moreover, the sludge storage areas are located aside discharge manifold and this seepage also causes secondary contamination of the sewage water after its treatment.

TABLE 1. Average values of some parameters of Chernivtsi wastewater after treatment

Parameter	Average value	Maximum permissible value
Bio-oxygen demand (full)	<b>22.6 ± 1.10</b>	3.0
Chemical oxygen demand	<b>31.1 ± 1.10</b>	15.0
Ammonium (salt)	<b>2.3 ± 0.09</b>	0.5
Nitrites	<b>0.4 ± 0.04</b>	0.08
Nitrates	17.0 ± 0.55	40.0
Phosphates	1.4 ± 0.04	1.7
Chlorides	156.0 ± 0.82	300.0
Sulfates	82.3 ± 1.81	100.0
Solid residue	432.3 ± 16.80	1,000
Suspended solids	15.7 ± 0.50	+0.25 over natural value

Therefore, we can conclude that the following renovation/reequipment measures are needed at Chernivtsi wastewater treatment plant:

- Reconstruction of all existing aeration basins and putting them into operation
- Building the sludge dehydration post
- Reconstruction of existing or building new waterproof sludge storage areas
- Finding solution for the sludge utilization through its conversion into humus products, building blocks components, etc.

## 6. Conclusion

Following risks have been identified in Chernivtsi water supply company functioning:

1. Drinking water overproduction of 50,000 m<sup>3</sup>/day.
2. Rising of the ground water level for about 2 m caused by drinking water ruptures and leakage.
3. Slope shifting, house footings deformation and water/sewage lines ruptures.
4. Outdated drinking water technologies and too poor quality of the surface water cause insufficient quality of the drinking water.
5. Low technological level and insufficient water treatment equipment do not ensure even minimal needful level of the waste water treatment and cause over-normative contamination of Prut water in the near-boundary region.

New ground water supply points should be built in order to meet drinking water quality challenges and cover all the city needs in drinking water. This

solution would also eliminate ground water rising problem and stop most slope shifting and deformation processes.

Very intense renovation is also required at the local wastewater treatment plant. Its capacity should be expanded to the level corresponding actual city population. Extra attention should be paid to excessive active sludge storage areas, which currently bring additional contamination to the groundwater, sewage water and require new and new ground areas.

New housing sewage lines should be designed and constructed separately from the rainwater collection lines in order to protect local wastewater treatment plant from the peak overloads during intense atmospheric precipitation, which are quite usual for that region.

## References

1. Semchuk G. *Human Health and Ecology. Air and Water Protection. Waste Utilization. Proceedings of 12 Int. Conf.* (Kharkiv, 2005), pp. 469–479 (In Ukrainian).
2. *Pricing Analysis for Centralized Water Supply in Chernivtsi* (Ukrainian National House in Chernivtsi, Chernivtsi, 2007) (In Ukrainian).
3. Trilovska M. and Kuzan M. *Proceedings of Int. Congress "Ecology, Technology and Economy of Water Supply and Sewage Systems"*. (Yalta, 2001), pp. 23–25 (In Ukrainian).
4. Walski T., Chase D., Savic D., Grayman W., Beckwith S. and Koelle E. *Advanced Water Distribution Modelling and Management*. (Bentley Institute Press, 2003).
5. Vasylenko S. and Kolotylo V. *Environment Ecology and Life Safety*. **2** 63–70 (2006) (In Russian).
6. *A Concept of Chernivtsi Water Supply*. (Alekt, Klagenfurt, 1998) (In Ukrainian).
7. Slavinskaya G. *Water Chemistry and Technology*. **13** 1013–1022 (1991) (In Russian).
8. Smagin V., Lukashev E and Kvitka L. *Water Chemistry and Technology*. **15** 37–46 (1993) (In Russian).
9. Danilyko T., Marshvsky V. and Turash M. *Young Scientists in Solving regional and Transboundary Ecological Problems. Proceedings of Int. Sci. Conf.* (Chernivtsi, 2006), pp. 300–303 (In Ukrainian).
10. Winkler I. *Dangerous Pollutants (Xenobiotics) in Urban Water Cycle*. (Springer, 2008), pp. 55–60.
11. Choban A. and Choban S. *Chernivtsi National Univ. Bulletin*. **270** (Chemistry) 113–118 (2005) (In Ukrainian).
12. Choban A. and Choban S. *Solid Wastes Storage Areas. Management and Ecological Problems. Proceedings of Sci. Conf.* (Kyiv, 2008), pp. 71–73.

# **WATER SAFETY PLANS IN DISASTER MANAGEMENT: APPROPRIATE RISK MANAGEMENT OF WATER, SANITATION AND HYGIENE IN THE CONTEXT OF RURAL AND PERI-URBAN COMMUNITIES IN LOW-INCOME COUNTRIES**

JAMES WEBSTER\*, JEN SMITH  
*Cranfield University, Bedfordshire, MK43 0AL. UK*

TIM SMITH  
*Hyder Consulting (UK) Limited, Birmingham, B6 5RQ. UK*

FRANCIS OKELLO  
*Tearfund, Teddington, Middlesex. TW11 8QE. UK*

**Abstract.** Water safety plans (WSPs) are promoted by the World Health Organisation (WHO) as the most effective method for ensuring safe drinking water. As a minimum, WSPs require of the drinking-water ‘supplier’ (1) a system assessment, (2) effective operational monitoring, and (3) management. Whilst WSPs are currently being developed and implemented throughout the high- and middle-income world they are only just being introduced in low-income countries. Developing WSPs in the context of disasters in rural and peri-urban areas of low-income countries presents particular challenges. This paper outlines some of these challenges.

**Keywords:** Water Safety Plans, disaster management, low-income countries, drinking water, relief, emergency, conflict, sanitation

## **1. Introduction**

The origins of Water Safety Plans (WSPs) can be traced back to 1854, when, during a hot summer in London, people drank cold water rather than boiling it for tea, as was the norm. A cholera outbreak resulted, killing 89 people within a

---

\* To whom correspondence should be addressed. Dr. James Webster, Lecturer Community Water & Sanitation, Centre for Water Science, Building 39, Cranfield University, Bedfordshire, MK43 0AL. UK; e-mail: r.j.webster@cranfield.ac.uk



few days. Dr. John Snow analysed the fatalities and discovered that all but ten lived closest to and collected their water from the Broad Street pump. He had the handle removed: immediately cases of cholera reduced. As a result, the UK improved drinking water treatment.

However, in the mid-1990s, cholera outbreaks were still occurring in affluent countries – for example, in 1992 there were 100 deaths in the USA.

A fundamental question needed answering: when the links between water quality and health were understood and the right technology was available to ensure safe drinking water, why were such problems still occurring?

## 2. The Swiss Cheese Model and Water Safety Plans

The answer came through consideration of risk analysis and risk management models such as the Swiss Cheese model (Figure 1). In this model, Reason (1990) depicted an organisation's defences against failure as a series of barriers, safeguards and defences, represented as slices of Swiss cheese.

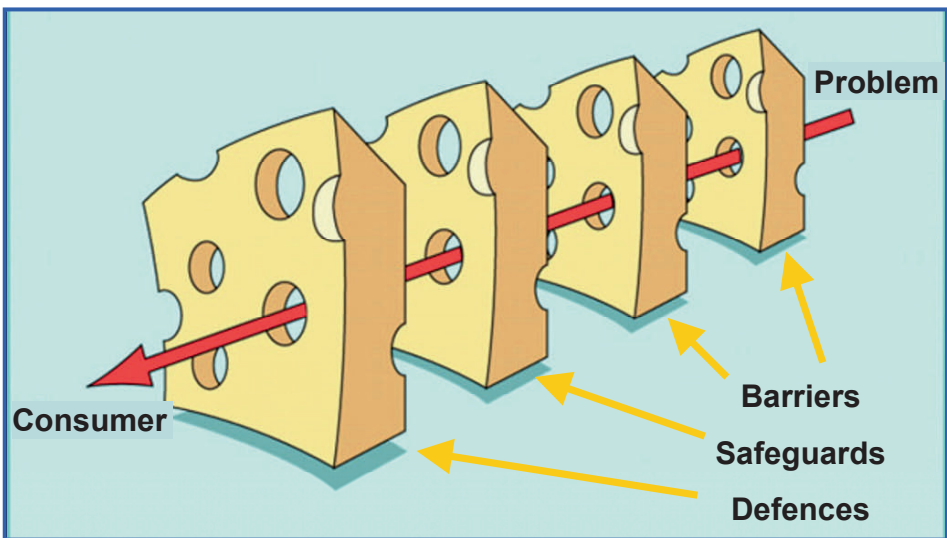

Figure 1. The Swiss Cheese model of accident causation (After Reason, 1990)

In high technology systems, these defensive layers are intended to protect potential victims and assets from local hazards, and may:

- Be **engineered** (physical barriers, alarms, automatic shutdowns)
- Rely on **people** (health staff, pilots, control room operators)
- Depend on **procedures** and **administrative** controls

Individual weaknesses in individual parts of the system are represented by holes in the slices of cheese. These holes continually open, shut, and shift their location. When the holes in multiple layers momentarily line up, a trajectory of accident opportunity occurs whereby a hazard passes through all of the defences, creating system failure.

The holes in the defences arise for two reasons: **active failures** (unsafe acts by people in direct contact with the system) and **latent conditions** (inevitable “resident pathogens” within the system). Nearly all adverse events involve a combination of these two sets of factors.

As a result of the consideration of such models, WSPs emerged through several parallel processes, activities and organisations, most prominently:

- The Bonn conference (2001) which resulted in the IWA Bonn Charter in 2004
- The WHO 3rd Edition “Guidelines for drinking-water quality” (2004)
- Australia’s National Health and Medical Research Centre’s “Framework for managing drinking water quality” (rolling revisions from 1996 onwards)

These marked a sea change in thinking: “the approach to the provision of safe drinking water has moved from almost total reliance on end of pipe testing to giving emphasis to effective management of the whole supply chain from source to tap” (Rouse, 2004).

WSPs essentially aim to be a cost effective, protective way of consistently assuring a supply of safe drinking water. They involve risk management, based on sound science supported by appropriate monitoring. As such, they theoretically contribute directly to Target 10 of the Millennium Development Goals 7: “Halve the proportion of people without sustainable access to safe drinking water and sanitation by 2015”.

WHO promote WSPs as the most effective method for ensuring safe drinking water, “from catchment to consumer” (WHO, 2005). WSPs are driven by health based targets and verified by health surveillance (Figure 2). As a minimum, WSPs require of the drinking-water ‘supplier’ (1) a system assessment, (2) effective operational monitoring, and (3) management. Within a WSP, the hazards and risks of any water supply system are identified and assessed so that suitable actions and training can be carried out to prevent the consumption of unsafe drinking water.

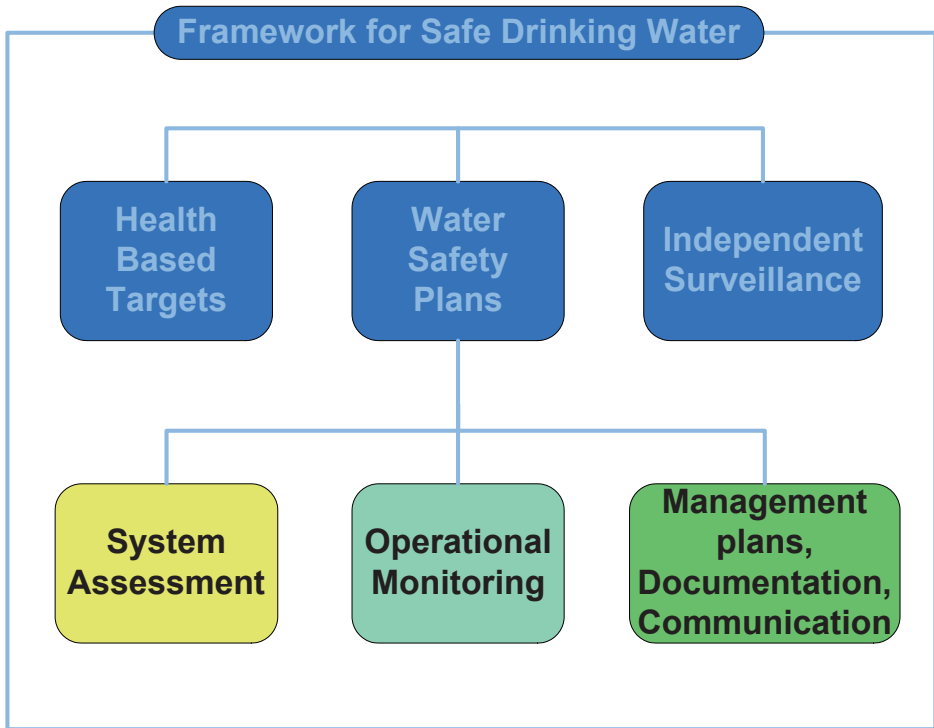

Figure 2. Framework for safe drinking water (WHO, 2004)

Key risk management terms within the context of WSPs may be defined as follows:

- **Hazard:** a biological, chemical, physical or radiological agent that has potential to cause harm.
- **Hazardous event:** incident or situation that can lead to the presence of a hazard.
- **Risk:** likelihood of identified hazard causing harm in exposed population in a specified time frame, including magnitude of consequences.

The development of WSPs involves the expansion of the three areas of system assessment, operational monitoring and management into several chronological yet potentially cyclical steps (Figure 3).

Whilst WSPs are currently being developed and implemented throughout the high- and middle-income world they are only just being introduced in low-income countries. Developing WSPs in the context of disasters in rural and peri-urban areas of such low-income countries presents particular challenges.

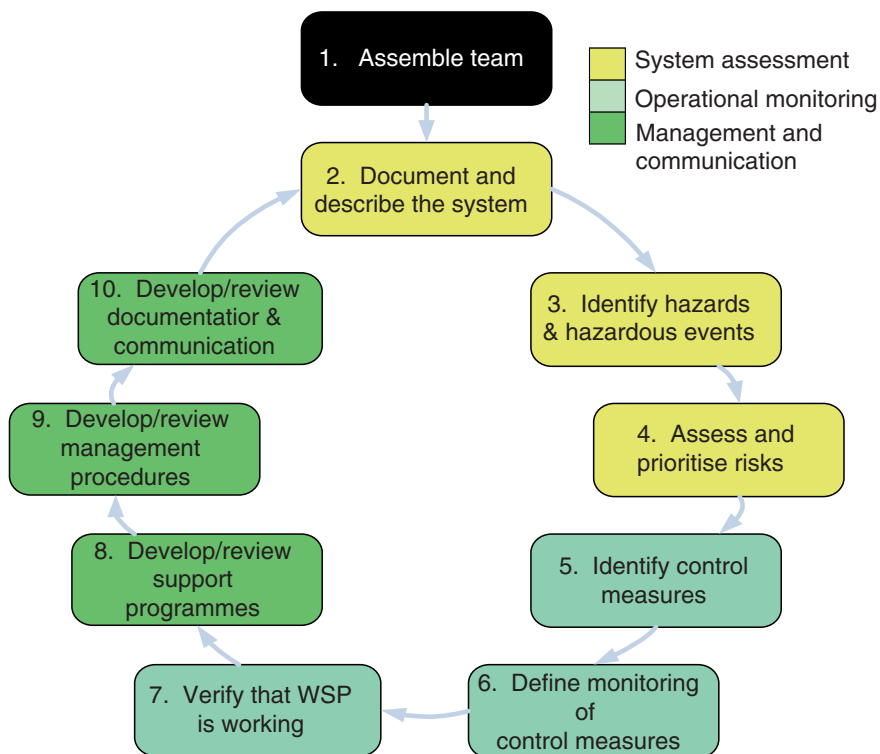

Figure 3. Ten steps in developing a Water Safety Plan (After WHO, 2004)

### 3. Water Safety Plans in Disaster Management in Low-Income Countries

Collectively, the authors have experience of natural and man-made disasters in the water and sanitation sector in the South Asia Earthquake, Darfur, Liberia and Sierra Leone, and more specifically in jointly developing a WSP for Tearfund's WASH programme in Liberia. In order to develop WSPs in these contexts, some of the assumptions that are made for WSPs in high- and medium-income countries require re-visiting. Similarly, assumptions that are made for WSPs for low-income countries, but in development rather than in disaster contexts, also need re-visiting. As a result, several fundamental questions are raised.

### 3.1. GENERIC QUESTIONS RAISED IN DEVELOPING WATER SAFETY PLANS FOR LOW-INCOME COUNTRY DISASTER CONTEXTS

- What are the water priorities of the end user? Especially thinking of the balance between water quality, quantity (including reliability) and access, where should a WSP focus its attention?
- How can you apply risk management to water *quantity and access*? In medium- and high-income countries these are invariably assured. In low-income countries, this is rare, especially in the context of disasters.
- What existing measures do users take to safeguard their drinking water? Even 'unprotected' sources have some safeguards that can be enhanced, and the motivation behind the safeguards can be tapped into to develop a WSP.
- What are the priorities of the water supplier? Purely commercial or with a balance of service delivery?
- How can WSPs be adapted for users of multiple supplies? At varying times of the year, users may fetch from streams, boreholes or roofs, for example, depending on issues such as access and availability.

These questions and challenges relate both to disasters and post-conflict/development situations, although it is inevitable that they will be more critical in the context of disasters.

Thus, whilst some of the principles of WSPs developed in high- and middle-income countries can be applied to small community-managed systems in low-income countries, others cannot, and require significant re-thinking.

Within the low-income context, across the spectrum from disaster through post-conflict/disaster to development many of the challenges are common:

- A wide range of technologies might be used but a common feature is limited specialist skills and resources.
- It is unlikely that a community will be able to carry out water quality testing, so a surveillance agency is needed to take responsibility for this area.
- Generic WSPs may be appropriate for very small communities, whereas small towns may have the capacity to make use of guides to support a local WSP.

### 3.2. ISSUES FROM THE LITERATURE

Literature on WSPs in low-income countries is very scarce due to the emerging nature of the concept. Nevertheless, the issues and challenges identified above, especially in relation to personnel, are echoed.

Kruathong (2007) identifies the development of control measures such as catchment management, water conservation and hygiene promotion as key constraints to the successful implementation of the WSP for the Tham Hin refugee camp in Thailand. This is linked to the lack of skills of critical personnel, namely the water operators.

Similarly, a report on a WSP for the Spanish Town Water Supply, St. Catherine, Jamaica (EEM, 2007), cites empowerment of key stakeholders as critical:

- Equitable collaboration is needed between ministries of health, environment, and water sectors through the formation of a WSP committee.
- Assistance to the National Water Commission, operators of the Spanish Town Water Treatment Plant, to write a WSP.

Mahmud et al. (2005) identify personnel issues as recurrent key issues concerning the development of the Chapai Nawabgonj Pourashava WSP in Bangladesh. Among the requisite improvements cited in the action plan are:

- Development of asset maintenance and calibration supporting programme
- Improved sanitary protection and water conservation
- Development of consumers' education supporting programme
- Development of operators' training supporting programme

#### **4. Conclusion**

WSPs are emerging in middle- and high-income countries as an effective method for ensuring safe drinking water. They are driven by health based targets and verified by health surveillance. The technologies, infrastructure, personnel and resources necessary to achieve this are frequently available in such contexts.

In low-income countries, and especially in the context of natural or man-made disasters, such support is rarely present.

In particular, areas to be assessed are: the focus on water quality; the priorities of end-users and suppliers; existing safeguards; variation of the source of supply; and limitations in specialist skills and resources.

#### **References**

EEM (Environmental & Engineering Managers Ltd.) (2007). Water Safety Plan, Spanish Town Water Supply, St. Catherine, Jamaica. Unpublished report. Jamaica.

- Kruathong, S. (2007). Water Safety Plan for Tham Hin Refugee Camp, International Rescue Committee – Thailand; Tham Hin Health Assistance Program; ECHO Report.
- Mahmud, S.G., Ibrahim, A.K.M., Deere, D., & Howard, G. (2005). Water Safety Plan for Chapai Nawabgonj Pourashava. Unpublished work. Working Draft Revision 3.
- Reason, J. (1990). Human Error. Cambridge University Press, New York, NY.
- Rouse, M. (2004). IWA and Global Water quality Management, Water21. [http://www.iwapublishing.com/template.cfm?name=w21apr04\\_thepres](http://www.iwapublishing.com/template.cfm?name=w21apr04_thepres).
- WHO (2004). Guidelines for Drinking Water Quality. WHO, Geneva.
- WHO (2005). Water Safety Plans: Managing drinking-water quality from catchment to consumer. WHO, Geneva.

# ONLINE MONITORING TECHNOLOGIES FOR DRINKING WATER SYSTEMS SECURITY

ANDREA G. CAPODAGLIO\* AND ARIANNA CALLEGARI  
*Department of Hydraulic & Environmental Engineering  
University of Pavia, Via Ferrata 1, 27100 PAVIA, ITALY*

**Abstract.** More stringent constraints placed nowadays on water companies to provide high quality drinking water, increasing water resources scarcity in many areas of the planet, forcing water companies to work on marginal water bodies for supply, and the threat of hostile actions by political extremists and terrorist groups, that may willingly and deliberately cause contamination of an otherwise safe supply, are recent issues that have spurred demand for more efficient and comprehensive online water monitoring technologies. Traditionally, quality parameters associated with drinking water provision were monitored using routine grab samples followed by laboratory analysis. This approach only allowed to capture small data sets, mostly unrepresentative of the true variance at the source, and allowed potentially important events to occur undetected. This paper examines state-of-the-art technologies for online monitoring of water quality in supply water systems, and reports some recent application examples.

**Keywords:** online monitoring, drinking water, system security, water quality, inorganic pollutants, organic pollutants, biological pollutants

## 1. Introduction

A safe and reliable supply of drinking water is nowadays an issue that bears strategic significance worldwide. In many areas of the globe the demand for high quality freshwater far exceeds the available supply, already; it is estimated, for example (WHO, 2003) that over 2 million deaths each year are currently caused worldwide by pathogenic bacteria during the consumption of unsanitary water: it is easily foreseeable that in the future the issue of freshwater resource

---

\* To whom correspondence should be addressed. Andrea G. Capodaglio, Department of Hydraulic & Environmental Engineering University of Pavia, Via Ferrata 1, 27100 Pavia, e-mail: Italy capo@unipv.it



and drinking water supply scarcity will continue to escalate, driven by population growth and economic development pressure.

More stringent constraints placed nowadays on water companies to provide high quality drinking water, increasing water resources scarcity in many areas of the planet, forcing water companies to work on marginal water bodies for supply, and the threat of hostile actions by political extremists and terrorist groups, that may willingly and deliberately cause contamination of an otherwise safe supply, are recent issues that have spurred demand for more efficient and comprehensive online water monitoring technologies.

Micro-biological contamination of drinking water has an immediate effect on the emergence of infectious diseases. Availability of micro-biologically safe drinking water is probably the most effective and economical way to ensure public health. In addition to “traditional” microbiological contamination by human waste, contamination of drinking water sources with pesticides and herbicides as part of the major contaminating factors is a growing problem worldwide.

During the last 2 decades, several studies revealed the presence of hazardous contaminants in wastewater effluents, being discharged in rivers and streams due to “normal” anthropic activities, including pesticides (Öllers et al., 2001), natural and synthetic hormones (Kolpin et al., 2002), plasticizers, personal care products and pharmaceuticals compounds (Daughton and Ternes, 1999; Jones et al., 2002).

A recent study estimated that there are 1,415 human pathogens including 217 viruses and prions, 538 bacteria and rickettsiae, 307 fungi, 66 protozoa and 287 helminths; about 12% are considered to be emerging pathogens. Their number continues to grow, as evidenced by the relatively recent emergence of severe acute respiratory syndrome (SARS), caused by a novel coronavirus. In the past 30–40 years, on average at least one new pathogen has been identified each year, and many more have re-emerged after periods of inactivity or by appearing in areas where they were not previously reported (Cunliffe, 2008). Pathogens identified in recent years include a range of organisms that can be transmitted directly from water or by water-related vectors. While a high proportion of the substantial burden of water-borne disease is caused by classical by pathogens such as *Salmonella typhi* and *Vibrio cholerae*, the spectrum of challenges is expanding (Table 1).

There are many reasons why water-borne pathogens emerge. In some cases this can be due to advancements in disease diagnosis and detection of the causative organisms: for example, it is likely that *Cryptosporidium* caused diarrhoeal illness before it was diagnosed as a human pathogen in 1976. In other cases true emergence can be caused by factors such as new environments, new technologies and changes in human behaviour. Some pathogens have

emerged for a combination of reasons. *Legionella* was first detected in 1977 following the 1976 outbreak of Legionnaires' disease in Philadelphia. However, increased use of water-cooled air conditioning systems and spa pools has contributed to increased incidence of Legionnaires' disease.

TABLE 1. Possible water borne pathogenic agents

Agent	Disease
<b>Viruses</b>	
Astroviruses	Diarrhoea
Hepatitis E virus	Hepatitis
Influenza A (H5N1)	Influenza
Rotaviruses	Diarrhoea (most common cause of infant death)
SARS coronavirus	SARS
Small round structured viruses (include norovirus)	Diarrhoea (most common cause of viral gastroenteritis)
West Nile virus	Encephalitis
<b>Protozoa</b>	
Blastocystis hominis	Diarrhoea
Cryptosporidium parvum, Cryptosporidium hominis	Diarrhoea
Cyclospora	Diarrhoea
Microsporidia	Enteritis
<b>Bacteria</b>	
Burkholderia pseudomallei	Melioidosis (pneumonia, skin abscesses)
Campylobacter	Diarrhoea
Coxiella burnetii	Q fever
Enterohaemorrhagic Escherichia coli	Bloody diarrhoea, haemolytic uraemic syndrome
Helicobacter pylori	Gastric ulcers
Legionella pneumophila	Legionnaires' disease, Pontiac fever
Mycobacterium ulcerans	Skin and subcutaneous ulcers
'atypical' Mycobacteria	Hypersensitivity pneumonitis, pulmonary disease, cutaneous infection
Vibrio cholerae O139	Cholera
<b>Helminths</b>	
Schistosoma	Schistosomiasis

As far as deliberate human hostile actions on urban water supplies, although none has been reported to date, in January, 2002, the FBI circulated a reserved bulletin warning water industry managers that al-Qaida terrorists may have been studying American dams and water-supply systems in preparation for new attacks (IonLife, 2002).

Traditionally, quality parameters associated with drinking water provision were monitored using routine grab samples followed by laboratory analysis. This approach only allowed to capture small data sets, mostly unrepresentative of the true variance at the source, and allowed potentially important events to occur undetected. It is clear, that, in view of what just reported, this can no longer be considered a satisfactory procedure, and that online monitoring of water supplies, for a larger number of parameters than currently available, is quickly becoming an unavoidable choice.

Water utilities around the world are already using some form of online monitoring to warn of contamination of drinking water, in anticipation of yet-to-be specified regulations: in the United States, turbidity is currently the only quality indicator for which there is a regulatory requirement for continuous online monitoring; in Europe, the EU drinking water monitoring regulations (Council Directive 98/83/EC) do not specifically require online measurements (Awwa, 2002).

## **2. Definition and Rationale for Online Monitoring**

Online monitoring is usually defined as the unattended sampling, analysis and reporting of a parameter; it produces a sequence of data at much greater frequency than that permitted by manual (grab) sampling and it also allows real-time feedback for either process control, water quality characterization for operational or regulatory purposes, and alert/alarm purposes.

Online monitoring can be carried out at onsite as well as remote locations and will deliver measurements at intervals of seconds-to-minutes apart. Clearly, online instrumentation must be placed at representative locations in the water system and must be periodically maintained by qualified technical personnel.

Monitoring requirements can be defined in relationship to:

- Source water quality: (a) variability, in space and time (very low for ground-water, low for lakes, high for rivers); (b) vulnerability (type and location of possible contaminating activity), time-of-travel of the contaminant to the intake, effectiveness of barriers, control options after an alarm
- Water treatment: process optimization options and response times, sampling frequency must allow adequate process control

- Distribution systems: minimization of deterioration of water quality over time and distance, early detection of cross-connections and water losses

In addition, it must be considered that online monitors could have different sensitivity and selectivity according to the matrix and range of concentrations analyzed.

TABLE 2. Online monitoring Objectives and Strategies in a multibarrier drinking water system (From Awwa, 2002)

Activity	Monitoring Strategy	Objectives
Contaminant source identification	Surrogate parameters (TOC, DOC, UV <sub>254</sub> , pH, conductivity) Specific parameters (related to known sources of contamination) Biotest and toxicity tests	Define potential contamination in relation to vulnerability of source water
Monitoring of discharges into the source water	Specific organic/inorganic contaminants	Identify water pollution accidents
BMPs/protection of water source	Hydrological parameters Environmental parameters (solar radiation, O <sub>2</sub> , Chl)	Prevent source deterioration Environmental Management
Drinking water quality protection	Specific organic/inorganic contaminants Treatment-related parameters (Q, turbidity, pH, TOC, DOC, etc.) Biotests/toxicity	Allow appropriate responses to contaminant presence (intake shut-up, additional treatment, treatment adjustment)
Emergency response	Specific organic/inorganic contaminants Biotests/toxicity	Drinking water pollution control Risk management Treatment modification

TABLE 3. Online monitoring parameters associated with source monitoring

Parameter
Ammonia, Biological/toxicity tests, Bromide, Chl, Conductivity, D.O., Flow, Nutrients (N,P), Metals, pH, Redox potential, Level (reservoir), Specific org. contaminants (e.g. pesticides, phenols, etc.) Temperature, TOC/DOC (or surrogates, e.g. UV <sub>254</sub> ), Turbidity

TABLE 4. Online monitoring parameters associated with water treatment

Parameter	Use
Alkalinity	Coagulation/corrosion control
Biological/toxicity tests	Treatment effectiveness
Flow	Chemical additives control, Disinfection control
Fluoride	Dosage control
Ozone	Disinfection/oxidation control
Particle count	Filtration control, Disinfection control
pH	Coagulation/corrosion control,
Redox potential	Disinfection/inactivation control
Residual disinfectant (free/comb. chlorine,	Disinfection/inactivation control
Ozone, chlorine dioxide)	Disinfection/oxidation control
TOC/DOC (or surrogates)	Coagulation control, Disinfection/oxidation control
Turbidity	Filtration optimization, disinfection control

A multibarrier approach to drinking water quality protection, such as those that are commonly used by facilities worldwide, is based on the concept that contaminants must be subject to as many points of control/treatment (barriers) as possible prior to the tap. The ideal location for control of contaminants is as close to the source as possible. A source water with low vulnerability is therefore characterized by few potential contaminant activities, transit time longer than that required for laboratory analysis, and the presence of multiple physical barriers between contaminating activities and point of intake. In a source water with moderate vulnerability, online monitoring of surrogate parameters (such as TOC, DOC, UV<sub>254</sub>, pH and conductivity) may be considered to keep track of potential pollution. In a high vulnerability water source, online monitoring of chemical–physical–biological parameters (turbidity, pH, conductivity, redox, fish toxicity) and surrogate parameters in addition to specific indicators (e.g. VOCs, phenols and specific toxicity tests) may be preferred. This is summarized in Table 2.

Some parameters commonly used to monitor in online mode a supply source are listed in Table 3. Parameters used to monitor online water treatment are listed in Table 4. Both tables list also parameters for which online monitoring technology may not be widely available, nor field proved at the moment, but that may be useful for the given purpose (Awwa, 2002).

The availability of real-time analytical information is one of the key benefits of online monitoring instrumentation: this information must however be conveyed to the appropriate user by means of a data collection and transmission system which is often referred to as SCADA, which consists of the individual online instruments, connected to Programmable Logic Controllers (PLCs) or

Remote Telemetry Units (RTUs), that convert instrument outputs to the desired units, compare them to criteria set by the user, and generate signals for alarm or control to other process equipment. A host computer, that can be used to visualize or store data, or to further utilize them for specific purposes, almost always complements these systems.

### 3. Online Monitoring Instrumentation Overview

Generally speaking, online monitoring instrumentation can be divided in:

- Physical monitors (Turbidity, particles, color, conductivity, TDS, hardness, alkalinity, acidity, streaming current, radioactivity, temperature, redox potential)
- Inorganic monitors (pH and DO, disinfectants, such as Chlorines and ozone, metals, fluoride, nutrients, cyanide)
- Organic monitors (Carbon and hydrocarbons, UV adsorption, VOCs, pesticides, disinfection by-products)
- Biological monitors (nonspecific, algae, protozoa, pathogens)
- Hydraulic monitors (flow, level and pressure)

This paper will focus on the four former classes, discussing for each basic operating principles, and evaluation of the technology for online applications in the water distributing system.

#### 3.1. PHYSICAL MONITORS

A wide array of technologies can be used for monitoring physical parameters, among them: light scattering/blocking (turbidity, particles, SS), light absorbance (color), electrochemical (conductivity, hardness, Redox), electrophoretic (streaming current), chemical titration (alkalinity, acidity, hardness) and other (radioactivity, temperature) (Table 5).

Turbidity refers to the clarity of a water sample, and can be defined as an optical property that causes light to be scattered and absorbed by suspended particulate matter (inorganic or organic) in the sample. It is one of the most commonly monitored parameters in the water industry, and the one that is most amenable to online monitoring. A turbidimeter consists of a light source, a sample cell and a photodetector; commercial instruments differ in the type of light source and the number and location of photodetectors.

Color is caused by the absorption of visible light by dissolved/colloidal substances or small suspended particles and can be an indication of pollution by disinfection by-products, industrial pollutants and/or metals, although it does

not, by itself, represent a health risk. Color is in fact regulated as an aesthetic parameter only and is seldom monitored online, except in cases where the water source is subject to industrial effluents and/or storm runoff inputs. Color is measured either visually or spectrophotometrically.

Dissolved organic/inorganic impurities (TDS) are compounds of different nature and sources, and constitute the solid residue after all the water evaporates. TDS must be determined gravimetrically in the laboratory, however, since these species tend to increase the electrical conductivity of the solution, conductivity is often used as a surrogate measure for TDS, especially when in online mode.

Hardness is defined as the sum of divalent cations in a water sample, and is relevant in drinking water systems for aesthetic reasons and for corrosion concerns. Alkalinity is defined as the acid-neutralizing capacity of a solution. Both can be determined by chemical titration (hardness with EDTA, alkalinity with an acid solution).

TABLE 5. Physical online monitors technology

Application	Most Appropriate Technology	Other Technologies
<b>Turbidity</b>		
Low turbidity raw water,	Single Beam (tungsten or LED) turbidimeter	Particle counters Particle monitors
Clarified water, Filter effluent	Modulated four-beam turbidimeter	
High turbidity raw water	Ratio turbidimeter Modulated four-beam turbidimeter	
Filter backwash	Transmittance turbidimeter Surface scatter Ratio turbidimeter Modulated four-beam turbidimeter	EMERGING TECHNOLOGIES Laser light source (660 nm) and improved optics turbidimeters
<b>Color</b>	Online colorimeter Spectrophotometer	
<b>TDS</b>	Two-electrode conductivity probe Electrodeless (toroidal) probes	
<b>Hardness</b>	EDTA titration online Ion-specific electrodes (ISE)	
<b>Alkalinity</b>	Online alkalinity titrator	

### 3.2. INORGANIC MONITORS

Inorganic monitors are used in online mode to detect influent and effluent water quality, and for treatment process control; the applicable technologies are listed in Table 6.

Online monitoring of inorganic constituents is still in the early phase for many elements of interest to drinking water concerns. For metals, available technology is an adaptation to automatic operation mode of complex colorimetric methods developed for laboratory applications, and therefore turns out to be expensive and/or complex to operate, nor still suitable for installation in remote or unmanned sites.

TABLE 6. Online inorganic monitor technology

Parameter	Currently applied technology	Other technology developments (not currently/commonly avail.)
D.O., pH Chlorine, nitrate, fluoride	Ion-selective electrodes (IESs) Membrane Electrode Sensors for DO (polarographic or galvanic)	Fiber-Optics Chemical Sensors (FOCSs or optodes) for pH, DO Iodometric DO measurements
Chlorine and compounds	Colorimetric (DPD), Iodometric, polarographic membranes and amperometric methods Absorbance (spectrometric) for ClO <sub>2</sub>	ClO <sub>2</sub> : Iodometry, Amperometric meth. I, DPD, amaranth, chlorophenol red, LGB dye, ion chromatography
Iron, manganese	x-ray fluorescence (complex), colorimetry	
Ammonia, nitrite, nitrate	Colorimetric, FOCS (ammonia) Ion Sensitive Gas Membrane electrodes	
Phosphorous, cyanide	Colorimetric, FOCS (cyanide)	

Also, for many metals of interest in drinking water systems (As, Cd, Pb, Hg, Se, Zn), online monitoring technologies do not exist at all. Some promise for future application comes from developments in optode technology, coupled with miniaturized spectrophotometry.



### 3.3. ORGANIC MONITORS

The technology for online monitoring of organic compounds includes TOC analyzers, UV absorption and differential spectroscopy; it is much more developed than that for inorganics, for this reason, although neither EU nor US regulations require online monitoring of these substances, many drinking water utilities routinely use online organics monitoring to some degree.

TOC methods measure the carbon content of dissolved and particulate organic matter in the water, without giving information about the nature of this organic substances. Table 7 shows the different fractions of carbon measured by an organic carbon analyzer.

TABLE 7. Carbon fractions measured by organic carbon analyzers

Carbon fraction		Definition
Total carbon	TC	Sum of organically and inorganically bound carbon (incl. elemental C) present in water
Total inorganic carbon	TIC	Sum of elemental carbon, CO <sub>2</sub> , CO, CN, CS, CCl <sub>4</sub> , etc.
Total organic carbon	TOC	Organic carbon bound to particles <100 μm (TOC = TC-TIC)
Dissolved organic carbon	DOC	Organic carbon in water bound to particles <45 μm
Nonpurgeable organic carbon	NPOC	Organic carbon present after scrubbing the sample to eliminate inorg. C and VOCs <sup>a</sup>
Volatile organic carbon	VOC	TOC fraction removed from the sample by gas stripping

<sup>a</sup>Most commercial TOC analyzers actually measure NPOC

TOC measurement is defined by well established methods and occurs generally according to a four-step process: sample treatment (filtration), inorg. C removal (acidification to pH < 2), oxidation (with UV, catalyzed UV, chemical oxidation, etc.) and CO<sub>2</sub> determination (NDIR detectors, colorimetry, or conductivity methods). Detection limits depend on the specific technique's operating temperature (usually >0.2 mg/l for low temp., >1 mg/l for high temp.).

Most organic compounds found in water absorb UV radiation: using a UV spectrometer it is therefore possible to estimate the concentration of these compounds. Originally, a UV light source with the single wave length of 254 nm was used for such measures, however, in recent years, instrumentation reading the entire UV-VIS spectrum (200-750 nm) has been developed and marketed (S-can, 2008). UV absorption is a well-defined and commonly used methodology; evidence shows strong correlation between these measurements and organic carbon concentration measured with standard methods such as

TOC or others (Figure 1). In addition, it has been shown that other parameters can be measured indirectly by correlating their concentration values to UV absorption in the full spectrum (Figure 2); several commonly sought organic compounds have typical absorption spectra that make their identification quite easy with appropriate instrumentation (Figure 3).

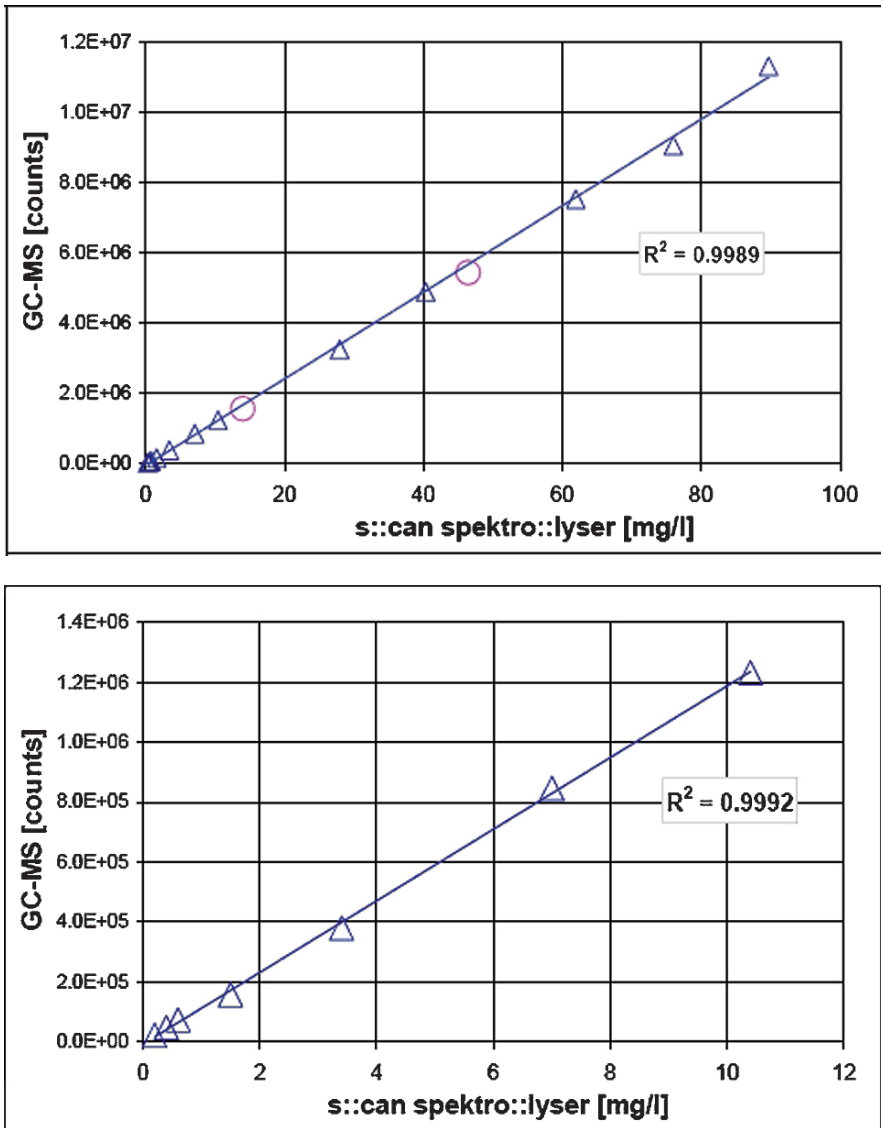

Figure 1. Calibration of an online UV-VIS spectrometer for benzene detection against GC-MS laboratory methods, in distilled water and groundwater (Courtesy S-can, 2008)

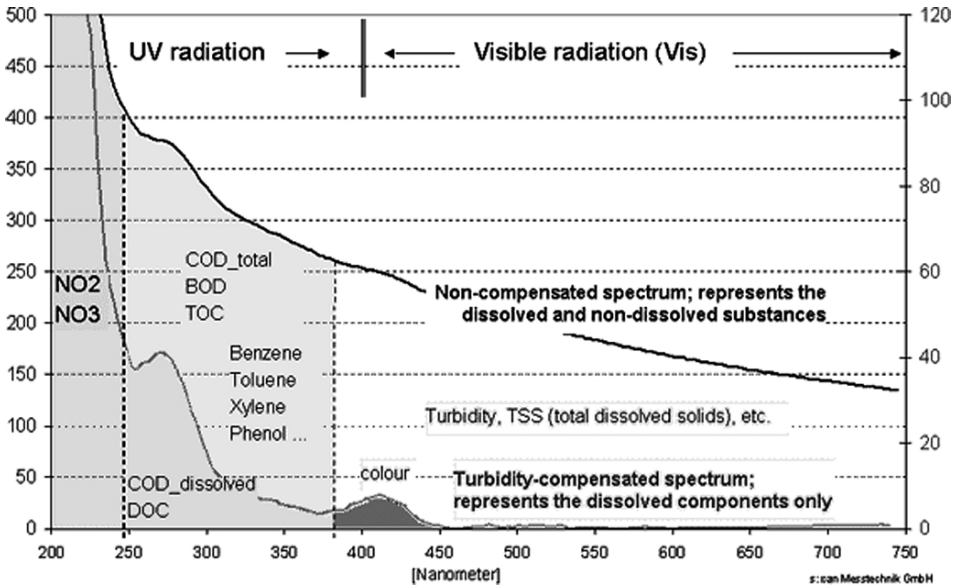

Figure 2. Correspondence between spectral absorption areas and quality parameters (Courtesy S-can, 2008)

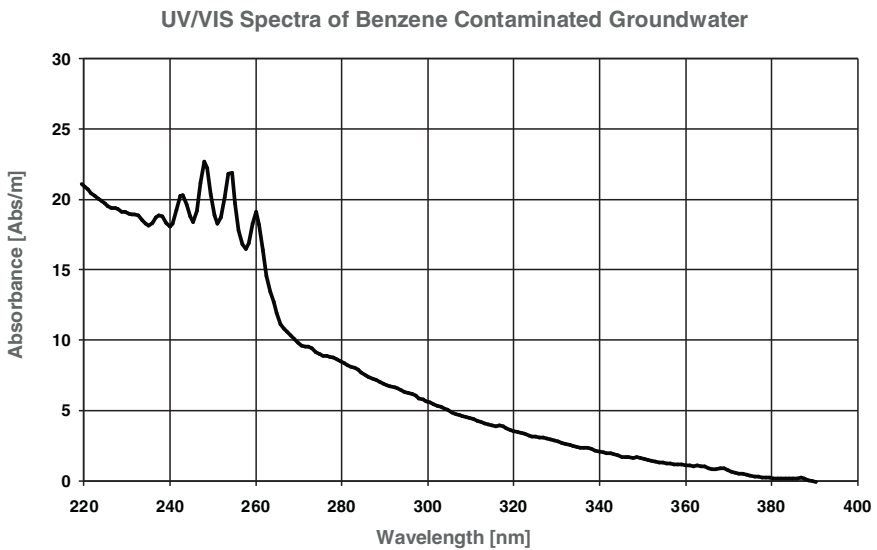

Figure 3. Typical spectral absorption image of benzene in water (Courtesy S-can, 2008)

Hydrocarbons in general are probably the main class of water pollutants found in surface and ground water (i.e., source water for drinking water systems). Methods for online hydrocarbon detection include: fluorometry, reflectivity, light scattering and turbidity measurement, ultrasonic methods, electrical conductivity, spectroscopy, gas-phase detection (after volatilization), resistance-based sensors; some of these methods, however, give just an indication of the presence/absence of oil on the water surface.

Volatile Organic Compounds (VOCs), including, among the others, aromatic compounds, halogenates and trihalometanes, are compounds that evaporate when exposed to air and can be of health concern when found in drinking water systems (trihalometanes are disinfection by-products – DBPs – that can be precursors to the formation of carcinogens). Their presence in drinking water can be a symptom of accidental pollution in the source water, of treatment failure/deficiency, or of incorrect disinfection procedures.

Current online monitoring technologies for VOCs include purge-and-trap gaschromatography with flame ionization (FID), electron capture (ECD) or photoionization detectors or mass spectrometry (MS). Detection limits for different substances vary according to the detector method.

Pesticides, including insecticides, fungicides and herbicides comprise triazines and phenylurea compounds; they are monitored in drinking water systems in order to: detect accidental pollution in source waters, and check the effectiveness of treatment specifically designed to remove such substances. Online monitoring of pesticides can be carried out using composite techniques, such as:

- High pressure liquid chromatography (HPLC)/diode array (DA) detection, consists of extraction and enrichment, chromatographic separation and DA detection.
- Gas chromatography (GC), consists of extraction and enrichment, GC separation and mass spectrometer (MS) detection.
- Liquid chromatography/mass spectrometry, consists in extraction and enrichment, LC separation and MS, thermospray, electrospray or particle beam detection.

Each technique is capable to optimally detect a group of compounds, for example, HPLC/DA can be used to analyse; atrazine, chlortoluron, cyanazine, desethylkatrazine, diuron, hexazinone, isoproruton, linuron, metazachlor, methabenzthiazuron, metobrorumon, metolachlor, metoxuron, monolinuron, sebutylazine, simazine and terbutylazine.

In theory, any analytical laboratory method can be adapted for use as online measurement, provided that the requirements for consumables and manual intervention can be minimized: current online systems are often a “robotized” adaptation of known offline laboratory procedures, however, not always this solution is the most efficient one. A series of novel technologies, such as optochemical sensors, biosensors, and microbiological sensors are being tested for organics and hydrocarbon analysis. Advances already in use include differential UV spectroscopy for DBPs detection and microphase solid-phase extraction (SPE) for the analysis of semivolatiles organics (Yongtao et al., 2000).

### 3.4. BIOLOGICAL MONITORS

There are two basic types of biological monitors currently in use: those that use biological species as indicators of the presence of contaminants of concern (e.g. toxic chemicals), and those that screen for the presence of biological species of concern (e.g. nuisance algae, pathogens). In common US terminology, the term *biomonitor* usually indicates the former, and is in fact used as synonymous with *toxicity monitor*. In EU terminology, biomonitor refers generally to all types of biologically-based systems.

At the present time, many existing biological monitors are quite new and can be considered experimental/unique applications. Table 8 shows an overview of the most common types of online biological monitors. Sensitivity of test organism to individual compounds must be determined initially.

Online biological monitors are a very active area of R&D due to increasing regulatory and public demand pressures. While bacterial-based systems show great sensitivity and ease of operation, and development in this area will likely derive from improved fingerprinting of organisms and maintenance cost reduction, most advances can be expected from protozoan monitor technology, with techniques in UV absorption/scattering analysis that may soon allow automated detection of *Cryptosporidium* and *Giardia*. Also, molecular techniques initially applied to the recognition of the genomic sequence of specific organisms in clinical applications (Bej, 2003), have also shown great potential for use in the detection of pathogens in water, and are producing extremely interesting results that could lead to widespread online use in the very next future (see also Section 5).

TABLE 8. Online biological monitors

Technology	Measurement	Comments
Fish tests	Swimming pattern	Low sensitivity
	Ventilation rate	Sophisticated requirements
	Bioelectric field	Requires exotic “electric fish” species
	Avoidance patterns	Interpretation complex
Daphnid tests	Swimming activity	Good performance, no determination of causes
	Behaviour	
Mussel tests	Shell positions/opening	
Algae tests	Fluorescence (photosynthesis)	Commercial monitors available
Bacteria tests	Luminescence	Commercially available, toxicity data for over 1,000 compounds
	Respiration of nitrifiers	
Chlorophyll-a	Fluorometry	Interference w/pigments, diss. organics, sensitive to environmental variables
Chlorophyll-a and algal absorption	Reflectance radiometry	Commercial systems available
Protozoan Monitors	Concentration	By filtration on membrane cartridge
	Centrifugation	With modified blood cell separators, minimal operation time
	Laser scanning cytometry	Analysis possible within 3 min, particles must be confirmed by trained operator
	Particle characterization	Measure particle size/distribution, high number of false positive and negative results
	UV spectroscopy	Online system, unlabeled parasites, differentiation problems
	Multiangle light scattering	Successfully tested in lab
	Nucleic acid molecules and magnetized microbeads	Oocysts detected within 20 min, not fully automated

### 3.5. INDIRECT MONITORING: “FINGERPRINTING”

Chemical fingerprinting describes the use of a unique chemical signature, isotopic ratio, mineral species, or pattern analysis to identify different chemicals. Optical fingerprinting by UV, VIS, and NIR absorption spectroscopy can be effectively achieved by low-cost and compact spectrometric devices, that can also be linked to an online diagnostic system, to directly identify some compounds (e.g. benzene) present in the water or to give an indication of the possibility of the presence of related compounds.

In optical fingerprinting, a wide portion of the UV, VIS and NIR spectrum can be monitored simultaneously at high measurement frequency (minutes or fractions thereof); Figure 4 shows the spectral fingerprint of a typical municipal wastewater, in the range 230–630 nm, together with three other spectral readings from the same source that were recorded within 18 min from the first. These show clearly different features, indicating a pronounced change in water quality. Although this alone will not, in general, indicate the compound or compounds responsible for the change (they will need to be further investigated, if a definite answer is desired), but that can nevertheless trigger an alert to the system's operator, indicating deviation from routine conditions.

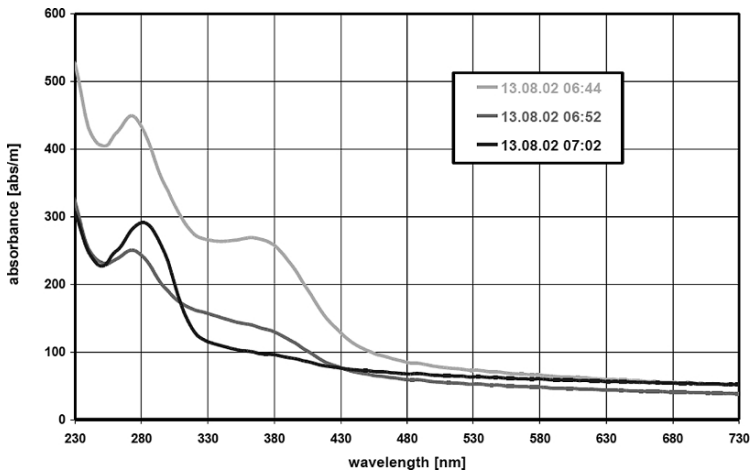

Figure 4. Optical fingerprinting of source water indicating rapid quality changes (Courtesy S-can GmbH)

#### 4. State-of-the-art Application Examples

Some relevant applications taken from recent literature, are illustrated in the following sections, as examples of the current state-of-the-art in online monitoring technology.

##### 4.1. RIVER TRENT (UK): ONLINE MONITORING OF MICROPOLLUTANTS

The River Trent drains the large, mainly urban, catchment of Midlands, with 4 million residents, in the UK; although traditionally it has been considered too polluted to serve as a drinking water supply source, the river has undergone marked improvements in quality until, in 1996, it was targeted as such. Water is currently withdrawn from the river into bankside storage lakes, from where is

taken to a purification plant. At this point, it became necessary to identify a suitable online monitoring strategy in order to protect this planned development (Kirmeyer et al., 2002).

TABLE 9. Online and laboratory parameters measured in the River Trent system

Parameter	Monitoring frequency	Method	
		Online	Laboratory
<i>Cryptosporidium</i> and <i>Giardia</i>	3/week		X
VOCs	Hourly	X	
Anions	Hourly	X	
Herbicides and phenols	Every 2 h	X	X
pH	Continuous	X	
Ammonia	Continuous	X	X
D.O.	Continuous	X	
Conductivity	Continuous	X	
Turbidity	Continuous	X	
Temperature	Continuous	X	
Nitrate	Continuous	X	X
Oil on water	Continuous	X	
TOC	Continuous		
Ammonia toxicity	Continuous		
Heavy metals			X
Antimony			X

In order to protect water quality and provide operational data to the treatment plant operators, a list of parameters subject to online/laboratory monitoring has been established (Table 9). Online monitors provide an alarm when a preset warning limit is exceeded, prompting immediate additional investigation. When a second, “action” preset limit is exceeded, water extraction into storage is automatically terminated.

Online monitors include traditional inorganic, organic and oil monitors, as well as an automated liquid chromatography (HPLC) system for monitoring organics, originally developed for analysis of triazine and phenylurea in the Rhine River, and uniquely adapted to detect other acid herbicides and phenolic compounds known to be frequently present in the Trent, at levels < 1.0 µg/l. VOCs are detected by means of a purge-and-trap GC analyzer. Maintenance requirements are relatively high (each unit requires 2–3 h of onsite attendance twice a week, in addition to the time required to review data, prepare buffers and standards, etc.).

Overall, in about 10 years of operation, the system has recorded several incidents of parameter abnormality in the River Trent, including ammonia



toxicity events and contamination by various herbicides. It has been confirmed that online monitoring gives a far better definition of each recorded event than otherwise available, while spot samples analyzed at the laboratory in parallel have always been in good agreement with the online results.

#### 4.2. THE LLOBREGAT RIVER AUTOMATIC MONITORING NETWORK

The Llobregat River, near Barcelona (Spain) is characterized by a highly variable flowrate; to ensure sufficient supply during drought periods, dams have been built along its course. In addition, a continuous, automatic system with ten stations along its course has been put in place to monitor critical water quality parameters; these may vary depending on the monitoring location, in order to account for different needs and conditions. There are three types of stations: basic (1, upstream), complete (2, midstream) and special (7, mid-to-downstream); these are described in Table 10.

TABLE 10. Llobregat River online monitoring stations characteristics

Station Type	Parameters monitored	Purpose
Basic	Temperature, pH, D.O., conductivity, turbidity, redox, TOC	Upstream impact of towns/industries Impact of tributary and drainage system
Complete	Basic station parameters PLUS ammonia and phosphates	Impact of tributary confluence
Special	Complete station parameters PLUS UV adsorption, cyanides, total Cr, hydrocarbons, organic micropollutants	Impact of potash mines on salinity Discharges from industries/farms

The objectives of the monitoring network are:

- To provide warning of pollution incidents, ensuring safety of the water produced by the purification plants
- To control instream water quality by monitoring changes in pollution indicators
- To provide information for the operators of the water systems and planners through data access with a specifically created SCADA user interface

In the course of several years of operation the Automatic Water Quality Monitoring Network has recorded various incidents of pollution, including:

- Repeated occurrences of salinity discharges from potash mines, caused by accidental breakage of collectors or leaching due to rainfall
- An event of chromium pollution in a tributary stream, due to industrial source discharges
- Multiple overflows of drainage and sewer systems causing variations of turbidity, TOC, ammonia, UV adsorption and DO
- Highly significant variations of physical and chemical parameters (mainly DO, pH) due to photosynthetic activity

#### 4.3. ON-LINE MONITORING NETWORKS FOR DRINKING WATER SECURITY OF KARST WATER

Springs in geological karstic formations are the main source for drinking water supply for about 60% of the Austrian population. Water quality from these springs shows rapid, occasional instabilities for some parameters, caused by natural events, such as heavy rainfalls. Rapid fluctuations of raw water quality, especially concerning turbidity, but also elevated concentrations of dissolved organic substances, and increased bacteria counts can occur in an unpredictable way during storm weather. Furthermore, anthropogenic events like accidents and spills in proximity of the springs might also affect the quality of the raw water.

The raw water quality is obviously one of the most important factors determining the final quality of the drinking water, in addition, rapid changes of source quality can limit the efficient usage of treatment procedures during drinking water production. As it is impossible to predict the impact of such events, it is vital to enhance drinking water security by monitoring the composition of the raw water continuously.

Main springs and important locations in the trunk mains had been monitored online since the late 1990s. Buildings equipped with power supply, pipe installations and special foundations had to be built for housing cabinet analysers, for monitoring spectral absorption coefficient ( $UV_{254}$ ), TOC, turbidity, electrical conductivity and pH. In year 2000, a novel submersible UV-VIS-spectrometer, introduced by Scan Messtechnik GmbH, capable of measuring light absorbance in the spectral range of 200 nm to 750 nm, and thus turbidity, organic carbons (e.g. TOC, DOC) and Nitrate without any sample preparation were adopted. This new monitoring equipment provided new opportunities to the Waterworks by allowing to monitor the totality of springs, even those without power supply, and by eliminating pumps, filters, membranes and reagents that were used by the old instrumentation, lowering substantially the overall cost of monitoring operations (Weingartner and Hosftaeder, 2006).

At present, Vienna Waterworks operates a SCADA-based monitoring systems in order to monitor turbidity, SAC254, Nitrate, TOC, DOC, temperature and electric conductivity at 22 locations, since monitoring just one parameter would not meet the needs of efficient and safe drinking water supply, as different types of events cause different changes in the composition of the spring water. The results of these monitoring systems are transferred in real time to an early warning system that can be accessed from four central stations. This early warning system manages the raw water sources 24 h a day. Whenever current readings exceed limits that are specific to each parameter, the water of the spring of concern will not be used for drinking water production but drained away.

#### 4.4. USE OF ONLINE UV-VIS SPECTROMETRY FOR DRINKING WATER TREATMENT CONTROL

Oxidation of organic materials for drinking water disinfection is a commonly applied treatment step. During oxidation of natural organic substances in the source water, for example using ozone, large molecules, such as humic and fulvic acids, are cracked into smaller ones. A side-effect of this procedure is the increased availability of microbiologically assimilable organic carbon (AOC): whereas the original large molecules are not readily accessible to microorganisms, the smaller oxidation products can be digested and thus can stimulate bacterial regrowth in the distribution network. AOC is an important parameter especially in drinking water networks where no residual disinfectant is present in the water; its measurement is performed using cell cultures, which is a lengthy procedure.

Online UV/VIS spectroscopy has proven itself as a tool that allows the collection of specific information on the removal efficiency for and subsequent concentrations of (organic) substances in water.

The use of two on-line spectrometer instruments, placed before and after a treatment step, and the calculation of the differential spectrum between these two sites could open up a further area in water quality monitoring and process control as it allows calculation and prediction of water quality parameters previously unavailable (van der Broeke et al., 2007).

Two on-line spectrometer probes were installed in the pilot plant of Amsterdam waterworks, Weesperkarspel. In this pilot plant, the full treatment train of the waterworks is represented. The source, an artificial lake with high concentrations of natural organic matter, is sequentially treated in an ozone reactor (four bubble columns), pellet softening reactor, biological activated carbon (BAC) filtration reactor and finally a slow sand filter. A parallel BAC reactor was fed with water from the full scale treatment plant, which uses

identical raw water, to be able to verify the effects of the changes in the ozone settings on water quality.

The AOC calibration obtained in this way is a surrogate parameter, in the sense that the AOC concentrations in the water are far below the concentrations that can be distinguished using a UV/VIS spectrophotometer without sample pre-concentration.

The developed calibration, in combination with the on-line spectrometer probe, allows for on-line, in-situ measurement of dissolved ozone concentrations. The use of two instruments simultaneously, required to perform on-line differential measurements, allowed the prediction of the changes in AOC levels in individual treatment steps in real-time.

#### 4.5. FULLY AUTOMATED WATER QUALITY ALARM STATION

The software *ana::alarm*, for use with online UV spectrometers in a specially-designed configuration (Figure 5), has been developed specifically for contaminant alarm systems based on thousands of spectra, and is successfully used in several applications in Europe.

The training of the alarm parameters can be done by the instrument automatically, or is done manually guided by the PC software. It allows for a very simple half- or fully automatic setup and configuration of up to eight spectral alarm parameters within a few minutes. It will react on any type of

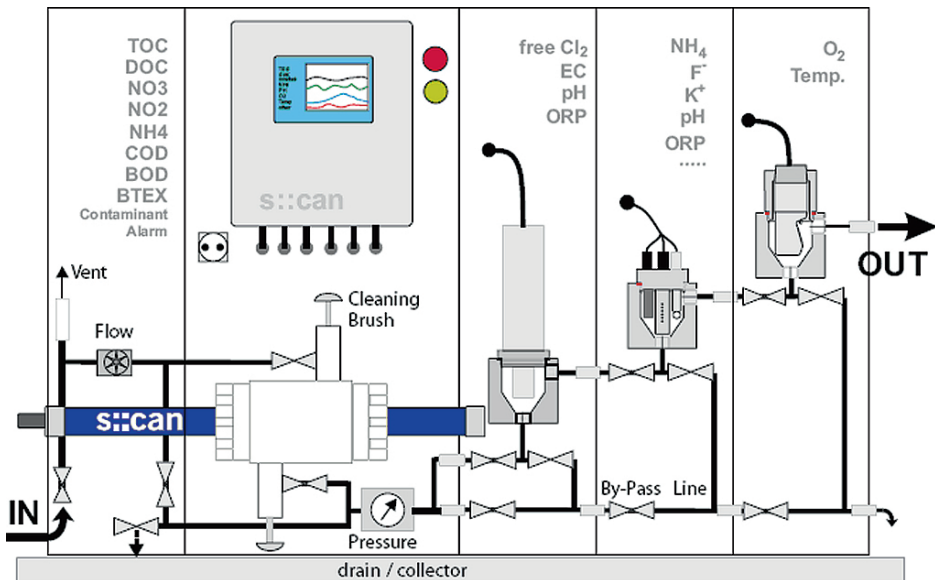

Figure 5. Configuration of online monitoring station for use with the software *ana::alarm*

organic contamination that provides an absorption signal in the UV range. The alarm sensitivity for many organic contaminants is between 1 and 500 ppb. At the same time it is most insensitive to any fluctuation of the matrix within the natural “normal” range, and thus keeps false alarms to an unmatched minimum. The approach and methods used are absolutely new and unique, and open a completely new perspective for water monitoring beyond the trending of “classical” concentration parameters (S-can, 2008b).

## **5. Recently Announced Technological Developments**

### **5.1. INTEGRATED CONTAMINANT WARNING SYSTEM**

A contaminant warning system (CWS) as an integrated tool that employs in-situ sensors, supervisory control and data acquisition (SCADA) systems, and water quality event detection systems (EDS) to continuously monitor network conditions and warn operations personnel of any potential contamination events, has been studied by the US Environmental Protection Agency (EPA) and Sandia National Laboratories (Hasan, et al., 2004; Grayman, et al., 2001). The sensor component can be comprised of various water quality sensing platforms, including contaminant-specific sensors, or existing water quality sensors (e.g., pH, Cl, electrical conductivity, etc.) as currently installed in many municipal water distribution systems to provide “surrogate” data to the CWS’s. It has in fact been proved by experiments conducted in laboratory and pipe test loop systems, that a majority of potential contaminants will change values of at least a surrogate parameter away from normal background levels (Byer and Carlson, 2005; Cook et al., 2005; Hall et al., 2007). Monitoring of surrogate parameters can therefore provide information on the presence of contaminants within a distribution system and this information can be transmitted to a central processing location through the SCADA system. The challenge is to analyze the surrogate parameter signals to accurately identify changes in water quality that are significantly beyond the range of the ambient variability of the background water quality. The recently developed the CANARY EDS software (Hart et al., 2007) is an open-source software platform that gathers water quality signal inputs from SCADA systems and processes the data using one or more event detection algorithms, using a number of statistical models to determine the probability of an anomalous water quality event occurring for a given time step and monitoring location within the distribution network (McKenna and Hart, 2008).

The CANARY system has not been used in real applications, yet, and offline case studies, based on real historical data, have evidenced some problems in correctly pinpointing alarm causes, as changes in the network

hydraulics (such as opening and closing valves, draining/filling of storage tanks and pump operations) can cause significant changes in water quality as waters of different ages and from different sources mix within the network.

## 5.2. EARLY DETECTION OF CONTAMINANTS

The existence of *Escherichia coli* (*E.coli*) in drinking water is an important indicator of faecal pathogens and potential micro biological contamination. Currently available detection methods for its presence in drinking water distribution networks are inadequate, for multiple reasons: first of all, current methods are very time consuming meaning that contamination will already have reached end-users before laboratory results are available; secondly, current sampling and analysis procedures lead to detection success rates of only 5% to maximum 25% (with optimized sample taking). Research by scientists from the Dutch KIWA shows that by using a network of on-line sensors, the success rate can be increased to 80% (Koerkamp and van Wijlen, 2008).

The core of this LabOnline system is based on a combination of a concentrator unit and a sensor system using disposable chips, which prevent the sensor system itself from cross-contaminations and guarantee reliable and high quality measurements in time. Initially designed for *E.coli*, the system is theoretically capable of detecting a broad group of microbiological contaminants like bacteria and viruses. Industrial production is scheduled for late 2009.

The same research group developed a sensor technology for pesticides based on a combination of an integrated optic chip, a biochemical transduction layer (micro)-fluidics, electronics and data acquisition and system control software, called Optiqua MobileLab. The Optiqua MobileLab sensor for the detection of pesticides will have the following characteristics: low cost per analysis, easy to use, detection of five pesticides (Simazine, Atrazine, Glyphosat, AMPA, BAM (2,6-dichlorbenzamide), detection of additional pesticides (available in later stages), on site detection, prompt analysis results (minutes), high resolution (e.g. detection limits 0.05 µg/L with a dynamic range of 0.05 – 10 µg/L), robust, low maintenance system.

## 5.3. MICRO ANALYSIS SYSTEM FOR WATER PATHOGEN MONITORING

Knowledge of the sequence of microbial genomes has led to the development of molecular methods for detection of microbial pathogens in clinical specimens as well as water and other environmental samples. A wide array of molecular techniques has therefore been applied to the study of microbiological water quality issues. The application of molecular techniques, such as PCR (Polymerase Chain Reaction) has generated a great deal of valuable information on the

occurrence, diversity, and biology of pathogens in water (Loge et al., 2002). In addition, molecular methods demonstrate rapid detection and enhanced specificity compared to other analytical methods.

A micro analysis system for water pathogen monitoring consists of a micro polymerase chain reaction (PCR) chip integrated with a continuous-flow microarray that is able to reduce the analysis time from about 24 h to within several hours as compared with the existing EPA approved methods was presented by Yong (2008).

Pathogen samples were successfully detected by the micro analysis system through DNA amplification by the micro PCR chip followed by direct transfer of the amplicons to the microarray for detection. In addition to one species monitoring, the system shows potential in direct monitoring of a range of pathogens at the same time through PCR and different probes immobilized on microarrays.

#### 5.4. TWO-DIMENSIONAL GAS CHROMATOGRAPHY SCREENING FOR NEW CONTAMINANTS

Comprehensive two-dimensional gas chromatography also referred to as GCxGC, is an analytical technique in which all the eluted compounds from a first column are successively submitted to a new separation in a second column with different selectivity. Contrary to gas chromatography (GC) which employs only one chromatographic column, GCxGC uses two chromatographic columns, coupled in series, with a modulator at their junction.

Developed in 1991, due to its principle, GCxGC offers a much better capacity of separation and a better sensitivity than conventional gas chromatography. Thanks to the sensitivity of GCxGC (three- to fivefold higher than GC) some compounds can be detected at the ng/L level. Semard et al. (2008) applied this technique to the screening of wastewater and effluents samples. A large range of drugs (antidepressors, antibiotics, anticoagulants...), personal care products (sunscreens, antiseptics, cosmetics...) and carcinogen compounds were found in the raw waste water samples. In addition to the above mentioned micropollutants, a wide variety of nitrogen aliphatic and aromatic structures that could act as DBP (disinfection by-products) precursors, were also uncovered. This technology does not yet have the potential for direct online application.

#### 5.5. MOLECULAR ONLINE DETECTION OF WATERBORNE PATHOGENS

Courtois et al. (2008) also propose a molecular technique, based on polymerase chain reactions to detect pathogens. To improve PCR diagnostics for routine analysis purposes, they focus on the processing of the sample, which is crucial



for the robustness and the overall performance of the method. Their objectives in sample preparation are to increase the concentration of the target organisms to the practical operating range of a given PCR assay; and to produce a purified DNA extract that would be representative of the initial water sample and would be free of PCR-inhibitory substances. This can be achieved by means of a two-step UltraFiltration (UF) procedure by using prototype hollow fiber UF cartridge, and a commercial UF centrifugal concentrator.

## 6. Discussion and Conclusions

This paper has overviewed existing instrumentation applicable to water supply online monitoring, and examined a few state-of-the-art application examples. It is clear that technological development in this field is very rapid, and that astonishing advances are anticipated in several areas (fingerprinting, opto-chemical sensors, biosensors, molecular techniques). Software applications, together with new generation sensors, are also contributing to the identification of otherwise difficultly monitored parameters.

In spite of the high technology being developed, monitoring costs are bound to become a lesser and lesser part of a water utility budget due to the fact that automation and technological simplification will abate the human cost factor (maintenance and other labour forms) and reduce significantly the complexity of procedures (with those, of reagent requirements, etc.).

Proper interpretation and use of the growing mass of water quality data that will become available through new technologies will allow better management of water resources, and water treatment and distribution facilities.

## References

- AWWA RF (2002) Online Monitoring for Drinking Water Utilities. Cooperative Research Report. (E. Hargesheimer, O. Conio and J. Popovicova, Eds.) AWWA Research Foundation, Denver, CO.
- Bej, A.K. (2003) Molecular based methods for the detection of microbial pathogens in the environment. *J Microbiol Methods*, **53**, 139–40.
- Byer, D. and K.H. Carlson, 2005, Real-Time Detection of Intentional Chemical Contamination in the Distribution System. *Am Water Works Assoc J* 97(7), 12.
- Cook, J. E., Roehl, R., Daamen, K. 2005, Decision Support System for Water Distribution System Monitoring for Homeland Security, Proceedings of the AWWA Water Security Conference, Oklahoma City, OK.
- Courtois, S., K. Sebti and Z. Do-Quang (2008) Universal concentration for large volumes of water samples before molecular detection of waterborne pathogens. Proceedings, Singapore International Water Week Conference, June, Singapore.



- Cunliffe, D.A. (2008) Emerging Enteric and Potentially Waterborne Pathogens in the Region. Proceedings, Singapore International Water Week Conference, June, Singapore.
- Daughton, C.G. and T.A. Ternes (1999) Pharmaceuticals and personal care products in the environment: agents of subtle change? *Environ. Health Perspect*, 107(6), 907.
- Grayman, W.M., R.A. Deininger, and R.M. Males (2001). Design of early warning and predictive source water monitoring systems, AWWA Research Foundation, Denver, 297 pp.
- Hall, J., A.D. Zaffiro, R.B. Marx, P.C. Kefauver, E.R. Krishnan, R.C. Haught and J.C. Herrmann (2007). On-line water quality parameters as indicators of distribution system contamination. *Am Water Works Assoc J* 99(1), 66.
- Hart, D.B., S.A. McKenna, K.A. Klise, V. Cruz and M. Wilson (2007). CANARY: A Water Quality Event Detection Algorithm Development Tool, in proceedings of: ASCE World Environmental and Water Resources Congress, Tampa, FL, May 15–19.
- Hasan, J., S. States, and R. Deininger (2004). Safeguarding the Security of public water supplies using early warning systems: A brief review. *J Contemp Water Res Educ*, 129, 27–33.
- Kirmeyer, G., N. Bazzurro and W. Grayman (2002). Case studies of online monitoring systems. In: *Online monitoring for Drinking Water Utilities*, AWWA Research Foundation, Denver, CO.
- Koerkamp M.K., M. van Wijlen (2008) Next generation sensors for detection of pesticides and E.coli in water. Proceedings, Singapore International Water Week Conference, June, Singapore.
- Kolpin, D.W., Furlong, E.T., Meyer, M.T., Thurman, E.M., Zaugg, S.D., Barber, L.B. and Buxton H. (2002) Pharmaceuticals, hormones, and other organic wastewater contaminants in U.S. streams, 1999–2000: A national reconnaissance. *Environ Sci Technol* 36, 1202.
- IonLife (2002) IonLife website (ionlife.org). “How safe is our water? The threat of terrorism” Jan. 31, 2002.
- Jones, O.A.H., Voulvoulis, N. and Lester, J.N. (2002) Human pharmaceuticals in the aquatic environment. *Environ Technol* 22(12), 1383.
- Loge, F.J., Thompson, D.E., & Call, D.R. (2002) PCR detection of specific pathogens in water: a risk-based analysis. *Environ Sci Technol* 36, 2754–9.
- McKenna, S.A., D. Hart (2008) On-Line Identification of Adverse Water Quality Events from Monitoring of Surrogate Data: CANARY Software. Proceedings, Singapore International Water Week Conference, June, Singapore.
- Öllers, S., Singer, H.P., Fässler, P. and Müller, S.R. (2001) Simultaneous quantification of neutral and acidic pharmaceuticals and pesticides at the low-ng/l level in surface waters. *J Chromatogr A* 911(2), 225.
- S-can (2008) S-can company website <http://www.s-can.at>. S-can GmbH, Vienna, Austria.
- Semard, G., Z. Do-Quang, A. Bruchet (2008) Screening of emerging contaminants in wastewaters using advanced GCxGC-TOFMS. Proceedings, Singapore International Water Week Conference, June, Singapore.
- van den Broeke, J., P.S. Ross, A.W.C. van der Helm, E.T. Baars, L.C. Rietveld (2007) Use of on-line UV/Vis-spectrometry in the measurement of dissolved ozone and AOC concentrations in drinking water treatment, Proceedings, IWA Automonet 2007.
- Weingartner, A. and F. Hofstaeder (2006) On-line monitoring networks for drinking water security of Karst water. *All About Karst and Water*, Vienna.
- WHO (2003) Emerging issues in water and infectious disease. World Health Organization, Geneva.

- Yong, C.K., I.K. Lao, R. Murthy, H.M. Ji, C.Y. Teo, Christophe Lay, H.H. Feng, W.T. Liu (2008) micro analysis system for water pathogen monitoring. Proceedings, Singapore International Water Week Conference, June, Singapore.
- Yongtao, Li, E.J. George, E.M. Hansen, J.J. Toma, M. Werner and P.D. Smith (2000) SPE Twin-PAL. Online in situ monitoring of semivolatile organic compounds in water. Proc. AWWA Water Quality Technology Conference, Salt Lake City, UT.

# THE USE OF DATA-DRIVEN METHODOLOGIES FOR PREDICTION OF WATER AND WASTEWATER ASSET FAILURES

DRAGAN A. SAVIC\*

*Centre for Water Systems, University of Exeter, North Park Road, Exeter, EX4 4QF, United Kingdom*

**Abstract.** The economic and social costs of pipe failures in water and wastewater systems are often large, emphasizing the need for development of replacement plans for critical pipes. These plans should balance investment with expected benefits in a risk-based management context. In addition to the need for a methodology for solving such a problem, analysts and water system managers need reliable and robust failure models for assessing network performance. In particular, they are interested in assessing how likely an asset is to fail and how to assign criticality to an individual asset. In this paper, pipe models are developed using a hybrid modeling technique, Evolutionary Polynomial Regression. This data-driven technique yields symbolic formulae that are intuitive and easily understandable by practitioners. The case studies involve failure model development for water distribution and wastewater systems in the UK and entail the collection of historical data to develop network performance indicators. By using Evolutionary Polynomial Regression, formulas for failures (bursts for water distribution and blockage and collapse events for wastewater systems) are obtained and their engineering interpretation is offered.

**Keywords:** water, wastewater, networks, assets, failure, modeling, risk

## 1. Introduction

Pipe failure in water distribution and wastewater networks imply a series of social, environmental and economic consequences often resulting in expensive repairs which are ultimately passed on to the customer. Therefore, there is a need to develop a process and methodology to robustly predict the failure

---

\* To whom correspondence should be addressed. Dragan A. Savic, Centre for Water Systems, University of Exeter, North Park Road, Exeter, EX4 4QF, United Kingdom; e-mail: d.savic@exeter.ac.uk

frequency of network assets. This can be used both in the business planning process to determine appropriate future investment strategies, and as part of proactive operational management.

The technical literature on water and wastewater network performance modeling reveals two main approaches. The first exploits technical expertise gained from the management of real networks and seeks to define a set of indicators shared by as many utilities as possible. Studies following this approach suggest a list of rationales for establishing whether a certain parameter can be considered as a Performance Indicator, PI (Alegre et al., 2000). The second approach aims at developing PIs from hydraulic (Cardoso et al., 1999) and asset performance (Savic et al., 2006, Berardi et al., 2005). These models are based on the analysis of existing company databases which archive data on pipe assets and preserve the historical records of failure events. The scope of such analyses is discovering patterns in asset data for describing pipe failures (e.g., sewer blockages or collapses and water distribution pipe bursts).

Water company asset and failure data sets tend to differ in both quality and quantity and are often stored in separate databases without adequate references to link them. Furthermore, the monitoring period is often short, which results in a small number of recorded failure events. This scarcity of historical data does not permit assessment of individual failure probabilities for each asset. An intuitive solution for this consists in aggregating pipes into homogeneous groups (Shamir and Howard, 1979). This way, the lack of data problem is overcome and unreliable information is averaged over groups. Pipe grouping allows also for the assessment of an individual pipe failure probability by assuming the same behavior for similar pipes. Once pipe groups have been defined, an effective modeling technique is needed to point out the most significant explanatory variables for describing the failure phenomenon. This paper presents the use of a novel hybrid data-driven modeling technique, Evolutionary Polynomial Regression, EPR (Giustolisi and Savic, 2006), to building mathematical models for pipe failure prediction, using the water company asset databases.

## **2. Evolutionary Polynomial Regression**

Numerical regression is the most powerful and commonly applied form of regression that provides a solution to the problem of finding the best model to fit the observed data (e.g. fitting a line/curve through a set of points). However, the form of a function (linear, exponential, logarithmic, etc.) has to be selected before the fitting commences. On the other hand, genetic programming uses a simple, but very powerful artificial intelligence tactics for computer learning inspired by natural evolution to find the appropriate mathematical model to fit a

set of points. The computer produces and evolves a whole population of functional expressions based on how closely each of them fit the data. The automated induction of mathematical models (descriptions) of data using genetic programming (Koza, 1992) is commonly referred to as symbolic regression (Babovic and Keijzer, 2000). Evolutionary Polynomial Regression (EPR) is a recently developed hybrid regression method by Giustolisi and Savic (2004, 2006) that integrates the best features of numerical regression (Draper and Smith, 1998) with genetic programming (Koza, 1992).

The key idea of the EPR is to start from a general polynomial family of functions (Giustolisi and Savic, 2006) and search first for the best form of the function, i.e. a combination of vectors of independent variables (asset attributes), and then to perform least-squares regression to find the adjustable parameters for each combination of inputs. To avoid the pitfalls of hill-climbing search methodologies, a global search algorithm is implemented for both the best set of input combinations and related exponents simultaneously, according to the user-defined objective function. EPR allows pseudo-polynomial expressions as in Eq. (1), allowing families of functions to be explored, such as:

$$\begin{aligned}
 \hat{Y} &= a_0 + \sum_{j=1}^m a_j (\mathbf{X}_1)^{ES(j,1)} \dots (\mathbf{X}_k)^{ES(j,k)} f\left((\mathbf{X}_1)^{ES(j,k+1)}\right) \dots f\left((\mathbf{X}_k)^{ES(j,2k)}\right) && \text{case 0} \\
 \hat{Y} &= a_0 + \sum_{j=1}^m a_j f\left((\mathbf{X}_1)^{ES(j,1)} \dots (\mathbf{X}_k)^{ES(j,k)}\right) && \text{case 1} \\
 \hat{Y} &= a_0 + \sum_{j=1}^m a_j (\mathbf{X}_1)^{ES(j,1)} \dots (\mathbf{X}_k)^{ES(j,k)} f\left((\mathbf{X}_1)^{ES(j,k+1)} \dots (\mathbf{X}_k)^{ES(j,2k)}\right) && \text{case 2} \\
 \hat{Y} &= g\left(a_0 + \sum_{j=1}^m a_j (\mathbf{X}_1)^{ES(j,1)} \dots (\mathbf{X}_k)^{ES(j,k)}\right) && \text{case 3}
 \end{aligned} \tag{1}$$

where,  $\hat{Y}$  is the vector of model predictions (e.g., number of failures),  $\mathbf{X}$  is the independent predictor vectors of asset attributes,  $\mathbf{X} = \langle \mathbf{X}_1 \mathbf{X}_2 \dots \mathbf{X}_k \rangle$ ,  $\mathbf{ES}$  is a matrix of exponents, and  $a_j$  are regression parameters.

From a system identification point of view (Ljung, 1999), EPR is a non-linear global stepwise regression approach providing symbolic formulae for the failure models. The stepwise regression feature of EPR originates from the Draper and Smith (1998) method aimed at selecting attributes for linear models considering the objective of fitting a model to data. Thus, the space of “linear solutions” is explored by changing the model input according to a set of rules and by evaluating model agreement with data. EPR generalizes the original stepwise regression method by considering non-linear structures, which are pseudo-polynomials. This means that the polynomial nature of the model assures a two ways relationship between each model structure and its parameters and,

consequently, the parameter estimation phase is cast as a linear inverse problem. Furthermore, the exploration of the solution space is performed using an evolutionary computing approach. Therefore, from an optimization standpoint, EPR can be classified as a global search method, working on a combinatorial problem which often does not have a unique solution (i.e., search space two dimensions is defined as a multimodal surface). This approach results in the evolutionary exploration of the solution space constrained to the non-linear models (the linear model is as special case) having a pseudo-polynomial structure and assuring linearity with respect to parameter estimation.

In comparison to other data-driven technique EPR could also be seen as an attempt to overcome some reported drawbacks of genetic programming (Koza, 1992; Babovic and Keijzer, 2000), as described in Giustolisi and Savic (2006). From a regressive standpoint, EPR has the following beneficial features not found in other data-driven techniques:

- A small number of constants to be estimated (helps avoiding over-fitting problems, especially for small data sets).
- A linear parameters estimation (assuring the unique solution is found when the inverse problem is well-conditioned).
- An automatic model construction (avoiding the need to preselect the functional form and the number of parameters in the model).
- A transparent form of the regression characteristics makes model selection easier, i.e., the multi-objective feature allows selection not only based on fitting statistics.

### 3. Case Studies

#### 3.1. WATER DISTRIBUTION SYSTEM ANALYSIS

The data in this case study were available at the pipe level for the period 1986–1999 and contain both asset information and recorded bursts. The database used here refers to one of the 48 water quality zones (WQZ) within a UK water distribution system. For each individual pipe, the database contains information on pipe diameter, material, year laid, length, number of properties supplied and the total number of bursts recorded during the 14-year monitoring period. Basic statistics of this data are shown in Table 1. Unfortunately, neither of the criteria adopted for designing this water quality zone nor the network map were available for this study. Furthermore, only the total number of bursts is known (i.e., the timing of each burst is unknown). Lack of the above information prevents verification of the potential existence of spatial and temporal clusters in the burst data.

TABLE 1. Pipe features in WQZ

Features	Values
Year the pipe was laid	From 1910 to 1999
Diameter	From 32 to 250 mm
Length	Total 172,984 m
Supplied properties	Total 19,494
Number of pipes	3,669
Number of bursts	354

Table 1 shows that, as in the majority of water distribution systems, the number of failures recorded during the monitoring period corresponds to less than 10% of the total number of pipes. Furthermore, several pipes failed more than once over the same time period. Therefore, mains failures occur on a small minority of mains and involve a significant random element which cannot feasibly be represented by pipe attributes, so it is necessary to carry out this analysis on groups (*classes*) of similar pipes, if a statistically robust model is to be generated.

Only four fields describing pipe features have been considered for modelling. These are *age* ( $Aep$ ), *diameter* ( $Dp$ ), *length* ( $Lp$ ) and number of *properties* ( $Prp$ ) supplied, all available at the pipe level. For each diameter-age class, the total number of recorded burst events ( $Brt$ ), the sum of pipe lengths ( $Lt$ ), the sum of properties supplied ( $Prt$ ) and the total number of pipes in the class ( $Np$ ) have been computed. Furthermore, to define a significant value of age and diameter for each *class*, the length weighted mean of relevant variables was computed as shown in Eq. (2). The values computed are the equivalent age ( $Ae$ ) and the equivalent diameter ( $De$ ).

$$Ae_{class} = \frac{\sum_{class} Lp \cdot Aep}{Lt}; \quad De_{class} = \frac{\sum_{class} Lp \cdot Dp}{Lt} \tag{2}$$

Once applied, the (single) EPR run returns a set of burst prediction models as a Pareto set, trading off model parsimony with fit to the observed data. The models obtain in this case study demonstrate that burst occurrence depends only on the following three (out of five) candidate input variables (asset attributes): the equivalent pipe class age  $Ae$ , the equivalent pipe class diameter  $De$  and the total pipe class length  $Lt$ . The inverse dependence between diameter and burst occurrence is confirmed by all models as well as is the direct dependence on the class length and equivalent age. Bearing in mind the above discussion and incorporating engineering insight into the problem, the following model is selected:

$$BR = 0.084904 \cdot \frac{AeLt}{De^{1.5}} \quad (3)$$

The above model fits the observed data with  $CoD = 0.822$ . The chosen model highlights that, for the analysed water distribution system, pipe age and diameter are important, but so too is pipe length. This confirms previous findings in most of the literature on the subject. In particular, the linear relationship between the number of pipe bursts and pipe age should be ascribed to the fact that the system is (on average) experiencing a wear-out phase on the so-called bathtub curve (Andreou et al., 1987a, b; Kleiner and Rajani, 2001; Watson, 2005). As reported previously (Kettler and Goulter, 1985; Zhao, 1998), pipe diameter plays an important role too, indicating that smaller diameter pipes are often laid less carefully than larger ones and thus exhibit a higher failure probability under external stresses. Equation (3) confirms that the longer is the pipe the higher is the number of bursts.

### 3.2. WASTEWATER SYSTEMS ANALYSIS

The EPR methodology is tested here on a case study consisting of two real UK sewer systems (denoted here as Case 1 and Case 2). Available data consists of: (1) two types of recorded sewer failures (collapses and blockages) recorded during a 5 year monitoring period and (2) pipe data (material, size, age, etc.). Both system datasets contain information on pipes with and without recorded failures. As expected, the number of recorded blockages (2,299 and 2,540 for systems 1 and 2, respectively) largely exceeds the recorded collapses (47 and 37 for systems 1 and 2, respectively). Also, all recorded data is available at the grouped pipe level only; that is, 824 (system 1) and 395 (system 2) polygon shape areas (or, simply, polygons). Each polygon is described by 44 attributes (fields) in the database. The first category of polygon data contains polygon area, number of associated properties, length of main roads and area of “hazardous” soil (e.g., clay). The second category of polygon data refers to asset features described by the mean sewer age in the area, namely gradient and cover depth which are in turn represented by three sub-classes describing the length of sewers with “low”, “normal” and “high” attribute values. For sewer gradients, the classes are “less than 0.01”, “between 0.01 and 0.05” and “greater than 0.05”. In the case of cover depth, the relevant thresholds are 0, 1.5 and 3.0 m, respectively. Sewer nominal diameter is also reported as three sub-classes corresponding to the “less than 350 mm”, “between 350 and 650 mm” and “greater than 650 mm”. The third category of polygon attributes refers to asset condition and reports the length of pipes surveyed by means of CCTV, the length of pipes exhibiting the worst operational (ocg) and service (scg)



condition grade (e.g., ocg and scg attributes equal to 4 or 5), the length of the so-called “Section 24” sewers (typically old, small diameter sewers close to houses) and the length of pipes which experienced surcharges during the monitoring period. Additional information about polygon data available can be found in Berardi et al. (2006). Data pre-processing: As expected, the quality of available data was not ideal. A number of inconsistencies were identified. As a consequence of preliminary analysis, 87 polygons in system 1 and 94 polygons in system 2 were omitted from further analyses.

Once the cleansing of two data sets was completed different attributes were enlisted as potential explanatory factors for modelling sewer blockage and collapse. Such a selection was driven by physical insight into the mechanisms leading to different types of failure (collapse and blockage). For modelling blockage, sewer cover depth is neglected in favour of gradient since this is more likely to explain the propensity to obstruction by directly addressing hydraulic conditions. Different mechanisms were identified for modelling sewer collapse. They are caused mainly by the transmission of surface loads and are thus better explained by cover depth than by sewer gradient. Finally, all other available attributes were chosen as possible explanatory factors for both collapse and blockage.

TABLE 2. Collapse prediction models identified by EPR

Model structure	$a_1$ – Case 1	$a_2$ – Case 1	CoD – Case 1
	$a_1$ – Case 2	$a_2$ – Case 2	CoD – Case 2
$CL = a_1 \cdot \frac{s24^2 \cdot ocg^2}{A^2}$	0.0450	–	0.45
	0.0133	–	0.43
$CL = a_1 \cdot \frac{s24^2 \cdot ocg^2}{A^2} + a_2 \cdot dh$	0.0345	0.0080	0.57
	0.0124	0.0108	0.50
$CL = a_1 \cdot \frac{s24^2 \cdot ocg^2}{A^2} + a_2 \cdot Age \cdot dh$	0.0318	0.0001	0.62
	0.0124	0.0001	0.49

Tables 2 and 3 report optimal one- and two-term polynomial model structures identified by the EPR for describing the number of collapses (i.e., CL) and blockages (i.e., BL) in systems (i.e., cases) 1 and 2. In addition to this, the CoD value is reported for each model shown. The following symbols are used in the tables: s24 is the length of “Section 24” sewers; ocp is the percentage of pipes surveyed by CCTV with the highest (worst) operational condition grade; ocg and scg are the lengths of pipes showing the worst operational and service condition grade; dl and dh denote “low” and “high” cover depth classes; Dl and Dm denote “low” and “normal” diameter classes; A is the polygon area; Haz is

the area of hazard soil in the polygon;  $s$  is the length of pipes which experienced surcharge during the monitoring period.

TABLE 3. Blockage prediction models identified by EPR

Model structure	$a_1$ – Case 1	$a_2$ – Case 1	CoD – Case 1
	$a_1$ – Case 2	$a_2$ – Case 2	CoD – Case 2
$BL = a_1 \cdot s24$	9.7435	–	0.86
	17.9908	–	0.69
$BL = a_1 \cdot s24 + a_2 \cdot \text{Haz}$	9.6002	22.9537	0.86
	14.9179	28.7993	0.76
$BL = a_1 \cdot s24 + a_2 \cdot \text{DI}^2$	9.7435	0.0000	0.86
	17.4793	0.0082	0.71

From the tables, it is clear that the prevalence of ‘S24’ sewers is a strong indicator of the likelihood of collapses and blockages. It is also worth noting that the same first polynomial term is reported in all three collapse models shown in Table 2. This term contains the following three significant variables: length of Section 24 sewers ( $S24$ ), length of sewers with the worst operating condition grade ( $ocg$ ) and total polygon area ( $A$ ). Relatively low values of CoD for collapse models can be explained by the low number of collapse events recorded in the systems being studied (which is an order of magnitude lower than the polygons).

Similarly to collapse models, Table 3 shows that ‘S24’ appears as a first term in all three blockage models. It is interesting to note that it explains 86% of variation (case 1) and 69% of variation in blockages. However, unlike in the case of collapse models, the addition of other input variables (e.g., Haz or DI) improves the model fit in Case 2 only (see blockage models in Table 3). This is a consequence of the lower quality of Case 2 data which, incidentally, was recorded by two separate companies during the monitoring period. The presence of unreliable/biased information in the second dataset leads to the selection of variables like Haz or DI which are not strictly needed for describing the physical phenomenon present in Case 1. Therefore, additional explanatory variables improve the model fit in Case 2 only.

#### 4. Conclusions

Water and wastewater utilities recognise increasing pressure to develop a thorough risk-based understanding of its networks and the linkages between

condition, performance, service and the likely impact of interventions. Deterioration of underground pipes is a complex problem in which many unknown factors combined with random influences combine to make deterministic approaches to model deterioration impossible. Therefore, new approaches are required that allow the probability of failure to be estimated.

A data-driven modelling strategy using Evolutionary Polynomial Regression has proved successful in the case studies. However, it was not possible to model pipe deterioration at a pipe level using data already available (due to both low quality and availability of data). A pipe grouping approach (into ‘homogeneous’ classes) to modelling pipe failure performance has been described in this study and has been demonstrated on real water distribution and sewer networks.

The development of the models for the case studies required data processing to both populate missing data fields and define new asset attributes. This task accounts for a significant proportion of process to develop predictive pipe failure models and influences the accuracy of the models.

## References

- Alegre, H., Hirnir, W., Baptista, J.M. and Parena, R. (2000). Performance Indicators for Water Supply Services. Manual of Best Practice. IWA Publishing, London.
- Andreou, S.A., Marks, D.H., and Clark, R.M. (1987a). A new methodology for modelling break failure patterns in deteriorating water distribution systems: Theory. *Advances in Water Resources*, 10, 2–10.
- Andreou, S.A., Marks, D.H. and Clark, R.M. (1987b). A new methodology for modelling break failure patterns in deteriorating water distribution systems: Applications. *Advances in Water Resources*, 10, 11–20.
- Babovic, V. and Keijzer, M. (2000). Genetic programming as a model induction engine. *Journal of Hydroinformatics*, 2(1), 35–61.
- Berardi, L., Savic, D.A. and Giustolisi, O. (2005). Investigation of burst-prediction formulas for water distribution systems by evolutionary computing. *Proceedings of the Eight International Conference on Computing and Control for the Water Industry, CCWI2005*, Savic, D.A., Walters, G.A., King, R. and Khu, S-T. (eds.), University of Exeter, UK, Vol. 2, pp. 275–280.
- Berardi, L., Kapelan, Z., Savic, D.A., Giustolisi, O. (2006). Modelling Sewer Performance Indicators, 7th International Conference on Hydroinformatics, HIC 2006, Nice, France, Gourbesville, P., Cunge, J., Guinot, V. and Liong, S.Y. (eds.), Research Publishing, Vol. 4, pp. 2829–2836, ISBN 81-903170-1-6.
- Cardoso, M.A., Coelho, S.T., Matos, J.S. and Matos, R.M. (1999). A new approach for diagnosis and rehabilitation of sewerage systems through the development of performance indicators. *Proc. of 8th International Conference on Urban Storm Drainage, Sydney*, Vol. 2, 610–617.
- Draper, N.R. and Smith, H. (1998). *Applied Regression Analysis*. Wiley, New York, USA.
- Giustolisi, O. and Savic, D.A. (2004). A Novel Genetic Programming Strategy: Evolutionary Polynomial Regression. *Proc. of Hydroinformatics 2004*, Liong, S.-Y., Phoon, K.-K. and Babovic, V. (eds.), World Scientific, 1, 787–794.

- Giustolisi, O. and Savic, D.A. (2006). A Symbolic Data-driven Technique Based on Evolutionary Polynomial Regression. *Journal of Hydroinformatics*, 8(3), 207–222.
- Kettler, A.J. and Goulter, I.C. (1985). An analysis of pipe breakage in urban water distribution networks. *Canadian Journal of Civil Engineering*, 12(2), 286–293.
- Kleiner, Y. and Rajani, B.B. (2001). Comprehensive review of structural deterioration of water mains: Statistical models. *Urban Water* 3(3), 121–150.
- Koza, J.R. (1992). *Genetic Programming: On the Programming of Computers by Means of Natural Selection*. MIT Press, Cambridge, MA, USA.
- Ljung, L. (1999). *System Identification: Theory for the User* (second edition). Prentice-Hall, Englewood Cliffs, NJ.
- Savic, D.A., Giustolisi, O., Berardi, L., Shepherd, W., Djordjevic, S. and Saul, A. (2006). Modelling sewers failure using evolutionary computing. *Proceeding of ICE, Water Management*, 159(2), 111–118.
- Shamir, U. and Howard, C.D.D. (1979). An analytic approach to scheduling pipe replacement. *Journal American Water Works Association*, 71(5), 248–258.
- Watson, T. (2005). A hierarchical Bayesian model and simulation software for water pipe networks, PhD in Civil Engineering, The University of Auckland, Auckland.
- Zhao, J.Q. (1998). Trunk Sewers in Canada. APWA International Public Works Congress Seminar Series, American Public Works Association, Las Vegas.

# PROACTIVE CRISIS MANAGEMENT OF URBAN INFRASTRUCTURE

## EXECUTIVE SUMMARY OF THE COST ACTION C19

J. RØSTUM\*

*COST C19 Chair, SINTEF Building and Infrastructure,  
Kløbuvegen 153, 7465 Trondheim, Norway*

**Abstract.** Modern developed societies are heavily dependent on urban infrastructures like road, railway, gas, electricity, and water supply. The breakdown of one of such critical infrastructures may cause serious consequences for the safety of the citizens. Managing the safety and security of these infrastructures taking into account prevention and preparedness, crisis interventions and restoring normal conditions using optimised and risk based approaches are important. Five years ago, a project on Proactive Crisis Management of Urban Infrastructure was submitted to the European Union under the COST programme. As a consequence, the COST C19 Action was created. This paper presents the main conclusions and lessons learned from the project.

**Keywords:** crisis management, critical infrastructure, COST programme

***Some key conclusions and recommendation from the action:***

*“There is need for better methods to address the complex interactions of urban infrastructure systems, physical environment, level of services and social factors.”*

*“Improved communication between different stakeholders is crucial for efficient risk management”*

*“There are needs for better understanding of risk within the society”*

*“...poor application of risk based methods within all phases of the crisis management cycle”*

*“Traditionally, engineers and practitioners are better trained for solving deterministic problems. There are needs for better training including uncertainty in problem solving”*

*“Systematic learning from past events/accidents gives valuable information both to the involved parties but also to similar institutions elsewhere.”*

\* To whom correspondence should be addressed. Jon Røstum, COST C19 Chair, SINTEF Building and infrastructure, Kløbuvegen 153, 7465 Trondheim, Norway; e-mail: jon.rostum@sintef.no

## 1. Background

Urban infrastructures like transport, railway, gas, electricity, and water supply are vital to a modern society, but are exposed to hazards which can have a critical influence on their operation. There are also interdependencies between the different infrastructures. For instance, a disruption in the electricity supply can also impact traffic services and water distribution. Managing the safety and security of these infrastructures taking into account prevention and preparedness, crisis interventions and restoring normal conditions using optimised and risk based approaches are important. Urban infrastructure is highly vulnerable to earthquakes, political conflicts, terrorism, droughts, floods, and other natural and societal disasters. Failures of some of these structures, such as water supply and other pipeline systems, roads and bridges, cable communications and energy supply may have major impacts in terms of human lives and economic losses. Even if an increased research effort within a single sector, e.g. transportation, may push forward the safety knowledge, overall safety research would gain more benefit from mutual co-operation involving other sectors as well. The scientific challenge is therefore more connected to the interaction of different sectors, and an increased co-ordination of the effort in safety research is preferred in the future.

## 2. Objective

The main objective of the action is to define current knowledge gaps and identify possible measures to improve the multi-disciplinary research on urban infrastructure vulnerability and handling of crisis situations. Additional objective of the action is to present a state-of-the-art on current know-how demonstrating its application in direct relation to crisis situations.

The work in C19 covers most of the phases in the risk-/crisis management wheel as illustrated in Figure 1, from *prevention, preparedness, warning and alarm, response, limiting the extent of loss and recovery*.

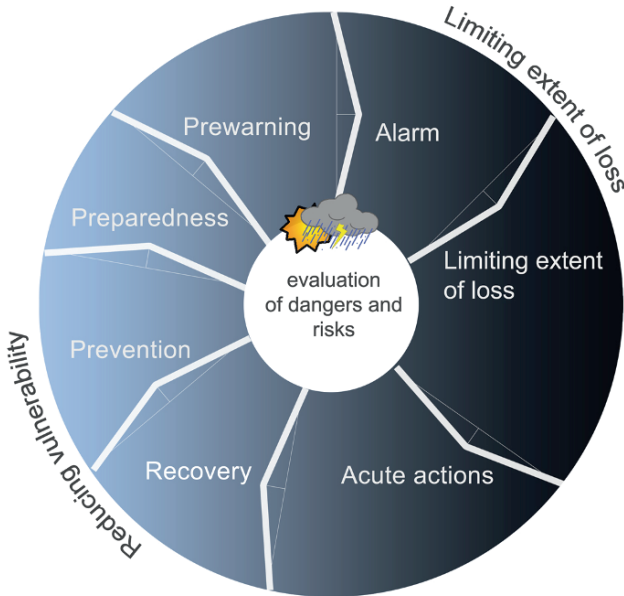

Inspired by the diagram of "Integrated risk management". (Federal Office for Spatial Development ; Federal Office for Water and Geology ; Swiss Agency for the Environment, Forests and Landscape (2005)).

Figure 1. Risk management cycle (Illustration by Marion Penelas)

### 3. Scope

The members of the actions represent 15 countries in Europe (Czech Republic, Finland, Germany, Italy, Netherlands, Norway, Portugal, United Kingdom, France, Switzerland, Serbia Montenegro, Slovenia, Cyprus, Iceland and Romania) and with expertise covering different infrastructures (road and railway transportation, water and wastewater, electricity supply, gas) and generic risk experts. In addition to this also invited experts have joined many of the meetings and given valuable contribution.

The work in the action has been organised in the following working groups (WG):

- WG A: Risk analysis and risk management with focus on theories, methods and tools for risk assessment
- WG B/C: Planning of handling of acute crisis

One important task of the action – and this is also the strength of the action – is the networking among different expert representing different disciplines/urban infrastructures. Even though each sector/discipline is unique and has its own challenges, learning from other sectors provides useful knowledge and insight about our complex integrated urban infrastructure.



A crucial part of the work has been the organisation of a series of local/national conferences/seminars. These conferences have addressed exchange of knowledge between urban infrastructure sectors, i.e. energy, traffic water, transport. The conferences have had a local/national aspect where case studies and field trips have been important and valuable for the knowledge/ dissemination process from the action. The documentation from all seminars/ conferences is available at the homepage of the action, [www.COSTC19.eu](http://www.COSTC19.eu) and the most important documents will in the future also be available from the homepage of COST ([www.cost.org](http://www.cost.org)). The documentation includes description of good cases illustrating the use of methods and lessons learned from previous crisis.

There are few attempts on developing a risk assessment methodology with an interdisciplinary perspective i.e. crosswise different infrastructures. As a part of the action a prototype tool (Figure 2) for identification and estimation of risk related to critical infrastructure has been developed and briefly tested. The method primarily focuses on the identification and estimation of the risk. The tool can be used for analysing risk and vulnerabilities between different sectors/ infrastructures and the interrelationship between the urban infrastructures. The risk is assessed and plotted directly into standard risk matrixes.

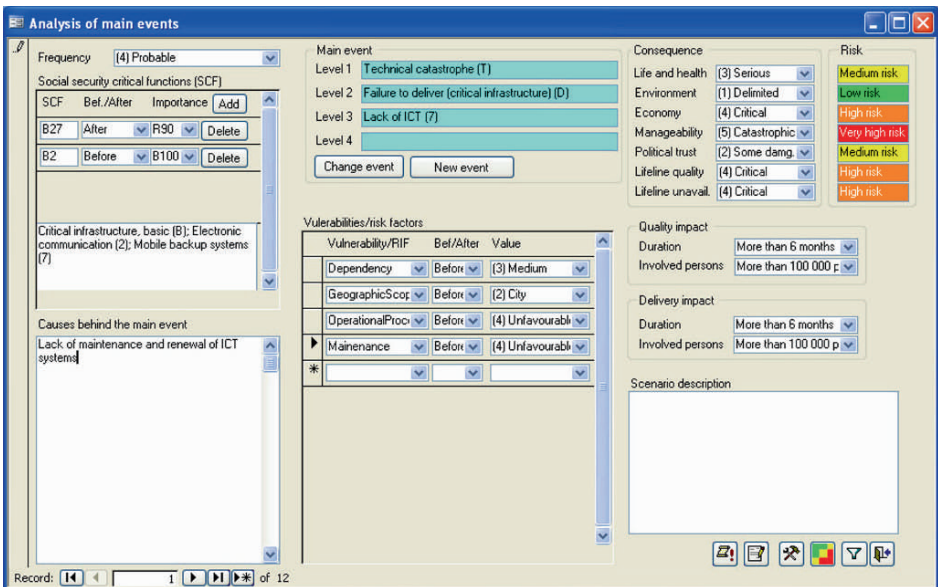

Figure 2. Prototype tool for risk analysis of urban infrastructures

C19 has published a common report (Røstum et al., 2008). The final report is divided into two main parts. The first session deals with generic methods for risk analysis with illustrative cases where some of the methods have been



applied on different infrastructures. The second part of the report, deals with acute crisis and the handling thereof and is also followed by case studies.

#### **4. Main Conclusions, Gaps and Recommendations**

The work in COST action C19 has identified knowledge gaps and future research needs. The identified gaps and recommendations result from questionnaires, case studies, papers and discussions within COST C19. The following gaps and recommendations are identified:

- The results from the questionnaires indicate poor application of risk based methods within all phases of the crisis management cycle. Application of risk based methods might contribute for risk managers to achieve better solutions.
- The interactions of urban infrastructure systems are physically very complex. There is need for better methods to address the complex interactions of urban infrastructure systems, physical environment, level of services and social factors.
- Of increasing importance is the exchange between different infrastructure-sectors and different utilities to (i) communicate the interdependence of infrastructure systems and (ii) to transfer knowledge from those sectors/utilities which already successfully apply risk based methods (e.g. oil industry).
- Circulation of information and mutual understanding (e.g. between experts and concerned citizens) are crucial for efficient risk management.
- Dealing with public utilities risks needs a comprehensive approach embedded in safety policy which requires a strong political support, involvement of different stakeholders, appropriate legal framework, institutional setup and proper funding. Furthermore appropriate strategy implementation calls for scientifically based data, monitoring and evaluation procedures (performance targets, indicators etc) and capacity building within the organisation and between organisations e.g. systematic creation of networks of resource persons (engineers, scientists, planners, and emergency managers) able to intervene in crisis as interdisciplinary groups.
- There should be more attention paid on the different scales where risks should be managed. Planning can raise different challenges according to the time and scales that are involved and these challenges must be tackled simultaneously.
- Liberalisation, privatisation and re-organisation have impacts on global safety level inside public utilities which should be properly analysed and assessed.

- Some recent tendencies such like global warming/security linked to terrorism should lead to a rethink of the traditional ways of dealing with risk management of urban infrastructure.
- Traditionally, engineers and practitioners are better trained for solving deterministic problems. There are needs for better training including uncertainty in problem solving.
- Rare events are more difficult to motivate for further investments and accurate decisions on risk compared to daily problems.
- It is difficult to demonstrate the cost-effectiveness or effect of most risk reducing measures.
- Special attention has to be paid to the role of human behaviour with respect to (i) leading to crisis situations and (ii) as reaction within crisis situations. Regarding the state of knowledge on human failure causes and spreading and its awareness in practice, there seems to be still a long way to go describe or predict human behaviour as function of different influencing factors.
- There are needs for better understanding of risk within the society. More awareness for possible critical events and the following consequences. One possible measure for improving the situation might be to put emphasis on education programs including training procedures for facing risk situations.
- Integrated management of different types of resources (land, water etc.) is important for assuring a sustainable solution able to handle extreme events.
- Systematic learning from past events/accidents gives valuable information both to the involved parties but also to similar institutions elsewhere. Even though the framework and constrains differ from site to site and country to country, some lessons learned can be concluded. The accident investigation should be carried out in a systematic way using appropriate methods/techniques.
- Integrated risk management between different types of infrastructures is important for analysing interdependencies and possible domino effects of hazardous events. Systematic prioritisation within each sector is normally taken into account, but less focus on the relationship between sectors.
- Appropriate data is crucial for making decisions in the context of risk management. This includes data collection for making good and reliable estimates for preparedness but also for processing during and after events. Systematic collection of data should be part of daily operations.

## **5. Acknowledgements**

This paper presents the experiences and lessons learned during the 4 years of the COST Action C19. The author, as chair of the Action, acknowledges the COST Office for making this Action possible, as well as to the working groups chairs and to all COST C19 members, who actively contributed to the success of the Action. Acknowledgements are also due to the invited experts who participated in the seminars, sharing their knowledge and experiences with the group.

## **Reference**

Røstrum, J., November, V., and Vatn, J. (2008). Proactive Crisis Management of Urban Infrastructure, final scientific report of COST Action C19, COST Urban Civil Infrastructure Development Domain, ISBN 978-82-536-1003-0, February 2008.

# WATER POLLUTION IMPACT ON IMMUNE STATUS OF HUMAN ORGANISM AND TYPICAL EPIDEMIC PROCESSES: MATHEMATIC MODEL, OBTAINING RESULTS, THEIR ANALYSIS AND PROPOSALS TO MANAGE RISK FACTORS

BORYS SKIP\*

*Chernivtsi National University, Chemistry Faculty, Kotsubinsky str.2, Chernivtsi, 58000, Ukraine*

**Abstract.** Application of pollutant dispersion modelling from settlers in aquiferous strata, interpolating procedure for concentration profiles calculation of dominant pollutants for real data of wells and analysis of the results of water pollution influence as a contact environment on the simple kinetic epidemic process of water-borne infectious with presence groundwater pollution from settlers taking into account immune system depression by pollutants is the focus of the paper. On the basis of the study effective environment activity can be proposed.

**Keywords:** pollutant dispersion modelling, groundwater pollution, immune system, water-borne infectious

## 1. Introduction

Ecological and epidemiological situation in Ukraine is believed to be unfavourable that is dependable on the quality of water that does not meet the standards for the majority of bodies of water. Observation after the dynamics of quality of surface and ground waters indicate the tendency of increase of number of sites where water samples were taken with maximum acceptable value exceeding ten and a number of cases with extremely high biological pollution of water at the sites.<sup>1-4</sup>

Higher level of contaminants has adverse affect on people's health, especially that of children, worsens the epidemiological situation in the area.

---

\* To whom correspondence should be addressed. Borys Skip, Chernivtsi National University, Chemistry Faculty, Kotsubinsky str.2, Chernivtsi, 58000, Ukraine.

The objective of the study is to produce a mathematical model of epidemiological situation of a place during flood, for example, taking into consideration both concentration values and types of pollutants in drinking water and seasonal temperatures and humidity.

Settlers of a distillery company and a village of Revno were chosen as an object for our model. As a result of filtration without pressure through layers of alluvium the filtrate is mixed with ground waters and is carried together with it.

Considerable part in chemical composition formation is played by impermeable bedrock with which water is contacting filtering and dissolving some minerals. Out of organic substances that come from outside, we would mention humic acids, considerable part of which is in colloidal state and is washed out by water. Iron compounds are found in natural ground waters quite often, and chemical transition of iron into a solution can take place under the action of oxygen or oxidisers or acids (carbonic, organic). It is characteristic for the area around the village of Revna.

## 2. Assumptions

Dispersion of water stratum pollutants was calculated according to solid residue (31.4 g/l),  $\text{Fe}^{2+}$ ,  $\text{Mn}^{2+}$ ,  $\text{NH}_4^+$  in a settler. We disregarded changes in the ground water level as well as the decolmatage process of the filtering layer of rock except in case of virtual experiment of the influence of the height of filtration layer on the speed of filtration.

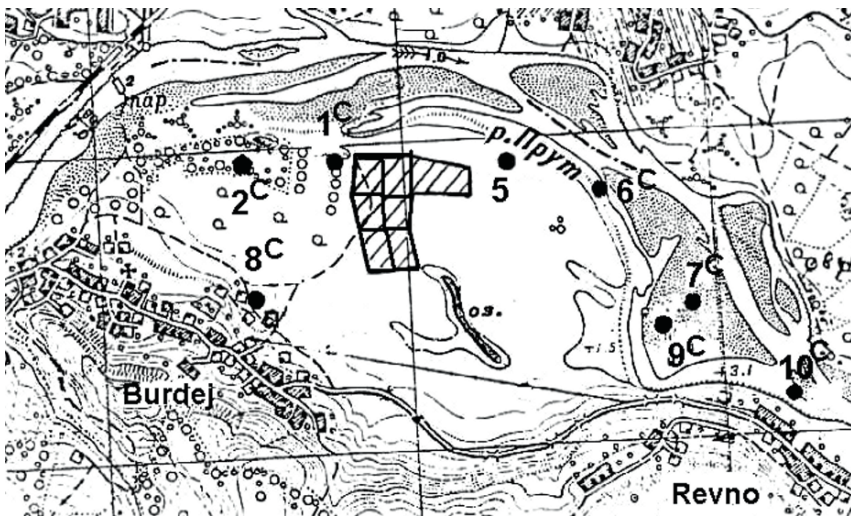

Figure 1. Map of the area around the settler. Storage ponds are marked by slanting lines, the wells are marked with upper index<sup>C</sup>

The basis for dispersal of substances calculations is the equation of nonstationary convectively diffuse mass transfer.<sup>4</sup>

Location of test bores, filtration fields, wells, and villages are given at Figure 1.

A short analysis of project documentation is worth to be done.<sup>5</sup> It illustrates the most polluted waters of modern alluvium deposits of the Prut river meadows and the waters of upper quaternary alluvial deposits of the first and second floodplain terraces where the settler is and the pollution is of local character.

### 3. The Results and Discussion

Comparing the results of analyses and data of modelling enables us to consider the availability of convective flow with perpendicular line of wells component  $2^C-1^C-5^C-6^C$  and additional places of groundwater discharge, most evidently within  $5^C-6^C-7^C$ . Comparing the maps of 2002 and 1994, we can see that in the bed of the Prut river on the marked area at the discharge point on 2002 map we see appendix peninsula and the test well  $6^C$  is in the river bed.

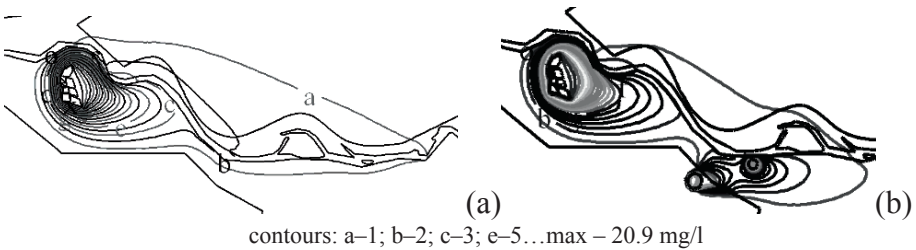

Figure 2. Profiles of scattering (a)  $Fe^{2+}$  ions, (b) with hypothetical wells on the slope of the hill and profile of  $NH_4^+$  scattering

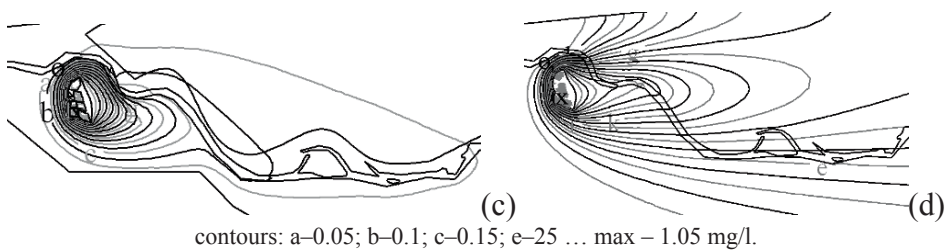

Figure 2. Profiles of scattering (c) influence of river bed on the concentration field, and (d) without influence of river bed on the concentration field

Model calculations fit with the analyses data. Deviation among model and experimental results is stipulated by the deposits of minerals that need

additional consideration in the model, e.g. by additional local wells as shown at Figure 2b. Exceeding mineralization level of  $>2$  g/l across and along the flow covers the area with deformed ellipse with 1,240 m along minor axis and 2,000 m along major axis of half ellipse of scattering. According to the map, the distance to the village of Burdey along the straight line from the perimeter of a settler that is covered with water is 325 m, so the mineralization that is caused by the settler equals  $2.5 \cdot 10^{-4}$  g/l that is lower from background mineralization. As far as the village of Revno is concerned, the concentration of the main components for the village cannot make a considerable impact on the level of pollution.

Increased level of nitrates at point 10<sup>C</sup> is 35 mg/l, at point 9<sup>C</sup> is 11.36 mg/l, compared with point 7<sup>C</sup> which is 4.77 mg/l that allows us to suppose that the direction 7<sup>C</sup>–9<sup>C</sup>–10<sup>C</sup> indicates the source of pollution on Revno slope.

Availability of considerable amount of nitrates in the samples is caused by sufficient aeration of water stratum. It indicates that the water stratum is not deeply set in the bedrock and infiltration of waste products of cattle farming.

Taking into consideration the fact that the sources of water in the village of Revno are on the height of more than 5 m above the water level of the Prut river, the hypothesis of water infiltration into water stratum due to infiltration from the riverbed of the Prut river by pressure has no ground to be true.

To establish the distribution of typical pollutants by means of interpolation we build the fields of ion concentration  $\text{Fe}^{2+}$ ,  $\text{Mn}^{2+}$ ,  $\text{NH}_4^+$ .

We can see that pollution trail is directed into the direction of well #2 and this direction indicates the local source of pollution. This trail overlaps with concentration field of a settler and that of increased level of nitrates on Revno slope where the waters contain organic substances that facilitate washing out of heavy metals from soils. Thus we can trace secondary pollution of water stratum as a result of local well functioning, and the flow from cattle farming.

Bearing in mind that the directions of groundwater flows as a rule coincide with the current of the nearby river, and there is a water drain from adjoining hills, there is no filtration under pressure on the slope and settlers cannot provide high concentrations of pollutants that were measured by metres.

Considerable increase in maximum acceptable value of resulting pollution levels in 10–25 times is noticeable in test wells #1–5, we can single out in a separate group taking into account the composition of bedrocks and the ones under the riverbed.

Distribution of the  $\text{Fe}^{2+}$  contents in a group of wells #9, 10, 11, forms the direction to the river Prut. Wells #8–11 of the other group are situated on the village of Revno slope therefore the pollution of this water bearing layer from the settler via groundwaters under the river Prut is unlikely. To prove this we can see that the wells #14, 11, 10 have increased levels of  $\text{Fe}^{2+} + \text{Fe}^{3+}$  which is



stipulated for the wells similar chemical properties of bedrocks and the map of soils confirms the deposits of these components which are washed out due to unestablished factors, and the check of this assumption supports high possibility of such a situation (Figure 2b).

We have established by the analysis that water intake for the village of Revno is done from two water bearing strata. The highest level of pollution is caused by local source near well #2 which is characteristic for the first group of wells. Another source of pollution is possible to occur on the slopes of Revno hill.

Waters of the water stratum are used for water supply to the city of Chernivtsi and local residents for their needs.

Let's consider most typical epidemic processes (we do not claim to fully all the cases and courses of diseases), e.g. diarrhoea when the population uses low quality water, including during flood period.

In current calculations the speed of any infection and reinfection is proportional to the resulting function of risk which, in its turn, depends on the immunity of the body, i.e. climatic conditions, quality of water and pathogenic factors caused by the flood.

One of the ways to assess risks of non carcinogenic illnesses is given in.<sup>6</sup> Composition of water pollutants is as follows: nitrates, nitrites, ammonium, ions of iron, ions of manganese. To simplify the calculations we take the same concentrations of the ions for all the inhabitants of the village. We discuss the worst ecological situation when the pollution levels by the above mentioned ions is maximum according to water samples taken during analyses. Virtual agent in our model is represented by one pathogenic pseudospecies.

The dynamics of number of corresponding groups of population is given at Figure 3.

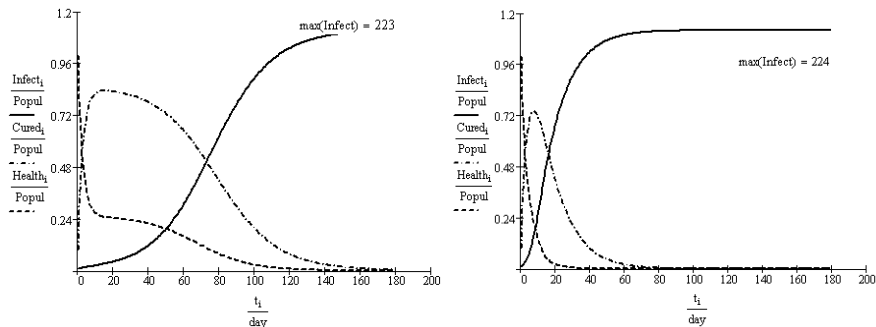

Figure 3. The dynamics of communicable diseases in the village of 225 people. Normalized values



With the increase of drinking water pollution we observe the decrease of time when the epidemic is spread with maximum speed and the time to recover is increased (Figures 3a, b).

Thus, the increase of pollution level in drinking water raises the risk of diseases and number of contagiously ill people that is transmitted by drinking water as a result of decrease of resistance of the body to infections. We can manage the risk by taking prophylactic and information measures that are taken into account in our model by a specific parameter, and therefore we can evaluate quantitatively the effectiveness of the measures.

## References

1. Strolberg F.V., 2000, City Ecology. Handbook, Kiyev, Libra, 464 p. (in Russian)
2. Vladimirov A.M., Kyahin U.I., Matvejev L.T., Orlov V.G., 1991, Environment Protection, Gidrometeoizdat Leningrad. 424 p. (in Russian)
3. Klyachkov V.A., Apelcin I.Je., 1971, Water Treatment, Moscow. Strojizdat. 579 p. (in Russian)
4. Strashkraba M., Gnauk A., 1989, Freshwater Ecosystems. Mathematic Modeling, Moscow. Mir, 376 p. (in Russian)
5. Report on research of settler impact on environment in area around the villages of Revna and Burdej. Lviv.: Nadra (1995). (in Ukrainian)
6. Rinehart W.E. and Hatch T., 1964, Concentration-time product (Ct) as an expression of dose in sublethal exposures to phosgene. Am Ind Hyg Assoc J 25, 545–553

# RISK ASSESSMENT OF WATER POLLUTION DRIVEN BY RANDOM CURRENTS

JACQUES GANOULIS \*

*UNESCO Chair and Network INWEB: International Network of Water/Environment Centres for the Balkans, Department of Civil Engineering, Aristotle University of Thessaloniki, 54124 Thessaloniki, Greece, <http://www.inweb.gr>*

**Abstract.** The influence of wind-induced currents on environmental water quality is investigated using mathematical modelling and risk analysis. Data from current meters of randomly varying wind-generated water currents and computerised mathematical codes are used to simulate the fate of pollutants and the risk of water pollution. The results of simulations are useful for deciding between alternatives in the design of outfalls from sewage treatment plants.

**Keywords:** environmental water pollution, modelling water quality, risk assessment, current meters, wind-induced random currents

## 1. Introduction

Significant concentrations of population near estuaries, coastal areas and lakes cause severe problems related to the degradation of environmental water quality. Such problems may arise from different sectors using water, such as municipal sewage disposal, industrial water use and agricultural irrigation, and concern deterioration of water quality and subsequent pollution phenomena.

It has been recognised that water pollution is nowadays one of the most crucial environmental problems world-wide and especially in Europe and the Mediterranean. Pollution originates from point sources discharging wastewaters of variable physicochemical composition and also from diffuse sources scattered over the entire river basin and coastal line. In recent years the substantial increase

---

\* To whom correspondence should be addressed. Prof. Jacques Ganoulis, UNESCO Chair and Network INWEB, Department of Civil Engineering, Aristotle University of Thessaloniki, 54124 Thessaloniki, Greece; e-mail: [iganouli@civil.auth.gr](mailto:iganouli@civil.auth.gr)

in the quantity and the deterioration of the quality of effluents from human activities have led to serious environmental and ecological impacts, including loss of biodiversity and risks to human health. This is particularly so in cases where the water body is enclosed, for example a lake, and suffers from weak water circulation, for example the semi-enclosed bays in the Mediterranean. The recent European Water Framework Directive describes an integrated methodology for planning, managing, establishing adequate institutional structures and enhancing public participation in order to achieve a “good status” of environmental water. This means that not only a good physicochemical quality of water but also an ecologically healthy situation should be obtained [1].

In this paper, the influence of different local meteorological conditions and pollutant sources on water quality of surface waters is investigated using mathematical modelling and risk analysis. The modelling of risk is developed in cases where data of wind-generated water currents are available. Random variabilities of the hydrodynamic process are taken into account using time series of current meter recordings. Using data of randomly varying water currents and a computerised mathematical code, the fate of pollutants and the risk of coastal pollution are simulated.

## **2. Pollutant Dispersion by Random Currents**

From the engineering point of view, the main problem in environmental water pollution is the prediction in space and time of the concentration of pollutants that are disposed of in a given environmental water body. The analysis of this problem by use of mathematical or physical models may assist the design of wastewater treatment plants, the evaluation of hydraulic properties of wastewater outfall pipes and the determination of the flow rate and composition of effluents at the discharge outlet. The basic criterion for such investigation is the need to ensure that a given pollution limit is not exceeded in water areas of particular interest (e.g. areas important for tourism or for economic reasons). The maximum allowable concentration limits are a matter for legislation and standards, and should take into account the protection of the ecological environment (phytoplankton, zooplankton, fishing, etc.) and also economic, aesthetic and cultural factors.

For the case of environmental pollution near a river's estuary, as shown in Figure 1, the general question is under which circumstances is there risk of pollution at a particular location M at the shore line?

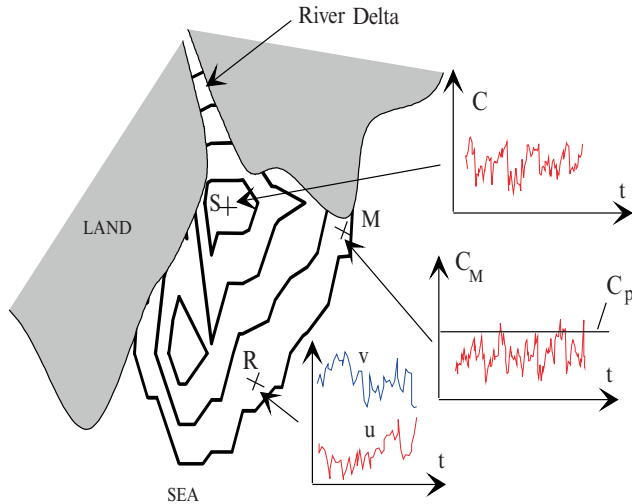

Figure 1. Risk of pollution in a coastal area near a river delta [2]

We assume that time series of a given pollutant concentration have been recorded at station S near the river mouth (Figure 1). In the same figure, the pollutant concentration contours are shown. Other available data are the current velocity components  $u$  and  $v$ , in form of time series recorded at station R (Figure 1).

Environmental quality standards (EU directives) provide the allowable levels of pollution in terms of percentile values  $C_p$  of pollutant concentration. These are pollutant levels not to be exceeded by at least  $p\%$  of the samples. In terms of probability, there is no pollution if

$$P(C_M < C_p) \geq p\% \tag{1}$$

where:

- $P(\ )$ : is the probability
- $C_M$ : the pollutant concentration at the station M
- $C_p$ : the percentile of the allowed pollutant concentration
- $p$ : a fixed level of confidence, for example 80%

There is risk of pollution if

$$P(C_M \geq C_p) > (1-p)\% \tag{2}$$

For  $p = 80\%$  the condition (2) means that there is pollution if more than 20% of the samples exceed the allowed level of concentration. In engineering risk and reliability analysis, if  $C_M$  is taken as a stochastic variable the probabilistic risk

may be evaluated by stochastic modelling. Alternatively, if  $C_M$  is considered as a fuzzy number; fuzzy calculus may be applied to obtain the fuzzy risk.

### 3. Risk-Based Mathematical Modelling

The fate of a conservative pollutant concentration is formulated by means of the convective-diffusion equation. This is a partial differential equation expressing the

- (a) Transport of pollutants by water currents, and
- (b) Dispersion process of pollutants in surface waters
- (c) Biochemical interactions between different pollutant constituents

Figure 2 shows a typical time history of the intensity of water currents recorded at one station.

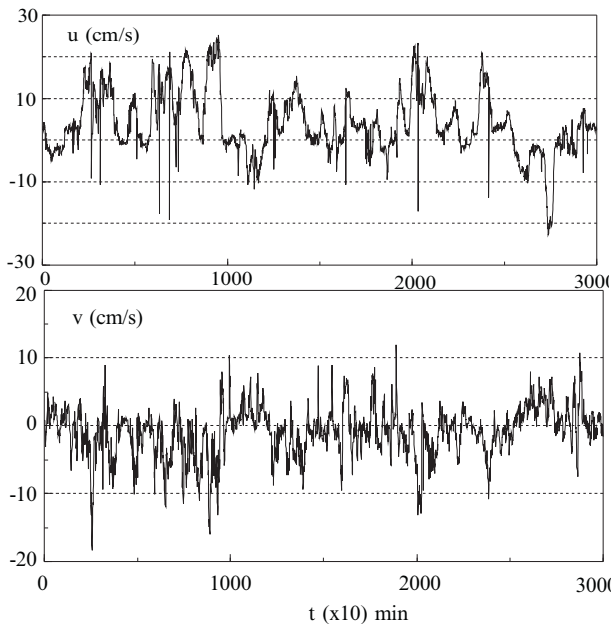

Figure 2. Time series of wind generated current components  $u$  and  $v$  [2]

The risk of pollution from wastewater discharges in the far field is more realistically assessed by using the time data recordings of currents. The time series of wind-generated current velocities which are measured over one whole season are usually *stationary*. Thus all *statistical properties* of the *random variables*,

such as the current velocity and direction (see Figure 2 for example) are independent from the time origin.

Now consider a large number of particles [3–5] initially located at the same point (point source), but departing at different times  $\tau = n \Delta t$ . Each particle moves during a given travel time  $T > t$ , where  $T = \tau + m$ ,  $\Delta t = (n + m) \Delta t$ . The final position  $\vec{r}(\tau + T)$  of the particle after time  $T$  may be evaluated using the randomly varying current velocity field  $\vec{V}(t)$

$$\vec{r}(t+T) = \int_{\tau}^{\tau+T} \vec{V}(t) dt \tag{3}$$

It is obvious that the final position of every particle depends on the initial departing time  $\tau$  (Figure 3). By allocating different values of  $\tau$  to each particle, different final positions of the particles after time  $T$  are found. Because of the stationarity of the random process, the concentration field and the probability of reaching a given location are independent of  $\tau$ .

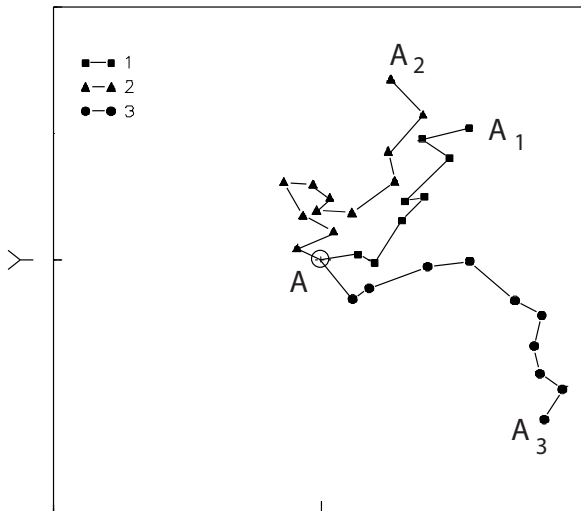

Figure 3. Final position of three particles after ten time steps.

Having a relatively long record of time series of currents, the impact probabilities and consequently the risk assessment of pollution at a given location are evaluated. After travel time  $T = (n + m) \Delta t$ , Eq. (3) takes the form

$$\bar{r}(t, \tau+T) = \sum_n^{n+m} \bar{V}_i \Delta t \quad i=n, \dots, n+m \quad (4)$$

Counting of the particles at every location is done by using a grid overlay. Pollutant concentrations and pollutant risk are proportional to the number of particles located within every square of the grid.

#### 4. Example of Application

As a first example of application, the risk of coastal pollution is considered from a point source, emitting various pollutants, such as nutrients, coliform bacteria and heavy metals. Different case studies have been analysed in the Mediterranean, aiming to establish an optimum design for a submarine outfall discharging wastewater into the sea. The problem is to find the best position for the outfall, so that pollution impacts along the shoreline are kept below the concentration values fixed by the guidelines [2].

Case studies have been developed in the Aegean and Ionian Seas, which form part of the Eastern Mediterranean. Uncertainties exist due to wind-generated currents, which vary randomly both in space and time.

As shown in Figure 4, the contour lines of equal impact probability of particles may be computed for a submarine outfall on the Greek island of Rhodes, by tracking a large number of particles, which simulate the wastewater discharge at the outfall's mouth. For every time series of currents, recorded using a submerged current meter, and which corresponds to a certain prevailing wind, regions where pollution exceeds the standards may be obtained.

For example, if we know the impact probabilities shown in Figure 4 and the E-coli bacteria concentration at the source to be equal  $10^3$  per 100 ml, then areas having impact probabilities greater than 0.1 are at risk, because the bacteria concentration is greater than  $0.1 \times 10^3 =$  greater than 100 per 100 ml, which is the concentration of E-Coli allowed for bathing waters. By repeating the simulations for different winds, a position for the outfall may be found that results in an acceptable level of risk of bacterial contamination along the shoreline.

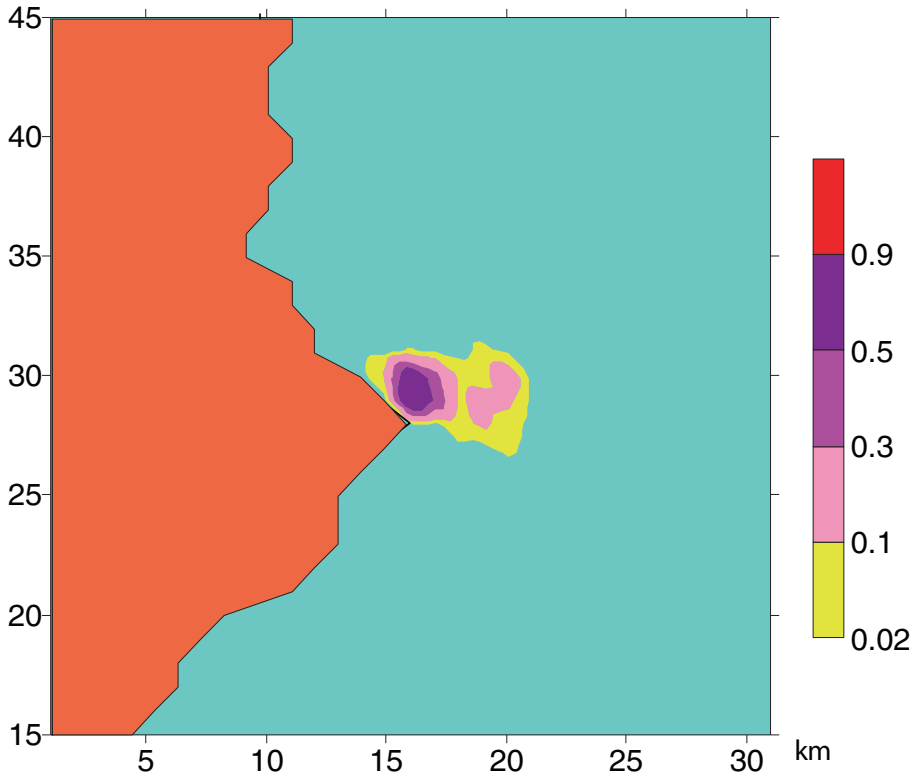

Figure 4. Contour lines of impact probabilities from a submarine outfall (Rhodes island, Greece)

## 5. Conclusions

The risk of environmental water pollution from point sources is simulated when dispersion is dominated by wind-generated currents. Data of random water currents recorded at different stations are used to move a large number of particles over a given grid. The number of particles counted in a given cell is taken as an indicator of the risk of pollution at this location. Numerical computations run in different case studies in the Mediterranean demonstrate the use of these simulations for optimising the design of sea outfalls and minimising the risk of coastal pollution.



## References

- [1] Directive 2000/60/EC of the European Parliament and of the Council of 23 October 2000 establishing a framework for Community action in the field of water policy, *Off. J. Eur. Communities* L 327, 22.12.2000.
- [2] Ganoulis, J. (2009) *Risk Analysis of Water Pollution* (2nd edition). WILEY-VCH, Weinheim, Oxford, NY, 320 pp.
- [3] Csanady, G.T. (1983) Dispersion by randomly varying currents. *J. Fluid Mech.* 132: 375–394.
- [4] Ganoulis, J. (1991) Risk in coastal pollution. In: Ganoulis, J. (ed.) *Water Resources Engineering Risk Assessment*. NATO ASI Series, Vol. G29, Springer, Heidelberg, pp. 167–188.
- [5] Roberts, P.J.W. (1989) Dilution and transport predictions for ocean outfalls, *Wat. Sci. Tech.*, Brighton, 21: 969–979.

# VULNERABILITY OF THE DRINKING WATER SUPPLIES OF ISTANBUL METROPOLITAN CITY: CURRENT STATUS AND FUTURE PROSPECTS

CEYDA SENEM UYGUNER\*

*Bogaziçi University, Institute of Environmental Sciences, 34342,  
Bebek, Istanbul, Turkey*

**Abstract.** Istanbul is a metropolitan city situated uniquely at the crossroads between Europe and Asia with a population around 13 million. Approximately 95% of the water demand of the city is provided from surface water resources. Besides the limitations of the sources, rapid population growth, and urbanization are placing new stresses on water supplies. Hence, providing public utilities and services and meeting the water supply requirements of this every year growing population are critical issues. Considering the geographical status of Istanbul with a sloping topography formed by several hills and valleys, natural landscape forming processes such as soil erosion, sediment mobilizations, transport and deposit of mass movements are potential threats to the drinking water supplies and reservoirs. This paper addresses the current status of the main drinking water supplies of Istanbul which are provided by Elmalı, Büyükçekmece and Omerli water reservoirs located on the eastern and western parts of the Bosphorous strait. Samples collected from the drinking water supplies were analyzed in terms of their chemical and spectroscopic properties and data were comparatively presented in order to set a general profile of the major water quality parameters. Furthermore, the precautions to preserve the present state and the preventive measures to counteract contaminants from the water resources are discussed according to the considerations of the water quality parameters.

**Keywords:** water reservoirs, water quality parameters

---

\* To whom correspondence should be addressed. Dr. Ceyda Senem Uyguner, Bogazici University, Institute of Environmental Sciences, 34342, Bebek, Istanbul, Turkey; e-mail: uygunerc@boun.edu.tr

## 1. Introduction

Istanbul is one of the most important centres of habitation geopolitically situated uniquely at the crossroads between Europe and Asia. The city is divided into two parts by the Bosphorus between the Black Sea and the Sea of Marmara. Around 40% of all Turkish industry is located within the boundaries of the city.

TABLE 1. Population growth and water demand of Istanbul (IMC, 1999)

Year	Population	Average raw water demand (m <sup>3</sup> /day)		
		Europe	Asia	Total
1995	10.7	1,292,892	819,946	2,111,838
2000	12.4	1,516,325	1,055,110	2,571,435
2010	15.2	1,994,086	1,560,871	3,554,957
2020	17	2,352,845	1,911,305	4,264,150
2030	18.1	2,684,214	2,127,166	4,581,380
2035	18.7	2,848,966	2,209,185	5,058,151

The population of Istanbul has reached 13 million according to the latest count as of 2007, and is estimated to increase by 1.5 in 2030 (Table 1). Sixty-five percent of the inhabitants live on the European side while the rest is on the Asian side. Considering the rapid population growth which has created infrastructure problems of water supply, wastewater treatment and disposal, providing public utilities, services and meeting the water supply requirements of the city are critical issues (Eroglu et al., 2001).

TABLE 2. Capacities and basic characteristics of the water reservoirs of Istanbul (ISKI, 2008)

Water source	Average inflow ( $\times 10^6$ m <sup>3</sup> /year)	Reservoir storage ( $\times 10^6$ m <sup>3</sup> )	Safe yields ( $\times 10^6$ m <sup>3</sup> /year)
<b>European side</b>			
Terkos Lake	162.2	145	142
Alibeykoy reservoir	67.4	34.1	36
Sazlidere reservoir	49.2	88.7	55
Buyukcekmece reservoir	108.8	148.9	100
Istiranca reservoir	199.1	146	159.8
<b>Asian side</b>			
Elmali reservoir	14.1	10	15
Omerli reservoir	242.3	235	220
Darlik reservoir	96.4	107.5	97
Yesilcay regulators	168.4	0	145

Approximately 95% of the water demand of the city is provided from surface water resources. Besides the limitations of the sources, rapid population growth, and urbanization are placing new stresses on water supplies. Total water demand of Istanbul is supplied from Terkos Lake, Alibeykoy, Sazlidere, Buyukcekmece and Istiranca reservoirs on the European side and Elmali, Ömerli, Darlik and Yesilcay reservoirs on the Asian side (Table 2). Water from the specified sources, typically provide 939 million m<sup>3</sup> per year; by 2010 the annual demand for water is predicted to rise to 1.7 billion m<sup>3</sup>.

General Directorate of Water and Sewerage Administration of Istanbul (ISKI) which is the local authority responsible for water supply and sewage services of Istanbul Metropolitan Municipality, has been serving to supply a huge amount of water demand that is consumed nearly 3 million m<sup>3</sup> per day operating approximately 700 km of raw-water and treated-water transmission systems. The water is being purified by the latest treatment technology i.e. pumps, pools, ozone treatment and then delivered to the citizens of the city. In the drinking water purification facilities in Omerli, Kagithane, Buyukcekmece, Elmali and Ikitelli, 1,861,878 m<sup>3</sup> water is purified daily. The distribution network amounted to 11,500 km of which approximately 93% comprised ductile iron pipes that have a life expectancy of up to 100 years under suitable conditions which are resistant to earthquake and heavy duty vehicle pressures. The achievements and approaches of ISKI to solve the water shortage problem and to improve services were outlined in the recent work of Yuksel et al. (2004).

## **2. Water Reservoirs and Drinking Water Treatment Plants**

Amongst the present water reservoirs of Istanbul, the main focus in this study will be directed to Buyukcekmece, Omerli and Elmali water reservoirs.

### **2.1. OMERLI DAM**

Omerli Dam is the largest water reservoir of the city and consists of five main plants that were constructed separately in accordance with the increasing water demand of Istanbul. The construction started in 1967 and was completed in 1972. Omerli Dam is located on the Riva stream, 5 km distance to Omerli Village which is on the north-east of Istanbul. It provides 220 million m<sup>3</sup> of water to Istanbul each year constituting a 36% share of the available water resources.

## 2.2. ELMALI DAM

The Elmali Dam Lake and Potable Water Treatment Plant are the oldest units of ISKI Administration. The plant was commissioned in 1886. It was the only plant in existence to meet the requirements of the Asian Side of Istanbul at that time. With the population growth, modifications were made at the plant over the years. Its maximum water-holding capacity is approximately 1,000,000 m<sup>3</sup>. It is fed from the second Elmali Dam (Upper Dam), which has a catchment area of 79 km<sup>2</sup>. The total catchment area of both dams is 81.5 km<sup>2</sup>. The second dam was completed and commissioned in 1955. It is fed by Budakdere, Cavusbasi and Karanlikdere streams. Elmali has the smallest share (2.5%) of the present water resources for water supply in Istanbul.

## 2.3. BUYUKCEKMECE LAKE

The catchment basin of Buyukcekmece Dam Lake is in the south of the Thracian Peninsula and stretches as far as the coast of the Sea of Marmara. The capacity of this plant is 400,000 m<sup>3</sup>/day. It was commissioned in February, 1989. Streams feeding the lake include Karasu Stream, Sarisu Stream and Çakıl Stream. Total drainage area is 620 km<sup>2</sup>, and area of the lake is 29 km<sup>2</sup>. Buyukcekmece reservoir has a share of 16.4% in the present water resources for water supply in Istanbul.

## 3. Source Water Characteristics

The distributed water quality has been improved significantly as a result of the upgrading operations. ISKI is performing daily examination and control of water by taking samples from the network from various points to check the compliance of the supplied drinking water to the standards. Water characteristics are monitored by measuring the chemical, physicochemical and microbiological properties. While the presence of common anions, cations, metals, trace metals and disinfection byproducts (DBPs) are outlined as chemical parameters, pH, conductivity, hardness, total dissolved solids (TDS) and turbidity are considered to be physicochemical parameters. Some of the water quality parameters of the treated drinking water samples from the reservoirs were compiled from the monthly reports of ISKI and presented as yearly average values (Table 3).

TABLE 3. Water quality parameters of the selected water sources in Istanbul (ISKI, 2008)

Parameters	Omerli	Elmali	Buyukcekmece
<b>CHEMICAL PARAMETERS</b>			
Common anions (mg L <sup>-1</sup> )			
Sulfate	27.5	57.5	69.5
Nitrate	4.16	5.93	2.81
Bromide	–	–	–
Chloride	23	45	65.5
Ammonium	<0.05	<0.05	<0.05
Common cations (mg L <sup>-1</sup> )			
Calcium	46.5	40	48
Magnesium	6.32	8.25	12.5
Hardness	143	132	172
Sodium	10.5	28	43
Potassium	1.5	3.2	4.5
Other anions (mg L <sup>-1</sup> )			
Fluoride	0.092	0.131	0.205
Metals (mg L <sup>-1</sup> )			
Aluminum	<0.1	<0.1	<0.1
Arsenic	0	0	0
Barium	<0.05	<0.05	<0.05
Cadmium	0	0	0
Chromium	0.001	0.001	0.001
Iron	<0.01	<0.01	<0.01
Manganese	<0.02	<0.02	<0.02
Copper	<0.005	<0.005	<0.005
Trace Metals: Lead, Mercury, Selenium, Silver, Antimony	–	–	–
DBP (µg L <sup>-1</sup> )			
THM	18	28.7	43
Bromate	<0.01	<0.01	<0.01
<b>MICROBIOLOGICAL PARAMETERS</b>			
Coliform bacteria (MPN/100 mL)	–	–	–
<b>PHYSICOCHEMICAL PARAMETERS</b>			
Color (Pt-Co units)	2.5	2.5	2.5
Turbidity (NTU)	0.38	0.3	0.2
Hardness, mg CaCO <sub>3</sub> L <sup>-1</sup>	79	146	171
TDS (mg L <sup>-1</sup> )	152	189	275
pH	7.4	7.3	7.2

The results of the analysis show that high quality drinking water complying with the standards of WHO, EPA and EU is flowing through the taps of Istanbul. However, data involving spectroscopic measurements and total organic carbon (TOC) contents of the water samples is missing. Hence, further characterization including spectroscopic measurements as absorbance values recorded at 254 nm ( $UV_{254}$ ,  $m^{-1}$ ), TOC and dissolved organic carbon (DOC) as indicators of organic matter present in water supplies and the specific UV absorbance ( $SUVA_{254}$ ,  $m^{-1} mg^{-1} L$ ) values were performed (Table 4). A further assessment could also be verified by the interpretation of the specific fluorescence intensities (SFI) by normalizing the fluorescence intensities of each treated sample at the maximum intensity wavelength of the corresponding raw water sample with respect to their corresponding DOC contents (Uyguner et al., 2007).

TABLE 4. Source dependent, specific water quality parameters

	Omerli	Elmali	Buyukcekmece
Alkalinity, mg $CaCO_3 L^{-1}$	61	71	133
$UV_{254}$ , $cm^{-1}$	0.107	0.225	0.094
$SUVA_{254}$ , $m^{-1} mg^{-1} L$	2.83	4.25	2.36
TOC, mg $L^{-1}$	3.90	5.50	4.40
DOC, mg $L^{-1}$	3.78	5.29	3.98
SFI	19.1	33.8	16.9

The alkalinities of water samples expressed quite different values ranging from 61 to 133 mg  $CaCO_3 L^{-1}$ . The  $SUVA_{254}$  parameter can be used to describe the composition of the water in terms of hydrophobicity, hydrophilicity and aromaticity (Edzwald, 1985).  $SUVA_{254}$  of Elmali water sample expressing a value greater than 4 indicates that the water sample is composed of polydisperse moieties containing a mixture of diverse molecular weight fractions.

According to the classification of drinking water reservoirs with reference to Water Pollution and Control Regulation of Turkey, Elmali was designated as highly polluted water (fourth class) in terms of physical and inorganic chemical parameters, as well as organic and inorganic pollution parameters (WPCR, 1988). The water characteristics for Elmali reservoir are already deteriorated both in terms of land and water resources as reflected to its high DOC,  $UV_{254}$  and color values compared to the other reservoirs of Istanbul. Moreover, it is also in danger of exceeding the national regulation for water quality limits. Omerli reservoir is the major reservoir of Istanbul in terms of water supply potential. However, rapid population increase, unplanned and illegal housing, irrelevant industries and motorways passing through the protection zones of the catchment area, together with insufficient infrastructure, cause the water quality

of the reservoir to tend towards the eutrophic stage from the mesotrophic stage parallel to the land use profile (Tanik et al., 2000). In order to achieve a long-term water supply from the reservoir, protection strategies should be proposed. The overall evaluation revealed class two as slightly polluted for Omerli and class three (polluted water) for Buyukcekmece and highly polluted for Elmali with the worst general and trophic class (Belir Baykal et al., 2000). Poor water quality in most of the reservoirs is attributed to the urban settlement, industries and farms in the catchment areas (Selcuk et al., 2005).

In all cases, the deterioration is due to land-based sources of pollution from the residential and industrial developments in the reservoir catchments. Although industrial areas were marked and planned in the land-use plans prepared for the city, lack of control and authority mainly hindered those plans from being fully followed. Today there are a variety of industrial activities and services around the reservoir catchment area. ISKI is working to improve the infrastructure to stop wastewater flows in the catchment basin of the surface-water reservoirs.

#### **4. Problems Encountered in the Drinking Water Reservoirs of Istanbul**

Istanbul is the most important industrial and commercial center of the country. Migration, together with random development of industry and uncontrolled urbanization cause the infrastructure to remain insufficient and unsatisfactory. The city is losing 50% of its supplies. Catchment areas are being turned into residential settlements due to badly planned urban development. There are golf courses, Formula 1 tracks, and residential areas around the water catchment basins of the city. The present land use around the reservoirs indicates that the area devoted to agricultural activities, forests and meadows varies between 73% and 97% and only a minor percentage (1–26%) is devoted to settlements and industries (ISKI, 2008). Consequently, the environmental evaluation of the catchment areas reveals that point sources of pollutants, especially of domestic origin, dominate over those from diffuse sources. The water quality studies also support these findings, emphasizing that there might not be any possibility of obtaining safe drinking water if substantial precautions are not taken.

One of the most effective water loss processes is the evaporation from lakes or dams. Although much effort, time and money is invested in storing water in these reservoirs, evaporation occurs often in large quantities. According to recent literature, the surface area of the lakes and reservoirs that provide fresh water to Istanbul City is 112.75 km<sup>2</sup> and the average annual evaporative loss from that area contributes to  $65.5 \times 10^6$  m<sup>3</sup> (Gokbulak and Ozhan, 2006). The annual water demand of Istanbul City was  $939 \times 10^6$  m<sup>3</sup> in 2000 (Eroglu et al., 2001). When the daily water consumption of the city that is  $2.57 \times 10^6$  m<sup>3</sup> is compared with annual evaporative loss, the amount of evaporation from lake



and reservoir surfaces in Istanbul could be expected to meet the water demand for only 25.5 days (Gokbulak and Ozhan, 2006).

Global climate change is a crucial subject of the world. New and changing patterns of climate change and variability will impact every aspect of the urban water cycle, including sea level, air temperatures, rainfall patterns, stream flow regimes, ground water recharge, extreme events, pollution risks as well as citizens served. Taking into account the global climate models, the temperature increase is estimated as 2°C during the winters and 2–3°C during the summer seasons in 2030 for Turkey (IPCC, 1990). Moreover, the precipitation is expected to decrease about 5–15% in summer with an insignificant amount of increase during winter. Hence, the frequency and volume of droughts will be higher encountering danger. Existing efforts regarding the climate change adaptation in urban water is usually short-term relief efforts limited to the voluntary action of consumers and conventional efforts such as increasing the utilization of surface water potential of the neighboring watersheds, building dams to increase water storage capacity, constructing new channels to augment water transport capacity and installing more pumps that produce water from deeper layers of the earth.

Considering the geographical status of the city of Istanbul with a sloping topography formed by several hills and valleys, natural landscape forming processes such as soil erosion, sediment mobilizations, transport and deposit of mass movements are potential threats to the drinking water supplies and reservoirs. In minimizing surface erosion and mass movements, forests reduce the problem of sedimentation. Suspended soil in water supplies can render potable water or greatly increase costs to make it useful. In addition sediment can reduce reservoir capacity prematurely.

The effects of natural hazards such as heavy rain, floods and earthquakes would also pose serious problems on the water reservoirs. Taking into account the devastating effects of the earthquake that struck in 1999, a master plan was prepared stating the possible effects of the natural hazard on the water distribution system of Istanbul. According to the report, throughout the water distribution network 1,395 probable defects were assumed using a model, whereas the application of another model predicted damage on 1,577 points (ISKI, 2008). In case of an emergency, supplying safe water would be a critical issue. Hence, apart from water required for human consumption, water would also be necessary for possible fire extinguishing purposes. Analysis of the sensitivity of water dams, preparation of alternative water sources, taking precautions against pollution, separation of rainwater and wastewater collection systems at high risk points are the important points outlined in the disaster management plan.

Apart from the problems stated above, to achieve a sustainable management plan, there should be a coherent cooperation between various governmental

organizations and municipalities on the management and authority of water reservoirs and surrounding areas. The overlapping of authority between the Greater Municipality of Istanbul and the Ministry of Environment and Forestry, and among the Greater and Local Municipalities especially on urban development is affecting even minimal efforts to protect water reservoir catchment area. Hence, there is an urgent need to develop effective strategies for water management adaptations for the coordination between the authorities.

## **5. Future Prospects and Concluding Remarks**

Considering that conventional strategies to further increase water supply can no longer meet the growing future needs, greater emphasis needs to be placed on a more effective management of existing water resources. The immediate precautions should depend on prevention and reduction of the pollution arising from the existing settlements whereas long-term measures would emphasize the preparation of new land use plans taking into consideration the protection of unoccupied lands and control of the reservoirs. Adaptation strategies regarding the urban water management necessitates a broader perspective which would include all sectors of water and require cooperation among various levels of social organizations, from national and local governments to the private sector and civil society. The metropolitan municipalities should implement effective measures through education, regulations, penalties, incentives etc. for the prevention of water loss and enhancing water reclamation and reuse.

From the perspective of escaping floods and dry periods with minimum loss, management of water supply systems is especially important. Under such conditions management of water supply system of any metropolis becomes a very complex hydrological, sociological and economical problem. Redesigning and re-engineering of infrastructure to withstand extreme events, adopting technological innovations with efficient and cost effective systems would be proper solutions for future. Being located on a geographically critical area and having experienced an earthquake hazard that is assumed to take place even with a higher magnitude in the following years, preventive solid measures against natural hazards were not taken into consideration for Istanbul. Hence, there is a need for scientific research or risk management plan covering the possible adverse effects of a possible hazard on the water reservoirs of Istanbul.

The latest five year strategic plan of ISKI includes solutions such as construction of new dams, exploitation of the available groundwater reservoirs, transfer of water from water-rich parts of Turkey by ocean tankers or balloons, desalination of seawater, reuse of reclaimed wastewater and rainfall harvesting. Furthermore, precautions such as reduction in water losses in water distribution systems, reservoirs, and transmission pipes between the dams and distribution

centers and water conservation using water-saving devices have also been proposed (ISKI Strategic Plan, 2008). Moreover, architectural designs and infrastructure solutions would play an important role for the reuse of water in the households.

## References

- Belçer Baykal, B., Tanik, A. and Gonenc, I.T., 2000, Water Quality in Drinking Water Reservoirs of a Megacity, Istanbul, *Environ. Manage.*, **26**(6): 607–614.
- Edzwald, J.K., Becker, W.C. and Wattier, K.L., 1985, Surrogate Parameters for Monitoring Organic Matter and THM Precursors, *J. Am. Water Works Assoc.*, **77**(4): 122–132.
- Eroglu, V. and Sarikaya, H.Z., 2001, Achievements Towards Better Water Supply and Wastewater Disposal in Istanbul, in: *Proceedings of the International Symposium on Water Supply and Treatment*, 25–26 May 1998, Istanbul.
- Eroglu, V., Sarikaya, H.Z. and Aydin, A.F., 2001, Planning of Wastewater Treatment and Disposal Systems of Istanbul Metropolitan Area. *Wat. Sci. Technol.*, **44**(2): 31–38.
- Gokbulak, F. and Ozhan, S., 2006, Water Loss Through Evaporation from Water Surfaces of Lakes and Reservoirs in Turkey, *E-Water*, 1–6.
- IMC (Istanbul Master Plan Consortium), 1999, Istanbul Water Supply, Sewerage and Drainage. Sewage Treatment and Disposal Master Plan, Final Report.
- IPCC, 1990, Climate Change, in: *The IPCC Scientific Assessment*, J.T. Houghton, G.J. Jenkins, J.J. Ephraums (Eds.) Cambridge University Press, Cambridge.
- ISKI (27.8.2008); [http://www.iski.gov.tr/Web/UserFiles/File/su\\_kalite\\_raporu/swf/sukalite\\_temmuz2008t.swf](http://www.iski.gov.tr/Web/UserFiles/File/su_kalite_raporu/swf/sukalite_temmuz2008t.swf)
- ISKI, 2008, Strategic plan 2008–2012, Istanbul Metropolitan Municipality, Istanbul Water and Sewerage Administration.
- Selçuk, H., Vitosoglu, Y., Ozaydin, S. and Bekbolet, M., 2005, Optimization of ozone and coagulation processes for bromated control in Istanbul drinking waters, *Desalination*, **176**: 211–217.
- Tanik, A., Belçer Baykal, B. and Gonenc, I.E., 2000, A Long-term Management Plan for a Watershed in a World Metropolis – Istanbul, *Environ. Manage. Health*, **11**(3): 208–215.
- Uyguner, C.S., Bekbolet, M. and Selçuk, H., 2007, A Comparative Approach to the Application of a Physico-Chemical and Advanced Oxidation Combined System to Natural Water Samples, *Sep. Sci. Technol.*, **42**(7): 1405–1419.
- Yuksel, E., Eroglu, V., Sarikaya, H.Z. and Koyuncu, I., 2004, Current and Future Strategies for Water and Wastewater Management of Istanbul City, *Environ. Manage.*, **33**(2): 186–195.
- WPCR, 1988, Water Pollution Control Regulation of the Turkish Republic. Turkish Federal Register, 4 September 1988.

# CONSEQUENCES OF NON PLANNED URBAN DEVELOPMENT DURING TURBULENT TIMES IN SERBIA – CASE STUDY OF SUBURB KUMODRAZ WATERSHED IN BELGRADE

JOVAN DESPOTOVIĆ\*, JASNA PLAVŠIĆ, ALEKSANDAR  
DJUKIĆ AND NENAD JAĆIMOVIĆ

*Institute for Hydraulic and Environmental Engineering, Faculty  
of Civil Engineering, University of Belgrade, P.O. Box 42, 11120  
Belgrade, Serbia*

**Abstract.** Development is usually based on numerous analyses accounting for planning, economy and population assessments as well as urbanism, architectural and civil engineering infrastructure planning and project design. The modern city planning begun during Napoleon in Paris, while modern urban planning in Belgrade started in mid nineteenth century. At the end of twentieth century turbulent times occurred in the area of ex Yugoslavia so that numerous plans of development started being misused or never completely respected. Actually, during 1990s urban development in cities of Serbia became rather uncontrolled. In addition, during 1990s many people moved from rural places to, to their opinion, more promising places, most frequently to the Capital city. This paper presents a series of consequences of non planned urban development on sewer infrastructure operation. Those includes high construction rate including increase of number of inhabitants at suburban part, namely watershed of the brook Kumodraz at the southern part of the city of Belgrade. Those changes were noticed during preparation of preliminary design for the reconstruction and upgrading of the combined waste water system at this part of the city. The design preparation included measurements of wastewater and rainfall runoff at the downstream outlet. During measurement period, which started in 1997, significant differences occurred in the both base flow, i.e. dry weather flow, as well as in peak flows during moderate and severe rainfall events.

**Keywords:** urban planning, sewerage, rainfall, runoff, infiltration, flooding

---

\* To whom correspondence should be addressed. Jovan Despotović, Institute for Hydraulic and Environmental Engineering, Faculty of Civil Engineering, University of Belgrade, P.O. Box 42, 11120 Belgrade, Serbia; e-mail: edespoto@hikom.grf.bg.ac.yu

## 1. Introduction

Kumodraz catchment covers 8 km<sup>2</sup> and is located in southern part of the city of Belgrade (Serbia). Urban development of the area was most intense during 1960s and 1970s when Kumodraz trunk sewer was constructed for conveying waters of Kumodraz brook as well as wastewaters and surface runoff from the catchment area. Construction of the trunk sewer was a part of realization of the Belgrade sewerage master plan in southern part of the city which foresaw development of mixed sewer system in the area: separate sewer systems in newly developed areas on upstream parts of the watershed and combined sewer system in downstream part of the catchment where combined sewerage already partly existed. Urban planning foresaw development of housing, industrial zone, while significant portion of the watershed in its upstream part should remained non-urbanized. Maximal capacity of the main trunk sewer was 8 m<sup>3</sup>/s, which corresponded to hydrological and hydraulic analyses at that time. The master plan also foresaw that further urbanization of the area in the future would require construction of retention basin(s) for lowering peak storm water flows, however these has not been constructed.

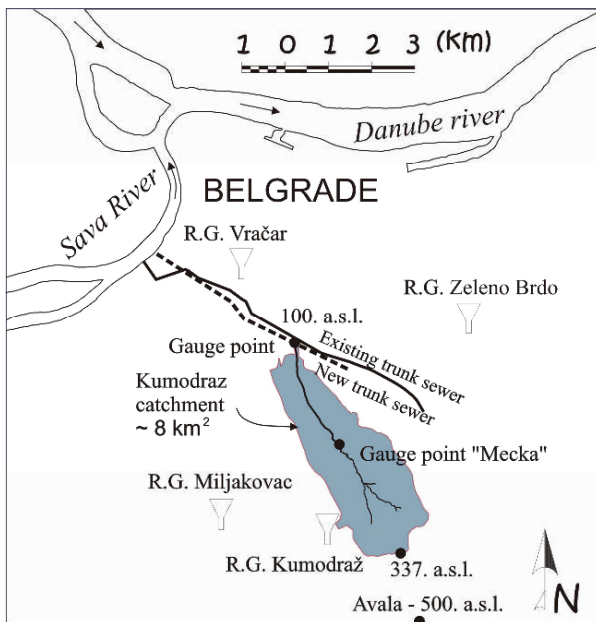

Figure 1. Kumodraz catchment and rain gauges (RG) in the area

## 2. Existing Conditions

Due to non planned urbanization and development in Belgrade during 1990s, particularly at the outskirts of it such as Kumodraz watershed area, numerous consequences appeared. In Figure 1 this watershed is presented. At this area a significant portions of agriculture fields and non-urbanized areas appeared to be convenient for a development, because of small taxes since situated at the outskirts of the city. On the other hand this area was convenient for development due to its vicinity of highway and other arterial roads and also because other urban infrastructure systems, public transportation and water supply were well developed. But waste water and storm water systems were developing at much slower pace. Therefore sanitation in newly developed areas were not up to the adopted standards while exiting sewer system was put under severe pressure from increased wastewater and storm water flow rates (Plavšić et al., 2006). Also, many uncontrolled outlets of used water into the brook and a series of not properly drained roofs and other impervious areas were noticed (Despotović et al., 2005).

In Figure 2 sewer system in late 1990s is presented, and it was a starting point for analyses and design for reconstruction and extension of the system. In addition Figure 2 also schematically presents recent urban development over the watershed. Accounting for modeling of the two processes, rainfall runoff and used water modeling, there are three marked large areas from which much more surface runoff during rainfall events and used water are produced. Also, in those areas used water is discharged into the environment mainly without any sewage system.

Area 1 was not urbanized until early 1990s, but since then numerous houses were build, predominantly without construction license. Sewerage system does not exist, and it will be very difficult to establish one because the majority of structures were built in a way to obstruct potential corridors for urban infrastructure, including sewerage.

Area 2 covers area that is used to be village Kumodraz and nowadays is being transformed into suburban settlement. However, recent development is more intense than anticipated by the plans and construction of sewerage has not started yet.

Area 3 is an extension of existing industrial zone in Kumodraz watershed and it comprises of numerous newly built industrial and commercial facilities along left bank of the Kumodraz brook. Area covered is larger than planned and new industrial zone obstructs establishment of retention basins for rain water which were foreseen as the key elements of the system for protection of densely populated downstream parts of the watershed and highway E-75 from flooding during heavy rain events (national standards prescribe that highways shall be protected from flooding events of return period 10 years).

### 3. Results of Investigations

Flow rates measurements at the downstream end of the main trunk sewer accomplished with rainfall measurements were performed, as well as measurements of several quality parameters of water samples from the Kumodraz brook (Despotović et al., 1996; Petrović and Despotović, 1998).

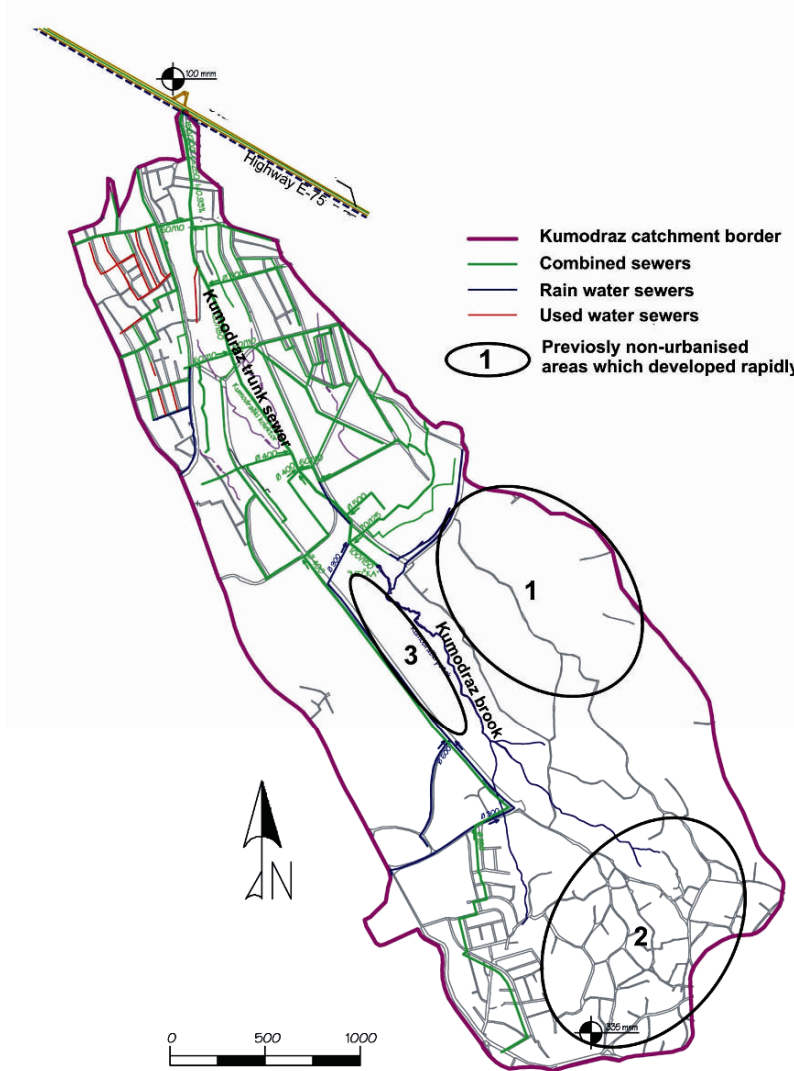

Figure 2. Existing sewerage on the Kumodraz catchment and three major non planned but densely urbanized areas without any waste and storm water systems



Base flows – dry weather flows, which were analyzed because of pollution aspects at the catchment, significantly increased over time. Over the period of 5 years, from 1997 to 2002, base flow was more than doubled from app. 250 lps up to over 500 lps (Figure 3). The reasons for this still have to be further investigated and possible causes for this may lie in increased infiltration (i.e. deterioration of structural integrity of sewers and/or broken connections of pipes and manholes) and increased sanitary wastewater production.

Also was noticed an increase of parasite water in the system, i.e. rain infiltrating water that is collected into the system with certain delay when base flow is considered before, during and after rainfall event, as it can be seen in Figure 3.

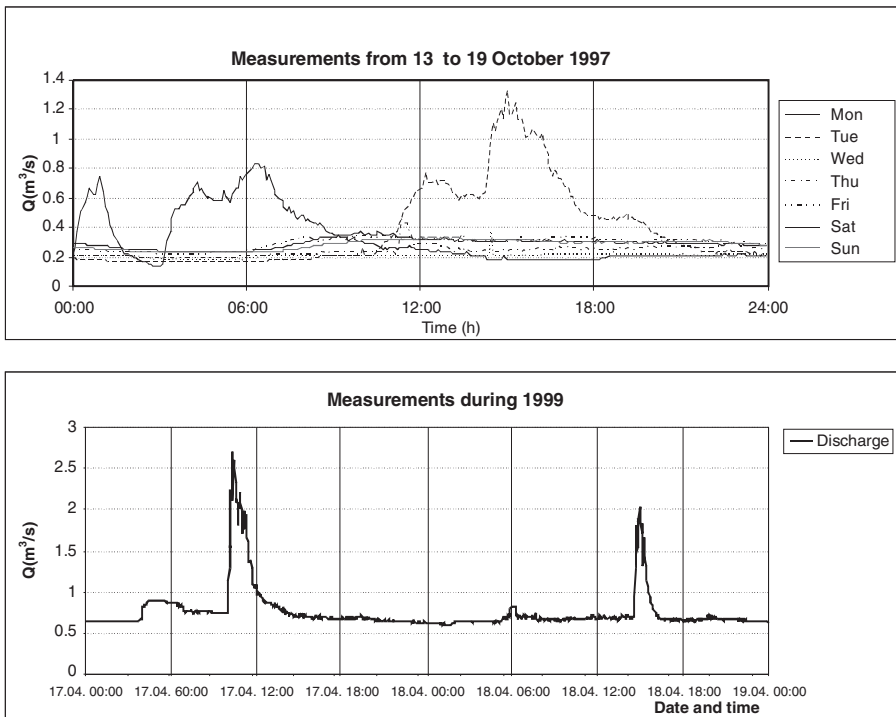

Figure 3. Recorded flow rates at the downstream end of the Kumodraz trunk sewer

During the period of 3 years of measurements, from 1997 till 1999, recorded maximal flows in the trunk sewer reached design flow rate of 8 m<sup>3</sup>/s several times, as it could be seen in Figure 4.



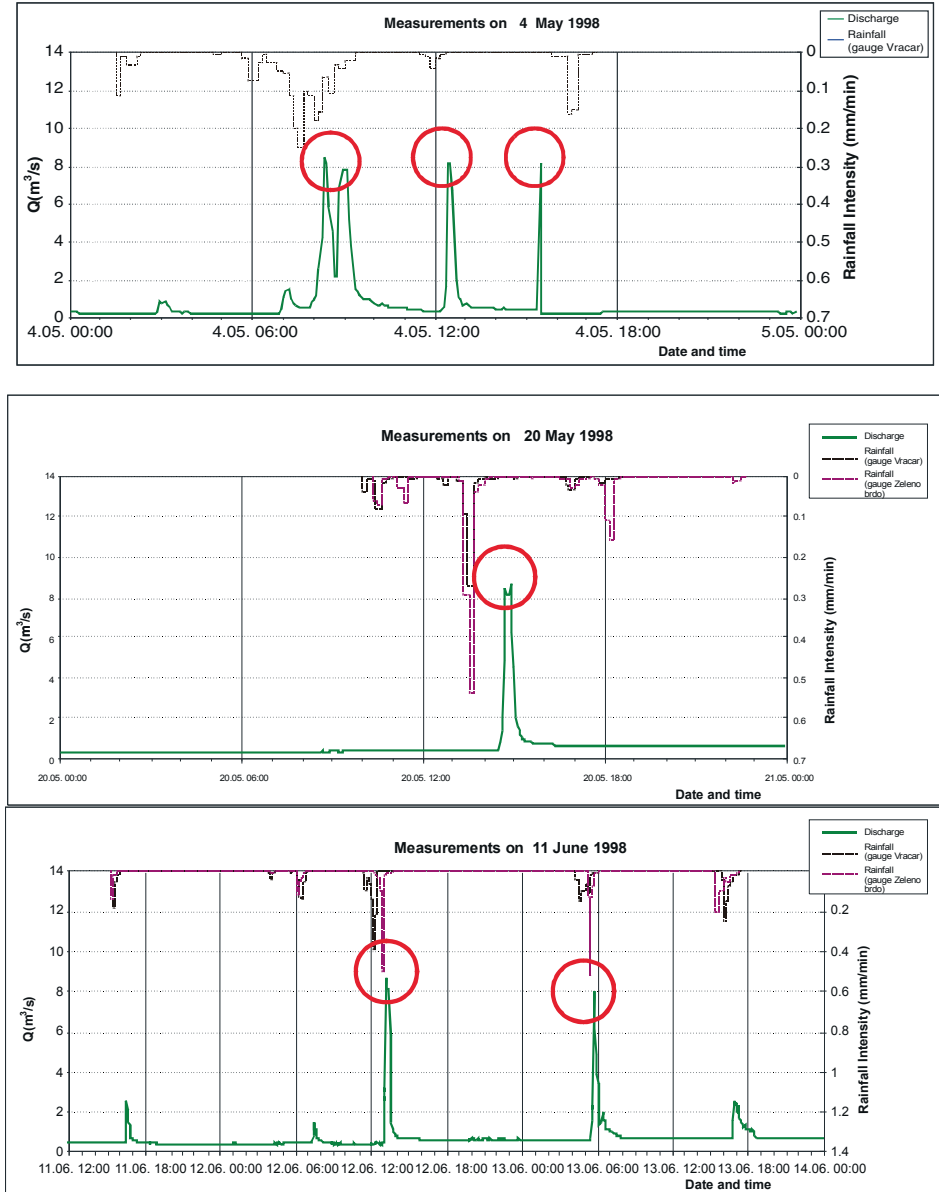

Figure 4. Recorded maximal flows in the trunk sewer

Analyzing the results for the previous figure it may be concluded that runoff coefficient in the system decreases with increase of rainfall intensity, which is opposite to theory of rainfall-runoff and practical experiences (Despotović et al., 2002). But it should be noted that during measurements at the times when

maximal capacity is reached ( $8 \text{ m}^3/\text{s}$ ) trunk sewer was full and could not accept any additional flow, therefore excess runoff flowed over the surface and partially flooded streets, pavements and yards. Keeping in mind that sewer system was designed to convey rainwater of 2 years return period, it can be concluded that in present condition sewer system is severely overloaded. This fact underlines necessity for development of system for storm water retention within the watershed, which establishment is hindered by the existing conditions on the watershed.

Changes of hydrological conditions over time (i.e. increase of frequency of heavy rainfalls, changes in rainfall distribution, etc.) may also played a role, but further investigations and analyses are needed to quantify these factors.

#### 4. Conclusions

Consequences of unplanned urbanization on urban infrastructure and sewerage are usually considered from the point of view of areas that are build not according to plans, which put emphasis on various adverse impacts including substandard sanitation of such areas and associated health and social risks. But unplanned urbanization may also have severe consequences on exiting sewer systems, including:

- Increased wastewater flows during dry weather
- Increased peak flows during rain events and increased frequency of flooding, which may increase health risks for downstream population in the case of combined sewer system
- Increased costs for operation and maintenance of sewerage
- Prolonged time for realization of proper measures for sanitation and storm water management due to difficulties in obtaining data on present condition and various restrictions imposed by existing structures and facilities

#### References

- J. Despotović, J. Petrović, V. Vukmirović (1996.) Some considerations of urban drainage design practice using experimental data, *Atmospheric Research*, Vol. 42, pp. 279–292. Elsevier.
- J. Petrović, J. Despotović (1998.) Historical rainfall for urban storm drainage design, *Water Science and Technology*, Vol. 37, No. 11, str. 105–111.
- J. Despotović, J. Petrović, N. Jaćimović (2002.) Measurements, calibration of rainfall-runoff models and assessment of the return period of flooding events at urban catchment Kumodraž in Belgrade, *Water Science and Technology*, Vol. 45, No. 2, pp. 127–133.

- J. Plavšić, J. Despotović, M. Stanić, M. Jovanović, B. Babić, A. Đukić (2006.) Savremeni postupci za kanalizaciju i zaštitu od plavljenja na slivu Kumodražskog potoka u Beogradu, *Ekolist*, Maribor, Vol. 3, pp. 15–18.
- J. Despotović, N. Stefanović, D. Pavlović, J. Plavšić (2005.) Inefficiency of urban storm inlets as a source of urban floods, *Water Science and Technology*, Vol. 51, No. 2, pp. 139–145.

# REUSE OF WASTE WATERS IN SLOVAKIA, WATER SUPPLY SUSTAINABILITY

ŠTEFAN STANKO\*

*Department of Sanitary & Environmental Engineering,  
Slovak University of Technology Bratislava, Slovak Republic*

**Abstract.** Continual population increase together with living standard has negative impact on local and global environment. The population produces the excessive amount of pollution through solid waste and wastewater. There are many possibilities how to solve this problem. The first one is to eliminate production of waste waters. The second one is to find the way how to disposal wastewaters. There are a lot of ways how to solve this problem, the possibility of wastewater recycling/reclamation, wastewater reuse, water price regulation, the setup of appropriate water demand. The next one problem is water acquiring in the water-poor areas, for example deserts and sea close areas with possibility of sea water but no potable water. The problem with water supply becomes very important not only in “dry” countries, but in some parts in Europe, following global warming – climate change. Water becomes the strategic raw, the production and distribution becomes rapidly expensive. The paper describes the types of alternative reuse of waste-water, the ways how to waste-water reuse with environmental protection aim, and how to protect the water sources with improving the waste-water management.

**Keywords:** wastewater reuse, recycling, reclamation, wastewater management, water supply, sustainability

## 1. Introduction

The idea of wastewater reuse is not new. The ancient practice of applying wastewater containing human excreta to the land has maintained soil fertility in

---

\* To whom correspondence should be addressed. Stefan Stanko, Department of Sanitary & Environmental Engineering, Slovak University of Technology Bratislava, Radlinského 11, 813 68 Bratislava, Slovak Republic; e-mail: stefan.stanko@stuba.sk

many countries of Eastern Asia and the Western Pacific for over 4,000 years, and remains the only agricultural use option in areas without sewerage facilities.

Humankind has a history roots on water reuse. There are examples of rainwater reuse since the Minoan time, ca. 3,000–1,100 BC. Wastewater reuse has been practiced since the Ancient Greek and Roman civilizations [1].

Land application of wastewater is an old and common practice, which has gone through different development stages with time, knowledge of the processes, treatment technology, and regulations evolution.

Slovakia is located in the Carpathian Mountains. The Slovak Republic shares borders with Austria, the Czech Republic, Hungary, Poland and Ukraine. Water management in Slovakia is determined by its geographic position on the watershed divide between the Black and Baltic Seas. The Danube river and its tributary rivers drain about 96% of the land to the Black Sea. About 25% of the country is formed by lowlands. The Slovak responsibility is to protect this river against the pollution, because this river is not only Slovak, by with European impact, with the impact on the mention sea.

Last years Slovakia are marked by a water imbalance in the summer season. This imbalance in water demand versus supply is due mainly to the relatively low and uneven distribution of precipitation, higher temperatures, increased demands for irrigation water, and the impacts of tourism. To alleviate water shortages, serious consideration must be given to wastewater reclamation and reuse. Reclaimed water can be used to reduce the demands on the available water supplies and to reduce costs. Decentralized reclamation and reuse can be used in a variety of applications. Some reason of this impact is attributed to climate change.

Reclaimed wastewater should be considered a reliable source of water in formulating public policy related to the conservation of natural resources and sustainability. Although the potential for wastewater reclamation and reuse in the countries is relatively high, only a few countries and states have recognized and exploited the value of reclaimed water. In those countries and states, laws and regulations exists that mandate water reuse under certain conditions. To increase the amount of reclamation and reuse in the EU-countries, the development of a uniform set of reuse standards and guidelines is essential. The U.S. Environmental Protection Agency (EPA) defines wastewater reuse as, “Using wastewater or reclaimed water from one application for another application”.

## **2. The Reasons of Waste Water Reuse in Slovakia**

(1) water-recipient protection against pollution, (2) insufficient of water sources, (3) the reduction of new sewerage systems demands, (4) improve of environment from various views, (5) protection of ground-water supply, particularly in Danube lowland – “Žitný Ostrov – Rye Island”, (6) increasing of water price.

Rivers in the Slovak Republic receive insufficiently treated wastewater from agglomerations, industry and agriculture. Smaller waters are often influenced by diffuse pollution from households in settlements which are not connected to public sewage systems. In 2007, only 57.6% of the population was connected to sewage systems.

Of the 1,659 surface water bodies identified in the Slovak part of the Danube River Basin District, 817 were classified as “*at risk*” of failing to reach “*good ecological status*” by the year 2015, 505 were classified as “*possibly at risk*” and 343 were “*not at risk*”.

The sewer systems build in Slovakia in the last century are in very poor conditions. The construction of sewer system was very fast in the most of the regional cities. The main press of the built was to drain the maximum of waste water, concerning storm waters, domestic waste waters and industrial and agricultural waste waters [9]. The approach after 1989 was to build the own WWTP for industrial and agricultural. It has the positive influence of the drained wastewater quality of storm waters and domestic waste waters. The positive impact is on the better treatment effect of WWTP [7]. The attention is turn to the “water management”, which is the historically no new idea, but in this time the new concept to the wastewater disposal.

Of the 96 groundwater bodies identified in the Slovak part of the Danube River Basin District, 7 are considered “*at risk*” of failing to reach “*good chemical statu*” due to point source pollution and 16 due to diffuse pollution. All 23 water bodies identified as lakes are heavily modified water bodies. Due to groundwater abstractions, 9 groundwater bodies are “*at risk*” of failing to reach “*good quantitative status*”.

The all aspects concerning water supply opening the term “water stress”.

### 3. Water Stress

occurs when the demand for water exceeds the available amount during a certain period or when poor quality restricts its use. The water stress index is the ratio between total freshwater abstraction and total annual renewable resources and indicates the pressure on water resources. The water stress index is a rough indicator for the urgency of water management in order to maintain supply and avoid conflicts amongst competing uses/users. Water stress causes deterioration of fresh water resources in terms of quantity (aquifer overexploitation, dry rivers, etc.) and quality (eutrophication, organic matter pollution, saline intrusion, etc.) [8].

Water stress is high in countries like Cyprus, Malta, Belgium and medium high in Spain, Germany and Italy. Turkey, France, Poland, and Greece are classified as moderately water stressed.

The total volume of reused treated wastewater in Europe is 964 Mm<sup>3</sup>/year, which accounts for 2.4% of the treated effluent. Spain accounts for largest proportion of this (347 Mm<sup>3</sup>/year); Italy uses another 233 Mm<sup>3</sup>/year. In both countries, agriculture absorbs most of the treated wastewater. Israel is another large user of treated wastewater (280 Mm<sup>3</sup> per year, around 83% of the total treated wastewater). The treated wastewater reuse rate is high in Cyprus (100%) and Malta (just under 60%), whereas in Greece, Italy and Spain treated wastewater reuse is only between 5% and 12% of their effluents. The amount of treated wastewater reused is mostly very small (less than 1%) when compared with a country's total water abstraction. Only Malta and Israel increase their water supply by 10% and 18% respectively, using treated wastewater as an alternative source.

#### 4. Types of Reuse

At first we need, what is wastewater. Wastewater is any water that has been adversely affected in quality by anthropogenic influence. It comprises liquid waste discharged by domestic residences, commercial properties, industry, and/or agriculture and can encompass a wide range of potential contaminants and concentrations. In the most common usage, it refers to the municipal wastewater that contains a broad spectrum of contaminants resulting from the mixing of wastewaters from different sources. The special type of wastewater is **stormwater**, which represents the large amount of total wastewater in the municipalities.

**Greywater** is the wastewater produced from anywhere in the home except in toilets, urinals, and any drains equipped with garbage disposals.

**Blackwater** is the wastewater generated by toilets.

Focusing on the type of waste water, we can choose the way how to disposal wastewater, or how to reuse, or reclaim, or recycle wastewater. The water management show, how to operate with wastewaters [6].

##### 4.1. AGRICULTURAL AND LANDSCAPE IRRIGATION, URBAN REUSE

The wastewater is reuse for the better of yield crops. The irrigation process is known for several millennia. Only in last century importance of the quality of irrigation water has been recognized. Irrigation is needs in dry land, but in the humid land to, for the case of dry periods. The design of the irrigation with municipal wastewater depends mainly on wastewater treatment plant technology.

There are some important physical and chemical factors of water quality: Salinity, Specific ion toxicity, Water infiltration rate, Nutrients and miscellaneous

problems. Every of this factors are very important at the design of wastewater reuse for irrigation.

*For example*, salinity of irrigation water is determined by measuring its electrical conductivity – EC, which indirectly represents the total dissolved solids concentration – TDS. The measure unit is dS/m (deciSiemens per meter). Values for salinity are reported as TDS in mg/L. For the most agricultural irrigation purposes, the values for EC and TDS are directly related and convertible within an accuracy of about 10%. For TDS determine we can use the formula

$$\text{TDS (mg/L)} = \text{EC (dS/m)} \times 640 \quad (1)$$

The TDS values are recommended for the plants. With increasing soil salinity in the root zone, plants expend more of their available energy on adjusting the salt concentration within the tissue to obtain needed water from the soil. Less energy is available for plant growth. The soil salinity will reach some constant value dependent on the leaching fraction – LF – the fraction of applied water that passes through the entire rooting and percolates below.

$$\text{LF} = D_d/D_i = (D_i - \text{ET}_c)/D_i \quad (2)$$

Where  $D_d$  – is the depth of water leached below the root zone;  $D_i$  – depth of water applied at the surface;  $\text{ET}_c$  – crop evapotranspiration.

There are some clogging problems with sprinkle and drip irrigation systems reported. The water needs the chlorine with the exact amount, against biological growth in the system, the sprinkler head, emitter orifice [10].

#### 4.2. INDUSTRIAL WATER REUSE

There is various example of wastewater reuse. Industry need huge amount of the water. The reuse water needs the quality control. Some type of reuse is cooling tower, which represents the significant water for many industries. Slovakia has two nuclear power stations Mochovce and Jaslovské Bohunice, which use the water for the nuclear reactor cooling. The next one use is in thermal power stations (Vojany). The basic principle of cooling tower operation is that of evaporative condensation and exchange of sensible heat. The air and the water mixture release latent heat of vaporization. The industrial wastewater reuse need the water quality control in many aspects: scaling, metallic corrosion, biological growth, fouling.



#### 4.3. GROUNDWATER RECHARGE WITH RECLAIMED WASTEWATER

This type of reuse has been used (a) to reduce, or stop reverse declines of groundwater level, (b) to protect underground freshwater in coastal aquifers against saltwater intrusion from the ocean (c) to store reclaimed wastewater and surface water for future use. There are methods of groundwater recharge: by surface spreading, by direct injection. The accent needs to turn for the dissolved inorganic and organic contaminants.

#### 4.4. POTABLE WATER REUSE

Quantity involved in potable reuse is small, the technological and public health interests are great, but considerable research has been directed toward potable water reuse. The potable water reuse can be indirect. The first well-documented case of this reuse occurred at Chanute, Kansas, in 1956–57 during the severe drought period of 1952–57. But there were some serious problems of public acceptance. The consideration we must take, whether the water is necessary for the short term emergency or for normal use in long period. For potable water reuse we have to take some reuse criteria. We have to keep the drinking water criteria.

### 5. Water Supply in Slovakia

**Use of groundwater bodies:** In the Danube River Basin district, 96 groundwater bodies have been identified, including: 15 groundwater bodies in significant Quaternary alluvial sediments, 56 groundwater bodies in prequaternary rocks, 25 geothermal groundwater bodies which present groundwater with temperatures above 14° (not used for drinking water production) [4]. Of all groundwater bodies, seven were identified as transboundary groundwater bodies – six on the border with Hungary and one on the border with the Czech Republic.

Around 80% of groundwater abstractions are used for drinking water, 17% for industry and around 3% for agricultural purposes [5]. There are 2,479 significant groundwater abstractions in the RBD. The percentage of groundwater bodies at risk in the RBD as a result of groundwater abstractions is 8%. The total volume abstracted in the RBD from significant groundwater abstractions is 403,570,000 m<sup>3</sup> per year.

**Use of surface water bodies:** In the Danube RBD 1,659 surface water bodies were identified as rivers, and 23 as lakes (all constructed reservoirs). Around 10% of all abstracted surface water is used for drinking water; the majority of abstracted water is used for industry (85%) and the rest (5%) for agriculture [3]. The drinking water supply is ensured mostly through reservoirs

and not from rivers. There are 55 abstraction points from surface waters, with 639,048,000 m<sup>3</sup> per year abstracted from the river basin district.

## 6. Organic Pollution from Sewerages

Organic loading from point pollution sources is a significant point source pollutant within the Danube RBD. Sources of such pollutant are effluents from insufficiently treated or untreated wastewater. The total amount of discharged organic pollution into surface waters of the Danube River Basin District from significant identified sources is around 17 kt of BOD and around 54 kt of COD in 2002. Organic loading from diffuse pollution sources is a significant pollutant within the RBD as well, but it is not possible to quantify it, as mentioned above. Mostly it is caused by soil erosion (agriculture, changes in land use) and by pollution from municipalities not connected to the sewerage or individual treatment system. In “*Conception of water management policy in the Slovak Republic in 2005*” approved by NR (national council) SR is planned perspective percentage of connection to year 2015 approximately 75%.

## 7. Conclusions

Only 57.6% of Slovak inhabitants are connected to the public sewer system. The concept of new approach of sewer system build with WWTP in Slovakia does not calculate with the wastewater reuse [2]. The reuse of wastewater is particularly appearing in the new buildings, which wants to save the operational and investments costs for the storm water dewatering, for water need for toilets flushing, in the car was industry.

Wastewater reclamation and reuse is becoming an increasingly attractive and required option as alternative water supply and conservation option. Water stress and scarcity as well as integrated water resources management approaches are major drivers for wastewater reuse. The further development of water reuse is slowed back by uniform guidelines or standards. Further research is needed on many areas such as economic incentives, health based risk assessment and technological innovation.

The world's freshwater resources are under strain. Reuse of wastewater, in concept with other water conservation strategies, can help lessen anthropogenic stresses arising from over-extraction and pollution of receiving waters.

## Acknowledgement

The paper has been written with the support of the Grant Research Tasks VEGA No. 1/0854/08 and KEGA 3/5125/07 dealt with at the Department of Sanitary and Environmental Engineering of the Faculty of Civil Engineering of the University of Technology Bratislava.

## References

- [1] Angelakis, A. N. and Koutsoyiannis, D.: 2003. *Urban Water Resources Management in Ancient Greek Times*. The *Encycl. of Water Sci.*, Markel Dekker Inc. (B.A. Stewart and T. Howell, Eds.), Madison Ave. New York, pp. 999–1007.
- [2] Belica, P. et al.: Evaluation issue in fact and demands for sewerage systems and WWTP concerning Government Act No 232/93 and EU directive, VUVH Bratislava, 2001.
- [3] Conception of Water Management Police for Slovak Republic to 2005. Ministry of Agriculture SR, 2001.
- [4] Danube Facts and Figures: Slovakia © ICPDR (International Commission for the Protection of the Danube River) – <http://www.icpdr.org>
- [5] Kriš, J., Faško, M. and Škultétyová, I.: Water resources and their protection in Slovak Republic. In: *Environment. Survival and Sustainability*. Abstracts: International conference. Nicosia- Northern Cyprus, 19.-24.2.2007. Nicosia, Near East University, 2007. ISBN 978-975-8359-41-7. S. p. 612.
- [6] Mahrikova, I.: Problematika odvádzania a čistenia odpadových vôd z malých územných celkov, Optimalizace návrhu a provozu stokových sítí a ČOV, MĚSTSKÉ VODY 2006, 5.-6.10.2006, Břeclav, s. pp. 129–135.
- [7] Mahrikova, I.: Waste Water Treatment from Small Urban Areas. In: *Dangerous Pollutants (Xenobiotics) in Urban Water Cycle*, ISBN 978-1-4020-6800-3, Springer 2008, The Netherlands, pp. 71–81.
- [8] Montero, C., Villaneuva, A., Hlavinek, P., and Hafskjold, L.: *Wastewater Rehabilitation Technology Survey*. CARE-S Report D12. 2004.
- [9] Sztruhar, D. and Kris, J.: Upgrade of Water And Sewerage Facilities in Slovakia to Achieve Compliance with Major EU Directives, workshop preprints NATO ARW, Enhancing Urban Environment by Environmental Upgrading and restoration, November 5–8, 2003, Rome, Italy, pp. 299–310.
- [10] *Wastewater Engineering, Treatment, Disposal and Reuse*, 3rd edition, Metcalf & Eddy, McGraw-Hill, New York, 1991, ISBN 0-07-100824-1.

## EXAMPLES OF RISK MANAGEMENT IN FLANDERS FOR LARGE SCALE GROUNDWATER CONTAMINATION

ILSE VAN KEER\*, RICHARD LOOKMAN, JAN BRONDERS,  
KAAT TOUCHANT, JOHAN PATYN, INGEBORG JORIS,  
DANNY WILCZEK, JOHAN VOS

*VITO (Flemish Institute for Technological Research), Boeretang  
200, B-2400 Mol, Belgium*

JAN DEWILDE, KATRIEN VAN DE WIELE, PASCAL  
MAEBE, FILIP DE NAEYER

*OVAM (Public Waste Agency of Flanders), Stationsstraat 110,  
B-2800 Mechelen, Belgium*

**Abstract.** With respect to soil and groundwater remediation in Flanders, regulators have recently adopted a new, risk-based, policy. This policy is illustrated by two examples of risk management applied for large scale groundwater contamination. The first case involves a benzene and MTBE groundwater contamination threatening a shallow drinking water production site. Source zone treatment combined with pump & treat plume interception may be the only risk-based remediation strategy applicable in such cases. The second example is a risk management plan designed for the redevelopment of a brownfield located near Brussels, Belgium. In this area, an extensive groundwater contamination of monoaromatic and chlorinated aliphatic hydrocarbons is present in the Quaternary aquifer drained by the river Zenne. The risk management plan involves the combination of intensive treatment of source zones and plume treatment.

**Keywords:** risk-based groundwater management, interception strategy, VOCs; urban & industrial area, drinking water production

---

\* To whom correspondence should be addressed. Ilse Van Keer, VITO (Flemish Institute for Technological Research), Boeretang 200, B-2400 Mol; e-mail: [ilse.vankeer@vito.be](mailto:ilse.vankeer@vito.be)

## 1. Introduction

Recently, the Flemish Decree on soil remediation established in 1995 was thoroughly revised in order to simplify the procedures for soil remediation and lower the costs of soil investigation and remediation. The “new” decree of October 2006 ([www.ovam.be](http://www.ovam.be)), which replaces the “old” decree of 1995, not only modified the structure and the outlines of the old decree, but also existing procedures and definitions are refined and/or simplified. Furthermore, new directives with respect to risk management, accidental pollution, soil protection, co-financing and further supportive measures are implemented.

According to the new decree, *risk management* is defined as management of the risks related to soil contamination by developing a risk management plan, implementing risk management measures and specific follow-up measures. A more phased planning and implementation of remedial actions is allowed. Risk management can be applied in case of severe “historical” (i.e. originating from earlier than 29 October 1995) or “mixed” soil contaminations (i.e. originating partly from before and partly after 29 October 1995). Hereby, a risk management approach, that focuses on the protection of receptors threatened instead of restoration of soil and groundwater quality to predefined limit concentrations, may thus be authorized by the Public Waste Agency of Flanders (OVAM).

In the following paragraphs two cases are illustrated in which risk management has been applied with respect to large-scale groundwater pollutions.

## 2. Interception Strategy to Control a Large-Scale MTBE and Benzene Groundwater Pollution Near a Drinking Water Extraction Site

### 2.1. HISTORY

In 1989 a spill of approximately 5 to 10 m<sup>3</sup> of gasoline occurred at a fuel station near Geel, Belgium. Seven hundred meters downstream, an important groundwater extraction site for drinking water is present, comprising 15 production wells distributed over an area of about 20 ha. The removal of the gasoline in the subsoil at the spill zone (source) was initiated in 1998 by airsparging and soil vapor extraction. Early 2002 the contaminated soil on the site was further excavated and transported to a soil treatment centre. By that time, the source had caused a substantial MTBE and to a lesser extent benzene groundwater contamination in the underlying aquifer. In this aquifer consisting of permeable tertiary sands, groundwater travels at about 25 m/year.

Pumping at the drinking water production site causes a strong flow field in a larger perimeter around the production site, drawing the pollution to it. Consequently, a long (over 300 m), narrow (10–20 m) and “diving” groundwater

contamination plume was developed. At smaller distances downstream of the pollution source only benzene (B) and MTBE remain. In the anaerobic (iron reducing) subsurface environment in the plume, toluene (T), ethyl benzene (E) and xylenes (X) are being fully biologically degraded.

## 2.2. RISK-BASED INTERCEPTION STRATEGY DESIGN AND OPERATION

Based on the conceptual site model and groundwater modelling the soil remediation plan (submitted in 2000) proposed a source excavation at the former fuel station together with pump & treat. Initially three vertical pumping wells (P1, P2 and P3) were installed (Figure 1). Designed pumping rates were 3.3; 8.3 and 4.2 m<sup>3</sup>/h, respectively. The interception pumping was commenced in April 2001. In April 2002 the excavation at the station, about 1.6·10<sup>6</sup> kg of contaminated soil, was completed. Initial pumping rates realized were lower than designed (about 6 m<sup>3</sup>/h in total for the three wells) due to substantial clogging of iron oxides in the water treatment system and effluent pipes. After some alterations to the system (de-ironing) this was solved. However, due to these problems, and because of a long period of severe frost in the following months, the interception pumping was interrupted for several months. As was established later, this caused plume breakthrough, leading to the need for an additional interception well (P4).

## 2.3. CONCENTRATION EVOLUTIONS IN MONITORING AND PUMPING WELLS

### 2.3.1. *Monitoring Wells*

In October 2002 already, a MTBE-front was predicted to arrive in monitoring well “Mpb3” within a period of about 2.5 years (mid-2004) after insufficient pumping due to clogging in the water treatment. This prediction, made on the basis of calculated groundwater migration velocities, was confirmed by the high MTBE concentration observed in monitoring well Mpb3e, which is 60 m downstream of interception well P1, in April 2004 (Figure 2). This plume breakthrough is a consequence of interrupted pumping in the period August 2002–February 2003. After increasing the pumping rates in interception well P1, concentrations in monitoring well Mpb3e eventually decreased to below detection limits.

Figure 3 shows the MTBE concentrations measured in monitoring wells “275”, which is directly upstream of interception well 1. Concentrations have been more or less stable at 10,000 µg/L (“275D”) and 1,000 µg/L (“275C”) but started to decrease since early 2008.

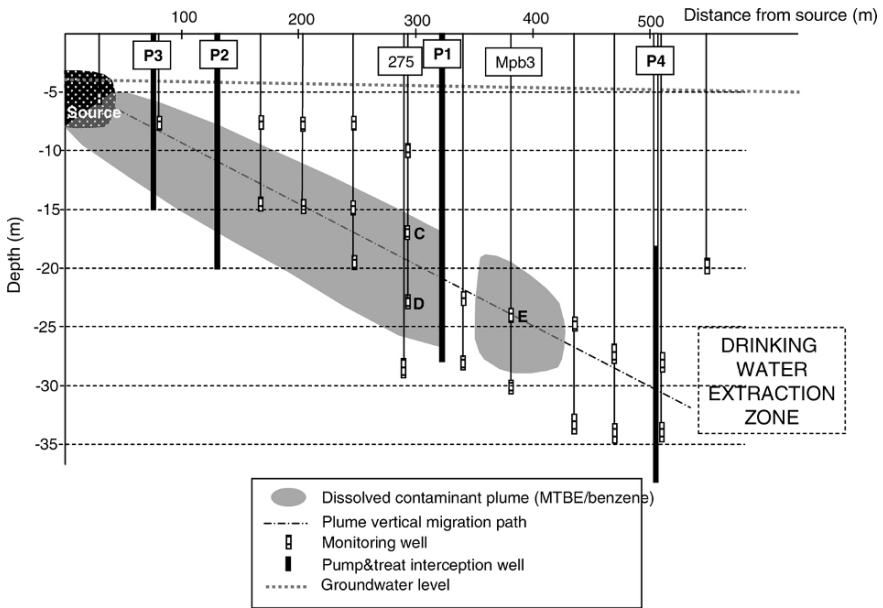

Figure 1. Conceptual model (vertical section) of the pollution source, plume, monitoring and interception wells (indicated P1–P4)

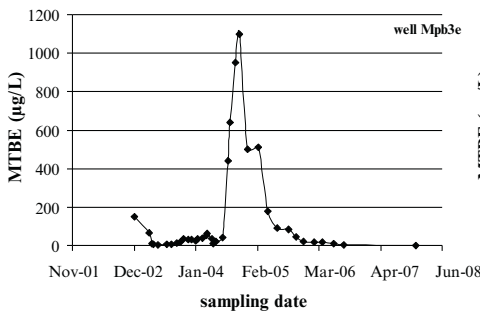

Figure 2. Concentration of MTBE in groundwater sampled from monitoring well “Mpb3e”. The period of interrupted pumping was 25/08/2002–27/02/2003

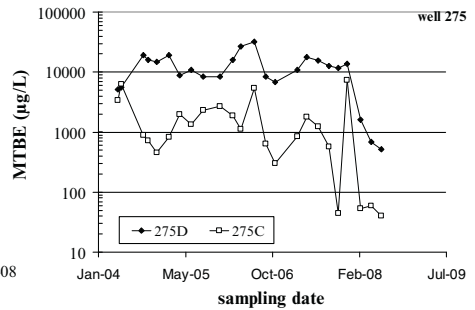

Figure 3. Concentrations of MTBE in monitoring wells “275”. C and D indicate screen depths (D is the deeper screen, ref. to Figure 1)

### 2.3.2. Interception Pumping Wells

The MTBE and benzene concentration trends in interception pumping wells P1 and P3 are shown in Figures 4 and 5 respectively. Concentrations in well P3, which is nearest to the excavated source, have been declining. In well P1, which

is initially farthest from the source, concentrations are still rather constant although a start of a decline seems to be initiated.

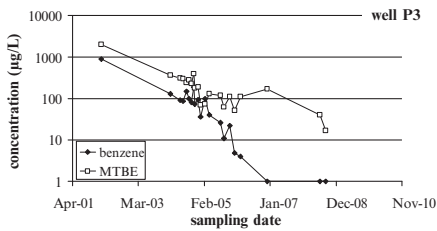

Figure 4. Concentrations of benzene and MTBE in interception well P3 over time

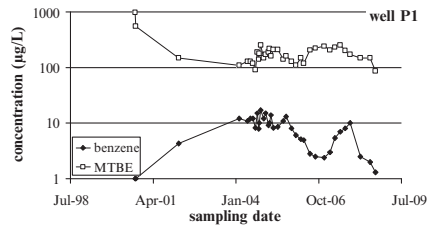

Figure 5. Concentrations of benzene and MTBE in interception well P1 over time

2.3.3. Installation of a Fourth Interception Well

To intercept the MTBE that had “escaped” interception well P1, a fourth interception well had to be installed at about 100 m downstream of Mpb3 (Figure 1). The MTBE was expected to reach that location in fall 2007. Early 2006, this well was installed and constantly operated at a rate of about 200 m<sup>3</sup>/d. Since then the pollution has adequately been captured (Figure 6) and over-all plume intensities have started to decrease since early 2008.

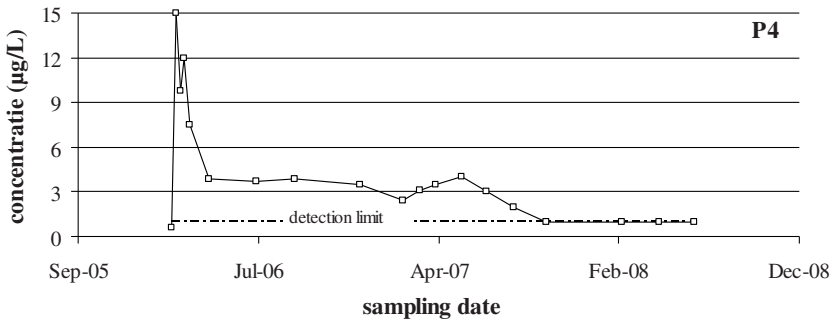

Figure 6. Concentrations of MTBE in interception well P4 over time



### **3. A Risk Management Plan for a Large Scale Groundwater Contamination in an Urban/Industrial Area**

#### 3.1. SITE SPECIFIC INFORMATION

Field investigations carried out at a brownfield located in the towns of Vilvoorde and Machelen (north of Brussels, Belgium) indicate the presence of an extensive regional groundwater contamination, consisting of a mixture of BTEX (benzene, toluene, ethylbenzene and xylene) and chlorinated aliphatic hydrocarbons (CAH).

The redevelopment of this area is complex since it consists of many parcels, both residential and industrial. Some locations within the area are abandoned industrial sites with a history of over 100 years of industrial activity. Investigation and remediation of every single site in this region will not result in an effective removal of the regional groundwater pollutants due to economic and legal restraints, fragmented remediation actions, and the rather large time span needed to complete such actions. Therefore a risk management plan (RMP) was developed to identify appropriate remedial options to control the potential negative effects of the groundwater pollution on the hydrological ecosystem and to enhance the cooperation between all stakeholders. Only then an effective redevelopment of the area will be feasible.

#### 3.2. STRATEGY

To work out a RMP in combination with appropriate remedial actions, in which the BATNEEC principle and land use are playing an important role, a tiered approach was adopted in which several steps were defined i.e., (1) characterisation of the hydrogeology and the pollution; (2) identification of the risks, (3) development of a remedial action plan and (4) definition of the RMP.

##### 3.2.1. *Characterisation of the Pollution*

To characterize the pollution, all existing analysis data were compiled using the OVAM data bank. Furthermore, a regional soil and groundwater investigation was carried out, including the drilling of boreholes, installation of monitoring wells, execution of MIP probings and the application of compound-specific isotope analyses (CSIA) (Bronders et al., 2008; Van Keer et al., 2008). According to these investigations and the results obtained, the polluted region corresponds to an area of at least 70 ha. Plume dimensions are 1.2 by 0.6 km (Figure 7). Chemical analyses indicate that most of the groundwater pollution is present at depths below 12 to 14 m bgs (Bronders et al., 2008; Van Keer et al., 2008). An arbitrary distinction was made between local (site) and regional scale

pollutions. According to the CSIA, combined with data on redox conditions and the presence of (partial) degradation products, natural attenuation processes were identified and found to be significant.

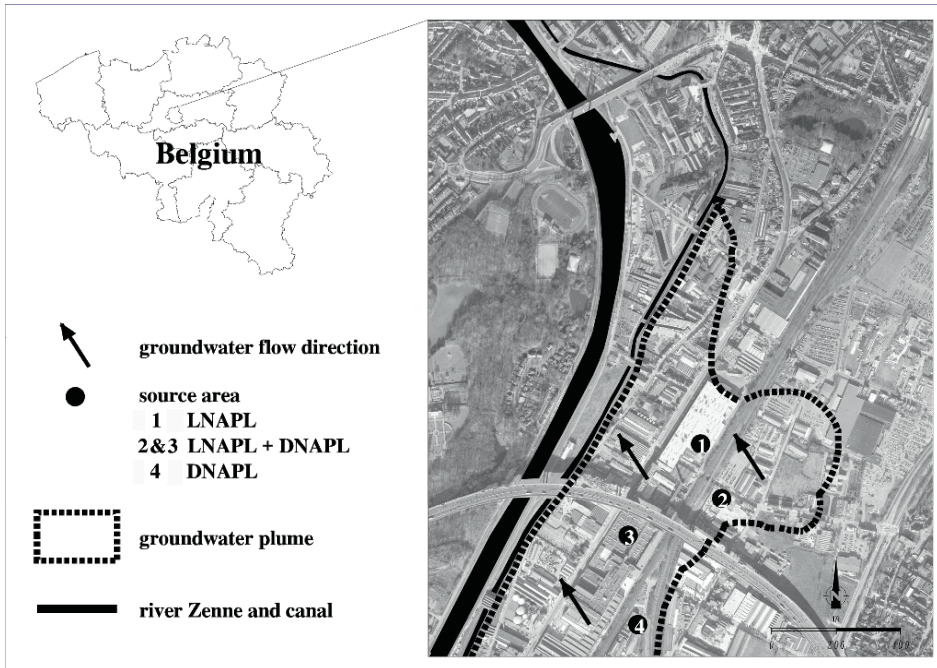

Figure 7. Location of the industrialised area of Vilvoorde – Machelen (near Brussels, Belgium) with indication of the major source zones and the area covered by the pollution plume. LNAPL: light non aqueous phase liquids (i.e. petroleum hydrocarbons); DNAPL: dense non aqueous phase liquids (i.e. chlorinated aliphatic hydrocarbons)

### 3.2.2. Overall Risk Evaluation

A regional groundwater flow model was developed (MODFLOW), including contaminant transport calculations (MT3D and Hydrus-2D). The groundwater modelling confirmed that the pollution present in the Quaternary aquifer is drained towards the nearby river Zenne (Figure 8). This indicates that the existing groundwater plume will not become much larger. Flow times to the river are in the order of decades. As a consequence, the pollutants will be present in the aquifer for many years to come.

At the same time a set of specific risk-based quality reference values for soil and groundwater were derived using the Flemish “Vlier-Humaan” exposure model (Provoost et al., 2004) based on local land use and possible exposure routes.

Although local pollution requires another approach than regional pollution, in both cases it is necessary to understand the pollution history and identify source-path-receptor relations. Subsequently, a risk assessment has to be carried out defining if and which remedial actions are needed. Currently the risk evaluation has not yet been completed. Not all possible future land uses have been taken into account and a detailed BATNEEC evaluation still has to be executed. The presented RMP is an example of the approach that can be used. The OVAM is taking further steps to complete the investigations needed.

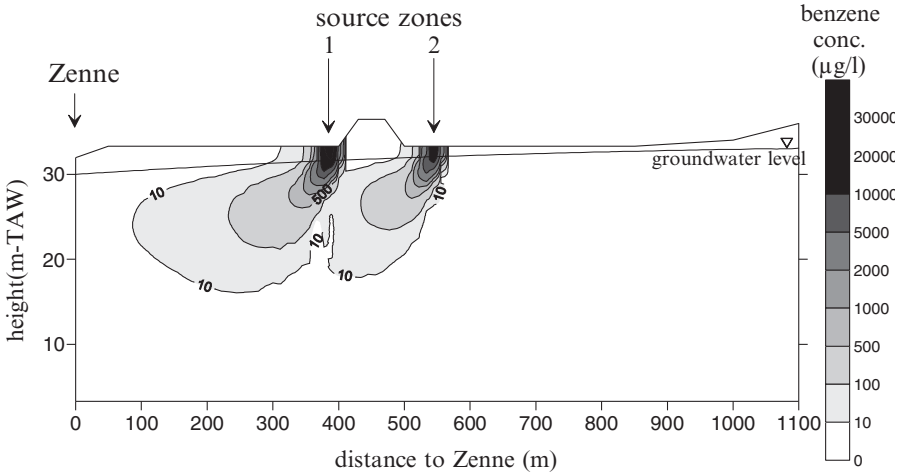

Figure 8. Calculated extension of the benzene pollution, present in the shallow aquifer, originating from source areas 1 and 2 (locations cf. Figure 7)

### 3.2.3. Risk Management Plan

Based on the characterisation of the pollution and the overall risk evaluation a RMP has been proposed for the Vilvoorde – Machelen pollution plume area (Figure 9), consisting of two components:

1. For the local scale (site specific) the current procedures for soil investigations should be followed if there is (1) no clear relation to the aquifer regional pollution and (2) no possibility of identifying a specific source of the groundwater plume. Consequently, for individual sites the “normal” procedure according to Flemish regulations must be followed and at the final investigation stage an individual site specific remediation project has to be executed. The person or party obliged to remediate (e.g. the operator or the owner) has to finance all necessary actions.
2. For the regional problem the RMP includes (1) an evaluation of the use of soil and groundwater (for the study area groundwater use is not allowed), (2) receptor-based (i.e. River Zenne) measurements, (3) an evaluation of

(stimulated) natural attenuation and (4) an evaluation of the possible application of pump & treat to prevent further migration of pollution. Therefore, continuous monitoring on a regular time base is required.

The presented RMP can be applied by the different stakeholders involved in the redevelopment of the area.

#### 4. Conclusions

The first case study illustrates on the one hand the vulnerability of shallow groundwater extraction sites common in Flanders and on the other hand a successful source zone treatment combined with a risk-based pump & treat interception strategy to protect an important drinking water production site. Hereby, careful and intensive monitoring is needed. Although insufficient pumping and pumping failures in the downstream interception well caused partial pollution breakthrough in this case, the pollution has adequately been captured after the installment of an additional interception well.

The second example involves a brownfield located in Vilvoorde/Machelen (near Brussels, Belgium). An extensive regional groundwater contamination of petroleum hydrocarbons and chlorinated aliphatic hydrocarbons is present in the Quaternary aquifer drained by the river Zenne. In such cases, a risk management plan can be developed combining intensive treatment of pollution source areas with a more extensive plume treatment (monitored natural attenuation).

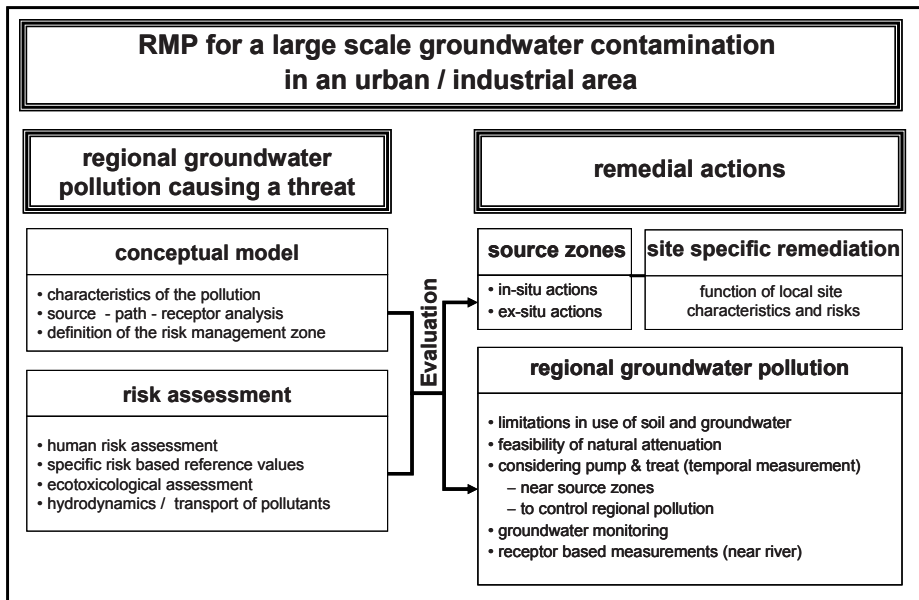

Figure 9. Schematic overview of the RMP proposed for the polluted area at Vilvoorde – Machelen

## References

- Bronders J., Touchant K., Van Keer I., Patyn J. & Provoost J., 2008. A risk management plan for the redevelopment of a brownfield: an example, pp. F47 – F56 in: Proceedings of the 10th International UFZ-Deltares/TNO Conference on Soil-Water Systems. Consoil 2008, Milan, 3–6 June 2008.
- Provoost J., Cornelis C., Van Gestel G., & Engels R., 2004. Technical guidance document, Part 3 – Background document with formulas for the multi-media model Vlier-Humaan, advise on behalf of the Flemish Public Waste Agency (OVAM), report in Dutch, 2004.
- Van Keer I., Bronders J., Touchant K., Verhack J. & Wilczek D. 2008. Detection and measurement techniques to identify the presence of NAPLS in the field, pp. 59–69 in: Methods and Techniques for Cleaning-up Contaminated Sites (Annable M.D., Teodorescu M., Hlavinek P. & Diels L., eds.). Springer, Dordrecht (The Netherlands).

## ENVIRONMENTAL BENEFITS OF WASTEWATER TREATMENT: AN ECONOMIC VALUATION

F. HERNANDEZ-SANCHO<sup>\*</sup>, M. MOLINOS SENANTE  
*Department of Applied Economics II: Faculty of Economics,  
University of Valencia, Campus dels Tarongers,  
46022 Valencia, Spain*

R. SALA-GARRIDO  
*Department of Math, Faculty of Economics, University of  
Valencia, Campus dels Tarongers, 46022 Valencia, Spain*

**Abstract.** The need of economic research into the design and implementation of policies for the efficient management of water resources has been emphasized by the European Water Framework Directive (Directive 2000/60/UE). The efficient implementation of policies to prevent the degradation and depletion of water resources requires determining their value in social and economic terms and incorporating this information into the decision-making process. A process of wastewater treatment has many associated environmental benefits. However, these benefits are often not calculated because they are not set by the market. Nevertheless, the valuation of these benefits is necessary to justify a suitable investment policy and the contributions existing in the literature are very limited. In this paper, we propose a methodology based on the estimation of shadow prices for the pollutants removed in a treatment process. This value represents the environmental benefit (avoided cost) associated with undischarged pollution. This is a pioneering approach to the economic valuation of wastewater treatment. The comparison of these benefits with the internal costs of the treatment process will provide a useful indicator for the feasibility of wastewater treatment projects.

**Keywords:** shadow prices, environmental benefits, wastewater treatment, economic valuation

---

<sup>\*</sup> To whom correspondence should be addressed. F. Hernandez-Sancho, Department of Applied Economics II: Faculty of Economics, University of Valencia. Campus dels Tarongers. 46022 Valencia, Spain; e-mail: Francesc.Hernandez@uv.es

## 1. Introduction

Economic studies for the design and implementation of policies for the efficient management of water resources are a necessity that is increasingly recognized – as set out for example in the Water Framework Directive (Directive 2000/60/UE) (Birol, 2006). Undoubtedly, the over-exploitation of resources and inefficient allocation is a result of the absence of a market that could adjust supply and demand through price; as well as the very limited success of authorities in attempting to manage by regulation. It is no longer sufficient to simply apply the precautionary principle and state that an issue such as drinking water quality or environmental water quality are more or less important than say cost or other environmental and social impacts (Schimmoller et al., 2008).

A number of methodologies can be used as support instruments when implementing policies and selecting measurements – with cost–benefit analysis (CBA) being the most accepted and used. This analysis is performed to compare the economic viability of different proposals.

Making a cost–benefit analysis of actions with environmental impacts is complex because many environmental resources (including most water resources) are public property, and so do not have a market that sets price (Koundouri, 2000).

Externalities refer to any consequence (positive or negative, intentional, or random) that derives from a project. The quantification of externalities is usually made using the *contingent valuation method* (CV). This method is based on the simulation of a scenario whereby individuals are asked about their willingness to pay, or be compensated, for an increase or decrease in the quality or quantity of environmental resources (Mitchell and Carson, 1989).

Despite the publication of a significant number of works based on the contingent valuation methodology there is no unanimous consensus in the literature regarding its validity as a tool for evaluating environmental resources. This debate, combined with the high financial cost of such methods, has aroused interest in alternatives to contingent valuation in the context of the environment, and especially water resources.

In this context and, from the pioneering work by Färe et al. (1989), and within the framework of studies into efficiency, a stream of research has been produced that aims to provide a valuation methodology for those undesirable outputs that have no market. Using the concept of the *distance function*, a *shadow price* is calculated for those goods arising from human activities and products (solid waste, pollutants, wastewater, etc.) which have no market value and yet have substantial environmental impacts. A series of studies (Färe et al., 1993, 1996; Yaisawarng and Klein, 1994; Ha et al., 2008) have been developing a valuation methodology for such undesirable goods that is fully supported by the literature.



Importantly, the undesirable outputs analyzed in the literature can be regarded as negative environmental externalities associated with a production process. In this sense, we consider water treatment as a productive process in which a desirable output is obtained together with a series of undesirable outputs. A shadow price for these undesirable elements would be the equivalent of the environmental damage avoided, or the environmental benefit gained from the treatment process. In other words, we would obtain the value of the positive externalities associated with wastewater treatment.

The advantages of valuing externalities using distance functions in comparison with the contingent valuation method described above include: the robustness of the model used; lower costs compared with the long and expensive process of questionnaire surveying; and the avoidance of possible bias in the questions asked by the interviewer.

**2. Methodology**

Distance functions were first introduced by Shephard (1970) and subsequently developed by Färe et al. (1993). Conceptually, a distance function generalizes the concept of conventional production functions and measures the difference between the outputs produced in the process under study and the outputs of the more efficient process. This function provides the distance of a vector of outputs from the frontier of maximum output and starting from a vector of constant inputs. Assuming that the production process uses a vector of  $N$  inputs  $x \in R_+^N$  to produce a vector of  $M$  outputs  $u \in R_+^M$ , the distance function is defined as:

$$D_0(x,u) = \text{Min } \{ \theta : (u/\theta) \in P(x) \} \tag{1}$$

where  $P(x)$  is a vector of outputs that are technically viable and use the vector of  $x$  inputs, while  $\theta$  is a ratio between 0 and 1, that is,  $D_0(x,u) \in [0,1]$ . Large values of indicate a good approximation to the production frontier, and therefore a high level of efficiency.

The relationship of duality between the distance function of output and the revenue function (Shephard, 1970) creates the link between relative and absolute output shadow prices (Färe et al. 1993). Under the assumption that distance functions and income are differentiable, Shephard’s dual lemma enables the following relationship to be established:

$$\nabla_u D_0(x,u) = r^*(x,u) \tag{2}$$

where  $r^*(x,u)$  is the maximum income function for a given vector of output prices.



The deduction of absolute shadow prices for the undesirable outputs using the distance function means assuming that the shadow price of an absolute wanted output coincides with the market price. In this way, if  $m$  is a desirable wanted output whose market price  $r_m$  is equal to its absolute shadow price ( $r_m^0$ ), then for all  $m' \neq m$  the absolute shadow prices are given by (Färe et al., 1993):

$$r_{m'} = r_m^0 \frac{\partial D_0(x, u) / \partial u_m}{\partial D_0(x, u) / \partial u_{m'}} \tag{3}$$

Linear programming is the most widely used method for estimating empirical distance functions – although some studies (for example, Hetemäki, 1996) use econometric methods. One advantage of this methodology is that no suppositions regarding the functional form are required. One possible drawback is that the calculated parameters do not have statistical properties.

The translog function offers the greatest flexibility in this area, and is therefore the most used. Applied to a problem with  $k$  units,  $n$  inputs and  $m$  outputs the formula is:

$$\begin{aligned} \ln D_0(x^k, u^k) = & \alpha_0 + \sum_{n=1}^N \beta_n \ln x_n^k + \sum_{m=1}^M \alpha_m \ln u_m^k + \frac{1}{2} \sum_{n=1}^N \sum_{n=1}^N \beta_{nm} (\ln x_n^k)(\ln x_n^k) \\ & + \frac{1}{2} \sum_{m=1}^M \sum_{m=1}^M \alpha_{mm} (\ln u_m^k)(\ln u_m^k) + \sum_{n=1}^N \sum_{m=1}^M \gamma_{nm} (\ln x_n^k)(\ln u_m^k) \end{aligned} \tag{4}$$

To calculate the parameters of the equation ( $\alpha, \beta, \gamma$ ) we need to solve the linear program (5) subject to the following restrictions:

- (i) All of the observations should be less than or equal to 1.
- (ii) The derivative of the distance function does not decrease with the desirable output. In this case, the denominator  $u_1^k$  is the only desirable output of the problem described in the following point.
- (iii) The derivative of the distance function with relation to the undesirable outputs ensures that these show negative prices. In this case,  $u_m^k$ , ( $m'=2,3,4,5,6$ ) are undesirable outputs of the problem in the following point.
- (iv) Degree 1 homogeneity of the function.
- (v) Parameter symmetry.

$$\begin{aligned}
 \text{Max } Z &= \sum_{k=1}^K [\ln D_0(x^k, u^k) - \ln 1] \\
 \text{s.t. :} \\
 (i) \quad &\ln D_0(x^k, u^k) \leq 0 \\
 (ii) \quad &\frac{\partial \ln D_0(x^k, u^k)}{\partial \ln u_1^k} \geq 0 \\
 (iii) \quad &\frac{\partial \ln D_0(x^k, u^k)}{\partial \ln u_m^k} \leq 0 \\
 (iv) \quad &\sum_{m=1}^M \alpha_m = 1 \\
 (v) \quad &\sum_{m'=1}^m \alpha_{mm'} = \sum_{m=1}^M \gamma_{nm} \\
 (vi) \quad &\alpha_{mm'} = \alpha_{m'm}
 \end{aligned} \tag{5}$$

### 3. Sample Data

The sample used in this empirical application consists of 43 wastewater treatment plants located in the Spanish region of Valencia. Statistical information has been supplied for the year 2004 by the local wastewater treatment authority (*Entitat de Sanejament d'Aigües – EPSAR*). The volume of wastewater treated in each plant varies between 1,000,000 and 10,000,000 m<sup>3</sup>/year. All of the facilities offer secondary treatment and the removal of nitrogen and phosphorus.

TABLE 1. Description of the Sample (Source EPSAR)

		Average	Deviation
INPUTS (€/year)	Energy	115,605.81	62,215.94
	Staff	194,375.70	107,894.27
	Reagents + maiten.	89,801.95	76,838.84
	Others	111,739.98	83,104.69
DESIRABLE OUTPUT (m <sup>3</sup> /year)	Treated water	3,469,253.74	1,941,214.35
UNDESIRABLE OUTPUTS (kg/year)	N	88,794.98	73,772.58
	P	17,463.23	16,977.39
	SS	1,196,525.19	1,097,032.56
	BOD	1,134,974.22	999,246.11
	COD	2,230,576.68	1,927,064.29

The process produces a desirable output, treated water ( $u_1$ ), and five undesirable outputs *nitrogen* ( $u_2$ ), *phosphorus* ( $u_3$ ), *suspended solids* ( $u_4$ ), and *organic matter* that is measured as *Biological Oxygen Demand* ( $u_5$ ) and *Chemical Oxygen Demand* ( $u_6$ ). The inputs needed to carry out the treatment are: *energy* ( $x_1$ ), *staff* ( $x_2$ ), *reagents and maintenance* ( $x_3$ ) and *others* ( $x_4$ ). Table 1 describes the data used:

#### 4. Results

The translog function for estimating the above information is as follows:

$$\ln D_0(x^k, u^k) = \alpha_0 + \sum_{n=1}^4 \beta_n \ln x_n^k + \sum_{m=1}^6 \alpha_m \ln u_m^k + \frac{1}{2} \sum_{n=1}^4 \sum_{n=1}^4 \beta_{nn} (\ln x_n^k)(\ln x_n^k) + \frac{1}{2} \sum_{m=1}^6 \sum_{m=1}^6 \alpha_{mm} (\ln u_m^k)(\ln u_m^k) + \sum_{n=1}^4 \sum_{m=1}^6 \gamma_{nm} (\ln x_n^k)(\ln u_m^k)$$

TABLE 2. Parameters and coefficients associated with a translog function

Parameter	Coefficient	Parameter	Coefficient	Parameter	Coefficient
$\alpha_0$	-3.328301	$\alpha_{33}$	-0.001426	$\gamma_{13}$	0.000250
$\alpha_1$	0.520093	$\alpha_{34}$	0.002435	$\gamma_{14}$	0.004429
$\alpha_2$	-0.001000	$\alpha_{35}$	0.019844	$\gamma_{15}$	-0.089114
$\alpha_3$	-0.003561	$\alpha_{36}$	-0.022291	$\gamma_{16}$	0.110522
$\alpha_4$	-0.056680	$\alpha_{44}$	-0.005906	$\gamma_{21}$	-0.041102
$\alpha_5$	1.359386	$\alpha_{45}$	0.002157	$\gamma_{22}$	0.000000
$\alpha_6$	-0.818238	$\alpha_{46}$	0.000475	$\gamma_{23}$	0.000788
$\beta_1$	-0.387763	$\alpha_{55}$	-0.245079	$\gamma_{24}$	0.007399
$\beta_2$	0.466536	$\alpha_{56}$	0.175919	$\gamma_{25}$	0.014293
$\beta_3$	-0.039217	$\alpha_{66}$	-0.127964	$\gamma_{26}$	-0.286168
$\beta_4$	-0.370059	$\beta_{11}$	0.009956	$\gamma_{31}$	0.000336
$\alpha_{11}$	-0.001410	$\beta_{12}$	-0.008381	$\gamma_{32}$	0.000000
$\alpha_{12}$	0.000000	$\beta_{13}$	0.012752	$\gamma_{33}$	0.000126
$\alpha_{13}$	-0.000526	$\beta_{14}$	0.005851	$\gamma_{34}$	-0.000949
$\alpha_{14}$	-0.001275	$\beta_{22}$	-0.012633	$\gamma_{35}$	0.047508
$\alpha_{15}$	-0.002447	$\beta_{23}$	-0.005977	$\gamma_{36}$	-0.045293
$\alpha_{16}$	-0.032949	$\beta_{24}$	0.053235	$\gamma_{41}$	0.026537
$\alpha_{22}$	0.000000	$\beta_{33}$	0.005319	$\gamma_{42}$	0.000000
$\alpha_{23}$	0.000000	$\beta_{34}$	-0.006546	$\gamma_{43}$	0.000826
$\alpha_{24}$	0.000000	$\beta_{44}$	-0.070453	$\gamma_{44}$	-0.003555
$\alpha_{25}$	0.000000	$\gamma_{11}$	-0.004186	$\gamma_{45}$	-0.064538
$\alpha_{26}$	0.000000	$\gamma_{12}$	0.000000	$\gamma_{46}$	0.081448

In this case, the objective function to maximize refers to the 43 sample units. The restriction (ii) on the derivative regarding the desirable outputs is expressed by a single equation as the subscript  $m$  ( $m = 1$ ) is unique. The restriction (iii) is represented by five equations – each relating to an undesirable output, that is,  $m'$  ( $m' = 2 a 6$ ). Table 2 lists the results for the parameters of the translog function.

The estimation of the distance function enables us to obtain the shadow prices of the undesirable outputs for each of the treatment plants in the sample. For the calculation of these shadow prices it is necessary to assign a reference price for the desirable output, that is, the treated water. Although the value of this resource is not determined by the market in most cases, it is nevertheless logical to assume that its price will depend on its destination and potential users.

In agreement with the existing literature (Reig et al., 2001, among others), the shadow prices obtained for undesirable outputs are negative. This is because from the viewpoint of the production process these prices are not associated with marketable outputs which could generate an income – in fact the opposite is true. However, from an environmental viewpoint these shadow prices can be interpreted positively because they represent damage which has been avoided; or a benefit for the receiving environment which does not have to suffer pollution. Table 3 shows the shadow prices created (expressed in average values of €/kg.) for the five undesirable outputs and in function of the four destinations.

TABLE 3. Shadow prices for undesirable outputs in €/kg

Effluent destination	Price water €/m <sup>3</sup>	N	P	SS	BOD	COD
River	0.7	-16.353	-30.944	-0.005	-0.033	-0.098
Sea	0.1	-4.612	-7.533	-0.001	-0.005	-0.010
Wetlands	0.9	-65.209	-103.424	-0.010	-0.117	-0.122
Reuse	1.5	-26.182	-79.268	-0.010	-0.058	-0.140

The benefit enjoyed by the receiving environment is variable – depending on the pollutants and the destination. It can be seen that the main environmental benefits for all four analysed destinations is the elimination of phosphorus and then nitrogen. Both nutrients are present in all organisms, but an excess causes eutrophication problems and significantly reduces biodiversity by stimulating the growth of algae.

According to the results presented in Table 4, the elimination of organic matter (BOD and COD) is the next most beneficial action for the environment. Organic matter is degraded by microorganisms in the receiving environment and this means a large volume of oxygen is consumed. The result may be

hypoxia (low level of oxygen in an organism) and asphyxia (shortage of dissolved oxygen in water) together with a modification of the substrate.

As for the suspended solids (SS), it is the undesirable output whose elimination supposes least environmental benefits. Nearly all inland waters naturally carry suspended solids from weathering and erosion. Their presence is dangerous only when levels are abnormally high or last for unusually long periods – and so changing the natural habitat.

Depending on the destinations analyzed, the greatest environmental benefit from the treatment process occurs when the destination are wetlands. These areas are particularly sensitive to eutrophication. However, only minor environmental benefits are enjoyed when treated water is poured into the sea because of the dilution and dispersion capacity of the receiving environment.

By considering the volume of pollutants eliminated in the treatment process (kg/year) and the shadow prices for each of these pollutants depending on the destination of the effluent (see Table 3), we can calculate the overall environmental benefit resulting from the treatment of wastewater, as shown in Table 4.

TABLE 4. Environmental benefit of treatment in €/year and €/m<sup>3</sup>

Pollutants	Pollutants eliminated (kg/year)	Environment value pollution (€/year)	Environment value pollution (€/m <sup>3</sup> )	%
N	4,287,717	98,133,996	0.481	59.6
P	917,895	50,034,733	0.245	30.4
SS	60,444,987	448,098	0.002	0.3
DOB	59,635,275	2,690,421	0.013	1.6
COD	113,510,321	13,364,429	0.066	8.1
TOTAL		164,671,677	0.807	100.0

The greatest environmental benefit is associated with the removal of nitrogen because it represents nearly 60% of the total profit. The next most important factor is phosphorus with a percentage weight of 30%. It is important to note that the elimination of these nutrients creates most of the environmental benefit (90%) resulting from the treatment process. This is because these contaminants have the highest shadow prices as shown in Table 4. Even though large volumes of suspended solids are removed from wastewater during treatment, their low shadow price means their removal contributes a very low percentage (0.3%) of the total environmental benefit. The share of the environmental benefit accounted for by organic matter COD and BOD is only 9.7% because, despite the fact that a great deal is removed during the treatment process, their shadow prices are comparatively low.

Finally, information is provided about the value of removed environmental pollutants per cubic metre of treated water. The global environmental benefit resulting from wastewater treatment stands at €0.807 per cubic metre – as shown out in Table 4. It would be interesting to compare this value with the direct cost of treatment in order to calculate the net profit generated by treatment. It is important to note that, based on the typical cost requirements for these treatment processes, the value of this net profit would always be positive.

## 5. Conclusions

In this work, a methodology is applied for assessing the environmental benefits which, in turn, enables feasibility studies to be made for water treatment and reuse projects – and which take into account the monetary value of environmental externalities.

In this sense, if we consider water treatment as a productive process in which a desirable output (treated water) is obtained together with a series of undesirable outputs (suspended solids, nitrogen, phosphorus, etc.) then we could calculate a shadow price for these undesirable elements. This shadow price would be the equivalent of the environmental damage avoided or the environmental benefit arising from the treatment process.

An empirical application is presented with a sample of 43 wastewater treatment plants located in the region of Valencia (Spain). Five undesirable outputs and four possible destinations for the treated water are included. The obtained results are varied in function of the destination and outputs.

The greatest environmental benefit is associated with the discharge of treated water in wetland areas. Logically, the lowest relative benefit is for discharge into the sea – because of the potential for dilution and dispersion. The reuse of treated water also offers significant environmental benefits because this reduces the pressure on conventional water resources, and simultaneously reduces the pollution of streams, lakes, and beaches.

Shadow prices also show a significant variability that depends on the type of undesirable output under analysis. The elimination of phosphorus is the most beneficial action from an environmental point of view – regardless of the receiving environment; and the treatment of suspended solids is the least environmentally beneficial action.

## Acknowledgement

The authors thank the statistical help from the *Entitat de Sanejament d'Aigües (EPSAR)* and the financial assistance obtained from the *NOVEDAR Project (CSD2007-00055)*.

## References

- Birol E. Karousakis K. Koundouri P. 2006. Using economic valuation techniques to inform water resources management: A survey and critical appraisal of available techniques and an application. *Science of the Total Environment* 365: 105–122.
- Färe R. Grosskopf S. Lovell C.A.K. Pasurka C. 1989. Multilateral productivity comparisons when some outputs are undesirable: a nonparametric approach. *Review of Economics and Statistics* 71 (1): 90–98.
- Färe R. Grosskopf S. Lovell C.A.K. Yaisawarng S. 1993. Derivation of shadow prices for undesirable outputs: a distance function approach. *Review of Economics and Statistics* 75 (2): 374–380.
- Färe R. Grosskopf S. Tyteca D. 1996. An activity analysis model of the environmental performance of firms – application to fossil – fuel – fired electric utilities. *Ecological Economics* 18: 161–175.
- Ha N.V. Kant S. Maclaren V.W. 2008. Shadow prices of environmental outputs and production efficiency of household-level paper recycling units in Vietnam. *Ecological Economics* 65 (3): 98–110.
- Hetemäki L. 1996. Essays on the Impact of Pollution Control on a Firm: A Distance Function Approach. Finnish Forest Research Institute, Research Papers 609.
- Koundouri P. 2000. Three approaches to measuring natural resources scarcity: theory and application to groundwater. Ph.D. thesis. Department of Economics University of Cambridge UK.
- Mitchell R.C. Carson R.T. 1989. Using surveys to value public goods: the contingent valuation method. Baltimore, MD: Johns Hopkins University Press.
- Reig E. Picazo A. Hernández F. 2001. The calculation of shadow prices for industrial wastes using distance functions: An analysis for Spanish ceramic pavement firms. *International Journal of Production Economics* 69: 277–285.
- Shephard R.W. 1970. *Theory of Cost and Production Functions*, Princeton, NJ: Princeton University Press.
- Schimmoller L. Bellamy B. Curl J. 2008. Indirect Potable Reuse: Balancing Cost and Benefits. IWA World Water Congress and Exhibition, Vienna.
- Yaisawarng S. Klein J.D. 1994. The effects of sulfur dioxide controls on productivity change in the U.S. electric power industry. *Review of Economics and Statistics* 76 (3): 447–460.

# ANOXIC GRANULATION OF ACTIVATED SLUDGE

PETRA PAGACOVA\*, KATARINA GALBOVA  
AND IVANA JONATOVA

*Department of Environmental Engineering, Institute of Chemical  
and Environmental Engineering, Faculty of Chemical and Food  
Technology, Slovak University of Technology, Radlinskeho 9, 812  
37 Bratislava, Slovak Republic*

**Abstract.** The creation of anoxic granulated biomass has been monitored in a laboratory USB (Upflow Sludge Blanket) reactor with a volume of 3.6 l. The objective of this research was to verify the possibilities of post-denitrification of residual  $\text{NO}_3\text{-N}$  concentrations in treated wastewater (denitrification of  $20 \text{ mg l}^{-1} \text{NO}_3\text{-N}$ ) and determine the maximum hydraulic and mass loading of the USB reactor with granulated biomass.

**Keywords:** denitrification, anoxic granulation, USB reactor

## 1. Introduction

This work is a prime example of technique, which focuses on the possibilities of using USB reactors with a high concentration of granulated biomass with denitrification of nitrates ( $\text{NO}_3\text{-N}$ ) in wastewater. Denitrification in USB reactors after activation and secondary clarification was tested as a possible way of further treating wastewater with a relatively low  $\text{NO}_3\text{-N}$  ( $20 \text{ mg l}^{-1}$ ) concentration level. Using a USB reactor as a post-denitrification reactor is logical (Kratochvíl et al., 1997), due to the following:

- Both reaction and secondary volumes are in one reactor.
- Granulated or well-sedimented biomass allows for high concentrations to be present in the reactor.

---

\* To whom correspondence should be addressed. Petra Pagacova, Department of Environmental Engineering, Institute of Chemical and Food Technology, Slovak University of Technology, Radlinskeho 9, 81237 Bratislava, Slovak Republic; e-mail: petra.pagacova@stuba.sk



- Reaction volume can be significantly lower due to higher loading.
- Volume-saving can also occur as there is no need for an inert biomass carrier to be in the reactor.
- Water flowing out of the reactor contains a minimal concentration of suspended solids (SS), so it is released directly into a water treatment plant outflow.
- Only a necessary amount of wastewater needs to be pumped into the post-denitrification reactor.

At the same time, it is assumed that after activation there will be a sufficient concentration of nutrients found – biologically treated wastewater has a concentration of  $\text{NH}_4\text{-N}$  and  $\text{P}$  at the level of  $0.5\text{--}1 \text{ mg l}^{-1}$ . This was kept in mind during the experiment ( $\text{NH}_4\text{-N}$  and  $\text{PO}_4\text{-P}$  were added to synthetic laboratory wastewater to a concentration of  $1 \text{ mg l}^{-1}$ ).

A basic requirement of USB reactor usage for denitrification is to cultivate a well-sedimentated or better yet, granulated biomass. The USB reactor was originally designed as an UASB (upflow anaerobic sludge blanket reactor) which has been successfully used for decades in anaerobic wastewater treatment (Lettinga et al., 1980; Lettinga & Hulshoff, 1986). In this process, the natural properties of anaerobic biomass create bigger granules (usually with a diameter of 2–3 mm). It was subsequently confirmed that denitrification biomass is also able to create larger and well-sedimented granules (Van der Hoek & Klapwijk, 1987; Green et al., 1994; Kratochvíl et al., 1996a, b; Bhatti et al., 2001). Prior works associated with anoxic granulation in USB reactors were carried out mainly in the event that they be used in water treatment (lowering the  $\text{NO}_3\text{-N}$  concentration in drinking water (Van der Hoek & Klapwijk, 1987; Green et al., 1994; Kratochvíl et al., 1996a, b; Bhatti et al., 2001)). Ethanol, acetate and glucose were used as the main external substrata. At the same time, it was shown as important to slowly mix these reactors to prevent biomass flotation (Kratochvíl et al., 1996a, b). The application of these water treatment reactors on a grand scale was minimal. The aim of this experiment was to verify the USB reactor properties with low  $\text{NO}_3\text{-N}$  concentrations (at levels of  $20 \text{ mg l}^{-1}$ ) and that of the external organic G-phase substrate (glycerine phase from methyl ester production), which are currently considered as perspective external substrata for denitrification in the Slovak Republic.

## 2. Methods and Objects

The laboratory USB reactor was in the shape of a cylinder with an overall volume of 3.6 l (reaction volume was 3.22 l) and an inner diameter of 10 cm (Figure 1). Activated sludge from municipal WWTP with nitrification–denitrification was used as the inoculum. The wastewater used contained nitrates ( $\text{KNO}_3$ ), phosphorous ( $\text{KH}_2\text{PO}_4$ ), ammonium nitrogen ( $\text{NH}_4\text{Cl}$ ) and a source of organic carbon. The reactor was mixed slowly (six rotations per minute) and not heated ( $18\text{--}20^\circ\text{C}$ ).

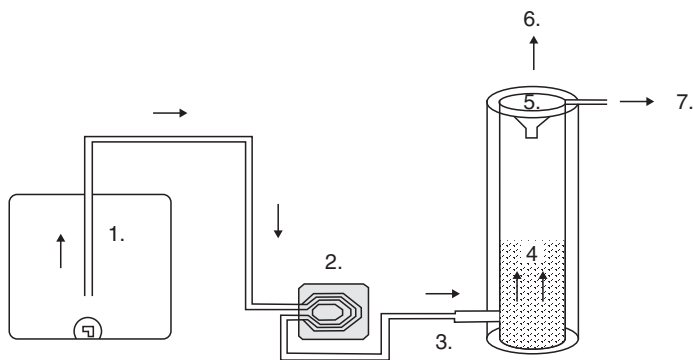

Figure 1. The technological scheme of a USB reactor. (1) Synthetic laboratory wastewater in storage tank, (2) pumping device, (3) inflow, (4) sludge bed, (5) separator G–L–S, (6) biogas ( $\text{N}_2 + \text{CO}_2$ ), (7) effluent

Analytical assessments were carried out using mixed and filtrated, and raw as well as treated wastewater according to Standard Methods APHA. After being taken out of the USB reactor, the sludge mixture was analysed for the following levels: mixed liquor suspended solids (MLSS), sludge volume index (SVI), sedimentation rates ( $u_s$ ), and specific denitrification rates.

## 3. Results and Discussion

### 3.1. DENITRIFICATION WITH G-PHASE

The external organic G-phase substrate was added to create a ratio of  $\text{COD}:\text{NO}_3\text{-N} = 6$ . The experiment was repeated several times. Individual results yielded a SVI inoculum of  $130\text{--}320 \text{ ml g}^{-1}$ , MLSS inoculum of  $0.42\text{--}4.9 \text{ g l}^{-1}$  and initial Bv was between  $0.4\text{--}1.3 \text{ kgCOD m}^{-3} \text{ d}^{-1}$ . A few hours after pumping into the reactor took place, a layer of biomass would float up and subsequently be directed into the effluent. Thus, using external organic G-phase substrate within the USB reactor was shown to be ineffective. Glycerine, as the main

component of G-phase, is biologically disintegratable, yet in the environment of the USB reactor it sticks to the biomass and causes flotation and the flowage of biomass into the effluent.

### 3.2. DENITRIFICATION WITH METHANOL

The external organic methanol substrate was added in a manner so that the ratio COD:NO<sub>3</sub>-N was 6 (this ratio was for experimental use and corresponds with figures from literary reports). The aim of the experiment was to contain the biomass in the reactor, achieve total denitrification and find the optimal mass and hydraulic loading levels of the reactor so that biomass flotation would not occur. Inoculum parameters were: SVI = 172 ml g<sup>-1</sup>, SRT = 15 days, MLSS = 3.1 g l<sup>-1</sup> and volatile suspended solids = 85%.

The reactor became gradually more and more mass and hydraulically loaded. Each increase in inflow and loading occurred when effluent concentration levels were (NO<sub>3</sub>-N + NO<sub>2</sub>-N) ≤ 1 mg l<sup>-1</sup> and simultaneously SS ≤ 40 mg l<sup>-1</sup> (similar as in works (Kratochvíl et al., 1996a, b, 1997)).

At the end of each stage of the experiment with the given mass and hydraulic loading, the resulting biomass was evaluated (concentration, morphology, sedimentation qualities) as well as the denitrific active biomass (endogenous r<sub>NO<sub>3</sub>-N,X,endo</sub> and overall r<sub>NO<sub>3</sub>-N,X,total</sub> specific denitrification speed).

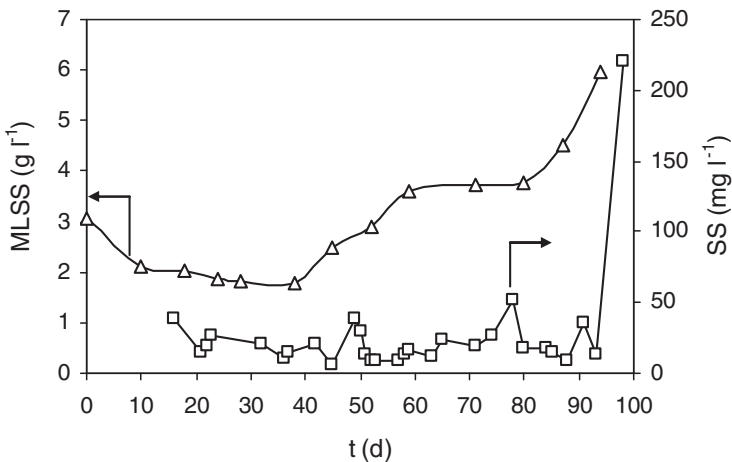

Figure 2. The development of MLSS in the reactor and SS concentration of the effluent throughout the whole experiment

After starting the reactor, there was no biomass flotation and the initial decrease in MLSS was slow. Only ca. a week later was the biomass (which had originally not been adapted to methanol) able to use the methanol as a substrate for complete denitrification (the difference between  $r_{\text{NO}_3\text{-N},\text{X,endo}}$  and  $r_{\text{NO}_3\text{-N},\text{X,total}}$  was significant). This adaptation period can pose as a problem in a water treatment plant if the operation of the reactor is interrupted according to concentrations of  $\text{NO}_3\text{-N}$  levels present. Continuous increase of  $\gamma$  and  $B_v$  (Figures 3 and 4) resulted in gradual biomass flotation from the inoculum and in the creation of new levels of  $B_v$ ,  $\gamma$  and MLSS in the reactor. It is obvious from Figure 2, that the amount of biomass in the reactor during the first 40 days gradually decreased. As the old biomass floated up, a new and better sedimentation as well as a more active biomass was growing and new levels were created. From day 40 to day 60, a growth in the amount of biomass in the reactor was recorded. From day 60 to day 80, in spite of the fact that  $B_v$  rose from 3.5 to 5.5  $\text{kg m}^{-3} \text{ day}^{-1}$ , the amount of biomass in the reactor did not increase significantly. From day 80, the level of concentrated biomass began to increase from 3.8 to 6.0  $\text{g l}^{-1}$ . On day 98, an increase in inflow up to 9  $\text{l h}^{-1}$  ( $\gamma = 1.15 \text{ m}^3 \text{ m}^{-2} \text{ h}^{-1}$ ,  $B_v = 8 \text{ kgCOD m}^{-3} \text{ day}^{-1}$ ) was recorded which caused an overload in the reactor by granulated biomass and consequently its abrupt flotation ( $\text{SS} = 220 \text{ mg l}^{-1}$ ). Suitable and safe loading levels at which the USB reactor was capable of total denitrification and no biomass flotation occurred were shown to be  $\gamma = 0.95 \text{ m}^3 \text{ m}^{-2} \text{ h}^{-1}$ ,  $B_v = 6.6 \text{ kgCOD m}^{-3} \text{ day}^{-1}$ . These levels are very high and show a prospective use of the reactor. If we compare the levels of  $B_v$  and MLSS

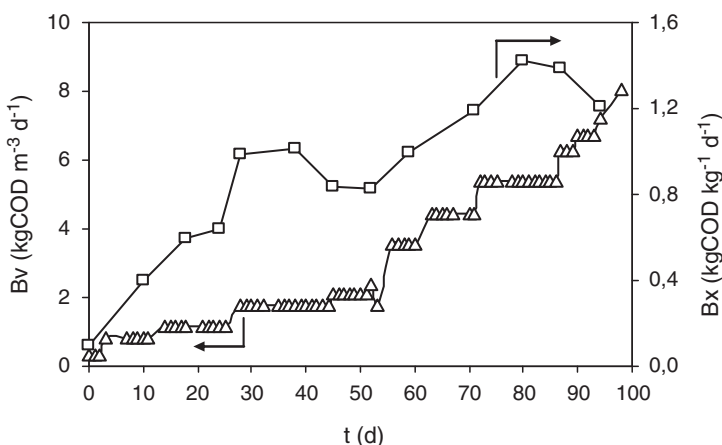

Figure 3. The course of volumetric loadings  $B_v$  and specific loadings  $B_x$  during the whole experiment

it is obvious that the specific loadings of biomass Bx (Figure 3) have a stated course of development. It is necessary to bring our attention to the loading levels of the granulated biomass at the end of the experiment: Bx at a level of 1.2–1.4 kgCOD kg<sup>-1</sup> h<sup>-1</sup> is very high, while denitrification is complete.

The outflow levels of biomass from the reactor (Figure 2) stayed at the same level 10 to 40 mg l<sup>-1</sup> SS in all cases but one. We did not take into consideration day 98, when biomass flotation occurred. During the experiment excess sludge uptake was not conducted. The balance of the amount of biomass in the reactor was thus created naturally.

From Table 1 it is conclusive that during the first phase connected with flotation and decay of inocula, the SRT was 3–5 days. After day 38, the SRT increased to 7–14 days (a better sedimentation of biomass with compact granules had already accumulated in the reactor).

From day 60 to day 94, the SRT decreased to 5–7.5 days despite the presence of excellent sedimentation of granulated biomass. This is the result of a high overflow, which causes an outflow of a large part of new biomass even when SS concentrations in the effluent are low (Figure 2). The SRT of 5–7 days means that a natural balance of MLSS is created and the growth of biomass is equal to the outflow and decay levels with no uptake. (This level of medium and low loaded activation is unknown to most water treatment plants as the uptake of excessive sludge is a necessity).

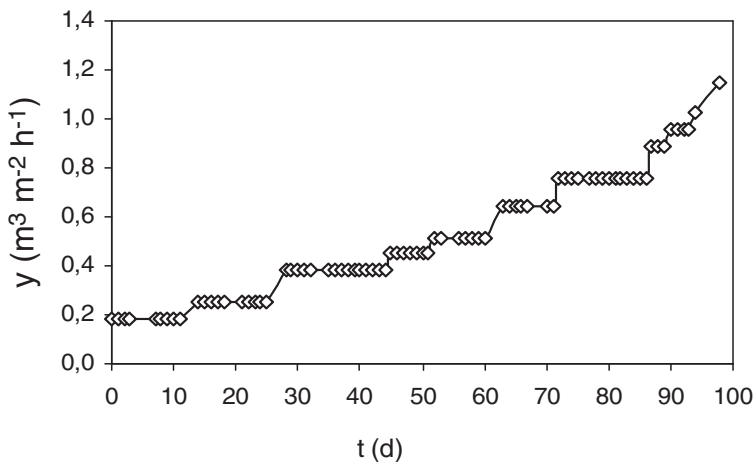

Figure 4. The course of surface hydraulic loadings  $\gamma$  during the whole experiment

TABLE 1. The calculated SRT for individual operation stages of the USB reactor

Day	Biomass retention time (days)	Additional notes – in comparison with Pic. 3 – biomass concentration Xc in the reactor
18	3.4	2.1 g l <sup>-1</sup> ; growth << decay and flotation ( biomass outflow); decrease in Xc
24	3.6	1.9 g l <sup>-1</sup> ; growth < decay and slower flotation; slight decrease in Xc
28	3.1	1.8 g l <sup>-1</sup> ; growth < decay and slower flotation; min. decrease in Xc
38	4.8	1.75 g l <sup>-1</sup> ; growth < decay and flotation; min. decrease in Xc
45	13.8	2.5 g l <sup>-1</sup> ; growth > decay and flotation; increase in Xc
52	9.7	2.9 g l <sup>-1</sup> ; growth > decay and flotation; increase in Xc
59	7.3	3.6 g l <sup>-1</sup> ; growth > decay and flotation; increase in Xc
71	5.0	3.7 g l <sup>-1</sup> ; growth ≈ decay and flotation; min. increase in Xc
80	5.0	3.8 g l <sup>-1</sup> ; growth ≈ decay and flotation; min. increase in Xc
87	5.7	4.5 g l <sup>-1</sup> ; growth > decay and flotation; increase in Xc
94	7.5	6.0 g l <sup>-1</sup> ; growth >> decay and flotation; increase in Xc
98	0.6	0.36 g l <sup>-1</sup> ; washout of the whole reactor; decrease in Xc

<sup>a</sup>SRT was measured as a portion of the amount of biomass in the USB reactor (g) and the amount of biomass in the outflow of the reactor on a given day (grams per day).

The sedimentation qualities of the biomass are documented in Figure 5. During the first 10 days, biomass flotation from the inoculum occurred. Due to further washing up of the old biomass and the increase of  $\gamma$  the voluminous and slowly sedimenting flakes began to get smaller, while small and compact biomass flakes with small granules (less than 1 mm) began to grow. They were also very well sedimented. SVI levels stabilized at 30–45 ml g<sup>-1</sup>. The  $u_v$  zone settling velocity (Figure 5), also increased from 4 m h<sup>-1</sup> to 11.5 m h<sup>-1</sup>.

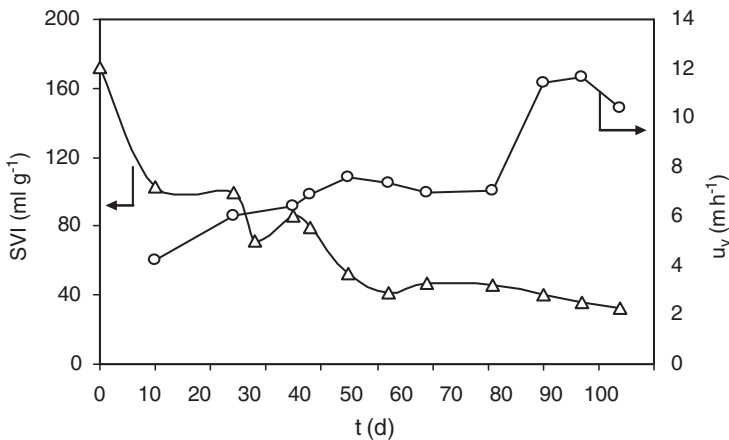

Figure 5. The course of SVI levels and the zone settling velocity  $u_v$  throughout the whole experiment

An interesting effect was achieved from day 70 – day 80, when small granulated flakes visibly increased their size throughout the whole reactor (reaching 1 mm). The granules were not as big as those recorded in previous works (Kratochvíl et al., 1996a, b, 1997), nevertheless, they were compact, had excellent sedimentation, and could be used with a USB reactor without any problems.

#### 4. Conclusion

- The USB reactor could be seen as inappropriate for the usage of external denitrification G-phase substrates. Even though the main ingredient of the G-phase is glycerine, which is biologically disintegratable and can be used for denitrification reaction; it also sticks to the biomass and causes its flotation and outflow.
- Methanol was a suitable substrate for denitrification in the USB reactor. The problem arising from the usage of external denitrification substrate is the adaptation of biomass. The experiment showed that for complete denitrification to take place in the USB reactor using methanol, at least a week must pass.
- A specification of the USB reactor is that maximum mass loading  $B_v$  must condone to sedimentation biomass qualities and that mass and hydraulic loading  $\gamma$  are both decisive of overall reactor loading.
- By observing biomass sedimentation qualities of the USB reactor, it can be confirmed that first the light flakes of active sludge are washed up. Due to further wash-up of the original biomass and the increase in hydraulic loading, the flakes begin to decrease in size. Consequently, the biomass begins to grow and produce small, compact flakes or granules (1 mm in size) which have excellent sedimentation. Sludge volume indexes (SVI) stabilized from 170 ml g<sup>-1</sup> to 30–45 ml g<sup>-1</sup> and biomass sedimentation rates grew from 4 m h<sup>-1</sup> to 10–12 m h<sup>-1</sup>. This kind of biomass can accept all advantages of the USB reactor without any problems.
- In a given USB reactor with concentrations from NO<sub>3</sub>-N to 20 mg l<sup>-1</sup>, a maximum mass loading of  $B_v = 6.6 \text{ kgCOD m}^{-3} \text{ day}^{-1}$ ,  $B_x = 1.2\text{--}1.4 \text{ kgCOD kg}^{-1} \text{ day}^{-1}$  and a maximum hydraulic loading  $\gamma$  at the level of 0.95 m<sup>3</sup> m<sup>-2</sup> h<sup>-1</sup> was achieved. At higher loading levels biomass flotation occurred.

Further experiments with denitrific USB reactors will be focused on recording the adaptation of biomass and its granulation with various kinds of inocula and the possibilities or limitations of the speediest possible start-up of the reactor.

## Acknowledgements

This work was supported by the Slovak Research and Development Agency under the contract No. APVV-0417-07.

## References

- Bhatti, Z.I., Sumida, K., Rouse, J.D., Furukawa, K. 2001. Characterization of Denitrifying Granular Sludge Treating Soft Groundwater in USB Reactor. *J. Biosci. Bioeng.* 91(4), 373–377.
- Green, M., Tarre, S., Shnizer, M., Bogdan, B., Armon, R., Shelet, R. 1994. Groundwater Denitrification Using an Upflow Sludge Blanket Reactor. *Water Res.* 28(3), 631–636.
- Kratochvíl, K., Drtil, M., Hutnan, M., Derco, J., Fargasova, A. 1997. Characteristic of Granulated Denitrification Biomass. *Vodni Hospodarstvi/Water Management* 47(2), 23–26 (in Slovak).
- Kratochvíl, K., Drtil, M., Hutnan, M., Derco, J., Fargasova, A. 1996a. Denitrification of Drinking Water in USB Reactor. *Vodohospodársky spravodajca/Water Management Reports* 39(2), 9–13 (in Slovak).
- Kratochvíl, K., Drtil, M., Derco, J., Bilanin, M. 1996b. Comparison of Ethanol and Glucose in Denitrification of Drinking Water in USB Reactor. *Vodohospodarsky spravodajca/Water Management Reports* 39(5), 15–17 (in Slovak).
- Lettinga, G., Hulshoff Pol, L.W. 1986. Advanced Reactor Design, Operation and Economy. *Water Sci. Tech.* 18, 99–108.
- Lettinga, G. et al. 1980. Use of the Upflow Sludge Blanket Reactor Concept for Biological Wastewater Treatment, Especially for Anaerobic Treatment. *Biotechnol. Bioeng.* 22, 699–734.
- Van der Hoek, J. P., Klapwijk, A. 1987. Nitrate Removal From Ground Water. *Water Res.* 21(8), 989–997.



# DRINKING WATER SUPPLY IN BELARUS: SOURCES, QUALITY AND SAFETY

TAMARA KUKHARCHYK\* AND VALERY KHOMÍCH  
*Institute for Problems of Natural Resources Use & Ecology of  
National Academy of Sciences of Belarus, Skoriny St. 10, 220114,  
Minsk, Belarus*

**Abstract.** In the paper sources of drinking water in Belarus are discussed. Types of water supply systems for urban and rural areas as well as tendencies of water consumption including daily water consumption are shown. Peculiarities of initial chemical composition of ground water used for drinking purposes are given. Drinking water quality in different regions and in Minsk city, factors of water pollution are discussed. Current condition of water distribution system and priorities measures for its improvement is discussed. It is shown, that ground water protection for safe drinking water quality is necessary.

**Keywords:** drinking water, water supply, groundwater, pollution, water quality

## 1. Introduction

Access to safe drinking water is essential for human health; it is a basic human right and a component of effective policy for health protection on global, regional and local levels (Guidelines for Drinking-Water..., 2006). According to (Europe's Environment..., 2007), more than 100 million people in European region still do not have access to safe drinking water; the quality of water supply in some countries has deteriorated continuously over the past 15 years. These problems are especially acute for developing countries and rural population, where drinking water is often taken from so-called "unimproved drinking water sources": unprotected dug wells, springs, surface water etc. According to (Progress in Drinking Water..., 2008), 100% of urban population in Belarus uses drinking water from improved sources: 94% uses piped connections in

---

\* To whom correspondence should be addressed. Tamara Kukharchyk, Institute for Problems of Natural Resources Use & Ecology, Skoriny st., 10, 220114, Minsk, Belarus; e-mail: kukharchyk@mail.ru

their dwellings and 6% – other improved drinking water sources: public taps, tube wells or boreholes. What concerns rural population, the situation is the following: 68% uses piped water, 31% – other improved drinking water sources, and 1% – unimproved drinking water sources. According to the data (Forecast of Environmental..., 2004), 75% of urban and 50% of rural population has access to centralized water supply. The remaining part of population uses water from shallow water wells. The main shallow wells contaminants are nitrates and Coliform bacteria. Improperly applied agricultural fertilizers and on-site pit latrines, used by rural population to dispose human wastes, represent major sources of shallow wells contamination.

Quality of drinking water is one of the pertinent ecological problems in Belarus that creates discomfort for population and increases the risk of human diseases. The outbreak of aseptic meningitis (400 cases) was registered in Gomel city in 1997. There are connections between water pollution by Coli-index and intestinal diseases as well as viral hepatitis. High risk of disease was revealed among children used drinking water with content of nitrates exceeding  $135 \text{ mg/dm}^3$  (Forecast of Environmental Changes..., 2004). Presence of nitrate and nitrite in water has been associated with methaemoglobinaemia, especially among bottle-fed infants.

The problem of drinking water quality in the country is conditioned by two factors: first of all by specific hydro-geochemical features of water-bearing horizons formation, and secondly, by technogenic contamination. Nitrate may originate from excessive application of fertilizers, as well as from leaching of wastewaters or other organic wastes into surface and groundwater.

## **2. Water Resources and Water Consumption in Belarus**

Belarus is a relatively “water-rich” country, in which accessible water resources are sufficient to meet both current and future demands. Belarus has a large number of aquatic ecosystems including rivers (20,800), lakes (10,800), water storage reservoirs (153) and ponds (1,500). The total length of Belarusian rivers reaches 90,600 km. They are within the catchment areas of the Black and Baltic Seas. The total river flow is about  $58 \text{ km}^3$ ,  $34 \text{ km}^3$  (64%) of which is formed within the country territory. Three rivers (the Zapadnaya Dvina, the Dniepr and the Pripyat) provide around 80% of the total river flow. Natural resources of fresh ground waters amount to  $15.8 \text{ km}^3$  per year. Large amount of underground water resources are revealed in the central, north-eastern and western parts of the country (State of Environment..., 2007).

In 2007 water intake from natural sources was 1,698 million  $\text{m}^3$ , including 737.5 million  $\text{m}^3$  taken from surface water bodies (e.g., rivers, lakes, reservoirs) and 960.6 million  $\text{m}^3$  – from groundwater sources. Losses of water during

transportation make up to 6.5% of the total intake (110 million m<sup>3</sup>). About 44% of the total volume of consumed water (653 million m<sup>3</sup>) is used for household and drinking purposes (State Water Survey..., 2008).

Since 1990 total water consumption in Belarus has considerably decreased (1.9 times). During that time the amount of water for households and drinking purposes was relatively stable (Figure 1).

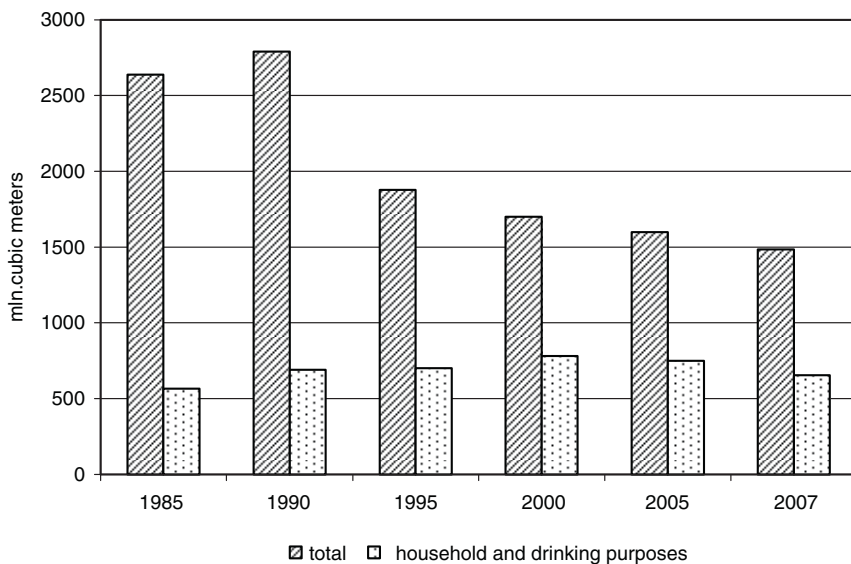

Figure 1. Dynamics of fresh water consumption in Belarus

Ground water represents the main source of water supply for households and drinking purposes. It provides around 95% of the total water consumption in Belarus. Surface water is used for this purpose only in two largest cities, Minsk and Gomel. According to the forecast by 2020 only ground water will be used for drinking purposes.

Centralized and non-centralized water supply systems (wells) are represented in Belarus. Centralized water supply system covers cities and large settlements; non-centralized water supply system covers rural settlements. Centralized water supply system dominates – it provides 70% of country population with drinking water.

The depth of water bearing horizons is 50–200 m for centralized and 1–20 m for non-centralized water supply systems. Water bearing layers have a tight hydraulic connection with upper underground layers and surface water. It means weak protection of underground waters from pollutants.

Group water intake is prevailing (totally there are 158 group water supply points in the country). There are more than 30,000 intakes and 400,000 shaft wells.

Average residential drinking water consumption in the country is quite high – about 214 l per capita per day (State Water Survey..., 2008). In major Belarusian cities, such as Brest and Grodno, consumption is about 200–230 l per capita per day, in Minsk – 270 l per capita per day. Water consumption in Minsk clearly declined after 2000 which can be explained by economic factors (Figure 2). This tendency is typical for some European cities (Cihakova, 2005).

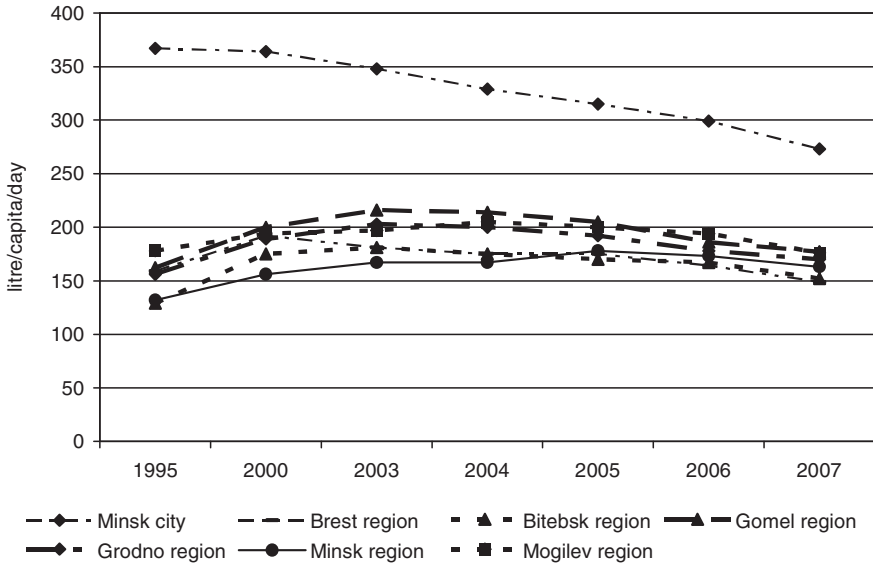

Figure 2. Daily water consumption in Minsk city and regions of Belarus

### 3. Sources of Pollution and Drinking Water Quality

In Belarus Ministry of Health is responsible for hygienic requirements (standards) development and drinking water monitoring. Control under drinking water quality is provided by laboratories of sanitary and epidemiological agencies. Thousand sources of water supply are annually inspected in Belarus. There are Maximum Permissible Level (MPL) for more than 1,500 chemical compounds (Requirements for Water Quality..., 2004), however only 10–20 parameters are measured in fact. Table 1 illustrates MPL for widely used components during monitoring; most of them are even more stringent than European indices.

The quality of drinking water in Belarus as well as in other countries depends on many factors: chemical composition of water, pre-treatment technologies, condition of pipelines etc. The following regional features are typical for ground water in Belarus: high concentration of iron and manganese, on the one hand, and insufficient content of iodide and fluorine, on the other. Belarus belongs to geochemical provinces of iron-containing ground water (Kudelsky et al., 1998). Increased concentration of iron (0.4–3.0 mg/dm<sup>3</sup>) is observed in forcing water-bearing stratum practically all over the country, and its highest value reaches 5–8 and sometimes 17 mg/dm<sup>3</sup>. Though iron is not hazardous to health, when present in high concentrations, it provides water with an unpleasant metallic taste, colour and turbidity.

TABLE 1. Maximum Permissible Limit of chemical components for drinking water, mg/dm<sup>3</sup>

Component	Belarus (Requirements for Water Quality..., 2004)	Europe (Guidelines for Drinking-Water Quality..., 2006)
pH	6.0–9.0	6.5–8.0
Nitrate	45	50
Sulphates	500	250
Chlorides	350	250
Sodium	200	200
Fluorine	1.5	1.5
Barium	0.1	0.7
Boron	0.5	0.5
Manganese	0.1 (0.5)*	0.4
Iron	0.3 (1.0)	0.3
Copper	1.0 (0.5)	2.0
Arsenic	0.05	0.01
Lead	0.03	0.01
Cadmium	0.001	0.003

\* MPL for drinking water from non-centralized water systems.

The analyses of water samples demonstrate that iron concentrations exceed MPL in 50% of samples. In 16% of cases, iron concentration exceeds MPL in five and more times. In Polesye region the excess of hygienic rates is detected in 60–80% of cases.

As to the content of manganese in water, the situation is less tense. Increased concentration of manganese occurs approximately in 6% of cases.

Among other chemicals that do not meet MPL are the following: nitrates, ammonium nitrogen, heavy metals etc. Pollution results from industry, waste storages, agricultural activities etc. The tendency of deterioration of ground

water quality is observed in water intake located near or within cities and industrial centers. For example, high concentrations of nitrates ( $45.6\text{--}87\text{ mg/dm}^3$ ) were revealed in some boreholes near Minsk, Borisov and Retshisa. In some cases ground water is polluted by ammonium nitrogen: its content makes up to  $10\text{ mg/dm}^3$  (Zhodino, Novopolotsk, Minsk). One of water supply points near Orsha city was closed because of an extremely high concentration of this pollutant (up to  $52\text{ mg/dm}^3$ ). In some cases high content of chromium ( $0.32\text{ mg/dm}^3$ ), arsenic ( $0.15\text{ mg/dm}^3$ ), lead ( $0.125\text{ mg/dm}^3$ ) and zinc ( $10\text{ mg/dm}^3$ ) were revealed (State of the Environment..., 2006, 2007).

Local ground water pollution occurs in areas where animal breeding complexes are operating, in the fields affected by their waste, in storage facilities for mineral fertilizes and pesticides. The content of chlorides, sulphates and nitrites exceeds MPL in two to three times, nitrates – in four to five times (Environment of Belarus, 2002).

On the whole, laboratory analyses undertaken by the National Sanitary-Epidemiological Service show that 30% of drinking water samples do not meet sanitary standards in Belarus. At the same time the share of unsatisfactory samples varies from 16.6% (Minsk city) to 49.5% (Brest region). There is no tendency of water quality improvement by chemical parameters in most regions of Belarus except Vitebsk region (Figure 3).

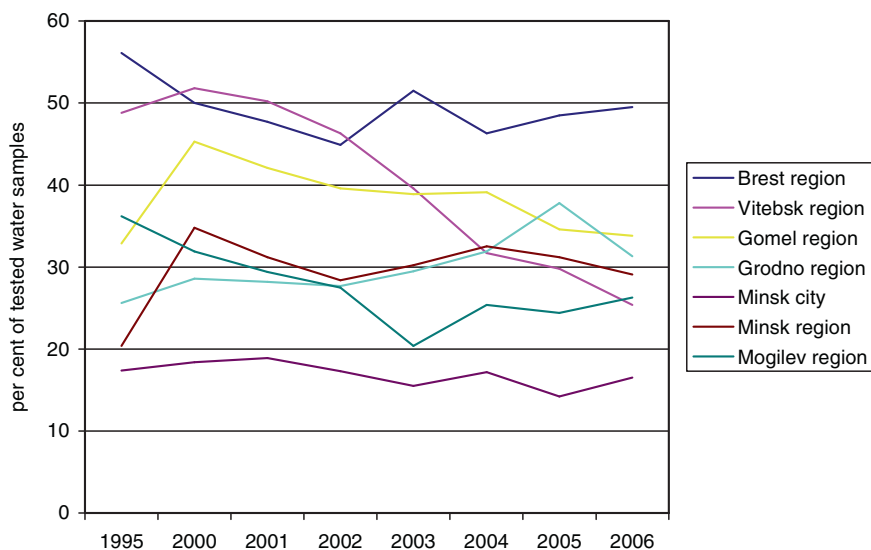

Figure 3. The share of water samples that do not correspond to hygienic standards by chemical parameters

Water quality checks according to microbiological indices show that in 1.3–5.4% of the total tested samples Coli-index exceeded the standard recommended

by WHO. Improvement of drinking water quality by microbiological indices is observed in contrast to chemical compounds (Figure 4).

Water quality in rural areas where population uses shallow wells is also of a primary concern. In the national context 30–40% of wells fail the existing national sanitary standards. According to (State Water Survey..., 2008) about 50% of samples failed the existing national sanitary standards and some 40% – the hygienic standard for microbiological composition. About 20% of tested samples contained Coli-index bacilli (over 23). In 2.5% of tested samples the sanitary-chemical standards were exceeded in five times or more. Most samples did not meet the standards for nitrates (45%), organoleptic qualities (15%), total magnesium and calcium content (6.8%) as well as content of iron compounds (5.2%) and ammonia (2.6%).

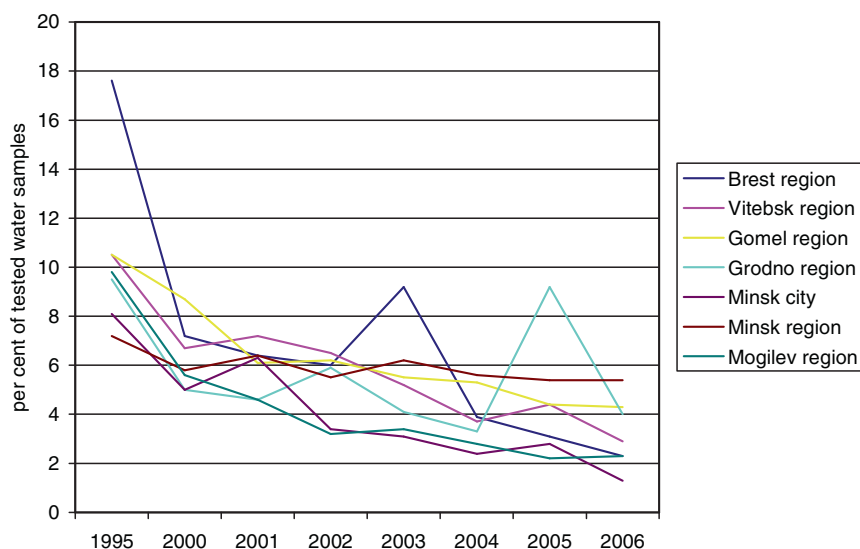

Figure 4. The share of water samples that do not correspond to hygienic standards by microbiological parameters

#### 4. Condition of Water Distribution System

Water supply system in Belarus includes around 23,000 km street pipe lines in 111 cities, 97 settlements and more than 5,000 villages. There are more than 13,000 boreholes, around 800 pumping stations, 200 de-ironing stations. The infrastructure of waste water system includes about 7,000 km of waste water network in 110 cities, 91 settlements and around 1,750 villages. Water distribution networks are worn down by 60% in Minsk and by 50% in Belarus.

On the whole low level of services and lack of financial resources lead to a very slow water supply system re-equipment and replacement: the rate of facilities renewal is 0.1–0.2% per year, meanwhile in UN counties – 1–2%. This leads to water losses and water quality deterioration (Gurinovich, 2007). To improve water distribution system the following measures should be undertaken: technical monitoring and inventory of water supply system; accounting of water consumption and waste water discharges; repair works of cold and hot water supply systems.

Increasing pressure on old water supply infrastructure can lead to frequent bursts of decrepit water pipes. The population of these towns is likely to suffer more frequently from disruptions of water supply, especially during dry summer periods. Significant number of people living in small towns will continue getting drinking water from often contaminated shallow water wells.

## **5. Water Management for Safe Drinking Water**

A lot of measures have been undertaken for water quality improvement in the country. The national Program on Clean Water for 2003–2007 was accepted; it will be prolonged up to 2012. Up to this moment three ministries have been responsible for water management in Belarus. Ministry of Natural Resources and Environmental Protection is responsible for water resources. Drinking water supply and sanitation sector in Belarus is regulated by the Ministry of Housing and Utilities. The Ministry is responsible for the overall supervision of construction works, operation, maintenance and management of the water supply and sanitation infrastructure regardless of their ownership status and affiliation. The Ministry of Health provides the hygienic requirements (standards) and monitoring of drinking water.

Among priority measures are the following: prevention of ground water pollution, strong control of sources of pollution, creation of protection zones. The majority of water intakes are located within city limits and industrial districts. That is way it is necessary to improve sanitary conditions of areas around water boreholes. Prevention of groundwater pollution is of critical importance because the consequences of ground water pollution last longer than surface water pollution; they are difficult and highly expensive to reveal and clean up afterwards.

Revelation water pollution sources, assessment of water quality and development of measures for water quality improvement should be considered among the most important questions for scientists, different ministries and services. It is very important to cooperation all of involved in water management and coordinate measures, their effectiveness.



## References

- Cihakova, I., 2005, Expected Development in the Supply and Distribution of Drinking Water in Czech Republic // *Security of Water Supply System: from Source to Tap*. NATO Security through Science Series – C: Environmental Security, pp. 31–38.
- Environment of Belarus*, 2002, ed. by V. F. Loginov. Minsk Belarus (in Russian).
- Environmental Protection in Belarus. Statistical Book*, 2007, Ministry of Statistics and Analysis of the Republic of Belarus. Minsk.
- Forecast of Environmental Changes of Belarus for 2010–2020*, 2004, ed. by V. F. Loginov. Minsk, RUP Minskproekt (in Russian).
- Guidelines for Drinking-Water Quality* [electronic resource]: incorporating first addendum, 2006. Vol. 1, Recommendations. World Health Organization, 3rd ed.
- Gurinovich, A. D., 2007, Water Supply and Waste Water Network: Problems and Solutions [electronic resource]:// [www.nestor.minsk.by/sn/](http://www.nestor.minsk.by/sn/) (in Russian).
- Health of Population and State of Environment of Minsk City*, 2006, 2007, Ministry of Health Protection. Minsk: Minsk City Center of Hygiene and Epidemiology (in Russian).
- Health of Population and State of Environment of Minsk City in 2007*, 2008, Ministry of Health Protection. Minsk: Minsk City Center of Hygiene and Epidemiology (in Russian).
- Kudelsky, B. A., Pashkevich, V. I., and Yasoveev, M. G., 1998, *Groundwater of Belarus*. Minsk: Institute of Geological Sciences, 260 p. (in Russian).
- Progress on Drinking Water and Sanitation*, 2008, Special Focus on Sanitation. UNICEF, New York and WHO, Geneva.
- Requirements for Water Quality of Centralized Sources of Water Supply*, 1999, Sanitary Protection of Water Sources. SanPiN10-124 RB 99 (in Russian).
- State of Environment in Belarus: Ecological Bulletin*, 2006, ed. by V. F. Loginov. Minsk, Belarus (in Russian).
- State of Environment in Belarus: Ecological Bulletin*, 2007, ed. by V. F. Loginov. Minsk, Belarus (in Russian).
- State Water Survey. Water Resources, Their Use and Water Quality*, 2008, Ministry of Natural Resources and Environmental Protection. Ministry of Health Protection. Minsk (in Russian).

# OPERATION OF HOUSEHOLD MBR WWTP – OPERATIONAL FAILURES

TINA PIKOROVA\*

*Department of Sanitary & Environmental Engineering, Slovak University of Technology, Radlinskeho 11, 813 68 Bratislava, Slovak Republic*

ZUZANA MATULOVA, PETR HLAVÍNEK

*Institute of Municipal Water Management, Brno University of Technology, Faculty of Civil Engineering, Zizkova 17, 612 00 Brno, Czech Republic*

MILOSLAV DRTIL

*Department of Environmental Engineering, Institute of Chemical and Environmental Engineering, Faculty of Chemical and Food Technology, Slovak University of Technology, Radlinskeho 9, 812 37 Bratislava, Slovak Republic*

**Abstract.** The aim of this research is to get a practical experience with operating of a household MBR plant under real conditions with real domestic wastewater that differs from the municipal wastewater. For household MBR plant is typical that the system must to cope with a long-time zero load or vice-versa with more concentrated wastewater in big amounts (i.e. on weekends).

**Keywords:** domestic wastewater, household MBR WWTP, temperature influence, filamentous bacteria, sludge bulking

## 1. Introduction

Decentralised wastewater treatment is used to treat and dispose relatively small volumes of wastewater, generally originating from groups of dwellings and

---

\* To whom correspondence should be addressed. Tina Pikorova, Department of Sanitary & Environmental Engineering, Slovak University of Technology, Radlinskeho 11. 81368 Bratislava, Slovak Republic; e-mail: tina.pikorova@stuba.sk

businesses that are located relatively close together, but are not attached to a central sewer system collecting the wastewater up to the wastewater treatment plant (WWTP). The MBR technology integrates biological degradation of wastewater pollutants with membrane filtration, ensuring effective removal of organic and inorganic contaminants and biological material from domestic and/or industrial wastewaters (Cicek et al., 1998).

In this study the treatment plant is fed by real domestic wastewater. In contrast to most other investigations with small-scale WWTPs, the wastewater does not originate from a sewer system. Several difficulties must therefore be overcome: this wastewater is not diluted by rainwater or infiltrated groundwater, it contains hair and particles, the water flow and pollutant load to the plant fluctuates greatly and is not controllable, and neither the wastewater composition nor the concentrations in the raw influent can be measured (Abegglen et al., 2008).

One of the main goals of this study was to investigate membrane reaction and activated sludge reaction to specific conditions in the decentralised (household) MBR wastewater treatment plant installed in real conditions. The specific conditions for the plant are for example: long-time zero load or vice-versa more concentrated wastewater in big amounts (i.e. on weekends), extreme temperatures i.e. less than 5–6°C (is one of the main impacts to the household WWTP), high pH values and the system is also influenced by the use of detergents.

## 2. Methods and Objects

### 2.1. DESCRIPTION OF THE HOUSEHOLD MBR PLANT

Experiment is carried out in the garden of a four-person house. All the wastewater is produced within the house flows through the treatment plant. The plant has no possibility of bypass or emergency overflow. The effluent is stored in a tank and can be used for watering lawn and garden and cleaning floors.

The pilot-scale MBR plant, shown in Figure 1, consists of three chambers in series; volume of each is 0.58 m<sup>3</sup>. The two first chambers are used as a preliminary treatment stage. In these settle chambers the majority of the solids are removed from the raw wastewater by sedimentation. The pretreated wastewater (from settle chambers) flows into the biological activated sludge reactor equipped with immersed membrane module, which parameters are shown in Table 1. Membrane module is from company A3 Water Solutions GmbH. Aeration is provided with fine-bubble aerator (beside the membrane module) and coarse-bubble aerators placed under the membrane module. Aeration provides aerating the activated sludge as well as cleaning of the membranes. The water level in the plant is controlled by water-level floats.

A hydraulic retention time (HRT) in whole household MBR plant is 7.2 days, HRT in the preliminary stage is 4.8 days and HRT in the biological reactor is 2.4 days; a volumetric loading is around  $0.35 \text{ kg COD m}^{-3} \text{ d}^{-1}$ .

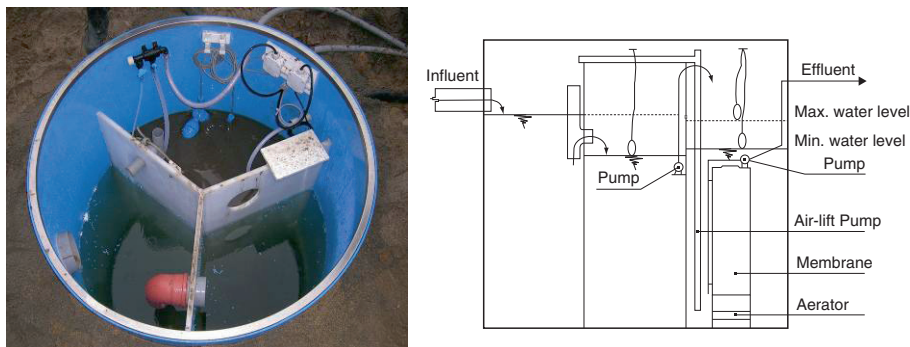

Figure 1. Pilot-scale MBR plant

TABLE 1. Technical parameters of the membrane module

Parameter	Unit	Value
Membrane type	–	Flat sheet
Membrane material	–	PVDF
Pore size	$\mu\text{m}$	0.1
Membrane area	$\text{m}^2$	6.7
Membrane parameters	mm	$185 \times 1,090 \times 316$ (w $\times$ h $\times$ l)
Pump power demand	W	35 (1. period), 90 (2. period), 38 (3. period)
Blower	$\text{l min}^{-1}$	80

### 2.1.1. Experimental Methods

Most of samples were taken two times per week, on Monday morning (as a weekend load) and Thursday (as work day load). The experiment contained three experimental periods: (1) winter period, (2) spring period, (3) summer period. During whole experiment no sludge was intentionally removed from the reactor except the samples for analyses. All the relevant indicators and parameters were analysed, i.e. quality of influent and effluent, pH, temperature, membrane flux; microbial morphology, physiology and activity of sludge etc.

### 3. Results and Discussion

#### 3.1. THE QUALITY OF RAW WASTEWATER AND EFFLUENT

The studied household pilot-scale MBR WWTP was inoculated by return activated sludge from municipal WWTPs again in each period. The concentration of MLSS was whenever around  $1 \text{ g l}^{-1}$ . Specific biomass yield (SBY) was during the whole experiment at the level  $0.1\text{--}0.3 \text{ g sludge g}^{-1} \text{ COD}$ .

As can be seen in Table 2 and in Figure 2 the concentrations of COD in the influent and supernatant quite fluctuated during every period. COD of permeate was relatively sustained value and the average value during monitored season was  $58 \text{ mg l}^{-1}$ .  $\text{BOD}_5$  concentrations in effluent varied from  $0.2$  to  $8 \text{ mg l}^{-1}$ , the removal efficiency was approximately 99.5%. Although, the initial effluent values of COD ( $125 \text{ mg l}^{-1}$ ) and  $\text{BOD}_5$  ( $8 \text{ mg l}^{-1}$ ) were relatively higher, they fulfilled legislative demands for household WWTP without problems during the whole experiment (Decree of the government ČR č. 229/2007 Zb., Regulation SR 684/2006 Zb).

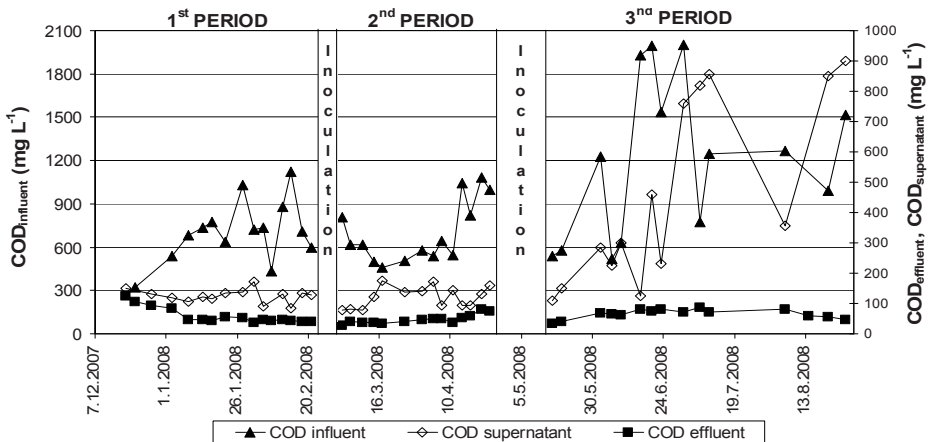

Figure 2. Comparison of COD values (influent, supernatant, effluent) during three periods

During the first two periods, only a minimal anaerobic degradation of primary sludge took the place in settling tanks (which was confirmed particularly by visual and smelling control of taken samples, the sludge was brown and without decomposition of large particles – beware application of this kind of sludge). Factors which contribute to these troubles are:

- Large particles of primary sludge are not grid in short sewer to the household WWTP.

- During winter and spring period (first and second period), low temperature had a great influence on the anaerobic degradation in tanks (markedly below 10°C).
- High pH (regard to the high concentrations of nitrogen – Figure 4).

During third period were temperatures higher and anaerobic degradation partly started. Sludge was black and unfortunately started floating and foaming. Gradually decreased pH even more intensifies anaerobic degradation (mainly hydrolysis).

TABLE 2. The quality of raw wastewater (influent) and the effluent from WWTP

Parameter			COD	BOD <sub>5</sub>	NH <sub>4</sub> -N	N <sub>tot</sub>	P <sub>tot</sub>	
<b>1. PERIOD</b>	<b>Influent</b>	<b>Average</b>	708.6	496	147.5	200.8	16.7	
		<b>(mg l<sup>-1</sup>)</b>	<b>Min-max</b>	320–1,125	224–787	89.6–250	94–322	11.1–28.9
	<b>Effluent</b>	<b>Average</b>	59.4	3	79.6	151.7	11.6	
		<b>(mg l<sup>-1</sup>)</b>	<b>Min-max</b>	37.2–125	0.4–8	49.9–129	80.4–238	7.2–15.6
		<b>η(%)</b>	91.2	99.4	–	–	–	
<b>2. PERIOD</b>	<b>Influent</b>	<b>Average</b>	697.8	488.5	166.5	174.7	14.1	
		<b>(mg l<sup>-1</sup>)</b>	<b>Min-max</b>	462–1,086	323.4–760.2	110–226	129–208	9.9–21.2
	<b>Effluent</b>	<b>Average</b>	47.9	2	60.4	123.2	9.0	
		<b>(mg l<sup>-1</sup>)</b>	<b>Min-max</b>	27.9–81.8	0.3–4	43.1–92	67.4–149.8	4.11–13.25
		<b>η(%)</b>	93.0	99.5	–	–	–	
<b>3. PERIOD</b>	<b>Influent</b>	<b>Average</b>	1,195.6	836.9	158.3	236.7	23.3	
		<b>(mg l<sup>-1</sup>)</b>	<b>Min-max</b>	518–2,000	362.6–1,400	59.4–214	153–360	11.6–40.1
	<b>Effluent</b>	<b>Average</b>	66	1.6	23.4	125.4	14.3	
		<b>(mg l<sup>-1</sup>)</b>	<b>Min-max</b>	35.4–89	0.2–3.6	0.3–75.5	61.8–198.5	4.1–20.3
		<b>η(%)</b>	93.5	99.7	–	–	–	
<b>AVERAGE VALUES</b>	<b>Influent</b>	<b>Average</b>	867.3	607.1	151.8	203.8	17.8	
		<b>(mg l<sup>-1</sup>)</b>						
<b>(all three periods)</b>	<b>Effluent</b>	<b>Average</b>	58	2.3	54.9	136.3	11.6	
		<b>(mg l<sup>-1</sup>)</b>	<b>η(%)</b>	92.5	99.5	–	–	–

### 3.2. QUALITY OF ACTIVATED SLUDGE AND ITS PARAMETERS

In the activated tank were also observed sludge sedimentation properties. Sedimentation was verified in each period that means with three inoculums. In Figure 3 is shown the evaluation of sludge volume index (SVI) and mixed liquor suspended solids (MLSS). During first two periods was household MBR WWTP inoculated by activated sludge from the municipal WWTP with worse SVI. At the beginning of first period (SVI of inoculum was 210 ml g<sup>-1</sup>) SVI

decreased, but after ca. 1 month the sedimentation rapidly got worse. Subsequently SVI gradually decreased, but only as a consequence of increased MLSS concentration. During the second period was the inoculum even more bulking (SVI 461 mL g<sup>-1</sup>). SVI gradually decreased in the same way. The real 30 min sediments were so high that it was not possible to separate supernatant; and the zone of free liquid above the sludge layer was minimal. The dominant filamentous bacteria were *Microthrix Parvicella* – the amount was 5 from 6 according to Jenkins (1993) (Žiláková, 2008). In this situation of massive sludge bulking, the household MBR plant offered advantage over the conventional WWTP by preventing failure of biological system due to biomass loss. The membrane is a physical barrier and this implies that all suspended solids had been retained in the system. In the third period was inoculum from another WWTP and it did not contain filamentous bacteria in such high amount (SVI less than 100 mL g<sup>-1</sup>). Even though after 1.5 month SVI increased above 250 mL g<sup>-1</sup> (max. 350 mL g<sup>-1</sup>), but subsequently gradually decreased to 200 mL g<sup>-1</sup> and the separation of clean water would be achievable by settling. From the results it can be seen that in household WWTPs sludge bulking may be a real problem (and if inoculum with filamentous bacteria is used, this problem is much more accentuated). In conventional activated sludge system (without membrane filtration) such bulking sludge will leak out in the outflow.

The activity of the sludge was measured by respiration rates. Despite of specific conditions in household WWTP, the activated sludge had a standard activity (respiration rates were typical for low loaded activated sludge process (Chudoba et al., 1991)). The total respiration rate  $r_{ox,tot}$  was 33 mg O<sub>2</sub> g<sup>-1</sup> h<sup>-1</sup>, the average endogenous respiration rate  $r_{ox,end}$  was 7.3 mg O<sub>2</sub> g<sup>-1</sup> h<sup>-1</sup>.

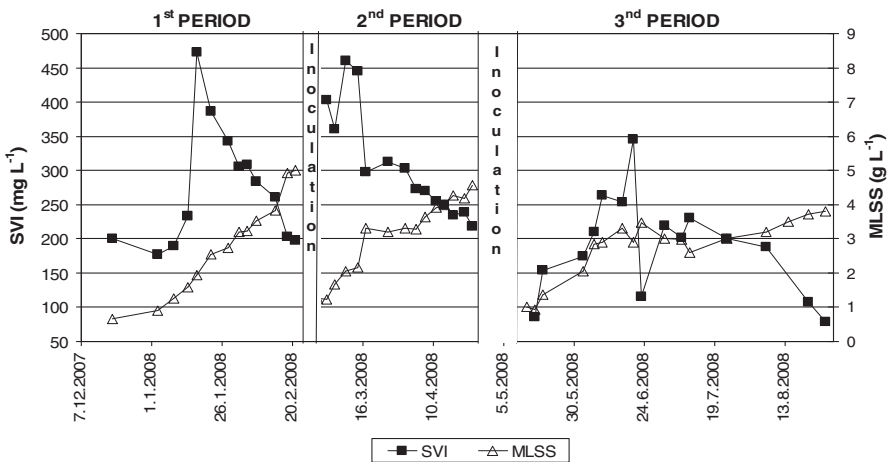

Figure 3. Progress of SVI and MLSS concentration during whole experiment

It was well known that nitrification could easily proceed in MBR because of complete rejection of nitrifier with membrane. However, the nitrifier still needed appropriate conditions, such as temperature, DO, pH etc., to live normally (Wei et al., 2006). And concentrated wastewater from household WWTP could be a problem.

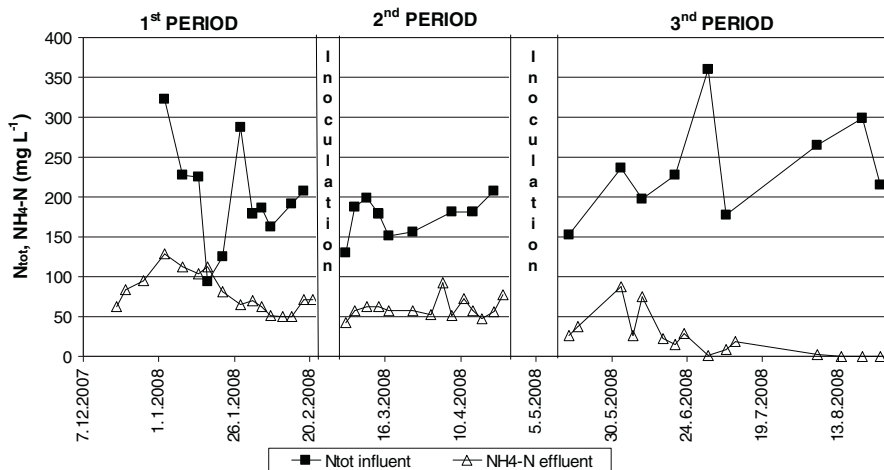

Figure 4.  $N_{\text{tot}}$  influent and  $\text{NH}_4\text{-N}_{\text{effluent}}$  concentrations

High concentration of  $N_{\text{tot}}$  in influent (usually above  $150 \text{ mg l}^{-1}$ , Figure 4) incurred higher pH (during first and second periods normally above 9) thus in activation tank was substrate inhibition achieved (inhibition with undissociated  $\text{NH}_3$ ) (Buday et al., 1999). During the low liquid temperature (during first and second periods mainly less than  $11^\circ\text{C}$ ; winter weeks even less than  $7^\circ\text{C}$ ), it was logical that nitrification was not complete. In the household WWTP the nitrification started only when the temperature was  $8\text{--}9^\circ\text{C}$ , despite of sufficient sludge age, high sludge concentration and high concentration of dissolved oxygen (constantly over  $5\text{--}6 \text{ mg O}_2 \text{ l}^{-1}$ ).  $\text{NH}_4\text{-N}$  concentrations less than  $50 \text{ mg l}^{-1}$  were achieved when the temperature was above  $20^\circ\text{C}$ . In a household WWTP may be the request of complete nitrification problematic.

### 3.3. FLUX AND MEMBRANE FOULING

A special attention was fixed on a flux. The filtration in first period started without regulation of flux or transmembrane pressure. The initial flux was  $45 \text{ l m}^{-2} \text{ h}^{-1}$  and we did not affect the system. We respected the probable situation that majority of owners and users of household WWTP would not be wastewater treatment experts, and they would not pay attention to the flux or



pressure regulation. The flux decreased from the value  $45 \text{ l m}^{-2} \text{ h}^{-1}$  below  $10 \text{ l m}^{-2} \text{ h}^{-1}$  after ca. 3 months (it corresponds to  $22 \text{ m}^3$  or  $3.2 \text{ m}^3/\text{m}^2$  of filtered wastewater through the membrane). We changed the membrane module to new one and started the second period. For the possibility of the flux regulation we installed a throttle at the effluent conduit. At the start-up we operated membrane module under the flux  $13 \text{ l m}^{-2} \text{ h}^{-1}$  for 3 days, then the flux was set at  $20 \text{ l m}^{-2} \text{ h}^{-1}$ . After 3 months the flux rapidly decreased to  $6 \text{ l m}^{-2} \text{ h}^{-1}$  again. The membrane was regenerated by 0.5% solution of acetic acid before the start of third period. The membrane module was operated at the low flux below  $10 \text{ l m}^{-2} \text{ h}^{-1}$  in this period. This value of flux appeared to be steady.

To membrane fouling probably contributed more factors:

- low temperature and sludge bulking - the overgrowth of filamentous bacteria could result in much more release of extracellular polymeric substances (EPS), and did great harm to membrane permeation (Meng et al., 2007, Jiang et al., 2005).
- The filamentous bacteria caused the formation of irregularly shaped sludge flocs, which worsen the membrane permeability for the fixing action of filamentous bacteria.
- High concentration  $\text{NH}_4\text{-N}$  in concentrated domestic wastewater caused higher pH and precipitation of phosphates  $\text{PO}_4\text{-P}$ . Incipient precipitation may foul membrane. In winter is this problem more striking, because in activated tank the nitrification does not work and so pH does not decrease.
- High flux, mainly in first days after start up (membrane producers recommend flux below  $15 \text{ l m}^{-2} \text{ h}^{-1}$ ).

The significant impact of temperature on MBR fouling suggests that winter is the critical time for membrane operation. To control the possible intensification of membrane fouling under winter conditions, it is suggested to run the MBR at lower filtration flux, if possible, and to intensify the coarse bubble aeration (Jiang et al., 2005).

When the lower filtration flux is used it is necessary to pay attention to retention volume in activated tank. Retention volume is volume between the minimal and maximal water level, by which is the filtration switched on and switched off (see Figure 1). This retention volume should be as big as possible, but it also depends on the height of membrane module. In our case the height of activated tank is 1.6 m and the height of membrane module with facilities (aerator and pump) is 1.44 m, so the retention volume was just 60 l. However by using another smaller commercial membrane module, which height is 0.98 m, we could have had in the same activated tank retention volume 235 l.

With regard to the third period, which was operated at the relative lower flux, the activated tank was flooded (flux through installed membrane was so

low, that it could not rise to the occasion off peak wastewater flow). These are particularity of membrane which must not be omitted by designer. Therefore the gravity inflow from second settle tank was changed to pumped inflow. Second settle tank was than used as a retention (buffer) tank (Figure 1).

#### 4. Conclusion

The small household pilot-scale MBR plant ran continuously for 9 months, in order to investigate the overall process performance and more specially the sludge and membrane behaviour to specific conditions like extreme temperature, high pH, long time zero load, etc. From this experiment the following conclusions could be drawn:

- Average influent: organic pollution COD = 867.3 mg l<sup>-1</sup>, BOD = 607.1 mg l<sup>-1</sup>, P<sub>total</sub> = 17.8 mg l<sup>-1</sup>, N<sub>total</sub> = 203.8 mg l<sup>-1</sup>, NH<sub>4</sub>-N = 151.8 mg l<sup>-1</sup>.
- Effluent quality COD = 58 mg l<sup>-1</sup>, BOD<sub>5</sub> = 2.3 mg l<sup>-1</sup> fulfilled legislative demands for household WWTPs without problems. Despite of sufficient sludge age request of complete nitrification in household WWTP may be a problem, mainly because of low temperature and substrate inhibition of nitrification.
- High pH and low temperature may markedly slow down anaerobic stabilization of primary sludge in settle tanks.
- Sludge separation by settling in a clarifier would be impossible because of massive sludge bulking, only installed membrane module guaranteed the perfect effluent quality.
- Low temperature, sludge bulking (supported the overgrowth of filamentous bacteria, which have great impacts on the performance of MBR system because it led to more release of EPS), high pH (coupled with precipitation PO<sub>4</sub>-P), request for minimum service work – difficult flux regulation in conditions of household WWTPs (particularly during start up the initial flux should be less than 15 l m<sup>-2</sup> h<sup>-1</sup>), a suitable and certain permeate pump (with references!) are the factors which may endanger function of membrane process in conditions of household WWTP.
- When the plant is operated at lower flux it is necessary to pay attention to correct calculation of retention volume and find membrane module with proper proportions.

## References

- Abegglen Ch., Ospelt M., Siegrist H., 2008, Biological nutrient removal in a small-scale MBR treating household wastewater, *Water Res.* 42 (1), 338–346.
- Buday J., Drtil M., Hutnan M., Derco J., 1999, Substrate and product inhibition of nitrification, *Chem. Papers*, 53 (6), 379–383.
- Cicek N., Winnen H., Suidan M., Wrenn B., Urbain V., Manem J., 1998, Effective of the membrane bioreactor in the biodegradation of high-molecular weight compounds, *Water Res.* 32 (5), 1553–1563.
- Chudoba J., Dohanyos M., Wanner J., 1991, *Biological wastewater treatment*, SNTL, Prague, Czech Republic.
- Decree of the government (Nařízení vlády ČR č. 229/2007 Zb.).
- Jenkins D., Richard M.G., Daigger G.T., 1993, *Manual on the Causes and Control of Activated Sludge Bulking and Foaming*, New York: Lewis Publishers.
- Jiang T., Kennedy M., Guinzbourg B., Vanrollenghem P., Schippers J., 2005, Optimising the operation of a MBR pilot plant by quantitative analysis of the membrane fouling mechanism, *Water Sci. Tech.* 51 (6), 19–25.
- Meng F., Shi B., Yang F., Zhang H., 2007, Effect of hydraulic retention time on membrane fouling and biomass characteristics in submerged membrane bioreactors, *Bioproc. Biosys. Eng.* 30, 359–367.
- Regulation (Vyhláška MŽP SR 684/2006 Zb).
- Wei Ch., Huang X., Wen X., 2006, Pilot study on municipal wastewater treatment by a modified submerged membrane bioreactor, *Water Sci. Tech.* 53 (9), 103–110.
- Žiláková L., *Microbial observations*, January 2008.

# PERSPECTIVE OF DECENTRALIZED SANITATION CONCEPT FOR TREATMENT OF WASTEWATER IN THE CZECH REPUBLIC, OTMAROV

TATIANA SKLENAROVA\* AND PETR HLAVINEK  
*Institute of Municipal Water management, Brno university of  
Technology, Faculty of Civil Engineering, Zizkova 17 612 00  
Brno, Czech Republic*

**Abstract.** Decentralised sanitation focuses on source separated collection of waste (yellow, brown and grey wastewater), treatment on/or close to the location and maximization of the possibilities to recover and reuse nutrients, water and energy. The current sanitation system in the Czech Republic is characterised by a high drinking water consumption, complex sewer infrastructure, large waste water treatment systems and a high production of waste. The main block for faster dissemination of suitable grey-water and brown-water management on the household level is the lack of knowledge (characteristic, treatment system) and experience. The first demonstration pilot project in the Czech Republic is based on DESAR principles for household and started in March 2006.

**Keywords:** decentralized sanitation concept, separation treatment, brown-water, grey-water, storage tank, nutrients, water pollutants

## 1. Introduction

Research project “Minimalization of nutrients and waste water emit into surface and underground waters” deal with a new approach for storm and wastewater management in urban areas and their application for decentralized system. The main consideration coming-out from limitation drainage of waste water, disposal, recycling of wastes and economic minimalization of nutrients and waste water emit into environment.

---

\* To whom correspondence should be addressed. Tatiana Sklenarova. Institute of Municipal Water management, Brno university of Technology, Faculty of Civil Engineering, Zizkova 17, 612 00 Brno, Czech Republic; e-mail: sklenarova.t@fce.vutbr.cz

## 2. Project

### 2.1. MINIMALIZATION OF NUTRIENTS AND WASTE WATER EMIT INTO SURFACE AND UNDERGROUND WATERS

Project deals with new progress approach and machines for waste water and their application for decentralized system. The main consideration coming-out from limitation drainage of waste water, disposal, recycling of wastes and economic minimalization of nutrients and waste water emit into environment.

Project have been started in March 2006 and comprise sanitation system between centralised (conventional flush-water toilet) and decentralised sanitation concepts (gravity separation toilet, waterless urinal). The project is divided into three phases.

### 2.2. PHASES OF THE PROJECT

#### 2.2.1. *Phase I. – “Pre-Study”*

In the phase I. we are picked up theoretical approach, collection information about the various project and compared cost between a conventional and new sanitation concept. Conventional sanitation concept – conventional flush-water toilets, one sewer system, normal gravity sewer system for the area transporting wastewater to the existing WWTP. Separation sanitation concept – waterless urinal + gravity separation toilet with separate outlet for urine and faeces, collection and storage of the urine, transport to the utilization tank, grey-water are transported in gravity sewer system, treatment in a package WWTP.

#### 2.2.2. *Phase II. – “Case-Study in Workroom”*

In the phase II. we are tested decentralized sanitation concept in existing workroom. In the sanitation concept is used waterless urinal, urine is collecting in utilization tank. The urine (dilution with minimum of water) is took off at regular intervals (twice per month). The values indicators of measurement are protocoling and evaluating. (COD, BOD, Ca, suspended solid, dissolved substance, pH,  $P_{total}$ ,  $N_{total}$ ,  $N-NH_4$ , bacteria: *Proteus vulgaris*, *Enterococcus*, *Klebsiella pneumoniae*, *Streptococcus alfa*, *Escherichia coli*, etc.). The urine is accumulated in urine tank. We are setting – up information for urine stripping (reuse nutrients, minimalization of dangerous pollutants).

### 2.2.3. Phase III. – “Pilot Project”

In the phase III. we are tested new sanitation decentralized concept in existing household (no-mix toilet, storage tank, urine tank, WWTP – Figure 1).

We break-up three stream of wastewater from the household:

1. *Grey water* – all remaining household wastewater (laundry, kitchen, bath) which is not faecally contaminated. By reusing domestic grey water for the purposes of toilet flushing, garden watering, there is potential to reduce potable water usage [1].
2. *Brown water* – water from separated toilet with special bowl for faeces – has gross faecal contamination.
3. *Yellow water* – water closet, bidet and bidets waste, separation toilets, waterless urinals – has faecal contamination.



Figure 1. Decentralized system in the household

The area has conventional sanitation concept. In the new sanitation concept is used separation toilet, type Dubbletten form separation yellow and brown water (Figure 2).



Figure 2. No mix toilet “Dubbletten”

Urine-separating toilets differ from ordinary toilets in that they have two bowls. One for faeces and toilet paper – has a bulge which prevents an overflow of the flushing water infected with bacteria and viruses to the front, second for urine. For flushing is used the storm water. The urine and flush-water mixture passes through a separate pipe system to a urine tank.

The yellow water (dilution with 1.2–1.5 dl of storm water) and effluent from WWTP are taken off at regular intervals – twice per month.

#### 2.2.4. Chemical Analysis (Grey and Brown Water)

Grey and brown water is treated in package WWTP, yellow water is accumulated in urine tank (chemical, bacterial analyses). Economy of centralized (autumn 2007) and decentralized systems is compared (Figure 3, 4) and advantages and disadvantages of both systems are discussed.

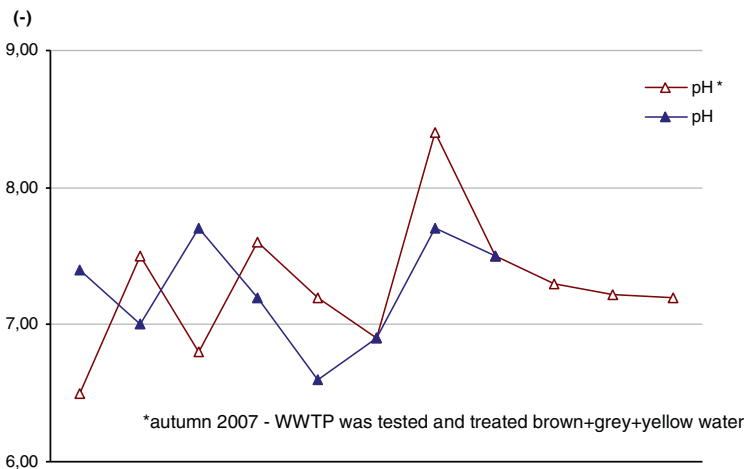

Figure 3. pH – chemical analysis (grey and brown water with brown+grey+yellow water)

From individual measurement it stands to reason, that we do not use decentralized system (autumn 2007) and subsequently we compare the research results we can claim (Figure 4):

- Depreciation BOD just about 59%
- Depreciation COD just about 77%
- Depreciation pH just about 1%
- Depreciation  $P_{total}$  just about 10%
- Depreciation  $N_{total}$  just about 8%

Ratio index  $N_{total}/P_{total}$  in grey and brown water is approximately 2, with the view of resulting, that this index is not optimal for plant absorption and we can not use this water as irrigation.

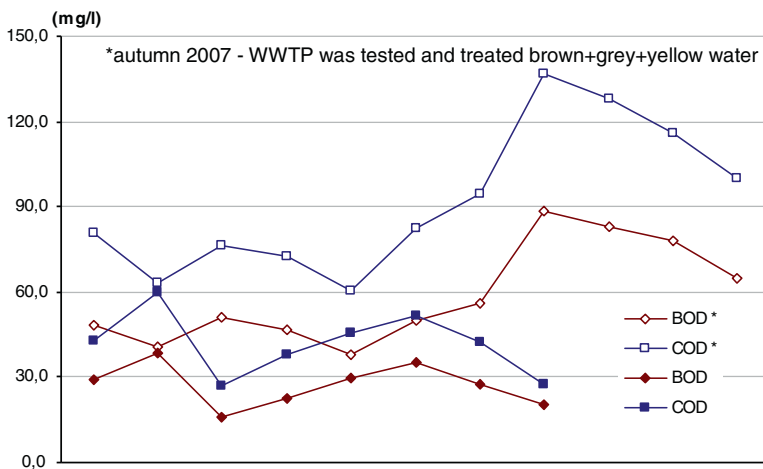

Figure 4. BOC, COD – chemical analysis (grey and brown water)

### 2.3. RESULTS OF THE PROJECT

- Presently project will be finished in December 2008 (presently project lasts 32 month). Individual advances are approaching to the end and results are subsequently evaluating and proceeding.
- We collected information about the various project and compared cost between a conventional and new sanitation concept in the background research.
- In the phase II. We are tested decentralized sanitation concept in existing workroom (waterless urinal, urine is collecting in utilization tank). We took



off values indicators of measurement (COD, BOD, Ca, suspended solid, dissolved substance, pH,  $P_{\text{total}}$ ,  $N_{\text{total}}$ ,  $N\text{-NH}_4$ , bacteria: *Proteus vulgaris*, *Enterococcus*, *Klebsiella pneumoniae*, *Streptococcus alfa*, *Escherichia coli*, etc.).

- In the phase III. we are tested decentralized sanitation concept in existing household (no-mix toilet Dubbletten, urine is collecting in utilization tank, storage tank AS-REWA). We took off values indicators of measurement (COD, BOD, Ca, suspended solid, dissolved substance, pH,  $P_{\text{total}}$ ,  $N_{\text{total}}$ ,  $N\text{-NH}_4$ , bacteria: *Proteus vulgaris*, *Enterococcus*, *Klebsiella pneumoniae*, *Streptococcus alfa*, *Escherichia coli*, etc.).
- Autumn 2007 we was tested WWTP and treated brown + grey + yellow water. We took off values indicators of measurement.
- Summer 2008 we was tested WWTP and treated brown + grey water. We took off values indicators of measurement.

### 3. Results and Discussion

Our results from projects will be important for next development in the decentralized sanitation in the Czech Republic. The main consideration coming-out from limitation drainage of waste water, disposal, recycling of wastes and economic minimalization of nutrients and water pollutants emit into environment.

### Reference

- [1] Morel, A., Imhof, B., Muhlemann, J.: Greywater treatment on household level in developing countries – a state of the art review. Semester work, February 2005, EAWAG Sandec & ETH Duwis.

# XENOBIOTICS IN PROCESS OF WASTEWATER TREATMENT – WEB KNOWLEDGE BASE

JIRÍ KUBÍK\* AND PETR HLAVINEK

*Brno University of Technology, Faculty of Civil Engineering,  
Institute of Municipal Water Management, Zizkova 17, Brno  
60200, Czech Republic*

**Abstract.** This paper describes structure and functionality of web-based database, which will be placed at [www.xenobiotika.cz](http://www.xenobiotika.cz) web page. This task is processed under the COST 636 Project “Xenobiotics in Urban Water Cycle”, work group WG2 Methods for Treatment and supported by Czech Ministry of Education.

**Keywords:** xenobiotics, web-based, database

## 1. Introduction

In the present time there doesn't exist a web space focused on xenobiotics in the form of articles, database of links and documents which can be fully accessible and editable by visitors. The xenobiotics knowledge base is also not available on the internet and it is only presented in some databases of chemicals (e.g. The Chemical Database, ChemBioFinder or ChemSpider).

The main purpose of the web page [www.xenobiotika.cz](http://www.xenobiotika.cz) is to concentrate available information about xenobiotics and then following utilisation in decision support tool (DSS) for optimal treatment technology selection. The DSS will be developed in PHP connected to MySQL database.

---

\* To whom correspondence should be addressed. Jiří Kubík, Brno University of Technology, Faculty of Civil Engineering, Institute of Municipal Water Management, Brno, Czech Republic; e-mail: [kubik.j@fce.vutbr.cz](mailto:kubik.j@fce.vutbr.cz), phone: +420541147729

## 2. Web Page

The web page is divided into four main sections: Articles, Download, Links and Database. The other two sections are description of the COST 636 project and acknowledgements.

### 2.1. ARTICLES

The visitor has possibility to add new article about xenobiotics. This section is used for smaller portion of information like an illustrative picture, table or notes with links to other web pages. The visual style of this section and the page is shown on Figure 1.

### 2.2. DOWNLOAD AND LINKS

The section download is prepared to store all general type of documents (doc, pdf, ppt etc.). In case the visitor wants to link to whole page or to document it is better to use the section Links.

The screenshot shows a web browser window displaying the website <http://www.xenobiotika.cz>. The page title is "XENOBIOTIKA.CZ". The header includes navigation links: "homepage", "contact", and "COST 636". Below the header is a banner image of a mountain landscape with a lake, and two chemical structures. A navigation menu contains: "About", "Articles", "Database", "Download", "Links", and "Acknowledgements".

The "Articles" section lists the following entries:

Article Title	Author	Date
Xenobiotika.cz	Jiří Kubík	2009-01-12 15:42:00
NATO Science for Peace and Security Series	Jiří Kubík	2009-01-12 15:37:00
Publikace "Dangerous Pollutants (Xenobiotics) in Urban Water Cycle"		
Schema odstranění xenobiotik z odpadních vod	Jiří Kubík	2009-01-12 15:34:00

The "Publikace" article includes the following details:

- Proceedings of the NATO Advanced Research Workshop on Dangerous Pollutants (xenobiotics) in Urban Water Cycle, Lednice, Czech Republic, 3-6 May 2007
- Series: NATO Science for Peace and Security Series
- Subseries: NATO Science for Peace and Security Series C: Environmental Security
- Hlavinek, P.; Bonacci, O.; Marsalek, J.; Mahrkova, I. (Eds.) 2008, XXII, 346 p., Softcover
- ISBN: 978-1-4020-6794-5

The "Schema" article shows a diagram with two blue boxes labeled "Biograde" and "Oxidace", with arrows pointing to "C<sub>10</sub>" and "C<sub>100</sub>".

Figure 1. Web page [www.xenobiotika.cz](http://www.xenobiotika.cz) print screen – section articles

### 2.3. DATABASE

The MySQL database is used to collect following data: name and description of substance, chemical and physical data (formula, chemical structure, density, pH, Henry constant, etc.), submission (pharmaceuticals, pesticides, heavy metals, etc.), removal efficiencies in selected process units (activated sludge, membrane bioreactor, advanced oxidation and next 17 processes) (Table 1).

TABLE 1. Print screen of basic database entry

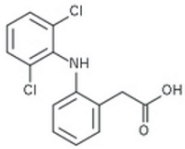
Parameter	Value
Name	<b>Diclofenac</b>
Formula	
Chemical Structure	C <sub>14</sub> H <sub>11</sub> Cl <sub>2</sub> NO <sub>2</sub>
Molar weight	296.15
CAS	15307-86-5, 15307-79-6
EEC	239-348-5
Submission	Antiphlogistika, Analgetika, COX-inhibitor
Chemical Name	2-[2-[(2,6-dichlorophenyl)amino]phenyl]acetic acid
Physical Condition	
Density	
pH	
Henry	2,17 E-07 (calc.)

Xenobiotics can be divided into several groups by using or source:

- Pharmaceuticals (antibiotics, estrogens, steroids)
- Personal care products (shampoos, detergents)
- Pesticides (fungicides, herbicides)
- Poisons
- Industrial chemical (polychlorinated biphenyl)
- Heavy metals (lead, mercury, cadmium)

The data about substances included in the database were provided by our partners in the COST 636 project. Some data will be available to general public and together with articles in this domain they could be used as basic educational capacity.

### 3. Methods of Treatment

The removal of xenobiotics is quite big problem. The conventional wastewater treatment systems are built to remove traditional types of pollution like BOD, COD, suspended solids, nitrogen or phosphorus. The effectiveness of conventional wastewater treatment containing xenobiotics depends on characteristics, volume and concentrations of xenobiotics present in wastewater.

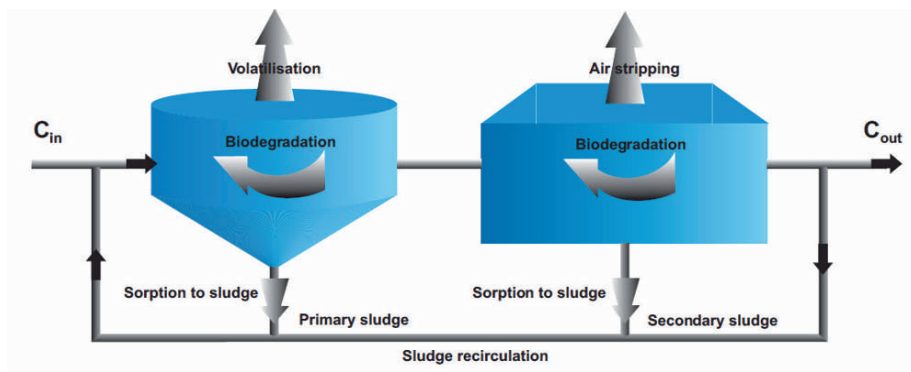

Figure 2. Schematic removal pathways in the conventional WWTP (Byrns, 2001)

Xenobiotics can be removed by biological and advanced wastewater treatment processes by the following physico-chemical mechanisms: sorption to sludge biomass with addition of activated carbon, volatilization, chemical oxidation, chemical flocculation, air stripping and following biological mechanisms: biodegradation and biotransformation (Bitton, 2005). The basic scheme of xenobiotics removal is shown Figure 2.

#### 3.1. PRIMARY TREATMENT

The xenobiotics are removed from wastewater by sorption to sludge during the primary treatment. The sludge is then pumped out. The next process is volatilisation to atmosphere by diffusion at water–air interface and finally by biotransformation which has a potential to reduce concentrations of chemicals during the retention time. Primary settling is able to reduce polar dissolved substances only.

#### 3.2. SECONDARY TREATMENT

There are similar processes compare to primary treatment. Another process connected to secondary treatment is air stripping in the reason of tank aeration.

Xenobiotics are usually very resistant to metabolic transformations but it was explored the power of biotransformation where the chemical structure of xenobiotics can be changed; xenobiotics could be detoxificated or totally mineralized. The ability of degradation of xenobiotics was found at all main taxonomic groups of micro organisms.

#### **4. Legislation**

Decision No 2455/2001/EC of the European Parliament and of the Council of 20 November 2001 established the list of priority substances in the field of water policy and amending Directive 2000/60/EC. The Commission has, on this basis, developed a combined monitoring-based and modelling-based priority setting (COMMPS) scheme, in collaboration with experts of interested parties, involving the Scientific Committee for Toxicity, Ecotoxicity and the Environment, Member States, EFTA countries, the European Environment Agency, European business associations including those representing small and medium-sized enterprises and European environmental organisations. The list contains 33 potential dangerous substances. Most of them are industrial chemicals and heavy metals.

#### **5. Conclusions**

The webpage [www.xenobiotika.cz](http://www.xenobiotika.cz) is now accessible and the database will be filled during first quarter of the year 2009. We hope that this webpage could be helpful source for researchers.

#### **6. Acknowledgments**

The authors acknowledge the European Commission, Czech Ministry of Education for funding this work within the COST 636 Project “Xenobiotics in Urban Water Cycle” and all the partners in the COST 636 project.

#### **References**

- Bitton, G., 2005, *Wastewater Microbiology*, Third Edition, Wiley, NJ, 746p. ISBN 0-471-65071-4.
- Byrns, G., 2001, The fate of xenobiotic organic compounds in wastewater treatment plants, *Water Res.* 10 (11), 2523–2533.
- Decision No 2455/2001/EC, [http://eur-lex.europa.eu/smartapi/cgi/sga\\_doc?smartapi!celexplus!prod!CELEXnumdoc&numdoc=32001D2455&lg=en](http://eur-lex.europa.eu/smartapi/cgi/sga_doc?smartapi!celexplus!prod!CELEXnumdoc&numdoc=32001D2455&lg=en)

Directive 2000/60/EC – The EU Water Framework Directive, [http://ec.europa.eu/environment/water/water-framework/index\\_en.html](http://ec.europa.eu/environment/water/water-framework/index_en.html)

Quintana, J.B., Weiss, S., and Reemtsma, T., 2005, Pathways and metabolites of microbial degradation of selected acidic pharmaceutical and their occurrence in municipal wastewater treated by a membrane bioreactor, *Water Res.* 39, 2654–2664.

# HYDRAULIC AND ENVIRONMENTAL RELIABILITY MODEL OF URBAN DRAINAGE

PETR HLAVINEK\*, PETR PRAX, VLADIMÍRA ŠULCOVÁ  
AND JIŘÍ KUBÍK

*Institute of Municipal Water Management, Brno University of  
Technology, Veveří 331/95, 60200 Brno, Czech Republic*

**Abstract.** The aim of the paper is to describe HELLMUD Tool developed for supporting decision-making process concerning sewer rehabilitation. Brief overview of methodology for calculation of probability of hydraulic and environmental failure, development of HELLMUD software tool and its application on real sewer network are main parts of the paper. Hydraulic and environmental performance of a sewer system on pipe and CSO (Combined Sewer Overflow) level were determined by means of 17 criteria, consequently transformed into five complex criteria describing and evaluating each pipe and CSO – hydraulic, velocity and infiltration risk (hydraulic viewpoint), exfiltration risk and CSO evaluation (environmental viewpoint). HELLMUD Tool was applied on Ivančice catchment. Reliability analysis provided by HELLMUD Tool can be used in the decision making process for evaluation or ranking rehabilitation projects, or to design of long term rehabilitation strategies.

**Keywords:** CARE-S, decision support system, sewer network, sewer rehabilitation, operational probability, hydraulic criteria, environmental criteria, HELLMUD Tool

## 1. Introduction

Two approaches to sewer rehabilitation can be distinguished. In the past (and in many cases up today), so called re-active approach was applied, that means that rehabilitation of sewage systems was performed on a crisis management basis – after the failure occurred, it was removed, mostly according to operator

\* To whom correspondence should be addressed. Petr Hlavinek, Institute of Municipal Water Management, Brno University of Technology, Veveří 331/95, 60200 Brno, Czech Republic, Tel: +420-541 147 733, Fax: +420-541 147 728, e-mail: hlavinek.p@fce.vutbr.cz



financial and technical possibilities. At present, there is a strong tendency to apply so called pro-active approach, which means firstly systematic evidence and control of sewer system and consequently predicting of probably failure occurrence and its removing even before the failure occurs on the network.

Pro-active approach requires good knowledge on network behavior and its real conditions. The investigation of structural failure is based on sewer inspection, while detection of hydraulic and environmental failures needs measurement or mathematical modelling to predict compliance of the system with performance criteria (i.e. CSO volumes and flooding). There is a need to develop new tools for evaluation of the system in terms of interconnection of potential hydraulic failure occurrence and its impact on environment in order to predict flooding and pollution load discharged into receiving waters. In case the evaluation is done on pipe level, user can determine exactly links causing the worst failures on the network. These pipes are recommended to be rehabilitated in preference which contributes to improving of sewer reliability and safety as well as maintenance of the system generally in good conditions.

## **2. Project CARE-S**

The paper was processed in the frame of the international research project CARE-S. CARE-S is an acronym of the project title “Computer Aided REhabilitation of Sewer Networks”. It is research project undertaken under the auspices of the European Union’s 5th Framework Program for Research and Development in 2002–2005. Fourteen partners from Europe and one from Australia together with wastewater service providers from 20 cities joined together to implement the project [19].

The objectives of CARE-S are to improve current analytic tools, link them and make them usable for the formulation of a rehabilitation strategy. The DSS (Decision support system) includes the following elements:

- A tool generating Performance Indicators that are relevant for rehabilitation decisions, including analytical and statistical procedures to assess and forecast some of the PIs [13, 14, 18].
- Several tools that allow to assess the hydraulic, environmental and structural conditions of the network including their change over time [7, 17].
- A procedure to define the socio-economic and environmental risks of malfunctioning sewer systems [23, 27].
- A multi-criteria decision tool supporting the choice of high priority rehabilitation projects [1].
- A database to be used for choosing an appropriate rehabilitation technology [16].

- A tool to define the best long-term strategy for rehabilitation investments.
- A software package, called “Sewer Rehab Manager” that will enable consultants and wastewater service providers to use the above products according to their individual needs and available data base [5, 6].

CARE-S is a decision support system for wastewater network rehabilitation based on available and developed technical tools plus research on socio-economic consequences of sewer failures and rehabilitation measurements. It includes methods for multi-criteria analysis leading to suitable pipe rehabilitation, technology and strategy determination. An integrated, generic prototype is available for support of rehabilitation decision, including analysis of structural, hydraulic, environmental and socio-economic aspects as well as annual rehabilitation planning, long-term strategic planning and financial distribution [4].

### 3. Description of the HELLMUD Tool

Mathematical model HELLMUD (Hydraulic and Environmental reLiabiLiTy Model of Urban Drainage) is focused on service reliability, which reflects the probability of hydraulic efficiency and environmental impacts of a sewer system for one predetermined scenario [10]. The model aims at a definition of several criteria that can be used for the assessment of reliability aspects on the current sewer system or for the testing of proposed scenarios of the urban drainage system rehabilitation. As the piping represents the most critical system component with respect to hydraulic and environmental deficiencies, the criteria are highlighted at the pipe level. The data is in relation to the risk assessment on combined sewer overflows (CSOs) which are perceived by the hydraulic model as boundary conditions of the mathematical modelling for each scenario. The assessment of environmental impacts is based on the national legislation, being defined in the CARE-S CAT (CSOs) and GAT (groundwater) modules.

HELLMUD tool is based on hydraulic and environmental criteria able to quantify reliability parameters defined on pipe and CSO level. Network topology is not taken into account, every link and CSO is evaluated separately without continual follow-up of pipes.

The list of hydraulic criteria includes:

1. Frequency and probability of specific filling water levels (named B, C, D)
2. Weighting of the link in terms of flow capacity (the bigger dimension of the pipe, the more critical flooding event can caused)
3. Insufficient capacity (evaluation whether flooding events detected on the pipe are produced by this pipe or caused e.g. by backwater from downstream)

4. Flow velocity (comparison with standard in order to evaluate problems with either minimal or maximal velocity)
5. Sewer typology (combined or separate)
6. Infiltration weighting (infiltration of the link with regards to the whole network)

While environmental criteria based on data derived from other CARE-S tools results are:

1. Exfiltration (vulnerability of the groundwater)
2. CSOs impacts criteria (level of hazard and appropriate range)

HELLMUD Tool was developed for calculation and further processing of the criteria. HELLMUD provides two main outputs – Process results and Final results. Process results cover calculation of criteria listed above; consequently HELLMUD combines these criteria and produces five complex Final hydraulic and environmental criteria on the pipe and CSO level:

- |                      |   |                                |
|----------------------|---|--------------------------------|
| 1. Hydraulic risk    | } | Complex hydraulic criteria     |
| 2. Velocity risk     |   |                                |
| 3. Infiltration risk | } | Complex environmental criteria |
| 4. Exfiltration risk |   |                                |
| 5. CSO evaluation    |   |                                |

Input data are loaded from hydraulic and environmental simulation. The tool cannot be used without previous hydraulic simulation of the catchment. MOUSE, SWMM or InfoWorks models can be used as the hydrodynamic tool (see [2, 15]). Environmental parameters for network probabilities of risk analyses are evaluated as defined by CAT and GAT Tools [21].

HELLMUD Tool works at two accuracy levels according to the user's approach to the hydrological data input for the validated deterministic simulation model:

- Historical Rain Data simulation (HRD) – at least 25 “worst” storms during 20 years
- Single Event simulations (SE) – at least three design rains, optimum is five events

Preparation of hydraulic input files for HELLMUD is similar for HRD and SE simulations. The difference is in amount of input rain data available.

Developing of methodology able to link both hydraulic and environmental indicators is based on classical statistical methods to determine the probability of occurrence of undesirable phenomena and hence possible hazard, as presented in the following.

HELLMUD toll can be run as stand-alone version or CARE-S integrated version, in both cases the results are saved in a text form (\*.csv files). Stand-alone version provides tables of Process and Final results with graphs of hydraulic load in dependence on frequency for every link. User can handle with the results according his or her wish similarly as with data stored in MS Excel files.

Results provided by HELLMUD tool integrated into CARE-S can be visualized for better understanding by CARE-S Rehab Manager's GIS system as hydraulic and environmental probability maps able to present in a direct way the most critical components for hydraulic and environmental aspects at different levels.

Within CARE-S, the probabilistic maps are combined with socio-economic and other criteria and together are processed by means of multi-criteria decision making, which produces the list of priority pipes in terms of rehabilitation request and final ranking of potential rehabilitation technologies. The effect of rehabilitation technologies on the network conditions is recorded in the Rehabilitation Manager. Changes produced in the system are defined and the hydraulic input can be corrected. With the new input files, it is possible to run the procedure again and to develop new probability maps after rehabilitation.

HELLMUD Tool can be applied to the whole network or part of it, without consideration of integrated topology (layout) of the network. Evaluation of CSO performance is assigned to each CSO separately in the frame of the network.

Accuracy of result strongly depends on input data available. Hydrotechnical information of the network, results from the hydraulic model, critical level and loading of Design Year Period value are necessary conditions for running the tool. In addition, CAT and GAT output files can be loaded for evaluation of environmental deficiencies. In case CAT and/or GAT file is not loaded, appropriate evaluation of CSO and/or exfiltration is not available (N/A).

#### **4. Hydraulic Criteria Definitions**

In the frame of CARE-S, hydraulic and environmental problems of sewer network are evaluated by means of 17 criteria (see TABLE 1). Hydraulic and environmental criteria evaluate each pipe and CSO either separately or in relation to the others, so the results can be used for assessment of sequenced list

TABLE 1. HELLMUD hydraulic and environmental criteria overview

No	Name	Criterion	Unit	Range	Level	Description	Tool
1	C1	FillingLevel	–	A, B, C, D	Pipe	Filling level	
2	C2A	FrequencyFillingLevelA	Year <sup>-1</sup>	<0.02; 5>	Pipe	Frequency – class A <sup>a</sup>	
3	C2B	FrequencyFillingLevelB	Year <sup>-1</sup>	<0.02; 5>	Pipe	Frequency – class B <sup>a</sup>	
4	C2C	FrequencyFillingLevelC	Year <sup>-1</sup>	<0.02; 5>	Pipe	Frequency – class C <sup>a</sup>	
5	C3B	ProbabilityB	1	<0; 1>	Pipe	Probability P(B) <sup>b</sup>	
6	C3C	ProbabilityC	1	<0; 1>	Pipe	Probability P(C) <sup>b</sup>	HELLMUD
7	C3D	ProbabilityD	1	<0; 1>	Pipe	probability P(D) <sup>b</sup>	HELLMUD
8	C4	WeightLink	1	<0; 1>	Pipe	Weight of link	
9	C5	InsufficientCapacity	1	<0; 1>	Pipe	Insufficient capacity	
10	C6	Velocity	–	Yes/no	Pipe	Velocity	
11	C8	SewerTypology	1	S/C	Pipe	Sewer typology	
12	C9	InfiltrationWeight	1	<0; 1>	Pipe	Infiltration weight	
13	C10	Exfiltration	–	High moderate low	Pipe	Exfiltration	GAT
14	C11	Overflow total load	Yes/no absolute value, %		CSO	Compliance of overflow total load with standard	
15	C12	Overflow frequency/spills	Yes/no absolute value, %		CSO	Compliance of overflow frequency/spills with standard	CAT
16	C13	Overflow volume	Yes/no absolute value, %		CSO	Compliance of overflow volume with standard	CAT
17	C14	Overflow duration	Yes/no absolute value, %		CSO	Compliance of overflow duration with standard	CAT

<sup>a</sup>Frequency for which filling level B (C, D) is exceeded just once.

<sup>b</sup>Probability appropriate to criterion C2.

of the pipes and CSOs according to their contribution to the failure occurrence on the network. Theoretical background and brief explanation of each criterion are listed in the following subsections.

4.1. C1 – FILLING LEVEL

The hydraulic reliability strategy of the model distinguishes four classes (A, B, C, D) to classify all pipes, overview of the pipe classification used in HELLMUD Tool is in TABLE 2 [26, 25]. Height (diameter or height of the pipe in the HELLMUD Tool),  $H_{crit}$  and the ground level as well as relation between Levels and Classes are shown in Figure 1. Overview of levels, classes and altitudes for pipe classification [10].

TABLE 2. Overview of pipe classification in HELLMUD Tool

Class	Range	Area	System behaviour	Status of the system	Over-loading
A	From invert level up to full pipe	Design	Reliable within the range of design	Safe	Non
B	From top of the pipe up to critical level	Storage	Unreliable	Safe	Low
C	From critical level to ground level	Dangerous	Unreliable	Unsafe	Medium
D	Above ground level	Flooding	Unreliable	Dangerous	High

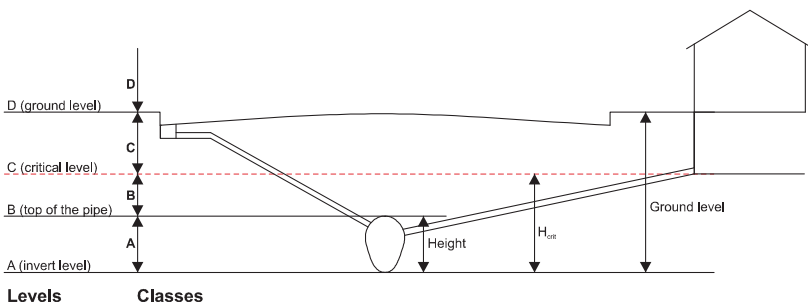

Figure 1. Overview of levels, classes and altitudes for pipe classification

Critical level is a fictive line between Class B and Class C, the level has got the range between the top of the pipe and the ground level of the elementary catchment of each pipe. The critical level is defined as a sewer network water

level that, if exceeded, starts to bring damages on properties within the urbanized catchment assigned to the pipe. All hydraulic events above the critical level are unsafe or dangerous and have to be controlled. User can change  $H_{crit}$  default value when an operational value is available or if national standards are preferred or required.

Criterion C1 defines the water filling level (A, B, C or D) that is not probably exceeded more than once during 20 years (frequency equals  $0.05 \text{ year}^{-1}$ ).

4.2. C2 – FREQUENCY

Following paragraphs describe the methodology for assessment of the criterion C2 from HELLMUD input data. For both SE and HRD simulation the procedure is the same, the only difference is internal HELLMUD assessment of shape of the curve outlined in Figure 2 (HRD uses statistical processing while for SE the points are directly obtained from simulation – water level for known frequency).

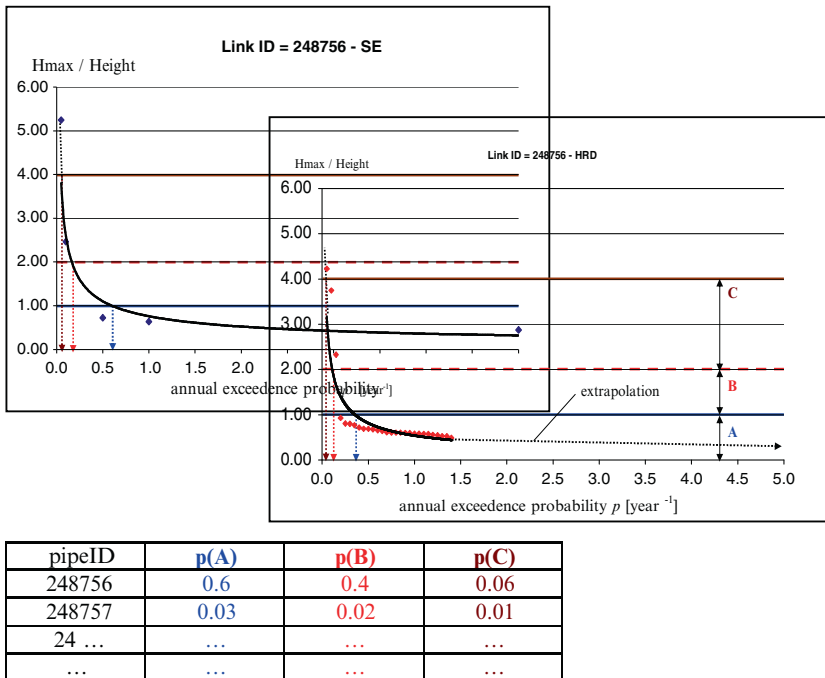

- a. the regression on historical rain data simulation (HRD), 26 catastrophic storms
- b. the regression on single event simulation (SE),  $p = 5; 1; 0.2; 0.1$  and  $0.333 \text{ year}^{-1}$

Figure 2. Relationship between the water levels and frequency

- (i) Firstly, the dependence of relation Hmax/Height on frequency  $p$  (=annual probability of exceedance) has to be found. Hmax is water level appropriate to the particular link loaded from the hydraulic model (either SE or HRD simulation); Height is the vertical dimension of the pipe. For input values (pointed in Figure 2) of the simulation, power function for the dependence is found (the curve).
- (ii) Secondly, intersections of the curve with three levels (B, C and D) are calculated. The value of Hmax/Height for level B is always "1", because the supposed maximal water level for level B is top of the pipe, i.e. height (diameter). Class C corresponds to Hcrit and class D corresponds to surface level.
- (iii) And finally, required results, frequencies  $p(A)$ ,  $p(B)$  and  $p(C)$ , are read on x-axis, and they are listed as part of HELLMUD Process results (criteria C2A, C2B, C2C). Frequency corresponds to annual exceedance probability  $p$ .

#### 4.3. C3 – PROBABILITY

Similarly to many other cases of engineering practice where natural phenomena of accidental character in both time and space such as storms, waves, winds, floods, etc. are to be assessed, the probability of the exceeding of sought indicators can be made with the use of the formulae below based on binomial probability distribution [11]. Characteristics of binomial random variable are following:

1. The experiment consists of  $N$  identical trials.
2. There are only two possible outcomes at each trial ("event will occur" x "will not occur").
3. The probability of "event will occur" is the same from trial to trial ( $p$ ).
4. The trials are independent.
5. The binomial random variable  $r$  is the number of "event will occur" in  $N$  trials.

The binomial probability distribution:

$$P_{(N,r)} = \binom{N}{r} p^r (1-p)^{N-r} = P_{(N,r)} = \frac{N!}{r!(N-r)!} p^r (1-p)^{N-r} \quad (1)$$

Explanation of the particular variables is listed in TABLE 3.

If  $r = 0$ , no floods will occur during the period  $N$  and the formula above is simplified into:

$$P_{(N,0)} = (1-p)^N ; p \in \langle 0.01 ; 1 \rangle \quad (2)$$

This is the probability that a flood (level B, C and D) with an annual exceedance probability  $p$  will not be exceeded at all in the period of  $N$  years.



Generally, hydraulic risk  $R$  can be counted as complement-on-one to probability  $P$ . The result of hydraulic performance is hydraulic risk for each pipe assessed by means of probability that water level appropriate to the particular pipe is equal or higher then appropriate level (B, C or D).

$$R = 1 - P(N, 0), \text{ where } P(N, 0) = P(H \geq \text{level } B, \text{ resp. } C \text{ or } D) \quad (3)$$

Where  $R$  – hydraulic risk for each pipe  
 $H$  – water level appropriate to the particular pipe (link)  
 $P, N$  – see Table 3

TABLE 3. Binomial probability distribution and variables

Variable	Unit	Binomial probability distribution	Explanation	HELLMUD Tool
$N$	Year	Number of trials	Number of years, after which occurrence of given event $r$ (given filling level) is admitted, e.g. the useful design life of the structure or duration of insurance	“Design Year Period” defined by user
$r$	1	Number of events in $N$ trials	Total number of achieved water levels within classes B, C or D	$r = 0$
$P(N, r)$	1	Probability of $r$ events occurring in $N$ possible events		$P(C2)$ $C3 = 1 - P(C2)$
$p$	Year <sup>-1</sup>	Probability of single event occurring in $N$ possible events	Annual probability of exceedance (frequency) $p = 1/T$	C2
$T$	Year	Recurrence interval	Return period $T = 1/p$	1/C2

Table 4 shows percent occurrence of the risk of one or more exceedance during the Design Year Period  $N$ . The values of the risk are listed in percentages (interval of <0, 100>) while in the TABLE 1 they are reduced to non-dimensional values in the range of <0, 1>. The basic formula and its parameters is explained and demonstrated by means of arrows. For example, a 20-year recurrence flood has a 10% chance of being exceeded within any 2-year period.

For better understanding of relationship among the variables see Table 4.

TABLE 4. Percent occurrence of the risk  $R$  (%)

$R = 1 - P_{(N,0)} = 1 - (1 - p)^N$

Recurrence Interval ( $T$ ) (years)	Annual Probability of Exceedence ( $p=1/T$ ) (years <sup>-1</sup> )	Design Year Period ( $N$ ) [years] (Time period, after which is admitted occurrence of given event. Defined by end-user)								
		$N=1$	$N=2$	$N=5$	$N=10$	$N=15$	$N=20$	$N=25$	$N=50$	$N=100$
50	0.02	2	4	10	18	26	33	40	64	87
30	0.03	3	7	16	29	40	49	57	82	97
20	0.05	5	10	23	40	54	64	72	92	99
10	0.10	10	19	41	65	79	88	93	99	100
5	0.20	20	36	67	89	96	99	100	100	100
2	0.50	50	75	97	100	100	100	100	100	100
1	1.00	100	100	100	100	100	100	100	100	100

4.4. C4 – WEIGHTING OF THE LINK

The ratio of capacity flow of full section inside the pipe and maximum of capacity flows. It provides information of the weight of the specific pipe considered, in terms of flow capacity compared with all the other pipes. This criterion is defined in order to weight in the simplest way the pipe responsibility to flooding events, and it is further used in CARE-S.

4.5. C5 – INSUFFICIENT CAPACITY

Ratio of maximum flow value inside the pipe during rain event of return period equals Design Year Period  $N$  and capacity flow of full section inside the pipe evaluates the possible insufficient flow capacity of a pipe, because the flooding event localized on a specific pipe could be produced by a downstream back-water due to another insufficient pipe.

4.6. C6 – VELOCITY

The HELLMUD Tool processes both low and high velocity problem and combines them, so that the result of the evaluation is deliverance whether or not the problem with velocity occurred. Among minimum velocity criteria belong self-cleaning slope, minimal shear stress, sediment transport velocity and full pipe velocity criteria, while maximum velocity is evaluated according to pipe material. User can tick one or more velocity criteria for calculation and change default reference minimal or maximal values in accordance with national standards.

#### 4.7. C8 – SEWER TYPOLOGY

The C8 criterion is defined to determine a type of sewer system on the pipe level. Separate and combined system can be distinguished for each pipe. This information is important for e.g. evaluation of minimal velocity criteria or for the different impact produced by overflows.

#### 4.8. C9 – INFILTRATION WEIGHTING

C9 criterion uses infiltration volume inflow per 1 m of a pipe length loaded, and by means of simple calculation transforms it into weight – “contribution” of the link with regard to the whole network.

Criterion C10 concerning exfiltration from the pipe comes from GAT Tool. HELLMUD processes C10 and produces Exfiltration risk in HELLMUD Final results. Criteria C11–C14 concern CSOs and they are calculated by means of CAT Tool as sum for all CSOs together. HELLMUD works with CAT output file (semi-results before summarization) and provides evaluation of each particular CSO as separate object on the network [20, 21].

### 5. Final Evaluation of the Links and CSO

Besides providing hydraulic and environmental criteria calculation, the HELLMUD tool was developed for evaluation of the sewer network based on these criteria in terms of service reliability and for determination of the pipes where hydraulic and environmental deficiencies will probably occur. The final HELLMUD results provide five complex criteria. Among complex hydraulic evaluation belong hydraulic, velocity and infiltration risk while exfiltration risk and CSO evaluation represent complex environmental evaluation. Hydraulic, velocity, infiltration and exfiltration risk is evaluated at the pipe level while CSO evaluation is provided for each combined sewer overflow on the network. Overview of the HELLMUD Final results can be found in Tables 5 and 6.

TABLE 5. HELLMUD Final results – pipes

Risk	Range	Unit
Link ID		–
Hydraulic	<0; 1>	1
Velocity	<0; 1>	1
Infiltration	<0; 1>	1
Exfiltration	<0; 1>	1

TABLE 6. HELLMUD Final results – CSOs

Evaluation	Range	Unit
Link ID		–
Hazard	<i>REL, LOW, MED, HIGH, UNREL</i>	–
Range	<0; 1>	1

Range of hydraulic and environmental HELLMUD results on pipe level is an interval of real numbers <0; 1>. The pipe without problem has appropriate criterion equals “0”. In all other cases, some problem occurs, and the closer the value is to “1”, the worse is the failure detected. The final decision concerning acceptable failure should make end user. He can rehabilitate the worst links with evaluation near “1” and by steps continue to less value according to his financial possibilities. A priori, it is not possible to assess hard thresholds for any of five parameters listed on HELLMUD results. HELLMUD compares pipes in relation to each other and gives the comparison of all pipes in four pipe-level parameters. It is not recommended to synthesize the parameters into the only one parameter expressing total reliability of the link without sensitivity analysis of particular parameters.

## 6. Application of the HELLMUD Tool

Final version, HELLMUD 3.4.7., was applied on real Ivančice network [24]. A simulation model MOUSE was used for hydraulic simulation. The synthetic rains consist of three synthetic design storms (according Šifalda), historical rain data from near catchment was used from a time period 1975–1996 (22 years).

This version was used for using HELLMUD integrated into CARE-S. Results of HELLMUD are displayed inside CARE-S as probability maps. Figure 3 shows probability of reaching level D, i.e. ground level, for single event calculation, results obtained from historical rain data are similar. User acquires visual overview and knowledge of the potential problematic pipes (tabular form is also available inside MS Access database file).

Hydraulic evaluation can be also seen in Final HELLMUD results (see Figure 4) as hydraulic and velocity risk. Infiltration criterion was not assessed because of lack of data, exfiltration risk came from GAT Tool run inside CARE-S and CSO evaluation form CAT Tool. Evaluation of five CSOs is listed in the figure as well, only one of them is of low hazard, the rest are unreliable in terms of impact on the water body, because they exceed limits determined during using CAT Tool.

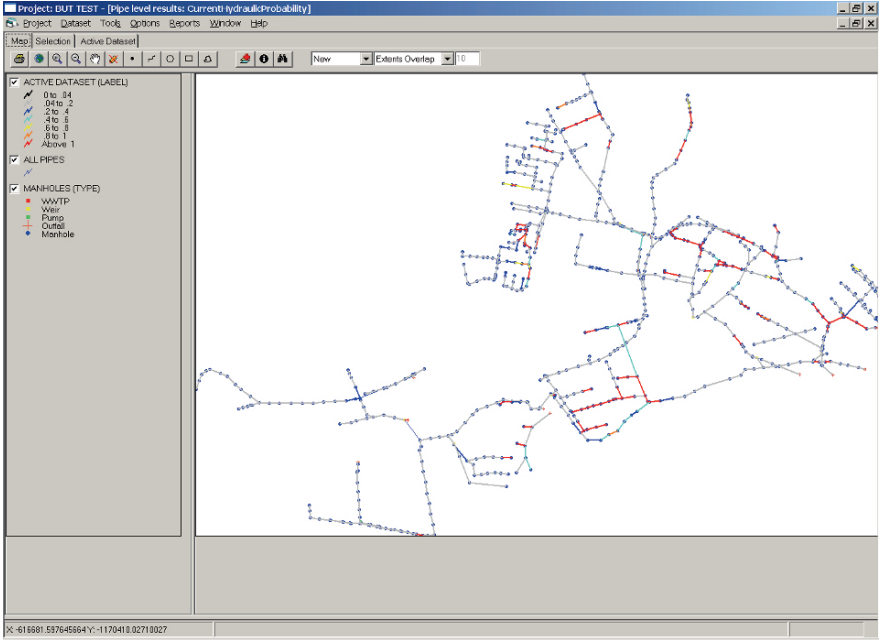

Figure 3. Probability of reaching surface

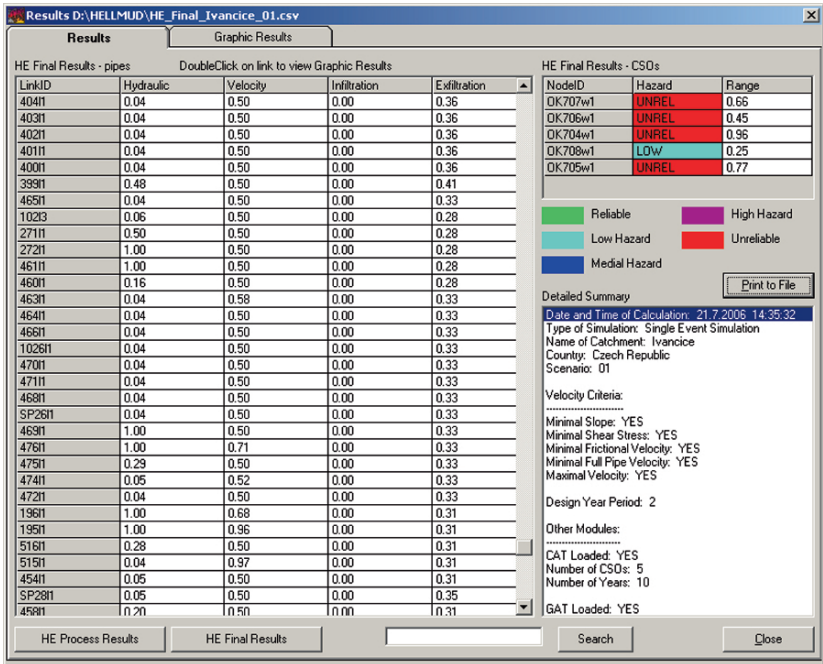

Figure 4. HELLMUD Final Results for Ivančice network

During the testing of the tool, the calculations suffered from lack of real data on the network performance. For this case study represented by small district is available neither extensive hydraulic nor environmental measurements. With respect to rather great requirements for input data for evaluation of the results, measurements, collection and recording of data are strongly recommended. The verification was performed by comparison with current Master plan of Ivančice municipality [12].

## 7. Conclusions

The paper describes methodology for calculation of probability of hydraulic and environmental failure, development of HELLMUD software tool and its application on real sewer network.

Hydraulic and environmental performance of a sewer system and consequently risk on pipe and CSO level were determined. The performance can be considered as ability to transport storm water and wastewater without hydraulic overloading, as well as returning minimal environmental impact and maintenance of good structural integrity. Among hydraulic criteria belong frequency and probability of filling water levels, insufficient capacity, velocity, sewer typology or infiltration; environmental criteria are represented by exfiltration and CSOs impacts.

Evaluation of the sewer network in terms of service reliability and assessment of critical pipes where hydraulic and environmental deficiencies will probably occur is achieved by five complex criteria describing and evaluating each pipe and CSO – hydraulic, velocity and infiltration risk (hydraulic viewpoint), exfiltration risk and CSO evaluation (environmental viewpoint).

For calculation of criteria and operational reliability mentioned above, HELLMUD software tool (Hydraulic and Environmental reLiabiLity Model of Urban Drainage) was developed.

Ivančice case study was carried out for HELLMUD Tool. Results were compared with Ivančice Masterplan [12] and comparison of the results with pipes suggested for rehabilitation by Masterplan verified excellent consistence of the results.

Reliability analysis provided by HELLMUD Tool can be used in the decision making process for evaluation or ranking rehabilitation projects, or to design of long term rehabilitation strategies.

The tool was developed in the frame of the international research project CARE-S relating computer aided rehabilitation of sewer networks. Close cooperation with project partners was performed during HELLMUD Tool development and testing. Also, inputs and outputs were several times changed according to CARE-S needs. CARE-S framework and management has

established basic requirements on hydraulic and environmental evaluation of sewer performance as well as coordination with other projects tasks, and so HELLMUD can exploit results of several CARE-S tools as input data and conversely, it provides data that can be further processed within CARE-S to complex evaluation of the network (e.g. in combination with socio-economic criteria).

The tool supports pro-active approach to sewer rehabilitation, based on hydraulic and environmental failure prevention. This enables:

- General improvement of current conditions of the network
- Support of further positive progress of the conditions
- Optimization of investments in the frame of long term rehabilitation plans
- Elimination of hydraulic failures/structural collapses and consequently complaints of inhabitants
- Influence of ground water quality and prevent pollution of water supply systems (reducing of exfiltration)
- Influence of treated wastewater volume (reducing of infiltration)
- Influence of surface water quality (reducing of overflow)

Most urban wastewater systems consist of three components: the sewer network, wastewater treatment plant and receiving water. In the last couple of years there is tendency to connect them as for planning, design and operation [22, 9]. Limitations of suitable methodology, available technology and historical reality obstruct to comprehensive management of urban wastewater systems. The tool can contribute to the future integrated approach by connection of hydraulic and environmental aspect of sewer rehabilitation management [3, 8].

## References

- [1] Baur, R., Herz, R., Kropp, I. Procedure for choosing the right sewer rehabilitation technology. CARE-S Report D16. 2003.
- [2] Freni, G., Maglionico, M., Federico Di V. State of the art in Urban Drainage Modelling. CARE-S Report D7. 2003.
- [3] Harremoës, P., Rauch, W. Integrated design and analysis of drainage systems, including sewers, treatment plant and receiving waters. *Journal of hydraulic Research*, 34, 815–826, 1996.
- [4] Hlavinek, P., Raclavský, J., Mičín, J., Baur, R., Shilling, W. Strategic Rehabilitation of Water Distribution and Wastewater Collection Systems, In 22nd International NO-DIG conference and Exhibition, Hamburg, Germany, 11/2004.
- [5] Hulance, J., Hurley, R., Kowalski, M., Orman, N. The CARE-S Procedure. CARE-S Report D20. 2004.

- [6] Hulance, J., Kowalski, M., Taylor, K., Hurley, R. User Interface for the CARE-S Wastewater Rehabilitation. CARE-S Report D21. 2004.
- [7] Knolmar, M., Szabo, G. C. Structural condition: Classification systems based on visual inspection. CARE-S Report D3. 2003.
- [8] Koniček, Z., Krejčík, J. Integrované řešení městského odvodnění. In Sborník pracovního semináře Způsob a podmínky vypouštění odpadních vod během dešťového odtoku. ČVVS, odborná skupina Kaly a odpady a ČVUT v Praze, FAST, Praha, 1996.
- [9] Krejčí et al. Odvodnění urbanizovaných území – koncepční přístup. NOEL 2000 s.r.o., 2002. ISBN 80-86020-30-4.
- [10] Kubik, J., Hlavinec, P., Prax, P., Šulcová, V., Ugarelli, R. Modelling hydraulic performance. Conclusive report. CARE-S Report D10. 2005.
- [11] Mandenhall, W., Sincich, T. Statistic for the Engineering and Computer Sciences. Dellen, San Francisco, CA, 1988. ISBN 0-02-380460-2.
- [12] Master Plan of Ivančice Catchment area. AQUAPROCON, 2005.
- [13] Matos, R., Ashley, R., Cardoso, A., Molinari, A., Schulz, A. Performance indicators for wastewater services, Manual of the Best Practice Series, IWA Publishing, London, 2003. ISBN 1-900222-18-3.
- [14] Matos, R., Cardoso, A., Pinheiro, I., Almeida, M.C. Selection of a listing of Performance Indicators for Rehabilitation. CARE-S Report D1. 2003.
- [15] Milina, J., Ugarelli, R., Federico, V., Maglionico, M., Liserra, T., Nascetti, D., Pacchioli, M., Freni, G., Pollert, J. Model of hydraulic performance temporal decline. CARE-S Report D8. 2004.
- [16] Montero, C., Villaneuva, A., Hlavinec, P., Hafskjold, L. Wastewater rehabilitation technology survey. CARE-S Report D12. 2004.
- [17] Pollert J. ml. Matematické modelování objektů stokové sítě. Disertační práce. ČVUT v Praze, Fsv, K183 LERMO, 2002.
- [18] Praça, P., Coelho, S.T. PI Tool/S – A control panel of performance indicators for sewer rehabilitation, Version 1.0.1., User's Manual, CARE-S project, 5th Framework Program of the European Union, LNEC, Lisbon, Portugal, 2004.
- [19] Saegrov, S. CARE-S Computer Rehabilitation of Sewer and Storm Water Networks. General scientific report. IWA Publishing, 2005. ISBN 1843390914.
- [20] Schulz, N. Tools in Work Package 3. CARE-S Report. 2004.
- [21] Schulz, N., Krebs, P. Environmental impacts of rehabilitation. CARE-S Report D9. 2004.
- [22] Shütze, M. Integrated simulation and optimum control of the urban wastewater system. PhD Thesis. Imperial College of Science, Technology and Medicine, London, 1998.
- [23] Silva, D., Barbier, R., Montginoul, M. Rehabilitation impact on social quality of life. CARE-S Report D14. 2005.
- [24] Šimčíková, P. Aplikace expertního systému pro rekonstrukce stokových sítí. Diplomová práce. ÚVHO, FAST, VUT v Brně, 2005.
- [25] Stránský, D. Spolehlivost a bezpečnost stokových sítí. In: Expertní systém pro vyhodnocování spolehlivosti a rizik městského odvodnění. Sborník přednášek. CERM, Brno, 2004. ISBN 80-7204-329-3.
- [26] Stránský, D. Spolehlivost stokových sítí navržených racionální metodou. Disertační práce. ČVUT v Praze, Fsv, K230 LERMO, 2003.
- [27] Wery, C., Torterotot, J.P., Silva, D., König, A., Peirera, A., Montginoul, M. Rehabilitation impact on socio-economic costs. CARE-S Report D13. 2005.



## SUBJECT INDEX

- activated sludge, 263, 284, 286, 287, 301
- aquifer, 88, 235, 241, 242, 247, 248, 249
- atrazine, 165
- biodiversity, 206, 257
- bioreactor, 292, 301, 304
- BOD, 239, 255, 257, 258, 291, 294, 297, 298, 302
- chlorine, 80, 89, 97, 125, 128, 129, 132, 138, 158, 237
- chromium, 56, 171, 278
- COD, 239, 255, 257, 258, 265, 266, 285, 286, 287, 291, 294, 297, 298, 302
- contaminants, 17, 61, 81, 88, 96, 97, 98, 154, 157, 158, 166, 174, 175, 176, 178, 199, 215, 236, 238, 258, 274, 284
- cytometry, 167
- database, 73, 77, 78, 102, 112, 184, 186, 299, 300, 301, 303, 306, 317
- decision support, 11, 299, 305, 306, 307
- degradation, 3, 131, 205, 247, 251, 284, 286, 287, 303, 304
- denitrification, 42, 43, 263, 264, 265, 266, 267, 270
- development, 4, 24, 25, 39, 42, 48, 51, 71, 91, 98, 99, 101, 102, 104, 111, 117, 135, 136, 147, 148, 149, 154, 166, 169, 175, 177, 181, 189, 221, 223, 225, 227, 234, 239, 246, 268, 276, 280, 298, 305, 319
- distribution system, 48, 52, 74, 81, 82, 89, 91, 95, 125, 127, 128, 174, 184, 186, 222, 273, 279, 280
- drinking water, 4, 6, 11, 47, 50, 77, 78, 80, 87, 88, 89, 90, 91, 95, 96, 98, 99, 115, 116, 119, 125, 126, 127, 128, 129, 130, 132, 135, 136, 137, 138, 140, 145, 146, 147, 148, 150, 151, 153, 154, 156, 157, 158, 160, 161, 162, 165, 168, 171, 172, 175, 200, 204, 215, 217, 218, 220, 221, 222, 238, 241, 242, 249, 252, 264, 273, 274, 275, 276, 277, 278, 280, 293
- effluent, 40, 42, 43, 44, 160, 161, 236, 243, 257, 258, 265, 266, 268, 284, 285, 286, 287, 289, 290, 291, 296
- emerging, 150, 151, 154
- evaporation, 5, 126, 139, 221
- failures, 10, 48, 49, 51, 65, 66, 67, 71, 82, 90, 91, 112, 147, 181, 182, 183, 185, 192, 249, 283, 306, 320
- fish, 158, 167
- GIS, 49, 102, 309
- grey water, 293, 295, 298
- groundwater, 7, 14, 63, 88, 136, 139, 141, 156, 199, 201, 202, 223, 235, 238, 241, 242, 243, 246, 247, 248, 249, 273, 274, 280, 284, 307, 308
- hazard, 75, 77, 81, 147, 148, 188, 222, 223, 308, 317
- heavy metals, 55, 56, 57, 58, 60, 61, 169, 202, 210, 277, 301, 303
- hydraulic performance, 11, 314, 321
- infiltration, 202, 229, 236, 305, 308, 316, 317, 319, 320
- integrated water resources management, 239
- management, 3, 4, 10, 11, 13, 25, 28, 36, 39, 40, 42, 48, 53, 87, 91, 94, 101, 103, 108, 112, 115, 116, 123, 128, 133, 136, 145, 148, 150, 151, 177, 181, 182, 191, 192, 193, 195, 222, 231, 233, 234, 235, 239, 241, 246, 251, 280, 283, 293, 305, 320
- MBR, 283, 284, 285, 286, 287, 288, 289, 291
- membrane, 63, 127, 167, 284, 285, 288, 289, 290, 291, 301, 304
- metabolites, 304
- micropollutants, 168, 176
- mitigation, 3, 4, 8, 10, 11, 27, 90, 135
- model, 49, 53, 65, 66, 72, 103, 117, 118, 120, 146, 181, 182, 183, 184, 185, 186, 187, 188, 189, 199, 200, 201, 202, 203, 204, 222, 243, 247, 253, 305, 307, 309, 311, 313, 319
- modelling, 65, 66, 71, 97, 185, 187, 189, 199, 201, 205, 206, 208, 243, 247, 303, 306, 307
- monitoring, 20, 23, 66, 71, 87, 88, 92, 95, 96, 98, 112, 125, 139, 145, 147, 148,

- 153, 154, 156, 157, 158, 159, 161, 162, 165, 167, 168, 169, 170, 171, 172, 174, 175, 176, 177, 182, 184, 185, 186, 187, 188, 195, 243, 246, 249, 276, 280, 303
- nitrification, 42, 139, 265, 289, 290, 291, 292
- nutrients, 126, 157, 210, 236, 257, 258, 293, 294, 298
- organic pollutants, 153
- pharmaceuticals, 154, 178, 301
- photocatalytic oxidation, 130, 131
- pipeline, 137, 192
- pollutants, 55, 56, 57, 61, 62, 138, 139, 153, 159, 165, 199, 200, 202, 203, 205, 206, 208, 210, 221, 246, 247, 251, 257, 258, 259, 275, 284, 293, 294, 298
- pollution, 13, 22, 23, 25, 40, 55, 56, 58, 60, 102, 126, 157, 158, 159, 165, 170, 171, 199, 201, 202, 203, 204, 205, 206, 207, 208, 209, 210, 211, 220, 221, 222, 223, 229, 233, 234, 235, 239, 242, 243, 245, 246, 247, 248, 249, 251, 257, 259, 273, 276, 277, 278, 280, 291, 302, 306, 320
- polychlorinated biphenyl, 301
- precipitation, 4, 5, 6, 7, 13, 19, 21, 102, 104, 106, 111, 126, 128, 133, 222, 234, 290, 291
- quality standards, 207
- receiving water, 38, 66, 320
- receiving water bodies, 66
- reconstruction, 19, 20, 30, 31, 35, 37, 38, 39, 41, 47, 48, 51, 52, 65, 66, 71, 112, 136, 140, 225, 227
- rehabilitation, 48, 49, 51, 52, 66, 81, 82, 112, 189, 240, 305, 306, 307, 309, 319, 320
- retention, 19, 23, 31, 35, 106, 112, 226, 227, 231, 269, 285, 290, 291, 302
- reuse, 223, 224, 233, 234, 236, 237, 238, 239, 240, 257, 259, 293, 294
- risk assessment, 32, 35, 74, 77, 83, 96, 101, 102, 103, 108, 111, 112, 193, 194, 205, 209, 239, 248, 307
- risk management, 3, 4, 10, 11, 74, 87, 88, 90, 101, 102, 103, 108, 145, 146, 147, 150, 191, 193, 195, 196, 223, 241, 242, 246, 248, 249, 250
- sanitation, 3, 4, 5, 6, 7, 8, 11, 12, 47, 71, 134, 145, 147, 149, 227, 231, 280, 281, 293, 294, 295, 297, 298
- sewerage, 3, 5, 6, 11, 12, 16, 65, 66, 67, 68, 69, 70, 71, 72, 134, 189, 217, 224, 226, 231, 234, 239, 240
- sewerage system, 3, 6, 11, 66, 67, 189, 234, 240
- simulation, 48, 65, 68, 70, 71, 190, 252, 308, 312, 313, 317, 321
- small urban areas, 37
- small urban rivers, 139
- snow, 4, 5, 13, 19, 112, 126, 133, 146
- spectroscopy, 59, 162, 165, 166, 167, 172
- storm water, 103, 104, 105, 226, 227, 228, 231, 239, 296, 319
- storm water management, 231
- surface water, 38, 55, 63, 74, 125, 127, 135, 137, 138, 140, 215, 217, 221, 222, 235, 273, 274, 275, 280, 320
- toxicity, 57, 96, 157, 158, 166, 170, 236, 303
- treatment technology, 138, 217, 234, 299
- urban water, 14, 115, 124, 141, 156, 190, 222, 223
- urbanized area, 227, 228
- virus, 155
- vulnerability, 3, 4, 6, 7, 8, 9, 11, 73, 74, 75, 76, 77, 87, 90, 91, 92, 93, 96, 98, 102, 135, 156, 158, 192, 215, 249, 308
- wastewater, 11, 12, 14, 16, 19, 20, 23, 25, 55, 63, 65, 66, 72, 88, 89, 135, 138, 139, 140, 141, 154, 168, 176, 178, 181, 182, 186, 188, 193, 206, 208, 210, 216, 221, 222, 223, 225, 227, 231, 233, 234, 235, 236, 237, 238, 239, 251, 252, 253, 258, 259, 263, 264, 265, 283, 284, 286, 289, 291, 293, 294, 295, 299, 302, 304, 306, 319, 320, 321
- wastewater management, 233, 293
- wastewater treatment, 14, 23, 25, 88, 135, 138, 139, 140, 141, 206, 216, 236, 251, 253, 255, 259, 264, 283, 284, 289, 293, 299, 302, 320
- water availability, 4
- water consumption, 116, 136, 221, 273, 274, 275, 276, 280, 293

- water level, 5, 21, 22, 29, 32, 33, 68, 71,  
135, 136, 140, 200, 202, 284, 285, 290,  
312, 313, 314
- water management, 37, 40, 115, 128, 137,  
223, 231, 233, 234, 235, 236, 239, 280,  
293
- water pollutants, 165, 203, 293, 298
- water quality, 17, 22, 48, 55, 63, 73, 76, 78,  
81, 82, 91, 92, 125, 126, 127, 129, 130,  
133, 137, 140, 146, 147, 150, 151, 153,  
156, 157, 158, 168, 169, 170, 171, 173,  
174, 175, 177, 184, 205, 206, 215, 218,  
220, 221, 236, 237, 252, 273, 274, 276,  
278, 279, 280, 320
- water resources, 53, 116, 130, 153, 154,  
177, 215, 217, 218, 220, 223, 235, 239,  
251, 252, 259, 274, 280
- water reuse, 233, 234, 237, 238, 239
- water sources, 8, 74, 88, 89, 95, 125, 126,  
127, 128, 130, 137, 154, 172, 222, 233,  
234, 273, 274
- water supply, 3, 5, 6, 7, 8, 10, 38, 44, 48,  
49, 73, 74, 75, 78, 82, 87, 88, 89, 90,  
91, 93, 94, 95, 96, 97, 115, 116, 135,  
136, 137, 138, 140, 147, 151, 154, 156,  
168, 171, 172, 177, 189, 191, 192, 203,  
215, 216, 218, 220, 221, 223, 227, 233,  
234, 235, 236, 238, 273, 275, 276, 278,  
280, 320
- water treatment, 22, 37, 38, 39, 40, 42, 43,  
44, 50, 63, 73, 74, 78, 79, 80, 88, 89,  
90, 91, 98, 127, 130, 131, 132, 137,  
146, 151, 156, 172, 177, 243, 253, 259,  
264, 267, 293
- WWTP, 9, 38, 39, 40, 41, 42, 43, 44, 235,  
239, 240, 265, 283, 284, 286, 287, 288,  
289, 291, 294, 295, 296, 298, 302
- WWTPs, 43, 284, 286, 288, 291
- xenobiotics, 299, 300, 301, 302, 303