

HEADQUARTERS
DEPARTMENT OF THE ARMY

TRAINING CIRCULAR 90-1

TRAINING FOR URBAN OPERATIONS

DISTRIBUTION RESTRICTION: Approved for public release, distribution is unlimited.

TRAINING FOR URBAN OPERATIONS

CONTENTS

| | Page |
|--|------|
| PREFACE | iii |
| CHAPTER 1. INTRODUCTION | |
| 1-1. Definitions..... | 1-1 |
| 1-2. Training Strategy..... | 1-1 |
| 1-3. Prerequisite Training..... | 1-7 |
| 1-4. Individual Task Training..... | 1-8 |
| 1-5. Collective Task Training..... | 1-9 |
| 1-6. Risk Assessment..... | 1-11 |
| CHAPTER 2. URBAN ASSAULT COURSE | |
| 2-1. Purpose..... | 2-1 |
| 2-2. Station 1: Individual and Team Task/Technique Trainer | 2-3 |
| 2-3. Station 2: Squad and Platoon Task/Technique Trainer..... | 2-6 |
| 2-4. Station 3: Grenadier Gunnery Trainer..... | 2-19 |
| 2-5. Station 4: Urban Offense/Defense Building, Task/ Technique Trainer | 2-22 |
| 2-6. Station 5: Underground Trainer | 2-26 |
| CHAPTER 3. SHOOT HOUSE | |
| 3-1. Purpose..... | 3-1 |
| 3-2. Description..... | 3-1 |
| 3-3. Training Audience..... | 3-3 |
| 3-4. Training Information..... | 3-4 |
| 3-5. Conduct of Training..... | 3-4 |
| 3-6. Training Support Requirements | 3-13 |
| 3-7. Training and Evaluation..... | 3-13 |

DISTRIBUTION RESTRICTION: Approved for public release, distribution is unlimited.

*This publication supersedes TC 90-1, 30 September 1993.

| | Page |
|---|---------------------|
| CHAPTER 4. BREACH FACILITY | |
| 4-1. Purpose..... | 4-1 |
| 4-2. Description..... | 4-1 |
| 4-3. Training Audience..... | 4-3 |
| 4-4. Training Information..... | 4-3 |
| 4-5. Conduct of Training..... | 4-4 |
| 4-6. Training Support Requirements..... | 4-5 |
| 4-7. Training and Evaluation..... | 4-6 |
| 4-8. Safety Considerations..... | 4-6 |
| | |
| CHAPTER 5. COMBINED ARMS COLLECTIVE TRAINING FACILITY | |
| 5-1. Purpose..... | 5-1 |
| 5-2. Description..... | 5-1 |
| 5-3. Tactical Exercise Without Troops..... | 5-4 |
| 5-4. Urban Operations Collective Training Exercises..... | 5-4 |
| 5-5. Infantry Rifle Platoon STX Attack..... | 5-5 |
| 5-6. Mechanized Infantry Platoon STX Defend..... | 5-8 |
| 5-7. Infantry Rifle Company FTX Attack..... | 5-16 |
| 5-8. Mechanized Infantry Company or Team FTX Defend..... | 5-25 |
| 5-9. Targetry..... | 5-37 |
| 5-10. Considerations for Training with Armor..... | 5-37 |
| | |
| APPENDIX A. TRAINING TIPS..... | A-1 |
| APPENDIX B. UNIT TRAINING MATRIX..... | B-1 |
| APPENDIX C. STABILITY AND SUPPORT OPERATIONS UNIT TRAINING MATRIX..... | C-1 |
| APPENDIX D. DEMOLITION EFFECTS SIMULATORS FOR THE URBAN ASSAULT COURSE, SHOOT HOUSE, AND COMBINED ARMS COLLECTIVE TRAINING FACILITY..... | D-1 |
| APPENDIX E. LEADER DEVELOPMENT TRAINING..... | E-1 |
| GLOSSARY..... | Glossary-1 |
| REFRERENCES..... | References-1 |
| INDEX..... | Index-1 |

PREFACE

This training circular is a training support package for training urban operations. It provides guidance for leaders conducting training in urban environments across the full spectrum of Army operations: offense, defense, stability, and support. The focus of this circular is on effective usage of the home station urban training facilities: Urban Assault Course (UAC), Shoot House (SH), Breach Facility (BF), and Combined Arms Collective Training Facility (CACTF). Although the primary focus of this circular is on the four primary home station facilities, with modification it can also support urban training in non-standard facilities.

The proponent of this publication is the US Army Infantry School. Submit changes for improving this publication on DA Form 2028 directly to Commandant, US Army Infantry School, ATTN: ATSH-OT, Fort Benning, Georgia 31905-5593.

Unless this publication states otherwise, masculine nouns and pronouns do not refer exclusively to men.

E-mail address for this training circular is:

doctrine@benning.army.mil

CHAPTER 1 INTRODUCTION

This chapter discusses the definitions, training strategy, prerequisite training, individual task training, and collective task training.

1-1. DEFINITIONS

The following includes some definitions of urban operations:

a. **Full Spectrum Operations.** Full spectrum operations include offensive, defensive, stability, and support (ODSS) operations. Missions in any environment require Army forces to conduct or be prepared to conduct any combination of ODSS operations.

b. **Urban Operations.** The urban operations (UO) are operations planned and conducted in an area of operations (AO) that includes one or more urban areas. Army forces normally conduct full-spectrum UO in urban environments. Often, the rules of engagement (ROE) and use of combat power are more restrictive than in other environments.

c. **Urban Area.** An urban area is a topographical complex where manmade construction or high-population density is the dominant features. The five categories of urban areas:

- Villages (population less than 3,000).
- Towns (population of 3,000 to 100,000).
- Cities (population over 100,000 to 1 million inhabitants).
- Metropolis (population over 1 million to 10 million inhabitants).
- Megalopolis (population over 10 million).

Brigades normally bypass, move through, defend from, and attack objectives within villages. Brigades normally participate in UO in towns, cities, metropolises, and megalopolises as part of a larger force.

d. **Urban Operations Under Precision Conditions.** Under precision UO conditions, either the enemy is so thoroughly mixed with noncombatants or political considerations are such that the use of more highly restrictive ROE and different tactics, techniques, and procedures (TTP), may be required during the execution of UO. Conventional Army forces routinely conduct UO under precision conditions.

e. **Urban Operations Under High-Intensity Conditions.** These conditions include combat operations against a determined enemy occupying prepared positions or conducting deliberate attacks against friendly forces. High-intensity UO require the synchronization of the full combat power of the joint combined arms team. Conventional Army forces must always be prepared to conduct UO under high-intensity conditions.

1-2. TRAINING STRATEGY

Urban terrain and environmental conditions challenge the trainer. The UO training strategy integrates live, virtual, and constructive training (Figure 1-1, page 1-2). Live, virtual, and constructive training is based on the unit's METL. The live environment consists of home station training using the urban operations facilities (Urban Assault Course [UAC], SH, battle force [BF], combined arms collective training facility [CACTF]), Combat Training Centers (CTC) rotations, and any other live training that supports the UO collective tasks list. The virtual environment consists of simulators such

as close combat tactical trainer (CCTT) or engagement skills trainer (EST) used to train small-unit leaders and crews. The constructive environment consists of battle staff training for battalion and above staff and leaders such as joint conflict and tactical simulation (JCATS)/OneSAF.



Figure 1-1. Live, virtual, constructive training support strategy.

FMs 25-100 and 25-101 explain how to determine a unit's METL and battle tasks, and how to plan, provide resources for, and execute training events. Due to limited training facilities, it is important that leaders use all available assets to train and maintain combat readiness. Specific FMs, TCs, and ARTEP MTPs provide the TTPs and standards to conduct and evaluate training. A complete training program emphasizes initial, intermediate, and culminating UO training (Figure 1-2).

a. **Initial Training.** This training is the first step in the building-block approach and sets the basis for unit or collective training. Mastery of individual and crew skills is an essential precondition for UO training. Initial-UO training includes but is not limited to precision marksmanship, EST, crew simulators and CCTTs.

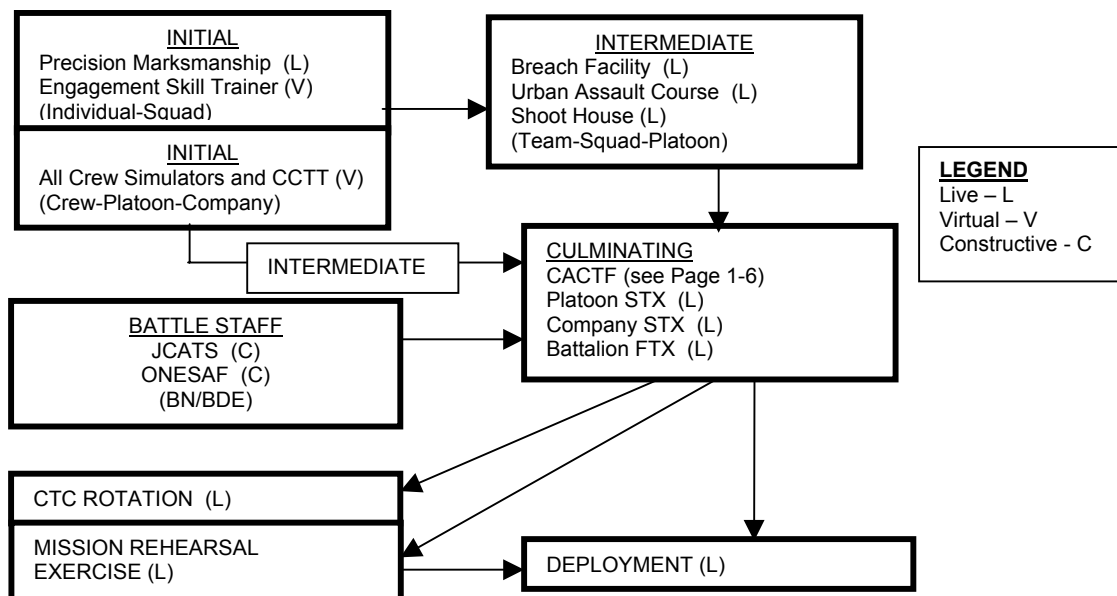

Figure 1-2. Urban operations strategy—live, virtual, and constructive training.

b. **Intermediate Training.** This phase of training is characterized by unit collective training and leaders varying the training conditions (limited visibility, different entry techniques, different entry points, use of combatants and noncombatants, OPFOR, MILES, and live-fire exercises) under which tasks are performed. Collective task training is the critical link between individual tasks and mission accomplishment. Intermediate training should be conducted at, but is not limited to, the breach facility, live-fire shoot house, and UAC. Figures 1-3 through 1-6 show the design and the purpose for each of these facilities.

(1) **Breach Facility.** The purpose of this facility is to train soldiers on the technical aspects of the breaching techniques (Figure 1-3). This facility is used to train TTPs, mechanical, ballistic, thermal, and explosive techniques.

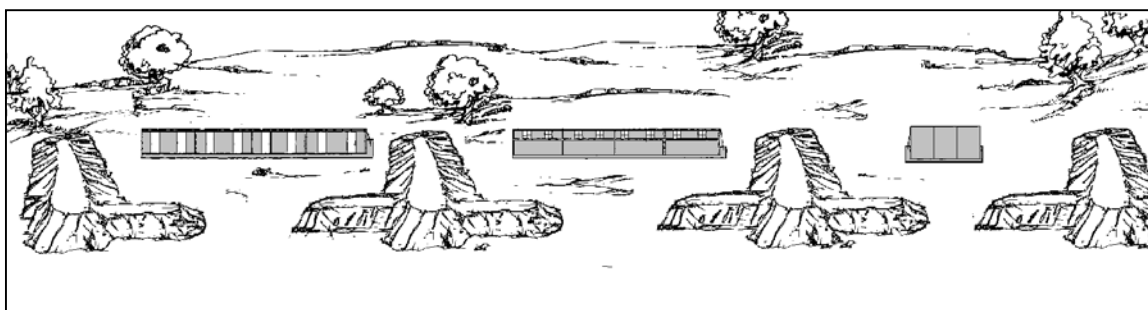

Figure 1-3. Breach facility.

(2) **Shoot House.** The purpose of this facility is to provide the leader with a facility to train and evaluate fire teams, squads, and platoons during a live-fire exercise

(Figure 1-4). Units are trained and evaluated on their ability to move tactically and engage targets, while practicing target discrimination in an urban environment.

NOTE: The specific design of the shoot house and all other facilities may differ based on unique training requirements at different installations.

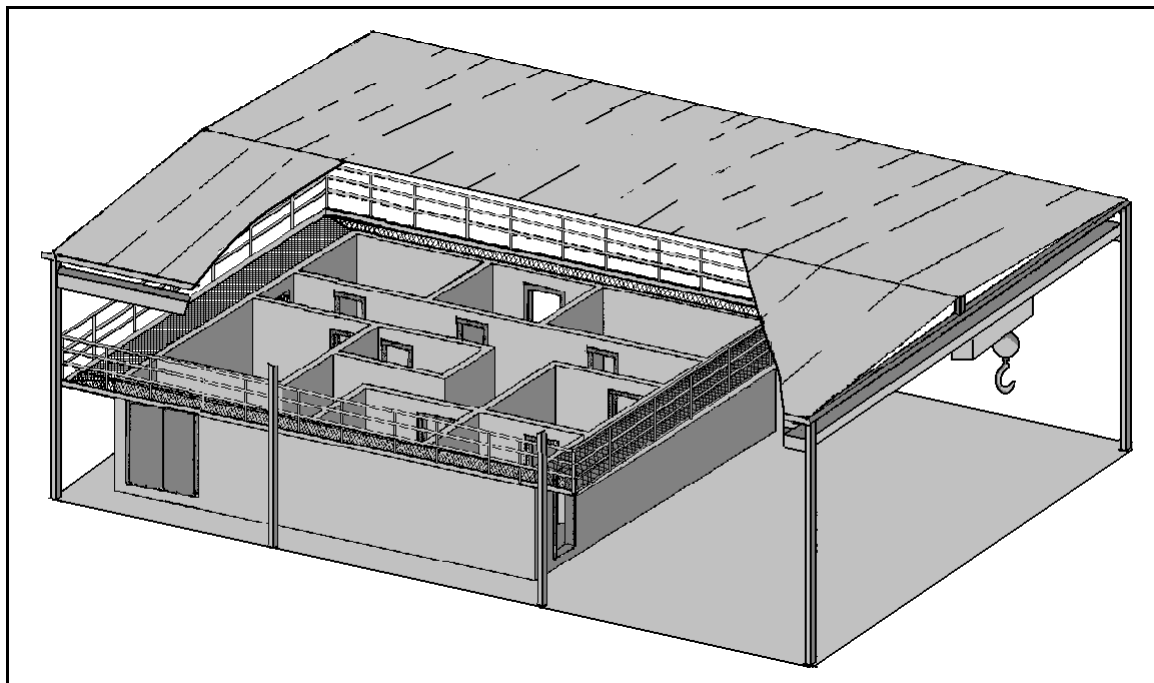

Figure 1-4. Shoot house.

(3) *Urban Assault Course*. The purpose of the UAC facility is to train squad-size units using the task Enter a Building/Clear a Room, grenadier gunnery, and subterranean TTPs. However, the unit's training requirements determine the size of the unit and the tasks to be trained. The unit develops its organizational structure and steps for conducting the exercise based on its METL and on their training needs (Figure 1-5).

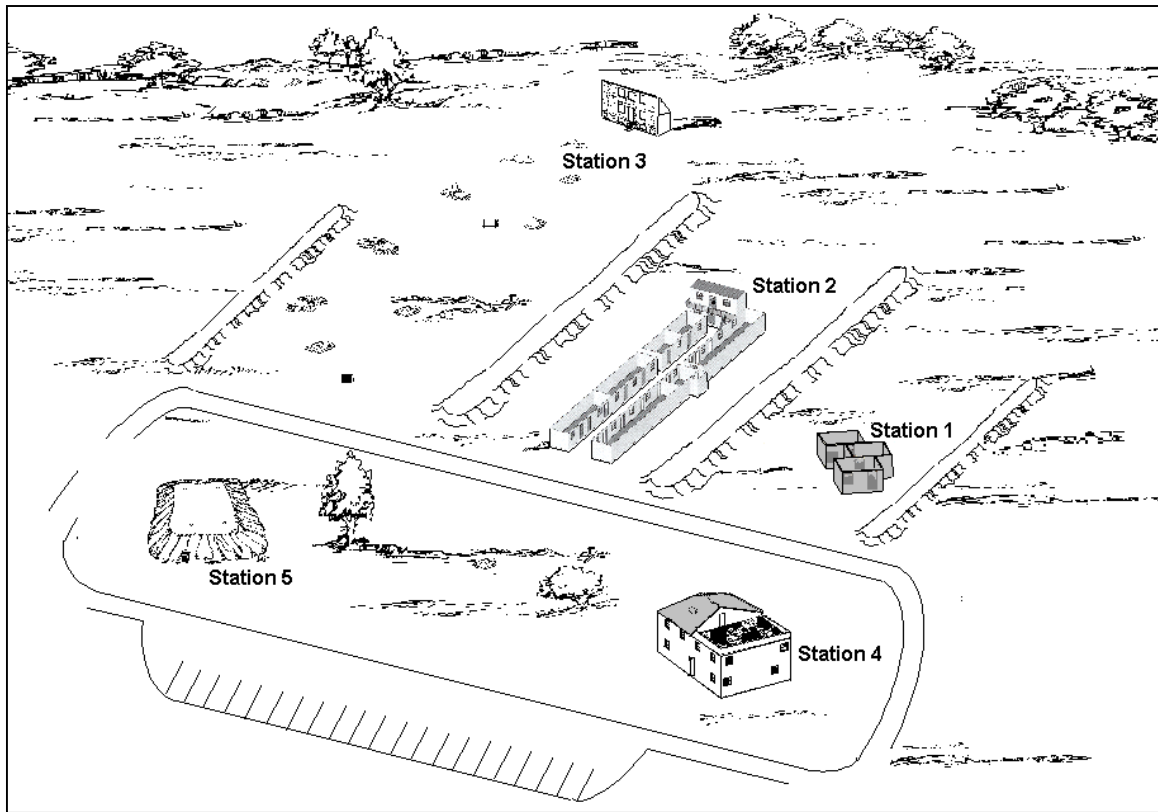

Figure 1-5. Urban assault course.

c. **Culminating Training.** During this phase of training, multiechelon, combined arms, and branch specific STX training may be conducted. Culminating training is conducted at the CACTF (Figure 1-6, page 1-6).

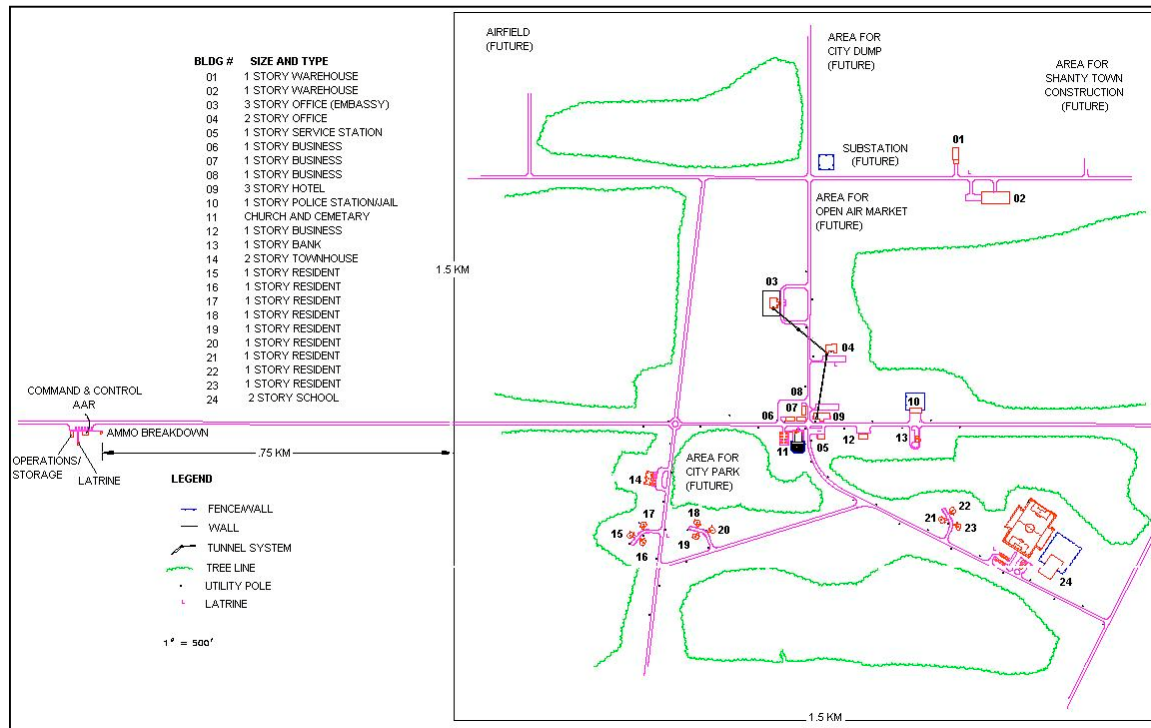

Figure 1-6. Combined arms collective training facility.

d. **Conduct of Training.** Depending on unit proficiency, every training event should follow a crawl-walk-run sequence, based on clearly defined standards.

(1) **Crawl.** The trainer explains each training objective and performance standards, and then talks the soldiers through the exercise, step by step, describing what each individual or unit must do. This training often includes a demonstration.

(2) **Walk.** The soldiers slowly practice each task to standard. Trainers coach soldiers at this stage stopping as often as needed to correct mistakes and provide feedback. Soldiers practice each task repeatedly until they can perform it to standard.

(3) **Run.** Soldiers perform each task at full speed as if they are in combat. The soldiers need feedback during this stage as well. The following can be used to enhance realism:

- Blank ammunition.
- Special effects small-arms marking system (SESAMS).
- Short-range training ammunition (SRTA).
- Service ammunition.
- Targetry.
- Pyrotechnics.
- Tactical engagement systems (MILES).
- Opposing forces (force on force).
- Nuclear, biological, and chemical simulation/weapons of mass destruction.
- Training in limited visibility conditions.

e. **After-Action Review.** Leaders conduct an after-action review (AAR) after each training event to help soldiers and units improve their skills by providing immediate feedback. An AAR increases the benefits gained from each training exercise by allowing the leader and soldiers to work together to analyze the performance of each task. Being involved in this analysis enables the soldiers to learn and retain more than they would if they were simply critiqued. An AAR improves the performance of soldiers, leaders, and unit tasks and provides the commander with information and insight that he needs to evaluate training.

1-3. PREREQUISITE TRAINING

Prerequisite training teaches individuals, crews, units, leaders, and command and staff what they need to know before they can perform a task. Prerequisite training builds teamwork at all levels.

a. **Command and Staff Training.** The battalion battle staff and leadership must train themselves before the execution of battalion collective training. The battalion command and staff culminates their prerequisite training with UO tactical exercise without troops (TEWTs) and UO command post exercises (CPXs). This procedure helps develop urban operations TTPs and unit standing operating procedure (SOP).

b. **Leader Training.** A comprehensive leader's training program is the key to successful UO training. Time spent teaching battalion leaders (trainers) during the planning and preparation phase pays dividends during the intermediate and culminating phases of training. Leader's training compliments institutional instruction (Basic and Career Officer Course, Basic Noncommissioned Officer Course [BNCOC], or Advanced Noncommissioned Officer Course [ANCOC], of current UO doctrine [FM 90-10 and FM 90-10-1], and unit knowledge based on experience and prior training events). Recommended subject areas include threat analysis, urban area and building analysis, weapons effects on urban structures, urban attack and defense, UO TTP, STP, and SOP development.

c. **Individual Training.** Many urban-specific tasks and skills can be trained, sustained, and maintained in a barracks environment. Other tasks can be trained at local UO facilities, and weapons ranges. The unit should focus on three general areas for preliminary training; urban combat skills, urban marksmanship skills, and physical fitness.

(1) The following are examples of preliminary training tasks and or TTPs:

- Individual movement techniques.
- Battle drills.
- Weapon positioning in an urban area.
- Roadblock and vehicle search procedures.
- Dismounted and mounted urban navigation.
- Urban scanning techniques.
- Quick fire techniques.
- Assault fire techniques.
- Hasty urban firing positions.
- Prepared urban firing positions.

(2) Prior to urban collective training cycle, trainers can develop urban-specific firing conditions in conjunction with weapons firing ranges. Build facades on existing ranges, or use the unit's local UAC (if available). Urban combat skills include:

- Firing positions behind rubble, around corners, from windows or rooftops.
- Urban targets behind rubble, in windows and doorways.
- Fire commands.
- Lifting and shifting fires from lower to upper story windows.
- Fire control and fire discipline.
- Rapid firing engagements.
- ROE firing scenarios.

(3) Urban physical fitness skills include:

- Endurance runs and upper body conditioning.
- Vaulting exercises.
- Urban-Specific Obstacle Course negotiation.
- Leadership Reaction Course (LRC) negotiation.

1-4. INDIVIDUAL TASK TRAINING

Urban operations require the soldier to be proficient in several individual tasks unique to urban fighting. Additional urban fighting techniques have been developed based on combat lessons learned and on evolving technology.

a. Army doctrine includes three individual urban-specific tasks:

STP 7-11BCHM14-SM-TG.

- 071-326-0541, Perform Movement Techniques During MOUT.
- 071-326-0550, Prepare Positions for Individual and Crew-Served Weapons During MOUT.
- 071-326-0557, Select Hasty Firing Positions During MOUT.

b. FM 90-10-1, An Infantryman's Guide to Combat in Built-up Areas:

(1) ***Movement Techniques.***

- Crossing of a wall.
- Movement around corners.
- Movement past windows.
- Use of doorways.
- Movement parallel to buildings.
- Crossing of open areas.
- Fire team employment.
- Movement between positions.
- Movement inside a building.

(2) ***Entry Techniques.***

- Upper building levels.
- Use of ladders.
- Scaling of walls.
- Entry at lower levels.
- Hand grenades.

(3) ***Firing Positions:***

- Hasty firing position.

- Prepared firing position.
- Target acquisition.
- Employment of snipers.

1-5. COLLECTIVE TASK TRAINING

Squads, platoons, and companies train on collective tasks IAW ARTEP MTPs. However, only a few of these tasks specifically address UO; the others must be adapted for the urban environment.

- a. Urban-specific tasks at squad and platoon level include the following tasks:
 - (1) **ARTEP 7-8-MTP.**
 - 07-3-1134, Conduct Tactical Movement (Mech Infantry Platoon).
 - 07-3-4141, Clear Built-up Area/Building (Infantry/Mech Infantry Platoon).
 - 07-3-1123, Defend Built-up Area/Building (Infantry Platoon/Squad).
 - (2) **ARTEP 7-7J-MTP.**
 - 71-2-0331.07-3126, Conduct Tactical Movement (Infantry Platoon Mounted).
 - 71-3-1110, Clear a Building.
 - 71-2-2026.07-3418, Defend Built-up Area/Building (Infantry Platoon Mounted).
 - 07-3-4141 Clear Built-up Area/Building (Infantry/Mech Infantry Platoon).
- b. Urban-specific tasks for the infantry company are as follows:
 - (1) **ARTEP 7-10-MTP.**
 - 07-2-1134, Conduct Tactical Movement (Infantry Company).
 - 07-2-1109, Assault Built-up Area/Building.
 - 07-2-1118, Defend Built-up Area/Building (Infantry Company).
 - 07-2-1401, Establish a Roadblock/Checkpoint (Infantry Company).
 - (2) **ARTEP 71-1-MTP.**
 - 71-2-1016.17-00KC, Conduct Tactical Movement.
 - 07-5-1097, Clear a Building.
 - 71-2-2026.17-00KC, Defend Built-up Area.
 - 71-2-2025.17-00KC, Clear Built-up Area.
 - 71-2-2027.17-00KC, Cordon and Search.
- c. Urban-specific tasks for the company team and infantry battalions are as follows:
 - **ARTEP 7-20-MTP.**
 - 07-1-3004, Conduct Tactical Movement (Battalion).
 - 71-1-2025.07-1164, Clear a Built-up Area.
 - 71-1-9220.07-1162, Traverse a Built-up Area (Battalion).
 - 71-1-9262.07-1163, Defend in a Built-up Area (Battalion).
- d. Urban-specific tasks for stability and support operations. The following tasks are samples that are listed in *TC 7-98-1*:
 - Perform Cordon and Search.
 - Search and Attach.
 - Checkpoints.
 - Disturbance.
 - Control Civilian Movement.
 - Conduct Platoon Riot Control Formation.

- Apprehend/Detain Noncombatants.

NOTE: See *FM 90-10-1* for a review of additional stability and support operations including but not limited to:

- Conduct Area Security Patrol.
- Conduct Convoy Escort.
- Open and Clear Routes.
- Cordon and Search.

e. The commander uses the battalion integrated training plan to establish the goals of the training density. He focuses on combined arms operations, emphasizing dismounted infantry maneuver. Tanks, BFVs, attack aviation and artillery normally provide supporting fires for the dismounted elements. The CS elements should be integrated at every level to ensure the battalion is prepared to fight as a task force (TF). The battalion CSS system is stressed during UO. The conditions of the urban environment, resupply, casualty evacuation, maintenance, and sustainment should be trained concurrently at every level within the battalion. Frequency of UO training is recommended to be semiannual for the CACTF, shoot house, and breach facility and quarterly for the UAC. Army training calendars are divided into cycles of training; mission, and support. Figures 1-7 and 1-8 below depict how the urban training strategy and facility usage might be programmed into unit cycles.

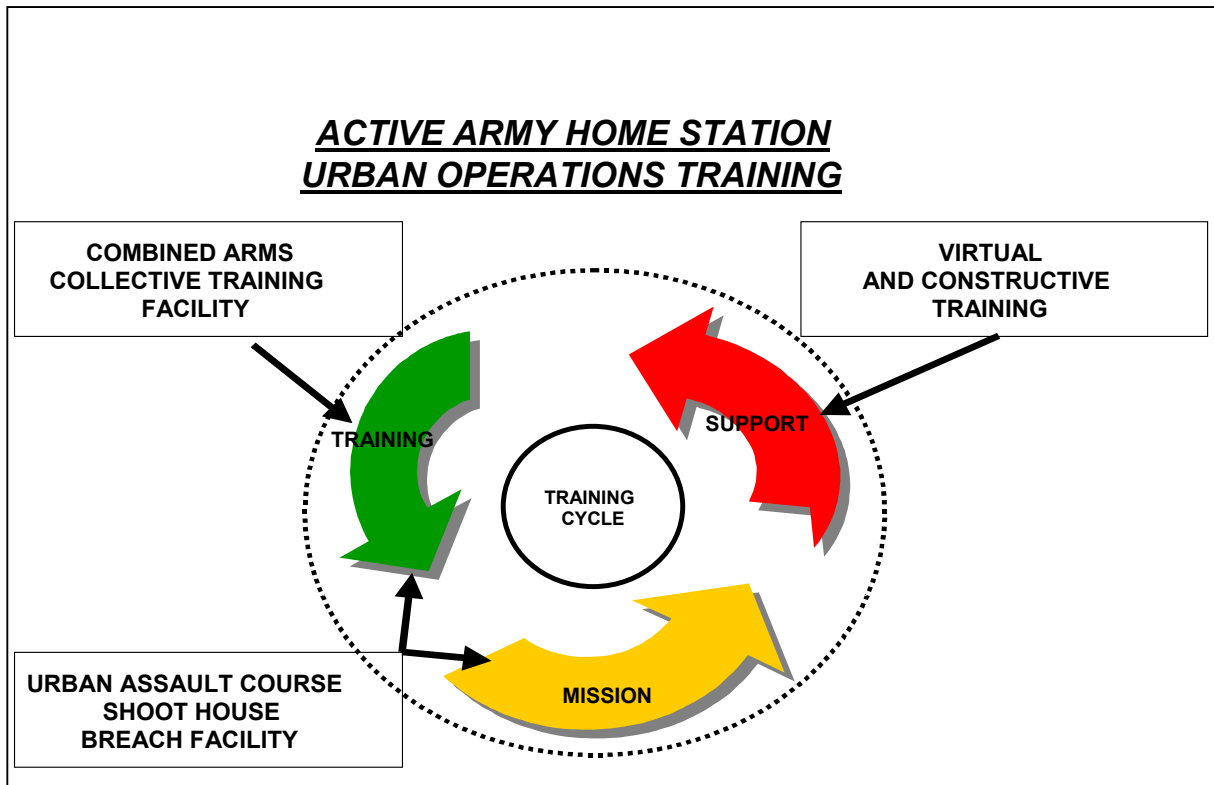

Figure 1-7. Active Army home-station urban operations training strategy.

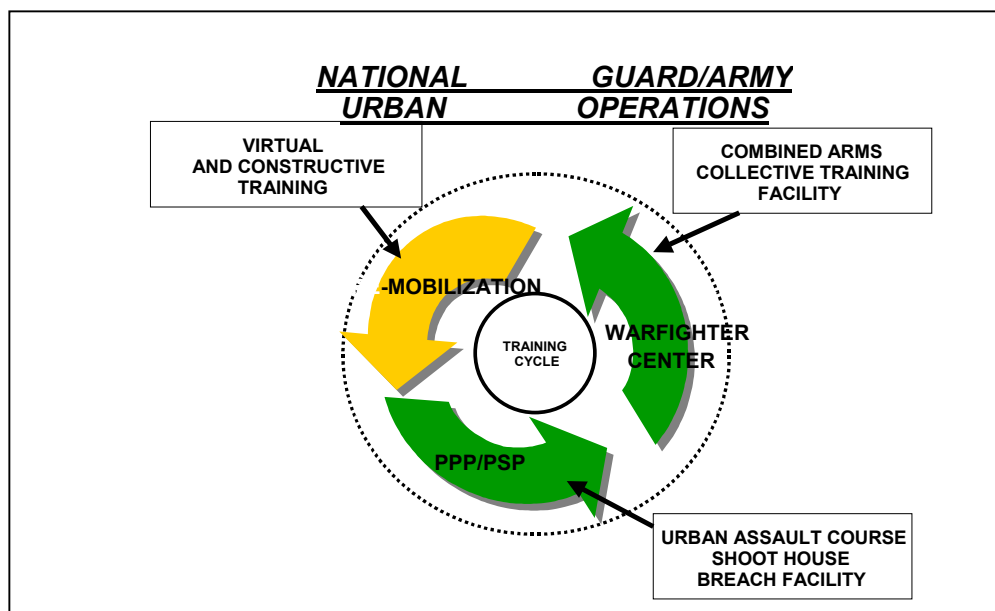

Figure 1-8. Army National Guard urban operations training strategy.

1-6. RISK ASSESSMENT

Risk assessment means making operations safer without compromising the mission (FM 25-101). Commanders continuously assess the risk of training conditions to prevent unnecessary loss of soldiers and equipment. The degree of risk depends on conditions. Just as this principle applies to other training and warfighting, it also applies to UO. In a training situation, for example, commanders determine whether soldiers and leaders have conducted this type of training before, whether conducting initial training at night or during limited visibility, and whether soldiers are tired or exhausted. Risk assessment ensures UO training is not only tough and realistic but also safe. Training enhancers, such as live fire, blank ammunition, simulators, fires, smoke, and other pyrotechnics, must be fully employed to achieve the training objectives. Soldiers are required to wear earplugs, protective vests, and protective eyewear in order to protect themselves from noise and debris.

a. The commander considers risk and safety in urban operations training situations such as:

(1) Soldiers engaging in close combat urban operations need to be safety conscious when using blanks, booby traps, and practice grenades. They may be unaware of the exact location of the OPFOR and may be susceptible to OPFOR flash suppressors, booby traps, and practice hand grenades.

(2) Soldiers may use ladders to enter buildings at upper stories, which creates the potential for dangerous falls.

b. The commander is the safety officer, but soldiers and leaders are responsible for safe training. All leaders must:

(1) Use mission, enemy, terrain, troops, time available, and civilians (METT-TC) factors to identify risks.

(2) Assess possible losses and their costs.

- (3) Select and develop risk-reduction measures.
- (4) Implement controls by integrating them into plans and orders, SOPs, training performance standards, and rehearsals.
- (5) Supervise and enforce risk reduction measures and safety standards at all times.

CHAPTER 2

URBAN ASSAULT COURSE

This chapter describes the Urban Assault Course (UAC), which incorporates doctrine and tactics from FM 90-10-1 and the ARTEP MTPs. The UAC contains five stations: Individual and Team Task/Technique Trainer Station 1, Squad and Platoon Task/Technique Trainer Station 2, Grenadier Gunnery Trainer Station 3, Urban Offense/Defense Building Station 4, and the Underground Trainer Station 5. These stations are designed for individual tasks and small-unit collective task training. Various types of organizations with a variety of missions can train at the UAC. Tactical operations in an urban environment may include combat to stability and support tasks. The UAC is a dismounted training facility.

2-1. PURPOSE

The purpose is to provide squad and platoon size units with a facility to train and evaluate urban operations tasks (Figure 2-1). With the exception of Station 3, Grenadier Gunnery, the UAC is not intended for live-fire training. Station 3, Grenadier Gunnery Trainer, is designed to support 40-mm TP and 5.56-mm service ammunition.

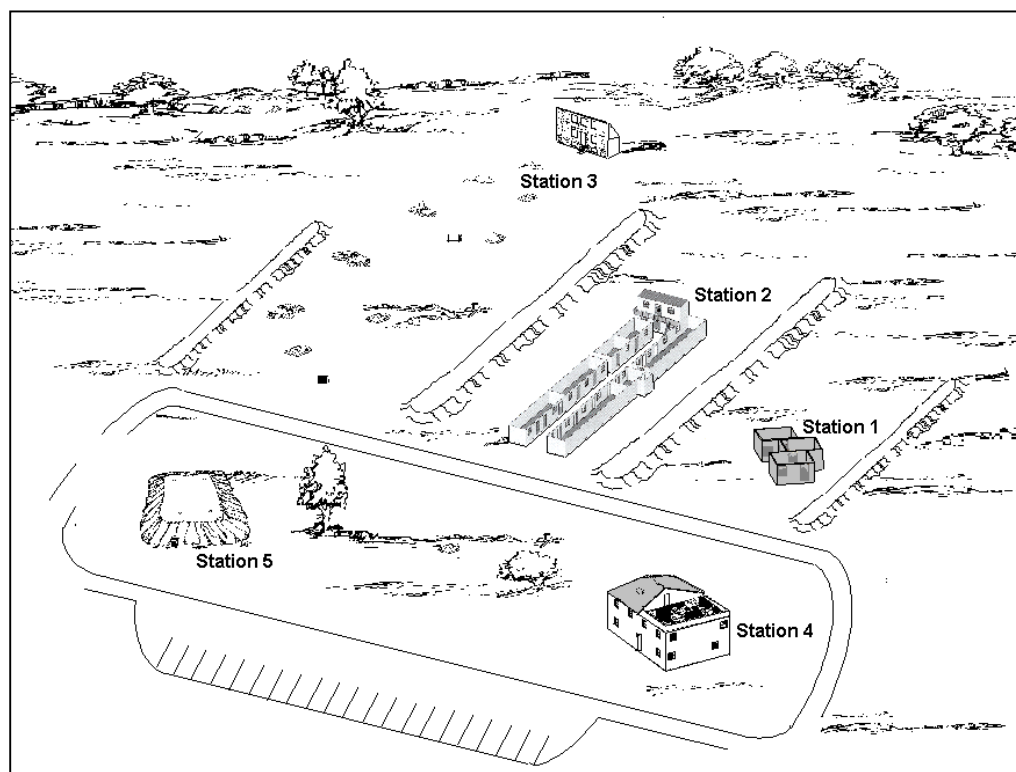

Figure 2-1. Urban assault course.

a. **Facility Description.** The UAC has five training stations that facilitate the crawl/walk/run training concept.

(1) **Station 1, Individual and Team Trainer.** This station is a three-room trainer where team leaders and squad leaders train the basics of building and room clearing.

(2) **Station 2, Squad and Platoon Trainer.** This station is a four-structure trainer with multiple rooms. Squads build upon tasks learned at Station 1 and begin to learn the concepts of clearing multiple buildings. The station is designed in such a way that it can be used as individual buildings with a narrow street or as rooms inside a building with a long connecting hallway.

(3) **Station 3, Grenadier Gunnery Trainer.** This station is a live-fire station where M203 gunners master target engagements in an urban area, move tactically, and respond to the fire commands.

(4) **Station 4, Offense/Defense House.** This station is where a platoon can train to attack and or defend a building. This station can also be divided into a number of smaller training stations to reinforce training or to train tasks not yet trained at the other stations. (For example, upper-level entry techniques.)

(5) **Station 5, Underground Trainer.** This station provides training for subterranean operations.

b. **Targetry.** Targets throughout the UAC are either 3D precision targets (for engagements less than 50 meters) or 2D non-precision targets (for engagements greater than 50 meters).

(1) Precision targets support short distance engagements. Sensors contained within the precision target respond only to lethal shot placement. The torso lethal zone is 18 inches by 8 inches and the neck-head lethal zone is 4 inches by 8 inches.

(2) Non-precision targets support engagements that are at ranges greater than 50 meters. These targets are 2D pop-up type targets.

c. **Training Audience.** The facility provides Infantry, Engineer, Military Police, Cavalry, and other units with a facility to train the individual soldier through platoon-level UO skills.

d. **Training Information.** Combat, CS, and CSS units can use this facility and the UAC can also be used as a mission rehearsal exercise site. Recommended training frequency is quarterly.

(1) The following information is provided for each UAC station, if applicable.

(a) **Purpose.** States the purpose of the station. Units may use the station in the manner originally intended, or they may modify it to meet their unique training needs.

(b) **Description.** Describes the station and its design.

(c) **Targetry.** Recommends the targetry required to train at the station. Targets may be moved, modified, or added based on available target systems and or training requirements.

(d) **Controller Requirements.** Based on unit's needs at each station.

(e) **Safety Requirements.** Provides the safety information and considerations for the station. The unit or installation range SOP may mandate additional safety requirements.

(f) **Individual MOUT Tasks or Skills Trained.** ARTEP 7-8-MTP, Chapter 2, contains a list of related common, individual, and urban specific training and evaluation outlines (T&EOs).

(g) **Training Support Requirements.** Describes minimum materiel requirements to support training at each station.

(h) *Conduct of Training*. Describes sample training scenarios and sequence of events for that station.

(2) The UAC can accommodate an assortment of training ammunition and pyrotechnics.

2-2. STATION 1: INDIVIDUAL AND TEAM TASK/TECHNIQUE TRAINER

This station is used to train individual and collective tasks, tactics, techniques, and procedures. Specifically: Enter a Building and Clear a Room, Engage Targets (Figure 2-2).

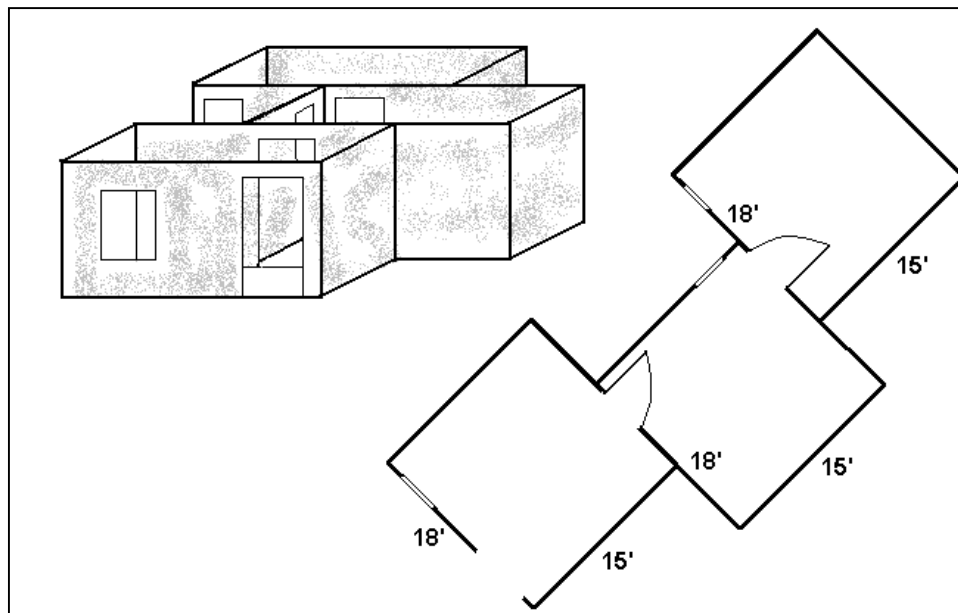

Figure 2-2. Individual and team task/technique trainer.

a. **Description**. This station is a single wood structure with three rooms that have open doorways, windows, and a man-size hole.

b. **Targetry**. Targets present realistic close quarters combat situations (0 to 15 meters), consisting of a possible mixture of combatant and noncombatant targets. Target discrimination is trained by presenting up to six precision targets. Targetry sensors respond only to lethal shot placement and also facilitate training during limited visibility.

c. **Controller Requirements**. As required by unit.

d. **Safety Requirements**. Only smoke, practice grenades, or M84 stun grenades may be used at this station.

WARNING

To avoid injury, place the weapon on SAFE when climbing through obstacles such as windows, fences, and walls during training.

e. **Individual and or Collective Tasks Trained.** (Non-inclusive.)

(1) **Collective Task.** Enter a Building/Clear a Room.

(2) **Supporting Individual Tasks.**

- 071-311-2007, Engage Targets With M16A1/2 Rifle.
- 071-315-2308, Engage Targets With M16A1/2 Rifle Using a Night Vision Sight AN/PVS 4.
- 071-010-0006, Engage Targets With M249 Machine Gun.
- 071-325-4407, Employ Hand Grenades.
- 071-326-0503, Move Over, Through, or Around Obstacles (Except Minefields).
- 051-193-1013, Neutralize Booby Traps.
- 071-326-0501, Move as a Member of a Fire Team.
- 071-326-0541, Perform Movement Techniques During MOUT.
- 071-326-0557, Select Hasty Firing Positions During MOUT.
- 071-326-5605, Control Movement of a Fire Team.
- 071-326-5611, Conduct the Maneuver of a Squad.
- 071-710-0008, Operate Night Vision Goggles AN/PVS7B.

(3) **Related Tactics, Techniques, and Procedures.**

(a) FM 90-10-1, Infantryman’s Guide to Urban Operations.

(b) FM 23-9, M16A1/2 Rifle Marksmanship.

f. **Training Support Requirements.** Use Table 2-1 for the minimum ammunition required to train at this station.

| AMMUNITION | ROUNDS PER WEAPON |
|-------------------------|-------------------|
| 5.56-mm Blank | 10 rounds |
| 5.56 mm Blank (Linked) | 15 rounds |
| Practice Grenade Bodies | 2 per team |
| Practice Grenade Fuses | 2 per team |

Table 2-1. Support requirements.

g. **Conduct of Training.** Table 2-2, page 2-6, lists the training sequence and Figures 2-3 and 2-4 provide sample scenarios. The following are only examples. The units should develop their training events based on their METL and training needs.

Example 1: Assault Teams, Battle Drill 6. The team leader first trains to execute Battle Drill 6 using no targets. This technique is the crawl phase of training. The trainer has the assault teams position to various places to demonstrate how the start position can affect the final points of domination. (Figure 2-3.)

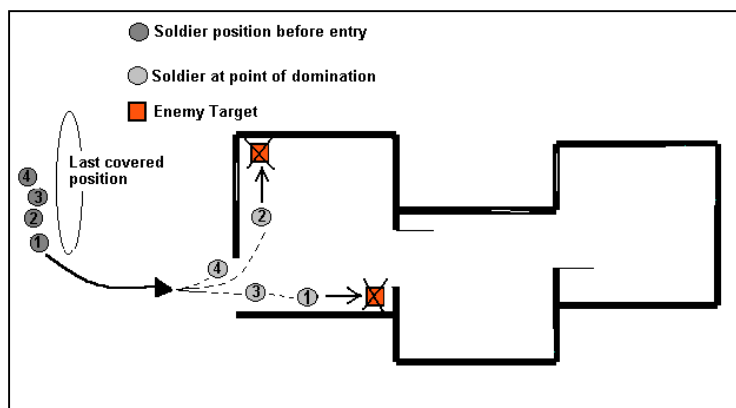

**Figure 2-3. Example Scenario 1,
Execute Battle Drill 6, Varied Entry Positions.**

(2) **Example 2:** Assault Teams, Battle Drill 6. The team leader trains soldiers to execute Battle Drill 6 using targets in a multiple room scenario. This technique is the walk phase of the training. The trainer has the assault teams enter the room and engage targets using precision marksmanship techniques with the tactical engagement system (TES) and or SESAMS (Figure 2-4). The assault team enters the first room and engages the targets. As the number two man clears his area of responsibility, he sees and engages the target in the second room, but remains in place until the assault teams finishes clearing the first room. Once the room is clear, the assault team moves to the second room and continues clearing or lets the next team move through.

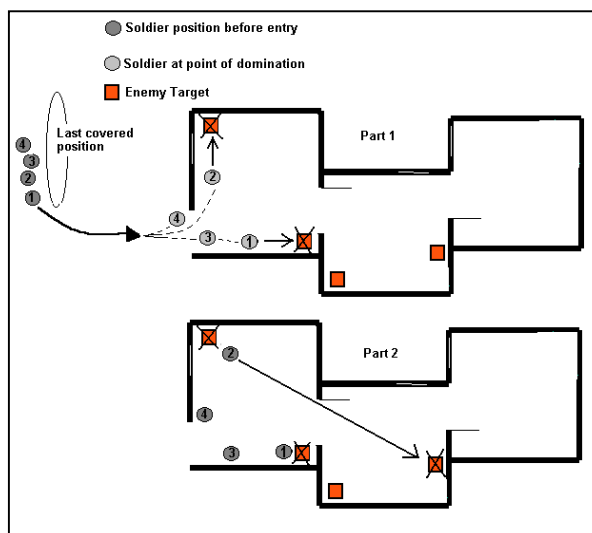

**Figure 2-4. Example Scenario 2,
Multiple Room Clearing Techniques.**

| EVENT | ACTION | ESTIMATED TIME |
|-------|---|--------------------------------|
| 1 | Employ Hand Grenades | 30 minutes Crawl, Walk, Run |
| | Perform Movement Techniques <ul style="list-style-type: none"> • Engage Target with M16 • Target Discrimination | 20 minutes Crawl |
| | | 20 minutes Walk |
| 2 | Enter a Building | 10 minutes Run |
| | | 20 minutes Crawl |
| | | 20 minutes Walk |
| 3 | Enter and Clear a Room | 10 minutes Run |
| | | 20 minutes Crawl |
| | | 20 minutes Walk |
| 4 | Conduct an AAR | 40 minutes |

Table 2-2. Sequence of training and time for Station 1.

2-3. STATION 2: SQUAD AND PLATOON TASK/TECHNIQUE TRAINER

Station 2 is used to train individual and collective tasks, tactics, techniques, and procedures. Specifically, Move Tactically Down a Street (Hallway), Enter a Building and Clear a Room, and Engage Targets. Station 2 increases the complexity of command, control, and maneuver (Figure 2-5).

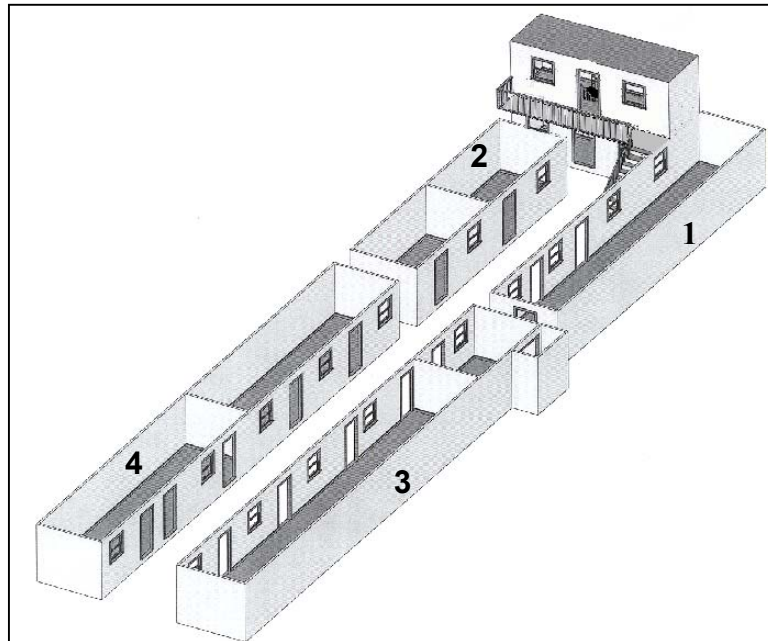

Figure 2-5. Squad and platoon task/technique trainer.

a. **Description.** This station has four separate structures that face inward to create a street and introduces a two-story building.

(1) Building One is an L-shape structure. The long leg of the building to the right looks like it is a single-story building; the short leg of the building to the front is a

two-story structure. A landing is located along the length of the second floor with outside stairs leading down. An inside stairway also joins the floors. The two legs of the L are adjacent, with no access between them to their interiors.

(2) Building Two has a single floor and two rooms; each room has a window and a doorway. An open area much like a street separates this structure from the first.

(3) Building Three is a structure that looks like a row of buildings along a street. The structure is made of wood and has many windows and doorways. At the far end of the structure is an adjoining room.

(4) Building Four is a structure to the left that is a mirror image of building three. It also has a wall on the side at the near end.

NOTE: Units can place additional walls in all the structures by using target cloth or some other material to add to the number of rooms or complexity of the training (Appendix A).

b. **Targetry.** Targets present realistic close quarters combat situations (0 to 15 meters), consisting of a possible mixture of combatant and noncombatant targets. Target discrimination is trained by presenting up to ten precision targets. Targetry sensors respond only to lethal shot placement and also facilitate training during limited visibility.

c. **Controller Requirements.** As required by unit.

d. **Safety Requirements.**

(1) While not intended as a live-fire station, it is capable of supporting live-fire training.

WARNING

To avoid injury, place the weapon on SAFE when climbing through obstacles such as windows, fences, and walls during training.

(2) Only smoke, practice, or M84 stun grenades may be used at this station.

e. Individual and Collective Tasks Trained. (Non-inclusive)

(1) **Collective Task.** Enter and Clear a Building.

(2) **Related Collective Tasks.**

- ARTEP 7-8-MTP, Perform Consolidation and Reorganization.
- ARTEP 7-8-MTP, Treat and Evacuate Casualties.
- ARTEP 7-8 MTP, Defend MOUT Building.
- ARTEP 7-8-MTP, Move Tactically.
- ARTEP 7-8-Drill, Battle Drill 6, Enter a Building/Clear a Room (Squad).

(3) **Supporting Individual Tasks.**

- 071-311-2007, Engage Targets with M16A1 or M16A2 Rifle.
- 071-315-2308, Engage Targets with M16A1/2 Rifle Using a Night Vision Sight AN/PVS-4.
- 071-010-0006, Engage Targets with M249 Machine Gun.
- 071-325-4407, Employ Hand Grenades.
- 113-571-1022, Perform Voice Communications.

- 071-326-0600, Use Visual Signaling Techniques While Dismounted.
- 071-326-0503, Move Over, Through, or Around Obstacles (Except Minefields).
- 051-193-1013, Neutralize Booby Traps.
- 191-377-5250, Handle Enemy Personnel and Equipment.
- 071-326-0501, Move as a Member of a Fire Team.
- 071-326-0541, Perform Movement Techniques During MOUT.
- 071-326-0557, Select Hasty Firing Positions During MOUT.
- 071-326-5605, Control Movement of a Fire Team.
- 071-326-5611, Conduct the Maneuver of a Squad.
- 071-710-0008, Operate Night Vision Goggles AN/PVS-7B.

(4) **Related Tactics, Techniques and Procedure.**

(a) FM 3-06.11 (90-10-1), Combined Arms Operations in Urban Terrain.

- Chapter 3, Offensive Operations.
- Chapter 5, Fundamental Combat Skills.
- Appendix M, Field Expedient Breaching of Common Urban Barriers.

(b) FM 23-9 (FM 3-23.9), M16A1/2 Rifle Marksmanship.

f. **Training Support Requirements.** Use Table 2-3, for the minimum ammunition required to train at this station.

| AMMUNITION | ROUNDS PER WEAPON |
|-------------------------|-------------------|
| 5.56-mm Blank | 16 |
| 5.56-mm Blank (Linked) | 24 |
| Practice Grenade Fuses | 8 per Squad |
| Practice Grenade Bodies | 8 |

Table 2-3. Support requirements.

g. **Conduct of Training.** Table 2-4 depicts sequence of events and Figures 2-6 through 2-28 depict sample scenarios that can be conducted at this station. This is only an example, and the unit should develop its training events based on their METL and training needs.

| EVENT | ACTION | ESTIMATED TIME |
|--|--|---|
| 1 | Conduct Tactical Movement in a Built-up Area Move Across an Open Area Move Parallel to Buildings | 10 minutes Crawl 20 minutes Walk 10 minutes Run |
| 2 | Enter and Clear a Room (SQUAD) Clear a Stairwell Clear a Hallway Conduct a Breach | 10 minutes Crawl 20 minutes Walk 10 minutes Run |
| 3 | Enter and Clear a Building (PLATOON) Clear Multiple Rooms Consolidate and Reorganize | 10 minutes Crawl 20 minutes Walk 10 minutes Run |
| 4 | Conduct AAR (Squad) | 10 minutes |
| NOTE: Training should include techniques outlined FM 3-06.11 (90-10-1). | | |

Table 2-4. Sequence of events and time requirements for Station 2.

(1) The squad is clearing Station 2 as if it is a single building, and the street is a hallway.

(a) Fire Team A moves down the left side, throws the appropriate grenade IAW ROE, enters, engages the target and clears the room on that side. The last man remains outside and secures the rear. Fire Team B prepares to enter the next room (Figure 2-6).

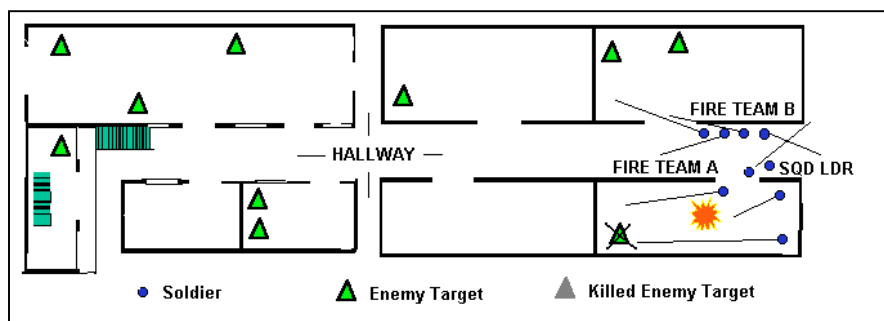

Figure 2-6. Move tactically.

(b) Fire Team B throws the appropriate grenade, enters, engages the targets, and clears the room on the right while the last man secures the rear. Fire Team A prepares to continue movement to the next room (Figure 2-7).

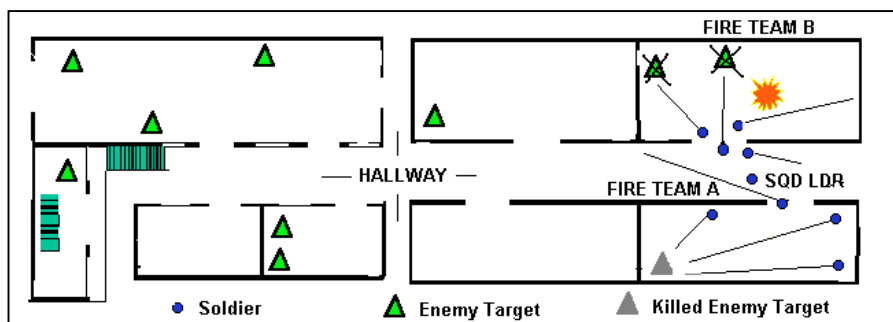

Figure 2-7. Team B clearing a building.

(c) Fire Team A moves across the hall, throws the appropriate grenade, enters, engages the target, and clears the next room. Three team members enter the room, the fourth remains in the doorway and secures the hallway (Figure 2-8).

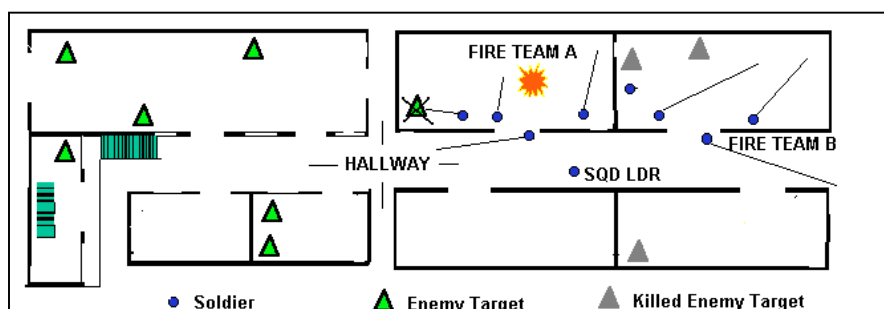

Figure 2-8. Team moving across the hall.

(d) Fire Team B moves in a cross-cover formation down the hallway to the next room, throws the appropriate grenade, and clears the room. As Fire Team B passes the security man of Team A, he turns and picks up rear security. The last man in Fire Team B remains in the vicinity of the doorway and secures the hallway (Figure 2-9).

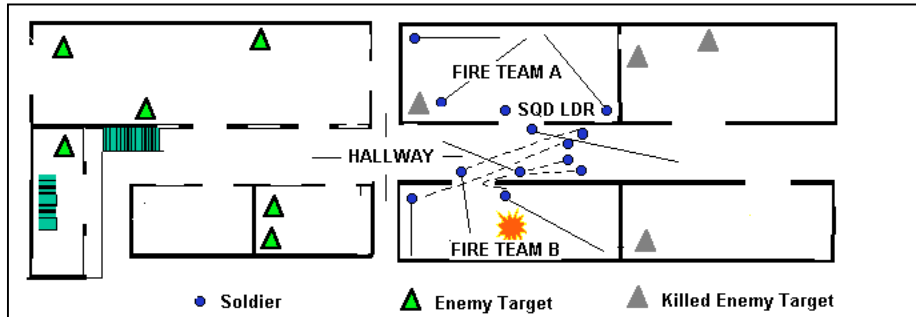

Figure 2-9. Team B in cross cover formation.

(e) Fire Team A clears the hallway intersection while Team B uses the Rolling-T technique to pass through Team A in route to the next room (Figure 2-10).

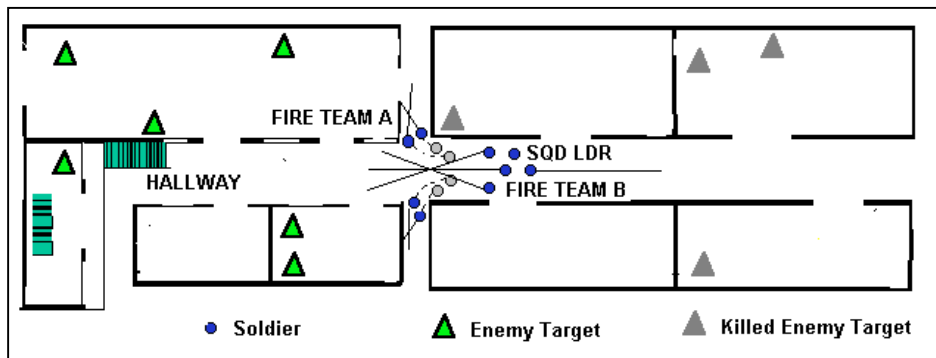

Figure 2-10. Team A clearing a hallway intersection.

(f) Fire Team B throws the appropriate grenade, enters, engages the targets, and clears the room. Only three men enter while the fourth man picks up rear security. Fire Team A prepares to move (Figure 2-11).

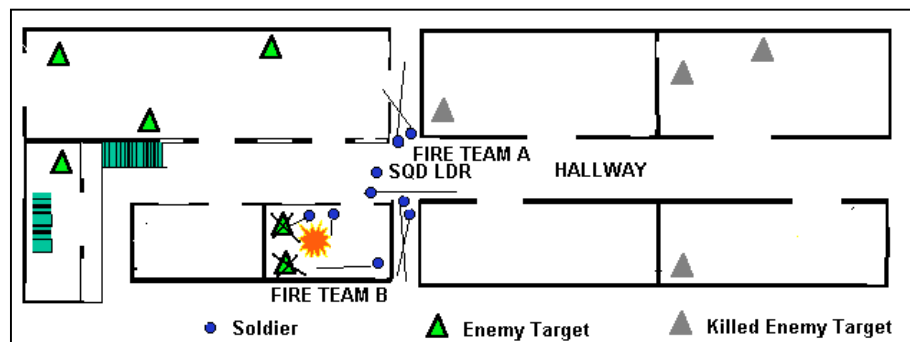

Figure 2-11. Team B clearing a room.

(g) Fire Team A moves from the intersection, throws the appropriate grenade, enters, then engages the targets, and clears the next room. All team members enter because of the size of the room. Fire Team B prepares to move (Figure 2-12).

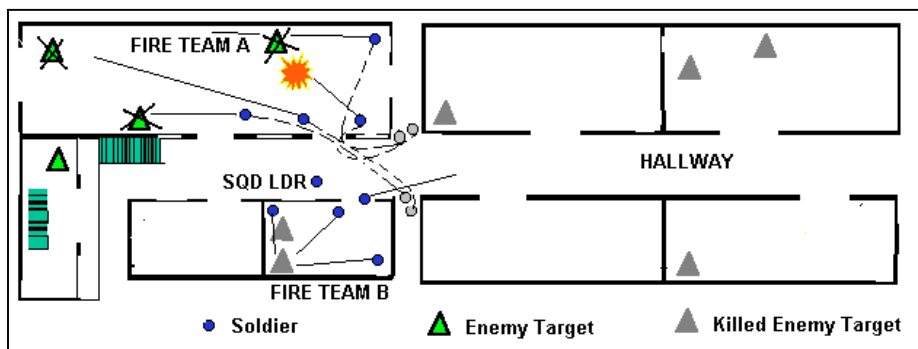

Figure 2-12. Team A clearing room by room.

(h) Fire Team B throws the appropriate grenade, enters, engages the target, and clears the next room using three men, the fourth man remains in the doorway and secures the rear. Fire Team A prepares to move up the stairs (Figure 2-13).

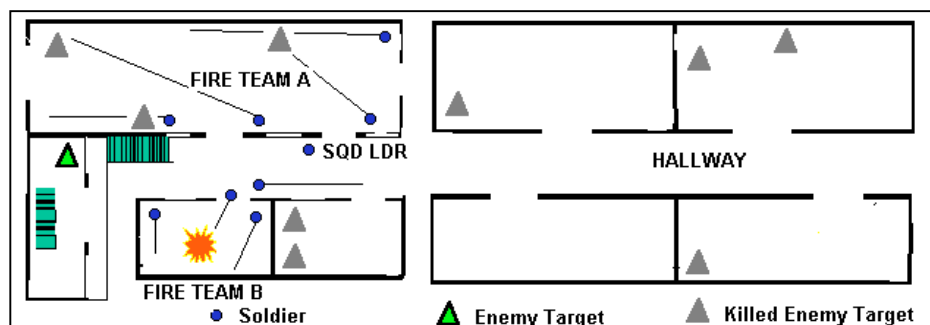

Figure 2-13. Team B clearing the next room.

(i) Fire Team A begins movement up the stairs and onto the landing. The team prepares to enter the room off the landing. Fire Team B splits and two members move around the corner and secure the area across from the stairs on the lower level. The other two members of Team B secure back down the hallway from where the squad moved from (Figure 2-14).

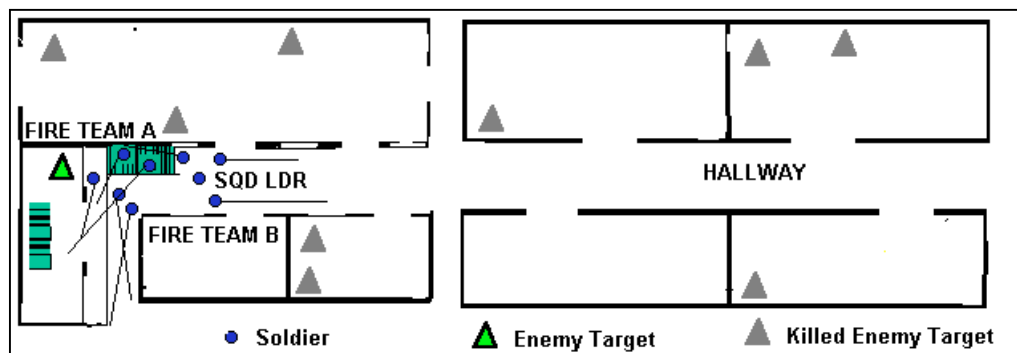

Figure 2-14. Securing the stairs and hallway.

(j) Fire Team A throws the appropriate grenade, enters, engages the target, and clears the room finding another set of stairs and prepares to continue clearing up the stairs. Fire Team B continues to secure the rear while the other team members move down to the end of the short hallway and secure both directions (Figure 2-15).

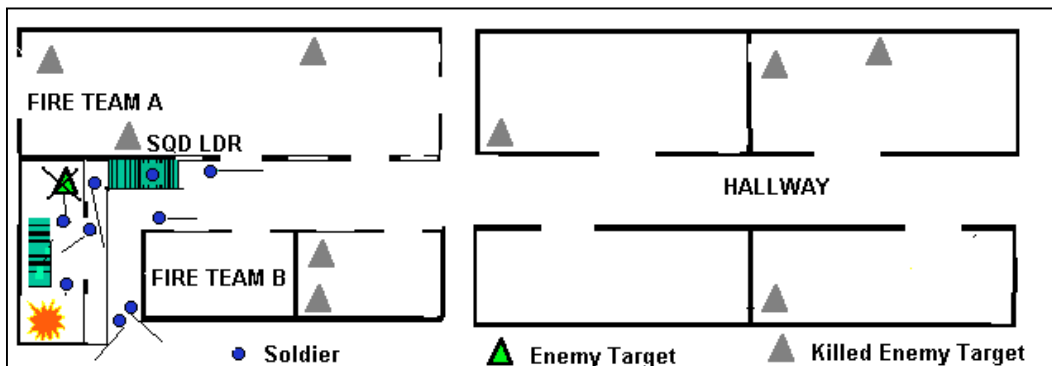

Figure 2-15. Preparing to clear more stairs.

(k) Fire Team A clears the stairs and the landing. Fire team B continues to secure the ground level ready to assist the other team, if necessary (Figure 2-16).

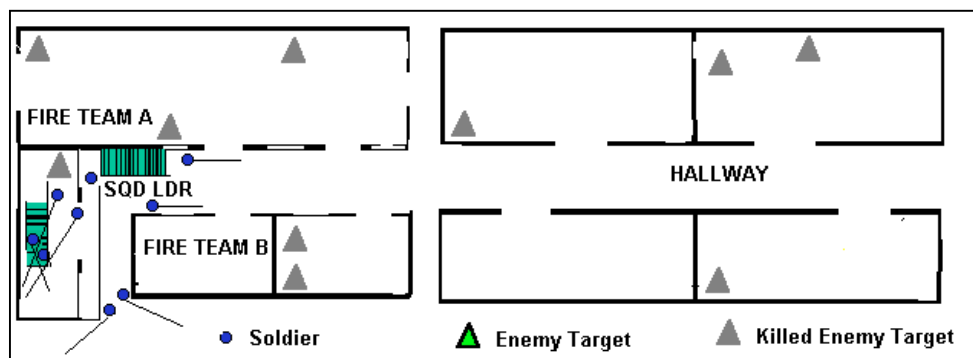

Figure 2-16. Team A clearing stairs and landing.

(2) The example was without noncombatant targets using blanks/SESAMS and TES. This technique is the crawl phase for this station. Once the squad is ready to move on to more challenging exercises the platoon leader/sergeant can add targets into the scenario. As proficiency increases, mixing both combatant and noncombatant targets can be added. At any point, the platoon leader/sergeant can include multiple squads on the station, which increases the complexity of the scenarios until the platoon has achieved proficiency.

(3) The following is an example of a platoon scenario. There are noncombatants on the battlefield. The platoon has decided to clear through the buildings without using the streets for movement from building to building whenever possible. The platoon is using two squads to assault and one squad in support/reserve.

(a) The support element isolates the buildings while the assault team for each squad prepares and executes the breach of each building to be able to gain a foothold (Figure 2-17).

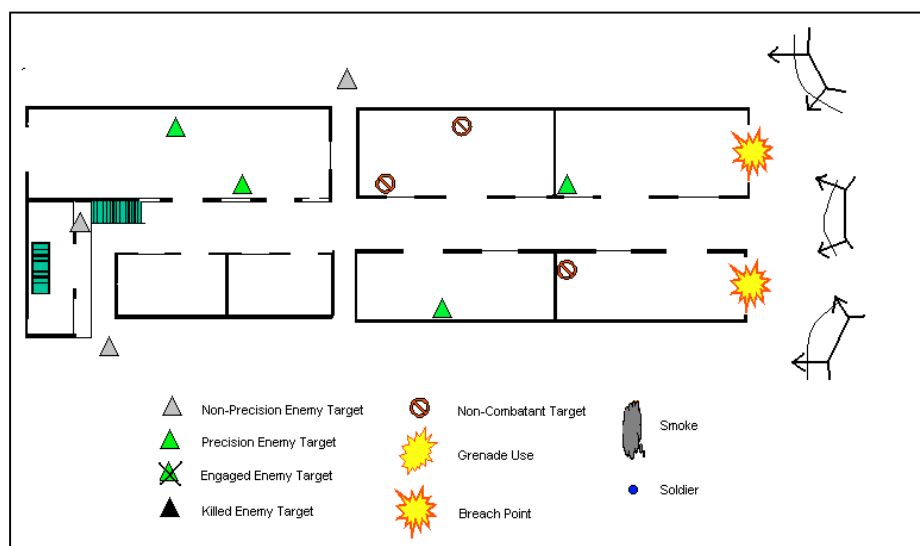

Figure 2-17. Preparing to gain a foothold.

(b) The assault teams throw a grenade into the breach and follows, engaging enemy targets, securing and moving noncombatants to the collection point (CP) (Figure 2-18).

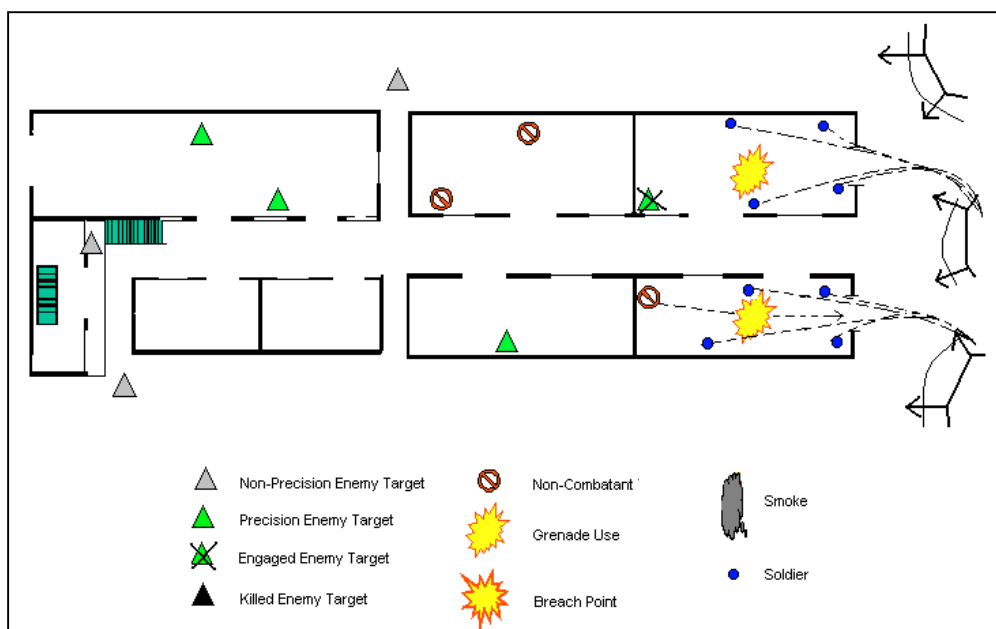

Figure 2-18. Secure and move noncombatants to the CP.

(c) The teams prepare and detonate wall breaches to continue movement through the building. Once the charges are ready for detonation, the assault teams move to a covered position and execute the breach (Figure 2-19).

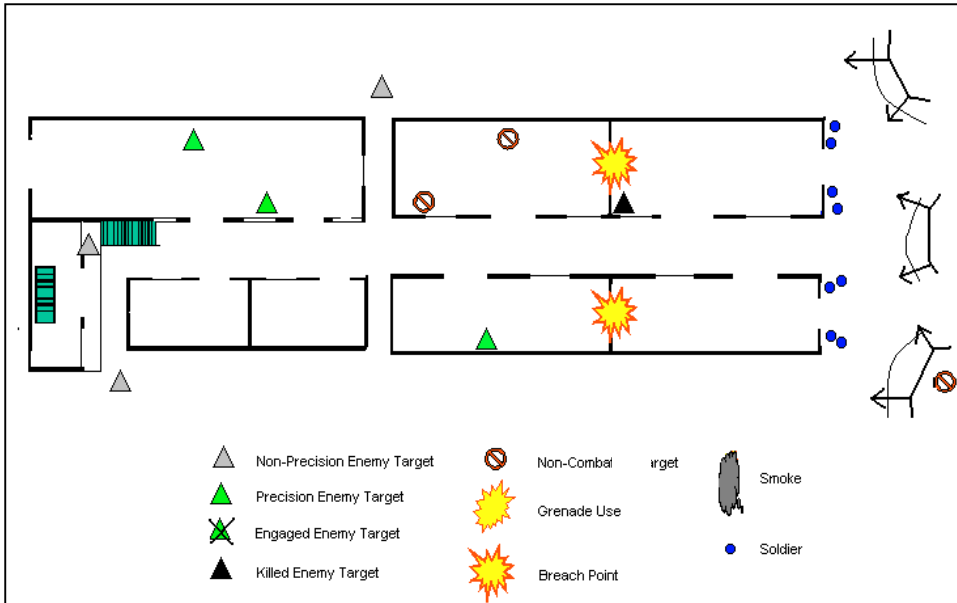

Figure 2-19. Execute breach.

(d) The assault teams lead into the next room with a grenade. Upon entering the teams engage any enemy targets and secure and move noncombatants to the CP. At the same time, the next assault team moves into the foothold. (Figure 2-20).

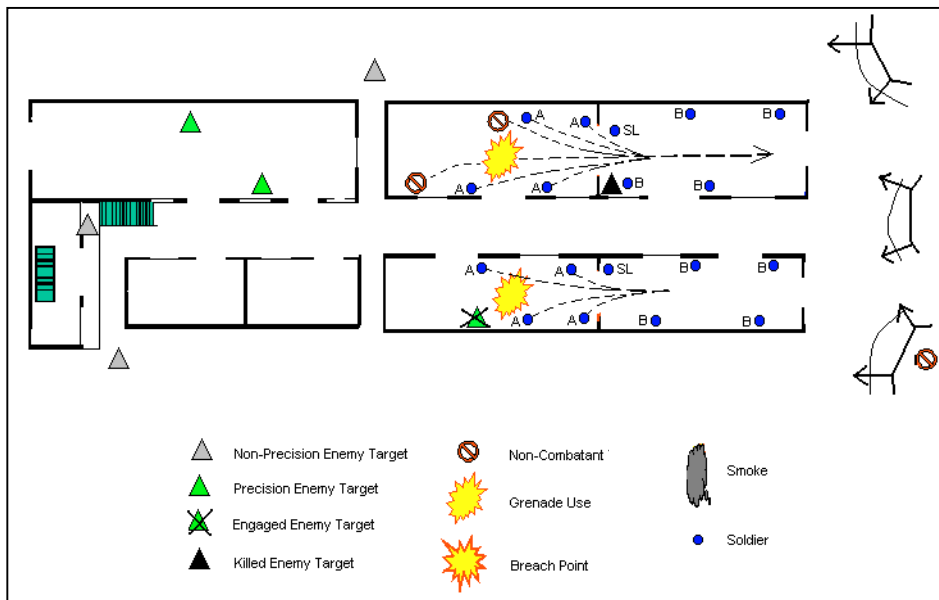

Figure 2-20. Move to the foothold.

(e) With the second room secured, the next assault team moves forward and prepares to breach the next wall. Once the charges are placed, the teams move back to a covered position and execute the breach. At the time the breach is executed, the first non-precision target is exposed and engaged by the support element (Figure 2-21).

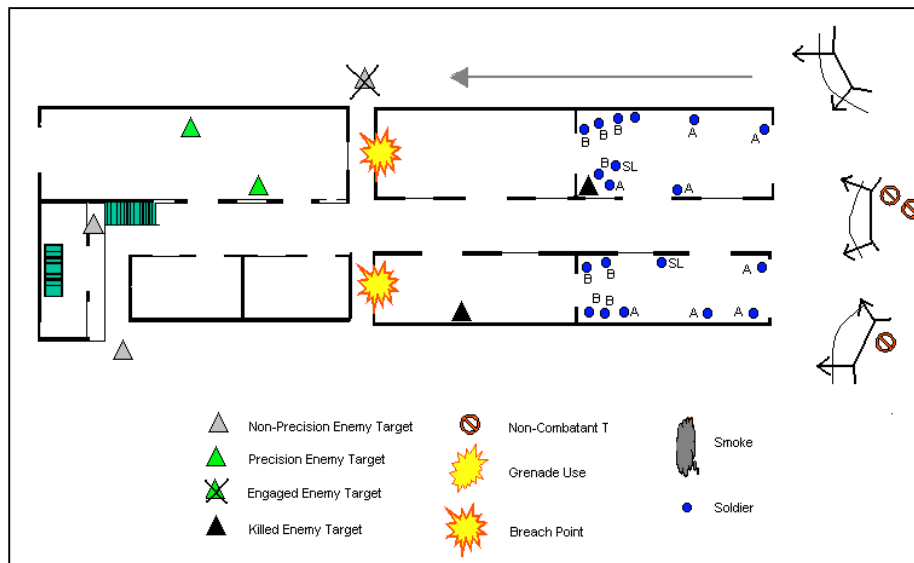

Figure 2-21. Breach the wall.

(f) Upon inspecting the breach, the assault teams find that they have an alley with another wall to breach. Smoke is employed to obscure the teams placing the breaching charge. The first assault teams take up securing positions throughout the already cleared areas while the follow-on assault teams move to a covered position and execute the breach (Figure 2-22).

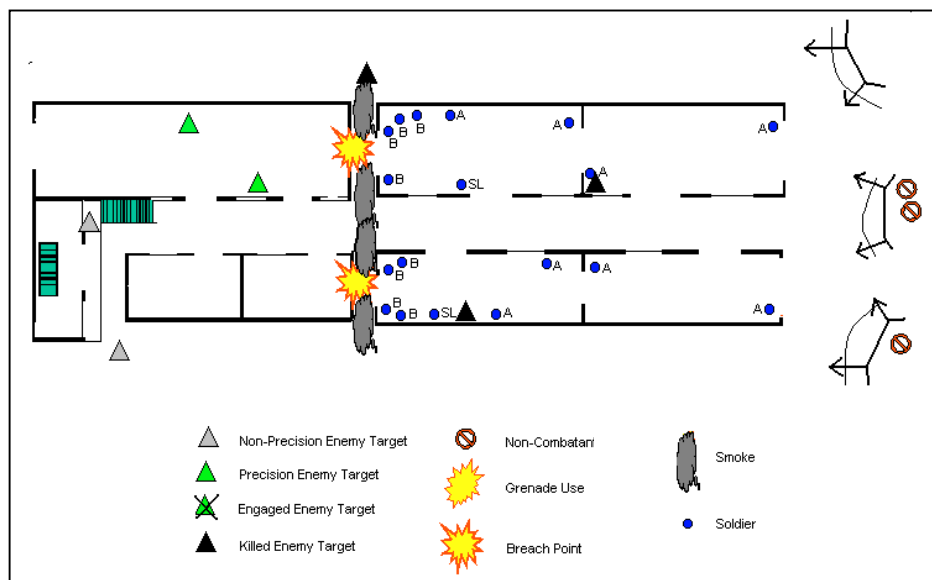

Figure 2-22. Secure a wall in an alley.

(g) Once the breach is executed, the assault teams must determine if there is still enough smoke to cover their movement, or if more smoke must be deployed. When obscurity is obtained, the assault teams throw in a grenade, then enter, engage any enemy targets, and clear the rooms (Figure 2-23).

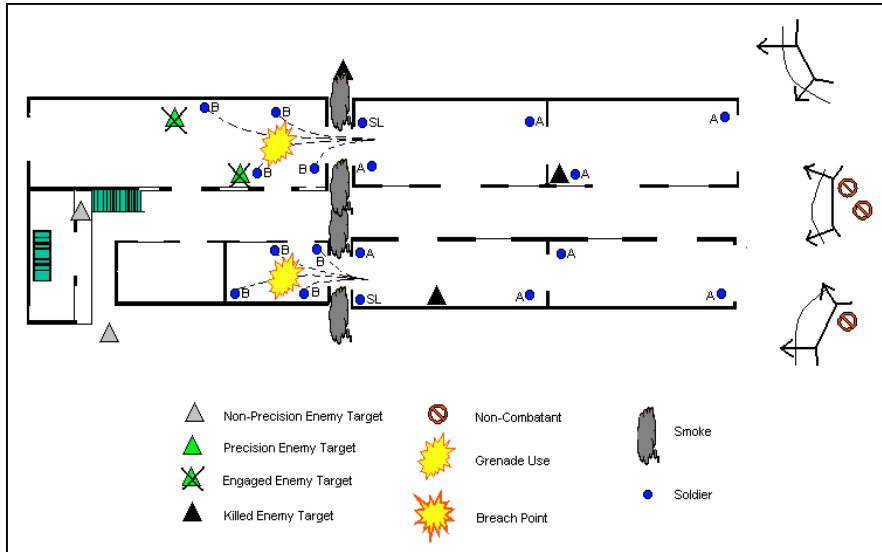

Figure 2-23. Obtain obscurity.

(h) While one team finds itself at the end of the building in their sector, the other team is faced with another wall and more clearing. While one team prepares to breach the wall, the other team takes up a hasty position and prepares for any counterattack. When the breach is executed, the next non-precision target is presented and is engaged by the support element (Figure 2-24).

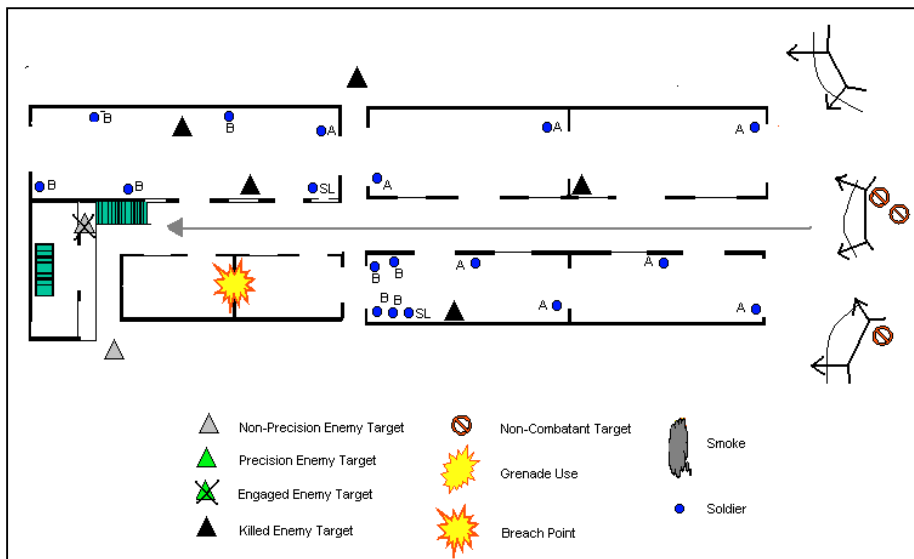

Figure 2-24. Clear the wall.

(i) A grenade is thrown through the breach and the assault team enters and secures the room. When the grenade explodes in the room, the final non-precision target is presented and engaged by the support element (Figure 2-25).

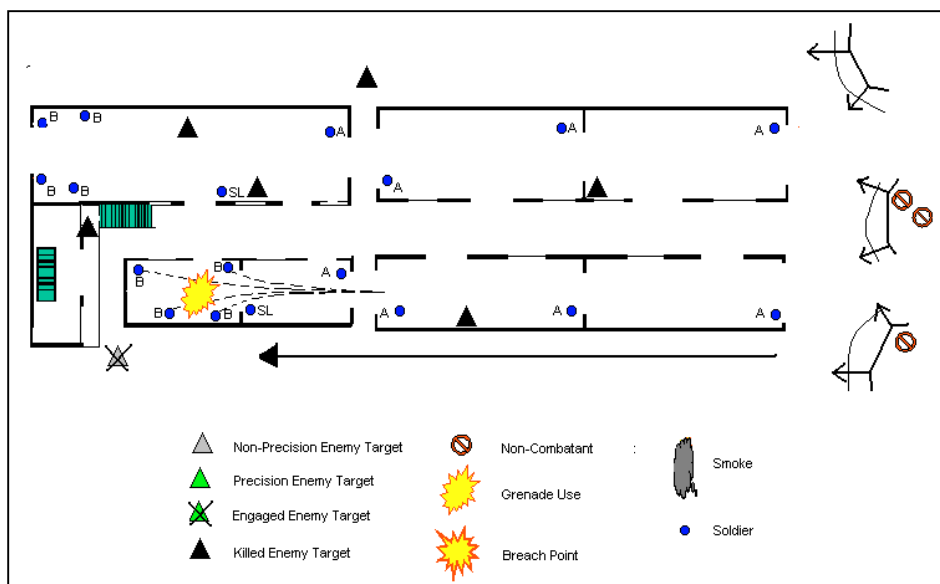

Figure 2-25. Secure a room.

(j) With the first squad reaching its limit of advance and the second squad reaching the end of the building, the platoon leader calls forward another assault team from the reserve. The reserve assault team moves forward through the buildings and positions to clear up the outside stairs of the two-story structure. The second squad places and detonates loophole charges on the far wall of the building so they can support the clearing of the last building (Figure 2-26).

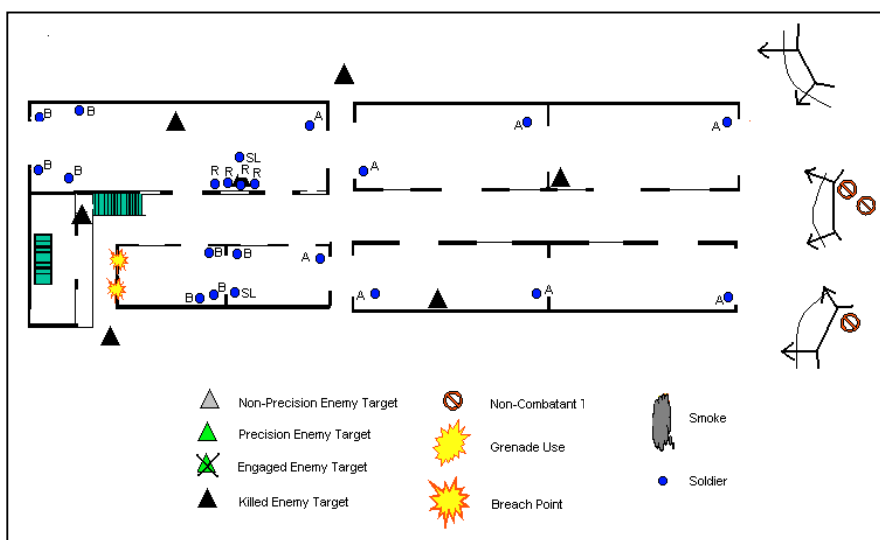

Figure 2-26. Reserve assault team.

(k) Team B of the second squad moves into supporting fire positions and the new assault teams move up the outside stairs to the second floor of the final structure and clear the balcony and the first room on the second floor. The support by fire position shift fires to the lower floor of the same structure that is being cleared (Figure 2-27).

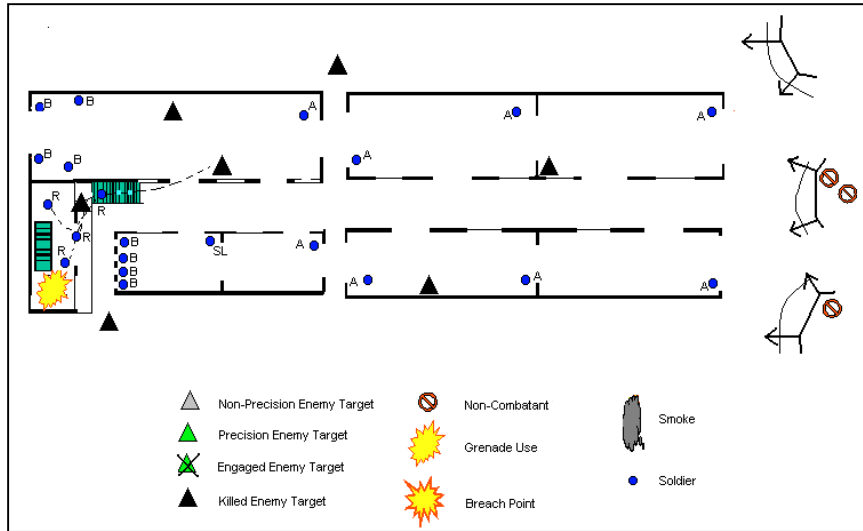

Figure 2-27. Team B, second squad, moves into the supporting fire position.

(l) Once the floor is secure, the assault team moves down the stairs and clears the remaining floor (Figure 2-28). During this time, the platoon repositions its soldiers and conducts consolidation and reorganization.

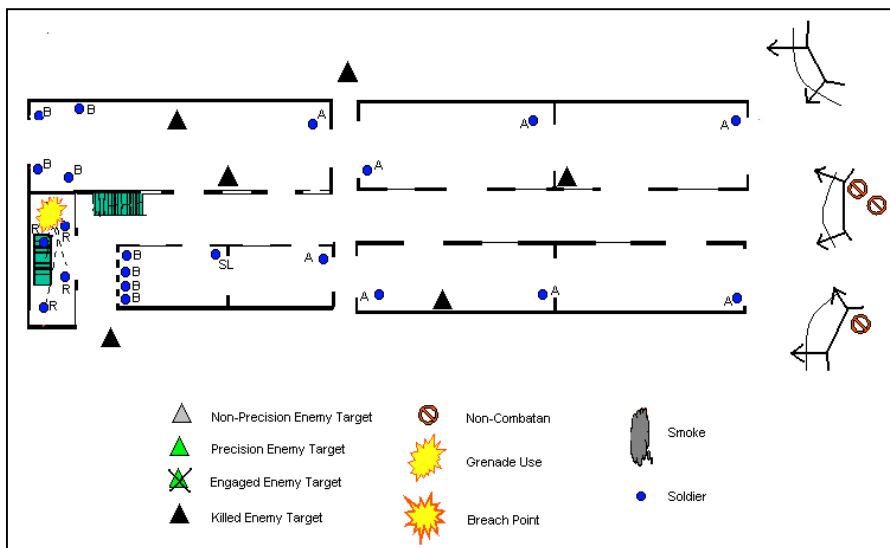

Figure 2-28. Consolidation and reorganization.

2-4. STATION 3: GRENADE GUNNERY TRAINER

This station is used to train M203 (Dual-Purpose Weapon) gunners on the engagement of targets in an urban area. Specifically, M203 point-type targets, M16 targets 50 to 150 meters. Tactical movement and fire commands are also trained at this station.

a. **Description.** This station has two main parts:

(1) The first part is a wooden facade wall that depicts a two-story building. This facade is about 20 feet high by 30 feet wide. It has three upper floor windows and two lower floor windows, a doorway with outside steps, and two basement windows at ground level (Figure 2-29).

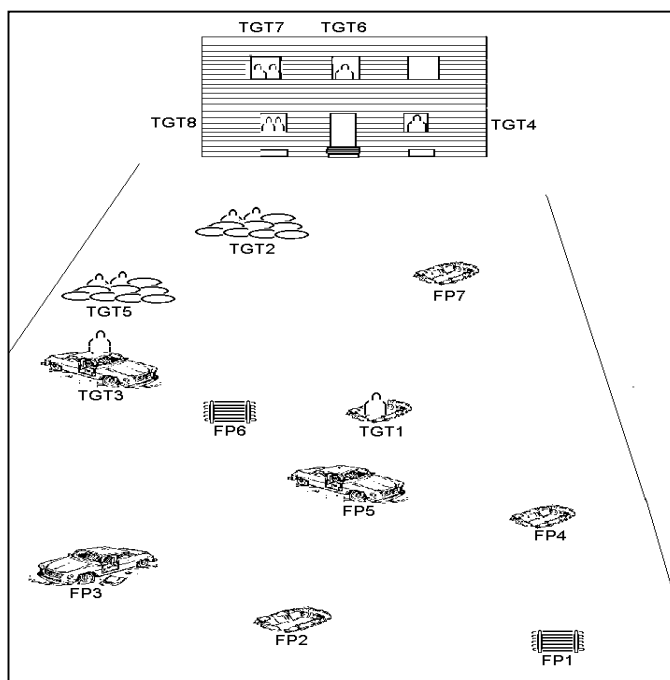

Figure 2-29. Part 1 of grenadier gunnery trainer.

(2) The second part consists of the target engagement lane and seven firing positions that are between the wooden façade and the first firing position. These positions have cover such as sandbags, log walls, and rubble. Firing points can be adjusted to support a variety of training scenarios (Figure 2-30, page 2-20).

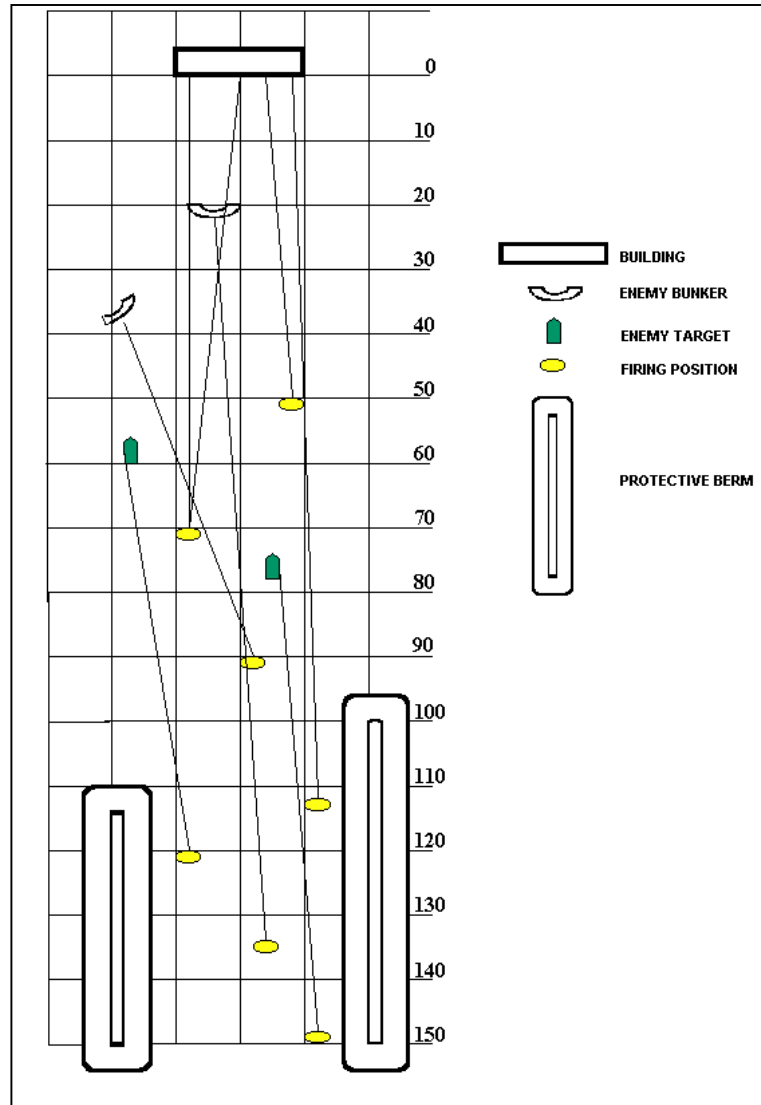

Figure 2-30. Part 2 of grenadier gunnery trainer.

WARNING

Never engage targets with the 40-mm at ranges less than 31 meters, which is the minimum safe range. Trainers ensure the station accommodates this requirement as well as the 14-meter arming range.

- b. **Targetry.** This station has twelve target mechanisms that are arranged in an array that influence the gunners decision as to which munition to use.
- c. **Controller Requirements.** As required by unit.
- d. **Safety Requirements.**
 - (1) Check the unit SOP and local safety regulations regarding live-fire ranges.

- (2) Ensure all weapon systems are on SAFE before moving to the next firing position.
- (3) Ensure that no 40-mm target is engaged at less than minimum arming range.
- e. **Individual and Collective Tasks Trained.** (Non-inclusive.)
- (1) **Supporting Individual Tasks.**
- 071-311-2007, Engage Targets with M16A1/2 Rifle.
 - 071-311-2130, Engage Targets with M203 Grenade Launcher.
 - 071-326-0608, Use Visual Signaling Techniques While Dismounted.
 - 071-326-0503, Move Over, Through, or Around Obstacles (Except Minefields).
 - 071-326-0541, Perform Movement Techniques During MOUT.
 - 071-326-0557, Select Hasty Firing Positions During MOUT.
- (2) **Related Tactics, Techniques and Procedures.**
- FM 3-06.11 (FM 90-10-1), Combined Arms Operations in Urban Terrain.
 - Chapter 3, Offensive Operations.
 - Chapter 5, Fundamental Combat Skills.
 - Appendix M, Field Expedient Breaching of Common Urban Barriers.
- f. **Training Support Requirements.** Use Table 2-5 for the minimum materials required to train at this station.

| AMMUNITION | ROUNDS FOR EACH WEAPON | TARGETS REQUIRED |
|--------------|------------------------|--|
| 5.56-mm Ball | 8 | Four non-precision human target mechanisms. |
| 40-mm TP | 8 | Eight non-precision human target mechanisms. |

Table 2-5. Support requirements.

- g. **Conduct of Training.** Table 2-6 depicts a sample sequence of events that can be conducted at this station, with the minimum amount of ammunition required as shown in Table 2-5. Table 2-7, page 2-22, shows a sample target scenario for Station 3.

| EVENT | ACTION | ESTIMATED TIME |
|-------|---|----------------|
| 1 | Perform Movement Techniques Select Hasty Firing Position Engage Targets With 5.56-mm (dry run) Engage targets with 40-mm | 20 minutes |
| 2 | Perform Movement Techniques Select Hasty Firing Position Engage Targets with 5.56-mm (live-fire) Engage targets with 40-mm | 10 minutes |

NOTE: Training should include techniques outlined in FM 3-06.11 (90-10-1)

Table 2-6. Sequence of events and time for Station 3.

| FIRING POSITION | WEAPON | PRESENTATION TIME | RANGE TO TARGET | TARGET PRESENTED |
|-----------------|---------|-------------------|-----------------|------------------------|
| 1 | 5.56-mm | 6 seconds | 67 meters | Single Human Target |
| 2 | 40-mm | 2 minutes | 105 meters | Multiple Human Targets |
| 3 | 5.56-mm | 6 seconds | 63 meters | Single Human Target |
| 4 | 5.56-mm | 6 seconds | 105 meters | Single Human Target |
| 5 | 40-mm | 2 minutes | 57 meters | Multiple Human Targets |
| 6 | 40-mm | 2 minutes | 70 meters | Multiple Human Targets |
| 6 | 5.56-mm | 6 seconds | 70 meters | Single Human Target |
| 7 | 40-mm | 2 minutes | 50 meters | Multiple Human Targets |

Table 2-7. Sample target presentation for Station 3.

2-5. STATION 4: URBAN OFFENSE/DEFENSE BUILDING, TASK/TECHNIQUE TRAINER

This station is used to train collective tasks and individual tasks, tactics, techniques, and procedures. This station allows the platoon to exercise the task steps and performance measures associated for the offense and defense tasks. Station 4 increases the complexity of command, control, and maneuver (Figure 2-31).

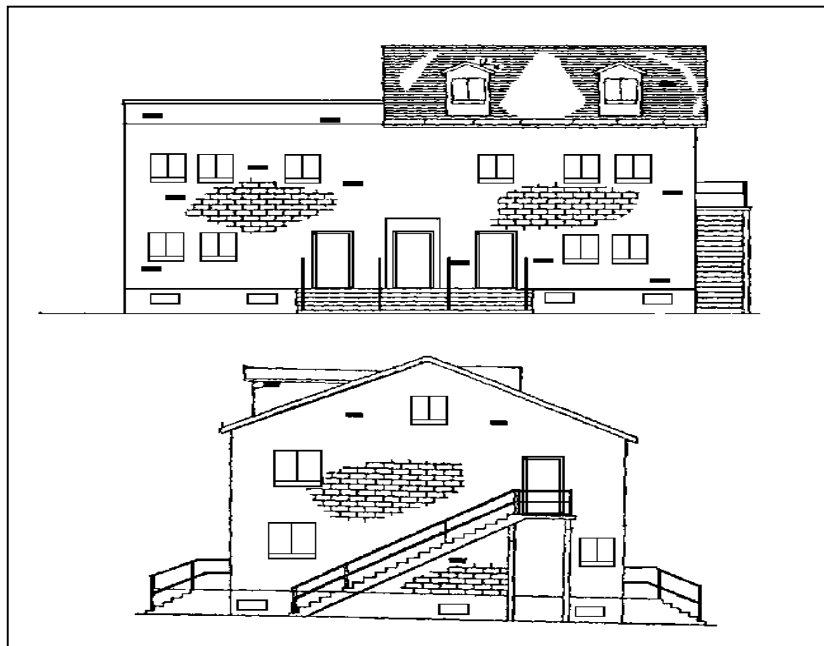

Figure 2-31. Urban offense/defense building.

a. **Description.** This station is a two-story building with a basement. Each floor has several rooms, windows, doorways, loopholes, and mouseholes. The gabled roof has windows and a hatch to the attic below and half of the rooftop is flat. The building has exterior and interior stairways.

b. **Targetry.** This station has ten target mechanisms.

c. **Controller Requirements.** As required by unit.

d. **Safety Requirements.**

(1) Only smoke, practice and M84 stun grenades may be used at this station.

WARNING

To avoid injury, place your weapon on SAFE when climbing through obstacles such as windows, fences, and walls.

(2) Station 4 is not a live-fire station. Training is conducted using TES with blank 5.56-mm, or TES and or SESAMS. Units should consult with their supporting combat engineers for the proper demolition effects simulators (DES) for use against the blow panels located through-out the station.

DANGER

TO AVOID ASPHYXIATION, NEVER DETONATE SMOKE GRENADES INSIDE BUILDINGS. ANY TYPE IS DANGEROUS IN AN ENCLOSED SPACE.

WARNING

To avoid inflicting carbon burns or more serious injury, never fire blank ammunition at other soldiers within 1 meter.

e. **Individual or Collective Tasks Trained.**

(1) **Collective Task.**

FM 7-8.

- 07-3-1110, Clear a Building.
- 07-3-1118, Defens a Built-up Area/Building.

(2) **Related Collective Tasks.**

- 07-3-4607, Perform Consolidation and Reorganization.
- 08-2-0003.07-3104, Treat and Evacuate Casualties.
- 19-3-3106.07-A256, Handle Prisoners of War.
- 19-3-3105.07-A255, Process Captured Documents and Equipment.
- 7-3-1134, Move Tactically.
- 7-3-1123, Conduct Tactical Roadmarch.

- Battle Drill 6, Enter and Clear a Building; Battle Drill 6a, Enter a Building and Clear a Room.

(3) **Supporting Individual Tasks.**

- 071-311-2007, Engage Targets with M16A1/2 Rifle.
- 071-315-2308, Engage Targets with M16A1/2 Rifle Using a Night Vision Sight AN/PVS-4.
- 071-010-0006, Engage Targets with M249 Machine Gun.
- 071-325-4407, Employ Hand Grenades.
- 113-571-1022, Perform Voice Communications.
- 071-326-0600, Use Visual Signaling Techniques While Dismounted.
- 071-326-0503, Move Over, Through, or Around Obstacles (Except Minefields).
- 051-193-1013, Neutralize Booby Traps.
- 191-377-5250, Handle Enemy Personnel and Equipment.
- 071-326-0501, Move as a Member of a Fire Team.
- 071-326-0541, Perform Movement Techniques During MOUT.
- 071-326-0557, Select Hasty Firing Positions During MOUT.
- 071-326-5605, Control Movement of a Fire Team.
- 071-326-5611, Conduct the Maneuver of a Squad.
- 071-710-0008, Operate Night Vision Goggles AN/PVS-7B.

(4) **Related Tactics, Techniques, and Procedure.**

(a) FM 3-06.11 (FM 90-10-1), Combined Arms Operations in Urban Terrain.

- Chapter 3, Offensive Operations.
- Chapter 5, Fundamental Combat Skills.
- Appendix M, Field Expedient Breaching of Common Urban Barriers.

(b) FM 23-9 (FM 3-23.9), M16A1/2 Rifle Marksmanship.

f. **Training Support Requirements.** Use Table 2-8 for the minimum ammunition required to train at this station.

| AMMUNITION | ROUNDS FOR EACH WEAPON |
|-------------------------|------------------------|
| 5.56-mm Blank | 16 |
| 5.55-mm Blank (Linked) | 24 |
| 7.62-mm Blank | 100 |
| Practice Grenade Bodies | 5 |
| Practice Grenade Fuses | 10 per platoon |
| M84 Stun Grenade Bodies | 5 |
| M84 Stun Grenade Fuses | 10 per platoon |
| Smoke Grenades | 4 per platoon |

Table 2-8. Ammunition requirements.

g. **Conduct of Training.** Table 2-9 depicts the sequence of training for Station 4. Figures 2-32 and 2-33 depict sample scenarios of training events that can be conducted at this station. These are only examples. The unit should develop their training events based on their METL and training needs.

| EVENT | ACTION | ESTIMATED TIME |
|-------|-------------------------------|----------------|
| 1 | Clear a Building | 2 Hours Crawl |
| | | 1 Hour Walk |
| | | 30 Minutes Run |
| 2 | Defend Built-up Area/Building | 1 Hours Crawl |
| | | 1 Hour Walk |
| | | 2. Hour Run |
| 3 | Conduct AAR | 1 Hour |

Table 2-9. Sequence of training.

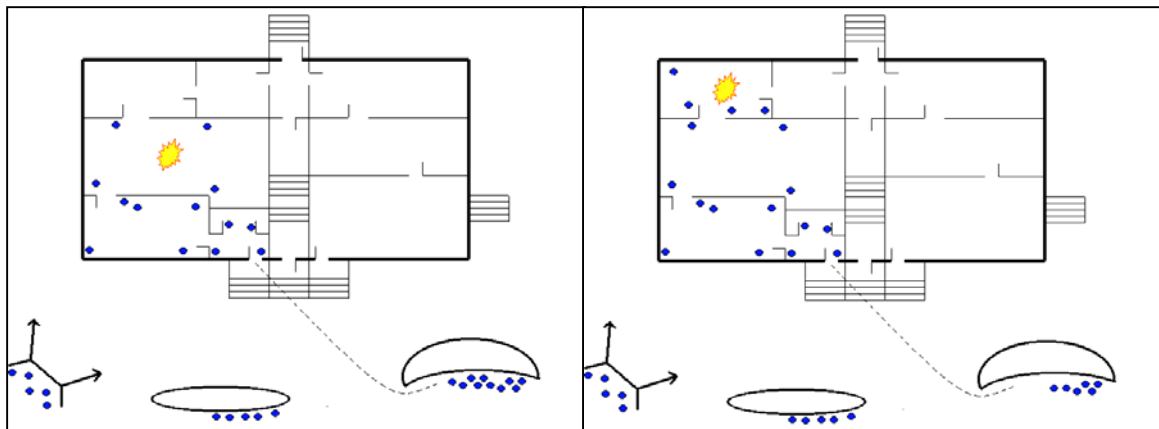

Figure 2-32. Event 1, Clear a building.

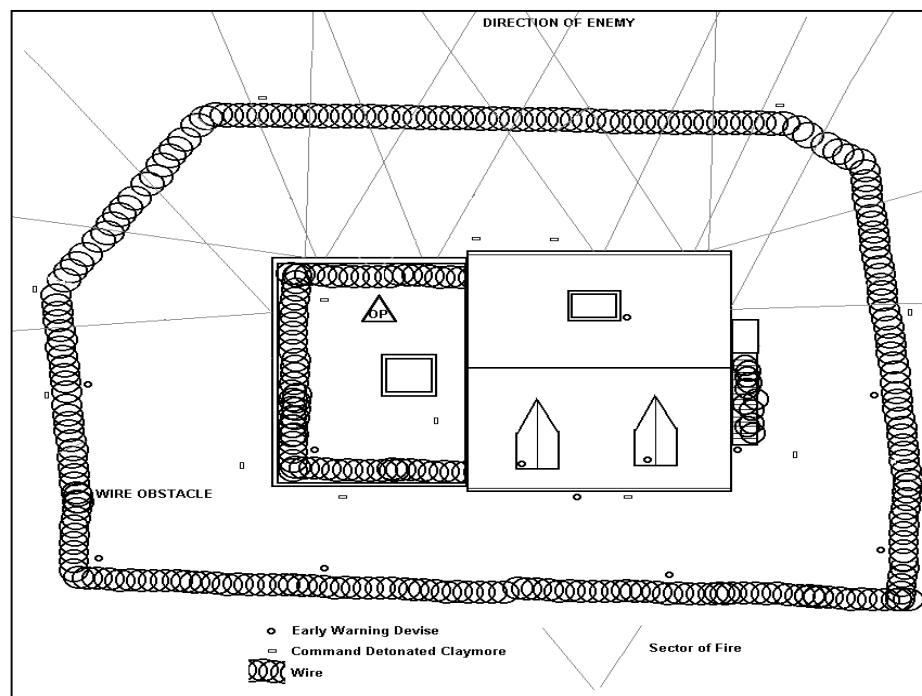

Figure 2-33. Event 2, Defend A Building.

2-6. STATION 5: UNDERGROUND TRAINER

Station 5 is designed to train up to a squad on clear and move tactically in a subterranean environment.

a. **Description.** This station is a sewer system built in an irregular pattern, with four manhole covers. Two access tunnels lead from the outside tunnel to the underground loop, and the station is completely covered by dirt, only the manholes and ground level entrances are exposed (Figure 2-34).

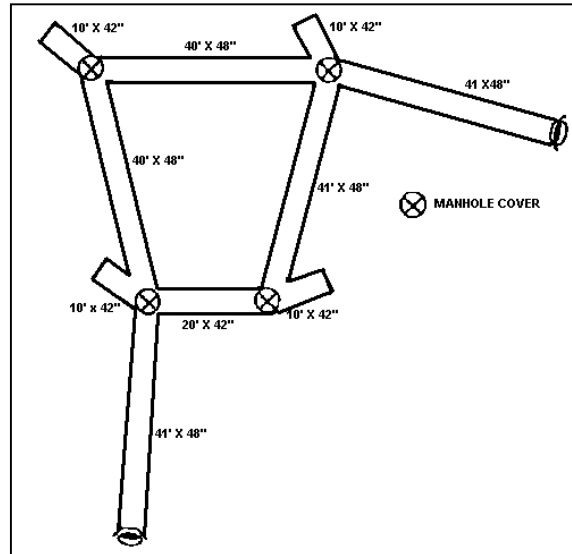

Figure 2-34. Underground trainer.

b. **Targetry.** Station 5 is a force-on-force training station and has no targetry.

c. **Controller Requirements.** As required by unit.

d. **Safety Requirements.**

(1) Soldiers should wear their helmets at all times when in the sewer system to avoid head injuries.

(2) Smoke grenades or M84 stun grenades *WILL NOT* be used in the underground trainer.

DANGER

TO AVOID ASPHYXIATION WHEN IN THE TRAINER, NEVER DETONATE SMOKE GRENADES IN THE SEWER. USING ANY TYPE OF EXPLOSIVE SIMULATOR IS DANGEROUS IN AN ENCLOSED SPACE. THE PROTECTIVE MASK IS NOT EFFECTIVE IN OXYGEN-DEFICIENT ATMOSPHERES.

e. **Individual or Collective Tasks Trained.**

(1) **Collective Task.**

- Move Tactically in a Subterranean Environment.
- Reconnoiter Area.

(2) **Related Collective Tasks.**

- 07-3-1137, Perform Infiltration/Exfiltration.
- 08-2-0003.07-3104, Treat and Evacuate Casualties.

(3) **Supporting Individual Tasks.**

- 071-311-2007, Engage Targets with M16A1/2 Rifle.
- 071-315-2308, Engage Targets with M16A1/2 Rifle Using a Night Vision Sight AN/PVS-4.
- 071-010-0006, Engage Targets with M249 Machine Gun.
- 113-571-1022, Perform Voice Communications.
- 071-326-0600, Use Visual Signaling Techniques While Dismounted.
- 071-326-0503, Move Over, Through, or Around Obstacles (Except Minefields).
- 051-193-1013, Neutralize Booby Traps.
- 191-377-5250, Handle Enemy Personnel and Equipment.
- 071-326-0501, Move as a Member of a Fire Team.
- 071-326-0541, Perform Movement Techniques During MOUT.
- 071-326-0557, Select Hasty Firing Positions During MOUT.
- 071-326-5605, Control Movement of a Fire Team.
- 071-326-5611, Conduct the Maneuver of a Squad.
- 071-710-0008, Operate Night Vision Goggles AN/PVS-7B.

(4) **Related Tactics, Techniques and Procedure.**

(a) FM 3-06.11 (FM 90-10-1), Combined Arms Operations in Urban Terrain.

- Chapter 3, Offensive Operations.
- Chapter 5, Fundamental Combat Skills.
- Appendix M, Field Expedient Breaching of Common Urban Barriers.

(b) FM 3-23.9, M16A1/2 Rifle Marksmanship minimum ammunition required to train at this station.

| AMMUNITION | ROUNDS FOR EACH WEAPON |
|------------------------|------------------------|
| 5.56-mm Blank | 20 |
| 5.55-mm Blank (Linked) | 40 |

Table 2-10. Ammunition requirements.

f. **Conduct of Training.** Table 2-11 depicts the sequence of training that can be conducted at this station. This training is only an example, and the unit should develop their training events based on their METL and training needs.

| EVENT | ACTION | ESTIMATED TIME |
|-------|-----------------------------------|--------------------|
| 1 | Reconnoiter | 30 minutes (Crawl) |
| | | 30 minutes (Walk) |
| | | 30 minutes (Run) |
| 2 | Perform Infiltration/Exfiltration | 30minutes (Crawl) |
| | | 30 minutes (Walk) |
| | | 30 minutes (Run) |
| 3 | Conduct AAR | 30 minutes |

Table 2-11. Sequence of training.

CHAPTER 3

SHOOT HOUSE

This chapter describes the live-fire shoot house and provides layouts and training scenarios. Fighting in built-up areas is fragmented; gains are often small. Therefore, units depend on the initiative, skill, and discipline of small-unit leaders and individual soldiers. Leaders must be competent and confident in their urban operations skills and must have the courage to accomplish their missions while isolated from their parent units. Soldiers and leaders require mission-type orders that allow for decentralized execution.

3-1. PURPOSE

To provide the leader with a facility to train and evaluate the unit during a live-fire exercise. Units are trained and evaluated on their ability to move tactically, engage targets, conduct breaches, and practice target discrimination in an urban environment.

3-2. DESCRIPTION

This facility has two parts, the live-fire facility and the AAR room. The live-fire facility is a single-level structure with a barn roof, catwalk, and eight adjoining rooms with video capture capability that should be used for AARs. The walls are bullet proof and prevent ricochets. There are four entrances, one on each side of the facility. Replaceable blow panels that can accommodate reduced DES are located throughout the facility for entry into the building by means other than through doors. The shoot house has a crane system in the roof that allows for removal of doorways and blow panels not needed for training and replace those panels with solid wall sections. This gives the unit the ability to vary the training scenarios. Unit's can conduct explosive and mechanical breaches. For safety reasons, there are no windows in the structure (Figure 3-1, page 3-2). The AAR building has a conference/AAR room that can accommodate up to a platoon size element, an instrumentation and targetry control room, and an AAR edit and projection room that can facilitate a formal AAR (Figure 3-2, page 3-2).

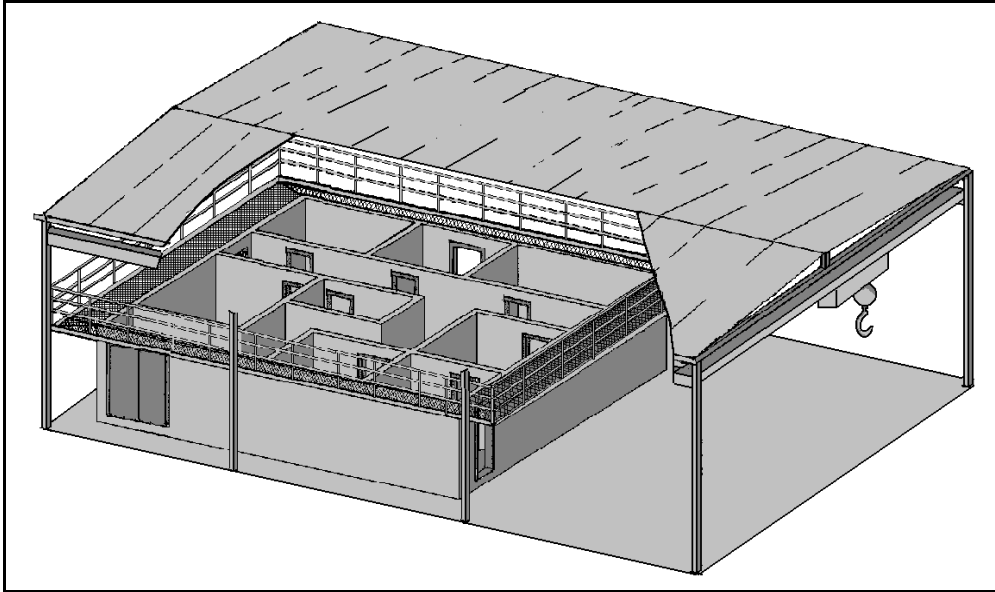

Figure 3-1. Shoot house.

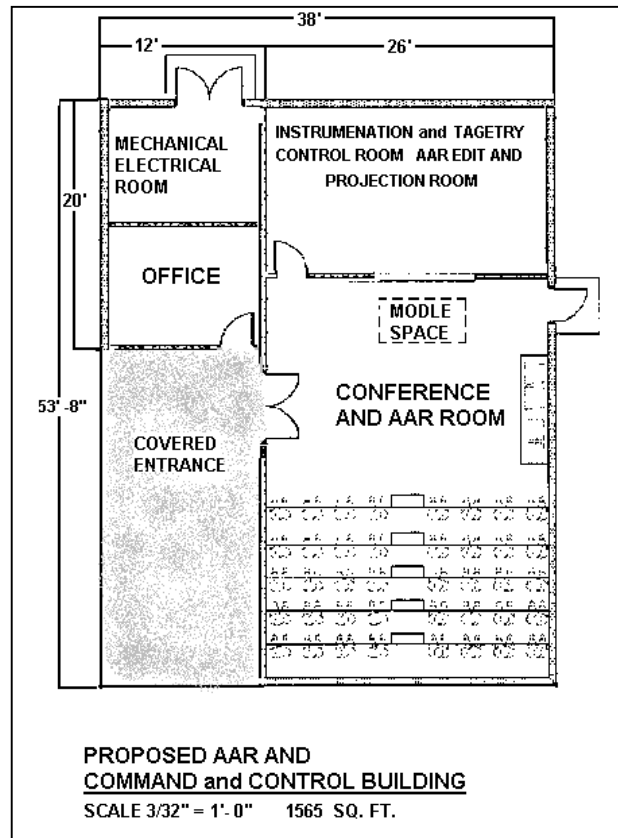

Figure 3-2. Command and control building and AAR room.

3-3. TRAINING AUDIENCE

The facility provides leaders the ability to train and evaluate the unit during a live-fire exercise. However, the unit's training requirements determine the size of the unit and the tasks to be trained at this facility. The unit develops its own organization and the steps for conducting the exercise based on its METL and training needs.

3-4. TRAINING INFORMATION

Tactical operations in an urban environment may range from combat missions to stability and support missions. Commanders should note that the shoot house *is not* suited for the employment of live-fragmentation/concussion grenades, 40-mm HE/HEDP, antiarmor weapons, mortars, artillery, or air delivered munitions. Crew-served weapon systems, M2 and M1 tanks, and machine guns can be employed against supplemental targetry that is exterior to the shoot house. The shoot house has specially constructed areas that are used to conduct either mechanical and or explosive breaching techniques. When conducting explosive breaching, units should consult with local Engineers for appropriate DES charges and consult Appendix A before conducting the training.

3-5. CONDUCT OF TRAINING

The unit develops realistic time frames for each operation or task. The times are based on the crawl, walk, and run concept. The training event or STX can be arranged in any order as long as they follow a tactical scenario. ARTEP 7-8-MTP, Assault a Building and ARTEP 7-8-Drill, Battle Drill 7-4-9109, Enter a Building and Clear a Room (Squad), ARTEP 7-7J-MTP, 07-3-1110, Clear a Building, and ARTEP 7-7J-Drill, Battle Drill 7-4-9109, Enter a Building and Clear a Room (Squad), are the primary collective tasks trained at this facility.

a. **Execution.** Tables 3-1 through 3-5, pages 3-4 through 3-7, depicts sequence of events and Figure 3-3 through Figure 3-6, pages 3-6 through 3-9, provides example scenarios. This table is only an example and the unit should develop its training events based on METL tasks and training needs. However, the leader should do the following when conducting training at the live-fire shoot house:

(1) Identify the unit's critical missions (see commander's training guidance) and select those tasks that support specific tasks related to urban operations.

(2) Arrange the related tasks in the order of their importance to mission accomplishment.

(3) Assess the unit's current level of proficiency (strengths and weaknesses) and determine the degree of difficulty of each task. The training events and scenarios should start from the least difficult to the most difficult tasks to instill confidence in the soldiers conducting the training.

(4) Identify the individual and leader tasks that are to be trained.

(5) Conduct individual training first, because it is the first step in the building-block approach and is the basis for unit or collective task training. The mastery of individual skills is an essential precondition for effective training.

(6) Set up training conditions based on unit proficiency. At first, conditions are basic until proficiency is attained. Increased difficulty and realism are incorporated as training progresses (limited visibility, NBC factors, and live fires with service or SRTA).

(7) Understand that the live-fire shoot house is a live-fire training facility; however, this facility is designed to accommodate any level of training proficiency (blank, TES, SESAM, SRTA, and ball). The leader must make an assessment of the unit’s proficiency.

| ELEMENT | EVENT ACTION | ESTIMATED TIME |
|---|--|----------------|
| All 1st Squad 2d Squad 3rd Squad | 1. Conduct precombat checks (for example; install, align, and trouble shoot MILES equipment; conduct inspection; draw equipment). 2. Support Operations. 3. Conduct Rehearsals. 4. Conduct Event 1 (Crawl). | 2 Hours |
| 3rd Squad 1st Squad 2d Squad | 5. Support Operations. 6. Conduct Rehearsals. 7. Conduct Event 1 (Crawl). | 2 Hours |
| 2d Squad 3rd Squad 1st Squad | 8. Support Operations. 9. Conduct Rehearsals. 10. Conduct Event 1 (Crawl). | 2 Hours |
| 1st Squad 2d Squad 3rd Squad | 11. Support Operations. 12. Conduct Rehearsals. 13. Conduct Event 1 (Walk). | 2 Hours |
| 3rd Squad 1st Squad 2d Squad | 14. Support Operations. 15. Conduct Rehearsals. 16. Conduct Event 1 (walk). | 2 Hours |
| 2d Squad 3rd Squad 1st Squad | 17. Support Operations. 18. Conduct Rehearsals. 19. Conduct Event 1 (walk). | 2 Hours |
| 1st Squad 2d Squad 3rd Squad | 20. Support Operations. 21. Conduct Rehearsals. 22. Conduct Event 1 (Run). | 1 Hours |
| 1st Squad 2d Squad 3rd Squad | 23. Support Operations. 24. Conduct Rehearsals. 25. Conduct Event 1 (Run). | 1 Hours |
| 1st Squad 2d Squad | 26. Support Operations. 27. Conduct Event 1 (Run). | 1 Hours |

Table 3-1. Sequence of events for the platoon.

| EVENT | EVENT ACTION | ESTIMATED TIME |
|----------------------|---|----------------|
| <p>1 (CRAWL)</p> | <p>Terminal Learning Objective Refamiliarize the squad on how to enter and clear a room during the crawl phase of training.</p> <p>Enter and Clear a Room (Squad).</p> <ul style="list-style-type: none"> • Perform Movement Technique. • Select Hasty Firing Position. <p>Conduct a Breach (Mechanical).</p> <ul style="list-style-type: none"> • Employ Hand Grenades. • Engage Targets with M16A2/M4. • Engage Targets with M249 Machine Gun. <p>NOTES:</p> <ol style="list-style-type: none"> 1. Should perform controlled pairs/target discrimination techniques outlined in FM 3-23.9 2. Should include techniques outlined in FM 90-10-1 and performance measures in ARTEP 7-8-MTP, ARTEP 7-7J-MTP | <p>2 Hours</p> |

Table 3-2. Event one, squad sequence (crawl).

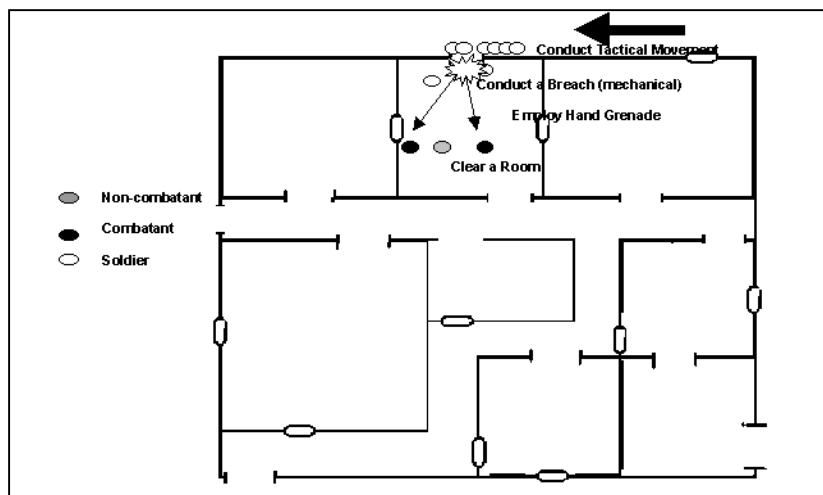

Figure 3-3. Event one, squad scenario (crawl) force on targetry.

| EVENT | EVENT ACTION | ESTIMATED TIME |
|---------------------|--|--|
| <p>2 (WALK)</p> | <p style="text-align: center;">Terminal Learning Objective</p> <p>Refamiliarize the squad on how to enter and clear multiple rooms during the walk phase of training.</p> <p>Enter and Clear a Building (Squad).</p> <ul style="list-style-type: none"> • Perform Movement Technique. • Select Hasty Firing Position. <p>Conduct a Breach (Explosive DES).</p> <ul style="list-style-type: none"> • Engage Targets with M16A2/M4. • Engage Targets with M249 Machine Gun. <p>Conduct AAR.</p> <p>NOTES:</p> <p>1. Should perform controlled pairs/target discrimination techniques as outlined in FM 3-23.9</p> <p>2. Should include techniques outlined in FM 90-10-1 and performance measures in FM 7-8-MTP, ARTEP 7-7J-MTP.</p> | <p style="text-align: center;">2 Hours</p> |

Table 3-3. Event two, squad sequence (walk).

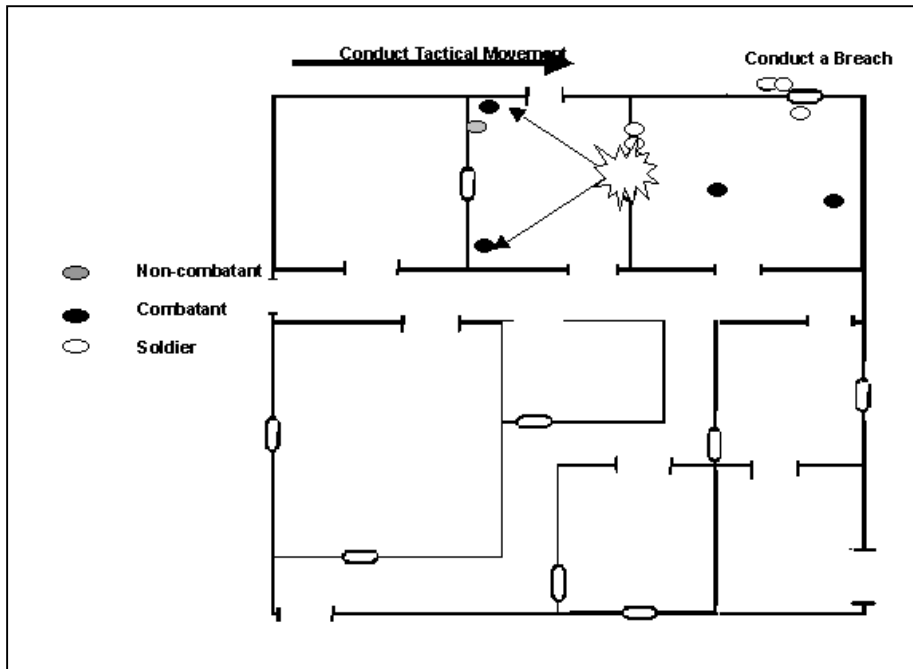

Figure 3-4. Event two, squad scenario (walk) force-on-force.

| EVENT | EVENT ACTION | ESTIMATED TIME |
|--------------------|--|----------------|
| <p>3 (RUN)</p> | <p style="text-align: center;">Terminal Learning Objective</p> <p>Refamiliarize squad on how to enter and clear multiple rooms during the run phase of training.</p> <p>Enter and Clear a Building (Squad).</p> <ul style="list-style-type: none"> • Perform Movement Technique. • Select Hasty Firing Position. <p>Conduct a Breach (Mechanical).</p> <ul style="list-style-type: none"> • Engage Targets with M16A2/M4. • Engage Targets with M249 Machine Gun. <p>Clear a Hallway.</p> <ul style="list-style-type: none"> • Engage Targets with M16A2/M4. • Engage Targets with M249 Machine Gun. <p>Conduct a Breach (Explosive DES)</p> <ul style="list-style-type: none"> • Engage Targets with M16A2/M4. • Engage Targets with M249 Machine Gun. <p>Conduct AAR.</p> | <p>1 Hour</p> |

Table 3-4. Event three, squad sequence (run).

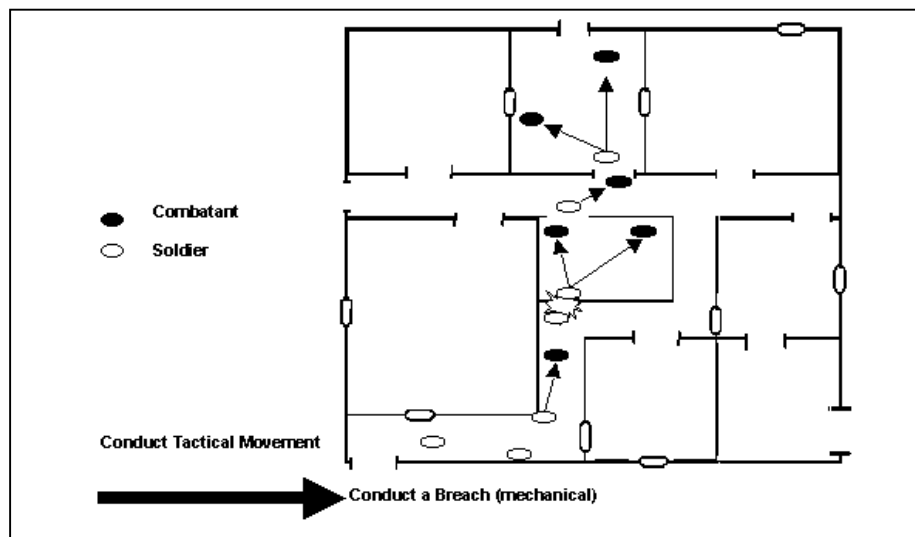

Figure 3-5. Event three, squad scenario (run) force-on-target.

| EVENT (STX) | ACTION | ESTIMATED TIME |
|-------------|--|--|
| 4 (RUN) | Occupy Assembly Area. Develop and Communicate a Plan. Prepare for Combat. Perform Passage of Line. Move Tactically. Break Contact. Intermediate AAR. Move Tactically. Perform Overwatch/Support by Fire. Assault a Building. Consolidate and Reorganize. Final AAR. | 1 Hour 2 Hours 30 minutes 1 Hour 5 minutes 20 minutes 1 Hours 1 Hours 2 Hours 1 Hours |

Table 3-5. Event four, platoon evaluation sequence (run).

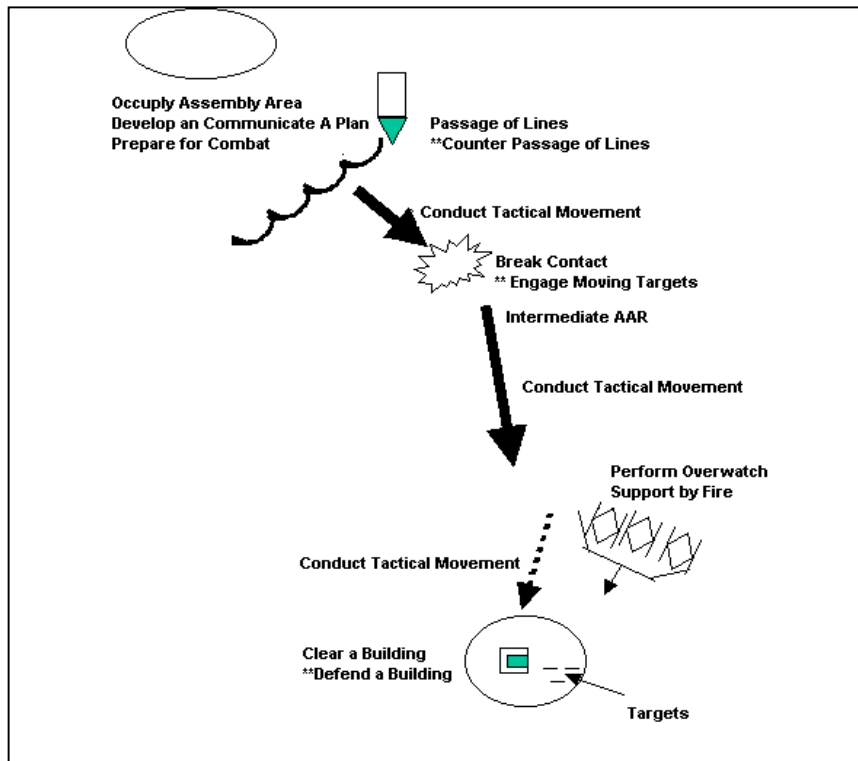

Figure 3-6. Sample platoon tactical scenario (run).

b. **Operation Order.** Table 3-6, page 3-10, provides a sample operation order for conduct of training.

| | |
|---|--|
| (Classification) | Copy ____ of ____ copies ____ Company ____ Infantry (Unit Location) _____ Date/time Group _____ |
| (Message Reference Number) | |
| OPORD: _____ Reference Map, Series _____ Time Zone used Throughout the Order: _____ | |
| TASK ORGANIZATION: | |
| ____ Platoon | Platoon |
| ____ Platoon | ____ 60-mm Section |
| ____ Antiarmor Section | |
| 1. SITUATION | |
| a. Enemy Forces. ANNEX B (Intelligence Overlay [prepared by battalion S2]). | |
| (1) The company is opposed by elements of the Red Company of the Blue Brigade at about 60 percent strength. Within our zone, we have a platoon-size element occupying a defensive position in a building in the vicinity of (____). The enemy has small arms weapons and may call on company mortars for support. | |
| (2) Current indications are the enemy is regrouping to initiate small-unit offensive actions in the area. His most likely course of action is to move to the (direction) to link up with elements of the parent unit. | |
| b. Friendly Forces. | |
| (1) (__) Infantry attacks at (____) hours to seize Objective ALPHA (grid). The intent is to prevent the enemy element from moving (direction) to link up with other enemy units. | |
| (2) Company (__) on our (left, right) makes the main attack at (____) hours to seize Objective RED (grid) in order to establish blocking positions to stop the enemy's movement to the (direction). | |
| (Classification) | |

Table 3-6. Sample of a company OPORD.

(Classification)

2. MISSION

Company () attacks to seize Objective BLUE (grid) at (date/time) hours in order to prevent the enemy from regrouping and engaging Company () (main effort) from Objective BLUE.

3. EXECUTION

a. **Concept of Operation.** ANNEX C (Operations Overlay). (This should include those steps listed in the task , Conduct Troop-Leading Procedures, paragraph 17. These should be written out when possible and not just placed on an overlay.)

(1) Maneuver. () Platoon establishes a defense in its zone, NLT (date/time) hours, to destroy small enemy elements moving or exfiltrating to the (direction), from the vicinity of Objective BLUE. This defense supports the attack on Objective BLUE by completing destruction of any enemy that may escape. (Evaluated) Platoon conducts the company main attack at (hours) to seize Objective BLUE to destroy the enemy or force them to withdraw into () Platoon's defense. () Platoon supports the attack of the (Evaluated) Platoon on Objective BLUE to suppress enemy fires and isolate the objective. On seizure of Objective BLUE, (Evaluated) Platoon and () Platoon will defend in sector to destroy the enemy elements withdrawing to avoid () Company's attack.

(2) Fire support.

- (a) Priority of fires.
- Initially to (Evaluated) Platoon.
 - Upon seizure of Objective BLUE, priority shifts to (Defensive) Platoon.
- (b) Priority targets.
- 60-mm priority target initially AA4031.
 - On initiation of assault on Objective BLUE, priority shifts to target AA4027 to isolate the objective.
 - Upon seizure of Objective BLUE, priority shifts to target AA4025.

(Classification)

Table 3-6. Sample of a company OPORD (continued).

(Classification)

b. Tasks to maneuver units.

(1) (___) Platoon. Destroy enemy elements moving to the (direction), NLT (date/time).

(2) (Evaluated) Platoon. Consolidate and defend in sector to destroy enemy elements following the seizure of Objective BLUE.

(3) (___) Platoon. Be prepared to assault Objective BLUE, on order, consolidate and defend in sector to destroy enemy elements following the seizure of Objective BLUE.

c. Tasks to combat support units.

(1) 60-mm Section. Initially in the vicinity of CP 7, priority of fires to the (Evaluated) Platoon. Move with the (Supporting) Platoon. On order, priority of fires to the (Defensive) Platoon.

(2) Antiarmor Section. Attached to the (Supporting) Platoon.

d. Coordinating Instructions:

(1) (Defensive) Platoon reports defense established and locations.

(2) Platoon reports the seizure of all objectives.

(3) Platoon reports the consolidation and establishment of the defense.

(4) Order of march from the assembly area to the objective: defense platoon, evaluated platoon, headquarters, support platoon, 60-mm mortar.

4. SERVICE SUPPORT

a. **General.** Company trains collocated with the battalion combat trains in the vicinity of (grid). Supply distribution at the company CP.

(Classification)

Table 3-6. Sample of a company OPORD (continued).

(Classification)

b. **Materiel and Services.**

- (1) Class I: Ration cycle MRE-MRE-MRE.
- (2) Class V: Pick up basic load at company CP, NLT (date/time).
- (3) Medical: Company casualty collection point is _____.
- (4) EPW: EPW collection point is _____.

5. **COMMAND AND SIGNAL**

a. **Command.** Company command group initially follows the (Evaluated) Platoon.

b. **Signal.**

- (1) Radio-listening silence is in effect until contact is made.
- (2) SOI _____ is in effect.

JONES
Commanding

ANNEXES:
B-Intelligence Overlay
C-Operations Overlay
D-Fire Support Overlay

(Classification)

Table 3-6. Sample of a company OPORD (continued).

3-6. TRAINING SUPPORT REQUIREMENTS

Minimum trainers and evaluators should be based on unit proficiency, training needs, and local safety requirements. Table 3-7 contains consolidated support requirements.

| AMMUNITION | EVENT 1 | EVENT 2 | EVENT 3 | EVENT 4 (optional) |
|---|----------|-----------|--------------|-----------------------|
| 5.56-mm (per Weapon) Ball, Blank, SRTA, or SESAMS | 20 Blank | 20 SESAMS | 20 Ball/SRTA | 20 Ball/SRTA |
| 5.56-mm Linked (per Weapon) | 30 Blank | 30 SESAMS | 30 Ball/SRTA | 30 Ball/SRTA |
| Hand Grenade Body (Practice) | 0 | | 4 | 4 |
| Hand Grenade Fuses (Practice) per platoon | 0 | | 4 | 4 |
| Hand Grenade Smoke per Platoon | 0 | 6 | 6 | 6 |
| M84 Hand Grenade Stun per Platoon | 0 | 4 | 4 | 0 |
| TES (MILES Equipment) | | | | |
| M16 (1 per weapon, 1 per OPFOR) | NO | YES | NO | NO |
| M249 (1 per weapon) | NO | YES | NO | NO |
| SAAF (1 per platoon) | NO | YES | NO | NO |
| Controller Gun (1 per OC) | NO | YES | NO | NO |
| TARGETRY | 5 | 0 | 5 | 10 |
| OPFOR | NO | 6 | NO | NO |

Table 3-7. Consolidated support requirements.

3-7. TRAINING AND EVALUATION

The T&EOs are the foundation of the MTP and the collective training of the platoon. T&EOs are training objectives (task, conditions, and standards) for the collective tasks that support platoon critical wartime operations. T&EOs may be trained separately, in an STX, in an FTX, or in live-fire exercises. For collective live-fire standards, the trainer needs to refer to the applicable Infantry Gunnery Manual for the appropriate course of fire. Those standards and courses of fire need to be integrated into the training exercise. Table 3-8 provides a list of related collective and supporting individual tasks.

| TASK | REFERENCES |
|--|--|
| Perform Consolidation and Reorganization Treat and Evacuate Casualties Process Enemy Prisoners of War/Captured Materiel Defend MOUT Building Move Tactically | ARTEP 7-8/FM 7-8, FM 90-10-1 ARTEP 7-8/FM 7-8, FM 90-10-1 ARTEP 7-8/FM 7-8, FM 90-10-1 ARTEP 7-8/FM 7-8, FM 90-10-1 ARTEP 7-8/FM 7-8, FM 90-10-1 |
| BATTLE DRILL | |
| Enter a Building and Clear a Room (Squad) | ARTEP 7-8-Drill (7-4-9109) FM 90-10-1 |
| SUPPORTING INDIVIDUAL TASKS | |
| Engage Targets with an M16A1/M16A2 Rifle Engage Targets with an M16A1/M16A2 Rifle Using a Night Vision Sight AN/PVS-4 Engage Targets with an M249 Machine Gun Employ Hand Grenades Move Over, Through, or Around Obstacles (Except Minefields) Neutralize Booby Traps Move as a Member of a Fire Team Perform Movement Techniques During MOUT Conduct the Maneuver of a Squad Conduct an Explosive Breach Execute a Mechanical Breach Conduct a Breach Operate Night Vision Goggles AN/PVS-7 Select Hasty Firing Positions During MOUT Control Movement of a Fire Team | STP 21-1-SMCT (071-311-2007) FM 90-10-1 STP 21-1-SMCT (071-315-2007) FM 90-10-1 STP 7-11BCHM (071-010-0006) FM 90-10-1 STP 21-1-SMCT (071-325-4407) FM 90-10-1 STP 21-1-SMCT (071-326-0503) FM 90-10-1 STP 21-24-SMCT (052-193-1013) FM 90-10-1 STP 7-11BCHM (071-326-0501) FM 90-10-1 STP 7-11BCHM (071-326-0541) FM 90-10-1 STP 7-11BCHM (071-326-5611) FM 90-10-1 STP 7-11BCHM (071-440-0030) FM 90-10-1 STP 7-11BCHM (071-440-0027) FM 90-10-1 STP 7-11BCHM (071-440-0029) FM 90-10-1 STP 7-11BCHM (071-710-0008) FM 90-10-1 STP 7-11BCHM (071-326-0557) FM 90-10-1 STP 7-11BCHM (071-326-5605) FM 90-10-1 |

Table 3-8. Related collective and supporting individual tasks.

CHAPTER 4

BREACH FACILITY

Urban operations require soldiers to enter buildings through walls, doors, windows, and roofs. The breach facility is designed to train soldiers using tasks and techniques on how to breach locked doors, windows, and create man-size holes in walls. The facility can be used to train mechanical, ballistic, thermal, and explosive breaching.

4-1. PURPOSE

The breach facility (Figure 4-1) is used to train soldiers semiannually on the technical aspects of breaching techniques. It is also used to train TTPs and explosive techniques not trained on any other type range.

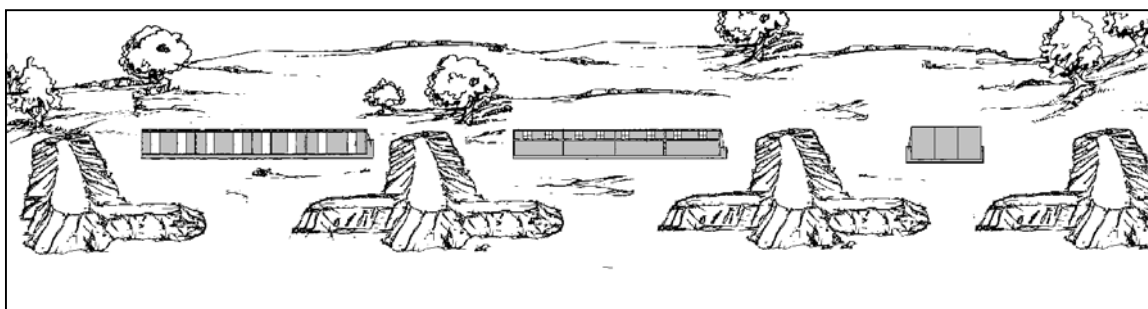

Figure 4-1. Breach facility.

4-2. DESCRIPTION

This facility has three stations.

a. **Station 1.** This station is a facade that is 8 feet high and 88 feet wide with four sections of two doors for a total of eight doors. Soldiers can conduct mechanical, thermal, ballistic, and explosive breaching techniques on doors at this station. Half of the doors open from the exterior, and the other half of the doors open from the interior (Figure 4-2, page 4-2).

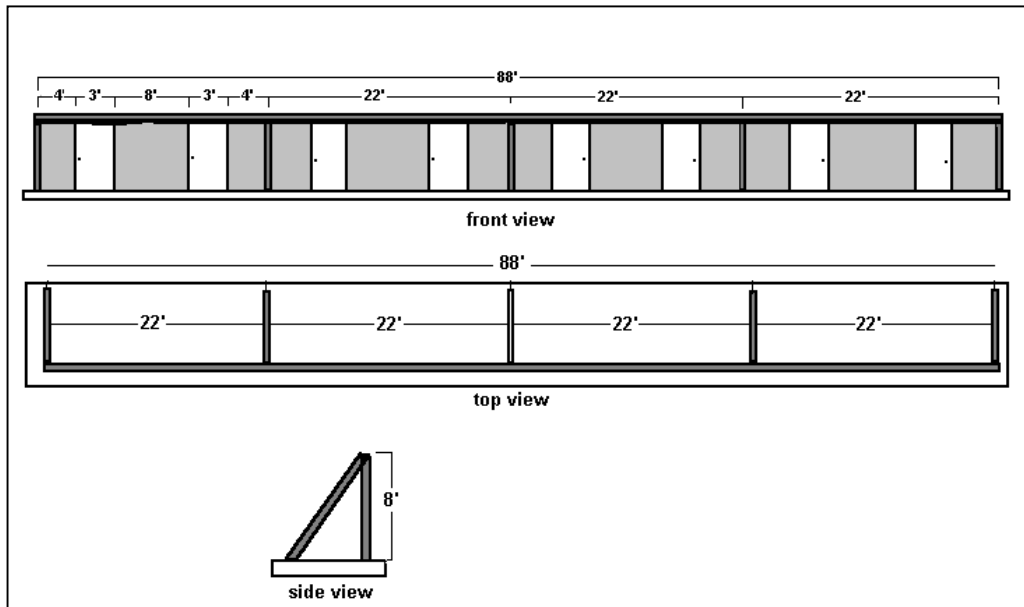

Figure 4-2. Station 1—door breaching.

b. **Station 2.** This station is a facade that is 10 feet high and 88 feet wide that has four sections of two windows each for a total of eight windows. Soldiers can conduct mechanical and explosive breaching techniques on windows at this station (Figure 4-3).

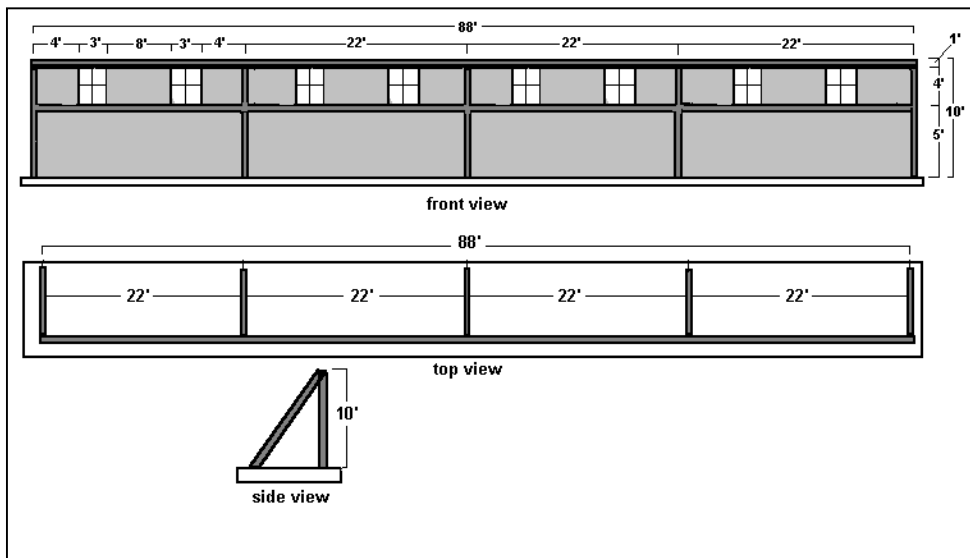

Figure 4-3. Station 2—window breaching.

c. **Station 3.** This station is a facade that looks like a wall of a building. This facade is about 8 feet high by 28 feet wide. The facade has three sections that precast built panels will fit into. The precast panels are 8 feet high by 8 feet wide and can be made of

concrete, concrete masonry unit (blocks), stone, brick, wood or other material. They are designed to accommodate thermal and explosive breaching techniques (Figure 4-4).

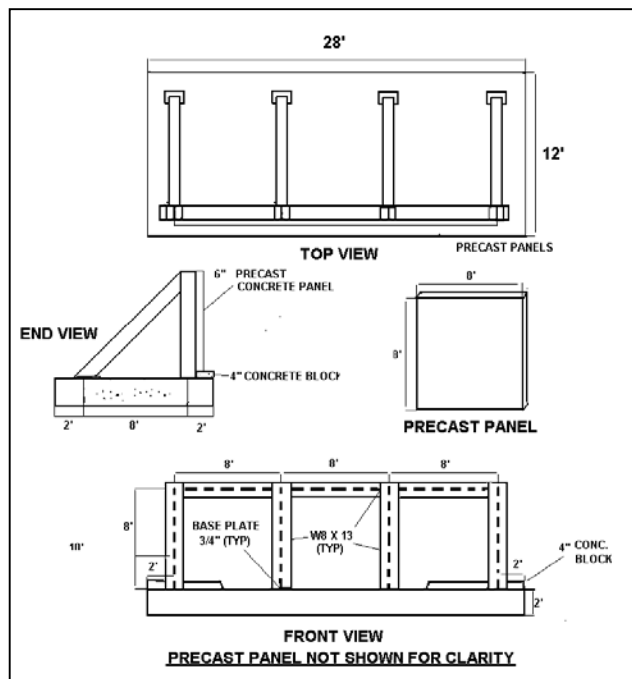

Figure 4-4. Station 3—wall breaching.

4-3. TRAINING AUDIENCE

The facility provides Infantry, Engineer, MP, and Cavalry leaders with a facility to train and evaluate individual and leader breaching tasks. Unit training requirements determine the size of the unit and the tasks to be trained at this facility. The individual tasks trained at the breach facility are as follows.

- 051-193-1003, Prime Explosives Nonelectrically.
- 071-440-0027, Execute a Mechanical Breach.
- 071-440-0030, Conduct an Explosive Breach.
- 051-193-1055, Construct a Nonelectric Initiating Assembly with Modernized Demolition Initiators (MDI).
- Conduct a Thermal Breach (Engineers only)

4-4. TRAINING INFORMATION

Many types of organizations (Combat, CS, CSS) can train at this facility. Tactical operations in an urban environment may range from combat missions to stability and support actions. Commanders should note that this facility is an individual task and technique trainer. Training at the breach facility should be conducted prior to conducting collective training at the UAC, shoot house, and the CACTF. Trainers *must be certified* before conducting demolition training per local SOP or MACOM policy.

4-5. CONDUCT OF TRAINING

Trainers develop realistic time requirements for each task to be trained based on the crawl, walk, and run concept and the size of the unit to be trained. The training event may be arranged in any order as long as it builds from simple to complex task and techniques. Table 4-1 contains a sample sequence of events to assist units in developing their training plan. Leaders should do the following prior to conducting training:

- a. Identify the unit’s critical missions (see commander’s training guidance) and select those tasks that support specific METL related to urban operations.
- b. Arrange the related tasks in the order of their importance to mission accomplishment.
- c. Assess the unit’s current level of proficiency (strengths and weaknesses) and determine the degree of difficulty of each task. The training events should start from the less difficult tasks to the more difficult tasks to instill confidence in the soldiers conducting the training. Leaders should consult FM 90-10-1 for more information on explosive breach techniques.
- d. Identify the individual and leader tasks that are to be trained.
- e. Set up training conditions based on unit proficiency.

NOTE: Before conducting ballistic breaching with automatic weapons, leaders should consult FM 90-10-1.

| ELEMENT | EVENT ACTION | ESTIMATED TIME |
|------------------------------------|--|----------------|
| 3rd Squad 1st Squad 2d Squad | Wall Breach: Explosive (crawl, walk, run) Door Breach: Mechanical, Ballistic, Explosive (crawl, walk, run) Window Breach: Mechanical, Explosive (crawl, walk, run) | 3 hours |
| 2d Squad 3rd Squad 1st Squad | Wall Breach: Explosive (crawl, walk, run) Door Breach: Mechanical, Ballistic, Explosive (crawl, walk, run) Window Breach: Mechanical, Explosive (crawl, walk, run) | 3 hours |
| 1st Squad 2d Squad 3rd Squad | Wall Breach: Explosive (crawl, walk, run) Door Breach: Mechanical, Ballistic, Explosive (crawl, walk, run) Window Breach: Mechanical, Explosive (crawl, walk, run) NOTE: Walls, doors, and windows require replacement after each run/iteration to train to standards. | 3 hours |

Table 4-1. Example platoon sequence of events.

4-6. TRAINING SUPPORT REQUIREMENTS

Table 4-2 depicts minimum requirements based on three breach teams for each platoon-size element. This facility is resource intensive, and Table 4-3, page 4-6, depicts the total annual requirements per platoon-size element.

| AMMUNITION/EQUIPMENT | Crawl | Walk | Run |
|---|----------------|---------------------------------------|---|
| Mechanical Breach: Prying , Striking, or Cutting Tool | | | |
| Door | (talk through) | 1 per team (defeat one lock) | 1 per team (defeat hinges) |
| Window | (talk through) | 1 per team (defeat one lock) | 1 per team (defeat hinges) |
| Ballistic Breach: Door Shot Gun *1 | (talk through) | 2 rds per weapon (defeat one lock) | 5 rds per weapon (defeat hinges) |
| RLEM (inert) *2 NOTES: * 1. If available to unit. 2. Rifle launched Entry munition (RLEM). | (talk through) | 1 per team – inert | 1 per team - service |
| Explosive Breach: Door: Det Cord (flex linear charge) Non electric firing system | (build) | (practice emplacement) | 29 feet per team 1 per team |
| Wall: C4 (satchel charge) Non electric firing system | (build) | (practice emplacement) | 4 blocks per team 23 feet per team 1 per team |
| Window: Det Cord (flex linear charge) Non electric firing system | (build) | (practice emplacement) | 29 feet per team 1 per team |
| Thermal Breach Equipment Sappers (Only) | 1 | 1 | 1 |

Table 4-2. Consolidated minimum support requirements.

| AMMUNITION/EQUIPMENT | TOTAL |
|----------------------------|-------------------|
| Doors | 6 |
| Windows | 6 |
| Wall Panels | 6 |
| Shot Gun Rounds | 42 |
| RLEM | 6 inert/2 service |
| DET Cord (feet) | 486 |
| C4 (blocks) | 24 |
| Nonelectric firing systems | 18 |

Table 4-3. Consolidated annual support requirements.

4-7. TRAINING AND EVALUATION

Individual training is the first step in the building-block approach and sets the basis for unit or collective training. Mastery of individual skills is an essential precondition for urban operations training and a good method for conducting individual training is through concurrent training. Concurrent training is designed to train groups of soldiers on different tasks or techniques and these tasks or techniques may or may not be related. For example, a leader may subdivide the unit at the breach facility into breaching orders. One group of soldiers may be conducting an explosive breach, while other groups are conducting mechanical and ballistic breaches. Ballistic breaching and explosive breaching does have a SDZ, an MSD, and ricochet considerations.

4-8. SAFETY CONSIDERATIONS

Safety requires effort on the part of everyone. It is not enough to teach safety rules; the rules must be practiced and enforced. Depending on the nature of the obstacle that must be breached, the breacher may use anyone of the following techniques: mechanical, ballistic or explosive techniques. The following guidelines should be followed when training at the Breach Facility. Wear all appropriate personal protective equipment and follow appropriate guidelines:

- Safety glasses.
- Hearing protection.
- Body armor.
- Helmet.
- Gloves.
- Elbow and knee pads.
- Inspect equipment before use.
- Use appropriate tool.
- Use appropriate amount of explosive not to exceed 4 blocks of C4.

- Stay within the surface danger zone.
- Always use the minimum safe distance.
- Do not modify tool.
- Ensure proper use and maintenance of hydraulic and pneumatic tools; tools can burst under pressure when improperly used.

CHAPTER 5

COMBINED ARMS COLLECTIVE TRAINING FACILITY

The home station CACTF is a training facility designed to conduct multi-echelon, full-spectrum operations training up to battalion TF level. Sample company and platoon STX lanes, and support and stability operations tasks, are provided to assist the units in developing training plans.

5-1. PURPOSE

The leader or commander is provided with a CACTF to evaluate unit urban operations proficiency. The CACTF is intended to support blank fire, MILES/TES, SESAMS, STX, and FTX scenarios on a semiannual basis. The CACTF supports branch-specific lane training and combined arms training up to battalion level across the full spectrum of operations: offense, defense, stability, and support.

5-2. DESCRIPTION

The CACTF replicates an urban environment. The facility consists of 2.25 square kilometers of urban sprawl with 20 to 26 buildings, roads, alleys, parking areas, underground sewers, parks, athletic fields, and command and control building. The actual size and configuration of the CACTF depends on the local installation site requirements. The CACTF is designed to support heavy and light infantry, armor, artillery, and aviation positioning and maneuver. Table 5-1 shows the recommended types of buildings and features in the CACTF.

| 20 TO 26 BUILDINGS (1.5 km by 1.5 km) | |
|---|---|
| <ul style="list-style-type: none"> • Tunnel/sewer system. • Shanty town. • One, three-story building. • Three, two-story buildings. • Industrial area. • Electricity and potable water. • City dump. | <ul style="list-style-type: none"> • Props/furniture. • Targetry. • Audio/image capture with an EDIT/REPLAY. • Control Building with AAR facility. • Breachable walls. |

Table 5-1. CACTF characteristics.

a. The buildings have one, two, or three stories (some with basements), sloped and flat roofs. CACTF building variations pose different tactical and technical training challenges. Figure 5-1 depicts an example CACTF containing 24 buildings with the following characteristics:

- (1) The hotel is a dominating structure typical of a central business district. The hotel has an elevator shaft, fire escapes, and a large first-floor lobby.
- (2) The two-story office building contains a series of identical rooms.
- (3) The school has a long, central corridor, large windows, and a single large room.
- (4) The townhouse has multiple sections with a common attic.
- (5) The service station accommodates combat vehicles in its service bay.

- b. The buildings have other features that enhance the CACTF's training value.
- (1) Constructed mouse-holes permit movement between rooms and floors.
 - (2) Loopholes in roofs and outside walls allow observation and fields of fire.
 - (3) Roof hatchways lead to the top floors of multiple story buildings.
 - (4) Rooms vary in size and in quantity of doorways and windows. These variations require soldiers to identify rooms that provide suitable indoor fighting positions for TOW, Javelin, Dragon, and AT4 antitank weapon systems.

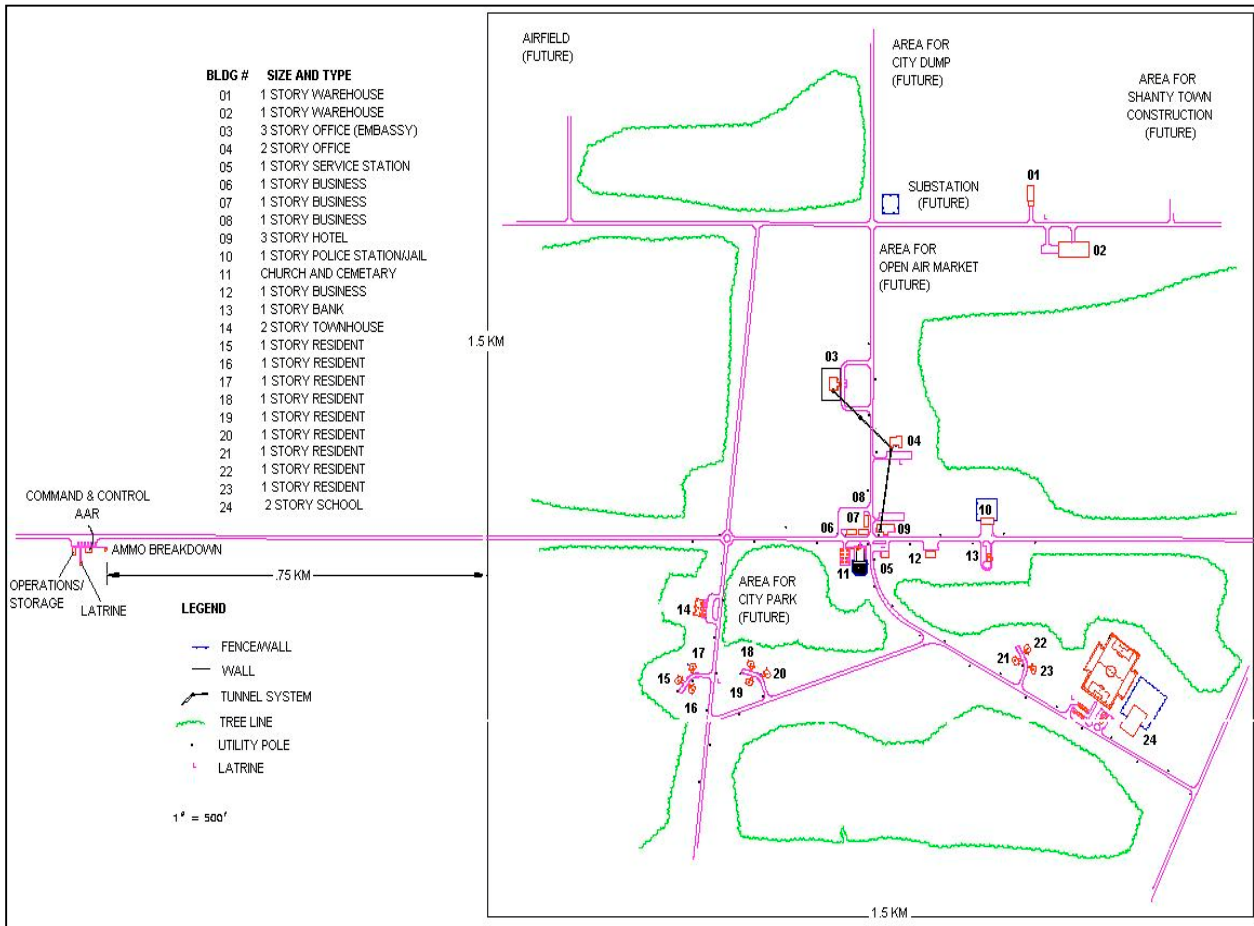

Figure 5-1. Example CACTF schematic.

c. Buildings are arranged in a realistic urban pattern. The CACTF represents an area consisting mainly of residential, commercial, public institutional, and light industrial buildings. Buildings and streets are arrayed with sufficient dispersion to allow up to nine platoon-size STX sectors (Figure 5-2) or three company/team STX sectors (Figure 5-3).

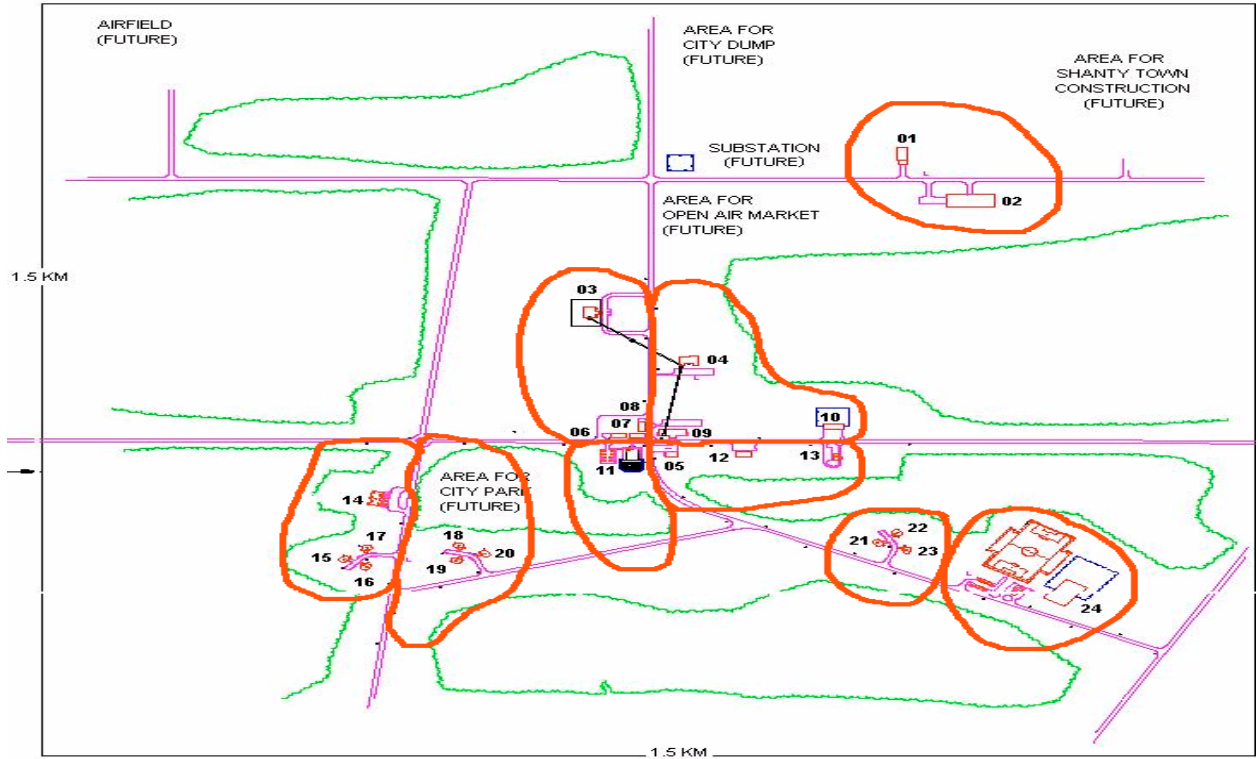

Figure 5-2. Platoon ODSS STX sectors.

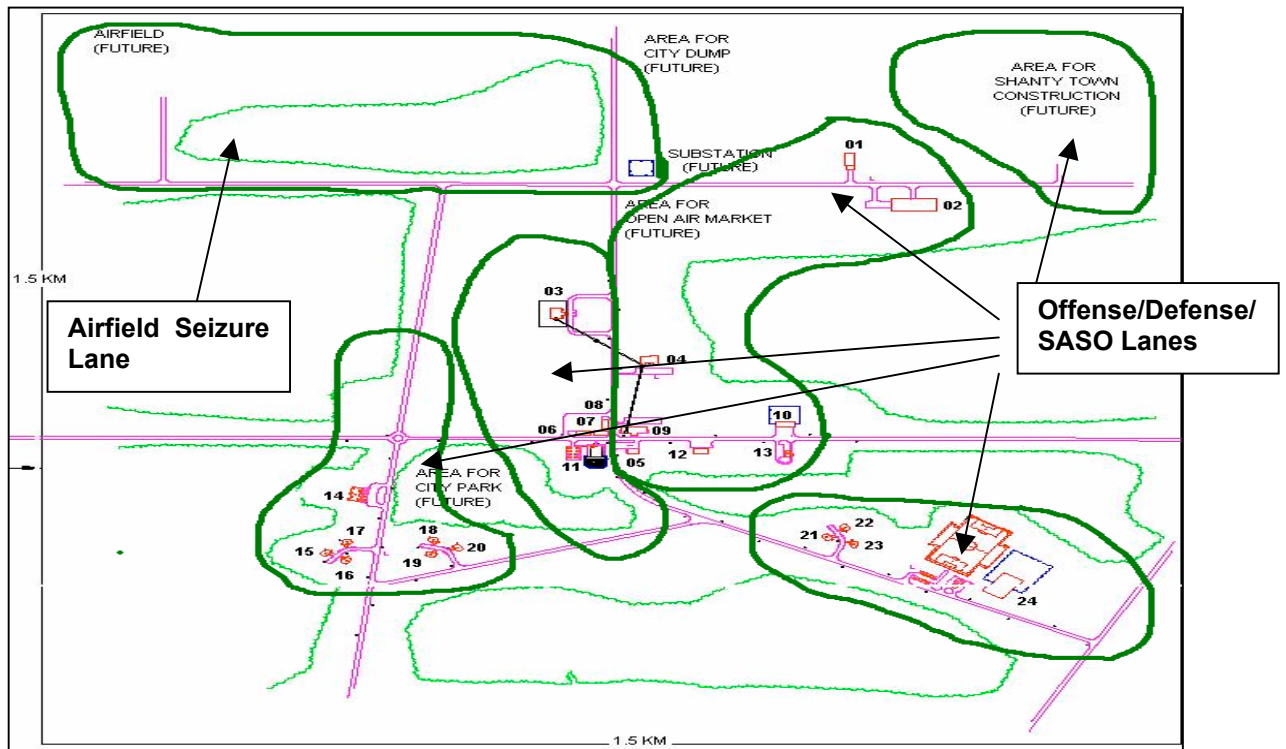

Figure 5-3. Company/team STX sectors.

d. Other urban features pose a variety of terrain considerations. The street network includes one and two-lane primary, secondary, local, and service roads. They join in T-shaped, L-shaped, and four-way intersections. Other features may be used to enhance realism such as signs, benches, furniture, newsstands, utility poles, street lights, vegetation, simulated rubble, live civilians on the battlefield, role players, and OPFOR. Open areas next to the CACTF can be used for maneuvering and staging areas. The specific details and layout of the CACTF may vary from one installation to another.

CAUTION

Trainers must ensure that fighting position reinforcement does not exceed the weight limits of the buildings in order to avoid structural damage and safety hazards to the soldiers.

5-3. TACTICAL EXERCISE WITHOUT TROOPS

A terrain walk and a TEWT may be conducted in a local downtown area to prepare leaders and to take advantage of the available time in the CACTF. Terrain walks and TEWTs are conducted to teach leaders the tactical value of urban terrain. Appendix A contains training tips and additional information regarding the conduct of a TEWT.

5-4. URBAN OPERATIONS COLLECTIVE TRAINING EXERCISES

Leaders use training exercises to train, evaluate, and practice performance-oriented collective tasks. TEWT, STX, and FTX are the three types of exercises covered in this chapter. Each is designed to help the trainer develop urban operations training skills and increase unit proficiency in an urban environment. The urban operations collective training exercises were developed using the standard CACTF described in this chapter and may be modified to fit available urban operations facilities. This chapter contains the following examples of STX and FTX scenarios and OPORDs.

- Infantry Rifle Platoon Attack STX.
- Mechanized Infantry Platoon Defend STX.
- Infantry Rifle Company Attack FTX.
- Mechanized Infantry Company Team Defend FTX.

a. These exercises were developed based on the principles outlined in ARTEPs, MTPs, and on the guidance provided in FM 25-101, FM 25-4, and TC 7-98-1.

b. This chapter provides examples of offensive and defensive scenarios for combat in urban areas. Paragraphs 5-5 and 5-6 include two platoon STXs, and paragraphs 5-7 and 5-8 include two company FTXs. Each of the example scenarios can be conducted with blank fire, MILES/TES, 9-mm/5.56-mm SESAMS for short-range precision target engagements (less than 50 meters), or force on force. The example exercises are designed to help the commander develop, sustain, and evaluate the unit's mission proficiency.

5-5. INFANTRY RIFLE PLATOON STX ATTACK

=

INFANTRY RIFLE PLATOON SITUATIONAL TRAINING EXERCISE ATTACK

1. Objective.

This example STX trains collective, leader, and individual tasks for the platoon operation, Attack in a Built-Up Area.

2. Interface.

This STX is supported by two drills from ARTEP 7-8-Drill: React to Contact and Enter and Clear a Building.

3. Training.

a. *Guidance.* ARTEP 7-8-MTP (Chapter 4), FM 25-100, and FM 25-101 provide training guidance, tips, and enhancers for planning and executing STXs. The trainer should review the individual, leader, and collective tasks to be performed during the STX to determine the ones that require initial or refresher training.

b. *General Situation.*

(1) The exercise scenario is as follows: Contact with the enemy has been reestablished. Initial reports indicate he is at 65 to 70 percent strength and has not been reinforced. His defensive positions are located in the CACTF and are not well established. He has the capability for indirect fire and CAS; he has already used chemicals and will probably do so again. The platoon receives an order to prevent the enemy from establishing a heavily fortified defense in the CACTF. Such a defense could prevent friendly forces from continuing offensive operations.

(2) This exercise begins when the platoon leader receives the company FRAGO, and it ends after the platoon consolidates and reorganizes on the objective. An AAR should be held after completing the task, React to Contact, and at the completion of the exercise. If necessary, portions of the exercise should be repeated until the platoon performs them to standard. Figure 5-4 provides a graphic scenario of task performance for the STX Attack. Table 5-2 provides a recommended sequence for performance of T&EOs from ARTEP 7-8-MTP and the time allotted for each portion of the STX.

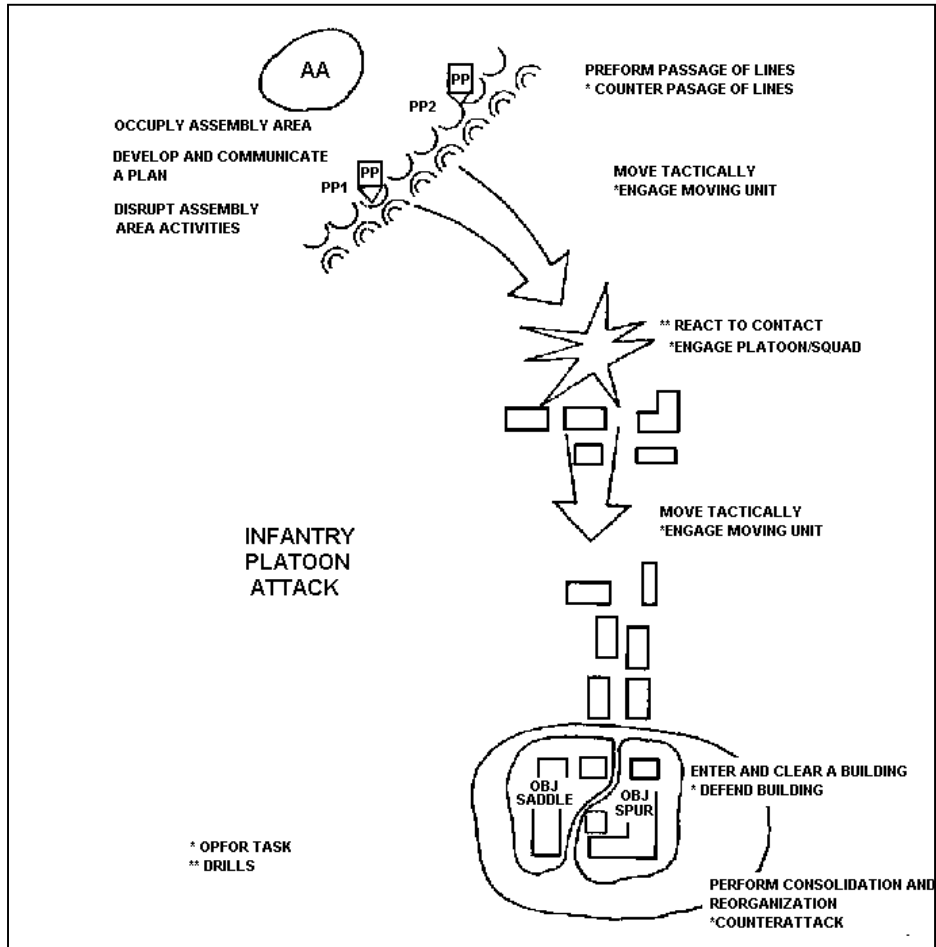

Figure 5-4. Attack STX scenario.

| EVENT | ACTION | ESTIMATED TIME |
|--|--|---------------------|
| 1 | Occupy Assembly Area | 1 hour |
| 2 | Develop and Communicate a Plan | 1 hour |
| 3 | Perform Passage of Lines | 1 hour |
| 4 | Move Tactically | 1 hour |
| 5 | React to Contact (Drill) | 30 minutes |
| 6 | Conduct Intermediate AAR | 30 minutes |
| 7 | Move Tactically | 30 minutes |
| 8 | Enter and Clear a Building (Drill) | 1 hour |
| 9 | Perform Consolidation and Reorganization | 1 hour |
| 10 | Conduct Final AAR | 1 hour |
| | * Total Time | 8 hours, 30 minutes |
| * Conducting an exercise at night or in increased MOPP requires additional time. | | |

Table 5-2. Sequence of events and times for STX attack.

c. *Special Situation.* The platoon is part of a company in a secure assembly area when a FRAGO to attack is received (Figure 5-5).

1. SITUATION. The company is opposed by one platoon.

a. *Enemy Forces.* The enemy is at 65 to 70 percent strength. He is preparing a defense in CACTF (**MOUT site**) to prevent friendly forces from continuing to attack along the CACTF avenue of approach. He is expected to use artillery-delivered nonpersistent nerve agents in the defense of CACTF.

b. *Friendly Forces.* (Battalion designation) attacks (**date-time group**) to destroy enemy forces at OBJ COWBOY (**CACTF**) in order to pass follow-on forces, allowing friendly forces to continue the attack.

2. MISSION. (___) Company seizes OBJ HORSE (CACTF) vicinity (**grid**) NLT (**date-time group**) to prevent the enemy from establishing a heavily fortified defense.

3. EXECUTION.

a. *Concept of the Operation.* (See overlay.) The company moves in a wedge to Assault Position 1, assault CACTF to seize OBJ HORSE, consolidate, and reorganize.

(1) Maneuver. (**Evaluated**) Platoon will lead the company and be the main effort in the attack. They seize OBJ SADDLE vicinity (**grid**) to allow passage of friendly elements through CACTF. (___) Platoon moves on the company's left and seize OBJ SPUR vicinity (**grid**) to protect the left flank of the main effort. (___) Platoon moves on the company's right and establish a support-by-fire position located vicinity (**grid**).

(2) Fire support. fires are used to obscure movement to OBJ HORSE and to suppress the enemy during the assault. Priority of indirect fires is to (**evaluated**) Platoon, which is allocated one priority target (**120-mm mortar**).

b. *Tasks to Maneuver Unit.*

(1) (**Evaluated**) Platoon.

(a) Use Passage Point 1.

(b) Orient defense from TRP 2 to TRP 3.

(c) Be prepared to employ a wire-mined obstacle vicinity TRP 5 during consolidation.

Figure 5-5. Example FRAGO for STX attack.

- (2) () Platoon.
 - (a) Use Passage Point 2.
 - (b) Orient defense from TRP 1 to TRP 2.
- (3) () Platoon
 - (a) Use Passage Point 2.
 - (b) Orient defense from TRP 3 to TRP 4.
 - c. *Coordinating Instructions.*
 - (1) Company RP is located (grid).
 - (2) Company linkup is (grid).
 - (3) MOPP1 is in effect (date and time).
 - (4) Selective rubbleing is authorized. Destruction of an area larger than one city block requires brigade commander approval.

Figure 5-5. Example FRAGO for STX Attack (continued).

4. Support Requirements.

- a. *Minimum Trainers/Evaluators:* This exercise can be conducted with the company commander or platoon leader acting as the trainer or primary evaluator. At least one more controller or evaluator is required with the OPFOR. Other platoons being trained or evaluated will increase support personnel requirements.
- b. *Vehicles/Communications:* All vehicles organic to the platoon should be included. The OPFOR should also possess some combat or combat support vehicles.
- c. *Opposing Force:* The OPFOR should consist of at least a reinforced squad.
- d. *Maneuver Area:* A training area at least 4 by 15 km is needed for cross-country movement and infiltration and the CACTF is the ideal objective area. The terrain should offer multiple covered and concealed approaches to the objective.

5. Evaluation.

Table 5-3 lists the T&EOs from ARTEP 7-8-MTP used to evaluate this STX.

| TASK/FUNCTION | TASK NUMBER |
|--|-------------|
| Perform Passage of Lines | 7-3-1125 |
| Move Tactically | 7-3-1134 |
| Occupy Assembly Area | 7-3-1136 |
| Develop and Communicate a Plan | 7-3-1605 |
| Perform Consolidation and Reorganization | 7-3-1607 |

Table 5-3. T&EOs used to evaluate STX attack.

5-6. MECHANIZED INFANTRY PLATOON STX DEFEND

- 1. **Objective.** This example STX trains collective, leader, and individual tasks for the platoon operation, Defend Urban Area/Building.
- 2. **Interface.** This STX is supported by two drills from ARTEP 7-8-Drill: React to Contact, and Enter and Clear a Building.
- 3. **Training.**

a. *Guidance.* ARTEP 7-8-MTP (Chapter 4), FM 25-100, and FM 25-101 provide training guidance, tips, and enhancers for planning and executing STXs. The trainer should review the individual, leader, and collective tasks to be performed during the STX to determine which require initial or refresher training.

b. *General Situation.*

(1) The exercise scenario is as follows: Latest INTSUMs indicate that enemy forces are expected to use a high-speed avenue of approach to counterattack. The approach is dominated by a small urban area containing strongly constructed buildings. The enemy has the capability for indirect fire, CAS, and chemicals. A defense in and around the town is necessary to deny the enemy the use of the avenue of approach. The platoon, as part of a larger force, is ordered to occupy and prepare defensive positions that overlook the avenue of approach. Indirect fire is available.

(2) Conduct of the exercise begins when the platoon receives an OPORD to move to establish a platoon defensive position. An AAR should be conducted after soldiers enter a building and clear a room, and a final AAR should be conducted once all evaluation notes are compiled. If necessary, portions of the exercise should be repeated until the platoon's performance is satisfactory.

(3) When the platoon receives a warning order to prepare to move to establish a defense, the platoon is part of a company, which is part of a task force, and is located in an assembly area. Figure 5-6 provides a graphic scenario of task performance for the Defend STX. Table 5-4 provides a recommended sequence for performance of T&EOs from ARTEP 7-8-MTP and the time allotted for each portion of the STX.

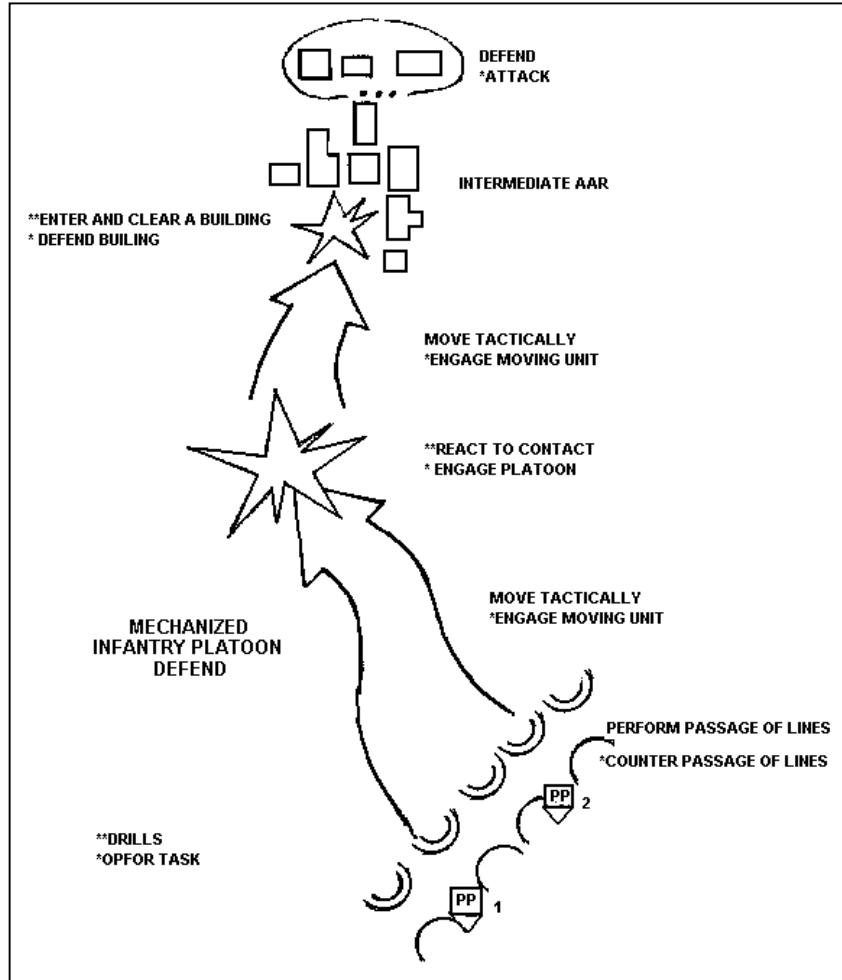

Figure 5-6. Defend STX scenario.

| EVENT | ACTION | ESTIMATED TIME |
|---|------------------------------------|---------------------|
| 1 | Perform Passage of Lines | 1 hour |
| 2 | Move Tactically | 30 minutes |
| 3 | React to Contact | 1 hours |
| 4 | Move Tactically | 30 minutes |
| 5 | Enter and Clear a Building (Drill) | 1 hour |
| 6 | Intermediate AAR | 30 minutes |
| 7 | Defend MOUT/Building | 6 hours |
| 8 | Conduct Final AAR | 1 hour |
| | *Total Time | 11 hr 30 min |
| *Conducting an exercise at night or in increased MOPP requires additional time. | | |

Table 5-4. Sequence of events and times for STX defend.

c. *Special Situation.* Thirty minutes after receiving the warning order, the platoon receives the company OPORD (Figure 5-7).

(Classification)

Copy no ___ of ___ copies
 ___ Battalion, ___ Infantry
 Unit location or place of issue
 Date-time group (with time zone)
 Message reference number

OPERATION ORDER NO. _____

References: Map, series no. ____, sheet no. ____, edition ____

Time Zone Used Throughout the Order: _____

TASK ORGANIZATION:

___ Platoon, ___ Platoon(-), ___ Platoon,

Company Control
 Company HQ
 1/1/C-52d Engr
 1/2 ____,
 (Reserve)
 Company Trains

1. SITUATION.

a. Enemy Forces.

(1) *Composition, Distribution, and Strength.* We are opposed by elements of the Liberation Guards Militia, Red Brigade. Several platoon-sized outposts are located within the battalion sector and consist of about 30 to 35 soldiers per platoon. They are equipped with an assortment of Soviet small arms, including AK-47s, RPKs, RPGs, and various wheeled and tracked vehicles including some BMPs. Enemy outposts are at 60 to 70 percent strength and have indirect fire assets available.

(2) *Capabilities.* The enemy units are well entrenched in their defensive positions. The strongpoints have dedicated fire support assets and are capable of using non-persistent nerve agents to prevent coordinated attacks. No enemy air threat exists but some heavy armored vehicles have been sighted in the area.

(3) *Probable Course of Action.* Intelligence indicates the enemy strongpoints will continue to fortify their positions until relief arrives within 24 hours in the form of a main enemy counterattack.

b. Friendly Forces. () TF defends in sector NLT () along PL () to deny enemy forces use of avenue of approach (). () TF must be prepared to continue movement forward of PL (), on order.

(1) Missions of units on left and right are (as required).

(Classification)

Figure 5-7. Example OPOD for STX defend.

(Classification)

(2) () TF defends in sector NLT () from (grid) to (grid) to (grid) to contain any penetrations of the brigade sector.

(3) () Battery, () Battalion provides DS to 1st Brigade.

c. **Attachments and Detachments.** 1/1/C-52d Engineers attached.

2. MISSION. () Company blocks enemy forces NLT (date-time group) to prevent them from using high-speed avenues of approach through (name of MOUT site), and to prevent the enemy from counterattacking into the battalion sector.

3. EXECUTION.

a. **Concept of the Operation.** (See overlay.) Company prevents the enemy from using the high-speed avenues of approach through (MOUT site) by moving to the site and establishing a blocking position, which overwatches the platoon BPs covering the main avenues. We will block in depth by placing two platoons forward and one back, and maintaining a reserve to block any penetration. We must ensure our sectors of fire are placed to mass fire at the decisive point.

(1) *Maneuver.* (Evaluated) Platoon acts as the main effort, blocking from BP (), vicinity (grid), to prevent enemy penetration of PL (). () Platoon occupies BP (), vicinity (grid), to block enemy movement into the main effort's left flank. () Platoon occupies BP () to prevent the enemy from making a coordinated attack on the main effort.

(2) *Fire Support.* The purpose of fires is to disrupt the enemy when his counterattack reaches PL (). Priority of indirect fires is to (evaluated) Platoon, which is allocated two 155-mm priority targets, one of which may be used as an FPF.

(3) *Intelligence.* Priority of collection is to identify and locate enemy combat reconnaissance patrols and the enemy main effort.

(4) *Engineering.* During movement to the battle position, obstacles are used to ensure mobility. During blocking actions, the purpose of obstacles is to prevent the enemy from advancing on larger streets and to canalize him into more restrictive terrain. Priority of effort is to countermobility. Priority of support is to (evaluated) Platoon.

b. Tasks to Maneuver Units:

(1) *(Evaluated) Platoon:*

(a) Conduct passage of lines using PP 1.

(b) Lead the company movement after crossing the LD. Be prepared to react to enemy contact when (MOUT site) is reached.

(c) Enter and clear building(s) (number determined by commander).

(Classification)

Figure 5-7. Example OPORD for STX defend (continued).

 (Classification)

- (d) Occupy BP () and orient on TRPs 2 and 3.
 - (e) Establish an OP vicinity (grid) to observe main avenue of approach.
 - (2) () *Platoon*:
 - (a) Conduct passage of lines using PP 2.
 - (b) Move second in order of movement.
 - (c) Enter and clear building(s) (number determined by commander).
 - (d) Occupy BP () and orient on TRP 1.
 - (3) () *Platoon*:
 - (a) Conduct passage of lines using PP 3.
 - (b) Move last in order of movement.
 - (c) Enter and clear building(s) (number determined by commander).
 - (d) Occupy BP () and orient on TRPs 4 and 5.
 - (e) Establish an OP vicinity (grid).
- c. **Tasks to Combat Support Units:** Engineer squad travels with the company headquarters behind (evaluated) Platoon and supports the main effort's emplacement of obstacles.
- d. **Coordinating Instructions.**
- (1) Timings.
 - (a) Brief back _____.
 - (b) Company rehearsal _____.
 - (c) SP time _____.
 - (d) In position NLT (time) _____.
 - (2) Report all enemy contact.
 - (3) Report crossing all phase lines.
 - (4) MOPP status ____; enemy chemical attack is expected.
 - (5) Air defense status is YELLOW, WEAPONS HOLD.
 - (6) Leaders briefback the movement and defense plan to the commander at the company CP at (date-time group).
 - (7) Destruction of subterranean approaches requires brigade commander's approval.
 - (8) Selective rubbleing is authorized. Destruction of more than one building requires commander's approval.
 - (9) Marking of rooms and buildings is IAW CO SOP.

 (Classification)

Figure 5-7. Example OPORD for STX defend (continued).

(Classification)

- (10) Rules of Engagement are as follows:
- (a) Minimize collateral damage to structures.
 - (b) Civilians have been evacuated. Evacuate to company CP any other civilians encountered.

4. SERVICE SUPPORT. IAW the battalion SOP.

a. Miscellaneous.

- (1) Battalion trains located vicinity (grid).
- (2) Company trains located vicinity (grid).

b. Materiel and Services.

- (1) *Supply.*
 - (a) Class I. Ration Cycle M-M-M. Platoons must maintain a three-day supply in each BP.
 - (b) Class II. Submit requirements for special equipment ASAP. Coordinate with 1SG.
 - (c) Class III. Refuel all vehicles before (date-time group).
 - (d) Class IV. Coordinate with S4 for delivery.
 - (e) Class V.

Platoons cache one additional basic load in BP.

Platoons submit request for additional demolitions NLT (date-time group).

- (2) *Services.* Battalion decontamination site is located vicinity (grid).
- (3) *Maintenance.*
 - (a) Priority to (evaluated) Platoon M2 BFVs.
 - (b) UMCP located vicinity (grid).

c. Medical Evacuation and Hospitalization.

- (1) Battalion aid station located vicinity (grid).
- (2) Company CCP located with company CP.

d. Personnel.

- (1) No replacements for next 72 to 96 hours.
- (2) Brigade mortuary affairs point located in BSA.
- (3) EPW collection sites located at (grid) for battalion and (grid) for company.

(Classification)

Figure 5-7. Example OPORD for STX defend (continued).

(Classification)

5. COMMAND AND SIGNAL.

a. **Command.** Initially, company CP will be traveling center of company wedge. Location in BP to be determined.

b. **Signal.**

- (1) Current SOI in effect.
- (2) Primary means of communication in BP is wire, FM, messenger, in that order.
- (3) Radio listening silence is in effect until after crossing PL (____) or until contact is made.

(Classification)

Figure 5-7. Example OPORD for STX defend (continued).

4. Support Requirements.

a. *Minimum Trainers/Evaluators:* This exercise is conducted by one company grade officer who is the trainer and primary evaluator.

b. *Vehicles/Communications:* All vehicles organic to the platoon should be included.

c. *Opposing Force:* The OPFOR should be platoon strength.

d. *Maneuver Area:* A training area at least 2 by 10 km, with hasty fighting positions, is desirable for cross-country movement. The CACTF serves as the objective area. The terrain, ideally, should offer multiple covered and concealed routes. Using terrain that limits the leader to a geographic or predictable route prevents evaluation of the unit's ability to conduct a terrain analysis and select covered and concealed routes.

e. *Barrier Materials.* Sufficient Class IV (sandbags, lumber, and so forth) must be made available to fortify positions, IAW chapter 3, FM 90-10-1.

5. Evaluation.

Table 5-5 lists the T&EOs from ARTEP 7-8-MTP used to evaluate this STX and Table 5-6 lists the supporting tasks.

| TASK/FUNCTION | TASK NUMBER |
|--------------------------|-------------|
| Defend MOUT/Building | 7-3-1118 |
| Perform Passage of Lines | 7-3-1125 |
| Move Tactically | 7-3-1134 |

Table 5-5. T&EOs used to evaluate STX defend.

5-7. INFANTRY RIFLE COMPANY FTX ATTACK

| FTX-1—ATTACK | | |
|--|------------------------------------|--|
| STX C-II-1 | STX C-II-2 | STX C-II-3 |
| Perform Infiltration/ Exfiltration | Perform Cordon and Search | Disarm Belligerents |
| Perform Linkup | Take Action on Contact | Handle Captured Insurgents or Belligerents |
| Execute an Assault (MOUT) | Perform Infiltration\ Exfiltration | Apprehend/Detain Noncombatants |
| Perform Consolidation and Reorganization | Perform Linkup | |
| | Perform Passage of Lines | |
| | Occupy Assembly Area | |

Table 5-6. Supporting tasks for company FTX.

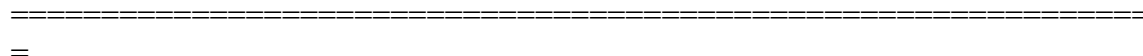

**INFANTRY RIFLE COMPANY
FIELD TRAINING EXERCISE
ATTACK**

1. **Objective.** This FTX is designed to train the infantry rifle company in conducting offensive operations. This exercise provides practice for the company commander, platoon leaders, squad leaders, and company headquarters personnel in planning, coordinating, and controlling combat operations.
2. **Interface.** This FTX is supported by STX C-II-1, C-II-2, and C-II-3 (Table5-6). It is also supported by two drills from ARTEP 7-8-Drill: React to Contact and Break Contact.
3. **Training.**
 - a. *Guidance.* ARTEP 7-8-MTP (Chapter 4), FM 25-100, and FM 25-101 provide training guidance, tips, and enhancers for planning and executing STXs. The trainer should review the individual, leader, and collective tasks to be performed during the STX to determine which require initial or refresher training.
 - b. *General Situation.*
 - (1) The battalion is ordered to conduct offensive operations in support of the brigade mission. The company is ordered to infiltrate enemy lines and to destroy an insurgent operations base located in the CACTF. The company must be prepared to remain in the CACTF to conduct cordon and search missions.
 - (2) This exercise should be conducted under various conditions.
 - (3) When the company receives the battalion warning order the planning process for the attack mission begins. The exercise ends when the company completes a passage of lines, occupies an assembly area, and completes preparations to continue its mission. Figure 5-8 shows a graphic scenario of task performance for the FTX Attack. Table 5-7 ,

page 5-18, provides a recommended sequence for performance of ARTEP 7-8-MTP T&EOs and the time allotted for each portion of the STX, including AARs.

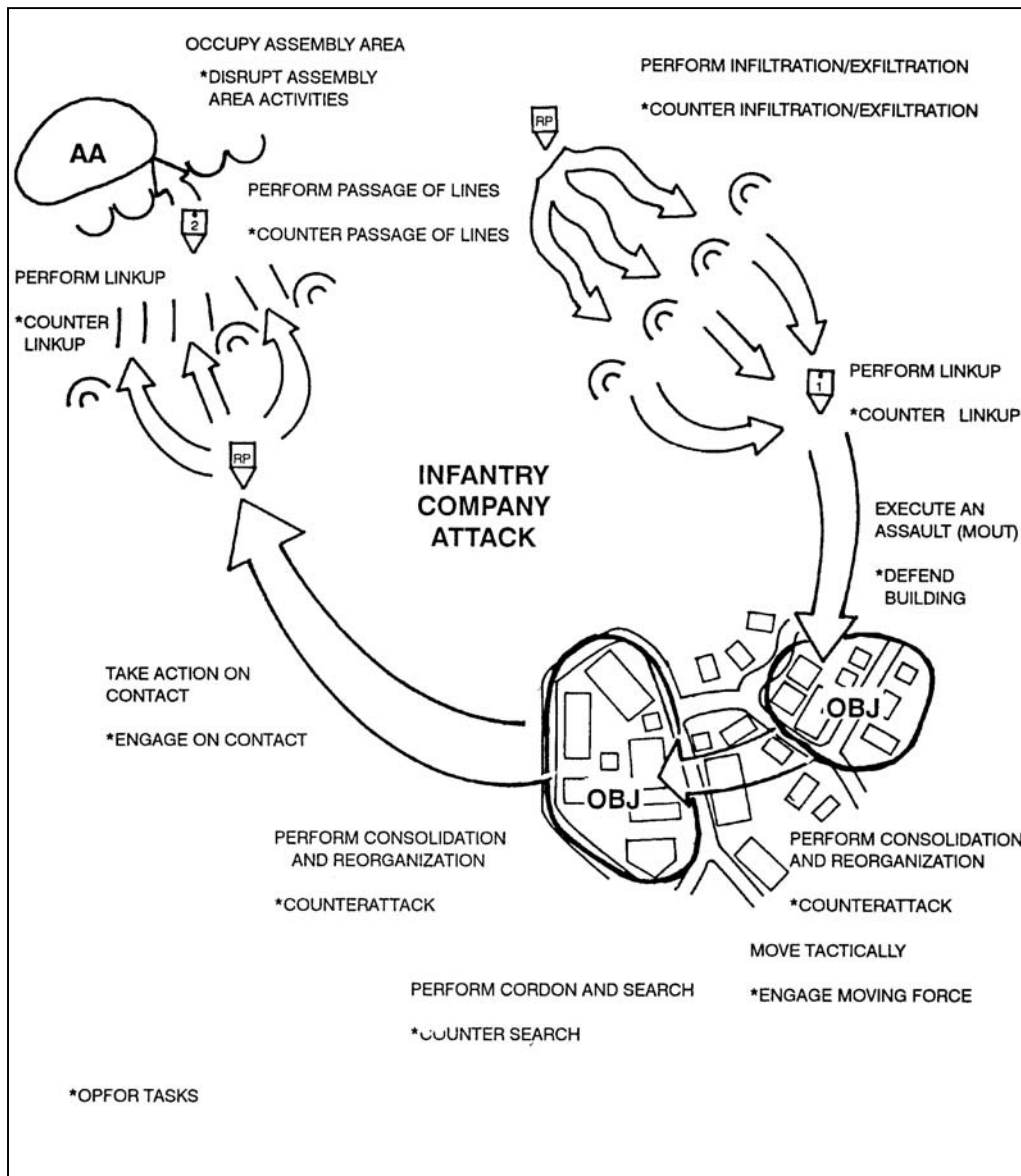

Figure 5-8. Attack FTX scenario.

| EVENT | ACTION | ESTIMATED TIME |
|--|--|-----------------|
| START STX C-II-1 | | |
| 1 | Issue Company OPORD | 4 hours |
| 2 | Perform Infiltration/Exfiltration | 6 hours |
| 3 | Perform Linkup 3 hr | 3 hours |
| 4 | Execute an Assault (MOUT) AAR | 3 hours |
| 5 | Perform Consolidation and Reorganization | 3 hours |
| ISSUE FRAGO, START STX C-II-2 | | |
| 6 | Perform Cordon and Search | 6 hours |
| 7 | Take Action on Contact AAR | 3 hours |
| 8 | Perform Infiltration/Exfiltration | 6 hours |
| 9 | Perform Linkup | 3 hours |
| 10 | Perform Passage of Lines | 2 hours |
| 11 | Occupy Assembly Area | 3 hours |
| START STX C-II-3 | | |
| 12 | Disarm Belligerents | 3 hours |
| 13 | Handle Captured Insurgents or | 4 hours |
| 14 | Belligerents | 4 hours |
| 15 | Apprehend/Detain Noncombatants | 2 hours |
| | Conduct Final AAR | |
| | ***Total Time | 55 hours |
| ** Prepare for Combat ** Maintain Operations Security ** Move Tactically ** Perform Consolidation ** Perform Reorganization ** Perform Stability and Support Operations | | |
| * The time required to train an event varies based on the factors of METT-T and on the unit's training proficiency. Regardless, training is conducted to standards, not to time limitations. | | |
| ** These tasks are integrated and evaluated throughout the exercise. | | |
| *** Time for intermediate AARs is not included in this total; additional time is required if much of the exercise is conducted at night or during other limited visibility. | | |

Table 5-7. Sequence of events and times for FTX attack.

(4) The battalion commander issues an OPORD to the company commanders (Figure 5-9).

(Classification)

Copy no ___ of ___ copies
 ___ Battalion, ___ Infantry
 Unit location or place of issue
 Date-time group (with time zone)
 Message reference number

OPERATION ORDER NO. _____

References: Map, series no. ___, sheet no. ___, edition ___

Time Zone Used Throughout the Order: _____

TASK ORGANIZATION:

___ Company ___ Company ___ Company

Battalion Control
 Scout Platoon
 81-mm Mortar Platoon
 Antitank Platoon
 1/C/58th ENGR (DS)
 Battalion Trains

1. SITUATION.

a. **Enemy Forces.** ANNEX A (See intelligence overlay [prepared by brigade S2].)

(1) *Disposition, Composition, and Strength.* The battalion is opposed by one company from the Dona Anna Militia Guards Battalion. This enemy company consists of 3 platoons with 35 to 40 soldiers, equipped with M16s, AK-47s, and LMGs. The company headquarters is currently located in the town hall of CACTF. The company is at 90 percent strength and has indirect fire support assets available.

(2) *Capabilities.* The enemy possesses nonpersistent nerve agents and indirect fire assets capable of delivery. He also has some light armored vehicles in the area, but their location is undetermined. No enemy air threat exists. However, the enemy may be able to reinforce CACTF with an additional company, within two hours.

(3) *Most Probable Course of Action.* The enemy defends CACTF and continues using it as a base of operations and to consolidate weapons and material. His intent is to prevent the capture of CACTF and its support base, provided by its facilities and population.

(Classification)

Figure 5-9 Example battalion OPORD for FTX attack.

(Classification)

b. Friendly Forces.

(1) () Brigade, () Division attacks at (date-time group) to seize the town of CACTF at (grid), to keep the enemy from using it as a base of operations. The intent is to secure the town and the road network in the area, to prevent the enemy from using it as a base of operations.

(2) () Battalion, () Infantry attacks to seize the road network at OBJ (), vicinity (grid), at (date-time group) to prevent enemy forces from counterattacking along Route ().

(3) () Battalion, () Infantry attacks at (date-time group), to seize the high ground at OBJ (), vicinity (grid), and to establish defensive positions to block enemy routes in and out of CACTF.

2. MISSION. () Battalion, () Infantry attacks at (date-time group) to seize CACTF, vicinity (grid), NLT (date-time group), to prevent the enemy from using the town as an operations and logistics base.

3. EXECUTION.

a. Concept of the Operation. The battalion will accomplish its mission, which is to deny the enemy use of CACTF and its surrounding terrain and population, by seizing the town and controlling the key areas in the vicinity. We will conduct a feint in the west and then attack the decisive point within CACTF (OBJ []).

(1) *Maneuver.* () Company conducts a feint to deceive the enemy, then the main effort (evaluated) company seizes OBJ (), to prevent the enemy from using CACTF as an operational and logistical base. () Company supports the main effort by seizing OBJ (), in order to prevent the enemy from counterattacking the main effort. () Company seizes OBJ () to support the main effort's attack.

(2) *Fire Support.* ANNEX C. (See fire support.) Purpose of fires is to suppress the enemy and to obscure movement to CACTF. Priority of artillery fires is to (feinting) Company; on order, priority will shift to (supporting effort) Company. Priority of 81-mm mortar fires is to (evaluated) Company.

(3) *Engineering.* The purpose of the engineers is to breach obstacles during the attack, to help (evaluated) Company seize OBJ (). Priority of support is to (evaluated) Company, () Company, and () Company in order. The battalion commander must authorize any booby traps, and point and hasty minefields.

(Classification)

Figure 5-9. Example battalion OPORD for FTX attack (continued).

(Classification)

b. Tasks to Maneuver Units.

(1) *(Evaluated) Company.*

- (a) Infiltrate using infiltration lane TANGO.
- (b) Seize OBJ (____), vicinity (grid), NLT (date-time group).
- (c) Be prepared to perform cordon and search of CACTF, after consolidation and reorganization.

(2) *(Supporting) Company.*

- (a) Follow (main attack) Company and infiltrate on infiltration lane TANGO.
- (b) Seize OBJ (____), vicinity (grid), NLT (date-time group).
- (c) Coordinate the attack with (evaluated) Company, so that both units attack at the same time.
- (d) Be prepared to perform cordon and search in the objective area after consolidation and reorganization.
- (e) Be prepared to assume the mission of (evaluated) Company.

(3) *(Supporting) Company.*

- (a) Infiltrate using infiltration lane ZEBRA.
- (b) Conduct feint to OBJ (____), vicinity (grid), NLT (date-time group).
- (c) Be prepared to establish defensive positions vicinity (grid) to prevent enemy movement to and from CACTF.

c. Tasks to Combat Support Units.

(1) *(Scout) Platoon.*

- (a) During movement, determine location, strength, and disposition of enemy forces in CACTF.
- (b) On order, screen the battalion flank from (grid) to (grid) to warn of the approach of enemy units from the southwest

(2) *Mortar Platoon.* Priority of mortar fire is to (evaluated) Company. Mortar platoon moves with (evaluated) Company, establishes a firing position vicinity (grid), and displaces on order.

(3) *Antitank Platoon.*

- (a) Initially, over watch from (grid) to (grid) to secure the unit infiltration.
- (b) On order, move vicinity (grid) to support (evaluated) Company's consolidation and reorganization.

(Classification)

Figure 5-9. Example battalion OPORD for FTX attack (continued).

(Classification)

(4) *1/C/58 Engineers.*

- (a) Move with (evaluated) Company to provide mobility support.
- (b) Be prepared to reduce obstacles in CACTF during cordon and search mission.

d. Coordinating Instructions.

- (1) Report when ready to execute an assault.
- (2) Report any movement of enemy forces from the southwest.
- (3) No rubble is authorized, so minimize collateral damage to property.
- (4) MOPP0 is in effect.
- (5) Terrorist threat warning is red.
- (6) Commanders brief back OPORD to battalion commander at battalion tactical CP at (date-time group).
- (7) Rules of Engagement (ROE).
 - (a) Commanders take all steps necessary and appropriate for their units' protection.
 - (b) The minimum necessary force is used to control the situation.
 - (c) Leaders must take measures to minimize risk to civilians, without endangering the unit.
 - (d) Fire is returned directly to its source, not sprayed into a general area.
 - (e) Firing ceases when the threat is over.
 - (f) Anyone trying to surrender is allowed to do so.
 - (g) Civilians and property are treated with respect.
 - (h) WP can be used vicinity CACTF to aid in isolating the objectives. The requests for indirect fire, within the town, must be authorized by the battalion commander.

4. SERVICE SUPPORT. (See Annex D.)

5. COMMAND AND SIGNAL.

a. Command.

- (1) The tactical CP moves with (evaluated) Company.
- (2) The main CP is vicinity (grid) and displaces on order.
- (3) The second in command remains in the battalion main CP.
- (4) The rear CP is the alternate battalion main CP.

(Classification)

Figure 5-9. Example battalion OPORD for FTX attack (continued).

(Classification)

- b. **Signal.**
- (1) Current SOI is in effect.
 - (2) Radio-listening silence is in effect for all elements except scouts, until prepared to attack.

ACKNOWLEDGE:

JONES
LTC

OFFICIAL:
SMITH
S3

Annexes: A—Intelligence
B—Operations Overlay
C—Fire Support
D—Service Support

(Classification)

Figure 5-9. Example battalion OPORD for FTX attack (continued).

(5) The battalion has destroyed the enemy operating in CACTF and seized the town. Two companies are defending against a limited counterattack with one company in a blocking position. The (evaluated) company receives a FRAGO (Figure 5-10, page 5-24) to conduct a cordon and search operation to locate enemy personnel and equipment remaining in the CACTF.

Enemy personnel in squad-size elements are reported by the civilian population to be hiding in the CACTF. Reports also indicate numerous weapons caches are being hidden by civilians collaborating with the enemy. Battalion has completed its mission and is preparing to conduct a cordon and search. After completing this, the battalion exfiltrates to perform a passage of friendly lines. (Evaluated) Company moves to perform cordon and search vicinity OBJ (____), beginning (date-time group) to (date-time group), to locate and seize enemy personnel or equipment. The (evaluated) company notifies the commander of the results of the search and when they are ready to start movement. They exfiltrate on order along Route Gold to perform linkup at (grid) and passage of lines at (grid). (See overlay for lanes.)

Figure 5-10. Example FRAGO for FTX attack.

4. Support Requirements.

a. *Minimum Trainers/Evaluators*: The company commander acts as the trainer/evaluator for the platoons. The battalion may direct the FTX internal evaluation along with a company evaluator and an FO evaluator. The platoon leaders and platoon sergeants are the primary trainers during the initial phases of the training. The company commander, the XO, the platoon leaders, and the platoon sergeants all act as trainers during the company phases of training. If the exercise is conducted by the battalion, either the battalion commander, XO, or S3 acts as the trainer and evaluator, but additional battalion assets may be required to support the evaluation phase. The controllers or evaluators are positioned at critical locations throughout the exercise to observe the action. They must not interfere with the conduct of the operation, except to halt it when a safety violation occurs or to conduct an AAR.

b. *Vehicles/Communications*: Those organic to the company are used in the exercise. This includes one designated medical evacuation vehicle per platoon and at least one aidman on site.

c. *Opposing Force*: The OPFOR ground force should be at least platoon-size. FTXs conducted by the company require internal resourcing; units should rotate to ensure total training. OPFOR tasks and standards are provided in each T&EO.

d. *Maneuver Area*: A training area 5 by 10 km which includes the CACTF is best for this exercise.

5. Evaluation.

Table 5-8 lists the ARTEP mission training plan T&EOs used to evaluate this STX.

| TASK/FUNCTION | TASK NUMBER |
|--|-------------|
| ARTEP 7-8-MTP | |
| Perform Cordon and Search | 7-3-1105 |
| Take Action on Contact | 7-4-1107 |
| Perform Passage of Lines | 7-4-125 |
| Perform Linkup | 7-4-1128 |
| Move Tactically | 7-4-1134 |
| Occupy Assembly Area | 7-4-1136 |
| Maintain Operations Security | 7-4-1409 |
| Prepare for Combat | 7-4-1606 |
| Perform Consolidation and Reorganization | 7-4-1607 |
| ARTEP 7-10-MTP | |
| Perform Cordon and Search | 7-2-1105 |
| Execute an Assault (MOUT) | 7-2-1109 |
| ARTEP 7-20-MTP | |
| Perform Exfiltration | 7-1-1146 |
| Perform Infiltration | 7-1-1147 |
| Perform Reorganization | 7-1-1608 |
| Perform Consolidation | 7-1-1609 |

Table 5-8. T&EOs used to evaluate STX attack.

===== END OF FTX ATTACK =====

5-8. MECHANIZED INFANTRY COMPANY OR TEAM FTX DEFEND

1. **Objective.** This FTX is designed to train the mechanized infantry company or team in conducting defensive operations in urban terrain. It also provides platoons an opportunity to prepare for full-scale FTXs conducted and evaluated by the parent battalion. This exercise provides practice for the company commander, platoon leaders, squad leaders, and company headquarters personnel in planning, coordinating, and controlling combat operations.

2. **Interface.** This FTX is supported by the STX C-II-4, C-II-5, and C-II-6 tasks shown in Table 5-9. It is also supported by two drills from ARTEP 7-8-Drill: React to Contact and Break Contact.

| FTX-2—DEFENSE | | |
|-------------------------------|----------------------------------|--------------------------------|
| STX C-II-4 | STX C-II-5 | STX C-II-6 |
| Occupy Assembly Area | Perform Ambush | Operate a Checkpoint |
| Perform Tactical Road March | Establish a Roadblock/Checkpoint | Interdict Smuggling Operations |
| Perform Relief in Place | Perform NBC Operations | Defend Convoy |
| Defend Built-Up Area/Building | Move Tactically | |
| | Perform Passage of Lines | |
| | Occupy Assembly Area | |

Table 5-9. Supporting tasks for company FTX.

3. Training.

a. *Guidance.* ARTEP 7-8-MTP, FM 25-100, and FM 25-101 provide training guidance, tips, and enhancers for planning and executing STXs. The trainer should review the individual, leader, and collective tasks to be performed during the STX to determine which require initial or refresher training.

b. *General Situation.*

(1) The battalion is ordered to conduct defensive operations in support of the brigade mission; the company is ordered to perform a relief operation and to prepare a defense in an urban area. The company remains in position for at least 36 hours before receiving a follow-on mission. Most civilians have been evacuated from the area, but a few remain. A terrorist threat exists as well as the possibility of enemy battalion-level offensive actions.

(2) This exercise should be conducted under various environmental conditions. The company also conducts operations under threat of NBC attack.

c. *Special Situation.*

(1) The planning process for the defense mission begins when the company receives a warning order. The exercise ends when the company completes the passage of lines and occupies an assembly area. Figure 5-11 shows a graphic scenario of task performance for the FTX Defend. Table 5-10, page 5-28, provides a recommended sequence for performance of T&EOs from ARTEP 7-8-MTP and the time allotted for each portion of the STX, including AARs.

(2) The battalion commander issues the defense OPORD to the company (Figure 5-12, page 5-29).

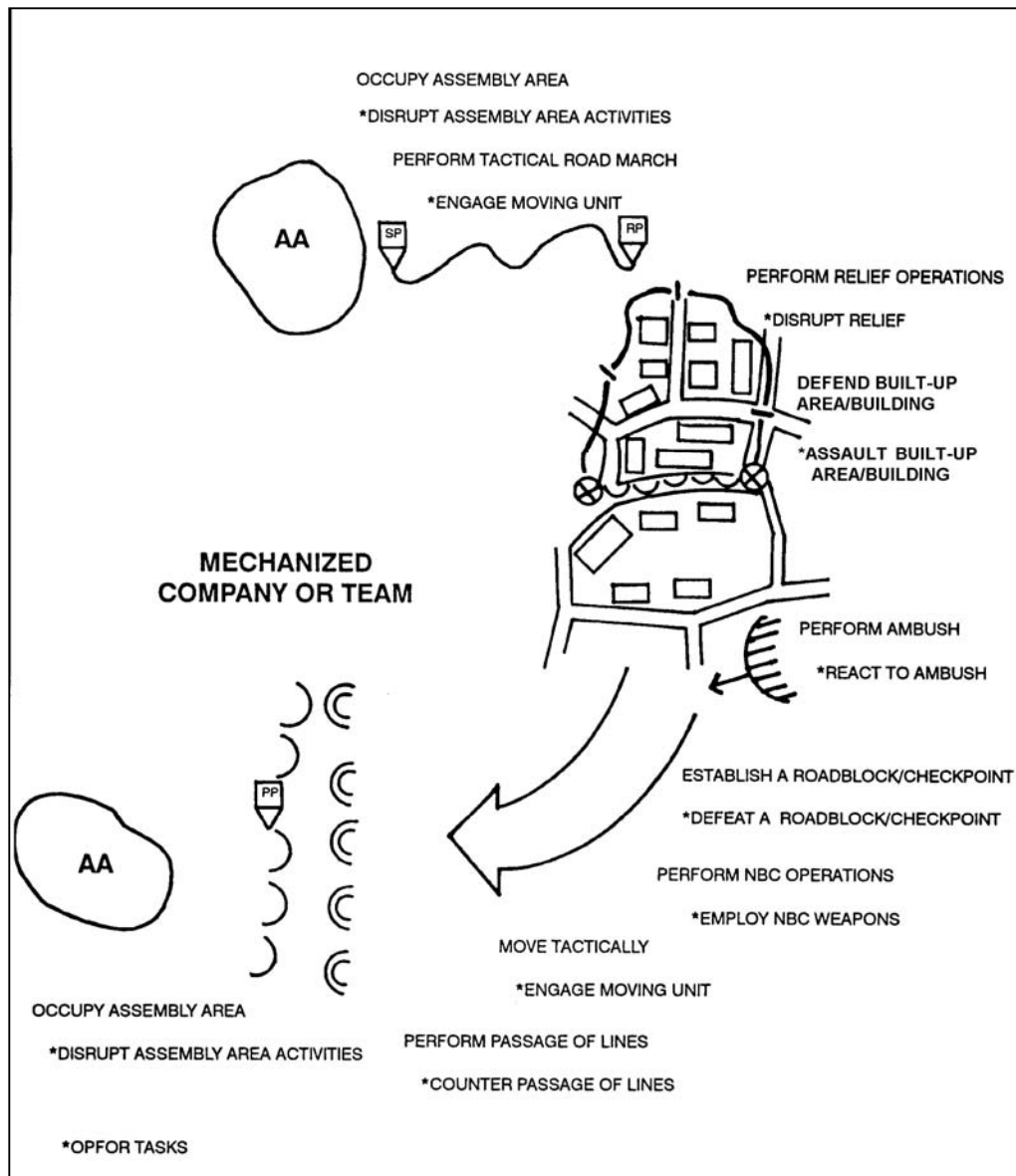

Figure 5-11. Graphic scenario of task performance for FTX defend.

| EVENT | ACTION | ESTIMATED TIME |
|---|--------------------------------------|-------------------------------|
| Start STX C-II-4 | | |
| 1 | Occupy Assembly Area | 2 hours |
| 2 | Issue Company OPORD | 4 hours |
| 3 | Perform Tactical Road March | 3 hours |
| 4 | Perform Relief Operations AAR | 6 hours |
| 5 | Defend MOUT/Building | 24 hours |
| Issue FRAGO, Start STX C-II-5 | | |
| 6 | Perform Ambush | 6 hours |
| 7 | Establish a Roadblock/Checkpoint AAR | 6 hours |
| 8 | Perform NBC Operations | 6 hours |
| 9 | Move Tactically | 3 hours |
| 10 | Perform Passage of Lines | 2 hours |
| 11 | Occupy Assembly Area | 3 hours |
| Start STX C-II-6 | | |
| 12 | Operate a Checkpoint | 2 hours |
| 13 | Interdict Smuggling Operations | 6 hours |
| 14 | Defend Convoy | 4 hours |
| 15 | Conduct Final AAR | 2 hours |
| ** Prepare for Combat ** Maintain Operations Security ** Perform Consolidation and Reorganization ** Perform Stability and Support Operations | | ***Total Time 79 hours |
| * The time required to train an event varies based on the factors of METT-T and on the unit's training proficiency. Regardless, training is conducted to standards, not to time limitations. ** These tasks are integrated and evaluated throughout the exercise. *** Time for intermediate AARs is not included in this total; additional time is required if much of the exercise is conducted at night or during other limited visibility. | | |

Table 5-10. Sequence of events and times for FTX defend.

(Classification)

Copy no ___ of ___ copies
 ___ Battalion, ___ Infantry
 Unit location or place of issue
 Date-time group (with time zone)
 Message reference number

OPERATION ORDER NO. _____

Reference: Map, series no. ____, sheet no. ____, edition ____

Time Zone Used Throughout the Order: _____

TASK ORGANIZATION:

___ Co ___ Tm ___ Tm (-)
 1/___/___/AR 2/___/___/AR

Team Tank E Co(-)

1/___/___/Inf

2/___/___/Inf

Battalion Control
 Scout Platoon
 120-mm Mortar Platoon
 1/C/1-222 ADA (Stinger) (DS)
 C/58 ENGR (DS)
 1/1 (GSR) TM A/58 MI Bn
 ATK Force B (1/___/___/Inf)
 Battalion Trains

1. SITUATION.

a. **Enemy Forces.** ANNEX A (see intelligence overlay [prepared by brigade S2]).

(1) *Composition, Disposition, Strength.* The company is opposed by the 1st Dragoons Regiment, 60th Guards Division. This regiment is at 85 percent strength and has received engineer and artillery reinforcements. The enemy is equipped with an assortment of former Soviet and Warsaw pact small arms, machine guns, and armored vehicles including T-62 tanks.

(2) *Capabilities.* The enemy has established defensive positions that follow a line from vicinity (grid) to vicinity (grid). Enemy armored reconnaissance units are operating in the more open terrain to the southwest of CACTF. The enemy has been observed moving forces in depth throughout the area in preparation for an offensive action.

(3) *Probable Course of Action.* The enemy's most probable course of action will be to begin offensive actions within the next 24 to 36 hours. Enemy encountered includes numerous reconnaissance elements trying to find the company's vulnerabilities and a main body trying to exploit any weakness.

(Classification)

Figure 5-12. Example battalion OPORD for mechanized company or team STX defend.

(Classification)

b. Friendly Forces.

(1) () Brigade, () Division relieves () Brigade in place at (date-time group), to defend in sector from (grid) to (grid) to (grid) to (grid), in order to secure the corps counterattack axis of advance, (grid). The intent is to secure the road network around CACTF to prevent the enemy from impeding the movement of the () Brigade, () Division.

(2) TF () is the main effort in the defense and, NLT (date-time group), holds key terrain vicinity (grid) on our left, to prevent an enemy bypass of the brigade left flank.

(3) TF (), on our right, defends along Route 360, vicinity (grid) to (grid) to (grid) to (grid), NLT (date-time group), to prevent an envelopment of the right flank. They conduct a supporting attack at (date-time group) to seize the high ground at OBJ OAK, vicinity (grid), to establish defensive positions that prevent the enemy armored reconnaissance units from interfering with the seizure of the pass at (grid) or the attack of the () Battalion, () Infantry, Mechanized.

2. MISSION. TF () defends NLT (date-time group), to retain the town of CACTF and its surrounding road network and allow brigade to prevent enemy interference with corps counterattack.

3. EXECUTION.

a. Concept of the Operation. ANNEX B (see operations overlay).

(1) *Maneuver.* Company (main effort) retains the main intersection (traffic loop) in CACTF, to prevent enemy movement through the sector. Team (evaluated) blocks movement west of 3d Street, to prevent the enemy from enveloping the main effort. The counterattack force is committed as needed. Team () blocks movement east of Oak Street, to canalize the enemy into EA (). Team () defends from BP1, to prevent a coordinated attack against the main effort. E Company occupies BPs, to destroy enemy vehicles and protect the TF flanks.

(2) *Fire Support.* (See ANNEX C.) Fires are used to suppress the enemy and obscure our movement during the relief operation. Once positions are occupied, fires are used to suppress enemy overwatch positions, disrupt attempts to breach obstacles, and separate enemy infantry from their supporting carriers. Priority of CAS and indirect fire is initially to Team (evaluated), during the relief operation, and then to Team (main effort). Teams (main effort) and (evaluated) each have two priority 155-mm targets. Each team may make one priority target an FPF.

(Classification)

Figure 5-12. Example battalion OPORD for mechanized company or team STX defend (continued).

(Classification)

(3) *Counter-Air Operations*. Priority of protection is to the TF trains and main CP. Air defense weapons status is free; air defense warning status is yellow.

(4) *Intelligence*. Priority of collection is to identify and locate the C2 elements of the MRR and MRB, enemy tank battalions, and the enemy assault detachments' actual axes of advance.

(5) *Engineering*. The purpose of obstacles is to turn the enemy into restrictive terrain and engagement areas. Priority of support is to Team (main effort), Team (evaluated), Team (), and Team (), in that order.

b. Tasks to Maneuver Units.

(1) *Team (Main Effort)*.

(a) Sector of defense includes the east side of Front Street, the south side of 1st Street, the west side of 3d Avenue area, and the north side of 3d Street.

(b) Team (main effort) relieves Team (), TF ().

(2) *Team (Evaluated)*.

(a) Sector includes the east side of 3d Avenue, the south side of 1st Street, the west side of 6th Avenue, and the north side of 3d Street.

(b) Team (evaluated) relieves Team (), TF ().

(3) *Team ()*.

(a) Sector includes the east side of Oak Street, the south side of 1st Street, the east side of Front Street, and the north side of 3d Street.

(b) Team () relieves Team (), TF ().

(c) Team () coordinates directly with right flank team of TF (), to ensure mutually supporting fires.

(4) *Team ()*

(a) Occupy BP 1 vicinity (grid)

(b) Be prepared to occupy BP 2 (grid) to engage enemy in EA ().

(5) *Company E*.

(a) Occupy BP 2-1 (grid) and move on order to BP 2-2 (grid).

(b) Provide antiarmor fires to destroy enemy tanks in EA ().

(6) *Counterattack B (Reserve)*.

(a) Occupy AA Black, vicinity (grid).

(b) Reconnoiter routes into TF (main effort) sector.

(Classification)

Figure 5-12. Example battalion OPORD for mechanized company or team STX defend (continued).

(Classification)

(c) Priority for planning:

Battle position to reinforce main effort.

Battle position to counterattack into Team (main effort) sector.

Battle position to counterattack into Team (evaluated) sector.

(7) *Scout Platoon.*

(a) Determine location, strength, and disposition of enemy forces.

(b) Perform a screen of the TF's right flank from (grid) to (grid) beginning (date-time group) to prevent enemy infiltration of CACTF.

c. Tasks to Combat Support Units.

(1) *Mortar Platoon.*

(a) Priority of fire to TF (main effort). Move with TF (main effort) and establish firing position vicinity (grid).

(b) Displace on order to (grid).

(2) *I/C/I-222 ADA.* Coordinate locations with S3 NLT (date-time group).

(3) *C/58 Engineers.*

(a) Coordinate the engineer effort with the team commanders NLT (date-time group).

(b) Provide an obstacle clearing team to Counterattack Force B, NLT (date-time group).

(4) *1/1 (GSR) TM A/58 MI.* Coordinate location of assets with the task force S3 NLT (date-time group).

d. Coordinating Instructions.

(1) Selective rubbleing is authorized, but destruction of more than one building requires TF commander approval.

(2) Destruction of subterranean approaches requires TF commander approval.

(3) Commanders brief back OPORD to TF commander at the TF tactical CP, vicinity (grid), at (date-time group).

(4) MOPP1 is in effect as of (date-time group).

(5) Decontamination site established vicinity Miller Pond (grid).

(Classification)

Figure 5-12. Example battalion OPORD for mechanized company or team STX defend (continued).

(Classification)

4. SERVICE SUPPORT. (See Annex D.)

a. General.

- (1) Combat trains located vicinity (grid).
- (2) Field trains located in the BSA, vicinity (grid).

b. Materiel and Services.

- (1) *Supply.*
 - (a) Class I. Ration cycle C-A-C. Team establishes MRE cache sufficient for 48 hours in sector.
 - (b) Class III. Resupply available on request. Class III located in combat trains.
 - (c) Class IV. Materials are allocated as shown in ANNEX D.
 - (d) Class V. Each team establishes ammunition caches in sector, but should also have two basic loads of ammunition on hand.
- (2) *Transportation.* The main streets are capable of two-way heavy vehicle traffic (class 60). Secondary streets may be one way and of lighter construction (class 50).
- (3) *Maintenance.*
 - (a) Priority by unit: Team (main effort), Team (evaluated), Team (___), Company E, Team (___).
 - (b) Priority by vehicle: M1A1, M2/M3, M113.

c. Medical Evacuation and Hospitalization.

- (1) TF aid station located vicinity (grid).
- (2) Civilian casualties should be transported by nonmilitary means to clinic, located vicinity (grid).

d. Personnel.

- (1) No replacements for the next 96 hours.
- (2) EPW collection point located vicinity (grid).
- (3) Mortuary affairs point located in BSA, vicinity (grid).

e. Civil-Military Cooperation.

- (1) Curfew in effect 1800 to 0800 daily.
- (2) Majority of civilians have been evacuated. Those remaining have been notified of the risk involved.

(Classification)

Figure 5-12. Example battalion OPORD for mechanized company or team STX defend (continued).

(Classification)

5. COMMAND AND SIGNAL.

a. Command.

- (1) Brigade main CP located vicinity (grid).
- (2) TF tactical CP located vicinity (grid).
- (3) TF main CP located vicinity (grid).
- (4) TF commander located at tactical CP.
- (5) TF XO located at Main CP.

b. Signal.

- (1) SOI INDEX 1-9 in effect.
- (2) Primary means of communication is wire, FM, messenger in that order.
- (3) Building and obstacle marking IAW TF SOP.

ACKNOWLEDGE:

WILLIAMS

LTC

OFFICIAL:

SMITH

S3

- Annexes: A—Intelligence
B—Operations Overlay
C—Fire Support
D—Service Support

(Classification)

Figure 5-12. Example battalion OPORD for mechanized company or team STX defend (continued).

- (3) The TF has retained the north half of the CACTF after the enemy attack. The enemy was defeated but has established squad-size to platoon-size strongpoints in the

southern half of the CACTF. The enemy is expected to receive reinforcements within the next 12 to 24 hours. To prevent enemy reinforcements from moving to the strongpoints to strengthen and resupply them, TF headquarters orders the team to conduct platoon-size ambushes. They also order the team to prepare to establish a roadblock, to control refugee flow through the area of operations, before the team moves out of the area. Headquarters issues a FRAGO (Figure 5-13).

Numerous enemy strongpoints are located to your front, vicinity (grid), (grid), and (grid). We expect these strongpoints to receive reinforcements within the next 12 to 24 hours. Your mission is to establish platoon ambushes on the likely avenues of approach to the strongpoints, NLT (date-time group), in order to prevent reinforcements or resupply to these strongpoints. Notify the TF commander when you are prepared to move. Coordinate with TF scouts for guides. On order, after return from ambush missions, establish roadblocks at (grid) and (grid). Be prepared to move within the next 36 to 48 hours to conduct further follow-on missions.

Figure 5-13. Example FRAGO for FTX defend.

4. Support Requirements.

a. *Minimum Trainers/Evaluators*: This exercise should be conducted for practice with the company commander as the trainer/evaluator for his platoons. The battalion may direct the FTX (internal evaluation) using a company evaluator and an FO evaluator. The platoon leaders and platoon sergeants are the primary trainers during the initial phases of the training. The company commander, the XO, the platoon leaders, and the platoon sergeants act as trainers during the company phases of training. If the exercise is conducted by the battalion, either the battalion commander, the XO, or the S3 acts as the trainer and evaluator, but may require additional assets from the battalion to support the evaluation phase. The controllers or evaluators must be positioned at critical locations throughout the exercise, to observe the actions. They must not interfere with the conduct of the operation, except to halt it when a safety violation occurs or to conduct an AAR.

b. *Vehicles/Communications*: Those organic to the company are used.

c. *Opposing Force*: The OPFOR ground force should be at least platoon-size. FTXs conducted by the company require internal resourcing, and units should be rotated to ensure total training. T&EOs provide training tasks and standards for the OPFOR.

d. *Maneuver Area*: A training area at least 5 by 15 km is best for this exercise.

e. *Consolidated Support Requirements*: This exercise requires the items shown in Table 5-11, page 5-36.

f. *Barrier materials*. Sufficient class IV must be made available to fortify positions, IAW FM 3-06.11 (FM 90-10-1).

| AMMUNITION | DODAC | Per Plt/Co/Bn FTX |
|--------------------------|----------|--|
| 5.56-mm blank | 1305A080 | 120 rounds per rifle |
| 5.56-mm SESAMS | | 120 rounds per rifle |
| 5.56-mm blank | 1305A075 | 200 rounds per M249 LMG |
| 5.56-mm SESAMS | | 200 rounds per M249 LMG |
| 7.62-mm | 1305A111 | 200 rounds per BFV/M1 |
| ATWESS cartridge | 1370L367 | 400 rounds per M60/240B 6 (Viper) (for LAW) 18 per Dragon 14 per TOW System 9 per OH-58D/AH-64 |
| Hoffman | 1370L602 | 6 per M1 2 per target |
| Hand grenade fuze (M228) | 1330G878 | 150 per Bn |
| Stun grenade M84 | 1330GG09 | 150 per Bn |
| Smoke grenade, HC | | 150 per Bn |
| Smoke pot | | 6 per Bn |

Table 5-11. Ammunition and pyrotechnics support requirements for a six days FTX.

5. Evaluation.

Table 5-12 lists the ARTEP mission training plan T&EOs used to evaluate this STX.

| TASK/FUNCTION | TASK NUMBER |
|--|-------------|
| ARTEP 7-8-MTP | |
| Defend MOUT/Building | 7-3/4-1118 |
| Perform Tactical Road March | 7-3-1123 |
| Perform Relief Operations | 7-3-4-1124 |
| Perform Passage of Lines | 7-3-4-1125 |
| Move Tactically | 7-3-4-1134 |
| Occupy Assembly Area | 7-3-4-1136 |
| Establish a Roadblock/Checkpoint | 7-3-4-1401 |
| Perform NBC Operations | 7-3-4-1406 |
| Maintain Operations Security | 7-3-4-1409 |
| Prepare for Combat | 7-3-4-1606 |
| Perform Consolidation and Reorganization | 7-3-4-1607 |
| ARTEP 7-10-MTP | |
| Perform Ambush | 7-2-1106 |

Table 5-12. T&EOs used to evaluate STX attack.

5-9. TARGETRY

Table 5-13 lists the combination of precision and non-precision targets to support the diversity of scenarios required to support combined arms and branch specific lane training. Precision targets, less than 50 meters, are used in and around buildings within the CACTF and reinforce precision marksmanship techniques described in FM 23-9 (Table 5-13).

| EVENT | NUMBER OF LANES | HUMAN TARGETS | | VEHICLE TARGETS | TOTALS | |
|--------------------------------|-----------------|---------------|---------------|-----------------|--------|----|
| | | Precision | Non-Precision | | HT | VT |
| Company/Platoon STX Offense | 3/9 | Precision | Non-Precision | 9 | 45 | 9 |
| | | 15 | 30 | | | |

Table 5-13. CACTF target requirements.

5-10. CONSIDERATIONS FOR TRAINING WITH ARMOR

Built-up areas consist mainly of man-made features such as buildings, streets, and subterranean systems. These features of urban terrain create a variety of tactical problems and possibilities. In order to ensure that the tank platoon can operate effectively in the urban environment, the platoon observation and direct-fire plans must address the ground-level or surface fight (in streets and on the ground floor of buildings), the above ground fight (intra-surface and super-surface), and the subterranean fight (Figure 5-14). Infantry can assist the tank platoon by—

- Locating targets for tanks to engage.
- Destroying antitank weapons.
- Assaulting enemy positions and clearing buildings with tank support.
- Protecting tanks from antitank fires.

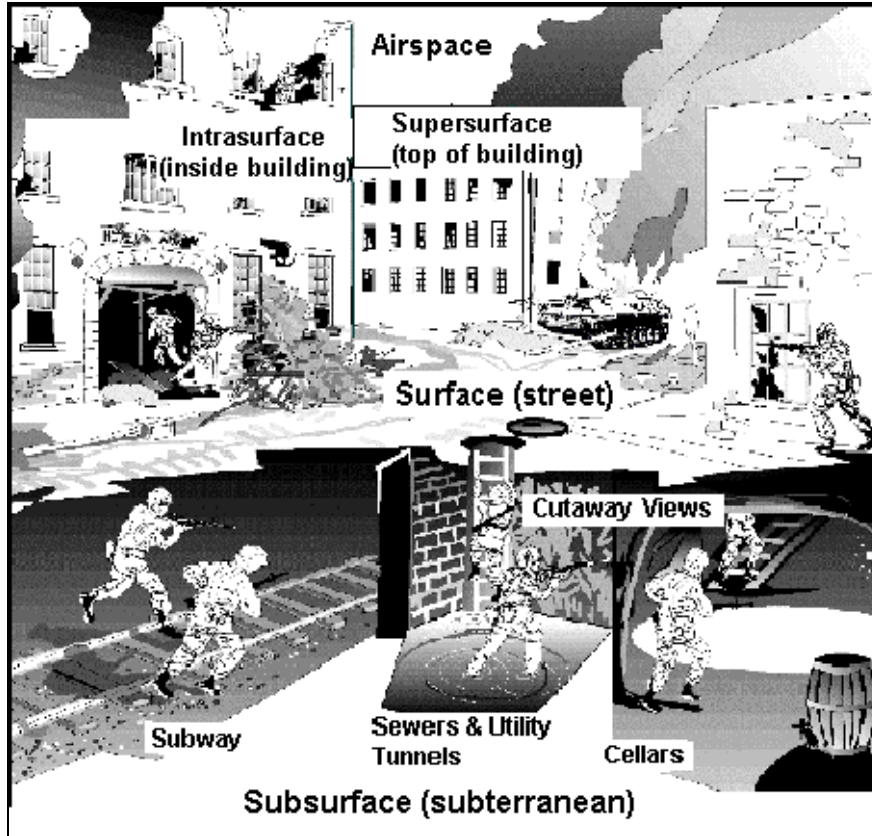

Figure 5-14. Urban battle space.

a. **Transporting Infantry.** At times, the tank platoon is required to transport infantrymen on its tanks (as illustrated in Figure 5-15). This technique is done only when contact is not expected. If the platoon is moving as part of a larger force and is tasked to provide security for the move, the lead section or element should not carry infantry.

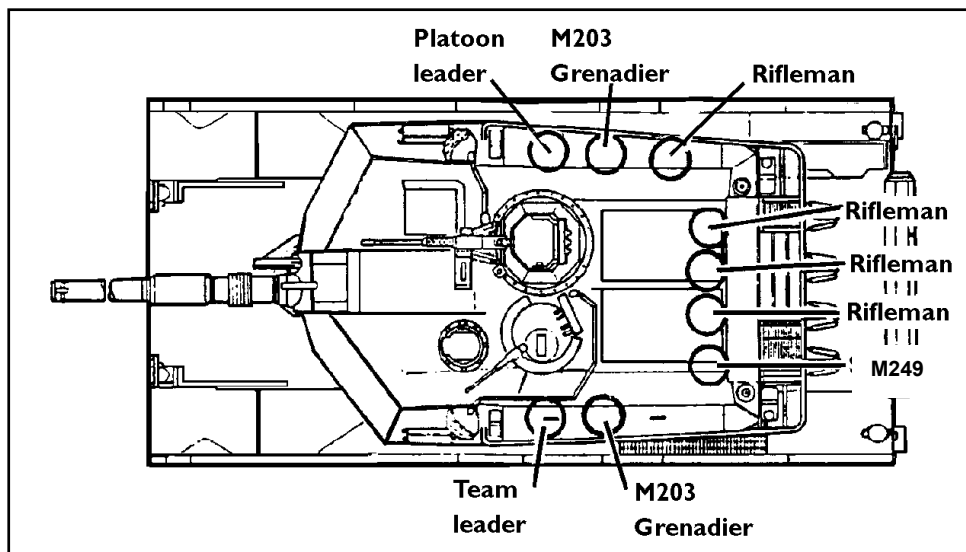

Figure 5-15. Sample positions for infantry riding on a tank.

Infantry and armor leaders must observe the following procedures, precautions, and considerations when infantrymen ride on tanks:

a. Infantry should thoroughly practice mounting and dismounting procedures and actions on contact.

b. Infantry must always alert the TC before mounting or dismounting. They must follow the commands of the TC.

c. Infantry platoons should be broken down into squad-size groups, similar to air assault chinks, with the infantry platoon leader on the armor platoon leader's vehicle and the infantry PSG on the armor PSG's vehicle.

d. Platoon leaders, PSGs, and team leaders should position themselves near the TC's hatch, using the external phone (if available) to talk to the TC and relay signals to the unit.

e. If possible, the lead vehicle should not carry infantrymen. Riders restrict turret movement and are more likely to be injured or killed on initial contact.

f. Whenever possible, Infantrymen should mount and dismount over the left front slope of the vehicle. This procedure ensures that the driver can see the infantrymen and that the Infantrymen do not pass in front of the coax machine gun. Infantrymen must ensure that they remain behind the vehicle's smoke grenade launchers. This will automatically keep them clear of all weapon systems.

g. Infantrymen must always have three points of contact with the vehicle; they must watch for low-hanging objects such as tree branches.

h. All Infantrymen should wear hearing protection.

i. Infantrymen should not ride with anything more than their battle gear. Rucksacks and B-bags should be transported by other means.

j. Infantrymen should scan in all directions. They may be able to spot a target the vehicle crew does not see.

k. Passengers should be prepared to take the following actions on contact:

- Wait for the vehicle to stop.
- At the TC's command, dismount **IMMEDIATELY** (one fire team on each side). **DO NOT** move forward of the turret.
- Move at least 5 meters to the sides of the vehicle. **DO NOT** move behind or forward of the vehicle.
- **DO NOT** move in front of vehicles unless ordered to do so. Main gun discharge overpressure can inflict severe injury or death to forward dismounts. See Figure 5-16 and warning below.
- **DO NOT** move in front of vehicles unless ordered to do so. Main gun discharge overpressure can inflict severe injury or death to forward dismounts.
- **DO NOT** dismount a vehicle unless ordered or given permission to do so.
- **DO NOT** dangle arms or legs, equipment, or anything else off the side of a vehicle; they could get caught in the tracks, causing death, injury, or damage to the equipment or vehicle.
- **DO NOT** place too many riders on the vehicle.
- **DO NOT** fall asleep when riding. The warm engine may induce drowsiness; a fall could be fatal.

- **DO NOT** smoke when mounted on a vehicle.
- **DO NOT** stand near a moving or turning vehicle at any time. Tanks have a deceptively short turning radius.

DANGERS

1. The overpressure from the tank 120-mm cannon can kill a dismounted infantryman within a 90-degree arc extending from the muzzle of the gun tube out to 200 meters.
2. From 200 to 1,000 meters along the line of fire, on a frontage of about 400 meters dismounted infantry must be aware of the danger from discarding sabot petals, which can kill or seriously injure soldiers.

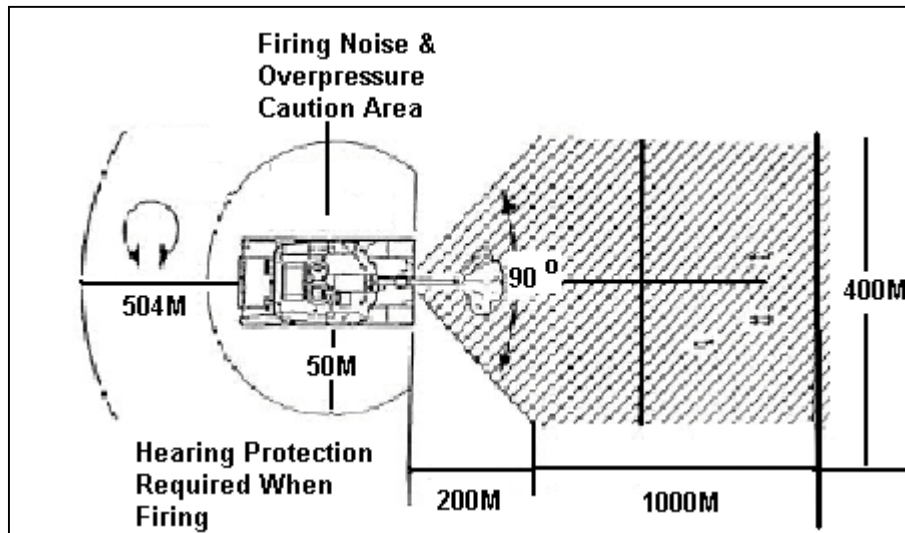

Figure 5-16. Danger areas around a tank when firing the 120-mm main gun.

b. **Additional Considerations.** Additional considerations and preparations for transporting infantrymen include the following.

- (1) The armor:
 - (a) Uses main-gun fire to reduce obstacles or entrenched positions for the infantry.
 - (b) Takes directions from the infantry ground commander (platoon leader/PSG/squad leader) to support their fire and maneuver.
 - (c) Provides reconnaissance by fire for the infantry.
 - (d) Should know and understand how the infantry clears buildings, how they mark cleared buildings, casualty evacuation plan, signal methods, engagement criteria for tank

main gun, front line trace reporting, ground communication from the tank with the dismounted Infantry.

(e) Uses its night vision capability to augment and supplement the Infantry's night vision capability.

(2) The Infantry:

(a) Provides real time information for the tank crewmen to help them overcome tank noise and the lack of ground situational understanding.

(b) Provides reconnaissance and fire direction of enemy positions for main gun attack.

(3) Considerations for dismounted tank security include the following:

(a) Tank crewman should rehearse the mounting and dismounting of Infantry from their vehicle, briefing the Infantrymen on safety procedures for the vehicle and weapon systems.

(b) Tank commanders need to rehearse communicating with dismounted soldiers by way of TA-1 and DR-8 in the bustle rack.

(4) Vehicle preparation for combat in urban terrain should cover these procedures:

(a) Keep at least one ballistic shield to the "Dog House" closed (most engagements will be under boresight range and the battlesight technique will suffice).

(b) Place sandbags around antenna connections and electrical wiring on the turret top.

(c) Place extra coax ammunition inside the turret.

(d) Remove any highly flammable products from the outside of the vehicle and from the sponson boxes.

c. **Vehicles, Weapons, and Munitions.** Numerous factors related to vehicles and their organic weapons and munitions affect the tank platoon's urban operation planning and execution, including the following:

(1) The preferred main gun rounds in the urban environment are HEAT, MPAT (ground mode), and MPAT-OR (XM908). These all perform much better than sabot rounds against bunkers and buildings.

(2) HEAT ammunition will open a larger hole in reinforced concrete or masonry structures than MPAT or MPAT-OR (XM908). Both MPAT and MPAT-OR, however, offer greater incapacitation capability inside the structure.

(3) HEAT ammunition arms approximately 60 feet from the gun muzzle. It loses most of its effectiveness against urban targets at ranges of less than 60 feet.

(4) MPAT and MPAT-OR rounds arm approximately 100 feet from the muzzle of the gun. Because of the shape and metal components of the projectiles, however, this ammunition remains effective at ranges of less than 100 feet.

(5) Sabot petals, including those on MPAT and MPAT-OR, endanger accompanying infantry elements. They create a hazard area extending 70 meters on either side of the gun-target line out to a range of 1 kilometer.

(6) The tank's main gun can depress only to -10 degrees and can elevate only to +20 degrees. This creates considerable dead space for the crew at the close ranges that are typical in the urban environment.

(7) The external M2 HB machine gun can deliver a heavy volume of suppressive fire and penetrate light construction, buildings and most barricades. The M2 HB MG can elevate to +36 degrees; however, the TC must be unbuttoned to fire the M2 on the M1A2 or M1A2 SEP.

(8) The M240 coax machine gun can effectively deliver suppressive fires against enemy personnel and against enemy positions that are behind light cover.

(9) The loader's M240 machine gun can effectively deliver suppressive fire against enemy personnel and against enemy positions that are behind light cover; however, the loader must be unbuttoned to operate it. This weapon may be dismantled and used in a ground role if units are equipped with the M240 dismount kit.

(10) When buttoned up, the tank crew has limited visibility to the sides and rear and no visibility to the top. Figures 5-17 and 5-18 illustrate the dead space associated with tank operations in an urban environment.

(11) FM 3-20.12 (FM 17-12-1-1) explains special uses for tank-mounted machine guns in the urban environment.

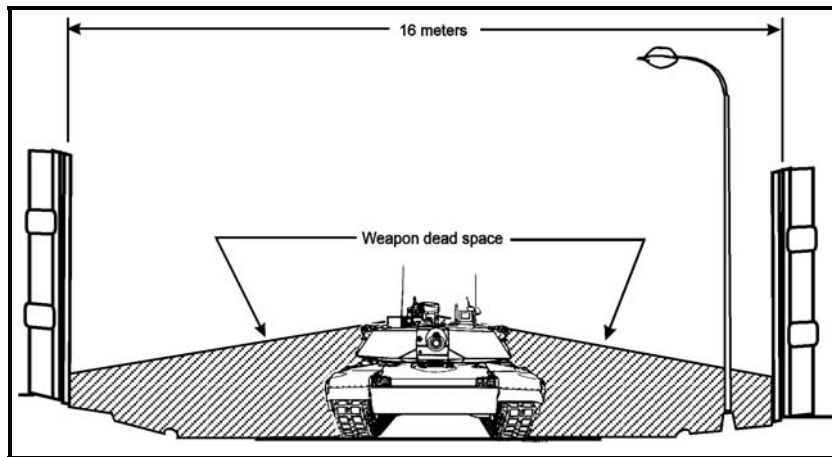

Figure 5-17. Tank weapon dead space at street level.

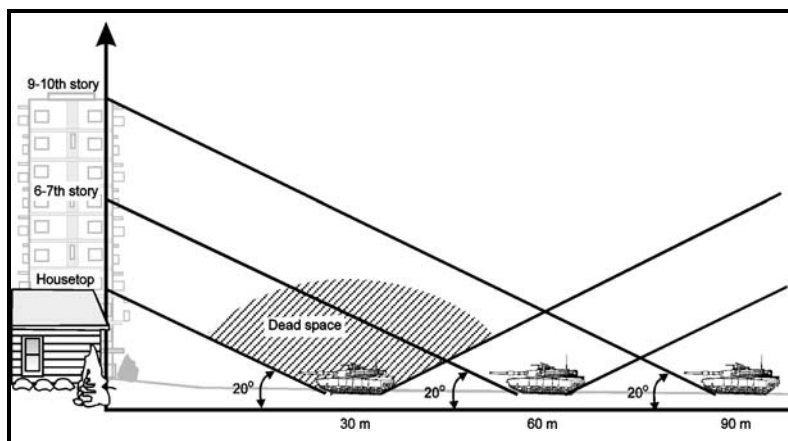

Figure 5-18. Tank main gun and coax dead space above street level.

d. **Tank Platoon Command and Control in Urban Operations.** The following command and control considerations affect the tank platoon's urban operations planning and execution:

(1) **Communications Problems.** The low-level task organization that may take place during urban operations requires elements to establish additional communications links, which can be disrupted by buildings and other urban terrain features.

(2) **Fire Control.** Extensive direct fire planning and restrictive fire control measures are an absolute requirement in urban operations.

(3) **Proximity and Visibility.** Friendly elements often must operate in confined and restrictive areas during urban operations, and they may not be able to see other nearby friendly forces. These factors significantly increase the danger of fratricide.

(4) **Personnel Factors.** Urban operations impose significant, and often extreme, physical and psychological demands on soldiers and leaders.

(5) **ROE/ROI and Civilians.** The ROE and/or ROI may restrict the use of certain weapon systems and TTP. As an integral part of urban operations, noncombatants create special operational problems. To deal with these concerns, units operating in urban terrain must know how to effectively employ linguists and counterintelligence and civil affairs teams.

(6) **Slow Pace Urban Operations.** This operation usually prevents the tank platoon from taking full advantage of the speed and mobility of its tanks.

APPENDIX A

TRAINING TIPS

The effectiveness of urban operations training programs depends on the imagination and thoroughness applied to a training plan. All trainers, from training managers to junior leaders, should prepare their units to fulfill their urban operations mission. They can employ procedures that are based on training doctrine and proven techniques. This appendix discusses several techniques for conducting urban operations training. Trainers make the choice based on the training needs and available resources.

A-1. CONCURRENT TRAINING

Concurrent training allows groups of soldiers to train on different tasks at the same time. This training requires a plan for rotating soldiers between the stations that teach different tasks. This procedure is referred to as round-robin training. Concurrent training is an efficient training technique since it makes the best use of training time and facilities. Concurrent training in the urban operations training facilities works best with performance-oriented tasks. It also requires detailed planning, control, coordination, and more assistant trainers. Trainers should use the example training exercise scenarios provided to develop training that meets their units' training needs.

a. **Urban Assault Course and Breach.** These facilities are well suited to conduct concurrent training. After mastering the tasks at one station, a group of soldiers rotates to the next station in the sequence. To avoid bottlenecks at any of the stations, trainers plan instructional blocks that last about the same length of time. Concurrent training is often conducted with dedicated instructors at each station. The *advantage* of this technique is that it ensures uniformity of performance standards and saves on trainer preparation time. The *disadvantage* is that the soldier is not always trained by his leader. Therefore, when feasible, small-unit leaders should rotate with their soldiers from station-to-station so they can take part in the training. This technique demands much preparation and expertise from leaders.

b. **Urban Assault Course and Combined Arms Collective Training Facility.** These facilities are well suited for conducting concurrent exercises. Concurrent exercises are variants of concurrent training. In a concurrent exercise, elements of the same unit receive different missions. These missions correspond to each element's training objective for that exercise. This technique can be used during FTXs, STXs, or CFXs. For example, one unit attacks; a second unit supports by fire; a third unit acts as a reserve. Also, elements of the same unit can challenge each other. For example, if a trainer has been training his unit in urban offense and defense operations, he can create a scenario in which one force is required to attack the other. This technique allows the unit to train with an OPFOR without an extra investment of resources. Leaders must remember to carefully plan the force ratios between the OPFOR and counterattacking forces.

A-2. DEMONSTRATIONS

Trainers may demonstrate the correct way to perform the tasks. A demonstration can include a skit, film, or videotape. A live demonstration is normally an effective teaching

method since it holds soldiers' interest. Demonstrations can be performed at the UAC and the Breach Facility. However, the trainers must demonstrate the task slowly so that the soldiers can see all the steps. They emphasize key points and stop the action to explain each one. The trainers can use video cameras to film the action occurring inside the buildings. Soldiers can watch the demonstrations on a remote monitor, and trainers can use the videotapes again for later training.

A-3. EXERCISES

Exercises help train soldiers and leaders to work well together and to use their equipment and resources properly. Table A-1 below lays out the type of training exercise, and the appropriate training facility.

| EXERCISE | CACTF | SHOOT HOUSE | SIMULATIONS | LOCAL TOWN |
|----------|-------|-------------|-------------|------------|
| MAPEX | X | | X | X |
| TEWT | X | | | X |
| CPX | X | | X | X |
| CFX | X | | | X |
| BSX | | | X | |
| LFX | | X | | |
| STX | X | X | | X |
| FTX | X | | | X |

Table A-1. Training exercise matrix.

a. **Map Exercise.** A MAPEX allows participants to plan and execute urban operations using maps, overlays, sand tables, photographs, or models. MAPEXs develop teamwork and skills in terrain analysis, planning, coordination, order writing, and employment of urban operation tactics and are more suited for battle staff and leaders.

(1) Using a model of the CACTF is an excellent training aid for instructing soldiers and leaders. Gather leaders around the map or model and have them devise a tactical plan. Use figures or markers to represent friendly units and the OPFOR. Create tactical situations that challenge participants to react as they would in real combat.

(2) Incorporate direct fire, casualties, NBC, logistics, and civilians into the exercise. Ensure the ROE for each exercise is clear to participants.

(3) Have plenty of detailed maps available for use in the MAPEX and in the planning and execution of subsequent CFX operations.

b. **Tactical Exercise Without Troops.** A TEWT focuses on leader and staff tasks. The senior trainer selects the terrain for the urban TEWT. Either the CACTF or a real village, town, or city is appropriate. The procedure for conducting a TEWT is as follows:

(1) Create a scenario and enemy situation, and assign missions.

(2) Allow the leaders to devise their reconnaissance plans and implement them on the terrain.

(3) Require the leader to brief subordinates while walking the terrain.

(4) Ensure their plans include the following tasks:

- Analyze the terrain.
- Employ units according to the terrain analysis.
- Emplace weapons.
- Devise a unit plan.
- Employ combat, CS, and CSS assets.

(5) Conduct an AAR.

c. **Command Post Exercise/Battle Simulation Exercise.** These exercises allow leaders and battle staffs to perform their tasks in a unit CP, where they receive information in the form of reports that require certain reactions. This type of training can be achieved through the constructive simulations training portion of the urban operations training strategy using JANUS or JCATS.

(1) The CPX/BSXs are most effective in achieving the following general training objectives:

- Preparing plans.
- Issuing orders.
- Building teams.
- Reconnoitering, selecting, and tactically occupying CP locations.
- Establishing and using communications.
- Preparing and sending reports.
- Coordinating between subordinate elements.

(2) A company CP is usually associated with a battalion level or higher CPX, but a company can conduct its own CPX. The headquarters section can set up a CP in a CACTF building, displace to another building, and repeat the exercise until they meet the required standards. The section can practice hiding wire on pavement, stringing it between buildings, and running it through sewers. The CP can practice receiving reports, posting situation maps, and sending reports forward to higher headquarters.

d. **Command Field Exercise.** The CFX is used to train commanders, staffs, and junior leaders. The CACTF or a local town can accommodate this type of exercise. However, the unit commander must go through the correct procedures when conducting training off federal property. The CFX employs all of a unit's command and control assets, with a number of subordinate elements reduced according to a set scale. For example, one soldier might represent an entire squad, one vehicle a platoon, or one gun an entire battery.

(1) Preliminary training, such as CPXs, TEWTs, MAPEXs, and BSXs, should precede the CFX. Units conduct operations, and controllers resolve battle outcomes. The exercise ends with an AAR. Fewer controllers are needed in a CFX than in an FTX. However, if the number of unit functions increases, the number of controllers must increase also.

(2) Combat in urban areas entails centralized planning with decentralized execution.

(a) Centralized planning can be practiced in a CFX; however, it can be practiced more efficiently in a CPX, TEWT, MAPEX, or BSX.

(b) Decentralized execution means that platoon, squad, and team leaders lead the battle in an urban area. However, because element participation is scaled down in a CFX, trainers usually find STXs, FTXs, and TEWTs more useful.

e. **Live-Fire Exercise.** Chapter 3 and local range regulations provide specific guidance for conducting LFXs at the shoot house. Live-fire training allows soldiers and leaders to maneuver while firing service ammunition or SRTA. An LFX is most productive when preceded by non-live-fire practice (dry fire or dry run). However, dry fire should *always* precede live fire either using TES or SESAM. An AAR should follow each repetition, and units should not proceed to the next level of difficulty until they master the current step. The training in a LFX occurs in the following sequence, which can be shortened if time and ammunition dictate.

(1) Dry fire to practice unit drills and individual tasks.

(2) Conduct an AAR.

(3) Practice drills and tasks a second time with limited expenditure of ammunition to show the complex coordination of fire and maneuver required.

(4) Conduct an AAR.

(5) Practice the exercise a third time with full use of ammunition to create realism and to build confidence.

(6) Conduct an AAR.

f. **Situational Training Exercise.** The STXs are mission-oriented, limited exercises used to train a unit to perform a single collective task or a series of related tasks and drills. With their distinct start and stop points, STXs represent a segment of battle. An STX is more flexible and complex than a single T&EO or drill. In fact, an STX typically includes drills, leader tasks, and separate individual tasks, and involves a unit's "slice" of external combat, CS, and CSS assets. An STX often precedes an FTX or CFX, and can be conducted in the CACTF by creating a brief situation and mission. For example, the MP company commanders might want to teach the soldiers about straggler control. They can string the tasks together into small scenarios such as STXs, describe a tactical situation that produces stragglers from nearby units, use other soldiers to represent the stragglers, and train soldiers to process stragglers at straggler collection and transport points.

g. **Field Training Exercise.** An FTX allows units to execute collective tasks under conditions that closely resemble actual urban terrain. The FTXs are suitable for the CACTF.

(1) An FTX requires significant time, resources, and planning. The time is well spent if units master their collective tasks. An FTX is an excellent way to conduct the *run* stage of collective training. Additionally, OPFOR and MILES greatly enhance the training value of the FTX.

(2) A unit's urban operation FTX training plan addresses ROE, maneuver restrictions, and the controller plan. Soldiers must know the exercise's training objectives before they begin so they can focus on the correct tasks. Every participant, regardless of position or rank, must fully understand all safety requirements.

(3) To make maximum use of their training time in the field, leaders must plan in great detail. The concept of multiechelon training demands that they consider what training can occur at each level in each event.

A-4. EVALUATORS

Soldiers from the training unit or from another unit can evaluate urban operations training, especially during the run stage of training in an STX, FTX, or CFX. A dedicated evaluator provides objective and thorough comments on the unit's performance throughout all stages of the exercise. Evaluators monitor the critical point of the action but must avoid interfering. They must not disrupt unit performance or undermine realism. They must be trained and given standardized evaluation guides if their feedback is to be meaningful; MTPs and T&EOs are a good start. Evaluators facilitate AARs alone or along with the unit leader.

A-5. TACTICAL ENGAGEMENT SYSTEM

The TES realistically replicates the effects of actual fire in training. It uses laser adapters on the weapons and laser-sensitive equipment on the soldiers and vehicles. A TES weapon emits a laser beam when fired. Accurate fire strikes the laser-sensitive equipment and scores a hit. The TES requires soldiers to aim accurately and to use cover and concealment effectively. When used with an OPFOR, TES offers realistic training. It is an excellent training aid for an FTX or STX. It is also effective at the shoot house as a substitute for live fire. The two major shortcomings of TES are that it allows soldiers to seek cover behind structures that normally would not protect them, and that it does not replicate suppression.

A-6. NAVIGATION

Navigational techniques for urban areas differ from those needed on other terrain.

a. A typical 1:50,000-scale military map provides insufficient detail for accurate navigation. Therefore, soldiers must learn to navigate using commercial maps, sketches, and aerial photographs. Leaders must learn how to plan operations using these items.

b. Underground navigation is a special challenge. Soldiers must know subway plans and be able to identify tunnels, elevated tracks, stairways, and other critical features. They must learn how to measure distance, remain oriented, and mark their routes.

c. Destruction often erases urban features that could aid in navigation. Soldiers must learn to orient using distinctive, difficult-to-erase features such as bridges, waterways, towers, and intersections.

d. Leaders conduct navigational exercises in an actual urban area. Soldiers must move from point to point while controllers at each point monitor and verify soldiers' progress.

e. The GPS is a navigational aid that triangulates with satellites to calculate position. However, this system may be affected by nearby tall buildings, and its effectiveness decreases inside buildings or underground.

A-7. LIMITED VISIBILITY TRAINING

Urban operations involve day and night operations. FTXs, STXs, CFXs, and CPXs are the valuable exercises for night training.

a. Field-expedient lighting, NVDs, illumination, and electrical lighting must be exploited when the tactical situation allows. Soldiers must learn discipline in their use of light, and also learn the lighting techniques that allow them to carry out their urban training program.

b. Situational awareness is the soldier's knowledge of his location, the locations of friendly forces, and the locations of the enemy on the battlefield. Situational awareness is the key to avoiding fratricide, especially during limited visibility operations. Units must plan to use all the equipment and devices available to mark friendly units and to avoid fratricide, without exposing themselves to enemy observation.

c. Reverse-cycle training should be part of an urban training program. Limited visibility fighting skills are perishable, but they can be sustained and improved by effective training. The goal is for every soldier to operate as effectively at night as during the day.

A-8. SAFETY/AMMUNITION CONSIDERATIONS

When using ammunition and pyrotechnics, all associated safety requirements must be adhered to. The following paragraphs describe some of the safety equipment and training procedures to be considered.

a. **Special Effect Small-Arms Marking System.** The SESAMS uses 5.56-mm and 9-mm ammunition that is used for urban training. It requires changing the bolt of the M16/M4 family of weapons and the barrel of the M9 pistol. The ammunition has a projectile that bursts on contact leaving a colored mark that is visible. Colors vary and different colors can be assigned to OPFORs for engagement identification and fratricide tracking. SESAMS, has a 30-meter effective range and activates TES (MILES). TES and SESAMS should be used together. When using SESAMS all exposed skin must be covered for protection such as gloves and eye protection worn. The projectile can break exposed skin at close ranges. Every precaution must be taken to protect the head during training with this ammunition. The eyes must be completely enclosed within the eye protection. The standard-Army's sun, wind, and dust goggles can be used to protect the eyes. Hearing protection must be worn to prevent injury. The mouth must remain covered to prevent any injury to the ears. Any time during a training exercise that a soldier loses any of his protective gear, he must immediately replace the gear. If the soldier is in an engagement when protective gear is lost, he should immediately cover his face and eyes with his hands and remain in that position until the engagement ends or is instructed that it is safe to replace his safety equipment. All individuals to include observer/controllers during exercises using SESAMS must wear protection.

b. **M84 Stun Grenade.** The M84 stun grenade is a non-lethal diversionary hand-deployed grenade, which produces an intense flash and bang. The bang level at 1.5 meters is over 170 dBs. Even though this level does not produce permanent hearing damage, one-time use soldiers are required to wear hearing protection when noise levels are above 85 dBs. Flash level is between 1 to 2.5 million candlepower. The M84 is designed to be a non-lethal grenade that is intended to provide a reliable, effective non-lethal means of neutralizing and disorienting enemy personnel and may be used tactically as well as in training. The M84 stun grenade has an M201A1 fuse and a pyrotechnic output charge in a synthetic casing with a one to two second delay fuse, which cannot be cooked off. The grenade body consists of a non-fragmenting metal hexagonal casing, which resists tendencies to roll once deployed.

c. **Smoke Grenades.** Smoke grenades are used throughout urban combat and are employed to cover movement, deceive enemy forces, and for signaling. Smoke should not be used in buildings and subterranean passages as it displaces oxygen and protective

masks do not filter the smoke or provide oxygen. Buildings in the urban area can affect air current, which influence emplacement; one grenade should be used to test the air's flow before employing any more.

A-9. OPPOSING FORCES

Trainers should include OPFOR in training, especially during FTXs, CFXs, and STXs. OPFOR counter tasks should be developed. Leaders should develop a thorough control plan for scenarios that include an OPFOR. This plan should include uniform and vehicle markings, ammunition, safety instructions, controller guidance, and guidelines for handling prisoners. ROE must clearly specify the limits of close combat between soldiers.

a. Using an OPFOR heightens the soldiers' interest by giving them a real opponent. This technique fosters unit competition and realism, especially when the OPFOR is used in addition to TES and SESAM.

b. An OPFOR challenges leaders' ability to improvise. However, this free-play scenario should be monitored to ensure the unit meets the training objectives.

c. The OPFOR can use threat urban operations doctrine. OPFOR uniforms, mock documents, overlays, and equipment to add realism and intelligence to the scenario. Leaders conduct preliminary training for the OPFOR, which helps the OPFOR recreate the threat's urban tactics.

d. Non-combatants should be integrated into training scenarios.

A-10. PRECISION MARKSMANSHIP TRAINING

The UAC, CACTF, and the Shoot House are designed to accommodate target discrimination training. However, precision marksmanship training should be conducted before training at these facilities, IAW FM 23-9 (3-23.9). This sequence ensures that the unit conducting the training gets the best use of time and resources.

A-11. PHYSICAL TRAINING

Combat in urban areas places extraordinary physical demands on soldiers. Therefore, physical training with emphasis on upper body development is paramount to any urban operations training program.

A-12. VARIED SCENARIOS

Leaders must use varied training scenarios to prevent redundant and predictable tactical behavior. Using predictable avenues of approach into the facility produces stereotypical tactical solutions.

A-13. BUILDING FAÇADE WALLS, WINDOWS AND DOORS

The use of façade walls, windows and doors, in conjunction with SESAMS in the interior of some stations at the UAC, provides for more realistic training. This method of training reinforces the fact that walls, windows, and doors in most cases DO NOT stop the penetration of service ammunition. Plastic wrap sheeting, tarpaper, or some other type of material can be used to allow SESAMS penetration (Figure A-1, page A-8).

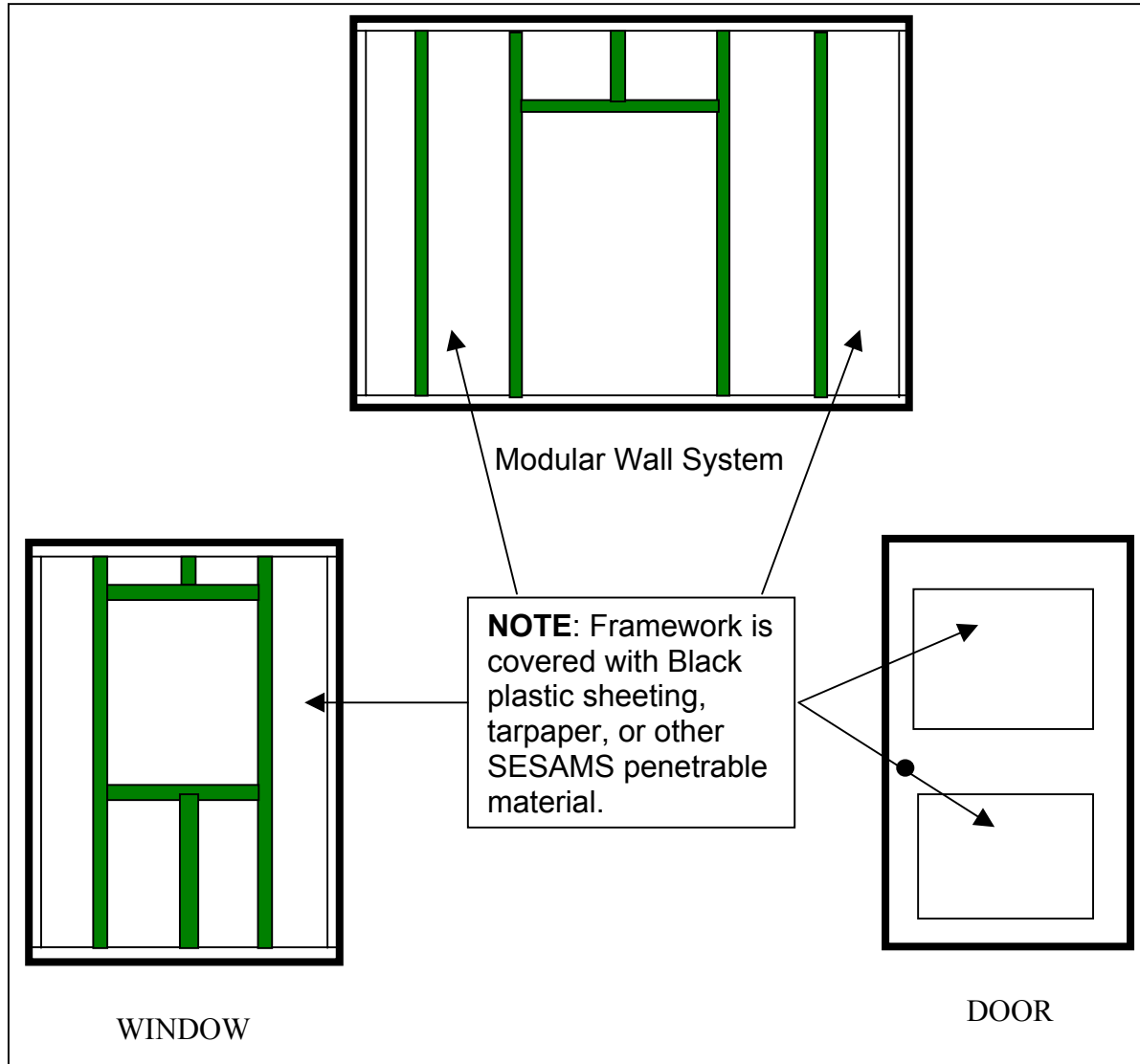

Figure A-1. Shoot through walls and doors.

A-14. USE OF OLDER OR NONSTANDARD FACILITIES

Some installations may not receive the UAC, SH, BF, and CACTF for some time until the necessary funding is allocated to construct the facilities. The older MOUT Assault Course (MAC) and Collective Training Facility (CTF) described in TC 90-1 can be used as substitute facilities along with nonstandard shoot houses. It can also be used with other nonstandard urban facilities to implement the training strategies outlined in this TC. Specific training tips for adaptation to these facilities are described in this paragraph.

a. **Urban Assault Course.** Generally, the MAC can be used to train the majority of tasks that would be trained in the UAC. The MAC will not have any targetry and instrumentation. Units can use portable video cameras for video capture and VCRs and television sets for video play back to facilitate an AAR. Targets can be OPFOR

with MILES. Role players in civilian clothes can be introduced to play the part of noncombatants.

b. **Shoot House.** Many nonstandard shoot houses, for example, tire houses, exist in different installations. Local range regulations and unit risk analyses will govern their use. Again, units can use portable video cameras for video capture and VCRs and television sets for video play back to facilitate an AAR. Both precision and nonprecision targets can be fabricated using E-type silhouettes on a stake, old BDUs/civilian clothes filled with straw, and so forth. Simulate noncombatants with E-type silhouettes painted white or dummies in civilian clothes. Place balloons in the head and upper torso area to simulate lethal shot placement. Where local policy permits, convert portions of collective training facilities into live-fire shoot houses using SRTA.

CAUTION

Units should ensure that they are in compliance with all local policies affecting live fire before attempting to use SRTA in an older collective training facility or non-standard urban training site.

c. **Breach Facility.** Existing demolition ranges may be used to conduct explosive breaching provided door, window, and wall units, or facsimiles, are available. Mechanical breaching can be practiced in older areas of the installation designated for demolition, if such facilities are available. In all cases, units must ensure that local safety policies are met.

d. **Combined Arms Collective Training Facility.** Generally the older CTF can be used to train the majority of tasks that would be trained in the CACTF. The CTF will not have any targetry and instrumentation. Again, units can use portable video cameras for video capture and VCRs and television sets for video play back to facilitate an AAR. Targets can be OPFOR with MILES. Role players in civilian clothes can be introduced to play the part of noncombatants. If armored vehicles will be used, units should ensure that local range policies allow for their use. Older CTFs are normally either a 16 or 32 building design. Appropriate unit-level training, platoon, company, or battalion, should be planned based on the size of the facility.

APPENDIX B
UNIT TRAINING MATRIX

Unit training plans are prepared IAW FM 25-101, which states that "Planning links the unit METL and the execution of battle-focused training." The commander begins his planning with guidance from a higher echelon and an in-depth assessment of METL tasks (in this case, mission-essential urban tasks). Based on his own observations, feedback from his subordinates, and other sources the commander determines which tasks should be trained, which should be trained first, and how much time should be allotted for each. Table B-1 provides a list of training tasks by BOS to be trained at each facility.

| BRIGADE TASKS | SHOOT HOUSE Semi-Annual | BREACH HOUSE Semi-Annual | UAC Quarterly | CA/CTF Semi-Annual | CTC *As Scheduled | SIMULATION Annual |
|---|------------------------------------|-------------------------------------|--------------------------|-------------------------------|---------------------------------|---------------------------------|
| Develop Intelligence Perform Intelligence Operations Perform S2 Operations | | | | | X X | X X |
| Deploy/Conduct Maneuver Attack Perform Air Assault Defend Lodgment | | | | | X X X X | X X X X |
| Exercise Command and Control Command and Control the Brigade Maintain Communications Coordinate Air Defense Operation Conduct Noncombatant Evacuation Develop a Media Plan Conduct Mediation and Negotiation | | | | | X X X X X X | X X X X |
| Employ Firepower Execute Fires Employ Air Support Employ Attack Helicopters Synchronize Fire Support Synchronize CAS Conduct Targeting Process | | | | | X X X X X X X | X X X X X X X |

Table B-1. Army unit training matrix.

| BRIGADE TASKS | SHOOT HOUSE Semi-Annual | BREACH HOUSE Semi-Annual | UAC Quarterly | CA/CTF Semi-Annual | CTC *As Scheduled | SIMULATION Annual |
|--|------------------------------------|-------------------------------------|--------------------------|--|---|--|
| Protect the Force Perform Mobility/Survivability Operations Provide Engineer Support Coordinate NBC Operations Conduct Operations Security | | | | | X X X X | X X X X |
| Perform CSS and Sustainment Perform Combat Service Support Evacuate Casualties Treat Casualties Sustain the Force Conduct a Civil-Military Operation Provide Humanitarian Support | | | | | X X X X X X | X X X X X X |
| Develop Intelligence Conduct S2 Operations | | | | X | X | X |
| Deploy/Conduct Maneuver Attack of a Built-Up Area Plan for Urban Operation Defend an Urban Area Conduct an Infiltration /Exfiltration Perform Cordon and Search Operations in an Urban Area Plan for Urban Operations Conduct Tactical Movement Conduct Presence Operation in a Stability Environment Defend an Urban Area Traverse a Built-up Area Conduct a Mobile Defense | | | | X X X X X X X X X X X X | X X X X X X X X X X X | X X X X X X X X X X |
| Employ Firepower Integrate Fires and Effects Support Establish the Fire Support Element | | | | X X | X X | X X |
| Protect the Force Conduct Mobility and or Survivability Operations Secure Civilians During Operation Conduct Passive Air Defense Measures Conduct Active Air Defense Measures Employ Operation Security Measures Integrate Air Defense Support | | | | X X X X X X | X X X X X X | X X X X X X |

Table B-1. Army unit training matrix (continued).

| BATTALION TASKS | SHOOT HOUSE Semi-Annual | BREACH HOUSE Semi-Annual | UAC Quarterly | CA/CTF Semi-Annual | CTC *As Scheduled | SIMULATION Annual |
|--|----------------------------|-----------------------------|------------------|---|----------------------------|----------------------------|
| Perform CSS and Sustainment Conduct S1 Operations Conduct S4 Operations Conduct a Civil Military Operations | | | | X X X | X X X | X X X |
| Exercise Command and Control Conduct S6 Operations Conduct Noncombatant Evacuation Conduct S3 Operations Conduct Mediation and Negotiations Plan Roadblocks and or Checkpoints Establish Liaison | | | | X X X X X X | X X X X X X | X X X X X X |
| COMPANY TASKS | SHOOT HOUSE Semi-Annual | BREACH HOUSE Semi-Annual | UAC Quarterly | CA/CTF Semi-Annual | | |
| Develop Intelligence Conduct an Area or Zone Reconnaissance Reconnoiter a Built-Up Area | | | | X X | | |
| Deploy/Conduct Maneuver Conduct Cordon and Search in a Built-Up Area Attack a Built-Up Area Conduct Presence Operations Conduct Tactical Movement in a Built-Up Area Defend in Urban Environment Conduct an Infiltration/Exfiltration Conduct Operations with Armored or Mechanized Infantry Vehicles in an Urban Environment Conduct Civil Disturbance Operations Establish Checkpoints | | | | X X X X X X X X X | | |
| Employ Firepower Integrate Direct Fires Integrate Indirect Fires | | | | X X | | |

Table B-1. Army unit training matrix (continued).

| COMPANY TASKS | SHOOT HOUSE Semi-Annual | BREACH HOUSE Semi-Annual | UAC Quarterly | CA/CTF Semi-Annual |
|--|-----------------------------------|-----------------------------|---------------------------------|--------------------------------------|
| Protect the Force Maintain Operation Security Conduct Passive Air Defense Measures Conduct Passive Air Defense Measures | | | | X X X |
| Perform CSS and Sustainment Treat and Evacuate Casualties Secure Civilians During Operations Conduct Resupply Operations Process Captured Documents and Equipment Handle Enemy Prisoners of War | | | | X X X X X |
| Exercise Command and Control Prepare for Combat Establish Communications Conduct Consolidation and Reorganization Conduct Negotiation Conduct Troop-Leading Procedures | | | | X X X X X |
| PLATOON/SQUAD TASKS | SHOOT HOUSE Semi-Annual | BREACH HOUSE Semi-Annual | UAC Quarterly | CA/CTF Semi-Annual |
| Develop Intelligence Report Tactical Information Conduct an Area or Zone Reconnaissance Reconnoiter a Built-Up Area | X X X | | X X X | X X X |
| Deploy/Conduct Maneuver Conduct tactical Movement in a Built-Up Area Assault a Building Conduct a Strongpoint Defense of a Building Conduct an Infiltration or Exfiltration Conduct Operations with Armored or Mechanized Vehicles in an Urban Environment Conduct a Presence Patrol React to a Civil Disturbance Establish a Checkpoint Search a Building | X X X X X | | X X X | X X X X X X X X |
| Employ Firepower Employ Fire Support | | | | X |

Table B-1. Army unit training matrix (continued).

| PLATOON/SQUAD TASKS | SHOOT HOUSE Semi-Annual | BREACH HOUSE Semi-Annual | UAC Quarterly | CA/CTF Semi-Annual |
|--|------------------------------------|-------------------------------------|------------------------------------|------------------------------------|
| Protect the Force Maintain Operation Security Conduct Passive air Defense Measures Conduct Active Air Defense Measures | | | | X X X |
| Perform CSS and Sustainment Secure Civilians During Operations Perform Resupply Operations Treat and Evacuate Casualties Handle Enemy Prisoners of War | X X X | | X X X | X X X X |
| Exercise Command and Control Conduct Troop-Leading Procedures Establish Radio Communication Conduct Consolidation and Reorganization Prepare for Combat | X X X X | | X X X X | X X X X |
| INDIVIDUAL TASKS/TECHNIQUES | SHOOT HOUSE Semi-Annual | BREACH HOUSE Semi-Annual | UAC Quarterly | CA/CTF Semi-Annual |
| Skill Level 1 Perform Movement Techniques in an Urban Environment, 071-326-0541 Prepare Positions for Individual and Crew-Served Weapons in an Urban Environment, 071-326-0550 Select Hasty Fighting Positions in an Urban Environment, 071-326-0557 Employ Hand Grenades, 071-325-4407 Engage Targets with an M16A1 or M16A2 Rifle, 071-311-2007 Execute a Mechanical Breach, 071-440-0027 | X X X X X X | X X X X X | X X X X X X | X X X X X X |
| Skill Level 2 Conduct an Explosive Breach Conduct a Breach, 071-440-0029 Prime Explosive Nonelectrically, 051-193-1003 Construct a Nonelectric Initiating Assembly with Modernized Demolition | X X X X | X X X X | X X X X | X X X X |

Table B-1. Army unit training matrix (continued).

APPENDIX C
**STABILITY AND SUPPORT OPERATIONS UNIT
 TRAINING MATRIX**

When assigned a stability or support mission, a well-trained unit must be able to rapidly shift its focus from war fighting to stability and support and also from stability and support to war fighting. During a stability or support operation, the unit performs numerous activities. Essentially, the unit accomplishes these activities through execution of tactical missions and tasks. While stability and support operations can occur anywhere, it is most probable that they will occur in an urban environment. Table C-1 provides a list of training tasks by BOS to be trained at each facility.

| BRIGADE TASKS | SHOOT HOUSE | BREACH HOUSE | UAC | CA/CTF | CTC | SIMULATION |
|--|----------------|-----------------|-----|--------|------------------|------------|
| Develop Intelligence Collect and Disseminate Information | | | | | X | X |
| Deploy/Conduct Maneuver Demonstrate a Show of Force Employ Psychological Operation | | | | | X X | X |
| Employ Firepower Provide Fire Support | | | | | X | X |
| Protect the Force Protect the Force | | | | | X | |
| Perform CSS and Sustainment Restore Law and Order | | | | | X | |
| Exercise Command and Control Establish an Evacuation Control Center/Conduct Evacuation Control Center Operations Negotiate Perform Noncombatant Evacuation Operations Plan a Media Visit | | | | | X X X X | |
| Develop Intelligence Collect and Disseminate Information | | | | X | X | X |

Table C-1. Stability and support operations unit training matrix.

| BATTALION TASKS | SHOOT HOUSE | BREACH HOUSE | UAC | CA/CTF | CTC | SIMULATION |
|---|--------------------|---------------------|------------|---------------------------------|---------------------------------|-------------------|
| Deploy/Conduct Maneuver Interdict Smuggling Operations Disarm Belligerents Handle Captured Insurgents or Belligerents Employ Psychological Operation React to Civil Disturbance | | | | X X X X X | X X X X X | |
| Employ Firepower Provide Fire Support | | | | X | X | X |
| Protect the Force Protect the Force | | | | X | X | |
| Perform CSS and Sustainment Restore Law and Order Identify and Process Detainees Deliver Supplies or Humanitarian Aid Control Civilian Movement Prepare Traffic Control Plan | | | | X X X X X | X X X X X | |
| Exercise Command and Control Negotiate Perform Noncombatant Evacuation Operations Conduct Marshalling Force Operations Negotiate a Belligerent Force Checkpoint Plan a Media Visit Perform a Cordon and Search Coordinate and Monitor Convoy Security | | | | X X X X X X X | X X X X X X X | |
| COMPANY TASKS | SHOOT HOUSE | BREACH HOUSE | UAC | CA/CTF | CTC | SIMULATION |
| Develop Intelligence Collect and Disseminate Information | | | | X | X | |
| Deploy/Conduct Maneuver Interdict Smuggling Operations Disarm Belligerents Handle Captured Insurgents or Belligerents Defend Convoy Apprehend/Detain Noncombatants Perform Cordon and Search | | | | X X X X X X | X X X X X X | |
| Employ Firepower Provide Fire Support | | | | X | X | |

Table C-1. Stability and support operations unit training matrix (continued).

| COMPANY TASKS | SHOOT HOUSE | BREACH HOUSE | UAC | CA/CTF | CTC | SIMULATION |
|---|--------------------|---------------------|------------|----------------------------|----------------------------|-------------------|
| Protect the Force Establish a Checkpoint Operate a Checkpoint Protect the Force | | | | X X X | X X X | |
| Perform CSS and Sustainment Process Captured Documents and Equipment | | | | X | X | |
| Exercise Command and Control Negotiate a Belligerent Force Checkpoint Conduct Marshaling Force Operations Negotiate a Belligerent Force Checkpoint Plan a Media Visit Coordinate and Monitor Convoy Security Link Up with a Convoy | | | | X X X X X X | X X X X X X | |
| PLATOON/SQUAD TASKS | SHOOT HOUSE | BREACH HOUSE | UAC | CA/CTF | CTC | SIMULATION |
| Deploy/Conduct Maneuver Disarm Belligerents Handle Captured Insurgents or Belligerents Apprehend/Detain Noncombatants Search a Building React to a Sniper Conduct Platoon Riot Control Formation | X | | X | X X X X X X | X X X X X X | |
| Protect the Force Establish a Checkpoint Operate a Checkpoint Protect the Force | | | | X X X | X X X | |
| Exercise Command and Control Negotiate a Belligerent Force Checkpoint | | | | X | X | |
| Exercise Command and Control React to a Media Interview | | | | X | X | |

Table C-1. Stability and support operations unit training matrix (continued).

APPENDIX D

**DEMOLITION EFFECTS SIMULATORS FOR THE URBAN
ASSAULT COURSE, SHOOT HOUSE, AND COMBINED
ARMS COLLECTIVE TRAINING FACILITY**

This appendix provides information on Demolition Effects Simulators (DES) that replicates breaching to gain entry to buildings and or rooms. The design of the UAC, Shoot House, and CACTF facilities allows for breaching of walls (wall breach charge DES). Generally, interior and exterior walls are constructed with blow panels using plasterboard or some other similar type of material approximately, 4 feet by 4 feet.

D-1. FACILITY

Many types of organizations (Combat, CS, CSS) can train at these facilities. Trainers *must* be certified before conducting demolition training per local SOP or MACOM policy. AR 385-63 lays out the safety requirements.

D-2. CHARGE

The DES charges for use at the UAC, shoot house, and the CACTF are constructed to affect the breach of a predetermined entry point but not to damage the facility itself. The flex-linear shape charge, the doorknob charge, and the E-silhouette charge are all field-expedient charges that are commonly used during urban operations training. Operational charges can be found in FM 3-06.11 (FM 90-10-1). However unit trainers must consult with installation safety and combat engineers to determine the appropriate reduced charge.

APPENDIX E

LEADER DEVELOPMENT TRAINING

To be successful in combat, the Army must continually train to develop and maintain combat-ready soldiers, leaders, and units that can perform assigned tasks to specific standards.

E-1. FUTURE SIMULATIONS TRAINING

Commanders train their staffs to plan, coordinate, and synchronize their units' operations from initial mobilization and deployment. These operations include the full spectrum of Army operations; offense, defense, stability, and support. Current simulations lack adequate replication of urban scenarios, terrain, and weapons effects. The introduction of WARSIM 2000 and OneSAF should help to solve these simulations modeling deficiencies.

a. For lower echelon units, battalion and below, constructive simulations (JANUS) complement collective battle staff training that occurs during virtual simulation similar to the close combat tactical trainer and *live* events. For echelons above battalion, it becomes difficult to use simulators or *live* maneuver to train. Studies to date indicate the crossover point for simulation versus simulator is at the battalion level. Some training events from battalion and below can be trained effectively using various types of simulators. Above battalion level, effective training almost has to be conducted with a simulation (Figure E-1).

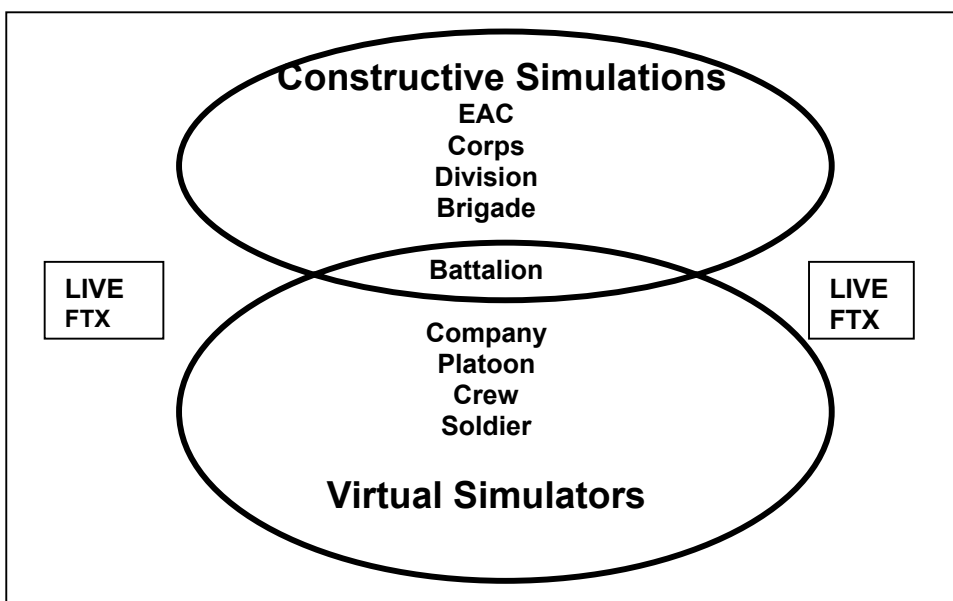

Figure E-1. Echelons and uses.

b. Simulations that support leader and battle staff training focus on collective tasks rather than individual leader tasks. Simulations, used in this context, rely on the human dynamics in the command setting and use real-time actions in a tactical environment with a unit's go-to-war systems. This process forces commander and staff interaction that

provides feedback and helps refine the integration process. Battle staff training encourages team building, task coordination, and standardization of staff actions.

(1) Constructive simulations can provide commanders large areas for conducting training, access to sensitive areas through computer and mapping technology, and futuristically provide a much better level of fidelity in terms of urban operations terrain and scenario replication.

(2) Simulations can portray large, capable, and doctrinally correct OPFORs. All of the soldiers portrayed in the units in a simulation do not have to be present in order for the training to be realistic. An attractive feature of simulations has always been the reduced staffing necessary to conduct this type of training exercise.

(3) Simulations can stress CPs and provide the realistic conditions under which commanders must make decisions. Brigade and below simulation (BBS) and corp battle simulation (CBS) are well known for the stressful environments created during an exercise. The stress is realistic and can assist in conditioning the training audience before CTC rotations.

(4) Simulations allow different units to train under the same conditions and to the same standards. This technique is a unique feature of simulations as the exact weather, opposing force organization, location of units, and equipment can be used to train many different units on the same terrain with the same conditions.

(5) The size and number of personnel in a battle staff vary depending on the echelon and other demands unique to that commander. However, the BOS are represented by the following staff officers: intelligence, operations, fire support, communications, logistics, air defense, and engineer (Figure E-2).

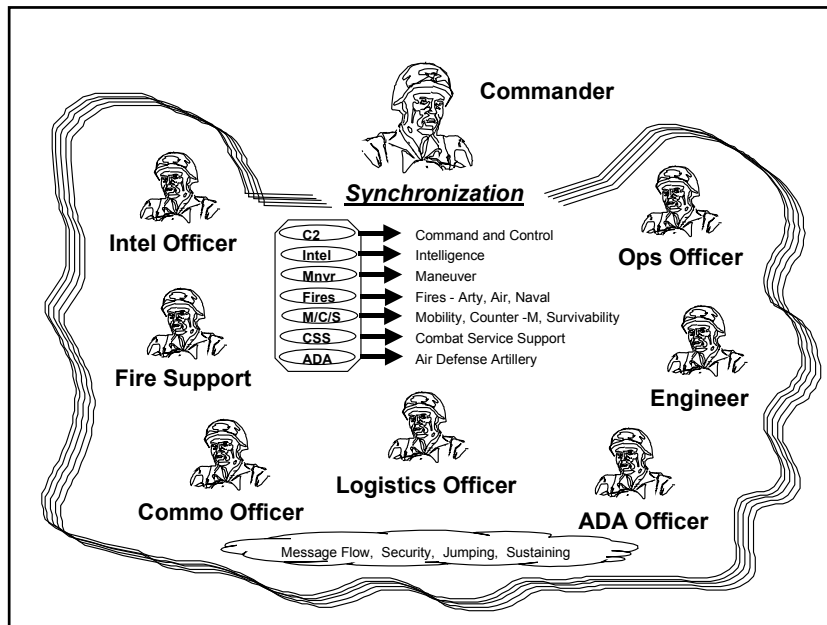

Figure E-2. Battle staff and command post.

(6) Characteristics and benefits of simulations used to support battle staff training are listed below:

- Builds and sustains staff teamwork.
- Builds and sustains effective and efficient organizations.
- Provides training and validation of command and staff procedures (SOPs, TACSOPs, FSOPs).
- Provides proficiency to the individual staff officer while building proficiency in a fully integrated staff.
- Allows practice of battle drills and tactical missions (movement to contact, hasty defense).
- Allows commanders to determine if their staff and subordinate commanders understand the commander's intent and concept of operations.

c. The major development efforts for FAMSIM is WARSIM 2000. WARSIM 2000, in conjunction with OneSAF, exploits new technologies to enable commanders and staffs at battalion through EAC to train in a realistic simulation environment (Figure E-3). The increased realism of WARSIM 2000 over existing models allows units to use ABCS systems to synchronize across the complete range of operations. WARSIM 2000's design allows warfighting CPs to use organic ABCS equipment to interact with the simulation from training sites in the field, as well as from simulation centers. WARSIM 2000 will also be capable of depicting a joint and combined environment across the operational continuum.

| Urban Operations Simulations | | |
|------------------------------|--|---|
| CAMTF TRAINING TASKS | WARSIM <small>Joint Land Component 2000</small> | One SAF <small>One Semi-Automated Force (OneSAF)</small> |
| CORPS | ● | |
| DIVISION | ● | |
| BRIGADE | | ● |
| BATTALION | | ● |
| COMPANY | | ● |
| PLATOON | | ● |

Figure E-3. Urban operations simulations crosswalk.

d. Future simulation capabilities simultaneously integrate live, virtual, and constructive environments (Figure E-4). The timeline in Figure E-4 below depicts when

this capability may be realized. Constructive simulation is a viable solution for battalion and above training and the federation of WARSIM and OneSAF models should alleviate the following training simulation problems:

- Eliminate the need for swivel chair interface
- Allows focus on subordinate units fighting the fight
- Digital and analog feeds to C4I systems including FBCB2
- May provide for distance learning opportunities
- Facilitates simultaneous multi-echelon urban operations training

(1) At company and below the best training solution is live and virtual. This is accomplished by linking the close combat tactical trainer (CCTT) to OneSAF and VLET to engagement skills trainer (EST) technology.

(2) Entity based models like OneSAF can allow the leader to fight from a TOC or vehicle if linked to virtual or live environments and also has the potential for distance learning.

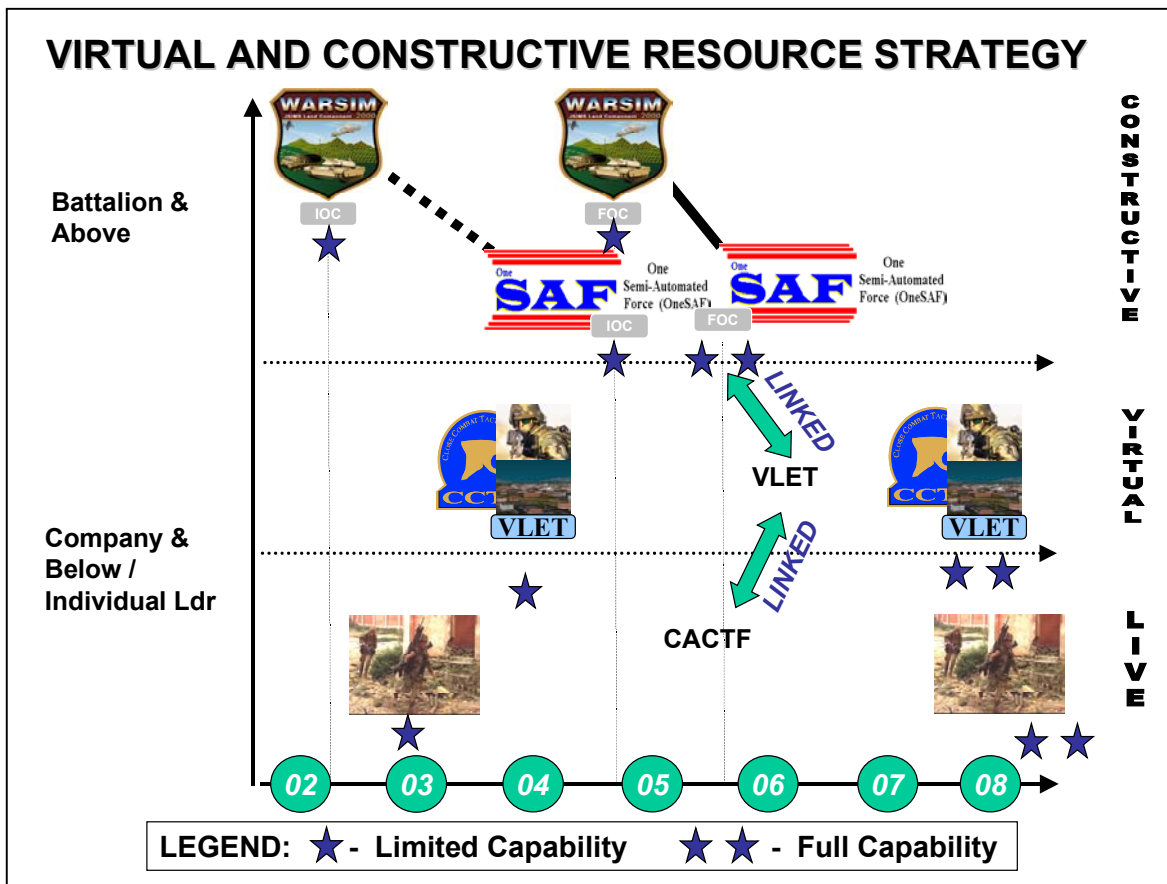

Figure E-4. Live, virtual, constructive training strategy.

E-2. URBAN OPERATIONS LEADER TRAINING

The CAMTF urban operations training strategy consists of initial, intermediate, and culminating stages.

a. These phases of training, depicted in Figure E-5, describe the sequence in which urban operations training tasks should be conducted.

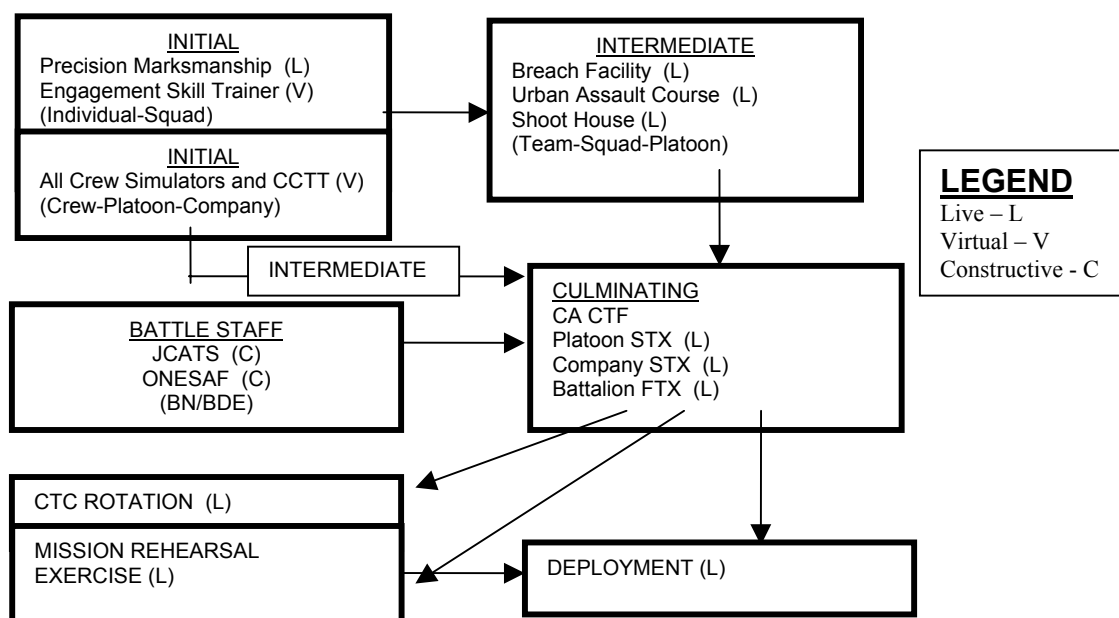

Figure E-5. Live/virtual/constructive training strategy.

(1) **Initial Phase.** The initial phase of training covers those individual and collective tasks that soldiers and leaders should be proficient at before arriving at any of the urban operations training sites. They consist primarily of basic marksmanship skills and soldier tasks needed to perform any tactical operation.

(2) **Intermediate Phase.** The intermediate phase consists of training conducted at the breach facility, shoot house, and the urban assault course. Urban operations training tasks should be conducted here before advancing to the combined arms collective training facility with the exception of Aviation, Armor, and other branches that have no practical use for the shoot house, breach facility, or urban assault course.

(3) **Culminating Phase.** The combined arms collective training facility is the culminating phase of urban operations training and focuses on multiechelon collective skills for all branches of the combined arms team.

b. Urban operations leader training currently exists in our leader professional development courses. Units have developed internal urban warfare training programs and TRADOC schools have assembled technical mobile training teams (MTTs) for marksmanship, combatives, and breaching techniques. An example of a leader's urban operations training program is as follows:

(1) **Education Phase.**

- Urban warfare reading/video list.
- Urban operations equipment.
- Review of doctrinal publications (FM 7-10, FM 90-10-1[3-06.11], for Infantry) and corresponding publications for other branches.
- Small-unit urban movement techniques and considerations.

(2) ***Planning and Execution Phase.***

- Prepare company OPORD or BOS related products.
- Brief platoon/company OPORD/BOS related products to commander or staff representative.
- Participate as briefer in urban environment TEWT.

(3) ***Sustainment Phase.***

- Participate in company/platoon TEWT or other urban operations event.
- Execute/facilitate a company or platoon TEWT.

c. A sample urban leaders' course POI, which is intended to provide unit trainers with a tailorable urban operations training program, is provided below. It is a *train-the-trainer* course for team leaders through platoon leaders to train tactics, techniques, and procedures of advanced urban operations skills. The length and focus of the POI can be tailored to support the commander's training objectives and unit METL. The target audience is newly arrived, or soon to be, small unit leaders. The recommended course length is about two weeks or 120 to 140 hours of instruction. Recommended POI subjects are as follows:

(1) ***Course Overview.***

- Introduction.

(2) ***Precision Marksmanship.***

- Firing techniques.
- Target discrimination.

(3) ***Breaching Techniques.***

- Explosive.
- Ballistic.
- Mechanical.

(4) ***Offensive Operations.***

- Planning considerations.
 - METT-TC.
 - Snipers.
 - CASEVAC.
 - Communications.
 - ROE.
- Platoon attack a built-up area (task organization)
 - Assault (isolate, enter, clear).
 - Rooms, hallway, stairs, superstructure, subsurface.
 - Markings.
 - Movement techniques.
 - Streets.
 - Alley ways.
 - Obstacles.
 - Other danger areas.
 - Open areas.
 - Roof tops.
- Combined arms.
 - Armor/mechanized platforms.

- Aviation assets.
 - Artillery.
 - Engineer.
 - Limited visibility.
- (5) ***Defensive Operations.***
- Planning considerations.
 - METT-TC.
 - Snipers.
 - CASEVAC.
 - Communications.
 - ROE.
 - Characteristics of urban areas.
 - Hasty defense.
 - Occupation and preparation of positions.
 - Hasty firing positions.
 - Improving the defense.
 - Deliberate defense.
 - Priorities of work and other considerations.
 - Defensive plan at platoon level.
 - Defense of a strongpoint.
 - Defense against armor.
 - Combined arms.
 - Armor/mechanized.
 - Aviation assets.
 - Artillery.
 - Engineer.
 - Limited visibility.
 - Fundamental combat skills.
- (6) ***Stability and Support Operations.***
- Principles of stability and support.
 - Stability and support activities.
 - NEO.
 - Humanitarian assistance.
 - Disaster relief.
 - Show of force.
 - Attack and raids.
 - Rules of engagement application.
 - Convoy operations.
 - Checkpoints.
 - Fire support.
 - Sniper employment/counter sniper measures.
 - Civil disturbance.
- (7) ***Urban Training Facilities.***
- Breach facility.
 - Urban assault course.

- Shoot house.
- CACTF.
- (8) ***New Technologies.***
 - Rifle launch entry munition.
 - Unmanned vehicles.
 - UAV.
 - UGV.
 - Ladders.
 - Night vision devices.

E-3. REALISTIC TRAINING OFF FEDERAL FACILITIES

Realistic training for urban operations is critical to force readiness. Training opportunities that are both realistic and challenging may not be available at federal installations or other facilities specifically established for the conduct of urban operations training. Training in off post civilian urban settings may become necessary in order to support readiness and training requirements.

To accommodate both military training needs and the unique concerns of civilian communities in which realistic urban training events are proposed, the following Department of Defense uniform procedures have been established for planning and approval of training activities in civilian urban settings:

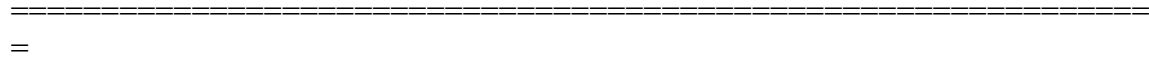

**UNIFORM PROCEDURES FOR
PLANNING AND APPROVING REALISTIC URBAN TRAINING**

1. REFERENCES.

- a. Secretary of Defense Memorandum, (date), Department of Defense Policy for Realistic Urban Training off Federal Facilities.
- b. 10 USC § 167, Unified Combatant Command for Special Operations Forces.
- c. 10 USC §§ 3013, 5013, 8013.
- d. Department of Defense Directive 5111.10.
- e. Unified Command Plan 99.

2. PURPOSE. This enclosure establishes uniform planning and approval procedures for realistic urban training (RUT) events conducted in civilian urban settings in the United States, its territories and possessions.

3. APPLICABILITY. This procedure applies to all RUT events in civilian urban settings conducted in the United States, its territories and possessions, by Active or

Reserve Forces, including National Guard Forces in Federal service. This policy does not apply to National Guard Forces while in State status (under title 32) or to aviation operations that do not require an exemption from standard Federal Aviation Regulations.

4. **DEFINITIONS.** For the purposes of this enclosure, the following definitions are applied:

a. **Military Operations on Urban Terrain.** MOUT is all military actions planned and conducted on a topographical complex and its adjacent natural terrain where man-made construction is the dominant feature. It includes combat-in-cities, which is that portion of MOUT involving house-to-house and street-by-street fighting in towns and cities.

b. **Realistic Urban Training.** RUT is high-intensity, close-quarter battle training and the use of live or non-lethal fires, demolitions/explosives (for example, breaching), and air and naval supporting platforms at the objective in civilian urban settings. It includes MOUT training that equals the definition of realistic urban training,

c. **Civilian Urban Setting.** A civilian urban setting is an area or areas located in or near a civilian community. This proposed realistic urban training event should not be located on federal, installations, state, local, or private facilities. These settings should not be developed or established for the purpose of training events especially where training activities are not expected to have an effect on civilian residences or commercial areas because of noise, traffic, or other foreseeable effects of the training activity.

5. **PROCEDURES.** The following procedures apply to the planning and approval of RUT in civilian urban settings.

a. It is the responsibility of the combatant commander or the service to ensure compliance with these procedures and the intent of the policy established by reference. Approval authority for RUT events may be delegated to a general or flag officer within the chain of command of the combatant command or service conducting the training.

b. Proposed training events are reviewed to determine whether they are necessary and appropriate for unit readiness. Training must support unit METs and JMETS.

c. Upon approval of the proposed training and not later than 14 days before the commencement of training, the combatant command or service notifies the SECR)PF through the CJCS (by way of message) of the approved training. At a minimum this notice will include the following:

(1) Name and location of the unit conducting training.

(2) A description of the scope of the, training and types of activities to be conducted during the training event (for example, live fire, breaching, use of aircraft).

(3) Start and end dates of the training.

(4) Training location.

(5) A statement that all necessary coordination has been accomplished IAW the procedures outlined below listing the names and positions of each official contacted IAW subparagraph d below.

d. Coordination with civilian officials.

(1) During the planning phase for the training event, the commander responsible for planning the training must coordinate with and obtain approval for the event from the appropriate federal, state, and local civilian authorities. Civil officials shall approve in writing. Commanders shall consult their legal and public affairs officers to assist in determining the appropriate civilian officials with whom to coordinate the training event. In determining the appropriate civilian officials for coordination, local government officials (for example, mayor, borough chief, county commissioners or supervisors), and local and Federal law enforcement agencies are consulted. At a minimum, a senior level official with responsibility for each affected civilian urban settings is consulted.

(2) Issues to be addressed with civilian officials, during coordination, shall include details on specific proposed training activities (such as whether the event involves live fire, the use of rotary- or fixed-wing aircraft, close quarters battle training, whether the exercises are to be conducted in daylight or at night, and so forth.), precautions to ensure public and participant safety, proposed public or resident notification/outreach procedures, and any other issues that might result in public interest or concern regarding the conduct of the exercise.

(3) To the maximum extent possible civilian officials are to be briefed in person on the exercise concept.

(4) The US congressional representative, or his/her staff, in whose district the training is taking place, and the US senators for the state, or their staffs, are advised of the proposed training event and provided information to the extent requested. Written approval or concurrence from the representative or senators is not a precondition to exercise execution. However, if objections or issues by the representative or senators are raised and cannot be resolved, the issues are immediately elevated to the Joint Staff, J3, and the service or combatant commander point of contact.

(5) For each training site, license agreements with civilian or government property owners or managers are executed. Agreements address liability and conditions on usage of property. Property owners are informed of the nature of the training to include written notification whether the activities will include Breaching charges (amount of explosive), live ammunition (type: for example, shotgun, frangible, and so forth.), rotary or fixed-wing aircraft, and whether the exercises will be conducted in daylight or at night. Before execution, license agreements must be reviewed for legal sufficiency. Copies of the

license agreements shall be provided to the senior civilian officials responsible for the affected civilian urban settings.

(6) A record of coordination activities is maintained for each training event. The record includes the names and positions of the officials that coordinate and approve the event. It also includes a summary of the information for the officials regarding the event (for example, date, time, and location of the training; types of activities to be conducted; proposed public notification/outreach plans, and so forth.). A follow-on letter is distributed to the senior civilian officials responsible for the affected civilian urban settings that confirms the training event and lists the names of the civilian officials that the plans for the training event.

(7) Training events that will be conducted on a recurring basis at the same area or location may be based on a single MOA with the appropriate authorizing civilian officials. The terms of the MOA must comply with the requirements of this attachment. The MOA, which authorizes the recurring training, is reviewed by the service or the combatant commander to ensure it complies with the procedures. Once the MOA is approved, individual training events conducted pursuant to the MOA can be conducted without further Joint Staff or OSD review. However, services and combatant commanders ensure that SO/LIC and the Joint Staff are notified 14 days in advance of the training events conducted pursuant to such MOA. Services and combatant commanders must ensure that such MOAs are periodically reviewed to ensure they continue to fulfill the intent.

(8) If nondisclosure agreements are required, they are reviewed by command legal representatives. Nondisclosure statements should clearly explain that the agreement does not preclude persons from informing others of general, nonsensitive information about the training exercise.

(9) To the extent practicable, consistent with OPSEC and safety considerations, recommendations of civilian officials regarding community notification/outreach and press procedures will be followed. Community notification/outreach procedures may include door-to-door notification conducted by the local law enforcement agency. Where notification/outreach and press recommendations cannot be followed, civilian officials will be so advised.

e. Other instructions include:

(1) Legal and PA representatives are present for final planning meetings and on-site for the duration of all training activities.

(2) The on-site PAO handles all press queries after coordinating with the on-scene commander.

(3) All requested training must be in accordance with all applicable statutes, law, DOD directives and other guidance, and implementing service directives.

GLOSSARY

| | |
|--------|---|
| AA | assembly area |
| AAR | after-action review |
| ADA | air defense artillery |
| ADCATT | air defense combined arms tactical trainer |
| AMTP | Army mission training plan |
| ANCOC | advanced noncommissioned officer course |
| AO | area of operations |
| ARTEP | Army training and evaluation program |
| ASAP | as soon as possible |
| AT | antitank |
| ATGM | antitank guided missile |
| ATWESS | antitank weapon effect signature simulator |
| AVCATT | aviation combined arms tactical trainer |
| | |
| BBS | brigade and below simulation |
| BBSAAR | brigade/battalion battle simulation after-action review |
| Bde | brigade |
| BFV | Bradley fighting vehicle |
| bldg | building |
| BMNT | beginning morning nautical twilight |
| Bn | battalion |
| BNCOC | basic noncommissioned officer course |
| BOS | battlefield operating system |
| BP | battle position |
| BSA | brigade support area |
| BSX | battle simulation exercise |
| | |
| CA | civil affairs |
| CACTF | combined arms collective training facility |
| CAMTF | combined arms MOUT task force |
| CAS | close air support |
| CBS | corp battle simulation |
| CCP | communications checkpoint |
| CCTT | close combat tactical trainer |
| cdr | commander |
| CEV | combat engineer vehicle |
| CFA | covering forces area |
| CFX | command field exercise |
| CI | counterintelligence |
| co | company |
| COA | course of action |
| catk | counterattack |
| CMTC | combat maneuver training center |

| | |
|----------|---|
| CP | command post |
| CPX | command post exercise |
| CS | combat support |
| CSS | combat service support |
| CTA | common table of allowances |
| CTC | combat training center |
| CTF | collective training facility |
| | |
| decon | decontamination |
| DES | demolition effects simulator |
| DODAC | Department of Defense Ammunition Code |
| DS | direct support |
| DTG | date-time group |
| | |
| EA | engagement area |
| EAC | echelons above corp |
| enr | engineer(s) |
| ENCATT | Engineer combined arms tactical trainer |
| EOD | explosive ordnance disposal |
| EST | engagement skills trainer |
| | |
| FAMSIM | family simulation |
| FM | field manual |
| FO | forward observer |
| FOB | forward operation base |
| FPF | final protective fires |
| FRAGO | fragmentary order |
| FSCATT | fire support combined arms tactical trainer |
| FTX | field training exercise |
| | |
| GPS | global positioning system |
| GSR | ground surveillance radar |
| | |
| HC | hexachloroethane |
| HE | high explosive |
| HELLFIRE | heliborne laser fire and forget (missile) |
| hq | headquarters |
| hr | hour |
| HRO | humanitarian relief organization |
| | |
| IAW | in accordance with |
| indiv | individual |
| inf | infantry |
| INTSUM | intelligence summary |
| IPB | intelligence preparation of the battlefield |
| IPW | interrogation of prisoners of war |

| | |
|---------|--|
| JANUS | joint Navy uniform simulation |
| JAWS | JANUS analyst workstation |
| JCATS | joint conflict and tactical simulation |
| JMET | joint mission-essential tasks |
| JRTC | joint readiness training center |
| JTX | joint tactical exercise |
| | |
| km | kilometer |
| | |
| LAW | light antitank weapon |
| LD | line of departure |
| LFX | live-fire exercise |
| LIC | low-intensity conflict |
| LMG | light machine gun |
| LO | liaison officer |
| LOGPAC | logistics package |
| LRC | leadership reaction course |
| LTC | lieutenant colonel |
| LZ | loading zone |
| | |
| MAPEX | map exercise |
| MBA | main battle area |
| MDI | modernized demolition initiators |
| MEDEVAC | medical evacuation |
| MET | mission-essential task |
| METL | mission-essential task list |
| METT-T | mission, enemy, terrain, troops, time available |
| METT-TC | mission, enemy, terrain, troops, time available, and civilians |
| MILES | multiple-integrated laser engagement system |
| min | minute(s) |
| MOA | memorandum of agreement |
| MOPP | mission-oriented protective posture |
| MOS | military occupational specialty |
| MOUT | military operations on urbanized terrain |
| MP | military police |
| MRE | meal, ready-to-eat |
| MSD | minimum safe distance |
| MTP | mission training plan |
| MTT | mobile training teams |
| | |
| NBC | nuclear, biological, chemical |
| NCO | noncommissioned officer |
| NCOIC | noncommissioned officer in charge |
| NGO | nongovernment organization |
| NLT | no later than |

| | |
|---------|--|
| NTC | national training center |
| NSC | national simulation center |
| NVD | night vision device |
| OAKOC | obstacles, avenues of approach, key terrain, observation and fields of fire, and cover and concealment |
| OBC | officer basic course |
| obj | objective |
| ODSS | offense, defense, stability, and support |
| OOTW | operations other than war |
| OP | observation post |
| OPCON | operational control |
| OPFOR | opposing force |
| OPORD | operation order |
| OPSKED | operational schedule |
| PA | public affairs |
| PADS | position and azimuth determining system |
| PL | phase line |
| plt | platoon |
| POI | program of instruction |
| POV | privately owned vehicle |
| PVO | private volunteer organization |
| prep | preparation |
| PSYOP | psychological operations |
| PW | prisoner of war |
| PZ | pickup zone |
| recon | reconnoiter or reconnaissance |
| RLEM | rifle launched entry munition |
| ROE | rules of engagement |
| RUT | realistic urban training |
| SBF | support by fire |
| SDZ | surface danger zone |
| SESAMS | special effects small-arms marking system |
| SO | special operations |
| SOF | special operations force |
| SOI | signal operation instruction |
| SOP | standing operating procedure |
| SP | start point |
| SRTA | short-range training ammunition |
| sqd | squad |
| STAFFEX | staff exercise |
| STP | soldier training publication |

| | |
|--------|---|
| STRAC | standards in training commission |
| STX | situational training exercise |
| T&EO | training and evaluation outline |
| TACSOP | tactical standing operating procedure |
| TBA | to be announced |
| TBD | to be determined |
| TC | training circular |
| TCP | traffic control post |
| TES | tactical engagement system |
| TEWT | tactical exercise without troops |
| TF | task force |
| TG | trainer's guide |
| tm | team |
| tng | training |
| TNT | A flammable toxic compound used as a high explosive. |
| TOC | tactical operations center |
| TOW | tube-launched, optically tracked, wire-guided missile |
| TP | training practice |
| TRP | target reference point |
| TSC | theater support command |
| TSP | training support package |
| TTP | tactics, techniques, and procedures |
| UAC | urban assault course |
| UO | urban operations |
| UMCP | unit maintenance collection point |
| WARSIM | war simulation |
| WFX | war fighting exercise |
| WP | white phosphorus |
| XO | executive officer |

REFERENCES

The publications with an asterisk by them will have new numbers (in parenthesis) when rewritten and published. They will also include all revisions and updates.

SOURCES USED

These are the sources quoted or paraphrased in this publication.

| | |
|-------------------|--|
| ARTEP 3-21.21-MTP | IBCT Infantry Battalion. To be published. |
| ARTEP 3-21.11-MTP | The IBCT Rifle Company. To be published. |
| ARTEP 3-21.9-MTP | The ICBT Rifle Platoon and Squad. To be published. |
| ARTEP 7-7J-Drill | Battle Drills for the Bradley Fighting Vehicle, Section, and Squad. 8 Dec 92 |
| ARTEP 7-8-MTP | Mission Training Plan for the Infantry Rifle Platoon and Squad. 29 Sep 94 |
| FM 5-34 | Engineer Field Data. 30 Aug 99 |
| FM 5-250 | Explosives and Demolitions. 30 Jul 98 |
| FM 7-7J | Mechanized Infantry Platoon and Squad (Bradley). 7 May 93 |
| FM 7-8 | Infantry Rifle Platoon and Squad. 22 Apr 92 |
| FM 23-9 | M16A1 and M16A2 Rifle Marksmanship. 3 Jul 89 |
| FM 23-31 | 40-mm Grenade Launcher, M203. 20 Sep 94 |
| FM 25-4 | How to Conduct Training Exercises. 10 Sep 84 |
| *FM 25-100 | Training the Force. 15 Nov 88. (Under revision, FM 7-0.) |
| *FM 25-101 | Battle Focused Training. 30 Sep 90. (Under revision FM 7-10.) |
| FM 3-06.11 | An Infantryman's Guide to Combat in Built-Up Areas. 28 Feb 02 |
| STP 21-1-SMCT | Soldier's Manual of Common Tasks, Skill Level 1. 1 Oct 94 |

TC 90-1

STP 21-24-SMCT Soldier's Manual of Common Tasks (SMCT), Skill Level 2-4. 1 Oct 92

STP 7-11BCHM1-SM-TG Soldier's Manual, Skill Level 1 and Trainer's Guide, CMF11, Infantry. 19 Jun 0

STP 7-11CHM24-SM-TG Soldier's Manual, Skill Level 2/3/4 and Trainer's Guide, CMF11, Infantry. 19 Jun 0

TC 7-98-1 Stability and Support Operations Training Support Package. 5 Jun 97

TC 7-9 Infantry Live-Fire Training. 30 Sep 1993

TC 25-20 A Leader's Guide to After-Action Reviews. 30 Sep 1993

INDEX

- AAR, 1-7
- ammunition, 5-36
 - blank, 1-6, 3-4
 - service, 1-7
 - SESAMs, A-6, 1-7, 3-4
 - SRTA, 1-7
- advanced noncommissioned officer course (ANCOC), 1-7
- armor, 5-37
 - command and control, 5-44
 - considerations, 5-37, 5-41
 - transporting infantry, 5-38
- Army training and evaluation program (ARTEP), 1-9
- assault teams, 2-14
- battle drills, 2-5
- battle simulation, E-1
- battle staff training, E-2
- Bradley fighting vehicle (BFV), 1-10, 3-3
- basic noncommissioned officer course (BNCOC), 1-7
- booby traps, 1-11
- breach facility, A-1, A-9, 1-3, 4-1
 - door, 4-2
 - window, 4-2
 - wall, 4-3
- breaching techniques, E-6, 2-14, 2-15
- battle simulation exercise (BSX), A-3
- buildings,
 - façades, A-7
 - shoot through walls, A-8
- combined arms collective training facility (CACTF), 1-6, 5-1
- clearing techniques,
 - building, 2-9
 - hallway, 2-10
 - room, 2-11, 12
 - stairs/landing, 2-12
- collective training, 5-4
- combined arms collective training facility, A-1, A-9, 5-1
- command and staff training, E-1, 1-7
- communications problems, 5-42
- concurrent training, A-1
- collective training facility (CTF), A-8
- demolitions effects simulator, D-1
- demonstration, A-1
- evaluators, A-4
- exercises, A-2
 - BSX, A-3
 - CFX, A-3
 - CPX, A-3
 - FTX, A-4
 - LFX, A-4
 - MAPEX, A-2
 - STX, A-4
 - TEWT, A-2, A-3

fire control, 5-43

force-on-force, 5-4

fragmentary order (FRAGO), 5-7

field training exercise (FTX), 5-16, 5-25

full spectrum operations, 1-1

grenade,
 M-84 Stun Grenade, A-6
 Smoke, A-6

grenade launcher,
 40-mm, 2-19, 3-3
 M203, 2-19

grenadier gunnery, 2-19, 2-20

hand grenades
 employment, 2-6
 M84 stun, A-6
 smoke, A-6

hearing protection, 4-6

leader training, E-1

leadership reaction course (LRC), 1-8

limited visibility training, A-5

live-fire exercise (LFX), A-4, 2-2, 2-20, 3-1

loopholes, 2-24

modernized demolition initiators (MDI), 4-3

M1 tanks, 3-3

mission-essential task list (METL), 1-2

multiple-integrated laser engagement system (MILES), 1-7

movement techniques, 2-9 thru 2-12

mission training plans (MTPs), 1-9

mouseholes, 2-24

navigation, A-5

noncombatants, 1-3

obscurants, 2-16

operations order,
 sample, 3-10, 5-11, 5-19, 5-29

operations,
 combined arms, 1-1
 defensive, E-7
 high intensity conditions, 1-1
 offensive, E-6
 precision conditions, 1-1
 stability and support, E-7
 urban, 1-1

opposing force (OPFOR), A-7

physical training, A-7

precision marksmanship, A-7

prerequisite training, 1-7

pyrotechnics, 5-36

risk assessment, 1-11

rifle-launched entry munition (RLEM), 4-6

room clearing,
 securing, 2-17

- rules of engagement, 1-1, 5-44
- safety, A-6, 2-3, 2-7, 4-6
- scenarios, 3-8
- securing,
 - alleys, 2-16
 - rooms, 2-17
 - walls, 2-17
- special effects small-arms marking system (SESAMS), A-6
- simulations, E-1
 - BBS, E-2
 - CBS, E-2
 - CCTT, E-4
 - EST, E-4
 - JANUS, E-1
 - OneSAF, E-3
 - WARSIM, E-3
 - VLET, E-4
- shoot house, A-8, 1-4, 3-1
- shoot through walls, A-8
- SRTA, 1-7, 3-4
- stability and support, C-1
- staff training, E-1
- situational training exercise (STX), 5-5, 5-8, 5-26, 5-29
- supporting tasks, 2-3, 2-7, 2-22, 2-24, 2-27, 3-14,
- tank cannon
 - characteristics, 5-41
 - deadspace, 5-43
 - effects and employment, 5-37
 - MPAT, 5-42
 - overpressure, 5-40
- tank, M1, 3-3
- targetry, 2-2, 2-3, 2-7, 2-21, 2-24, 5-37
- tactical engagement system, A-5, 3-4
- tactical exercise without troops (TEWT), 5-4
- training,
 - armor, 5-37
 - conduct, 2-4, 2-8
 - crawl, 1-6
 - walk, 1-6
 - run, 1-6
 - leader development, E-1,4
 - limited visibility, A-5
 - matrix, B-1, C-1
 - off federal facilities, E-8
 - realistic urban training, E-9
 - civilian urban setting, E-9
 - procedures, E-9
 - urban operations (UO), E-9
 - phases, E-5
 - culminating, E-5, 1-6
 - education, E-5
 - initial, E-5, 1-2
 - intermediate, E-5, 1-3
 - planning and execution, E-5
 - sustainment, E-6
 - precision marksmanship, A-7, E-6
 - prerequisite, 1-7
 - command and staff, 1-7
 - individual, 1-7
 - leader, 1-7
 - physical, A-7
 - strategy,
 - active, 1-1, 2, 10
 - reserve component, 1-11
 - support requirements, 2-4, 2-8, 3-13, 4-5, 5-8, 5-15, 5-24, 5-35
 - tasks
 - collective, 1-9, 2-3, 2-7
 - individual, 1-8, 2-3, 2-7
- tips, A-1

urban assault course, A-1,8, 1-5, 2-1
facility description, 2-1
Stations,
#1--Individual and Team
Task/ Technique Trainer,
2-3
#2--Squad and Platoon Task/
Technique Trainer, 2-6
typical layout, 2-1
#3--Grenadier Gunnery,
2-19,20
#4--Urban Offense/Defense
Building, 2-22
#5--Underground Trainer,
2-26

urban training facilities, E-7

TC 90-1
1 APRIL 2002

By Order of the Secretary of the Army:

ERIC K. SHINSEKI
General, United States Army
Chief of Staff

Official:

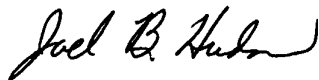

JOEL B. HUDSON
Administrative Assistant to the
Secretary of the Army
0208804

DISTRIBUTION:

Active Army, Army National Guard, and US Army Reserve: To be distributed in accordance with initial distribution number 113858, requirements for TC 90-1.

PIN: 060024-000