

**ARMY, MARINE CORPS, NAVY, AIR FORCE**

**MULTISERVICE  
TACTICS,  
TECHNIQUES,  
AND PROCEDURES  
FOR  
BIOLOGICAL  
SURVEILLANCE**



**FM 3-11.86  
MCRP 3-37.1C  
NTTP 3-11.31  
AFTTP (I) 3-2.52**

**OCTOBER 2004**

**DISTRIBUTION RESTRICTION:** Approved for public release;  
distribution is unlimited.

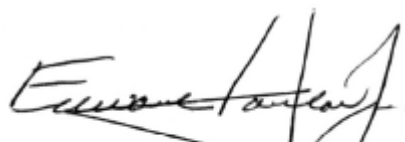
**MULTISERVICE TACTICS, TECHNIQUES, AND PROCEDURES**

## FOREWORD

This publication has been prepared under our direction for use by our respective commands and other commands as appropriate.



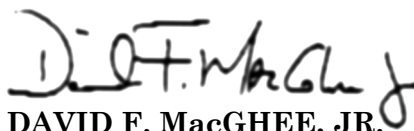
**STANLEY N. LILLIE**  
Brigadier General, CM  
Commandant  
United States Army Chemical School



**EDWARD HANLON, JR.**  
Lieutenant General, USMC  
Commanding General  
Marine Corps Combat  
Development Command



**JOHN M. KELLY**  
Rear Admiral, USN  
Commander  
Navy Warfare Development Command



**DAVID F. MacGHEE, JR.**  
Major General, USAF  
Commander  
Headquarters Air Force Doctrine  
Center

**This publication is available at Army Knowledge Online  
<[www.us.army.mil](http://www.us.army.mil)>.**

# PREFACE

## 1. Scope

This multiservice operations publication provides tactics, techniques, and procedures (TTP) for planning and conducting biological-surveillance operations to monitor, detect, sample, identify, report, and evacuate samples of biological-warfare (BW) agents used against United States (US) forces. The term “biological surveillance”, as used in this publication, refers to the actions taken to detect that a BW attack has occurred and identify the suspected BW agent involved. Users of this manual are nuclear, biological, and chemical (NBC) or chemical, biological, and radiological (CBR) staff and medical officers, unit commanders, NBC noncommissioned officers (NCOs), and others involved in planning and conducting biological-surveillance operations.

**NOTE: The United States Marine Corps (USMC) uses the acronym METT-T (mission, enemy, terrain and weather, troops available, and time). Civilian considerations are inherently measured within the context of this acronym.**

## 2. Purpose

a. The purpose of this publication is to provide commanders, staffs, and unit leaders with a reference for the planning and conduct of biological-surveillance operations. It serves as a key source document for the development of other multiservice manuals and the refinement of existing training support packages, training center exercises, and service school curriculum.

b. This manual provides the commander and his staff with tools to support:

- Countering a biological threat.
- Providing input to support force protection (FP).
- Supporting medical requirements.
- Supporting the decision making process.

## 3. Application

This publication is designed for use at the operational and tactical level. The publication will support command staff planning in preparing for and conducting biological-surveillance operations. This publication also provides guidance to biological-detection unit leaders and personnel for conducting biological surveillance.

## 4. Implementation Plan

Participating service command offices of primary responsibility (OPRs) will review this publication, validate the information, and reference and incorporate it in service and command manuals, regulations, and curricula as follows:

**Army.** The United States Army (USA) will incorporate this publication in training and doctrinal publications as directed by the commander, USA Training and Doctrine Command (TRADOC). Distribution is according to Department of the Army (DA) Form 12-99-R (Initial Distribution [ID] Requirements for Publications).

**Marine Corps.** The USMC will incorporate the procedures in this publication in training and doctrinal publications as directed by the commanding general (CG), US Marine Corps Combat Development Command (MCCDC). Distribution is according to the USMC publication distribution system.

**Navy.** The United States Navy (USN) will incorporate the procedures in this publication in training and doctrinal publications as directed by the commander, Navy Warfare Development Command (NWDC). Distribution is according to the military standard requisitioning and issue procedures (MILSTRIP).

**Air Force.** The United States Air Force (USAF) will validate and incorporate appropriate procedures in accordance with the applicable governing directives. It will develop and implement this and other NBC multiservice tactics, techniques, and procedures (MTTPs) through a series of USAF manuals providing service-specific TTPs. Distribution is according to the USAF publication distribution system.

## **5. User Information**

a. The USA Chemical School (USACMLS) developed this publication with the joint participation of the approving service commands.

b. We encourage recommended changes for improving this publication. Key your comments to the specific page and paragraph and provide a rationale for each recommendation. Send comments and recommendations directly to—

## **Army**

**Commandant  
US Army Chemical School  
ATTN: ATSN-CM-DD  
401 MANSCEN Loop, Suite 1029  
Fort Leonard Wood, MO 65473-8926  
COMM (573) 596-0131, extension 3-7364**

## **Marine Corps**

**Commanding General  
US Marine Corps Combat Development Command  
ATTN: C42 (Director)  
3300 Russell Road  
Quantico, VA 22134-5001  
DSN 278-6234; COMM (703) 784-6234**

## **Navy**

**Commander  
Navy Warfare Development Command  
ATTN: N5  
686 Cushing Road  
Newport, RI 02841-1207  
DSN 948-4201; COMM (401) 841-4201**

## **Air Force**

**HQ Air Force Doctrine Center  
ATTN: DJ  
155 North Twining Street  
Maxwell AFB, AL 36112-6112  
DSN 493-7442; COMM (334) 953-7442  
Webpage: <[www.doctrine.af.mil](http://www.doctrine.af.mil)>**

Unless this publication states otherwise, masculine nouns and pronouns do not refer exclusively to men.

**\*FM 3-11.86  
MCRP 3-37.1C  
NTTP 3-11.31  
AFTTP(I) 3-2.52**

**FM 3-11.86 US Army Training and Doctrine Command  
Fort Monroe, Virginia**

**MCRP 3-37.1C Marine Corps Combat Development Command  
Quantico, Virginia**

**NTTP 3-11.31 Navy Warfare Development Command  
Newport, Rhode Island**

**AFTTP(I) 3-2.52 Headquarters Air Force Doctrine Center  
Maxwell Air Force Base, Alabama**

**4 October 2004**

**MULTISERVICE TACTICS, TECHNIQUES, AND PROCEDURES  
FOR  
BIOLOGICAL SURVEILLANCE**

**TABLE OF CONTENTS**

	<b>Page</b>
<b>EXECUTIVE SUMMARY .....</b>	<b>xii</b>
<b>Chapter I</b>	
<b>BIOLOGICAL SURVEILLANCE PRINCIPLES, CONCEPTS, AND THREATS.....</b>	<b>I-1</b>
Background .....	I-1
Surveillance Principles .....	I-2
Biological- and Medical-Surveillance Concepts.....	I-3
Execution of Operational Concepts of Biological and Medical Surveillance .....	I-8
Biological-Warfare Threat Triggers.....	I-9
Application of Principles of Biological Surveillance .....	I-10
Commander's Information Requirements—Sample Results and Medical Surveillance.....	I-12

---

DISTRIBUTION RESTRICTION: Approved for public release; distribution is unlimited.

\*This publication supersedes FM 3-101-4, 9 June 1997 and FM 3-101-6, 25 March 1999.

---

	<b>Page</b>	
<b>CHAPTER II</b>	<b>BIOLOGICAL-SURVEILLANCE FUNCTIONS, RESPONSIBILITIES, AND CAPABILITIES.....</b>	<b>II-1</b>
	Background .....	II-1
	Responsibilities .....	II-2
	Capabilities.....	II-7
	Applying Biological-Detection Capabilities .....	II-14
<b>CHAPTER III</b>	<b>BIOLOGICAL-SURVEILLANCE PLANNING .....</b>	<b>III-1</b>
	Background .....	III-1
	Integrated Biological-Surveillance Operations .....	III-1
	Tactical, Operational, and Strategic Planning.....	III-2
	Planning Process.....	III-2
	Integration.....	III-14
<b>CHAPTER IV</b>	<b>BIOLOGICAL-SAMPLE EVACUATION .....</b>	<b>IV-1</b>
	Background .....	IV-1
	Sample Evacuation Requirements.....	IV-1
	Supported Unit Sample Evacuation Plan.....	IV-2
	Biological Detection Asset Sample Evacuation Plan .....	IV-2
	Biological-Detection Asset Sample Evacuation Planning and Operational Considerations .....	IV-3
	Sample Evacuation Execution.....	IV-4
	Chain-of-Custody .....	IV-4
<b>CHAPTER V</b>	<b>INFORMATION MANAGEMENT .....</b>	<b>V-1</b>
	Background .....	V-1
	Information Management.....	V-1
	Priority Information Requirements .....	V-2
	Reporting .....	V-2
	Information Collection and Operational Level Assessments .....	V-4
	Unit Incident Reporting.....	V-8
	Communications Architecture.....	V-14
<b>APPENDIX A</b>	<b>MEDICAL COUNTERMEASURES AND PROTECTION.....</b>	<b>A-1</b>
	Background .....	A-1
	Medical Countermeasures .....	A-1
	Vaccines .....	A-2
	Medical Intervention.....	A-3
	Restriction of Movement.....	A-3
<b>APPENDIX B</b>	<b>FIELD LAB SUPPORT .....</b>	<b>B-1</b>
	Background .....	B-1
	Types of Labs.....	B-1
	Confidence Levels of Lab Analysis Results .....	B-2
	Employment of Labs .....	B-4
	Laboratory Response Network for Biological Terrorism .....	B-4

	Page
<b>APPENDIX C</b>	<b>BIOLOGICAL-COLLECTION AND -DETECTION CAPABILITIES AND LIMITATIONS.....C-1</b>
	Background .....C-1
	Joint Portal Shield .....C-1
	Biological Integrated Detection System .....C-2
	Joint Biological Point Detection System, Fixed-Site or Trailer-Mounted Version .....C-4
	Long-Range Biological Standoff Detection System .....C-4
	Maritime Biological Agent Detection Capabilities.....C-4
	Dry Filter Unit .....C-5
	Department of Defense Biological Sampling Kit .....C-6
	Common Limitation .....C-7
<b>APPENDIX D</b>	<b>BIOLOGICAL-DETECTION CONTRACTED LOGISTICS SUPPORT .....D-1</b>
	Background .....D-1
	Principles.....D-1
	Contracted Logistics Support Planning Considerations.....D-2
	Employment .....D-3
	Responsibilities .....D-3
	Contracted Logistics Support Capabilities and Constraints .....D-8
	Contracted Logistics Support Team Assessment.....D-8
	Contracted Logistics Support Control .....D-8
	Contracted Logistics Support Concept .....D-9
<b>APPENDIX E</b>	<b>BIOLOGICAL-COLLECTION AND -DETECTION SYSTEM EMPLOYMENT .....E-1</b>
	Background .....E-1
	Mission .....E-1
	Concept of Operations.....E-1
	Employment Considerations .....E-5
	Biological-Warfare Threat Analysis (Intelligence Preparation of the Battlespace).....E-6
	Duration and Modes of Operation for Biological Detection.....E-7
	Biological-Detection and/or -Collector Employment Tactics .....E-10
	Preparing a Biological-Surveillance Plan.....E-13
	Maritime Biological -Detection and -Collection Employment Tactics .....E-18
	Common Detection Site Selection Criteria for Biological-Detection Systems .....E-19
	Indoor Site Selection for Biological Detectors or Collectors .....E-22
<b>APPENDIX F</b>	<b>BIOLOGICAL-WARFARE ATTACK WARNING .....F-1</b>
	Background .....F-1
	Warning Without a Biological-Detection and -Identification Capability .....F-1
	Warning With a Biological-Detection and -Identification Capability .....F-2
	Centralized Versus Decentralized Warning.....F-2



	Page
<b>APPENDIX G</b>	
<b>BIOLOGICAL-WARFARE SAMPLE EVACUATION PLANNING, HANDLING, AND CHAIN-OF-CUSTODY .....</b>	<b>G-1</b>
Background .....	G-1
Sample Evacuation Planning and Execution .....	G-1
Sample Evacuation Logistics Requirements .....	G-4
Chain-of-Custody Document Preparation .....	G-4
Biological Sample Packaging.....	G-8
Sample Identification Number Assignment .....	G-9
Supporting Documentation Packaging .....	G-10
Completed Evacuation Package .....	G-10
Sample Evacuation Planning Considerations .....	G-11
Background Sample Evacuation .....	G-11
<b>APPENDIX H</b>	
<b>LONG-RANGE BIOLOGICAL STANDOFF DETECTION SYSTEM OPERATIONS.....</b>	<b>H-1</b>
Background .....	H-1
Mission.....	H-1
Capabilities.....	H-1
Organization.....	H-2
Employment Planning .....	H-4
Long-Range Biological Standoff Detection System Employment .....	H-6
Long-Range Biological Standoff Detection System Mission Profiles .....	H-8
Mission Planning .....	H-9
Long-Range Biological Standoff Detection System Mission Phases .....	H-16
<b>APPENDIX I</b>	
<b>BIOLOGICAL INTEGRATED DETECTION SYSTEM UNIT OPERATIONS (M31A1 AND M31A2) .....</b>	<b>I-1</b>
Background .....	I-1
Preplanned Product Improved Biological Integrated Detection System .....	I-1
Joint Biological Point Detection System (M31A2-Biological Integrated Detection System) Operations .....	I-13
Biological Integrated Detection System Unit Information Management and Reports.....	I-18
Biological Integrated Detection System Unit Communication .....	I-24
<b>REFERENCES .....</b>	<b>References-1</b>
<b>GLOSSARY .....</b>	<b>Glossary-1</b>
<b>INDEX .....</b>	<b>Index-1</b>

## FIGURES

Figure I-1. METT-TC Factors That Impact Biological Surveillance .....	I-4
Figure I-2. Preparing BW Risk Reduction Measures .....	I-5
Figure II-1. JBPDS and Dry Filter Unit Coverage of an APOD .....	II-10
Figure II-2. BIDS Platoon Emplacement to Provide Coverage for JTF (Corps Size) Maneuver Forces for a Long Line Source Attack .....	II-11
Figure II-3. Employment of Multiple Biological-Detection Collection Systems (System of Systems) .....	II-12
Figure III-1. Biological-Surveillance Operations.....	III-15
Figure IV-1. Field Confirmatory Lab Support From USN Capability.....	IV-5
Figure IV-2. Sample Collection Flow .....	IV-6
Figure V-1. Maintaining Mission Readiness: “Detect to Treat” .....	V-3
Figure V-2. Possible Biological-Detection Network with Centralized Warning .....	V-4
Figure V-3. Tracking BW Data.....	V-6
Figure V-4. Biological-Event-Tracking Tool.....	V-7
Figure V-5. Incident Report (Sample).....	V-9
Figure V-6. Biological-Event-Tracking Tool (Sample) .....	V-13
Figure B-1. Field Confirmatory Testing.....	B-5
Figure B-2. Laboratory Response Network Structure.....	B-5
Figure E-1. Biological-Surveillance Mission Planning—Preattack .....	E-2
Figure E-2. Biological-Surveillance Mission Planning—Attack and Postattack .....	E-4
Figure E-3. Conducting BW-Threat Analysis (IPB) .....	E-8
Figure E-4. Dice Five Array.....	E-12
Figure E-5. Circle Employment .....	E-12
Figure E-6. Picket Line Employment.....	E-12
Figure E-7. Semicircle Employment.....	E-13
Figure E-8. Dense Picket Employment.....	E-13
Figure E-9. Critical-Node Array .....	E-14
Figure E-10. Area Array Support .....	E-17
Figure E-11. BIDS Deployment Areas.....	E-20
Figure G-1. Sample Chain-of-Custody Form .....	G-5
Figure H-1. LRBSDS Employment Concept .....	H-4
Figure H-2. Sample LRBSDS Mission .....	H-8
Figure H-3. Flight Profile Examples for LRBSDS Missions .....	H-11
Figure H-4. Sample Air Mission Briefing Guide.....	H-19
Figure H-5. Optimal Altitude for Air Release .....	H-22
Figure H-6. Optimal Altitude for Ground Release .....	H-23
Figure H-7. Difference in Helicopter Altitude and NAI Elevation .....	H-23

	<b>Page</b>
<b>Figure H-8. Low-Altitude Flight Profile</b>	
<b>Considerations .....</b>	<b>H-24</b>
<b>Figure H-9. Two LRBSDSs Scanning an Entire NAI .....</b>	<b>H-24</b>
<b>Figure H-10. An LRBSDS Scanning a Checkerboard</b>	
<b>Pattern Into an NAI .....</b>	<b>H-25</b>
<b>Figure H-11. An LRBSDS Scanning the Front and</b>	
<b>Rear Edges of an NAI.....</b>	<b>H-25</b>
<b>Figure H-12. Optimal Data Collection Altitude .....</b>	<b>H-26</b>
<b>Figure H-13. Minimum Single-Pass Altitude .....</b>	<b>H-27</b>
<b>Figure H-14. Minimum Multipass Altitude .....</b>	<b>H-27</b>
<b>Figure H-15. Departure Report .....</b>	<b>H-29</b>
<b>Figure H-16. Course Leg Commencement Request .....</b>	<b>H-30</b>
<b>Figure H-17. Course Leg Commencement SITREP.....</b>	<b>H-30</b>
<b>Figure H-18. Initial LAZER Detection Report .....</b>	<b>H-31</b>
<b>Figure H-19. Follow-Up Detection Report .....</b>	<b>H-32</b>
<b>Figure H-20. Cloud Loss Detection Report.....</b>	<b>H-32</b>
<b>Figure I-1. Sample BIDS SITREP.....</b>	<b>I-20</b>
<b>Figure I-2. Sample Event-Tracking Form.....</b>	<b>I-22</b>
<b>Figure I-3. Sample BIDS Incident Report for</b>	
<b>Event Tracking.....</b>	<b>I-23</b>
<b>Figure I-4. Sample Biological-Detection Platoon</b>	
<b>Sector Sketch.....</b>	<b>I-24</b>
<b>Figure I-5. HF Network .....</b>	<b>I-28</b>
<b>Figure I-6. MSE Network .....</b>	<b>I-29</b>
<b>Figure I-7. VHF Network for M31, M31A1, and M31A2</b>	
<b>and FBCB2 for M31A2 Only.....</b>	<b>I-29</b>
<b>Figure I-8. Sample FBCB2 Free Message Text for</b>	
<b>Biological-Incident Reports.....</b>	<b>I-30</b>

## **TABLES**

<b>Table I-1. Biological-Surveillance Principles.....</b>	<b>I-11</b>
<b>Table II-1. Command Staff Biological-Defense</b>	
<b>Responsibilities.....</b>	<b>II-2</b>
<b>Table II-2. Biological-Detection and -Collection</b>	
<b>Assets—Operational Envelope .....</b>	<b>II-8</b>
<b>Table II-3. Biological-Sample Courier Tasks.....</b>	<b>II-13</b>
<b>Table III-1. Identifying Risk Reduction Measures.....</b>	<b>III-4</b>
<b>Table III-2. Biological-Surveillance Planning—Situation ...</b>	<b>III-5</b>
<b>Table III-3. Biological-Surveillance Planning—Mission .....</b>	<b>III-6</b>
<b>Table III-4. Biological-Surveillance Planning—Execution..</b>	<b>III-6</b>
<b>Table III-5. Biological-Surveillance Planning—Service</b>	
<b>Support .....</b>	<b>III-11</b>
<b>Table III-6. Biological-Surveillance Planning—Command</b>	
<b>and Signal.....</b>	<b>III-14</b>
<b>Table V-1. Warning Level Applicability.....</b>	<b>V-9</b>
<b>Table V-2. System Confidence Levels.....</b>	<b>V-10</b>
<b>Table C-1. BIDS Comparison.....</b>	<b>C-3</b>

	<b>Page</b>
Table C-2. Dry Filter Unit 2000 Functions.....	C-5
Table C-3. Dry Filter Unit 2000 Biological-Detection Process .....	C-6
Table E-1. Favorable, Marginal, or Unfavorable Meteorological Conditions for BW Line Source Release .....	E-9
Table E-2. Sample Duration Intervals for Biological Detection System or Collector Operations.....	E-9
Table F-1. Pros and Cons of the Centralized Warning System .....	F-3
Table F-2. Pros and Cons of Decentralized Warning System .....	F-3
Table G-1. Sample Identification Numbers .....	G-7
Table G-2. Preparing a Dry Filter Unit Filter for Shipment .....	G-9
Table G-3. Packaging Supporting Documents for Evacuation .....	G-10
Table H-1. LRBSDS Employment Options .....	H-7
Table H-2. Example of an LRBSDS Staff Planning Checklist.....	H-9
Table H-3. Helicopter NOE Altitude (150 to 1,000 Feet AGL).....	H-13
Table H-4. Helicopter NOE Altitude (1,001 to 5,000 Feet AGL).....	H-13
Table H-5. LRBSDS Mission Planning Checklist .....	H-15
Table H-6. LRBSDS Mission Preparation Checklist.....	H-18
Table H-7. LRBSDS Biological-Detection Process .....	H-20
Table H-8. LRBSDS Biological-Surveillance Mission Execution Checklist (Sample) .....	H-21
Table H-9. Data Items for LRBSDS Detection Report .....	H-33
Table H-10. LRBSDS Postoperations Checklist.....	H-35
Table I-1. P3I BIDS (M31A1) System Functions .....	I-1
Table I-2. Preparing the Wet Collector for Evacuation.....	I-4
Table I-3. Preparing an Alternate Sample Container for Shipment .....	I-5
Table I-4. Packing Supporting Documents for Evacuation .....	I-6
Table I-5. Comparison of the UVAPS, CBMS, and Mini-FCM.....	I-7
Table I-6. UVAPS, CBMS, and Mini-FCM Capabilities.....	I-8
Table I-7. Possible Impact of the Environment on BIDS Component Results .....	I-9
Table I-8. P3I BIDS Background Data .....	I-9
Table I-9. P3I BIDS Event Data .....	I-10
Table I-10. P3I BIDS System-Level Process.....	I-11
Table I-11. P3I BIDS System-Level Response Profile.....	I-12
Table I-12. Factors That Could Influence Medium or Low Confidence Levels .....	I-13

	<b>Page</b>
<b>Table I-13. JBPDS (M31A2-BIDS) System Functions .....</b>	<b>I-13</b>
<b>Table I-14. Packaging Supporting Documents for Evacuation (JBPDS [M31A2-BIDS]).....</b>	<b>I-15</b>
<b>Table I-15. Background Characteristics.....</b>	<b>I-17</b>
<b>Table I-16. JBPDS (M31A2-BIDS) Background Data.....</b>	<b>I-18</b>
<b>Table I-17. JBPDS (M31A2-BIDS) Event Data.....</b>	<b>I-18</b>

# **EXECUTIVE SUMMARY**

## **Multiservice Tactics, Techniques, and Procedures for Biological Surveillance**

### **Biological-Surveillance Principles, Concepts, and Threats**

Chapter I provides the principles and concepts of biological and medical surveillance. It discusses the execution of biological and medical surveillance and provides information on assessing the BW threat.

### **Biological-Surveillance Functions, Responsibilities, and Capabilities**

Chapter II provides an overview of the functions of biological surveillance. It continues to define responsibilities of the staff in conducting biological-surveillance operations. It also provides the capabilities required to execute biological-surveillance operations.

### **Biological-Surveillance Planning**

Chapter III discusses the planning of biological-surveillance operations. It discusses integrated biological-surveillance operations. It provides guidance for planning biological surveillance at the tactical, operational, and strategic levels. The chapter culminates with a discussion on the biological-surveillance process and the integration of biological-surveillance assets. The chapter provides a discussion on the biological-surveillance annex to an operation order (OPORD).

### **Biological-Sample Evacuation**

Chapter IV provides guidelines for conducting biological-sampling operations. It discusses sample evacuation requirements, coordination, planning, and execution. It provides guidance on maintaining the sample chain of custody and conducting sample transfers. It also discusses the sample evacuation plan and subsequent sample analysis.

### **Information Management**

Chapter V provides an overview of biological-detection information management. It discusses the elements of BW attack determination and decision making to include priority information requirements, reports, communications, operational-level assessments, and decisions.

## **PROGRAM PARTICIPANTS**

The following commands and agencies participated in the development of this publication:

### **Army**

United States Army Chemical School, 401 MANSCEN Loop, Suite 1029, Fort Leonard Wood, MO 65473.

United States Army Medical Department Center and School, 1400 E. Grayson Street, Fort Sam Houston, TX 78234.

United States Army Soldier Biological Chemical Command, Aberdeen Proving Ground, MD 21040.

### **Marine Corps**

United States Marine Corps Combat Development Command, 3300 Russell Road, Suite 318A, Quantico, VA 22134-5021.

### **Navy**

United States Navy Warfare Development Command, 686 Cushing Road, Sims Hall, Newport, RI 02841.

### **Air Force**

United States Air Force Civil Engineer Support Activity, 14A Barnes Drive, Suite 1, Tyndall AFB, FL 32403.

United States Air Force Doctrine Center, 155 North Twining Street, Maxwell AFB, AL 36112-6112.

# Chapter I

## BIOLOGICAL-SURVEILLANCE PRINCIPLES, CONCEPTS, AND THREATS

### 1. Background

Biological- and medical-surveillance operations are mutually supportive and critical in support of FP. Biological detection and medical surveillance could be the first line of defense against a biological attack. These operations can support identifying whether or not a BW attack occurred prior to the onset of symptoms among the force.

a. **Biological Surveillance.** Surveillance is the systematic observation of aerospace, surface, or subsurface areas, places, persons, or things by visual, aural, electronic, or other means. Specifically, biological surveillance is the observation of specific areas of an area of operations (AO) for biological hazards. This includes the use of biological-detection or -collection assets (such as conducting background monitoring and biological-detection operations) and all source intelligences capable of providing information that a biological attack has occurred. It “paints the picture” of the status of the biological threat for the commander. It also includes the analysis and dissemination of the data collected.

b. **Medical Surveillance.**

(1) Medical surveillance is the ongoing, systematic collection of health data essential to the evaluation, planning, and implementation of public health practice. It is closely integrated with timely dissemination of data as required by a higher authority. A medical-surveillance system includes a functional capacity for the collection, analysis, and dissemination of data linked to public health programs. The foundation of a medical-surveillance program is the determination of unit-specific rates of illness and injuries of public health significance (see *Appendix A*). Medical surveillance is closely integrated with the timely dissemination of this data to those responsible for the prevention and control of disease and nonbattle injuries (DNBIs) and biological-defense planning. The establishment of uniform, standardized health surveillance and readiness procedures for all deployments is listed in Chairman of the Joint Chiefs of Staff (CJCS) Memorandum Military Classification Manual (MCM)-0006-02, Department of Defense Directive (DODD) 6490.2, and Department of Defense Instruction (DODI) 6490.3.

(2) Medical surveillance may provide the first indicator that a biological attack has occurred. If an attack is not detected directly, the first indication may be an increase of illness among the affected population. Most BW agents induce symptoms after an incubation period. An influx of patients reporting similar symptoms may indicate that an attack has occurred. Although it may be too late for medical countermeasures to help individuals who already show symptoms (see *Appendix A*), the trend can alert the medical system to initiate protective measures such as vaccines or antibiotics for those who have been exposed but are not yet sick.



## 2. Surveillance Principles

Biological and medical surveillance are used to support early detection and identification of a biological-agent attack. Early identification of a BW attack is critical to support measures such as postattack medical prophylaxis and treatment. The principles of biological and medical surveillance directly support the NBC defense principles of *Joint Publication (JP) 3-11* and *Multiservice Tactics, Techniques, and Procedures for Nuclear, Biological, and Chemical Defense Operations*. Biological and medical surveillance support measures such as BW agent contamination detection and identification or the initiation of postattack medical prophylaxis. The common features of biological and medical surveillance support identifying whether a threat BW attack occurred. The principles below support the surveillance process of detecting and identifying BW attacks.

### a. Maximize the Probability of Detection.

(1) Thorough intelligence preparation of the battlespace (IPB) allows commanders to optimally position detection and medical resources and establish strategies to increase the probability of detection and identification.

(2) The information collected and reported is directly applicable to the commander's critical information requirements (CCIR) developed during IPB, the prevention of DNBI, and the ongoing identification of the biological threat in the AO. For example, the supporting information from a lab conducting field confirmatory or definitive identification (see *Appendix B*) directly supports a commander's priority information requirements (IRs) (such as identifying that a threat BW attack has occurred).

### b. Orient on the Threat.

(1) The threat BW situation is assessed before commencing operations. The IPB process assesses where, when, how, and why the threat may employ biological weapons. IPB assists in focusing the surveillance efforts at the critical places and times. For example, biological-detection and medical assets are assigned areas of responsibility (AORs) based on the IPB. The IPB process evaluates the weather and terrain of the AOR to assess the impact of the environment on BW agent employment.

(2) The surveillance process also focuses on background conditions such as the development of a profile of disease occurrence in the AO. This allows the staff planners to identify and differentiate background disease occurrence from actual BW attacks.

### c. Report All Information Promptly and Accurately.

(1) Biological and medical surveillance are performed to obtain information. Higher commanders merge this information with other intelligence indicators to confirm biological attacks and make decisions. The information source will generally have a confidence level associated with it. The source of the information can be an important element in the decision-making process.

(2) Transmission of the collected information is uniform in method and schedule. Reports of the interpreted information are clear, predictable, and coordinated with operation plans (OPLANs) and OPORDs.

d. Develop the Situation Rapidly.

(1) Once the unit or activity performing the biological- or medical-surveillance mission detects or identifies a BW agent, the information is forwarded rapidly through the reporting chain. The information is time sensitive and must be evaluated along with other intelligence indicators to update the commander's situational awareness (SA).

(2) The surveillance plan uses the communications and network capabilities of the theater and the sustaining base to rapidly disseminate surveillance results throughout the command (such as intelligence, NBC, and command channels) and within the combat health support system.

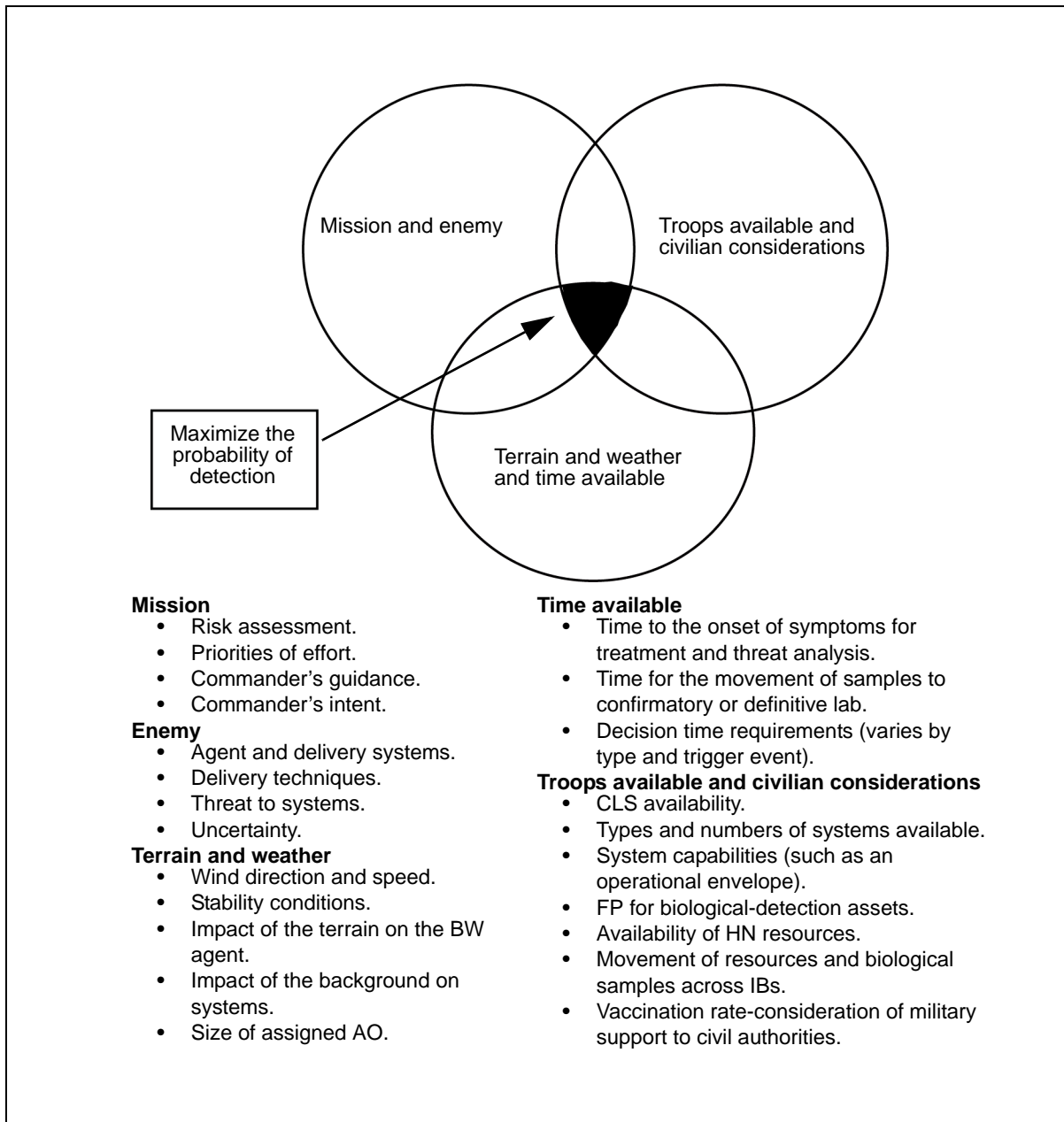
e. Optimize the Use of Biological-Surveillance Capabilities. When selecting biological- (see *Appendix C*) and medical-surveillance assets to perform a task, the commander considers the capabilities of the available assets. Based on the assigned mission, threat IPB, and system capabilities, the NBC and medical staff prepare their surveillance plans.

### 3. Biological- and Medical-Surveillance Concepts

The operational concept for biological surveillance is impacted by multiple factors such as mission, enemy, terrain and weather, time, troops available, and civilian (METT-TC) considerations. These factors are interrelated (terrain and weather impact BW agent employment and the location of a biological-detector array). The biological-surveillance planner considers these factors and analyzes the tradeoffs that exist between these different considerations (such as the tradeoff between mission requirements and troops and support available). Achieving the tradeoff between these factors results in an overlap that should maximize the probability of detection (see *Figure I-1* [page I-4]). The siting of biological-surveillance systems will be impacted by the following factors:

- Mission—What are the commander's IRs and priorities of effort?
- Enemy—What agent and delivery systems may be used by the threat?
- Terrain and weather—What terrain is available to position available assets? How will weather and terrain impact BW aerosol releases?
- Troops available—How does the plan allocate a limited number of surveillance assets? How does the plan apportion sustainment resources? (See *Appendix D*.)
- Time available and civilian considerations—How much time is available before the onset of BW agent symptoms? What is the estimated time for evacuation and lab analysis of samples? What is the estimated time to conduct postattack medical prophylaxis?

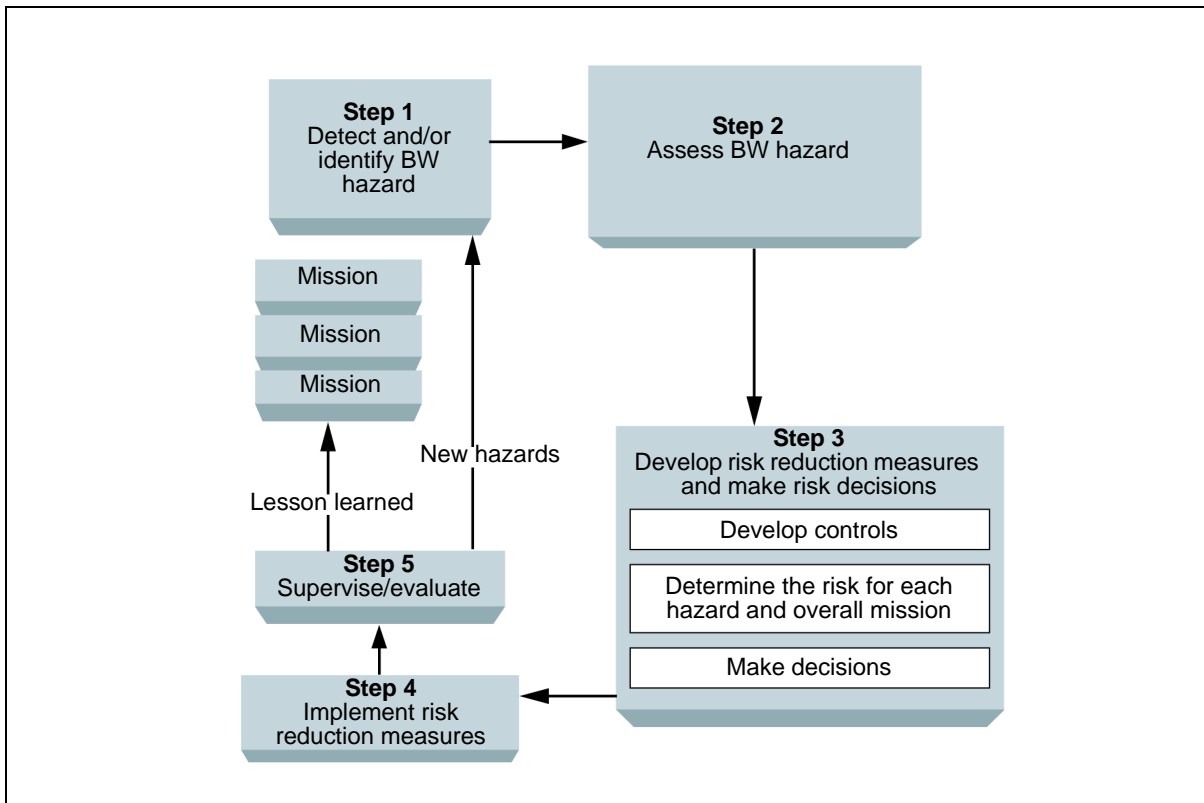
The operational concept integrates the METT-TC conditions into practical terms that drive an effective probability of detection and support the development of viable courses of action (COAs) that are operationally and logistically supportable. Defining the operational concept in terms of a workable process leads to the development of risk reduction measures. Before the process of defining risk reduction measures begins, the command and staff ensure that they understand the assigned mission and the higher commander's intent, guidance, risk assessment, constraints, and priorities of effort. An



**Figure I-1. METT-TC Factors That Impact Biological Surveillance**

understanding of the mission provides the link between the mission and the concept of operations (CONOPS). To implement an operational concept that recommends effective risk reduction measures (see *Figure I-2*), the command and staff can use the following steps: detect and/or identify the BW hazard, assess the BW hazard, develop risk reduction measures and make risk decisions, implement risk reduction measures, and supervise and evaluate.

a. Detecting and/or Identifying the BW Hazard. Risk decisions should be based on SA of the threat. The threat of a BW attack can be found in nearly all operational



**Figure I-2. Preparing BW Risk Reduction Measures**

environments, and the ability of unit leaders and staff to detect and/or identify the hazard is essential. The command and staff consider the following threats—

- BW agent capabilities.
- Available delivery systems.
- Delivery techniques.
- The likelihood of the use of a BW agent.
- The threat capability to attack and destroy US biological-detection assets.

(1) Identifying the threat BW agent capability is critical. Ensuring that biological- and medical-surveillance resources are prepared to support force health protection is vital.

(2) Identifying the BW hazard examines how and where a threat may use a BW agent (such as inside a building or outside with a line or point source). This is a challenging process with the unpredictability of BW agent use.

b. Assessing the BW Hazard. The command and staff assess the probability and severity of BW attacks to determine the potential risk to the mission and personnel. The end result is an estimate of risk and an assessment of the overall risk to the mission. The risk assessment is directly related to the BW hazard identification and method of BW employment. BW hazard identification is key to determining protective measures, casualty estimates, and the time before the onset of symptoms. Methods of employment include aerial sprayers, infected persons or vectors, or contaminated food or water. When

sprayers and explosive devices are used, factors that will impact the risk assessment include terrain and weather. BW hazard identification and the method of employment are interlinked and are used to support BW risk assessments. See *Appendix E*.

(1) Terrain and weather impact the assessment of the BW hazard. Specific factors that are part of the assessment include—

- The wind direction and speed.
- Atmospheric stability conditions (stable, neutral, or unstable).
- The impact of terrain (natural and man-made) on BW agent cloud behavior.
- The impact of background conditions (environmental or man-made) on biological-detection capabilities.
- The size of the AO.
- The impact of weather phenomena on biological-detection capabilities.

(2) The time available is impacted by the time—

- To the onset of symptoms following exposure to a BW agent.
- For the movement of samples and for lab analysis.
- For support of the decision-making process.

(3) The protective posture of the personnel in the affected area is impacted by the—

- Immediate availability of respiratory protection.
- Vaccination rate.
- Immediate availability of collective protection.

c. Developing Risk Reduction Measures and Making Risk Decisions.

(1) After assessing the BW threat and the potential hazard of a BW attack, the command and staff develop risk reduction measures that should reduce the risk to the force. To be effective, each risk reduction measure developed must meet the following criteria:

- **Suitability.** It must reduce the hazard.
- **Feasibility.** The unit must have the capability to implement the risk reduction measure.

(2) Examples of risk reduction measures include the following critical measures:

- Preparing an employment plan that optimizes the use of available biological-detection resources (see *Appendix E*).
- Establishing centralized or decentralized warning and reporting (see *Appendix F*).

- Preparing a sample collection plan that integrates the use of laboratories, sample courier assets, and biological-detection assets (see *Appendix G*).
- Providing the required reports through the established communications architecture to support the commander's SA.
- Preparing a logistics plan that integrates the use of contracted logistics support (CLS) and standard military support.
- Preparing a plan for medical prophylaxis and treatment.
- Ensuring that command and control (C2) and support relationships are specified.
- Preparing a plan for minimizing the spread of the contamination, whether from the agent itself or contagious personnel.
- Implementing quality management practices.
- Providing quality management practices for the FP of surveillance resources.
- Establishing a plan for the use of standoff detection systems (see *Appendix H*).
- Preparing a restriction of movement plan to limit the possible transmission of a contagious BW agent.

(3) The development of risk reduction measures hinges on suitability and feasibility considerations. Factors that impact the risk reduction measure selected include the—

- Number of biological systems available.
- Capability of the systems available (for example, what is the operational envelope for the systems, individually or collectively). (See *Appendixes C and I*.)
- Availability of CLS to support at one or more locations.
- Availability and location of supporting confirmatory and/or definitive laboratories and sample couriers.
- Availability of security resources to provide FP for low-density biological-detection assets.
- Availability of host nation (HN) resources to support biological surveillance.
- Mobility to move the required resources (such as samples and logistics) intratheater, intertheater, and between theaters.
- Capability to communicate the required information and obtain the required technical reach-back capability.
- Number of people exposed to the BW agent.

(4) The development of risk reduction measures is directly linked to variables associated with BW hazard identification and assessment. Further, the risk associated with each control measure is assessed along with the overall risk to the force.

d. **Implementing Risk Reduction Measures.** The command and staff ensure that controls are integrated into standing operating procedures (SOPs), written and verbal orders, mission briefings, and staff estimates. The critical check for this step is to ensure that controls are converted into clear, simple execution orders that are understood at all levels.

e. **Supervising and Evaluating.** During mission preparation and execution, leaders complete the risk assessment process through supervision and evaluation. The continuous evaluation and assessment of risk levels may yield lessons learned and/or the identification of new hazards. Supervision and evaluation is a basic form of quality management.

#### **4. Execution of Operational Concepts of Biological and Medical Surveillance**

a. **Biological Surveillance.** Biological-detection and -collection assets are employed based on the mission, the risk assessment, and an evaluation of the threat force capability to use BW agents. The commander will prioritize the use of available assets and establish an employment plan that integrates the use of fixed-site and maneuver or maritime biological-detection and -collection assets. The operational settings for employing biological-detection and -collection elements include fixed sites, ports, or airfield FP (critical node) and maneuver or maritime FP (area array).

(1) **Fixed sites, ports, or airfield force protection.** This operational setting can occur when biological-detection and/or -collection assets are placed on or near a site to provide biological surveillance. They can be used to detect off-site or on-site attacks and can be employed to protect early-entry sites and C2 sites such as an installation, aerial port of debarkation (APOD), seaport of debarkation (SPOD), or specific buildings. A METT-TC analysis will determine the number of systems required as point detectors or samplers for critical target areas such as logistics bases, C2 locations, major airfields, airbases (ABs), naval bases, or ports. In joint operations, biological-detection and -collection systems can also be placed inside critical buildings. Guidance on site selection, placement, and spacing can found in *Appendix E*.

(a) **Fixed-site biological surveillance** provides for a redundant biological-detection and -collection capability. This capability may address the need for surveillance of the outside ambient air and internal building air.

(b) **Monitoring the outside ambient air** provides a capability to detect an external release of a biological agent from an overt or covert release. Additionally, critical buildings may be provided with biological-detection or -collection capabilities internal to the heating, ventilation, and air conditioning (HVAC) systems of the structure. These systems are used to detect possible covert or overt use of biological agents.

(2) **Maneuver or maritime force protection.** In this operational setting, the biological-detection and/or -collection elements are employed in an array designed to optimize the probability of detection consistent with FP security requirements. Maritime or land force assets will be placed based on METT-TC considerations. The size of the

force to be protected also has a direct impact on system placement. The biological-detection assets should ideally be placed in depth throughout the AO to detect a biological-agent cloud that may have been disseminated as a large-area-coverage or line source attack from a ground, maritime, or aerial platform. Guidance for employing assets can be found in *Appendix E*.

b. **Medical Surveillance.** Executing medical surveillance is a responsibility that is shared by the individual, unit leaders, senior commanders, and the health service support (HSS) system.

(1) Individuals support medical surveillance by—

- Reporting outbreaks of sickness or illness in the ranks.
- Complying with preventive-medicine (PVNTMED) guidance.

(2) In executing medical surveillance, unit leaders—

- Inform personnel of illness, injury, and disease threats; the risks associated with those threats; and the countermeasures in place (or to be used) to minimize those risks while deployed.
- Ensure that individuals comply with PVNTMED guidance.
- Promote PVNTMED programs and policies.
- Ensure the completion of predeployment and postdeployment health assessment forms.
- Ensure that environmental-health assessments are documented to record any exposures.

(3) Senior commanders support the execution of their medical-surveillance responsibilities through—

- Supporting medical surveillance within their units with appropriate planning, resources, policy, enforcement, education, and training.
- Using medical-surveillance information as the basis for unit health reporting and in all phases of planning.
- Reporting unit DNBI rates and health readiness according to joint guidance, service policy, OPORDs, and OPLANs.
- Providing unit personnel status reports.
- Consolidating medical-surveillance report information to determine health status and medical threat.
- Ensuring that personnel complete predeployment and postdeployment health assessment forms (Department of Defense [DD] Form 2795 [Pre-Deployment Health Assessment/ and DD Form 2796 [Post-Deployment Health Assessment] and other requirements according to joint guidance (see DODD 6490.2).

## **5. Biological-Warfare Threat Triggers**

From an operational standpoint, the command and staff IPB assesses the threat BW capability (when, where, and how a threat may employ BW agents). However, the



command and staff retain a pragmatic view that threat use of BW could be unpredictable. In response to a BW threat with unknown factors, the applicable OPLAN and/or OPORD outlines the priorities of effort and trigger events (decision points) that will result in a response that includes biological-defense countermeasures. Understanding different trigger events is important because trigger events help determine how far into a BW attack the response to the event begins. This helps shape the ability of the force to respond. The closer the response to an actual BW event (detect to treat), the less severe the damage to operations will be (fewer number of casualties). BW attacks could occur against small- (fixed sites such as ports or airfields) or large-area (such as maneuver or maritime forces) targets. A threat could use point or line source BW weapons (overt or covert) against small or large targets to achieve surprise and unpredictability as to the time and place of attack. Several key indicators that might signal a BW attack are medical surveillance, detector triggers, intelligence triggers, and weapons event triggers.

a. Medical surveillance may be the first detection of a BW event; casualties may be the first indication of a biological attack. A postattack analysis of the event will influence operational decisions—decisions likely to be complicated by uncertainties regarding the nature and scope of the attack. For example, use of an infectious agent could lead to quarantine or restriction of movement for US or HN assets.

b. Detector trigger events refer to the discovery, via a detection device signal that a biological agent may be present in the environment. Detectors may or may not indicate the presence of all BW agents due to the sensitivity of the devices and the possibility of false positives and false negatives. Detectors are limited to those BW agents for which they are designed to find. They may not detect BW agents in certain media (food, water, or soil). Networked aerosol detectors, positive presumptive test results, and supporting field confirmatory lab results help determine if a biological event occurred and is identified before the onset of casualties.

c. Intelligence triggers occur when a commander receives an intelligence report indicating that a threat possesses an offensive biological capability, that there is unusual threat activity consistent with the logistics and operational use of a biological agent, or that a fixed site may be attacked with a biological agent. Information and intelligence from multiple sources (the general public, military intelligence, or national intelligence institutions in the HN) can provide advance warning of a biological attack. Intelligence warning is the most likely, and perhaps the only, trigger event that allows a commander the opportunity to take preattack actions.

d. Weapons event triggers refer to an overt attack by weapon systems, such as theater ballistic missiles (TBMs), submunitions, or artillery that might be armed with a BW. If intelligence has assessed a biological-weapon capability, a weapons event in high-threat areas will likely be initially treated as an unknown agent. Detection, observation, or other notices of attack prior to casualties trigger during-attack actions. These actions initially focus on immediate actions to preserve human life. Detection of an attack in progress may result from an upwind attack warning, a detector alarm, or observable weapons events and should determine if a chemical or biological agent was used.

## **6. Application of Principles of Biological Surveillance**

a. Applying the principles of biological surveillance helps ensure that the supported commander receives the required capabilities. *Table I-1* provides a sample of

the biological-surveillance principles and example capabilities that could be required to support a joint-force commander (JFC). In this example, a JFC is moving elements of a USA corps and light infantry division into an APOD (a main operations base [MOB]) and a maritime force is supporting operations from offshore.

**Table I-1. Biological-Surveillance Principles**

<b>Biological-Surveillance Principles</b>	<b>Capability</b>
Maximize probability of detection	Provide the JFC with biological- and medical-surveillance assets to support mission-essential APOD and maritime operations.
Orient on the threat	Conduct IPB to ensure understanding of the operational environment (such as background conditions) and threat intent and capabilities.
Report information rapidly and accurately	Establish a warning-and-reporting network between service components and the JFC.
Develop the situation rapidly	Provide for the evacuation of presumptively identified BW samples to the supporting confirmatory or definitive lab.
Optimize biological-surveillance capabilities	Provide the JFC with biological surveillance, lab, and sample courier assets.

(1) Maximize the probability of detection. JFC biological-surveillance capabilities are supported by the MOB Joint Portal Shield network and dry filter unit detection and collection capabilities. USA biological-detection assets also support operations from detector sites around the APOD. Shipboard biological-surveillance capabilities include the Interim Biological Agent Detector System (IBADS), Joint Biological Point Detection System (JBPDS) dry filter units, and handheld assays. Confirmatory lab support can be provided by an Air Force biological augmentation team, an Army medical laboratory, and Navy forward deployable preventive medicine units and is available on aircraft carriers and large deck amphibious ships. A Navy environmental and preventive medicine unit can provide a reach-back capability.

(2) Orient on the threat. The command and staff conduct IPB to understand the operational environment (the impact of background conditions on biological detection) and the threat intent and capabilities.

(3) Report all information rapidly and accurately. The JFC's warning-and-reporting system facilitates the prompt reporting and tracking of BW event information.

(4) Develop the situation rapidly. The movement of presumptively identified samples to confirmatory laboratories within 6 hours provides critical information to support decision points for the commander.

(5) Optimize biological-surveillance capabilities. A networked team composed of medical and biological surveillance and sample couriers provides the resources needed for the support of biological-attack surveillance.

b. Implementing effective biological and medical surveillance should include quality-management practices that provide a group or series of measures and actions that are employed to ensure that a system, process, or analytical test is functioning properly. Omission of any aspect of the quality-management program decreases the

overall quality of the analytical result. Elements of a quality-management program can include ensuring—

- That proper operator training and certification is performed to maintain knowledgeable, skilled operators and technicians to perform the analysis. Documentation of both initial and continuing training for all operators of the system or process must be maintained.
- The proficiency of each operator is maintained through the periodic analysis of unknown samples (such as proficiency tests). The results must be verified and documented by a supervisor or designated observer who attests to the accuracy of the analysis and adherence to the proper analytical process.
- The preventive maintenance checks and services (PMCS) on all equipment and instruments are conducted on a routine basis as recommended by the equipment operating manual. Documentation of the performance of PMCS and the problems corrected must be maintained.
- That critical reagents and controls are transported and stored in the proper environment as directed by the manufacturer.
- That positive and negative controls are performed and the results are obtained and documented.
- That management and supervisory personnel maintain awareness of potential errors and problems with the system or process, evaluate personnel and process, document errors or problems, and take corrective action to eliminate or minimize such errors or problems.

## **7. Commander's Information Requirements—Sample Results and Medical Surveillance**

a. The analysis and identification of a BW sample will support a commander's IRs. The analysis of a sample can range from presumptive, to confirmatory, to definitive identification. The three levels of identification and their associated sample analysis definitions are addressed below.

(1) Biological-warfare agent field presumptive identification. Presumptive identification is provided by the positive results from a device such as a handheld assay. This process provides for the identification of a suspect BW agent by means of devices, materials, or technologies that detect biological markers (biomarkers) using a single methodology (see *Appendix B*). Agent identification to species level or differentiation among a family of similar agents, may not be possible. This is equivalent to the Laboratory Response Network for bioterrorism Level A and the USA Biological Integrated Detection System (BIDS).

(2) Biological-warfare agent field confirmatory identification. This process provides for the identification of a suspect BW agent by means of devices, materials, or technologies that detect biomarkers using two or more independent biomarker results. The field confirmation identification process can be accomplished in a matter of hours (6 to 8 hours). Examples might include the findings of the presumptive biomarker identification with the addition of a positive polymerase chain reaction, enzyme-linked immunosorbent assay, or electrochemiluminescence results, using specific target nucleic

acid sequences for the organism and antibody recognition of agent specific antigen sites, respectively. This is equivalent to field sample or specimen identification conducted by forward-deployed or forward-positioned laboratories such as the USAF biological augmentation team, the Army medical laboratory, forward-deployed preventive medicine unit (USN), or homeland security Laboratory Response Network Level B or C asset (USA community hospitals or medical centers). BW-agent field confirmation identification is also available aboard selected aircraft carriers and amphibious ships and at selected medical facilities. These laboratories also have a reach-back capability with a definitive lab for consultation.

(3) Biological-warfare agent definitive identification. This process provides for the specific identification of a suspect biological agent as to genus and species, serological type, or toxin. This level of identification is by means of devices, materials, or technologies that detect based on two or more independent biomarker results using different methodologies. The definitive identification process can be accomplished in several hours to a couple of days, depending on the number of tests required. This level of identification is performed in a reference lab with a broader variety of methodologies available and highly skilled testing personnel, thus providing the highest levels of accuracy. Final sample or specimen identification is accomplished at one of the nationally recognized continental US (CONUS) reference laboratories such as the United States Army Medical Research Institute of Infectious Diseases (USAMRIID), the Navy Medical Research Center, or the Centers for Disease Control and Prevention (CDC).

b. Sample analysis from the BW-agent identification process can provide the commander with critical information. However, the first obvious indicator of a BW attack may be an increase of illness among the affected population (medical surveillance).

c. The commander uses multiple information sources (sample analysis results and medical surveillance). This information supports the commander's SA and is critical input for critical decisions (detect to treat).

## Chapter II

# BIOLOGICAL-SURVEILLANCE FUNCTIONS, RESPONSIBILITIES, AND CAPABILITIES

### 1. Background

The commander will use all available assets (intelligence and medical and biological surveillance) to detect and reduce the effects of biological attacks. Resulting detection information will feed directly into the US force warning-and-reporting network. Intelligence and medical and biological surveillance are used to assess whether the threat has used BW agents. For example, signals intelligence (SIGINT) may intercept threat employment orders for a BW attack. Human intelligence (HUMINT) may also provide information on future threat intentions and BW manufacturing capabilities and locations. Medical surveillance assesses the incidence of illness to determine whether a biological attack may have occurred. Biological surveillance serves as another critical component of awareness. Biological-surveillance capabilities include the following:

a. **Monitoring.** When a biological-detection asset such as a Joint Portal Shield network or the JBPDS is operational, it is continuously monitoring the air for an increase in the number of aerosol particles within a certain size range that would indicate a BW attack. In addition, this may include the random or routine monitoring of food and water sources for contamination by HSS personnel.

b. **Alerting.** Alerts provide the initial determination that a biological attack may be occurring. Alerting devices determine if any change in the particulate background at the sensor may indicate a possible presence of biological agents. Selected alerting devices are also capable of determining whether biological mass is present in the ambient air.

c. **Sampling.** Sampling of the biological agent is a crucial part of the identification system. The sampling process collects possible BW samples for subsequent use in the identification process. It is important to note that the chain-of-custody must be initiated by the person who takes the sample.

d. **Detecting.** Once a sample has been collected and concentrated, the detection process in selected biological systems determines if the particulates are biological or inorganic in origin. To accomplish this, the sample passes to a generic detection component that analyzes the aerosol particles to determine if they are biological in origin. This component may also classify the suspect aerosol by broad category (for example, a spore, bacterium, or toxin).

e. **Identifying.** The identification process provides a presumptive identification of the biological agent collected at the system level. Identification is generally limited to a preselected set of agents and cannot identify agents outside of this set without the addition of new identifier chemistry, equipment, or preprogramming. Antibody-based assays are used for the presumptive identification of all fielded BW detection systems.

f. **Reporting.** The results from the biological-surveillance process are reported through the established reporting architecture. The controlling headquarters (HQ) NBC control center analyzes these biological reports to determine and assess whether a BW

attack occurred. Normally, this can be a joint task force (JTF), corps, numbered air force (NAF), or other operational level HQ.

g. Evacuating a sample and maintaining the chain-of-custody. Presumptively identified and background (environmental) samples are evacuated. Samples are collected, packaged, sealed, and documented. The chain-of-custody begins with the person taking the samples. A complete history of the circumstances about the acquisition of each sample is provided. The purpose of the sample may be for support of treatment or attribution (evidentiary) or both. It is critical that the sample be maintained at 1-4°Celsius (C) during storage and transport. Samples are evacuated to preselected sample transfer points, sample management facilities, or directly to supporting laboratories. The chain-of-custody is maintained throughout the transfer process. Sampling and evacuation procedures are discussed in detail in *Appendix G*.

## 2. Responsibilities

The NBC officer, medical officer, and intelligence staff work closely to manage biological-surveillance operations. They ensure that biological-and medical-surveillance considerations are integrated in the decision-making process. Command and staff responsibilities for biological defense are outlined in *Table II-1*. Biological-defense responsibilities define command and staff responsibilities relative to biological planning and operations.

**Table II-1. Command Staff Biological-Defense Responsibilities**

<b>BW Detection Planning and Execution Responsibilities</b>	
JTF/operational-level commander	Allocates BW defense resources based upon METT-TC considerations. Determines protection required including immunizations.
COS	Reviews recommendations for priority IRs, priority target listing, and protective posture.
Intelligence	Assists in developing the biological-surveillance plan in support of the R&S plan. Coordinates BW intelligence reports and potential threat BW activities with the operations and NBC staffs and FSEs.
Operations	Integrates BW defense training into unit combat mission training requirements. Develops risk assessment for operations in BW environments and assesses the OPTEMPO impact. Recommends targeting of BW-related activities. Rehearses/practices biological-sample evacuation plans.
NBC officer/NCO	Develops the biological-surveillance annex in support of the R&S plan. Acts as the primary battle staff advisor on NBC defense. Ensures that BW defense considerations are part of the IPB process. Recommends biological-detection and -collection requirements and plans.
Logistics	Provides for supply and maintenance requirements.
Medical	Advises and assists the commander and his staff on health and human safety in a BW environment (including health effects, PVNTMED, treatment, and patient evacuation). Recommends vaccinations, a pretreatment regime, and a treatment plan. Conducts liaison with field confirmatory laboratories and medical facilities. Conducts health risk assessments and provides commanders with health risk information for operational decision making. Provides a health risk assessment to the commander.

The following list of responsibilities and roles for operational-level or tactical commanders and staffs during biological-defense operations is not all-inclusive, but

rather a general guide. The AF roles and responsibilities vary slightly from the guidance below and are outlined in AF Manual (AFMAN)-10-2602.

- a. Commander.
  - Prepares forces to defend, including training and equipping, against possible BW attacks.
  - Orders preemptive strikes on threat BW capabilities.
  - Directs the appropriate BW protective measures.
  - Allocates biological-defense resources.
  - Directs biological surveillance based on threat and intelligence indicators.
  - Determines protection and warning criteria and the dissemination of a BW attack warning.
- b. Chief of Staff (COS) and/or Executive Officer (XO).
  - Ensures that staff estimates are coordinated and the staff integrates biological-defense considerations into the tactical decision-making process.
  - Ensures that BW threat information is included when developing potential CCIR recommendations for the commander.
  - Ensures that BW surveillance is synchronized with other intelligence collection efforts and the mission.
  - Reviews staff recommendations for the employment of biological-detection assets and warning the force.
  - Ensures that critical BW information is presented to the commander.
  - Reviews recommendations for priority IRs, priority target listing, and protective posture.
- c. Operations.
  - Coordinates the staff BW risk assessment and recommends appropriate risk reduction measures to conserve combat power and protect the force.
  - Recommends troop listing for BW defense assets based on the BW threat and mission.
  - Integrates BW defense training into unit combat mission training that orients toward the conditions and standards of combat.
  - Implements FP measures for reaction to threat BW operations.
  - Considers the employment of biological-detection assets in planning future operations.
  - Recommends the nomination of threat BW targets and related activities with the fire support coordinator (FSCOORD), intelligence, civil affairs (CA), and the NBC defense officer.
  - Allocates biological-detection assets to current operations according to guidance.

- Ensures that the biological-detection asset employment is synchronized with current (close, deep, and rear) operations.
  - Assesses the impact of operations in a BW environment on operating tempo (OPTEMPO).
  - Integrates the biological-detection asset employment with the branches developed to support current operations.
  - Directs aviation and long-range biological-detection assets to execute long-range BW surveillance according to the commander's guidance and priorities.
  - Coordinates a rehearsal of the sample evacuation plan.
- d. Intelligence.
- Applies IPB products to support the targeting of BW-related activities with fire support and tactical air assets.
  - Disseminates weather reports and products from the staff weather officer and assesses implications in a BW threat environment.
  - Analyzes BW attack information to develop intelligence to predict future BW employment.
  - Creates the reconnaissance and surveillance (R&S) plan. This plan, which can be embedded in existing war plans, should include the biological-surveillance plan as an annex. The NBC defense officer will complete the biological-surveillance annex, with input from the medical and intelligence officer, ensuring synchronization with the overall unit R&S plan.
- e. Fire Support.
- Uses the fire support target acquisition battery radar and sound/flash ranging equipment to identify the locations of threat indirect firing points used to conduct BW attacks.
  - Destroys possible threat BW attack indirect fire systems using counterbattery fire.
  - Provides an alternate means of determining local weather.
  - Provides data to NBC defense personnel so that collateral damage estimates can be made regarding the release of BW agents that may occur as a result of the attack on threat systems.
- f. Logistics.
- Coordinates biological-detection system CLS, as required.
  - Coordinates with the HN through CA for any available biological-detection supplies unique to the biological-detection unit through foreignation support (FNS) channels.
  - Coordinates biological-detection asset recovery and evacuation operations as necessary.



- Recommends the allocation of transportation capabilities to support the rapid displacement of biological-detection assets.
  - Forecasts resource requirements to support BW defense logistics requirements.
- g. Personnel.
- Advise the commander and NBC defense officer on matters concerning biological-detection asset personnel replacements.
  - Request and allocate biological-detection personnel replacements as required.
- h. Civil Affairs.
- Coordinates use of HN medical facilities to treat BW casualties, if necessary.
  - Determines the availability of biological-detection supplies unique to the supported biological-detection asset from the local civil sector.
  - Provides information (in the chief military observer [CMO] estimate) on likely civilian actions reactions to a BW attack.
- i. Nuclear, Biological, and Chemical Defense Officer.
- Advises the commander and staff on operations in a BW environment.
  - Ensures BW-related activities are part of the IPB process.
  - Recommends actions to minimize friendly and civilian vulnerability to BW attacks.
  - Conducts BW vulnerability analysis in conjunction with the appropriate staff elements (such as a staff threat working group).
  - Participates in the target nomination process for threat BW-related targets.
  - Recommends tasking biological-detection assets to support the scheme of maneuver and incorporates these assets into plans and orders.
  - Coordinates biological-detection asset requirements with subordinate commands.
  - Recommends surveillance missions based on BW indicators and technical knowledge of BW dissemination methods, agents, and favorable conditions.
  - Plans, coordinates, and evaluates BW defense training in cooperation with the operations.
  - Coordinates with the surgeon and medical staff in developing priorities of effort for BW surveillance assets.
  - Provides the biological-surveillance annex for the R&S plan to the intelligence officer. The annex will include a sample evacuation appendix that is coordinated with the surgeon or medical officer, staff intelligence and transportation officer or NCO, and sample courier unit.

j. Surgeon or Medical Officer.

(1) DODI 6490.3 provides the following guidance for medical surveillance: during a deployment, the surgeon and the JTF surgeon will—

“Deploy technically specialized units with capability and expertise in the conduct of surveillance for occupational and environmental illnesses, injuries, and diseases, health hazard assessments, and advanced diagnostic testing. . . . These specialized units may be deployed to meet the requirements of the deployed force through surveillance for occupational and environmental illnesses, injuries, and diseases, application of preventive medicine, use of advanced diagnostic testing, and coordination with combat stress control personnel. These units shall conduct health assessments of potential exposure to biological, chemical, or physical agents that threaten the health and safety of the command.”

(2) The surgeon, medical officer, or medical NBC defense officer also—

- Advises and assists the commander and staff on health and human safety issues, including health effects, PVNTMED, treatment, and patient evacuation, in a BW environment.
- Evaluates national medical intelligence in developing the BW vulnerability analysis and analyzes information on endemic diseases.
- Identifies and coordinates the training and education of medical personnel on the medical management of personnel exposed to BW agents.
- Coordinates with designated supporting medical lab to plan for the receipt and confirmatory analysis of suspected BW samples.
- Identifies HN and other lab support that may be available, including integration with local and regional US and HN civilian medical-surveillance assets.

k. Staff Weather Officer.

(1) Advises and assists the operations, intelligence, and NBC defense officers with weather support capabilities and limitations in support of operations in a BW threat environment (for example, provides data used by the NBC staff in predicting the plume).

(2) Prepares climatological studies and analyses in support of operations in a BW threat environment.

(3) Evaluates and disseminates weather data, including forecasts, in support of operations in a BW threat environment.

(4) Responds to requests for information (for example, analyzes weather effects on BW).

l. Staff Judge Advocate (SJA).

(1) Provides legal advice regarding the law of armed conflict (LOAC) and attack of facilities suspected of being related to BW activities.

- (2) Reviews chain-of-custody procedures.
- (3) Provides guidance on issues that may occur if quarantine, restriction of movement, and mass-vaccination operations are considered.

### 3. Capabilities

The commanders establish requirements for biological-surveillance capabilities and synchronize their use to complement other supporting capabilities (such as medical surveillance and intelligence). The integrated use of biological-detection assets, communication resources, sample courier and transportation assets, and lab resources is required to support an effective risk reduction strategy.

a. Biological-detection and -collection assets. The concept of employment (COE) for biological-detectors and -collection systems helps define where and how these assets will be used. Execution of biological-detection operations supports fixed-site ports, airfields, and/or maneuver force operations. Individual systems can be employed collectively or as a system of systems (integrating the use of different systems). The COE for biological-detection and -collection systems lends itself to employment at fixed sites (critical-node array) or to support of maneuver or maritime forces (area array). However, the COE for selected systems only lends itself one setting (fixed sites). See *Table II-2* (page II-8) for information on the operational envelope for biological-detection and -collection assets. *Table II-2* outlines the operational envelope for multiple biological-detection and -collection assets.

(1) COE for fixed sites, ports, and airfields and maneuver land or maritime forces. The COEs for multiple detectors and collectors lend themselves to fixed-site operations and land and maritime forces.

(a) Without the BIDS and Joint Service Light NBC Reconnaissance System (JSLNBCRS), these point detectors do not have authorized mobility assets or organic assigned operators. The fixed-site commander provides the operators that are required to move these assets. Systems employed at fixed sites, ports, and airfields include—

- Joint Portal Shield.
- M31A1 or M31A2 BIDS.
- Fixed-site and/or trailer-mounted JBPDS and man-portable JBPDS.
- Dry filter units.
- JSLNBCRS.

(b) Maneuver land or maritime forces. These systems are still point detectors, but have assigned, organic ground transportation (except the shipboard JBPDS or IBADS). These systems include—

- M31A1- and/or M31A2-BIDS.
- JSLNBCRS.
- Shipboard JBPDS/IBADS (maritime only).
- Shipboard dry filter units.

Table II-2. Biological-Detection and -Collection Assets—Operational Envelope

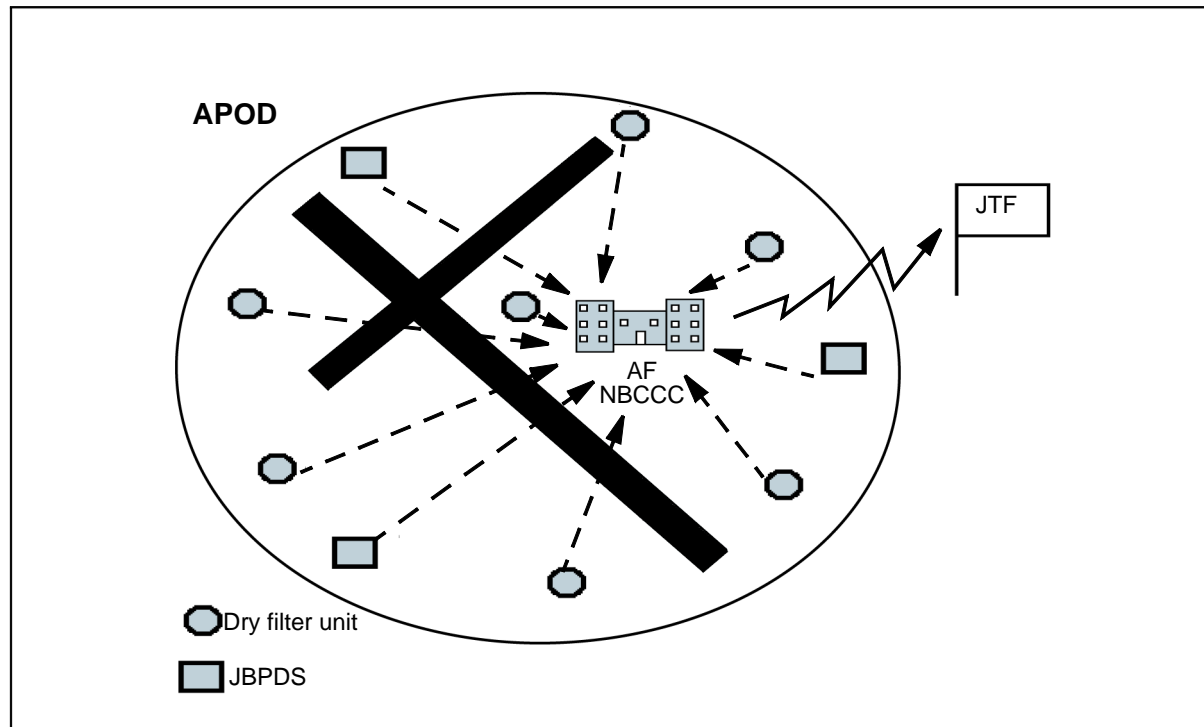
System/ Kit	COE	Capability	Point or Standoff Detection	CLS Required	Produce Sample for Evacuation	Prime Mover Available	Power Source Available (i.e., generator)	Limitation	Organic Communications Capability
Joint Portal Shield	Fixed sites, ports, airfields	Monitors, alerts, collects, and identifies (outside ambient air)	Point	Yes	Yes	No	Yes	No detection capability to complement the alert and presumptive identification capability	None
M31A2- BIDS	Land maneuver force, fixed sites, ports, airfields		Point	Yes	Yes	Yes	Yes		AM/FM
M31A1- BIDS	Land maneuver force, fixed sites, ports, airfields		Point	Yes	Yes	Yes	Yes	Approximately 25 minutes required from alert to presumptive identification	AM/FM
Fixed- Site/ Trailer- Mounted JBPDS	Fixed sites, ports, airfields		Point	Yes	Yes	No	Yes		None
Man- Portable JBPDS	Fixed sites, ports, airfields		Point	Yes	Yes	No	Yes		None
Shipboard JBPDS	Maritime force		Point	Yes	Yes	N/A	Yes		None

**Table II-2. Biological-Detection and -Collection Assets—Operational Envelope (Continued)**

<b>System/ Kit</b>	<b>COE</b>	<b>Capability</b>	<b>Point or Standoff Detection</b>	<b>CLS Required</b>	<b>Produce Sample for Evacuation</b>	<b>Prime Mover Available</b>	<b>Power Source Available (i.e., generator)</b>	<b>Limitation</b>	<b>Organic Communications Capability</b>
Dry Filter Unit 1000	Fixed sites, ports, airfields	Collects and identifies (internal building air)	Point	Yes	Yes	No	No (AC required)	No alerting capability	None
Dry Filter Unit 1000	Shipboard Operations	Collects and identifies (outside ambient air and internal air)	Point	No	Yes	No	No (AC required)	No alerting capability	None
Dry Filter Unit 2000	Fixed sites, ports, airfields	Collects and identifies (outside ambient air or internal building air)	Point	Yes	Yes	No	No (AC required)	No alerting capability	None
JSLNBCR S	Fixed sites, ports, airfields, land maneuver force	Monitors, alerts, collects, and identifies (outside ambient air)	Point	Yes	Yes	Yes	Yes	N/A	FM
DOD Biological Sampling Kit	Maneuver land force, maritime force, fixed sites, ports, airfields	Samples and identifies (surface contamination)	Point	No	Yes	N/A	N/A	No alerting capability	None
LRB SDS	Maneuver land force, maritime force	Detects (outside ambient air)	Standoff	Yes	No	Yes	N/A	No presumptive identification capability	None

(2) Applying the COE for fixed sites, ports, and airfields (critical-node array) and maneuver land and maritime forces (area array).

(a) Fixed Sites, ports, and airfield biological surveillance. *Figure II-1* shows how the JBPDS and dry filter unit can provide biological-surveillance coverage of an APOD. This same employment can be used for other fixed sites, ports, and airfields. The biological-detection assets provide decentralized reporting to the fixed site, port, or airfield NBC center.

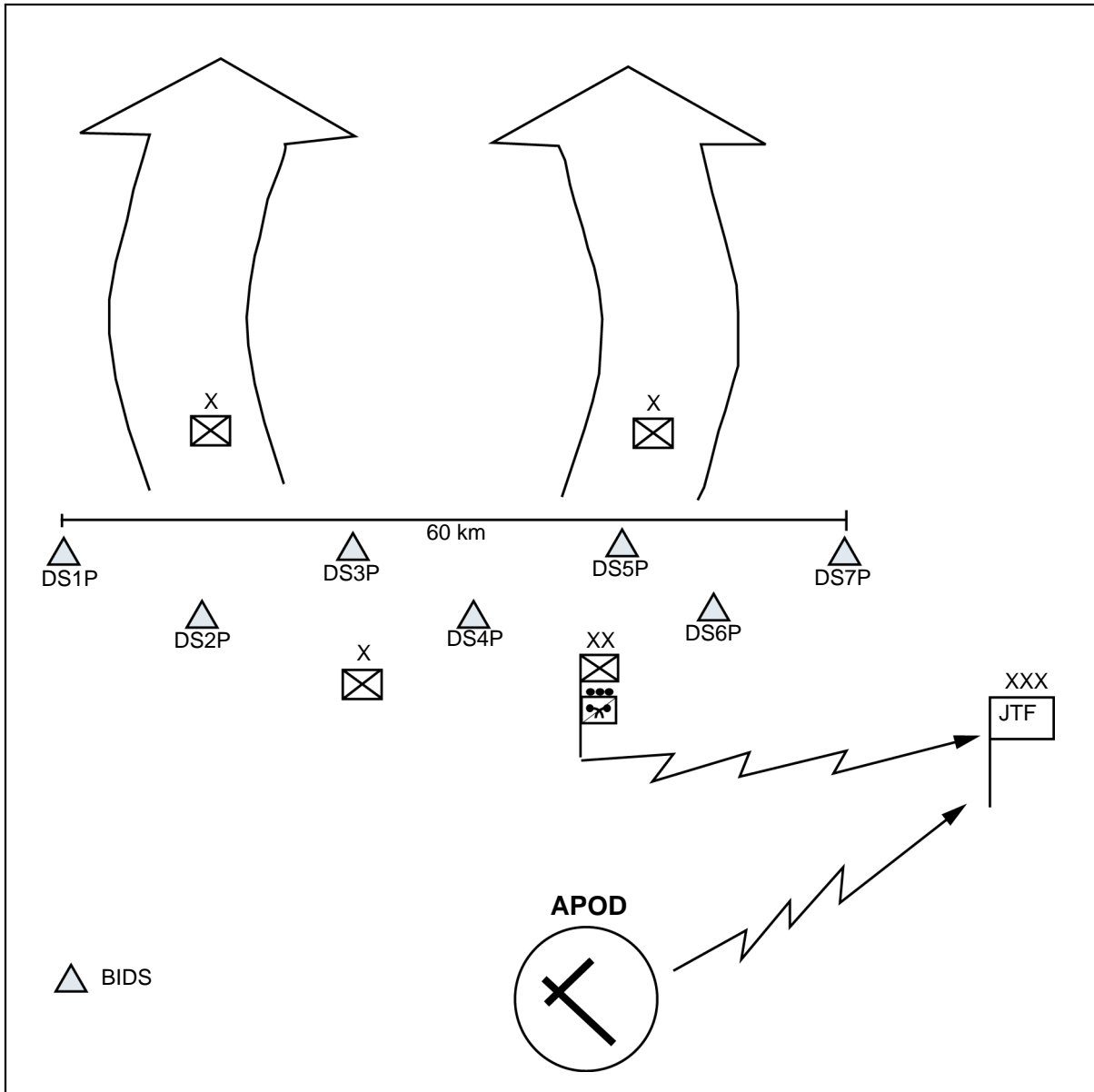


**Figure II-1. JBPDS and Dry Filter Unit Coverage of an APOD**

(b) Maneuver forces biological surveillance. *Figure II-2* shows a biological-detection platoon providing surveillance for JTF maneuver forces (corps size) against a long line source attack. Concurrently, surveillance support is still provided at the APOD. The USA biological-detection platoon provides centralized reporting directly to the JTF.

(c) Use of multiple systems to support biological surveillance (such as a system-of-systems concept). See *Figure II-3* (page II-12) for an illustration that indicates use of dry filter units and JBPDS (trailer-mounted and man-portable) and a USA biological-detection unit. The dry filter unit and JBPDS are located within the APOD perimeter using a dice five employment tactic (see *Appendix E*). The BIDS unit is using a circular employment tactic within a US AO that is secure. The biological-detection unit HQ provides decentralized reporting to the AB NBC center.

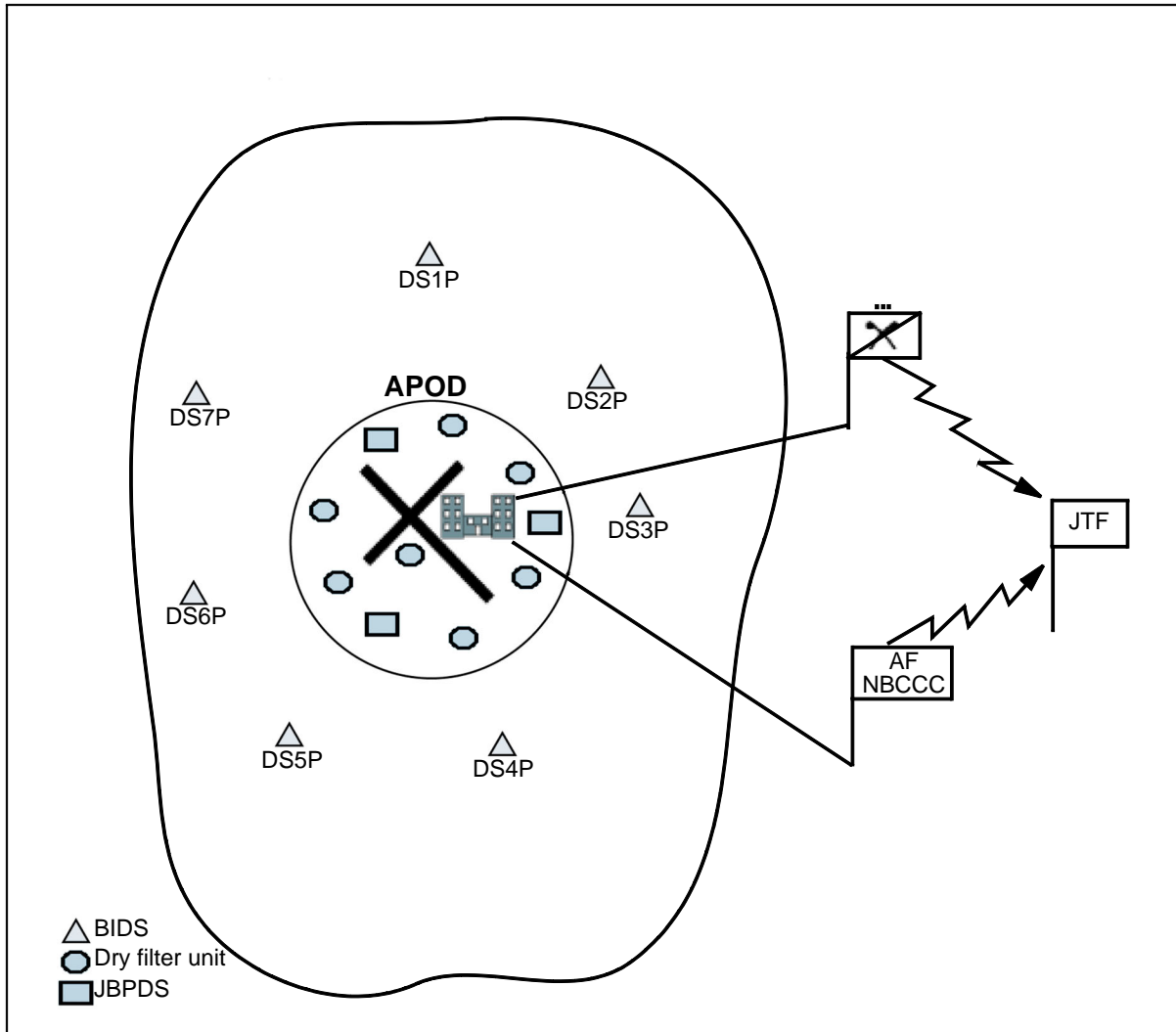
b. Communications. Communications are important during biological-surveillance operations. Biological-surveillance assets must be capable of the timely reporting of biological-surveillance data to include personnel and logistics status. Units with biological-surveillance assets must be capable of effective warning and reporting to subordinate and adjacent units, as well as higher commands.



**Figure II-2. BIDS Platoon Emplacement to Provide Coverage for JTF (Corps Size) Maneuver Forces for a Long Line Source Attack**

c. Lab Support. The commander has a number of critical decisions to make in a BW environment that require information that can only be provided by a supporting medical lab. A designated supporting lab will perform the field confirmatory identification of a BW attack. Service and in theater lab support include the Navy environmental and preventive medicine units, forward deployable preventive medicine units, Navy large deck platforms, the AF biological augmentation team, a theater Army medical laboratory, and other forward fixed-site laboratories (theater medical surveillance teams).

d. Sample Courier.



**Figure II-3. Employment of Multiple Biological-Detection Collection Systems (System of Systems)**

(1) The ability to courier suspected biological samples from biological-detection assets to supporting laboratories while maintaining chain-of-custody is of significant importance. Under normal circumstances the biological-detection asset is responsible for the evacuation of their samples to a designated sample transfer point. However, depending on the proximity of the supporting lab, the biological-detection asset may be required to evacuate the sample directly to the lab.

(2) The command must ensure it has an executable plan to get the samples to the supporting laboratories. In some cases, dedicated technical escort unit (TEU) assets are used to escort samples. The priority for dedicated TEU assets will likely go to escorting samples from the theater back to the CONUS-based national laboratories for definitive analysis and identification.

(3) The combatant commander's sample evacuation plan must include the escort of samples within his AOR with and without a TEU. This may require using other available assets besides a TEU. A set of basic tasks that can be used to train in-theater couriers to transport biological samples is provided in *Table II-3*. At all times, the chain-



of-custody must be maintained to ensure legal and accurate reporting of biological attack surveillance results. Safety and security for the courier and the sample package are important.

**Table II-3. Biological-Sample Courier Tasks**

Task	Action			
	Avoidance	Protection	Decontamination	Battle Management
Conduct coordination	Obtain DOD sampling kits.	Obtain appropriate respiratory protection and gloves.  Ensure that immunizations are up to date.  Begin prophylaxis if required.	Obtain approved decontaminant solution.	Establish a linkup point with the biological-sample generation asset.
Link up	N/A	Don respiratory protection and gloves prior to the linkup.	N/A	Report the linkup to higher HQ.
Ensure package integrity	Use a DOD biological sampling kit to determine if the outside of the package is contaminated.  Ensure that the package is packed according to applicable guidance (for example, IATA, CFR).	Place in an additional transport bag/container as appropriate.  Once the package integrity is verified, respiratory protection is no longer required.	Conduct a surface wipe-down of the package.  Conduct self-decontamination if required.	N/A
Transfer the sample (chain-of-custody)	Transfer sample package using the appropriate chain-of-custody forms and procedures.	N/A	N/A	Report the transfer of custody to higher HQ.
Coordinate movement	N/A	N/A	N/A	Report the departure and start of movement to higher HQ.  Coordinate with the applicable operations elements as required (for example, movement through unit sectors.)

**Table II-3. Biological-Sample Courier Tasks (Continued)**

Task	Action			
	Avoidance	Protection	Decontamination	Battle Management
Safeguard and transport the sample	Be prepared to conduct immediate action in the event of package breach.	Ensure IPE is on-hand during movement.  Maintain the sample at 1-4°C.  Seal and repackage if required.	Conduct decontamination of the package if required.	Report a package breach if required.
Transfer sample	Transfer the sample package using the appropriate chain-of-custody forms and procedures.	N/A	N/A	N/A

(4) The transportation and storage of suspected biological samples is time-sensitive, and the commander needs timely feedback so he can affect or initiate the appropriate countermeasures or prophylaxis. The samples must be properly packaged, sealed, and labeled. To support effective sample transport, the sample evacuation plan must allocate and task for the means to transport the sample.

#### **4. Applying Biological-Detection Capabilities**

a. The actual “on-the-ground” biological-surveillance requirements for an operation will be METT-TC dependent. The planning process described in *Chapter III* provides an understanding of how to determine resource requirements for biological-surveillance operations. The operational-level commander’s subordinate commanders may have available surveillance capabilities. The operational-level commander task-organizes and synchronizes the use of all available capabilities to meet mission requirements.

b. A commander must be aware of all the resources available (See *Appendix C*) to provide him with a robust and integrated biological-detection plan of action. Not only must he know what his organic capabilities are, but he must also be aware of other HN assets that might be available.

c. The commander integrates the use of all available assets to include combat service support (CSS) (CLS—See *Appendix D*) to meet FP requirements. The commander integrates the use of maritime and land force biological-surveillance assets.

(1) The maritime component provides surveillance support from the seaward side with ship-based IBADS, JBPDS, and dry filter units. Additionally, the land force commander uses USA biological-detection assets to provide critical-node support at the APOD.

(2) The JFC NBC control center receives and integrates the input from both sources to maintain the required SA and uses the information to support required decisions.

## Chapter III

# BIOLOGICAL-SURVEILLANCE PLANNING

### 1. Background

Biological-surveillance planning supports the commander's CONOPS. The commander's clear, concise statement of where, when, and how he intends to concentrate combat power to accomplish the mission uses biological surveillance to maintain the required SA. The commander's concept broadly outlines considerations necessary for developing viable biological surveillance. Biological surveillance is conducted from peacetime to war. The nature of the threat and the technical complexity of conducting and maintaining adequate detection, identification, and warning against a biological attack necessitates BW defense preparedness and the facilitation of appropriate and prompt medical actions. Biological-detection planning occurs at all levels of operations, from the strategic to the tactical levels, and across the spectrum of military operations. Planning for biological detection provides the opportunity for leaders to limit the impact threat BW agents have on operations.

### 2. Integrated Biological-Surveillance Operations

Biological-detection resources are integrated into the unit intelligence, surveillance, and reconnaissance (ISR) plan. Biological-detection assets are employed based on an assessment of the threat force capability to use BW agents. The commander will prioritize the use of available assets and establish a plan that integrates the use of all available capabilities. The combatant commander's biological-surveillance plan integrates the use of land force, fixed-site, and maritime assets. See *Appendix E*.

a. Land-force biological-detection assets are employed in arrays designed to optimize the probability of detection consistent with the security requirements. Assets will be located based on METT-TC factors and the size of the critical asset to be protected. Ideally, the biological-detection assets will be placed upwind of the target area to detect a biological-agent cloud that has been primarily disseminated as a point or line source from a ground or aerial platform.

b. Fixed-site biological-detection assets are placed on or upwind of a site to provide BW detection. Fixed-site biological-detection operations focus on a specific target such as a port, APOD, or SPOD. Biological-detection assets are placed anywhere upwind or within the site to confirm or deny the presence of a biological agent. METT-TC analysis will determine the number of systems required as point detectors for critical target areas such as logistics bases or major airfields and/or ABs, naval bases, or ports. In joint operations (for example, the protection of critical port facilities) biological-detection systems can also be placed on ships for improved operational dispersion. Detectors and collection devices can also be placed inside critical facilities to monitor for BW agents.

**NOTE: Detectors may have to be moved throughout the year as there are seasonal wind patterns that would change the physical location of "upwind of a site."**

c. Maritime assets use biological-protection assets to support increased FP. Biological detectors are used to support monitoring operations while ships are underway, in port, or operating close to landmasses.

### 3. Tactical, Operational, and Strategic Planning

Tactical, operational, and strategic planning are interrelated. The actions taken at the tactical level have implications at the operational and strategic levels of war. For example, the liquid sample of a biological agent collected at the tactical level could be evacuated to the field confirmatory lab (operational level of war asset), and/or the definitive lab (strategic level of war asset).

a. Tactical. The tactical planning for biological surveillance focuses on ensuring that biological-detection and -collection operational requirements are met. The specific planning factors that are considered include ensuring that—

- Biological-detection requirements are resourced (for example, operators are trained and tasked to operate biological-detection systems).
- Sample collection techniques and procedures are rehearsed and understood.
- A NBC warning-and-reporting system is established and provides the required reports to higher and adjacent commands (see *Appendix F*).
- The sample evacuation process is rehearsed and understood.
- Biological-detection resources are integrated into FP plans.

b. Operational. Operational planning focuses on biological-detection, -identification, and -warning capabilities to support air, maritime, and ground operations. IPB evaluates threat capabilities and assesses what biological-surveillance and -detection assets may be required to reduce identified vulnerabilities or capabilities. For example, adjustment of the time-phased force and deployment list (TPFDL) may be needed to add TEUs, Army medical laboratory capabilities, and biological-detection units such as the BIDS or Long-Range Biological Standoff Detection System (LRBSDS) (see *Appendix H*).

c. Strategic. Strategic planning prioritizes and provides required assets to support missions within the CONUS and outside CONUS (OCONUS). These assets include biological-detection units, supporting labs, and biological-detection equipment. Applicable strategic-level intelligence information is also furnished to provide timely and effective IPB. The following may be included:

- Priority intelligence requirements (PIRs) to the commander.
- Named areas of interest (NAIs) for biological-surveillance operations.
- Biological-detection unit taskings for the R&S plan.

### 4. Planning Process

a. The commander implements the CONOPS (see *Chapter I*) for biological surveillance through planning and implementing risk reduction measures. The command and staff use their SA (battlespace visualization) to identify the risk reduction measures that will be implemented in supporting OPLANs and/or OPODs. Methods

that can be used to examine, assess, and implement the risk reduction measures are included in *Table III-1* (page III-4).

b. As a continuous process, this is an iterative method. The different factors interrelate (for example, the linkage between biological-detection system presumptive and field lab confirmatory identification), support a time-sensitive process, and focus on maximizing the probability of detection.

c. Preparation of a biological-surveillance plan entails completing mission analysis, assessing COAs, preparing staff estimates, and developing the OPLAN and/or OPORD or annex. Critical operations considerations must be assessed during the decision-making process; *Table III-1* outlines many of the operational implications that must be considered and used during the planning process.

d. The operational-level commander develops an OPLAN and/or OPORD as a directive to issue to supporting or subordinate units that have biological-surveillance responsibilities. Situation, mission, execution, service support, and command and control are the key data elements in the command OPORD that the supporting or subordinate unit used to prepare OPORDs or fragmentary orders (FRAGORDs) to support the higher supported commander's intent.

(1) **Situation.** The situation paragraph of the biological-surveillance plan (*Table III-2* [page III-5]) is used to provide the most likely and most dangerous COAs of the threat. It provides the mission, commander's intent, and CONOPS for the HQ one and two levels up. The situation paragraph also provides actions that other units (such as flank units) may take that can have significant effects on biological-surveillance operations.

(2) **Mission.** The mission statement in the biological-surveillance plan (*Table III-3* [page III-6]) is based on the mission analysis.

(3) **Execution.** The execution paragraph of the biological-surveillance plan (*Table III-4* [page III-6]) describes how the commander sees the actions of the subordinate biological-surveillance assets fitting together to accomplish the biological-surveillance mission. It states the missions or tasks assigned to each subordinate biological-surveillance asset to include any combat and combat support (CS) units that support biological-surveillance operations.

(4) **Service Support.** The service support paragraph of the biological-surveillance plan (*Table III-5* [page III-11]) clarifies the concepts of support, materiel services, medical support, and personnel support.

(5) **Command and Signal.** This paragraph of the biological-surveillance plan (*Table III-6* [page III-14]) identifies the chain of command and its location and provides signal operating instructions (SOI), required reports and formats, and times the reports are to be submitted.

Table III-1. Identifying Risk Reduction Measures

Receive and analyze the mission	Identify the enemy BW hazard and friendly BW defense capabilities	Assess the BW hazard and friendly situation (high/medium/low)	Propose risk reduction measures	Reassess the BW risk (high/medium/low)	Implement risk reduction measures in the OPLAN/OPORD	Execute the OPLAN/OPORD
How (How many agents were used?) (How will US forces detect threat use of BW agents?)	Identify threat delivery TTP; identify friendly BW detection capabilities.	Assess the impact of BW use. <ul style="list-style-type: none"> <li>Point release.</li> <li>Line release.</li> <li>Outside or inside.</li> </ul>	Provide a biological-surveillance employment/medical-surveillance plan.	Assess the probability of detection.	Implement a biological-surveillance plan (critical-node or area array).	Supervise, provide feedback, and revise as required.
What (What agents may be used?)	Identify threat BW agents.	Assess the impact of BW agents. <ul style="list-style-type: none"> <li>Detection capability.</li> <li>Treatment capability.</li> </ul>	Provide BW detection capability. <ul style="list-style-type: none"> <li>Provide lab capability.</li> <li>Provide courier capability.</li> </ul>	Assess whether capability gaps exist.	Deploy and synchronize the required capability.	Supervise, provide feedback, and revise as required.
When (When may an threat use BW agents?)	Identify threat windows of opportunity.	Assess the time required to implement risk reduction measures.	Provide warning and reporting and establish trigger points and decision points.	Assess the timeliness and accuracy of the C4I system.	Implement the sample evacuation plan and staff WG.	Supervise, provide feedback, and revise as required.
How (How will threat use of BW be confirmed?)	Confirm threat use of BW.	Assess confidence in reported result.	Ensure coordinated medical/NBC/intelligence information management. Implement the sample-evacuation plan.	Assess the quality and timeliness of reports.	Implement the warning-and-reporting network.	Supervise, provide feedback, and revise as required.
Where (Where is the AO?)	Identify areas of possible BW employment.	Assess the impact of the AO on BW agents and US biological-detection capability. <ul style="list-style-type: none"> <li>Weather.</li> <li>Terrain.</li> <li>Background.</li> </ul>	Provide periodic weather forecast and analysis. Provide background monitoring and analysis.	Wargame options for threat BW use.  Assess background data.	Implement the weather forecasting capability and conduct a routine assessment of background data.	Supervise, provide feedback, and revise as required.

**Table III-2. Biological-Surveillance Planning—Situation**

Situation	Factor	Operational Implications
Threat Forces	Identify threat list of BW agents. <ul style="list-style-type: none"> <li>• Detector/handheld-assay tailoring.</li> <li>• Depth of array.</li> </ul>	The list of AOR specific threat agents can affect requirements for different types of detectors and the specific handheld assays used. Also, the type of threat agent can drive the depth of the array used. It should be noted that all common surveillance reagents may be initially used and all attacks may be surprise attacks.
	Identify dissemination method. <ul style="list-style-type: none"> <li>• Munitions.</li> <li>• Dispersal systems.</li> <li>• Terrorist-type attack (food/water).</li> <li>• Direct contact with vector or contagious person.</li> </ul>	The type of delivery systems the threat has available can affect how the biological-detector array is positioned (critical node versus area array).
	Surprise.	Surprise attacks by the threat can never be fully planned for. Yet, they can potentially be the most effective. Flexibility, effective C2, and a robust detection array are keys to providing full-spectrum biological-surveillance operations that can potentially provide coverage against surprise attacks.
	Identify potential biological-surveillance assets within the AOR.	Planning, coordination, and liaison determine what HN or other government organizations and NGOs can provide for support of biological surveillance. The commander and his staff must “think outside the box” about ways they can augment unit biological-surveillance capabilities.
Friendly forces	Identify biological-surveillance assets.	The command and staff analyze the task organization. The review determines what capabilities are available to support biological-detection, medical-lab, and escort operations.
	Review for other units or assets that may possess a BW agent detection capability.	The command and staff determine what other military assets are available within the AOR. Some of these assets may include HN and allied military assets.
Attachments and detachments	Review task organization for biological-surveillance assets, C2 units (for example, a chemical brigade), and technical escort, theater Army medical laboratory.	The established command and/or support relationship must be understood. This will impact factors such as reporting and logistics.
	Identify assets available for biological-surveillance operations, to include medical lab support and technical escort assets.  Identify requests for assets to fill shortfalls.	Identify any required capabilities that are not available.

**Table III-3. Biological-Surveillance Planning—Mission**

Mission	Factor	Operational Implications
	<p>Assess the mission statement to determine specified and implied tasks. Use this information for mission analysis.</p>	<p>The mission statement contains the five elements associated with every operation—</p> <ul style="list-style-type: none"> <li>• Who will execute the biological-surveillance operations?</li> <li>• What are the essential biological-surveillance tasks?</li> <li>• When will the biological-surveillance operation begin?</li> <li>• Where will the biological-surveillance operations occur (AO, objectives, grid coordinates)?</li> <li>• Why (for what purpose) will the force conduct biological-surveillance operations?</li> </ul>

**Table III-4. Biological-Surveillance Planning—Execution**

Execution	Factor	Operational Implications
Maneuver	Timeline	<p>The biological-surveillance plan must emphasize time as a critical factor of effective biological surveillance. biological-surveillance data and samples are time-sensitive. The window of opportunity to protect the force through warning and protective measures is very small. Samples sent to supporting laboratories for confirmatory identification can deteriorate over time.</p>
	<p>Decision tree</p> <ul style="list-style-type: none"> <li>• High threat</li> <li>• Medium threat</li> <li>• Low threat</li> </ul>	<p>A decision tree can be established identifying the types of decisions that need to be made at different levels of threat. These decision trees should never provide rubber-stamp actions for each threat level. They should instead identify when a decision is needed and possibly a tentative set of options that have been developed during the wargaming process.</p>
	<p>Risk</p> <ul style="list-style-type: none"> <li>• Plan ahead</li> <li>• Redundant systems in place</li> <li>• FP depth</li> </ul>	<p>The amount of risk the command is willing to assume will impact the monitoring methodology (for example, all systems operational or sampling interval).</p>
	<p>Confidence in results</p> <ul style="list-style-type: none"> <li>• Lab</li> <li>• Detector</li> </ul>	<p>The confidence in a detection of a biological attack is affected by how it has been detected.</p> <p>Detection by one biological detector has a lower confidence level (medium) than if two biological detectors have made the detection (high).</p> <p>Confirmatory identification from a supporting lab confirms and bolsters medium-confidence detections and further reinforces high-confidence detections.</p> <p>Confidence in a biological detection will affect how a commander and his staff implement reduction measures.</p>



**Table III-4. Biological-Surveillance Planning—Execution (Continued)**

Execution	Factor	Operational Implications
Maneuver (continued)	Post attack <ul style="list-style-type: none"> <li>• Reduction</li> <li>• Sampling/ detector operations</li> </ul>	After an attack has been identified (through presumptive and confirmatory identification) the unit must affect reduction measures. These measures may come in the form of prophylaxis, heightened protective postures, and warning and reporting.  Post attack sampling and detector operations must be addressed (for example, increased or decreased sampling).
	Controlling HQ command and staff <ul style="list-style-type: none"> <li>• Receive</li> <li>• Analyze</li> <li>• Recommend</li> <li>• Decide</li> <li>• Disseminate</li> <li>• Execute C2</li> </ul>	The HQ command and staff that control the biological-surveillance operations have the responsibility to— <ul style="list-style-type: none"> <li>• Be the central node for the receipt of any information that may have an impact on biological-surveillance operations. This includes actual detection data and intelligence, meteorological, and medical information.</li> <li>• Analyze and synthesize all pertinent biological surveillance-related information into reliable action sets.</li> <li>• Recommend COAs in response to biological attacks.</li> <li>• Decide on a COA in response to a biological attack.</li> <li>• Disseminate information and guidance about COAs in response to a biological attack.</li> <li>• Provide C2 of operations conducted in response to a biological attack.</li> </ul>
	Preplan <ul style="list-style-type: none"> <li>• What</li> <li>• When</li> <li>• Value</li> <li>• Cost</li> </ul>	The importance of preplanning cannot be overestimated. An effective and well-thought-out plan will save lives.  The cost and value of the employment of biological-surveillance assets must always be considered. The costs of an effective biological-surveillance program are weighed against the catastrophic effects of a successful biological attack.
	Operational implication	The plan should include the operational impact of biological surveillance on the force. It provides a clear and concise direct relation between benefits and/or losses and effective and/or ineffective biological-surveillance operations.

**Table III-4. Biological-Surveillance Planning—Execution (Continued)**

Execution	Factor	Operational Implications
ISR	Point detection	Provide critical nodes to be protected.
	Standoff detection	Provide guidance on the use of standoff detectors (when available).
	Minimum protocols  Sampling intervals  Consistency/ standardization  Logistically supportable	Provide standard protocols to be used during biological-surveillance operations. These protocols should provide the minimum expected standards of conducting biological surveillance, such as minimum sampling intervals, spacing between detectors, packaging of samples, and the time to execute a sample evacuation.  Any standard set should be logistically supportable. For example, if the dry filter units are set with sampling intervals of 24 hours a day at 6 hour intervals, then each dry filter unit will be using, as a minimum, 4 handheld assays a day. The use rate of consumables (in this case handheld assays) will need to be considered when establishing these standards.
	Employment Plan <ul style="list-style-type: none"> <li>• Where to assign assets</li> <li>• Spacing                             <ul style="list-style-type: none"> <li>- Lateral</li> <li>- Depth</li> </ul> </li> <li>• Number of assets                             <ul style="list-style-type: none"> <li>- Prioritize</li> <li>- Allocate</li> </ul> </li> </ul>	To support the higher command OPLAN, the unit prepares a monitoring plan to indicate how biological detectors will be employed.  Fixed site (critical node). To support fixed-site requirements, the commander will likely allocate Joint Portal Shield, dry filter unit, or JBPDS (trailer-mounted and man-portable) assets (see <i>Chapter II</i> ).  Maneuver force (area array). To support maneuver force requirements, the commander will likely allocate JSLNBCRS or BIDS assets (see <i>Chapter II</i> ).  This monitoring plan should assign assets to specific critical nodes or into area arrays.  Spacing guidance should be provided not only for the distance between detectors laterally, but also in depth.  Guidance should be provided on what the priority of effort is and how the command will allocate biological-surveillance assets to provide coverage in that priority.
Air and missile defense	Air defense warning	Other systems within the battlespace can impact how biological surveillance occurs. The air and missile defense warning system can affect how biological surveillance is conducted. For example, upon warning of a missile attack, biological-surveillance assets may be directed to switch from periodic to continuous monitoring.

**Table III-4. Biological-Surveillance Planning—Execution (Continued)**

Execution	Factor	Operational Implications
Information operations	OPSEC/Handheld-Assay Agent Codes	<p>Codes have been assigned to the various biological agents that handheld assays detect. The codes on the agent decode list are classified SECRET.</p> <p>The classification of these codes helps to maintain control of how a force reacts to a biological attack. The HQ that controls the biological-detection assets maintains the codes and thus controls the release of detection data.</p>
	Automated Decision Support Tools	<p>Automated decision support tools can assist the commander and his staff in determining the impact of a biological attack. These decision support tools can provide estimates of how far downwind the biological cloud will travel as well as an estimated footprint of the biological attack.</p> <p>Select decision support tools also have the ability to transmit this data to subordinate, higher, and adjacent units.</p>
Tasks to other CS units	Determine the tasks for biological-surveillance assets and priorities of effort	<p>Specific tasks should be provided to biological-surveillance assets to include supporting units. These tasks could include specific locations to conduct detection operations, directions for technical escort assets on where to set up sample transfer points, instructions for medical assets on the storage and location of prophylaxis (for example, the forward positioning of antibiotics).</p>
CCIRs	Identify locations in space and time for NAIs/PIR	<p>PIRs and CCIRs provide a focus for making the decisions on where to position biological-detection assets.</p>
Risk reduction control measures	VA outputs	<p>During the planning process, the staff planner must conduct a biological VA of the organization. The results of this VA are a set of vulnerability reduction measures meant to lessen the risk and impact of a biological attack. The VA can influence how and where biological-surveillance assets are deployed.</p>
Environmental considerations	Meteorological data	<p>There are various sources of meteorological data. The staff meteorological officer must be consulted to determine which of these sources are appropriate for use with any dispersion predictions (see also <i>Chapter V</i>). Once identified, these sources should also be disseminated to biological-detection assets.</p>
	Effect on detection	<p>The background environmental conditions can also have various effects on biological-detection operations. (For example, an area with a high pollen count may cause false alerts in some field detectors).</p> <p>Harsh weather can cause difficulties in conducting biological-surveillance operations. Sandstorms, freezing rain, snow, ice, heat, and high humidity can affect air monitoring, sampling, and sample transport.</p>

**Table III-4. Biological-Surveillance Planning—Execution (Continued)**

Execution	Factor	Operational Implications
Environmental considerations (continued)	Terrain <ul style="list-style-type: none"> <li>• Detector locations</li> <li>• Field behavior</li> <li>• Borders                             <ul style="list-style-type: none"> <li>- Samples</li> <li>- Resupply</li> </ul> </li> </ul>	Terrain will also affect how and where detectors should be placed. Terrain can create both direct and indirect effects on biological-agent dispersion and downwind travel.  International borders can affect how suspected biological samples are transported. They may also affect resupply operations for biological assets.
	Background	Assess the impact of background environmental conditions on detection capabilities (for example, background conditions will vary by season and time of day).  Determine whether background levels may require the use of alternate procedures for biological detectors (for example, a release may not register due to high background and relatively low concentrations or a highly variable background).
FP	FP Conditions	FP conditions are other tools that influence biological-surveillance operations. The higher the FP condition, the higher the threat. The planner can directly correlate his biological detection modes of operations (continuous versus periodic) as well as sampling intervals to current FP condition levels.
	FP	Biological surveillance and detection can be an integral part of force protection operations. Biological surveillance provides the tools required to protect the force from a biological attack.
	Survivability	Inversely, the planner must ensure that biological-surveillance assets are provided the tools and ability to effectively survive. Biological-surveillance assets are unique within the battlespace. Their capabilities cannot be easily duplicated or reproduced. Thus, survivability is of key importance when planning biological surveillance.
Any additional coordinating instructions	Sample evacuation architecture	Sample evacuation is a key element of biological surveillance. It must be thoroughly planned and executed to be successful. Key components of this plan include escort elements, routes, communications, control and visibility, and designated lab facilities.
	TPFDL	A high priority should be given to planning the flow of biological-surveillance assets into the AOR. As forces build up, so must the network of biological-surveillance assets, to conduct health-risk assessment and FP.  This network of biological-surveillance assets not only includes biological detectors and samplers, but also the mechanisms needed to affect biological surveillance (such as escort, labs, and CLS).

**Table III-5. Biological-Surveillance Planning—Service Support**

Service Support	Factor	Operational Implications
Support concept	HNS	HNS must be considered when planning biological-surveillance operations. The HN can provide invaluable assistance in characterizing the AOR (developing baseline biological-background data). It could possibly provide valuable lab support as well as hospital access for mass-casualty events.
	CLS	<p>The service support section of the OPLAN/OPORD should indicate key information that includes—</p> <ul style="list-style-type: none"> <li>• The CLS arrival time.</li> <li>• CLS operating locations.</li> <li>• The CLS support concept.</li> <li>• The life-support concept for CLS (for example, who provides CSS support?).</li> <li>• Any restrictions on the use of CLS within the AOR.</li> </ul> <p>Retrograde instructions for CLS line replacement units or supplies.</p>
	Standard military support	Wherever possible, the use of standard military support is encouraged. Many biological-surveillance assets use unique items not normally found using standard military logistics channels. Many such systems are supported by CLS. The planner must be aware that even though a biological-detection asset may have CLS available for its unique supply and maintenance requirements, they also require standard military support for all classes of supply as well as maintenance on common service items.

**Table III-5. Biological-Surveillance Planning—Service Support (Continued)**

Service Support	Factor	Operational Implications
Transportation	Transport for BW surveillance assets	Transportation for biological assets must be planned well enough in advance to not hinder operations.
	Transport of samples	<p>Transportation of samples occurs—</p> <ul style="list-style-type: none"> <li>• From the detection site to the sample transfer point or directly to the supporting theater lab.</li> <li>• From a sample transfer point to a supporting theater lab or back to CONUS.</li> <li>• From a supporting theater lab back to CONUS.</li> </ul> <p>The plan must address what assets will be required to make the transport happen. Time plays a critical factor in transporting samples. Samples can be perishable and will lose their efficacy over time. Also, the longer it takes to accurately identify the biological agent, the more casualties should be expected.</p>
	Transport of CLS	Movement of biological-surveillance assets may be complicated by the requirement for their maintenance and support sections (often times CLS) to move parts and personnel within the AOR and back to CONUS.
Materiel services	<p>Quality management, QA, and QC</p> <p>Tracking sample information</p> <p>Coordination</p> <p>CSS shelf life</p> <p>PMCS</p> <p>Safety</p>	<p>The effectiveness of biological-surveillance operations greatly rests on how QA and QC checks are accomplished.</p> <p>Establishing a chain-of-custody from the theater of operation (TO) sample takers to the sample evaluators and to the archives requires a comprehensive understanding of the end-to-end sample flow, including all intermediate custodians and their ability to execute their portion of the chain without compromising sample integrity.</p> <p>QA and QC must be maintained in the tracking of sensitive limited shelf life items such as handheld assays.</p> <p>The quality of the maintenance and storage of certain items affects the quality and effectiveness of biological-surveillance operations.</p> <p>Safety must be addressed during all aspects of biological surveillance. The collection, transport, and analysis of potentially dangerous BW agents must always be conducted with the utmost care. Deliberate planning and precise execution of developed plans should provide the framework for safe and effective operations.</p>

**Table III-5. Biological-Surveillance Planning—Service Support (Continued)**

Service Support	Factor	Operational Implications
Materiel services (continued)	Cost of consumables	The cost of consumables must always be deliberately planned. Heightened threat levels will cause a higher rate of consumption of resources. For example, sampling intervals during these higher threat levels can impact on national/wholesale supply systems.
Medical evacuation and hospitalization	Lab support	<p>Lab support for biological surveillance must be identified and defined in the plan. Understanding the capabilities of the supporting theater laboratories is of key importance. The planner must understand the number of samples expected to be produced and sent to the lab, the surge capabilities of the lab, and the expected turnaround time for confirmatory identification of suspected biological samples. If the supporting lab cannot process the expected volume of samples, an alternate COA must be developed quickly to ensure timely confirmatory identification. These alternate COAs could include the use of HN labs, requests for and augmentation of lab capabilities, or prioritization of samples.</p> <p>Lab considerations need to be made for both clinical and environmental samples.</p>
Personnel service support	Assign personnel	Many biological detectors do not specifically come with dedicated operators. As such, operators must be identified. These operators can be regularly assigned personnel, augmentation personnel, or contracted personnel.
	Train personnel	The planner must ensure that personnel identified to operate any biological detectors are properly trained not only on the operation of their systems, but on other tasks such as packaging samples, reporting, and supply and maintenance procedures.

**Table III-6. Biological-Surveillance Planning—Command and Signal**

Command and Signal	Factor	Operational Implications
Command	Who makes decisions regarding— <ul style="list-style-type: none"> <li>• Prophylaxis.</li> <li>• Protection.</li> <li>• Warning.</li> </ul>	The plan must identify the person that will make decisions concerning prophylaxis, protection, and warning. The plan must be clear and concise and leave no doubt which level of command will make each specific decision. When this decision-making is delegated to subordinate commanders, a clear understanding of the process of reporting any changes in prophylaxis, protection, and warning must exist.
Signal	Communications support architecture	The plan must include a communications support architecture. This architecture will include how communications will occur among— <ul style="list-style-type: none"> <li>• The biological-surveillance asset.</li> <li>• Supporting laboratories.</li> <li>• Sample escort assets.</li> <li>• C2.</li> </ul>
	Reach back	Reach back assets should be provided in the plan, as well as information on how to communicate with reach back assets.
	Reports	Required biological-surveillance reports should be identified, along with instructions on how and when they are to be submitted.

## 5. Integration

Planning biological-surveillance operations includes the integration of METT-TC considerations and biological-surveillance assets. This integration provides the commander with the ability to protect the force while efficiently executing his assigned missions.

a. *Figure III-1*, illustrates the integration of METT-TC factors in the preparation of a biological-surveillance employment plan. Employment planning considers the following factors.

(1) **Mission.** The JTF NBC staff receives mission guidance to provide maneuver forces and critical fixed-site assets with biological-surveillance support. The commander’s priorities include supporting the first and second brigade and two critical fixed sites (for example, the JTF HQ and the USAF bare base within the AO) with biological-surveillance support.

(2) **Enemy.** The IPB indicates that the threat has line and point source delivery capabilities with BW agents (bacterial agents and toxins).

(3) **Terrain and weather.** The terrain is relatively flat and dusty (an arid environment), and the wind speed and direction favor threat use of agents.

(4) **Time.** Based on the time required for field confirmatory identification, postattack medical prophylaxis is a viable option for the protection of US forces.



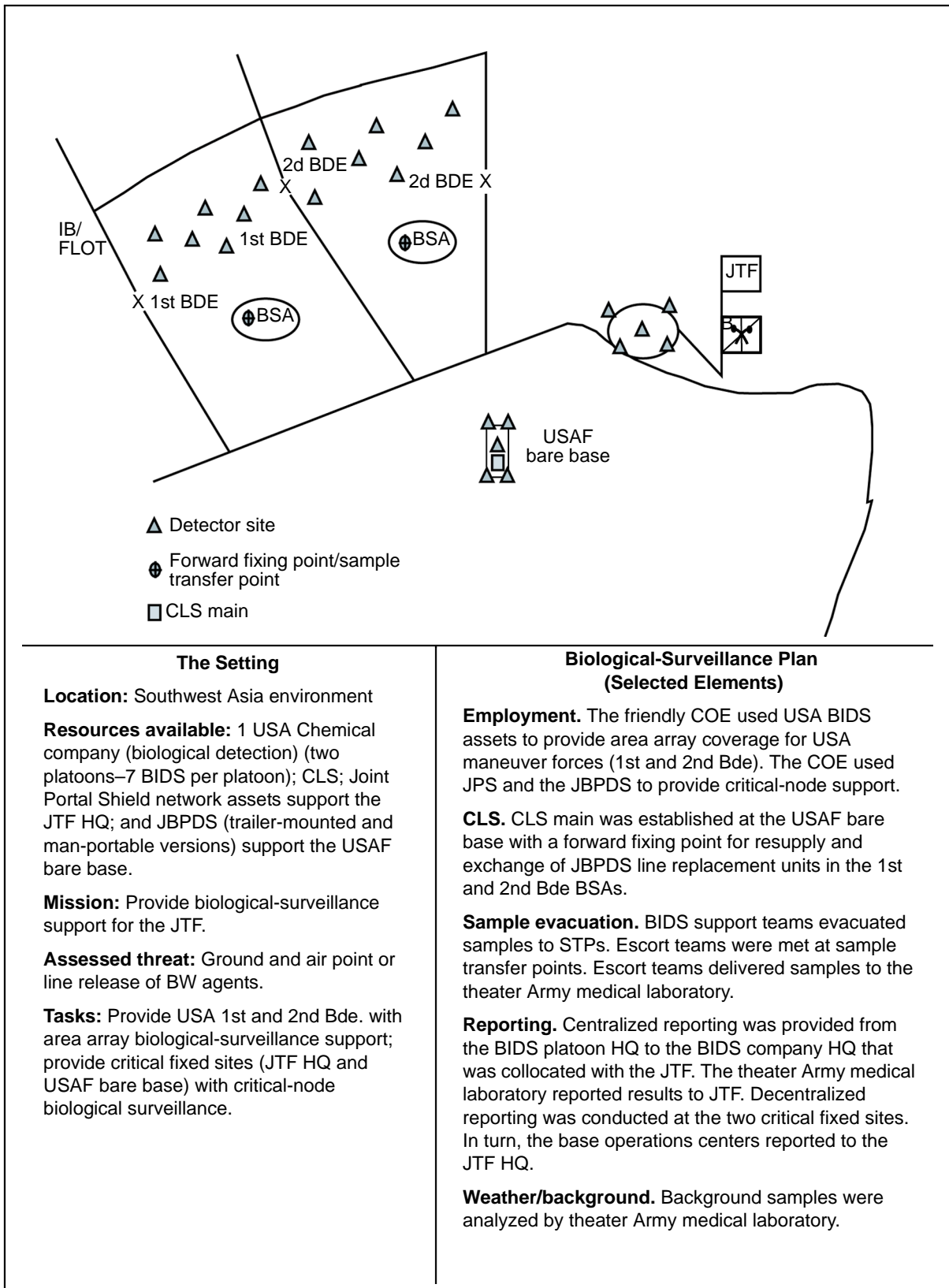


Figure III-1. Biological-Surveillance Operations

(5) Troops available. JTF assets include one USA chemical company (biological detection) with two BIDS platoons (7 systems per platoon; 14 systems total), and Joint Portal Shield network (available at the JTF HQ) and JBPDS assets (available at the USAF bare base).

b. The JTF integrates the biological-detection assets into the command overall reconnaissance and surveillance plan to support the command maneuver forces and fixed sites.

(1) Maneuver force support (area array). Based on a threat line source capability, USA BIDS platoon assets provide the maneuver force with area array support. The biological-detection unit leader applies METT-TC factors and uses the tools in *Appendix E* to estimate separation distances between systems and how far downwind from an estimated BW agent release point (RP) to place the array. The biological-detection unit leader balances the actual siting of the systems with FP guidance. The modified dice five employment tactic is used in the brigades to provide coverage in depth.

(2) Fixed-site support (critical node). Based on an threat point source capability, Joint Portal Shield network and JBPDS (trailer-mounted and man-portable) are used in critical-node arrays at the JTF HQ and USAF bare base. The planning process applies METT-TC and uses the tools in *Appendix E* tools to provide guidance on estimated separation distances for the systems. A dice five employment tactic is used at the fixed sites to provide biological-surveillance support.

## Chapter IV

### BIOLOGICAL-SAMPLE EVACUATION

#### 1. Background

Biological sampling is the process or technique of selecting, packaging, and documenting the collection of biological material. Correct techniques for collecting, packaging, handling, and transporting suspected biological agents are critical for accuracy in the analysis of environmental samples and clinical specimens. The quality of any analytical evaluation is directly related to the quality of the sample or specimen and the degree of postcollection degradation that occurs prior to testing. HSS personnel collect and submit specimens for suspect biological hazards and/or agents involving humans and animals. PVNTMED and veterinary personnel collect and submit water, ice, food (for example, fruits and vegetables), environmental samples (including soil), as well as specimens from animals for suspect biological hazards and/or agents. Collected specimens and samples that are suspected of being exposed to or containing a biological agent are forwarded to the field confirmatory lab designated by the applicable combatant commander, and in turn, to the CONUS reference lab for definitive identification directed in current OPLANs and operation tasks (OPTASKs). The command surgeon will recommend priorities of effort and what labs should receive samples for confirmatory and/or definitive identification. See *Appendix G*.

#### 2. Sample Evacuation Requirements

There are specific requirements to effectively evacuate a sample to the appropriate agency. Some of these requirements are as follows:

- Maintain sample integrity through packaging the sample properly, maintaining the sample at 1-4°C, and ensuring an uninterrupted chain-of-custody and timely exfiltration.
- Obtain effective transportation and shipment coordination and clearances.
- Prioritize the process for the transport and analysis of samples.
- Provide appropriately trained personnel or units to transport samples.
- Coordinate with appropriate command and staff transportation authorities to help ensure that the transport and transfer of a sample is uninterrupted across international borders or to another government agency. The intent is unimpeded and controlled sample flow.
- Evacuate background samples for lab analysis to characterize the background environment within the AO.
- Maintain sample tracking and visibility.
- Identify the sample destination (for example, the theater lab or CONUS lab). The theater surgeon or medical officer coordinates this action.
- Identify HN lab capabilities in coordination with the CA staff.

### 3. Supported Unit Sample Evacuation Plan

Detailed planning and coordination are critical for successful sample evacuation. There are two key levels of command in the sample evacuation and planning process—the supported unit and the biological detection unit. Once planning and coordination have been accomplished, the OPLAN and/or OPORD provides the who, what, where, when, and why to ensure successful sample evacuation.

a. The planning and coordination process begins at the supported unit. The allocation of time is a critical factor, and the commander must provide guidance to subordinate units as early as possible.

b. The supporting unit should ensure that the following topics are covered in the OPLAN and/or OPORD. See *Appendix G*.

(1) **Assets.** List the assets needed to execute the sample and specimen evacuation mission. As a minimum, biological detection assets, courier assets, and medical and environmental lab assets are required. If medical lab support is not available in-theater, samples will be forwarded to alternate locations (CONUS). Identification of the lab location and point of contact (POC) is also required.

(2) **Priorities.** The OPLAN and/or OPORD sample evacuation annex may direct that selected samples (such as the first reported use of BW in the AOR by presumptive identification) be evacuated to designated sample transfer points within a specific time frame. For example, the Army medical laboratory mission statement indicates that the BIDS sample should be completed within 12 hours of the reported attack. It can take the Army medical laboratory approximately 6 to 8 hours for field confirmatory analysis and days for a definitive analysis. Therefore, it is important that the sample evacuation process be completed as soon as possible.

(3) **Reporting.** The higher HQ should direct any reporting requirements, such as how many samples have been evacuated.

(4) **Coordination.** The annex should indicate specific instructions on topics such as locations for supporting assets such as the sample courier, the supporting medical lab, or security elements and/or provide supporting communications information.

c. The supported unit (higher HQ) should conduct actions to support the overall sample evacuation process (for example, providing resources, establishing priorities, conducting coordination, and providing and requesting reports); however, the issuing of FRAGORDs to initiate the sample evacuation process will likely occur at the detection unit command.

### 4. Biological Detection Asset Sample Evacuation Plan

The biological detection unit sample evacuation plan should complement the supported unit sample evacuation plan and describe what will be accomplished. It should be coordinated with higher HQ, the NBC officer, the intelligence officer, the courier element, and the supporting Army medical laboratory. The plan should include the following elements:

- The designation of primary and alternate sample transfer points for the biological detection asset and TEU or designated unit for linkup. The sample transfer points should be as close as possible to the biological detection asset.

- The provision of frequencies for communications between all elements involved in the sample evacuation process. This allows two-way communications (as required) between the detection asset, technical escort, and lab.
- The designation of what unit (if any) has been tasked to provide security for support teams and/or technical escort.
- The designation of primary and alternate evacuation routes.
- The designation of sample transfer point reporting requirements. The sample transfer teams should notify their controlling HQ with information such as sample transfer point arrival and departure times and/or the time the sample was transferred to a technical escort.
- The sample identification (confirmatory or definitive) will be reported from the supporting lab to the theater surgeon or medical officer. He will recommend further dissemination if required. The supported commander will determine the distribution of the results within the AO.
- Coordination with the supporting unit and the tasked sample courier unit to ensure that all sample numbers, supporting documentation, and sample preparation is correct to ensure that a viable sample is delivered to the supporting medical lab.

## **5. Biological-Detection Asset Sample Evacuation Planning and Operational Considerations**

a. The unit or command with biological detection assets must publish an OPLAN and/or OPORD before any operation. The commander or leader ensures that the unit OPLAN and/or OPORD reflects the higher commander's intent.

b. The biological detection asset plays a critical role in the sample evacuation process. It must supply a sample evacuation plan and ensure that the following concerns are taken into consideration:

- Higher HQ, on an exception basis, may manage individual sample evacuation (for example, the first reported BW event in the combatant commander's AOR).
- Samples that support presumptive identification should be evacuated.
- Sample evacuation should occur as soon as the operational situation permits.
- The technical escort, theater medical and/or environmental laboratories, and biological detection assets coordinate directly unless otherwise directed.
- Sample evacuation is a time-sensitive process due to multiple factors including legal implications, the verification of first use, and agent viability.
- Priorities should be established for sample evacuation based on factors associated with BW event tracking.

## 6. Sample Evacuation Execution

a. In preparing for the execution of a sample evacuation, the commander prioritizes the samples that should be evacuated. The commander considers the following when determining the priority of samples:

- What is the time sensitivity for a specific sample evacuation package?
- Where was the sample collected (the proximity of transportation or courier assets for sample transport)?
- What is the role of the sample in the overall process of the operation (is it being used to support “detect to treat” or “verification of agent or release decisions”)?
- How many resources (consumables) are needed to support analysis and testing?

b. All samples will be evacuated to confirmatory laboratories for analysis. Laboratories will prioritize sample analyses based on critical background information (for example time sensitivity and role of the sample). The lab commander will determine the number and types of samples to be analyzed.

c. Sample evacuation execution relies on an effective means to evacuate the sample. TEU assets may be available; however, if TEU assets are not available, other courier personnel can be trained to perform escort responsibilities.

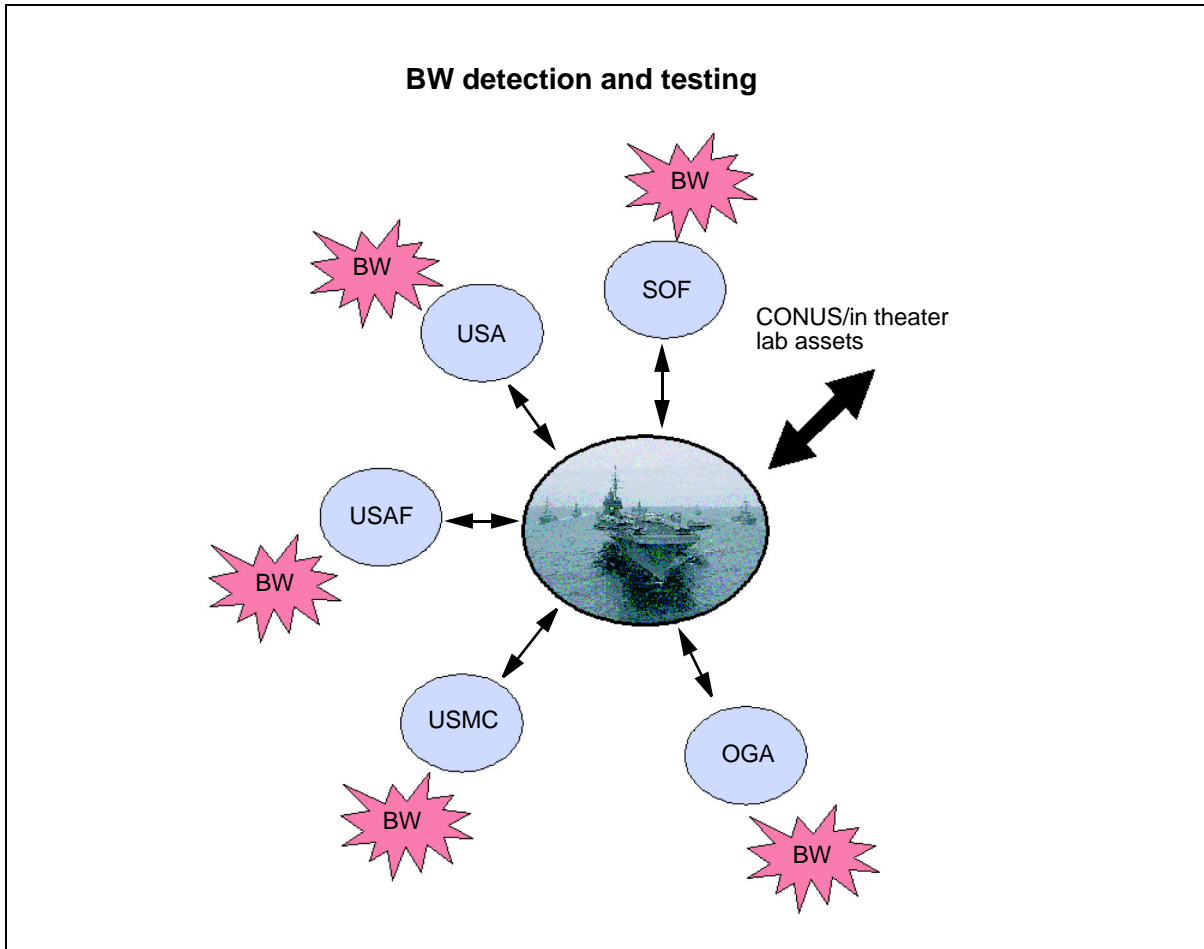
d. Sample evacuation packages from biological detection units require field confirmatory identification support. The applicable service component or special operations forces (SOF) element prepares the sample and an escort element transports the sample. The supporting medical and/or environmental lab destination for field confirmatory testing could range from sending the package to a ship-based lab (see *Figure IV-1*), an USAF lab, or to an Army medical laboratory.

e. The personnel packaging, transporting, and storing samples must ensure the integrity of the sample from the time it is first taken until it is delivered to the supporting lab. The temperature at which the sample is stored and transported is crucial to its viability. Samples should be transported and stored at 1-4°C. The sample courier should be able to periodically check the temperature within the sample transfer case to ensure continued sample viability.

f. Samples can also be evacuated to CONUS definitive laboratories for further analysis. The decision to return a sample to CONUS will be made by the confirmatory lab, theater medical officer, theater commander, or CONUS higher commands. *Figure IV-2* (page IV-6), provides a depiction of sample flow from sample collection to CONUS definitive lab analysis and reporting.

## 7. Chain-of-Custody

a. A strict chain-of-custody must be maintained for every sample or specimen collected. The chain-of-custody document must accompany the sample or specimen during transport from the point of collection to the receiving medical lab to the final disposition of the sample. Each time the sample or specimen is transferred to another individual, the receiving person must sign the document to show that he received the



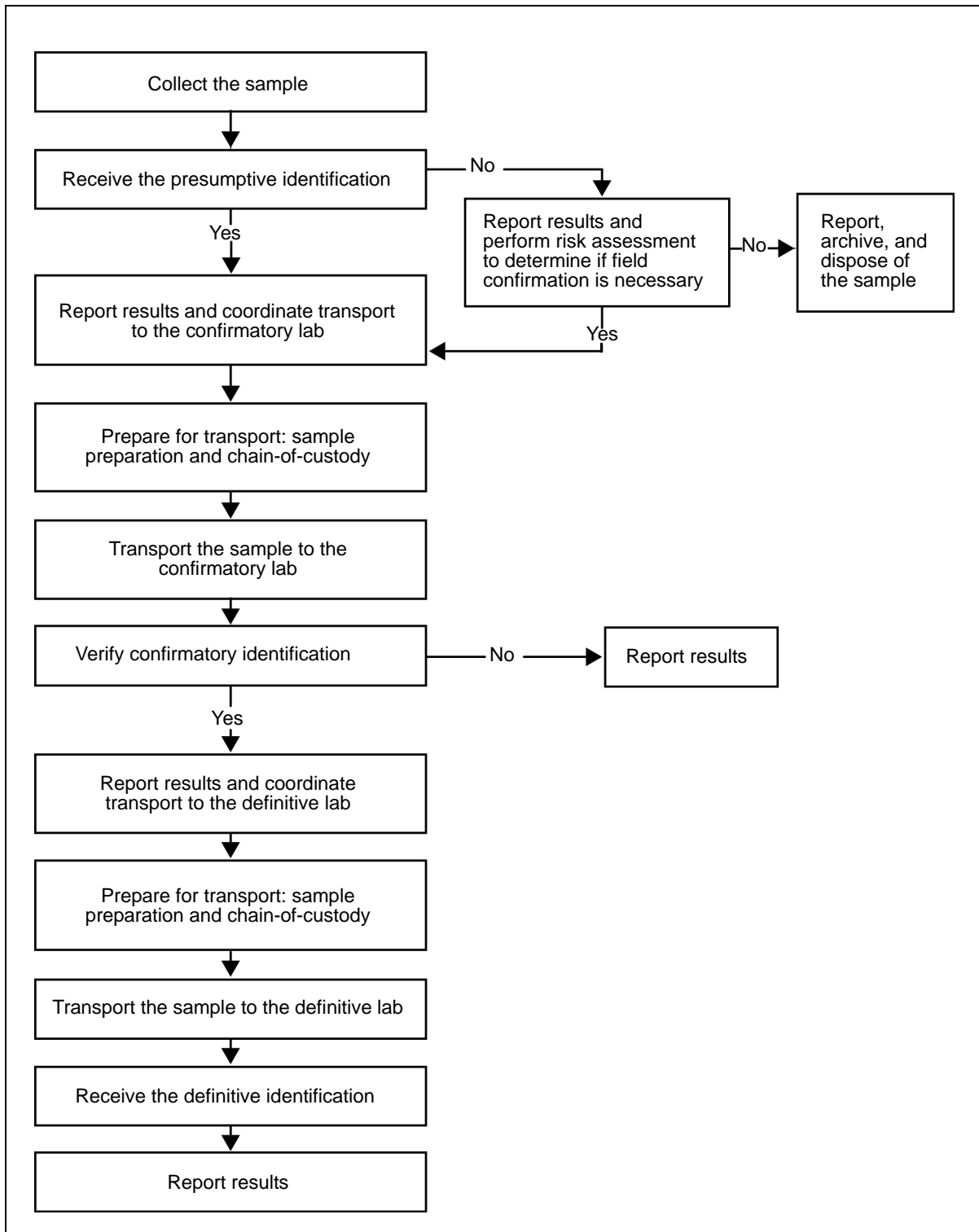
**Figure IV-1. Field Confirmatory Lab Support From USN Capability**

sample or specimen and state what happened to it while in his custody. The document will provide answers to the following questions about the sample or specimen.

- When was it collected?
- Who has maintained custody of it?
- What has been done with it at each change of custody?

b. The samples or specimens must be appropriately packaged, labeled, and evacuated to the designated medical and/or environmental lab for confirmation of a biological attack. The standard chain-of-custody for the evacuation could be as follows.

- Sampling unit.
- Sample courier or other command-designated courier personnel.
- In-theater supporting lab.
- Designated CONUS lab.



**Figure IV-2. Sample Collection Flow**



# Chapter V

## INFORMATION MANAGEMENT

### 1. Background

The collection, analysis, and integration of biological- and medical-surveillance information support the identification of the agent that was used, provide the exposed location, and aid medical assets in determining the proper treatment. This information management integration process will likely occur at operational-level HQ (JTF, component command) and/or at fixed-site, port, or airfield operations centers (OPCENs). The objectives of timely BW information management focus on early warning and saving lives. These objectives support SA, reducing the decision cycle and decreasing the detection time. The time gained by decreasing the detection time can support the early initiation of medical-intervention measures and save lives.

### 2. Information Management

a. Commanders require accurate and timely information as they prepare for operations in a biological-threat environment. The NBC staff monitors and tracks biological-surveillance information and the command surgeon monitors and tracks medical surveillance data. Ongoing coordination between the NBC staff, medical staff, and the intelligence section supports decisions that rely on SA and an understanding of the significance of the gathered data. The commander and staff apply the information from intelligence, medical, and surveillance systems to support—

- Aerosol tracking (BW event).
- Hazard predictions.
- Warning, reporting, and notification.
- Casualty prevention.
- Prophylaxis and treatment plan execution.
- Sample evacuation operations.
- Casualty management.

b. Units obtain relevant data from multiple sources (such as sensors, detectors, and medical staffs). The applicable report data (for example, lab results, the time of detection, BW sensor result from BIDS [see *Appendix I*], weather data, and the location) is processed, extracted, formatted, and forwarded. Commanders and their staff evaluate the information to assess any impact on operations. Risk assessment is part of the decision-making process and may result in directives and/or orders to help reduce the impact of the assessed biological hazard. Commanders may direct an integrated series of protective measures (for example, the administration of prophylaxis) to decrease the level of risk (decrease exposure opportunities) or reduce the effects of exposure. Because SA is an ongoing process, the plan is revised as updated information is received.

c. HSS personnel establish an exposure record documenting exposure levels and risk assessment information for each affected person.

### 3. Priority Information Requirements

a. The commander and staff determine priority information requirements and IRs to support biological and medical surveillance. The commander and his staff preplan to determine critical data requirements. The relevant choices are prioritized as priority information requirements and a data collection plan is prepared. The overall data collection effort shares the following common characteristics:

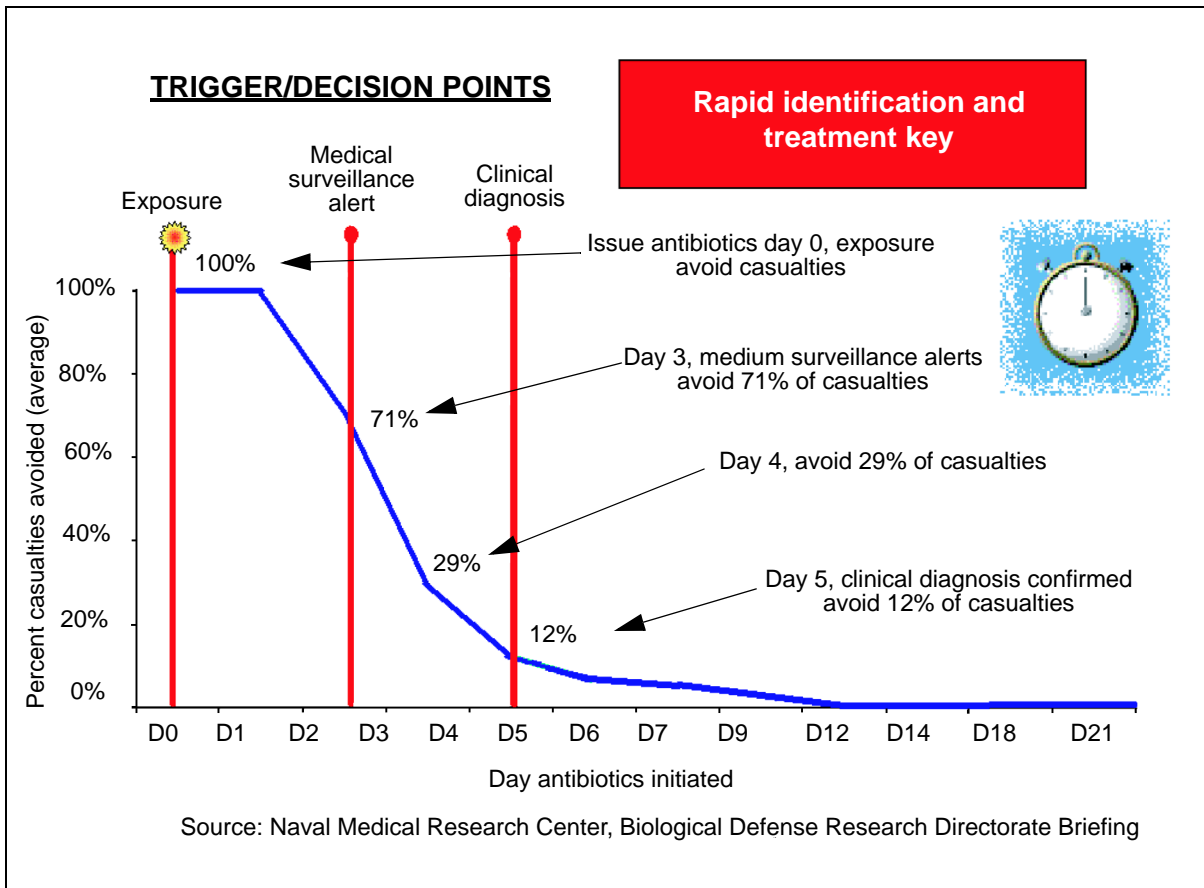
- Connectivity from lower-to-higher and higher-to-lower levels of command with adjacent and supporting units and state/HN agencies (for example, communications with supporting medical laboratories and BW sensors).
- The ability to forward relevant data to multiple echelons of command simultaneously.
- The ability to conduct technical reach back to obtain access to national-level medical, intelligence, operational, logistics, or technical information to provide information for operational assessments. Reach back provides the additional capability to improve the effective use of modeling and simulation to conduct region-specific, expert evaluation of potential biological-weapons effects as well as toxic industrial biological releases.
- The ability to receive, process, and evaluate data. Data received may be incomplete; therefore, it is assessed and evaluated in light of available information sources.
- The ability to focus data collection on the commander's IRs (for example, has a threat BW attack occurred?).

b. Multiple risks impact BW defense planning. It is impractical to require units to don individual protective equipment (IPE) for prolonged periods. It is critical to be able to determine if a BW attack has occurred before agent symptoms begin appearing, if possible. Initiating prophylaxis before the onset of symptoms will reduce the number of casualties. Before implementing critical decisions, the command and staff assess confidences in the information that is provided. *Figure V-1* provides an approximate average for the percentage of casualties avoided if antibiotics are issued promptly after exposure. The averages are based on the initiation of prophylaxis for traditional BW bacterial agents.

### 4. Reporting

If properly executed, biological reporting provides commanders with time and information (as much as possible) to react to biological events. Commanders direct the actions needed to minimize the impact of attacks. Quick and accurate reporting provides the necessary information for command decisions and responses.

a. Reporting is the link between successful battlespace awareness, decision-making, and effective operations in a biologically contaminated environment. To be useful, biological-surveillance report information (such as medical surveillance and BW sensor results) must be collected, distributed, and quickly analyzed. Once analyzed, this information is used as battlefield intelligence. During a biological event, the volume of information received by C2 elements could become overwhelming and slow information analysis. Programs such as the Joint Warning-and-Reporting Network and the Force

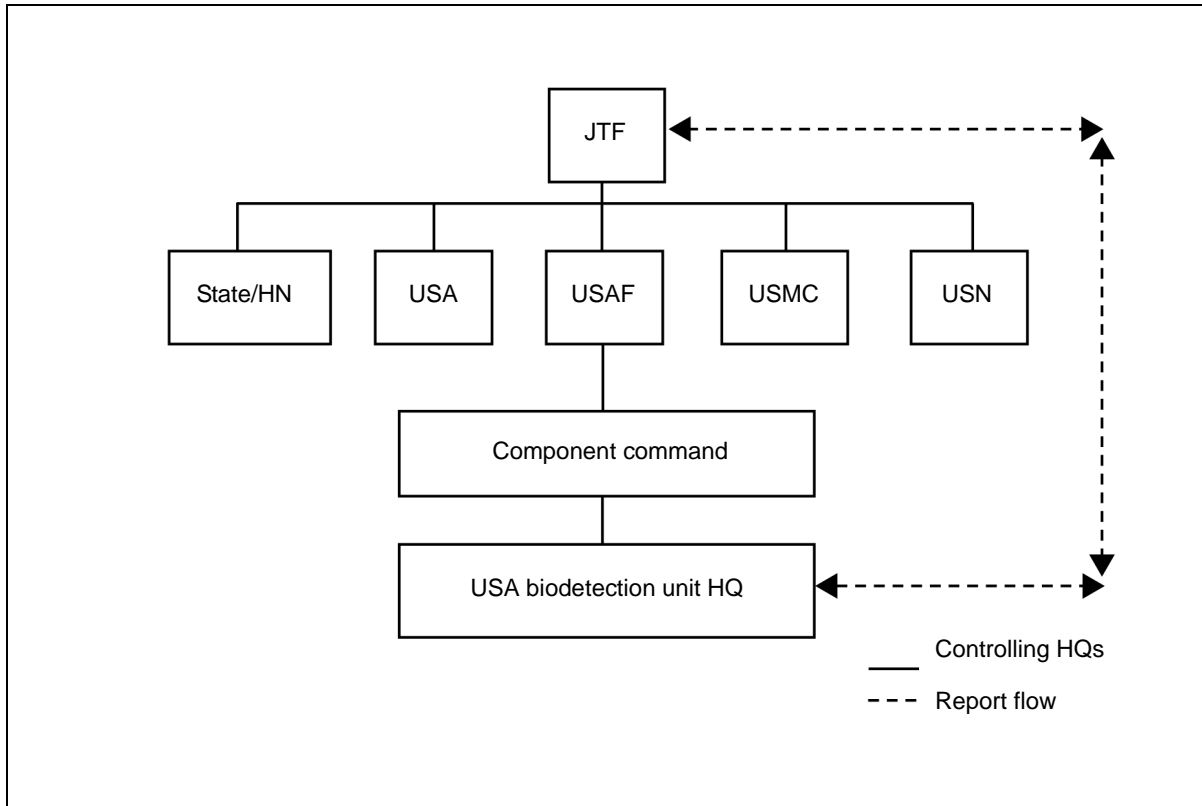


**Figure V-1. Maintaining Mission Readiness: “Detect to Treat”**

XXI Battle Command Brigade and Below (FBCB2) help automate the reporting process and organize biological-detection data.

b. Maintaining SA is critical. Timelines of reporting are critical to ensure that time-sensitive decisions are made within other critical timelines (such as before the onset of BW agent symptoms). For example, a biological-detection asset (such as a USA BIDS unit) could be required to support the USAF component of a JTF. The USA biological-detection element complies with a direct reporting requirement through the AF component. However, the JTF OPOD requires that the biological-detection unit HQ also provide voice and/or digital reporting to the JTF NBC control center (see *Figure V-2* [page V-4]). The prompt, accurate reporting of biological-surveillance information is critical, and the operational-level commander (for example, a JTF) uses this information to support time-sensitive decisions.

c. NBC control centers receive reports from subordinate NBC control centers and/or supporting biological-detection units. Many of the reports will be preformatted NBC Warning-and-Reporting System reports according to service doctrine manuals such as *Chemical and Biological Contamination Avoidance*. For example, an NBC-1 (biological [BIO]) report should be reported from a biological-surveillance unit HQ. For example, an NBC-1 (BIO) report should be reported from a biological-surveillance unit HQ to the supported NBC control center. The NBC control center also coordinates with the medical and intelligence staff to receive key information from assets such as the



**Figure V-2. Possible Biological-Detection Network with Centralized Warning**

medical and/or environmental laboratories. This information will most likely be in the form of unformatted free text messages. The NBC control center is responsible for the following:

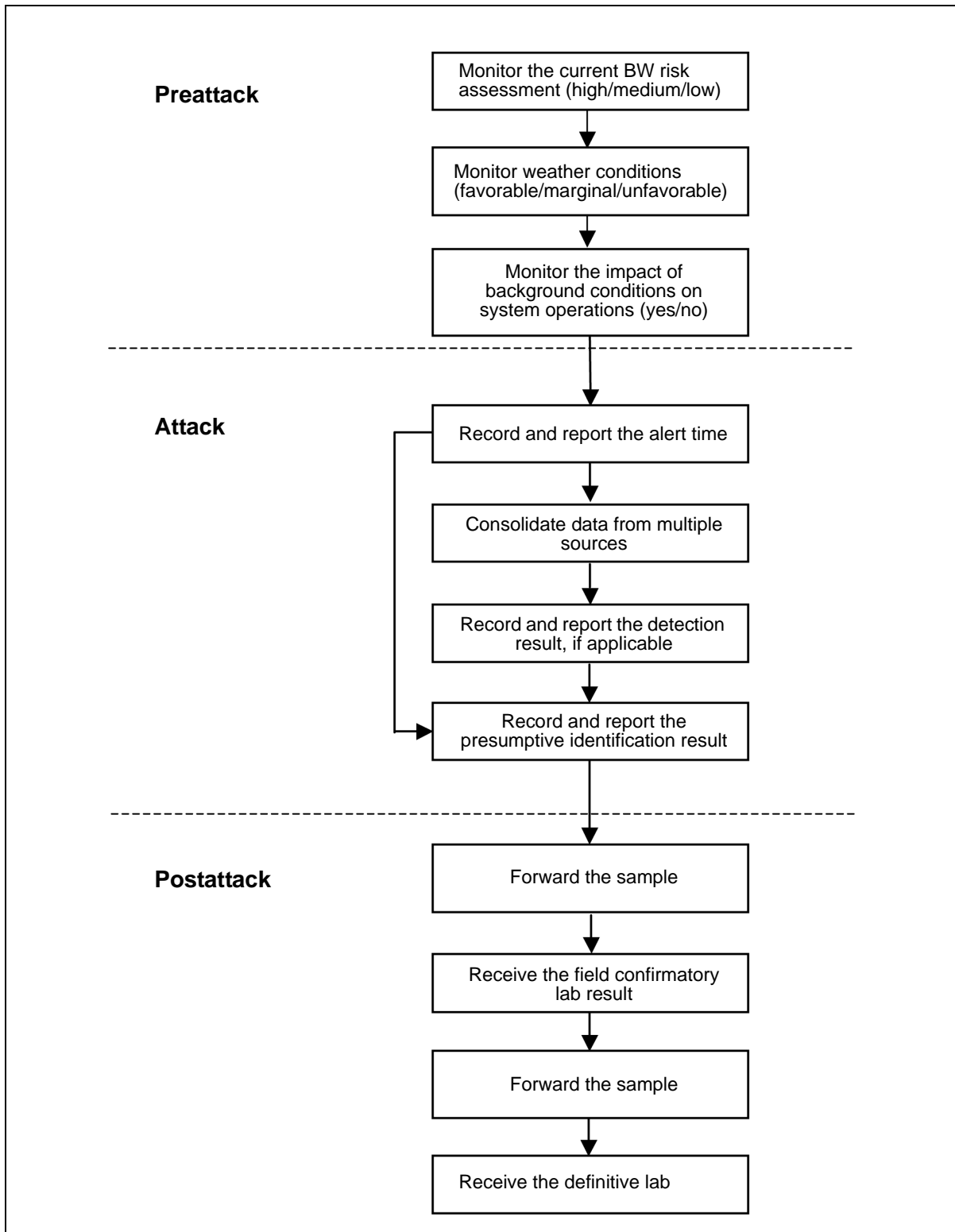
- Correlating and validating all NBC reports from subordinate commands and reporting activities (for example, fixed-site detection or collection assets; LRBSDS; JSLNBCRS; and BIDS units).
- Assigning a temporary strike serial number to all validated attacks. The combatant command (command authority) (COCOM) NBC center assigns the permanent strike serial number.
- Preparing formatted NBC reports and overlays for the Global Command and Control System (GCCS), FBCB2, Joint Warning-and-Reporting System, and NBC Warning-and-Reporting System.
- Ensuring that subordinate reporting activities use standard reporting formats.
- Reporting any issues regarding interoperability within the reporting network.

## 5. Information Collection and Operational Level Assessments

Information collection should generally follow a pattern and can be tracked during preattack, attack, and postattack operations (see *Figure V-3* [page V-6]). The unit or staff

may use an integrated information collection tool (such as a matrix) to record and assess the input from different sources (see *Figure V-4* [page V-7]). The biological-event-tracking tool can be used to monitor medical surveillance results, preattack data (current BW risk assessment, weather conditions, and the impact of background conditions), attack data (alert, detection, and identification), postattack data (lab results), and remarks data (such as local activity). Tracking key information can support decisions to warn, protect, or treat. The decisions are based on input from the NBC, medical, and intelligence staffs. They are products of the IPB and include consideration of risk.

- **Warn.** The decision to warn is based on the assumption that there is a threat of an upwind aerosol cloud moving toward the warned forces. It also can be a notification that exposure may have already occurred. A warning should be accompanied by treatment and/or protection guidance to ensure a consistent, effective response.
- **Protect.** The decision to assume a protective posture must take force capabilities and vulnerabilities into account. Implemented control measures could include using available protective equipment, conducting detection and identification of biological agents, and assessing unit vulnerability to a suspected agent (vaccinated or unvaccinated forces).
- **Treat.** The decision to administer postexposure prophylaxis or treatment is made after there is evidence of likely exposure to a BW agent. The commander makes the decision with advice from the surgeon and supporting input from the NBC officer and intelligence staff. The senior medical officer will recommend the appropriate prophylaxis or treatment regimen.
  - a. **Medical Surveillance.** The collection, analysis, and dissemination of surveillance information may be the first and only indicator of BW use. The direct and clear flow of information to the controlling HQ commander, medical officer (primary recipient), and NBC defense officer facilitates the rapid dissemination of protection, prophylaxis, and warning guidance.
  - b. **Preattack Information.** Preattack information recorded will include the current BW risk assessment, weather conditions, and the impact of background conditions on system operations.
  - c. **Attack Information.** The evaluated BW report results from BW attacks provide alert, detection (if applicable), and presumptive identification with an associated confidence level (low, medium, or high).



**Figure V-3. Tracking BW Data**

Medical Surveillance	Preattack			Attack*			Postattack	Remarks														
BW Used Yes/No/ Unknown	Current BW Risk Assessment H/Med/L	Weather Conditions F/M/U	Impact of Background Conditions on System Operations Yes/No	Alert Time (Time)	Detection Result C/S/T	ID Result (PI)/Time/ Confidence Level	ID Result (FC/DI/Time)	<b>Record information such as other available intelligence, local activity, and the type of biological-detection system used.</b>														
<p><b>*Attack results are recorded following the receipt, analysis, and evaluation of reports to help ensure consistency and correlation of data.</b></p> <p><b>Legend:</b></p> <table border="0"> <tr> <td>Unk – Unknown</td> <td>C – Cells</td> </tr> <tr> <td>H – High</td> <td>S – Spores</td> </tr> <tr> <td>Med – Medium</td> <td>T – Toxin</td> </tr> <tr> <td>L – Low</td> <td>PI – Presumptive identification</td> </tr> <tr> <td>F – Favorable</td> <td>FC – Field confirmatory</td> </tr> <tr> <td>M – Marginal</td> <td>DI – Definitive identification</td> </tr> <tr> <td>U – Unfavorable</td> <td>ID - Identification</td> </tr> </table>									Unk – Unknown	C – Cells	H – High	S – Spores	Med – Medium	T – Toxin	L – Low	PI – Presumptive identification	F – Favorable	FC – Field confirmatory	M – Marginal	DI – Definitive identification	U – Unfavorable	ID - Identification
Unk – Unknown	C – Cells																					
H – High	S – Spores																					
Med – Medium	T – Toxin																					
L – Low	PI – Presumptive identification																					
F – Favorable	FC – Field confirmatory																					
M – Marginal	DI – Definitive identification																					
U – Unfavorable	ID - Identification																					

**Figure V-4. Biological-Event-Tracking Tool**

(1) At the operational or tactical level (for example, a JTF HQ or a fixed-site OPCEN, respectively), an aggregate picture is available from the information generated by a biological detector array. From these results, aerosol-tracking hazard predictions and reports are prepared.

(2) Other key information that the NBC staff may track includes consistency among the NBC-1 (BIO) reports received, the type of biological-detection system that reported the information, the confidence level associated with the report, and any other related analysis (such as consistency and correlation in the reported results).

d. Postattack. The result of the identification from the supporting lab will be recorded.

e. Remarks. Other information (such as available intelligence) will be provided in the remarks section of the BW event-tracking tool.

## 6. Unit Incident Reporting

a. The biological-detection unit HQ or system-level operator should report the following to the designated HQ (for example, a NBC control center or unit OPCEN):

- Presumptive positive BW identification results.
- Status reports as required.
- Other reports as required by the mission, threat, background, meteorological conditions, or location characteristics.

b. All report information from the biological-surveillance assets are recorded manually or electronically. For example, JBPDS data is recorded and saved electronically. Following a BW event (for example, alert and/or identification data), the information is saved to provide a record. At end of the shift or the end of mission, the information is saved for follow-on use and analysis, as required. Background data is also saved as a baseline for future use.

c. The operator uses the incident report (see *Figure V-5*) to record and report alert and/or sampling interval and identification information obtained during biological-detection operations. It reports both background and actual alert and/or sampling intervals and identification information. The biological-detection or -collection system operators maintain the information for each background collection and identification result. For the biological-detection system incident report, there are two fundamental fields of data that are compiled and reported for a BW event. These are the alert and/or collection and identification fields of data. Alert and/or collection data includes alert and/or sampling interval times and meteorological data. The identification data provides positive (an agent code) or negative results. The remarks section is used to record the associated confidence result, external conditions and/or activities, and the system-operating mode, if applicable. The remarks section of the sampling incident report will include weather information (as of the time of the sample collection) to include environmental conditions (such as a sandstorm).

d. biological-surveillance information reporting can be set up for three levels of warning. *Table V-1* provides a summary of the warning levels.



Alert/ Collection	Meteorological Data	Identification		
1. Alert Time (DTG): _____	2. Meteorological data: a. Wind speed (kph/mph): _____	System 1: a. Location/ID: _____	System 2: a. Location/ID: _____	System 3: a. Location/ID: _____
2. Collection interval: _____	b. Wind direction (degree): _____	b. DTG: _____	b. DTG: _____	b. DTG: _____
		c. Agent code: _____	c. Agent code: _____	c. Agent code: _____
		or Negative	or Negative	or Negative
Team ID:				
Team leader signature:				
Sample identification number:				
Remarks:				
Confidence level:				
External conditions:				
Operating mode:				

**Figure V-5. Incident Report (Sample)**

**Table V-1. Warning Level Applicability**

Warning Level	Applicable to Automated Detection Assets	Applicable to Manual Sampling Assets	Applicable to the Supporting Lab
Level 1 - Detection Notice <ul style="list-style-type: none"> <li>Applicable only to automated detection assets (Joint Portal Shield/JBPDS) because of their system detection capability.</li> <li>Not applicable to manual sampling assets (dry filter units). They do not have an alerting capability.</li> </ul>	X	N/A	N/A
Level 2 - biological-Presumptive Identification Based on a presumptive identification from a biological-detection system or handheld-assay testing.	X	X	N/A
Level 3 - Field Confirmatory Identification Applicable to the receipt of results from a supporting lab.	N/A	N/A	X

**NOTE: The incident report format may be adapted to meet theater requirements; however, the basic data fields must be used. Additionally, some system specific reporting requirements may require additional data (for example, the M31A1 BIDS incident report provides detection data).**

- (1) Level 1: Detection Notice.
  - This indicates that the detector has alerted to the presence of biological particles in the air. Level 1 capability is not applicable to manual sampler operations.
  - Upon a detection notice, the system will automatically collect an aerosol sample and analyze it using automated assays to determine if a BW agent is present. A Level 2 warning occurs if the handheld-assay result is positive. If the assay result is negative, the Level 1 warning will be cleared.
- (2) Level 2: Biological-Presumptive Identification.
  - This indicates that the system has read one or more of the assays as being positive or a single handheld assay has shown positive results from a collection asset (such as a dry filter unit).
  - Upon receipt of positive presumptive identification, the operator will prepare a collected sample (liquid or dry) for evacuation.
- (3) Level 3: Validated Biological-Confirmatory Identification.
  - This indicates that a medical lab provided a positive field confirmatory result.
  - Communication and coordination is maintained with the command surgeon and the NBC control center.

e. The analysis of the results from multiple BW detectors or collectors consists of assessing the results from subordinate units and consolidating and evaluating the data to ensure that the information is usable and complete. The objective of BW event tracking is to assess the probability that a BW attack has been detected. Based on BW event tracking, the results provide an associated confidence level (*Table V-2*). During the planning process, the confidence level is assigned to a BW event and may serve as a trigger to support a commander’s decision points (such as protection or treatment). A single-system presumptive identification provides a medium level of confidence. A medium level of confidence indicates the potential presence of a BW agent; however, other information sources (such as medical surveillance, other biological-detector results, or intelligence) must be reviewed to determine if there is other confirming data. Multiple confirming, consistent indicators of a BW attack (for example, two or more biological detectors with consistent, presumptive identification results) provide a high confidence level.

**Table V-2. System Confidence Levels**

Number of Systems Reporting Presumptive Identification Results	Level of Confidence	
	Medium	High
Single-system presumptive identification	X	
Multiple-system presumptive identification		X

f. The biological-detection unit HQ should report the following to the higher HQ NBC center:

- Positive BW identification results.
- Other reports required by the mission, threat, background, meteorological conditions, or location characteristics. This information may include reports on system and/or component operational readiness or significant local activities (such as an unusual weather phenomena).
- Status reports as required.

g. All report information is recorded manually or electronically. Following a BW event (for example, alert and/or identification data), the information is saved to provide a record. At the end of a mission, the information is saved for further follow-on use and analysis as required. Background data is also saved as a baseline for future use. This information will be retained for a minimum of 3 years following the end of the operation unless otherwise instructed by individual service regulation or Department of Defense (DOD) policy. This background information is especially important for after action reviews (AARs) and follow-on health surveillance as required.

h. Incident reports are used to record and report alert and identification information obtained during biological-detection operations to the NBC center. The NBC center generates the appropriate NBC report (for example, an NBC-1) from the incident reports. It is used to report both background and actual detection and identification information. For the incident report, there are two fundamental fields of data that are routinely compiled and reported for a BW event. These are the alert and identification fields of data and detection data (if applicable). Alert data includes the alert time and meteorological data. Identification data contains the agent identification code (or negative if none is identified) and the mode of operation of the system during the event. The incident report also includes environmental conditions (for example, a sandstorm) and the presumptive identification result.

i. Field confirmatory lab results may take hours and definitive results could take days. The definitive results provide a more sensitive result; however, the commander may assess that in-theater field confirmatory results provide a sufficient basis for approving prophylaxis and other treatment recommendations.

j. The reporting of supporting information is important for a BW attack assessment. The supporting information can be used to help corroborate that a BW occurred.

(1) Intelligence. Intelligence represents a valuable and significant source of information. The confidence placed in detection and identification increases with the certainty that the threat is assessed to have a particular agent. For example, if a group of detectors are indicating anthrax and it is known that the threat has anthrax in its arsenal, then higher confidence may be placed in the detector response. Other intelligence considerations may include the following:

- Any indication of intent or instances of past use of BW agents by the threat.
- Past employment techniques may determine a threat pattern of agent use.

- IPB also plays a key role in the assessment of results from medical surveillance and BW sensors. Assessing where the threat is most likely to originate a biological attack in advance, and then actually detecting a biological attack downwind from that source can increase confidence that this might be an actual attack. Determining where these potential dissemination points are depends on intelligence information, such as what agents the threat is known to possess and what dissemination equipment they have (for example, point source or line source weapons).

(2) **Weather.** Weather has an important influence on whether a threat can disseminate a biological agent effectively or not. For BW, meteorological data at ground level and up to 100 meters or more over a large area is important. Among the considerations are—

- **Wind direction.** The wind direction should be towards friendly forces.
- **Wind speed.** Wind speed should be conducive to effective agent dissemination, while minimizing agent dilution through turbulence and dispersion. Biological agents can be employed effectively at most wind speeds.
- **Atmospheric stability.** A combination of wind speed, cloud cover, and solar angle (time of day) can be represented as stability factors 1 (very unstable) through 7 (very stable). A large-scale biological attack would most likely be effective under somewhat stable atmospheric conditions. Unstable conditions involve a large degree of vertical dispersion, resulting in decreased downwind travel. Further information on how atmospheric stability can affect biological attacks can be found in service publications such as *Field Behavior of NBC Agents (Including Smoke and Incendiaries)*.
- **Precipitation.** Generally, precipitation does not have much of an impact on biological-aerosol cloud “washout” unless the rain is unusually heavy for an extended time.
- **Effect of terrain on meteorology.** Surface contours and the overall roughness of the surface, influence the direction and speed of agent flow. Higher concentrations can be expected in valleys and depressions, which also tend to direct the flow of the aerosol cloud. Rough ground (vegetation, forests, and rocks) tends to retard agent flow and increase vertical dispersion of the agent resulting in decreased downwind travel and concentration.
- **Agents.** Not all agents can be effectively dispersed in the atmosphere.

k. The systematic collection of information over time supports SA. *Figure V-6* provides a sample BW event tracking tool that used the following information input to track BW-related activity from preattack through postattack.

Medical Surveillance	Preattack			Attack*			Postattack	Remarks														
	Current BW RA H/Med/L	Weather Conditions F/M/U	Impact of Background Conditions on System Operations Yes/No	Alert Time (Time)	Detection Result C/S/T	ID Result (PI)/Time/ Confidence Level			ID Result (FC/DI/Time)													
BW Used Yes/No/ Unknown								<b>Record information such as other available intelligence, local activity, and the type of biological-detection system used.</b>														
Unk	Med	M	No	220100L	N/A	Positive for agent XXXX@ 22012 High	FC positive for agent XXXX 220700L	JBPDS ID @ APOD; no unusual outside activity														
<p>* Attack results are recorded following the receipt, analysis, and evaluation of reports to help ensure consistency and correlation of data.</p> <p><b>Legend:</b></p> <table> <tr> <td>Unk – Unknown</td> <td>C – Cells</td> </tr> <tr> <td>H – High</td> <td>S – Spores</td> </tr> <tr> <td>Med – Medium</td> <td>T – Toxin</td> </tr> <tr> <td>L – Low</td> <td>PI – Presumptive identification</td> </tr> <tr> <td>F – Favorable</td> <td>FC – Field confirmatory</td> </tr> <tr> <td>M – Marginal</td> <td>DI – Definitive identification</td> </tr> <tr> <td>U – Unfavorable</td> <td>ID - Identification</td> </tr> </table>									Unk – Unknown	C – Cells	H – High	S – Spores	Med – Medium	T – Toxin	L – Low	PI – Presumptive identification	F – Favorable	FC – Field confirmatory	M – Marginal	DI – Definitive identification	U – Unfavorable	ID - Identification
Unk – Unknown	C – Cells																					
H – High	S – Spores																					
Med – Medium	T – Toxin																					
L – Low	PI – Presumptive identification																					
F – Favorable	FC – Field confirmatory																					
M – Marginal	DI – Definitive identification																					
U – Unfavorable	ID - Identification																					

Figure V-6. Biological-Event-Tracking Tool (Sample)

- (1) Preattack information collection.
  - Current BW risk assessment was assessed as medium based on threat activity.
  - Weather conditions were assessed as marginal within the AO.
  - Reports from the biological-detection unit HQ indicated that background conditions were having no impact on system-level results.
- (2) Attack information collection.
  - Collated and evaluated incoming reports from a JBPDS-equipped BIDS unit that indicated an alert time at 220100L May 03.
  - Follow-up reports indicated a presumptive identification at 220120L May 03, confidence level high.
- (3) Postattack information collection. Lab feedback provided positive field confirmatory results at 220700L May 03.
- (4) Remarks information collection. No unusual outside activity was noted on any of the incoming reports.

## **7. Communications Architecture**

a. The communications architecture uses standard, existing protocols. For example, the NBC Warning-and-Reporting System is used as the basis for forwarding of NBC reports. The standard communication guidelines that are used for command or supporting relationships also apply. For example, supporting biological detection or medical laboratories provide report results to those supported HQ that are designated in OPORDs and/or OPLANs.

b. The communications architecture identified in the controlling HQ OPLAN, OPORD, and/or SOI identifies the key linkages. These communications linkages include a requirement for the exchange of information between the supporting laboratories and the command surgeon or between the biological-surveillance resources and the supporting confirmatory lab (for example, advance notification to the lab that a sample is enroute).

## Appendix A

### MEDICAL COUNTERMEASURES AND PROTECTION

#### 1. Background

Medical countermeasures can include PVNTMED, immunization, diagnosis, prophylaxis, treating mass casualties, and supporting psychological casualties. Medical countermeasures focus on the prevention of BW agent casualties. The unit surgeon provides recommendations to the commander on medical countermeasures that are implemented through applicable directives and OPLANs and/or OPORDs.

#### 2. Medical Countermeasures

a. PVNTMED. Specially trained medical personnel and units assist in maintaining the health of the command with the goal of preventing diseases before they occur. Recent conflicts have demonstrated that PVNTMED practices, such as good field sanitation and hygiene, can significantly reduce natural occurrences of infectious diseases. Many of these principles can be applied as countermeasures against BW agents.

b. Immunization. Making an individual immune is one of the most effective defenses against BW agents. Immunity is produced when an individual is vaccinated with a vaccine or toxoid. Vaccine lead time will have a major impact on operations, particularly during the critical phase of deployment. Time impacts must be considered in force projection and requirements for early intelligence assessment and predeployment planning.

c. Epidemiological Analysis.

(1) Any unusual occurrence of simultaneous cases of illness with similar presenting symptoms, especially in regions with a higher likelihood of biological attack, should prompt the medical staff to consider biological agents as a cause. Epidemiological analysis can only be effective if the system responds quickly and decisively to medical trends. Although it may be too late for medical countermeasures to help individuals who already show symptoms, the trend can alert the medical system to initiate protective measures such as vaccines or antibiotics for those who are exposed but not yet sick.

(2) With a covert biological agent attack, the most likely first indicator of an event would be an increased number of patients who present clinical features caused by the disseminated disease agent. Therefore, health care providers must use epidemiology to detect and respond rapidly to a biological agent attack.

(3) A sound epidemiologic investigation of a disease outbreak, whether natural or human engineered, will assist medical personnel to identify the pathogen and institute the appropriate medical interventions. Documenting the affected population, possible routes of exposure, and signs and symptoms of disease—along with rapid lab identification of the causative agents—will greatly increase the ability to institute an appropriate medical and public health response. Good epidemiologic information can guide the appropriate follow-up of those potentially exposed, as well as assist in risk communication and responses to the media.

(4) Many diseases caused by weaponized biological agents present nonspecific clinical features that could be difficult to diagnose and recognize as a biological attack. The disease pattern that develops is an important factor in differentiating between a naturally occurring event and a terrorist or warfare attack. It is important to remember that naturally occurring epidemics can have one or more of these characteristics and a biological attack may have none.

(5) Once a biological attack or any outbreak of disease is suspected, the epidemiologic investigation should begin. Whether the outbreak is intentional or not, the conduct of the investigation will not differ significantly. The first step is to confirm that a disease outbreak has occurred. A case definition should be constructed to determine the number of cases and the attack rate. The case definition allows investigators who are separated geographically to use the same criteria when evaluating the outbreak. The use of objective criteria in the development of a case definition is very important in determining an accurate case number, as additional cases may be found and some cases may be excluded, especially with the potential for mass hysteria to be confused with actual disease. The estimated rate of illness should be compared with rates during previous years to determine if the rate constitutes a deviation from the norm.

d. Prophylaxis and Treatment. Prophylaxis is preventive action taken before infection. Treatment is the care of personnel after they have been exposed to a biological agent. For some BW agents, there is a window of opportunity between infection and the onset of symptoms where medical treatments are particularly effective. Medical treatments that are initiated outside the window of opportunity are less effective. Therefore it is critical to ascertain which agents were used in the attack and when the attack occurred. See *Field Hygiene and Sanitation*.

e. Mass Casualties and Quarantine. Providing medical support for large numbers of biological casualties will strain the medical system. If large numbers of casualties occur, the unit commander will be responsible for some primary care with organic assets and limited medical augmentation. The provision of this care will need to be a coordinated effort. Units attacked with contagious BW agents may have to be quarantined. The US force commander may need to request and obtain additional support to handle mass casualties.

f. Psychological Effects. The use of biological weapons will cause some personnel to seek medical treatment although they have not been infected with a biological agent. Combat stress control and mental health detachments or teams will be needed to provide counseling for these personnel. Trained and disciplined units will be less susceptible to the psychological effects of BW.

### **3. Vaccines**

Currently, the only Food and Drug Administration (FDA) approved vaccines are for the following BW agents: anthrax, Venezuelan equine encephalitis, and smallpox. While vaccination before exposure provides a high level of protection from the specific biological agent, vaccination after exposure can be an effective medical alternative for some agents. The anthrax vaccine is effective if administered according to guidelines and can reduce the impact of an attack with anthrax spores. If all military personnel in the affected area are immunized against anthrax, the effect and impact on medical resources will be reduced.



#### **4. Medical Intervention**

a. When available, vaccinations can reduce the susceptibility of target populations to attacks by specific biological agents. Vaccines for some agents are more effective than for others, though most will reduce the vulnerability of the immunized population.

b. Treatments after a BW attack are available for many agents. Treatments administered after exposure, but before symptoms, are referred to as postexposure prophylaxis or preventive treatment. Vaccinations are available for some agents, but in most cases they must be applied before the onset of symptoms. In most cases, preventive treatments will only be initiated if the attack is detected before the onset of symptoms. This is problematic in a threat environment where covert attacks are possible. Attacks using toxins are more difficult to address because, in general, toxins act more quickly than pathogens, leaving less time for detection, identification, and evaluation before large segments of the population fall ill.

c. A BW attack could quickly overwhelm any local medical system. To be prepared, prestaged equipment and medications and a robust program to train medical personnel and exercise procedures are required. Medical treatment facilities (MTFs) must be prepared to issue medical countermeasures, decontaminate, and treat expected biological casualties. Nonmedical personnel may be required to assist with basic maintenance tasks and quarantine. Additionally, MTFs should anticipate the need for, and incorporate the resources of, the surrounding medical community into their biological detection response plans. MTFs must provide the installation commander with timely and accurate assessments of capabilities and limitations. These assessments must take into account any coordination that may have occurred for local medical support.

d. Even if an attack is detected in time to implement medical countermeasures, organization, infrastructure, and equipment must be in place in advance for the response to be effective. Contingency plans should designate facilities for holding large numbers of casualties (for example, gymnasiums, schools, and churches) while providing care based on triage reports. This may also require planning for vehicles (such as buses and vans) to transport the mass casualties to the designated facilities. Public information countermeasures can also help limit the problem. Additionally, the quarantine of potentially exposed personnel and isolation of patients are required to prevent the spread of disease. The mission impacts of the implementation of the restriction of movement and the transportation of personnel, patients, and supplies need to be considered for movement within, into, and out of the theater.

#### **5. Restriction of Movement**

a. The terms quarantine and isolation are often used in the context of preventing contact between healthy populations and those either infected or suspected of being infected with an infectious disease. Quarantine involves the detention of an individual or group suspected of having been exposed to an infectious disease, until it is deemed that they have escaped infection (usually once the incubation period has lapsed). Isolation is the separation of an infected individual from a healthy population (usually refers to patients in an MTF). During military operations where personnel have contracted or are suspected of having been exposed to an infectious disease, the commander conducts mission assessments to consider quarantine or isolation. Restriction of movement, the

more universal term, is used to prevent contact with or detain persons suspected of having been exposed or are known to have been exposed to an infectious agent.

b. Restriction of movement is a tool for maintaining operational effectiveness in the face of an infectious disease, whether natural or artificial (such as a BW attack). The goal is to control the spread of the disease by restricting contact between healthy groups of personnel and those who have, or are suspected of having, contracted it. Personnel covered by restriction of movement do not necessarily need to be removed from operations. Wherever possible, restriction of movement should be implemented to allow them to continue their mission. It may also be necessary to reduce the risk of transferring an infectious disease back to the home base.

c. If restriction of movement is contemplated at any stage during an operation, coordination should be conducted with assets such as HN forces. This coordination must be with the full knowledge that the impact on operational effectiveness is likely to be significant. The unit surgeon, with assistance from other staff elements (for example, the legal and CA staff), will support the commander in the unit operational assessment. The only stage of an operation when restriction of movement is unlikely to play a significant deleterious role is during the close of an operation when personnel are being returned home. Here, restriction of movement would be aimed not at preserving the fighting integrity of the force, but rather reducing the risk of introducing infectious disease into the CONUS base.

d. Restriction of movement implementation will restrict the ability of the commander to use affected force elements. In practice, the operational impact of disease control measures will need to be balanced against the potential consequences of the spread of an infectious disease. Operational pressures may dictate a policy that accepts the limited spread of an infectious disease because the implementation of restriction of movement would result in the loss of the military objective.

## Appendix B

### FIELD LAB SUPPORT

#### 1. Background

Field lab support includes labs with various capabilities for analyzing clinical and environmental samples that may contain BW agents. Depending on which labs are deployed and available, one or more may be designated to confirm a presumptive identification of a BW agent sample that was analyzed at another site or by another method. This confirmatory identification enhances the COCOM ability to make timely and accurate decisions. Field confirmatory identification may require definitive identification by a CONUS lab.

#### 2. Types of Labs

Analysis of biological threat agents generally requires labs with capabilities different from those possessed by routine hospital or clinical labs. Because of the risk of shutting down an entire hospital lab (and therefore the functionality of the hospital) if the lab becomes contaminated with a BW agent from an environmental source (such as powders), it is inadvisable or even prohibited to take many types of environmental samples into a hospital lab. Clinical specimens containing BW agents do not pose the same degree of risk for contaminating the lab, so processing routine clinical specimens that contain BW agents is acceptable in a hospital lab. Even if associated with or collocated with hospitals, the following labs possess the special capabilities necessary for field confirmatory identification of biological threat agents.

a. Air Force. The biological augmentation team is a flexible, rapidly deployable lab team assigned to the deployed MTF. The biological augmentation team expands theater force health protection (FHP) by introducing the most advanced microbiological testing capabilities available, such as the Joint Biological Agent Identification and Diagnostic System (JBAIDS). The biological augmentation team analytical tools can identify both naturally occurring and induced pathogens in clinical and environmental samples. The biological augmentation team provides a preventive capability through analytical test data to support early warning of pathogen exposures as well as the assessment of the extent and type of microbial contamination in other various substances (food, air, water, or soil).

b. United States Army.

(1) An Army medical laboratory is the specialized lab in a theater AO that provides medical and chemical lab support. The Army medical laboratory provides in-theater field confirmatory identification of NBC threat agents in various samples and specimens. Using sophisticated equipment and methods, the Army medical laboratory has the capability to analyze and identify NBC agents in a variety of specimens or samples such as air, soil, water, animal tissue, vegetation, or food, as well as human blood, sputum, and feces. Direct support from CONUS-based labs aids the Army medical laboratory in identifying NBC agents. Command decisions on the use of protective and/or preventive measures and patient care may be based on the Army medical laboratory

findings. However, further CONUS-based testing must be undertaken for definitive identification of NBC agents and for forensic analysis purposes.

(2) The clinical lab of the combat support hospital (CSH) will have microbiology culture and identification capability when augmented with the microbiology augmentation set (M403). This may be accomplished either by directly augmenting the hospital lab or by augmenting with a medical team (infectious disease). When the JBAIDS instrument is used in the microbiology augmentation set, this lab will have the capability of providing detection and field confirmatory identification testing for BW agents in clinical specimens that are collected for patient diagnosis.

c. United States Navy and United States Marine Corps.

(1) Support ashore.

(a) The Navy environmental preventive medicine unit has the mission to provide specialized consultation, advice, recommendations, and technical support in matters of environmental health. PVNTMED, and occupational safety support to USN and USMC shore activities and units of the operational forces within their designated AOR. This lab is on call to provide technical assistance and field confirmatory analysis for biological and chemical agents. A Navy environmental and preventive medicine unit expands theater FHP by employing the best available advanced microbiological testing capabilities such as JBAIDS.

(b) Forward-deployable preventive medicine units enhance FHP by identifying and evaluating environmental health hazards (including CBR and physical agents), assessing the risk of adverse health outcomes, monitoring the health of deployed forces, advising the operational commander concerning significant risks, and recommending countermeasures and interventions needed to protect the health of the force. A designated forward-deployable preventive medicine unit will deploy to provide short duration, specialized PVNTMED support. The Forward-deployable preventive medicine unit provides technical assistance and field confirmatory analysis for biological and chemical agents.

(2) Support afloat. Medical departments on aircraft carriers (CV); aircraft carriers, nuclear (CVNs); large deck amphibious assault ships (general purpose) (LHA); hospital ships (T-AHs); and command ships are equipped to provide confirmatory testing capability for environmental samples from other ships assigned to a carrier strike group and expeditionary strike group. They can receive, sample, test, report, package, and transport suspected BW samples.

### **3. Confidence Levels of Lab Analysis Results**

There is no set parameter that determines levels of confidence in lab results. Confidence in lab results is based on a combination of the scientific quality and accuracy of the test methodology, the number and type of biomarkers detected, the technical expertise of the testing personnel, and the environmental conditions in which the lab is operating.

a. Biomarker. A biomarker refers to the characteristics of a biological agent (microorganism or toxin) that are specific or unique to that agent. Some biomarkers are more useful or accurate in identifying the biological agent than others. Likewise, some

types of scientific devices and/or methodologies are more sensitive and accurate in detecting certain types of biomarkers.

(1) The types of biomarkers include specific—

- Nucleic acid sequences unique to the bacteria or viruses identified by a technique such as polymerase chain reaction.
- Antigens associated with the bacteria, viruses, or toxins identified by techniques such as enzyme-linked immunosorbent assay, electrochemiluminescence assay, or handheld immunological assay.
- Enzymatic or growth properties as demonstrated on biochemical tests or selective media, such as characteristic colony morphology on culture and phage inhibition.
- Microscopic characteristics, such as those identified using Gram stain, fluorescent antibody stain, immunohistochemical stain, or cytopathic effects.

(2) Confirmatory and definitive testing requires positive results of two or more independent biomarkers. Independent biomarkers are significantly different from each other biologically, such as with uniquely different gene sequences or antigens. Different methodologies test for biomarkers in technologically different manners, such as polymerase chain reaction versus electrochemiluminescence, or handheld assay versus polymerase chain reaction. Analyzing a sample twice using handheld assays is only employing one methodology. However, the level of confidence is increased if a particular methodology is employed to test for two different biomarkers (for example, polymerase chain reaction testing for two or more gene sequences).

b. Sensitivity. The sensitivity of a test is its ability to detect the presence of a biological agent. This is the proportion of samples with positive test results out of all samples that truly contain the biological agent (regardless of whether the biological agent is detected or not).

(1) Sensitivity is the percentage of true positives divided by the total of true positive and false negative results. The more false negatives a test allows, the less sensitive it is.

(2) A false negative test result is negative although the biological agent is actually present. It may occur because of a concentration of a biological agent below the detection level of the test methodology and/or instrument, binders or inhibitors that may be present in the sample, temperature deviations from the test protocol, bad reagents, and/or equipment malfunctions.

c. Specificity. The specificity of a test is its ability to correctly indicate that a biological agent is not present in the sample when, in fact, the sample is devoid of that agent. Specificity is the proportion of samples with true negative test results divided by the total of true negative and false positive results. The more false-positives a test allows, the less specific it is. A false positive test result is one that indicates that a biological agent is present when that agent is actually not present. Common causes for false positive results are cross-reactions with various substances in the sample or reagents.

#### d. Predictive Value of Test Results.

(1) Screening tests are often designed to be very sensitive so that they do not miss a true biological agent (detecting all true positives and a few false positives). However, an increase of false positives results in decreased specificity, so a positive screening test is only a presumptive positive.

(2) The positive predictive value of a positive test result from a single screening test is the ability of the test to correctly predict the actual presence of a biological agent. Prevalence of infection is very useful when evaluating a stable population or infection rates for epidemiologic studies. However, prevalence is very difficult to accurately assess when the likelihood of the biological agent being present is extremely low (such as in BW scenarios). Repeating a positive screening test does not add clarity or accuracy. Tests may react positively or negatively from one sample to another when the concentration of the biological agent is near the threshold limits of detection for the test methodology.

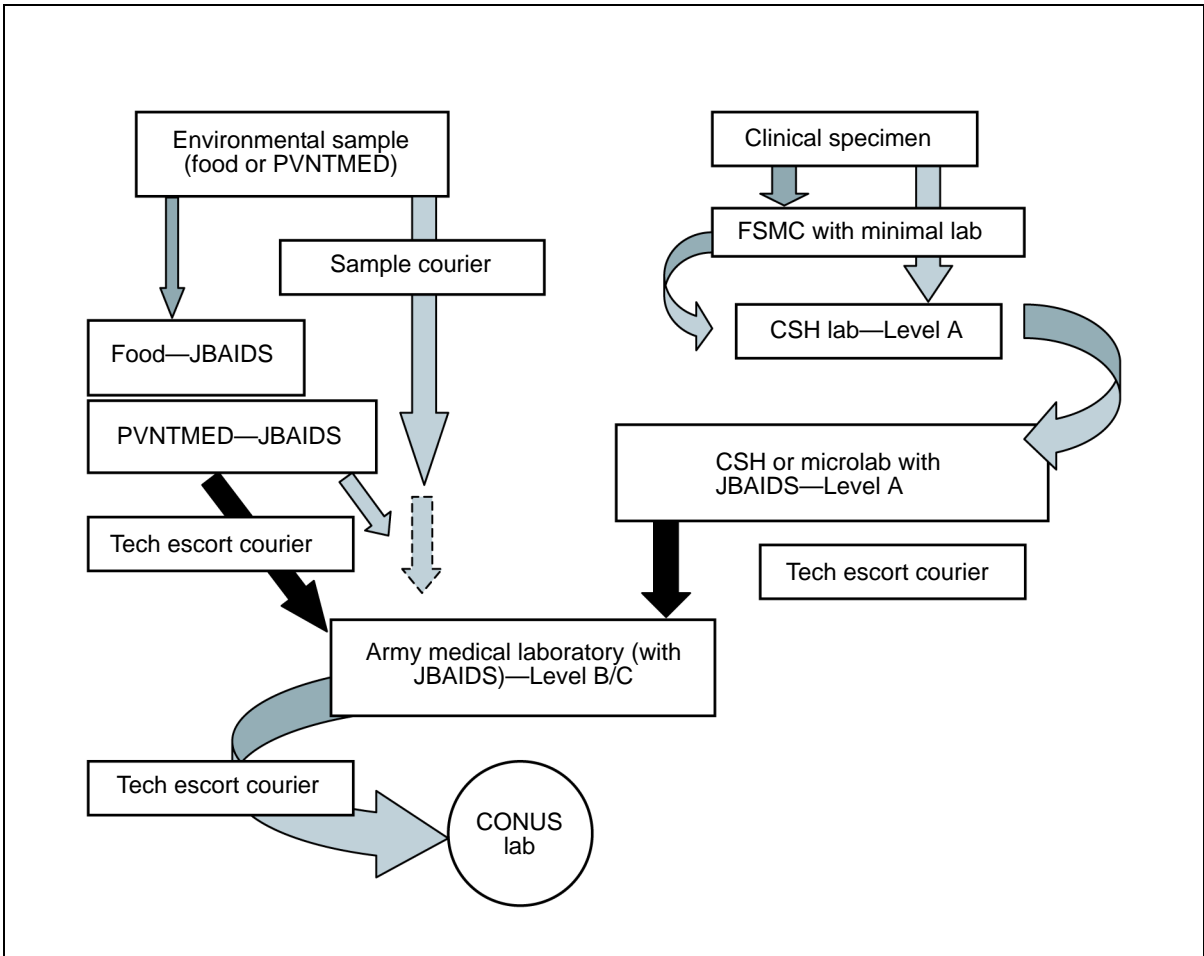
(3) The challenges of predictive values and specificity associated with screening tests are largely alleviated by confirmatory tests. Confirmatory tests have been designed to be highly specific in identifying biological agents. However, this design may result in an increase of false negative results, thus leading to decreased sensitivity, so it would not be ideal as a screening test. To increase the accuracy and specificity of confirmatory tests, testing is conducted for more than one biomarker, by the same or different methodologies.

#### **4. Employment of Labs**

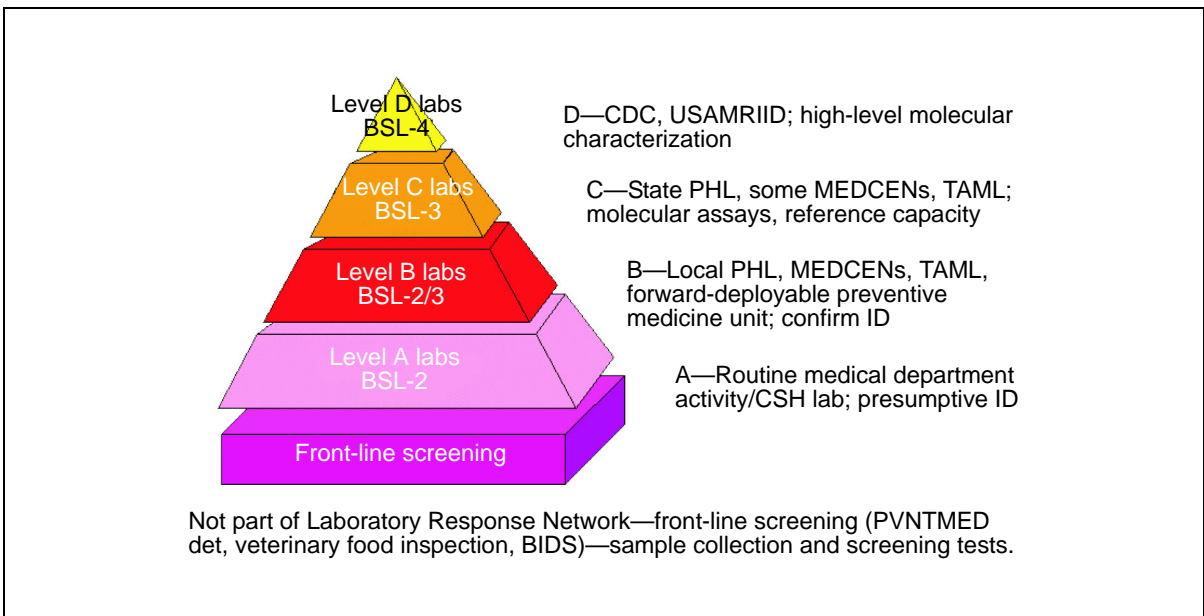
The determination of which labs are deployed depends on the anticipated nature of samples to be processed. The following illustration indicates the possible employment of labs to perform presumptive and confirmatory testing. Labs employing JBAIDS (see *Figure B-1*) are employing field confirmatory testing. However, positive results are checked by the Army medical laboratory or other designated higher-level confirmatory lab. The JBAIDS helps to serve as a quality screening system to reduce the workload on the Army medical laboratory (or other designated confirmatory lab).

#### **5. Laboratory Response Network for Biological Terrorism**

The Laboratory Response Network is a multilevel system (see *Figure B-2*) in CONUS that is designed to link front-line hospital and state public health microbiology labs with federal and military reference labs supporting advanced capabilities in testing human, veterinary, food, and environmental samples. Labs participating in the Laboratory Response Network employ common SOPs and reagents to process and identify potential BW threat agents. Upon obtaining a presumptive identification, lower-level labs (Level A) send the samples and/or microorganisms to higher-level labs (Level C) for confirmatory identification. Upon confirmation of the identification at Levels B/C labs, other appropriate labs are employed for forensic testing.



**Figure B-1. Field Confirmatory Testing**



**Figure B-2. Laboratory Response Network Structure**

## Appendix C

### BIOLOGICAL-COLLECTION AND -DETECTION CAPABILITIES AND LIMITATIONS

#### 1. Background

biological-point detection and -collection capabilities provide commanders with critical SA information. This appendix provides information on detector and sampling capabilities.

#### 2. Joint Portal Shield

a. The Joint Portal Shield network provides a capability to alert, collect, identify, and warn commanders and the site populace of biological attacks. Upon detection, the system provides automatic warning to active and passive command post (CP) computers.

b. The Joint Portal Shield network is typically a suite of 10 to 24 detectors with hardwired electricity and communications with radio frequency (RF) backup. The Joint Portal Shield consists of a particle counter (aerodynamic particle sizer) and cyclone sampler. The suite of components includes the following:

- Global positioning system (GPS) and weather station.
- Central processing unit (CPU) and radio modem data management. The CPU controls the hardware associated with the system and compiles and stores historical data from the detector.
- Automated warning and reporting and downwind hazard prediction. The The Joint Portal Shield network is capable of providing an automated warning of a biological-agent release directly to a computer in the OPCEN.
- Environmental control unit (ECU). An ECU keeps the components, to include the internal computer, cool.
- Computer control component. The computer is a standard, commercial off-the-shelf (COTS) high-speed personal computer (PC) with a dedicated monitor and printer. The computer contains Joint Portal Shield network-unique software that will generate system status and alarm data (visual and audible) on the PC. The system software is also ATP-45 compatible and can automatically prepare properly formatted NBC reports.

(1) The number of sensors employed at each site will depend largely on the size of the installation and the shape of its perimeter. The sensors will be positioned at stationary, presurveyed locations around an AB or seaport perimeter. The Joint Portal Shield network allows the operator to configure the network by selectively activating those sensors that are appropriate for the current BW threat. Additionally, individual sensors, designated by the operator to be part of the network, can be further programmed to operate in either an unarmed or armed mode. Unarmed sensors only monitor the atmosphere for a rise in the particle count. If an airborne particle rise is detected, the sensor will not collect a wet sample. Unarmed sensors will not collect wet



samples and will not inject a portion of the wet sample for testing. Armed sensors perform surveillance and wet sample collection functions and, when conditions warrant, they will accept a command from the computer to inject and test the wet sample.

(2) Tailoring the network is highly suited for accommodating changes in the threat between operations during daylight and periods of darkness. Since BW attacks are less likely to occur during daylight hours, the network may be configured to include most upwind sensors—half of them armed with the remaining half unarmed—and some downwind sensors, most in the unarmed mode. Because BW attacks are more likely during hours of darkness, the number of active and armed sensors on the upwind and downwind sides of the perimeter should be increased. The ability to tailor the net and operating status of each sensor extends component life, minimizes operator maintenance requirements, and reduces the consumption of expendable materials.

(3) Three network operating logic modes are available. They are the smart, random, and manual modes. The computer logic that dictates sensor activity in the smart and random modes is related to meteorological conditions and is intended for use during high and low threat periods, respectively. The network logic should be set to the smart mode when wind conditions are favorable for a BW attack. When in the smart mode, all sensors that are designated as part of the network should be armed. The random mode is desirable for periods when the wind speed is unfavorable or marginal for a BW attack. In the manual mode, the operator initiates the sampling sequence. Because of the reduced threat of a BW attack, some active sensors may be unarmed.

c. The Joint Portal Shield network is capable of monitoring the local atmosphere and testing samples for the presence of eight different biological agents simultaneously. The eight agents that the system is set to monitor and test for are selected from a larger menu of possible agents (the list of specific agents that can be detected is classified). The selection of specific biological agents for monitoring is a command decision and will be based on AOR threat information that is provided to the installation commander by the medical and operational intelligence communities.

d. The Joint Portal Shield network accomplishes biological detection by injecting a small amount of a wet sample that is suspected of containing a BW agent onto its immunoassay optical ticket reader. The sensor contains immunoassay tickets that react to BW agents. The Joint Portal Shield network sensors also incorporates a computer and a built-in communications capability. All active sensors continuously report their status and activities to the CP computer. The computer continuously analyzes all reported data received from the sensors. Once the system has advanced to the network activation stage, the computer will direct all triggered sensors to initiate wet sample testing for the presence of BW agents. The Joint Portal Shield network alerting, sampling, identifying, and reporting process parallels the process used by the BIDS (see *Appendix D*).

### **3. Biological Integrated Detection System**

a. The BIDS provides the capability to alert, detect, collect, and identify BW agents. It is a biological-detection asset designed for defense against a long line source BW attack. BIDS units are operational level-of-war assets. The unit is optimally deployed as a company-sized asset; however, platoon-sized deployments (with supporting CSS, including CLS) can be planned and executed. BIDS units can be placed throughout the AO to create a wide-area sensor array or network. Any presumptive identification is reported directly to the operational-level commander. The operational-level commander

and staff then determine if a BW attack has taken place (as opposed to the single system alert being due to local fluctuations—a false positive). If the determination is that an attack has occurred, then appropriate warning and postattack actions are executed. The BIDS functions are described in *Appendix I*.

b. The BIDS consists of a shelter (S-788 lightweight multipurpose shelter) mounted on a dedicated vehicle (high mobility multipurpose wheeled vehicle [HMMWV]). It is equipped with a biological-detection suite employing complementary technologies to detect large-area biological attacks.

(1) The system is capable of generating its own electrical power. To ensure uninterrupted operation for at least 3 days, the complete BIDS system also includes a second HMMWV that is used as a support vehicle (to carry spares and repair parts and to courier suspect samples to a collection point). It also carries two of the BIDS four-man crew.

(2) While each individual BIDS system is robust in itself, the fact that so few systems are used to monitor large areas means that localized, point BW attacks may go undetected. Several BIDS can be employed at a single high-priority site to provide coverage of that site. There are currently three versions of BIDS in the USA inventory: the M31, M31A1, and M31A2.

c. See *Appendix I* for a description of system capabilities and operations. The BIDS detection process includes monitoring, alerting, sampling, collecting, identifying, and reporting (see *Table C-1*).

**Table C-1. BIDS Comparison**

	<b>Monitoring</b>	<b>Alerting</b>	<b>Sampling</b>	<b>Identifying</b>	<b>Reporting</b>
<b>M31A2</b>	Determines if an increase in the number of particles within a certain size range occurs.	Determines if aerosol particles contain biological material. Detection is based on single component, rather than multiple components as in the M31/M31A1.	The sample collector is automatically activated.	Determines the presumptive identification of up to ten preselected BW agents.	The time range for reporting presumptive identification is 18 minutes. Data recording and display and formatting to a NBC report is automated.
<b>M31A1</b>	Determines whether biological mass is present within aerosol particles of a certain size range.	Determines with greater sensitivity than the M31 if aerosol particles contain biological material—cells, spores, or toxins.	The biological and liquid sampler is automatically activated.	Determines the presumptive identification of up to eight preselected BW agents.	The time range for reporting presumptive identification is 18-25 minutes. The recording and display of data is automated.
<b>M31</b>	Determines if an increase in the number of particles within a certain size range occurs.	Determines if aerosol particles contain biological material—cells, spores.	The biological and liquid sampler is manually activated.	Determines the presumptive identification of four to eight BW agents.	The time range of reporting presumptive identification is 30-40 minutes. The recording of data is manual.

#### **4. Joint Biological Point Detection System, Fixed-Site or Trailer-Mounted Version**

The trailer-mounted JBPDS provides an alert, collection, and identification capability. A designated prime mover tows the two-wheeled trailer. It can be transported by the landing craft air cushion (LCAC). The trailer has the following components mounted on its platform: basic biological suite unit, ECU, 2-kilowatt tactical quiet generator, two 20-liter diesel fuel cans, stowage boxes, and a ladder. Power is supplied to the system by the generator. Public utility power can also be used to supply power to the system. The trailer-mounted JBPDS is essentially a man-portable JBPDS that has been modified for trailer mounting. The trailer-mounted JBPDS is mounted on a modified M116A3 trailer chassis. The fully integrated system consists of the JBPDS, shock isolators, government-furnished equipment [GFE] components, cabling, and integration hardware mounted on an M116A3 chassis.

#### **5. Long-Range Biological Standoff Detection System**

a. LRBSDS capabilities include being able to discriminate between man-made and naturally occurring clouds in the atmosphere. See *Appendix H*.

b. Just as many military systems employ the concept of defense-in-depth, biological detection can be viewed as providing detection at different physical and operational levels. In this context, the LRBSDS performs at the outer edge of the detection environment, providing perhaps the earliest detection of a possible biological attack. As an operational-level asset, the LRBSDS is flown as close to the forward line of own troops (FLOT) as is safe and practical—the system is designed to be flown in a utility helicopter; specifically, the UH-60. The long range of the system (30 kilometers or more) allows detection of long line source attacks before the suspected agent has reached and affected US forces, preventing what could be a substantial negation of US military capability.

c. The LRBSDS only warns that it has detected a man-made aerosol cloud; it cannot determine if that cloud contains biological material. Other systems, such as the BIDS, will be required to actually determine that there is an agent present once the cloud reaches US forces.

#### **6. Maritime Biological Agent Detection Capabilities**

a. The shipboard JBPDS provides a capability to alert, collect, and identify biological agents to support maritime operations. The first two components of the JBPDS continuously monitor the air for a significant rise in particulate concentrations and/or biological mass. If a significant rise over the background is detected, the instruments will automatically collect an aerosol sample and alert the ship damage control center (DCC) of the need to collect the sample and screen it using a handheld assay for a possible presumptive identification. Positive presumptive identification results from the IBADS and/or JBPDS providing a high-confidence result.

b. The maritime JBPDS detects and identifies BW agents. It contains or connects to navigation, meteorological, and communications equipment that is used to identify the location and sense the conditions under which the agent was detected. The maritime JBPDS has the ability to detect and identify up to ten BW agents (for example, bacteria,

rickettsia, viruses, and toxins) during a mission. BW agent identification is limited only by the available agent reactive assay strips housed within the identifier. It provides the ability to collect and save BW agent samples for later lab analysis. The JBPDS consists of the basic biological suite unit and a power pack.

c. The maritime JBPDS provides the capability to monitor the ambient air for the presence of BW agents. It is employed to provide presumptive identification support to the commander and alerting, collecting, identifying, and reporting capabilities.

## 7. Dry Filter Unit

a. The dry filter unit 2000 provides the commander with a capability for biological sampling. This system, complemented by handheld assays, provides the command with a manual presumptive identification capability for the analysis of the samples. See *Table C-2*.

**Table C-2. Dry Filter Unit 2000 Functions**

	<b>Collecting</b>	<b>Identifying</b>	<b>Reporting</b>
Dry Filter Unit 2000	Collects a sample at a prescribed interval.	Determines the presumptive identification based on a manual handheld assay.	The time range for the reporting of presumptive identification is 18-20 minutes following collection of the sample.
<b>NOTE: The dry filter unit has no trigger.</b>			

b. The dry filter unit 2000 consists of a dry filter unit 1000 air sampler, outer shelter, and preseparator. The system uses commercial power but comes equipped with a generator that has automatic-start capability to change power sources in case of a commercial power failure.

- c. The capabilities of the dry filter unit 2000 include—
- biological-air sampling.
  - Collection and concentration of biological-particulate matter from the air.
  - A collection time of 1 to 8 hours.
  - Presumptive identification of BW agents. The filter is placed into the buffer solution, shaken to extract particles, and analyzed using a handheld assay.
  - Simple operation and maintenance.
  - Contained within a shelter for use in harsh exterior climates.
  - Exclusion of large particles and rain from the filters (via preseparator).

d. The dry filter unit 2000 collects particles from the ambient air for analysis. It is a continuous sampler that collects and traps airborne particles onto a filter for later extraction and analysis. Testing may be performed through antibody-antigen analysis, such as with handheld assays. The dry filter unit 2000 requires minimal training and maintenance. Operations are simple and require very little time. When deployed with handheld assays and dry filter unit consumable kits, the dry filter unit 2000 becomes both a biological-sampling and a presumptive identification system.

e. The dry filter unit sampling and identification process (capabilities) consists of collecting, identifying, reporting, and packaging the sample. See *Table C-3* for process information.

**Table C-3. Dry Filter Unit 2000 Biological-Detection Process**

<b>Mission Essential Task</b>	<b>Product(s)</b>
Collecting	Physical sample for analysis
Identifying	Presumptive identification
Reporting	Incident report
Evacuating	Confirmatory identification

(1) **Collecting.** The decision to conduct dry filter unit 2000 sampling operations is made by the commander with input from his NBC, intelligence, medical, and FP staff.

(2) **Identifying.** Manual presumptive identification, using handheld assays and samples collected by the dry filter unit 2000, is conducted at intervals established by the commander or his designated representative (for example, the FP officer).

(3) **Reporting.** The dry filter unit 2000 provides information based on the results from the handheld-assay testing. The dry filter unit 2000 is deployed within an installation. Communications linkages between the operators conducting the handheld-assay testing and the installation OPCEN allow critical BW agent identification information to support the commander’s SA.

(4) **Evacuating.** Following presumptive identification, the installation provides a FRAGORD, when applicable, for sample evacuation. This FRAGORD directs when to evacuate the collected sample or samples, the sample transfer point location, specific identification of the receiving courier team, and a not later than (NLT) time to link up with the escort team at the sample transfer point.

## **8. Department of Defense Biological Sampling Kit**

a. The DOD biological sampling kit capability provides a presumptive identification capability for areas suspected of being contaminated with BW agents. The kits include all the necessary components to acquire a sample and provide presumptive identification. The basic functions of the kit include collecting, identifying, and reporting.

b. The DOD biological sampling kit is a single-use package containing the handheld-assay sampling panel and all the supporting supplies to collect and process suspect samples. Each kit holds up to eight handheld assays, phosphate-buffered saline solution in a dropper bottle, two sterile cotton-tipped swabs, directions for use, and a blue-capped 50-milliliter conical tube.

c. The DOD biological sampling kit provides a capability to test areas suspected of being contaminated with BW agents on a surface that is conducive to testing. The handheld assays are designed to identify a limited list of biological agents from relatively clean, nonporous surfaces. The handheld assay is not designed for soil, skin, wood, food, or water sampling and is not for diagnostic use.

- d. The DOD biological sampling kit and its associated handheld assays are employed for—
- Field-screening suspect munitions.
  - Munitions fragments.
  - Suspicious liquids.
  - Powders (or suspensions).
  - Terrorist labs or weapons materials that might be associated with the manufacture or delivery of BW agents.
  - Reconnaissance of indoor or outdoor surfaces where it is suspected that BW agents were released in fairly high concentrations.
- e. The DOD biological sampling kit sampling and identification process consists of—
- **Sampling.** The decision to conduct sampling is made by the commander with input from the NBC, intelligence, and medical staffs and NBC reconnaissance or explosive ordnance disposal (EOD) teams.
  - **Identifying.** The sampling team conducts manual presumptive identification on completion of the sampling.
  - **Reporting.** The results of the presumptive identification process are reported by the sampling team to the controlling OPCEN (for example, the NBC control center).
  - **Packaging.** The sampling team ensures that sample are packaged according to *Appendix G*.
  - **Evacuating.** Following a presumptive identification, the installation provides a FRAGORD, when applicable, for sample evacuation. The FRAGORD directs when and where to evacuate the sample.

## 9. Common Limitation

a. Each of the systems and the kit described in this appendix use immunoassay technology to presumptively identify BW agents. This technology has limitations. Handheld assays are not designed to be the sole method of identification, but are part of a layered defense capability using follow-on lab assets to perform definitive or confirmatory identification of the agent. Handheld-assay limitations include the following.

(1) Handheld assays should not be used where there might be extremely high concentrations of the agents. Clogging may occur during the assay and lead to an inconclusive result.

(2) Handheld assays should not be removed from their foil packaging until just prior to the assay. Additionally, do not use the handheld assay if the packaging has been breached prior to testing. The handheld-assay membrane can absorb humidity from the air and lead to an inconclusive test result.

(3) BW-aerosol concentrations might be below detectable limits for the handheld assay, yet be above the infectious dosage. This could lead to false negative

results. Due to the limitations of the handheld assay, additional testing is always necessary to assess an area as free of contamination from that BW agent.

b. The handheld assay allows for presumptive identification only. Like all assays, the handheld assay has a threshold of sensitivity—if the amount of the agent present is below this concentration, the handheld assay will not detect it. Although the handheld assay is sensitive, the infective dose for most pathogens is far lower than the sensitivity of the handheld assay. Use of the handheld assays leads to presumptive identification only (whether negative or positive) and must be confirmed by additional testing at a lab using multiple microbiological methodologies.

## Appendix D

### BIOLOGICAL-DETECTION CONTRACTED LOGISTICS SUPPORT

#### 1. Background

Biological-detection assets use standard military support for supply and maintenance; however, biological-detection assets often require the use of CLS as an integrated element of their support and deployment package. Validated OPLANs and/or OPORDs outlining the biological-detection logistics support concept and CLS must be integrated into contingency planning. Logistics support planning must address CLS considerations during mobilization, employment, and deployment. Planning also addresses the contingency that multiple mission requirements will split biological-detection operations into different theaters of operation, increasing risk and degrading CLS support (the dilution of limited CLS assets).

#### 2. Principles

The use of CLS for military operations is governed by principles that emphasize ensuring that a plan is executable from both an operational and a logistics perspective. The following principles provide a framework for the use of CLS.

a. **Risk Assessment.** Commanders must assess risk, evaluate factors (such as the impact of the threat on contractor safety), and determine where CLS can safely operate. The risk assessment identifies the survival training and equipment (for example, IPE) that CLS will require during the assigned mission.

b. **Force Structure Augmentation.** CLS is an integral support requirement for many biological-detection assets. CLS provides a force structure augmentation for biological-detection units that may not be part of military core capabilities (for example, a military unit may not be available to perform the required maintenance on biological-detection suite components).

c. **Mission, Enemy, Terrain and Weather, Time, Troops Available, and Civilian.** METT-TC considerations help commanders and staff planners evaluate when and where to use CLS. For example, the commander must consider the time required for CLS to repair a component using a centrally located facility versus forward-deployed maintenance contact teams. Additionally, commanders must consider other factors such as the threat to operations involving low-density, highly skilled CLS technicians.

d. **Integrated Planning.** CLS leaders must participate in the logistics planning process. CLS representatives must be present at planning sessions on the receipt of alert directives or an OPLAN and/or OPORD. CLS representatives can provide useful input on the logistics feasibility of COAs and the preparation of the administrative and/or logistics annex to the OPLAN and/or OPORD.

e. **Customer Support.** Links between the biological-detection unit and CLS must not place additional burdens or requirements on the supported unit. CLS can use whatever internal systems or procedures they choose; however, they must use the military systems and procedures when interfacing with the military.



f. International Agreements. International agreements and HN laws that apply to the AO directly affect the use of CLS. Use of CLS may incur legal obligations to the HN such as customs, taxes, vehicle registration and licensing, communications, support, passports or restrictions, and inter- or intra-country travel. These agreements must be considered when preparing contracts and OPLANs and/or OPORDs.

g. Habitual Relationships. A habitual relationship is a long-term relationship between CLS and the biological-detection asset. The nature of this relationship is established through the terms and conditions of a contract and extends beyond that of the organization to include the individual contractor, employee, and supported unit.

### **3. Contracted Logistics Support Planning Considerations**

Planning for CLS support is integral to any operation. Planning for an operation involves several critical decisions concerning the integration of CLS capabilities. Key CLS planning considerations are addressed in the following paragraphs.

a. Responsibilities. Unit planning responsibilities ensure that the right resources are deployed to support a mission.

b. Operation Plan. The CSS sections of applicable OPLANs address the use and employment of CLS. The level of detail in the OPLAN will vary depending on the level of command.

c. Risk Assessment. Risk assessment evaluates the ability of CLS to support missions during the transition from peace to conflict. As mission requirements increase, CLS must still respond with the same required support.

d. Responsiveness of Support. The nature of the operational environment (for example, operations in multiple AOs and theaters of operation) may require the ability of CLS to support deployed assets; however, uninterrupted sustainment support is still required. CLS must be prepared to task-organize its assets to meet unanticipated requirements.

e. Transition From Peace to War. The risk of using CLS during peacetime is normally low, increasing as operations transition from peace to war. The supported force must protect CLS personnel in hostile areas, and the CLS contractor and his employees must be trained and ready to operate and survive in an NBC environment.

f. Communication Requirements. The CLS contract describes the scope of CLS support. The contractor is not legally obligated to meet any requirement not in the contract. Without a requirement specified in the contract, the government has no basis for directing or requiring any contractor action. All requirements for CLS are communicated to the contractor through the contract.

g. Coordination Requirements.

(1) The supporting COCOM, the gaining COCOM, the biological-detection unit, and CLS plan in coordination. CLS planning and coordination must address the responsibility of the chain of command to feed, house, and protect contractor employees operating on the battlefield. It must also include predeployment training and integrated, time-phased force deployment planning.

(2) Within the scope of the existing contract, the major command contracting office should appoint a task monitor. The appointed task monitor must be familiar with

CLS operations. Additionally, a CLS appointment letter will outline the task monitor's responsibilities. See *paragraph 5* for information on task monitor responsibilities. The task monitor must also be familiar with biological-detection operations.

(3) CLS must be attached to a military support element for functions such as life support and personnel accountability. For example, the United States Army Materiel Command logistics support element (LSE) would coordinate day-to-day life support services for the CLS team; however, the LSE may not be within the AOR initially. In the absence of the LSE, a designated unit such as a biological-detection company or a C2 HQ element will coordinate the required life-support efforts for CLS personnel. A HN, another service, or another Army unit could also furnish the actual life-support services. Effective coordination and deployment planning ensures that deploying CLS teams receive notification of deployment (concurrent with notification of biological-detection assets) to allow CLS time to prepare for movement.

#### **4. Employment**

Employment considerations include—

- Obtaining information on the safety zone requirements. The safety zone is an FP control measure for CLS operations. The boundaries are determined by the COCOM, based on threat and mission considerations.
- Locating CLS near the biological-detection assets C2 element.
- Informing the gaining command of CLS facility requirements and conducting coordination to ensure that required assets are furnished.
- Locating CLS near main supply routes (MSRs), airfields, or ports of debarkation (PODs) (air or sea) to facilitate the movement of supplies and equipment.
- Recognizing the requirement for permits or authorizations to move CLS teams across international borders.

#### **5. Responsibilities**

Managing and maintaining visibility over CLS requires the involvement of commanders and their staffs at all levels. In planning and execution, responsibilities for the integration of CLS range from the strategic to tactical level. It is necessary to ensure that CLS is integrated into the decision-making process.

a. Supporting COCOM (Force Provider). The supporting combatant commander's responsibilities may include—

- Providing the contracting officer for the CLS support effort.
- Validating force requirements to support an OPLAN (ensure that OPLANS address CLS requirements).
- Preparing forces for commitment in support of OPLAN execution.
- Coordinating movement with and deploying forces as scheduled by US Transportation Command (USTRANSCOM).

- Coordinating deployment changes with the supported COCOM and USTRANSCOM.
- Coordinating and supporting deployment requirements for biological-detection and CLS assets.
- Notifying the CLS contracting officer at the area contracting center on deployment notification.
- Designating installations (for example, Fort Benning, Georgia) as mobilization stations for the execution of the mobilization mission (receiving, processing, training, equipping, validating, and deploying CLS personnel).

b. Installation. Installation responsibilities can include supporting deployment operations or supporting other personnel, medical, or logistics issues.

(1) For deployment, installations such as Fort Benning, Georgia, or Fort Polk, Louisiana, may be designated as mobilization stations and aerial ports of embarkation (APOEs). The primary responsibilities of the mobilization stations are to receive, house, command, support, share assets, train, validate, and deploy biological-detection units and CLS.

(2) Support from the installation can range from personnel, to medical, to logistics issues. For example, the installation transportation officer may provide guidance and help units prepare, maintain, and execute movement plans. They also coordinate and monitor unit movement, provide assistance to units within or traversing the installation support area, and coordinate commercial transportation support. They prepare movement reports, process convoy clearances and special hauling permits, and approve unit movement plans and associated data. Installation staffs should also be responsible for physically processing military units and supporting biological-detection CLS elements for deployment according to their readiness SOP. This support includes conducting military and civilian readiness processing verification. This process can include medical and dental processing, chemical defense equipment issue, and organizational clothing and individual equipment issue.

c. Continental United States Replacement Center.

(1) The CONUS Replacement Center (CRC) responsibility includes receiving, processing, training, equipping, validating, deploying reserve soldiers and contract civilians, and providing theater-specific equipment. The CRC coordinates equipping, transporting, training, validating, and staging personnel for movement to a TO. The CRC can also become a CONUS demobilization center upon redeployment. It receives, out-processes, and accounts for individuals returning from the theater, to include soldiers and civilians. Further, a military installation staff (supporting the CRC) will physically process the military and civilian personnel. This includes functions such as administration, soldier and civilian readiness processing, billeting, communications, medical and dental support, organizational clothing and individual equipment issue, and training.

(2) CRCs have responsibility for the following critical tasks:

- Certifying military personnel and/or civilian contractor readiness-processing qualifications.

- Coordinating installation-processing requirements, when needed.
- Coordinating the equipping of military personnel, government civilians, and contract civilians.
- Coordinating theater-specific briefings and training requirements.
- Coordinating movement around the installation and to the port of embarkation (POE).
- Creating and providing manifests.
- Coordinating out-processing procedures with the installation.

d. Gaining Combatant Command Responsibilities. The supported geographic COCOM accomplishes key tasks that include—

- Preparing operational plans that address CLS requirements. The OPLAN has the time-phased force and deployment data (TPFDD), non-unit-related cargo and personnel data, and movement data for the OPLAN. The TPFDD includes integrated information for both the biological-detection and CLS assets.
- Providing facilities to support CLS requirements.
- Requesting CLS capabilities and approving TPFDD requirements for the biological-detection unit and their supporting CLS assets.
- Ensuring the reception, staging, onward movement, and integration (RSOI) of CLS assets.

e. Service Component Commander. COCOMs may be forward-stationed or CONUS-based. The service component develops the TPFDD and ensures that the supporting plans are consistent with the unified commander's OPLAN. The service component is responsible for the following:

- Developing supporting plans for OPLANs.
- Training and preparing assigned forces for deployment.
- Maintaining accurate unit movement data (UMD) for its assigned units.
- Prescribing procedures, requirements, and responsibilities for deployment planning and execution.
- Coordinating deployment activities as scheduled by USTRANSCOM.
- Planning and preparing to receive and support forces if deployed to its AOs.

f. Senior Theater Logistics Command. The senior theater logistics command is responsible for synchronizing logistics and support operations, and for integrating CLS into the overall support structure. The senior logistics command in the AOR assumes responsibility for visibility of the CLS element in the theater, and maintains visibility over who is in the theater, where they are operating, what support functions they are performing, and when they provide support. The functions performed by the logistics command are not related to contract compliance.

g. Biological-Detection Assets. The biological-detection asset responsibilities can include—

- Coordinating FP for CLS assets.
- Employing CLS capabilities.
- Providing integrated unit and CLS movement data for submission to support the TPFDL.
- Coordinating the required life support for CLS during deployments.
- Integrating CLS into readiness processing.
- Offering training, as required.
- Integrating CLS considerations and CLS team leaders into the contingency planning process.

h. United States Transportation Command. The major transporter of CLS equipment and supplies is USTRANSCOM and its transportation component commands—Military Traffic Management Command (MTMC), Military Sealift Command (MSC), and the Air Mobility Command (AMC). USTRANSCOM provides strategic air, land, and sea transportation for biological-detection and CLS resources. USTRANSCOM provides centralized global transportation management to ensure in-transit asset visibility. USTRANSCOM assets support the biological-detection CLS effort through the movement of CLS personnel and equipment, furnishing transportation assets for resupply of consumables and line replacement units, and transporting CLS assets between areas of responsibility, if required.

i. Military Departments. Service departments support the geographic COCOMs and/or JFCs through ensuring administrative and logistics support for COCOM and/or JFC forces.

j. Contracted Logistics Support Responsibilities.

(1) The CLS team provides system support for systems such as BIDS, Joint Portal Shield, JBPDS, and LRBSDS. The CLS project manager supervises CLS team activities and ensures that CLS elements are ready to support biological-detection unit requirements.

(2) The CLS team has the overall responsibility for each aspect of the support activity. These responsibilities include, but are not limited to the following:

- Providing CLS planning for the supported unit.
- Providing CLS load planning data to the supported unit and establishing priorities for work accomplished.
- Reviewing work and supply requests from the supply unit.
- Managing and ensuring that CLS team personnel remain ready for deployment (for example, monitoring training and medical and dental requirements)

k. Contracting Officer's Representative or Task Monitor.

(1) The contracting officer's representative or task monitor is the contracting officer's designated representative who assists in the technical monitoring and

administration of a contract. The contracting officer's representative is the link of the supported unit to the contractor using the contract administration and management process. This task monitor is designated, in writing, to perform the duties and responsibilities delegated by the contracting officer.

(2) The contracting officer's representative, administrative contracting officer's representative, or task monitor gives specific duties and responsibilities that are delegated in writing by the contracting officer. Typically, a contracting officer's representative will be responsible for assisting the contracting officer in the following areas:

- Maintaining liaison and direct communications with both the contractor and the contracting officer.
- Monitoring the contractor's performance, notifying the contracting officer of deficiencies observed during surveillance, and recommending appropriate corrective action.
- Verifying that the contractor has performed the technical and managerial requirements of the contract.
- Performing all necessary inspections.
- Verifying that the contractor has corrected all correctable deficiencies.
- Accepting supplies and services received (for the government).

(3) Although the contracting officer's representatives provide a vital link between the military and the contractor, there are certain limits to their authority. The contracting officer's representative, administrative contracting officer's representative, or task monitor is prohibited from—

- Making any agreement with the contractor requiring the obligation of public funds.
- Making any commitments or changes that affect price, quality, quantity, delivery, or other terms and conditions of the contract.
- Discouraging the contractor from undertaking new work or extending existing work beyond the contract period by words, actions, or a failure to act.
- Authorizing a contractor to obtain property for use under a contract.
- Interfering with the contractor's management prerogative by "supervising" contractor employees or otherwise directing their work efforts.
- Modifying the tour of duty or hours.

(4) The task monitor's responsibilities include—

- Monitoring contract performance and notifying the contracting officer's representative of deficiencies observed during surveillance (making recommendations).
- Receiving feedback from the biological-detection and CLS leaders on sustainment operations.

- Coordinating with the CLS contractor on any changes in contract requirements, if directed by the contracting officer and/or contracting officer's representative.

## **6. Contracted Logistics Support Capabilities and Constraints**

CLS requirements may include biological-detection systems specific maintenance and/or supply support as required by the applicable contract. CLS requirements may also include operating biological-detection equipment.

## **7. Contracted Logistics Support Team Assessment**

It is especially critical that CLS teams are responsive to short-notice deployment requirements. The contracting officer and/or contracting officer's representative may assess the preparedness of CLS to respond.

a. On receipt of notification of a requirement to deploy CLS, negotiation between the CLS contractor and contracting officer results in agreement and/or certification that the contractor will fulfill the requisite contractual requirements.

b. Additionally, the contracting officer's representative receives reports or assessments from task monitors on the CLS team preparation for deployment. The task monitor coordinates with units such as the on-site CLS team, the biological-detection element, and applicable installation-level POCs. Examples of key information that the task monitor may report during deployment processing include—

- Satisfactory completion of readiness processing by CLS personnel, to include required training.
- Results of technical inspections of CLS vehicles.
- The receipt of required organizational clothing and equipment (such as protective masks and overgarments).
- Completed packing of specified line replacement units, consumables, spare parts, and other necessary items.
- Responsiveness of CLS.

## **8. Contracted Logistics Support Control**

Planning for CLS addresses the military responsibility to feed, house, equip, and protect contractor employees operating on the battlefield. It also includes predeployment training and time-phased, force deployment planning. Overall, the CLS planning effort must address the following considerations.

a. Command and Control. When coordinating CLS, the contract addresses the relationship between the CLS team and support of the CLS team as a system contractor to the military. This is a crucial point since commanders cannot order contractors to provide services; they must use the contracting officer's representative to direct work within the scope of the existing contract. Additionally, the government CLS contracting officer can appoint, in writing a military unit commander or his designated representative as a task monitor. The task monitor has the authority to monitor CLS operations. He provides general guidance and furnishes missions and priorities to the

supporting CLS team. The appointed task monitor should be familiar with biological-detection CLS operations.

b. Deployment of Contracted Logistics Support Personnel. The CLS personnel will deploy in support of biological-detection unit operations. These deploying CLS teams require early notification of deployment to allow adequate preparation time for movement to become an integral part of the deployment package.

c. Location on the Battlefield. Site determination of a CLS team requires the consideration of several factors. Some of these include—

- Geographical limits of the contractor safety zone and physical-security requirements. The safety zone is an FP control measure for CLS operations. The boundaries are determined by the COCOM, based on threat and mission considerations.
- The location of CLS teams near the biological-detection asset for responsiveness, access to communications and biological-detection asset logistics information, and daily coordination.
- Facilities that support CLS supply and maintenance requirements (for example, refrigeration support for selected supplies, power sources, and a relatively dust-free environment).
- The location of CLS teams near MSRs or PODs (air or sea) to expedite the receipt or transport of supplies, components, or CLS teams to other locations within or outside the theater.
- Requirements to move CLS teams across international borders and the corresponding requirements for permits and authorizations.

## **9. Contracted Logistics Support Concept**

a. Concept. CLS could range from maintenance and supply operations to providing equipment operators for biological-detection systems.

b. Maintenance Support.

(1) In general, military units are responsible for requesting, maintaining, and turning in standard military issue equipment. This equipment includes items such as generators, gas particulate filter units, vehicles, and radios.

(2) Military biological-detection asset leadership carefully analyzes maintenance requirements with respect to movement and maintenance times for repair versus replacement and evacuation of components. Unit leaders consider actions such as establishing forward fixing points and weigh the travel and repair time for a contact team at a forward fixing site versus the travel and repair times at a centralized location. The biological-detection unit considers maintenance that may include repair by replacement or repair forward.

(a) Repair by replacement. After troubleshooting fails to resolve the problem, the biological-detection unit may request maintenance support. For example, the biological-detection unit can remove the line replacement unit (enclosed in a carrying case) for transport to the maintenance collection point or for a one-for-one, on-site swap with a unit contact team. Alternatively, a military unit support crew could bring the line replacement unit (with carrying case) to the detection site location and replace the line



replacement unit on site. Multiple options are available for the execution of repair by replacement. Additionally, operational-readiness floats may be used when downtime would degrade overall operational readiness to an unacceptable level and/or when repair would exceed a specific time frame. Specific operational-readiness float procedures for the issue and turn-in of components or systems will be outlined in unit SOPs. Repair by replacement is generally the preferred option.

(b) Repair forward. The biological-detection unit, in coordination with supporting CSS and CLS elements, designates forward fixing sites that are within the safe zone and are secure. The forward fixing site is an intermediate point between the biological-detection site and support elements for the repair and/or exchange of systems, components, or consumables. Based on the assessment of repair requirements, a CSS maintenance team may recommend the repair of the component at the CSS main logistics support base.

c. Supply Concept.

(1) Biological-detection teams require common, as well as unique supplies to execute their missions. The unit requisitions unique supply items from the CLS supply team based on standardized, onboard stockage levels and projected consumption rates for current operations. The biological-detection unit in conjunction with the CLS contractor, carefully plans and establishes CLS reorder points based on anticipated supply transit times.

(2) Based on coordination between the CLS team leader and the biological-detection unit, key leadership remains informed of key CLS logistics issues. To ensure responsiveness, CLS prepares supply push packages. Daily coordination also helps identify critical supply items that may require the biological-detection unit to establish controlled supply rates. Alerting rear CLS to critical supply issues allows direct coordination with the vendor for issue resolution.

(3) Resupply can be executed either on a centralized or decentralized basis depending on METT-TC considerations. The biological-detection unit can pick up supplies from a central supply point or supplies could be delivered to biological-detection assets individually. Multiple factors will influence what resupply concept is used. Factors to be considered include the location of the biological-detection element, location of CLS supply points, urgency of a resupply requirement, and transport of supplies across international borders.

d. System Operators. CLS may be required to provide operators for biological-detection systems. The system operators are responsive to the supported unit. Factors that are especially critical to CLS system operations include, but are not limited to, ensuring the—

- Requisite survival training and equipping (based on the risk assessment).
- Uninterrupted continuity of operations.
- Maintenance of operator-training proficiency.

## Appendix E

# BIOLOGICAL-COLLECTION AND -DETECTION SYSTEM EMPLOYMENT

### 1. Background

Biological detectors provide the commander with BW-collecting, sampling, and presumptive identifying capabilities. The detectors provide a sample for presumptive identification and follow-on analysis at higher-level labs. Biological detectors provide SA and information (presumptive identification) that can be used to support detect-to-treat decisions.

### 2. Mission

Biological collectors and detectors are used to provide biological-detecting, collecting, and presumptive identifying capabilities. They add to the commander's total chemical, biological, radiological, or nuclear (CBRN) common operational picture (COP).

### 3. Concept of Operations

The employment of a biological-collection and -detection system is directly impacted by the supported commander's CONOPS. The CONOPS addresses preattack planning along with during attack and postattack operations.

a. **Concept of Operations.** Biological detectors should be used, operated, maintained, and redeployed using a phased operation. The duration and implementation of each of these phases is on order and therefore dependent on METT-TC considerations.

b. **Preattack.** biological-surveillance CONOPS begins with the receipt of the mission and guidance (see *Figure E-1* [page E-2]). METT-TC considerations play a vital role in establishing the CONOPS for biological surveillance. They are used throughout the planning and development of the biological-surveillance plan. The preattack CONOPS includes—

- **Conducting a BW-threat analysis.** The BW-threat analysis is a continual process of compiling and examining all available threat BW information to identify the BW threat. This is done using the IPB process. BW-threat analysis uses the best available information; however there will be gaps in the overall intelligence and medical surveillance SA. The complete picture (for example, did a BW attack occur or not occur) is a composite of information from multiple sources.
- **Conducting a BW-vulnerability analysis.** The BW-vulnerability analysis is a continual process of compiling and examining information on the BW-protective posture of a force or facility. It assesses the BW-defense strengths and weaknesses of a force or facility BW-protective posture. The NBC and medical planner analyze friendly-force BW-defense preparedness, including the adequacy of individual and collective

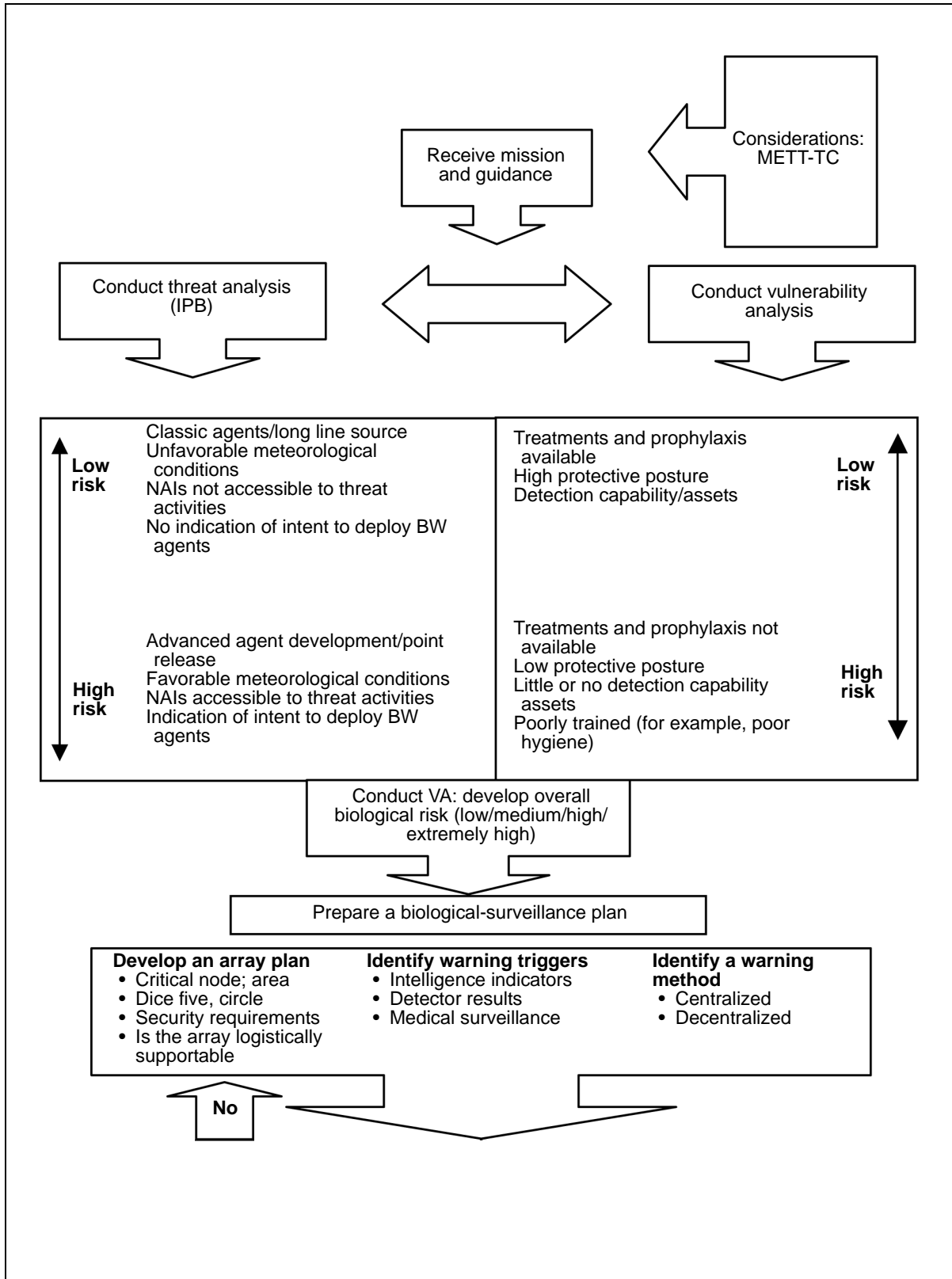
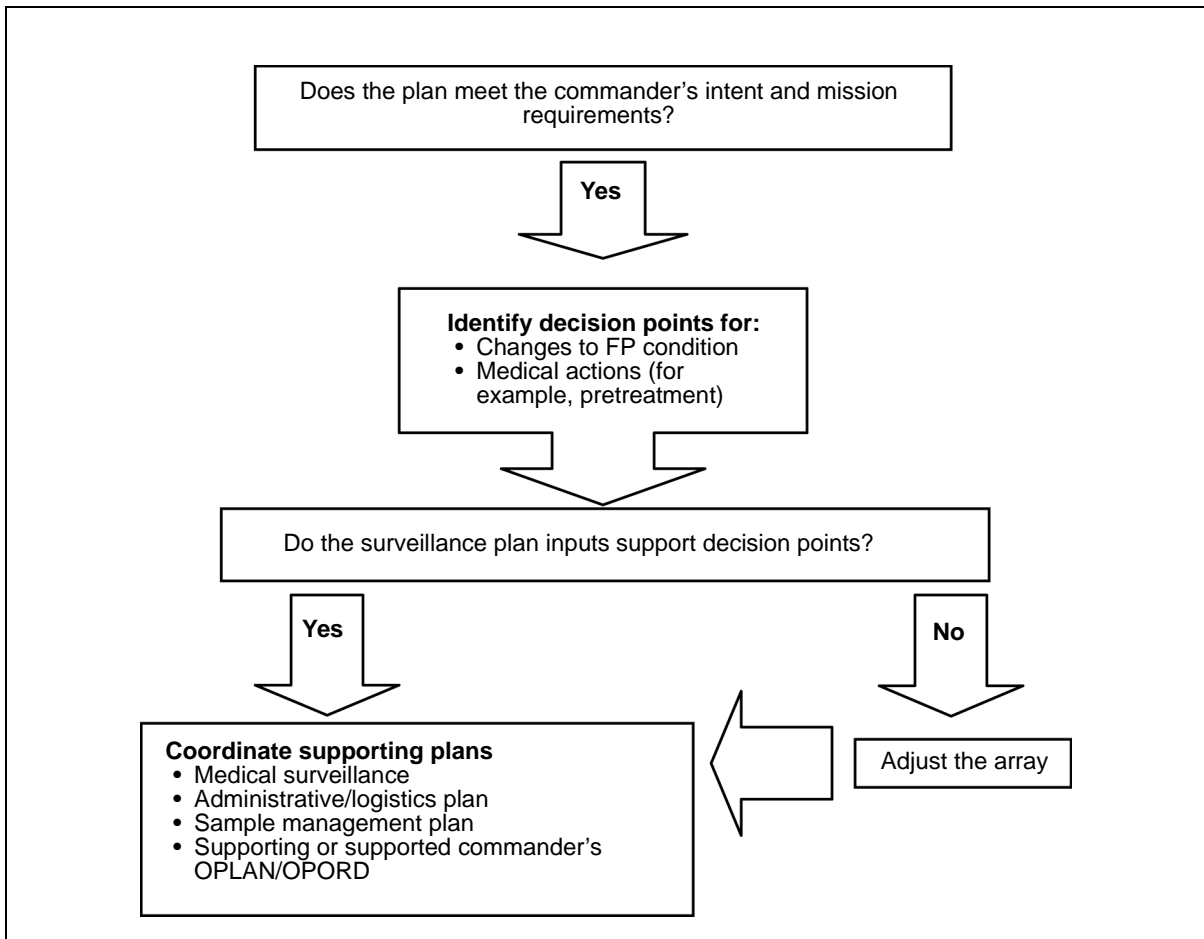


Figure E-1. Biological-Surveillance Mission Planning—Preattack



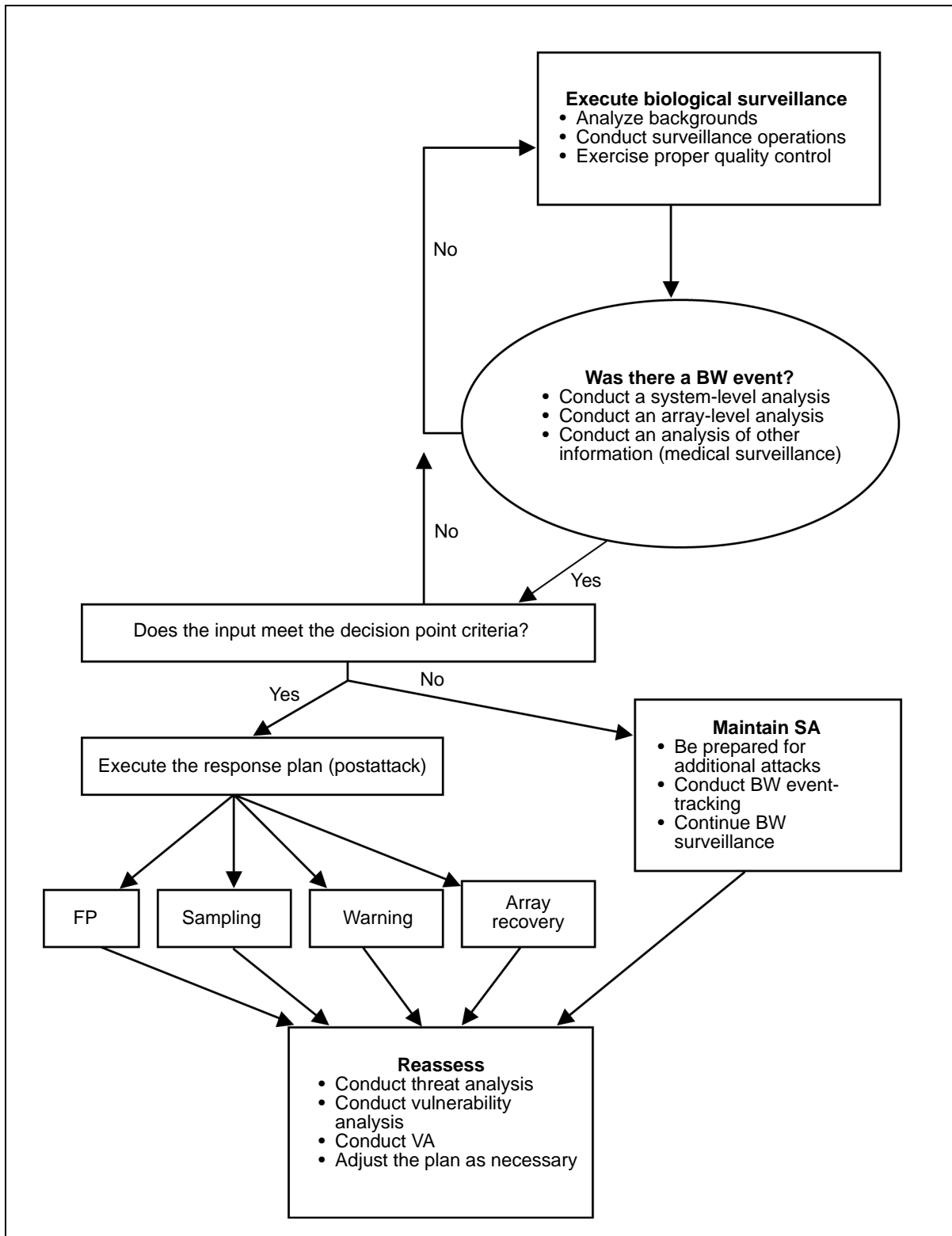
**Figure E-1. Biological-Surveillance Mission Planning—Preattack (Continued)**

protection and detection, medical, and decontamination resources against possible BW releases.

- **Conducting BW-vulnerability assessment (VA).** The BW-threat analysis is compared with the BW-VA to create the NBC VA. The process compares the BW threat with the force or facility ability to protect against and/or reduce the threat of BW attacks. For example, if the BW-VA is assessed as low, the biological-surveillance plan may direct that detectors conduct collection operations in a standard mode (and thereby conserve resources). Conversely, a high BW-VA will likely increase the number of detectors used and lengthen the monitoring periods.
- **Preparing the biological-surveillance plan (including BW-response planning).** See *paragraph 4* for information elements that should be included in the plan.

c. **Attack and Postattack.** The biological-surveillance CONOPS for conducting during and postattack biological-surveillance operations (see *Figure E-2* [page E-4]) includes—

- Executing the biological-surveillance plan.
- Maintaining SA.
- Reassessing and adjusting as necessary.



**Figure E-2. Biological-Surveillance Mission Planning—Attack and Postattack**

## 4. Employment Considerations

Although some biological detectors provide the commander with the capability to alert, sample, and even provide a presumptive identification capacity, not all deployed systems have these functions. Dry filter units, for example, sample the particles present in the nearby air and do not have an alerting capability. A dry filter unit is a continuous collector that collects and traps airborne particles onto a filter at pre-established intervals for manual presumptive identification.

a. Biological detectors such as the JBPDS, Joint Portal Shield network, and BIDS have both a monitoring and alert capability. These detectors collect particles from the ambient air for analysis following an alert. Following the collection of the sample, these systems begin the presumptive identification process.

b. The operational envelope for the use of biological detectors (such as determining when or where to use detectors and/or collectors) is dependent on factors such as system capabilities. As outlined in *Chapter II*, the operational envelope of some systems is only applicable to fixed-site operations (for example, Joint Portal Shield network, JBPDS [trailer-mounted and man-portable], or dry filter unit), while other systems can be used to support maneuver land forces and/or maritime forces (for example, BIDS and maritime dry filter units and JBPDS). BIDS units can be used for fixed sites or to support maneuver forces. METT-TC factors will also impact where and how detection and collection devices are used.

(1) Mission. Mission requirements will dictate where the detectors will be employed.

(2) Enemy. Planners must consider threat capabilities such as the type of BW agents that could be used and the method of dissemination (line or point source).

(a) Line source. The agent is disseminated along a line perpendicular to the wind and upwind of the target. Example delivery systems include track-mounted sprayers, aircraft sprayers, tanks, agricultural sprayers, or releases from ships.

(b) Point source. Agents are disseminated from single or multiple fixed points. Example delivery systems include bombs, unitary missile warheads, submunitions, fixed generators, or back sprayers.

(3) Terrain and weather. Planners remain aware that terrain and weather conditions can impact biological-detection operations. A dirty environment may adversely impact detector or sampler operations (for example, false positives on handheld assays from nonspecific binding or a clogged detector filter). Additionally, areas with high organic content in the ambient air may cause false positives during the presumptive identification process. Other conditions such as sandstorms could also degrade biological-detection operations (for example, the shutdown of alerting devices to prevent damage to components).

(4) Troops available. The availability of a supporting lab, sample courier assets, and CLS is critical for the support of biological-detector and -sampling systems. Additionally, the use of systems such as the dry filter unit, Joint Portal Shield, and JBPDS require deploying units to provide manpower and resources to conduct filter collection and handheld-assay testing.

(5) Time available. Planners must consider time when employing detectors and samplers. Detect-to-treat information may be especially critical if a fixed site has a high throughput population. The fixed site may be an APOE, seaport of embarkation (SPOE), APOD, or SPOD with a highly transient population. In this situation, the frequency of sampling may need to be increased in order to limit the potential spread of a biological agent by exposed personnel.

(6) Civilian. Planners consider and plan for the availability of civilian assets such as CLS or the possibility of lab support from a civilian source (such as another government agency).

c. METT-TC factors are applied to achieve tradeoffs. Tradeoffs are necessary to optimize the probability of detection for biological-detection surveillance support for critical-nodes or area arrays.

(1) During planning for biological-surveillance operations, information such as the following is used: the commander's guidance, weather and terrain information, intelligence information (such as agent types and the type of release), and the size of the base or activity or the areas that require support. This information is used to produce the biological-surveillance plan.

(2) The surveillance plan should include the—

- BW-surveillance vulnerability analysis.
- Meteorological assessment.
- Recommended duration of operation for detectors and/or collectors.
- Recommended mode of operation.
- Separation distance between detectors and/or collectors.
- Number of detectors required.
- Detector array employment tactic (for example, dice five or line) and the plan for siting systems (such as the distance from the perimeter [critical node] or downwind distance from an estimated RP for a biological agent [area array]).
- Mission and the commander's guidance and priorities (for example, biological-detection array confidence results [medium or high]) would serve as input for triggering the commander's decision.

(3) The commander approves the biological-surveillance plan. (See *paragraphs 5, 6, and 7* of this appendix.) Modifications to the plan may be required based on changes in weather, the operational situation, or resource issues (such as equipment, supply, or operator issues). There is risk associated with the implementation of a plan. The commander uses other information sources (such as medical surveillance or intelligence information) to maintain SA and to increase the confidence in an operational assessment (to confirm or deny that a BW attack has occurred).

## **5. Biological-Warfare Threat Analysis (Intelligence Preparation of the Battlespace)**

It is important to be aware of how the operational environment and meteorological conditions affect biological-surveillance operations. The operational environment

(biological threat) and meteorological conditions will affect how often and how long biological-detection and -sampling operations are conducted.

a. BW-threat analysis is conducted to determine a recommended biological-threat risk status—low, medium, or high (*Figure E-3* [page E-8]). Risk assessments are qualitative. The intelligence estimates are derived from the best available information, and will likely not definitely answer intelligence IRs that may be on a checklist.

b. Meteorological conditions are assessed. Meteorological conditions are assessed to determine if weather conditions would be favorable for an enemy biological attack. Stability, wind, direction, speed, turbulence, humidity, precipitation, heat, and cold are factors that should be considered as part of the meteorological assessment.

(1) *Table E-1* (page E-9) provides information on favorable, marginal, and unfavorable conditions for BW-line source releases. Favorable conditions for line source releases generally include the presence of stable meteorological conditions. Stable conditions with accompanying winds support the wide-area dissemination of a BW aerosol.

(2) Unstable meteorological conditions are more effective for dispersal of a BW aerosol in a point attack. Unstable conditions provide the agitation that allows for a wider dissemination of a BW agent on a target such as a fixed site. Conversely, stable conditions during a BW attack would likely lead to thin, “cigar-shaped” cloud formations.

(3) Additionally, terrain features and man-made structures will cause a BW aerosol to break up and increase the heterogeneous nature of the cloud. The determination of cloud dynamics using dispersion models over terrain features and man-made structures has yet to be fully realized.

## **6. Duration and Modes of Operation for Biological Detection**

The biological-surveillance plan should address the duration of the operation for the detection and/or collection assets in the array. The surveillance plan will also indicate the recommended mode of operation for the array.

a. Comparison of threat and meteorological information provides input that can be used to recommend the duration of the collection and/or detection intervals. For example, during favorable conditions for threat BW use and high BW-risk conditions, the commander may decide to conduct detection operations 24 hours per day, 7 days per week (see *Table E-2* [page E-9]).

(1) The recommended detection and/or collection intervals can be tailored for specific locations and situations. For example, based on a low VA (such as peacetime threat, FP conditions Alpha or Bravo), the commander may decide to use collection system capabilities (dry filter units) and conserve assets that require more resources to operate (biological-detection systems).

(2) Risk is taken when BW-detection and -collection operations are not conducted. However, the commander’s common operational pictures (COPs) (for example, IPB and weather and terrain assessments) provide the basis for directing detection and collection intervals.



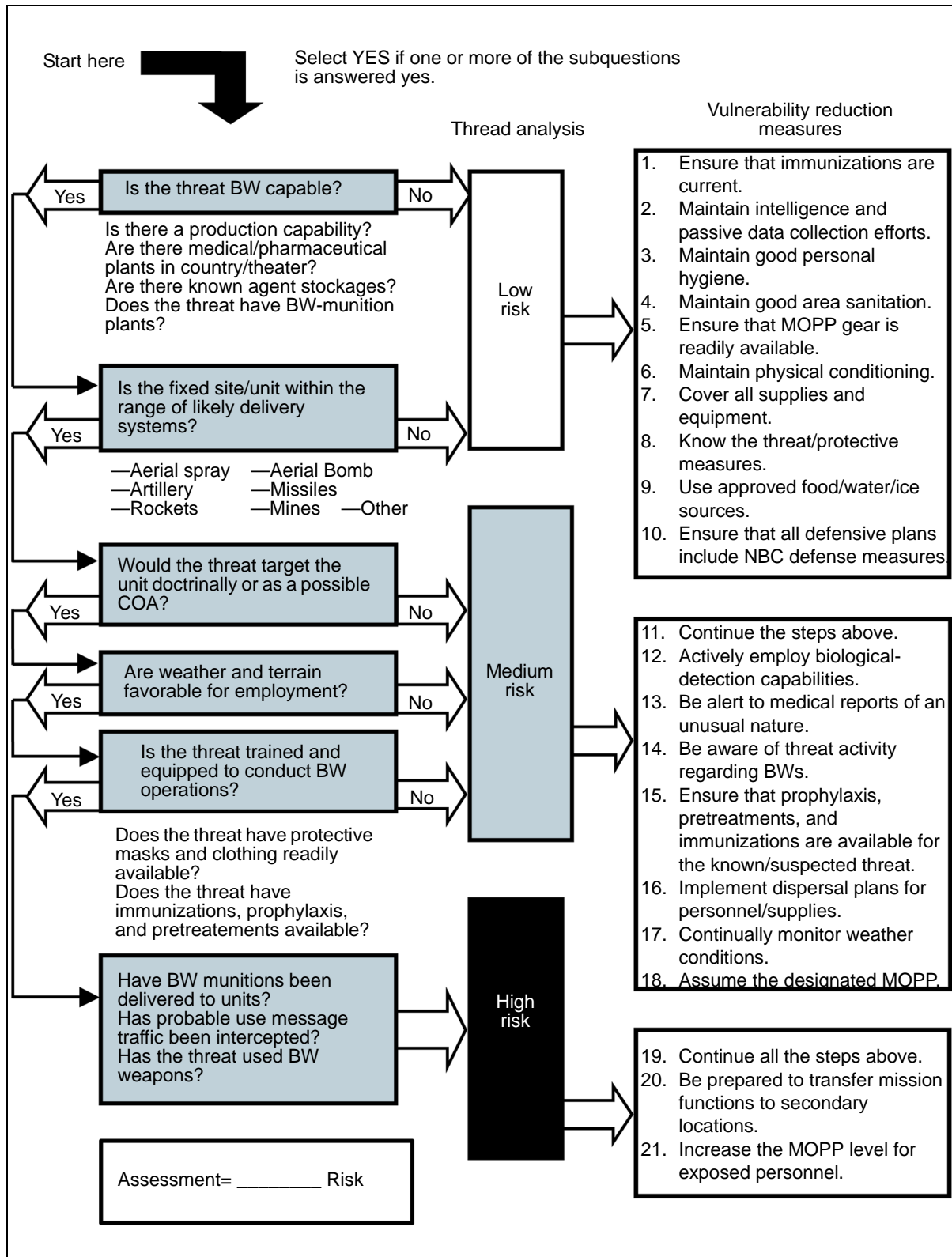


Figure E-3. Conducting BW-Threat Analysis (IPB)

**Table E-1. Favorable, Marginal, or Unfavorable Meteorological Conditions for BW Line Source Release**

Meteorological Conditions	Favorable for BW Use	Marginal for BW Use	Unfavorable for BW Use
Wind speed at heights below 16 meters	9-15 kph	15-32 kph	Less than 9 or greater than 32 kph
Stability	Stable	Neutral	Unstable
Temperature	1-20°C	Less than 0 or 21-29°C	More than 30°C
Precipitation	None to very light	Light	Moderate to heavy
<b>NOTE: Point dissemination can still be effective in less than favorable conditions.</b>			

**Table E-2. Sample Duration Intervals for Biological Detection System or Collector Operations**

	Low Risk (The threat has the capability to employ BW agents—peacetime threat—FP condition Alpha or Bravo)	Medium Risk (Intelligence reports indicate an increase in the threat—FP condition Charlie or Delta)	High Risk Wartime/Conflict (Hostilities have begun)
Meteorological conditions	Day/night	Day/night	Day/night
Favorable for BW use	8 hours <sup>3</sup> /8 hours <sup>3</sup>	8 hours <sup>3</sup> /12 hours <sup>1</sup>	12 hours <sup>1</sup> /12 hours <sup>1</sup>
Marginal for BW use	4 hours <sup>3</sup> /8 hours <sup>3</sup>	8 hours <sup>3</sup> /8 hours <sup>3</sup>	8 hours <sup>1</sup> /12 hours <sup>1</sup>
Unfavorable for BW use	See <sup>2</sup>	See <sup>2</sup> /12 hours <sup>3</sup>	4 hours <sup>3</sup> /12 hours <sup>3</sup>
<p><b>1 The biological detection system operates in standard mode.</b></p> <p><b>2 The biological detectors of the array operate in standby mode. Based on notification that an attack is imminent, the biological detectors of the array could be changed to standard mode.</b></p> <p><b>3 The biological detectors or collectors of the array operate with a 4-hour collection interval.</b></p>			

b. The tailoring of the biological surveillance can also be applied to the mode of operation of the array (for example, standard mode, single sample, collection only, standby). System level technical publications (such as technical orders [TOs] and technical manuals [TMs]) provide detailed information on the mode of operation for the different detectors. The biological-detector mode of operation can be tailored based on the operational situation. The modes of operation for a biological-detection system could be adapted as follows:

- Use the single-sample mode of operation to support specific requirements such as taking a background sample to support environmental characterization.
- Use the collection capability of detectors during low-risk situations and save considerable amounts of resources (such as consumables) that otherwise would have been used during a standard mode of operation.
- Use a periodic sampling mode based on an imminent threat (threat missile is inbound or a BW cloud is expected to arrive at a certain time).

## 7. Biological-Detection and/or -Collector Employment Tactics

The NBC staff recommends the employment of biological-surveillance assets. Many factors impact employment, and the plan may be adjusted based on changes in the weather, threat, and available assets. No employment tactic is 100-percent successful in detecting and identifying a BW agent. For example, a terrorist could employ a single-point source BW munition without the release being detected by a biological-detection array. Factors that are considered in the employment of biological-surveillance assets include:

- Estimating separation distances between detectors and/or collectors at critical nodes.
- Estimating separation distances between detectors and/or collectors in area arrays.
- Recommending employment tactics for the detectors and/or collectors of the array.

a. **Critical-Node Separation Distances Between Collectors and/or Detectors.** The estimated separation distance between detectors or samplers will vary depending on terrain and weather considerations; however, the following are suggested separation distances.

(1) For on-target or near point source releases, the preferred distance between detector and/or samplers is 200 to 400 meters. A 200- to 400-meter separation distance is a general rule of thumb for the approximate cloud radius after cloud dissemination.

(2) For line source releases, the distances between detectors and samplers should not exceed 800 meters. The actual distance will be determined based on the number of detectors or samplers available and the area to be covered.

b. **Area Array Separation Distances for Collectors and/or Detectors.**

(1) Estimating line source separation distances for biological detectors in an area array. The estimate associated with the separation distances considers the size (in width) of the area to be protected, an estimate of the length of the line source, and the number of detectors that should be in the cloud path to support BW event-tracking. For example, if the width of the area to be protected equals approximately 60 kilometers, the estimated length of a BW-line source is 20 kilometers, and the commander determines that he wants two detectors intersecting with the cloud, a total of 7 detectors would be required.

$$\left( \frac{\text{width of sector being protected}}{\text{estimated length of line source}} \times \text{number of detectors intersecting with the cloud} \right) + 1 = \text{number of detectors required}$$

$$\left( \frac{60 \text{ km}}{20 \text{ km}} \times 2 \right) + 1 = 7 \text{ detectors}$$

(2) Locating biological-detection arrays downwind of the point of release of a BW agent. As a general rule of thumb, a biological-detection array should be located within 20 to 25 kilometers of the estimated RP of a BW agent to enable the detection of this agent. Additionally, an aerially delivered BW agent aerosol may not reach near

ground level for 1 to 5 kilometers. The distance depends on the height of release, type of aircraft, and wind speed. Also, a ground BW-point source will require 1 to 2 kilometers before the aerosol begins to coalesce into an organized cloud.

c. **Biological-Detector Employment Tactics.** The NBC staff will recommend a BW-detector and -collection employment plan. The employment tactic for detectors and collectors will be based on the capabilities and COE for the systems. For example, detectors and collectors like the Joint Portal Shield, JBPDS (trailer-mounted and man-portable), or dry filter unit are well suited for employment as point detectors or collectors or a critical-node array at a fixed site. The specific employment tactics that may be used will vary based on factors such as:

- The BW-risk assessment and IPB (for example, the delivery system and tactics for delivery).
- Terrain and weather conditions.
- The location and size of assigned NAIs.
- The number of detection and/or collection assets that are available.
- The commander's guidance.
- The desired confidence level to be achieved from the biological-detection array.

(1) **Dice Five.** The dice five pattern of deployment refers to the deployment of detectors or samplers in the pattern of the pips for the number 5 on a die. The dice five array (*Figure E-4* [page E-12]) is well suited for employing a detector or collector on an APOD or SPOD (with one detector for each cardinal direction—north, south, east, and west). Detectors or collectors could be shifted based on out-of-service detectors, weather pattern shifts, or other METT-TC factors. The dice five tactic provides the most flexibility and is particularly applicable for support of critical node (fixed site) or area array operations. The dice five tactic is also adaptable to a varying number of detectors or samplers (such as seven or nine detectors or samplers). This tactic provides depth to an array (if an aerosol cloud misses one detector, another detection deeper in the array should detect the cloud). A dice five tactic is a preferred tactic because in depth features should increase the probability of detection.

(2) **Circle.** Employment of detectors or samplers in a circle configuration provides 360° coverage. This tactic is effective when wind directions are constantly changing. *Figure E-5* (page E-12), provides an example of a circle employment of samplers or detectors. The circle tactic is particularly applicable to critical-node operations. However, this tactic could be resource-intensive (based on the size of the base) and does not provide the depth of coverage provided by other tactics.

(3) **Picket line.** The picket line is designed to capture a BW-aerosol attack coming from a specific direction. Ideally, it is placed upwind of friendly positions to capture a line source attack. *Figure E-6* (page E-12) is an example of a picket line employment of detectors and collectors. The picket line tactic would be particularly applicable for support of a maneuver land force; however, biological detectors may require relocation if the wind direction shifts. This employment tactic provides no depth to the array and has a limited application.

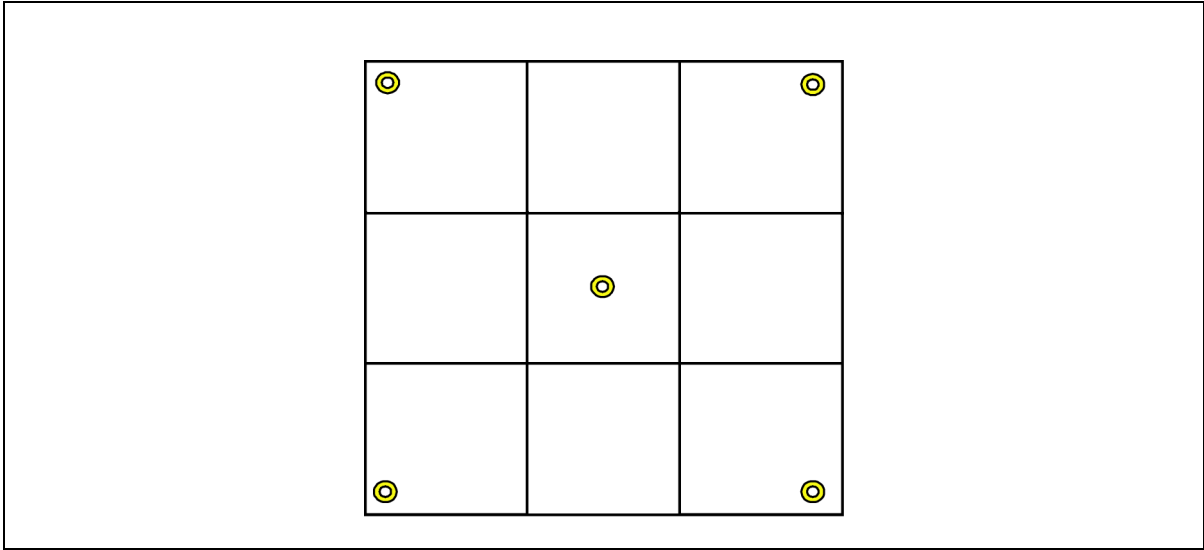


Figure E-4. Dice Five Array

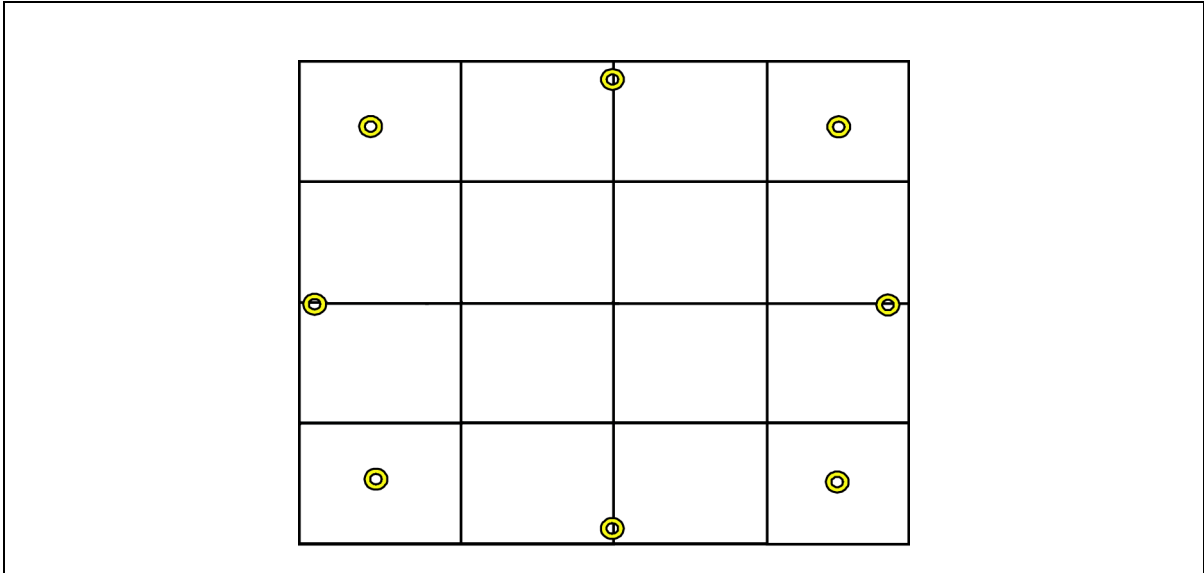


Figure E-5. Circle Employment

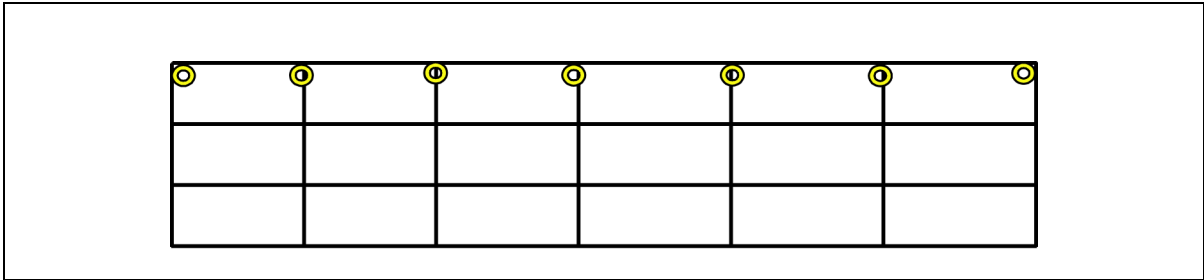
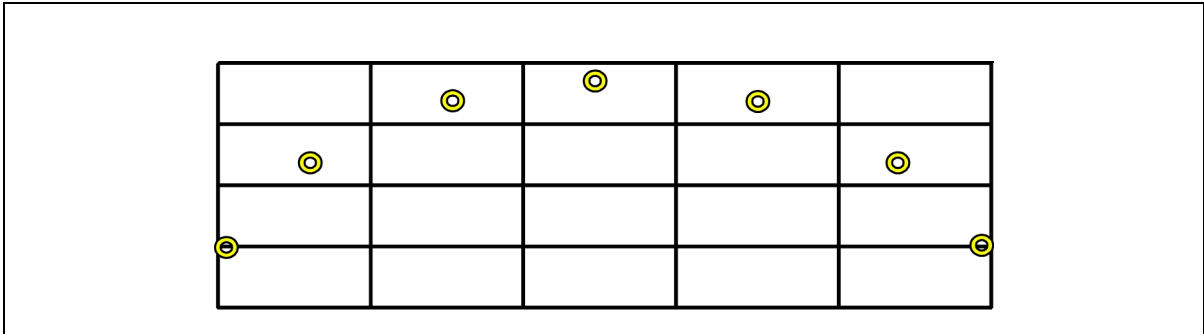


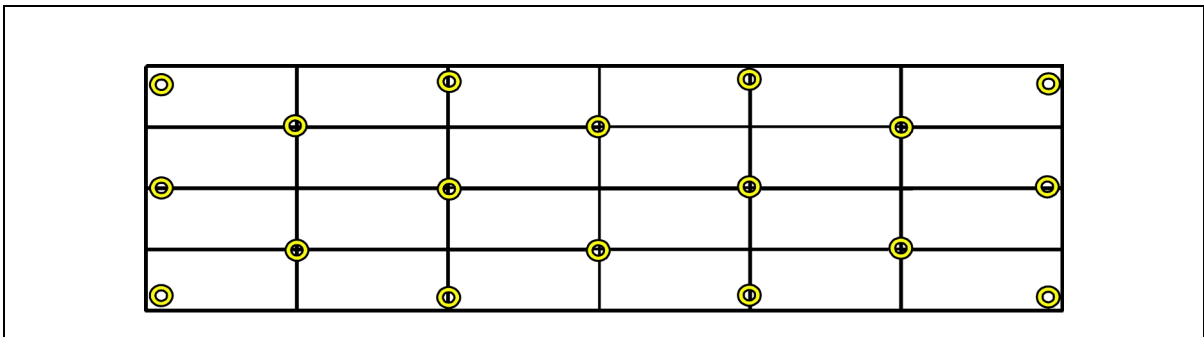
Figure E-6. Picket Line Employment

(4) Semicircle. The semicircle employment of detectors and samplers provides approximately 180-degree coverage. It is still directional in that it protects from an upwind line source release, yet gives more coverage than a picket line and provides for moderate wind direction changes. *Figure E-7* provides an example of a semicircle employment of detectors and collectors. The semicircle tactic could be used to support fixed-site or maneuver forces; however, this tactic does not provide detectors in depth.



**Figure E-7. Semicircle Employment**

(5) Dense picket. The dense-picket employment of detectors and collectors provides higher density coverage against line and point source attacks than the other employment strategies. It is resource intensive and requires large amounts of detectors and sensors. *Figure E-8* provides an example of a dense picket employment of detectors and collectors. The dense-picket tactic could be used for support of fixed site or maneuver forces.



**Figure E-8. Dense Picket Employment**

## 8. Preparing a Biological-Surveillance Plan

This paragraph provides two brief descriptions of sample biological-surveillance plans. The NBC staff has only limited information for the two sample scenarios. The sample scenarios indicate what tradeoffs were among METT-TC factors to increase the probability of detection.

a. *Figure E-9* (page E-14), provides a notional setting for a JTF HQ in Northeast Asia. Based on this setting, the NBC staff must prepare a biological-surveillance plan. The NBC staff uses available information to proceed through the planning process.

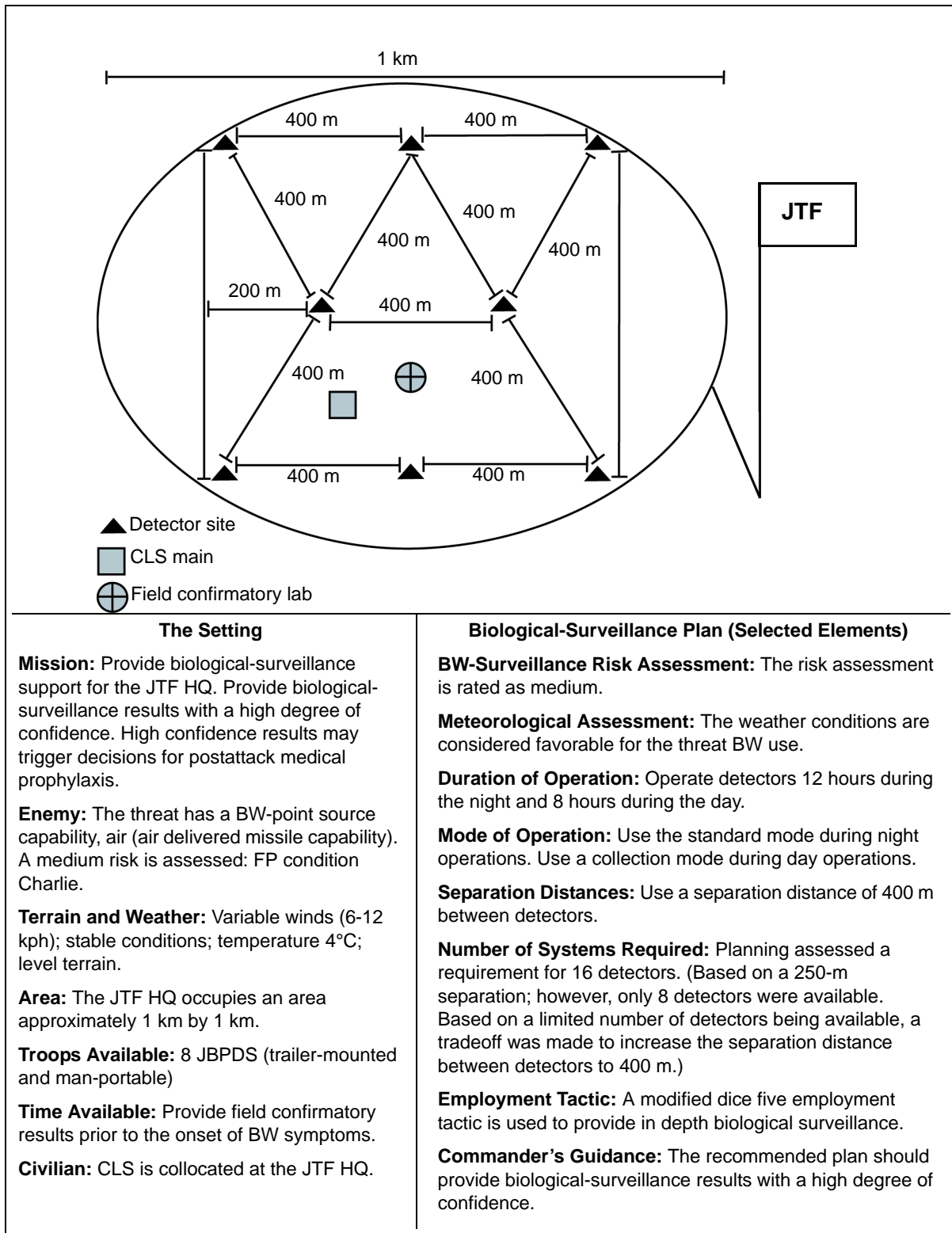


Figure E-9. Critical-Node Array

- The risk assessment for this OCONUS location is rated as medium (see *Figure E-3* [page E-8]).
  - The threat is BW capable.
  - The JTF HQ is within range of threat delivery systems.
  - The weather and terrain are favorable for BW employment.
- Weather conditions are assessed as favorable for threat BW use (see *Table E-1* [page E-9]).
- The schedule for biological-detection array operations establishes a duration of 12 hours of monitoring during the night and 8 hours of monitoring during the day (see *Table E-2* [page E-9]).
- A standard mode of operation is used during night operations and a collection mode is used during the day.
- An estimated separation distance of 400 meters between detectors is used based on the threat point source capability (see *paragraph 7a*).
- The NBC staff initially estimates a requirement for 16 biological detectors (based on a separation distance of 250 meters); however, only 8 JBPDS are available (see *paragraph 7a*).
- A modified dice five employment tactic is recommended based on the variable winds and the requirement for depth within the array.
  - Based on the 8 detectors being available, the separation distance between systems is increased to 400 meters. The array in depth will also be ready if there is a change in wind direction (see *paragraph 7a*).
  - The modified dice five array provides an in depth detection capability. If a heterogeneous BW-aerosol cloud misses one detector, another detector should detect the cloud. If only one detector provides a presumptive identification, other operational intelligence and medical surveillance information would be assessed. Additionally, if an upwind detector detects a cloud then downwind detectors will be directed to conduct periodic monitoring (see *Chapter V, paragraph 6*).
- The NBC staff reviews the biological-surveillance plan to ensure that the commander's guidance is met. The commander wants a high-level of confidence in the biological-surveillance plan. Based on the tradeoffs that are made among the METT-TC factors, the biological-surveillance plan is recommended for approval.

b. *Figure E-10* (page E-17), provides a notional setting for a US land force conducting a combined arms exercise with a friendly nation. The combined forces operate in an exercise area (20 by 30 kilometers) with an east and west orientation. The international border is approximately 20 kilometers to the north. A belligerent nation with a BW-line source capability lies to the north. The friendly nation land forces are deployed near their northern border. One USA chemical company (biological detection), a company HQ, and two platoons (14 BIDS total), are assigned a mission of providing biological surveillance for the land forces operating within the exercise area. Based on



this setting, the NBC staff uses this limited information to prepare a biological-surveillance plan.

- The risk assessment for this OCONUS situation is assessed as medium (see *Figure E-3* [page E-8]).
  - The threat is BW capable.
  - Exercise land forces are within the potential downwind path of a BW-aerosol cloud.
  - The weather and terrain are favorable for threat BW employment.
- Weather conditions are assessed as favorable for threat BW use (see *Table E-1* [page E-9]).
- The schedule for biological-detection array operations establishes a duration of 12 hours of monitoring during the night and 12 hours of monitoring during the day (see *Table E-2* [page E-9]). Based on the risk assessment and weather conditions, the extended schedule (24 hours per day) of operation is recommended.
- A standard mode of operation is used during night operations and a collection mode is used during the day. Samples are collected twice (at 6-hour intervals) during the day.
- Separation Distances.
  - To estimate the separation distance that will be used between biological detectors, the NBC staff determines the width of the area to be protected (30 kilometers). Coordination between NBC and intelligence staff estimates that the possible length of a threat BW-line source could range from 5 to 10 kilometers. To establish a high degree of confidence in system-level results, the commander wants a minimum of two detectors intersecting with the cloud.

$$\left( \frac{\text{width of sector being protected}}{\text{estimated length of line source}} \times \text{number of detectors intersecting with the cloud} \right) + 1 = \text{number of detectors required}$$

$$\left( \frac{30 \text{ km}}{5 \text{ km}} \times 2 \right) + 1 = 13 \text{ detectors}$$

Based on a 5- or 10-kilometer BW-line source distance, 13 or 7 detectors, respectively, would be required. A third calculation using a line source distance of 7 kilometers indicates that 10 detectors would be required. To provide depth to the array, the NBC planning uses an approximate 3-kilometer separation between systems (see *paragraph 7b*).

- The biological-detection array is placed within 20 to 25 kilometers of the estimated RP for a threat BW-agent line source release.
- Changes to the operational situation or the commander's guidance could increase or decrease the numbers of detectors required (for example, the commander wants a minimum of three detectors intersecting with a BW

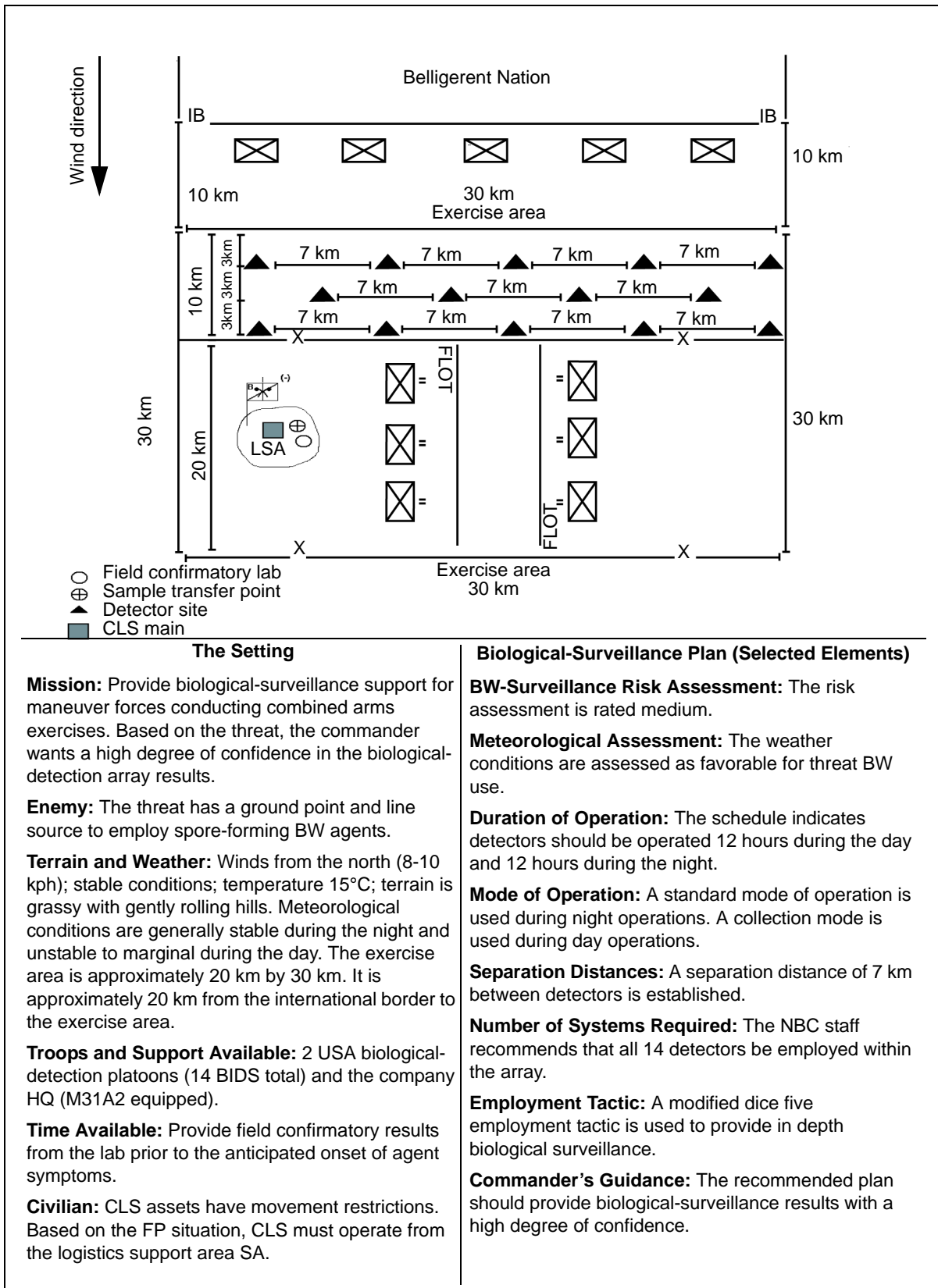


Figure E-10. Area Array Support

cloud to increase the level of confidence). However, based on the current situation, the NBC staff recommends using 14 detectors.

- A modified dice five employment tactic provides an in-depth biological-detection capability. If a heterogeneous BW-aerosol cloud misses one detector, another detector should detect the cloud. Coordination between the intelligence and NBC staff assessed that a threat BW-line source attack would likely be a minimum of 5 to 10 kilometers in length. Based on this assessment, two or more detectors should be in the path of a BW aerosol.
- The NBC staff reviews the biological-surveillance plan to ensure that the commander's guidance is met. Based on an assessment of METT-TC factor tradeoffs, it is assessed that the plan meets the commander's guidance. The area array characteristics are as follows:
  - A modified dice five employment tactic is used for the two platoons (14 BIDS).
  - East to west separation distances of 7 kilometers between systems and north to south separation distances of 3 kilometers.
  - The two platoons are arrayed approximately 10 to 20 kilometers from the international border.
  - The commander's guidance for high confidence results should be attained by placing BIDS assets in depth.
  - The biological-detection array uses a standard mode of operation during night operations (with stable meteorological conditions) and a collection mode of operation during day operations (with unstable to marginal meteorological conditions).

## **9. Maritime Biological -Detection and -Collection Employment Tactics**

The operational envelope for USN employment of JBPDS detectors and dry filter unit collectors includes their use on surface ships. USN ships spend approximately 20 percent of their total deployment in port for liberty and/or uploading of supplies. These ships are vulnerable to covertly released BW-agent aerosols due to their static position and geographical location (for example, the Middle East or Mediterranean).

a. The detectors and collectors are used in conjunction with handheld assays. This provides a presumptive identification ability.

b. The CONOPS for collectors and detectors is to operate them in high-threat areas using scheduled intervals (for example, 12-hour sample collection time and 24-hours per day sampling during a high-threat condition).

(1) The number of samplers or detectors used is dependent on the ship class. Staggered sample retrieval times will provide a periodic series of test results. For example, if a ship is in port by itself for 3 days and is operating 2 collectors with an 8-hour collection time, the time of resolution is 4 hours. Therefore, if operations turn on both at 0000, check unit number 1 at 0400, check unit number 2 at 0800, check unit number one at 1200, and so forth. Timely detection information could be obtained in 4-hour increments for the entire 3-day visit.

(2) Multiple ships and coordination between them will yield even lower time resolutions. Collectors may also be used to sample air in the event of intelligence threats or indications of an environmental release. Positive results using handheld assays will be positive presumptive identification and samples will be properly packaged and shipped to a medical lab that will be housed on large-deck surface ships. Samplers will probably be positioned on the deck and/or dirty side of ventilation systems for collective protection system ships.

c. During in-port operations or when underway (for example, at chokepoints, during amphibious operations or at sea release) dry filter units should be placed in locations where there may be a high concentration of agents in the event of an attack.

d. Internal sampling by dry filter units could be conducted in compartments receiving outside supplies or in mission critical spaces at 1- to 8-hour collection intervals.

e. The collection interval established by the commander will vary depending on the threat (for example, a 4- to 6-hour collection interval if a BW attack is probable or imminent).

## **10. Common Detection Site Selection Criteria for Biological-Detection Systems**

a. Reconnaissance. Reconnaissance is a fundamental step in site selection. Begin with a map reconnaissance. Use the map reconnaissance to determine initial surveillance areas that support the employment tactic, then select primary, alternate, and supplemental surveillance sites within each surveillance area. Some rules of thumb for the reconnaissance include the following:

- Reconnoiter detection areas and potential sites first-hand, if possible.
- Coordinate reconnaissance with the owner of the terrain before conducting the reconnaissance.

b. Site Selection. Factors that may affect site selection include the following:

- Trafficability.
- Security.
- Communications.
- The location of friendly activities.
- Down-valley or up-valley winds.

c. Exterior Deployment Area Selection.

(1) Deployment areas are planning tools that give biological-detection asset leaders a frame of reference for selecting detection sites that are mutually supporting and meet the requirement for FP. The rules of thumb for detection areas are as follows:

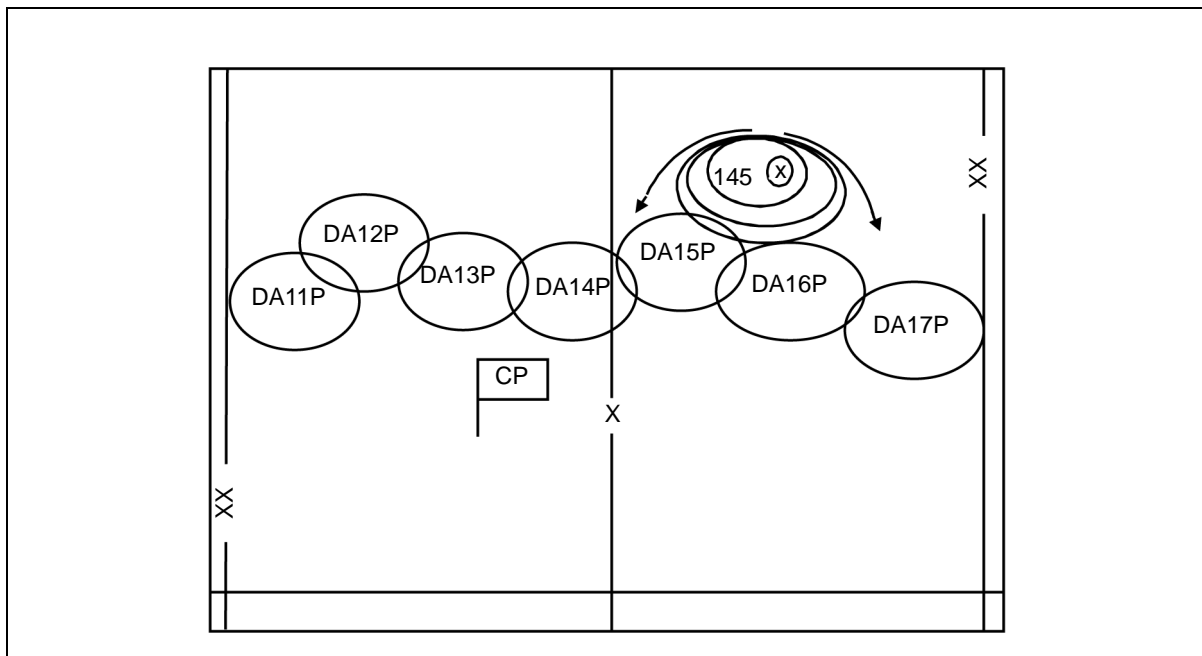
- One-kilometer diameter for detection systems such as the BIDs.
- One hundred and fifty-meter radius for collection and detection systems.
- Upwind placement of a fixed site or supported unit. Do not select deployment areas immediately downwind of areas and/or facilities

that might generate interferants (for example, forward arming and refueling points [FARPs] or farms).

(2) When assigning deployment area numbers, use a five-digit alphanumeric code for deployment areas and six digits for detection sites as follows:

- The first two characters designate either deployment or detection areas.
- The third character is the unit designation (for example, a biological-detection platoon).
- The fourth character is the team designation (for example, a BIDS team).
- The fifth character is the primary (P), alternate (A), or supplemental (S) area.
- The sixth character is the sequence number for the detection site.

(3) *Figure E-11* provides an example of a deployment area for a BIDS unit. In this example, a BIDS platoon has deployment areas assigned to its seven detection teams.



**Figure E-11. BIDS Deployment Areas**

d. Detection Site Selection. Detection sites are the actual biological-detection positions. Leaders at all levels must deconflict site selection to reduce vulnerability to fratricide and ensure that the coverage is within unit capabilities. Some rules of thumb in selecting detection sites are as follows:

- Has a 100-meter radius.
- Permits maximum airflow of possible hazards.

- Has minimal overhead cover. This will be very difficult for tactical commanders to accept. However, without minimal overhead cover, various detectors will not get maximum airflow over the collector-concentrators.
- Is upwind of the supported unit or critical node.
- Permits rapid ingress and egress.
- Is protected from threat direct fire. Depressions that do not exceed 4 meters in depth are ideal for protection; yet do not canalize steering winds away from the site. The object is to not allow the biological-detection team to be exposed to direct fire hazards.
- Is concealed and camouflaged.
- Is out of threat mortar and artillery range, if possible.
- Permits effective communications.

e. Outdoor Site Selection Considerations. Several considerations must be taken into account when positioning individual biological-detection systems. Ensuring that the site allows for the greatest probability of detecting a biological cloud will be a major concern. To understand how the biological-cloud behavior impacts on your site selection process, consider the—

- Effects of environment, terrain, and weather on BW agents.
- Biological-agent cloud behavior.
- Methods of dissemination.

f. Biological-Detection and -Collection Operations in Unusual Conditions.

(1) Cold weather operations. BW in the arctic is a possibility. It has been found that the survival of microorganisms increased significantly at temperatures below freezing. Temperature inversions that exist over snowfields tend to prolong the integrity of an aerosolized biological cloud. It disperses more slowly and remains a threat for a longer period. If an attack with these agents occurs, it will most likely be delivered by covert means.

(2) Desert operations. During daylight, most aerosolized live biological agents are short-lived. Spore-forming biological agents are an exception. This is a result of low humidity and the ultraviolet (UV) radiation of direct sunlight and atmospheric disturbance. But at night, favorable conditions could occur. Effectiveness of the live biological agent, however, would quickly diminish during the daytime. Toxins are more resistant to this harsh environment and could still be effectively employed.

(3) Jungle operations. Jungles provide excellent conditions for the use of biological agents and toxins. Warm temperatures, high humidity, and protection from sunlight all aid the survivability of disease-causing microorganisms. Low wind speeds and jungle growth limit downwind hazards.

(4) Mountain operations. Detection of live biological agents in mountains creates the same problems as in lower areas—the effects of the terrain on the agent cloud.

(5) Urban terrain operations. Operations in an urban environment present special problems for detecting biological agents. Just as with rough terrain, wind turbulence caused by structures influences the dispersion of BW agents by reducing agent effectiveness and area coverage. In addition, pollutant gases can interfere with detection of BW agents and have been found to decrease the survival of many pathogens.

g. Communications. Communications may affect site selection. While planning site selection, communications considerations include—

- The type of operation, the units involved, and the support requirements.
- The physical characteristics of the AO and probable weather conditions.
- The capabilities of the organic radio assets.
- Alternate means of relaying information.

**NOTE: Never rely on a single means of communication.**

## **11. Indoor Site Selection for Biological Detectors or Collectors**

Conducting indoor biological-detection and sample collection operations presents some unique challenges and considerations in detector emplacement. The following considerations affect biological-detector or sampler emplacement:

a. The Coverage Required (Size of the Building Versus the Number of Detectors Required). The size of the building will impact the number of detectors required to properly provide coverage. Although size alone is not the determining factor, it is a contributing factor when determining the number of detectors and sample collectors required.

b. The Type of Release to be Protected Against (Exterior Versus Interior Release). The type of release to be protected against may determine the placement of detectors.

(1) Exterior release. If the building provides for adequate security controls and measures, the threat of an interior release is decreased. Thus, the threat will most likely come from an exterior release. In this instance, the placement of detectors and/or collectors in the interior of the building should emphasize capturing air coming into the building through air inlets, entrances, and exits. This method is likened to setting up a perimeter defense. In such instances, detectors placed on the exterior of the building will also provide a much-needed layer of protection outside of the perimeter.

(2) Interior release. Providing detector coverage against the threat of an interior release will greatly influence the placement of detectors. When providing coverage against an interior release, the method of providing a perimeter of detectors does not work effectively. Detector and/or collector locations to be covered throughout the building should include air exhausts, HVAC systems, high-value targets (HVTs) within the building, high population areas, areas of congregation, high-risk billets, and high-risk personnel.

c. The Interior Airflow. The flow of air throughout a building will affect the number and placement of detectors. Some buildings can be highly segregated in nature, especially newer larger buildings—while others can be very open in terms of airflow. The more segregated the building and its HVAC system, the less likely the chance of biological contamination spreading.

d. **Building Air Exhausts (the Location and Number).** Building air exhausts can provide the best payback in providing coverage of large buildings. In comparison to building air inlets, there tend to be fewer building air exhausts. The laws of physics and common sense say that in order to provide equilibrium, whatever air enters the system must exit through an air exhaust somewhere. These points of exhaust will contain air that has passed through the building and may contain samples of biological agents that have circulated within the building.

e. **Air Handling Systems (Heating, Ventilation, and Air Conditioning Systems).** Air handling systems provide fresh air from the exterior of a building and recirculate interior air. Detectors placed in air handling systems or other means of obtaining air from air handling systems also provide an indication of a biological agent release within a building. They can also further the spread of contamination by moving air around different parts of the building. Care should be taken when emplacing detectors to sample air from air handling systems. If there is adequate detector coverage outside the building and the detector is meant to protect against an interior release, then ensure that the detector is sampling the air that is circulating and/or recirculating within the building and not air entering from the outside.

f. **Traffic Throughout the Building.** High-volume traffic throughout a building or in certain areas of a building should also be considered. The movement of air in these areas, as compared to areas of less movement (small office spaces), may present a target of opportunity to capture an agent release within a building.

g. **Critical Infrastructure.** Some buildings may contain critical infrastructure that presents lucrative targets for a biological release. C2 nodes and areas critical to the health and safety of an operation (such as clinics and hospitals) may receive detector coverage.

h. **High-Value Targets, High-Risk Billets, and High-Risk Personnel.** HVTs, high-risk billets, and high-risk personnel may require biological-detection coverage depending on their “worth” to an operation. HVTs could be lucrative targets for a threat in disseminating an agent. Examples of targets may include cafeterias, conference and/or meeting rooms and centers, waiting areas, elevator areas and shafts, underground transportation building connections, and areas of congregation (for example, large office spaces, theaters, and entertainment areas).

i. **Detector Limitations, Capabilities, and Requirements (Sensitivity, Size, and Power).** Detector characteristics may determine placement. The ability to sample large volumes of air, the size, and capability to draw air from small spaces (such as inside air ducts), and the power it requires to operate for extended durations may affect placement.

j. **Building Characteristics.** Every building is different. Each is a mini-environment, with some being microcosms of mini-environments. Some are very porous, letting air in and out from numerous locations throughout. Some are very secure in terms of airflow, with the air circulating throughout easily monitored. Prior to developing a detector plan for a building, obtain as much information about it as possible, for example—

- HVAC plans.
- Areas not covered by HVAC systems.



- Architectural and engineering plans (for example, sewage and water diagrams).
- Security plans.
- The organization and distribution of the population within.
- The local weather around the building.

k. Coordination. The placement of systems within the interior of a building requires coordination with building engineers and management. Placement within HVAC and air handling spaces, such as inlets and outlets, may need modification requests for both insertions of the equipment and power requirements. Systems that use additional tubing to bring air to a sampler should also be checked following placement using accurate equipment to ensure that the intent of the air movement was met and flow levels have not been compromised. This may require consultation with the manufacturer or testing to verify that the equipment has been installed in a manner that best contributes to the capture of the intended aerosol.

## Appendix F

### BIOLOGICAL-WARFARE ATTACK WARNING

#### 1. Background

a. The decision to disseminate a BW-attack warning, with its requirement to assume a protective posture, is an important one for the force commander. The commander must minimize the occurrence of false alarms while ensuring that the warning process is carried out as rapidly as possible to minimize exposure and maximize opportunities for medical treatments.

b. The results from a single component in a biological-detection suite, a single biological sensor, or the results from a single biological-detection suite, are not necessarily enough to decide to warn. This decision must be made considering all the evidence available: detection, intelligence, meteorological, and medical information. The analysis of this information will provide the basis for the decision to warn. The information required for the warning decision comes together best at the JTF and/or corps level.

c. Due to the dynamics of many BW agents, centralized analysis is generally preferred prior to issuing a BW warning to the threatened force. Decentralized warning may be ordered for specific phases of the operation or to units in the immediate suspected hazard area.

d. Intelligence, NBC, and medical officers analyze initial detection reports in light of the current situation. They evaluate each piece of data to determine if it is consistent with a BW attack. Based on the commander's decision and his guidance on warning and protection criteria, the unit may execute its BW-warning and -reporting procedures in one of two ways. It may warn—

- Without a biological-detection and -identification capability.
- With a biological-detection and -identification capability.

#### 2. Warning Without a Biological-Detection and -Identification Capability

a. Determining that a BW attack has occurred will be difficult without a biological-detection capability in the TO. Units are generally unable to distinguish a biological attack from a chemical attack. The method of attack (for example, a spray, a bomb, or a projectile) could be the same for BW and chemical warfare (CW). If a unit observes a possible chemical-biological (CB) attack, but is unable to confirm it as a CW attack (for example, an automatic chemical-agent detector and alarm not sounding or negative results on M8 and/or M9 paper or M256A1 detectors), the unit should send an NBC-1 Report—Agent Unknown.

b. If the IPB is inconclusive for either CW or BW, a downwind hazard prediction with the largest suspected hazard area should be disseminated in order to warn affected units. The NBC control center generates and disseminates an NBC-3 (chemical or BIO) report to warn the force.

### 3. Warning With a Biological-Detection and -Identification Capability

A biological collector or detector can be deployed into an AO to provide a reliable asset (a presumptive identification capability) to assess the possibility of a BW attack. The results of the process are reported through the warning-and-reporting network. This reported information, along with other intelligence and medical data, provides the chain of command with the capability to assess whether a BW attack has occurred.

### 4. Centralized Versus Decentralized Warning

An operational-level HQ is in a position to assess whether a BW attack has occurred. As a general rule, any HQ receiving information indicating that a BW attack occurred must produce and disseminate warnings. The protection afforded by assuming at least a mask only mission-oriented protective posture (MOPP) level can significantly reduce numbers of BW-attack casualties. The commander that has the biological-detection assets must decide on what method of warning to employ. His decision should take all the advantages and disadvantages of each method, centralized and decentralized, into account.

a. **Centralized Warning and Reporting.** The centralized warning-and-reporting network is used when the operational level HQ makes a determination on when, to whom, and where to issue the warning and appropriate protective measures (see *Table F-1*). A centralized warning system will likely be used to support an area array. The operational-level HQ will have access to multiple information resources (for example, battlespace intelligence and medical surveillance). The reports of the biological-detection unit contribute to the operational-HQ SA and assessments. For example, in a biological-detection unit, incident reports flow up to the controlling HQ where they are reviewed, consolidated, and analyzed by the NBC control center in coordination with the unit surgeon. While the biological-detection asset may be physically located in a major subordinate command (MSC) AO, the reports do not go through the subordinate units. Since the controlling HQ makes the warning determination in the centralized option, speed is of the essence and the reports need to be transmitted as rapidly as possible to the controlling HQ. The operational, level-of-war controlling HQ has access to additional potential BW-attack intelligence indicators that may not be available to lower HQ. The results from the biological-detection asset should not be considered 100-percent accurate; therefore, other attack indicators must be evaluated before arriving at the conclusion that a BW attack has actually occurred. With the controlling HQ making the warning determination, false alarms should be kept to a minimum. Upon the determination that an actual BW attack has occurred, the appropriate warning is issued to the affected commands with a directive to assume a higher protective posture. A simplified biological-hazard prediction is performed followed by an NBC-3 (BIO) report.

b. **Decentralized Warning and Reporting.** The decentralized warning-and-reporting network delegates the warning to MSCs (see *Table F-2*). A decentralized warning system will likely be used to support fixed-site operations. The fixed site (for example, an AB or port) may have strategic- or operational-level significance. The reports of the biological-detection unit contribute to the fixed-site HQ SA and assessments.

**Table F-1. Pros and Cons of the Centralized Warning System**

<p><b>Advantages</b></p> <ul style="list-style-type: none"><li>• Reduces false alarms to a minimum. False alarms have the potential to cause subordinate units to continually raise and then lower the protective posture. That can significantly affect OPTEMPO.</li><li>• Ties together other indicators that may not be available to subordinate commanders.</li><li>• Provides the ability to rapidly assess the situation with other corps staff sections before making a recommendation to the corps commander to warn.</li></ul> <p><b>Disadvantages</b></p> <ul style="list-style-type: none"><li>• Potentially slows down the warning time and could result in increased casualties throughout the corps AO.</li><li>• MSCs do not receive any biological-detection information and are kept in the dark while the BW cloud is moving over their units. Analysis of the data would not happen below corps level.</li></ul>
---

**Table F-2. Pros and Cons of Decentralized Warning System**

<p><b>Advantages</b></p> <ul style="list-style-type: none"><li>• Allows for faster warning of personnel for actual BW attacks since reports go directly to MSCs.</li><li>• Faster warning equals fewer casualties.</li><li>• Mask-only MOPP is available to MSCs. This could minimize heat stress degradation.</li></ul> <p><b>Disadvantages</b></p> <ul style="list-style-type: none"><li>• Requiring biological-detection units to send reports through normal command channels as well as MSCs adds an additional report requirement to biological-detection unit operations.</li><li>• MSCs do not always have access to all the other attack (intelligence) indicators. Decisions to warn by MSCs could be based on incomplete data.</li></ul>
---

(1) In the decentralized warning system, the biological-detection unit will send a summary of detection reports to the command delegated to receive the warnings. The summary information should include the following data as a minimum:

- The location of each biological-detection asset showing positive results.
- The micrometeorological conditions of each biological-detection asset showing positive results.
- The agent identified.
- The confidence level: very high, high, medium, or low (if applicable).

(2) The delegated command makes the warning determination on whether to warn and raise the protective posture based on the information reported. A simplified biological-hazard prediction is then performed and an NBC-3 (BIO) report is sent to lower, higher, and adjacent commands.

## Appendix G

# BIOLOGICAL-WARFARE SAMPLE EVACUATION PLANNING, HANDLING, AND CHAIN-OF-CUSTODY

### 1. Background

Samples are collected and initially packaged by the unit obtaining the sample. The sample is properly labeled, double-bagged, and prepared for evacuation. Ensuring that the chain-of-custody is maintained, the sample is evacuated to a sample transfer point for further evacuation, or possibly to a ship-based medical lab for field confirmatory identification. If a sample transfer point is used, a sample courier receives the sample for transport to an in-theater medical lab or ship-based lab for field confirmatory identification to support any appropriate treatment decisions. If there is an in-theater Army Medical Laboratory, the sample can be split for in-theater field confirmatory analysis and evacuation to CONUS for analysis and definitive identification. A portion of the initial sample will ultimately be evacuated to CONUS for definitive identification. If background samples are requested by an in-theater lab or ship-based lab, for whatever reason, evacuation will be conducted in the same manner ensuring that the chain-of-custody is maintained throughout the evacuation process.

**NOTE: Precautions should be taken to protect the sample collector from potential BW agents. At a minimum, respiratory protection, goggles, and protective gloves must be worn. Additional care must be taken to prevent cross contamination when collecting samples. Sample containers and packaging should be decontaminated with a 0.5 percent chlorine solution to protect those who handle the package.**

### 2. Sample Evacuation Planning and Execution

As indicated in *Chapter IV*, detailed planning and coordination by higher-level units (JTF or HQ); units possessing biological-detection assets (such as BIDS, Joint Portal Shield, or dry filter unit and handheld assay), hereafter referred to as biological-detection units; NBC unit HQ elements (such as a NBC control center); medical units; and supporting sample courier assets (such as a TEU) are required for supporting successful sample operations.

a. The supported unit prepares the required OPLANs and/or OPORDs to support the sample evacuation process. OPLANs and/or OPORDs have previously alerted and identified the assets needed to support the sample evacuation (for example, transportation and communication assets). biological-detection units, escorts, and medical activities form three of the basic elements of the evacuation process.

b. Biological-detection units begin the process by collecting a liquid sample and initiating the required chain-of-custody. The courier element provides safe handling and security, with appropriately trained personnel for the shipment of the sample. Courier personnel know key technical information (such as agent effects and characteristics) and how to respond to emergencies. The supporting Army Medical Laboratory has the capability to furnish in-theater sample analysis for field confirmatory identification. This

analysis can support joint force medical-treatment decisions. The supporting medical lab also provides feedback to the biological-detection unit and the supported unit (JTF) on sample analysis from background monitoring and suspected BW events. If an Army medical laboratory or ship-based lab is not present, custody samples may be forwarded to a CONUS reference lab by the courier element for definitive identification. Advanced arrangements must be made with the reference lab, if possible. Coordination must also be made with the HN when transporting samples through HN territories. This coordination may involve the State Department.

c. The following are examples of the types of planning and operations conducted by the supporting unit.

- The supported unit requests the deployment of a biological-detection unit, a sample courier, and medical lab assets. There is also follow-up and coordination to ensure the availability of biological-detection, courier, and medical assets to support the sample evacuation process.
- The commander and staff outline multiple options for the movement of sample evacuation packages to CONUS for definitive identification. Resources are requested to accomplish the requisite biological-detection, courier, transport, and medical procedures. The commander prioritizes the use of available assets to help ensure that the samples are moved within the required time frames.
- The command prepares and coordinates sample evacuation plans with the applicable JTF component (Army forces [ARFOR] or Navy forces [NAVFOR] medical lab activities) elements to support the option of in-theater lab analysis and to ensure asset visibility throughout the evacuation process. Planning must identify the use of all available designated laboratories such as Navy laboratories afloat or ashore, other service labs, or other agency labs within the region designated by the COCOM. For example, Navy confirmatory labs include Navy environmental and preventive medicine units, forward-deployed preventive medical units, selected aircraft carriers and amphibious ships, and selected medical facilities. These laboratories also have a reach-back capability with a definitive lab for consultation.
- The supported unit ensures that coordination for the designation of potential sample transfer points is conducted between sample courier and biological-detection units.
- The command requests and designates alternate sample courier assets if TEU assets are not available.
- The supported commander requests that the supporting biological-detection, escort, and medical-lab assets be provided with the requisite communications capability if they lack an organic capability.
- The supported commander plans for the receipt of biological-sample analyses (results) from the supporting Army medical laboratory.

d. The following provide examples of the type of planning and operations that should be conducted by the biological-detection unit:

- Deploy an advance element to coordinate sample evacuation activities with the supported unit and other key activities (such as sample courier elements and Army medical laboratory and/or ship-based lab elements).
- Establish sample transfer points, routes, and local security for moving escort elements to sample transfer points in coordination with the supported unit and courier assets.
- Ensure the proper handling and storage of liquid samples.
- Rehearse the sample evacuation and the chain-of-custody.
- Use the sample evacuation plan of the supported unit to prepare a unit OPLAN and/or OPORD (for example, sample transfer point locations, courier, security, and identification requirements).
- Plan for the receipt of results from supporting medical lab analyses.
- Train sample courier teams on topics such as the preparing, packaging, and safely handling samples; using IPE; executing emergency procedures; determining decontamination requirements; maintaining the security of the sample; completing sample documentation; and conducting sample transfer procedures.
- Prepare to handle multiple samples concurrently based on several detections within a short time frame (12 to 24 hours).

e. The commander's NBC control center must be prepared to coordinate the evacuation of samples from the subordinate units to a sample transfer point or directly to a supporting lab. Samples to be evacuated will not only be suspected BW samples, but also routine background samples when directed by higher HQ.

(1) The sample evacuation order should include the following:

- Transportation requirements and taskings.
- The sample courier qualification and training requirements.
- Travel clearances.
- The identification of the sample destination (lab).
- Communications.

(2) The commander's NBC control center must ensure that they understand where samples are being taken. Communications with the lab are established so that the lab knows samples are being shipped. Communications from the supporting lab to the supported NBC control center are of key importance. A NBC control center must be proactive in establishing these communications to ensure a timely report of confirmatory or definitive identification and the status of the samples.

(3) Following presumptive identification, the NBC control center provides instructions for sample evacuation. These instructions direct when to evacuate the collected sample or samples, the sample transfer point location, specific identification of the receiving escort team, and the NLT time to link up with the escort team at the sample transfer point.

(4) Coordination should be conducted with the receiving lab when the tactical situation or mission permits. Coordination facilities advance notification that a sample will be forwarded.

(5) All samples will be evacuated to a lab for analysis. Laboratories will prioritize sample analysis. The lab commander will determine the number and type of samples to be analyzed.

### 3. Sample Evacuation Logistics Requirements

To properly prepare a sample and the accompanying documentation for transport, specific materials are required. The following are examples of some of the key items used to properly package the sample:

- A sample transfer case will be used to transfer samples. Sample transfer cases can provide temporary storage for samples pending evacuation and should have an internal visual temperature monitoring capability. Samples should be kept at 1-4°C during storage and transportation.

**NOTE: The Navy uses a shipping container specifically designed to ship infectious substances.**

- Sample containers such as vials and bottles are provided as part of each system and the associated sampling kits. The specific size of a container will vary depending on the system that is providing the sample.
- Clear plastic bags to double-bag collection items.
- Tamper-resistant tape.
- Lab film.

**NOTE: Specific step-by-step procedures for the packaging of samples collected for systems such as the BIDS or Joint Portal Shield network will vary but still follow the basic steps indicated in this appendix. System-level sample-packaging instructions are provided in system-level service guides, TMs, and other reference publications.**

### 4. Chain-of-Custody Document Preparation

a. The chain-of-custody form establishes the biological sample as official government evidence and is a critical document. This document identifies who collected the sample, who maintained custody of the sample, and what has been done with the sample. A chain-of-custody must be maintained for every sample collected. The chain-of-custody document must accompany the sample during transport from the point of collection to the final receiving lab.

b. Whenever samples are transferred from one person to another, a custody transfer occurs. For example, sample transfer occurs when the operator who packaged the sample transfers the sample package to a sample courier. A custody transfer also occurs whenever supervision of the sample changes, such as when an operator changes shifts. All sample transfers or custody changes will be documented on this form.

*Figure G-1* provides a sample of a completed chain-of-custody form.



**NOTE: This form is not reproducible. Unless no other option is available in the field, use only original or computer-generated chain-of-custody forms.**

**Step 1.** Receiving activity. Enter your unit designation.

**Step 2.** Location. Enter the address, code, or coordinates of the collecting organization according to the SOP.

**Step 3.** Name, grade, and title of person and unit from whom received. Enter the name, grade, and title of the operator. The title could be either “Operator” or “Maintainer.” Always mark the Other block with an X.

**Step 4.** Address. If applicable, enter the nearest large city and the country. Include the mailing address—Army Post Office (APO), fleet post office (FPO), or the zip code.

**Step 5.** Location from where obtained. Enter the address, code, or coordinates according to the SOP for the location where the sample was collected (for example, 16SEC127731500).

**Step 6.** Reason obtained. Enter “Operational Biodetection.”

**Step 7.** Time/date obtained. Enter the date-time group (DTG) of the sampling period in Zulu (Z) time. Obtain this information from the biological-event log. For a sampler such as the dry filter unit, include the time sampling began, the time sampling stopped, and the time of presumptive identification (handheld-assay testing).

**NOTE: For a detection system such as the BIDS or Joint Portal Shield, the operator enters the DTG for the time that the system alerted.**

Receiving activity HQ, CO, 3rd BN 8th USMC		Location FN 12177 31500	
Name, grade and title of person from whom received <input type="checkbox"/> Owner Rogers, C.C. <input checked="" type="checkbox"/> Other CWO4, NBCDOIC		Address (include zip code) Camp Lejune, NC 28542, USA	
Location from where obtained FN 12177 31500		Reason obtained Operational biodetection	Time/date obtained 0600/19 Aug 01
Item No.	Quantity	Description of Articles (Include model, serial number, condition, and unusual marks or scratches)	
1	1	50-ml conical tube, containing a cold-weather filter, placed in less than 40 ml of collection fluid, wrapped with lab film, sealed with tamper-resistant tape, in double clear plastic bags. Designated container and clear plastic bags individually labeled US010902001WAAZZ1A.	
2	1	Sealed disk mailer, containing 1 biological-event log and 1 incident report individually labeled US010902001WAAZZ1A.	

**Figure G-1. Sample Chain-of-Custody Form**

_____ Nothing Follows _____ <i>jc</i>		_____ Nothing Follows _____ <i>jc</i>		
Chain-of-Custody				
Item number	Date	Released by	Received by	Purpose of change of custody
ALL	010819	Signature <i>Jeffrey Curry</i>	Signature <i>Curt Rogers</i>	NBCCC Shift change
		Name, grade or title Curry, Jeffrey NBCDO	Name, grade or title Rogers, Curt CWO4 NBCDO	
ALL	010819	Signature <i>Curt Rogers</i>	Signature <i>Ann Gossage</i>	Released for packaging and evacuation
		Name, grade, title Rogers, Curt CWO4 NBCDO	Name, grade, title Gossage, Ann MGySgt NBCD SNCOIC	
ALL	010819	Signature <i>Ann Gossage</i>	Signature <i>Keith Bradfield</i>	Release for escort to lab
		Name, grade or title Ann Gossage MgySgt	Name, grade or title Bradfield, Keith Technical Escort	
		Signature	Signature	
		Name, grade or title	Name, grade, or title	

**Figure G-1. Sample Chain-of-Custody Form (Continued)**

**Step 8.** Item number. Enter and itemize each package being evacuated.

**Step 9.** Quantity. The quantity will be always be “1” or greater.

**NOTE: Finish the entries with an initialed line and the words “Nothing Follows.”**

**NOTE: If item descriptions will not fit in the description block, continue the descriptions on a plain sheet of paper, remembering to close out with initials and the words “Nothing Follows.”**

**Step 10.** Description of articles. Example descriptive information for evacuation items follows:

- **Sample vial package.** Sample vial, containing less than 10 milliliters of the sample, wrapped with lab film, sealed with tamper-resistant tape, placed into a 50-milliliter tube, with absorbent material, in double clear

plastic bags. Sample vial and clear plastic bags individually labeled US010902001WAAZZZ1A.

- **Sample bottle.** Sample bottle less than 50 milliliter of the sample, wrapped with lab film, sealed with tamper-resistant tape, with absorbent material, in double clear plastic bags. Sample bottle and clear plastic bags individually labeled US010902001WAAZZZ1A.

**NOTE: A sample bottle may contain fluid from multiple BW events. The alert time recorded on the chain-of-custody form should be the first alert time associated with the fluid that is in the sample bottle. A dry filter unit record should indicate the estimated time period for the material (in the sample bottle) that was sampled from Time “A” to Time “B”.**

- **Cold-weather sample.** 50-milliliter conical tube, containing a cold weather filter, placed in less than 40 milliliters of collection fluid, wrapped with lab film, sealed with tamper-resistant tape, in double clear plastic bags. Designated container and clear plastic bags individually labeled US010902001WAAZZZ1A.
- **Supporting documents.** Sealed disk mailer containing paper copies of key information (for example, one each biological-event log and one each incident report) individually labeled according to *Table G-1* (for example, US010902001WAAZZZ1A).

**Table G-1. Sample Identification Numbers**

Example Sample Identification Number: LA010115002WAAZZZ2D					
LA	010115	002	WAAZZZ	2	D
Country code	Date (YYMMDD)	Daily sequence number	UIC	Detachment	Team
Identified in the unit OPORD.	The date the sample was collected. Given as year, month, and day.	The first sample collected each day starts with 001, and following samples are numbered in sequence.	The company UIC. This identifies the specific company that collected the sample. This number is unique for a unit.	This number identifies the detachment that collected the sample. It is only unique when combined with the UIC.	This number identifies the team that collected the sample. It is only unique when combined with the UIC.
This sample was collected in Laos.	This sample was collected in 2001 on January 15.	This was the second sample collected on January 15.	This is a fictional UIC for company Z. If you do not know your UIC, ask your team leader.	This sample was collected by a member.	More precisely, this sample was collected by an individual assigned to Team D.
<b>NOTE: If this sample is a background sample, it should also include the word “Background” below the sample ID number.</b>					

**Step 11.** Chain-of-custody item number. Chain-of-custody applies to each item number (see *Step 8*) entered on the form. If a separate action is done with only one of the items on the list, then a separate entry for that action and item must be entered.

- **Date.** The date of the transaction entered as (yymmdd).
- **Released by.** Enter the name of the person currently responsible for the custody of the item number.
- **Received by.** Enter the name of the person assuming responsibility for the items described by the item number.
- **Purpose of change of custody.** Enter a brief, accurate explanation of why the custody of the sample was transferred. The following are some examples.
  - Released for a shift change.
  - Released for evacuation.
  - Released for escort to a sample transfer point or lab.
  - Released 5 milliliters (example amount) for in-theater field confirmatory analysis.
  - Released for escort to final destination.

## 5. Biological Sample Packaging

a. All samples must be packaged in three layers of containment to meet air transport regulations (the sample container, a primary container, and a secondary container). Do this by using specialist transport media that comply with the United Nations (UN) handling regulations, consisting of a primary container, held in absorbent material within a secondary container, which is carried within an outer container; or by double-wrapping or double-bagging the primary container for less hazardous samples. For double-bagging or double-wrapping, the plastic bags or plastic container containing the sample should be placed into a second bag. Excess air pockets should be removed. The sample bags should be carried within an outer container packed with absorbent material. Any breakable containers should be placed in more rigid containers to protect them from puncture or breakage. Commercially manufactured packs specifically designed for the transport of dangerous pathogens and approved by International Air Transport Association (IATA), are widely available.

(1) Volume not exceeding 50 milliliters. Material will be placed in a securely closed, watertight container (primary container—for example, a wet collector or vial), which will be enclosed in a second, durable, watertight container (secondary container). Several primary containers may be enclosed in a single secondary container, if the total volume of all the primary containers enclosed does not exceed 50 milliliters. The space at the top, bottom, and sides between the primary and secondary containers shall contain enough nonparticulate absorbent material (paper towels) to absorb the contents of the primary containers in case of breakage or leakage. Each set of primary and secondary containers will then be enclosed in an outer shipping container (sample transfer case) constructed of corrugated fiberboard, cardboard, wood, or other material of equivalent strength.

(2) Volume greater than 50 milliliters. Packaging of material in volumes of 50 milliliters or more will comply with requirements specified in *paragraph 5a* of this appendix. In addition, a shock-absorbent material, in volume at least equal to that of the absorbent material between the primary and secondary containers, will be placed at the top, bottom, and sides between the secondary container and the outer shipping container. Single primary containers shall not contain more than 1,000 milliliters of material. However, two or more primary containers whose combined volumes do not exceed 1,000 milliliters may be placed in a single secondary container. The maximum amount of agent that may be enclosed within a single outer shipping container shall not exceed 4,000 milliliters.

b. When handling the sample, eye protection, respiratory protection, and gloves must be worn. See the applicable system-level TMs or TOs for specific instructions on packaging liquid samples, such as sample vials or sample bottles. See *Table G-2* for specific instructions on preparing unique items, such as the dry filter unit filter pads, for evacuation.

**Table G-2. Preparing a Dry Filter Unit Filter for Shipment**

Dry Filter Preparation Procedures		
	Item	Instructions
	1	Obtain the tube that contains the dry filter unit filter.
	2	Place an adhesive label containing the sample identification number on the tube.
	3	Seal the tube first with lab film and then with tamper-resistant tape. Apply two strips of tape across the cap in an "x" pattern ensuring that the tape reaches down both sides of the tube. Ensure that the tape covers a portion of the label on the tube, but does not cover the sample identification number.*
	4	Place the tube inside a plastic bag or IATA container containing absorbent material. If using a plastic bag, remove excess air, twist the neck of the bag until it forms a tight coil with the bag snug around the tube, and seal it with a strip bag tie.
	5	Place an adhesive label containing the sample identification number on the IATA container or plastic bag.*
	6	Place the tube inside a second bag or an IATA container. If using a plastic bag, remove the excess air, twist the neck of the second bag until it forms a tight coil, and seal it with a strip bag tie.
	7	Place an adhesive label containing the sample ID number on the outer packaging.*
	8	Place the package inside the sample transfer case.
	9	Complete the chain-of-custody document. Ensure that the operator handling the sample signs the initial signature immediately.
*After steps 3, 5, and 7, spray and wipe the package with a 0.5 percent chlorine solution.		

## 6. Sample Identification Number Assignment

a. The minimum essential information that must be addressed in the sample identification number is as follows (see *Table G-1* [page G-7]):

- The country code (2 digits).
- The year, month, and day the sample was collected (6 digits; yymmdd).
- The daily sequence number (3 digits).
- The unit identification code (6 digits).

- The identification of the unit collecting the sample, down to the team or detachment level (2 digits).

b. If a shift change occurs prior to the evacuation notice, the stored sample must be released to a new shift leader using the chain-of-custody form. The sample identification number must be applied to the chain-of-custody form when a shift change occurs.

## 7. Supporting Documentation Packaging

The documents that support the evacuated sample are integral components of the evacuation package and must accompany the sample. *Table G-3* provides representative instructions for packaging this material.

**Table G-3. Packaging Supporting Documents for Evacuation**

Packaging Supporting Documents		
	Item	Instructions
	1*	Provide two copies of the biological-event log and incident report. Label each log sheet and report with the sample identification number.
	2	Place one copy of the log inside the disk mailer. Maintain the second copy of the log and incident report.
	3	Place an adhesive label containing the sample identification number on the disk mailer.
	4	Seal the disk mailer.
	5	Place tamper-resistant tape over all sealed edges of the disk mail sealer. Do not cover the sample identification number with the tape. Place the sealed disk mailer into a plastic bag so that it does not get wet.
	6	Place the supporting documents package in the sample transfer case.
	7	Complete the chain-of-custody document. Ensure that the operator handling the sample signs the initial signature immediately.
*USN guidance lists supporting documentation as a handheld-assay report and a chain-of-custody form.		

**NOTE: In the event that additional mailers are used, each one must have a separate item description on the corresponding chain-of-custody form.**

## 8. Completed Evacuation Package

Each completed sample evacuation package is composed of the following items:

- The sealed and packaged sample container.
- The sealed disk mailer.
- The chain-of-custody form. The completed chain-of-custody form will be hand-carried by the sample courier. There will be one complete sample evacuation package for each sample.

## **9. Sample Evacuation Planning Considerations**

Once samples are collected they must be evacuated in a timely manner. Specifically, samples should arrive at an in-theater lab within 6 hours of collection. The samples should be delivered to a CONUS lab within 24 to 48 hours.

**NOTE: The time planning factors serve as guidelines. Samples should still be evacuated even when mission constraints delay evacuation. Sample evacuation planning and operations require close coordination between the installation and the supporting lab. Samples should be kept at 1-4°C during shipment.**

**NOTE: Biological samples should be delivered to the supporting lab in the AO for in-theater confirmatory analysis before they are transported out of the AO. The supporting lab is responsible for providing confirmatory identification in the AO.**

## **10. Background Sample Evacuation**

Depending on ambient background conditions, samples are collected for an evaluation of background conditions. This could result in a sample being forwarded to the supporting medical lab for analysis. As required, the supporting lab may maintain negative samples on hand for historical record purposes.

## Appendix H

# LONG-RANGE BIOLOGICAL STANDOFF DETECTION SYSTEM OPERATIONS

### 1. Background

a. This appendix addresses long-range biological-agent detection using the USA biological-detection company LRBSDS, which is a corps and/or echelons above corps (EAC) asset. The LRBSDS assists in providing early warning to maintain a COP and to enhance FP. It employs a laser system that is mounted in a helicopter to scan a designated area of interest (AOI) and find large, man-made aerosols suspected of containing BW agents.

b. LRBSDS teams obtain detection data and use the helicopter radios to submit incident reports to a biological-detection company. The biological-detection company uses the information to alert the ground-based biological-detection assets and to work with the corps NBC officer to analyze data and determine if a biological attack has occurred. When a potential BW attack is detected, the NBC center can predict the hazards. The corps NBC officer, along with other battle-staff members, integrates the operational indicators from the LRBSDS with biological-surveillance data from biological-detection assets (BIDS), other intelligence, and other staff input. The staff analyzes and evaluates all available indicators to ascertain if a biological attack has occurred and to determine the appropriate recommendations for the force commander.

### 2. Mission

The LRBSDS provides long-range biological-detection information to the designated HQ (biological-detection company). The crew uses the LRBSDS that is mounted in a UH-60 helicopter to scan the designated AOIs to detect, range, and track large-area aerosols disseminated on the ground or in the air. Based on the LRBSDS outputs and operator assessment, the team interprets the data presented and forwards an LRBSDS incident report according to the instructions provided in the higher HQ OPOD. Although the LRBSDS is configured for aerial-based surveillance, the system cannot be configured for use on other small or medium rotary-winged aircraft. An LRBSDS mission can be divided into the following three phases: preoperations, biological surveillance, and postoperations. These three operations are discussed later in this appendix.

### 3. Capabilities

a. The LRBSDS provides the operational-level commander with multiple capabilities. These capabilities include—

- Cueing BW point detectors about incoming, man-made aerosols.
- Providing early warning for forces on the move.
- Providing a limited capability to detect man-made aerosols in an economy-of-force role (for example, with a limited number of point detectors, the LRBSDS can supplement other detection systems).



- Enhancing the biological-detection surveillance array probability of detection (specifically, the LRBSDS may detect man-made aerosols that miss point detectors because of gaps in the cloud or low aerosol concentration).

b. The capabilities of the LRBSDS enable it to detect aerosol clouds and classify them as man-made or naturally occurring. Therefore, depending on multiple METT-TC factors (such as the available flight time and the assigned mission), commanders may instruct the LRBSDS team to conduct the following tasks.

(1) Detecting and mapping a man-made aerosol. The team uses this technique to map the left and right limits of the cloud and estimate the downwind drift (direction and speed). This technique requires about 30 to 45 minutes and can support the warning of specific areas.

(2) Detecting and tracking an aerosol. The team uses this technique to estimate the downwind cloud drift and classify the aerosol as naturally occurring or man-made. This technique does not determine the left and right limits of the cloud. It requires about 15 minutes.

(3) Detecting and classifying an aerosol. The team uses this technique to classify an aerosol as naturally occurring or man-made. This technique requires about 5 minutes. For example, the role of the LRBSDS could include detection and classification to enable the cueing of downwind point detectors, detecting and mapping, or detecting and tracking to support the tracking of an aerosol cloud. This information supports estimates on the size of the area that needs early warning.

#### **4. Organization**

a. LRBSDS Teams. A six-man element is organic to the biological-detection company HQ section. The element consists of three, two-man LRBSDS teams (one E6 and one E5). The LRBSDS noncommissioned officer in charge (NCOIC) is the senior operator. The teamwork of the LRBSDS team and flight crew is important for successful mission accomplishment.

b. Command and Support Relationships. Since the LRBSDS is organic to the biological-detection company, the biological-detection company commands the element, receives and analyzes LRBSDS reports, and provides administrative and logistics support. One or more LRBSDS teams are normally placed within operational control (OPCON) of an Army aviation brigade. The aviation brigade receives long-range detection missions from corps OPORDs and/or FRAGORDs, assists in planning, and controls mission execution. The aviation brigade provides mission helicopters from an aviation company, trains the helicopter crews on LRBSDS missions, and provides logistical support as directed. The aviation brigade NBC officer and/or NCO plans and coordinates LRBSDS missions assigned to the brigade. If LRBSDS teams cannot communicate directly to the biological-detection company, they radio their mission reports to the aviation brigade tactical operations center (TOC) or other station for relay to the biological-detection company CP where they are analyzed, acted on, and/or passed to the corps NBC control center. If a biological-detection capability is needed for an early-entry operation, the force package should include (as a minimum) a biological-detection company consisting of a LRBSDS and biological-detection team, elements of the

biological-detection company HQ, and CLS teams. The biological-detection company expertise is required to analyze the information generated by the LRBSDS and BIDS.

c. Organizational Functions. The key functions of each member of the LRBSDS teams are shown below.

(1) LRBSDS NCOIC (senior operator). The LRBSDS NCOIC is responsible for—

- Supervising and leading the LRBSDS teams.
- Providing input to the biological-detection planning process, coordinating and preparing for LRBSDS missions, receiving LRBSDS missions from the aviation brigade (when OPCON or attached), monitoring the execution of missions, assisting in postmission debriefings, and supervising custodial procedures for data tapes.
- Coordinating missions with the aviation brigade chemical officer and flight operations center. With the tasked aviation company, he directs and coordinates movement and linkup with the aviation brigade and ensures that mission aircrews are briefed on laser hazards.
- Obtaining meteorological data.
- Training teams, maintaining equipment, and ensuring that logistics, morale, and discipline are maintained.

(2) Operator. The LRBSDS operator is responsible for—

- Coordinating and preparing for missions.
- Receiving missions from the LRBSDS NCOIC.
- Transporting equipment to the staging area.
- Coordinating with pilots.
- Loading and/or unloading the LRBSDS and preparing it for operations.
- Operating the LRBSDS during missions, interpreting LRBSDS data, and downloading data and maintaining the data tapes.
- Performing postsurveillance operations for the LRBSDS and support equipment.
- Conforming to safety procedures for the LRBSDS, the helicopter, the generator, and the forklift.
- Performing operator maintenance on LRBSDS and support equipment.

(3) Assistant operator. The assistant operator is responsible for—

- Assisting the operator with the functions shown above.

- Recording detection information on the mission data sheet (during missions), obtaining flight information from the pilot, ensuring the completeness of reports, and transmitting the reports.

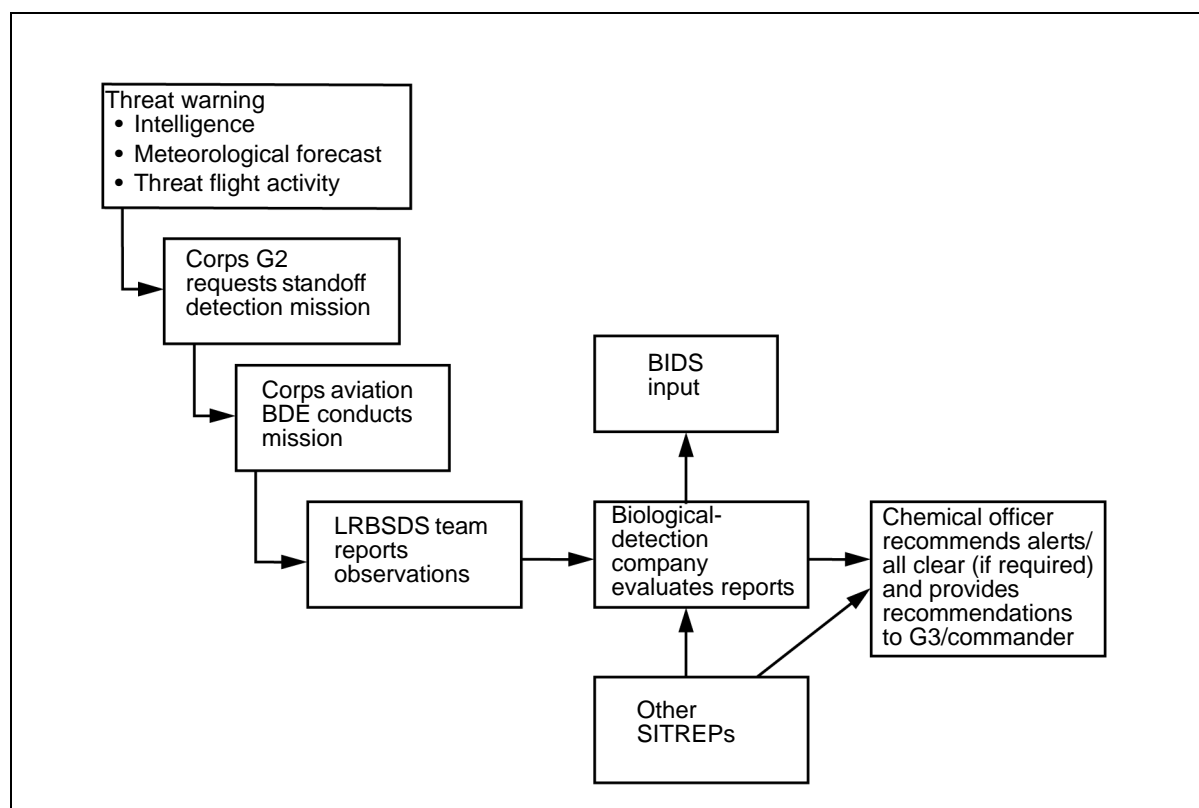
d. Quality Management. Biological-detection company and LRBSDS unit leaders assure team proficiency. Team proficiency is maintained through measures such as periodic hands-on training that involves the controlled and approved use of simulants to support system detection.

**NOTE: The operator's and assistant operator's roles may alternate depending on factors such as mission length.**

## 5. Employment Planning

a. LRBSDS planning will include information such as the time and desired surveillance tracks to be flown and will identify the laser eye safety risk to personnel and recommend measures to minimize that risk.

b. To support LRBSDS, the corps aviation brigade will normally provide aircraft support for the surveillance mission. *Figure H-1* provides a flow diagram of the LRBSDS employment concept.



**Figure H-1. LRBSDS Employment Concept**

c. LRBSDS operations will be planned to maximize the warning time for a large-scale line source biological-agent attack against US forces. The primary value of LRBSDS is to provide early indication of a possible line source attack by determining the

location and size of the suspect cloud. This allows time for the cueing of ground-based biological detectors and casualty avoidance measures.

d. The corps aviation brigade will conduct the LRBSDS surveillance mission according to the approved plan. The aviation officer will allocate the necessary aircraft and coordinate airspace utilization with the USAF tactical air control system or other airspace management authorities as appropriate. The aviation officer may adjust the planned aircraft flight route to minimize risk, and mission planning could include measures for suppression of enemy air defenses (SEAD).

e. Conducting routine environmental checks to acquire background aerosol data is a key to successful employment. Access to accurate meteorological forecasts, intelligence information on threat BW capabilities, and timely information on potential line spray activities (surface or air) help support a quick response by the airborne LRBSDS team. For the LRBSDS to conduct the detection of a biological attack, the aircraft should fly on a track parallel to the cloud with the appropriate standoff distance. Normally, the planned flight track will be perpendicular to the surface wind direction.

f. Effective use of the LRBSDS increases the overall probability of BW detection (detecting a man-made aerosol). Planners coordinate with intelligence and aviation personnel to analyze the air defense threat to minimize risks to the crew and aircraft. Additionally, planners provide maximum flexibility in flight coordination measures because of the many variables that can impact the downwind drift (wind shift) of man-made aerosols.

g. The basic information provided from LRBSDS operations can help to answer the following questions:

- Is there a suspect aerosol?
- Where is the suspect aerosol, and where is it traveling?
- How large is the suspect aerosol?

h. The force commander's R&S plan organizes the collection of information. The R&S plan will include specific biological-surveillance requirements and the biological-detection company and/or the aviation brigade OPLAN and/or OPORD will integrate requirements for long-range biological-detection missions. The LRBSDS element implements the OPORD and responds to FRAGORDs.

i. Planners consider multiple factors when employing the LRBSDS, including the following:

- What is the LRBSDS mission?
- What are the required actions (detecting and mapping, detecting and tracking, or detecting and classifying) to support the mission?
- What friendly-force biological-detection assets are available? Are planners using the LRBSDS and BIDS in an integrated manner or in an economy-of-force role (for example, is the LRBSDS operating without BIDS)?
- What is the size of the NAI? The NAI size and location may cause modification of flight tactics.

- What threat information is available? For example, the threat is using an air release, the estimated length of the long line source release is 50 kilometers, and the air defense threat dictates the use of the detection and classification technique.
- What is the threat BW capability?
- What are the airspace flight coordination restrictions? Specifically, flight corridors and/or egress routes will vary depending on the operational situation.

## 6. Long-Range Biological Standoff Detection System Employment

a. When employed, the LRBSDS is used to enhance the force commander's BW detection capability. The LRBSDS can be used to provide large-area surveillance during any type of operation when there is a possibility of a BW aerosol threat. It is especially important to provide early warning during large-force movement. The information from the LRBSDS supports the IPB process and directly supports ongoing and future operations.

b. The normal basis of issue for a corps will be three LRBSDS systems. The systems should be retained as a corps asset. The area of concern for a mission, will be determined by the commander and the duration of the surveillance mission or the number of systems used will be based on factors such as—

- Beneficial meteorological conditions for BW employment.
- Force vulnerability (for example, during movements).
- Indicators from intelligence sources.
- The size of the AO.

c. The options available for employing an LRBSDS team are shown in *Table H-1*. The LRBSDS is most efficient when three systems are used together; however, LRBSDS teams could be split. For example, two LRBSDS teams could be staged at one airfield and the third LRBSDS team elsewhere.

**NOTE: To split base the teams, the supporting aviation brigade will be required to furnish additional logistics assets such as a forklift. In selecting the employment option, planners consider NAI size (the area to be scanned), meteorological conditions, force vulnerability, the degree of the threat, the terrain within the LRBSDS scan area, the flight time required to detect or track an aerosol cloud, the availability of helicopters and LRBSDS, and logistics support.**

d. Split basing the LRBSDS offers advantages and disadvantages. One advantage is the ability to conduct additional aerial BW surveillance in a distant portion of the AO. Disadvantages include part-time rather than full-time coverage at two locations (which may result in decreased scanning time and periods of time with no LRBSDS coverage), decreased biological-detection company flexibility during mission execution, and the need for additional operational planning and logistics support at the additional LRBSDS staging site.

e. LRBSDS employment techniques could include the following alternatives.

**Table H-1. LRBSDS Employment Options**

Coverage Required	Number Of LRBSDS Used	Considerations
Full time (continuous coverage)	1	Breaks in coverage due to refueling the aircraft and changing aircrews may occur if assets are unavailable to put more LRBSDSs in the air.
	2 or 3	Can use two systems on station. Requires aircrew change for lengthy missions.
Part time (interrupted coverage)	1	Least resource-intensive. Least coverage per unit of time. Appropriate for low-threat conditions. Can use for background missions.
	2	Each system can cover one-half of the area or can alternate systems on station.
	3	Each system can cover one-third of the area or can rotate systems on station. Best option for long-duration missions.

(1) Operate Three Systems Simultaneously.

(a) Each system conducts surveillance on a portion of the corps AO. This option allows for maximum coverage and early warning potential. However, it is resource intensive and allows no reserve detectors. Additionally, coverage is limited or nonexistent during refueling and/or rearming operations. Operational work-arounds, such as nonsimultaneous refueling operations, could reduce this limitation.

(b) Each system can scan one-third of the AO for part-time coverage. Careful planning is required for aircrew changes and refueling operations. Using all three may be appropriate when the threat is high and meteorological conditions are favorable for BW employment. This option provides the fastest, most complete, and most in-depth coverage of the NAI. It is also the most resource-intensive option.

(2) Operate Two Systems Simultaneously. Each system is responsible for one-half of the surveillance area. The third system is used to provide surveillance during refueling and/or rearming operations.

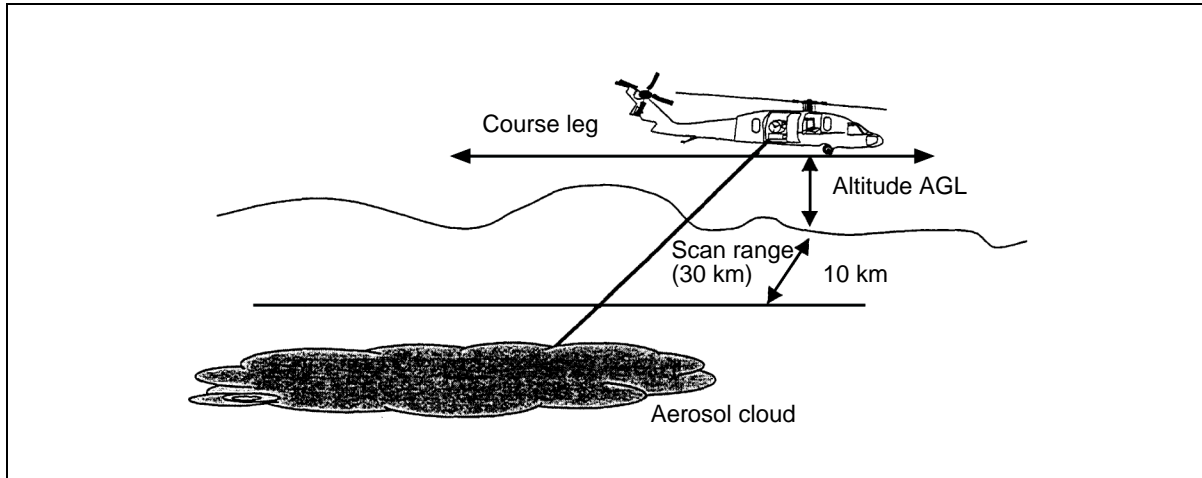
(3) Operate One System.

(a) The system conducts surveillance of the entire AO. It is the least resource intensive and provides a maximum reserve capability; however, it provides the least amount of coverage and limits early-warning potential.

(b) It is possible to scan the AO with one LRBSDS; however, the helicopter must go off station to refuel and to change aircrews during long missions. This option is the least resource intensive, provides the least amount of coverage per unit of time, and limits early-warning potential. The use of a single system could be appropriate for use when the threat is low or for background missions. This option could also be used in case LRBSDS teams are split-based—two at one location and a third at another staging site.

f. Planners may use any of the options during a given surveillance period. The LRBSDS is employed to detect and report suspected BW aerosols at distances of 5 to

30 kilometers under various atmospheric conditions. The LRBSDS requires a clear line of sight (LOS) between the system and the aerosol. It cannot reliably detect point source aerosols but can detect broken, long line source releases. The system is operated above friendly territory and out of the range of effective threat fire. A typical mission is illustrated in *Figure H-2*.



**Figure H-2. Sample LRBSDS Mission**

**NOTE: Figure H-2 shows a mission being flown on a course leg at a given altitude, 10 kilometers behind the FLOT, and scanning at a range of 30 kilometers (20 kilometers beyond the FLOT). However, the distance from the FLOT could range from 5 to 20 kilometers, depending on the threat.**

## **7. Long-Range Biological Standoff Detection System Mission Profiles**

The LRBSDS has two mission profiles—scheduled and preplanned. These missions are designed as follows.

a. **Scheduled.** This mission is normally conducted to obtain aerosol background information on the AO or to conduct other administrative missions. Scheduled missions are routinely conducted to acquire atmospheric environmental data in the AOs. The missions are planned and conducted as preplanned missions. The mission will appear in the air tasking order as biological-surveillance missions.

b. **Preplanned.**

(1) This mission is normally conducted when the threat of a BW attack is high, based upon threat information and meteorological conditions. During this type of mission, the LRBSDS team transports the system using assets organic to the aerial platform. Upon arrival, the system is installed. The aviation brigade conducts all airspace coordination and route planning. Preflight checks are completed. The mission is executed at the prescribed time. Preplanned requests require at least 24 hours advance notice for aircraft scheduling.

(2) Preplanned missions are designed to search for and detect biological attacks. These missions are normally performed during periods of high risk based on intelligence or meteorological forecasts. This mission category requires advance planning to coordinate aircraft availability, routes, and duration.

## 8. Mission Planning

A staff planning checklist is outlined in *Table H-2*. The checklist provides guidance for staff planners when planning LBRSDS missions.

**Table H-2. Example of an LRBSDS Staff Planning Checklist**

Requirements	
Obtain the commander's guidance.	
Know the friendly situation.	
Know the threat situation.	
Assist in the preparation of IPB.	
Develop the concept for LRBSDS employment.	
Provide input for the R&S plan.	
Consider command and support relationships.	
Obtain approved NAIs for LRBSDS coverage.	
Develop/update the time line for LRBSDS mission execution.	
Coordinate with the aviation officer, biological-detection company, and aviation brigade to obtain, recommend, provide, conduct, and coordinate the following: <ul style="list-style-type: none"> <li>• Weather data for the AOI.</li> <li>• Obscurant situation for the AOI.</li> <li>• Map reconnaissance.</li> <li>• Flight corridors (primary/alternate).</li> <li>• Ingress/egress routes.</li> <li>• Flight tactics during LRBSDS scanning.</li> <li>• Airspace control measures.</li> <li>• Communications frequencies.</li> <li>• Required reports/formats.</li> <li>• NAI priorities.</li> <li>• Alternate NAIs.</li> <li>• Contingency plans.</li> <li>• Input for air-tasking order.</li> <li>• Downwind drift war-gaming of biological agents.</li> <li>• LRBSDS capabilities/laser safety considerations.</li> <li>• The required time on station.</li> <li>• Provisions for SEAD.</li> <li>• Risk management.</li> <li>• Lost communications procedures.</li> <li>• The status of LRBSDS teams/equipment.</li> <li>• Threat updates.</li> </ul>	
Obtain updates on the LRBSDS CLS status.	
Review the AAR from previous LRBSDS mission.	
Obtain update on evacuation procedures for LRBSDS topics/reports.	
Anticipate and plan future missions.	

a. The JTF and/or corps NBC officer, assisted by the biological-detection company operations officer, has the primary responsibility for LRBSDS mission planning. The corps OPORD will provide guidance to the aviation brigade and the biological-detection company. Subsequent FRAGORDs will include—

- The LRBSDS mission to be performed (the area to be scanned and mission times).



- biological-detection sectors to provide sufficient coverage of the target area to be scanned.

b. The aviation brigade NBC officer analyzes the LRBSDS mission. He coordinates with the CP or the corps NBC control center of the biological-detection company to determine the following:

- The BW threat assessment, type of agent, threat targets, and threat intent.
- The ground and air defense area threat situation.
- Current BW indicators and any estimates on potential windows (times) when biological weapons may be employed.
- Meteorological conditions for the duration of the mission (see *paragraph 5*).
- JTF and/or corps commander's mission, intent, and CONOPS.
- NAIs.
- Aircraft decontamination.

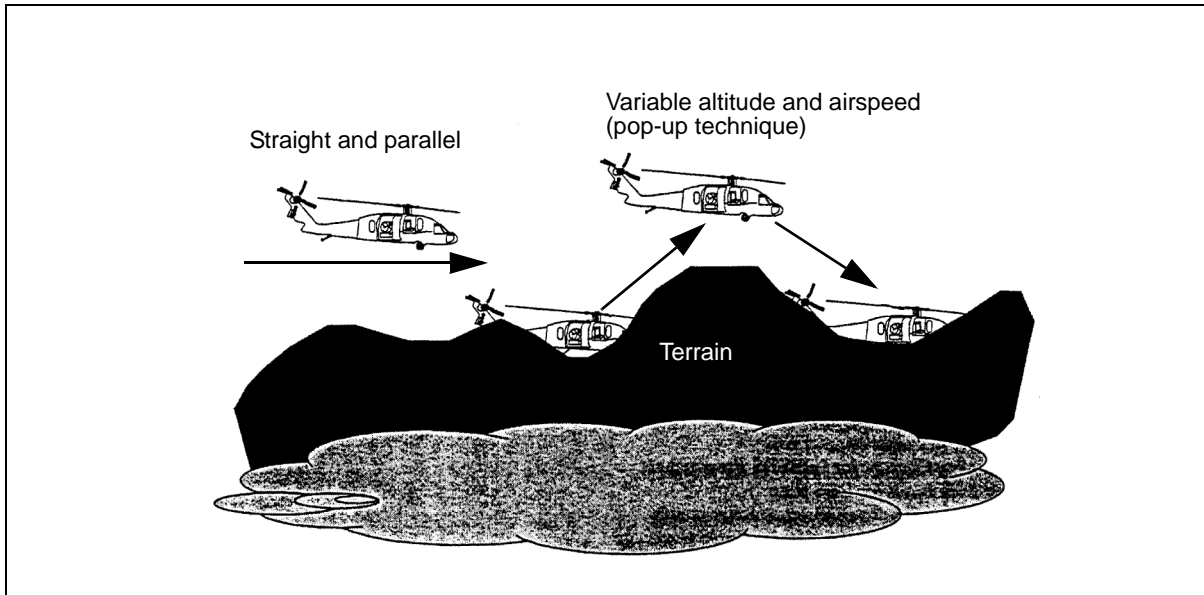
c. The aviation brigade operations staff officer (S-3) performs the following functions:

- Determines aircraft support requirements.
- Determines and plots the designated biological-detection sectors and course legs.
- Selects the routes to and from the search area.
- Recommends the flight profile to be employed during biological-detection operations.
- Determines refuel points and emergency landing zones (LZs).
- Plans handoff procedures (times and locations) for primary and backup aircraft.
- Plans for SEAD.
- Conducts airspace coordination.

d. Flight planning by the aviation brigade includes the selection of the flight profile to be employed. The profile includes designating the routes to and from the biological-surveillance target area, identifying the use of the designated course legs in the biological-surveillance sectors, and prescribing the helicopter altitude and speed. The altitude above ground level (AGL) and standoff distance from the FLOT will vary in the flight profile. For example, the altitude can range from 200 to 5,000 feet AGL, and the standoff distances from the FLOT can be 5 to 20 kilometers. Two general flight profile options are shown in *Figure H-3*.

e. Flight Profile. There are two basic flight profiles. These basic profiles may be adjusted to fit the needs of the mission.

(1) A straight-and-parallel (racetrack) flight profile involves the helicopter flying at a predetermined altitude and speed on a flight track downwind and parallel



**Figure H-3. Flight Profile Examples for LRBSDS Missions**

with the anticipated release line. For example, a general rule of thumb is that the LRBSDS should maintain a LOS with an aerosol cloud every 15 to 20 kilometers during the flight leg. This equals about 1 minute of scan time for every 5 minutes of flight time at altitudes of 4,000 to 5,000 feet AGL. This flight profile could be used when hostilities have not commenced or the air defense artillery (ADA) threat is low. This technique provides the best probability of detection because more time is spent tracking.

(2) A variation of this straight-and-parallel technique involves an effort to retrace the cloud. For example, after first contacting the cloud, contact with the cloud is lost. Subsequently, the aircraft turns around until it can reacquire the cloud. The goal is to map the ends of the cloud. The use of this technique depends on different factors, but especially on having the airspace authorization to spend additional time within a specific flight corridor.

(3) A variable altitude and airspeed flight profile is used in moderate to high ADA threat environments. It allows the helicopter to fly alternately between masked and LOS altitudes (pop-up technique). For example, the flight and LRBSDS crew picks various points along a course leg. At those points, the helicopter flies at an altitude where operators could scan the NAI. The helicopter flies at that altitude for a given time period, then moves to a lower masked altitude until the next LOS requirement. This profile has a lower probability of detection because less time is spent scanning for aerosol clouds. The variable altitude and airspeed flight profile may be used when—

- The detection and classification technique is employed. (The limited time spent scanning the cloud will not provide enough information to track or map the cloud.)
- The mission is to detect long line source (100 kilometers or more), point source, or short line source releases (less than 30 kilometers long) where the variable flight profile will be of limited or no value.

- The ADA threat is moderate to high, SEAD fires are unavailable, and nap-of-the-earth (NOE) flying will not allow the LRBSDS to detect man-made aerosols.

f. LRBSDS planning will limit the time that the threat ADA can target the helicopter; however, the LRBSDS operator must see five consecutive scans of an aerosol cloud to make a classification. Planners use this information as a basis for calculating the time required for LRBSDS scanning. Because the time required for five scans is different for various altitudes, the time is calculated for three different altitude ranges. When using a “sawtooth” flight profile, the following represents the minimum time the helicopter must remain at an altitude to give the operator a sufficient LOS to the NAI and allow scanning time to obtain sufficient returns:

- 1 minute for altitudes of 4,000 to 5,000 feet AGL.
- 45 seconds for altitudes between 2,000 to 4,000 feet AGL.
- 30 seconds for altitudes of 2,000 feet AGL or less.

g. The LRBSDS can maintain a specific amount of time on station—generally about 2 hours for most environments. Due to the limited time available for an LRBSDS to conduct scanning, additional systems may be required during detection and mapping missions. Conversely, limited on-station time and system availability may cause the use of the detection and classification missions. For example, if detection and mapping are required and the aerosol is greater than 25 kilometers in length, the majority of the LRBSDS on-station time would be spent mapping one cloud.

h. Planners must be aware of factors that can impact the LRBSDS probability of detection. For example, atmospheric visibility, the cloud particle backscatter, and the range to the target cloud will influence LRBSDS detection ability.

(1) Atmospheric visibility has the strongest effect on LRBSDS ability to detect aerosol clouds. Visibility is essentially a measure of how dirty or clean the air is. The more particles there are in the air, the more they affect how well the energy of the laser transmits through the air and how well the signals, reflecting from downrange targets (aerosol clouds), reach the LRBSDS. Good visibility means that there is less pollen, dust, and water (in the form of fog or haze) floating in the air. These particles greatly affect the minimal density of an aerosol cloud that the LRBSDS can detect and the range at which the LRBSDS can detect it.

(2) Particle backscatter is a measure (in terms of a percentage) of how much of the energy of the laser a specific particle reflects back to the receiving telescope. A higher particle backscatter means that a specific particle reflects more of the energy of the laser back to the receiving telescope than a particle with lower particle backscatter. If the LRBSDS is used to look at two clouds with the same density (particles per liter) and different particle backscatter, the cloud with higher particle backscatter will be more visible. In essence, the cloud with higher particle backscatter will be brighter to the LRBSDS and will be detectable at greater distances.

(3) The distance to the cloud determines how much of the energy of the laser intersects the particles of the cloud. As the distance between the laser and the cloud increases, the amount of the energy of the laser that reaches the cloud decreases. Applying more energy to the cloud by decreasing the distance means that it will appear

brighter to the LRBSDS. Simply put, the closer the LRBSDS is to the target NAI, the better chance it has of detecting man-made aerosol clouds.

i. *Tables H-3 and H-4* support LRBSDS planning. They provide estimates on how far away an LRBSDS can conduct detecting and mapping, detecting and tracking, or detecting and classifying operations.

**Table H-3. Helicopter NOE Altitude (150 to 1,000 Feet AGL)**

LRBSDS Range (km)	Visibility (km)			
	5	10	23	80
5	Detecting and mapping	Detecting and mapping	Detecting and mapping	Detecting and mapping
10	Detecting and tracking	Detecting and mapping	Detecting and mapping	Detecting and mapping
15	Detecting and classifying	Detecting and mapping	Detecting and mapping	Detecting and mapping
20	Detecting and classifying	Detecting and tracking	Detecting and mapping	Detecting and mapping
25			Detecting and tracking	Detecting and mapping
30			Detecting and tracking	Detecting and mapping
35			Detecting and classifying	Detecting and mapping
40			Detecting and classifying	Detecting and mapping
Detecting and mapping—detect and map for 30 to 45 minutes after release Detecting and tracking—detect and track for 15 minutes after release Detecting and Classifying—detect up to 5 minutes after release				

(1) *Tables H-3 and H-4* contain data that is based on the LRBSDS scanning a 1-kilogram-per-kilometer initial release of a dry form of *Bacillus globigii*. The tables represent a worst-case threat using dry spores. Spores have a particle backscatter that is lower than other agents (such as vegetative bacteria, toxins, and viruses).

**Table H-4. Helicopter NOE Altitude (1,001 to 5,000 Feet AGL )**

LRBSDS Range (km)	Visibility (km)			
	5	15	23	80
5	Detecting and mapping	Detecting and mapping	Detecting and mapping	Detecting and mapping
10	Detecting and mapping	Detecting and mapping	Detecting and mapping	Detecting and mapping
15	Detecting and classifying	Detecting and mapping	Detecting and mapping	Detecting and mapping
20	Detecting and classifying	Detecting and tracking	Detecting and mapping	Detecting and mapping

**Table H-4. Helicopter NOE Altitude (1,001 to 5,000 Feet AGL (Continued))**

LRB SDS Range (km)	Visibility (km)			
	5	15	23	80
25		Detecting and tracking	Detecting and tracking	Detecting and mapping
30		Detecting and classifying	Detecting and tracking	Detecting and mapping
35		Detecting and classifying	Detecting and tracking	Detecting and mapping
40		Detecting and classifying	Detecting and tracking	Detecting and mapping
Detecting and mapping—detect and map for 30 to 45 minutes after release Detecting and tracking—detect and track for 15 minutes after release Detecting and classifying—detect up to 5 minutes after release				

(2) The particle backscatter is higher for other types of agents—meaning that another threat cloud with the same number of particles as the spore cloud will appear brighter to the LRBSDS. While this implies that the helicopter can fly the LRBSDS farther from the NAI and still detect a threat cloud, the situation is not so simple because of the difficulty in anticipating the selected agents and dissemination methods of the threat.

(3) *Tables H-3* (on page H-13) and *H-4* also provide guidance on LRBSDS scanning ranges. The other factors in the tables address the altitude and visibility of the helicopter. Use *Table H-3* (on page H-13) if the flight altitude of the helicopter is 1,000 feet AGL or less, and use *Table H-4* if the flight altitude is 1,001 to 5,000 feet AGL. For example, if a helicopter is flying at an altitude of 500 feet and visibility is at 80 kilometers, planners estimate that detection and mapping can be conducted at a 5- to 40-kilometers scanning range with the LRBSDS.

j. BW threats can be disseminated in either wet or dry forms. The LRBSDS will see a wet dissemination (with the same concentration, at the same distance, and in the same visibility) twice as bright as a dry dissemination. Wet dissemination, however, is considerably less efficient than dry dissemination. Wet agents do not travel as far as a dry dissemination and do not have as many agent containing particles that can infect personnel on the ground.

k. To optimize LRBSDS performance when selecting a flight profile, planners consider the altitude, search angle, and airspeed. LRBSDS biodetection operations should be conducted at an altitude of 150 to 5,000 feet AGL at 75 to 100 knots. The type of flight profile selected will affect the settings of the system. The pilot must provide flight profile information to the LRBSDS operators before commencing altitude changes.

(1) The distance from the helicopter to the NAI is also determined during preflight planning. Specifically, the LRBSDS is limited to a 12-kilometers scan depth when flying at altitudes of 2,000 feet and below. At lower altitudes, the LRBSDS can only fully cover a 12-kilometer portion of the NAI. Planners must consider this when assigning the air corridor that the helicopter will fly. If the depth of the NAI cannot be reduced, flying at an altitude above 2,000 feet AGL could be considered. At an altitude over 2,000 feet AGL, the LRBSDS operator can easily set the system to scan the full depth of the NAI (from 10 to 30 kilometers).

(2) The selection of the flight profile is METT-TC dependent. For example, if the atmospheric visibility is below 5 kilometers, the LRBSDS is not effective; it becomes more effective as the visibility increases. Flight profiles that take advantage of available terrain, especially when using a variable-altitude profile, are used. METT-TC considerations that can impact flight profile selection include the following.

- **Mission.** The number of NAIs requiring LRBSDS support, the command and support relationships, reporting requirements, and the NAI size.
- **Enemy.** Threat ADA capability, BW threat agent, and the BW intent and capability of the threat.
- **Terrain.** Terrain characteristics, the available LOS, the atmospheric visibility, and planning for fallback flight corridors to help preclude flying through a threat cloud.
- **Troops.** Number of LRBSDS available, CLS capability, BIDS array availability and location, and the location of friendly forces.
- **Time available.** Estimated time required for the LRBSDS to be on station, the lead time required to obtain airspace clearance, the time to analyze LRBSDS detection reports, and the mission time frames.
- **Civilian considerations.** Civilian and HN assets within NAIs.

(3) To support the planning process, the LRBSDS NCOIC may use a mission planning checklist (see *Table H-5*).

**Table H-5. LRBSDS Mission Planning Checklist**

Requirement	Actions Required
Plan for future missions	Perform maintenance and PMCS on equipment. Conduct operator training. Report any equipment/personnel problems. Obtain the necessary supplies. Maintain the current intelligence/operations status.
Obtain the mission	Receive a WARNORD, OPORD, or FRAGORD.
Analyze the mission	Analyze the mission using METT-TC factors.
Issue a WARNORD	Determine which LRBSDS team is to perform the mission. Issue a WARNORD to the team and clarify questions.
Perform coordination	Coordinate with the aviation brigade chemical officer, the LRBSDS team, and the supporting helicopter unit. Determine METT-TC information, logistics support, ground movement (if required), rehearsals, and communications. Obtain maintenance support (as required).
Make a tentative plan	Plan ground movement (if required). Analyze biological-surveillance requirements (sectors or legs). Plan the necessary support.
Conduct map reconnaissance	Select the route to and from the airfield (if necessary to travel).
Complete the plan	Refer to <i>FM 101-5, Appendix H</i> .

## 9. Long-Range Biological Standoff Detection System Mission Phases

An LRBSDS mission is divided into three phases: preoperations, biological-surveillance operations, and postoperations. Each phase is discussed below.

### a. Preoperations Phase.

(1) Mission factors. To ensure success, LRBSDS capabilities are matched to mission factors, including operational coverage needs, meteorological conditions, threat, and aircraft availability. The biological-detection company operations officer and detachment NCOIC have the primary responsibility for mission planning and reconnaissance. Initial planning will normally occur at the corps NBC center or at the biological-detection company. The biological-detection company operations officer and/or detachment NCOIC will coordinate with the corps or controlling HQ staff to obtain—

- The commander's intent and CONOPS.
- The aerial platform, number, usage windows, and location.
- Meteorological conditions (for example, wind information at various heights for the duration of the operation, stability categories, sunrise and sunset information, and other pertinent factors; such as rain and snow).
- The type of threat expected.
- The duration of the mission.
- CONOPS for other BW detectors.

(2) Reconnaissance. Reconnaissance of the AO is required. If possible, the leader coordinates for an aerial reconnaissance; however, if this is not possible, the leader conducts a map reconnaissance to determine—

- Surveillance sectors (it is best to select a primary and secondary to compensate for major changes in wind directions).
- Primary and alternate traveling routes and times.
- Surveillance leg distance and duration.

(3) Flight profiles. Detailed planning determines what flight profile will be employed during surveillance operations. The flight profile is METT-TC dependent. When selecting a flight profile, the decision maker will consider three major factors: the level of threat to the aircraft, location and size of the surveillance area, and LOS. Generally, there are the following two general flight profile options.

(a) Straight and parallel. The platform flies at a predetermined altitude and speed, scanning perpendicular to the wind. The key is to ensure LOS to the target. This flight profile could be used when hostilities have not commenced or the anti-air threat is very low.

(b) Variable altitude and airspeed. The platform flies alternately between a masked and LOS altitude. For example, the platform would rise to an LOS altitude, conduct surveillance for a certain amount of time, and then descend to a masked altitude and fly until the next LOS rise.

(4) Other planning factors. Additional detailed planning requirements for the LRBSDS detachment include coordinating the passage of lines, communication requirements, logistical support from the biological detector and supporting unit, locations of the supporting airfields and FARPs, and decontamination support enroute to the supporting unit.

(a) Following the initial planning, the LRBSDS will normally be located with the HQ element of the biological-detection company, host unit, or the supporting aviation brigade. Upon notification of a mission, the detachment or biological-detection company operations officer conducts initial coordination with the biological-detection company commander, JTF, corps NBC officer, and/or the corps NBC control center. Initial information requirements include determining—

- The BW threat window and the overall BW threat, type, direction, and intent.
- The ground, anti-air, and threat situation.
- Current BW indicators.
- Meteorological conditions for the duration of the mission.
- The corps or JTF commander's mission, intent, and CONOPS.
- Current information.
- Key areas of concern.

(b) The detachment NCOIC provides the warning order (WARNORD) to the teams and directs initiation of preoperational checks. The team leaders begin preoperational actions, and conduct PMCS of associated support items of equipment and detectors.

(c) The detachment conducts movement to effect a linkup with the supporting operational platform, if required. On arrival, systems are installed onto the aerial platforms. The detachment teams conduct preoperational checks on the system and PMCS of associated support items of equipment as appropriate. The LRBSDS team and the aerial platform crew conduct coordination with each other. The LRBSDS team briefs the aerial platform crew on the following:

- An LRBSDS orientation presentation—specifically LRBSDS safety features and eye safety parameters.
- Reporting procedures and formats are provided to the pilot and crew.
- Instructions on operating the laser are reviewed with the pilot.
- The flight path and type are given to the team by the pilot (for example, NOE, height above ground, speed, and flight duration).

(5) Final mission preparation.

(a) During the final mission preparation, the LRBSDS detachment follows the checklist information found in *Table H-6* (page H-18). The LRBSDS NCOIC (or the aviation brigade chemical officer and/or NCO) provides the WARNORD or movement order to the team and directs the initiation of preoperational checks.



Following the preparation of the WARNORD, many key factors are verified or researched. These factors could include planning estimates for the potential length and location of course legs that must be flown. War-gaming provides estimated downwind distances for BW aerosols. This premission planning is conducted in coordination with the intelligence section (intelligence staff officer [S-2 and/or G-2]) and is used to help determine the locations and lengths of the course legs for biological-surveillance missions. Other input for this type of planning includes the threat BW capabilities, weather data, NAI locations, and the length and location of the line source. During the final preplanning, aviation personnel and LRBSDS teams consider and confirm what tactics will be used for the missions. Map reconnaissance identifies any obstacles that could block the scanning of the laser along a course leg.

**Table H-6. LRBSDS Mission Preparation Checklist**

<b>Preparation Required</b>	<b>LRBSDS Team Actions</b>
Issue WARNORD/movement order	Prepared by the LRBSDS NCOIC or aviation brigade chemical officer.
Move to link up with helicopter (if required)	Load equipment. Conduct road march. Report movement per SOP.
Conduct preflight equipment checks	Conduct PMCS of equipment. Perform initial adjustments, checks, and self-test of LRBSDS. Conduct inspections.
Conduct rehearsals	Conduct rehearsals.
Issue team OPORD/FRAGO	Prepared by detachment NCOIC or aviation brigade chemical officer.
Install/check equipment	Install LRBSDS on helicopter. Conform to safety procedures. Perform preflight operational checks on LRBSDS. Perform troubleshooting on LRBSDS. Perform PMCS on generator. Use generator to warm laser.
Coordinate with aircrew	Conduct air mission briefing. Coordinate flight information. Conduct laser safety briefing.
Report status	Report per SOP.

(b) The LRBSDS NCOIC or aviation brigade NBC officer and/or NCO briefs the OPORD and/or FRAGORD of the LRBSDS team. The team OPORD and/or FRAGORD is oral or written. It outlines important elements that include routes to and from the biological-detection mission (normally two entry and exit routes will be planned), flight corridors and/or course legs for LRBSDS scanning that include alternate course legs, the distance of the NAI from the FLOT, and the depth of the NAI. Coordinating instructions will also indicate that course legs crossing key boundaries (corps or ARFOR and/or Marine Corps forces [MARFOR] boundaries) have been coordinated by the appropriate aviation airspace activities (the joint airspace control center [JACC]).

(c) If the LRBSDS team is not collocated at the supporting airfield, the team or the supporting helicopter moves to the designated staging area. Movement is reported according to the OPORD or SOP. On arrival, the team installs the LRBSDS equipment on the helicopter, conducts preflight operational checks on the system, and conducts PMCS on the equipment according to *TM 3-6665-351-10*.

(d) The LRBSDS team and helicopter crew conduct air mission briefings (see *Figure H-4*) and coordination. The team briefs the helicopter crew on the LRBSDS system (specifically LRBSDS safety features and eye safety), reporting requirements and/or procedures, pilot clearance to operate the laser, and details of the biological-surveillance mission. Preflight instructions will indicate that during full- or part-time coverage, replacement LRBSDS units will receive an update on the mission situation from the supporting OPCEN (biological-detection company CP or aviation brigade OPCEN). Finally, the team receives a briefing from the pilot on safety, emergency operations, and flight information (such as the flight path, the height above the ground, the airspeed, and the flight duration).

Time.
Introduce team members.
General information.
Ground situation (S2/intelligence).
Weather.
Call signs.
Frequencies and communications net (all participants must monitor a common frequency).
Appropriate take-off times.
Flight route, altitude, time en route, airspace control measures, and egress routes.
Flight corridors (primary and backup).
Authentication procedures.
Abort codes.
Map datum.
Mission commander to LRBSDS team (airborne briefing sequence).
NAI description.
NAI location and elevation.
Terrain obstacles.
Required reports/SITREPs.
Communication nets and agencies.
Airspace coordination measures.
Restrictions.
Friendly troop locations.
Threat ADA.

**Figure H-4. Sample Air Mission Briefing Guide**

b. Biological-Surveillance Operations Phase.

(1) LRBSDS detection process. The steps of the LRBSDS process are detection, reporting, and postoperations analysis. The LRBSDS detection process is summarized in *Table H-7*.

**Table H-7. LRBSDS Biological-Detection Process**

Tasks	Products	Required Components
Detect	Nonspecific alert	LRBSDS
Report	Detection report	Helicopter radio
Postoperations analysis	AAR	Detection report, mission logs, and LRBSDS 8-mm

(a) Detection. LRBSDS detection is nonspecific. The system relies on operator experience and judgment to discriminate between natural and man-made aerosols. An experienced operator can reasonably determine if the suspected aerosol is man-made, but he cannot determine if it is a BW agent. When a biological agent is released, the LRBSDS will detect the aerosol as long as its concentration is sufficiently above the background for the current meteorological conditions. This detection window lasts minutes to hours, depending on meteorology, the specific agent used, and the initial amount and method of agent dissemination.

(b) Reporting. The LRBSDS team uses the helicopter radio to report the detection of a possible biological aerosol by submitting a detection report. Planning identified the following critical elements (as a minimum) to support reporting requirements: call signs, frequencies, report formats, and content to ensure that the ground station and flight crew understand required reports between the LRBSDS and flight crews or any in-flight coordination requirements between members of the LRBSDS crew.

**NOTE: The helicopter can transmit reports via the following communication capabilities: frequency modulation (FM) secure with KY-58, very high frequency (VHF)-FM (nonsecure), or ultrahigh frequency (UHF) (nonsecure) with frequency hopping.**

(c) Postoperations analysis. Following an LRBSDS mission, the crew consolidates key information gathered during the mission. Specifically, the crew records will include detection reports (if any), mission logs, and 8-millimeter data tapes from the LRBSDS. This information is safeguarded and, upon request, is forwarded to the biological-detection company CP. Chain-of-custody documentation will accompany the LRBSDS data tapes and documents if the information is required by the biological-detection company CP.

(2) Biological-surveillance execution.

(a) The LRBSDS team uses the information in *Table H-8* as a sample checklist for executing a biological-surveillance mission. At the beginning of a course leg and on the pilot's order, the operator puts the laser into operation and scans the target area. The laser is turned off at the end of a course leg before the helicopter executes its turn. The laser is turned back on when the pilot notifies the operator that the helicopter is at the beginning of the next leg. The operator begins tracking techniques on detection of a suspicious aerosol. The assistant operator records information on the mission data sheet and transmits incident reports. The laser operator ensures that the LRBSDS scan

remains on the NAI and that ongoing communications with the flight crew are maintained to ensure that the scan is adjusted (as required) to remain within the NAI.

**Table H-8. LRBSDS Biological-Surveillance Mission Execution Checklist (Sample)**

Actions Required	LRBSDS Team Actions
Prepare to conduct a biological-surveillance mission	Check equipment. Set flight parameters. Conduct equipment function tests.
Conduct the biological-surveillance mission	Operate the LRBSDS. Scan along the course legs in the designated area. Analyze the display of any aerosol cloud detected. Record aerosol cloud information and flight data.
Provide reports	Prepare detection report.
Complete the biological-surveillance mission	Download data onto data tapes, if required.

(b) The operator determines the length of the aerosol cloud. If multiple LRBSDS are used, each detector scans its own AO for the left and right limits of the aerosol. If an aerosol is discovered on a course leg and then lost, the team requests permission to backtrack along the same leg to reacquire the aerosol. If an aerosol is being tracked on a leg and it continues beyond the course leg or across the corps boundary, the team reports this and requests instructions. The helicopter does not deviate from the approved flight plan without authorization or coordination.

(c) If directed by the biological-detection company, the operators will attempt to determine the length of the aerosol cloud. This is accomplished in two ways.

- The pilot hovers the helicopter perpendicular to the cloud and the operator manipulates the detector to scan for the ends of the cloud.
- The helicopter is flown parallel to the cloud until the end of the cloud is reached. If multiple detectors are in the air, then each detector will scan its own AO for the left and right limits of the cloud.

(d) During LRBSDS operations, the operator determines the following information:

- The presence of a suspected biological aerosol using a monitor display of changes from the background.
- Whether the cloud is natural or man-made, based on aerosol characteristics.
- The distance (range) of the cloud from the helicopter.
- The height, length, and width of the cloud.
- The height of the cloud above the ground.

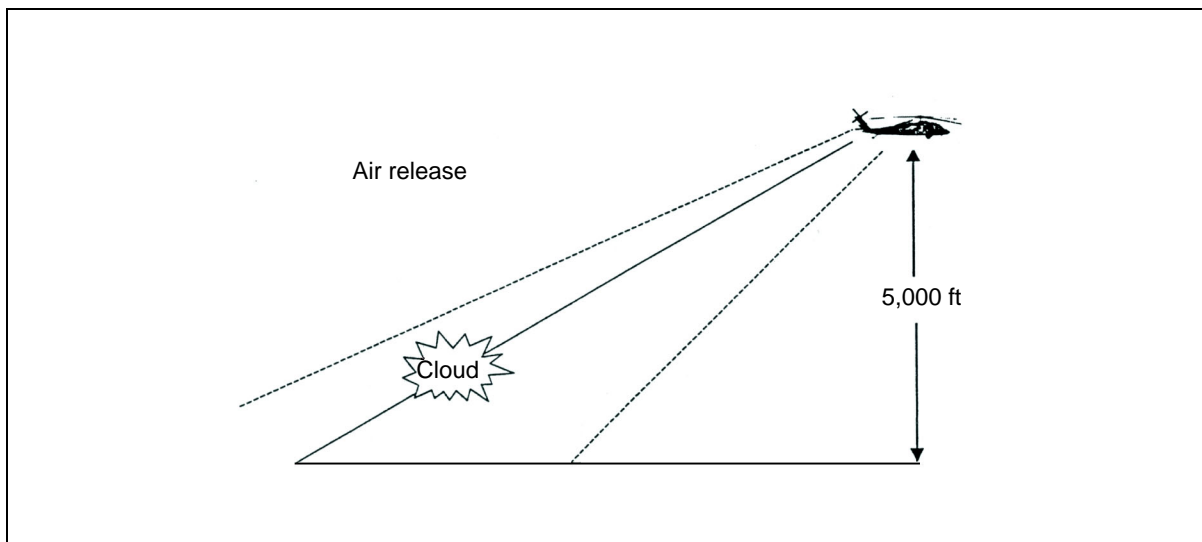
- The relative aerosol concentration (high, medium, or low), which may be estimated from the intensity of the color and returned energy signal.

(e) During biological-surveillance operations, the assistant operator uses a map to plot and track any aerosol clouds that were detected during the mission. By plotting both ends of the cloud and estimating the forward edge, cloud movement can be estimated. Communications with the flight crew on cloud movement can also decrease the chances that the helicopter would inadvertently fly into a BW cloud.

(3) LRBSDS flight operations. LRBSDS biological-surveillance operations require synchronization of flight operations between LRBSDS operators, flight-crew personnel, and operations and planning sections. Operational factors that influence flight operations include flight profile selection, aerial releases, ground releases, elevation differences, altitude and flight profile considerations, optimal data collection altitude, detections, laser scanning, in-flight protocols, communications protocols, and reporting.

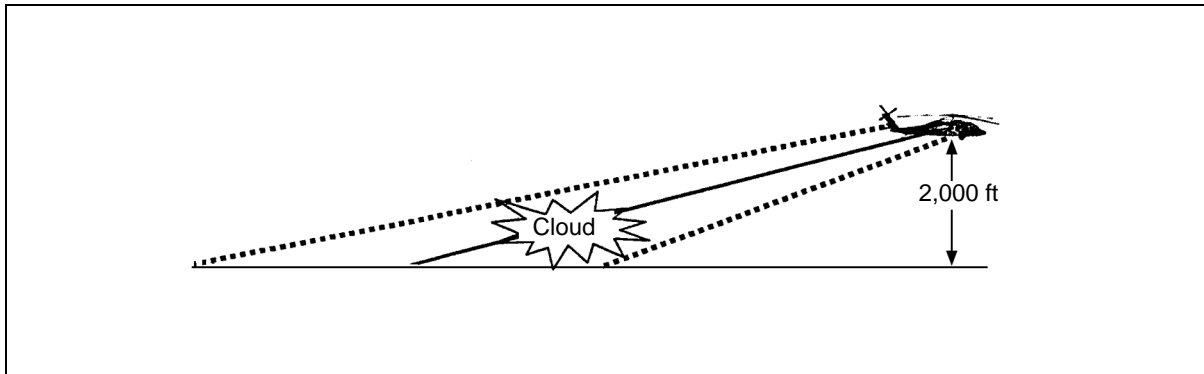
(a) Flight profile selection. The profile considers the altitude, the search angle, and the airspeed that optimize LRBSDS performance. The LRBSDS can be flown from 150 to 5,000 feet AGL. The optimal airspeed is between 100 and 120 knots. If the atmospheric visibility is less than 5 kilometers, the system is marginally effective. Higher altitude AGLs increase the LRBSDS scanning range and the probability of detecting aerially disseminated man-made clouds within designated NAIs. Using straight and level profiles rather than variable-flight also increases the probability of detecting an aerosol cloud because of increased scanning time.

(b) Aerial releases. It is better to fly higher (see *Figure H-5*) to detect aerial releases. The air at lower altitudes has more aerosol particles (dust, pollen, and smoke) that reduce the power of the laser before it strikes the suspect cloud. Flying higher means that more laser energy hits the suspect cloud, thus giving the operator a stronger return signal. Flying at 4,000 to 5,000 feet AGL to scan the NAI provides an optimal vantage point for detecting an aerial release.



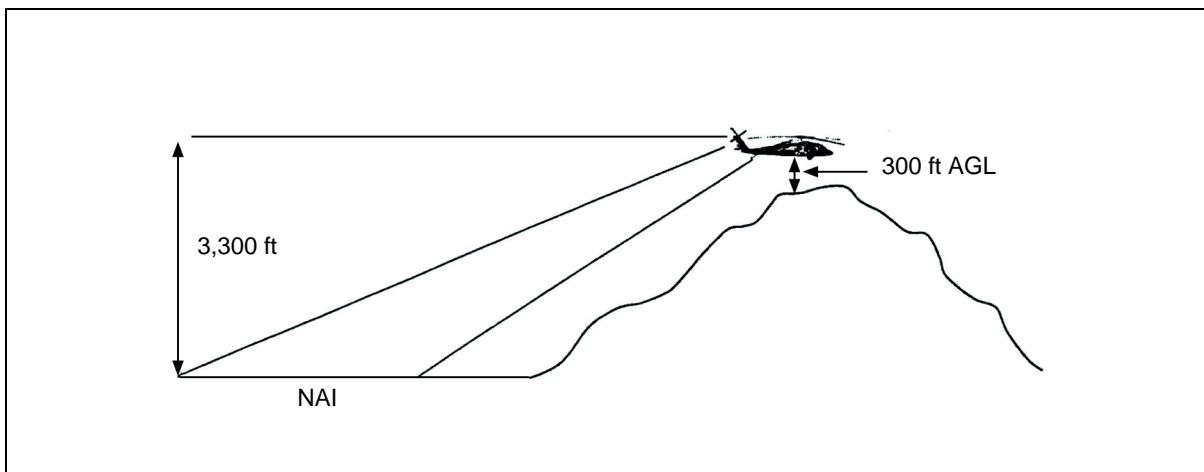
**Figure H-5. Optimal Altitude for Air Release**

(c) Ground releases. Ground releases are more difficult to detect because the operator has to differentiate the suspect cloud from the ground. Although less laser energy hits the cloud, it is better to fly lower to reduce the angle at which the laser strikes the cloud (see *Figure H-6*). This shallower angle improves the operator's chances of differentiating between the cloud and the ground. The optimal altitude for detecting a ground release is 1,000 to 2,000 feet AGL.



**Figure H-6. Optimal Altitude for Ground Release**

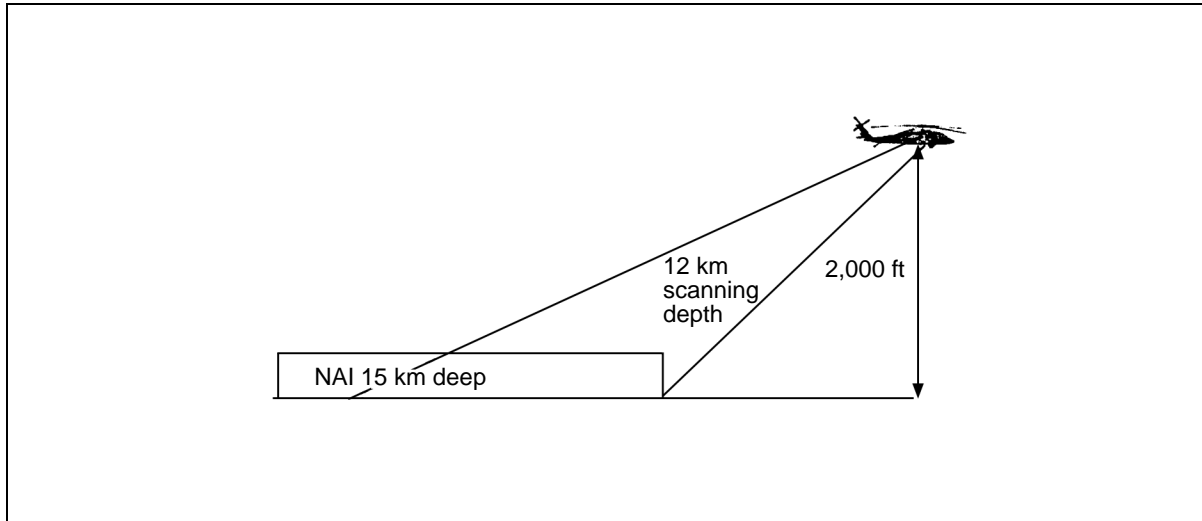
(d) Elevation differences. The LRBSDS operators should note that the helicopter flight altitude AGL might be different from the elevation of the NAI. For example, the helicopter could fly just above a mountain ridge and be at 300 feet AGL; however, the NAI being scanned could be 3,000 to 4,000 feet below the level of the helicopter (see *Figure H-7*). Before a mission, LRBSDS operators conduct a map reconnaissance of the NAI and the flight corridor to determine if an altitude and/or elevation difference exists. The operators note any changes in the elevation of the NAI that would require changes to LRBSDS settings.



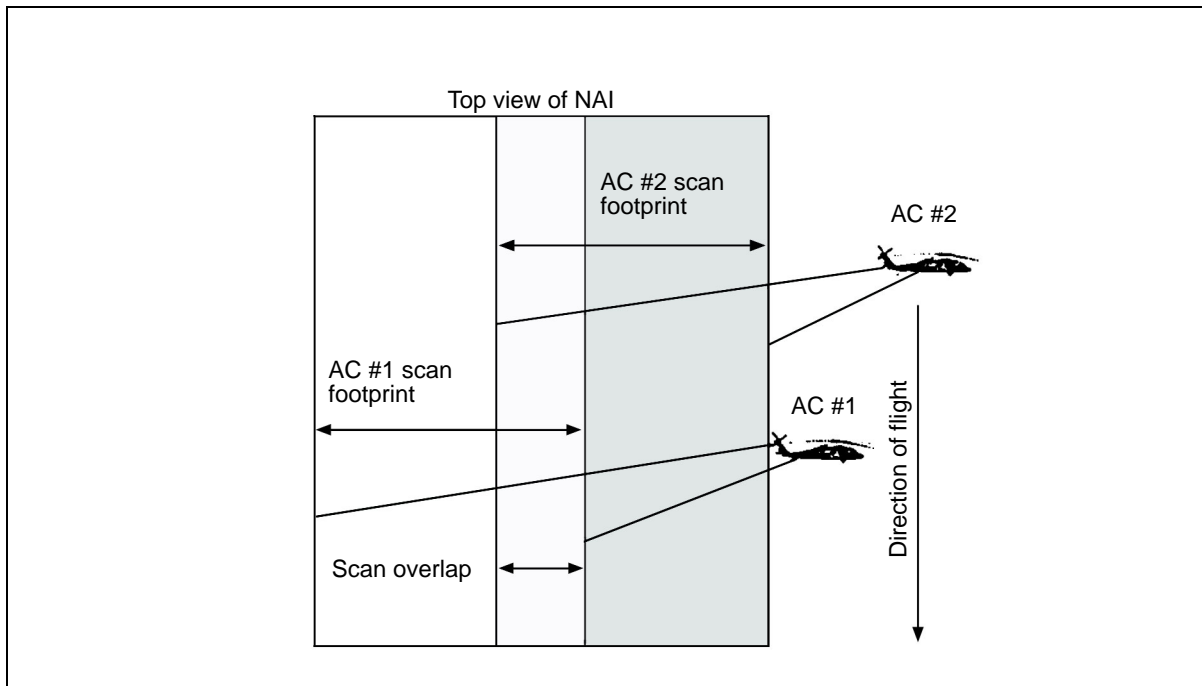
**Figure H-7. Difference in Helicopter Altitude and NAI Elevation**

(e) Altitude and flight profile considerations. At altitudes less than 2,000 feet AGL, the LRBSDS is limited to scanning only 12 kilometers deep into the NAI (see *Figure H-8* [page H-24]). If the NAI is deeper than 12 kilometers, planners may consider using two LRBSDS to scan the entire NAI (see *Figure H-9* [page H-24]). Other

alternatives include scanning the front edge of the NAI using a checkerboard pattern (see *Figure H-10*) or alternately scanning the near and far edges of the NAI. *Figure H-11* shows another technique for a LRBSDS scanning an NAI that is more than 12 kilometers deep at an AGL below 2,000 feet. During the flight leg, the LRBSDS initially scans the front edge of the NAI and then scans the rear portion of the NAI. To ensure adequate coverage, this alternative should only be used when the width of the NAI is less than 60 kilometers.

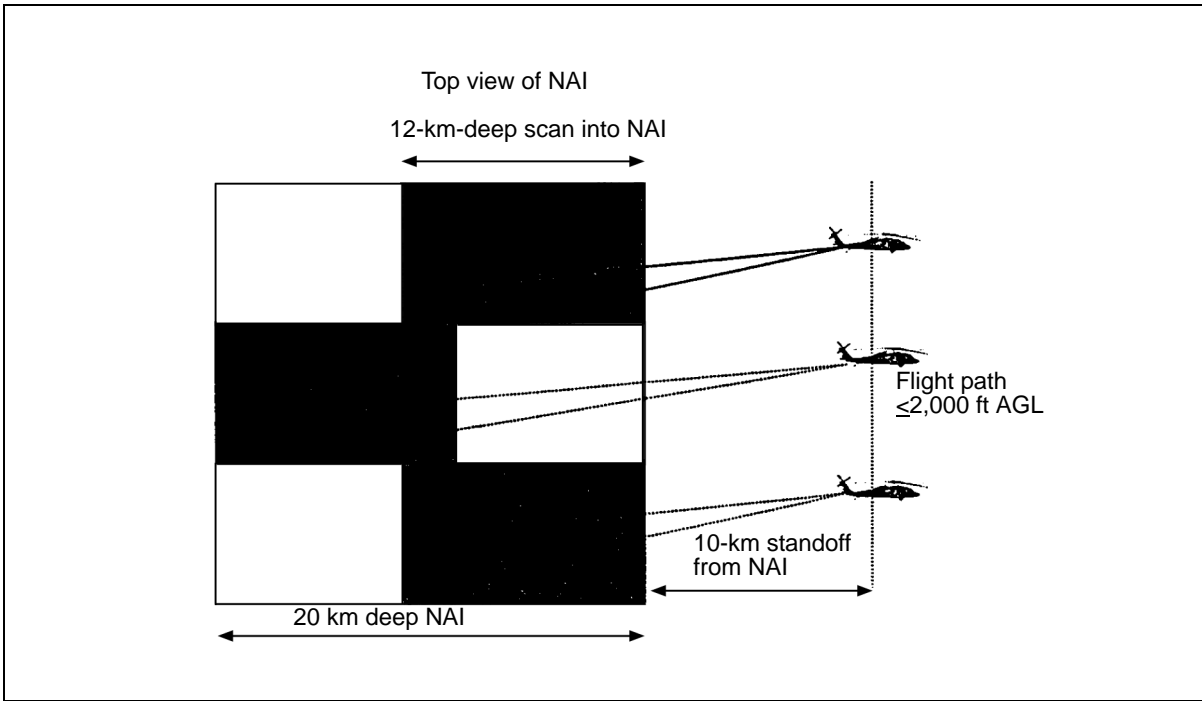


**Figure H-8. Low-Altitude Flight Profile Considerations**

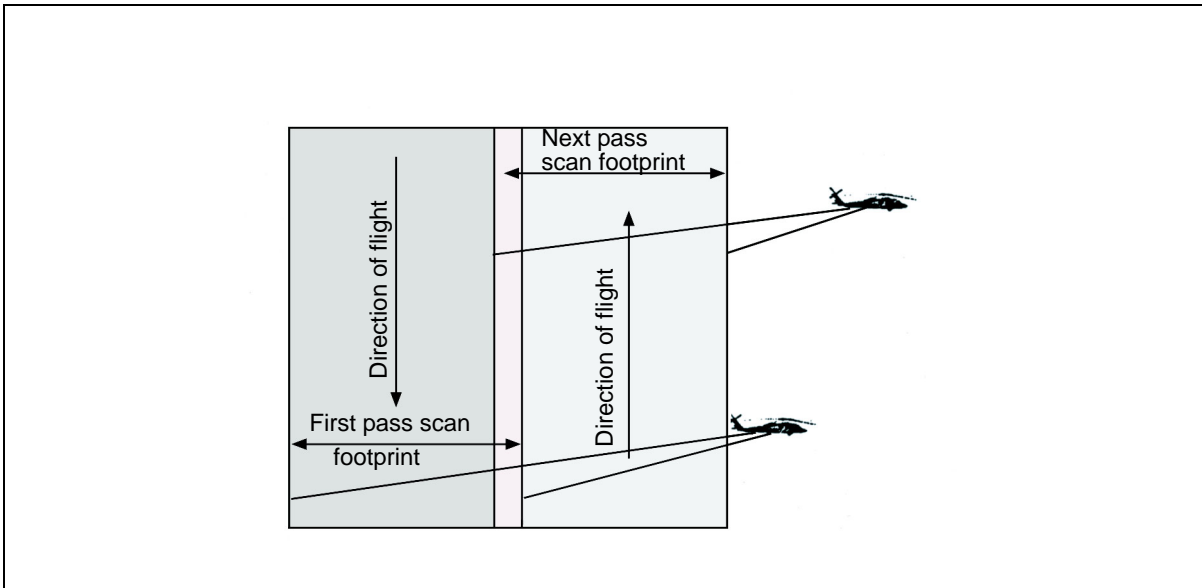


**Figure H-9. Two LRBSDSs Scanning an Entire NAI**

(f) Optimal data collection altitude. The LRBSDS aircraft operates at an altitude that should be an optimal data collection altitude for scanning the entire NAI



**Figure H-10. An LRBSDS Scanning a Checkerboard Pattern Into an NAI**

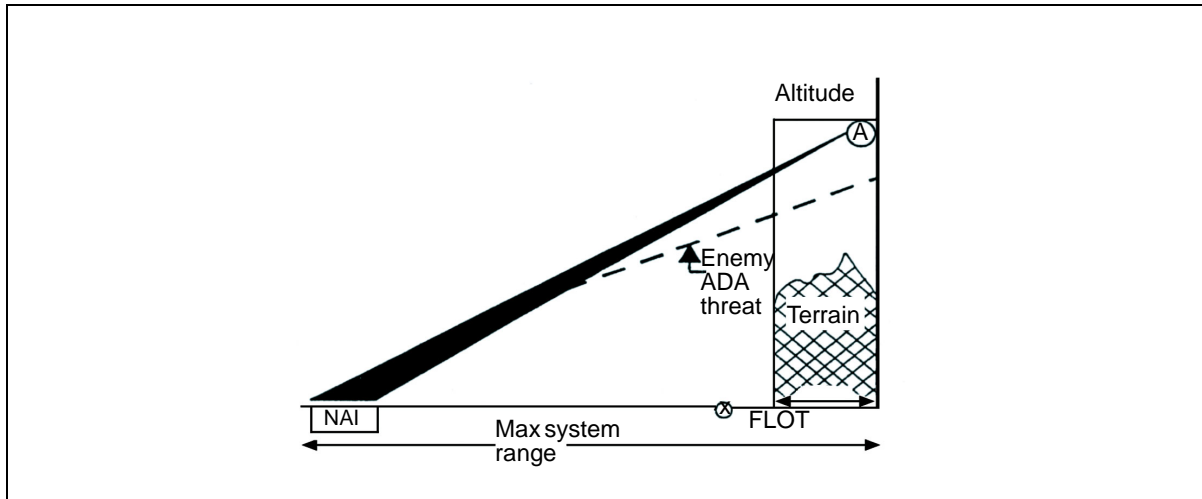


**Figure H-11. An LRBSDS Scanning the Front and Rear Edges of an NAI**

in one pass. However, the aircraft may be within the threat ADA LOS, creating a need for the aircraft to fly a major portion of the surveillance mission at the optimal collection altitude, then go to a safer—but less advantageous—altitude for that portion of the course leg where the ADA threat exists.

**NOTE:** See *Figure H-12* (page H-26) for an example that indicates aircraft A could be at risk from threat ADA capabilities.

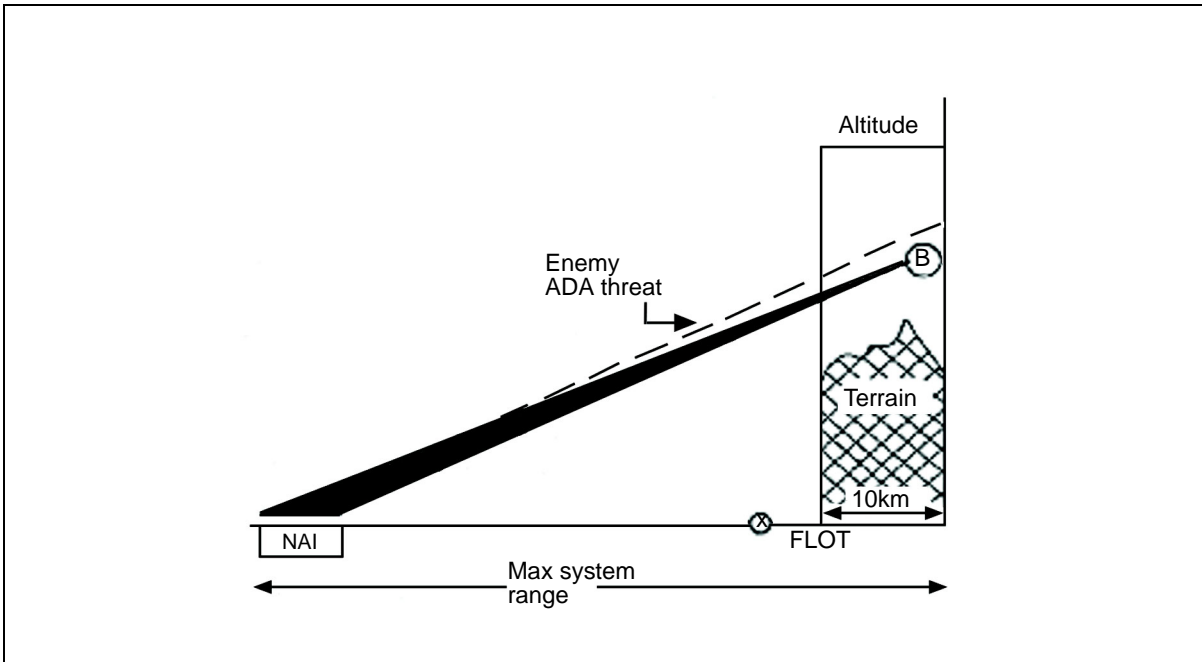




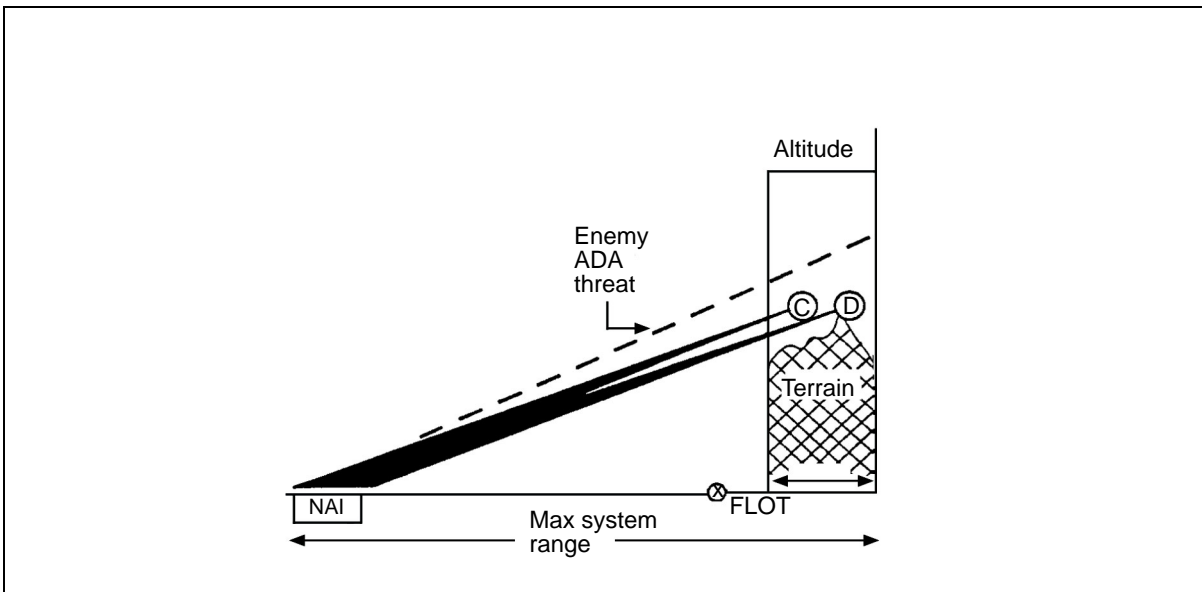
**Figure H-12. Optimal Data Collection Altitude**

- In *Figure H-13* aircraft B is at an altitude allowing single pass NAI coverage; however, due to the reduced altitude, the LRBSDS operator may experience less data resolution and less aerosol discrimination. This qualitative degradation does not necessarily prevent the operator from identifying the cloud, but it may make the task more difficult depending on system alignment, range, moisture and background particulates in the air, and BW-agent concentration. Any one of these factors can prevent detection or discrimination. The more likely situation, however, is the cumulative impact of several factors. The NBC staff planner must appreciate these potential impacts and recommend altitudes that will permit detection and discrimination.
- The examples in *Figures H-12* and *H-13* focus on single pass options on a NAI. The third flight profile option (shown in *Figure H-14*) depicts multiple passes on the NAI to obtain full target coverage. In this example, aircraft C flies a low-level pass at maximum range to scan the back half of the NAI, followed by a second pass by aircraft D (flown farther from the FLOT) to scan the closer half of the NAI. The staff may recommend this option when flying multiple, low-altitude aircraft passes rather than higher altitude passes would increase survivability.

(g) Detection. The LRBSDS detection capability depends on the operator's skill and ability. As the system receives the returning laser signature, it displays the information to the operator as a waveform display (similar to an oscilloscope) and a graphical depiction of the scans that approximate the appearance of the cloud. The operator interprets the display and determines whether the signal is a man-made or naturally occurring aerosol. During the mission, the operator's attention is on the waveform display. The operator looks for five consecutive scans that are at least twice as high as the background noise level. After observing five consecutive scans using this criterion, the operator will direct the assistant operator to fill out a detection report. After using the detection criteria, the operator also monitors the range to the cloud, cloud



**Figure H-13. Minimum Single-Pass Altitude**



**Figure H-14. Minimum Multipass Altitude**

size and shape, height above the ground, relative intensity in the scan display, and cloud travel consistent with the speed and direction of the wind.

- If the LRBSDS crew scans the aerosol within 15 to 30 minutes of the release, the LRBSDS operators should be capable of further classifying a man-made cloud. Smoke clouds, vehicle dust, and fog oil have very distinctive shapes and intensities.

- Other discriminators that the LRBSDS operator evaluates include whether there is a rapidly moving cloud edge, a poorly defined plume pointing toward the ground, or no distinct cloud edges that may be indicative of vehicle dust. A cloud close to the ground that gradually builds to a high concentration and then gradually dissipates is generally indicative of a large-area smoke cloud. Large, stable clouds at ground level with no significant buildup are indicative of haze and fog. However, BW agents may be embedded within any of these aerosols. Such conditions make BW detection more difficult, but an experienced operator may be capable of picking out a BW cloud if agent concentrations are above sensor thresholds.

(h) Laser scanning. During scanning, the following operational feedback indicates guidance that should help increase the probability of detection when scanning.

- Remain aware of the correct LRBSDS settings (for example, scan extents and roll correction). Check for proper settings before events (for example, starting a mission leg) instead of randomly trying different settings.
- Ensure that scanning occurs in the designated NAIs and that friendly troop positions are not scanned.
- Check that the LRBSDS roll setting value allows the best view into the NAI when scanning up slope.
- Check for the presence of a terrain obstacle (near-terrain blocking) during scanning, if there is no ground return.
- Remember that the LRBSDS waveform window may provide the first indication of an aerosol cloud.
- Use the color compression setting to help detect the extreme ends of the aerosol when using the retrace flight technique (for example, the aircraft turning around in mid-flight of the leg to reacquire a lost cloud).
- Ensure that the LRBSDS upper (waveform) and lower (scan) windows are monitored continuously. When a cloud signal is received, the assistant operator will get a mark (position location) immediately from the flight crew or from their GPS.
- Ensure that a solid ground return is present in the waveform window before estimating cloud height.

(i) In-flight protocols. The LRBSDS crew operates as a team with the UH-60 flight crew. Examples of the crew interaction and teamwork may involve the following situations.

- **Lost cloud.** The LRBSDS operator will request a mark (such as a position location) from the flight crew or their GPS immediately upon losing contact with the biological cloud. The operator will declare cloud contact lost if 2 minutes have elapsed since the last positive scan.

- **Enemy ADA avoidance.** The LRBSDS operator will turn off the laser during evasive aircraft action. He will request a mark from the flight crew or from their GPS upon initiation of aircraft evasive-action maneuvers. He will also request the time he may resume scanning along a course leg and a mark before resumption of scanning.
- **The end of the previous leg and/or start of the next leg.** Before starting a course leg for LRBSDS scanning, the operator requests a 10-second lead time (advance notice) from the flight crew before scanning. At the end of the 10-second countdown, the pilot provides the operator permission to scan. When turning around at the end of a flight leg, the aircraft turns away from the FLOT. The LRBSDS operator and flight crew ensure that the LRBSDS is prepared to scan in the proper direction. A situation report (SITREP) will be provided to the TOC if a biological cloud is tracked beyond the end of a course leg.
- **In-flight communications.** The flight crew and LRBSDS operators communicate when the UH-60 changes altitude, when the LRBSDS is not receiving ground return, when the laser is turned on or off, when starting a course leg, on completion of a course leg, before activating the laser (about 10 seconds before), when an upcoming terrain feature may cause terrain blocking, when a cloud detection occurs, when obtaining marks (position location) as part of the critical information exchange (such as cloud location), or when evasive action is required.

(j) Communications protocols. Communications between the flight crew, the LRBSDS team, and the TOC require timely and effective SITREPs and detection reports. This section provides suggested message content and formats for communications between the various members of the biological-surveillance team.

**NOTE: The call signs used for this section are: LRBSDS team = Bloodhound 2; ground controller = Eagle 24; biological-detection company officer = E5K.**

- **Departure report.** A departure report is used to notify the TOC that the aircraft has cleared airfield traffic control. *Figure H-15* is an example of a departure report transmission.

**Copilot to Assistant Operator:** "As soon as we have cleared the airfield traffic control, please send your departure report."  
**Operator:** "The system is operational."  
**Assistant Operator:** "Eagle 24, this is Bloodhound 2. Departure report, over."  
**Operations Center NCO:** "Bloodhound 2, this is Eagle 24. Send, over."  
**Assistant Operator:** "Bloodhound 2 has departed airfield Eagle at 2130 local. System green. Relay to E5K. Over."  
**Operations Center NCO:** "WILCO. Out."

**Figure H-15. Departure Report**

- **Course leg commencement request.** A course leg commencement request is used to notify the TOC that the aircraft is close to reaching a specific course leg. *Figure H-16* is an example of a course leg commencement request.

**Copilot to Assistant Operator:** "We are 5 minutes from ACP 108, the starting point for course leg Zulu. The pilot recommends commencing the LRBSDS mission. Call operations and request permission to execute."  
**Assistant Operator:** "Eagle 24, this is Bloodhound 2. Over."  
**Operations Center:** "Bloodhound 2, this is Eagle 24. Over."  
**Assistant Operator:** "We are preparing to execute LRBSDS mission along course leg Zulu. Over."  
**Operations Center:** "Roger. Out."  
**Operator to Copilot:** "Request permission to initialize the laser from ACLEFT."  
**Copilot to Operator:** "You are cleared to initialize the laser ACLEFT."  
**Operator:** "Initializing ACLEFT."  
**Assistant Operator:** "Laser ACLEFT."  
**Copilot to Operator:** "Commencing east-west run on course leg Zulu. You are clear to begin lasing ACLEFT."  
**Operator:** "Lasing ACLEFT."

**Figure H-16. Course Leg Commencement Request**

- **Course leg commencement SITREP.** The course leg commencement SITREP format provides a notional situation that informs the TOC that a new course leg is just beginning. *Figure H-17* is an example of a course leg commencement SITREP transmission.

**Copilot:** "Coming up to start of second course leg, course leg Whiskey. Location ACP 55. You are clear to lase ACLEFT!"  
**Operator:** "Initializing ACLEFT."  
**Assistant Operator:** "Laser is ACLEFT."  
**Operator:** "Lasing ACLEFT."  
**Assistant Operator:** "Eagle 24, this is Bloodhound 2. SITREP, over."  
**Operations Center:** "Bloodhound 2, this is Eagle 24. Send it, over."  
**Assistant Operator:** "Time 2220 local. Beginning course leg Whiskey at FS 470490. System green. Relay to E5K. Over."  
**Operations Center:** "WILCO. Out."

**Figure H-17. Course Leg Commencement SITREP**

- **Initial LRBSDS detection report.** The initial LRBSDS detection report notifies the TOC of a possible detection. *Figure H-18* is an example of an initial LRBSDS detection report.
- **Follow-up detection report.** The follow-up detection report transmission notifies the TOC when a cloud is reacquired. *Figure H-19* (page H-32) is an example of a follow-up detection report transmission.

**Operator:** "We have a possible detection. Mark."

**Assistant Operator:** "Time is 2303 local."

**Copilot:** "Our present position is FS 315 558. Ground heading 200 degrees magnetic. Crab angle 1° right; speed 85 knots, altitude 3,000 feet but are going to drop to 1,000 feet and attempt to detect the cloud from further down the course leg."

**Operator:** "The cloud appears man-made in a course line configuration. Width is 4 kilometers. Height is 80 meters. Range is 35 kilometers. Intensity is high. Seven scans. Continuing to track."

**Copilot to Operator:** "We are descending to 1,000 feet. You need to shut down the laser until we climb back up."

**Operator:** "Laser off."

**Assistant Operator:** "Eagle 24, this is Bloodhound 2. LAZER report, over."

**Operations Center:** "Bloodhound 2, this is Eagle 24. Send it, over."

**Assistant Operator:**

    "Line: L1 FS 315 588

        A1 35 kilometers

        A2 4 kilometers

        A3 N/A

        A4 80 meters

BREAK.

    Line: Z 2305 local

        E1 3,000 feet

        E2 200 degrees magnetic

        E3 One degree right

BREAK.

    Line: R1 Initial

        R2 60 minutes

        R3 N/A

        R4 Confidence - High

        R5 High-intensity, seven scans. Continuing to track, over."

**Operations Center:** "Roger. Out."

**Figure H-18. Initial LAZER Detection Report**

- **Cloud loss detection report.** The cloud loss detection report transmission notifies the TOC that LRBSDS scanning has lost contact with the cloud. *Figure H-20* (page H-32) is an example of a cloud loss detection report transmission.

(k) **Reporting.** The LRBSDS team provides SITREPs according to the biological-detection company SOP (such as the location and personnel and supply statuses). During mission operations, the LRBSDS crew submits detection reports using the information from *Table H-9* (page H-33).

- **Detection and incident reports.** The LRBSDS team reports the detection of man-made clouds using the helicopter radio on

**Copilot:** "We have now leveled back off at 3,000 feet. You can turn your laser back on."

**Operator:** "Laser is on ACLEFT. It appears that I have reacquired the cloud. Range 36 kilometers. Cloud width is 5 kilometers. Cloud is 30 meters above the ground. Detected with three scans."

**Copilot:** "Our position is FS 330560. All previously reported information is the same."

**Assistant Operator:** "Eagle 24, this is Bloodhound 2. Follow-up detection report, over."

**Operations Center:** "Bloodhound 2, this is Eagle 24. Send, over."

**Assistant Operator:**  
"Report follows:  
L1 FS 330560  
A1 36 kilometers  
A2 5 kilometers  
A4 30 meters  
Z 2315 local  
R1 Follow-up  
R5 3 scans/relay to E5K. Over."

**Operations Center:** "Roger, WILCO, out."

**Figure H-19. Follow-Up Detection Report**

**Operator:** "No longer tracking cloud. Mark."

**Copilot to Operator:** "Our present location is FS 390550 and our ground heading is 300 degrees magnetic. Additionally, we are at ACP 36 at the end of course leg Zulu. You need to turn off the laser."

**Operator:** "Laser off."

**Assistant Operator:** "Eagle 24, this is Bloodhound 2. Cloud loss detection report, over."

**Operations Center:** "Bloodhound 2, this is Eagle 24. Send, over."

**Assistant Operator:**  
"Line:  
L1 FS 390500  
Z 2345 local  
E2 300 degrees magnetic  
BREAK.  
Line:  
R1 Loss report  
R5 Relay to E5K. Also, we have completed the second pass on course leg Zulu. Over."

**Operations Center:** "Roger, WILCO, out."

**Figure H-20. Cloud Loss Detection Report**

the appropriate communications net. The detection report may be sent to the aviation brigade TOC (or other relay station) for relay to the biological-detection company CP; however, the preferred approach is to submit detection reports directly to the

**Table H-9. Data Items for LRBSDS Detection Report**

Line		Data Item	Leg Identification
L	L1	Position of the observer	Start track position, latitude/longitude, or coordinates
A	A1	Helicopter to aerosol range	Distance from helicopter to aerosol, in km
	A2	Aerosol width	Width of aerosol, in m (cross section)
	A3	Aerosol height (optional)	Height from ground to underside of aerosol, in m
	A4	Aerosol height above ground	Altitude (AGL), in ft
Z	Z	Detection time	
E	E1	Helicopter altitude	Direction of flight, ground track, and azimuth, in degrees
	E2	Helicopter heading	Degrees from heading (left or right)
	E3	Helicopter crab angle	Degrees from heading (left or right)
R	R1	Type of report	Initial, follow-on, or loss of cloud
	R2	Flight time remaining	Estimated time the helicopter can remain on station
	R3	Ground track (optional)	Direction on the map that the helicopter is tracking
	R4	Confidence	High, medium, or low
	R5	Remarks	Other information

biological-detection company CP. Incident reports are not required for LRBSDS background missions.

- **Detection report data items.** The data items on the detection report may vary during a mission, depending on the specific objective assigned to the LRBSDS team. The team will use one of the following techniques to accomplish the assigned objective:
  - **Detection and mapping.** Each data item on the detection report is reported.
  - **Detection and tracking.** The following critical data items from *Table H-9* are associated with detection and tracking: L1, A1, Z, E1, E2, E3, R1, R4, and R5.
  - **Detection and classification.** The following critical data items from *Table H-9* are associated with only detection and classification: L1, A1, Z, E1, E2, E3, R4, and R5.
- **Detection report remarks item.** The remarks column holds information such as the current ground speed and operator’s assessment as to the type of man-made cloud (smoke or vehicle dust). Operators may also generate a follow-on report once they reacquire the cloud. This report consists of the same type of information as the initial report. Follow-on reports provide the ability to further track the cloud and determine the cloud drift. Operators should also generate a loss-of-cloud report after there has been no contact with the cloud for more than 2 minutes. The loss-of-cloud report contains the time of cloud loss and the last known location.



c. Postoperations Phase.

(1) The LRBSDS team completes the checklist information shown in *Table H-10* after a mission. Since the LRBSDS internal hard drives have limited storage capacity, the data from biological-surveillance missions must be downloaded from the hard drives to tapes. Team members download the mission information and archive the data tapes immediately after concluding the aerial mission. Archiving includes labeling each tape with the times and locations of the biological-surveillance missions, matching each tape with its corresponding mission documentation, and storing the tapes and documents in the LRBSDS area. The team uses the tapes to conduct mission debriefs and training. The biological-detection company may determine that some tapes are needed for further review or interpretation. In such a situation, the team packages the tapes and mission documentation for evacuation using a chain-of-custody form.

(2) Following the mission, the operator contacts the LRBSDS NCOIC, briefs his current status, and receives follow-on orders. The operator receives an update from the detachment NCOIC or the aviation brigade chemical officer on the current friendly and threat situations. The team shuts down the LRBSDS if it is not immediately going on another mission.

(3) The LRBSDS operator also completes a postmission debriefing with the aircrew. Key data points of the mission are verified between the team and the aircrew. The mission checklist is archived along with all other mission documentation.

(4) Upon completion of a mission, the aviation brigade chemical officer will determine if the LRBSDS is to be removed (for example, if no other mission is scheduled). If removal is required, operators remove the system, conduct PMCS, and return the system to the storage site. The NCOIC finalizes return movement plans (if required), such as passage of lines and support, and the team conducts movement. The team NCOIC conducts planning, crew debriefing and training, equipment maintenance, and resupply to prepare for future missions.

(5) The senior team member receives a brief from the detachment NCOIC on the current friendly and threat situation.

(6) The senior team member finalizes return movement plans, such as passage of lines and support.

(7) The unit conducts movement.

**Table H-10. LRBSDS Postoperations Checklist**

<b>Actions Required</b>	<b>LRBSDS Team Actions</b>
Perform the download of data	Download data onto data tapes. Remove and package data tapes (if required). Initiate DA Form 4137 procedures.
Determine the future mission requirement from LRBSDS NCOIC	Obtain orders/updates. Determine the requirement for future missions. Obtain permission to remove the LRBSDS. Determine the disposition of data tapes.
Shut down the LRBSDS	Power down all components. Lower the laser platform. Lock the azimuth brakes.
Conduct the postmission debriefing with the aircrew	Verify mission data points with the aircrew. Annotate/verify the mission work sheet entries.
Remove the LRBSDS from the helicopter	Disconnect the power. Remove attachment fixtures from the helicopter floor. Use the forklift to remove the LRBSDS from the helicopter. Conduct PMCS of the equipment. Conduct inspections.
Perform troubleshooting	Perform troubleshooting as required.
Conduct movement (if required)	Load the equipment. Conduct the road march. Report the movement per the SOP.
Prepare for the next mission	Perform planning, training, maintenance, and resupply.

## Appendix I

### BIOLOGICAL INTEGRATED DETECTION SYSTEM UNIT OPERATIONS (M31A1 AND M31A2)

#### 1. Background

This appendix provides information on the M31A1 and M31A2 BIDS. This appendix also addresses BIDS unit information management and communications architecture.

#### 2. Preplanned Product Improved Biological Integrated Detection System

a. Preplanned Product Improvement Biological Integrated Detection System (M31A1) Functions. The preplanned product improvement (P3I) BIDS is an enhanced biological-agent detection system. It performs the basic functions (see *Table I-1*) of monitoring, sampling, detecting, identifying, and reporting to presumptively identify that a large-scale biological attack has occurred. Improvements in the P3I BIDS individual components, as well as overall system design, provide an operator friendly, automated detection suite that has a significantly increased capability.

**Table I-1. P3I BIDS (M31A1) System Functions**

Mission-Essential Tasks	Products	Required Components
Monitor	Nonspecific alert	UVAPS
	Nonspecific alert	CBMS
Sample	Physical samples for analysis	Liquid sampler and/or biological sampler
Detect	Generic biological indicators	Mini-FCM CBMS
Identify	Specific presumptive identification	Biological detector Handheld assay
Report	PIRs/IRs	HF radio, FBCB2, and SINCGARS radio (Platoon HQ—HF/FBCB2 [M31A2 only]/ SINCGARS/MSRT)

(1) Monitor. The P3I BIDS continuously monitors the air for an increase in the number of aerosol particles within a certain size range. The product-improved system uses two monitoring devices—the ultraviolet aerodynamic particle sizer (UVAPS) and the chemical-biological mass spectrometer (CBMS)—to provide an added discriminatory capability. The UVAPS can determine whether a biological mass is present within the aerosol particles being monitored; the CBMS also supports this function and can generically classify the biological material.

(2) Sample. The liquid sampler and the biological sampler are automatically activated immediately following an alert within the P3I BIDS. The P3I BIDS liquid

sampler dispenses preset amounts for further tests that minimize the requirement for any pipetting or transferring of liquid from one tube to another.

(3) Detect. The P3I BIDS detection capability (through the use of the miniature flow cytometer [mini-FCM] and the CBMS) determines whether biological material (cells, spores, or toxins) is present with greater sensitivity than previous BIDS versions. A positive result from either the CBMS or the mini-FCM can lead to further testing for identification results.

(4) Identify. The P3I BIDS uses the biological-detector device to presumptively identify biological agents. The biological detector can identify up to eight preselected BW agents. The biological detector is a more sensitive instrument and is nearly completely automated compared to the nondevelopmental item counterpart (which is much more labor intensive to operate).

(5) Report. The biological-detection teams report to the platoon HQ using the AN/GRC-193A high frequency (HF), single-channel ground and airborne radio system (SINCGARS) radio, and/or FBCB2 system. The following list provides general reporting requirements. These requirements may vary based on the JFC PIR and/or IR and other protection and warning criteria. During biological-detection operations, the biological-detection team operates on a shift basis. The incoming shift receives a thorough brief (for example, materiel and supply status, BW event status, and sample evacuation status) from the outgoing shift.

(a) biological-detection teams report to the platoon leader when—

- A new biological-detection site becomes occupied.
- A new biological-detection site becomes operational.
- Processing event data during operations at the biological-detection site.
- Mission-essential components fail.
- A biological-detection team change of shift occurs.

(b) Biological-detection teams submit personnel status, logistics status, and SITREPs as required. These reports help provide the command with the overall readiness level of a biological detection team.

(c) Platoon leaders report to company operations when—

- Any biological-detection team reports a positive detection.
- Any biological-detection team reports a positive identification.

(d) Platoon leaders submit SITREPs as required. These include weather and background data, key friendly information, and sample evacuation requests.

(e) It is critical for the biological-detection team to maintain communications during biological-detection operations. BIDS incident report information is time sensitive. For example, the leading edge of a BW aerosol cloud is moving at about 1½ times the average wind speed. As each minute elapses from the time of the alert, the suspected BW cloud is moving further downwind. Effective biological-detection team reporting keeps unit leaders informed as to the current status of their systems. Effective, timely event reporting also facilitates the event tracking process by platoon leaders.

(f) BIDS unit leaders conduct contingency planning to identify alternate communications capabilities should the HF or the VHF fail. For example, the platoon HQ can use their authorized mobile subscriber equipment (MSE) for forwarding reports.

(6) Communication. The following communication equipment and capabilities allow the P3I BIDS to communicate with the biological-detection platoon, company, and supported command; maintain SA; and report findings.

(a) High-frequency radio. The AN/GRC-193A HF radio allows long-range secure communications between widely dispersed units of the biological-detection company. The HF radio is an amplitude modulation (AM) radio that, depending on atmospheric conditions, can communicate over extended distances. It is the primary means for voice communications between the BIDS company HQ, platoons, and individual detection teams. Each BIDS vehicle is equipped with a HF radio.

(b) Force XXI Battle Command/Brigade and Below. The FBCB2 system provides SA and C2 capabilities to all elements of the BIDS company and facilitates C2 between the biological-detection company and FBCB2 equipped supported and supporting units. For the M31A2 equipped biological-detection company, FBCB2 is the primary means for digital communications between the BIDS company HQ, platoons, and individual detection teams. Each BIDS is equipped with FBCB2. The FBCB2 system is comprised of the following: AN/UyK-128 digital computer set; FBCB2 software; position navigation and reporting capability (GPS); interface to a terrestrial communication system (such as SINCGARS and/or Enhanced Position Location Reporting System [EPLRS] radio); and combat identification capability. Only the biological-detection platoon and company HQ for M31A2 units will have FBCB2 with an EPLRS capability.

(c) Mobile subscriber receiver/transmitter. The mobile subscriber receiver/transmitter (MSRT) is at the company and platoon level; the biological-detection team does not have a MSRT. A MSRT has a secure digital and facsimile communications capability and serves as the primary means of communication at the CP level. It is normally used as the alternate operations and intelligence net. A MSRT may also be used as the primary means to pass operations and intelligence information directly from the biological-detection company CP to the FBCB2-equipped supported HQ chemical officer.

b. P3I (M31A1) Sample Handling and Chain-of-Custody.

(1) P3I (M3A1) Sample Requirements. The supporting data provided by the P3I BIDS will include alert, detection, and identification results. This data is provided on data collection forms and as numerical, graphical information (communications interface processor [CIP] mission files) stored on computer files. The P3I BIDS team provides—

- A liquid biological-agent sample for confirmatory lab analysis.
- Supporting information that provides descriptive data for the sample.
- Environmental background samples with their supporting information.

(2) Logistics requirements. The following items specifically apply to sample handling and the chain-of-custody for the P3I BIDS:

- Sample transfer case. A direct current (DC) powered sample transfer case is located in the biological-detection team support vehicle and enables the support crew to conduct a sample evacuation. The support vehicle sample transfer case provides a sturdy, rigid container that maintains the sample temperature at 1-4°C and eases carry and transport. A temperature monitor provides the biological-detection team with the assurance that the sample transfer case temperature remains between 1-4°C.
- Onboard cooler. The BIDS vehicles have onboard coolers that are identical to the sample transfer cases located in the support vehicles. These items provide temporary storage for samples pending evacuation. The P3I BIDS has one cooler.
- Clear plastic bags. Clear plastic bags are the approved secondary container for biological wet collectors. Due to the requirement to double-bag these items, the recommended basic load for each BIDS should be increased from 25 to 50 bags.
- Tamper-resistant tape.
- Lab film.

(3) Air-sample collection from the biological sampler. The primary purpose of the P3I BIDS biological sampler is to collect and contain suspect material in a collection medium for transport. In the P3I system, the sampler is normally activated by the CIP in response to a UVAPS or CBMS alert. Upon completion of the sampling cycle, the sampler provides the operator with about 40 milliliters of liquid in the wet collector.

(4) Chain-of-custody instructions. Instructions for filling out the chain-of-custody form can be found in *Appendix G*.

(5) Biological sample packaging. *Table I-2* gives specific instructions for preparing the P3I BIDS wet collector for evacuation.

**Table I-2. Preparing the Wet Collector for Evacuation**

Completed	Item	Instructions
	1	Close the wet collector with the prepacked rubber grommet.
	2	Ensure that the lower lid is tight. Ensure that the upper lid is secured to the lower lid of the wet collector. Apply lab film around the upper lid in case of leakage from the wet collector.
	3	Label the wet collector with the sample identification number.
	4	Seal the lid of the wet collector with tamper-resistant tape. Apply the tape in an x pattern, ensuring that the tape is long enough to reach the wet collector. Ensure that the tamper-resistant tape covers a portion of the label on the wet collector.
	5	Place the wet collector, with absorbant material, inside a clear plastic bag with. Remove the excess air and twist the neck of the bag until it forms a tight coil with the bag snug around the wet collector. Label and secure the bag with a quick-lock fastener. Ensure that the sample identification number can still be read.

**Table I-2. Preparing the Wet Collector for Evacuation (Continued)**

Completed	Item	Instructions
	6	Place the bagged wet collector inside another clear plastic bag. Remove the excess air and twist the neck of the bag until it forms a tight coil with the bag snug around the wet collector. Place an adhesive label containing the sample ID number on the bag. Secure the bag with a quick-lock fastener.
	7	Place the packaged wet collector in the sample transfer case.
	8	Complete the chain-of-custody form.

(6) Alternate sample containers. If the biological sampler is not mission capable, the liquid sampler will provide the liquid sample for evacuation (see *Table I-3*). This procedure is restricted to situations when the biological sampler is either not mission capable or the current operating protocol does not require the use of the biological sampler. The conical tube should be selected according to guidance in TM 3-6665-350-12&P.

**NOTE: When using this procedure, ensure that the appropriate entries are made on the corresponding chain-of-custody form.**

**Table I-3. Preparing an Alternate Sample Container for Shipment**

Completed	Item	Instructions
	1	Ensure that the wet collector is properly secured with a cap. Wrap lab film around the cap.
	2	Affix an adhesive label containing the sample ID number on the wet collector in a lengthwise manner.
	3	Seal the wet collector by applying a strip of tamper-resistant tape in a lengthwise manner; starting at the side, run the strip up, over the cap, and down the other side. Ensure that the tamper-resistant tape covers a portion of the label on the wet collector. Add a temperature monitor strip.
	4	Place the wet collector, with absorbent material, inside a clear plastic bag. Remove the excess air and twist the neck of the bag until it forms a tight coil. With the bag snug around the wet collector, place an adhesive label containing the sample identification number on it. Secure the bag with a quick-lock fastener.
	5	Place the bagged wet collector inside another clear plastic bag. Remove the excess air and twist the neck of the bag until it forms a tight coil. With the bag snug around the wet collector, place an adhesive label containing the sample ID number on it. Secure the bag with a quick-lock fastener.
	6	Place the package in the sample transfer case.

(7) Supporting Documents. The documents that support the evacuated sample are integral components of the evacuation package. These items must accompany the sample. Routinely, they will be comprised of a printed copy of the CIP display; however, under some circumstances (such as the CIP or printer not being mission capable), a copy of the BIDS incident report will be provided in lieu of page 2 from the CIP display. *Table I-4* (page I-6) provides instructions for packaging this material.

**Table I-4. Packing Supporting Documents for Evacuation**

Completed	Item	Instructions
	1	Ensure that the chain-of-custody form is accurate.
	2	Ensure that the printed copy of page 2 of the CIP display has the sample identification number annotated.
	3	Check the CIP printout for consistency with the chain-of-custody form.
	4	Ensure that the sample ID number is present and consistent with the chain-of-custody form and that the BIDS incident report is also submitted.
	5	Place the printout and biological-incident report in a floppy disk mailer and seal it. If additional mailers are used, each one must have a separate item description on the corresponding chain-of-custody form.
	6	Place an adhesive label containing the sample ID number on the outside of the mailer, and place the mailer in the sample transfer case.

(8) The completed evacuation package. The completed sample evacuation package is comprised of the following items, packed in either the P3I BIDS onboard cooler or the support vehicle sample transfer case:

- A sealed and packaged wet collector.
- A sealed floppy disk mailer with the CIP printout or the BIDS incident report.

**NOTE: The completed chain-of-custody form will be hand carried by the escort.**

(9) Evacuation methods. The methods used for executing a sample transfer will vary. For example, the following options could be used:

- The BIDS biological-detection team support crew could transport the sample to the designated sample transfer point for pickup by escort personnel.
- Escort personnel could pick up the sample at the BIDS site.
- Other BIDS unit personnel could receive custody from the biological-detection team and transport the sample to a designated sample transfer point.

c. P3I BIDS (M31A1) Unit Employment. See *Chapter III*.

d. P3I BIDS (M31A1) Operational Modes and Data Analysis. This paragraph outlines the basic operational modes and data collection and analysis information for the P3I BIDS.

(1) Data collection methods. There are four basic methods for data collection.

(a) Standard protocol. The standard protocol is executed in response to a UVAPS or CBMS alert condition. When a UVAPS and/or CBMS alert condition occurs, the CIP activates both the liquid sampler and the biological sampler. The CIP uses input from the generic detection components (UVAPS, CBMS, and mini-FCM) to determine if detection has occurred. If positive detection results are obtained, a representative sample is analyzed with a specific identification component (such as the biological detector or the handheld assay). A detailed discussion of the standard protocol can be found in *TM 3-6665-350-12&P*.



(b) Continuous-sampling protocol. The continuous-sampling protocol involves activating the liquid sampler and turning off both monitoring devices (the UVAPS and CBMS) to prevent damage to these components. The sampler collects one liquid sample every 15 minutes for testing. This protocol could be used when directed by the biological-detection company or platoon CPs. It can also be used during a weather event (such as a severe dust storm) to prevent clogging of the UVAPS and/or CBMS air intake and ensure that a BW cloud is not missed. See *TM 3-6665-350-12&P* for a detailed discussion of continuous sampling.

(c) Reduced-capability operations. The P3I BIDS can operate at reduced capability when one or more components of the biological-detection suite become inoperable. Specific procedures for reduced-capability operations are summarized in *TM 3-6665-350-12&P*.

(d) Threat-based protocol. The standard P3I BIDS operating protocol can be adapted as a potential countermeasure against a threat BW capability (for example, linking the biological-detection array to the command air defense early-warning system [cued monitoring]). On receipt of a warning, the BIDS array initiates continuous sampling (both triggers continue to operate). Therefore, if an alert occurs, the BIDS is ready to test liquid samples almost immediately.

(2) Overall P3I BIDS system-level process. The system-level process begins with a triggering event by either the UVAPS or the CBMS that indicates an alert condition. This marks the beginning of a BIDS event. The second phase (detection) occurs when the CIP receives all of the generic results from the UVAPS, CBMS, and mini-FCM. If the system detection results are negative, the BIDS event ends; however, if the detection results are positive, the BIDS team conducts presumptive-identification procedures.

(a) P3I BIDS event cycle. The P3I BIDS event cycle, inclusive of the alert, detection, and identification phases, could range from 18 to 25 minutes. Following the alert, the detection process will last 3 to 11 minutes. During this phase, the CIP receives UVAPS, mini-FCM, and CBMS data for a detection decision. During detection, operator-1 tests two liquid samples on the mini-FCM, and the CBMS completes two pyrolysis cycles (about 3 minutes each). Next, based on a positive detection, the identification process (on the biological detector or the handheld assay) will take about 15 minutes.

(b) P3I BIDS detection classification. Each of the three components that contribute to the P3I BIDS detection decision performs functions that complement each other. See *Table I-5* for a brief comparison of UVAPS, mini-FCM, and CBMS functions. *Table I-6* (page I-8) provides a brief description of each generic detectors capability.

**Table I-5. Comparison of the UVAPS, CBMS, and Mini-FCM**

Component	Results	Function	Speed
UVAPS	Detects a biological mass in an agent containing particles	Continuously monitors (triggering device)	Updates results every 60 seconds
CBMS	Detects ion activity, biological versus nonbiological; cell, spores, or toxins	Continuously monitors (triggering device)	Updates results every 3 minutes
Mini-FCM	Detects cells or spores	Operates on demand (detection role only)	Results available in +/-100 seconds

**Table I-6. UVAPS, CBMS, and Mini-FCM Capabilities**

Component	Capability
UVAPS	Fluoresces biological material within aerosol particles with an ultraviolet laser.
CBMS	Analyzes ionized molecules for characteristic patterns of cells, spores, and toxins. The CBMS results are likely to be more accurate for spores and toxins than for cells.
Mini-FCM	Detects the presence of DNA/RNA within insoluble components (0.5 to 2.0 m) of aerosol particles. Statistically, mini-FCM results are more accurate for cells than for spores.

(3) Background effects. It is important to be aware of background data results. In general, background can be broadly categorized into three types—low, high (biological), and high (nonbiological).

(a) Background characteristics. The general characteristics of these background types and their possible effects on the P3I BIDS are included in *Table I-7*. For example, areas with a high biological background may yield positive mini-FCM results and/or nonspecific binding results from the biological detector.

- High (nonbiological) background conditions are often attributed to high winds, which can cause more reaerosolization of soil or surface particles. This type of background activity may cause short-duration UVAPS alerts (most will be 1 minute) or low UV fluorescence results.
- Low wind speeds (less than 1 or 2 meters per second) may cause high background results. If large numbers of aerosol particles are present in the ambient air, low wind speeds may help keep the background conditions high. Furthermore, biological-detector results may also indicate nonspecific binding in very high dust concentrations. Nonspecific binding may also occur based on the BIDS being downwind of some artillery or weapons fire by-products.
- Background materials that may cause responses on the mini-FCM or biological detector may not trigger the UVAPS or the CBMS. Therefore, it is important for the BIDS team to be aware of local background conditions. For example, detection results could be affected by high-protein backgrounds and extremely short aerosol dwell times.

(b) Background data recording. Certain data must be recorded during the monitoring phase of a BIDS operation to ensure that all the pertinent information is available for system-level analysis. This information (referred to as background) is listed in *Table I-8*. Background data collection consists of position location, weather data, local activity and conditions, mini-FCM and biological-detector results, and the sample from the biological sampler. The wind speed and direction will be included in the report of background data to the biological-detection platoon. A modified BIDS incident report form can be used for recording background data at team level. The unit SOP or the OPLAN and/or OPORD will specify the reporting frequency.

**Table I-7. Possible Impact of the Environment on BIDS Component Results**

Background Type	Environmental Factors	Possible Impact On BIDS Component Results
Low	Cold climates, snow-covered terrain, temperate climates with dormant vegetation, coastal areas, and regions of sparse vegetation with low levels of fine sand or dust	All components typically negative
High (biological)	Temperate/tropical climates with high levels of vegetation, primarily early in the growing season; agricultural areas during the growing season; and areas near industrial facilities with biological processes/sewage treatment	Biological detector—possible nonspecific binding Mini-FCM—possible cell results
High (nonbiological)	Dry/desert regions with high levels of fine sand or dust; dry grassland/scrub, primarily late in the growing season; urban or industrial areas; and artillery/weapons fire by-products	UVAPS—short-duration alerts CBMS—possible cell results Mini-FCM—possible spore results Biological detector—may cause nonspecific binding

- Background data should be recorded at the beginning of a mission and periodically updated during the mission (every 4 to 8 hours and especially after sunset or sunrise). The recording frequency depends on background conditions and operator workload (see *Table I-8*).

**Table I-8. P3I BIDS Background Data**

Component	Data	CIP screen
GPS	Position location	CIP screen
Meteorological sensor	Wind direction (degrees) Wind speed (kph) Temperature (°C) Relative humidity (percent)	CIP screen
BIDS team	Local activity/conditions	Support crew
Mini-FCM	Cell result Spore result	CIP screen and mini-FCM LCD
Biological detector or handheld assay	Biological detector or handheld-assay result	CIP screen or biological detector or handheld-assay strip
Biological sampler	Wet-collector contents	Biological sampler

- If background conditions produce positive results on either the biological detection or the mini-FCM, more frequent background sampling should be conducted (but not more often than every 2 hours). For example, the initial positive results on the mini-FCM and biological detector may be a short-term anomaly, and one or two follow-on assays could result in negative results. Positive background results on the mini-FCM and biological detector may be due to local activity (such as vehicle dust).

- It may become necessary to move the BIDS to an alternate detection area away from the source of background data that causes the positive mini-FCM and biological-detector results. It is important to know if the background information has changed before an alert condition to provide an accurate system-level result.

(4) Data analysis (system-level analysis). A BIDS event begins with a UVAPS and/or CBMS alert condition and ends when all steps in the data collection process have been completed. See *Table I-9* for BW event data. These results are used for the P3I BIDS incident report. Critical event data includes local meteorological readings; observations of local activity or weather conditions; alert, detection, and identification results; and the location.

**Table I-9. P3I BIDS Event Data**

Source	Data
Alert result	Alert time
Meteorological sensor	Wind direction (degrees) Wind speed (kph) Temperature (°C)
Detection result	Cell, spore, toxin
Identification result	Agent result
BIDS team	Local activity/conditions
BIDS team	Location

(a) System-Level Analysis Process. The system-level analysis process is summarized in *Table I-10*. The first phase of the process (alert) occurs when the UVAPS or the CBMS indicates an alert condition. The second phase (detection) occurs when all BIDS generic results have been obtained from the UVAPS, mini-FCM, and CBMS following an alert. If all of these results are negative, the detection result is also negative. If one or more of these results is positive, the detection result is positive. If the detection event is negative, the incident is considered a nonevent, and the process is terminated. The third phase (presumptive identification) occurs when specific results are available from either the biological detector or handheld assay following a positive detection. If all of these results are negative, the identification result is also negative. If one or more of these results is positive, the identification result is positive. The fourth phase (reporting) marks the end of a BIDS event.

(b) System-level analysis. The BIDS system-level analysis consists of obtaining alert, detection, and identification results and adding information (as required) about background results. In turn, the system-level results are reported to the platoon HQ for use in unit-level analysis. This process consists of the following steps:

- **Alert.** Consider alert results from the UVAPS and CBMS and the most recent background results from the monitoring devices. Report in the remarks section of the BIDS incident report whether earlier background UVAPS monitoring caused recurring ultraviolet fluorescence low or high results or whether CBMS monitoring caused recurring positive results.

**Table I-10. P3I BIDS System-Level Process**

Phase	Criteria	Result
Alert	UVAPS or CBMS alert condition	Alert (event begins)
Detection	Negative results from CBMS, mini-FCM, or UVAPS following an alert	Negative detection (nonevent or no report) (analysis terminated)
	Positive results from CBMS (toxin/spores), mini-FCM (cells/spores), or both CBMS/UVAPS alert	Positive detection (conduct biological detection/handheld assay)
Presumptive identification	Negative results from biological detection/handheld assay following a positive detection	Negative identification
	Positive results from biological detector/handheld assay following a positive detection	Positive identification
Reporting	Positive detection and identification result	P3I BIDS event data and BIDS location (event ends)

- **Detection.** If the detection decision is positive, go to “identification.” If generic detection devices (such as the mini-FCM and the CBMS) have provided positive results during previous background testing, record that information in the remarks section of the biological-detection team BIDS incident report.
- **Identification.** Consider current identification results and the most recent background results from the biological detector. Report in the remarks section of the BIDS incident report whether previous background assays indicated positive biological-detector results for a specific agent.
- **Report.** Review and report the final system results.

(c) The BIDS incident report (plus any unusual local activity or weather conditions) and associated background information is forwarded to the platoon HQ for use in unit-level analysis. Follow-up reports of BW event results should include or reference the alert time for the specific event being analyzed.

(5) System-level response profiles. Each decision regarding a possible BW attack must consider all of the results produced by the P3I BIDS biological-detection suite. The full set of results from the alert, detection, and identification components is referred to as an event response profile. The biological-detection platoon and company CPs use the results from their biological-detection team BIDS incident reports to determine and assess system-level response profiles.

(a) Determining system-level response profiles. Response profiles are determined by using alert, detection, and identification results from the P3I BIDS incident report. The confidence level of the resulting profile is obtained from *Table I-11* (page I-12). The final system-level result correlates agent classification results from the detection and identification process and assigns an associated confidence level. Consistency between the detection and identification results provides a high confidence level.

- Detection response profiles can be expressed in differing confidence levels, depending on the concentration (high, medium, or low) associated with the detection result. For example, detection with an associated high concentration (identification—none) results in a medium confidence level. A confidence level of medium to high is typically considered a possible BW attack indicator, and a low confidence level has poor reliability. The assigned confidence level from *Table I-11* indicates the relative probability that a particular response is indicative of an actual BW attack.
- Other factors can also influence the overall confidence associated with a possible BW event. Factors such as the current intelligence situation, LRBSDS results, and weather will influence platoon- and company-level analyses.

**Table I-11. P3I BIDS System-Level Response Profile**

Alert	Detection	Identification	Confidence
UVAPS and/or CBMS	Toxin (H/M/L)	Toxin (such as Ricin)	Very high
	Cell, spore, or biological (H/M/L)	Toxin (such as Ricin)	High
	Spore	Spore (such as Anthrax)	Very high
	Cell, toxin, or bio (H/M/L)	Spore (such as Anthrax)	High
	Cell	Cell (such as Plague)	Very high
	Spore, toxin, or bio (H/M/L)	Cell (such as Plague)	High
	Toxin, spore, or bio (H/M/L)	Virus (such as Venezuelan Equine Encephalitis)	High
	Spore (H), cell (H), toxin (H), or bio (H)	None	Medium
	Spore (M/L), cell (M/L), Toxin (M/L), or bio (M/L)	None	Low
<b>NOTE: H indicates a high concentration, M indicates a medium concentration, and L indicates a low concentration.</b>			

(b) Factors that can impact system-level response profiles. The BIDS teams maintain SA through the knowledge of key factors such as environmental conditions, local activity, and METT-TC. This awareness leads to an understanding of the impact that factors such as high wind speed may have on BW aerosols. See *Table I-12* for information on environmental or threat factors that could result in medium or low system-level response profiles.

(6) P3I Biological Integrated Detection System information management. The P3I BIDS system-level results displayed on the CIP or the information management system (IMS) are recorded by the operator on the BIDS incident report. Alternatively, if the CIP becomes not mission capable, the BIDS operator will then observe and analyze component-level responses and manually record the system-level results on the BIDS incident report.

(7) P3I BIDS Records. The CIP mission files are downloaded onto compact discs (CDs) following each mission (about a 12-hour duration). Data from each BW event resulting in a positive detection or identification are also transferred to separate CDs.

**Table I-12. Factors That Could Influence Medium or Low Confidence Levels**

<b>Selected Factors</b>	<b>Potential Impact on Bids System-Level Response</b>
High wind speed	Short BW cloud duration (1 to 2 minutes) <ul style="list-style-type: none"> <li>• Detection—positive</li> <li>• Identification—negative</li> <li>• Confidence—medium or low</li> </ul>
Threat point source BW attack	Short BW cloud duration (1 to 2 minutes) <ul style="list-style-type: none"> <li>• Detection—positive</li> <li>• Identification—negative</li> <li>• Confidence—medium or low</li> </ul>
Significant aerosolization of dust in a dry, grassland area late in the growing season	UVAPS—short ultraviolet alert; mini-FCM—spores <ul style="list-style-type: none"> <li>• Detection—positive</li> <li>• Identification—negative</li> <li>• Confidence—medium or low</li> </ul>
Terrain/vegetation causes large area BW aerosol clouds to separate	Multiple short-duration BW clouds (1 to 2 minutes) <ul style="list-style-type: none"> <li>• Detection—positive</li> <li>• Identification—negative</li> <li>• Confidence—medium or low</li> </ul>

These records are complemented by the BIDS team written message logs. The BIDS team maintains accurate records for each mission and forwards mission records to higher HQ for retention upon the completion of an operation.

### **3. Joint Biological Point Detection System (M31A2-Biological Integrated Detection System) Operations**

a. Functions. The JBPDS provides the commander with an automated BW agent detecting, collecting, identifying, reporting, and sample-evacuating capability. The JBPDS is a biological-agent detection system that performs the same basic functions—detecting, collecting and identifying—as its counterpart, the M31A1-BIDS (P3I). However, the JBPDS provides more automated capabilities than the M31A1-BIDS. See *Table I-13* to see how system functions are accomplished by the M31A2-BIDS system.

**Table I-13. JBPDS (M31A2-BIDS) System Functions**

	<b>Alerting</b>	<b>Collecting</b>	<b>Identifying</b>	<b>Reporting</b>
JBPDS (M31A2-BIDS)	Determines if an increase in the number of particles within a certain size range occurs and if aerosol particles contain biological material. Detection is based on a single component, rather than multiple components as in the M31/M31A1-BIDS.	The activation of the sample collector is automatic.	Determines the presumptive identification of up to 10 preselected BW agents.	The time range for the reporting of presumptive identification is 18-20 minutes. Data recording and display is automated.

(1) Alerting. The JBPDS biological-aerosol warning sensor continuously monitors the air for an increase in particles that may contain biological material. The

biological-aerosol warning sensor contains a particle counter that constantly compares the airborne particle count of a given size range against an established background. The biological-aerosol warning sensor laser detector fluoresces particles and measures their emission wavelengths to determine if the airborne particles contain biological mass. Based on an increased number of particles of the correct size and emission signature, the biological-aerosol warning sensor triggers an alert and the follow-on collection and identification process.

(2) Collecting. Following an alert, the collector begins a collection cycle to gather a representative sample for analysis. The collector draws in air and captures particulate matter using a cyclone principle that concentrates the sample in collector fluid. The concentrated sample is then sent by the fluid transfer system to the identifier for analysis. If the presumptive identification is positive for a BW agent, the fluid transfer system routes a volume of the collected sample to either a sample vial or sample bottle for evacuation.

(3) Identifying. The identifier uses immunoassay technology to presumptively identify any of 10 preselected BW agents. Presumptive identification processing is completed in approximately 15 minutes.

(4) Reporting. The time from the detection to presumptive identification is approximately 20 minutes. Data is automatically displayed to the operator and recorded in a JBPDS (M31A2-BIDS) biological-event log.

b. Sample Handling and Chain-of-Custody. The JBPDS (M31A2-BIDS) provides a liquid biological-agent sample for lab analysis and supporting information that provides descriptive data for the sample. The JBPDS (M31A2-BIDS) sample evacuation guidance is consistent with BIDS (P3I) sample evacuation guidance. The supporting data includes the biological-event log that provides information about positive identifications and detection events associated with a selected JBPDS (M31A2-BIDS) as each event occurs. This information includes the date and time, agent identified, location of the biological event, elevation, wind direction, and wind speed. The biological-event data is stored on a CD and printed out on a paper copy. The printed copy will be packaged as part of the sample evacuation process.

(1) Logistics requirements.

(a) Sample transfer case. The sample transfer case used for the JBPDS (M31A2-BIDS) is identical to the one used in the BIDS (P3I). The JBPDS (M31A2-BIDS) has one on-board cooler identical to the sample transfer cases located in support vehicles. The cooler provides temporary storage for samples pending evacuation.

(b) Sample vial and sample bottle. These collection items used in the JBPDS (M31A2-BIDS) are packaged separately. The sample vials are bulk packaged at 100 vials per box, and sample bottles are packaged two per box (two boxes are provided as part of the system basic load). The sample extraction bottle is used in the dry collection mode for the M31E2 for sample evacuation.

(c) Packaging container. The requirement for packaging the M31A2-BIDS sample is described in the JBPDS TM or TO.

(d) Tamper-resistant tape. The requirement for tamper-resistant tape is the same for the JBPDS (M31A2-BIDS) as for the BIDS (P3I). Tamper-resistant tape is a



special tape that tears easily after application. Tears in the tape indicate that the sealed container has been opened.

(e) Lab film. The requirement for lab film is the same for the JBPDS (M31A2-BIDS) as for the M31/M31A1.

(2) Sample collection. The primary purpose of the JBPDS (M31A2-BIDS) is to collect and contain suspect materiel for evacuation and evaluation. If a presumptive identification is made, a sample will be stored for evacuation and further analysis in one of four sample vials. After the fourth sample vial has been used, any additional samples will be stored in the sample bottle, if the sample vials are not replaced.

(3) Packaging the biological sample. When handling the sample from the JBPDS (M31A2-BIDS), eye protection, respiratory protection, and gloves must be worn. See instructions in the JBPDS TM or TO for specific instructions of preparing the JBPDS (M31A2-BIDS) sample for evacuation. When directed to prepare the sample and supporting materials for evacuation, operator 1 or 2 will package the sample and release it to operator 3 or 4 using the chain-of-custody form. Operator 3 or 4 will then evacuate the sample to the sample transfer point.

**NOTE: The use of tamper resistant tape and the labeling of each packaging container with the sample identification number for the M31A2 sample is consistent with M31A1 sample processing procedures.**

**NOTE: If a shift change occurs prior to the evacuation notice, the stored sample vial or common sample bottle must be released to the new shift leader using the chain-of-custody form.**

(4) Packaging the supporting documentation. The documents that support the evacuated sample are integral components of the evacuation package and must accompany the sample. While either operator 1 or 2 prepares the sample vial, sample bottle, or sample extraction bottle for evacuation, the other should collect and package the supporting documents for evacuation with the sample. *Table I-14* provides instructions for packaging this material.

**Table I-14. Packaging Supporting Documents for Evacuation (JBPDS [M31A2-BIDS])**

Packaging Supporting Documents		
	Item	Instructions
	1	Print two copies of the biological-event log with the sample identification number. Label the handwritten biological-incident report with the sample identification number.
	2	Place one copy of the biological-event log and one copy of the biological-incident report inside the disk mailer. Maintain the second copy of the biological-event log and the biological-incident report with the JBPDS (M31A2-BIDS) vehicle log.
	3	Place an adhesive label containing the sample identification number on the disk mailer.
	4	Seal the disk mailer.
	5	Place tamper-resistant tape over all sealed edges of the disk mail sealer. Do not cover the sample identification number with the tape.
	6	Place the supporting documents package in the sample transfer case.
	7	Complete the chain-of-custody form. Ensure that the operator handling the sample signs the initial signature immediately.

(5) The completed evacuation package. Each completed sample evacuation package is comprised of the following items packed in the temperature-monitored JBPDS (M31A2-BIDS) on board cooler or the support vehicle sample transfer case:

- Sealed and packaged sample vial, sample bottle, or sample evacuation bottle.
- Sealed disk mailer with the printout of the biological-event log and handwritten biological-incident report.

The completed chain-of-custody form will be hand carried by the escort. There will be one complete sample evacuation package for each sample.

- c. JBPDS (M31A2-BIDS) Unit Employment. See *Chapter III*.
- d. JBPDS (M31A2-BIDS) Operational Modes and Data Analysis.

(1) The JBPDS (M31A2-BIDS) uses five operational modes to collect data. They are discussed below.

(a) Standard mode. The biological-detection team initiates the standard mode during normal JBPDS (M31A2-BIDS) operations when the system is fully functioning. In standard mode, the M31A2 monitors ambient air particles, and, if required, the biological-aerosol warning sensor will initiate the collection sequence, perform the identification process, and store a portion of the sample.

(b) Single sample mode. The biological-detection team may initiate the single sample mode to take a background reading or check conditions after an event such as a sandstorm or a weather front moving through the area. In this mode, conducted according to the SOP or on order, the detection process is not used (the biological-aerosol warning sensor is not utilized; only collection and identification functions are performed by the JBPDS). The JBPDS changes to the previous operational mode at the end of the sequence.

(c) Periodic mode. The biological-detection team may use the M31A2 periodic mode when the biological-aerosol warning sensor is not functioning, or during an operational situation such as an air defense alert (such as an imminent air or missile attack or one in progress where the use of BW agents is suspected). In this mode, the biological-detection team initiates established time intervals for the collection and identification sequence that can range from 5 to 60 minutes in 5-minute intervals. The operator ensures that consumables in the fluid transfer system are replenished.

(d) Degraded mode. The JPBDS enters the degraded mode automatically when the identifier fails during either standard mode or single sample mode operation. While in the degraded mode, the JPBDS performs detection and collection operations only and stores the collected sample in the common sample bottle. In turn, the biological-detection team used the identification assay strips to conduct the identification process manually.

(e) Extreme cold mode. Operating the JBPDS (M31A2-BIDS) in extreme cold conditions may cause the liquid in the JBPDS to freeze. When these conditions are present (-10°C to -28°C), an audible and visual alarm will be sounded. The biological-detection team places the system in the extreme cold mode.

(2) Background characteristics. It is important to be aware of background data results. In general, background can be broadly categorized into three types that are characterized as low, high (biological), and high (nonbiological).

(a) The general characteristics of these background types and their possible effect on the JBPDS (M31A2-BIDS) are included in *Table I-15*.

**Table I-15. Background Characteristics**

Background Type	Environmental Factors	Possible Impact on M31A2 Component Results
Low	Cold climates; snow-covered terrain; temperate climates with dormant vegetation; coastal areas; regions of sparse vegetation with low levels of fine sand or dust	All components are typically negative
High (biological)	Temperate/tropical climates with high levels of vegetation, primarily early in the growing season; agricultural areas during growing season; areas near industrial facilities with biological processes/sewage treatment	Possible positive on biological-aerosol warning sensor Identifier and manual identification—possible nonspecific binding
High (non-biological)	Dry/desert regions with high levels of fine sand or dust; dry grassland/scrub, primarily late in the growing season; urban/industrial areas; artillery/weapons fire by-products	Identifier and manual identification—possible nonspecific binding

(b) JBPDS (M31A2-BIDS) background data should be recorded in the log of the biological-detection team at the beginning of a mission and periodically updated during the mission, especially after sunset or sunrise. It is important to know if the background has changed prior to a “DETECTION” condition to provide an accurate system level result. Further, a “POSITIVE” response on the identifier may necessitate the evacuation of a biological sample to a supporting medical lab to determine the reason for the positive results.

(3) System and platoon level reporting will include background data and the BIDS incident report. Data analysis is conducted at two levels within the biological-detection platoon. The first consists of system-level assessment using a single JBPDS (M31A2-BIDS). The second level of analysis is unit-level analysis using input from multiple JBPDS (M31A2-BIDS). This analysis is accomplished at the platoon level and includes event tracking that is used to merge individual BIDS level results within the platoon AOs.

(4) *Table I-16* (page I-18) lists the information required for a background report. Complete background data is obtained by operating the JBPDS in an iteration of a single-sample mode operation.

(5) An M31A2-BIDS BW event begins with an alert condition and ends when all steps in the data collection process have been completed. See *Table I-17* (page I-18) for BW event data that are needed for reporting purposes. These results are used for the M31A2-BIDS incident report.

**Table I-16. JBPDS (M31A2-BIDS) Background Data**

Component	Data	Source
GPS	Position location	Time/location/weather screen (basic biological suite unit)
Meteorological sensor	Wind direction (degrees) Wind speed (mph)	Time/location/weather screen (basic biological suite unit)
JBPDS (M31A2-BIDS) team	Local activity/conditions	Support crew
Identifier or manual identification	Positive or negative result	Alarm/screen or activity summary screen (basic biological suite unit)
Collector/fluid transfer system	Sample vial, bottle, or extraction bottle	Biological sample

**Table I-17. JBPDS (M31A2-BIDS) Event Data**

Source	Data
Alert results	Alert time
Meteorological sensor	Wind direction (degrees) Wind speed (kph)
Identification result	Agent identification result (positive or negative) and identification time.
JBPDS (M31A2-BIDS) team	Local activity/conditions

(6) The system level analysis is summarized in the four steps below. This process consists of obtaining detection and identification results. System-level results are reported to the platoon HQ for use in unit-level analysis. The system-level analysis steps include:

*Step 1.* Alert. Record alert results from the biological-aerosol warning sensor.

*Step 2.* Report. Review and report alert results.

*Step 3.* Identification. Record current identification results.

*Step 4.* Report. Review and report identification results (positive or negative).

**NOTE: It is critical that the biological-detection team reports alert results, and then follows up with reporting either positive or negative identification results.**

#### **4. Biological Integrated Detection System Unit Information Management and Reports**

a. BIDS Unit Reports. The following paragraphs contain generic sample information and report formats for BIDS units. This section specifically outlines reports that are used by biological-detection teams or biological-detection platoons, a suggested incident data report format, and suggested techniques and procedures for biological-event tracking. Specific reports required by different units or TM guidance may require changes in these formats. Additional information management report formats may be required to meet specific mission or unit requirements. The use of brevity codes (as directed by the unit SOP or OPLAN) should also shorten the required message transmissions.

(1) BIDS team reporting requirements require them to report to the platoon leader at the following times:

- Upon occupation of a new biological-detection site.
- When operational at a new biological-detection site.
- During operations at the biological-detection site. Submit BW event data in the BIDS incident report format. BIDS incident reports should include the following:
  - The time of the alert.
  - The identification result and time.
  - Weather data (for example, wind speed and direction).
  - The confidence level assigned to the BW agent detection or identification.
  - The location.
- When mission-essential components fail.
- When operations at the biological-detection site are complete.
- When the mission, SOP, threat, background, or location characteristics change.
- When the SOP or OPLAN requires a personnel or logistics situation report.

(2) The platoon leader submits reports to company operations based on:

- The analysis of detection and/or identification data from BIDS teams require a report.
- The mission, SOP, threat, background, or location characteristics require a report.

b. Biological Integrated Detection System Situation Report. The sample BIDS SITREP shown in *Figure I-1* (page I-20) can be used to provide a complete status report at pre-established times according to the unit SOP. It can also be used to report partial information (such as an “operational at new site” report). For example, an “operational at new site” report would simply state: “P61 this is T51, SITREP over.” “T51 this is P61, send over.” “This is T51, line five ALPHA GOLF ONE, over.” “T51 this is P61, Roger, out.” The team leader (TL) just communicated to his platoon leader that his team is in position, fully mission capable, and operational.

c. Biological Integrated Detection System Incident Reports. The BIDS incident report is used by BIDS team members to record and subsequently report pertinent information obtained during biological-detection operations. There are three fundamental fields of data that are routinely compiled and reported by BIDS teams during operations—alert, detection, and identification. As the data is completed for each of these areas, it is transmitted to the platoon HQ element.

d. Biological-Event Tracking. The analysis of BIDS incident reports is a dynamic process. The platoon HQ is the first organizational element to compile and assess report data from multiple systems. Event tracking enables the platoon HQ to systematically

Line	Item	Content	Remarks
1	Platoon location	Grid coordinates or no change	NA
1 (alternate)	Team location	Grid coordinates	NA
2a	COMM status: SINCGARS	G, A, R, or B	(Anything less than GOLF requires explanation)
2b	COMM status: HF	G, A, R, or B	
3	Personnel status	G, A, R, or B	
4a	Supply status: Class I	G, A, R, or B	
4b	Supply status: Class III	G, A, R, or B	
4c	Supply status: Class V	G, A, R, or B	
4d	Supply status: Class IX	G, A, R, or B	
5a	System status: Team A	G, G1, A, R, or B	
5b	System status: Team B	G, G1, A, R, or B	
5c	System status: Team C	G, G1, A, R, or B	
5d	System status: Team D	G, G1, A, R, or B	
5e	System status: Team E	G, G1, A, R, or B	
5f	System status: Team F	G, G1, A, R, or B	
5g	System status: Team G	G, G1, A, R, or B	
6	Leader assessment	G, A, R, or B	
<p>GOLF (G)—fully mission capable (green).</p> <p>GOLF ONE (G1)—fully operational (green one).</p> <p>ALPHA (A)—requires resupply or maintenance after mission (amber).</p> <p>ROMEO (R)—requires resupply or maintenance before mission (red).</p> <p>BRAVO (B)—NMC.</p>			

**Figure I-1. Sample BIDS SITREP**

evaluate the BIDS-report information. The characteristics associated with the downwind travel of a BW aerosol cloud, as well as the effects of weather and terrain, provide the basis for tracking the BW event. Based on a large-area BW attack, the data from multiple BIDS are used by the platoon CP to make estimates on BW-aerosol cloud direction. For example, BIDS teams deployed in depth could alert sequentially, based on a BW aerosol cloud moving downwind. Two or more BIDSs located in a general crosswind direction could detect the same BW aerosol cloud almost simultaneously. The BIDS alert times also depend on factors such as wind speed and the downwind separation distance between the BIDS.

**NOTE: The leading edge of a BW aerosol cloud moves downwind at about 1.5 times the average wind speed, whereas the trailing edge of an aerosol cloud moves at about 0.5 times the average wind speed.**

(1) Event Tracking.

(a) The event-tracking process is normally initiated as a result of one or more positive alert, detection, or identification results from an individual BIDS. The following process is repeated each time a BIDS report is received.

- **Characterization.** Characterization assigns a label to each BIDS event. The label consists of the BIDS number; location; time; weather data; and alert, detection, and identification results to include the confidence level taken from the BIDS incident report. All results should be considered during unit-level analysis.
- **Grouping.** The second step is to group events by assigning each BIDS event to a specific group based on spatial and temporal relationships. Relative time and space relationships exist among the various BIDSs events because of the large area over which the teams are placed and the nature of a BW attack. These relationships are due to local meteorological conditions and the physical distance between detectors. Detection and/or identification conditions caused by a BW attack should occur sequentially in a downwind direction with detection and/or identification times between BIDSs related to wind speed and downwind separation distance. Since the distance between BIDSs will often be large (10-30 kilometers), the time interval between adjacent downwind BIDS events is expected to be on the order of 10 minutes to 3 hours. Two or more BIDSs located in a general crosswind direction could detect the same BW aerosol cloud nearly simultaneously. Events are assigned to the same group if they could reasonably have resulted from the same BW release, based on the relationship of their locations and detection times with the prevailing wind speed and direction. Any new event that does not appear to satisfy the time and space relationships for a group is assigned to a new group. Each group consists of one or more events, and the membership of any particular group can change as more information becomes available.
- **Attribution.** Review all available information on local conditions, friendly and threat information, and weather data to determine if any non-BW causes exist for each group of BW events. If a specific cause is identified, it is added to the event tracking information. If no probable cause is identified, it is labeled as unknown. If non-BW causes are identified, the BIDS-team data is not deleted from the group array. Information of each group array is augmented with applicable narrative information on local activity or terrain data specific to the AO.

(b) Event tracking is a systematic process that is continually revised as additional information becomes available. To support platoon-level BW event tracking,

Figure I-2 provides a sample BIDS incident report event-tracking format for recording data from multiple systems. As information is received, it is recorded sequentially in chronological order (left to right) on an event-tracking form.

BIDS Teams							
Alert Time							
Type (UVAPS, CBMS, APS)							
Meteorological—Wind Speed (kph)							
Meteorological—Wind Direction (deg)							
Detection Time (If applicable)	<b>SAMPLE</b>						
Type of Detection							
Identification Time							
Agent(s)							
Notes							

**Figure I-2. Sample Event-Tracking Form**

(2) Other Planning Factors. Other factors that platoon leaders should consider include—

- Whether multiple BIDSs are providing similar information.
- The influence of wind or terrain on aerosols as the BW event reaches various BIDSs.
- Whether the specific agent or type of agent detected is suspected to be in the arsenal of the threat.
- The degree to which a BIDS event cannot be attributed to other (non-BW) causes such as friendly activity or known background ambient-air characteristics.
- The current intelligence assessment of threat plans and operational factors (such as air defense warning status, threat tactics, doctrine, patterns of prior use, medical and operational impacts, potential target value, and downwind hazards). This assessment should be used to supplement the checklist, as required.

e. Sample Biological-Warfare Event-Tracking. *Figure I-3* illustrates a sample scenario for a series of sample P3I BIDS incident reports submitted by individual M31A1s. The scenario indicates a potential sequence of events when a BW aerosol cloud



passes over a platoon array. *Figure I-4* (page I-24) provides a sample sector sketch for a biological-detection platoon.

BIDS Teams	D	A	C	B	E	F	G
Alert Time	2300	2315	2318	2320	0300	0305	0308
Meteorological Wind Speed (mph)	008	010	009	011	008	008	009
Meteorological Wind Direction (deg)	270	260	260	260	270	270	260
Detection Time	2306	2320	2321	2323	0306	0310	0313
Type Detection (Spores=S, Cells=C, Toxin=T, Biological=B, None=N)	S	S	S	C	C	C	C
Identification Time	2322	2336	2337	2339	0326	0328	0330
Agent Code (Example Only)	65	Neg	65	Neg	64	64	Neg
Agent(s) Name	Anthrax		Anthrax		Plague	Plague	
<b>NOTE: For example, “65” and “64” are the two-digit codes displayed by the biological detector for anthrax and plague, respectively. The actual codes are classified.</b>							

**Figure I-3. Sample BIDS Incident Report for Event Tracking**

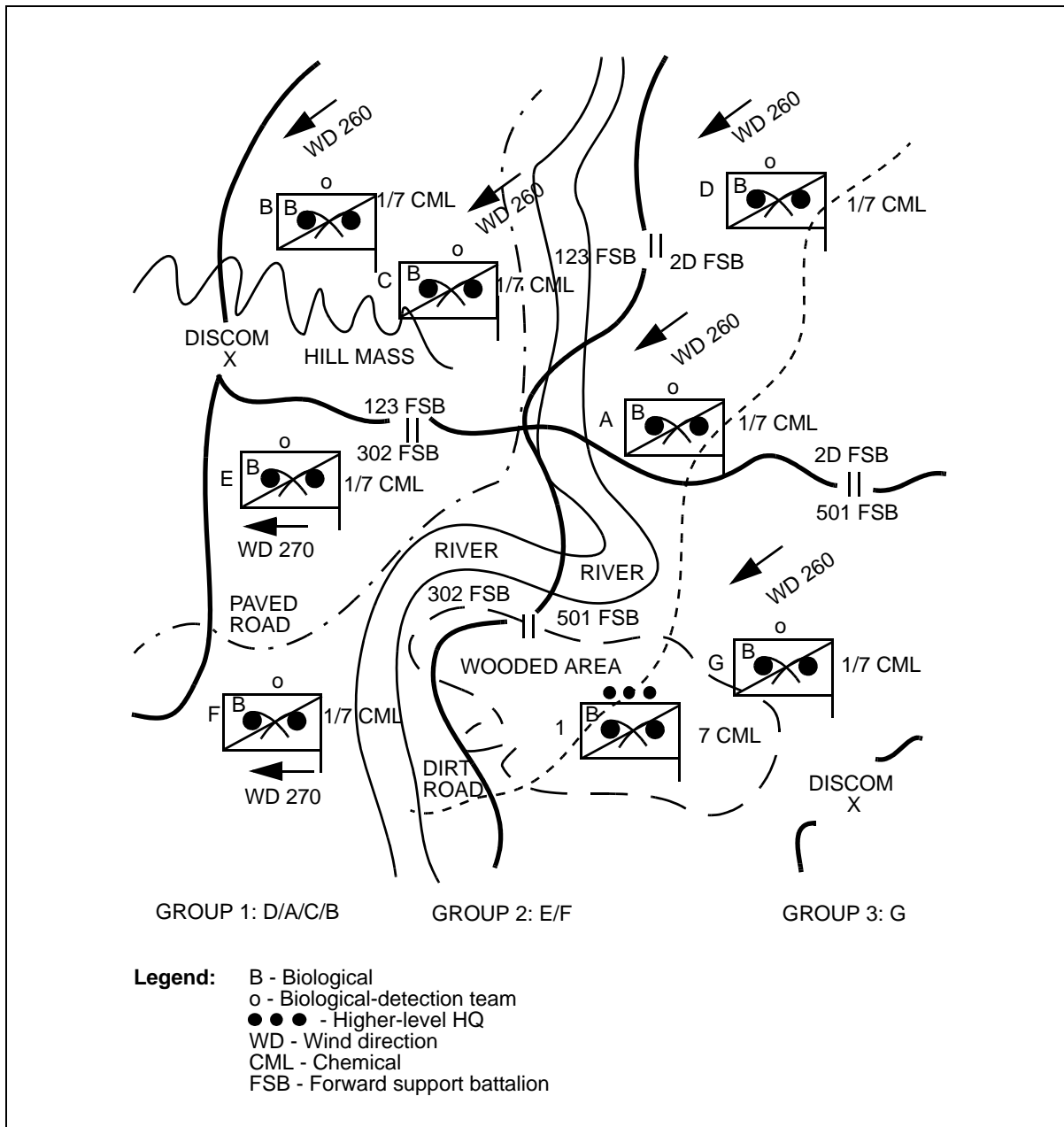
(1) A biological cloud was first detected at 2200 hours northwest of the Division Support Command (DISCOM) sector by the LRBSDS. Traveling at a speed of about 8 to 10 kilometers per hour, the aerosol cloud reached the first BIDS (Team D) in the 501-support area about 1 hour later at 2300.

(2) With the wind direction at 260 degrees and the wind speed at 8 kilometers per hour, the next BIDS (Team A) alerted at about 2315, followed by Teams C and B at 2318 and 2320, respectively. Based on the event-tracking process, the platoon HQ element assigns Teams A, B, C, and D and BW event data to Group 1.

(3) Subsequently, Teams E and F provided BIDS report information to the platoon CP about 4 hours later (within a 5-minute time frame of each other). The platoon CP conducted BW event tracking and assigns Teams E and F to the same group (for example, Group 2).

(4) Finally, Team G forwarded a BIDS incident report to the platoon CP. The information cannot be readily correlated with any other team information. In turn, Team G results are assigned to a separate group (for example, Group 3).

(5) The sample sketch (*Figure I-4*) is not drawn to a specific scale, but report information (along with the sector sketch) provides a way to characterize and group platoon BW information. The platoon CP could circle the team or group of teams that come up with the same identification results. Event information indicates that Teams A, B, C, and D can be grouped together as Group 1 and Teams E and F as Group 2. Team G stands alone as Group 3. In examining this information, a platoon leader can



**Figure I-4. Sample Biological-Detection Platoon Sector Sketch**

characterize, group, and attribute all information for his platoon by using the sample format in *Figure I-2* (page I-22) and their sector sketch or operation map.

## 5. Biological Integrated Detection System Unit Communication

### a. Communications and Organization.

(1) The biological-detection company or platoon is an operational level-of-war asset. In general, the biological-detection unit HQ will establish a CP as close as possible to the corps and/or JTF NBC control center. Generally, the biological-detection unit CP and the corps chemical brigade main CP will be located where they can best support the

corps and/or JTF HQ. Normally, this will be within the same base cluster as the corps and/or JTF main CP.

(2) A biological-detection company has a HQ element, three LRBSDS teams, and five biological-detection platoons; each platoon has seven biological-detection teams. The platoon leaders are generally located where they can best support their biological-detection teams. Because of the size of the area covered, the platoon leader may be located near a division main CP or logistics base. Biological-detection teams will normally be positioned as far forward as possible, but out of threat direct fire or observed indirect fire weapons range. Systems are widely separated, so biological-detection teams operate an independent communications net. LRBSDS teams will likely be collocated with an aviation unit that is tasked to fly LRBSDS missions. The communications link for LRBSDS reports should be directly to the biological-detection company operations section. However, factors such as distance or communications system compatibility may require LRBSDS reports to be forwarded through the aviation unit back to the biological-detection company operations section.

(3) Since the biological-detection company CP is generally located within the same base cluster as the corps main CP and chemical brigade main CP, the corps and chemical brigade staffs must establish requirements for running subscriber access cables to the biological-detection unit CP. This hardwire system architecture should permit the biological-detection unit CP to pass critical operational information directly to the supported unit battle staff.

b. Communications Equipment.

(1) Company, platoon, and team equipment. The biological-detection company CP, each biological-detection platoon CP, and each biological-detection team should have the following communications equipment:

- One AN/GRC-193A HF radio.
- One AN/VRC-90 VHF radio (SINCGARS).
- For M31A2 units, one FBCB2 system. The biological-detection company and platoon will have EPLRS capability.
- One AN/VRC-97 MSRT (biological-detection platoon and company only).

**NOTE: The biological-detection team does not have an MSRT.**

(2) Use of the communications capability. The biological-detection company and platoon coordinate to determine communications interoperability requirements with their supporting and supported units. Key items for coordination include frequencies, interoperability of communications capabilities (for example, identifying whether the biological-detection company and platoon is supporting a digitized or nondigitized unit), and periodic reporting requirements.

(a) For M31A2 equipped units, FBCB2 is the biological-detection team primary means of forwarding reports (for example, BIDS incident reports and other reports as required by the SOP) to the biological-detection platoon. The FBCB2 system (which includes SINCGARS) provides SA information, and burst digital data transmission. The system is capable of secure communications and has a range of approximately 20 kilometers; however, the EPLRS nets at the biological-detection

platoon or company can support retransmission of data across the digital theater. The biological-detection platoon uses FBCB2 as a primary means of communication with the biological-detection company to forward required reports. FBCB2 communication from the biological-detection teams to the biological-detection platoon is limited by the capabilities of the AN/VRC-90 VHF radio (approximately 20 kilometer LOS).

(b) The HF radio (AN/GRC-193A HF radio) becomes an alternate means of communication if distance or other operational factors prevent communication through use of the FBCB2 system. The HF radio provides a long-range (300+ miles) communications capability to send and receive reports. The HF radio provides a command net capability for use by the biological-detection company.

(c) The SINCGARS (AN/VRC-90 VHF radio) provides a LOS (range approximately 20 kilometers) communications capability. Distance permitting, the SINCGARS provides a command net capability for use by the biological-detection company. Additionally, SINCGARS is the primary means of communication internal to the biological-detection platoon (for example, communication between the support crew and BIDS crew). Coordination with the supported or supporting unit may identify retransmission stations for transmittal of SINCGARS communications to tactical satellite (TACSAT) interfaces. This allows biological-detection companies access to the corps or theater “warfighter net” in the event other means of communication are not available.

(d) Each biological-detection company and platoon CP has a MSRT, which is similar to a modern cellular telephone. It provides continuous access to the area communications system during movement and CP displacement. The MSRT has a secure digital and facsimile communications capability. This is a particularly useful capability for sending status reports and issuing FRAGORDs. The MSRT will serve as the primary means of communication at the CP level. The LRBSDS will communicate with the biological-detection company CP. LRBSDS reports may be communicated through aviation unit communications assets (the MSRT or VHF) to the biological-detection company CP.

c. Communications Planning and Nets.

(1) Units must plan for the rapid transmission of a high volume of data to and from the biological-detection company. Therefore, units plan for and use brevity codes to communicate recurring items of information. Other key communications planning considerations include the following:

- Plan for interface between the supported unit and higher HQ communications circuits and automated data processing (ADP) systems.
- Plan to use complementary communications to reduce the impact of radio-electronic combat operations.
- Ensure the interoperability of communications capability (connectivity between nondigitized and digitized units). For example, FBCB2 M31A2 units provide a digital communications capability. M31A1 and M31 equipped units do not have a digital communications capability.

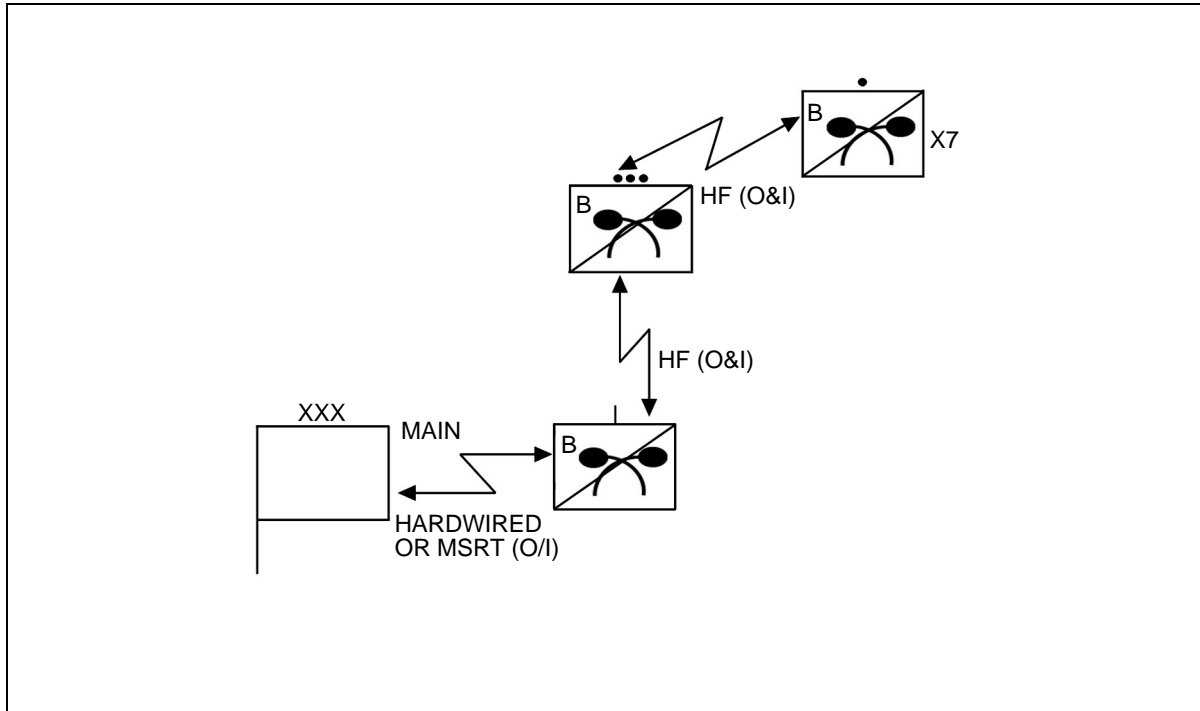
- Use data architecture planning to ensure that the systems are interoperable and that the biological-detection company is included in technical operational data (TECHOPDAT) instructions. Ensure that the biological-detection company is provided a copy of exchange message protocols.
- Ensure that aviation assets for the LRBSDS are included in the communications plan.
- Plan for and monitor message precedence allocation.
- Establish a combined coordination, communication, and integration center for exchange of operational information. This is imperative during joint or combined operations
- Plan for communications with the supporting medical lab, theater TEU, and theater CLS element for BIDS and/or LRBSDS.
- Provide contingency plans for alternate communications (such as losing the HF capability).
- Plan for signal security (SIGSEC).
- Plan for obtaining a set of SOI for frequencies and internal nets for the biological-detection unit.
- Guard against self-induced electromagnetic frequency interference and keep a 10 to 15 megahertz separation between adjacent transmitters for HF RF management.

(2) There are four primary nets to consider:

- FBCB2 net (for M31A2 unit only). This is the primary net for passing the required reports as specified by the unit SOP (such as biological-detection reports, SITREPs, logistics status reports, and sensitive item reports) Use the FBCB2 net to maintain and transmit SA data to communicate with the supporting unit and as a complementary means of communication.
- HF net. This is the primary operations and intelligence net and is an alternate net for passing biological-detection reports for M31A2 units. It remains the primary means of passing biological-detection reports for M31A1 and M31 equipped units.
- VHF net. This is the primary administrative and logistics net. Use the VHF net to maintain and transmit SA data to communicate with the supporting unit and as a complementary means of communication (for example, forwarding biological-detection reports with the biological-detection company and platoon CPs. This net is also used to gain access to TACSAT and Joint Surveillance Target Attack Radar System (voice and digital communications systems).
- MSE network and MSRT. This is the alternate operations and intelligence net. MSRT may also be the primary means to pass operations and intelligence information directly from the biological-detection company CP to the corps chemical officer. For example, the

corps chemical battle staff may have a subscriber access node that allows them to speak directly to the biological-detection company.

(3) *Figures I-5 through I-7* provide graphical representations of the communications architecture for biological-detection units.



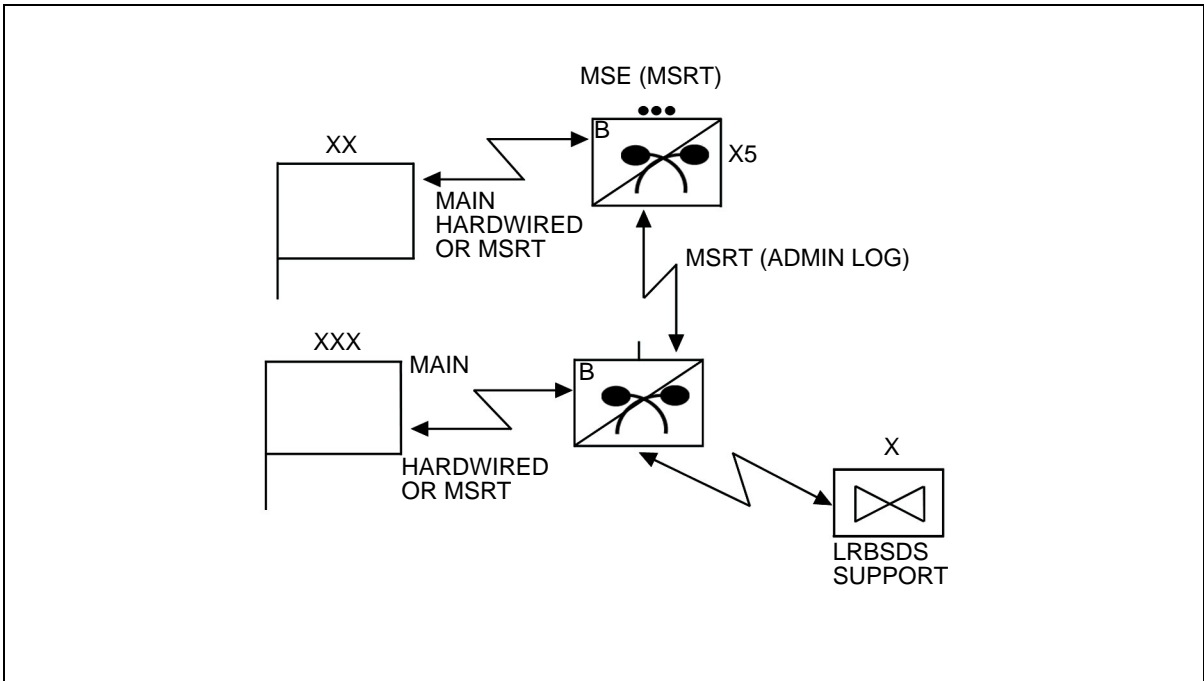
**Figure I-5. HF Network**

d. Force XXI Battle Command Brigade and Below (for M31A2 Units Only).

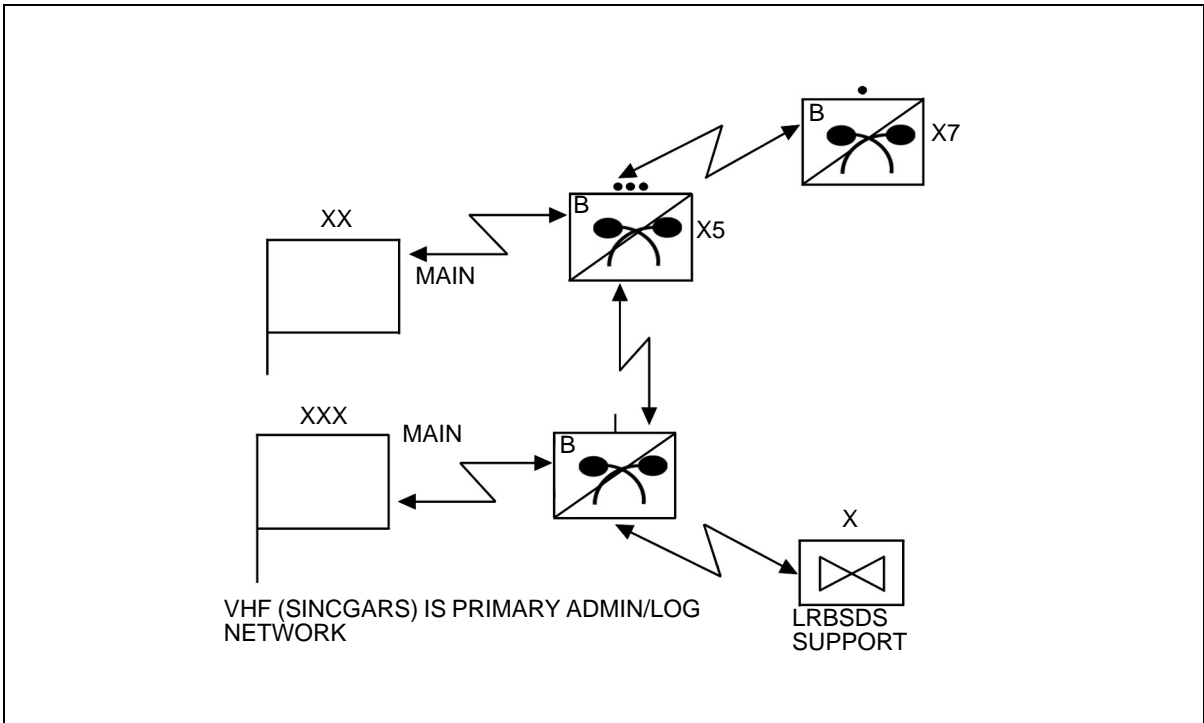
(1) FBCB2 integration. FBCB2 is an additional communications capability for M31A2 units. The FBCB2 system exchanges position locations, spot reports, biological-incident reports, and SITREPs. FBCB2 software is presently found in hardware in other platforms including combat vehicles, HMMWVs, and C2 operations centers. FBCB2 software is also embedded in new combat vehicle upgrades and C2 components of the Army Tactical Command and Control System.

(2) FBCB2 Message Protocols. FBCB2 uses the joint variable message format message set and the new military standard (MIL-STD) 188-220(A) message protocol. Although designed primarily for use at the battalion, company, and below, there is overlap through use of the embedded command interface between the Maneuver Control System (MCS) and FBCB2, thereby closing the communications seam.

(3) Functional description. FBCB2 hardware is a militarized computer communications capability. FBCB2 is connected to a positioning and navigation device, for example, GPS and other embedded platform interfaces such as the Battlefield Combat Identification System. These interfaces enhance the capability of FBCB2 to provide relevant information to commanders, staffs, units, and soldier and/or weapon platforms.



**Figure I-6. MSE Network**



**Figure I-7. VHF Network for M31, M31A1, and M31A2 and FBCB2 for M31A2 Only**

(4) Employment.

(a) FBCB2 provides interoperability for the exchange of information with other Army Battle Command Systems over a tactical network. For example,

biological-detection teams digitally submit biological-incident reports to the biological-detection platoon using preformatted free message text reports (*Figure I-8*). The biological-detection platoon receives, consolidates, and evaluates the incoming reports and prepares and forwards an NBC-1 (BIO) report. The digitized message saves the time required for voice communication.

BIDS Number: _____
Sample Identification Number (19 Digits) : _____
1. Detection time
a. DTG
b. Background sample
c. Command directed sample
2. Meteorological data
a. Elevation
b. Direction
c. Wind speed
d. Temperature
e. Relative humidity
3. Identification
a. DTG
b. Agent code
c. Negative
4. Mode of operation
a. Standard
b. Single sample
c. Periodic
d. Degraded
e. Extreme cold

**Figure I-8. Sample FBCB2 Free Message Text for Biological-Incident Reports**

(b) FBCB2 supports the biological-detection company and platoon with seamless C2 capabilities through interfaces with other Army and joint C2 HQ. Communications planning identifies whether the M31A2 digitized reporting capability is compatible with the supporting and supported unit. These capabilities allow the user to send and receive C2 information horizontally and vertically across the AO irrespective of task organization. FBCB2 facilitates a flow of communications that effectively supports the synchronization of close combat operations.

(c) FBCB2 provides support for the following functional areas: situational understanding, battle command, communications management, and connectivity with other units.

(5) FBCB2 capabilities.



(a) FBCB2 capabilities provide the biological-detection team, platoon, and company with the ability to create a common tactical picture that includes mapping, maneuver, weather, CSS, intelligence, air defense, and fire support features. There is applicability in each of these domains (for example, weather and mapping) for biological-detection unit operations. For example, FBCB2 provides—

- A visual image of the AO showing unit locations and the location of the surrounding FBCB2 equipped systems. The FBCB2 system provides each echelon with SA of the battlespace, two echelons up and down, and units on the right and left.
- The automatic display of SA data, maps, grids, and overlays (for example, the identification of friendly units, own unit, threat units, fire plans, routes, unknown units, and obstacles).
- Micrometeorological weather data for other locations within the AO.
- Visual imagery of digital maps to support biological-detection site selection for primary, alternate, and supplemental sites.
- Information on friendly force NAIs.
- Available information on threat locations and the threat status.
- Information on friendly force intent and locations to support current and future operations.
- Information on the air defense umbrella.
- A capability to identify routes of march and movement times between points.
- Precise lightweight GPS receiver (PLGR) location (the PLGR is connected to the FBCB2 through a serial interface).

(b) Battle command provides—

- The capability for the biological-detection company or platoon to send and receive orders and the attached graphical overlays (for example, sending the biological-employment plan overlay to higher HQ or subordinate biological-detection teams).
- The capability to forward biological-detection reports digitally from the biological-detection team to the biological-detection platoon or company; thereby saving the time required to transmit the reports via voice.

**NOTE: The capability to transmit reports will be dependent on the range of the communications system used (for example, HF or FBCB2).**

- An enhanced capability to track multiple biological events graphically at different levels of command.
- A capability to respond to emergency situations (such as a request for medical evacuation [MEDEVAC] or calls for fire).

- An immediate method of notifying a unit if they are within the danger area of a warning event (for example, an air defense warning). The platform distance away from the warning event can be displayed in meters.
- (c) Communications management provides a means to—
- Preformat and provide standard digitized preaddressed message formats.
  - Establish electronic message folders and address groups to more efficiently monitor and track incoming and outgoing message traffic.
  - Provide periodic reminders of required activities or reports (for example, periodic submission of SITREPs).

**NOTE: The SINCGARS radio transmits and receives SA and C2 between platforms on the same data net frequencies if SINCGARS is attached. SINCGARS is the primary communications system for the FBCB2 below platoon level. It is used to transmit and receive SA and C2 between platforms using data network frequencies.**

(d) Interface with other Army Battle Command Systems (for example, support to nondigitized and digitized forces). Communications planning considers the interoperability between the biological-detection unit and the unit being supported (for example, a JTF, other service, HN, and/or Army major command). For example, if an Army nondigitized force unit is supported, the appropriate nondigitized (voice communications) means will be used. Internal to the biological-detection unit, FBCB2 capabilities can be used (distance and other factors being considered); however, there must be interoperability for submission of reports to the required C2 node.

**NOTE: At the biological-detection company and platoon HQ level, data transfer occurs through use of the EPLRS. The EPLRS is both a data radio and a location device and the primary data transfer system for those C2 nodes equipped with EPLRS. EPLRS acts as a hub, relaying information to platforms outside the local net. Information is relayed to the local net SA server, which relays it over EPLRS to the receiving end. The EPLRS transmits and receives SA and C2 from the FBDB2 system.**

(6) Limitations.

- When a user must change platforms due to battle damage or mission requirements, data that was stored on the previous FBCB2 is lost.
- The computer and keyboard are susceptible to damage from dust and dirt. Users should take all practical steps to prevent this from happening.
- Interoperability must be assured to ensure communications between biological-detection units and nondigitized and digitized units.

## REFERENCES

### Department of Defense

- DODD 2000.12, *DoD Antiterrorism (AT) Program*, 18 April 2003.
- DODD 3025.1M, *Manual for Civil Emergencies*, June 1994 (unclassified [U]).
- DODD 3025.12, *Military Assistance for Civil Disturbances (MACDIS)*, 4 February 1994 (U).
- DODD 3025.15, *Military Assistance to Civil Authorities*, 18 February 1997.
- DODD 5100.77, *DoD Law of War Program*, 9 December 1998.
- DODD 5240.1, *DoD Intelligence Activities*, 25 April 1988 (U).
- DODD 6490.2, *Joint Medical Surveillance*, 30 August 1997.
- DODI 6490.3, *Implementation and Application of Joint Medical Surveillance for Deployments*, 7 August 1997.
- DODD 5525.5, *DoD Cooperation with Civilian Law Enforcement Officials*, 15 January 1986.

### Joint

- Chairman of the Joint Chiefs of Staff Instruction (CJCSI) 3125.01, *Military Assistance to Domestic Consequence Management Operations in Response to a Chemical, Biological, Nuclear, or High-Yield Explosive Situation*, 3 August 2001.
- CJCSM 3150.03B, *Joint Reporting Structure Event and Incident Reports*, 28 July 2003.
- Chairman of the Joint Chiefs of Staff Manual (CJCSM) 3500.04B, *Universal Joint Task List (UJTL)*, 1 July 2002.
- JP 1, *Joint Warfare of the Armed Forces of the United States*, 14 November 2000.
- JP 1-01, *Joint Doctrine Development System, Change 1*, 5 July 2000.
- JP 1-02, *Department of Defense Dictionary of Military and Associated Terms*, 12 April 2001.
- JP 2.01.3, *Joint Tactics, Techniques, and Procedures for Joint Intelligence Preparation of the Battlespace*, 24 May 2000.
- JP 3-0, *Doctrine for Joint Operations*, 10 September 2001.
- JP 3-01, *Joint Doctrine for Countering Air and Missile Threats*, 19 October 1999.
- JP 3-01.5, *Doctrine for Joint Theater Missile Defense*, 22 February 1996
- JP 3-04.6, *Joint Tactics, Techniques, and Procedures for Foreign Humanitarian Assistance*, 15 August 2001.
- JP 3-07, *Joint Doctrine for Military Operations Other Than War*, 16 June 1995.

JP 3-07.1, *Joint Tactics, Techniques and Procedures for Foreign Internal Defense (FID)*, 26 June 1996.

JP 3-07.2, *Joint Tactics, Techniques, and Procedures for Antiterrorism*, 17 March 1998.

JP 3-07.7, *Joint TTP for Domestic Support Operations*, June 1996.

JP 3-10, *Joint Doctrine for Rear Area Operations*, 28 May 1996.

JP 3-10.1, *Joint Tactics, Techniques and Procedures for Base Defense*, 23 July 1996.

JP 3-11, *Joint Doctrine for Operations in Nuclear, Biological, and Chemical (NBC) Environments*, 11 July 2000.

JP 3-33, *Joint Force Capabilities*, 13 October 1999.

JP 4-0, *Doctrine for Logistics Support of Joint Operations*, 6 April 2000.

JP 4-02, *Doctrine for Health Service Support in Joint Operations*, 30 July 2001.

JP 5-0, *Doctrine for Planning Joint Operations*, 13 April 1995.

JP 5-00.2, *Joint Task Force Planning Guidance and Procedures*, 13 January 1999.

JP 5-03.1, *Joint Operation Planning and Execution System Vol I: (Planning Policies and Procedures)*, 9 August 1993.

JP 5.03.2, *Joint Operation Planning and Execution System (JOPES), Volume II*, 10 March 1992 (U).

JP 6-0, *Doctrine for Command, Control, Communications, and Computer (C4) Systems Support to Joint Operations*, 30 May 1995.

Joint Service Chemical and Biological Defense Program FY 00-02 Overview.

Joint Service Chemical and Biological Defense Fact Sheet, August 1998.

Joint Service Nuclear, Biological, and Chemical Defense Concept, September 1997.

MCM-0006-02, *Updated Procedures for Deployment Health Surveillance and Readiness*, 1 February 2002.

### **Multiservice**

FM 3-3/Fleet Marine Force Manual (FMFM) 11-17, *Chemical and Biological Contamination Avoidance*, 16 November 1992, C1, 29 September 1994.

FM 3-3-1/FMFM 11-18, *Nuclear Contamination Avoidance*, 9 September 1994.

FM 3-11.4/Marine Corps Warfighting Publication (MCWP) 3-37.2/Navy Tactics, Techniques, and Procedures (NTTP) 3-11.27/Air Force Tactics, Techniques, and Procedures (AFTTP)(Instruction [I]) 3-2.46, *Multiservice Tactics, Techniques, and Procedures for Nuclear, Biological, and Chemical (NBC) Protection*, 2 June 2003.

FM 3-5/MCWP 3-37.3, *NBC Decontamination*, 8 July 2000, Change 1, 31 January 2002.

FM 3-6/AFM 105-7/FMFM 7-11H, *Field Behavior of NBC Agents (Including Smoke and Incendiaries)*, 3 November 1986.

FM 3-9/Navy Facilities (NAVFAC) P-467/Air Force Regulation (AFR) 355-7, *Potential Military Chemical/Biological Agents and Compounds*, 12 December 1990.

FM 3-11/MCWP 3-31.1/Naval Warfare Publication (NWP) 3-11/AFTTP(I) 3-2.41, *Multiservice Tactics, Techniques, and Procedures for Nuclear, Biological, and Chemical Defense Operations*, June 2002.

FM 3-11.34/MCWP 3-37.5/NTTP 3-11.23/AFTTP (1) 3-2.33, *Multiservice Tactics, Techniques, and Procedures for Nuclear, Biological, and Chemical (NBC) Defense of Theater Fixed Sites, Ports, and Airfields*, 29 September 2000.

FM 3-11.19/MCWP 3-37.4/AFTTP (I) 3-2.44, *NBC Reconnaissance*, 19 November 1993. To be published in the next 6 months.

FM 3-11/MCWP 3-37.1/NWP 3-11/AFTTP(I) 3-2.42, *Multiservice Tactics, Techniques, and Procedures For Nuclear, Biological, and Chemical Defense Operations*, 10 March 2003.

FM 8-9/Navy Medical Publication (NAVMED P)-5059/Air Force Joint Manual (AFJMAN) 44-151V1V2V3, *NATO Handbook on the Medical Aspects of NBC Defensive Operations AMed P-6(B)*, 1 February 1996.

FM 4-02.33, *Control of Communicable Diseases Manual*, 31 December 1999.

FM 8-284/NAVMED P-5042/AFMAN (I) 44-156/Marine Corps Reference Publication (MCRP) 4-11.1C, *Treatment of Biological Warfare Agent Casualties*, 17 July 2000.

FM 21-10/MCRP 4-11.1D, *Field Hygiene and Sanitation*, 21 June 2000.

FM 6-02.85/MCRP 3-40.2A/NTTP 3-13.1.16/AFTTP(I) 3-2.22, *Multi-Service Tactics, Techniques, and Procedures For Joint Task Force Information Management*, 10 September 2003.

## Army

USAMRICD, *Medical Management of Biological Casualties Handbook, 4th Ed*, February 2001.

FM 3-0, *Operations*, 14 June 2001.

FM 3-7, *NBC Field Handbook*, 29 September 1994.

FM 3-14/MCRP 3-37.1A, *Nuclear, Biological, and Chemical (NBC) Vulnerability Analysis*, 12 November 1997, Change 1, 24 September 1998.

FM 3-19 (FMFM 11-20), *NBC Reconnaissance*, 19 November 1993.

FM 3-90, *Tactics*, 4 July 2001

FM 3-101, *Chemical Staffs and Units*, 19 November 1993.

FM 4-02, *Force Health Protection in a Global Environment*, 13 February 2003.

FM 4-02.7, *Health Service Support in a Nuclear, Biological, and Chemical Environment Tactics, Techniques, and Procedures*, 1 October 2002.

FM 8-42, *Combat Health Support in Stability Operations and Support Operations*, 27 October 1997.

FM 8-500, *Hazardous Materials Injuries, a Handbook for Prehospital Care (4th Edition)*, January 1997.

FM 4-25.11/Naval Training Reference Publication (NTRP) 4-02.1/AFMAN 44-163(I), *First Aid*, 23 December 2002.

FM 100-6, *Information Operations*, 27 August 1996.

FM 100-7, *Decisive Force: The Army in Theater Operations*, 31 May 1995.

FM 100-23, *Peace Operations*, 30 December 1994.

FM 101-5, *Staff Organization and Operations*, 31 May 1997.

TRADOC Pamphlet 525-63, *Operations Concept for Biological Defense*, 1 December 1994.

USACMLS, *Concept for Biological Detection Future*, 18 September 1996.

USACMLS, *Chemical Vision 2010*, 3 February 1999.

USACMLS, *Theater Missile Defense, Joint Project Optic Cobra 1996, After Action Report*, 1996.

USACMLS, *TOE Summary Book*, 1 June 2000.

Army Chemical Review, *NBC Operations in Bosnia*, July 1996.

Army Chemical Review, January 1997.

US Army Maneuver Support Center, *Force Development BR DCD*, 15 October 2001.

USAMRIID, *Medical Management of Biological Casualties Handbook*, Fourth Edition, February 2001.

Training Circular (TC) 3-4, *Chemical Battle Staff Handbook*, 3 October 1995.

### **Air Force**

Air Force Doctrine Document (AFDD)-1, *Air Force Basic Doctrine*, September 1997.

Air Force Handbook (AFH) 32-4014 V1, *Operations in a Chemical and Biological (CB) Warfare Environment, CB Planning and Analysis*, 1 March 1998.

AFH 32-4014 V2, *USAF Operations in a Chemical and Biological (CB) Warfare Environment*, 1 December 1997.

AFH 32-4014 V3, *USAF Operations in a Chemical and Biological (CB) Warfare Environment*, 1 February 1998.

AFH 32-4014 V4, *USAF Ability to Survive and Operate Procedures in a Nuclear, Biological, and Chemical (NBC) Environment*, 1 March 1998.

Air Force Instruction (AFI) 32-4002, *Hazardous Material Emergency Planning and Response Program*, 22 March 1999.

AFMAN 10-2602, *Nuclear, Biological, Chemical, and Conventional (NBCC) Defense Operations and Standards*, 29 May 2003.

AFMAN 32-4004, *Emergency Response Operations*, 1 December 1995.

AFMAN 32-4005, *Personnel Protection and Attack Actions*, 30 October 2001.

AFMAN 32-4017, *Civil Engineer Readiness Technician's Manual for Nuclear, Biological, and Chemical Defense*, 29 May 2003.

Air Force Pamphlet (AFPAM) 32-4019, *Chemical-Biological Warfare Commander's Guide*, 1 April 1998.

Air Force Policy Directive (AFPD) 32-40, *Disaster Preparedness*, 1 May 1997.

US Air Force Engineering Support Activity, *Chemical and Biological Defense Concept of Operations*, January 1998.

US Air Force Institute for National Security Studies, *Countering the Proliferation and Use of Weapons of Mass Destruction*, 1998.

### **Marine Corps**

MCWP 3-37, *Marine Air-Ground Task Force (MAGTF) Nuclear, Biological, and Chemical Defensive Operations*, September 1998.

### **Navy**

ATP 45 (B), *Reporting Nuclear Detonation, Biological And Chemical Attacks, and Predicting and Warning of Associated Hazards and Hazard Areas (Operators Manual)*, 1 July 2001.

Commander, Fleet Forces Command Naval Message: 142055Z, *BW Agent Detection and Response Guidance*, March 2003.

Naval Doctrine Command, US Navy, Executive Summary, *Multinational Maritime Operations*, September 1996.

Naval Doctrine Publication 1, *Naval Warfare*, 28 March 1994.

Naval Doctrine Publication 2, *Naval Intelligence*, 30 September 1994.

Naval Doctrine Publication 4, *Naval Logistics*, 20 February 2000.

NWP, 3-20.31 (Revision A), *Ship Survivability*, January 2000.

*Trainee Guide, Disaster Preparedness Operations Specialist*, US Navy Detachment, Fort Leonard Wood, MO, June 1998.

NATO Standardization Agreements (STANAG) and Publications

Standardization Agreement (STANAG) 2002, *Warning Signs for the Marking of Contaminated or Dangerous Land Areas, Complete Equipment, Supplies, and Stores*, 29 January 1999.

STANAG 2103, *Reporting Nuclear Detonations, Biological and Chemical Attacks, and Predicting the Warning of Associated Hazards and Hazard Areas ATP 45 (B)*, 31 August 2001.

STANAG 2112, *NBC Reconnaissance*, 6 March 1998.

STANAG 2353, *Evaluation of NBC Defense Capability*, 6 March 2000.

### **Other Sources**

DA Form 12-99-R. *Initial Distribution (ID) Requirements for Publications*, April 1996.

Allied Engineering Publication (AEP) (10), Sampling and Identification of CB Agents.

DA Form 4137. *Evidence/Property Custody Document*, July 1976.

DA Form 2028, *Recommended Changes to Publications and Blank Forms*, February 1974.

DD Form 1911, *Material Courier Receipt*, May 1982.

DD Form 2795. *Pre-Deployment Health Assessment*, May 1999.

DD Form 2796. *Post-Deployment Health Assessment*, April 2003.

Defense Intelligence Agency Manual 58-13, Defense Human Resources Intelligence Collection Procedures (SECRET/NOFOR).

Department of Transportation, *2000 Emergency Response Guidebook, A Guide for First Responders During the Initial Phase of a Dangerous Goods/ Hazardous Materials Incident*.

49 Code of Federal Regulation (CFR) Part 173.196, *Hydrogen cyanide, anhydrous, stabilized (hydrocyanic acid, aqueous solution)*, 1 October 2003.

Federal Emergency Management Agency (FEMA), Federal Radiological Emergency Response Plan (FRERP), 1 May 1996 (U).

FEMA 9230.1-PL, *Federal Response Plan: Interim*, January 2003.

IATA Packaging Instruction 602, 2001.

IATA Packaging Instruction 650, 2001.

IATA Dangerous Goods Regulation (DGR), 1 January 2004–31 December 2004.

Technical Instructions on the Safe Transport of Dangerous Goods by Air, 2003–2004 Edition.

Memorandum, Under Secretary of Defense, Military and Veterans Health Coordinating Board and Presidential Review Directive (PRD-S), 7 December 1999.

Deterrence and Defense in a Nuclear, Biological, and Chemical Environment, Robert B. Joseph and John F. Reichart, 1999.

Office of Special Assistant for Gulf War Illness, Lessons Learned Implementation, 18 November 1999.

Presidential Decision Directive (PDD)/National Security Council (NSC) 39, *U.S. Government Policy on Counterterrorism*, 21 June 1995.

Soldier Training Publication (STP) 8-91B-15-SM-TG, MOS 91W, *Health Care Specialist*, 10 October 2001.



TM 3-6665-350-12&P, *Operator's and Unit Maintenance Manual (Including Repair Parts and Special Tools List) for Alarm Biological Agent, Automatic: Integrated Detection System, M31A1*, 31 December 2001.

# GLOSSARY

## PART I—ABBREVIATIONS AND ACRONYMS

### A

<b>AAR</b>	after-action report
<b>AB</b>	airbase
<b>ABCS</b>	Army Battle Command System
<b>AC</b>	alternating current
<b>ACLEFT</b>	aircraft left
<b>ACP</b>	aerial checkpoint
<b>ADA</b>	air defense artillery
<b>admin</b>	administrative
<b>ADP</b>	automated data processing
<b>ADTDL</b>	Army Doctrine and Training Digital Library
<b>AFB</b>	Air Force base
<b>AFDD</b>	Air Force doctrine document
<b>AFH</b>	Air Force handbook
<b>AFI</b>	Air Force instruction
<b>AFJMAN</b>	Air Force joint manual
<b>AFM</b>	Air Force manual
<b>AFMAN</b>	Air Force manual
<b>AFPAM</b>	Air Force pamphlet
<b>AFPD</b>	Air Force policy directive
<b>AFR</b>	Air Force regulation
<b>AFTTP</b>	Air Force tactics, techniques, and procedures
<b>AGL</b>	above ground level
<b>AL</b>	Alabama
<b>AM</b>	amplitude modulation
<b>AMC</b>	Air Mobility Command
<b>AMed</b>	allied medical
<b>AO</b>	area of operations
<b>AOI</b>	area of interest
<b>AOR</b>	area of responsibility
<b>APO</b>	Army post office
<b>APOD</b>	aerial port of debarkation
<b>APOE</b>	aerial port of embarkation
<b>APS</b>	aerodynamic particle sizer

<b>ARFOR</b>	Army forces
<b>AT</b>	antiterrorism
<b>ATIA-M</b>	Army Training Information Architecture-Migrated
<b>ATP</b>	allied tactical publication
<b>attn</b>	attention
<b>AUG</b>	August
<b>B</b>	
<b>bde</b>	brigade
<b>BIDS</b>	Biological Integrated Detection System
<b>bio</b>	biological
<b>bn</b>	battalion
<b>br</b>	branch
<b>BSA</b>	brigade support area
<b>BW</b>	biological warfare
<b>C</b>	
<b>C</b>	Celsius
<b>C2</b>	command and control
<b>C4</b>	command, control, communications, and computers
<b>C4I</b>	command, control, communications, computers, and intelligence
<b>CA</b>	civil affairs
<b>CB</b>	chemical-biological; chemical and biological
<b>CBMS</b>	chemical-biological mass spectrometer
<b>CBR</b>	chemical, biological, and radiological
<b>CBRN</b>	chemical, biological, radiological, or nuclear
<b>CCIR</b>	commander's critical information requirements
<b>CD</b>	compact disc
<b>CDC</b>	Centers for Disease Control and Prevention
<b>CFR</b>	Code of Federal Regulations
<b>CG</b>	commanding general
<b>CHS</b>	combat health support
<b>CIP</b>	communications interface processor
<b>CJCS</b>	Chairman of the Joint Chiefs of Staff
<b>CJCSI</b>	Chairman of the Joint Chiefs of Staff instruction
<b>CJCSM</b>	Chairman of the Joint Chiefs of Staff manual
<b>CLS</b>	contracted logistics support
<b>CM</b>	chemical
<b>CMLO</b>	chemical officer
<b>CMO</b>	chief military observer

<b>co</b>	company
<b>COA</b>	course of action
<b>COCOM</b>	combatant command (command authority)
<b>COE</b>	concept of employment
<b>COMM</b>	communications; commercial
<b>CONOPS</b>	concept of operations
<b>CONPLAN</b>	concept plan
<b>CONUS</b>	continental United States
<b>COP</b>	common operational picture
<b>COS</b>	chief of staff
<b>COTS</b>	commercial off-the-shelf
<b>CP</b>	command post
<b>CPU</b>	central processing unit
<b>CRC</b>	CONUS replacement center
<b>CS</b>	combat support
<b>CSH</b>	combat support hospital
<b>CSS</b>	combat service support
<b>CV</b>	aircraft carrier
<b>CVN</b>	aircraft carrier, nuclear
<b>CW</b>	chemical warfare
<b>CWO</b>	chief warrant officer
<b>D</b>	
<b>DA</b>	Department of the Army
<b>DC</b>	direct current
<b>DCC</b>	damage control center
<b>DCD</b>	Directorate of Combat Development
<b>DD</b>	Department of Defense
<b>deg</b>	degree
<b>det</b>	detachment
<b>DGR</b>	dangerous goods regulation
<b>DISCOM</b>	division support command
<b>DNA</b>	deoxyribonucleic acid
<b>DNBI</b>	disease and nonbattle injury
<b>DOD</b>	Department of Defense
<b>DODD</b>	Department of Defense directive
<b>DODI</b>	Department of Defense instruction
<b>DOT</b>	Department of Transportation
<b>DSN</b>	Defense Switch Network
<b>DTG</b>	date-time group

## **E**

<b>EAC</b>	echelons above corps
<b>ECU</b>	environmental control unit
<b>EOD</b>	explosive ordnance disposal
<b>EPLRS</b>	Enhanced Position Location Reporting System

## **F**

<b>F</b>	Fahrenheit
<b>FARP</b>	forward arming and refueling point
<b>FBCB2</b>	Force XXI battle command/brigade and below
<b>FDA</b>	Food and Drug Administration
<b>FEMA</b>	Federal Emergency Management Agency
<b>FHP</b>	force health protection
<b>FID</b>	foreign internal defense
<b>FLOT</b>	forward line of own troops
<b>FM</b>	field manual; frequency modulation
<b>FMFM</b>	Fleet Marine Force Manual
<b>FNS</b>	foreign nation support
<b>FP</b>	force protection
<b>FPO</b>	fleet post office
<b>FRAGORD</b>	fragmentary order
<b>FRERP</b>	Federal Radiological Emergency Response Plan
<b>FS</b>	fire support
<b>FSCOORD</b>	fire support coordinator
<b>FSE</b>	fire support element
<b>FSMC</b>	forward support medical company
<b>FY</b>	fiscal year

## **G**

<b>G-2</b>	Army or Marine Corps component intelligence staff officer (Army division or higher staff, Marine Corps brigade or higher staff)
<b>GA</b>	Georgia
<b>GCCS</b>	Global Command and Control System
<b>GFE</b>	government-furnished equipment
<b>GPS</b>	global positioning system

## **H**

<b>HF</b>	high frequency
<b>HMMWV</b>	high mobility multipurpose wheeled vehicle
<b>HN</b>	host nation

<b>HNS</b>	host-nation support
<b>HQ</b>	headquarters
<b>HSS</b>	health service support
<b>HUMINT</b>	human intelligence
<b>HVAC</b>	heating, ventilation, and air conditioning
<b>HVT</b>	high-value target
<b>I</b>	
<b>I</b>	instruction
<b>IATA</b>	International Air Transport Association
<b>IB</b>	international border
<b>IBADS</b>	Interim Biological Agent Detector System
<b>ID</b>	identification
<b>IMS</b>	Information Management System
<b>IPB</b>	intelligence preparation of the battlespace
<b>IPE</b>	individual protective equipment
<b>IR</b>	information requirement
<b>ISR</b>	intelligence, surveillance, and reconnaissance
<b>J</b>	
<b>JACC</b>	joint airspace control center
<b>JBAIDS</b>	Joint Biological Agent Identification and Diagnostic System
<b>JBPDS</b>	joint biological point detection system
<b>JFC</b>	joint-force commander
<b>JOPEs</b>	Joint Operation Planning and Execution System
<b>JP</b>	joint publication
<b>Jr.</b>	junior
<b>JSLNBCRS</b>	Joint Service Light Nuclear, Biological, and Chemical Reconnaissance System
<b>JSTARS</b>	Joint Surveillance Target Attack Radar System
<b>JTF</b>	joint task force
<b>K</b>	
<b>kg</b>	kilogram
<b>km</b>	kilometer(s)
<b>kph</b>	kilometers per hour
<b>L</b>	
<b>LCAC</b>	landing craft air cushion
<b>LHA</b>	amphibious assault ship (general purpose)
<b>LOAC</b>	law of armed conflict

<b>LOS</b>	line of sight
<b>LRBSDS</b>	Long-Range Biological Standoff Detection System
<b>LSE</b>	logistics support element
<b>LZ</b>	landing zone
<b>M</b>	
<b>m</b>	month; meter
<b>MACDIS</b>	military assistance for civil disturbances
<b>MAGTF</b>	Marine Air-Ground Task Force
<b>MANSCEN</b>	Maneuver Support Center
<b>MARFOR</b>	Marine Corps forces
<b>MCCDC</b>	Marine Corps Combat Development Command
<b>MCM</b>	military classification manual
<b>MCRP</b>	Marine Corps reference publication
<b>MCS</b>	maneuver control system
<b>MCWP</b>	Marine Corps Warfighting Publication
<b>MD</b>	Maryland
<b>MEDCEN</b>	medical center
<b>MEDEVAC</b>	medical evacuation
<b>met</b>	meteorological
<b>METT-T</b>	(Marine Corps) mission, enemy, terrain and weather, troops available, and time
<b>METT-TC</b>	mission, enemy, terrain and weather, time, troops available, and civilian
<b>MGySgt</b>	master gunnery sergeant
<b>mil</b>	military
<b>MIL-STD</b>	military standard
<b>MILSTRIP</b>	military standard requisitioning and issue procedures
<b>mini-FCM</b>	miniature flow cytometer
<b>ml</b>	milliliter
<b>mm</b>	millimeter
<b>MO</b>	Missouri
<b>MOB</b>	main operations base
<b>MOS</b>	military occupational specialty
<b>MOPP</b>	mission-oriented protective posture
<b>mph</b>	miles per hour
<b>MSC</b>	Military Sealift Command; major subordinate command
<b>MSE</b>	mobile subscriber equipment
<b>MSR</b>	main supply route
<b>MSRT</b>	mobile subscriber radio terminal
<b>MTF</b>	medical treatment facility

<b>MTMC</b>	Military Traffic Management Command
<b>MTTP</b>	multiservice tactics, techniques, and procedures
<b>N</b>	
<b>N/A</b>	not applicable
<b>NAF</b>	numbered air force
<b>NAI</b>	named area of interest
<b>NATO</b>	North Atlantic Treaty Organization
<b>NAVMED</b>	Navy medical
<b>NAVFAC</b>	Navy facilities
<b>NAVFOR</b>	Navy forces
<b>NBC</b>	nuclear, biological, and chemical
<b>NBCCC</b>	nuclear, biological, and chemical control center
<b>NBCD</b>	nuclear, biological, and chemical defense
<b>NBCDO</b>	nuclear, biological, and chemical defense officer
<b>NBI</b>	nonbattle injury
<b>NC</b>	North Carolina
<b>NCO</b>	noncommissioned officer
<b>NCOIC</b>	noncommissioned officer in charge
<b>neg</b>	negative
<b>NGO</b>	nongovernmental organization
<b>NLT</b>	not later than
<b>no</b>	number
<b>NOE</b>	nap-of-the-earth
<b>NSC</b>	National Security Council
<b>NTRP</b>	Naval training reference publication
<b>NTTP</b>	Navy tactics, techniques, and procedures
<b>NWDC</b>	Navy Warfare Development Command
<b>NWP</b>	naval warfare publication
<b>O</b>	
<b>O&amp;I</b>	operations and intelligence
<b>OCONUS</b>	outside the continental United States
<b>OGA</b>	other government agency
<b>OPCEN</b>	operations center
<b>OPCON</b>	operational control
<b>OPLAN</b>	operation plan
<b>OPNAV</b>	chief of Naval operations
<b>OPORD</b>	operation order
<b>OPR</b>	office of primary responsibility



<b>OPSEC</b>	operations security
<b>OPTASK</b>	operation task
<b>OPTEMPO</b>	operating tempo
<b>P</b>	
<b>P</b>	promotable
<b>P3I</b>	preplanned product improvement
<b>PC</b>	personal computer
<b>PDD</b>	presidential decision directive
<b>PHL</b>	public health lab
<b>PIR</b>	priority intelligence requirement
<b>PLGR</b>	precise lightweight GPS receiver
<b>PMCS</b>	preventive maintenance checks and services
<b>POC</b>	point of contact
<b>POD</b>	port of debarkation
<b>POE</b>	port of embarkation
<b>PRD</b>	presidential review directive
<b>PVNTMED</b>	preventive medicine
<b>Q</b>	
<b>QA</b>	quality assurance
<b>QC</b>	quality control
<b>R</b>	
<b>R&amp;S</b>	reconnaissance and surveillance
<b>recon</b>	reconnaissance
<b>RF</b>	radio frequency
<b>RI</b>	Rhode Island
<b>RNA</b>	ribonucleic acid
<b>RP</b>	release point
<b>RSOI</b>	reception, staging, onward movement, and integration
<b>S</b>	
<b>S-2</b>	battalion or brigade intelligence staff officer (Army, Marine Corps battalion or regiment)
<b>S-3</b>	battalion or brigade operations staff officer (Army; Marine Corps battalion or regiment)
<b>SA</b>	situational awareness
<b>SEAD</b>	suppression of enemy air defenses
<b>SIGINT</b>	signals intelligence
<b>SIGSEC</b>	signal security

<b>SINCGARS</b>	single-channel ground and airborne radio system
<b>SITREP</b>	situation report
<b>SJA</b>	Staff Judge Advocate
<b>SM</b>	soldier's manual
<b>SNCIOC</b>	senior noncommissioned officer in charge
<b>SOF</b>	special operations forces
<b>SOI</b>	signal operating instructions
<b>SOP</b>	standard operating procedure
<b>SPOD</b>	seaport of debarkation
<b>SPOE</b>	seaport of embarkation
<b>STANAG</b>	standardization agreement
<b>STP</b>	soldier training publication
<b>T</b>	
<b>TACON</b>	tactical control
<b>TACSAT</b>	tactical satellite
<b>T-AH</b>	hospital ship
<b>TAML</b>	theater Army medical laboratory
<b>TBM</b>	theater ballistic missile
<b>tech</b>	technical
<b>TECHOPDAT</b>	technical operational data
<b>TEU</b>	technical escort unit
<b>TG</b>	trainer's guide
<b>TL</b>	team leader
<b>TM</b>	technical manual
<b>TO</b>	theater of operations, technical order
<b>TOC</b>	tactical operations center
<b>TPFDD</b>	time-phased force and deployment data
<b>TPFDL</b>	time-phased force and deployment list
<b>TRADOC</b>	United States Army Training and Doctrine Command
<b>TTP</b>	tactics, techniques, and procedures
<b>U</b>	
<b>U</b>	unclassified
<b>UHF</b>	ultrahigh frequency
<b>UIC</b>	unit identification code
<b>UJTL</b>	universal joint tack list
<b>UMD</b>	unit movement data
<b>UN</b>	United Nations
<b>US</b>	United States

<b>USA</b>	United States Army; United States of America
<b>USACMLS</b>	United States Army Chemical School
<b>USAF</b>	United States Air Force
<b>USAMRIID</b>	United States Medical Research Institute of Infectious Diseases
<b>USMC</b>	United States Marine Corps
<b>USN</b>	United States Navy
<b>USTRANSCOM</b>	United States Transportation Command
<b>UV</b>	ultraviolet
<b>UVAPS</b>	ultraviolet aerodynamic particle sizer
<b>V</b>	
<b>VA</b>	Virginia, vulnerability assessment
<b>VHF</b>	very high frequency
<b>W</b>	
<b>WARNORD</b>	warning order
<b>WILCO</b>	will comply
<b>WMD</b>	weapons of mass destruction
<b>www</b>	world wide web
<b>X</b>	
<b>XM</b>	experimental model
<b>XO</b>	executive officer
<b>Y</b>	
<b>y</b>	year
<b>Z</b>	
<b>Z</b>	zulu

## PART II—TERMS AND DEFINITIONS

**Aerosol.** A liquid or solid composed of finely divided particles suspended in a gaseous medium. Examples of common aerosols are mist, fog, and smoke. (JP 1-02)

**Air defense area.** 1. overseas—A specifically defined airspace for which air defense must be planned and provided. 2. United States—Airspace of defined dimensions designated by the appropriate agency within which the ready control of airborne vehicles is required in the interest of national security during an air defense emergency. (JP 1-02)

**Air defense artillery.** Weapons and equipment for actively combating air targets from the ground. Also called **ADA**. (JP 1-02)

**Air Mobility Command.** The Air Force component command of the US Transportation Command. Also called **AMC**. (JP 1-02)

**Area of interest.** That area of concern to the commander, including the area of influence, areas adjacent thereto, and extending into enemy territory to the objectives of current or planned operations. This area also includes areas occupied by enemy forces who could jeopardize the accomplishment of the mission. Also called **AOI**. (JP 1-02)

**Area of operations.** An operational area defined by the joint force commander for land and naval forces. Areas of operation do not typically encompass the entire operational area of the joint force commander, but should be large enough for component commanders to accomplish their missions and protect their forces. Also called **AO**. (JP 1-02)

**Area of responsibility.** The geographical area associated with a combatant command within which a combatant commander has authority to plan and conduct operations. Also called **AOR**. (JP 1-02)

**Assembly Area.** 1. An area in which a command is assembled preparatory to further action. 2. In a supply installation, the gross area used for collecting and combining components into complete units, kits, or assemblies. (JP 1-02)

**Avoidance.** Individual and/or unit measures taken to avoid or minimize nuclear, biological, and chemical (NBC) attacks and reduce the effects of NBC hazards. (JP 1-02)

**Battlespace.** The environment, factors, and conditions that must be understood to successfully apply combat power, protect the force, or complete the mission. This includes the air, land, sea, space, and the included enemy and friendly forces; facilities; weather; terrain; the electromagnetic spectrum, and the information environment within the operational areas and areas of interest. See also electromagnetic spectrum; information environment; joint intelligence preparation of the battlespace. (JP 1-02)

**Biological agent.** A microorganism that causes disease in personnel, plants, or animals or causes the deterioration of materiel. See also biological operation; biological weapon; chemical agent. (JP 1-02)

**Biological defense.** The methods, plans, and procedures involved in establishing and executing defensive measures against attacks using biological agents. (JP 1-02)

**Biological operation.** Employment of biological agents to produce casualties in personnel or animals or damage to plants. See also biological agent; biological threat. (JP 1-02)

**Biological threat.** A threat that consists of biological material planned to be deployed to produce casualties in personnel or animals or damage plants. See also biological agent; biological ammunition; biological defense; biological environment; chemical, biological, and radiological operation; contamination; contamination control. (JP 1-02)

**Biological weapon.** An item of materiel which projects, disperses, or disseminates a biological agent including arthropod vectors. (JP 1-02)

**Blister agent.** A chemical agent which injures the eyes and lungs, and burns or blisters the skin. Also called **vesicant agent**. (JP 1-02)

**Boundary.** A line that delineates surface areas for the purpose of facilitating coordination and deconfliction of operations between adjacent units, formations, or areas. See also airspace control boundary. (JP 1-02)

**Casualty.** Any person who is lost to the organization by having been declared dead, duty status – whereabouts unknown, missing, ill, or injured. See also casualty category; casualty status; casualty type; duty status - whereabouts unknown; hostile casualty; nonhostile casualty. (JP 1-02)

**Chemical agent.** Any toxic chemical intended for use in military operations. See also chemical ammunition; chemical defense; chemical dose; chemical environment; chemical warfare; riot control agent. (JP 1-02)

**Chemical defense.** The methods, plans, and procedures involved in establishing and executing defensive measures against attack utilizing chemical agents. See also nuclear, biological, and chemical defense. (JP 1-02)

**Chemical environment.** Conditions found in an area resulting from direct or persisting effects of chemical weapons. (JP 1-02)

**Chemical operation.** Employment of chemical agents to kill, injure, or incapacitate for a significant period time, man or animals, and deny or hinder the use of areas, facilities, or materiel; or defense against such employment. (JP 1-02)

**Chemical warfare.** All aspects of military operations involving the employment of lethal and incapacitating munitions/agents and the warning and protective measures associated with such offensive operations. Since riot control agents and herbicides are not considered to be chemical warfare agents, those two items will be referred to separately or under the broader term “chemical,” which will be used to include all types of chemical munitions/agents collectively. Also called **CW**. See also chemical agent; chemical defense; chemical dose; chemical environment; chemical weapon; riot control agent. (JP 1-02)

**Chief of staff.** The senior or principal member or head of a staff, or the principal assistant in a staff capacity to a person in a command capacity; the head or controlling member of a staff, for purposes of the coordination of its work; a position that in itself is without inherent power of command by reason of assignment, except that which is invested in such a position by delegation to exercise command in another's name. (JP 1-02)

**Civil affairs.** Designated Active and Reserve component forces and units organized, trained, and equipped specifically to conduct civil affairs activities and to support civil-military operations. Also called **CA**. See also civil affairs activities; civil-military operations. (JP 1-02)

**Combatant command (command authority).** Nontransferrable command authority established by title 10 ("Armed Forces"), United States Code, section 164, exercised only by commanders of unified or specified combatant commands unless otherwise directed by the President or the Secretary of Defense. Combatant command (command authority) cannot be delegated and is the authority of a combatant commander to perform those functions of command over assigned forces involving organizing and employing commands and forces, assigning tasks, designating objectives, and giving authoritative direction over all aspects of military operations, joint training, and logistics necessary to accomplish the missions assigned to the command. Combatant command (command authority) should be exercised through the commanders of subordinate organizations. Normally this authority is exercised through subordinate joint force commanders and Service and/or functional component commanders. Combatant command (command authority) provides full authority to organize and employ commands and forces as the combatant commander considers necessary to accomplish assigned missions. Operational control is inherent in combatant command (command authority). Also called **COCOM**. See also combatant command; combatant commander; operational control; tactical control. (JP 1-02)

**Combat service support.** The essential capabilities, functions, activities, and tasks necessary to sustain all elements of operating forces in theater at all levels of war. Within the national and theater logistic systems, it includes but is not limited to that support rendered by service forces in ensuring the aspects of supply, maintenance, transportation, health services, and other services required by aviation and ground combat troops to permit those units to accomplish their missions in combat. Combat service support encompasses those activities at all levels of war that produce sustainment to all operating forces on the battlefield. Also called **CSS**. See also combat support. (JP 1-02)

**Combat support.** Fire support and operational assistance provided to combat elements. Also called **CS**. See also combat service support. (JP 1-02)

**Command and control.** The exercise of authority and direction by a properly designated commander over assigned and attached forces in the accomplishment of the mission. Command and control functions are performed through an arrangement of personnel, equipment, communications, facilities, and procedures employed by a commander in planning, directing, coordinating, and controlling forces and operations in the accomplishment of a mission. Also called **C2**. (JP 1-02)

**Commander's critical information requirements.** A comprehensive list of information requirements identified by the commander as being critical in facilitating timely information management and the decisionmaking process that affect successful mission accomplishment. Two key subcomponents are critical friendly force information and priority intelligence requirements. Also called CCIR. See also critical information; information; information requirements; intelligence; priority intelligence requirements. (JP 1-02)

**Command post.** A unit's or subunit's headquarters where the commander and the staff perform their activities. In combat, a unit's or subunit's headquarters is often divided into echelons; the echelon in which the unit or subunit commander is located or from which such commander operates is called a command post. Also called **CP**. (JP 1-02)

**Common operational picture.** A single identical display of relevant information shared by more than one command. A common operational picture facilitates collaborative planning and assists all echelons to achieve situational awareness. Also called **COP**. (JP 1-02)

**Concept of operations.** A verbal or graphic statement, in broad outline, of a commander's assumptions or intent in regard to an operation or series of operations. The concept of operations frequently is embodied in campaign plans and operation plans; in the latter case, particularly when the plans cover a series of connected operations to be carried out simultaneously or in succession. The concept is designed to give an overall picture of the operation. It is included primarily for additional clarity of purpose. Also called **commander's concept** or **CONOPS**. (JP 1-02)

**Contamination.** 1. The deposit, absorption, or adsorption of radioactive material, or of biological or chemical agents on or by structures, areas, personnel, or objects. See also fallout; induced radiation; residual radiation. 2. Food and/or water made unfit for consumption by humans or animals because of the presence of environmental chemicals, radioactive elements, bacteria, or organisms, the byproduct of the growth of bacteria or organisms, the decomposing material (to include the food substance itself), or waste in the food or water. (JP 1-02)

**Contamination control.** Procedures to avoid, reduce, remove, or render harmless (temporarily or permanently) nuclear, biological, and chemical contamination for the purpose of maintaining or enhancing the efficient conduct of military operations. See also biological agent; biological ammunition; biological defense; biological environment; biological threat; chemical agent; chemical ammunition; chemical, biological, and radiological operation; chemical defense; chemical environment; contamination. (JP 1-02)

**Continental United States.** United States territory, including the adjacent territorial waters, located within North America between Canada and Mexico. Also called **CONUS**. (JP 1-02)

**Contingency Plan.** A plan for major contingencies that can reasonably be anticipated in the principal geographic subareas of the command. See also joint operation planning. (JP 1-02)

**Contracted logistic support.** Support in which maintenance operations for a particular military system are performed exclusively by contract support personnel. Also called **CLS**. See also logistic support; support. (JP 1-02)

**Contracting officer.** A US military officer or civilian employee who has a valid appointment as a contracting officer under the provisions of the Federal Acquisition Regulation. The individual has the authority to enter into and administer contracts and determinations as well as findings about such contracts. (JP 1-02)

**Control Point.** 1. A position along a route of march at which men are stationed to give information and instructions for the regulation of supply or traffic. 2. A position marked by a buoy, boat, aircraft, electronic device, conspicuous terrain feature, or other identifiable object which is given a name or number and used as an aid to navigation or control of ships, boats, or aircraft. 3. In marking mosaics, a point located by ground survey with which a corresponding point on a photograph is matched as a check. (JP 1-02)

**Course of action.** 1. Any sequence of activities that an individual or unit may follow. 2. A possible plan open to an individual or commander that would accomplish, or is related to the accomplishment of the mission. 3. The scheme adopted to accomplish a job or mission. 4. A line of conduct in an engagement. 5. A product of the Joint Operation Planning and Execution System concept development phase. Also called **COA**. (JP 1-02)

**Decontamination.** The process of making any person, object, or area safe by absorbing, destroying, neutralizing, making harmless, or removing chemical or biological agents, or by removing radioactive material clinging to or around it. (JP 1-02)

**Deliberate Attack.** A type of offensive action characterized by preplanned coordinated employment of firepower and maneuver to close with and destroy or capture the enemy. (JP 1-02)

**Detection.** 1. In tactical operations, the perception of an object of possible military interest but unconfirmed by recognition. 2. In surveillance, the determination and transmission by a surveillance system that an event has occurred. 3. In arms control, the first step in the process of ascertaining the occurrence of a violation of an arms control agreement. 4. In nuclear, biological, and chemical (NBC) environments, the act of locating NBC hazards by use of NBC detectors or monitoring and/or survey teams. See also hazard; monitoring; nuclear, biological, and chemical environment. (JP 1-02)

**Direct action.** Short-duration strikes and other small-scale offensive actions conducted as a special operation in hostile, denied, or politically sensitive environments and which employ specialized military capabilities to seize, destroy, capture, exploit, recover, or damage designated targets. Direct action differs from conventional offensive actions in the level of physical and political risk, operational techniques, and the degree of discriminate and precise use of force to achieve specific objectives. Also called **DA**. See also special operations; special operations forces. (JP 1-02)



**Doctrine.** Fundamental principles by which the military forces or elements thereof guide their actions in support of national objectives. It is authoritative but requires judgment in application. (JP 1-02)

**Explosive ordnance disposal.** The detection, identification, on-site evaluation, rendering safe, recovery, and final disposal of unexploded explosive ordnance. It may also include explosive ordnance which has become hazardous by damage or deterioration. Also called **EOD**. (JP 1-02)

**Fire support.** Fires that directly support land, maritime, amphibious, and special operation forces to engage enemy forces, combat formations, and facilities in pursuit of tactical and operational objectives. Also called **FS**. (JP 1-02)

**Force health protection.** All services performed, provided, or arranged by the Services to promote, improve, conserve, or restore the mental or physical well-being of personnel. These services include, but are not limited to, the management of health services resources, such as manpower, monies, and facilities; preventive and curative health measures; evacuation of the wounded, injured, or sick; selection of the medically fit and disposition of the medically unfit; blood management; medical supply, equipment, and maintenance thereof; combat stress control; and medical, dental, veterinary, laboratory, optometry, medical food, and medical intelligence services. See also force; protection. (JP 1-02)

**Force protection.** Actions taken to prevent or mitigate hostile actions against Department of Defense personnel (to include family members), resources, facilities, and critical information. These actions conserve the force's fighting potential so it can be applied at the decisive time and place and incorporate the coordinated and synchronized offensive and defensive measures to enable the effective employment of the joint force while degrading opportunities for the enemy. Force protection does not include actions to defeat the enemy or protect against accidents, weather, or disease. Also called **FP**. See also force; force protection condition; protection. (JP 1-02)

**Forward line of own troops.** A line that indicates the most forward positions of friendly forces in any kind of military operation at a specific time. The forward line of own troops (FLOT) normally identifies the forward location of covering and screening forces. The FLOT may be at, beyond, or short of the forward edge of the battle area. An enemy FLOT indicates the forward-most position of hostile forces. Also called **FLOT**. (JP 1-02)

**Health service support.** All services performed, provided, or arranged by the Services to promote, improve, conserve, or restore the mental or physical well-being of personnel. These services include but are not limited to the management of health services resources, such as manpower, monies, and facilities; preventive and curative health measures; evacuation of the wounded, injured, or sick; selection of the medically fit and disposition of the medically unfit; blood management; medical supply, equipment, and maintenance thereof; combat stress control; and medical, dental, veterinary, laboratory, optometric, medical food, and medical intelligence services. Also called **HSS**. (JP 1-02)

**High-value target.** A target the enemy commander requires for the successful completion of the mission. The loss of high-value targets would be expected to seriously degrade important enemy functions throughout the friendly commander's area of interest. Also called **HVT**. See also high-payoff target; target. (JP 1-02)

**Host nation.** A nation that receives the forces and/or supplies of allied nations, coalition partners, and/or NATO organizations to be located on, to operate in, or to transit through its territory. Also called **HN**. (JP 1-02)

**Host-nation support.** Civil and/or military assistance rendered by a nation to foreign forces within its territory during peacetime, crisis or emergencies, or war based on agreements mutually concluded between nations. Also called **HNS**. (JP 1-02)

**Human intelligence.** A category of intelligence derived from information collected and provided by human resources. Also called **HUMINT**. See also human resources intelligence. (JP 1-02)

**Identification.** 1. The process of determining the friendly or hostile character of an unknown detected contact. 2. In arms control, the process of determining which nation is responsible for the detected violations of any arms control measure. 3. In ground combat operations, discrimination between recognizable objects as being friendly or enemy, or the name that belongs to the object as a member of a class. Also called **ID**. (JP 1-02)

**Individual protection.** Actions taken by individuals to survive and continue the mission under nuclear, biological, and chemical conditions. See also protection. (JP 1-02)

**Individual protective equipment.** In nuclear, biological, and chemical warfare, the personal clothing and equipment required to protect an individual from biological and chemical hazards and some nuclear effects. (JP 1-02)

**Industrial chemicals.** Chemicals developed or manufactured for use in industrial operations or research by industry, government, or academia. These chemicals are not primarily manufactured for the specific purpose of producing human casualties or rendering equipment, facilities, or areas dangerous for human use. Hydrogen cyanide, cyanogen chloride, phosgene, and chloropicrin are industrial chemicals that also can be military chemical agents. See also chemical warfare (JP 1-02)

**Information requirements.** Those items of information regarding the enemy and his environment which need to be collected and processed in order to meet the intelligence requirements of a commander. See also priority intelligence requirements. (JP 1-02)

**Intelligence.** 1. The product resulting from the collection, processing, integration, analysis, evaluation, and interpretation of available information concerning foreign countries or areas. 2. Information and knowledge about an adversary obtained through observation, investigation, analysis, or understanding. See also acoustic intelligence; all-source intelligence; basic intelligence; civil defense intelligence; combat intelligence; communications intelligence; critical intelligence; current intelligence; departmental intelligence; domestic intelligence; electronic intelligence; electro-optical intelligence; foreign intelligence; foreign instrumentation signals intelligence; general military intelligence; human resources intelligence; imagery intelligence; joint intelligence; laser intelligence; measurement and signature intelligence; medical intelligence; merchant intelligence; military intelligence; national intelligence; nuclear intelligence; open-source intelligence; operational intelligence; photographic intelligence; political intelligence; radar intelligence; radiation intelligence; scientific and technical intelligence; security intelligence; strategic intelligence; tactical intelligence; target intelligence; technical intelligence; technical operational intelligence; terrain intelligence; unintentional radiation intelligence. (JP 1-02)

**Intelligence preparation of the battlespace.** An analytical methodology employed to reduce uncertainties concerning the enemy, environment, and terrain for all types of operations. Intelligence preparation of the battlespace builds an extensive database for each potential area in which a unit may be required to operate. The database is then analyzed in detail to determine the impact of the enemy, environment, and terrain on operations and presents it in graphic form. Intelligence preparation of the battlespace is a continuing process. Also called **IPB**. (JP 1-02)

**Interoperability.** 1. The ability of systems, units, or forces to provide services to and accept services from other systems, units, or forces and to use the services so exchanged to enable them to operate effectively together. 2. The condition achieved among communications-electronics systems or items of communications-electronics equipment when information or services can be exchanged directly and satisfactorily between them and/or their users. The degree of interoperability should be defined when referring to specific cases. (JP 1-02)

**Joint force commander.** A general term applied to a combatant commander, subunified commander, or joint task force commander authorized to exercise combatant command (command authority) or operational control over a joint force. Also called **JFC**. See also joint force (JP 1-02)

**Joint publication.** A publication containing joint doctrine and/or joint tactics, techniques, and procedures that involves the employment of forces prepared under the cognizance of Joint Staff directorates and applicable to the Military Departments, combatant commands, and other authorized agencies. It is approved by the Chairman of the Joint Chiefs of Staff, in coordination with the combatant commands and Services. Also called **JP**. See also Chairman of the Joint Chiefs of Staff Instruction; Chairman of the Joint Chiefs of Staff Manual; joint doctrine; joint tactics, techniques, and procedures; joint test publication. (JP 1-02)

**Joint task force.** A joint force that is constituted and so designated by the Secretary of Defense, a combatant commander, a subunified commander, or an existing joint task force commander. Also called **JTF**. (JP 1-02)

**Logistics.** The science of planning and carrying out the movement and maintenance of forces. In its most comprehensive sense, those aspects of military operations that deal with: a. design and development, acquisition, storage, movement, distribution, maintenance, evacuation, and disposition of material; b. movement, evacuation, and hospitalization of personnel; c. acquisition or construction, maintenance, operation, and disposition of facilities; and d. acquisition or furnishing of services. (JP 1-02)

**Logistic support.** Logistic support encompasses the logistic services, materiel, and transportation required to support the continental United States-based and worldwide deployed forces. (JP 1-02)

**Main operations base.** In special operations, a base established by a joint force special operations component commander or a subordinate special operations component commander in friendly territory to provide sustained command and control, administration, and logistical support to special operations activities in designated areas. Also called **MOB**. See also advanced operations base; forward operations base. (JP 1-02)

**Main supply route.** The route or routes designated within an operational area upon which the bulk of traffic flows in support of military operations. Also called **MSR**. (JP 1-02)

**Maritime environment.** The oceans, seas, bays estuaries, islands, coastal areas, and the airspace above these, including the littorals. (JP 1-02)

**Mission-oriented protective posture.** A flexible system of protection against nuclear, biological, and chemical contamination. This posture requires personnel to wear only that protective clothing and equipment (mission-oriented protective posture gear) appropriate to the threat level, work rate imposed by the mission, temperature, and humidity. Also called **MOPP**. See also mission-oriented protective posture gear. (JP 1-02)

**Mission-oriented protective posture gear.** Military term for individual protective equipment including suit, boots, gloves, mask with hood, first aid treatments, and decontamination kits issued to soldiers. Also called **MOPP gear**. See also decontamination; mission-oriented protective posture. (JP 1-02)

**Monitoring.** 1. The act of listening, carrying out surveillance on, and/or recording the emissions of one's own or allied forces for the purposes of maintaining and improving procedural standards and security, or for reference, as applicable. 2. The act of listening, carrying out surveillance on, and/or recording of enemy emissions for intelligence purposes. 3. The act of detecting the presence of radiation and the measurement thereof with radiation measuring instruments. Also called **radiological monitoring**. (JP 1-02)

**Movement to contact.** A form of the offense designed to develop the situation and to establish or regain contact. See also meeting engagement; reconnaissance in force. (JP 1-02)

**Named area of interest.** The geographical area where information that will satisfy a specific information requirement can be collected. Named areas of interest are usually selected to capture indications of adversary courses of action, but also may be related to conditions of the battlespace. Also called **NAI**. See also area of interest. (JP 1-02)

**Nonbattle injury.** A person who becomes a casualty due to circumstances not directly attributable to hostile action or terrorist activity. Also called **NBI**. (JP 1-02)

**Nongovernmental organizations.** Transnational organizations of private citizens that maintain a consultative status with the Economic and Social Council of the United Nations. Nongovernmental organizations may be professional associations, foundations, multinational businesses, or simply groups with a common interest in humanitarian assistance activities (development and relief). “Nongovernmental organizations” is a term normally used by non-United States organizations. Also called **NGOs**. (JP 1-02)

**Nuclear, biological, and chemical defense.** Defensive measures that enable friendly forces to survive, fight, and win against enemy use of nuclear, biological, or chemical (NBC) weapons and agents. United States forces apply NBC defensive measures before and during integrated warfare. In integrated warfare, opposing forces employ nonconventional weapons along with conventional weapons (NBC weapons are nonconventional). See also integrated warfare. (JP 1-02)

**Nuclear, biological, and chemical environment.** Environments in which there is deliberate or accidental employment, or threat of employment, of nuclear, biological, or chemical weapons; deliberate or accidental attacks or contamination with toxic industrial materials, including toxic industrial chemicals; or deliberate or accidental attacks or contamination with radiological (radioactive) materials. See also contamination. (JP 1-02)

**Objective.** 1. The clearly defined, decisive, and attainable goals towards which every military operation should be directed. 2. The specific target of the action taken (for example, a definite terrain feature, the seizure or holding of which is essential to the commander’s plan, or, an enemy force or capability without regard to terrain features). See also target. (JP 1-02)

**Obstacle.** Any obstruction designed or employed to disrupt, fix, turn, or block the movement of an opposing force, and to impose additional losses in personnel, time, and equipment on the opposing force. Obstacles can be natural, manmade, or a combination of both. (JP 1-02)

**Operational control.** Command authority that may be exercised by commanders at any echelon at or below the level of combatant command. Operational control is inherent in combatant command (command authority) and may be delegated within the command. When forces are transferred between combatant commands, the command relationship the gaining commander will exercise (and the losing commander will relinquish) over these forces must be specified by the Secretary of Defense. Operational control is the authority to perform those functions of command over subordinate forces involving organizing and employing commands and forces, assigning tasks, designating objectives, and giving authoritative direction necessary to accomplish the mission. Operational control includes authoritative direction over all aspects of military operations and joint training necessary to accomplish missions assigned to the command. Operational control should be exercised through the commanders of subordinate organizations. Normally this authority is exercised through subordinate joint force commanders and Service and/or functional component commanders. Operational control normally provides full authority to organize commands and forces and to employ those forces as the commander in operational control considers necessary to accomplish assigned missions; it does not, in and of itself, include authoritative direction for logistics or matters of administration, discipline, internal organization, or unit training. Also called **OPCON**. See also combatant command; combatant command (command authority); tactical control. (JP 1-02)

**Operation plan.** Any plan, except for the Single Integrated Operational Plan, for the conduct of military operations. Plans are prepared by combatant commanders in response to requirements established by the Chairman of the Joint Chiefs of Staff and by commanders of subordinate commands in response to requirements tasked by the establishing unified commander. Operation plans are prepared in either a complete format (OPLAN) or as a concept plan (CONPLAN). The CONPLAN can be published with or without a time-phased force and deployment data (TPFDD) file. a. OPLAN--An operation plan for the conduct of joint operations that can be used as a basis for development of an operation order (OPORD). An OPLAN identifies the forces and supplies required to execute the combatant commander's strategic concept and a movement schedule of these resources to the theater of operations. The forces and supplies are identified in TPFDD files. OPLANs will include all phases of the tasked operation. The plan is prepared with the appropriate annexes, appendixes, and TPFDD files as described in the Joint Operation Planning and Execution System manuals containing planning policies, procedures, and formats. Also called OPLAN. b. CONPLAN--An operation plan in an abbreviated format that would require considerable expansion or alteration to convert it into an OPLAN or OPORD. A CONPLAN contains the combatant commander's strategic concept and those annexes and appendixes deemed necessary by the combatant commander to complete planning. Generally, detailed support requirements are not calculated and TPFDD files are not prepared. c. CONPLAN with TPFDD--A CONPLAN with TPFDD is the same as a CONPLAN except that it requires more detailed planning for phased deployment of forces. Also called **CONPLAN**. See also operation order; time-phased force and deployment data. (JP 1-02)

**Operations center.** The facility or location on an installation, base, or facility used by the commander to command, control, and coordinate all crisis activities. See also base defense operations center; command center. (JP 1-02)

**Operations security.** A process of identifying critical information and subsequently analyzing friendly actions attendant to military operations and other activities to: a. identify those actions that can be observed by adversary intelligence systems; b. determine indicators that hostile intelligence systems might obtain that could be interpreted or pieced together to derive critical information in time to be useful to adversaries; and c. select and execute measures that eliminate or reduce to an acceptable level the vulnerabilities of friendly actions to adversary exploitation. Also called **OPSEC**. See also command and control warfare; operations security indicators; operations security measures; operations security planning guidance; operations security vulnerability. (JP 1-02)

**Ordnance.** Explosives, chemicals, pyrotechnics, and similar stores, e.g., bombs, guns and ammunition, flares, smoke, or napalm. (JP 1-02)

**Persistency.** In biological or chemical warfare, the characteristic of an agent which pertains to the duration of its effectiveness under determined conditions after its dispersal. (JP 1-02)

**Port of debarkation.** The geographic point at which cargo or personnel are discharged. This may be a seaport or aerial port of debarkation; for unit requirements, it may or may not coincide with the destination. Also called **POD**. See also port of embarkation. (JP 1-02)

**Port of embarkation.** The geographic point in a routing scheme from which cargo or personnel depart. This may be a seaport or aerial port from which personnel and equipment flow to a port of debarkation; for unit and nonunit requirements, it may or may not coincide with the origin. Also called **POE**. See also port of debarkation. (JP 1-02)

**Preventive medicine.** The anticipation, communication, prediction, identification, prevention, education, risk assessment, and control of communicable diseases, illnesses and exposure to endemic, occupational, and environmental threats. These threats include nonbattle injuries, combat stress responses, weapons of mass destruction, and other threats to the health and readiness of military personnel. Communicable diseases include anthropol-, vector-, food-, waste-, and waterborne diseases. Preventive medicine measures include field sanitation, medical surveillance, pest and vector control, disease risk assessment, environmental and occupational health surveillance, waste (human, hazardous, and medical) disposal, food safety inspection, and potable water surveillance. Also called **PVNTMED**. (JP 1-02)

**Priority intelligence requirements.** Those intelligence requirements for which a commander has an anticipated and stated priority in the task of planning and decision making. Also called **PIRs**. See also information requirements; intelligence; intelligence cycle; intelligence requirement. (JP 1-02)

**Protection.** 1. Measures that are taken to keep nuclear, biological, and chemical hazards from having an adverse effect on personnel, equipment, or critical assets and facilities. Protection consists of five groups of activities: hardening of positions, protecting personnel, assuming mission-oriented protective posture, using physical defense measures, and reacting to attack. 2. In space usage, active and passive defensive measures to ensure that United States and friendly space systems perform as designed by seeking to overcome an adversary's attempts to negate them and to minimize damage if negation is attempted. See also mission-oriented protective posture; space control. (JP 1-02)

**Protective clothing.** Clothing especially designed, fabricated, or treated to protect personnel against hazards caused by extreme changes in physical environment, dangerous working conditions, or enemy action. (JP 1-02)

**Protective mask.** A protective ensemble designed to protect the wearer's face and eyes and prevent the breathing of air contaminated with chemical and/or biological agents. See also mission-oriented protective posture. (JP 1-02)

**Reconnaissance.** A mission undertaken to obtain, by visual observation or other detection methods, information about the activities and resources of an enemy or potential enemy, or to secure data concerning the meteorological, hydrographic, or geographic characteristics of a particular area. Also called **RECON**. (JP 1-02)

**Risk assessment.** The identification and assessment of hazards (first two steps of risk management process. (JP 1-02)

**Search.** 1. An operation to locate an enemy force known or believed to be at sea. 2. A systematic reconnaissance of a defined area, so that all parts of the area have passed within visibility. 3. To distribute gunfire over an area in depth by successive changes in gun elevation. (JP 1-02)

**Security.** 1. Measures taken by a military unit, activity, or installation to protect itself against all acts designed to, or which may, impair its effectiveness. 2. A condition that results from the establishment and maintenance of protective measures that ensure a state of inviolability from hostile acts or influences. 3. With respect to classified matter, the condition that prevents unauthorized persons from having access to official information that is safeguarded in the interests of national security. (JP 1-02)

**Signal security.** A generic term that includes both communications security and electronics security. See also security. (JP 1-02)

**Signals intelligence.** 1. A category of intelligence comprising either individually or in combination all communications intelligence, electronic intelligence, and foreign instrumentation signals intelligence, however transmitted. 2. Intelligence derived from communications, electronic, and foreign instrumentation signals. Also called **SIGINT**. See also communications intelligence; electronic intelligence; intelligence; foreign instrumentation signals intelligence. (JP 1-02)

**Situation report.** A report giving the situation in the area of a reporting unit or formation. Also called **SITREP**. (JP 1-02)



**Special operations forces.** Those Active and Reserve Component forces of the Military Services designated by the Secretary of Defense and specifically organized, trained, and equipped to conduct and support special operations. Also called **SOF**. See also Air Force special operations forces; Army special operations forces; naval special warfare forces. (JP 1-02)

**Subordinate command.** A command consisting of the commander and all those individuals, units, detachments, organizations, or installations that have been placed under the command by the authority establishing the subordinate command. (JP 1-02)

**Suppression of enemy air defenses.** That activity that neutralizes, destroys, or temporarily degrades surface-based enemy air defenses by destructive and/or disruptive means. Also called **SEAD**. See also electromagnetic spectrum; electronic warfare. (JP 1-02)

**Surveillance.** The systematic observation of aerospace, surface, or subsurface areas, places, persons, or things by visual, aural, electronic, photographic, or other means. See also air surveillance; satellite and missile surveillance; sea surveillance. (JP 1-02)

**Survey.** The directed effort to determine the location and the nature of a chemical, biological, and radiological hazard in an area. (JP 1-02)

**Tactical control.** Command authority over assigned or attached forces or commands, or military capability or forces made available for tasking, that is limited to the detailed direction and control of movements or maneuvers within the operational area necessary to accomplish missions or tasks assigned. Tactical control is inherent in operational control. Tactical control may be delegated to, and exercised at any level at or below the level of combatant command. Also called **TACON**. When forces are transferred between combatant commands, the command relationship the gaining commander will exercise (and the losing commander will relinquish) over these forces must be specified by the Secretary of Defense. Tactical control provides sufficient authority for controlling and directing the application of force or tactical use of combat support assets within the assigned mission or task. Also called **TACON**. See also combatant command; combatant command (command authority); operational control. (JP 1-02)

**Tactical operations center.** A physical groupment of those elements of a general and special staff concerned with the current tactical operations and the tactical support thereof. Also called **TOC**. (JP 1-02)

**Tactics.** 1. The employment of units in combat. 2. The ordered arrangement and maneuver of units in relation to each other and/or to the enemy in order to use their full potentialities. (JP 1-02)

**Terrorism.** The calculated use of unlawful violence or threat of unlawful violence to inculcate fear; intended to coerce; or to intimidate governments or societies in the pursuit of goals that are generally political, religious or ideological. See also antiterrorism; combatting terrorism; counterterrorism; force protection condition; terrorist; terrorist groups. (JP 1-02)

**Theater of operations.** A subarea within a theater of war defined by the geographic combatant commander required to conduct or support specific combat operations. Different theaters of operations within the same theater of war will normally be geographically separate and focused on different enemy forces. Theaters of operations are usually of significant size, allowing for operations over extended periods of time. Also called **TO**. See also theater of war. (JP 1-02)

**Time-phased force and deployment data.** The Joint Operation Planning and Execution System database portion of an operation plan; it contains time-phased force data, non-unit-related cargo and personnel data, and movement data for the operation plan, including the following: a. In-place units; b. Units to be deployed to support the operation plan with a priority indicating the desired sequence for their arrival at the port of debarkation; c. Routing of forces to be deployed; d. Movement data associated with deploying forces; e. Estimates of non-unit-related cargo and personnel movements to be conducted concurrently with the deployment of forces; and f. Estimate of transportation requirements that must be fulfilled by common-user lift resources as well as those requirements that can be fulfilled by assigned or attached transportation resources. Also called **TPFDD**. See also time-phased force and deployment data maintenance; time-phased force and deployment data refinement; time-phased force and deployment list. (JP 1-02)

**Time-phased force and deployment list.** Appendix 1 to Annex A of the operation plan. It identifies types and/or actual units required to support the operation plan and indicates origin and ports of debarkation or ocean area. It may also be generated as a computer listing from the time-phased force and deployment data. Also called **TPFDL**. See also Joint Operation Planning and Execution System; time-phased force and deployment data; time-phased force and deployment data maintenance; time-phased force and deployment data refinement. (JP 1-02)

**Unit movement data.** A unit equipment and/or supply listing containing corresponding transportability data. Tailored unit movement data has been modified to reflect a specific movement requirement. Also called **UMD**. (JP 1-02)

**Unit type code.** A Joint Chiefs of Staff developed and assigned code, consisting of five characters that uniquely identify a “type unit.” (JP 1-02)

**Weapons of mass destruction.** Weapons that are capable of a high order of destruction and/or of being used in such a manner as to destroy large numbers of people. Weapons of mass destruction can be high explosives or nuclear, biological, chemical, and radiological weapons, but exclude the means of transporting or propelling the weapon where such means is a separable and divisible part of the weapon. Also called **WMD**. See also destruction; special operations. (JP 1-02)

## INDEX

### A

air exhaust E-22  
Air Force B-1  
air handling system E-23  
air-sample collection I-4  
amphibious operation E-19  
area array III-16, E-10  
Army B-1  
Army medical laboratory I-13  
array III-1, E-6, E-9  
assets IV-2  
assistant operator H-3  
atmospheric visibility H-12  
attack E-3

### B

background characteristic I-8  
background data I-17  
background data recording I-8  
background sample E-9, G-3  
BIDS II-10, C-2, E-5  
BIDS incident report I-2, I-12, I-17  
BIDS unit report I-18  
biological reporting V-2  
biological sampler I-1  
biological surveillance I-1  
biological surveillance capabilities  
    alerting II-1  
    detecting II-1  
    identifying II-1  
    monitoring II-1  
    sampling II-1  
biological surveillance plan E-6  
    command and signal III-6  
    execution III-6  
    mission III-6  
    service support III-6  
biological-detection and -collection assets II-7  
biological-detection asset responsibilities D-6  
biological-detection unit G-3  
biological-surveillance execution H-20  
biological-surveillance plan  
    situation III-3  
biological-surveillance planning III-1

biomarker B-2  
building characteristic E-23  
BW attack warning F-1  
BW hazard  
    assessing I-5  
    detecting I-4  
    identifying I-4  
BW-threat analysis E-7

### C

Centers for Disease Control and Prevention (CDC) I-13  
centralized D-10  
centralized warning and reporting F-2  
chain-of-custody IV-4, I-3, I-14  
chain-of-custody form G-4  
chemical-biological mass spectrometer (CMBS) I-1  
chokepoint E-19  
cloud loss detection report H-31  
CLS D-1  
cold-weather sample G-7  
Combatant Command Responsibilities D-5  
commander's responsibilities D-3  
communication requirement D-2  
communications II-10  
communications architecture V-14  
communications planning and net I-26  
completed evacuation package I-6, I-16  
concept of operations E-1  
confidence level V-10  
confirmatory B-3  
confirmatory lab B-4  
confirmatory laboratory support I-11  
contingency plan A-3  
continuous-sampling protocol I-7  
contracted logistics support  
    responsibilities D-6  
contracting officer's representative D-6  
    limits D-7  
CONUS Replacement Center (CRC) D-4  
coordination IV-2  
courier team G-3  
critical data requirement V-2  
critical infrastructure E-23  
critical node III-16, E-10

## D

data analysis I-10  
data collection method I-6  
decentralized D-10  
decentralized warning F-1  
decentralized warning and reporting F-2  
definitive identification I-13  
definitive testing B-3  
deployment area number E-20  
deployment of contracted logistics support personnel D-9  
detection I-2  
detection and incident report H-31  
detection report data item H-33  
detection site E-20  
detector trigger I-10  
disk mailer G-7  
distance E-10, H-12  
DOD biological sampling kit C-6  
downwind hazard prediction F-1  
dry dissemination H-14  
dry filter unit I-11, II-10, C-5, E-18, E-19  
duration E-7

## E

employment E-10  
employment tactic E-11  
circle E-11  
dense picket E-13  
dice five E-11  
picket line E-11  
semicircle E-13  
epidemiological analysis A-1  
evacuating a sample II-2  
evacuation route IV-3  
event tracking I-20  
exterior deployment area E-19  
exterior release E-22

## F

facility requirement D-3  
false negative B-3  
FBCB2 I-3, I-28  
field confirmatory identification I-12, IV-4  
field confirmatory testing B-4  
field lab support B-1  
fixed sites, ports, or airfield FP I-8  
fixed-site III-1

flight profile H-10, H-16  
straight-and-parallel H-10  
variable altitude and airspeed H-11  
follow-up detection report H-30  
force structure augmentation D-1  
Force XXI Battle Command Brigade and Below (FBCB2) V-2  
forward-deployed preventive medicine unit I-13

## H

habitual relationship D-2  
handheld assay C-7  
high-risk billet E-23  
high-risk personnel E-23  
HVT E-23

## I

immunization A-1  
incident report V-8, V-11, I-19  
incubation period I-1  
indoor biological detection E-22  
initial LRBSDS detection report H-30  
installation responsibilities D-4  
intelligence trigger I-10  
interior release E-22  
internal sampling E-19  
international border D-3

## J

JBPDS II-10, E-5, E-18  
JBPDS (M31A2-BIDS) function I-13  
JBPDS (M31A2-BIDS) operational mode I-16  
background characteristic I-17  
degraded mode I-16  
extreme cold mode I-16  
periodic mode I-16  
single sample mode I-16  
standard mode I-16  
Joint Biological Point Detection System (JBPDS) C-4  
Joint Portal Shield II-10  
Joint Portal Shield network I-11, C-1, E-5  
Joint Service Light Nuclear, Biological, and Chemical Reconnaissance System (JSLNBCRS) II-10  
Joint Warning and Reporting Network V-2

## L

- lab support II-11
- laboratories B-1
- Laboratory Response Network I-12, I-13, B-4
- laser scanning H-28
- legal obligation D-2
- line source E-10
- liquid sampler I-1
- logistics planning D-1
- logistics requirement I-14
- long line source H-11
- Long-Range Biological Standoff Detection System (LRBSDS) III-2, C-4, H-1
  - capabilities H-1
  - classifying H-2
  - mapping H-2
- lost cloud H-28
- LRBSDS
  - detection H-26
  - detection process H-20
  - employment concept H-4
  - flight operation H-22
  - NCOIC H-3
  - operator H-3
  - planning H-4
  - scanning range H-14

## M

- maintaining the chain of custody II-2
- maintenance support D-9
- maneuver or maritime FP I-8
- man-portable JBPDS II-10
- mass casualties and quarantine A-2
- medical surveillance I-1
- meteorological condition E-7
- method of dissemination E-5
- METT-TC conditions I-3
- microbiology augmentation set B-2
- mission factor H-16
- mission profile H-8
  - preplanned H-8
  - scheduled H-8
- mode
  - collection only E-9
  - periodic sampling E-9
  - single sample E-9
  - standard E-9
  - standby E-9

## N

- Navy B-2
- Navy Medical Research Center I-13
- NBC control center V-3
- NBC reports and overlay V-4
- NBC-1 biological BIO report V-3
- NBC-1 Report F-1

## O

- onboard cooler I-4
- operational concept for biological surveillance I-3
- operational planning III-2
- operations in unusual conditions E-21
  - cold weather operation E-21
  - desert operation E-21
  - jungle operation E-21
  - mountain operation E-21
  - urban terrain operation E-21
- other planning factor H-17

## P

- P3I BIDS detection classification I-7
- P3I BIDS event cycle I-7
- P3I Biological Integrated Detection System information management I-12
- particle backscatter H-12, H-14
- point source E-10, H-11
- postattack E-3
- postoperation H-34
- preattack E-1
- predictive value B-4
- preplanned product improvement I-1
- presumptive identification IV-3
- priorities IV-2
- priorities of effort I-10
- prophylaxis and treatment A-2
- protect V-5
- PVNTMED A-1

## Q

- quality management H-4
- quality-management program I-12
- quarantine A-3

## R

- reconnaissance E-19, H-16
- reduced-capability operation I-7
- reference laboratory I-13

report information V-11  
reporting II-1, IV-2  
reporting requirement IV-3, I-19  
responsiveness of support D-2  
restriction of movement A-4  
resupply D-10  
risk assessment D-1  
risk reduction measures I-3

**S**

safety zone D-3  
sample bottle G-7  
sample container G-4  
sample courier II-11  
sample evacuation IV-2, G-1  
    handling G-9  
    packaged G-8  
sample evacuation execution IV-4  
sample evacuation plan II-12, IV-2  
sample handling I-3, I-14  
sample identification number G-9  
sample transfer case G-4, I-4  
sample transfer point IV-2, G-3  
sample vial G-6  
scheduled interval E-18  
selecting a flight profile H-14  
senior theater logistics command D-5  
separation distance E-17  
service component commander (SCC) D-5  
shipboard JBPDS C-4  
short line source H-11  
single-point source E-10  
site selection E-19  
situation report I-19  
source  
    line E-5  
    point E-5  
specificity B-3  
split basing the LRBSDS H-6  
standard protocol I-6  
strategic planning III-2  
supporting data I-3  
supporting document G-7, I-5  
supporting lab G-3  
surveillance plan III-1  
system operator D-10

**T**

tactical planning III-2  
task monitor D-6

technical escort unit (TEU) II-11  
threat I-2  
threat analysis E-1  
threat-based protocol I-7

**U**

ultraviolet aerodynamic particle sizer  
(UVAPS) I-1  
unit requisition D-10  
United States Army Medical Research  
Institute of Infectious Diseases  
(USAMRIID) I-13

**V**

vaccines A-2  
vulnerability analysis E-1  
vulnerability assessment (VA) E-3

**W**

warn V-5  
weapons event trigger I-10  
weather V-12  
wet dissemination H-14

**FM 3-11.86  
MCWP 3-37.1C  
NTTP 3-11.31  
AFTTP(I) 3-2.52  
4 OCTOBER 2004**

By Order of the Secretary of the Army:

**PETER J. SCHOOMAKER**  
*General, United States Army*  
*Chief of Staff*

Official:



**JOEL B. HUDSON**  
*Administrative Assistant to the*  
*Secretary of the Army*  
*0424605*

**DISTRIBUTION:**

*Active Army, Army National Guard, and U.S. Army Reserve:* To be distributed in accordance with the initial distribution number 115441, requirements for FM 3-11.86.

By Order of the Secretary of the Air Force

DAVID F. MACGHEE, JR.  
Major General, USAF  
Commander  
Headquarters Air Force Doctrine Center

Air Force Distribution: F

Marine Corps PCN: 144 000145 00

**PIN: 081853-000**