



Wind rotor blade construction

Small Wind Systems for Battery Charging

Contract R 7105

By Teodoro Sanchez Campos ITDG,
Sunith Fernando and
Hugh Piggott

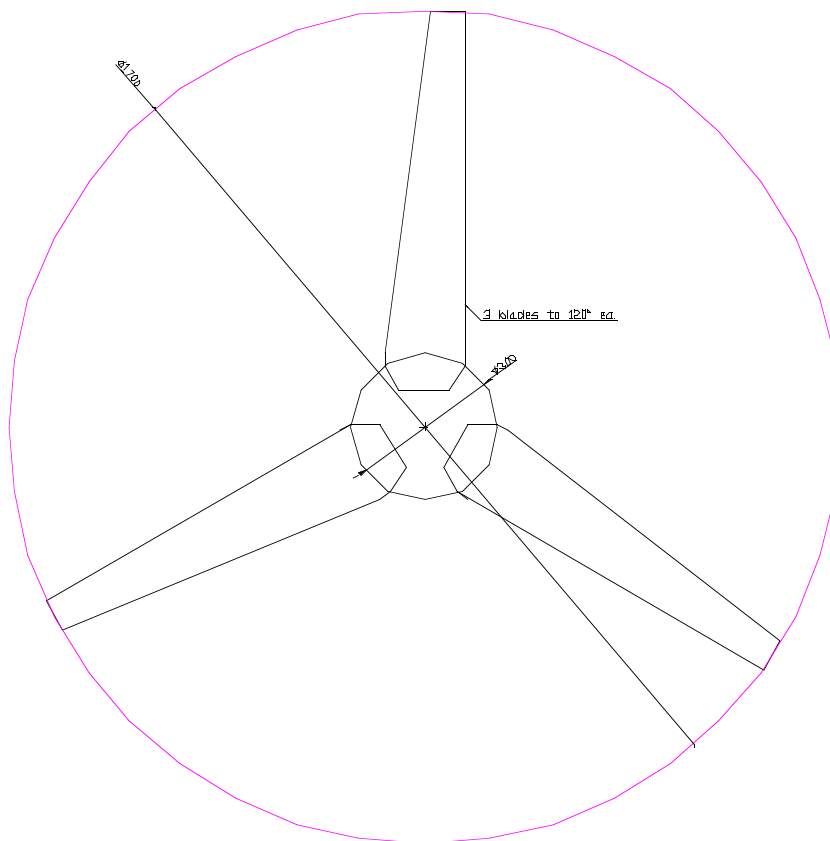

In association with : ITDG-UK; ITDG Peru and ITDG South Asia

This research on small wind energy systems for battery charging is the result of a collaborative effort involving numerous contributors.

The project was managed by Intermediate Technology (known as The Intermediate Technology Development Group or ITDG) under a contract to the UK Department for International Development.

The overall international project was co-ordinated by **Dr Smail Khennas**, Senior Energy Specialist from ITDG with support from Simon Dunnett. The field work in Peru and Sri Lanka were respectively managed by Teodoro Sanchez and Rohan Senerath.

Teodoro Sanchez Campos (ITDG Peru), Sunith Fernando (Sri Lanka) and Hugh Piggott (a UK technical consultant for the project), are the authors of this booklet on the rotor blade manufacture.

The views expressed in this report are those of the authors and do not necessarily represent the views of the sponsoring organisations, the reviewers or the other contributors.

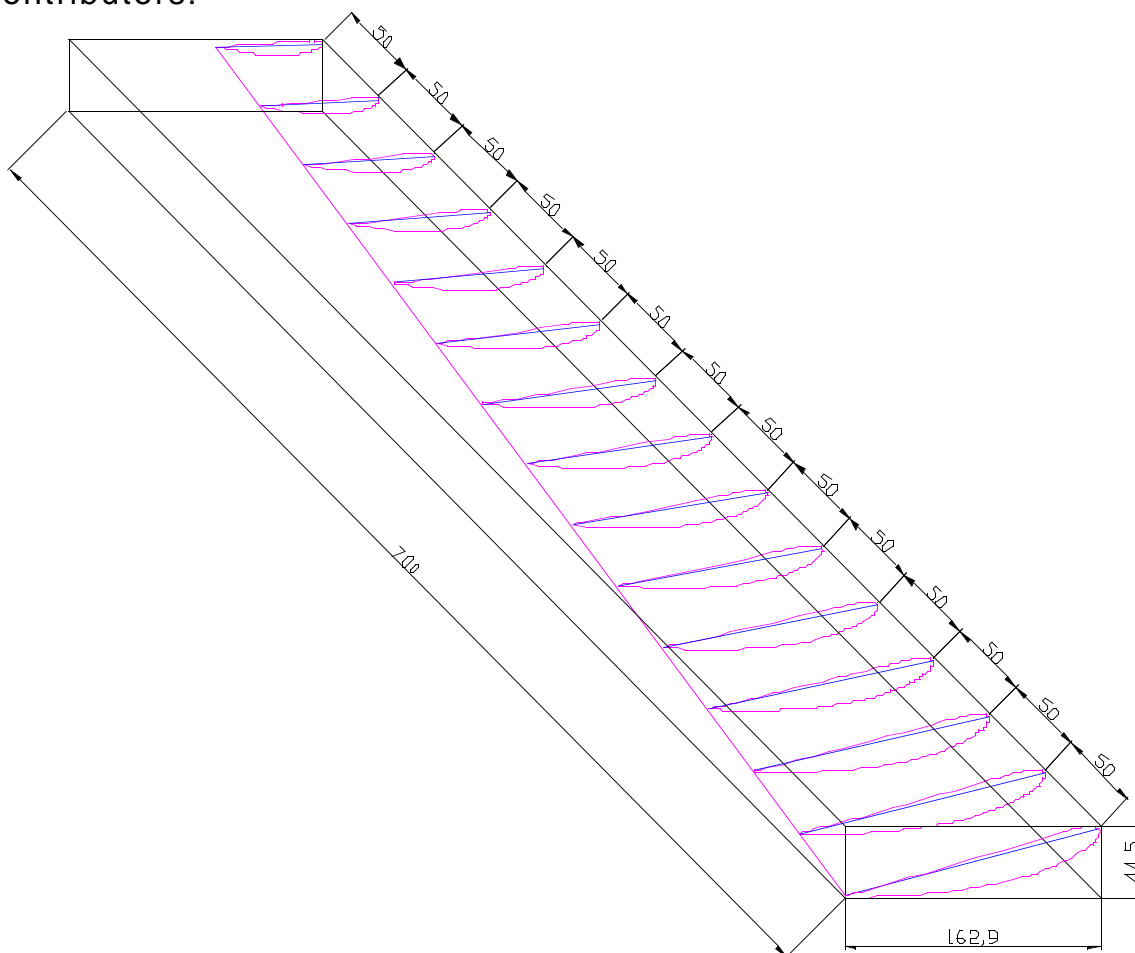

This diagram shows the shape of a blade pattern.

Wind rotor blade construction

Small Wind Systems for Battery Charging

CONTENTS

1. Introduction.....	4
The wind generator	4
Steps in the wind rotor construction procedure	4
The two rotor designs	5
The shapes of the blades	7
2. Templates, Patterns and Moulds	8
Templates	8
Patterns	8
Making two separate patterns	9
Finishing of the surface.	10
An alternative idea : making patterns from metal	10
Making the moulds	11
3. Blade construction.....	13
The procedure in Peru is as follows.	13
4. Testing for strength.....	15
5. Balancing and mounting.....	16
Balancing the rotor	16
Mounting the rotor blades	17
Appendix I :Blade design details	18
Sri Lanka K2 blade design by Sunith Fernando	18
Peru NACA4412 blade designed by Teodoro Sanchez	18

1. Introduction

The wind generator

This booklet is to assist manufacturers in make the blades, or 'wind rotor' for a small wind generator. Another booklet tells how to build the permanent magnet generator (PMG). The wind rotor will be fitted to the PMG. It turns the PMG, and the PMG charges a battery.

The PMG and rotor blades have to be mounted on a 'yaw bearing' at the top of a tower (usually made from steel pipe). The wind generator also needs a tail to make it face the wind. The tail must also automatically turn the wind generator away from strong winds to protect it from damage. The yaw bearing, tail and tower are not described further in this booklet.

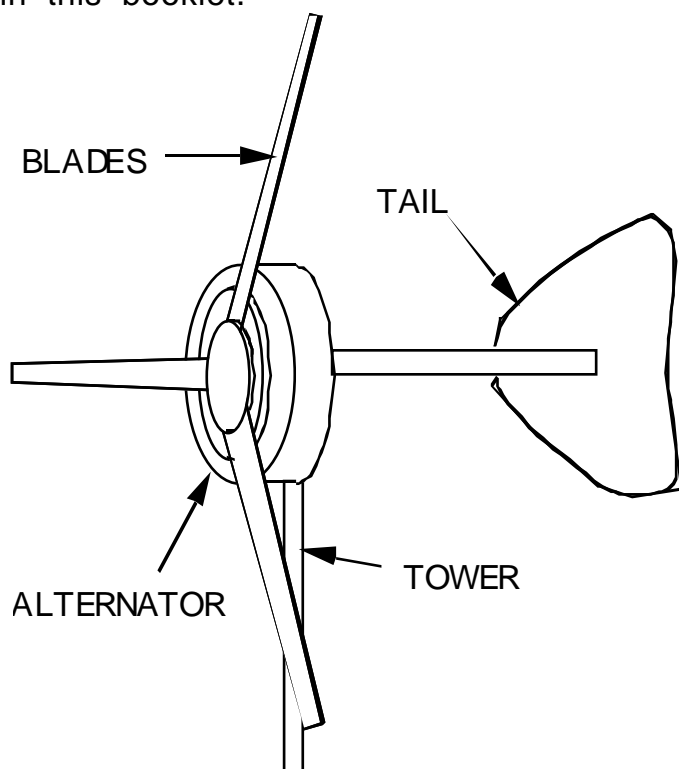

The wind generator is suitable for family needs such as lighting and radio, powered by a 12-volt battery. It is for low and medium windspeeds, common in Peru and Sri Lanka, where the wind turbine is being built.

The blades described in this book are made from fibreglass, (although would also be possible to make them from wood.)

Steps in the wind rotor construction procedure

1. Choose a design for the blades, and make templates from paper or thin aluminium sheet. Copy the drawings

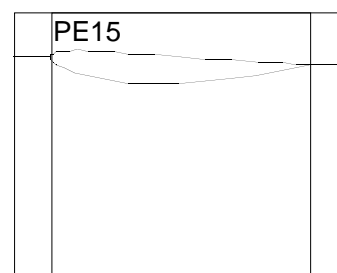

in Appendix II for the templates. The templates will fit the outside of the blades exactly.

2. Use these templates to make a three dimensional pattern in the shape of the actual blade. One can carve a pattern from wood. Or metal sheet or foam could be used instead.
3. Around the pattern, cast fibreglass moulds. We might make enough moulds for a full set of blades for one rotor (three moulds for a three bladed rotor).
4. Use the moulds to make the blades.
5. Make a hub for the blades and assemble the rotor.

If the production team have no experience with fibreglass resin, they may need to ask an expert for help.

We will need to test the strength of the blades, and balance them, so they will be safe and run smoothly.

The two rotor designs

Here are the main features of the two rotor designs described in this booklet:-

Country of origin	Peru	Sri Lanka
Designer	Teodoro Sanchez	Sunith Fernando
Blade section	NACA 4412	K2
Diameter	1.7metres	2.0metres
Tip speed ratio	5	6
Number of blades	3	2

SECTION

The 'blade section' is the shape of the blade in cross-section (cut at 90 degrees). The NACA4412 section is made from two skins with space between. The K2 section can be solid fibreglass resin.

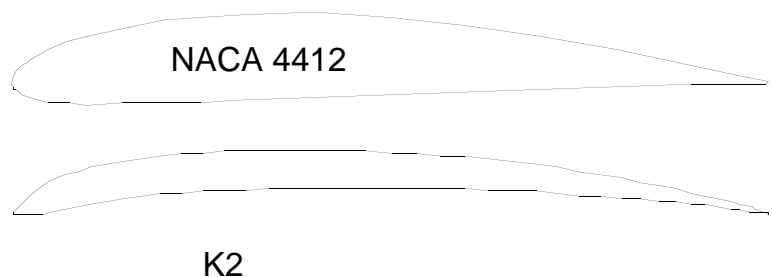

DIAMETER

The larger, 2.0 metre diameter rotor will sweep across more wind, and therefore it can produce more power, in a given windspeed.

TIP SPEED RATIO

The 'tip-speed-ratio' is the speed at which the blade tip should run compared to the windspeed. The shaft speed in revolutions per minute (rpm) depends on the tip speed and the diameter.

$$\text{Rpm} = \text{windspeed} \times \text{tip-speed-ratio} \times 60 / (\text{diameter} \times \Pi)$$

The main reason why the two blade rotor can work at higher tip-speed-ratio is that it only has two blades. The smaller, three bladed rotor will have a slower tip-speed, but will run more smoothly because it has three blades.

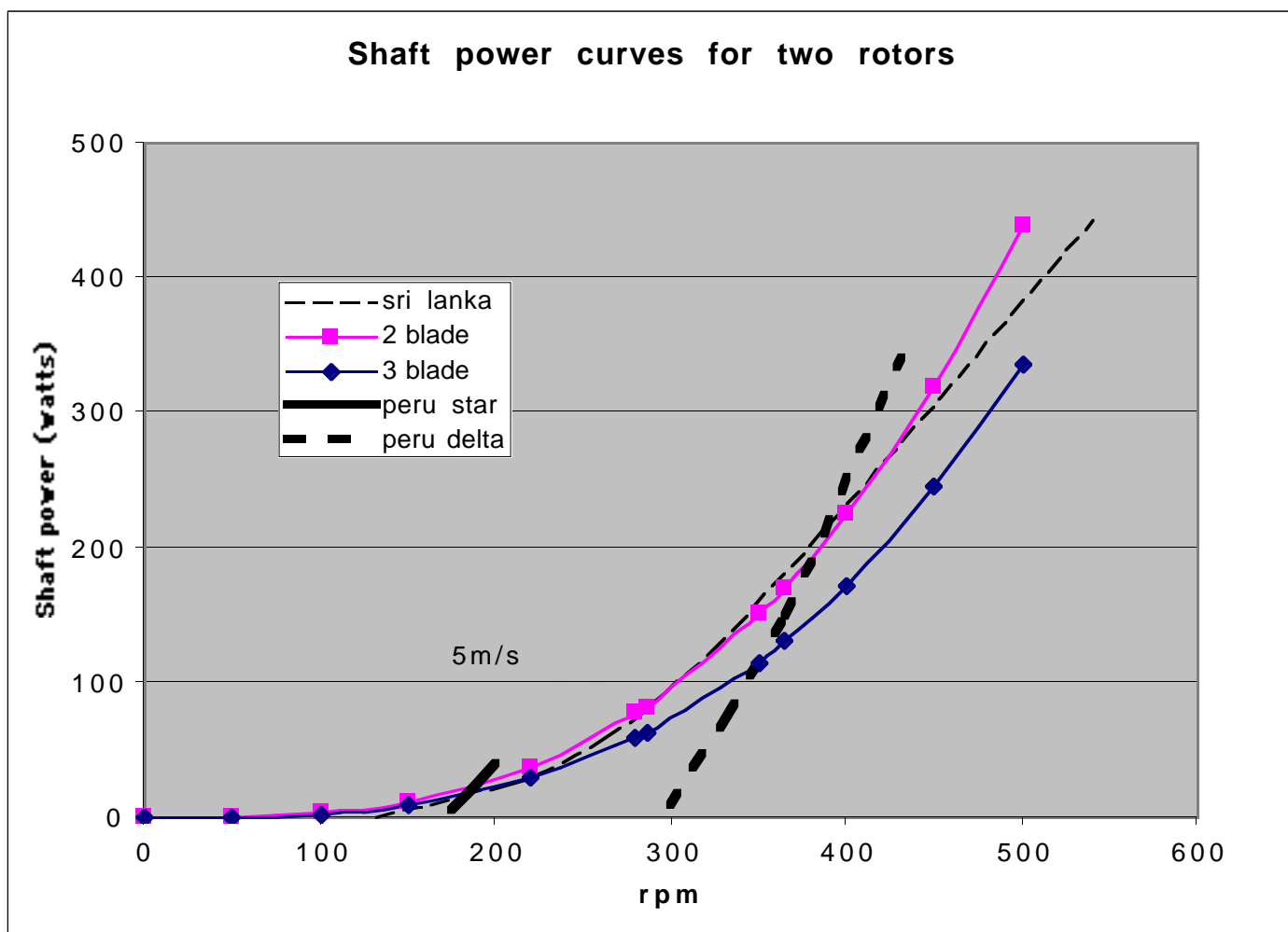

Each rotor is carefully designed to work well with the PMG used in each country. The PMG used in Peru has thicker magnets and a different way to connect the windings. Above is a chart of the power produced by the two rotors over a range of speeds (based on the theory). The chart also shows how much power is needed to drive the alternators in Sri Lanka (dotted) and Peru (two curves for two connections). The 2-bladed rotor (purple) designed in Sri Lanka produces exactly the power required for the alternator used in Sri Lanka. The 3-bladed rotor (blue) from Peru is designed to match the two different cases for the Peru alternator : star connected and delta connected.

At a windspeed 5 metres/second, the two rotors will produce 80 watts and 60 watts of mechanical (shaft) power respectively at 286 and 280 rpm respectively. This point is marked on each curve.

The speed of the wind rotor depends on how it is loaded. If the PMG is disconnected from the battery, the rotor will become unloaded and will run much faster. We try to avoid running the wind rotor unloaded, because it is noisy and stressful.

The shapes of the blades

The dimensions of the blades are listed in Appendix I. The blades are defined at a number of 'stations'. SEE FIGURE 'BLADE DIMENSIONS AT STATIONS' BELOW. Each station has a 'local radius', which is the distance of the station from the centre of the rotor. For each station there is a 'chord width', which is the width of the blade, from one edge to the other.

The 'chord line' is defined as the longest line within the blade section, and it joins the leading edge to the trailing edge. The 'blade angle' (beta) is the angle between the chord line and the plane in which the rotor spins. Given the local radius, chord width and blade angle at each station, we can construct the shape of the whole blade. This is done in Appendix II.

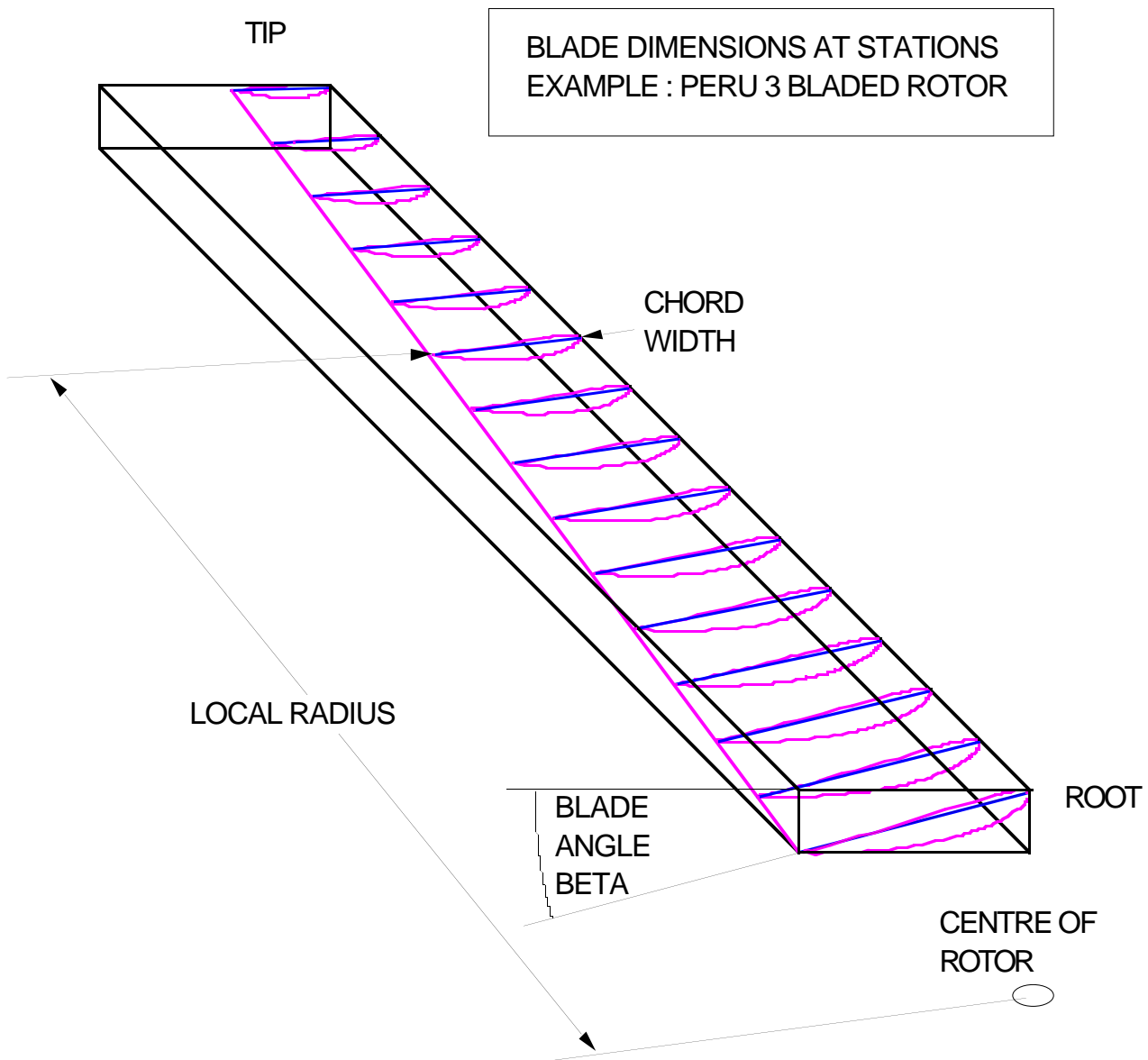

At the root, the shape of the blade changes from an airfoil section into a shape which is suitable for the hub assembly

2. Templates, Patterns and Moulds

Templates

Choose a blade design and make photocopies of the templates in Appendix II. Either cut out these copies and use paper templates to make the pattern, or alternatively use thin aluminium sheet for the templates.

Transfer the shape to the aluminium sheet using carbon paper to trace it, and/or using a punch through the paper to mark the aluminium with the lines.

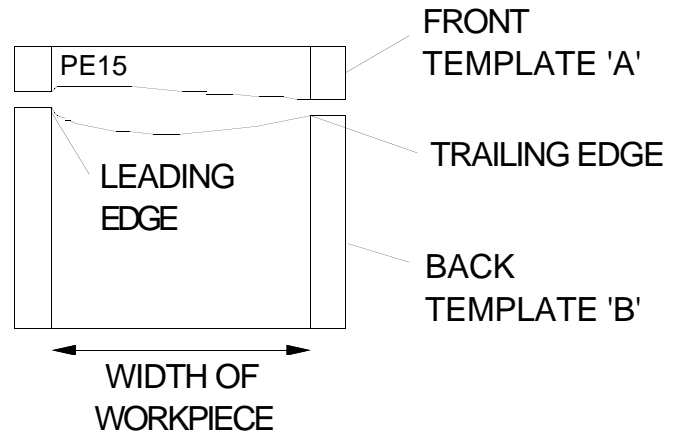

Each template drawing has 3 areas within it:

1. A blade section (remove this)
2. A front template A
3. A back template B (turn it over and use it when carving the back of the pattern)

The vertical lines on the template show the width of the workpiece for the pattern after it has been tapered. The angle of the blade section is the exact blade angle. The top edge of template A is exactly 10mm from the top surface of the blade. The bottom of template 'B' is 60mm below the top surface.

Patterns

The pattern is an object which is exactly the shape of the blade. Use it to make moulds for the blades. There are various ways to make a pattern. It can be made from wood. This is normal. However, wood can warp, and change its shape. It is important to choose a very stable wood. In Peru they have used Coava, which is a hard wood with good stability.

Sunith Fernando in Sri Lanka tried a wooden pattern initially but warping became a problem. "For K2, which is a slender profile, I made the pattern out of two materials. First I got a steel sheet (~ 0.8 mm thick) rolled into K2 outer profile – more or less, and then filled the inside with a paste that we use to fill up dents of automobile bodywork (we call it Cataloy paste). I used the paste to fill up the outer profile also as a thin layer. Then I filed the hardened cataloy paste to the required profile. Thereafter, I got the blade pattern cast in aluminium. It is the aluminium pattern that I gave for fibreglass work."

For the construction of the wooden pattern follow this procedure:

- a). - Buy a rectangular block of wood 45mm x 165mm x 700 mm. The wood should be dry enough before starting the work of carving.

b)- Mark the position of each station. Then draw two lines along the wider faces using the 'workpiece width' on the templates, and cut the wood to the correct width at each station.

c)- Use the templates to mark a leading edge line and a trailing edge line. These are the lines where the two moulds will meet. Here is how to mark these lines: The top of the workpiece should be 60mm above the level of the bench. The right hand side of each template 'B' is the trailing edge. Place it on the bench, against the left hand side of the workpiece as shown, and mark the trailing edge. Do this at each station and then do the same for the leading edge.

d)-Then carve the curved shape of the blade pattern, checking very carefully with the templates at each station.

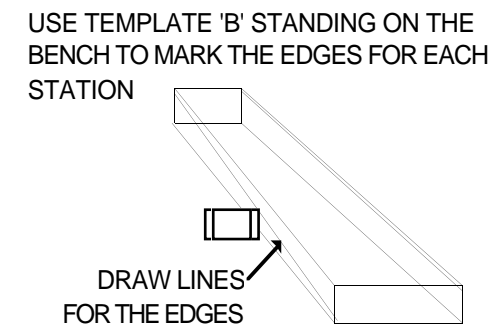
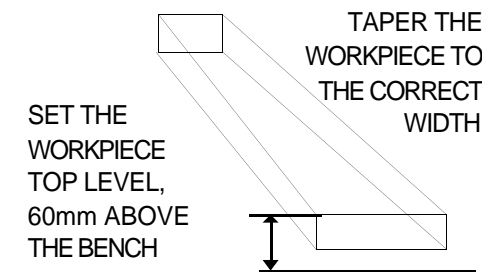
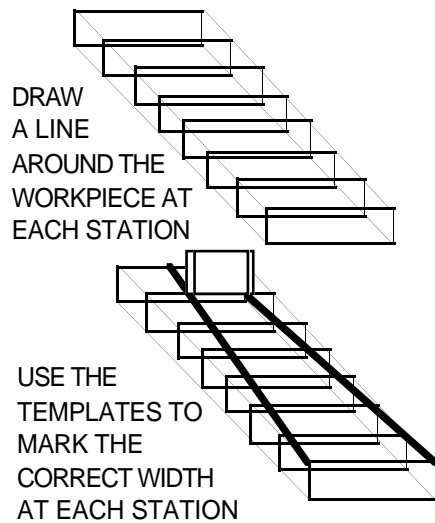

The templates in Appendix II are printed in such a way that one should look at them from the tip of the blade inward. Place the template over the workpiece at its

station. When the pattern is finished, the top edge of the template should be exactly level, and the leading and trailing edge lines should meet the lines drawn earlier on the sides of the workpiece.

Making two separate patterns

The moulds for the blades will be made in two pieces: one for each side of the blade. It is possible therefore to use two patterns instead of one, one for each mould. If there are two patterns, they do not have to be thin, like the blade itself. They can be made from big thick pieces of wood, which will not easily warp.



The photo (last page) shows a pattern being carved from a wooden workpiece which has been built up out of three pieces of wood glued together.

Finishing of the surface.

The finishing of the surface is an important feature because the quality of the surface of the blades will depend on that, therefore it is recommended to use some substance to feel tiny imperfections of wood, and later polish the surface until it looks as regular as possible, paint the pattern and polish again until it is soft enough or good enough to be used as a pattern.

An alternative idea : making patterns from metal

First I must state that this idea has not been tried at the time of writing. It is possible to make patterns for the blades using sheet metal wrapped over metal formers (support pieces). Make two patterns - one for each mould. One is for the back of the blade, and one is for the front.

Cut out the support pieces using the template shapes in Appendix II.

They will be used to support the pattern surface sheet, rather than just to check its shape.

Glue all the support pieces onto a level base at the correct spacings, and then glue a surface sheet down onto them tightly.

There are yet more, other ways to make the patterns. It is possible to make them from foam, cut with a hot wire. This method is popular with model makers.

Probably the simplest method is to carve them from wood, as described above.

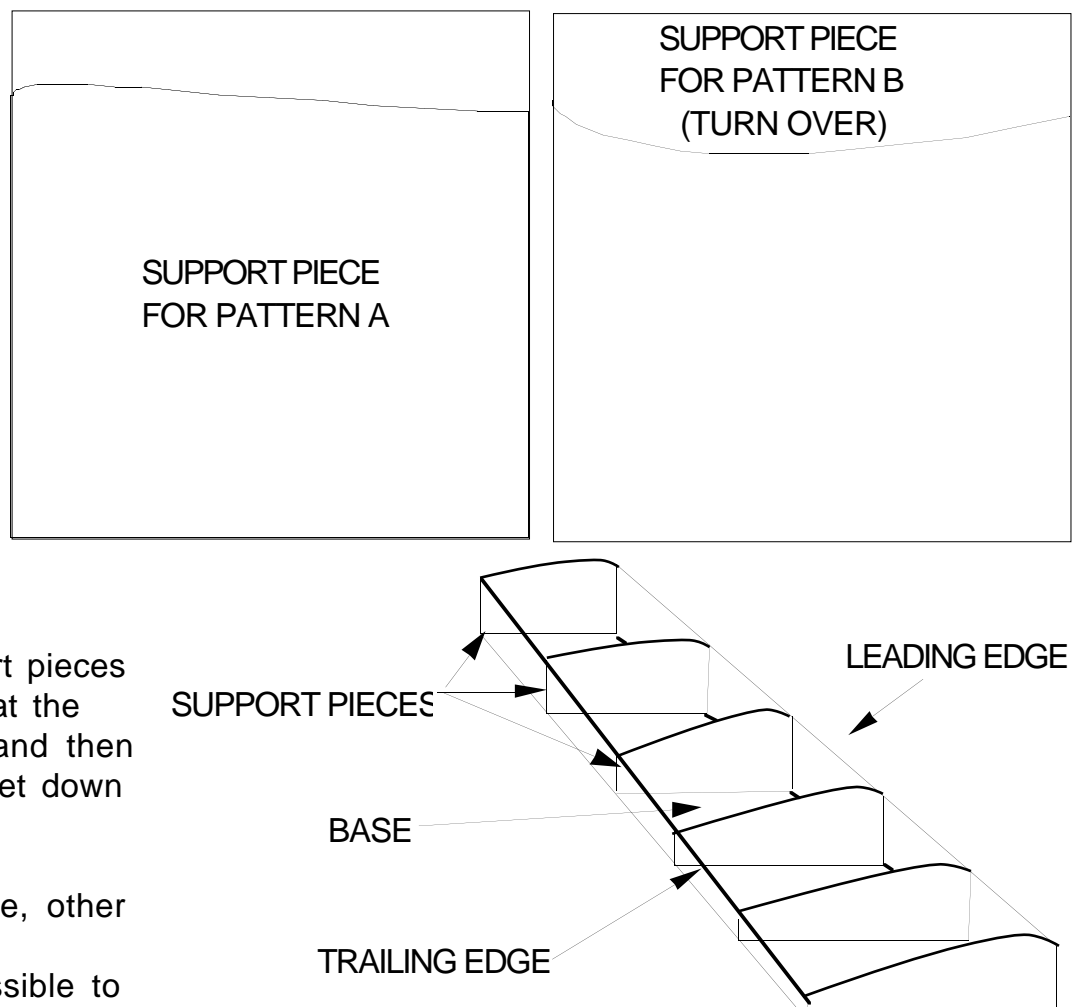

Making the moulds

In Peru, the moulds were manufactured in fibreglass. “The mould is done in two pieces, therefore it is convenient to be careful with splitting the blade into two parts, (or with the splitting line)

“The moulds can be of different materials, resin and fibreglass is always a good option, however it does not have a long life, it is expected that each mould can be useful to produce up to 50 or 60 units of blades.



“Therefore in some cases it would be preferable to use metal ones. Aluminium is a good alternative and it is widely used for fibreglass products.”

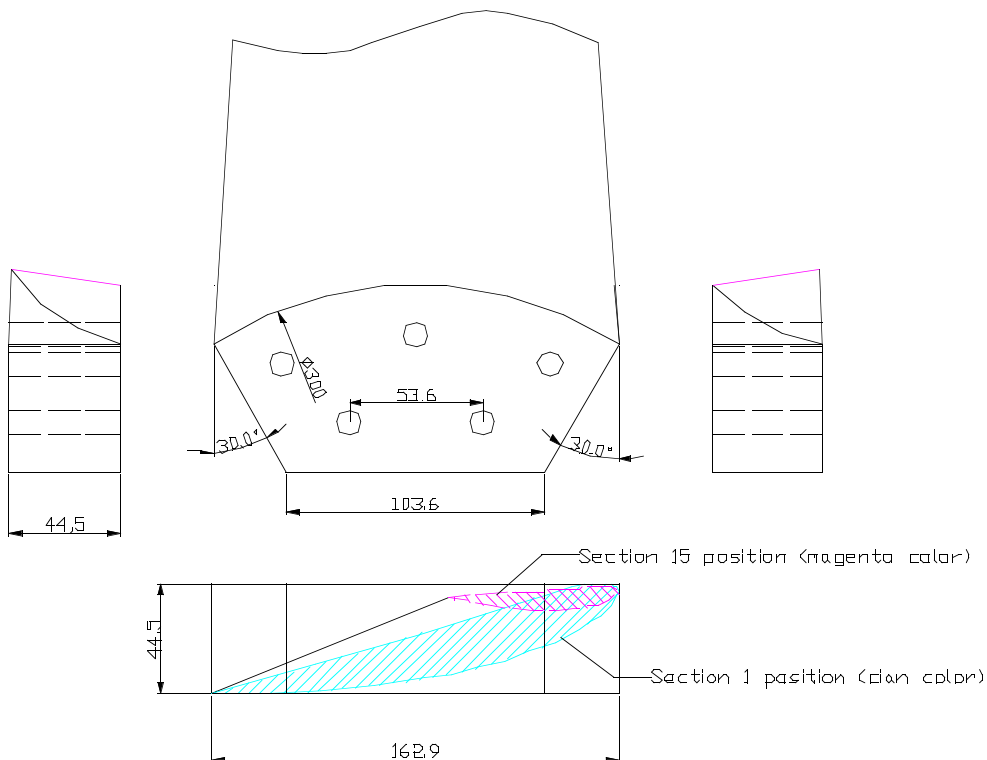

The blade root needs to be shaped to mount easily onto the wind generator. In Peru the root shape is as shown above. All three blade roots are clamped between two steel plates. The transition between the root (mounting portion) and the blade (airfoil

section portion) is to be made smoothly. Avoid using sharp curves which would weaken the fibreglass.

The moulds for the Sri Lankan blades are shown to the right. They were made in fibreglass on an aluminium pattern. One side of the K2 mould is convex, because the upwind side of the blade is to be concave.

The two halves of the mould

When making the first half of the mould, use only one face of the pattern. Make a flat surface around the edges of the pattern which will later become the faces where the two moulds will meet. This can be done with fibreglass resin, wood or plasticene or any material which is easy to work. Take care to follow the edges of the pattern very exactly. When the first half mould has been made one can destroy this flat surface.

It is a good idea to make two holes in the flat surface at the edge of the first half, so that the second half will have two lumps. Later, we will fit the two halves of the blade together inside the moulds. If the lumps are in the holes then the two halves are correctly lined up.

When making the second half of the mould, place the first half against the other side of the pattern. Polish the flat surface around the edges, in the same way as the pattern, so that the fibreglass resin will not stick to it. Make the second half of the mould cover the pattern and also the flat surface, so that the two moulds fit each other perfectly.

If there will be two separate patterns for the two halves of the mould, take great care that the final blade will be the correct shape when the halves are put together. It would be easy to alter the thickness of the blade by inaccurate patterns.



3. Blade construction

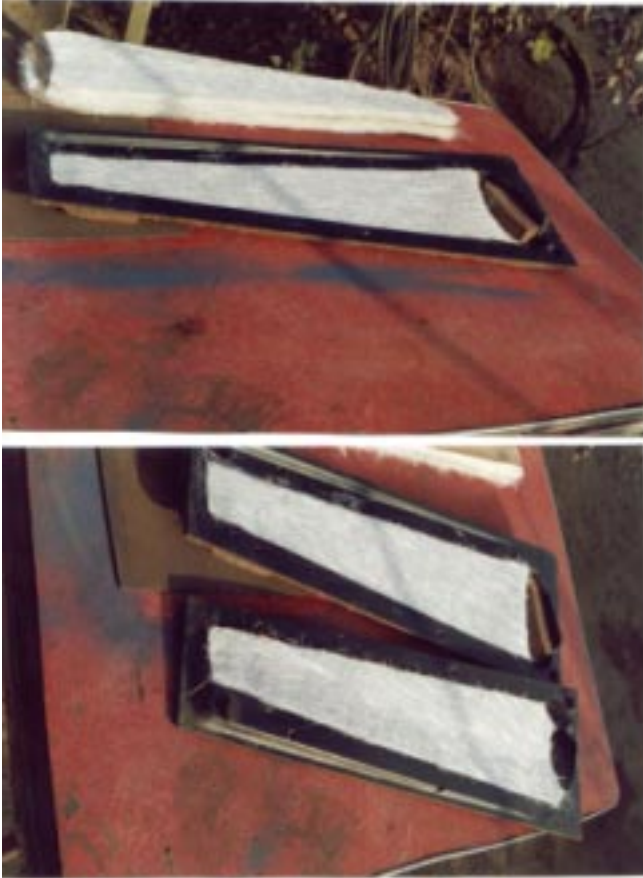

The procedure in Peru is as follows.

- a) The mould should very clean before using the resin and fibreglass. Use alcohol or other solvent to clean it.
- b) Use some substance to facilitate the mould separation from the blade when it is ready.
- c) Paint a thin layer of resin in each side of the mould, then a layer of fibreglass (approximately 1mm).
- d) Again a layer of resin on top of the fibreglass, and so on until there is approximately 3 to 4 mm thickness
- e) In the root end of the blade it is possible to use a piece of wood (see diagram below) in on top of one of the sides in order to lower the quantity of fibreglass and resin.
- f) Also in the root of the blade there should be holes in order to assemble the blades to the central hub.

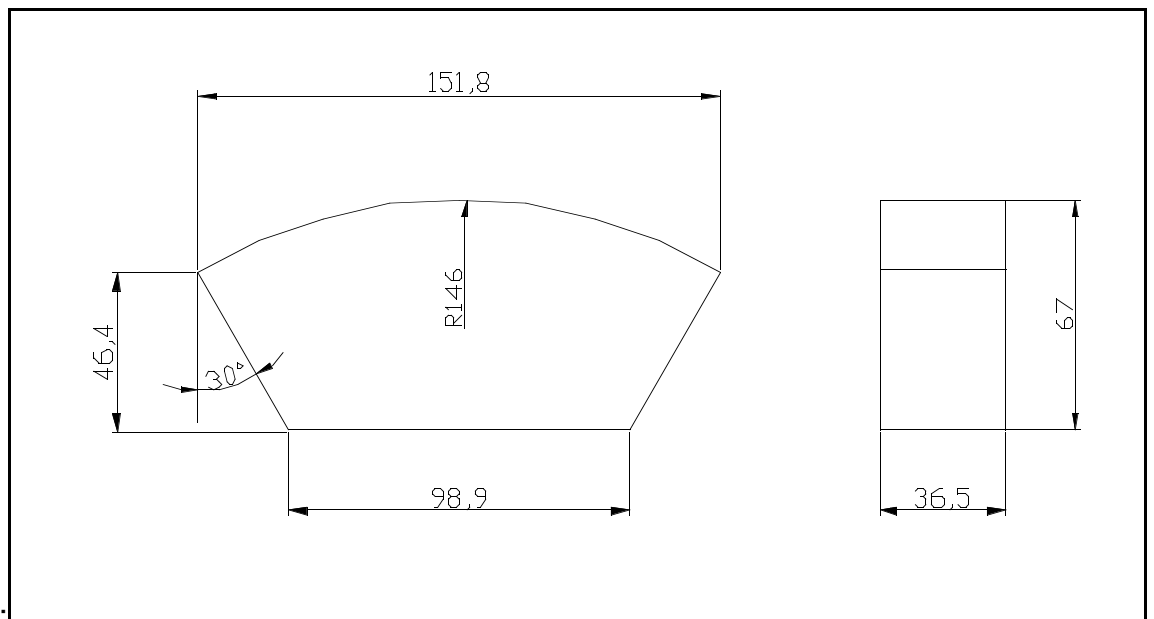

Wood:

g) Once the 3 to 4 mm of fibreglass have been placed each side of the mould, the next step is to join the halves and tie them together. It is advisable to put some resin in the borders of the moulds in order to fill all the small gaps.



h) Finally, after joining the two pieces of the moulds, it is necessary to use bolts to clamp it. Leave it to set for about 12 to 15 hours.



On the right is a picture of the finished blades.

The outer portion of each blade is hollow. The Sri Lankan rotor has solid blades.

Another option is to use a foam core inside the blade. This can make it stronger if the bending stress causes problems (see section 4).

The outer layer of the blade (gel coat) must be waterproof, with no cracks or fibres on the surface. If water enters the blade, it degrades the strength and changes the balance. If the piece of wood in the blade root becomes wet and then dry, then the blade root will work loose in the hub mounting.

If the blades run for long periods in strong winds, then the leading edges will be eroded. A special adhesive tape is available for protecting the leading edges. Or they can be repaired with cataloy resin, and re-balanced as part of routine maintenance work.

4. Testing for strength

It would be wise to ask an engineer to check the structural design strength of the blades one is building. It is possible to calculate whether the stresses in the fibreglass skin are safe or not. We need to have a safety margin to allow for unexpected events, and for fatigue.

The main stresses on small wind turbine blades arise from centrifugal and gyroscopic forces. The centrifugal force on the blades when they are running at full speed (around 500 rpm) will be approximately 100 times the weight of the blade. If a blade weighs 1.5kg, then the centrifugal force will be around 1.5kN (equivalent to 150kg weight) at this speed. At 1000 rpm the force will be equivalent to 600 kg. This speed could arise if the tail furling system does not work correctly for example.

Wind thrust on each blade is only 50-100N (5-10kg). Thrust force imposes a bending stress on the blade, which adds to the stress from the centrifugal force. Gyroscopic bending moments could also be of that order of size (but rapidly alternating).

For peace of mind and safety it would be wise to test a sample blade by hanging and swinging weights on it until it breaks. This will indicate how large the factor of safety is (if there is one).

If there is a problem with inadequate strength in the blades, then increase the amount of fibreglass, especially in the root area. The resin has no real strength except to bond the glass fibres. If possible, use 'uni-directional' fibreglass mat. It may not be easy to find, but it has double the tensile strength for the same weight. This is a big advantage where the main forces are inertial (centrifugal, and gyroscopic).

Blades will tend to crack at 'stress concentrations' where the skin undergoes sharp changes in shape. Try to keep the blade skin smooth and straight in its transition from the airfoil portion to the root portion.

Blade failures are dangerous and very discouraging. When they occur, it may be necessary to recall and reinforce or replace a large number of blades. It is better by far to ensure that the blades are sufficiently strong at the start of manufacture.

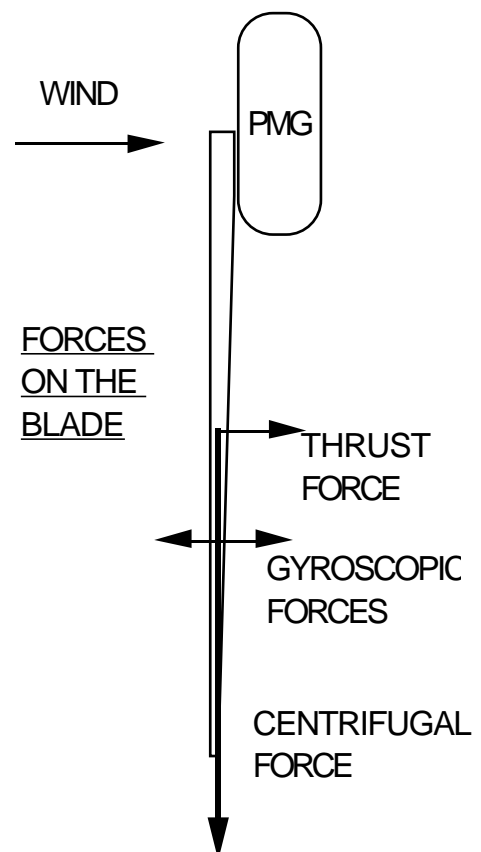

5. Balancing and mounting

Balancing the rotor

If the wind rotor is not balanced then the wind generator will shake as it spins. After hours and days of shaking, parts will begin to drop off. Usually the tail is first to go. It is important to balance the wind rotor carefully. Here are some steps to balance the rotor blades:

1. Support each blade at the root, and weigh the tip. Each blade should have the same tip weight. In order to do this test accurately we support all of the blade roots in exactly the same way. Make a jig which supports the blade root at the centre of the rotor.

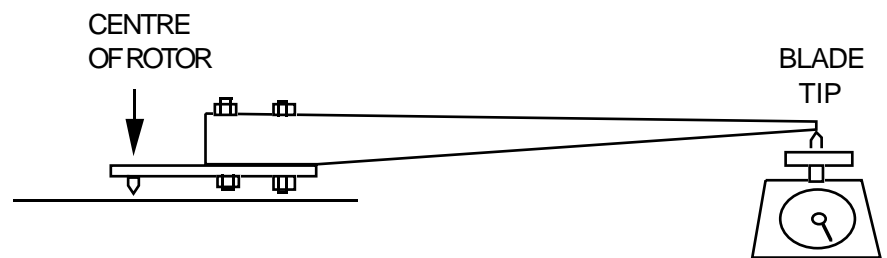

2. Mount the blades on the rotor hub accurately. If there are three blades, then the distance between the blade tips must be the same for each pair. If there are two blades then the line between the tips must pass exactly through the centre of the rotor.

ALL 3 SHOULD
BE EQUAL

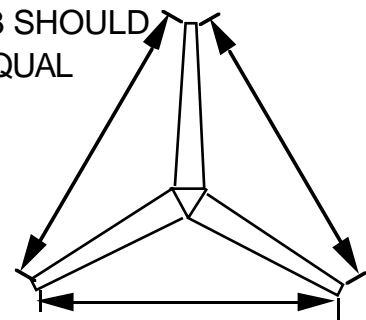

3. When the blades are mounted on the wind generator, check that the tips pass through exactly the same space as they turn. One blade tip should not be in front or behind the others.

LINE PASSES THROUGH CENTRE

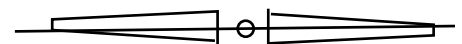

4. Use the balancing techniques described in the PMG manual to check the balance of the whole assembly before using it.

Mounting the rotor blades

The blades must be securely bolted to a central hub which fits on the PMG. Do not bolt the blades directly to the front magnet-rotor, because the gyroscopic forces on the blades will stress the magnet rotor and cause the magnets to hit the stator.

In Peru, the blades are 'sandwiched' between two steel plates. This makes a simple, strong hub. See also the diagram on the cover of this booklet.

In Sri Lanka, the two blades are bolted into a hub which is constructed as a part of the PMG. The rotor hub is an extra plate welded to the front of the PMG bearing-housing tube. Each blade is cradled between two pieces of steel angle which are welded to the plate.

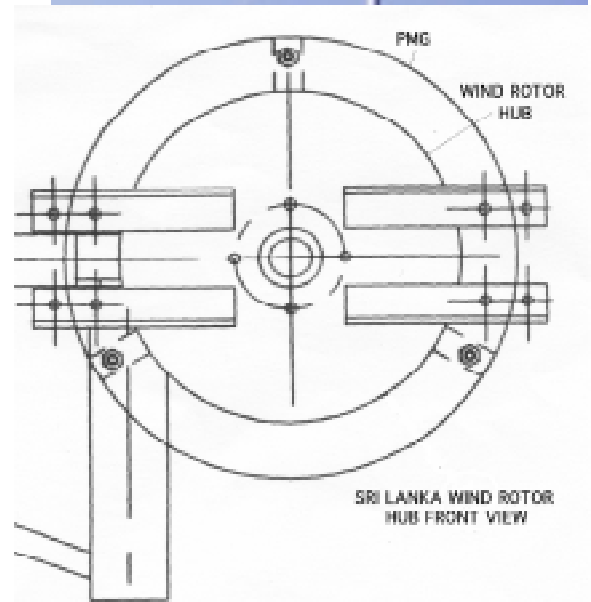
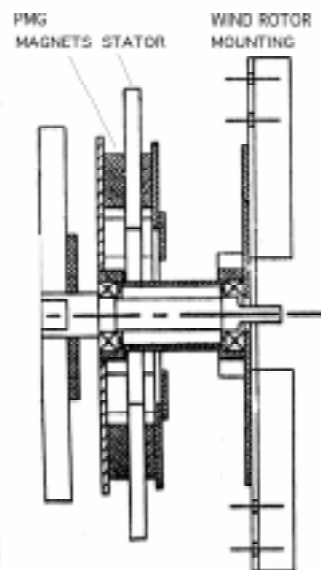

Appendix I :Blade design details

Sri Lanka K2 blade design by Sunith Fernando

Blade station	Local radius	Local speed ratio	Flow angle	Actual chord - m	Re Number	Recalc C_l	Recalc alpha	Recalc Blade angle beta	Actual beta degrees
1	0.2	1.2	29.1	0.180	7.72E+04	1.76	22.9	6.1	11
2	0.3	1.8	20.3	0.170	1.02E+05	1.38	11.0	9.3	10
3	0.4	2.4	15.5	0.160	1.25E+05	1.15	6.6	8.9	9
4	0.5	3.0	12.5	0.150	1.44E+05	1.00	4.7	7.8	8
5	0.6	3.6	10.5	0.140	1.60E+05	0.90	3.7	6.8	7
6	0.7	4.2	9.0	0.130	1.73E+05	0.84	3.2	5.8	6
7	0.8	4.8	7.9	0.120	1.82E+05	0.80	2.9	5.0	5
8	0.9	5.4	7.0	0.110	1.87E+05	0.77	2.7	4.3	4
9	1.0	6.0	6.3	0.100	1.89E+05	0.77	2.7	3.7	3

Peru NACA4412 blade designed by Teodoro Sanchez

Blade station	Local radius metres	Chord width metres	Blade angle beta degrees
1	.15	.1679	14.5
2	.2	.1608	13.6
3	.25	.1537	12.7
4	.3	.1466	11.8
5	.35	.1395	10.9
6	.4	.1324	9.9
7	.45	.1253	9.1
8	.5	.1182	8.2
9	.55	.1111	7.3
10	.6	.104	6.3
11	.65	.0969	5.4
12	.7	.0898	4.5
13	.75	.0827	3.6
14	.8	.0756	2.7
15	.85	.0685	1.8

APPENDIX II : BLADE TEMPLATES ACTUAL SIZE

*THESE TEMPLATES ARE VIEWED FROM THE TIP
LOOKING TOWARD THE CENTRE OF THE ROTOR*

TEMPLATES FOR SRI LANKA 2-BLADE DESIGN USING K2 PROFILE
- 9 STATIONS -

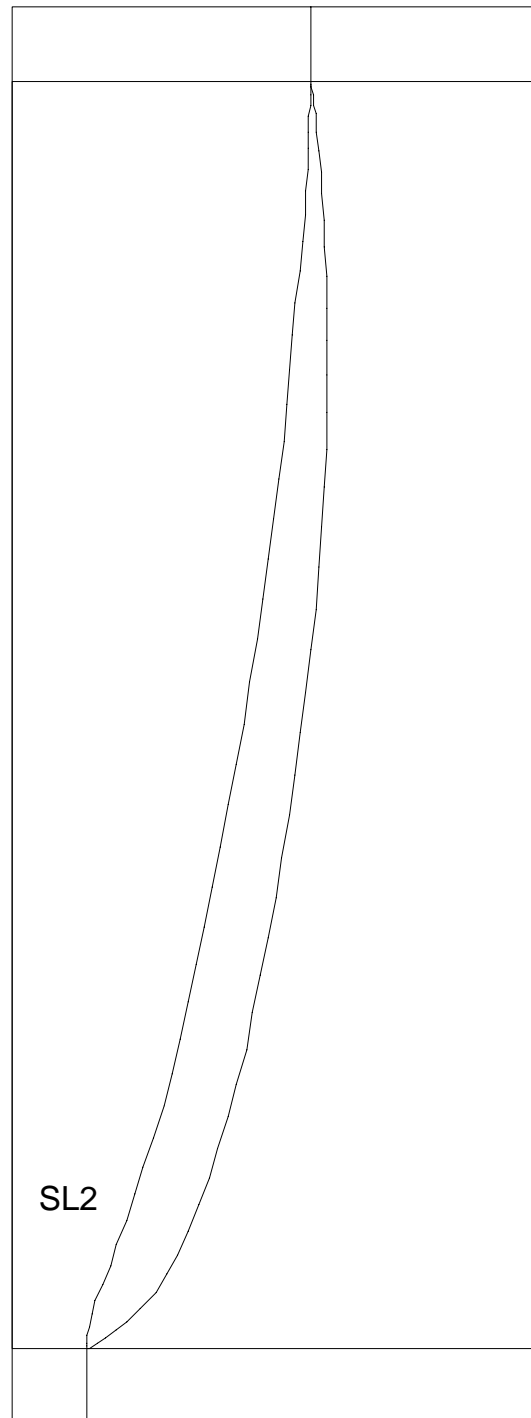
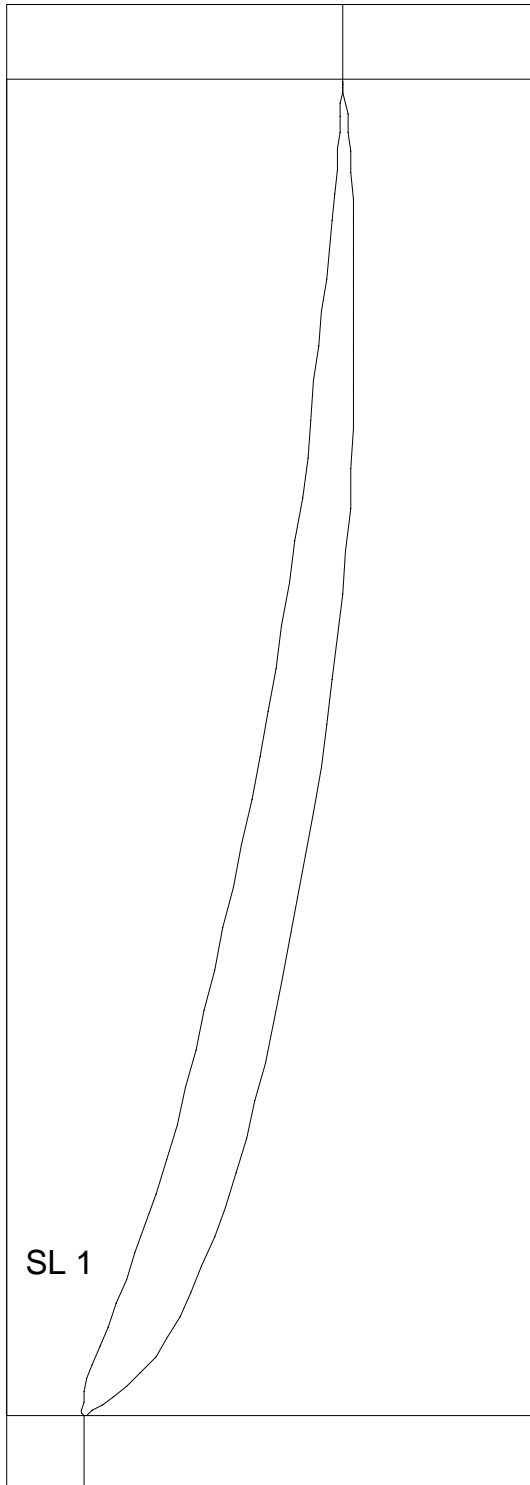

TEMPLATES FOR SRI LANKA 2-BLADE DESIGN USING K2 PROFILE
- 9 STATIONS -

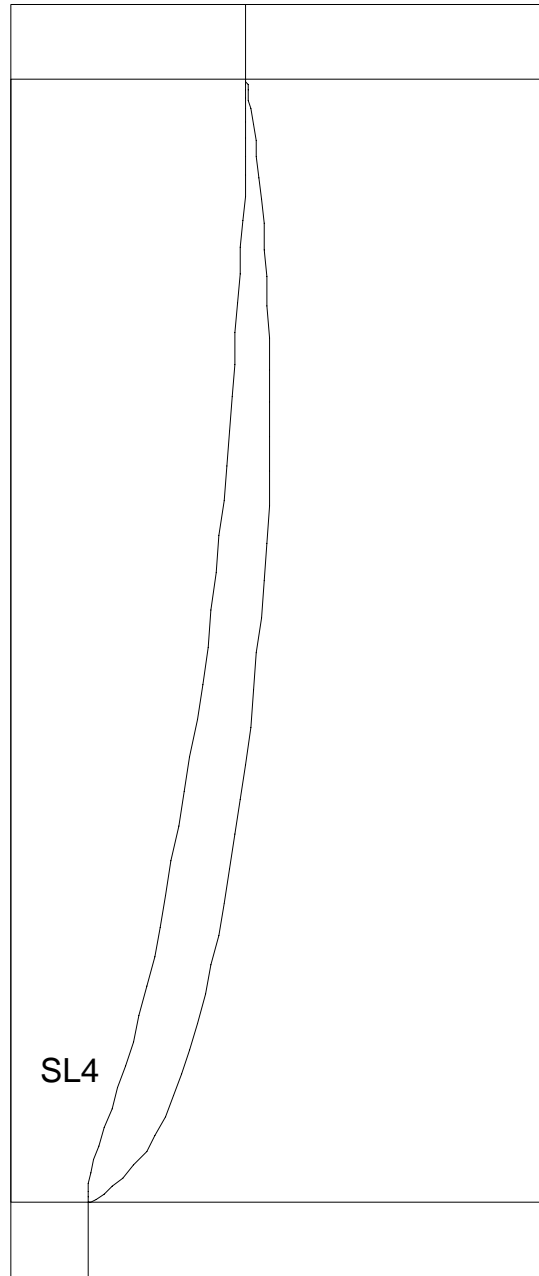
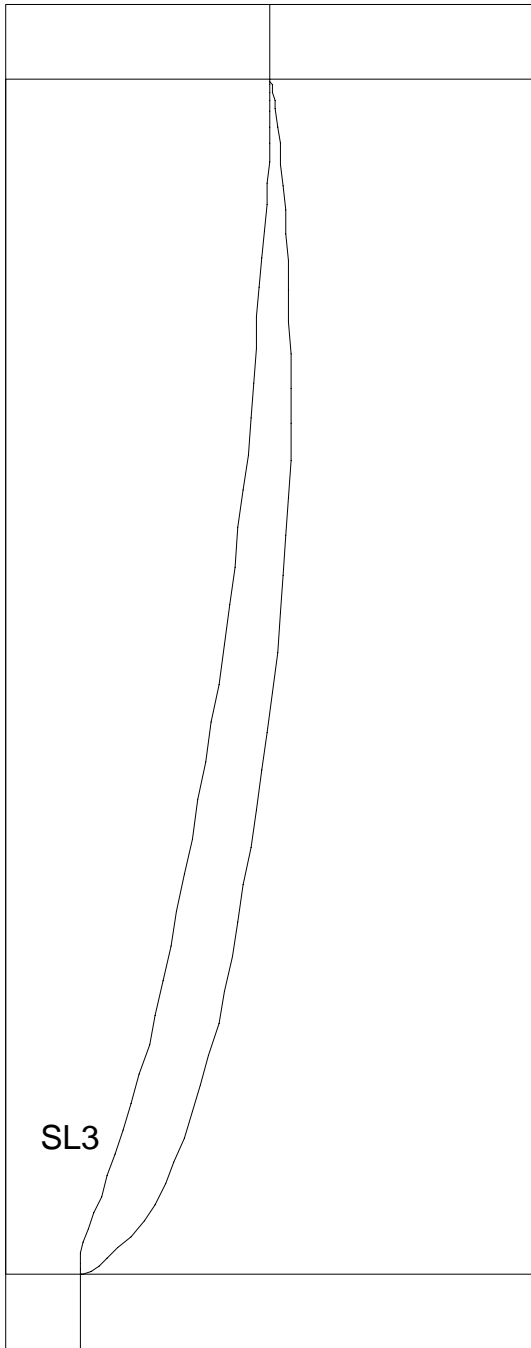

TEMPLATES FOR SRI LANKA 2-BLADE DESIGN USING K2 PROFILE
- 9 STATIONS -

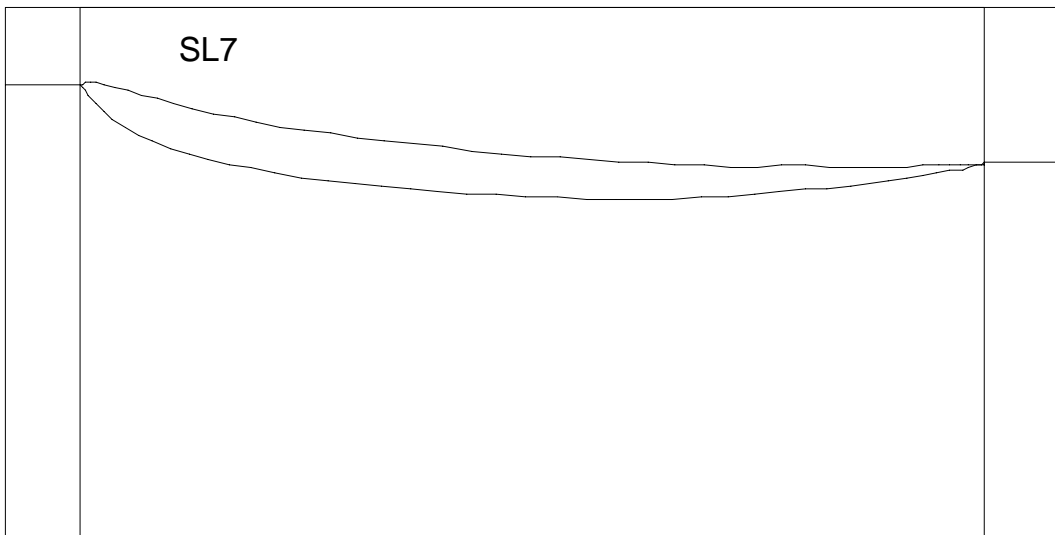
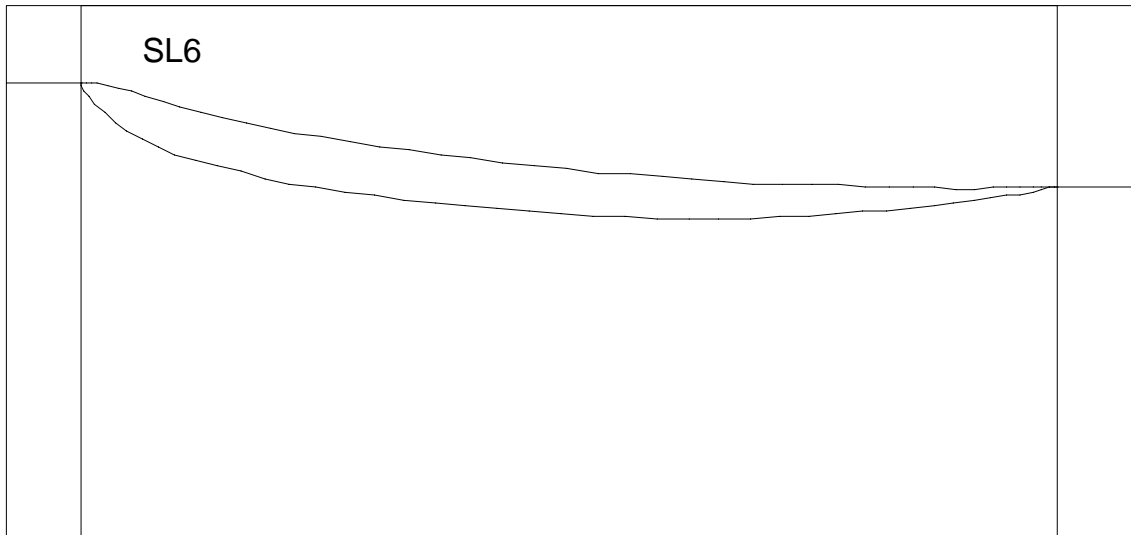
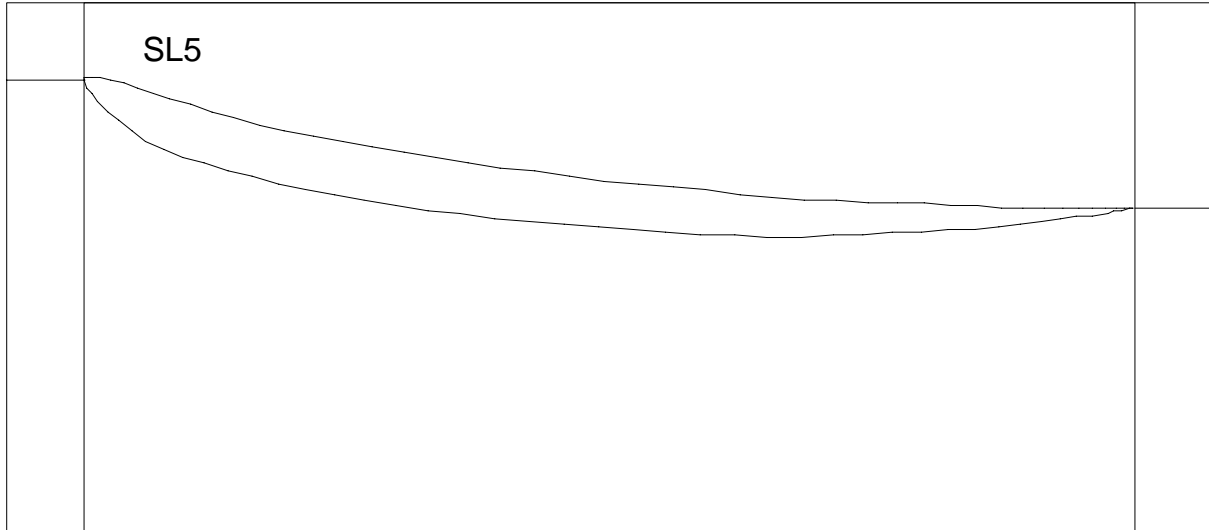

TEMPLATES FOR SRI LANKA 2-BLADE DESIGN USING K2 PROFILE
- 9 STATIONS -

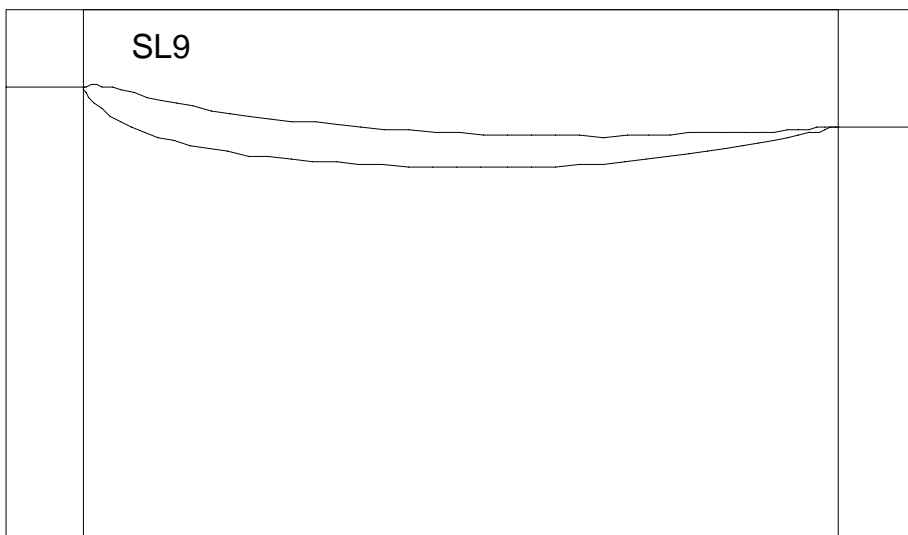
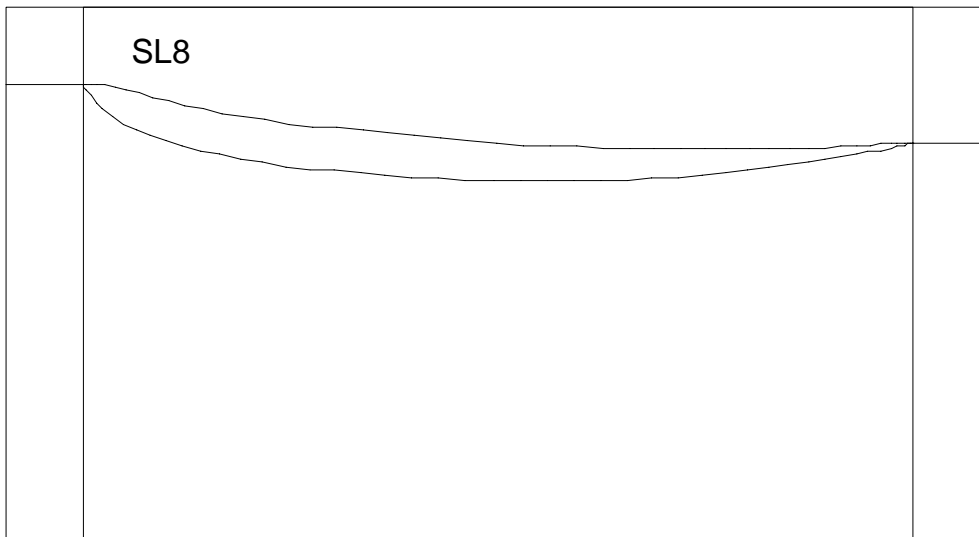

TEMPLATES FOR PERU 3-BLADE DESIGN USING NACA 4415 PROFILE
- 15 STATIONS -

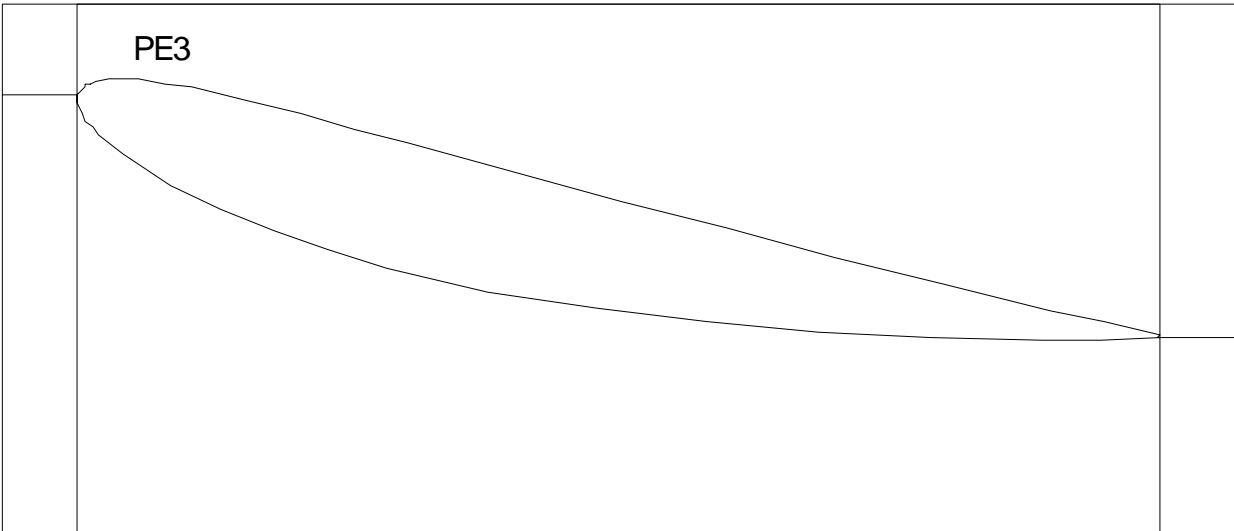
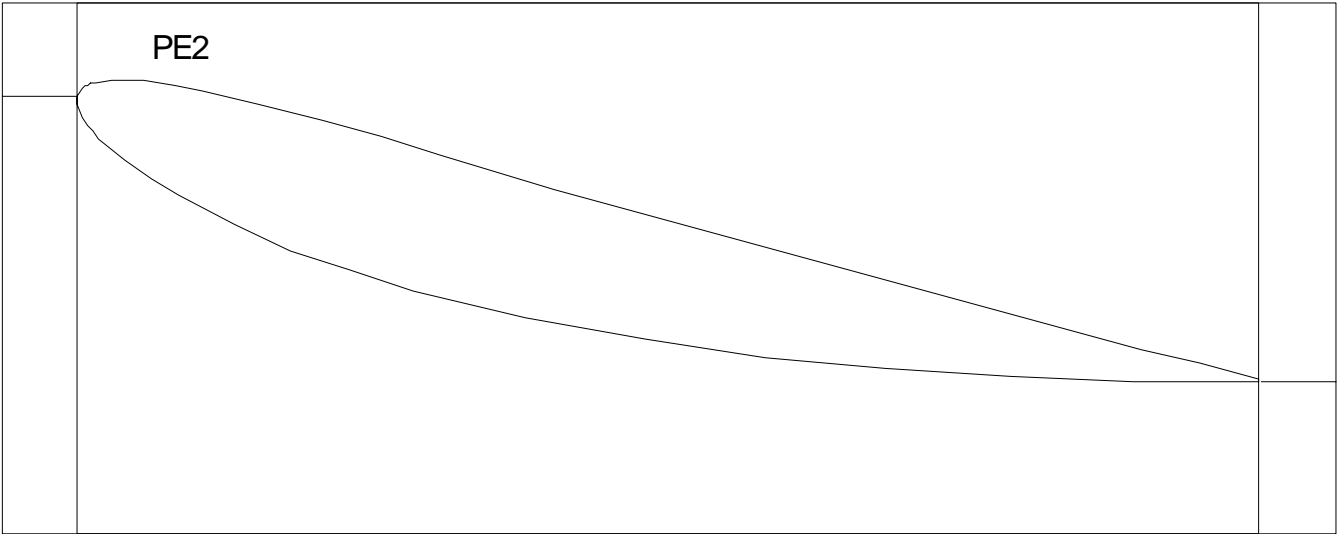
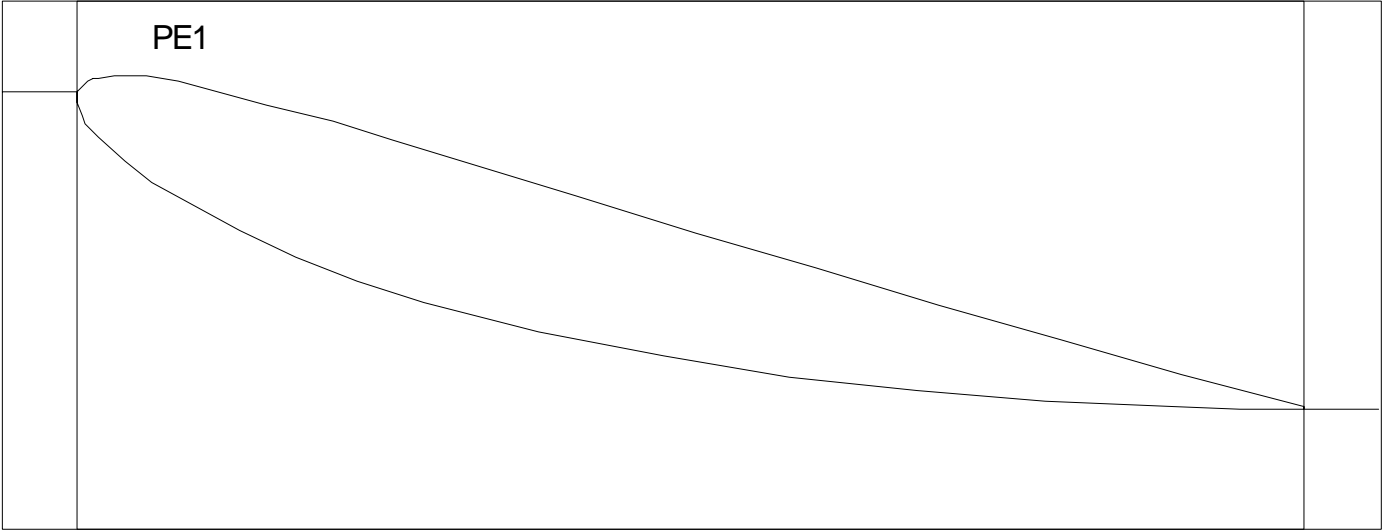

TEMPLATES FOR PERU 3-BLADE DESIGN USING NACA 4415 PROFILE
- 15 STATIONS -

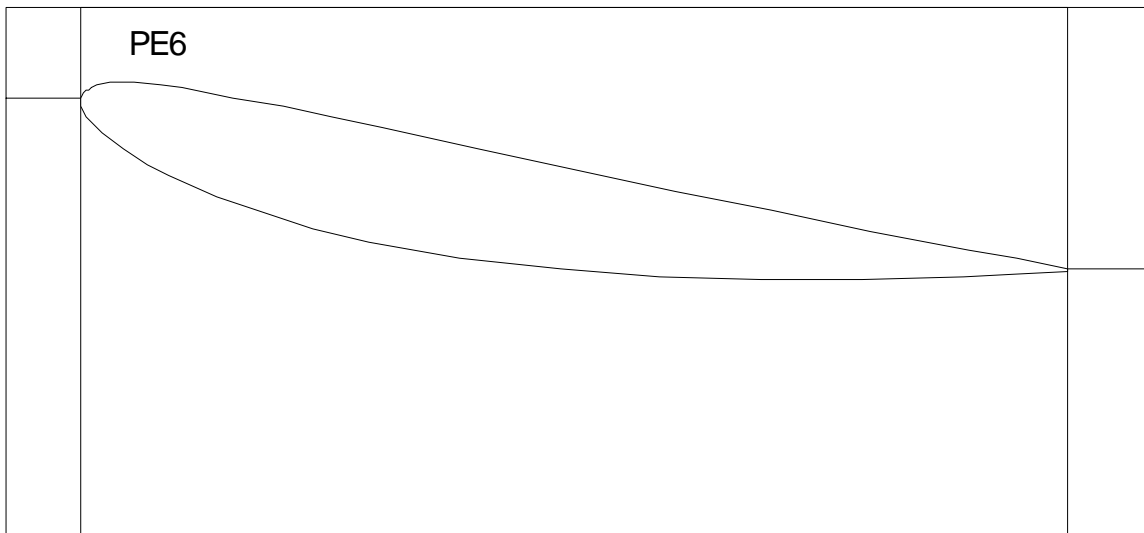
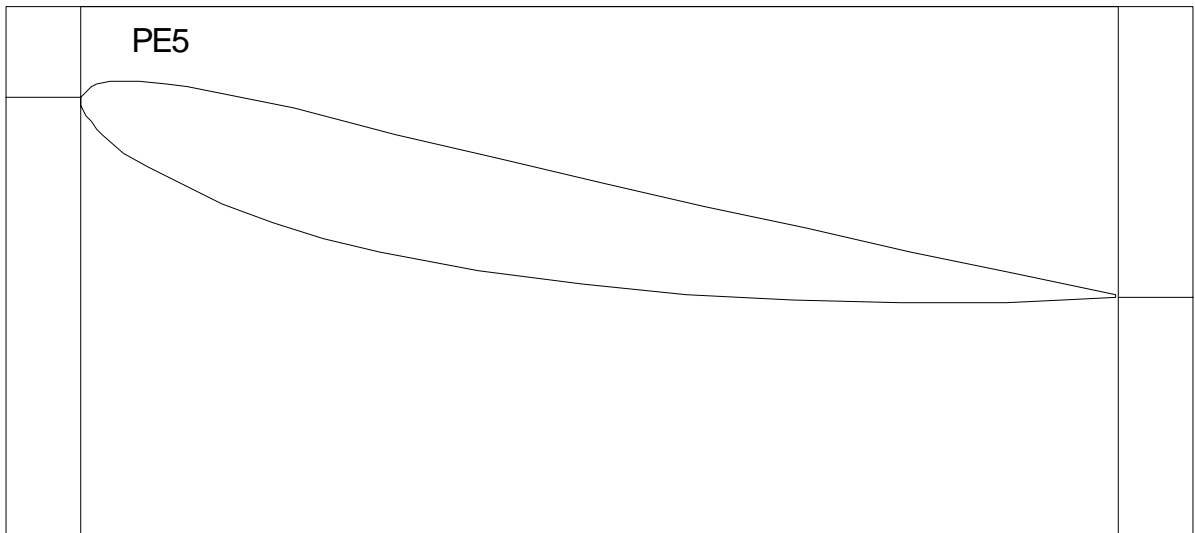
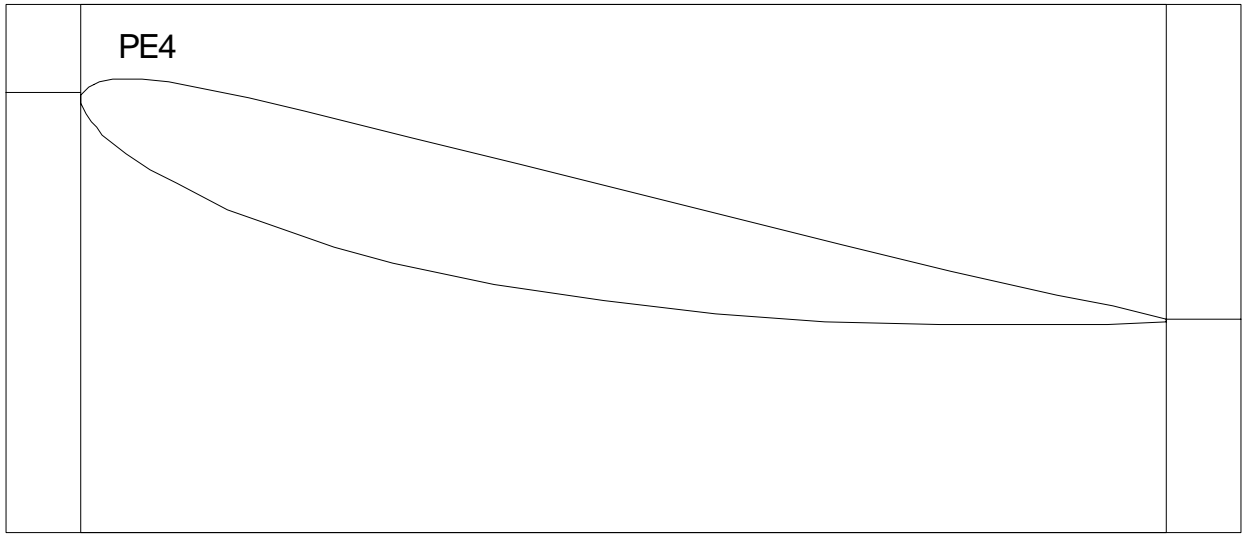

TEMPLATES FOR PERU 3-BLADE DESIGN USING NACA 4415 PROFILE
- 15 STATIONS -

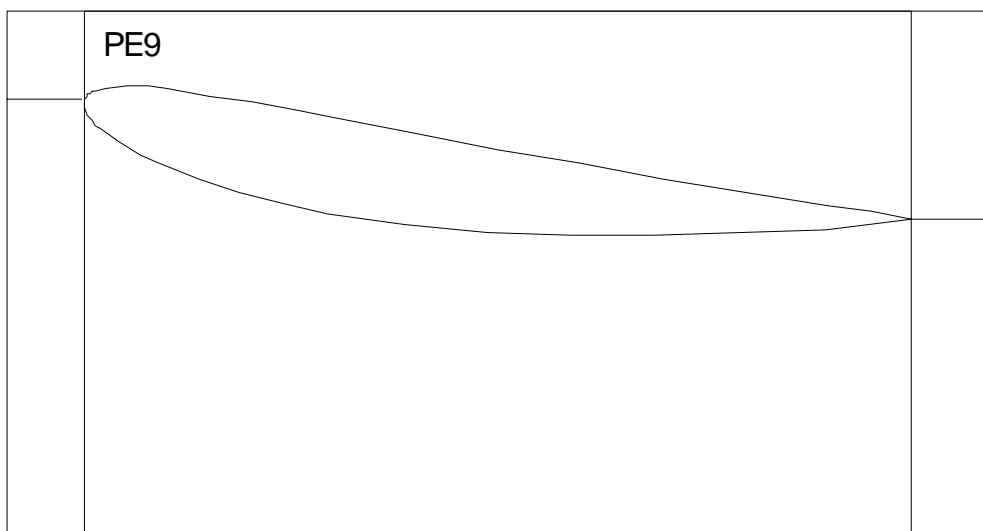
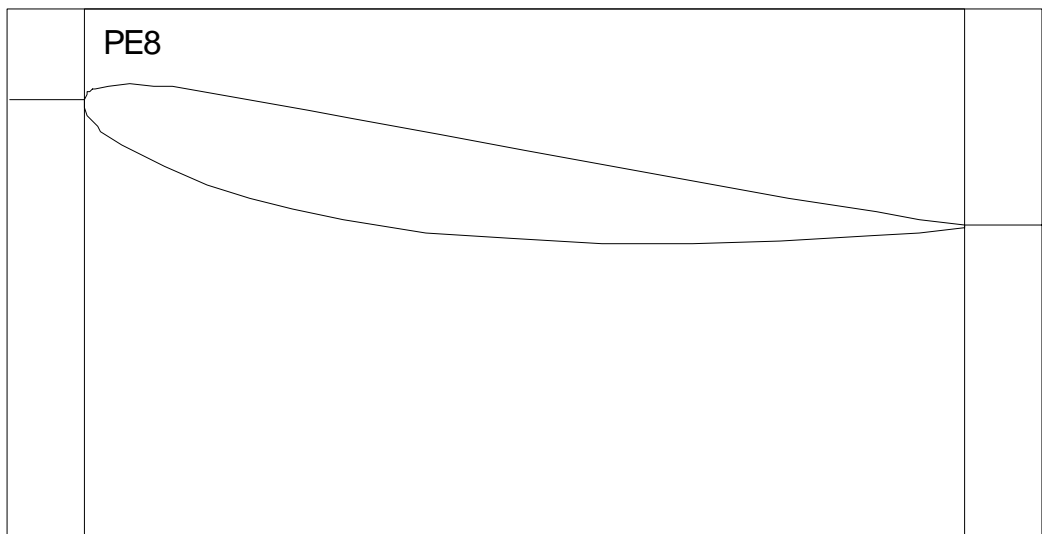
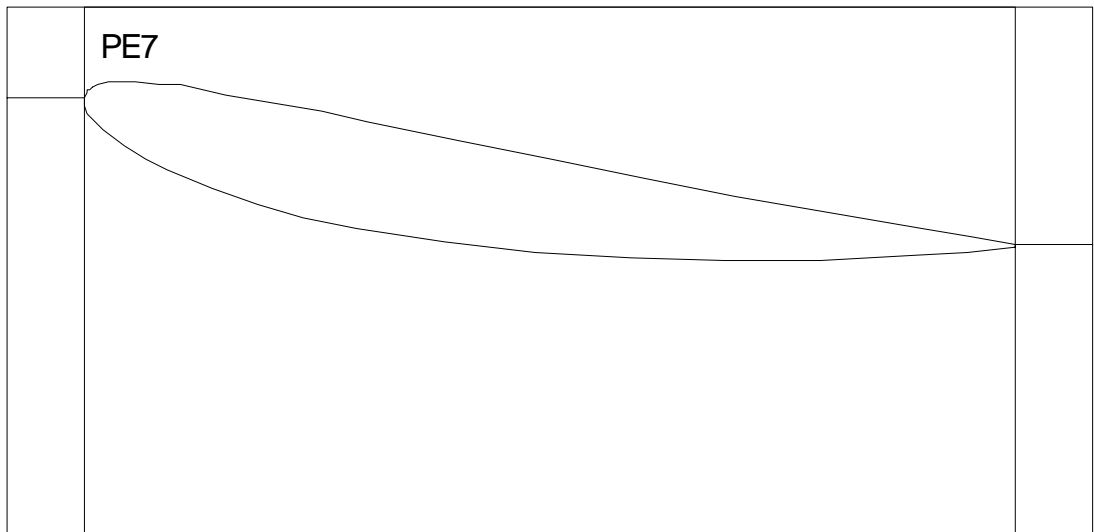

TEMPLATES FOR PERU 3-BLADE DESIGN USING NACA 4415 PROFILE
- 15 STATIONS -

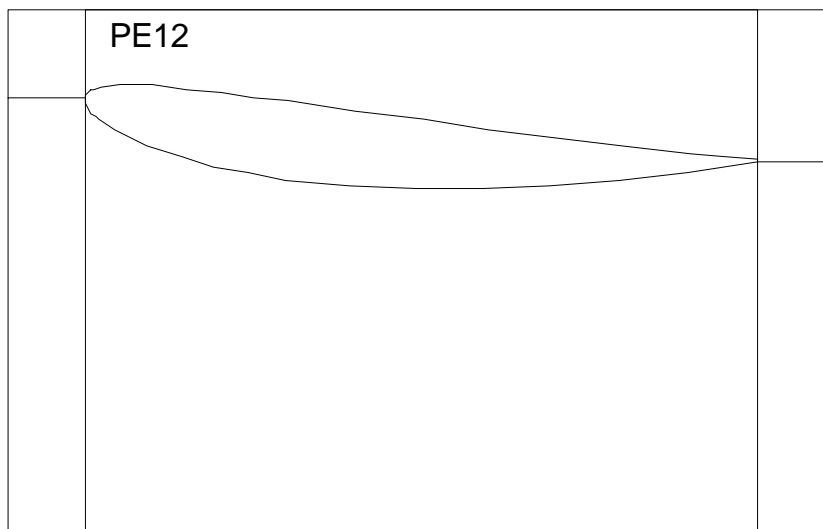
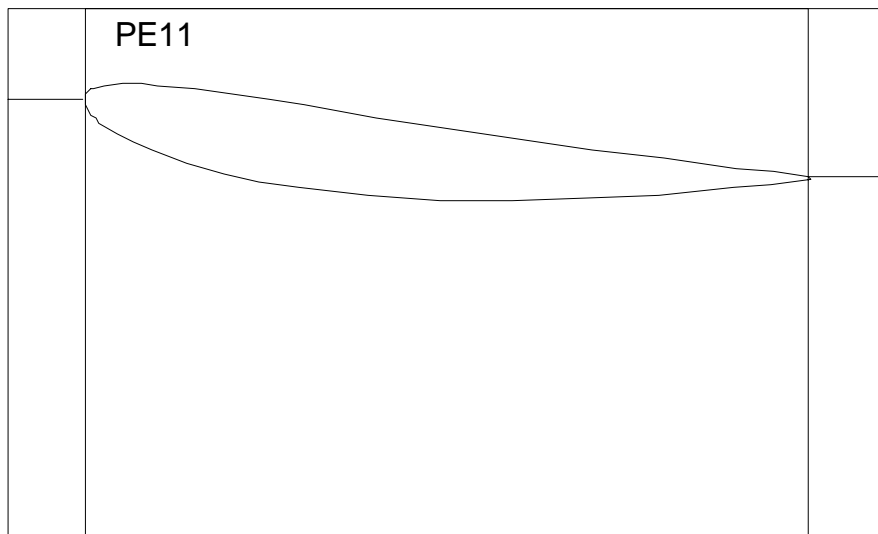
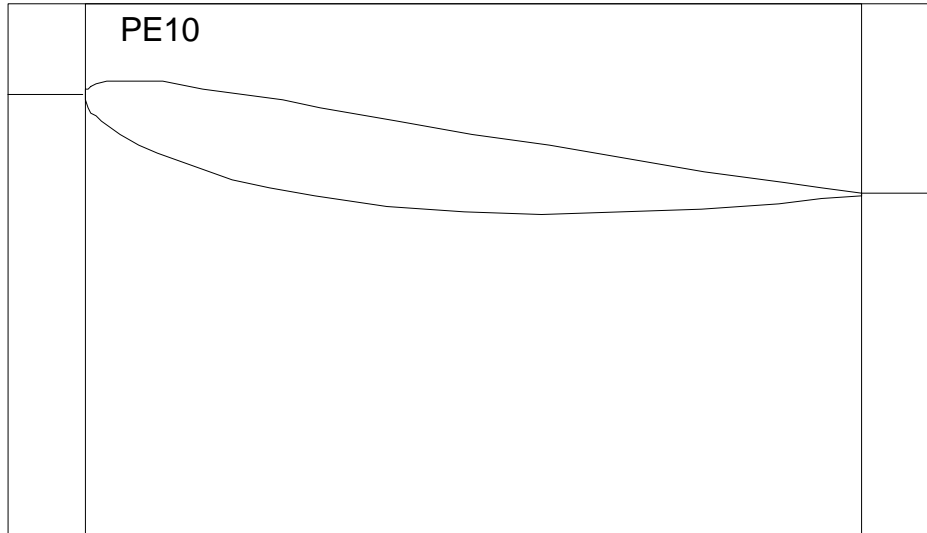

TEMPLATES FOR PERU 3-BLADE DESIGN USING NACA 4415 PROFILE
- 15 STATIONS -

