

Construction of a Simplified Wood Gas Generator for Fueling Internal Combustion Engines in a Petroleum Emergency

2nd Edition by BEF PRESS

by:

H. LaFontaine, Biomass Energy Foundation, Inc.
Miami, Florida

and

F. P. Zimmerman, Oak Ridge National Laboratory, Energy Division

FEMA Interagency Agreement Number: EMW-84-E-1737

Work Unit: 3521D

for:

Federal Emergency Management Agency
Washington, D.C. 20472

"This report has been reviewed in the Federal Emergency Management Agency and approved for publication. Approval does not signify that the contents necessarily reflect the views and policies of the Federal Emergency Management Agency."

Date Published: March 1989

APPROVED FOR PUBLIC RELEASE: DISTRIBUTION UNLIMITED

Prepared by:

Oak Ridge National Laboratory
Oak Ridge, Tennessee 37831-6285
for the U.S. Department of Energy



INTRODUCTION TO 2nd EDITION

This construction manual was prepared by my friend and colleague, Harry LaFontaine for the Federal Emergency Management Agency, FEMA, assisted by F. P. Zimmerman at the Oak Ridge National Laboratory. The justification for writing this report was that in the event of a war or natural emergency, when liquid fuel supplies were interrupted, individuals could build gasifiers to run engines for transport and power. The manual was originally distributed by FEMA. This edition is the first edition by the Biomass Energy Foundation Press.

Harry was uniquely qualified to write this manual because he built and operated gasifiers during World War II during the daytime as a cover for his Danish Underground activities at night. Harry was also very ingenious in working with the people and materials at hand, so that this is a very practical manual. However, in the intervening years he also came to appreciate the fundamentals of gasification and he also explains these here.

It has been a pleasure to know and work with Harry. He was the founder of the Biomass Energy Foundation in 1983. The BEF is a 501 3C not for profit organization established to promote the use of biomass.

It grieves me to say that Harry died (while still in the midst of many projects) on April 12, , 1994. However, this report lives on as a very useful memorial to his life and experience.

Thomas B. Reed

The Biomass Energy Foundation Press

1810 Smith Rd., Golden, CO.

CONTENTS

	Page
EXECUTIVE SUMMARY	v
S.1. PRINCIPLES OF SOLID FUEL GASIFICATION	vi
S.2. THE STRATIFIED, DOWNDRAFT GASIFIER	vi
CONVERSION FACTORS FOR SI UNITS	xiii
LIST OF FIGURES	xv
LIST OF TABLES	xvii
ABSTRACT	1
1. WHAT IS A WOOD GAS GENERATOR AND HOW DOES IT WORK? ...	3
1.1. INTRODUCTION	3
1.2. PRINCIPLES OF SOLID FUEL GASIFICATION	4
1.3. BACKGROUND INFORMATION	5
1.3.1. The World War II, Imbert Gasifier	6
1.3.2. The Stratified, Downdraft Gasifier	7
2. BUILDING YOUR OWN WOOD GAS GENERATOR	13
2.1. BUILDING THE GAS GENERATOR UNIT AND THE FUEL HOPPER	14
2.2. BUILDING THE PRIMARY FILTER UNIT	17
2.3. BUILDING THE CARBURETING UNIT WITH THE AIR AND THROTTLE CONTROLS	19
3. OPERATING AND MAINTAINING YOUR WOOD GAS GENERATOR ...	55
3.1. USING WOOD AS A FUEL	55
3.2. SPECIAL CONSIDERATIONS AND ENGINE MODIFICATIONS ...	55
3.3. INITIAL START-UP PROCEDURE	56
3.4. ROUTINE START-UP PROCEDURE	56
3.5. DRIVING AND NORMAL OPERATION	57
3.6. SHUTTING-DOWN THE GASIFIER UNIT	57
3.7. ROUTINE MAINTENANCE	57
3.7.1 Daily Maintenance	58
3.7.2 Weekly Maintenance (or every 15 hours of operation)	58
3.7.3 Biweekly Maintenance (or every 30 hours of operation)	58
3.8. OPERATING PROBLEMS AND TROUBLE-SHOOTING	58
3.9. HAZARDS ASSOCIATED WITH GASIFIER OPERATION	58
3.9.1. Toxic Hazards	58
3.9.2. Technical Aspects of "Generator Gas Poisoning"	59
3.9.3. Fire Hazard	59
BIBLIOGRAPHY	67

EXECUTIVE SUMMARY

This report is one in a series of emergency technology assessments sponsored by the Federal Emergency Management Agency (FEMA). The purpose of this report is to develop detailed, illustrated instructions for the fabrication, installation, and operation of a biomass gasifier unit (i.e., a "producer gas" generator, also called a "wood gas" generator) which is capable of providing emergency fuel for vehicles, such as tractors and trucks, should normal petroleum sources be severely disrupted for an extended period of time. These instructions have been prepared as a manual for use by any mechanic who is reasonably proficient in metal fabrication or engine repair.

Fuel gas, produced by the reduction of coal and peat, was used for heating as early as 1840 in Europe and by 1884 had been adapted to fuel engines in England. Prior to 1940, gas generator units were a familiar, but not extensively utilized, technology. However, petroleum shortages during World War II led to widespread gas generator applications in the transportation industries of Western Europe. (Charcoal-burning taxis, a related application, were still common in Korea as late as 1970.) The United States, never faced with such prolonged or severe oil shortages, has lagged far behind Europe and the Orient in familiarity with and application of this technology. However, a catastrophic event could disrupt the supply of petroleum in this country so severely that this technology might be critical in meeting the energy needs of some essential economic activities, such as the production and distribution of food.

In occupied Denmark during World War II, 95% of all mobile farm machinery, tractors, trucks, stationary engines, and fishing and ferry boats were powered by wood gas generator units. Even in neutral Sweden, 40% of all motor traffic operated on gas derived from wood or charcoal. All over Europe, Asia, and Australia, millions of gas generators were in operation between 1940 and 1946. Because of the wood gasifier's somewhat low efficiency, the inconvenience of operation, and the potential health risks from toxic fumes, most of such units were abandoned when oil again became available in 1945. Except for the technology of producing alternate fuels, such as methane or alcohol, the only solution for operating existing internal combustion engines, when oil and petroleum products are not available, has been these simple, inexpensive gasifier units.

This report attempts to preserve the knowledge about wood gasification that was put into practical use during World War II. In this report, detailed step-by-step procedures are presented for constructing a simplified version of the World War II wood gas generator; this simple, stratified, downdraft gasifier unit (shown schematically in Fig. S-1) can be constructed from materials which would be widely available in the United States in a prolonged petroleum crisis. For example, the body of the unit consists of a galvanized metal garbage can atop a small metal drum; common plumbing fittings are used throughout; and a large, stainless steel mixing bowl is used for the grate. A prototype gasifier unit was fabricated from these instructions (see Fig. S-2); this unit was then mounted onto the front of a farm tractor and successfully field tested, using wood chips as the only fuel (see Fig. S-3). Photographic documentation of the actual assembly of the unit, as well as its operational field test, is included in the body of this report.

The use of wood gas generators need not be limited to transportation applications. Stationary engines can also be fueled by wood gasifiers to run electric generators, pumps, and industrial equipment. In fact, the use of wood gas as a fuel is not even restricted to

gasoline engines; if a small amount of diesel fuel is used for ignition, a properly adjusted diesel engine can be operated primarily on wood gas introduced through the intake manifold.

S.1. PRINCIPLES OF SOLID FUEL GASIFICATION

All internal combustion engines actually run on vapor, not liquid. The liquid fuels used by gasoline engines are vaporized before they enter the combustion chamber above the pistons. In diesel engines, the fuel is sprayed into the combustion chamber as fine droplets which burn as they vaporize. The purpose of a gasifier, then, is to transform solid fuels into gaseous ones and to keep the gas free of harmful constituents. A gas generator unit is simultaneously an energy converter and a filter. In these twin tasks lie its advantages and its difficulties.

In a sense, gasification is a form of incomplete combustion—heat from the burning solid fuel creates gases which are unable to burn completely because of the insufficient amounts of oxygen from the available supply of air. The same chemical laws which govern combustion processes also apply to gasification. There are many solid biomass fuels suitable for gasification—from wood and paper to peat, lignite, and coal, including coke derived from coal. All of these solid fuels are composed primarily of carbon with varying amounts of hydrogen, oxygen, and impurities, such as sulphur, ash, and moisture. Thus, the aim of gasification is the almost complete transformation of these constituents into gaseous form so that only the ashes and inert materials remain. In creating wood gas for fueling internal combustion engines, it is important that the gas not only be properly produced, but also preserved and not consumed until it is introduced into the engine where it may be appropriately burned.

Gasification is a physiochemical process in which chemical transformations occur along with the conversion of energy. The chemical reactions and thermochemical conversions which occur inside a wood gas generator are too long and too complicated to be covered here; however, such knowledge is not necessary for constructing and operating a wood gasifier. By weight, gas (wood gas) produced in a gasifier unit contains approximately 20% hydrogen (H_2), 20% carbon monoxide (CO), and small amounts of methane, all of which are combustible, plus 50 to 60% nitrogen (N_2). The nitrogen is not combustible; however, it does occupy volume and dilutes the wood gas as it enters and burns in an engine. As the wood gas burns, the products of combustion are carbon dioxide (CO_2) and water vapor (H_2O).

One of the by-products of wood gasification is carbon monoxide, a poisonous gas. The toxic hazards associated with breathing this gas should be avoided during refueling operations or prolonged idling, particularly in inadequately ventilated areas. Except for the obvious fire hazard resulting from the combustion processes inside the unit, carbon monoxide poisoning is the major potential hazard during normal operation of these simplified gasifier units.

S.2 THE STRATIFIED, DOWNDRAFT GASIFIER

Until the early 1980s, wood gasifiers all over the world (including the World War II designs) operated on the principle that both the fuel hopper and the combustion unit be absolutely airtight; the hopper was sealed with a top or lid which had to be opened every time wood was added. Smoke and gas vented into the atmosphere while wood was being loaded; the operator had to be careful not to breathe the unpleasant smoke and toxic fumes.

Over the last few years, a new gasifier design has been developed through cooperative efforts among researchers at the Solar Energy Research Institute in Colorado, the University of California in Davis, the Open University in London, the Buck Rogers Company in Kansas, and the Biomass Energy Foundation, Inc., in Florida. This simplified design employs a balanced, negative-pressure concept in which the old type of sealed fuel hopper is no longer necessary. A closure is only used to preserve the fuel when the engine is stopped. This new technology has several popular names, including "stratified, downdraft gasification" and "open top gasification." Several years of laboratory and field testing have indicated that such simple, inexpensive gasifiers can be built from existing hardware and will perform very well as emergency units.

A schematic diagram of the stratified, downdraft gasifier is shown in Fig. S-1. During operation of this gasifier, air passes uniformly downward through four zones, hence the name "stratified:"

1. The uppermost zone contains unreacted fuel through which air and oxygen enter. This region serves the same function as the fuel hopper in the older, World War II designs.
2. In the second zone, the wood fuel reacts with oxygen during pyrolysis. Most of the volatile components of the fuel are burned in this zone and provide heat for continued pyrolysis reactions. At the bottom of this zone, all of the available oxygen from the air should be completely reacted. The open top design ensures uniform access of air to the pyrolysis region.
3. The third zone is made up of charcoal from the second zone. Hot combustion gases from the pyrolysis region react with the charcoal to convert the carbon dioxide and water vapor into carbon monoxide and hydrogen.
4. The inert char and ash, which constitute the fourth zone, are normally too cool to cause further reactions; however, because the fourth zone is available to absorb heat or oxygen as conditions change, it serves both as a buffer and as a charcoal storage region. Below this zone is the grate. The presence of char and ash serves to protect the grate from excessive temperatures.

The stratified, downdraft design has a number of advantages over the World War II gasifier designs. The open top permits fuel to be fed more easily and allows easy access. The cylindrical shape is easy to fabricate and permits continuous flow of fuel. No special fuel shape or pretreatment is necessary; any blocky fuel can be used.

The foremost question about the operation of the stratified, downdraft gasifier concerns char and ash removal. As the charcoal reacts with the combustion gases, it eventually reaches a very low density and breaks up into a dust containing all of the ash as well as a percentage of the original carbon. This dust may be partially carried away by the gas and might eventually begin to plug the gasifier. Hence, it must be removed by shaking or agitation. When the stratified gasifier unit is used to power vehicles, it is automatically shaken by the vehicle's motion.

An important issue in the design of the stratified, downdraft gasifier is the prevention of fuel bridging and channeling. High-grade biomass fuels, such as wood blocks or chips, will flow down through the gasifier because of gravity and downdraft air flow. However, other fuels (such as shredded chips, sawdust, and bark) can form a bridge, which will obstruct

continuous flow and cause very high temperatures. Bridging can be prevented by stirring, shaking, or by agitating the grate or by having it agitated by the vehicle's movement. For prolonged idling, a hand-operated shaker has been included in the design in this report.

A prototype unit of the stratified, downdraft gasifier design (see Figs. S-2 and S-3) has been fabricated according to the instructions in this report; however, it has not been widely tested at this time. The reader is urged to use his ingenuity and initiative in constructing his own wood gas generator. As long as the principle of airtightness in the combustion regions, in the connecting piping, and in the filter units is followed, the form, shape, and method of assembly is not important.

The wood gasifier design presented in this report has as its origin the proven technology used in World War II during actual shortages of gasoline and diesel fuel. It should be acknowledged that there are alternate technologies (such as methane production or use of alcohol fuels) for keeping internal combustion engines in operation during a prolonged petroleum crisis; the wood gasifier unit described in this report represents only one solution to the problem.

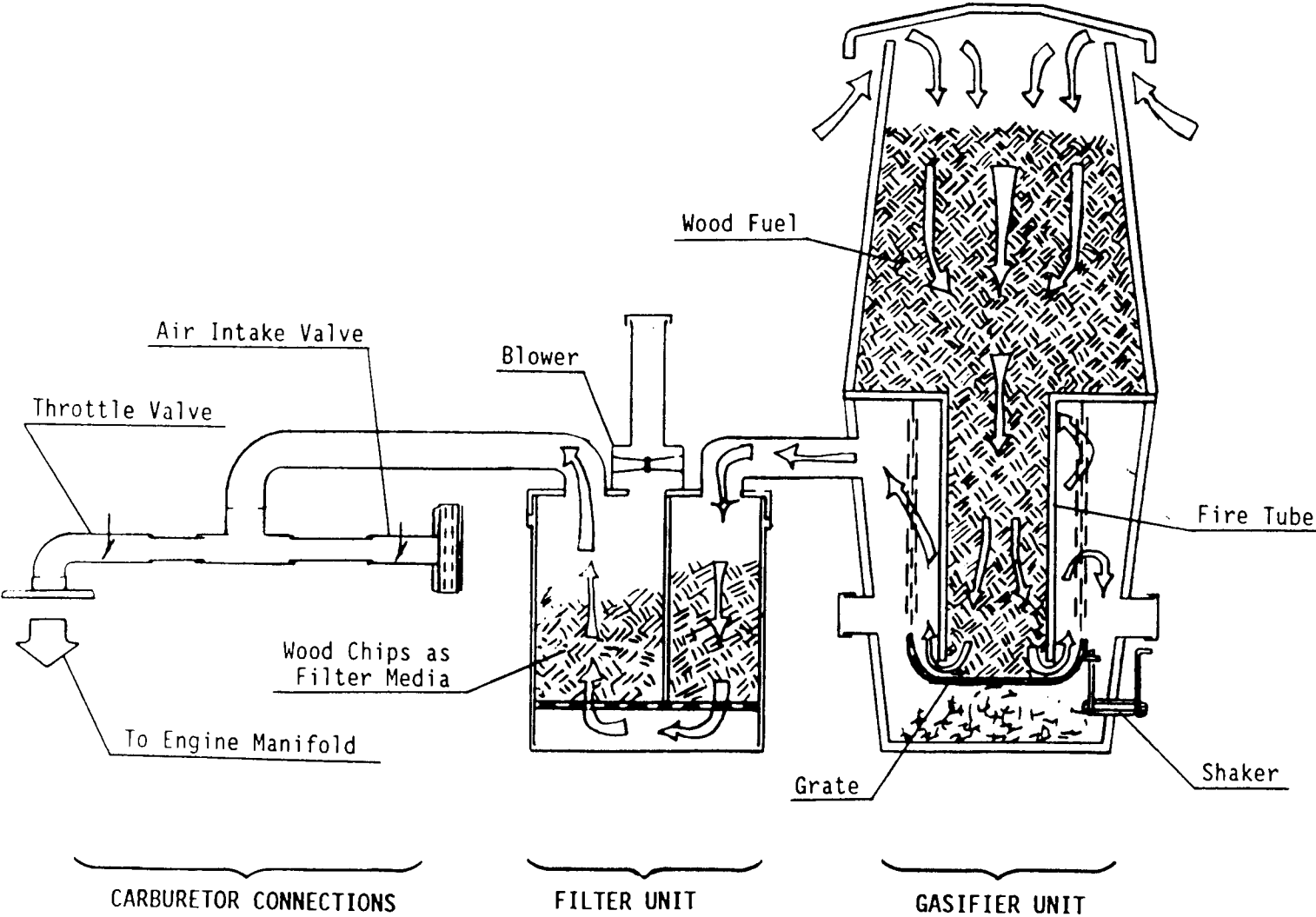

Fig. S-1. Schematic view of the stratified, downdraft gasifier.

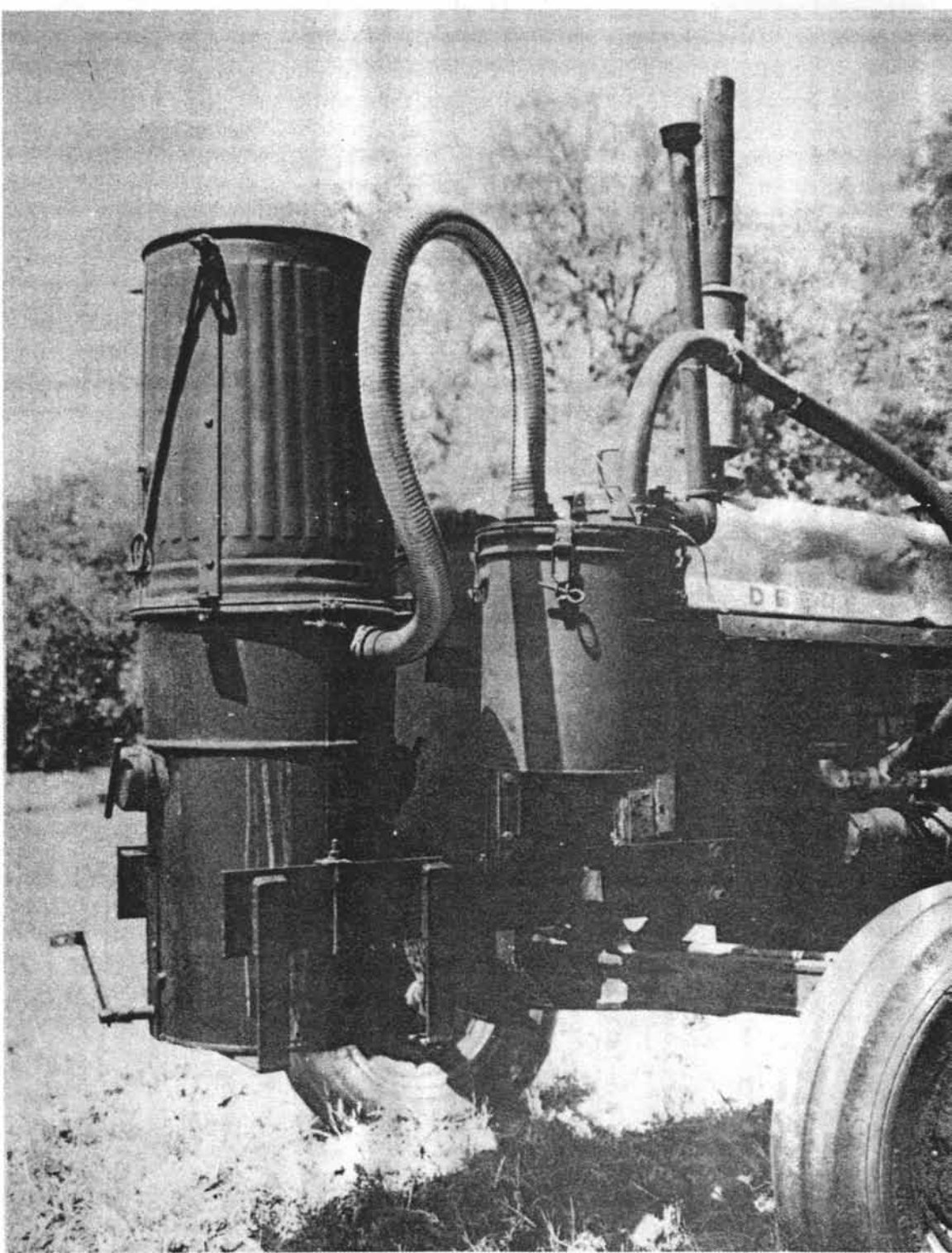

Fig. S-2. The prototype wood gas generator unit mounted onto a tractor.



Fig. S-3. Wood gas generator unit in operation during field testing.

CONVERSION FACTORS FOR SI UNITS

English units have been retained in the body of this report. The report refers to commercially available materials and sizes which are commonly expressed in English units. The conversion factors for SI units are given below:

<u>To convert from</u>	<u>To</u>	<u>Multiply by</u>
cubic feet (ft ³)	cubic meters (m ³)	0.0283
cubic yards (yd ³)	cubic meters (m ³)	0.7646
Fahrenheit degrees (°F)	Kelvin degrees (°K)	(see Note 1)
foot (ft)	meter (m)	0.3048
gallon (gal)	cubic meters (m ³)	3.785 X 10 ⁻³
horsepower (hp)	watt (W)	745.7
inch (in.)	meter (m)	0.0254
pound (lb)	kilogram (kg)	0.4536
quart (qt.)	cubic meters (m ³)	9.464 X 10 ⁻⁴

Note 1: To convert temperatures, use the following equation,

$$K = 273 + 0.5556 \times (F - 32) ,$$

where

F is the temperature in Fahrenheit degrees, and

K is the temperature in Kelvin degrees.

LIST OF FIGURES

Fig. S-1.	Schematic view of the stratified, downdraft gasifier	ix
Fig. S-2.	The prototype wood gas generator unit mounted onto a tractor	x
Fig. S-3.	Wood gas generator unit in operation during field testing	xi
Fig. 1-1.	Wood gas generator unit in operation during field testing	9
Fig. 1-2.	Schematic view of the World War II, Imbert gasifier	10
Fig. 1-3.	Schematic view of the stratified, downdraft gasifier	11
Fig. 2-1.	The prototype wood gas generator unit mounted onto a tractor	22
Fig. 2-2.	Exploded, schematic diagram of the wood gas generator unit and the fuel hopper	23
Fig. 2-3.	The fire tube and circular top plate of the gasifier unit	24
Fig. 2-4.	Drilling holes into the stainless steel mixing bowl to be used for the grate	25
Fig. 2-5.	Chains attached to the lip of the stainless steel mixing bowl	26
Fig. 2-6.	Connect the mixing bowl to the top plate with chains	27
Fig. 2-7.	Braze, <u>do not weld</u> , the plumbing fittings to the thin walled drums	28
Fig. 2-8.	Exploded, schematic diagram of the grate shaking mechanism	29
Fig. 2-9.	Parts for the shaker assembly	30
Fig. 2-10.	The support frame can be brazed or bolted to the side of the gasifier unit	31
Fig. 2-11.	Containers used in constructing the prototype gasifier unit	32
Fig. 2-12.	Cover for the fuel hopper.	33
Fig. 2-13.	Operating configuration of the fuel hopper and its cover	34
Fig. 2-14.	Lock ring and welded tabs	35
Fig. 2-15.	Exploded, schematic diagram of the filter unit	36
Fig. 2-16.	Detail of the standoffs for the bottom plate of the filter unit	37
Fig. 2-17.	Divider plate (#1) and bottom plate (#3), with standoffs (#4), for the filter unit	38
Fig. 2-18.	Circular lid (#1) for the filter unit	39
Fig. 2-19.	Blower (#1) with exhaust extension assembly	40
Fig. 2-20.	Assembled and installed blower (#1), extension assembly (#4), and conduit connectors for gas inlet (#2) and outlet (#3) on lid of filter unit	41
Fig. 2-21.	Filter container (#1) showing latches (#2) for lid and hose (#3) around top	42
Fig. 2-22.	Exploded, schematic diagram of the carbureting unit and control valves	43
Fig. 2-23.	Schematic diagram of a butterfly control valve.	44
Fig. 2-24.	Parts required for the butterfly valve	45
Fig. 2-25.	Butterfly valve assembly	46
Fig. 2-26.	Assembled butterfly valves	47
Fig. 2-27.	Assembled carburetion unit	48

LIST OF FIGURES (continued)

Fig. 2-28.	Carburetion unit attached to engine's existing intake manifold	49
Fig. 3-1.	Virtually all varieties of wood chips can be used for fuel	60
Fig. 3-2.	Ignite a single piece of newspaper to start the gasifier unit; push the flaming newspaper through the ignition port and directly into the grate	61
Fig. 3-3.	Igniting the exhaust gas will demonstrate that the gasifier unit is working properly	62
Fig. 3-4.	Refill the fuel hopper before it becomes two-thirds empty	63
Fig. 3-5.	The lid must be used to cover the fuel hopper in wet weather or when shutting the unit down	64

LIST OF TABLES

Table 2-1.	List of materials for the gasifier unit and the wood fuel hopper	50
Table 2-2.	Fire tube dimensions	52
Table 2-3.	List of materials for the primary filter unit	53
Table 2-4.	List of materials for the carbureting unit	54
Table 3-1.	Trouble-shooting your wood gas generator	65
Table 3-2.	Effects of breathing carbon monoxide	66

CONSTRUCTION OF A SIMPLIFIED WOOD GAS GENERATOR FOR FUELING INTERNAL COMBUSTION ENGINES IN A PETROLEUM EMERGENCY

H. LaFontaine
G. P. Zimmerman

ABSTRACT

This report is one in a series of emergency technology assessments sponsored by the Federal Emergency Management Agency (FEMA). The purpose of this report is to develop detailed, illustrated instructions for the fabrication, installation, and operation of a biomass gasifier unit (i.e., a "producer gas" generator, also called a "wood gas" generator) that is capable of providing emergency fuel for vehicles, such as tractors and trucks, in the event that normal petroleum sources were severely disrupted for an extended period of time. These instructions have been prepared as a manual for use by any mechanic who is reasonably proficient in metal fabrication or engine repair.

This report attempts to preserve the knowledge about wood gasification that was put into practical use during World War II. Detailed, step-by-step fabrication procedures are presented for a simplified version of the World War II, Imbert wood gas generator. This simple, stratified, downdraft gasifier unit can be constructed from materials that would be widely available in the United States in a prolonged petroleum crisis. For example, the body of the unit consists of a galvanized metal garbage can atop a small metal drum; common plumbing fittings throughout; and a large, stainless steel mixing bowl for the grate. The entire compact unit was mounted onto the front of a farm tractor and successfully field tested, using wood chips as the only fuel. Photographic documentation of the actual assembly of the unit as well as its operation is included.

1. WHAT IS A WOOD GAS GENERATOR AND HOW DOES IT WORK?

This report is one in a series of emergency technology assessments sponsored by the Federal Emergency Management Agency (FEMA). The purpose of this report is to develop detailed, illustrated instructions for the fabrication, installation, and operation of a biomass gasifier unit (i.e., a "producer gas" generator, also called a "wood gas" generator) that is capable of providing emergency fuel for vehicles, such as tractors and trucks, in the event that normal petroleum sources were severely disrupted for an extended period of time. These instructions have been prepared as a manual for use by any mechanic who is reasonably proficient in metal fabrication or engine repair.

1.1 INTRODUCTION

Fuel gas, produced by the reduction of coal and peat, was used for heating, as early as 1840 in Europe, and by 1884 it had been adapted to fuel engines in England. Before 1940, gas generator units were a familiar, but not extensively utilized, technology. However, petroleum shortages during World War II led to widespread gas generator applications in the transportation industries of Western Europe. (Charcoal-burning taxis, a related application, were still common in Korea as late as 1970.) The United States, never faced with such prolonged or severe oil shortages, has lagged far behind Europe and the Orient in familiarity with and application of this technology; however, a catastrophe could so severely disrupt the supply of petroleum in this country that this technology might be critical in meeting the energy needs of some essential economic activities, such as the production and distribution of food.

This report attempts to preserve the knowledge about wood gasification as put into practical use during World War II. Detailed, step-by-step procedures are presented in this report for constructing a simplified version of the World War II, Imbert wood gas generator. This simple, stratified, downdraft gasifier unit can be constructed from materials that would be widely available in the United States in a prolonged petroleum crisis. For example, the body of the unit consists of a galvanized metal garbage can atop a small metal drum; common plumbing fittings throughout; and a large, stainless steel mixing bowl for the grate. A prototype gasifier unit was fabricated from these instructions. This unit was then mounted onto the front of a gasoline-engine farm tractor and successfully field tested, using wood chips as the only fuel; see Fig. 1-1 (all figures and tables are presented at the end of their respective sections). Photographic documentation of the actual assembly of the unit, as well as its operational field test, is included in this report.

The use of wood gas generators need not be limited to transportation applications. Stationary engines can also be fueled by wood gasifiers to run electric generators, pumps, and industrial equipment. In fact, the use of wood gas as a fuel is not even restricted to gasoline engines; if a small amount of diesel fuel is used for ignition, a properly adjusted diesel engine can be operated primarily on wood gas introduced through the intake manifold. However, this report is concerned with the operation of four-cycle gasoline engines rated from 10 to 150 horsepower. If more information is needed about operating gasifiers on other

fuels (such as coal, charcoal, peat, sawdust or seaweed), a list of relevant literature is contained in the Bibliography at the end of this report.

The goal of this report is to furnish information for building a homemade wood gas generator made out of ordinary, available hardware, in order to get tractors, trucks, and other vehicles operating without delay, if a severe liquid fuel emergency should arise. Section 1 describes gasification principles and wood gas generators, in general, and gives some historical background about their operation and effectiveness. Section 2 contains detailed step-by-step instructions for constructing your own wood gas generator unit; illustrations and photographs are included to prevent confusion. Section 3 contains information on operating, maintaining, and trouble-shooting your wood gas generator; also included are some very important guidelines on safety when using your gasifier system.

The wood gasifier design presented in this report has as its origin the proven technology used in World War II during actual shortages of gasoline and diesel fuel. It should be acknowledged that there are alternate technologies (such as methane production or use of alcohol fuels) for keeping internal combustion engines in operation during a prolonged petroleum crisis; the wood gasifier unit described in this report represents only one solution to the problem.

1.2 PRINCIPLES OF SOLID FUEL GASIFICATION

All internal combustion engines actually run on vapor, not liquid. The liquid fuels used in gasoline engines are vaporized before they enter the combustion chamber above the pistons. In diesel engines, the fuel is sprayed into the combustion chamber as fine droplets which burn as they vaporize. The purpose of a gasifier, then, is to transform solid fuels into gaseous ones and to keep the gas free of harmful constituents. A gas generator unit is, simultaneously, an energy converter and a filter. In these twin tasks lie its advantages and its difficulties.

The first question many people ask about gasifiers is, "Where does the combustible gas come from?" Light a wooden match; hold it in a horizontal position; and notice that while the wood becomes charcoal, it is not actually burning but is releasing a gas that begins to burn brightly a short distance away from the matchstick. Notice the gap between the matchstick and the luminous flame; this gap contains the wood gas which starts burning only when properly mixed with air (which contains oxygen). By weight, this gas (wood gas) from the charring wood contains approximately 20% hydrogen (H_2), 20% carbon monoxide (CO), and small amounts of methane, all of which are combustible, plus 50 to 60% nitrogen (N_2). The nitrogen is not combustible; however, it does occupy volume and dilutes the wood gas as it enters and burns in an engine. As the wood gas burns, the products of combustion are carbon dioxide (CO_2) and water vapor (H_2O).

The same chemical laws which govern combustion processes also apply to gasification. The solid, biomass fuels suitable for gasification cover a wide range, from wood and paper to peat, lignite, and coal, including coke derived from coal. All of these solid fuels are composed primarily of carbon with varying amounts of hydrogen, oxygen, and impurities, such as sulphur, ash, and moisture. Thus, the aim of gasification is the almost complete transformation of these constituents into gaseous form so that only the ashes and inert materials remain.

In a sense, gasification is a form of incomplete combustion; heat from the burning solid fuel creates gases which are unable to burn completely, due to insufficient amounts of

oxygen from the available supply of air. In the matchstick example above, as the wood was burned and pyrolyzed into charcoal, wood gas was created, but the gas was also consumed by combustion (since there was an enormous supply of air in the room). In creating wood gas for fueling internal combustion engines, it is important that the gas not only be properly produced, but also preserved and not consumed until it is introduced into the engine where it may be appropriately burned.

Gasification is a physiochemical process in which chemical transformations occur along with the conversion of energy. The chemical reactions and thermochemical conversions which occur inside a wood gas generator are too long and too complicated to be covered here. Such knowledge is not necessary for constructing and operating a wood gasifier. Books with such information are listed in the Reference Section (see, for example, Reed 1979, Vol. II; or Reed and Das 1988).

1.3 BACKGROUND INFORMATION

The use of wood to provide heat is as old as mankind; but by burning the wood we only utilize about one-third of its energy. Two-thirds is lost into the environment with the smoke. Gasification is a method of collecting the smoke and its combustible components. Making a combustible gas from coal and wood began around 1790 in Europe. Such manufactured gas was used for street lights and was piped into houses for heating, lighting, and cooking. Factories used it for steam boilers, and farmers operated their machinery on wood gas and coal gas. After the discovery of large petroleum reserves in Pennsylvania in 1859, the entire world changed to oil—a cheaper and more convenient fuel. Thousands of gas works all over the world were eventually dismantled.

Wood gas generators are not technological marvels that can totally eliminate our current dependence on oil, reduce the impacts of an energy crunch, or produce long-term economic relief from high fossil fuel prices, but they are a proven emergency solution when such fuels become unobtainable in case of war, civil upheaval, or natural disaster. In fact, many people can recall a widespread use of wood gas generators during World War II, when petroleum products were not available for the civilian populations in many countries. Naturally, the people most affected by oil and petroleum scarcity made the greatest advancements in wood gas generator technology.

In occupied Denmark during World War II, 95% of all mobile farm machinery, tractors, trucks, stationary engines, fishing and ferry boats were powered by wood gas generators. Even in neutral Sweden, 40% of all motor traffic operated on gas derived from wood or charcoal (Reed and Jantzen 1979). All over Europe, Asia, and Australia, millions of gas generators were in operation between 1940 and 1946. Because of the wood gasifier's somewhat low efficiency, the inconvenience of operation, and the potential health risks from toxic fumes, most of such units were abandoned when oil again became available in 1945. Except for the technology of producing alternate fuels, such as methane or alcohol, the only solution for operating existing internal combustion engines, when oil and petroleum products are not available, has been these simple, inexpensive gasifier units.

1.3.1 The World War II, Imbert Gasifier

The basic operation of two gasifiers is described in this and the following section. Their operating advantages and disadvantages will also be discussed. This information is included for the technically interested reader only; it is intended to give the reader more insight into the subtleties of the operating principles of the wood gas generator described in this manual. Those readers who are anxious to begin construction of their own wood gas generator may skip the material below and proceed directly to Sect. 2 without any loss of continuity.

The constricted hearth, downdraft gasifier shown in Fig. 1-2 is sometimes called the "Imbert" gasifier after its inventor, Jacques Imbert; although, it has been commercially manufactured under various names. Such units were mass produced during World War II by many European automotive companies, including General Motors, Ford, and Mercedes-Benz. These units cost about \$1500 (1985 evaluation) each. However, after World War II began in 1939, it took six to eight months before factory-made gasifiers were generally available. Thousands of Europeans were saved from certain starvation by home-built, simple gasifier units made from washing machine tubs, old water heaters, and metal gas or oxygen cylinders. Surprisingly, the operation of these units was nearly as efficient as the factory-made units; however, the homemade units lasted for only about 20,000 miles with many repairs, while the factory-made units operated, with few repairs, up to 100,000 miles.

In Fig. 1-2, the upper cylindrical portion of the gasifier unit is simply a storage bin or hopper for wood chips or other biomass fuel. During operation, this chamber is filled every few hours as needed. The spring-loaded, airtight cover must be opened to refill the fuel hopper; it must remain closed and sealed during gasifier operation. The spring permits the cover to function as a safety valve because it will pop open in case of any excessive internal gas pressure.

About one-third of the way up from the bottom of the gasifier unit, there is a set of radially directed air nozzles; these allow air to be injected into the wood as it moves downward to be gasified. In a gas generator for vehicle use, the downstroke of the engine's pistons creates the suction force which moves the air into and through the gasifier unit; during startup of the gasifier, a blower is used to create the proper airflow. The gas is introduced into the engine and consumed a few seconds after it is made. This gasification method is called "producer gas generation," because no storage system is used; only that amount of gas demanded by the engine is produced. When the engine is shut off, the production of gas stops.

During normal operation, the incoming air burns and pyrolyzes some of the wood, most of the tars and oils, and some of the charcoal that fills the constricted area below the nozzles. Most of the fuel mass is converted to gas within this combustion zone. The Imbert gasifier is, in many ways, self-adjusting. If there is insufficient charcoal at the air nozzles, more wood is burned and pyrolyzed to make more charcoal. If too much charcoal forms, then the charcoal level rises above the nozzles, and the incoming air burns the charcoal. Thus, the combustion zone is maintained very close to the nozzles.

Below this combustion zone, the resulting hot combustion gases—carbon dioxide (CO_2) and water vapor (H_2O)—pass into the hot charcoal where they are chemically reduced to combustible fuel gases: carbon monoxide (CO) and hydrogen (H_2). The hearth constriction causes all gases to pass through the reaction zone, thus giving maximum mixing and minimum heat loss. The highest temperatures are reached in this region.

Fine char and ash dust can eventually clog the charcoal bed and will reduce the gas flow unless the dust is removed. The charcoal is supported by a movable grate which can be

shaken at intervals. Ash buildup below the grate can be removed during cleaning operations. Usually, wood contains less than 1% ash (by weight). However, as the charcoal is consumed, it eventually collapses to form a powdery charcoal/ash mixture which may represent 2 to 10% (by weight) of the total fuel mass.

The cooling unit required for the Imbert gasifier consists of a water-filled precipitating tank and an automotive radiator-type gas cooler. The precipitating tank removes all unacceptable tars and most of the fine ash from the gas flow, while the radiator further cools the gas. A second filter unit, containing a fine-mesh filtration material, is used to remove the last traces of any ash or dust that may have survived passage through the cooling unit. Once out of the filter unit, the wood gas is mixed with air in the vehicle's carburetor and is then introduced directly into the engine's intake manifold.

The World War II, Imbert gasifier requires wood with a low moisture content (less than 20% by weight) and a uniform, blocky fuel in order to allow easy gravity feed through the constricted hearth. Twigs, sticks, and bark shreds cannot be used. The constriction at the hearth and the protruding air nozzles present obstructions to the passage of the fuel and may create bridging and channeling followed by poor quality gas output, as unpyrolyzed fuel falls into the reaction zone. The vehicle units of the World War II era had ample vibration to jar the carefully sized wood blocks through the gasifier. In fact, an entire industry emerged for preparing wood for use in vehicles at that time (Reed and Jantzen 1979). However, the constricted hearth design seriously limits the range of wood fuel shapes that can be successfully gasified without expensive cubing or pelletizing pretreatment. It is this limitation that makes the Imbert gasifier less flexible for emergency use.

In summary, the World War II Imbert gasifier design has stood the test of time and has successfully been mass produced. It is relatively inexpensive, uses simple construction materials, is easy to fabricate, and can be operated by motorists with a minimum amount of training.

1.3.2 The Stratified, Downdraft Gasifier

Until the early 1980s, wood gasifiers all over the world (including the World War II designs) operated on the principle that both the fuel hopper and the combustion unit be airtight; the hopper was sealed with a top or lid that had to be opened every time wood was added. Smoke and gas vented into the atmosphere while new wood was being loaded; the operator had to be careful not to breathe the unpleasant smoke and toxic fumes.

Over the last few years, a new gasifier design has been developed through cooperative efforts among researchers at the Solar Energy Research Institute in Colorado, the University of California in Davis, the Open University in London, the Buck Rogers Company in Kansas, and the Biomass Energy Foundation, Inc., in Florida (Reed and Das 1988). This simplified design employs a balanced, negative-pressure concept in which the old type of sealed fuel hopper is no longer necessary. A closure is only used to preserve the fuel when the engine is stopped. This new technology has several popular names, including "stratified, downdraft gasification" and "open top gasification." Two years of laboratory and field testing have indicated that such simple, inexpensive gasifiers can be built from existing hardware and will perform very well as emergency units.

A schematic diagram of the stratified, downdraft gasifier is shown in Fig. 1-3. During operation of this gasifier, air passes uniformly downward through four zones, hence the name "stratified:"

1. The uppermost zone contains unreacted fuel through which air and oxygen enter. This region serves the same function as the fuel hopper in the Imbert design.
2. In the second zone, the wood fuel reacts with oxygen during pyrolysis. Most of the volatile components of the fuel are burned in this zone and provide heat for continued pyrolysis reactions. At the bottom of this zone, all of the available oxygen from the air has completely reacted. The open top design ensures uniform access of air to the pyrolysis region.
3. The third zone is made up of charcoal from the second zone. Hot combustion gases from the pyrolysis region react with the charcoal to convert the carbon dioxide and water vapor into carbon monoxide and hydrogen.
4. The inert char and ash, which constitute the fourth zone, are normally too cool to cause further reactions; however, since the fourth zone is available to absorb heat or oxygen as conditions change, it serves both as a buffer and as a charcoal storage region. Below this zone is the grate. The presence of char and ash serves to protect the grate from excessive temperatures.

The stratified, downdraft design has a number of advantages over the World War II, Imbert gasifier. The open top permits fuel to be fed more easily and allows easy access. The cylindrical shape is easy to fabricate and permits continuous flow of fuel. No special fuel shape or pretreatment is necessary; any blocky fuel can be used.

The foremost question about the operation of the stratified, downdraft gasifier concerns char and ash removal. As the charcoal reacts with the combustion gases, it eventually reaches a very low density and breaks up into a dust containing all of the ash as well as a percentage of the original carbon. This dust may be partially carried away by the gas; however, it might eventually begin to plug the gasifier, and so it must be removed by shaking or agitation. Both the Imbert gasifiers and the stratified concept have a provision for shaking the grate; when they are used to power vehicles, they are automatically shaken by the vehicle's motion.

An important issue in the design of the stratified, downdraft gasifier is the prevention of fuel bridging and channeling. High-grade biomass fuels such as wood blocks or chips will flow down through the gasifier under the influence of gravity, and downdraft air flow. However, other fuels (such as shredded wood, sawdust, and bark) can form a bridge that will prevent continuous flow and cause very high temperatures. Obviously, it is desirable to use these widely available biomass residues. Bridging can be prevented by stirring, shaking, or by agitating the grate or by having it agitated by the vehicle's movement. For prolonged idling, a hand-operated shaker has been included in the design.

A prototype design of the stratified, downdraft gasifier design has been developed. The detailed but simple design is described and illustrated in Sect. 2; however, it has not been widely tested at this time. The reader is urged to use his ingenuity and initiative in constructing his own wood gas generator. As long as the principle of airtightness in the combustion regions, in the connecting piping, and in the filter units is followed, the form, shape, and method of assembly is not important.

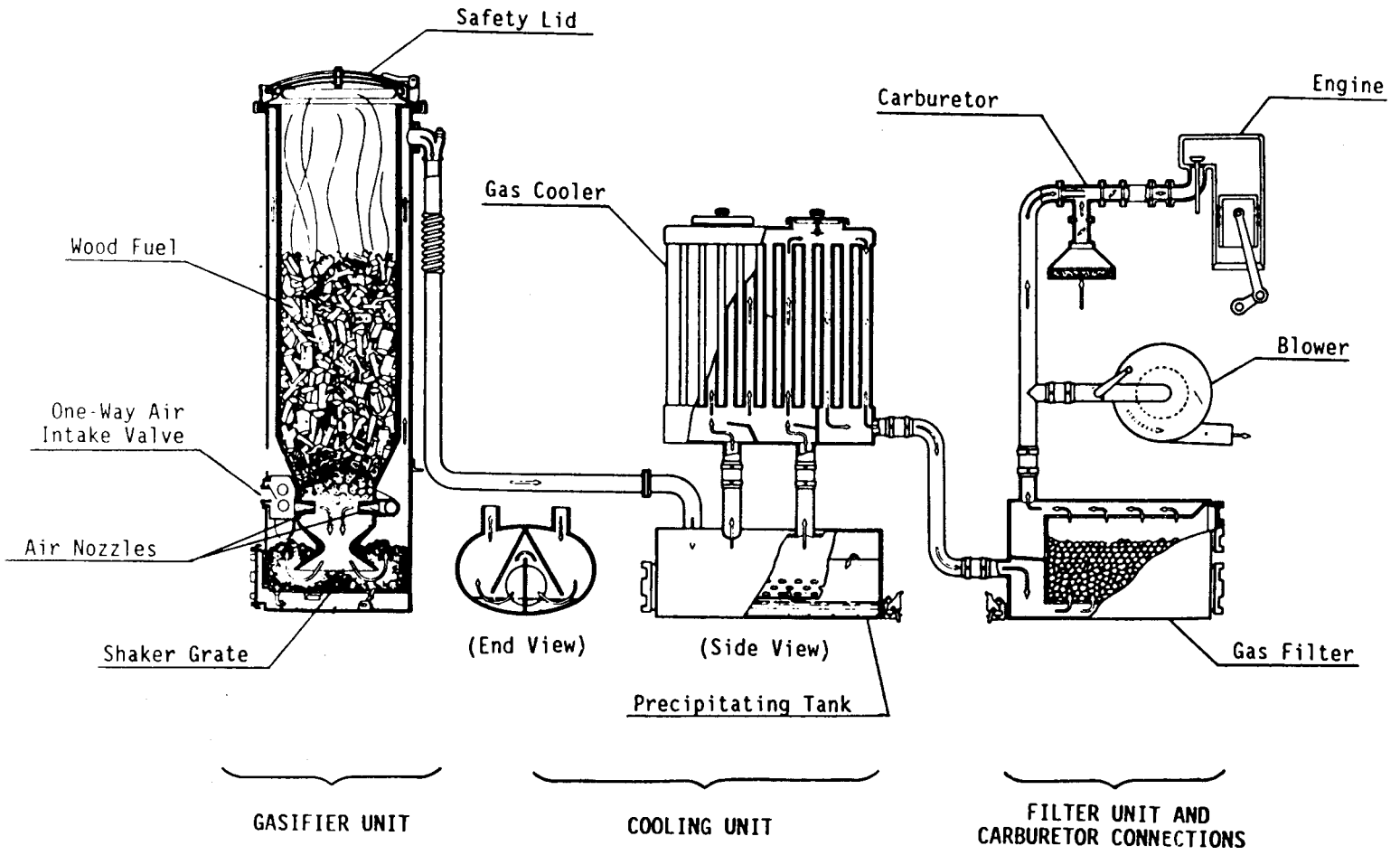

Fig. 1-2. Schematic view of the World War II, Imbert gasifier.

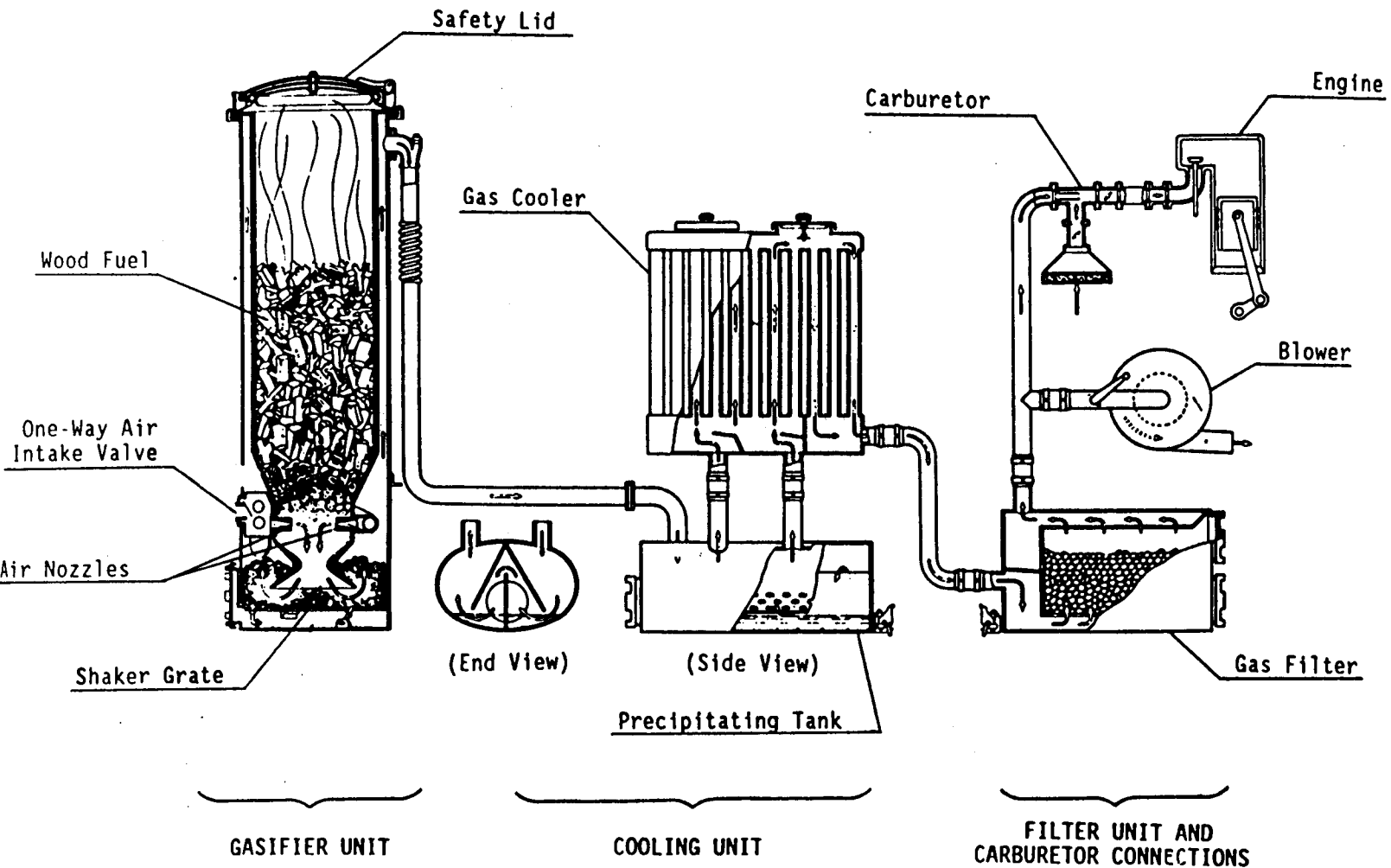

Fig. 1-2. Schematic view of the World War II, Imbert gasifier.

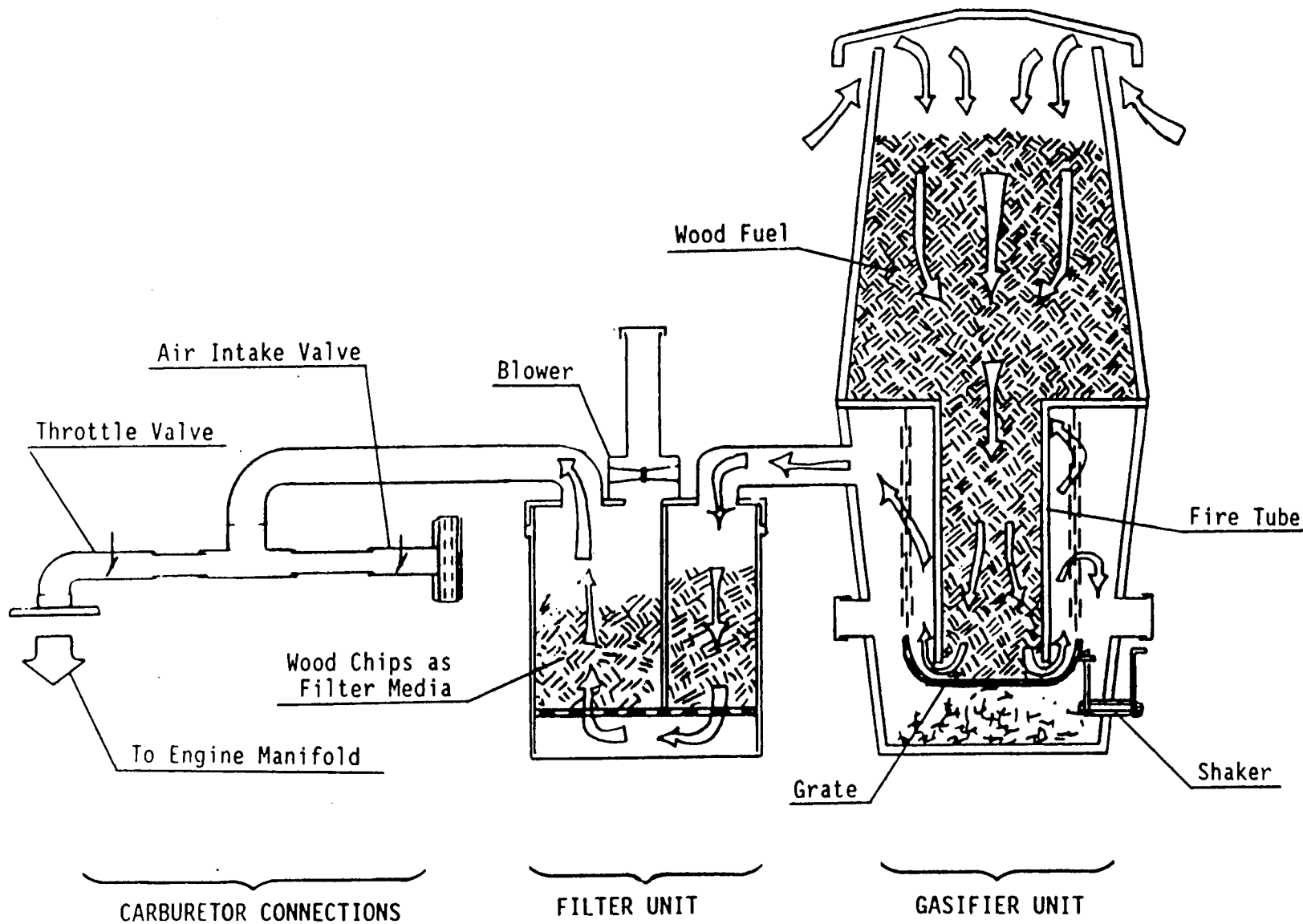

Fig. 1-3. Schematic view of the stratified, downdraft gasifier.

2. BUILDING YOUR OWN WOOD GAS GENERATOR

The following fabrication instructions, parts lists, and illustrations describe the prototype gasifier unit shown schematically in Fig. 1-3. These instructions are simple and easy to follow. The dimensions in the following plans are given in inches rather than in millimeters to make construction easier for those who might be unfamiliar with the metric system and to allow the builder to take advantage of available, alternate construction materials. It will be obvious to the experienced engineer, mechanic, or builder that most of the dimensions (for example, plate thicknesses and cleanout diameters) are not critical to the acceptable performance of the finished gasifier unit.

The prototype gasifier unit described in the following text was actually constructed and field tested on a gasoline-engine farm tractor (a 35-hp, John Deere 1010 Special); see Fig. 2-1. The unit operated very well, and on par with the European, World War II designs, but it has not had the test of time nor the millions of operating hours like the older Imbert design. This new stratified design was developed for the construction of simple, inexpensive emergency wood gas generator units. The prototype design below should be considered to be the absolute minimum in regard to materials, piping and filter arrangement, and carburetor system connections.

The gasifier unit, as described below, is designed to maintain proper cooling, even at moderate vehicle speeds. If this unit is to be used on stationary engines or on slow-moving vehicles, a gas cooler and a secondary filter must be placed in the piping system between the generator unit and the carburetor. The ideal temperature for the wood gas at the inlet to the carburetor manifold would be 70°F, with acceptable peaks of 140 to 160°F. For every 10 degrees above 70°F, an estimated 1% horsepower is lost. Cooler gas has higher density and, therefore, contains more combustible components per unit volume.

The millions of wood gasifiers built during World War II proved that shape, form, and construction material had little or no effect on the performance of the unit. Judicious substitution or the use of scavenged parts is, therefore, quite acceptable. What is important is that:

1. the fire tube dimensions (inside diameter and length) must be correctly selected to match the rated horsepower of particular engine which is to be fueled,
2. airtightness of the gas generator unit and all connecting piping must be maintained at all times, and
3. unnecessary friction should be eliminated in all of the air and gas passages by avoiding sharp bends in the piping and by using piping sizes which are not too small.

2.1. BUILDING THE GAS GENERATOR UNIT AND THE FUEL HOPPER

Figure 2-2 shows an exploded view of the gas generator unit and the fuel hopper; the list of materials is given in Table 2-1 (all figures and tables mentioned in Sect. 2 are presented at the end of Sect. 2). Only the dimensions of the fire tube (Item 1A) must be reasonably close; all other dimensions and materials can be substituted as long as complete airtightness is maintained. In the following instructions, all item numbers refer both to Fig. 2-2 and to Table 2-1.

The prototype unit described in this report was constructed for use with a 35-hp gasoline engine; the unit has a fire tube diameter of 6 in. (as determined from Table 2-2). A gas generator unit containing a fire tube up to 9-in. diameter (i.e., a gasifier unit for fueling engines up to about 65 hp) can be constructed from the following instructions. If your engine requires a fire tube diameter of 10 in. or more, use a 55-gal drum for the gas unit and another 55-gal drum for the fuel hopper.

The following fabrication procedure is very general and can be applied to the construction of gas generator units of any size; however, the specific dimensions which are given in the parts list and in the instructions below are for this particular prototype unit. All accompanying photographs were taken during the actual assembly of the prototype unit.

The fabrication procedure is as follows:

1. Using the displacement or horsepower rating of the engine to be fueled by the gasifier unit, determine the dimensions (inside diameter and length) of the fire tube (Item 1A) from Table 2-2. Fabricate a cylindrical tube or cut a length of correctly sized pipe to match the dimensions from Table 2-2. (For the prototype gasifier unit illustrated in this report, a 6-in.-diam firetube was used; its length was 19 in.)
2. The circular top plate (Item 2A) should be cut to a diameter equal to the outside diameter of the gasifier housing drum (Item 3A) at its top. A circular hole should then be cut in the center of the top plate; the diameter of this hole must be equal to the outside diameter of the fire tube. The fire tube (Item 1A) should then be welded at a right angle to the top plate (Item 2A) as shown in Fig. 2-3.
3. The grate (Item 4A) should be made from a stainless steel mixing bowl or colander. Approximately 125 holes with diameters of 1/2 in. should be drilled in the bottom and up the sides of the mixing bowl; see Fig. 2-4. A U-bolt (Item 5A) should be welded horizontally to the side of the grate, 2 in. from its bottom. This U-bolt will be interlocked with the shaker mechanism (Item 12A) in a later step.
4. The support chains (Item 6A) are to be attached to the grate in three evenly spaced holes drilled under the lip of the mixing bowl or colander; see Fig. 2-5. These chains are to be connected to the top plate (Item 2A) with eyebolts (Item 7A), as shown in Fig. 2-6. Each eyebolt should have two nuts, one on each side of the top plate, so that the eyebolts can be adjusted to the proper length. When assembled, the bottom of the firetube should be 1.25 in. above the bottom of the mixing bowl.
5. A hole equal to the outside diameter of the ash cleanout port (Item 8A) should be cut into the side of the gasifier housing drum (Item 3A); the bottom edge of this hole

should be about 1/2 in. from the bottom of the drum. Because of the thin wall thickness of oil drums and garbage cans, welding is not recommended; brazing such parts to the drums or cans will ensure both strength and airtightness (see Fig. 2-7).

6. Two holes, equal to the outside diameters of the ignition ports (Item 10A), are to be cut with their centers at a distance from the top of the housing drum (Item 3A) equal to the firetube length less 7 in. (19 in. less 7 in. equals 12 in. for this prototype unit); the holes should be placed opposite each other as shown in Fig. 2-2. The ignition ports should be attached to the wall of the housing drum by brazing.
7. When the ash cleanout port (Item 8A) and the ignition ports (Item 10A) have been attached to the wall of the gasifier housing drum (Item 3A), they should then be closed with pipe caps, Items 9A and 11A respectively. The threads of the pipe caps should be first coated with high temperature silicone (Item 27A) to ensure airtightness. An optional steel crossbar welded to the pipe cap will reduce the effort required to open these caps later.
8. The shaker assembly (Item 12A) is shown in Fig. 2-8. The 1/2-in. pipe (Item 1AA) should be brazed into the side of the housing drum (Item 3A), 1.5 inches from the bottom of the drum; the length of this pipe which protrudes into the drum must be chosen so that the upright bar (Item 2AA) is in line with the U-bolt (Item 5A) on the grate. Likewise, the length of the upright bar must be selected so as to connect into the U-bolt.
9. Weld the upright bar (Item 2AA) to the head of the bolt (Item 3AA). The threaded end of the bolt should be ground down or flattened on one side, as shown in Fig. 2-9, to positively interlock with a slot to be drilled and filed in the handle (Item 4AA). The handle can be formed or bent into any desired or convenient shape.
10. A hole should be drilled in the pipe cap (Item 7AA) so that there is a close fit between this hole and the bolt (Item 3AA). The close fit will help to ensure airtightness.
11. Before assembling the shaker, as shown in Fig. 2-8, coat the bolt (Item 3AA) with a small amount of grease. Before inserting the bolt, fill the pipe (Item 1AA) with high temperature silicone (Item 27A) to ensure airtightness. Tighten the nuts (Item 6AA) so that the position of the handle (Item 4AA) is maintained by friction, yet is capable of being turned and agitated during cleanout or stationary operation.
12. Fabricate the supports (Item 13A) for the gasifier unit housing drum (Item 3A) out of rectangular, iron bar stock. The shape and height of the support flanges must be determined by the frame of the vehicle to which the gasifier is to be mounted. The supports can either be bolted to the bottom and side with the 1/4-in. bolts (Item 14A) or can be brazed directly to the drum; see Fig. 2-10. Remember to seal all bolt holes for airtightness.
13. Completely cover the bottom of the housing drum (Item 3A) with 1/2 in. of hydraulic cement (Item 28A). The cement should also be applied to the inside of the drum for

about 5 in. up the inside walls near the bottom. All edges should be rounded for easy ash removal.

14. The fuel hopper (Item 15A) is to be made from a second container with its bottom up as shown in Fig. 2-11. Remove the bottom, leaving a 1/4-in. lip around the circumference.
15. A garden hose (Item 17A) should be cut to a length equal to the circumference of the fuel hopper (Item 15A) and should then be slit along its entire length. It should be placed over the edge of the fuel hopper from which the bottom was removed. This will prevent injury to the operator when adding wood fuel to the unit. To insure close fit of the garbage can lid (Item 16A), a piece of weather stripping (Item 18A) should be attached under the lid where it makes contact with the fuel hopper.
16. Cut four support bars (Item 19A) to lengths 2.5 in. longer than the height of the fuel hopper (Item 15A). Drill a 3/8-in. hole in each end of all four support bars; these holes should be centered 3/4 in. from the ends. Bend 2 in. of each end of these support bars over at a right angle; then, mount them evenly spaced around the fuel hopper (Item 15A) with 1/4-in. bolts (Item 20A). One of the bends on each support bar should be as close to the lower edge of the fuel hopper as possible.
17. Cut four metal triangular standoffs (Item 21A) and braze, weld, or rivet them flat against the edge of the garbage can lid (Item 16A) as shown in Fig. 2-12; they must be aligned with the four support bars (Item 19A) attached to the fuel hopper. During operation, the garbage can lid must have a minimum 3/4-in. opening for air passage; the standoffs should provide this clearance when they are engaged into the holes in the top edges of the support bars (Item 19A); see Fig. 2-13.
18. Two eye hooks (Item 22A) should be attached to opposite sides of the garbage can lid (Item 16A). Two screen door springs (Item 23A) should be attached to the garbage can handles and used under tension to keep the top lid (Item 16A) either open or closed.
19. Cut the oil drum lock ring (Item 24A) to the exact circumference of the top plate (Item 2A) so that it will fit snugly around the gasifier unit housing drum (Item 3A).
20. Cut four 2 by 2 by 1/4-in. tabs (Item 25A); then, braze these tabs to the lock ring (Item 24A), evenly spaced and in alignment with the support bars (Item 19A) on the fuel hopper. Drill a 3/8-in. hole in each tab to align with the holes in the fuel hopper support bars (Item 19A). The lock ring is shown in Fig. 2-14.
21. The connecting pipe (Item 29A) between the gasifier unit and the filter unit should be attached to the gasifier housing drum (Item 3A) at a point 6 in. below the top of the drum. This pipe must be a minimum of 2-in. in diameter and should be at least 6 ft long for cooling purposes. At least one of the ends of this pipe must be removable for cleaning and maintenance. On this prototype unit, an airtight electrical conduit connector was used; this connection is visible in Fig. 2-1. Many similar plumbing devices

are available and can be used if they are suitable for operation at 400° F and above. The pipe can also be welded or brazed directly to the housing drum.

22. When assembling the gasifier unit, the upright bar (Item 2AA) on the shaker assembly must be placed inside the U-bolt (Item 5A) on the grate.
23. The lock ring will then clamp the gasifier unit housing drum (Item 3A) and the top plate (Item 2A) together. The fuel hopper support bars (Item 19A) must be attached to the tabs (Item 25A) on the lock ring with bolts (Item 26A). High temperature silicone (Item 27A) should be applied to all edges to make an airtight connection. The lock ring connections are shown in the lower portion of Fig. 2-13.

2.2 BUILDING THE PRIMARY FILTER UNIT

Figures 2-15 and 2-16 show exploded views of the primary filter unit; the list of materials is given in Table 2-3 (all figures and tables mentioned in Sect. 2 are presented at the end of Sect. 2). In the following instructions, all item numbers refer to either Fig. 2-15 or 2-16 and to Table 2-3.

The prototype primary filter unit was made from a 5-gal paint can. That size seems to be sufficient for gasifiers with fire tubes up to 10 in. in diameter. If a fire tube diameter of more than 10 in. is required, then a 20-gal garbage can or a 30-gal oil drum should be used. The filter unit could be fabricated in any shape or form as long as airtightness and unobstructed flow of gas are provided. If a 5-gal container is used, it must be clean and free of any chemical residue. The top edge must be straight and without any indentations. If an alternate container can be found or fabricated, a larger diameter will permit longer operation between cleanings.

The piping (Item 29A in Figs. 2-2 and 2-15) which connects the gas generator unit to the primary filter should be considered to be a necessary part of the cooling system and should never have an inside diameter less than 2 in. A flexible automotive exhaust pipe was used on the prototype filter unit described below; it was shaped into a semicircular arc so that increased length would achieve a greater cooling effect.

The fabrication procedure for the filter unit follows:

1. A hole equal to the outside diameter of the drain tube (Item 13B in Fig. 2-15) should be cut into the side of the filter container (Item 1B); the bottom edge of this hole should be about 1/2 in. from the inside bottom of the container.
2. The drain tube (Item 13B) should be inserted into the previously cut hole in the filter container and should be positioned so that its nonthreaded end is near the center of the container and is about 1/2 in. off the bottom. Once this position has been ensured, braze (do not weld) the drain pipe into the side of the filter container. Close the threaded, exterior end of the drain pipe with the pipe cap (Item 14B).
3. Coat the bottom of the filter container (Item 1B) with a 1/2-in. layer of hydraulic cement (Item 28A), taking care not to plug or obstruct the end of the drain tube (Item 13B) with cement (i.e., fill the drain tube with a paper, styrofoam, or other easily removable, but rigid material). The cement should also be applied for about 1.5 in. up

the inside walls of the container near its bottom. Round the edges slightly; the cement is to provide a pathway for any liquid condensate to drain out through the drain tube. The cement must be allowed to harden before proceeding with the fabrication steps below. Remove the filler material from the drain tube when the cement has hardened.

4. A circular bottom plate (Item 2B) should be cut to a diameter 1/2 in. smaller than the inside diameter of the filter container (Item 1B). This will allow for heat expansion and easy removal for cleaning. This bottom plate should be drilled with as many 3/4-in. holes as are practical for the size of the plate. Three evenly spaced 3/8-in. holes should also be drilled around the edge of the bottom plate for the spacer bolts (Item 3B).
5. Fig. 2-16 shows the detail of using three bolts (Item 3B) as spacers for the bottom plate (Item 2B). The length of the bolts should be adjusted to provide a clearance of about 2-in. between the layer of cement in the bottom of the container (Item 1B) and the bottom plate (Item 2B).
6. A rectangular divider plate (Item 4B) should be cut to a width 1/4 in. less than the inside diameter of the filter container (Item 1B) and to a height 2.5 in. less than the inside height of the container. This divider plate should then be welded at a right angle to the centerline of the bottom plate (Item 2B) as shown in Fig. 2-17.
7. Cut a piece of high-temperature hydraulic hose (Item 5B) to a length equal to the circumference of the filter container. It should be slit along its entire length and then placed over the top edge of the filter container (Item 1B) to ensure airtightness.
8. A circular lid (Item 6B) should be cut equal to the outside diameter of the filter container (Item 1B). Three holes should be cut into this lid for the exhaust pipe (Item 29A) from the gasifier unit, the blower (Item 7B), and the filter exhaust pipe (Item 10B) to the engine manifold. Note the arrangement of these holes: the pipe (Item 29A) from the gasifier unit must enter the lid on one side of the divider plate (Item 4B); the blower (Item 7B) and the filter exhaust pipe (Item 10B) to the engine manifold must be located on the other side of the divider plate. This arrangement can be seen in Fig. 2-18.
9. The connecting pipe (Item 29A) between the gasifier unit and the filter unit should be attached to the lid (Item 5B) of the filter container. At least one of the ends of the connecting pipe (Item 29A) must be removable for cleaning and maintenance. On this prototype unit, an airtight electrical conduit connector was used. Many similar plumbing devices are available and can be used if they are suitable for operation at 400° F and above. The pipe can also be welded or brazed directly to the lid.
10. Attach the blower (Item 7B) to the filter container lid (Item 6B). On the prototype gasifier illustrated in this report, a heater blower from a Volkswagen automobile was used. Connections for a vertical extension tube (Item 8B) will have to be fabricated as shown in Fig. 2-19. A closing cap (Item 9B) is required for the blower exhaust tube. A plumbing cap of steel or plastic with a close fit can be used or fabricated to fit. The vertical extension and the closing cap are visible in Fig. 2-1.

11. The gas outlet (Item 10B) to the carbureting unit on the engine should be 1.25 in. minimum diameter. In fabricating this connection, all abrupt bends should be avoided to ensure free flow of gas. Using plumbing elbows is one solution. The gas outlet (Item 10B) can either be welded or brazed to the lid (Item 6B) of the filter container or an airtight, electrical conduit connector can be used.
12. Latching devices (Item 11B) should be welded or brazed to the lid (see Fig. 2-20) and to the sides (see Fig. 2-21) of the filter container. An air-tight connection between the lid and the filter container must be maintained.
13. Cut two lengths of high-temperature hydraulic hose (Item 12B) equal to the height of the divider plate (Item 4B); cut a third length of hose equal to the width of the divider plate. Slit each hose along its entire length. Place the first two hoses on each side of the divider plate, and place the third hose along the top edge of the divider plate as shown in Fig. 2-17.
14. Insert the divider plate (Item 4B) into the filter container (Item 1B), making sure that the hoses (Item 12B) create an airtight seal along all sides. By changing the length of the spacer bolts (Item 3B), adjust the height of the divider plate so that it is exactly flush with the top of the filter container. Make sure that the lid (Item 5B) will seat flatly and tightly against the top edge of the divider plate.
15. Fill the filter container (Item 1B) on both sides of the divider plate with wood chips, the same kind as would be used for fuel in the gasifier unit. After carefully packing and leveling these wood chips, place the lid (Item 6B) on the filter container, and close the latches tightly.

2.3. BUILDING THE CARBURETING UNIT WITH THE AIR AND THROTTLE CONTROLS

Figures 2-22 and 2-23 show exploded views of the carbureting unit; the list of materials is given in Table 2-4 (all figures and tables mentioned in Sect. 2 are presented at the end of Sect. 2). In the following instructions, all item numbers refer both to Figs. 2-22 and 2-23 and to Table 2-4. The following is a simple and easy way to assemble a carburetor to achieve both air mixture and throttle control. It can be mounted to either updraft or downdraft manifolds by simply turning the unit over. Most of the fabrication procedure below is devoted to the assembly of two butterfly valves: one for the throttle valve and one for the air mixture valve. The remainder of the carburetor unit can be assembled from ordinary, threaded plumbing parts.

The inside diameter of the piping used in the carburetor unit must be related to the size of the engine and should never be smaller than the intake opening on the engine manifold. If in doubt on the inside diameter for the pipe and/or hose sizes, always go with a larger diameter. This will reduce friction losses and will give longer operating hours between cleanings.

When the wood gas leaves the filter unit it should normally be below 180°F. About 2 ft from the filter container, an automotive water hose can be connected to the pipe on the carbureting unit. This rubber hose will keep engine vibration from creating air leaks in the

filter unit or in the connecting piping. The hose must be a fairly new item; such hoses have a steel spring inside to keep them from collapsing when negative pressure is applied. The spring will soon rust if it has first been subjected to water and then to the hot wood gas enriched with hydrogen.

The fabrication procedure for the assembly of two butterfly valves follows:

1. The manifold adapter (Item 1C in Fig. 2-22) must be fitted with bolts and/or holes for mounting onto the engine's existing intake manifold. Because gasoline engines are produced with so many different types of intake manifolds, ingenuity and common sense must be used to modify the manifold adapter (Item 1C) for each different engine to be operated on wood gas. A gasket (Item 7C) should be cut to match the shape of the engine intake fitting.
2. The butterfly valve (Item 3C) is shown in Figs. 2-24 and 2-25; two such valves are required. A 3/8-in. hole should be drilled through the diameter of each valve body (Item 1CC) at the midpoint of its length.
3. The valve plate (Item 2CC) must be oval in shape with the dimensions given in Table 2-4. An oval valve plate must be used so that, in the closed position, the valve will be about 10° off center. This will ensure that the valve will come to a complete stop in the closed position.
4. The edges of the valve plate (Item 2CC), around the longer diameter of the oval, should be beveled to provide a positive, airtight closure. Two evenly spaced, 1/4-in. holes should be drilled along the shorter diameter of the oval plate.
5. The valve support rod (Item 3CC) should be filed or ground flat on one side as shown in Fig. 2-24; the flat area must begin 1/4 in. from one end and must continue for a distance equal to the inside diameter of the valve body (Item 1CC).
6. Two 3/16-in. holes should be drilled into the flat area of the valve support rod (Item 3CC); these holes must align with the holes in the valve plate (Item 2CC). They must also be tapped (with threads) to accept the valve plate screws (Item 4CC).
7. The butterfly valve (Item 3C) should be assembled by first placing the valve support rod (Item 3CC) through the hole in the valve body (Item 1CC). The valve plate (Item 2CC) should be dropped into one end of the valve body and then inserted into the flat area of the valve support rod. The two screws (Item 4CC) should be used to attach the valve plate to the support rod. Check to see that the assembled valve plate rotates freely and seats completely in the closed position.
8. A nut (Item 6CC) should be welded flat against one side of the throttle arm (Item 5CC) near its end. A 1/8-in. hole should be drilled into the side of the nut and must be threaded to accept the set screw (Item 7CC). At least one hole should be drilled into the throttle arm for attachment of the engine throttle control or air control linkages.

9. Place the nut (Item 6CC) on the throttle arm over the end of the valve support rod (Item 3CC) and use the set screw (Item 7CC) to secure the assembly. The throttle arm can be placed in any convenient orientation. Assembled butterfly valves are shown in Fig. 2-26.
10. The remaining parts of the carburetor assembly should be screwed together as shown in Fig. 2-27. Pipe thread compound should be used to make airtight connections. The assembled carburetor unit should be attached to the engine's intake manifold as shown in Fig. 2-28
11. This prototype gasifier was designed to operate if gasoline were unavailable; but, if dual operation on wood and gasoline is desired, the elbow (Item 2C) could be replaced with a tee, allowing a gasoline carburetor to also be mounted.
12. The arm on the butterfly valve (Item 3C) which is closest to the elbow (Item 2C) is to be connected to the foot- (or, on tractors, hand-) operated accelerator. The other butterfly valve is to be used as the air mixture control valve and can be operated with a manual choke cable. If the engine has an automatic choking device, then a hand-operated choke cable should be installed. Both butterfly valves and their connecting control linkages must operate smoothly with the ability to adjust the valve yet keep it stationary in the selected position during operation. The linkages must close the valves airtight when the engine is off.
13. The air inlet (Item 6C) should be connected by an extension hose or pipe, either iron or plastic, to the existing engine's air filter in order to prevent road dust or agricultural residue from entering the engine.
14. The wood gas inlet (Item 5C) is to be connected to the outlet piping (Item 10B as shown in Fig. 2-15) from the wood gas filter unit. Part of this connection should be a high-temperature rubber or neoprene hose to absorb engine vibration.

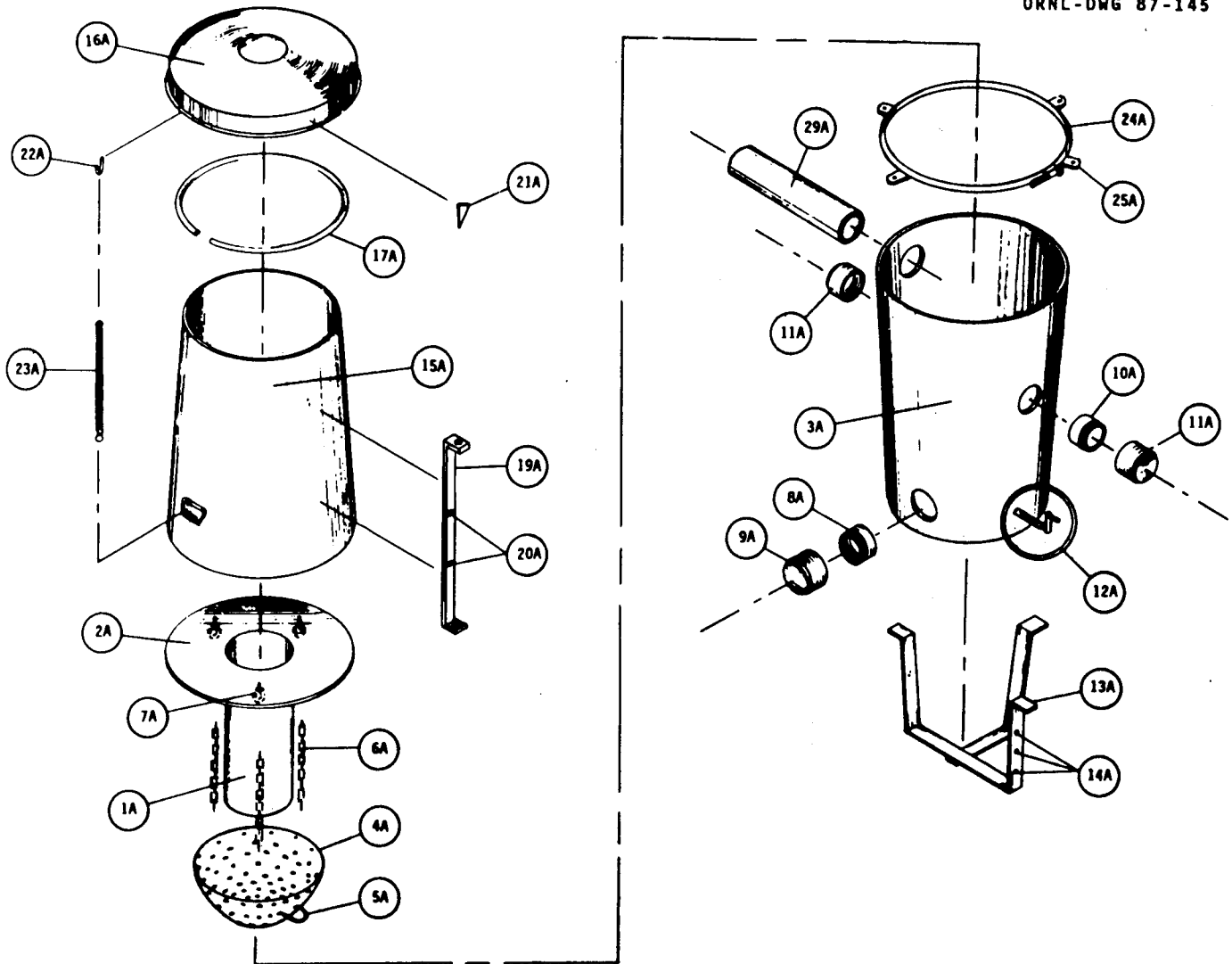

Fig. 2-2. Exploded, schematic diagram of the wood gas generator unit and the fuel hopper.

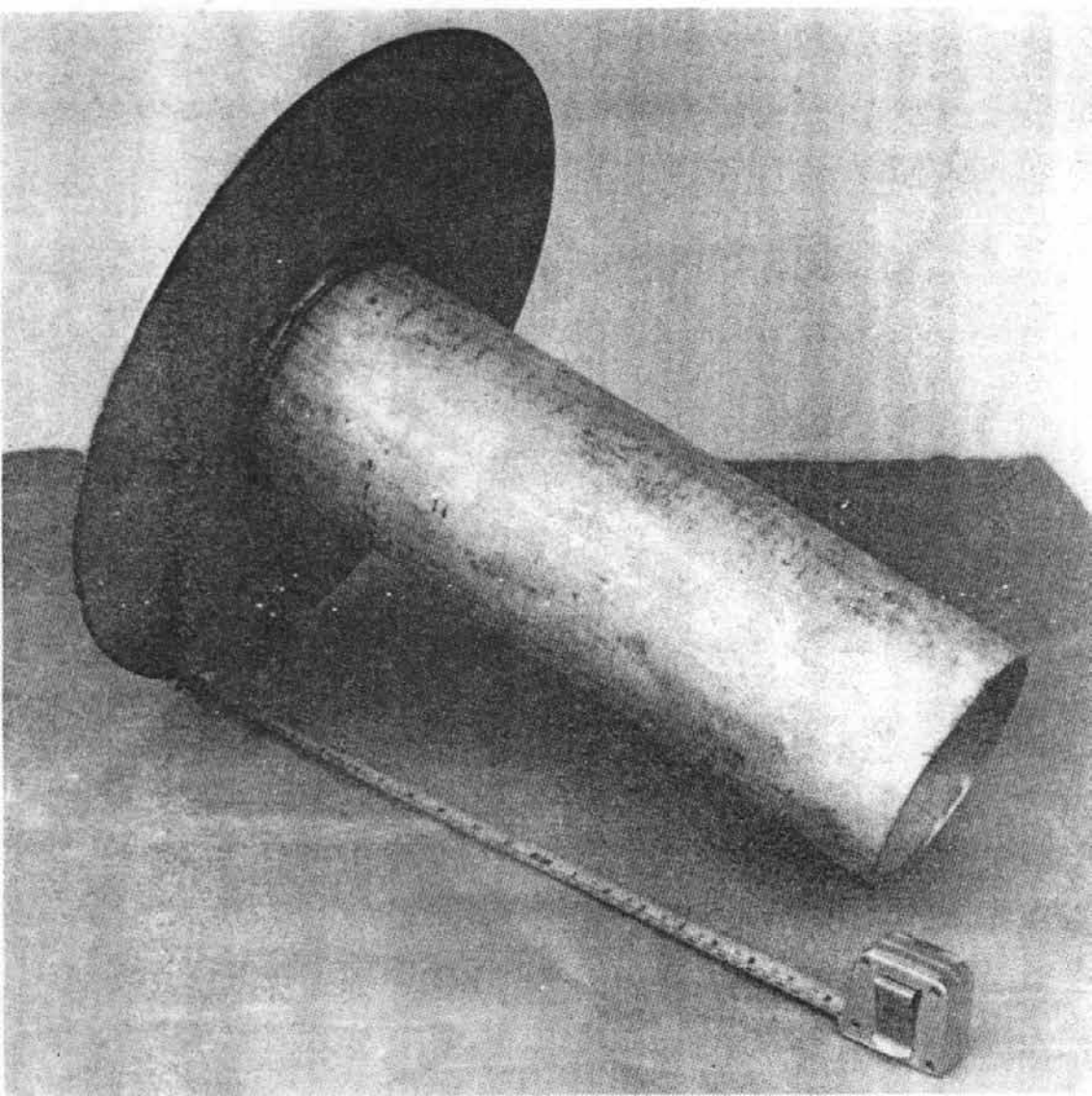

Fig. 2-3. The fire tube and circular top plate of the gasifier unit.

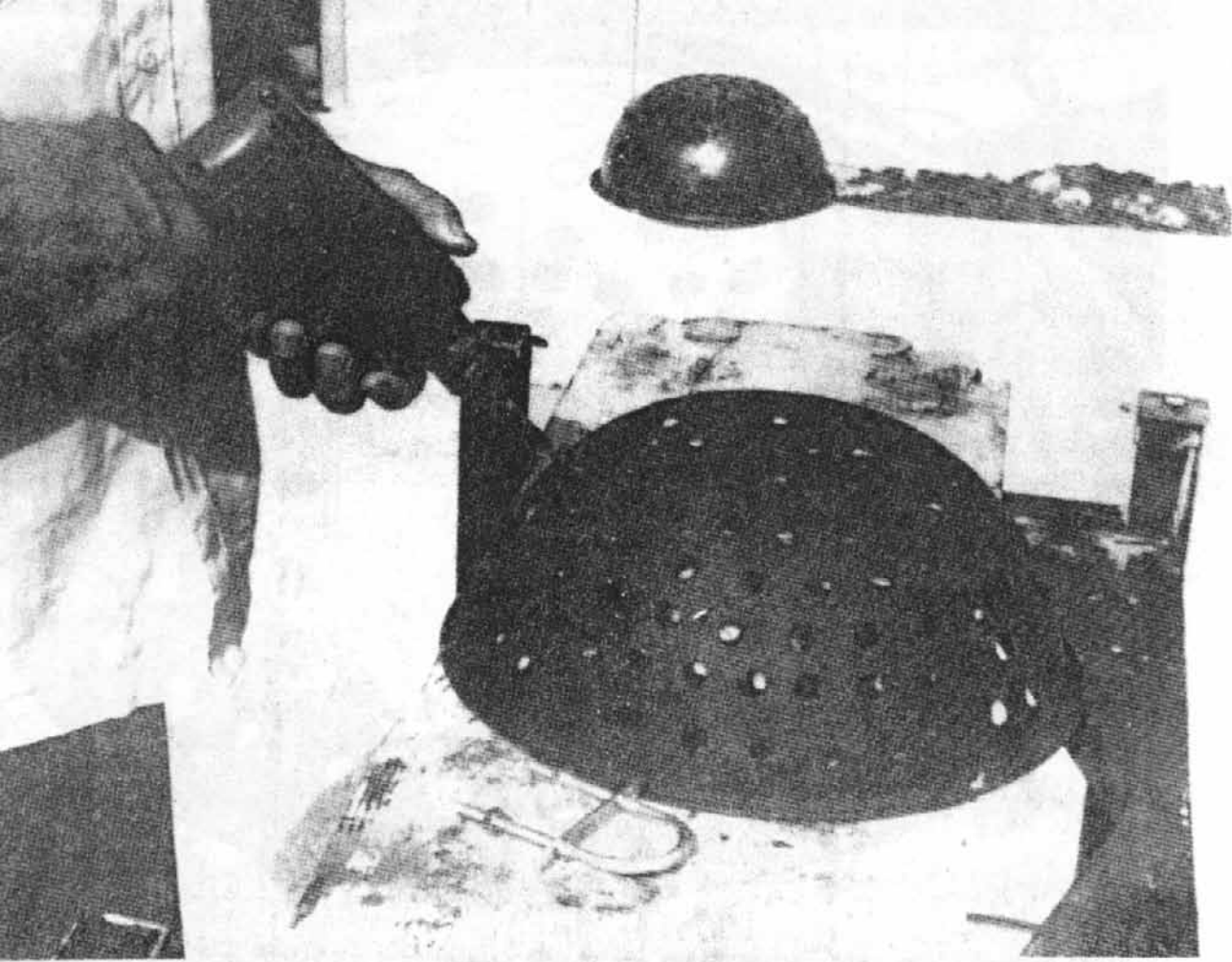

Fig. 2-4. Drilling holes into the stainless steel mixing bowl to be used for the grate. Note the U-bolt in the foreground.

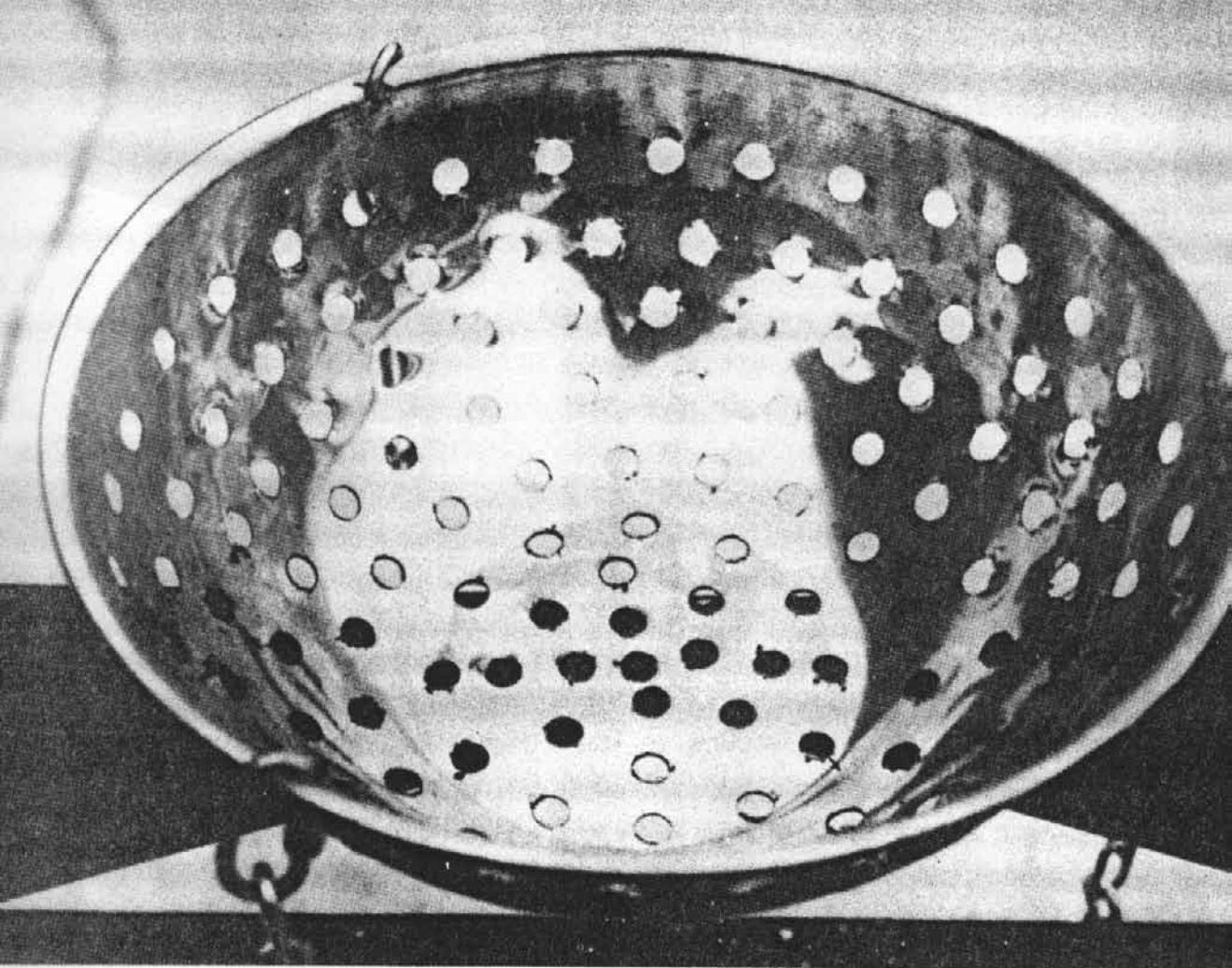

Fig. 2-5. Chains attached to the lip of the stainless steel mixing bowl.

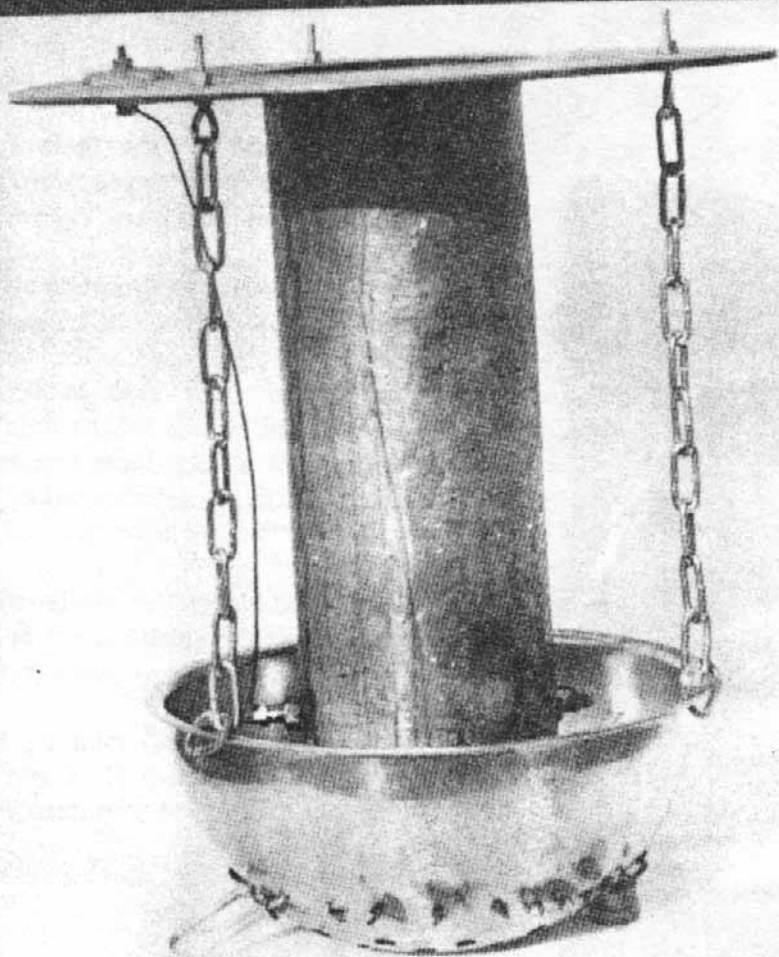

Fig. 2-6. Connect the mixing bowl to the top plate with chains. Note that the diesel ignitor "glow plugs" shown in this photograph were included for experimentation only; they were abandoned in the final prototype design.

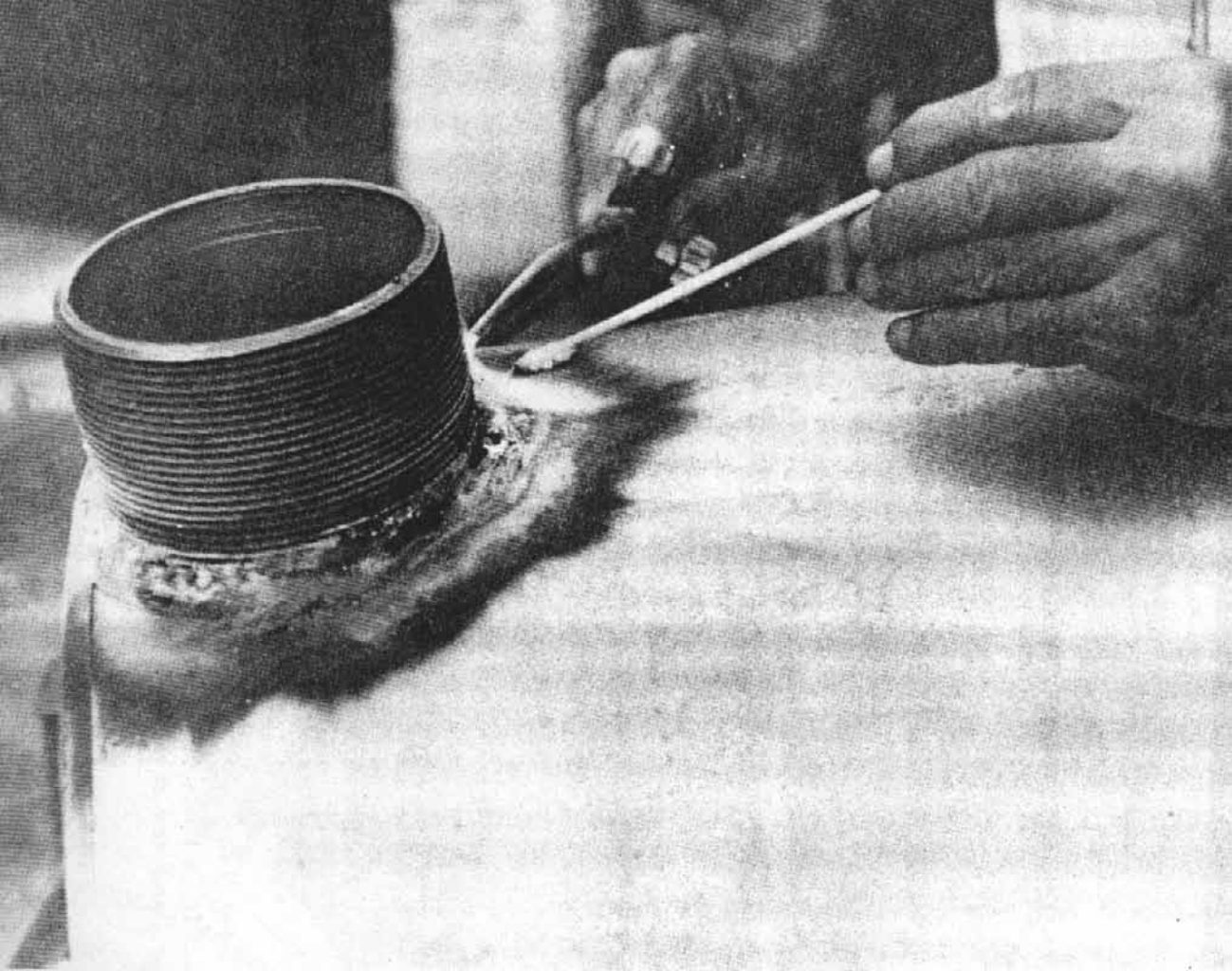

Fig. 2-7. Braze, do not weld, the plumbing fittings to the thin walled drums.

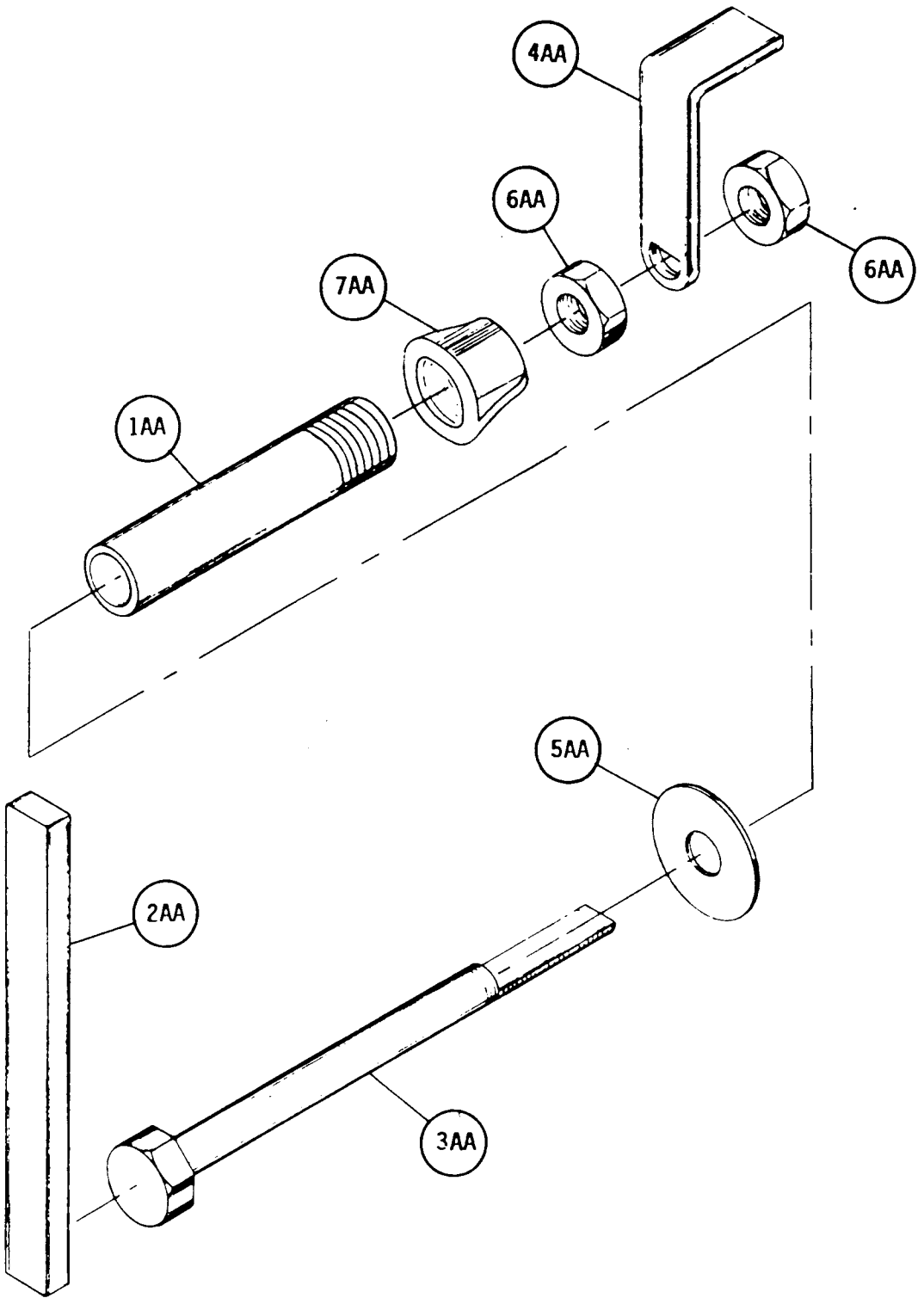

Fig. 2-8. Exploded, schematic diagram of the grate shaking mechanism.

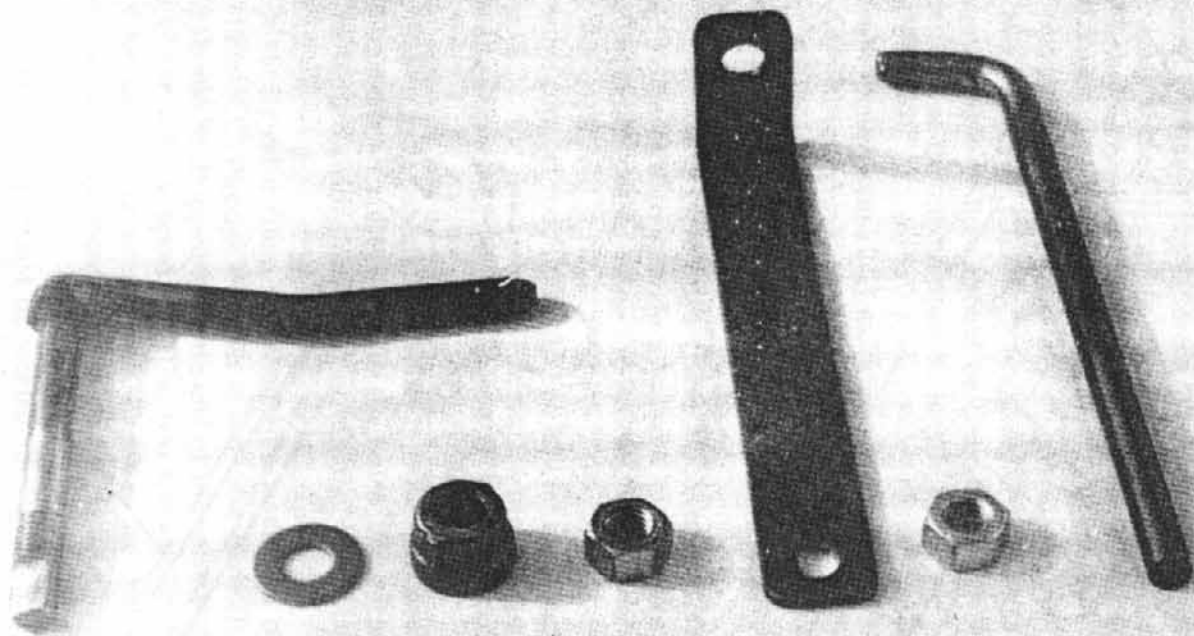

Fig. 2-9. Parts for the shaker assembly. Note the flattened portion of the bolt (at extreme left) which positively locks into the handle (third from right). At the extreme right is a "poker bar" which engages into the hole in the top of the handle to operate the shaker mechanism; the shaker handle will get very hot during normal gasifier operation.

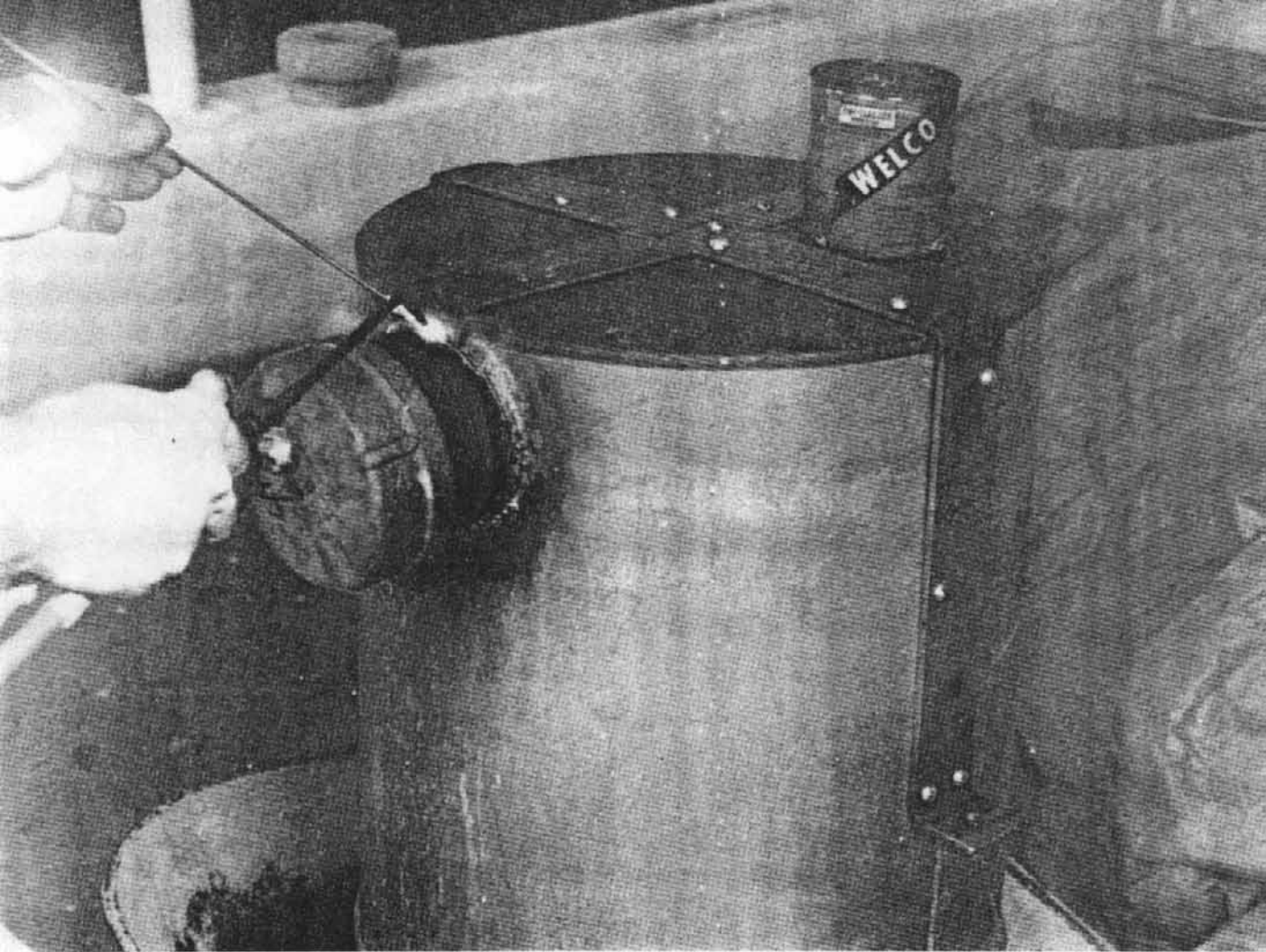

Fig. 2-10. The support frame can be brazed or bolted to the side of the gasifier unit. All bolts should be sealed air tight.

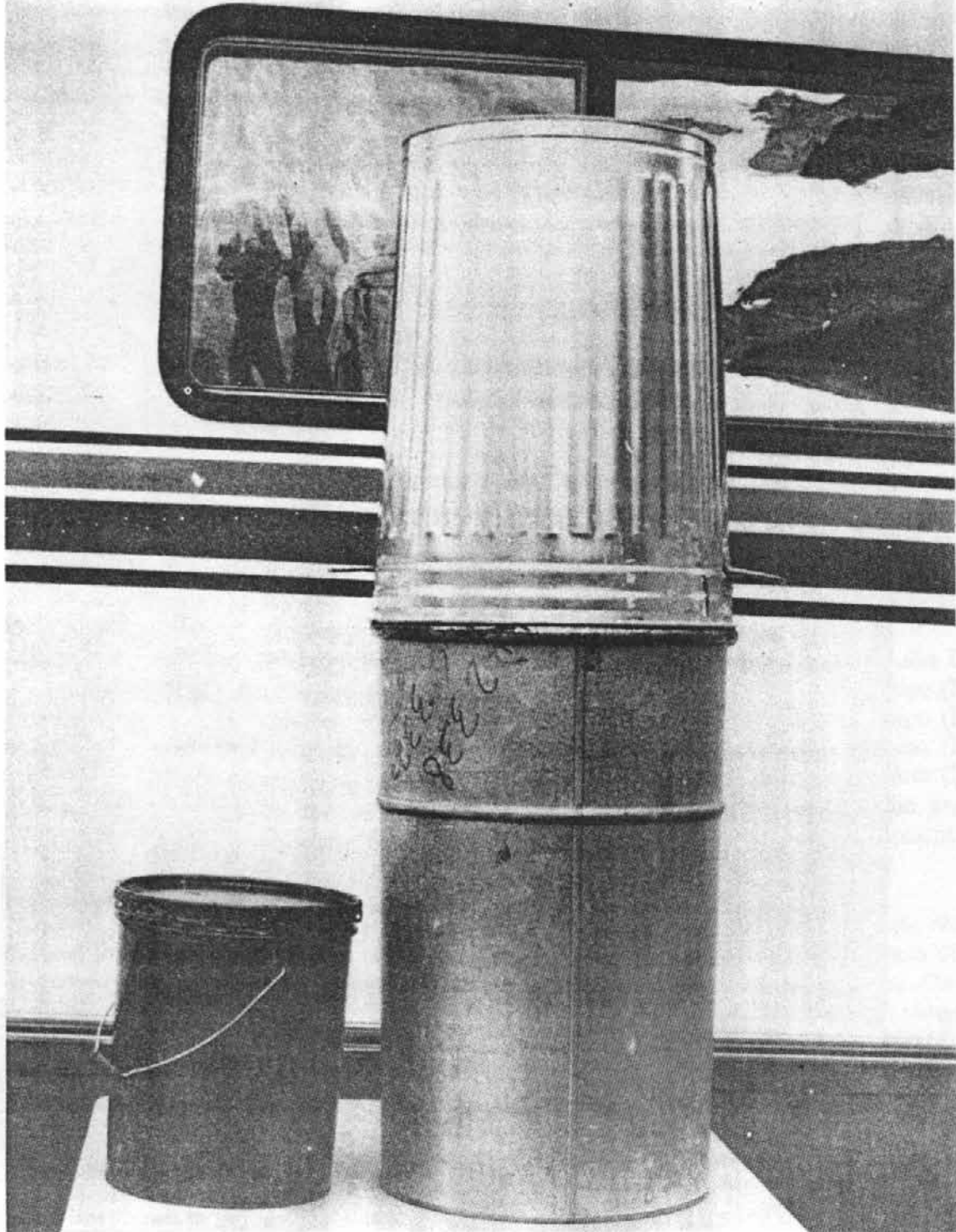

Fig. 2-11. Containers used in constructing the prototype gasifier unit. At right, a 20-gal garbage can (the fuel hopper) is shown on top of a 30-gal metal drum (the gasifier unit housing). The 5-gal paint can, at left, is used as the filter container.

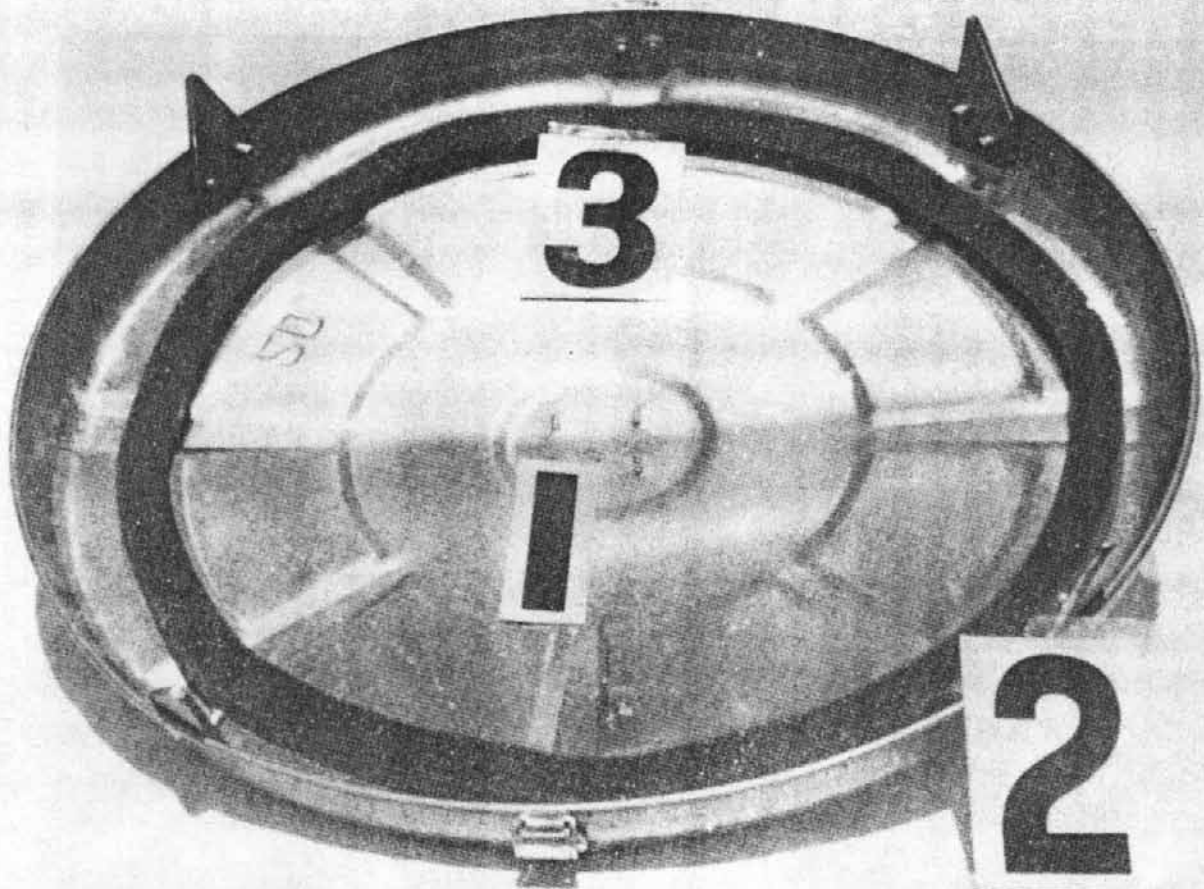

Fig. 2-12. Cover for the fuel hopper. Note the foam weatherstripping (#3) attached to the underside of the lid where it contacts the fuel hopper. Attach four standoffs (#2) to the lid (#1) as shown.

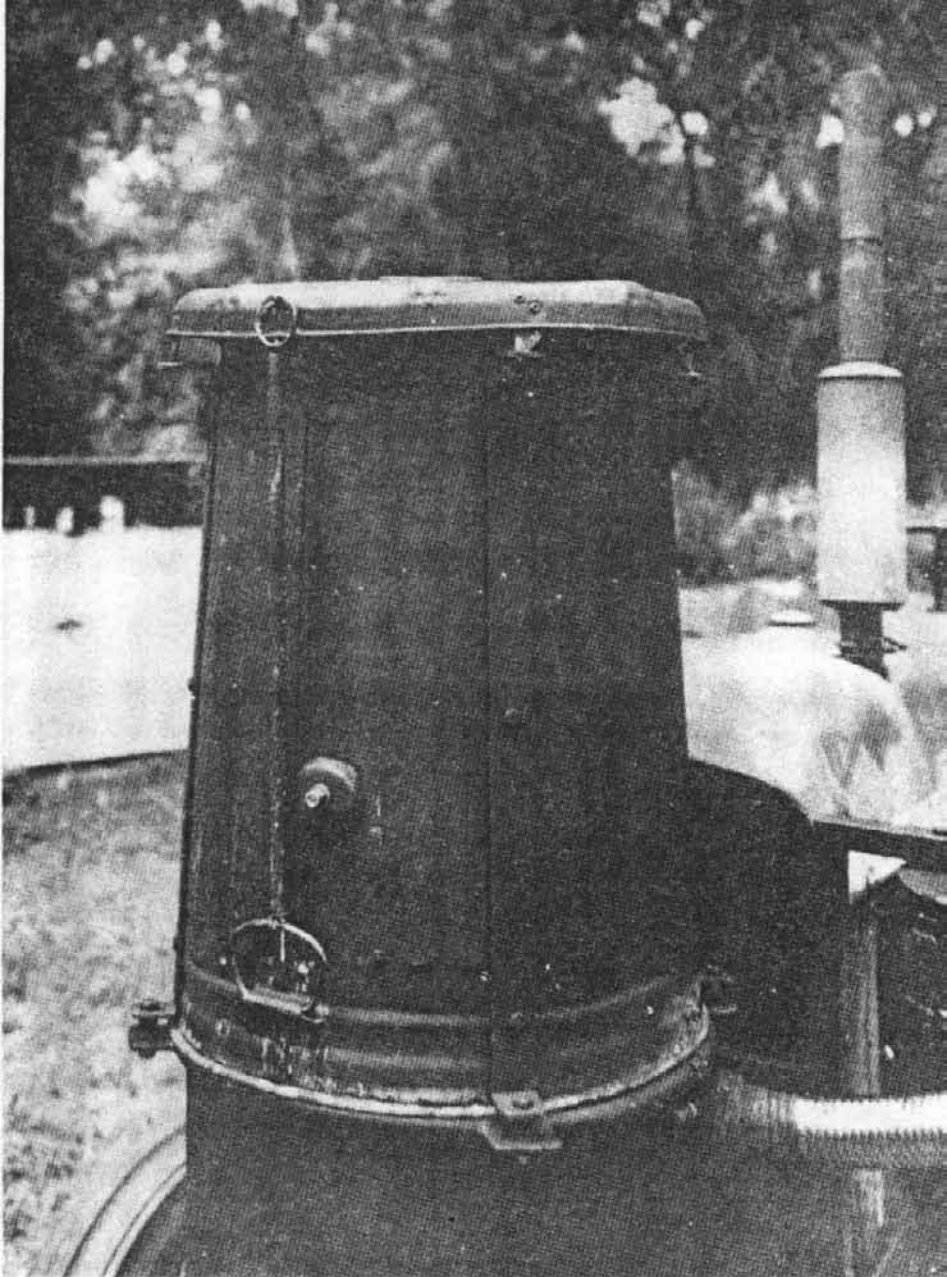

Fig. 2-13. Operating configuration of the fuel hopper and its cover.

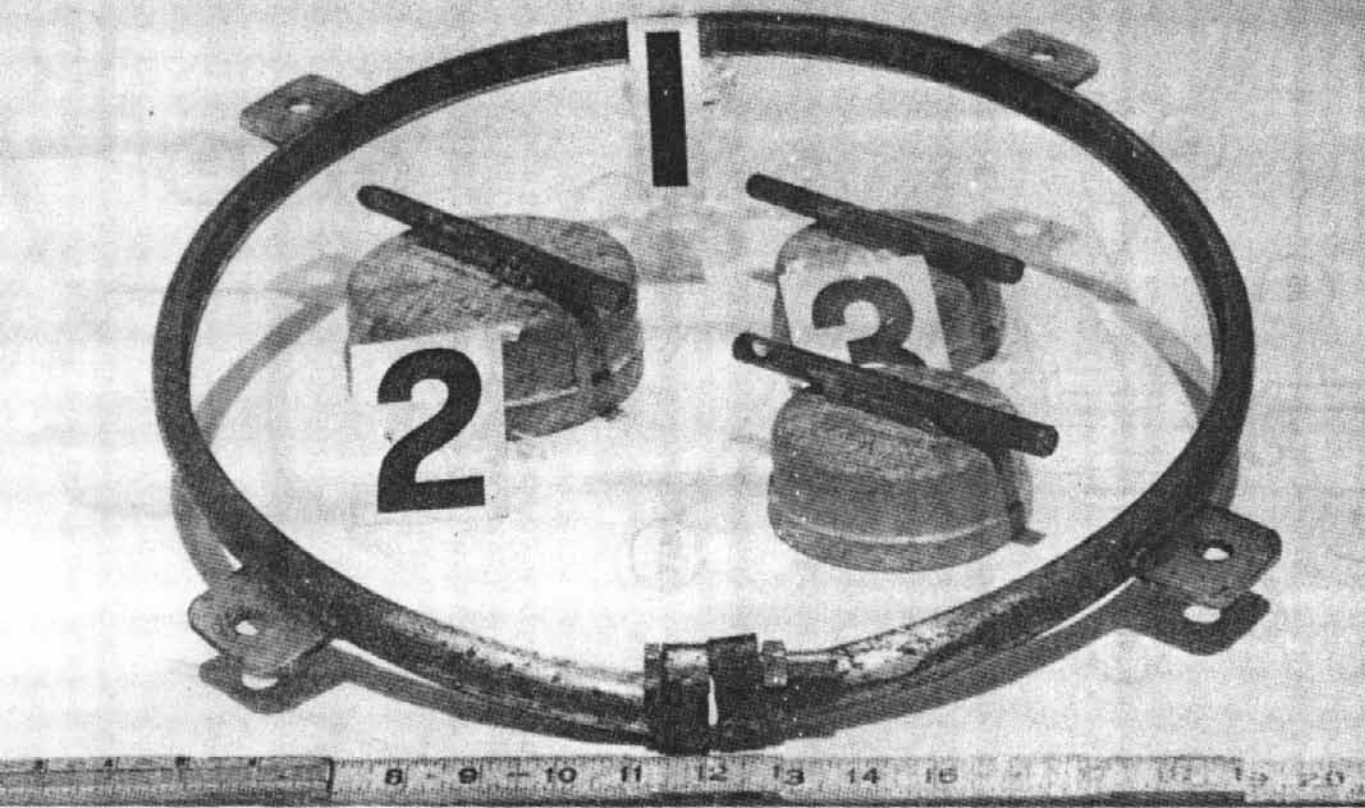

Fig. 2-14. Lock ring and welded tabs. Also pictured inside the lock ring (#1): the ash cleanout cover cap (#2), and the ignition cover cap (#3).

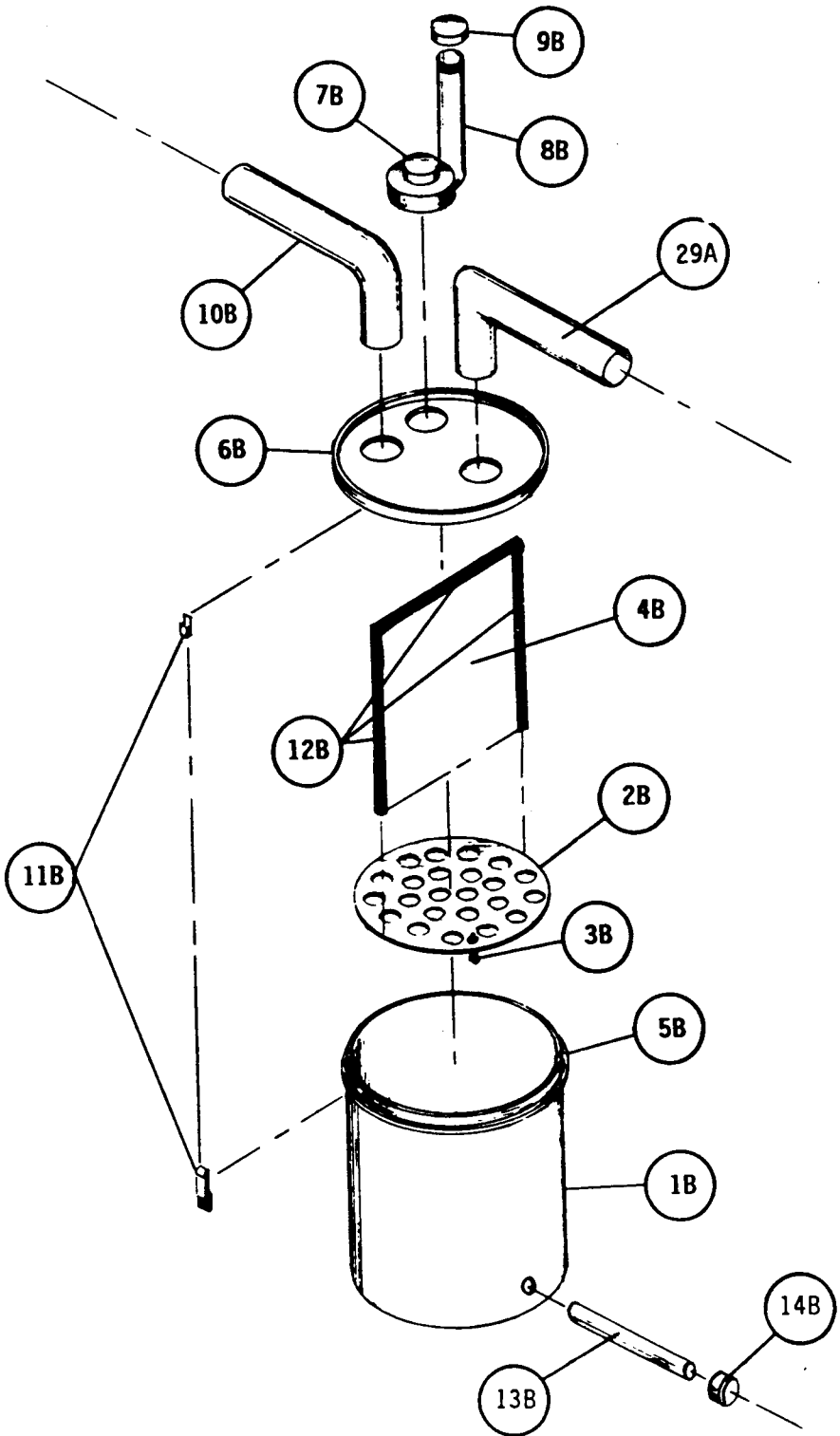

Fig. 2-15. Exploded, schematic diagram of the filter unit.

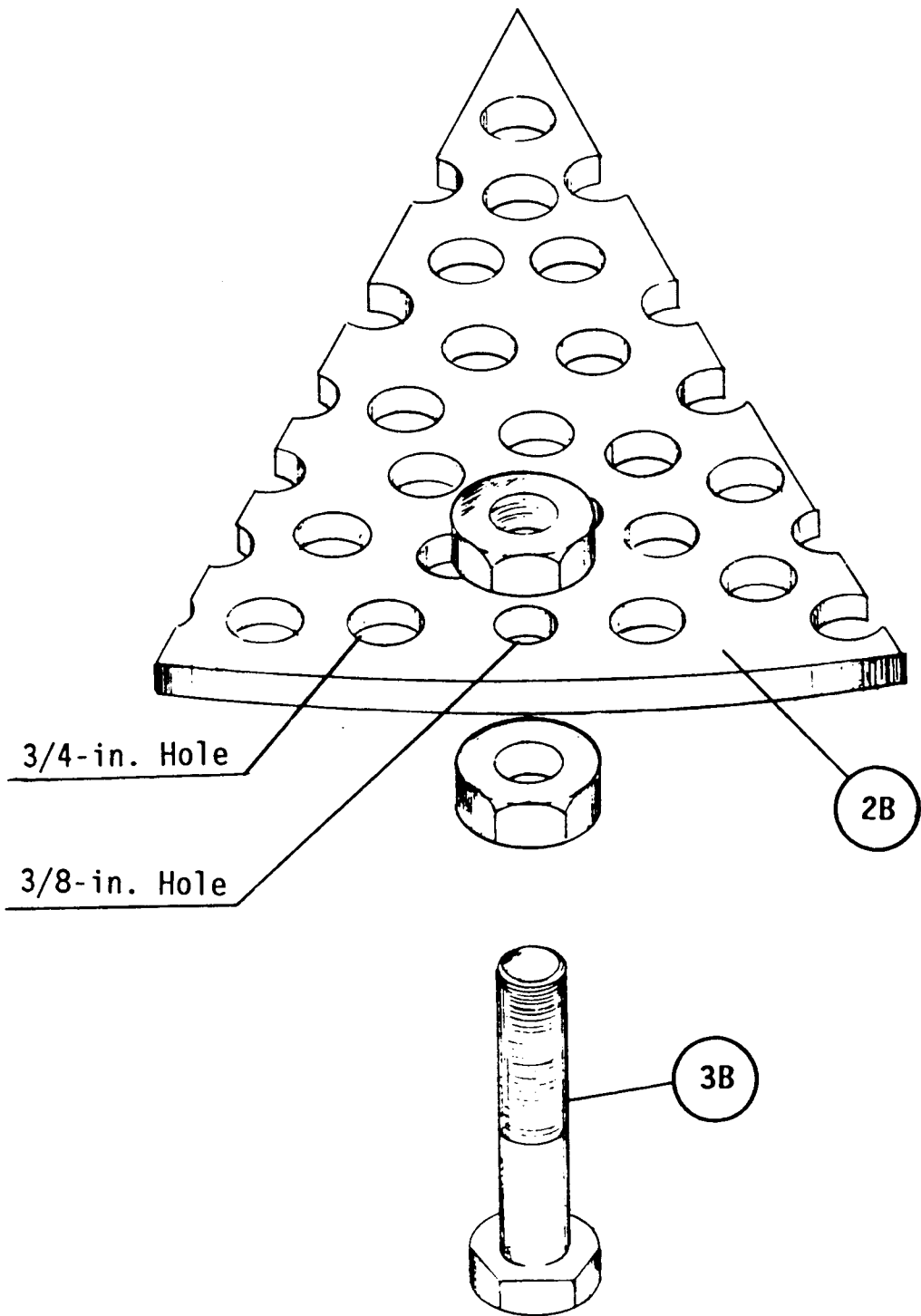

Fig. 2-16. Detail of the standoffs for the bottom plate of the filter unit.

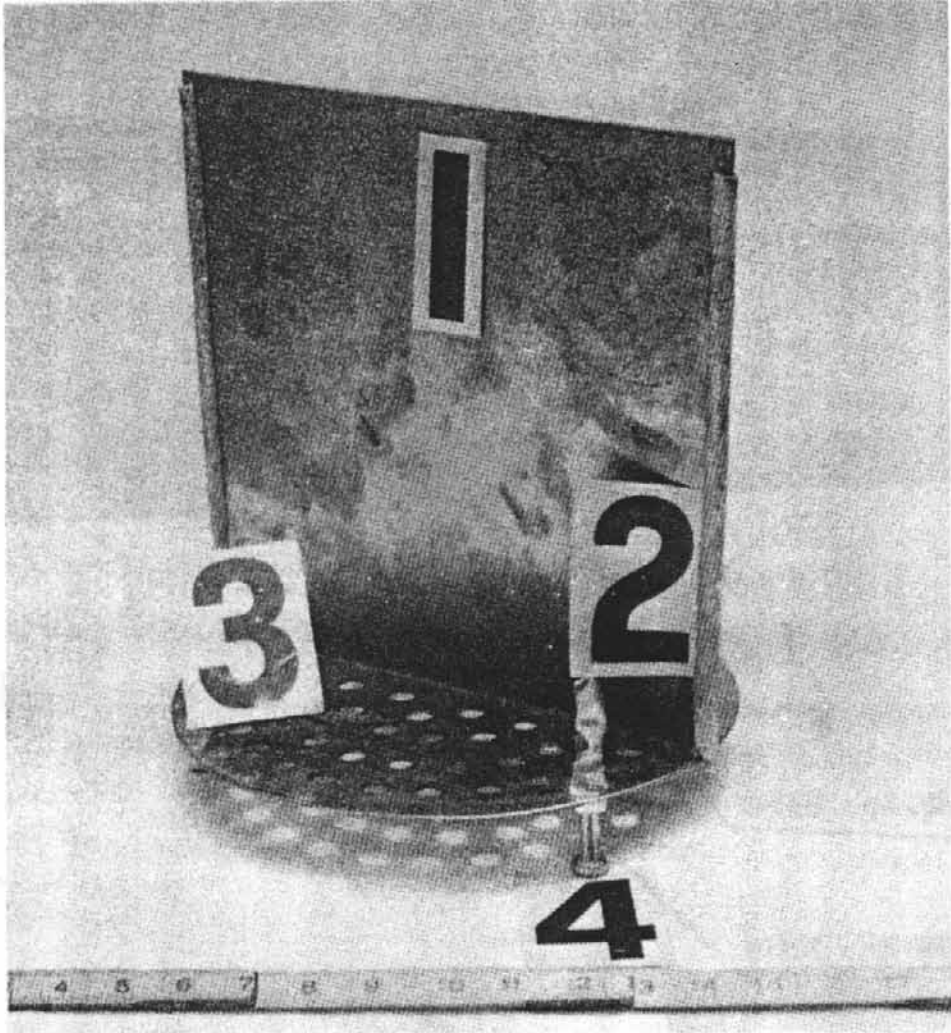

Fig. 2-17. Divider plate (#1) and bottom plate (#3), with standoffs (#4), for the filter unit. Note the high-temperature hose lining the sides of the divider plate.

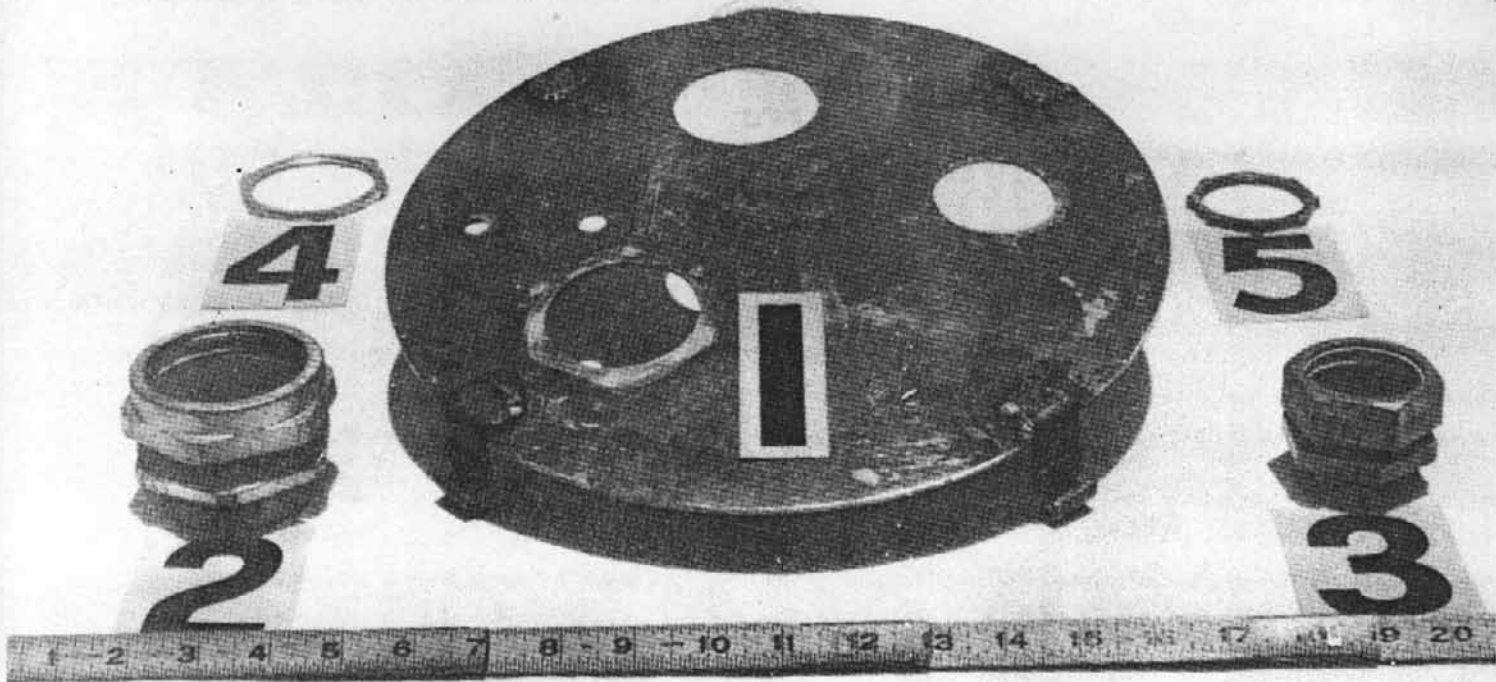

Fig. 2-18. Circular lid (#1) for the filter unit. Note the arrangement of the holes; divider plate would roughly run from 10 o'clock position to 4 o'clock position (assuming 12 o'clock is taken to be at the rear of the photograph). Also shown are the conduit connectors (#2 and #3) and accompanying nuts (#4 and #5) for inside the lid.

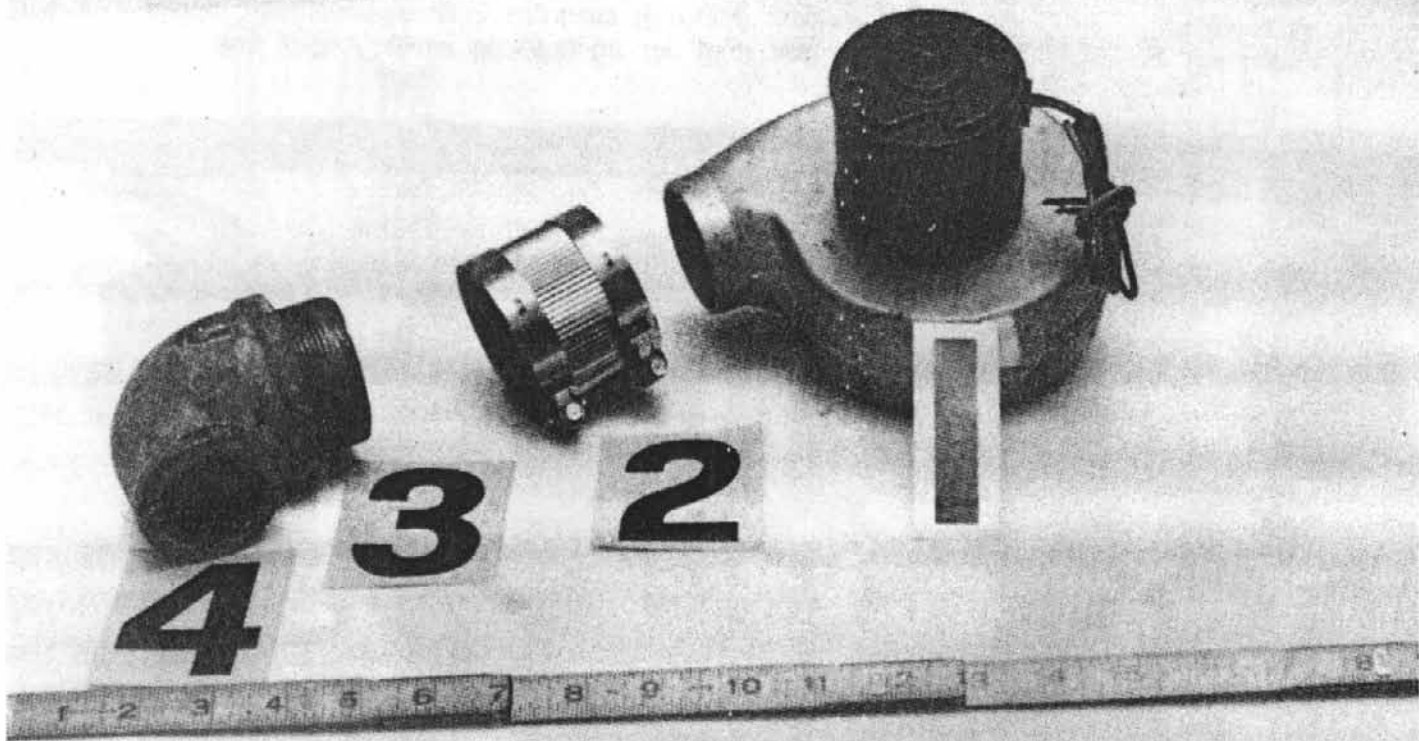

Fig. 2-19. Blower (#1) with exhaust extension assembly. Note adapter coupling (#2), pipe nipple (#3), and elbow (#4) for vertical exhaust pipe.

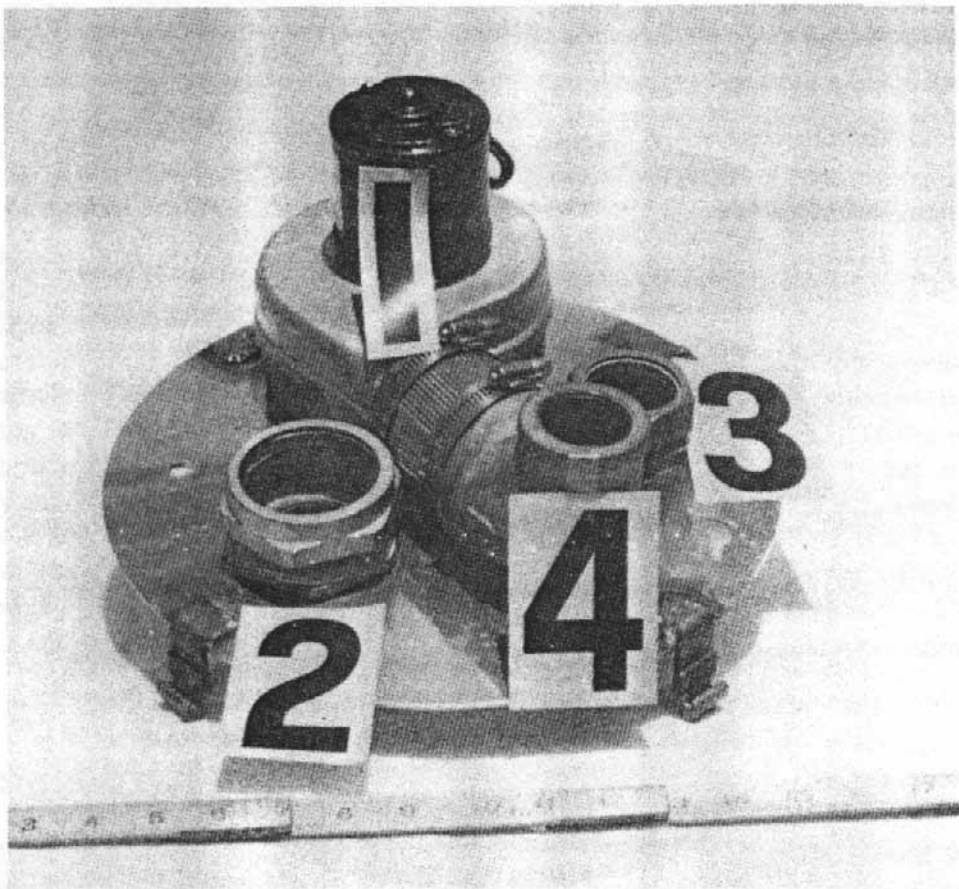

Fig. 2-20. Assembled and installed blower (#1), extension assembly (#4), and conduit connectors for gas inlet (#2) and outlet (#3) on lid of filter unit. Note hook attachments at edge of lid for latches.



Fig. 2-21. Filter container (#1) showing latches (#2) for lid and hose (#3) around top.

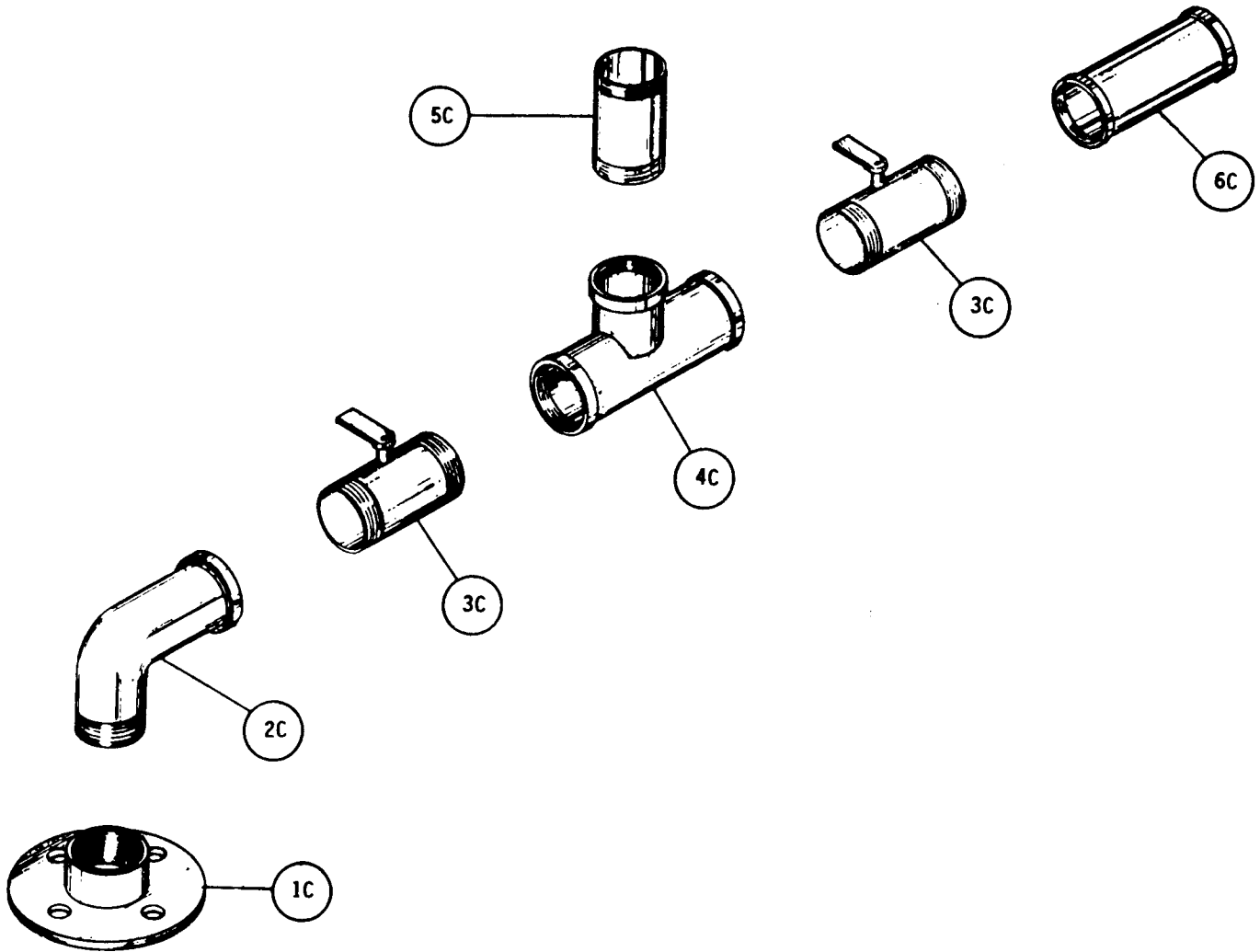

Fig. 2-22. Exploded, schematic diagram of the carbureting unit and control valves.

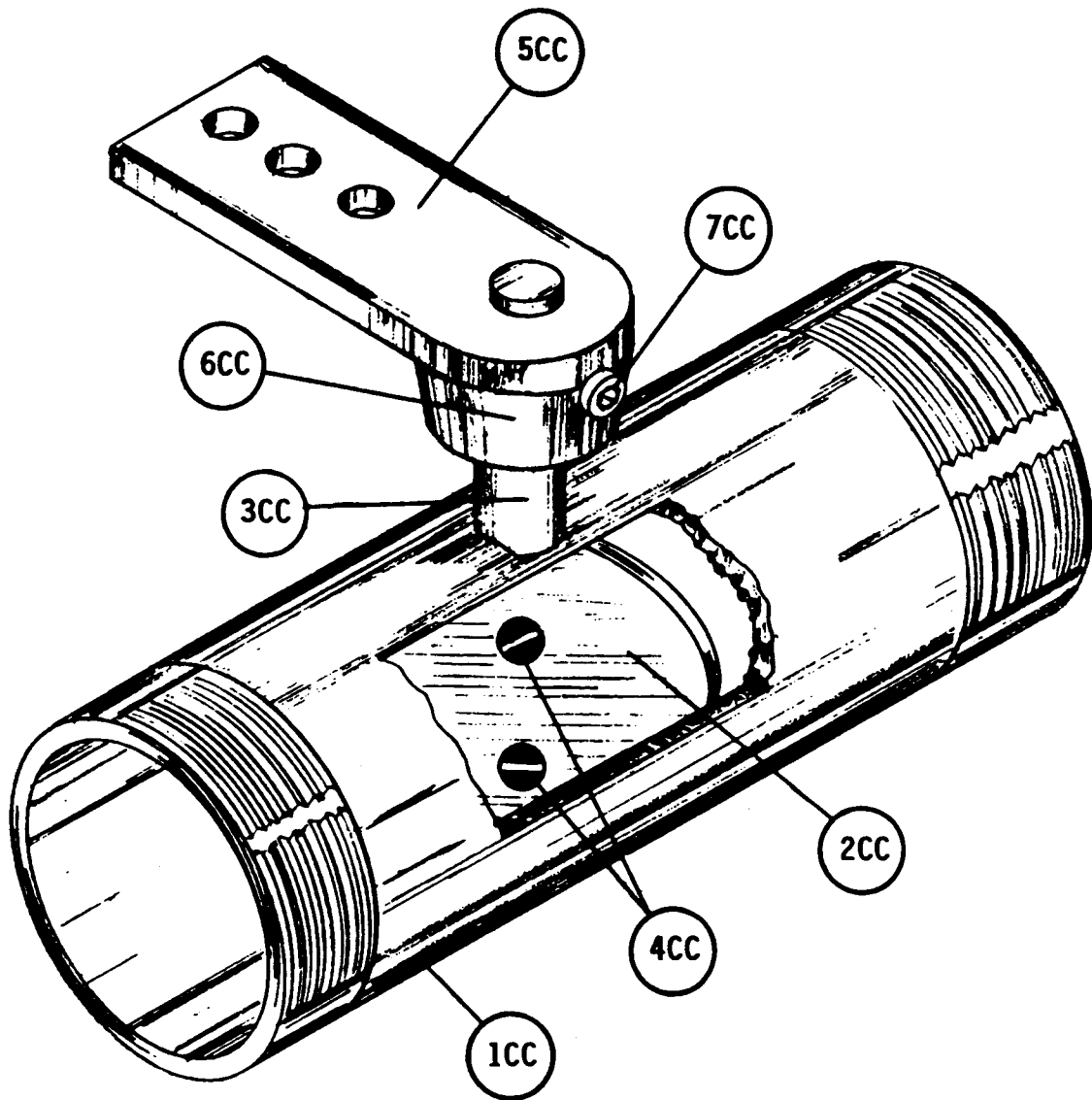

Fig. 2-23. Schematic diagram of a butterfly control valve.

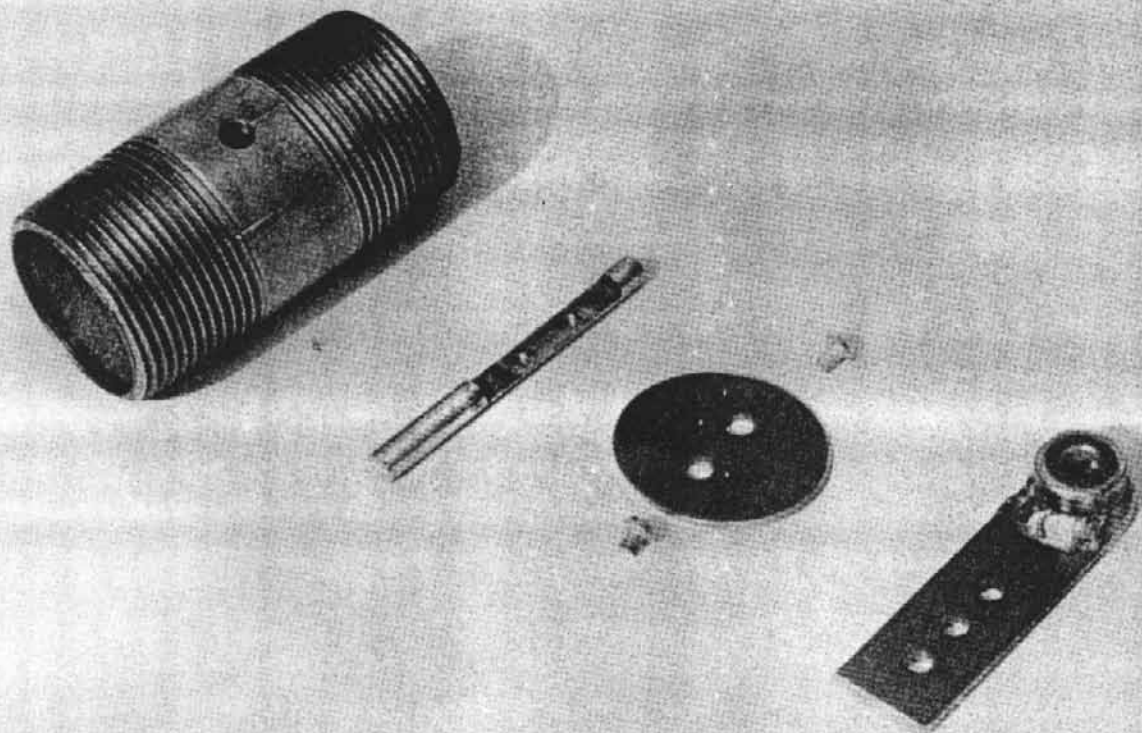

Fig. 2-24. Parts required for the butterfly valve.

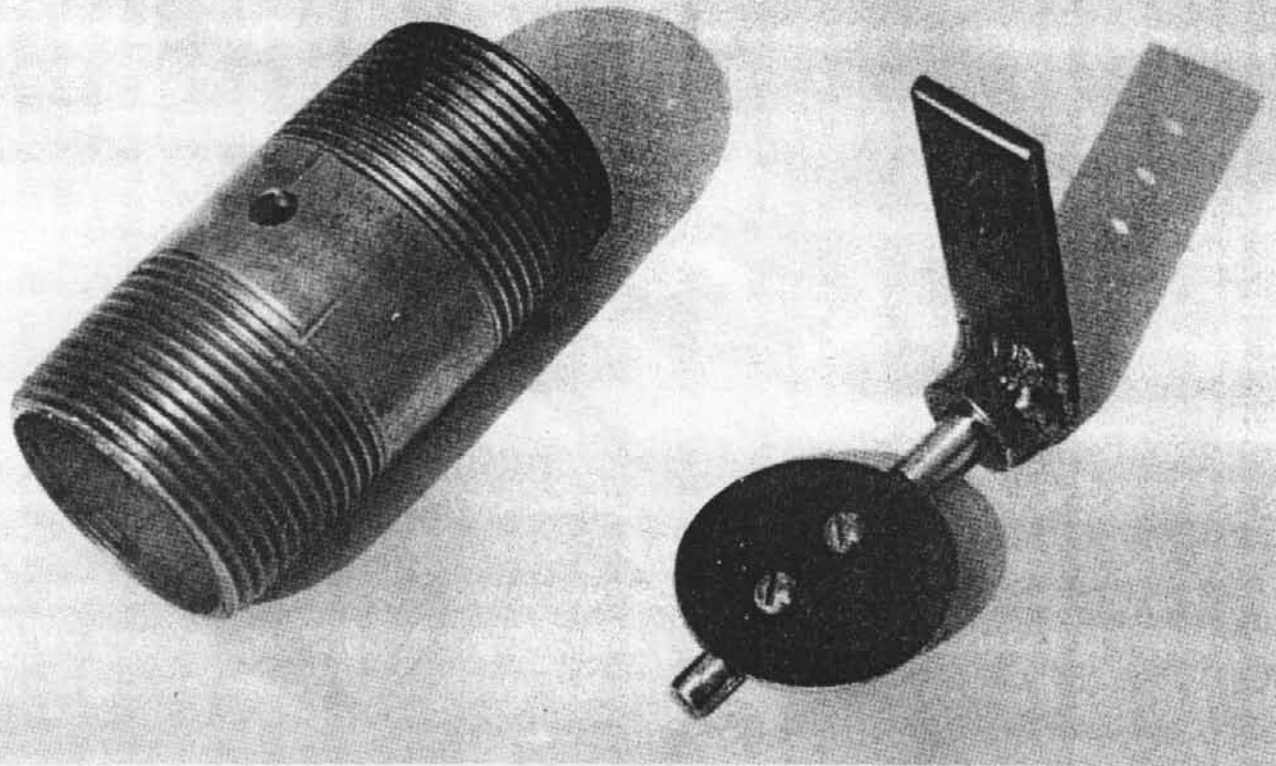

Fig. 2-25. Butterfly valve assembly. Note that the valve has been assembled outside of the valve body for clarity.

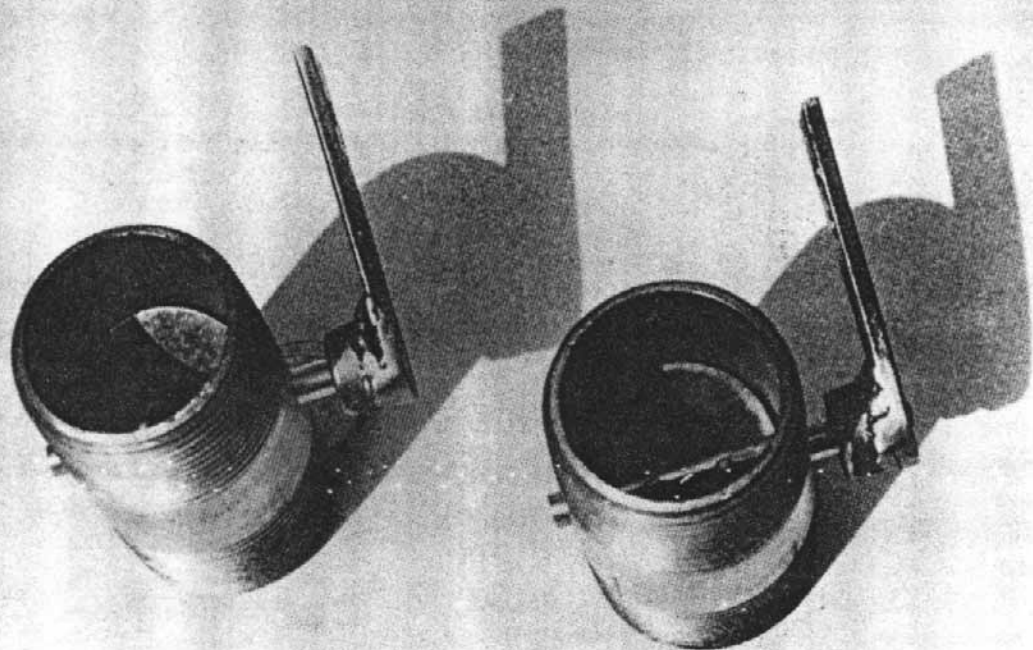

Fig. 2-26. Assembled butterfly valves.

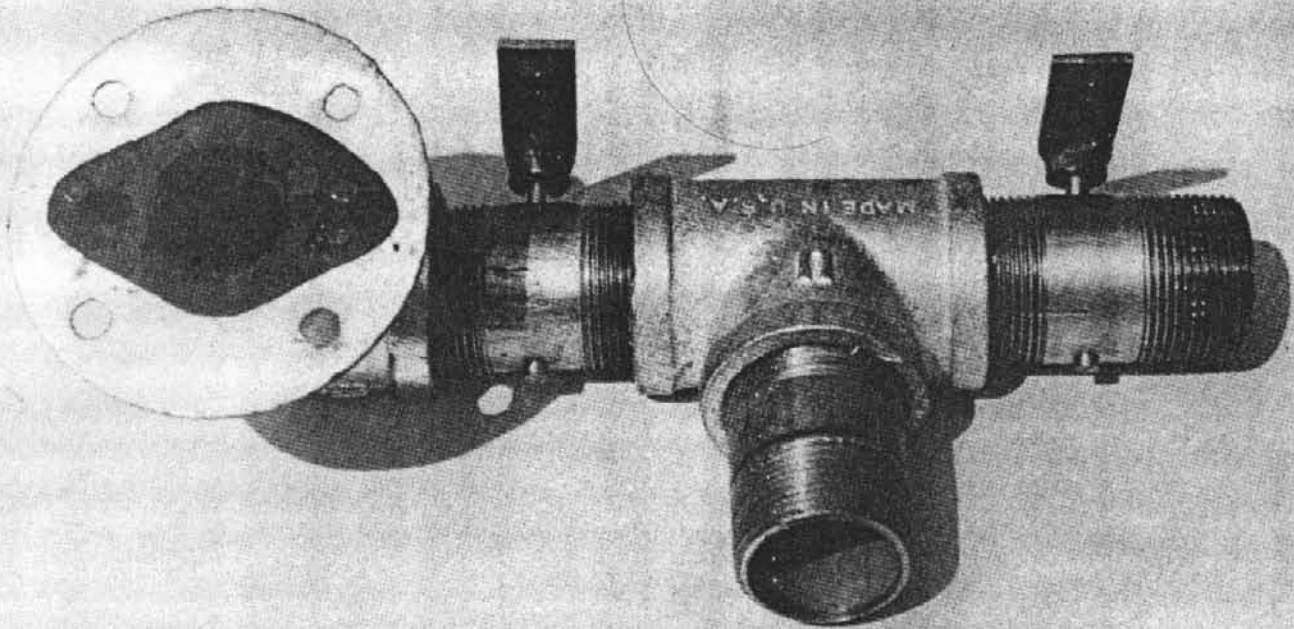

Fig. 2-27. Assembled carburetion unit. Note the gasket on the closet flange.

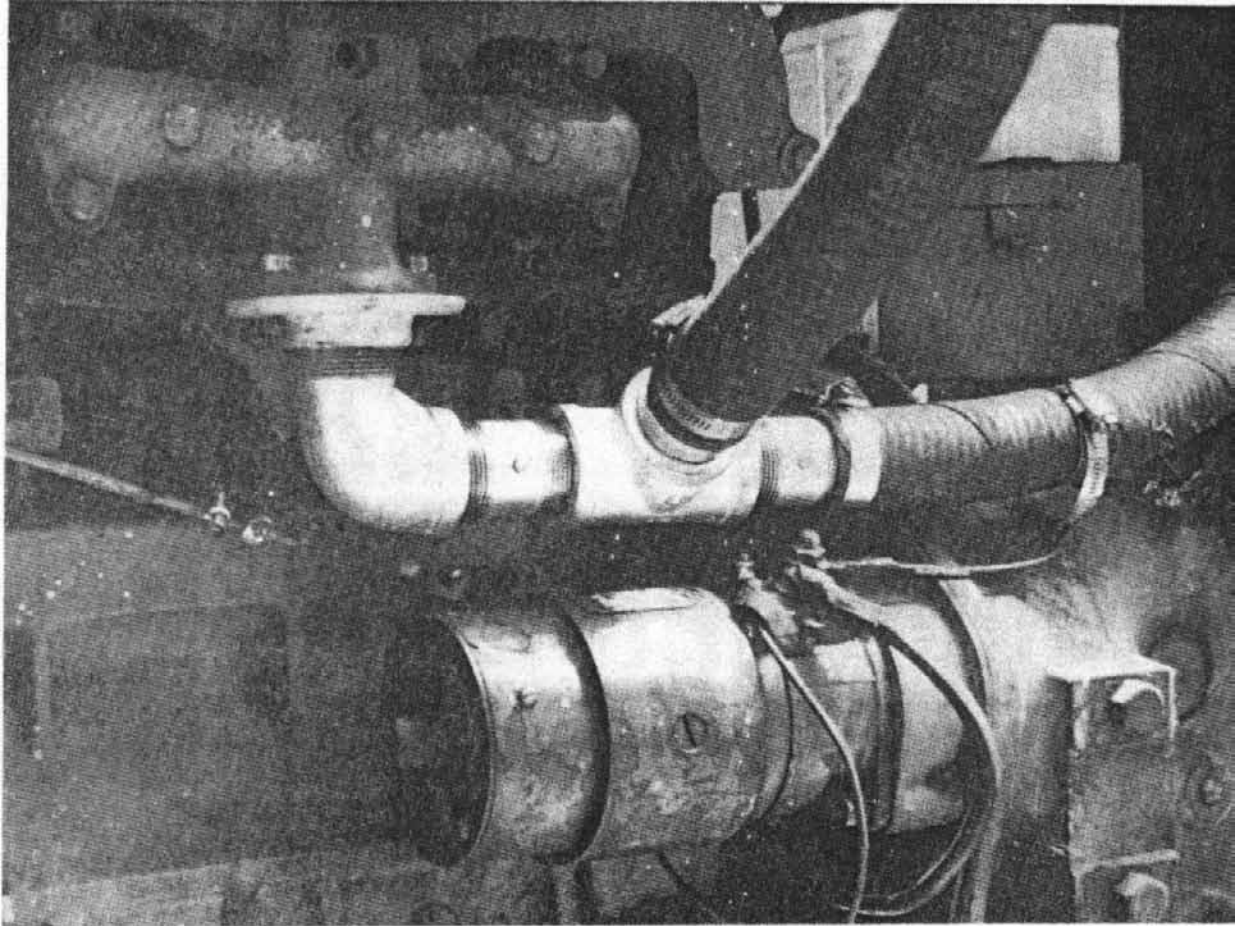

Fig. 2-28. Carburetion unit attached to engine's existing intake manifold. Wood gas enters from the side of the tee; air enters from the right-hand end. The butterfly valve at the right (partially obscured) is connected to the air control (choke) cable; the left valve is connected to the throttle linkage.

Table 2-1. List of materials for the gasifier unit and the wood fuel hopper

Item	Quantity	Description
1A	1	Metal pipe, tube, or other, open-ended metal cylinder; diameter and length from Table 2-2; minimum wall thickness of 1/4 in.
2A	1	Circular metal plate with thickness of 1/8 in.; diameter equal to outside diameter of Item 1A.
3A	1	30-gal metal oil drum or metal container with approximate dimensions of 18 in. (diameter) by 29 in. (height); container must have a bottom.
4A	1	10-quart stainless steel mixing bowl, colander, or other stainless steel bowl with approximately 14-in. diameter and 6-in. depth.
5A	1	2-in. metal U-bolt.
6A	1	3/16-in. metal chain with 1-in. links; 7 ft total length.
7A	3	1/4-in. eyebolts, 3 in. length with two nuts for each eyebolt.
8A	1	4-in. metal pipe nipple.
9A	1	Metal pipe cap for Item 8A.
10A	2	3-in. metal pipe nipple.
11A	2	Metal pipe cap for Item 10A.
12A		Shaker assembly; see Fig. 2-8.
1AA	1	Metal 1/2-in. pipe; 6 in. length.
2AA	1	Iron bar stock; square or round, 1/2 in.; 6 in. length.
3AA	1	1/2-in. bolt; 8 in. long.
4AA	1	Iron bar stock; rectangular, 1/4 by 1 in.; 10 in. length.
5AA	1	1/2-in. flat washer.
6AA	2	1/2-in. nuts.
7AA	1	Metal pipe cap or bushing for Item 1AA.

Table 2-1. (continued)

Item	Quantity	Description
13A	1	Iron bar stock; rectangular, 1/4 by 2 in.; 10 ft length.
14A	25	1/4-in. bolts; 3/4 in. length; with nuts.
15A	1	20-gal metal garbage can or metal container with approximate dimensions of 18 in. (top diameter) by 24 in. (height); bottom is not required.
16A	1	Lid for 20-gal garbage can.
17A	1	Garden hose; 1/2 to 5/8 in. diameter; length equal to circumference of Item 15A.
18A	1	Foam weather stripping with adhesive backing; 1/4 by 1 in.; length equal to circumference of Item 15A.
19A	1	Iron bar stock; rectangular, 1/4 by 2 in.; 10 ft length.
20A	12	1/4-in. bolts; 3/4 in. length; with nuts.
21A	4	Metal triangles; 2 by 2.5 in., 1/8 to 1/4 in. thick.
22A	2	Metal eye hook.
23A	2	Screen door spring, 14 in. length.
24A	1	Lock ring for 30-gal (or larger) oil drum.
25A	4	Metal squares; 2 by 2 in., 1/4 in. thick.
26A	4	3/8-in. bolts; 3 in. length.
27A	1	Tube of high temperature silicone or liquid high temperature gasket material.
28A	1	60-lb. sack of hydraulic or other waterproof cement [such as SEC-PLUG (tm), which is manufactured by the Atlas Chemical Company, Miami, FL].
29A	1	2-in. pipe, electrical conduit, flexible automobile exhaust pipe, or other metal tubing; 6-ft minimum length. Pipe must be able to withstand temperatures of 400°F.

Table 2-2. Fire tube dimensions

Inside diameter (inches)	Minimum length (inches)	Engine power (horsepower)	Typical engine displacement (cubic inches)
2 ^a	16	5	10
4 ^a	16	15	30
6	16	30	60
7	18	40	80
8	20	50	100
9	22	65	130
10	24	80	160
11	26	100	200
12	28	120	240
13	30	140	280
14	32	160	320

^aA fire tube with an inside diameter of less than 6 in. would create bridging problems with wood chips and blocks. If the engine is rated at or below 15 horsepower, use a 6-in. minimum fire tube diameter and create a throat restriction in the bottom of the tube corresponding to the diameter entered in the above table.

NOTES:

For engines with displacement rated in liters, the conversion factor is 1 liter = 61.02 cubic inches.

The horsepower listed above is the SAE net brake horsepower as measured at the rear of the transmission with standard accessories operating. Since the figures vary when a given engine is installed and used for different purposes, such figures are representative rather than exact. The above horsepower ratings are given at the engine's highest operating speed.

Table 2-3. List of materials for the primary filter unit

Item	Quantity	Description
1B	1	5-gal metal can or other metal container with minimum dimensions of 11.5-in. diameter and 13 in. tall.
2B	1	Circular metal plate; diameter equal to 1/2 in. smaller than inside diameter of Item 1B; thickness of 1/8 in.
3B	3	3/8-in. bolts; 3 in. length with two nuts for each bolt.
4B	1	Rectangular metal plate; width equal to 1/4 in. smaller than inside diameter of Item 1B; height equal to 2.5 in. smaller than internal height of Item 1B; 1/8 in. thick.
5B	1	High-temperature hose, 3/8 to 5/8 in. diameter; length equal to circumference of Item 1B.
6B	1	Circular metal plate; diameter equal to outside diameter of Item 1B; thickness of 1/8 in.
7B	1	12-volt blower (automotive heater type); case and fan must be all metal.
8B	1	Metal extension pipe for blower outlet, including elbows and connections for vertical orientation; 1 ft. minimum length.
9B	1	Cap for Item 8B; plastic is acceptable.
10B	1	1.25-in. metal pipe, electrical conduit, automotive exhaust pipe, or other metal tubing; 2 ft minimum length.
11B	3	Metal latch for securely connecting Items 1B and 6B together. Such devices as suitcase or luggage catches, bail-type latches, window sash catches (with strike), or wing-nut latches are acceptable.
12B	1	High-temperature hose, 3/8 to 5/8 in. diameter; length equal to three times the height of Item 4B.
13B	1	Metal 1/2-in. pipe, threaded on one end; 8 in. length.
14B	1	Metal pipe cap for Item 13B.

Table 2-4. List of materials for the carbureting unit

Item	Quantity	Description
1C	1	1.25-in. closet flange.
2C	1	1.25-in. male-to-female 45° pipe elbow.
3C		Butterfly valve; see Fig. 2-23.
1CC	2	1.25-in. pipe nipple or threaded length of pipe, 3-in. length.
2CC	2	Oval metal plate; 1/16 in. thick; short dimension equal to inside diameter of Item 1CC; long dimension equal to 1.02 times the short dimension.
3CC	2	3/8-in. diameter rod; 2.5 in. length.
4CC	4	3/16-in. screws; 3/16 in. length.
5CC	2	Flat bar stock; rectangular, 1/2 by 3 in.; 1/8 in. thick.
6CC	1	7/16-in. nut.
7CC	1	1/8-in. set screw.
4C	1	1.25-in. tee with all female threads.
5C	1	1.25-in. pipe nipple or threaded length of pipe, 3 in. length.
6C	1	1.25-in. pipe or hose.
7C	1	Gasket material; sized to cover Item 1C.
8C	1	Tube of pipe compound or Teflon tape for sealing threaded assemblies.

3. OPERATING AND MAINTAINING YOUR WOOD GAS GENERATOR

3.1 USING WOOD AS A FUEL

Because wood was used extensively as generator fuel during World War II, and since it is plentiful in most parts of the populated United States, it merits particular attention for use as an emergency source of energy. When used in gas generators, about 20 lb of wood have the energy equivalence of one gallon of gasoline.

Wood consists of carbon, oxygen, hydrogen, and a small amount of nitrogen. As a gas generator fuel, wood has several advantages. The ash content is quite low, only 0.5 to 2% (by weight), depending on the species and upon the presence of bark. Wood is free of sulphur, a contaminant that easily forms sulfuric acid which can cause corrosion damage to both the engine and the gas generator. Wood is easily ignited—a definite virtue for the operation of any gas generator unit.

The main disadvantages for wood as a fuel are its bulkiness and its moisture content. As it is a relatively light material, one cubic yard of wood produces only 500 to 600 lb of gas generator fuel. Moisture content is notoriously high in wood fuels, and it must be brought below 20% (by weight) before it can be used in a gas generator unit. By weight, the moisture in green wood runs from 25 to 60%, in air-dried wood from 12 to 15%, and in kiln-dried wood about 8%. Moisture content can be measured quite easily by carefully weighing a specimen of the wood, placing it in an oven at 220°F for thirty minutes, reweighing the specimen, and reheating it until its weight decreases to a constant value. The original moisture content is equivalent to the weight lost.

The prototype unit in this manual (with an 6-in.-diam firetube) operated well on both wood chips (minimum size: 3/4 by 3/4 by 1/4 in.) and blocks (up to 2-in. cubes); see Fig. 3-1 (all figures and tables mentioned in Sect. 3 are presented at the end of Sect. 3). Larger sizes could be used, if the firetube diameter is increased to prevent bridging of the individual pieces of wood; of course, a throat restriction would then have to be added to the bottom of the firetube so as to satisfy the dimensions in Table 2-2 in Sect. 2.

3.2 SPECIAL CONSIDERATIONS AND ENGINE MODIFICATIONS

To start the fire in the gasifier, the blower must be used to create a suction airflow through the wood in the hopper and downward in the firetube. If an especially high horsepower engine is to be fueled by the gasifier unit, then it might be necessary to install two such blowers and run them simultaneously during start-up.

When the wood gas leaves the gasifier unit, all the oxygen pulled down with the air through the firetube has been chemically converted and is contained in carbon monoxide (CO) and water (H₂O). The wood gas is unable to burn without being mixed with the proper amount of additional oxygen. If an air leak develops below the grate area, the hot gas will burn while consuming the available oxygen and will create heat; this will almost certainly destroy the gasifier unit if it is not detected soon. If an air leak develops in the filter unit or in the connecting piping, the gas will become saturated with improper amounts of oxygen

and will become too dilute to power the engine. Therefore, airtightness from the gasifier unit to the engine is absolutely essential.

Ideally, as the wood gas enters the engine manifold it should be mixed with air in a ratio of 1:1 or 1.1:1 (air to gas) by volume. The carburetion system described in this report will provide this mixture with a minimum of friction losses in the piping. The throttle control valve and the air control valve must be operable from the driver's seat of the vehicle.

The engine's spark plug gaps should be adjusted to between 0.012 and 0.015 in.; the ignition timing should be adjusted to "early."

3.3 INITIAL START-UP PROCEDURE

Initially, you will need to add charcoal to the grate below the firetube. Subsequent operation will already have the grate full of charcoal which has been left over from the previous operating period.

Fill the firetube with charcoal* to a level 4 in. above the grate. Fill the hopper with air-dried wood; then, proceed with the routine start-up directions below.

3.4 ROUTINE START-UP PROCEDURE

1. Agitate the grate shaker handle for at least twenty seconds to shake down the charcoal from the previous operating period.
2. Open the ash cleanout port and remove the ashes from the generator housing drum. Lubricate the threads of the cleanout port with high-temperature silicone, and close the cover of the cleanout port so that it is airtight.
3. Fill the hopper with wood fuel, and tamp the fuel down lightly. Either leave the lid completely off the fuel hopper, or adjust the opening around the lid to a 3/4-in. (or larger) clearance.
4. Close the carburetor's air control valve and remove the cover from the blower exhaust on top of the filter unit. Start the blower, and let it run for thirty seconds to avoid explosion of residual gas in the system. Then, with the blower still operating, proceed with the next step.
5. Open the ignition port, and ignite a 12- by 12-in. piece of newspaper; with a long stick or wire, push the burning sheet of newspaper into the grate; see Fig. 3-2. Close the ignition port. If no smoke appears at the blower's exhaust port, repeat the start-up

*Charcoal produced for outdoor barbecue grills is not well suited for gas generator use. To produce a better grade of charcoal, place a rag soaked in alcohol on the grate, or place 3 to 5 pages of newspaper on the grate, then fill the fire tube to a height of 10 to 12 in. with well-dried wood. Have all the valves closed and let the fire tube act as a chimney until the wood is converted to charcoal.

sequence from Step (e). If repeated attempts fail, new charcoal should be added to the unit as described in Sect. 3.3, above, and the start-up ignition sequence should be repeated.

6. After a few minutes of smoky exhaust, test the gas at the blower exhaust by safely and carefully attempting to ignite it; see Fig. 3-3. When the gas burns consistently well, stop the blower and replace the cover on the blower exhaust.
7. Open the carburetor's air control valve, adjust the engine's accelerator, and start the engine in a normal manner. Let the engine warm up slowly (two to five minutes). If the engine fails to start or dies repeatedly, restart the blower and repeat the ignition sequence from Step (4).

3.5 DRIVING AND NORMAL OPERATION

Shift gears so as to keep the engine speed (rpm) high at all times. Remember that it is the vacuum created by the pistons that provides the force which moves the gas from the gasifier unit into the engine.

Refill the hopper with wood (as shown in Fig. 3-4) before it is completely empty, but avoid refilling just before the end of engine operation. Periodically shake down the ashes from the grate. If your system is equipped with a gas cooler, drain water from the cooler from time to time.

Under operation in dry weather, the gasifier can be operated without the lid on the fuel hopper. However, when the gasifier unit is shut down the hopper must be covered to prevent air from continuing to burn the wood in the hopper. Under wet-weather operation, the cover must be placed on the fuel hopper, and then lifted up and rotated about 2 in. until the triangular pieces line up with the holes in the support bars. The tension of the screen door springs will then hold the lid closed. See Fig. 3-5 for clarification.

3.6 SHUTTING-DOWN THE GASIFIER UNIT

When shutting down the gasifier unit, turn off the ignition switch and open the carburetor's air control valve for ten seconds to relieve any pressure from within the system. Then, completely close the air control valve, and place the cover tightly on the fuel hopper. When restarting after a short stopover, let the engine warm up briefly. After longer stops (up to one hour), tamp down the wood lightly and try to use the blower for restarting without relighting the wood fuel. After very long stops (over two hours) the charcoal must be ignited again.

3.7 ROUTINE MAINTENANCE

Periodically check all nuts on the gasifier unit, the fuel hopper, the filter unit, and the carburetor for snugness; check all penetrations and fittings for airtightness. In addition, perform the following maintenance activities as scheduled:

3.7.1 Daily Maintenance

Open the ash cleanout port of the gasifier housing drum and remove the ashes after shaking the grate for at least thirty seconds. Replace the cover of the port after coating the threads with high-temperature silicone to ensure airtightness. Open the drain tube at the bottom of the filter container and allow any liquid condensate to drain out; remember to close the drain tube when finished.

3.7.2 Weekly Maintenance (or every 15 hours of operation)

Clean out the gasifier housing drum, the fuel hopper, and the filter. Rinse out the piping and connections to and from the filter. Replace the wood chips inside the filter. (The used wood chips from the filter can be dumped into the fuel hopper and burned to produce wood gas.) Use high-temperature silicone on all pipe connections and on the filter lid to ensure airtightness.

3.7.3 Biweekly Maintenance (or every 30 hours of operation)

Make sure that all pipe connections are secure and airtight. Check and tighten all mounting connections to the vehicle chassis. Check for rust on the outside of the gas generator housing drum, especially on the lower region. Coat with high-temperature protective paint as necessary.

3.8 OPERATING PROBLEMS AND TROUBLE-SHOOTING

A discussion of problems and their related causes and cures is contained in the troubleshooting guide of Table 3-1. Many operational problems can be traced to failure to maintain the airtightness of all piping connections and fittings; the piping should be routinely checked to prevent such problems.

3.9 HAZARDS ASSOCIATED WITH GASIFIER OPERATION

Unfortunately, gas generator operation involves certain problems, such as toxic hazards and fire hazards. These hazards should not be treated lightly; their inclusion here, at the end of this report, does not mean that these hazards are unimportant. The reader should not underestimate the dangerous nature of these hazards.

3.9.1 Toxic Hazards

Many deaths in Europe during World War II were attributed to poisoning from wood gas generators. The danger of "generator gas poisoning" was one of the reasons that such gasifiers were readily abandoned at the end of World War II. It is important to emphasize that "generator gas poisoning" is carbon monoxide (CO) poisoning. Acute "generator gas

poisoning" is identical with the symptoms that may develop if a heating stove damper is closed too early, or if a gasoline vehicle is allowed to idle in a poorly ventilated garage. Table 3-2 shows how poisoning symptoms develop according to the concentration of carbon monoxide in breathable air. It is important to note that rather brief exposures to very small concentrations of carbon monoxide result in undesirable physiological effects.

In case of carbon monoxide poisoning, first aid should consist of the following procedures:

1. Move the victim quickly out into the open air or to a room with fresh air and good ventilation. All physical exertion on the part of the victim must be avoided.
2. If the victim is unconscious, every second is valuable. Loosen any tight clothing around the neck. If breathing has stopped, remove foreign objects from the mouth (false teeth, chewing gum, etc.) and immediately give artificial respiration.
3. Keep the victim warm.
4. Always call a physician.
5. In case of mild carbon monoxide poisoning without unconsciousness, the victim should be given oxygen if possible.

3.9.2 Technical Aspects of "Generator Gas Poisoning"

Generator gas poisoning is often caused by technical defects in the functioning of the gas generator unit. When the engine is running, independent of the starting blower, the entire system is under negative pressure created by the engine's pistons; the risk of poisoning through leakage is therefore minimal. However, when the engine is shut off, formation of wood gas continues, causing an increase of pressure inside the generator unit. This pressure increase lasts for approximately 20 minutes after the engine is shut off. For this reason, it is not advisable to stay in the vehicle during this period. Also, the gas generator unit should be allowed to cool for at least 20 minutes before the vehicle is placed in an enclosed garage connected with living quarters. It should be emphasized that the gas formed during the shut-down period has a carbon monoxide content of 23 to 27% and is thus very toxic.

3.9.3 Fire Hazard

The outside of a gas generator housing drum may reach the same temperature as a catalytic converter on today's automobiles. Care should be taken when operating in areas where dry grass or combustible material can come into contact with the housing drum of the gas generator unit. If a gas generator unit is mounted on a personal car, bus, van or truck, a minimum 6-in. clearance must be maintained around the unit. Disposal of ashes must only be attempted after the unit has cooled down (to below 150°F). Such residue must be placed away from any combustible material and preferably be hosed down with water for absolute safety.

Table 3-1. Trouble-shooting your wood gas generator

Trouble	Cause	Remedy
Start up takes too long.	1. Dirty system or clogged pipes.	Clean the gasifier unit and all connecting piping.
	2. Blower is too weak.	Check the blower and test the battery's charge.
	3. Wet or poor quality charcoal.	Check charcoal and replace or refill to proper level.
	4. Wood fuel bridges in the fire tube.	Lightly tamp down the wood fuel in the hopper and fire tube or replace the fuel with smaller-sized chips.
Engine will not start.	1. Insufficient gas.	Use the blower longer during start up.
	2. Wet wood fuel.	Vent steam and smoke through the fire tube and fuel hopper for several minutes.
	3. Incorrect fuel-air mixture.	Regulate the carburetor's air control valve for proper mixing.
Engine starts, but soon dies.	1. Not enough gas has been produced.	Use low RPM while starting engine and do not rev engine for several minutes.
	2. Air channels through fire tube.	Tamp down wood fuel lightly in hopper. <u>Do not</u> crush charcoal above the grate.
Engine loses power under load.	1. Restricted gas flow in piping.	Reduce air mixture valve setting. Check for partial blockage of unit or piping.
	2. Leaks in system.	Check all covers and pipes for air tightness.

Table 3-2. Effects of breathing carbon monoxide

Carbon monoxide content of inhaled air (%)	Physiological effects
0.020	Possible mild frontal headache after two to three hours.
0.040	Frontal headache and nausea after one to two hours; occipital (rear of head) headache after 2.5 to 3.5 hours.
0.080	Headache, dizziness, and nausea in 45 min; collapse and possible unconsciousness in two hours.
0.160	Headache, dizziness, and nausea in 20 min; collapse, unconsciousness and possible death in two hours.
0.320	Headache and dizziness in 5 to 10 min; unconsciousness and danger of death in 30 min.
0.640	Headache and dizziness in 1 to 2 min; unconsciousness and danger of death in 10 to 15 min.
1.280	Immediate physiological effect; unconsciousness and danger of death in 1 to 3 min.

Source: Murakoa, J. S., *Shelter Habitability Studies—The Effects of Oxygen Depletion and Fire Gases on Occupants of Shelter*, NCEL-TR-144, U.S. Naval Civil Engineering Laboratory, Port Hueneme, CA, July 1961.

BIBLIOGRAPHY

- Anonymous, "Coast to Coast on Homemade Fuel," **The Mother Earth News** (No. 73) pp. 178-179 (January/February 1982).
- Anonymous, "Wood Gas Update," **The Mother Earth News** (No. 71) pp. 164-165 (September/October 1981).
- Anonymous, "Mother's Woodburning Truck," **The Mother Earth News** (No. 69) pp. 126-129 (May/June 1981).
- Chatterjee, A.K., *State of the Art Report on Pyrolysis of Wood and Agricultural Biomass*, PN-AAK-818, U.S. Department of Agriculture, Newark, NJ, March 1981.
- Cruz, I.E., *Producer-Gas Technology for Rural Applications*, published by the Food and Agriculture Organization of the United Nations, New York, NY, 1985.
- Donath, E.E., "Vehicle Gas Producers," **Processing Technology** (3) pp. 141-153 (1980).
- Eoff, K.M., and D.M. Post, "How to Power a Gasoline Engine with Wood," Technical Reprint No. 1, **The Mother Earth News**, Hendersonville, NC, 1981.
- Kaupp, A., and J.R. Goss, *State of the Art Report for Small Scale (to 50kW) Gas Producer-Engine Systems*, USDA Contract No. 53-319R-O-141, University of California, Davis, CA, March 1981.
- Miller, B., *State-of-the-Art Survey of Wood Gasification*, EPRI-AP-3101, Fred C. Hart Associates, Inc., Washington, DC, May 1983.
- Nygards, N., *Wood Gas Generator for Vehicles* (a translation of the Swedish book), published by Purwaco International, Minneapolis, MN, 1979.
- Oliver, E.D., *Technical Evaluation of Wood Gasification*, EPRI-AP-2567, Synthetic Fuels Association, Inc., Palo Alto, CA, August 1982.
- Reed, T.B. (ed), *A Survey of Biomass Gasification, Vol. I--Synopsis and Executive Summary*, SERI/TR-33-239 (Vol. I), Solar Energy Research Institute, Golden, CO, July 1979.
- Reed, T.B. (ed), *A Survey of Biomass Gasification, Vol. II--Principles of Gasification*, SERI/TR-33-239 (Vol. II), Solar Energy Research Institute, Golden, CO, July 1979.
- Reed, T.B. (ed), *A Survey of Biomass Gasification, Vol. III--Current Technology and Research*, SERI/TR-33-239 (Vol. III), Solar Energy Research Institute, Golden, CO, April 1980.
- Reed, T.B., and A. Das, *Handbook of Biomass Downdraft Gasifier Engine Systems*, SERI/SP-271-3022, Solar Research Institute, Golden, CO, March 1988.

Reed, T.B., and D. Jantzen, *Generator Gas: The Swedish Experience from 1939-1945* (a translation of the Swedish book, *Gengas*), SERI/SP-33-140, Solar Energy Research Institute, Golden, CO, January 1979.

Skov, N., and M.L. Papworth, *PEGASUS (Petroleum/Gasoline Substitute Systems)*, published by the Pegasus Publishing Co., Miami, FL, 1974.

Vietmeyer, N.L., et al., *Producer Gas: Another Fuel for Motor Vehicle Transport*, published by the National Academy Press, Washington, DC, 1983.

Wise, D.L. (ed.), *Fuel Gas from Biomass*, published by the CRC Press, Boca Raton, FL, 1981.

Construction Plans for Other Wood Gas Generator Units
can be Purchased from the Following Organizations:

PEGASUS Publishing Co.
1995 Keystone Blvd.
Miami, FL 33181

Missouri Gasification Systems, Inc.
Route 3, Box 198
California, MO 65018

Mother's Plans
The Mother Earth News
P.O. Box 70
Hendersonville, NC 28791

Nunnikhoven Industries
P. O. Box 580
Mediapolis, IA 52637



BIOMASS ENERGY FOUNDATION, INC.

"A non-profit, Federal tax exempt, Energy Research Institute"

The following Invention was presented and demonstrated at the I.G.T. "BIOMASS SYMPOSIUM" Washington D.C. March 28 - 1991.

"AN INVERTED DOWNDRAFT WOOD-GAS-STOVE AND CHARCOAL PRODUCER"

Harry La Fontaine Ph.D.

Biomass Energy Foundation Inc.
1995 Keystone Blvd.
Miami, Florida, 33181
Phone or FAX (305) 891-4601

ABSTRACT

In 1990 our Foundation Scientists developed a new technology to recover the wasted gas energy in the smoke from wood stoves, creating a clean pollution free wood-gas, and in the process producing charcoal for further cooking, or sale.

The stove is ignited from the top and burns down through a reservoir of wood, forming charcoal. No external power is needed, natural convection causes air to flow up through the wood, burning and gasifying most of the volatiles which then pass through the glowing charcoal, resulting in a relatively clean combustible gas. A secondary flow of preheated air is supplied to the combustible gases which result in an intense clean wood-gas flame with a miniscule amount of soot and smoke.

We have tested this wood-gas-stove in water heating experiments and found the efficiency to range from 50% to 70% based on the actual wood mass consumed. In addition, approximately 15% of the original wood mass is converted to charcoal which can be used for further cooking or providing support for the low-income sections of the Third World.

The goals of our volunteer research Foundation is to provide the know-how on such efficient Wood-Gas-Stoves, and help in planning for fast growing fuelwood plantations.

AN INVERTED DOWNDRAFT WOOD-GAS-STOVE AND CHARCOAL PRODUCER

INTRODUCTION

The threat of wide-spread famine hangs over the population of the Third World. The supply of wood needed to cook their meals is running out creating one of the most serious problems the world faces today. United Nation's Food and Agriculture Organization forecast that there will be a shortfall between supply and demand in 1995 amounting to the needs of 650 million people.

The problem can be solved only by increasing the supply or by decreasing the demand. Action must be taken quickly to stave off this pending catastrophe.

It is impossible to reforest the vast areas needed in the short time before the supply runs out. It is totally impractical for the Third World to import any appreciable portion of the billion tons of wood needed to fuel the cooking fires of the poorest people of the Third World. Alternate sources of energy such as solar can help very little. There is truly no hope for an adequate increase in the supply to meet the need.

Supply cannot be increased, but demand can be decreased. Mankind must solve this problem by reducing the wasteful use of wood for cooking over open fires; or nature will reduce the demand as, Malthus theorizes, by reducing mankind. Six hundred and fifty million people without wood to cook their food will die of starvation each year. This will reduce the demand temporarily, but is it an acceptable solution?

At the heart of the problem is the intolerable waste of more than 80% of the energy in fuelwood because people follow the footsteps of our ancestors, and cook over open fires as they did thousands of years ago. If people would change over to fuel efficient stoves, the demand for fuelwood would be reduced by 80%.

BACKGROUND

Most civilizations have depended on wood for their very existence. Forty centuries of history tell us that civilizations declined, collapsed or were conquered when they permitted their lands to become deforested. The ample forest of Crete became depleted by excessive usage of wood in their bronze foundries twenty centuries before Christ. Timber was then imported from Sicily, Cyprus and mainland Greece, but the industries and influence of Crete as a nation faded away.

Next Cyprus and Greece followed the same path. Cypriot copper production peaked in the 13th century BC, but declined thereafter, as the forest wasted away. Two hundred million oaks were used by the Greeks to process the silver which brought in much wealth.

This contributed to the devastation of their forest to such an extent that Plato described the remaining land as "something rather like the skeleton of a body wasted by disease; the rich, soft soil has all run away leaving the land nothing but skin and bone".

The Romans used their wood wastefully. Whole trees were burned to heat the baths where thousands of the citizens luxuriated. Rain washed the mountain sides clear of soil and pushed debris into the plains below, choking up the streams and turning lush land into uninhabitable swamps.

Most of the energy for the first industrial revolution in England came from the burning of wood in the Factories and much wood was used to build the British Navy whose ships were almost entirely wood. Within a century most of the forests disappeared and serious shortages of wood for heating and cooking made life difficult. However, England was able to substitute coal for the wood used, and soon steel replaced the wood in the ships. England was thus spared the fate suffered by Greece and Rome when their forests disappeared.

SUPPLY

A hundred years ago the forests of the Third World flourished. Ample supplies of wood were available for industry, construction and for people to cook their food. There was no need for economy. Most families cooked their meals in clay or metal pots supported by three stones over an open fire just like our ancestors did thousands of years ago. Each family used from two to four tons of wood per year.

Localized over-cutting caused serious ecological damage and Nations began to realize that their forests were important natural resources which should be protected, but made only feeble attempts to do so.

Programs for afforestation and reforestation have been woefully inadequate. Typical is the situation in the Sahel where only 3000 hectares are reforested annually instead of the 150,000 which are needed.

The supply of fuelwood for cooking decreases rapidly. Note the curve in Fig. 1. Forests, built up in the Third World over thousands of years, are being used wastefully for fuelwood at such a fast pace that the few remaining trees may be gone within 30 years.

There was a time when degraded land could be bought cheaply and reforested, but governments procrastinated, and the ecological damage has been so great that the devastation of the forests has almost passed the point of no return. The cost of reforestation is now enormous.

"The Christian Science Monitor," estimates that \$4 billion must be spent every five years on reforestation to avert an energy crisis. The World Bank outlined a plan to spend \$2 billion every five years to double the rate of reforestation, and set a stage for an expanded effort in the late 1990's. "Global Future" recommended that US AID increase its assistance for fuelwood plantations by \$10 million per year for at least five years. "The Global Possible" study calculates that preservation of the tropical forest, so crucial to all inhabitants of the earth, will cost \$5.3 billion a year from now until the end of the century.

Expenditure of such magnitude is well meant but totally inadequate to meet urgent demands of the fuelwood shortage. The FAO has predicted that by 1995 the Third World will face a shortfall of 650 million cu. m. of fuelwood.

This quantity would furnish the cooking needs of 650 million people. It is equivalent to the supply from 130 million hectares of forest.

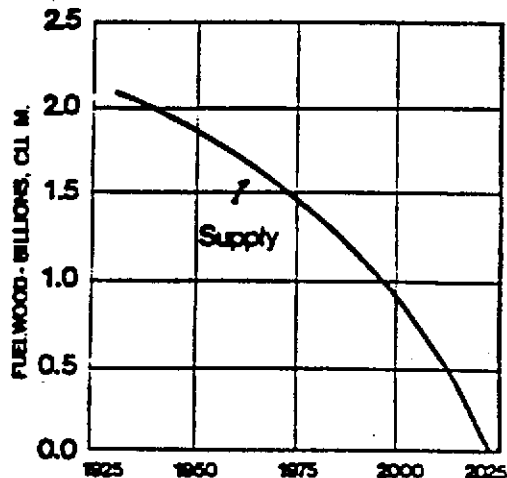

FIGURE 1 FUEL WOOD SUPPLY

Reforestation costs close to \$1000 per hectare, so to reforest 130 million hectares in 10 years would require an expenditure of \$13 billion a year. This amount far exceeds the different estimates, and is even more than double the figures from "The Global Possible". It is much larger than the \$1 billion yearly spent on reforestation by China each year.

Reforestation must be done regardless of the high cost. Forest are essential to the life cycle of mankind. However, it cannot be done quickly enough to correct the critical situation the Third World now faces.

In less than five years the demand will exceed the supply. It takes longer than that to start a forest, and bring the trees to the harvest stage. Meanwhile the supply of fuelwood will be continuing on its downhill path. Increase in supply cannot be a solution to the immediate problem.

The demand for fuelwood for cooking is increasing almost as fast as the supply decreases. Demand increases is shown in Fig. 2 at about the same rate as population increase. In 1950 demand was 700 million cu. m. per year and now it is twice that. In the Sahel, the Club du Sahel note that the demand was 16 million cu. m. in 1975 and is estimated to be 33.5 million cu. m. in the year 2000.

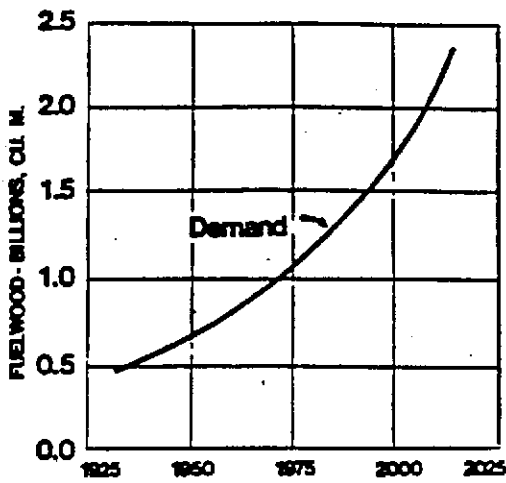

FIGURE 2 FUEL WOOD DEMAND

Family demand varies considerably from place to place. The Peace Corps reports Senegal and Upper Volta at 1.7 tons per year, the Sudan at 3.9 and the Tanzania at 7 tons because of its need for heating. Aprovecho Institute reports that average consumption is 4 tons per family. Figures from FAO indicate about 2 tons per year. Based on this conservative 2 tons estimate per family per year, the demand for 400 million families is 800 million tons annually.

Fuelwood on the open market is priced at the remarkably low figure of about \$30.00 per ton. This is only 1.5 cents per lb., but it is rising rapidly. The 800 million ton demand presently has a value of \$24 billion annually. As the supply decreases this figure will increase precipitously.

Demand for fuelwood can be reduced by conservation. Just as the demand for fossil fuels has been reduced by reduction in consumption.

DEMAND vs. SUPPLY

FOA's (predicted) annual shortfall of 650 million cu. m. by 1995 is an alarming projection. If a shortage of that magnitude exists five years from now and 650 million people have no fuel to cook their food. What about years 2,000, 2,010, 2,020, when the shortage will be still greater?

The supply and demand curves are combined in Fig. 3 to show their inter-relationship. The Third World rapidly approaches a "crucial crossover" when demand will exceed the supply unless we change the shape of the curves. Note that the FAO prediction of a 650 million cu. m. of fuelwood shortfall in 1995 is, de facto, predicting that the demand will exceed the supply as early as 1992-1993.

The two curves accurately portray the FAO prediction, but they ignore the solution offered by Malthus that nature will correct a serious shortages by reducing the population. The 650 million cu.m. shortfall needed for 650 million people will be wiped out by their starvation but the problem will recur again each year thereafter.

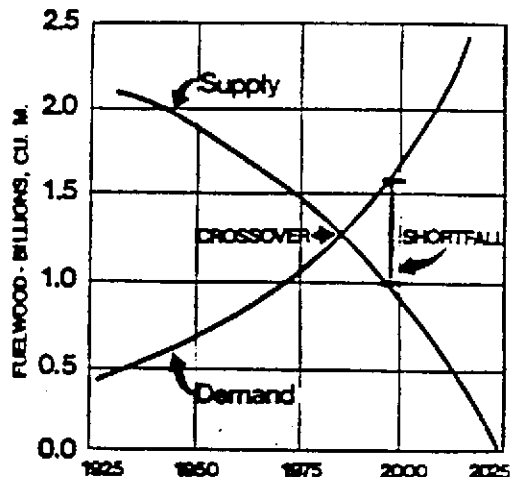

FIGURE 3 SHORTFALL AND CROSSOVER

That number of people will be sacrificed yearly on the altar of open fire cooking unless action is taken to teach the population of the Third World the up to date technology which can decrease their demand for fuelwood up to 80 %.

The price of fuelwood escalates rapidly. In Kathmandu, where the nearest trees are 180 miles away, the cost of fuelwood rose 300 % in two years. Nairobi in Kenya has pushed its forest the same distance away.

Demand must be reduced on an urgent basis or the forest of the Third World will disappear. The people will starve or out-migrate--- and to where will they out-migrate?

In Thailand the situation has become so serious that the government announce that it will use summary judgment and even execution to punish unauthorized cuttings in their National Forests. Even the most optimistic estimates of the rate of deforestation offers no hope of signifiant forest stands in Thailand beyond 1993.

Consumption of fuelwood in Africa far exceed the replacement capacity of trees so shortages of wood for cooking and for boiling of water have reached crisis proportions. In some areas food is inadequately cooked or meals omitted due to lack of fuelwood. Wood, which was once free, is now being sold on the open marked and the poor have to seek elsewhere for fuel to cook their meals.

ENERGY ALTERNATIVES

Dung has been used as fuel since time immemorial. FAO estimates that up to 400 million tons are used for cooking each year. If used as fertilizer, this amount of dung would supply enough nutrients to grow crops to take care of the food needs of 700 million people.

A high Indian official declared that : "The use of cowdung as a fuel is virtually a crime". Still, over 200 million tons of cowdung were burned in India 1989. It should not be used as a fuel but use of efficient stoves would decrease the use of dung by 80 %.

Charcoal is also commonly used, but it is not an energy alternate since it is made from wood. Present procedures for making charcoal are extremely wasteful, they discard the 60% of the energy from the combustion of volatiles. Million tons of pollution are released into the atmosphere from primitive charcoal production in the Third World thereby greatly contributing to the " Greenhouse Effect".

Coal is a good energy alternative for wood, at least where it is plentiful. It requires cooking equipment that is considerably more expensive than wood burning. Transporting coal in the Third World would be a problem.

Biogas generators can be an excellent energy alternative. They transform animal dung, human and vegetable wastes into easy burning methane gas. As a by-product they produce an excellent fertilizer. Many should be put to use quickly but progress has been slow. China has 7 million small and large Biogas digesters in operation and have plans for 70 million more in the future.

Solar energy for cooking does not look promising because the amount of energy from the sun reaching the ground is quite small compared to the energy needed for cooking. At noon about 400 Btu of heat falls on a square ft. of surface in an hour, compared to the 1500 Btu needed to cook a gallon of food.

The most efficient use of solar energy is in growing trees. E.F.Schumacher taught that a tree is an ideal three dimensional collector of solar energy. It collects energy during every daylight hour, transforms radiant energy into chemical energy, and stores it away indefinitely available for use as man needs it.

CONSERVATION - THE SOLE RECOURSE

When demand exceeds supply, people will suffer. The supply cannot be increased quickly enough, therefore demand must be reduced. It can be reduced by improving efficiency in cooking procedures.

Benjamin Franklin was inspired by the threat of a fuelwood shortage to invent the wood burning "Franklin Stove". He declared: "By the help of this saving invention our wood may grow as fast as we consume it, and our posterity may warm themselves at a moderate rate without being obliged to fetch their fuel over the Atlantic".

His stove was far more efficient for heating than an open fire since it reduced the heat lost up the chimney.

Unfortunately it is not an efficient cooking stove.

If all households used stoves with a minimum of 30% efficiency, the demand for fuelwood shown in Fig. 3 would be only 0,24 billion cu.m. rather than 1.2 . If the demand is lowered to that point, the forest could regenerate and the supply would increase.

400 million efficient stoves are needed to achieve this goal. It cannot be done overnight, but by massproduction efficient stoves can be built fast enough to keep the demand curve below the crossover.

An inversion which can be achieved practically is shown in Fig. 4. Demand can be reduced at a reasonable pace as stove production builds up the supply will increase equivalently.

Demand now increases at 2.2% rate while supply decreases at 2.7% of demand. The sum indicates that a 4.7% correction is needed urgently.

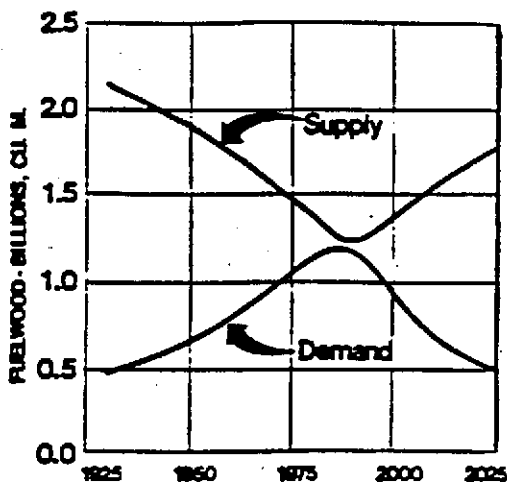

FIGURE 4 FUEL WOOD INVERSION

This can be accomplished by supplying 6% of the Households with stoves using 80% less fuel. The result will be a 4.8% reduction in demand.

Close to 600 million households burn wood for cooking, so 18 million such stoves are needed as quickly as possible. This should be a start up goal for annual production, which should then be stepped up, to supply all households with efficient stoves as quickly as possible.

As the demand for wood decreases, the supply will gradually start to increase. Forests will regenerate as the wood drain is relieved. The increase shown on the curve in Fig. 4. may be over optimistic but it should be assisted by reforestation programs.

When the majority of households are equipped with efficient stoves, a comfortable margin will develop between supply and demand even with a continuing 2.2% population increase.

THE OTHER SIDE OF THE COIN

Some authorities take a pessimistic view of the potential of efficient stoves to alleviate the fuelwood shortage.

Gerald Foley and Patricia Moss writing for Earthscan: "Improved Stoves in Developing Countries", have presented in interesting fashion a wealth of data in a worthwhile report. However, they seem to draw some conclusions which are not supported by facts.

One conclusion: "Stove programs are unlikely to have a major impact in preventing deforestation or reducing wood consumption." The body of the report states that there is no firm evidence that worthwhile savings in wood consumption occur, under actual working conditions, resulting from the use of modern stoves.

Thus their conclusion is based on no firm evidence. It could better be classified as an opinion rather than a conclusion. (Please note that their paper was written before the 1990 discovery of the inverted downdraft Wood-Gas-Stove technology).

Their report further states that it is hard to establish a reliable baseline against which energy saving achievements can be measured. Such a baseline is essential. One must know what the present day cooking efficiency is, to have a comparison for proposed improvements.

It is not easy to establish such a baseline, but information from the following reputable authorities provides solid support for a baseline figure of 6% efficiency of cooking over open fires and conventional inefficient chulas (stoves) in use today.

Howard S. Geller in a paper presented before the ASTRA Indian Institute states that the cooking efficiency in the Ungra Area averages only 6%.

J. Goldenberg and R.I. Brown report to the Univ. of Sao Paulo in Brazil that the efficiency of primitive wood stoves is 5%.

Nigel Smith in a "WORLD WATCH" paper No. 42 states that open fires are only 6 to 8% efficient.

TATA Energy Research Institute - open fires protected by a few stones give efficiency as low as 5 to 8%.

Financial Express, Bombay, July 1981: "Prevailing 5 to 6% efficiency in most open inefficient chulas" (stoves)

From the above, our Foundation considers that 6% is a reasonable average which may well be used as a baseline.

In addition it is interesting to note that the total consumption of wood annually, compared to the amount of cooking done, gives a positive indication that open fire cooking efficiency is not more than 6%.

A household using 2 tons of fuelwood per year at 6% efficiency would boil 30 lbs of food per day, and keep it boiling for thirty minutes. Few families would consume this quantity of food or could even afford it.

At the other end of the scale is the measured efficiency of many modern stoves, using test procedures set up by top organizations, including Tata Energy Research Inst., Eindhoven Univ., I T D G Approvecho Institute and VITA . Many stoves tested by them show efficiencies in excess of 30%.

The Earthscan conclusion that: "Energy savings in the laboratory are a poor guide of what is achievable in practice seems to question either the intelligence or integrity of many individuals, who have devoted much effort to explain remote incidents, where results in practice differ from laboratory measurements. Energy savings shown in the laboratory when properly interpreted are an excellent guide for what will be achieved by efficient stoves in practice.

TIME RUNS OUT

The Third World is only a few years away from a terrible catastrophe. Reforestation programs now under way will accomplish nothing in the immediate future. Decades will pass before intensive silviculture proves itself. It takes time to grow a tree in Brooklyn or any other place.

Deforestation is proceeding at the rate of 20 million hectares per year. Reforestation of that lost acreage costs 20 billion per year, which is almost four times the value set by Global 2000 as needed to preserve the tropical forest. As a matter of fact less than \$1 billion is spent so there is a shortfall of \$19 billion per year.

Fortunately, there is time to set up and mass-produce enough efficient stoves to stem the tide. The task will not be easy but it is far from impossible. Forty million stoves are needed yearly, starting now, to hold a gap between supply and demand.

Production of kerosene stoves increased in the USA from 20,000 in 1977 to 1.2 million in 1981, so 40 million simpler wood stoves is a reasonable figure. Less than 10 thousand unskilled workers after 3 week training can build 3 million wood stoves per year using inexpensive simple handtools.

The starvation crisis has not come without due warning. Forty years ago the great Mahatma Gandhi foresaw the impending shortage of fuelwood and urged that efficient stoves be developed to reduce the wasteful consumption of wood. Progress has been very slow. Since then, probably less than 10 million better stoves have been put into service. Nearly all cooking stoves in India are built on site and are not mass-producible.

To reach high production goals, it seems mandatory that emphasis be placed on factory made mass producible stoves.

THE WOOD GAS TECHNOLOGY

BACKGROUND

The use of wood to cook food is as old as mankind, but burning wood only utilizes 1/3 of the present energy; 2/3 goes into the air with the smoke contributing to the "Greenhouse" effect. It is estimated that the Third World countries pollute the atmosphere with over 3 billion tons of carbon dioxide per year from cooking with wood and dung on inefficient stoves.

Gasifying biomass, started in Europe in the mid 18th. century. Such manufactured Gas was widely used for street lights and was piped into houses for heat, cooking and light.

After the discovery of oil in the 1800's, the entire world changed over and most of the gas factories all over the world were dismantled.

During W.W.I and II, smaller portable wood and charcoal gas producers were re-invented and many millions were used in the occupied Countries to power combustion engine equipment. Trucks, Tractors, Fishing Boats and Farm Machinery.

Our Foundations senior scientist and CEO Dr. Harry La Fontaine was from 1940 to 45 engaged in designing such wood gas generators in his native country, Denmark.

After immigrating to the US in 1950 and retiring from University teaching in 1978, he, after requests from DOE and other US agencies, agreed to research and develop thermo-chemical biomass Gas technology in the U.S.

The Biomass Energy Foundation Inc. was started in 1980, and granted I.R.S. 501 3c tax-exempt status in 1983, as a scientific research organization. The board members hold Ph.D.'s or/and other degrees. They are volunteers and retired from academic positions around the World. None receive salaries or remuneration, except for travel and per diem expenses.

Since 1980 the Foundation has invented and developed several new concepts in the field of biomass gasification and has built and demonstrated automobiles, trucks, tractors, and electric producing generators operated solely on wood gas.

Demonstrations and lectures at Energy Seminars and many U.S. Universities were sponsored by DOE, FEMA, TWA. Oak Ridge National Laboratory and the U.S. Academy of Sciences. At the 1986 I.G.T. Seminar the Foundation demonstrated the Worlds first stratified, electricity producing wood-gas generator.

"Stratified gasification" is a new development in wood gasification. It is a balanced negative pressure concept, where the old expensive vacuum sealed gasifier construction was no longer necessary, and it permitted easy loading of feedstock and continuous operation. This new invention has several popular names including "Stratified Gasification", "Open Top Gasification", or the sexy name "Topless Gasification".

In 1987 our Foundation (under contract with DOE, FEMA and Oak Ridge Laboratories) developed a design for a simple, inexpensive homebuilt, wood-gas generator for powering tractors and other farm equipment in case of a severe fossil fuel emergency. (see page 14)

During a lecture trip to the far east in 1988, sponsored by the U.S. agencies SCORE and AID, our members became aware of the Third World's wood crisis, and after 2 years of extensive research, our Foundation developed the World's first naturally aspirated wood-gas-stove in 1990.

The stratified, inverted wood-gas-stove concept is a new and novel approach to remove the gas energy from the wood, cook the food with the wood-gas and retrieve the charcoal for further cooking or sale. (see pictures on page 16-17-18)

Fabricated in the Third World, such lightweight 7.5 pound metal wood-gas-stoves would cost \$7.00 to \$10.00 (1990 estimate). By using 80% less wood, each wood-gas-stove will save 10 times the cost of the stove each year.

The wood-gas-stove operating at 50 to 60% efficiency, will boil 4 liter of water in less than 15 minutes, cook a kilo of rice in only twice that time, all on one pound (450 gram) of wood chips, tree limbs or other wastewood.

No electric or other external power is needed, the wood gas stove operates on the natural internal updraft, created by the heat in the pyrolysis zone and the gas burning zone at the top section of the wood-gas-stove. (see schematic on page 15)

The wood-gas-stove consists of two stages. Gasification takes place in the lower stage, where the gasification occurs and the residual charcoal is produced. (see schematic page 15)

Combustion of the produced gas take place at the upper burner section where the gas is mixed with the proper amount of secondary air.

The secondary air is heated by moving upward in the small area between the fire box and the isolated outer walls. The amount of primary and secondary air is very critical for efficient operation. The tolerance in the controlling valve system must be exact, which can best be assured by a factory type of production.

Unlike any other stoves, the stratified wood-gas-stove is designed to be ignited from the top and the fire burns downward.

This concept, starting the fire at the top of the wood, makes it much easier to ignite and operate, while the fire is burning downward it creates layers of charcoal above the wood, this novel procedure cleans the gas on its upward journey to the burner, and arrests sparks and flyashes.

The glowing layers of charcoal above the burning wood convert the produced carbon dioxide to carbon monoxide and mix it with the hydrogen and methane present to a gas which is not combustible because the all the oxygen in the primary air has been used up in the pyrolysis zone.

When the wood-gas reaches the secondary heated air inlet in the burner section of the stove, it is mixed with oxygen, becomes combustible and ignites.

The thermochemical reaction of biomass (wood) in the process of gasification and combustion, including the pyrolysis, the oxidation of carbon and oxygen, the reduction of carbon, carbon dioxide and water; is well documented since the mid 18th century, as the "The Boudouard and water-gas reaction" also named "Adiabatic Char Gasification".

The chemical reaction and thermochemical conversion which takes place in the wood gasification process is too long and complicated to be covered in this paper. Such knowledge is not necessary for building and operating wood-gas-stoves. Books and manuals on this subject are listed in the enclosed reference section.

In principle, the stratified, inverted wood-gas-stoves can be scaled up to any size, because it operates as a plug-flow reactor, with the air and fuel uniformly mixed. A 30 inch, 0.77 m. internal diameter firebox wood-gas-stove is estimated to produce 750 kw.energy.

The first question many people ask at our Foundation's wood-gas Seminars and Workshops around the World is:

"Where does the combustible wood-gas come from?".

Try to light a wooden match, hold it in a horizontal position and notice that when you strike the match it is not actually burning, but while the wood becomes charcoal it is releasing wood-gas that begins to burn brightly a short distance from the match.

Notice the gap between the match and the luminous flame; this zone contains the wood-gas, which only starts burning when mixed with air which contains oxygen.

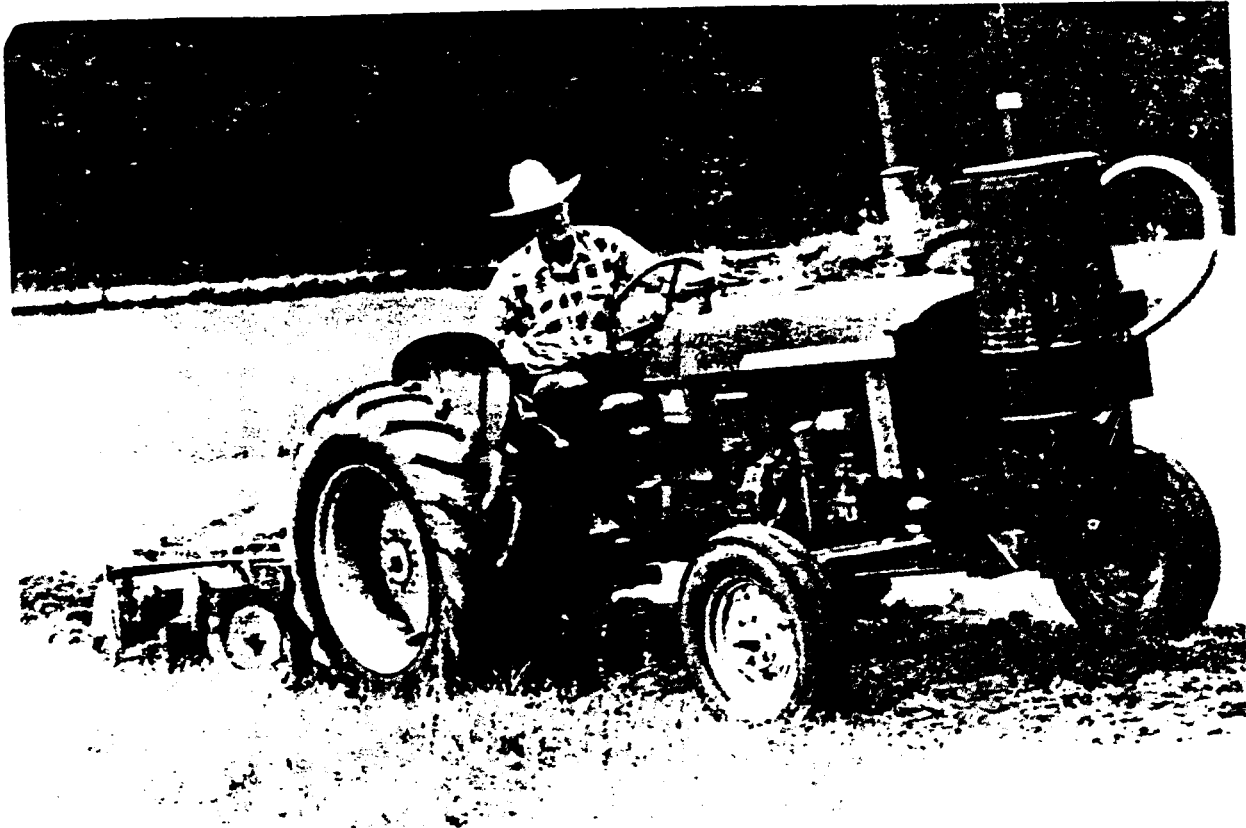

In 1987 our Foundation developed and built the above "Stratified Wood Gas Generator" for "FEMA" and produced a do-it-yourself manual for building emergency gas-generators. From this concept, which can power engines from 5 to 5000 HP, the new idea of "wood-gas-stoves" was developed, using the same basic technology described in the schematic below.

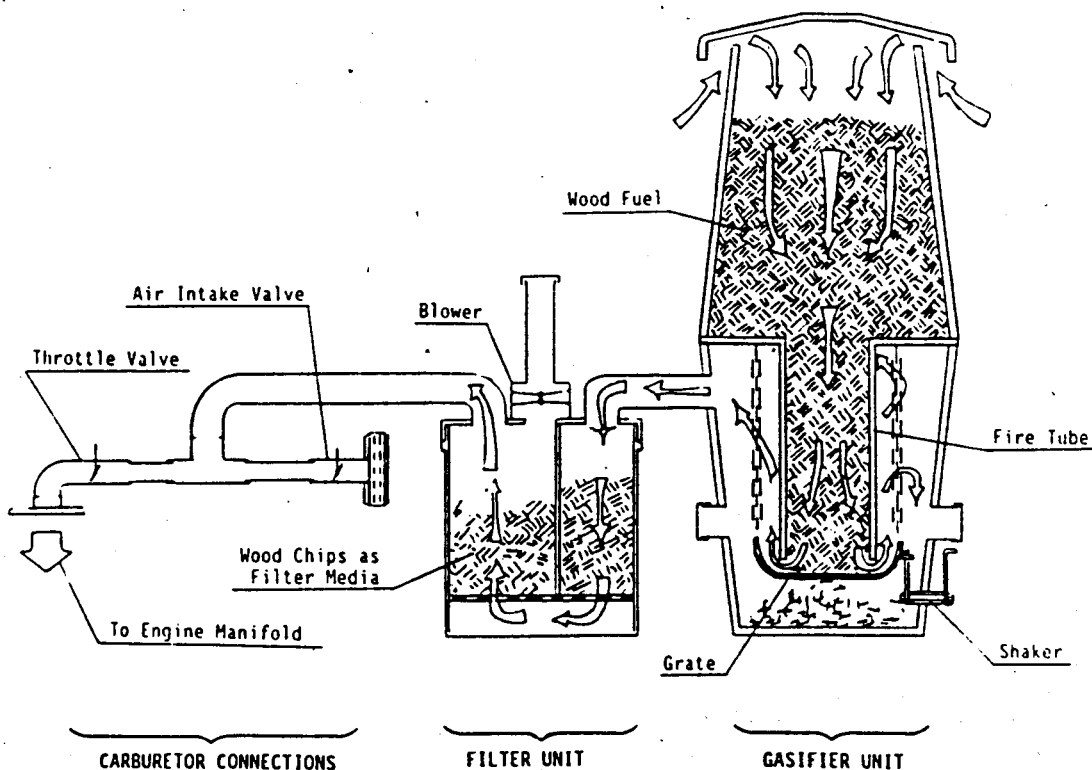

Schematic view of the stratified, downdraft gasifier.



This is the smallest practical, inverted wood-gas-stove for gasifying, maximum one pound of wood, dung, peat or other carbon materiel.

Fabricated from Sheet metal:
weight: 7 1/2 lb.
Size: 14" X 9"

The removable Firepot is 9" high and 4 3/4" in diameter.

It can contain up to 1 lb. = 450 gr. of any kind of dung and waste wood from 1/2" woodchips to limbs and cuttings up to: 9" by 3".

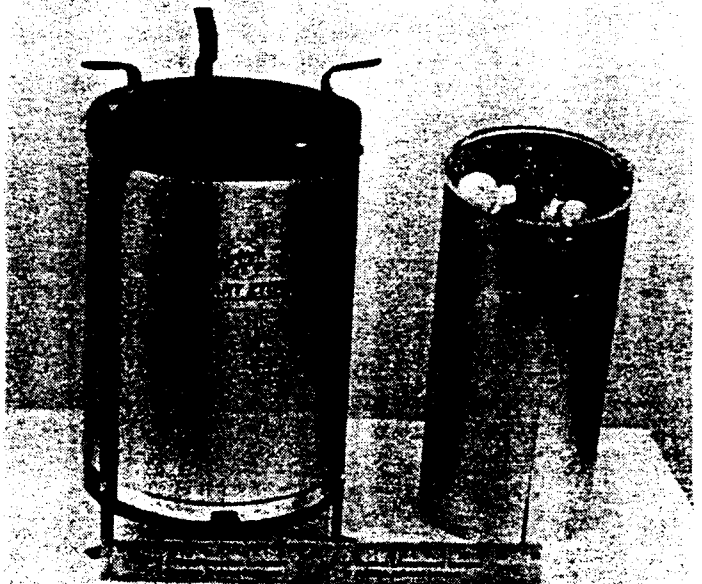

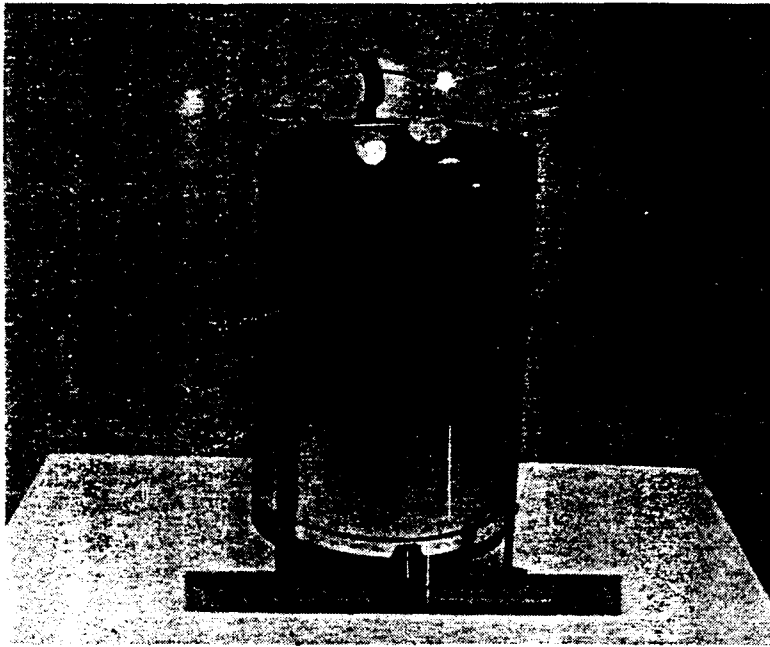

The stove is ignited from the top with damper control full open

After charcoal develops on the top of the feedstock wood gas is being produced and start burning above the charcoal.

Heat output can be regulated with a zero to ten adjustment.

Ordinary cooking equipment can be utelized.

Different attachment for roasting, smoking, baking etc. is being developed.

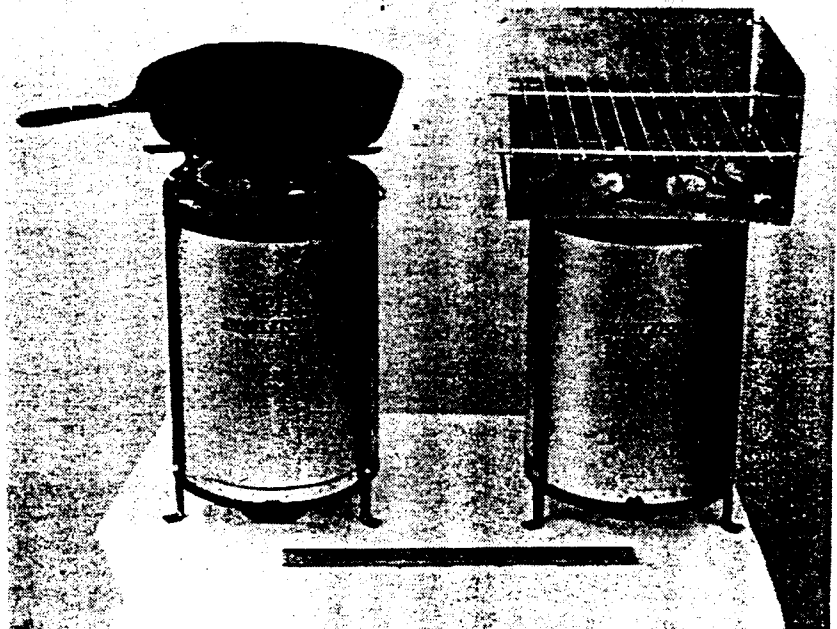

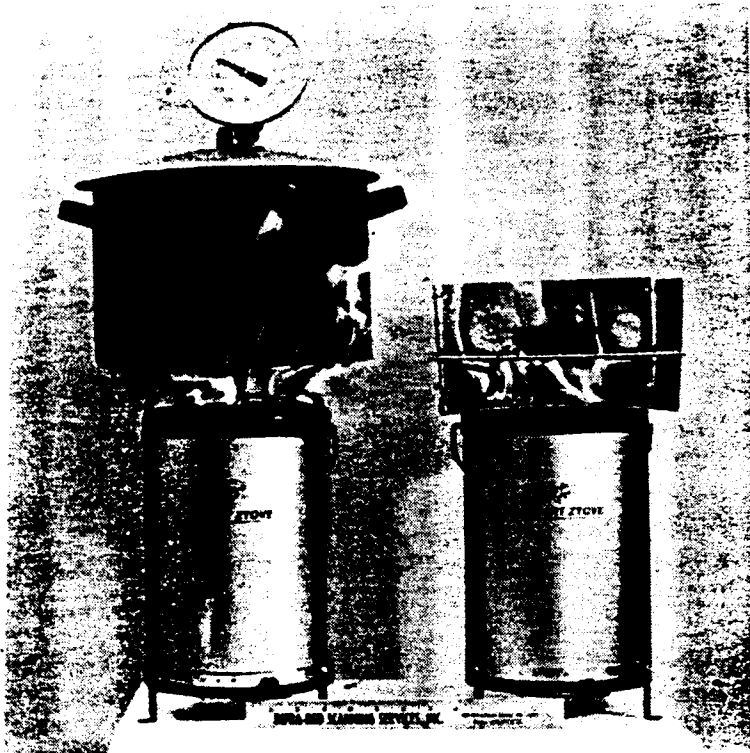

Notice the clear wood-gas flame with no visible soot or smoke.

Because of close to 100% complete combustion and the high operating temperature, nearly all tar and creosote have been eliminated.

Proper adjustment of the heat control from zero to ten will regulate the fire to any size of cooking utensils.

When all gas has been extracted from the feedstock, 15% remains as charcoal for further cooking or sale.

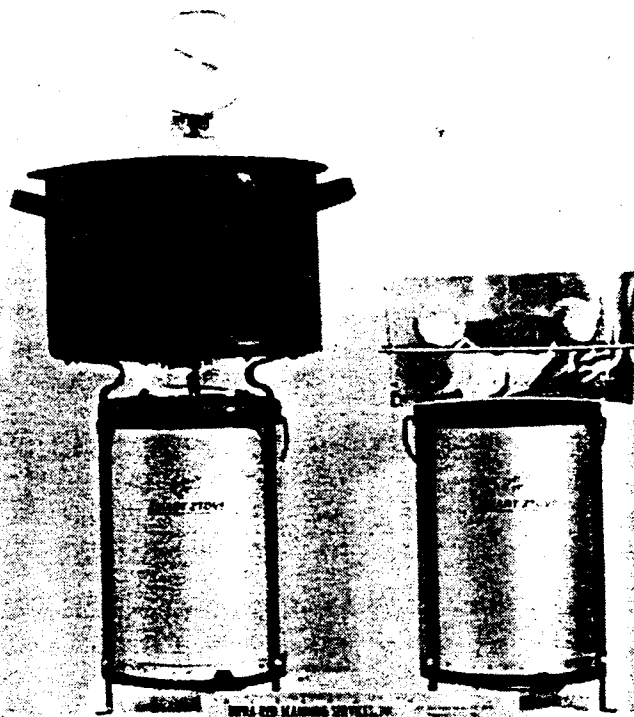

This paper is not addressed to individuals who wish to build homemade stoves. Our research indicate that high efficiency, wood-gas-stoves, with exact tolerances, can only be inexpensively mass produced by properly trained craftsmen and craftswomen.

PEOPLE BENEFITS

Survival is the main benefit to be gained by people in the Third World through the use of efficient stoves.

At the present rate of destruction the forests will be gone in forty years, nations and mankind cannot exist without forests

People who use efficient wood-stoves will spend 80% less for their fuelwood or spend 80% less time foraging for dung or wood.

Women will enjoy better health. Third Worlds Housewives now suffer severe problems with eyes, throat, nose and lungs from the excessive smoke given off by open fire stoves. Wood-gas-stoves have better combustion and create only a miniscule amount of smoke.

Wood-gas-stoves are easier to light, because of the new concept of lighting the stove from the top, they cook the food faster, need very little attention, and there is less danger of children getting burned or badly scalded when romping around open fires with unstable pots balanced on three stones.

COST OF WOOD-GAS-STOVE PROGRAM

Efficient wood-gas-stoves can be mass produced in the Third World for eight to ten dollar each. Upkeep may cost \$2.00 yearly to replace expendable items such as firepots and grates. Over a twenty year period the wood-gas-stove will will have cost \$2.50 per year.

Each wood-gas-stove will save \$48.00 worth of fuel wood annually so the investment has a fine rate of return, and factory built stoves have a much longer life than home made stoves built of mud or clay stoves.

Most families, however, will find it difficult to adjust to cook only one item at a time. Most cultures have two items as their main meal such as rice and sauce, meat and potatoes, fish and a vegetable. For these households a two stoves is needed. The cost of two wood-gas-stoves will be about \$20.00 with a maintenance cost of less than \$4.00 per year. (see page 16-17-18)

COOPERATIVE PROMOTIONS

The fuelwood shortage is so serious that the World's government and non-governmental agencies, has over the last 50 years expended billions to find the evasive solution.

The list includes: UNICEF - FAO - THE WORLD BANK - US AID - CEAO - WHO - ASEAN - CARICON IEA - WOODSTOVE GROUP IN THE NETHERLANDS - EINDHOVEN UNIV. - VITA - APROOVECHO INSTITUTE - ITDG - BELLERIVE FOUNDATION - TATA ENERGY RESEARCH - INSTITUTE - UNIV. of LOUVAIN - GREEN DESERTS - TREES UNLIMITED - RAINFOREST INFORMATION CENTRE of AUSTRALIA and many, many others.

These organizations are all aware that a shortage is developing but few seem to be aware of how critical the situation is today and how urgently practical solutions are needed.

Governmental agencies concentrate most of their efforts and funds on reforestation with only slight attention to conservation by use of efficient stoves.

The forest are needed, the forest are disappearing, so the emphasis has been on rehabilitating the forest.

Unfortunately the poorer nations of the world have neither the cash, the credit or even the motivation to take the big step to really rebuild the forests. Reforestation underway in India is less than 5% of what it should be according to Shankar Ranganathan a leading expert in the forestry fields.

The Agencies listed above should intensify their activities for reforestation but should also promote the use of fuel efficient stoves. Forests are needed but efficient stoves to save the forests are more urgently needed.

Global 2000 refers often to the fuelwood shortage and describes the outlook as bleak for one quarter of mankind who rely on wood for fuel. It advises that wood can be conserved by use of efficient stoves which reduce the consumption of wood by 70%. The follow up, "Global Future - Time to act", unfortunately ignores the benefits of efficient stoves in the recommendations it makes to the World Bank, AID, and other agencies.

The U.S. National Academy of Science in the book "Firewood Crops" declares: "Improving Wood-burning devices seems to be one of the best ways to alleviate the twin curses of firewood scarcity and forest depletion".

While governmental agencies have been directing their attention to reforestation, some of the the non-governmental organizations have been striving diligently to develop and promote the use of efficient wood stoves. They have tried hard to design stoves which could be built by the householder with locally available tools and materials.

The track record indicates that the need for millions of stoves, quickly, cannot be met by do-it-yourself programs. Locally available materials are poorly suited to the application. Mud and sand are poor insulators which will not stand up to the high temperatures encountered. Householders require so much training that the cost of training exceeds the cost of a factory built stove.

Some of the organizations are now promoting the production and use of mass produced, factory made stoves. Waclaw Micuta of the Bellerive Foundation has had success with the charcoal stove "Jitko".

VITA has made extensive tests of various stoves in Montserrat, West Indies and has developed and started to mass produce stoves in Upper Volta. Aprovecho Institute is recommending factory mass-produced stoves in its drive for 100 million stoves in 20 years.

Emphasis must be on production. There is no time left for endless discussion. Leadership is needed to guide the efforts of field workers in directions which will put most stoves in service, in the shortest possible time.

A sense of urgency must be promoted. Much can be achieved quickly if the efforts of the many fine individuals trying to develop field built stoves are channelled into promoting the use of factory built, mass produced stoves.

GOVERNMENT PARTICIPATION

Governments of the Third World must be made aware of the fact that projected loss of their forests by 2025 will devastate the nations and make mass starvation unavoidable

Erik Eckholm predicts: "The accelerating degradation of woodlands throughout Africa, Asia and Latin America, caused in part by fuel gathering, lies at the heart of what will likely be the most profound ecological challenge of the late twentieth century".

Within five years one stove per 100 people would be adequate to stave off the crisis. Then production should increase to meet all needs. People in the Third World and their governments could again breathe more easily.

Top priority should be given by governments to the production and distribution of stoves. Nothing is more important or of greater urgency. A cabinet level administrator should be given full authority to administer the stove program to keep it moving and eliminate bottlenecks.

Stoves are far less costly than reforestation so governments should be extremely liberal in furnishing stoves to the poor at minimal or no cost. They might set up work programs for reforestation with stoves given as a reward for participation.

The Biomass Energy Foundation has been doing research on wood-gas-stoves for less than 3 years, but the concept of Stratified Gasification is based on 50 years of research on wood-gas for use in the automotive and industrial combustion engines from 5 to 5000 Hp.

CONCLUSION

The US, industrial society, is releasing more than seven billion tons of carbon pollutant into the air every year. This layer of carbon dioxide circles our planet and act as a blanket of insulation; trapping the heat so that the earth is slowly warming. At the same time, the world is losing most of its forest cover.

Trees and other vegetation, through photosynthesis, have the ability to remove carbon from the atmosphere, replacing it with oxygen,

The University of Florida and the University of Alabama have for several years been developing fast growing tree's from the seed of the Albizia, Leucaena, and other trees in the legume family.

Such tree's will grow from seed to 6-10 ft high in 12 month, with branches 1" to 1.5" thick and can be harvested, every year with machetes, cuttings have been tested in wood-gas-stoves by our Foundation and found to produce the same heat value as wood from trees 20 to 25 years old.

It has been calculated that an average family of four in the United States wanting to offset their share of the carbon pollution would need to plant Six acres of trees.

Not many families in the Unites States could do this! For one thing, they don't have that much land, and planting about 5000 trees would be extremely expensive.

Because the problem is worldwide, so is the answer! The land is there --- 30,000 acres more of it every day ---as the destruction of the World's forests continues.

The people are there to plant the fast growing fuelwood plantations. They are waiting for help because they know the cost of this destruction in human terms.

Families are losing their lands as the forest vanishes before them; and when the land can no longer produce their needs, they're forced, as beggars, to a slow death in the slums of major cities where they have no skills to support themselves.

These people will make any effort or sacrifice, to save their land and their way of life, but they need help in obtaining efficient wood stoves and know-how on developing the best tree planting project for fuelwood plantations.

To overcome these interrelated problems; we must find ways to solve the problems on two fronts:

First, reduce the growing demands for fuelwood by teaching the Third World People to use more efficient wood stoves, thereby, cut the use of fuelwood by 80%;

Second, start fuelwood plantations programs with fast growing tree's, in order to supply the wood for cooking and decrease the "Greenhouse effect".

Using the above programs we intend to prove that soil destroyed in the past, from logging, poorly managed agriculture or grazing, can be brought back to life; by planting fuelwood trees the land can then continue to provide the people with a good standard of living and quality of life.

The goals of the volunteer scientists of our Foundation are to provide the know-how on mass production of efficient wood-gas-stoves, and help in planning for fast growing fuelwood plantations.

BIBLIOGRAPHY

- 1 (Anon 1943) "Air-Gas Mixing Valves", Automobile Engineer, Sept. 1943 p. 377.
- 2 (Arthayukti 1984) Arthayukti, W., "Biomass Gasification in Thailand", National Energy Administration Ministry of Science, Technology and Energy, Bangkok, 1984.

- 3 (Barber 1990) Barber Ben, Washington D.C. Journalist "Burning the Third World's last tree". The Washington Post, December 30 1990 p. c 2
- 4 (Beenackers 1982) Beenachers, A.A.C.M. and van Swaaij W.P.M., in Palz,W. and Grassi, "Energy from Biomass" Vol. 3, p. 201. Reidel, Dordrecht, 1982
- 5 (Brigdwater 1984) Brigdwater, A.V. ed., "Thermochemical Processing of Biomass", Butterworth. London, 1982.
- 6 (Carr'e 1945) Carr'e, J. et al., "Densified Product to be used in Gas Producers," in "Symposium on Forest Products Research International" - 22 April, Pretoria, South Africa, Vol.5, National Timber Research Institute.
- 7 (Das 1985) Das, A. "Contaminant Testing Method for Biomass Gasifier Engine System, TIPI Workshop, P.O. Box 84, Allens, Col., 80510, 1985.
- 8 (Deppner 1988) Deppner, Dave, "Trees Unlimited." A paper on fast growing fuelwood for harwest each year to provide fuelwood, for the people in the poorest sections of the Third World. Dave Deppner, President, "Trees for the Future.", 11306 Estonia Drive, Silver Springs. MD. 20902.
- 9 (Edrich 1985) Edrich, R., Bradley, R.T., and Graboski, M., "The Gasification of Ponderosa Pine Charcoal," in Fundamentals of Thermochemical Conversion; "An International Conference, Estes Park, Colo., October 18-22, 1982. Proceedings edited by R.P. Overend, T.A. Milne, and L. Mudge, Elsevier 1985.
- 10 (Eckholm) Eckholm, Eric., "UNICEF and the Household Fuel Crisis." UNICEF, United Nation, NY. NY.
- 11 (Ekstrom 1985) Ekstrom C., Lindeman, N., and Peterson ,R., "Catalytic Conversion of Tars, Carbon Black, and Methane," Fundamentals of Thermochemically Biomass Conversion: An International Conference, Estes Park, Colo., October 18-22, 1982.
- 12 (Fiebelkorn 1938) Fiebelkorn, Hans. Oberinspector an der Panzertruppendschule in Weunsdoef. Fahrzeug-Dieselmotoren und Fahrzeug Gsgeneratoren. Union Deutsche Verlagsgesellschaft Berlin, Roth & Co. 1938.
- 13 (Field) Field, D.C., "Internal Combustion Engines" A History of Technology. Edited by Ch. Singer, et al. Vol. V. Oxford Univ ersity Press. 1958

- 14 (Ferguson) Ferguson, Eric T., "A Wood Stove Compendium." Eindhoven University, The Netherland.
- 15 (Gengas 1950) Gengas: Svenska Erfarenheter fran aren 1939 - 1945, Stockholm, 1950; Translated as Generator Gas: The Swedish Experience from 1939-1945 by M. Geuther (T. Reed and D. Jantzen, eds.) reissued as "GENGAS" with index added by A. Das, TIPI Workshop Books, P.O. Box 84, Allenspark, Colo., 1982.
- 16 (Global) The Global 2000 Report to the President, Vol. 2 page 406. Penguin Books, 625 Madison Ave. NY, NY 10022.
- 17 (GRAW 1934) Graw, Mc. Gas Engineers Handbook 1934
- 18 (Hottenroth) Hottenroth F. W. 1984 "Shall India Survive or Perish," - Efficient Stoves are essential for Survival - A paper on past and present problem on wood and dung used for fuel and the deforestation of India. F. W. Hottenroth, Pres., Z.Z. Corporation, 10806 Kaylor Street, Los Alamitos, Cal., 90720.
- 19 (Hottenroth) Hottenroth F.W. 1987 "As the Forest die - so will the People." A paper about possible starvation of 600 million People each year after if efficient cooking stoves are not supplied, in sufficient amount to the Third World, before 1995 (sAds. as in 12)
- 20 (IGT) This reference is to the Proceedings of the 11 technical symposia on biomass energy organized and presented by the Institute of Gas Technology, Chicago ILL. They are:
 "Clean Fuel From Biomass, Sewage, Urban Refuse, Agricultural Wastes," January 27-30 1976, Orlando , Fla..
 "Clean Fuels From Biomass and Wastes," January 25-28, 1977, Orlando, Fla.
 "Energy from Biomass and Wastes," August 14-18, 1978, Washington, D.C.
 "Energy from Biomass and Wastes IV," January 21-25, 1980 Lake Buena Vista, Fla.
 "Energy from Biomass and Wastes V," January 26-30 1981, Lake Buena Vista, Fla.
 "Energy from Biomass and Wastes VI," January 25-29 1982 Lake Buena Vista, Fla.
 "Energy from Biomass and Wastes VII," January 24-28 1983 Lake Buena Vista, Fla.
 "Energy from Biomass and Wastes VIII," January 30-February 3, 1984, Lake Buena Vista, Fla.
 "Energy from Biomass and Wastes IX," January 28-February 3, 1985, Lake Buena Vista, Fla.
 "Energy from Biomass and Wastes X," April 7-11, 1986, Washington D.C.,
 "Energy from Biomass and Wastes XI," March 16-20, 1987, Orlando, Fla.

- 21 (Jantsch 1943) Jantsch, F., Zentralstelle für Generatoren beim Generalbevollmächtigten für Rüstungsaufgaben. Reichsmaster Speer. Fahrzeugsgeneratoren. Joh. Kasper & Co. Berlin 1943
- 22 (Kjellstrom) Kjellstrom, B., Stassen, H., and Beenacker, A.A.C.M., "Producer Gas 1982: A collection of Papers on Producer Gas with Emphasis on Applications in Developing Countries." Producer Gas Conference, Sri Lanka, ISBN; 91-86618-00-8, The Beijer Institute, Stockholm, Sweden, 1983.
- 23 (La Fontaine) La Fontaine H. A detailed Manual: "Construction of a simplified Wood Gas Generators for Fueling Internal Combustion Engines in a Petroleum Emergency." FEMA/DOE contract No. 98x-6446-7v with Biomass Energy Foundation, 1995, Keystone Boulevard Miami, Fla. 33181 USA. Telephone (305) 891-4601
- 24 (Miles 1982) Miles, T.R. and Miles T.R. Jr. "The Preparation Biomass for Gasification," edited by T.B. Reed and M. Graboski, SERI/CP-234-1590, Solar Research Institute, Golden, Colo. 1982.
- 25 (Perlin) Perlin, John., et al. "Running Out." Co-EV. Qrtly, Box 428 Sausalito, Ca. 97402.
- 26 (Ranganatan) Ranganatan, Shanker, reference.the Bombay Review, Nov. & Dec. 1978. Tata Press Ltd. Bombay, India 400 125.
- 27 (Ranganatan) Ranganatan. Shanker, "Social Forestry." National Seminar on Energy Dec. 1982 Bombay, India.
- 28 (Reed 1978) Reed, T.B. "Biomass Energy A Two Edged Sword," one of Dr. Reed's many papers presented at Energy Seminars around the the World this paper is from the Annual Meeting of the International Solar Energy Society, Denver, Colo., Aug.28, 1978. SERI DDS-011.
- 29 (Reed 1984) Reed, T.B. and Levie, B., "A Simplified Model of the Stratified Downdraft Gasifier, in "The International Bio-Energy Directory and Handbook 1984," edited by Paul F. Bente, Jr. The Bio-Energy Council 1625 E St. NW, Suite 825A, Washington, D.C.
- 30 (Roy 1983) Roy, C.et al., "Design et Construction d'un Reacteur de Pyrolyse sous Vide," in Comptes Rendu de L'Aatelier de Travail sur la Liquefaction de la Biomasse Proceedings of the 3rd Liquefaction Expert Workshop Sept. 28, 1983, Sherbrooke University, Quebec, Canada, NRCC 23130.

- 1 (Skov 1974) Skov, Niels A. and Papworth, Mark L. "The Pegasus Unit: "The Lost Art of Driving Without Gasoline" Reprints now available from H. La Fontaine CEO, Biomass Energy Foundation, 1995 Keystone Blvd., Miami, Fla. 33181.
- 32 (Smith 1985) Smith, Wayne H., IFAS, University of Fla. Gainesville, Florida. "Biomass Energy Development" 667 hardcover, Plenum Publishing Corporation, 233 Spring Street, New York, N.Y. 10013
- 33 (Susanto 1983) Susanto, H., Beennackers, A.A.C.M. and van Swaij, W.P.M.,. "Moving Bed Gasifier with Internal Recycle of Pyrolysis Gas," In Producer Gas 1982: "A Collection of papers on Producer Gas," from Producer Gas Conference, Sri Lanka, ISBN-91-86618-00-8, The Beijer Institute, Stockholm, Sweden, 1983.
- 34 (Vietmeyer) Vietmeyer, Noel., "Producer Gas Another Fuel for Motor Transport." 101 p. Office of International Affairs, (JH-21-7D), National Research Council, 2101 Constitution Avenue, Washington D.C. 20418, USA.
- 35 (Walawender 1985) Walawender, W.P., Chern, F.M. and Fan, L.T. "Fundamentals of Thermochemical Biomass Conversion:" An International Conference, Estes Park, Colorado, October 18-24 1982. Elsevier, 1985.
- 36 (Wartluft) Wartluft, Jeff,. "Cookstove Improvement." Ministry of Agriculture, Plymouth, Montserrat, W. Indies
- 37 World Council of Churches. "Bio Gas in a Integrated Farming System" W.C.C., Box 38-206, Cambridge, Ma. 02138.
- 38 Denmark Teknologiske Institut, Report 1945
- 39 Motor, Copenhagen April 1974
- 40 World Watch paper 42 p. 17. World Watch Inst. 1776 Mass, Ave. N.W. Washington DC. 20036.
- 41 "Firewoods Crops". pp 1 & 164, Nat'l Academy of Sciences, 2101 Constitution, Ave. Washington, DC. 20418.
- 42 "Producer Gas: Another Fuel for Motor Transport." Nat'l. Academy of Sciences, 2101 Constitution Ave. Washington, DC 20418.
- 43 "Gengas Bilen" March 1941. Forlaget Fremad, Copenhagen Denmark.
- 44 "Modern Stove for all" Fondation de Bellerive, Case Postale 6, 1211 Geneva CH.

Typical costs: gasification versus diesel (in US cents/kWh)

	Conventional diesel engine	Diesel engine fitted with gasifier
Capital cost	3.4	4.3
Maintenance and running cost	1.6	4.5
Fuel cost - diesel	16.0	3.2
wood	-	2.8
	-----	-----
Total cost of power	21.0	14.8
	-----	-----

Table 1: Ash content and gasification properties of biomass fuels

Material	Ash Content (% of dry weight)	Remarks
Alfalfa straw	6.0	no slagging
Almond shells	4.8	no slagging
Barley straw mixture	10.3	severe slagging
Bean straw	10.6	severe slagging
Coconut husks	6.0	some slagging
" shells	0.8	no slagging
Cotton gin trash	17.6	severe slagging
" " stalks	17.2	severe slagging
Maize cobs	1.5	no slagging
Olive pits	3.2	no slagging
Peach pits	0.9	no slagging
Pelleted rice hulls	14.9	severe slagging
Prune pits	0.5	no slagging
Safflower straw	6.0	minor slagging
Sugarcane bagasse	1.5 - 11.3	slagging
Walnut shells	1.1	no slagging
Wood	0.2 - 1.0	no slagging

(Source: Kaupp and Goss, 1981; Kjellstrom, 1980; Hoglund, 1981)

Viele der normalen VW-Kübelwagen 82 wurden serienmäßig im Jahre 1942–1945 mit verschiedenen Gasgeneratoren ausgerüstet. Diese Entwicklung lief unter der Typenbezeichnung »230«, »231« und »239«. Hier der VW-Kübelwagen »239« mit Holzkohlengenerator.



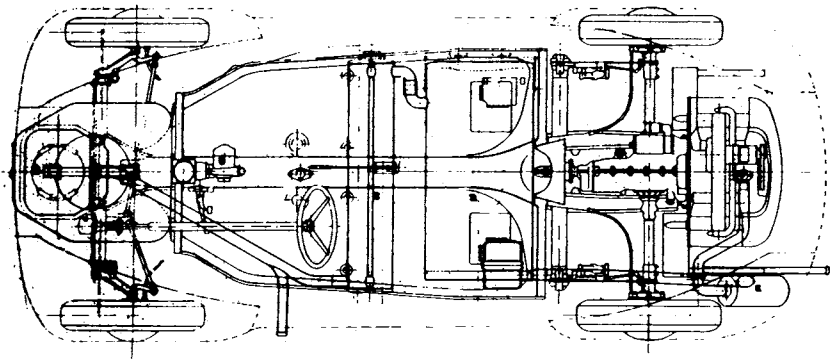
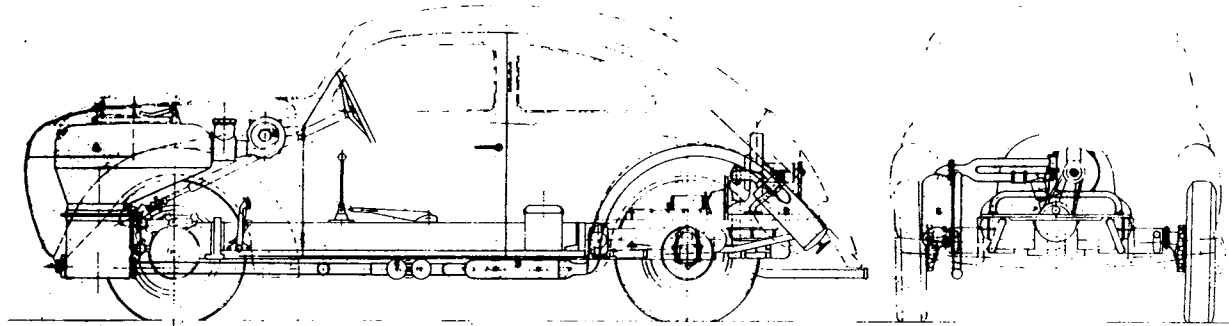

- 1. Motor
- 2. Pleuel
- 3. Pleuellager
- 4. Pleuellager
- 5. Pleuellager
- 6. Pleuellager

Motoranlage für K. 8. 8. 8.

Blatt 1/1

11 2264

Gezeichnet	11 2264
Geprüft	
Freigegeben	
Datum	



LOWA-Dampf-Zugmaschinen

Zur Frühjahrsmesse 1951 in Leipzig präsentierte die Vereinigung LOWA eine 65 PS-Dampf-Zugmaschine. Von Vorteil war zum damaligen Zeitpunkt die Unabhängigkeit von flüssigen Kraftstoffen und die Verwendung fester Brennstoffe wie Kohle und Koks. Die Dampf-Zugmaschine ging auf eine Kriegsentwicklung der Sachsenberg-Werft in Roßlau zurück. Nach 1945 war das Projekt zunächst vom Ingenieurbüro Fritsch in Dresden weitergeführt worden.

Das in Werdau gebaute 65 PS-Fahrzeug hatte Koksfeuerung und war längere Zeit zu Versuchszwecken beim Institut für Schienenfahrzeuge eingesetzt. Im LOWA-Konstruktionsbüro wurde 1951 auch eine 125-PS-Straßenzugmaschine mit Braunkohlen-Brikettfeuerung entwickelt, die im LOWA-Werk in Vetschau/Lausitz gebaut wurde. Der Einsatz im Straßenverkehr scheiterte jedoch am Funkenflug, der nicht zu beherrschen war.

Offensichtlich entsprachen die praktischen Erfahrungen mit beiden Ausführungen nicht den hohen Erwartungen, so daß eine Serienfertigung nie zustande kam.



"Best invention for backpackers since feet."

"Excellent value-for-money...Unique among backpacker stoves...In a class by itself...Four minutes to boil a quart of water in cold weather."

- Backpacker Magazine

"Backpacker's stove really works...In less than a minute we had a hot fire six inches above the stove...Coffee perking in less than four minutes."

-Dan Sellard, Oregon Sports Editor

"Dry wood works best but I've managed good flames from damp stuff."

-Outdoor Life Magazine

"We have been camping for more than 20 years and this is the greatest little stove we have ever seen."

-Edinburg, New York

"Fantastic little stove. Best I've ever used (and I've used them all!)."

-Springfield, Oregon

Guarantee

ZZ Corp. will repair or replace at no charge any of its products which fail to operate satisfactorily as long as the sun shines, the moon rises, the trees grow and the rivers flow or two years from date of purchase, whichever comes first!

For more information call:

(310) 598-3220



Z.Z. CORP.

10806 Kaylor Street
Los Alamitos, CA 90720 USA



VISA & MasterCard orders accepted



Patent Numbers 3 159 119 / 3 219 024 / 3 199 555 / 3 279 452 / 3 868 943 / 5 024 208

ZIP ZTOVES

MADE IN USA



The Friendly Stoves

Great for camping, hunting, tailgate picnics, backpacking, or cycling. Ideal for Scouts!

Safest Stoves: No propane or gasoline to leak, spill, splash or explode. Burn twigs, bark, pine cones, scrap wood or charcoal.
Hottest Stoves: Twice the heat of most other stoves.

Economical: Low first cost and fuel is generally free.

Lightweight: Remember—no need to carry fuel.

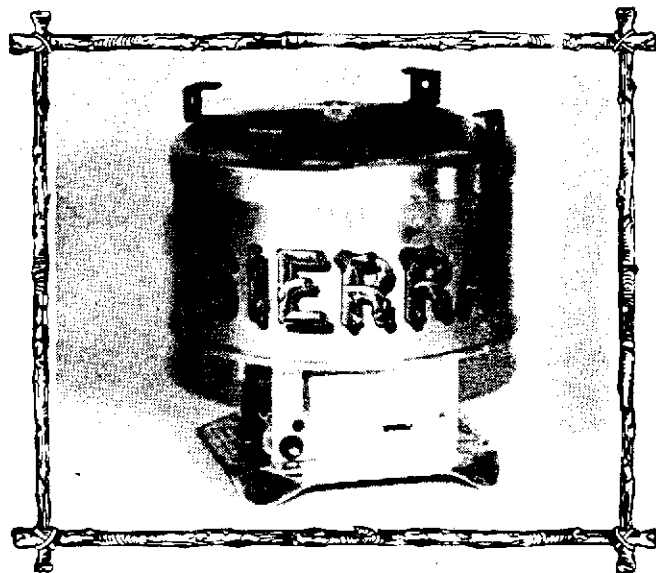

SIERRA

- ▲ Heats like a blacksmith's forge
- ▲ 18,000 BTU/hr. - all altitudes
- ▲ Easy heat control - adjustable draft
- ▲ Boils quart of water in 4 minutes
- ▲ Weight: 15 oz.
- ▲ Size: 4" x 5" Dia. Cat. #111



JAMAICA ZTOVE

- ▲ Burns wood or charcoal
- ▲ High heat even at high altitude
- ▲ Easy to light - Adjustable draft
- ▲ Includes Starting Chimney
- ▲ Boiling Time: 6 min. to boil 1 qt. water at sea level
- ▲ Weight: 1.4 lbs.
- ▲ Size: 7" x 7.5" dia.....

Cat. #122

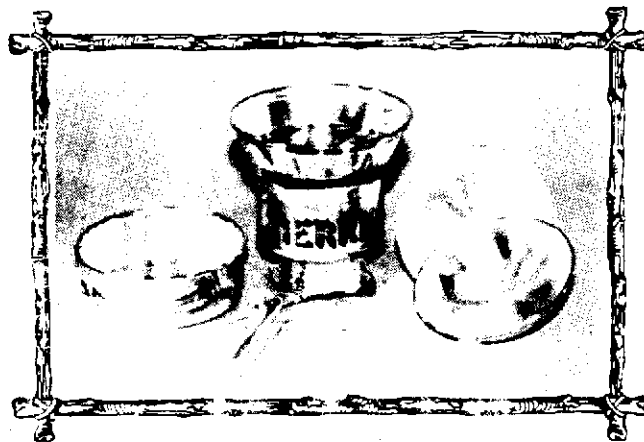

MEZZ KIT

- ▲ Includes: Sierra, one quart pot, fry pan, pot lifter, 2 plates and tie strap
- ▲ Handles the cooking needs of two or more
- ▲ Extra space for salt, pepper, or other spices
- ▲ Weight: 32 oz.
- ▲ Size: 5" x 7" Dia.

Cat. #155

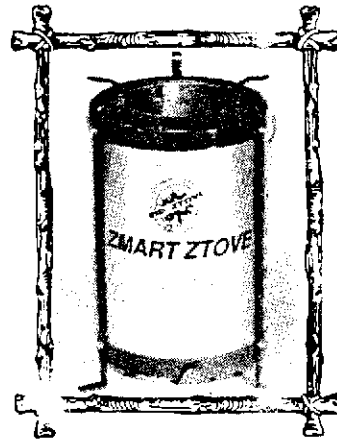

ZMART ZTOVE

- ▲ Large fuel capacity - 5" dia. x 9" deep fire pot
- ▲ Easy to light - Adjustable draft
- ▲ Heat range 5,000 to 20,000 BTU/hr
- ▲ Boils one gallon of water in 14 minutes
- ▲ Weight: 7 lbs..
- ▲ Size: 11.5" x 7.5" Dia.

Cat. #117

ATTENTION MR. ZIP:
 A thin coating of vegetable oil on the inside of a fry pan keeps food from sticking to the pan. Animal fats are not as good as vegetable oils for this usage. Also a few drops of vegetable oil wiped on the outside of a pot makes it easy to remove the soot from wood fires using a small brush like a toothbrush.

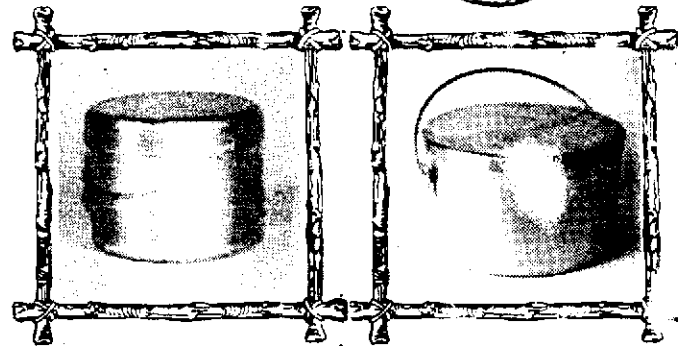

LITER POT

- ▲ Aluminum Pot & Pan
- ▲ Holds 4 cups of water
- ▲ Lid serves as a fry pan
- ▲ Great for storing Sierra
- ▲ Easy to clean
- ▲ Easy to carry
- ▲ Weight: 7 oz.
- ▲ Size: 5" x 5.5" Dia.

Cat. #140

STEW POT

- ▲ Five Quart Pot
- ▲ Aluminum Pot & Pan
- ▲ Lid serves as a fry pan
- ▲ Cleans up quickly
- ▲ Lightweight yet sturdy
- ▲ Ideal for dishpan
- ▲ Weight: 24 oz.
- ▲ Size: 5.5" x 9" Dia.

Cat. #145

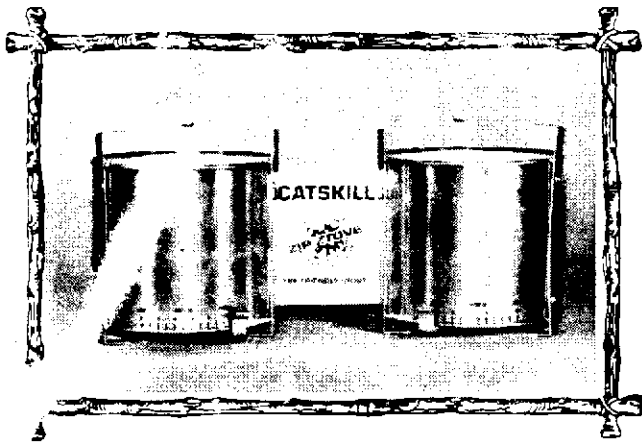

CATSKILL

- ▲ Ideal two burner stove for outdoor family cooking
- ▲ Thoroughly reliable
- ▲ Barbeque steaks, hot dogs, etc. with Jamaica Grill
- ▲ Easy to light and easy to use
- ▲ Holds 2 nine inch pots or eighteen inch grill
- ▲ Lightest two-burner stove - Weight: 3 lbs.
- ▲ Shipping carton acts as carrying case with handle
- ▲ Size: 7" x 7" x 19" Cat. #123

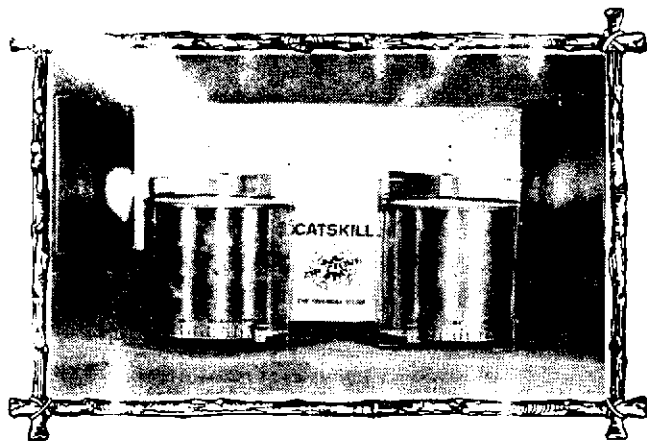

CATSKILL WINDSHIELD

- ▲ Speeds up cooking on blustery days
- ▲ Use as tray when there is no wind
- ▲ Packs in carton with Catskill above
- ▲ Weight: 1 lb.
- ▲ Size: 18" x 15" Cat. #396

- A TIP FROM MR. ZIP:
- Foods containing any moisture deteriorate rapidly at temperatures above 40° F. One bacterium multiplies and becomes 4 bacteria in one day at 50° F - 12 million in one day at 71° F!

- TIPS FROM MR. ZIP:
- A ZIP ZTOVE makes a good lantern. As much light as twenty candles.
- ALSO - Turn down the heat as soon as a pot reaches boiling. Food cooks just as fast at simmer as at full rolling boil.

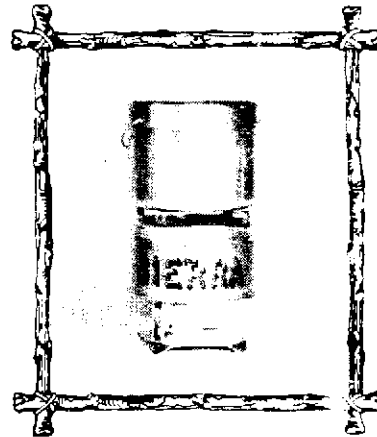

BACKPACKER

- ▲ Includes Sierra and Liter Pot
- ▲ Perfect for climbers, backpackers, hikers
- ▲ Stove fits into pot
- ▲ Weight: 24 oz.
- ▲ Size: 5.5" x 5.5" Dia.
- ▲ Cat. #152

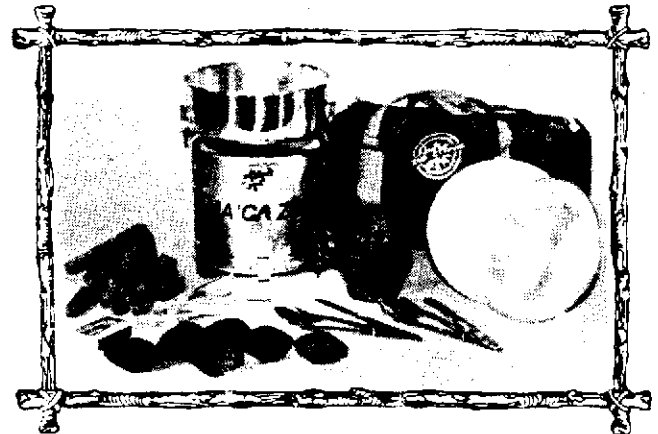

PREPAREDNESS KIT

- ▲ Complete Cook & Serve Kit
- ▲ Includes: Jamaica Ztove, one quart pot, pan handler, 2 plastic cups, 2 aluminum plates, 2 knives, 2 forks, 2 spoons, 6 charcoal briquettes, 12 fire starters & 1 box waterproof matches all packed in Bantam Ztuff Zock
- ▲ Add your own food and water for complete subsistence
- ▲ Ready for picnic or for emergency use
- ▲ Stores easily in car trunk
- ▲ Size: 7" Dia. x 12" Long Cat. #170

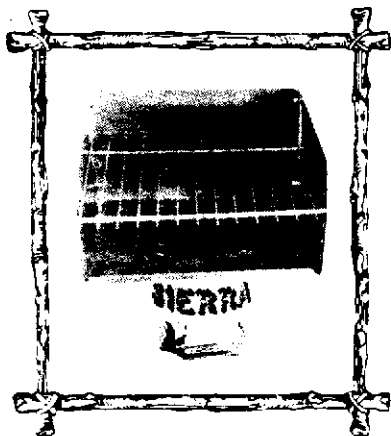

A TIP FROM MR. ZIP:
 One good way to start a fire is with wood shavings. With your pocket knife shave thin slices from a piece of wood. Make a pile and light with a match.

WINDSHIELD & GRILL

- ▲ Windshield - assures fast cooking on windy days
- ▲ Grill - Barbeque steaks, hot dogs, fresh fish and shish ke-babs over charcoal fire (DON'T barbeque over gasoline or propane stoves)
- ▲ Lightweight aluminum
- ▲ Folds flat as a pancake for easier traveling
- ▲ Weight: 16 oz.
- ▲ Size: 9.5" x 9.5" x 4" high, folds to 1/4" Cat. #395

ZTUFF ZACKS

- ▲ Ideal lightweight sacks
 - ▲ One day hike, picnic, tailgate party,
 - ▲ Weather resistant, washable & durable
 - ▲ Water repellent nylon
 - ▲ Zipper closure
 - ▲ Only 6 oz.
 - ▲ 7" Dia. x 12" Long
- Cat. #382

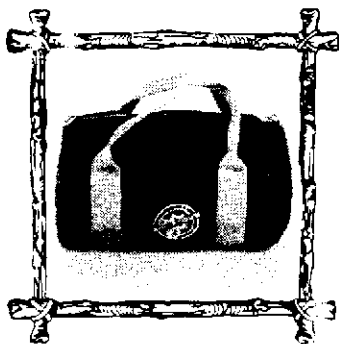

SHOULDER STRAP

- ▲ Nylon strap for Bantam and Jumbo Ztuff Zacks
 - ▲ Adjusts to 52" length
 - ▲ Snap-hooks on each end
 - ▲ Weight: 4 oz.
 - ▲ 2" Wide
- Cat. #383

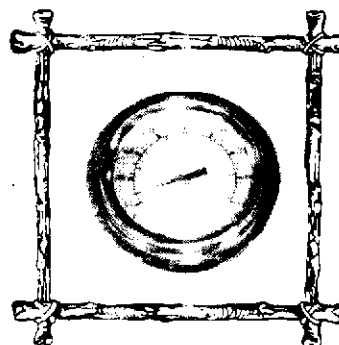
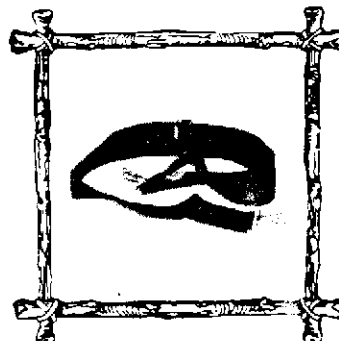

THERMOMETER

- ▲ Excellent for frying foods which require careful temperature control, like bacon or eggs
- ▲ Just lay it on the pan and cook when the pan is at the right temperature
- ▲ Weight: 1 oz.
- ▲ Size: 2" Dia.

Cat. #630

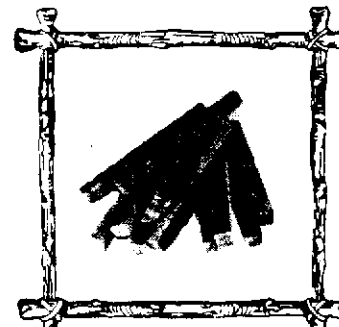

ZIP FIRES

- ▲ Clean & Odorless
- ▲ Safe & Easy
- ▲ Use for lighting barbeques, campfire, or Zip Ztoves
- ▲ Light even when wet
- ▲ Stay lit in strong wind.
- ▲ 10 chunks per ounce
- ▲ Pack holds 108 chunks

Cat. #511

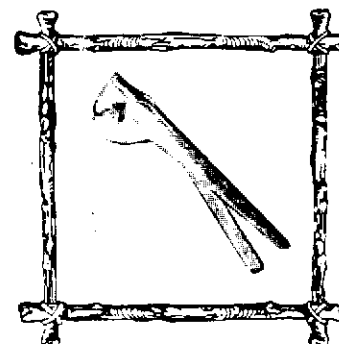

PANHANDLER

- ▲ Securely grips pot or pan
- ▲ Holds cloth to clean pot
- ▲ White glove cooking
- ▲ Weight: 2 oz.
- ▲ Size: 5" Long

Cat. #392

JAMAICA GRIDDLE

- ▲ Heavy gauge aluminum griddle ideal for preparing meals
- ▲ Non-stick surface allows easy clean up
- ▲ Covers grate area of 2-burner Catskill Ztove
- ▲ Size: 10" x 16" Cat. #147

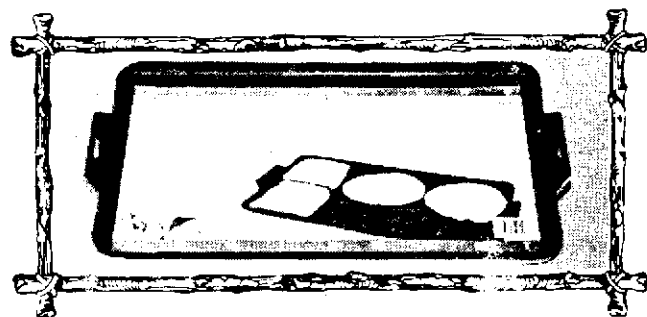

INSTRUCTIONS

SEQUOIA

SAFETY

The SEQUOIA Stove was designed with safety in mind. However, due to the use of open flames and high temperatures, these stoves, as with any stove can be hazardous if misused. All appropriate safety precautions should be taken during and after use of the stove to insure safe operation. Make sure all combustible material is removed from around the stove before it is ignited. **NEVER** leave the stove unattended. **NEVER** use the stove in an unventilated space. Toxic fumes may accumulate and cause death. Always dispose of the ashes properly. --Be Responsible; misuse may not only cause harm to the user, but the forests and wildlife too--

OPERATING INSTRUCTIONS

For efficient burning in the SEQUOIA, the incoming air is preheated. The preheating is accomplished by circulating the incoming air from the bottom of the stove to the top and returning the air down the outside of the burner and injecting it into the burner. For this to be effective, the burner walls must be hot. This is important whenever you are starting the fire and is even more important in cold weather. In cold weather a fire must be well established in the burner bowl before adding the full compliment of fuel.

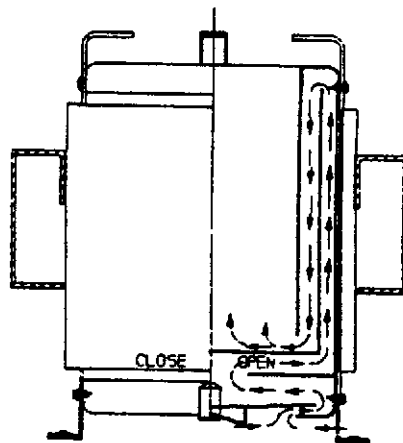

To start the fire, open the damper. Start a small fire in the burner bowl using dry kindling, artificial fire starters or papers. Allow the fire to develop. Add fuel. Under most circumstances, a good fire can be established in 2 or 3 minutes.

Newspaper can be used very effectively. Twist each of three pages of newspaper to form thin "logs". Put two of the pieces vertically into the burner bowl. Light the end of the third piece and put it in with the other two pieces with the lighted end downward. Put the initial load of fuel on top of the newspapers. As the paper burns, it not only heats the side walls but also starts the fuel burning.

If charcoal briquets are used, start a small fire with a few briquets. Filling the burner with charcoal and spraying lighter fluid on the top is not effective. Using match-light charcoal for the initial fire or starting a small wood fire before adding the charcoal work well.

For some wood fires it may be desirable to raise the pot higher than the pot supports allow. A "riser" is provided for this purpose. The notched ends of the riser fit into the burner bowl. Using this riser will not only improve the combustion but will make it easier to feed wood into the fire without removing the pot. With charcoal fires the pot can be put directly on the pot supports.

The heat can be controlled by changing the amount of inlet air with the damper control.

For high heat level, wood is superior. For extended and controlled heating, charcoal briquets are excellent. Natural charcoal such as mesquite, is a good compromise between the two. For fast heat and lots of black smoke, the artificial logs made of sawdust and wax are exceptional - small pieces of the log do make good fire starters, however.

The volatiles in wood will condense on a cooking pot. If cleaner cooking is desired, charcoal can be used. To make a pot easier to clean after using wood, the outside of the pot can be coated with PAM or some similar anti-stick compound. The rim of the stove may get black from use with some wood. This will normally burn itself off with continued use or subsequent use of the stove.

Wet fuel can be used on an established fire.

After extended burning, particularly with charcoal briquets that contain a high level of ash, the inlet air at the bottom of the burner bowl can become blocked and the fire will start to die. It is best to dump the ashes at this time. The hot coals can be used to restart the fire.

After use, the fire can be left to burn down. After the ashes are cool to the touch, they can be disposed of in a safe manner. Pouring water into the stove to douse the fire is not recommended. To extend the stove life, the coals should be poured into a suitable container or pit and soaked with water. Storing the stove in a wet environment is also not recommended. If the stove has seen heavy use, a light coat of oil before storage will prolong the burner bowl life.

Suggestions

You can attach a wooden or metal base to the stove. Holes are provided in the stove feet. The base will provide additional support for the stove in snow or soft soil.

The SEQUOIA does an excellent job barbecuing. Almost any grill can be used. It should be positioned 2 or 3 inches above the pot supports. Concrete blocks serve as good supports for backyard use. It may be desirable to use aluminum foil around the stove and base to protect against the "drippings".

INSTRUCTIONS

SIERRA STOVE

SAFETY

The SIERRA stove was designed with safety in mind. However, due to the use of open flames and high temperatures, these stoves, as with any stove, can be hazardous if misused. All appropriate safety precautions should be taken during and after use of the stove to insure safe operation. Make sure all combustible material is removed from around the stove before igniting. NEVER leave the stove unattended. Always dispose of the ashes properly.--Be Responsible; misuse may not only cause harm to the user, but the forests and wildlife too--

OPERATING INSTRUCTIONS

1. Remove the "blower" and "power supply" from the "burner".
2. Place an AA Battery where indicated in the power supply. **Be sure the battery is put in with the + and - in the proper position. Otherwise, the flames are drawn down into the blower which is very undesirable!**
3. Attach the blower to the bottom of the burner. Squeeze the supports on the blower and clip the blower to the bottom of the burner.
4. Place the stove on a level surface free of combustible materials.
5. Start a small fire in the burner bowl with dry twigs or other suitable fire starters. Allow the fire to become established. Add additional fuel and turn on the fan. With dry wood, you should have a good fire within 2 minutes.
6. Start your cooking. Control the heat by setting the fan speed to "high", "low", or "off". The heating will also be a function of the type and amount of fuel and how high the pot is above the burner. The Xtra Grate can be used to raise the pot for slower cooking.
7. When finished cooking, let the coals burn out. Turn on the fan to cool the burner until everything is cool to the touch. There should only be a fine ash remaining. If any chunks are remaining, these should be put on the ground and extinguished. All the residue can be put in a small wide mouth plastic bottle (or possibly a Zip lock bag) "ash" container with a couple of tablespoons of water or sufficient to make sure all the material is damp. Chunks can be used for future fires. The ash can be used for coating the kettle before its next use (see suggestion 6). If you must, due to an urgent schedule, you can pour the coals into a pit and extinguish them. Pour water on them until they are cool to the touch. Put them in a dampened "ash" container and carry them out. Covering the ashes is not recommended for forest or wilderness areas where there is any fire danger or ecology could be altered.

SOME QUESTIONS AND SUGGESTIONS

1. **What if the sticks are too long to fit in the burner bowl and they keep the pot from setting on the pot supports? Use the Xtra grate (those two pieces of metal with the slots in the middle). Put the two pieces together so they form an X. Put them on the top of the burner with the notched corners down. Now you can feed the long sticks in under the pot.**

2. **What if the sticks are wet?** Get a good fire going with dry wood. Then use the Xtra grate with the long sticks. As the end of the stick dries and burns, the stick will automatically feed into the fire. Be extra careful that the pieces do not fall out of the stove.
3. **What if it's windy?** Use the wrap-around windshield. The three tabs on the windshield fit under the pot supports on the burner. You can use the windshield even when it is not windy since it does improve cooking with the kettle by channeling the heat up along the side of the Kettle.
4. **How can I make the water boil faster?** Keep the pot covered. Use less water. Use dry wood in small pieces.
5. **How well does charcoal work?** Natural charcoal (i.e., not briquettes) works well and will give a good fire for an extended period. Some charcoal briquettes may need to be broken in half to improve their burning characteristics. Due to the danger in burying hot embers from charcoal briquettes, some local regulations prohibit the use of charcoal. Check your local regulations.
6. **How do I keep the pot clean?** In addition to using the white ash from prior fires as a tooth paste, it is also a very effective way to keep the pot clean. Wet the ash and coat the outside of the kettle. After cooking, take a paper towel or a rag or sand and wipe off the black. No water is required.
7. **What can I do with the cotton balls and vaseline/petroleum jelly?** For a very effective, lightweight fire starter, pack cotton balls in vaseline in 35 mm film containers. To light a fire take out one cotton ball, pull it apart and put it in the stove. Put some light kindling over the cotton and light the cotton.
8. **What if the fan doesn't work?** Be sure the battery spring is keeping a good contact on the battery. It can be bent to provide more pressure on the contact. You might try another battery. You might try cleaning the battery terminals and both ends of the battery. Are any wires shorting out? There have been very few problems with the motor and the motor can probably be ruled out unless
 - a, it has been submerged, or
 - b, the blower has been liberally coated with oven cleaner so as to degrade the bearings, or
 - c, the stove has been operated with the battery in backwards and the fire has been sucked into the blower unit.
9. **What can I do with the small plastic "T shirt" bags I get at the grocery?** You can always put the stove in one of them before you put it in the Kettle. The inside of the Kettle will then be clean when you get to your next stop. You can also put the kettle in another one before putting the Kettle in the Carry Sack and keep the Carry Sack relatively clean
10. **Why does the SIERRA work so well?** Fuels burn better with hot air. The air for combustion in the SIERRA is preheated to high temperatures before it enters the burner bowl by circuitous routing within the burner. This gives the good combustion. The air flow has another important function; it cools the burner bowl to assure long life.

Under cold conditions, it becomes very important to preheat the cold air coming into the combustion chamber. It may be necessary to use the low speed or cycle the fan on and off to reduce the air flow or to use extra dry wood to get a good fire started.

CPC's New Wood-Gas TurboStove™

CPC's TurboStove™ combines advanced gasification technology and forced convection to virtually eliminate smoke and harmful emissions with traditional biomass fuels while substantially reducing the amount of fuel required to cook a meal.

From: High Smoke, Low Efficiency  To: Minimal Smoke, High Efficiency



The TurboStove is a new, low-cost cooking device that can use a variety of wood, agricultural residues or coal to approach the performance and convenience of modern bottled gas cooking. Households with PV Solar Home Systems or other sources of a few watts of DC or utility AC electricity can substantially reduce air pollution in their households and improve their quality of life and health with the TurboStove.



Prototype TurboStove in India



Features of CPC's TurboStove™

- ▶ Clean burning biomass stove uses gasification technology to produce extremely low emissions that can substantially reduce respiratory and eye diseases due to indoor air pollution
- ▶ Easy "no smoke" start and ready for high intensity cooking in about one minute
- ▶ Adjustable heat from high to low intensity for rapid boil or slow simmer. Can boil a typical teapot of water in 3-4 minutes, or simmer for long periods
- ▶ TurboStove can use most traditional biomass fuels (small pieces of wood, wood pellets, briquettes, nut shells, densified agricultural residues, or even coal)
- ▶ High efficiency (~50%) saves fuelwood. Much more efficient than traditional "three-stone" wood stove
- ▶ Uses about 3 watts of electricity to produce/control 3 kilowatts of heat from biomass or ag residues
- ▶ TurboStove can be adapted for high efficient community cooking applications (restaurants), health clinics, small rural industries, etc.
- ▶ Suitable for low cost, local manufacture and commercial distribution



2 Burner Turbo Stove W/ Oven

CPC is seeking opportunities to collaborate with development institutions, foundations and local public or private sector organizations to develop and commercialize the TurboStove technology.



PV Turbo Stove



Community Power Corporation

8420 S. Continental Divide Road
Littleton, Colorado 80127
(303) 933-3135, Fax: (303) 933-1497
<http://www.gocpc.com>

For more information please contact:

Robb R. Walt (President) rwalt@gocpc.com
Dr. Neway Argaw nargaw@gocpc.com
Dr. Tom Reed treed@gocpc.com

Efficiency Tests on the New Peko Pe Stove in Uganda

By Per S. Nielsen, Technical University of Denmark, Denmark.

There are many options for reducing the biomass consumption in the food preparation process. Looking at the total energy chain from biofuel to the final meal, many technical improvements are possible. There are also many options which are non-technical. These are closely related to the cooking performance. In relation to technical options, the choice of fuel, optimisation of heat transfer, and efficient combustion processes are important. The non-technical options include, for instance, the use of lid, skills in firing control, and organisation of the food preparation process.

The central problem in obtaining high efficiency for the popular three-stone stove in real life is the firing control. With three-stone stoves, it is difficult to obtain the optimal distance between fire and pot and to keep the fire in the optimal combustion state, as heat is lost with large flames.

Peko Pe Tested

The Peko Pe is a newly developed gasifier stove developed by the Norwegian Paal Wendelbo. It is basically a pyrolysis gasifier. (See figure.)

The stove was tested at the Technical University of Denmark and in the Adjumani Refugee Camp in Uganda in 1995:

- In Denmark, the stove efficiency was 24-26% burning dry woodchips (10% moisture) with a caloric value of 16MJ/kg of woodchips.
- In Uganda, the tests showed a stove efficiency of 21-23% with a caloric value of 15 MJ/kg of grass.

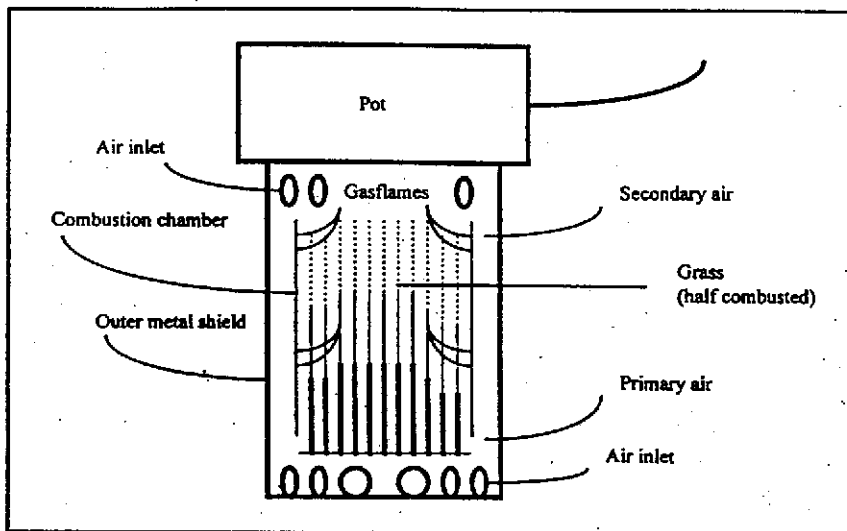

The Peko Pe gasifier stove.

The figure illustrates the pyrolysis in the stove while burning grass. It shows the combustion 5-10 minutes after ignition where the upper part of the grass is burned. The grass is ignited from the top and placed vertical. The stove is made of 2 tins: an inner combustion chamber and an outer shell. The inner chamber (Ø15cm, 20cm high) has Ø0.8 cm air-holes in the bottom, in the middle and at the top.

The idea of the tests with grass in the Adjumani refugee camp in Uganda was to develop the gasifier stove to be able to use as fuel the grass available in the refugee camp, which in any case would be burned in bush-fires.

In the refugee camp, the stove was tested with 20-cm-long grass straw of two different diameters, 3-4 mm and 7-8 mm. Generally, the thinner grass burned better than the thicker grass.

The stove provided heat enough to boil a meal in around 45 minutes after reaching the boiling temperature. The radiated heat made it possible to boil the water for another 25-30 minutes after the combustion was stopped. This is a so-called charcoal effect. This effect was not seen in the tests on woodchips in Denmark.

Further technical options to examine to improve the efficiency of the stove include: changing the number of holes, the height of the chamber, variation of biofuel source, and specifying the role of the moisture percentage.

Socio-economic aspects

In the camp of 100,000 refugees in Uganda, a workshop was established in cooperation with Accord, a UK NGO and the Norwegian Association for the Disabled.

Technicians, disabled people and women were trained to produce, sell the stoves and cook with the stove. Further aspects to examine are:

- How is it received by the cook?
- What kinds of food can be made on the stove?
- Even though the stove is cheap, can people afford to buy it?
- To what extent are people willing to accept preparation of the biomass if necessary?

Peko Pe / Three-Stone Stove

Advantages:

- burns without smoke and CO emissions are low.
- is easy to ignite.
- is rapid in achieving boiling temperature, and it has a charcoal effect, when grass is used.
- is relatively cheap to produce.
- easy to move and carry around.

Disadvantages:

- metal, tools, skills are needed to produce the stove.
- biomass needs treatment which depends on the biomass source. It needs dry biomass.

More info: Per S. Nielsen, Dept. of Buildings & Energy, Bldg. 118, Technical Univ. of Denmark, 2800 Lyngby, Denmark. Ph/fax: +45-4525-1949/ -45934430, e-mail: psn@ibe.dtu.dk.

[\[Subject Prev\]](#)[\[Subject Next\]](#)[\[Subject Index\]](#)

Pyromid Outdoor Cooking Systems

- *To:* stoves@crest.org
 - *Subject:* Pyromid Outdoor Cooking Systems
 - *From:* phait@transport.com (John Doe)
 - *Date:* Sat, 3 May 1997 09:36:15 -0700
 - *Cc:* stoves@crest.org
 - *Reply-To:* stoves@crest.org
 - *Sender:* owner-stoves@crest.org
-

Dear Stovers,

5/3/97

Over the past several months I have been reading with great interest the ideas, opinions, musings, frustations, experiencies, and desires of the numerous leaders of the World Stove programs. The focus and dedication to finding an answer to this extremely challenging and serious World problem is very impressive and all participants are to be complimented for their enthusiasm and dedication. I am sure that the problem will ultimately be solved with the kind of solid technical effort that is being applied. I have stayed out of the dialog until now because I did not feel that I could contribute at the level of the expertise that appears to exist on the technical side of the organization. However, I now hope that this message will stimulate some new thinking and set some deadlines and goals in addressing the monumental problem of the inefficient burning of natural fuels worldwide. I look forward to any questions or comments you may have after you read my thoughts. (Ronal and Tom Miles are fairly aware of what I have been doing at Pyromid over the past 15 years.)

Almost 15 years ago, I had the opportunity to interface with Stanford Research on a project that was to define the TOP 3 problems in the World. This was a project that was requested by a large multinational American Corp. SRI concluded that the TOP problems were (1.) The inefficient burning of fuel worldwide, (2.) Potable (clean) Water, and (3.) Communication between developed and underdeveloped countries. As we are all aware, the world is still struggling with all three of these problems today. The clean water problem can be solved fairly easily through new methods of sterilization and filtering and the Internet will have a great effect on the communication issue, and we all hope that this could lead to the rapid exposure of superior World Stove ideas to the 3,000,000,000 people throughout the world in desperate need of Clean Burning and MUCH MORE efficient stoves. This great need and opportunity explains all of our dedication to solving this huge problem. Would'nt it be nice if we could dedicate the organization to coming up with THE BEST OVERALL TECHNICAL ANSWER by the year 2000. If we can put MAN ON THE MOON, we should be able to build a simple, cost effective, safe, low polluting, and efficient WORLD STOVE!!!! Just imagine what would happen if our government committed \$30,000,000,000 to solving the #1 problem in the World for 3,000,000,000 fuel defficient people like they did in putting man on the moon. The cost

of \$10/3rd world person is not a bad investment to help mankind and the environment. Solving problems always gets down to money, need, motivation, ideas, recognition, time, education, resources, customs, awareness, and PERSEVERANCE. However creating the awareness and seriousness of the problem can only occur through a massive PR campaign that takes BIG \$\$\$ or through the World experiencing a major crisis because the problem was allowed to fester to the point where it was almost irreversible. I believe we are rapidly reaching that point.

First, a little background on myself. My name is Paul Hait. I am 56 years old and President of Pyromid Outdoor Cooking Systems located in Redmond, Oregon. I am also President of American Innovation(A product development Corp.) and Slatcraft Corporation(A supplier of precision wood to the Toy Industry). I am a Stanford Mechanical Engineering Graduate, Class of 1962, Olympic Gold Medal Winner in 1960, Married for 34 years with three children and 2 grandchildren, holder of over 50 patents in numerous diversified fields and hold 31 patents on the Pyromid Product Line. I was Systems Engineering Mgr. of Varian Associates Ultra High Vacuum Division for 7 years, Vice President and founder of J W Cross, a Medical/ Dental Co. which we sold out in 2 years, President and Founder of Aroma Taste Inc., manufacturer of Pemman Brand Beef and Buffalo Jerky, which I sold to General Mills Corp. in 1978 after building 3 plants in 7 years (one in Australia). I worked for General Mills for two years and then founded American Innovation Corp. in 1980. In 1981 I founded Pyromid Outdoor Cooking Systems and have been running it ever since. We have invested over \$10,000,000 in R&D, patents, tooling, production facilities, market testing , advertising and PR. You can find information on Pyromid by going to the Internet and using the address <http://www.estore.com>

Our goal at Pyromid was to design and market the most truly portable, safe, durable, efficient, multi-fueled, versatile, cost effective and environmentally sensitive natural fuel burning stove line in the world today. We believe we have made great progress towards meeting this corporate goal. However, after reading the stove list correspondence it is obvious there are many ways to skin the cat. Therefore, I would like to make a "Modest Proposal". How about the stove list participants establishing a functional specification that we all work towards or fulfill. Getting an agreement on such a spec. should fill up the cache on our computers for the next several months. The functional spec we have set at Pyromid might serve as a basis for this effort. It is as follows:

The World Stove should;

1. Cost less than \$15(ideally \$10).
2. be made from a durable material(preferably Stainless Steel).
3. be multifueled (not fuel dependant).
- 4 be multifunctional(bake,boil,roast,broil,steam,fry,toast,smoke,simmer,etc.).
5. be safe to use.
6. be easy to light,easy to extinguish,and easy to clean.
7. be better than 50% efficient in the burning of any natural fuel.
8. be low polutting of the air while being used for cooking.
9. be easy , compact and safe to transport.
- 10.be able to cook above and below the stove.
- 11.be easy to manufacture in volume any where in the world.
- 12.be useful for the industrial world as well as the third world.
- 13.be able to make charcoal efficiently and then burn it efficiently.
- 14.be able to also serve as a solar stove, solar still and multifueled natural fuel burning stove.
- 15.be truly portable for easy storage and mobility in case of emergencies or rapid changes of living locations, as is frequently the case in disaster

prone third world countries.

16.be easy to tool

17.apply basic physics principals of efficient fuel burning.

18.should make use of local fuels(preferably briquetts)

19.be light in weight.

20.be profitable to the creator and sellers of the product.

I look forward to the responses to this proposal.

Our company would like to play a roll in putting together a World Stove conference where we all meet and discuss an effective way to bring this problem to the forefront of everybodys thinking. If this could be accomplished with proper Media support it would have a positive effect on the Environmental Health of the World in a MASSIVE way.I hope that we all agree with this one basic statement.

I look forward to the response.

Sincerely ,

Paul w. Hait

President

Pyromid Outdoor Cooking Systems

Plant Address;

3292 S. Hwy 97

Redmond, Oregon 97756

1.541.5481041

PS We look forward to shipping Pyromid Stoves for test and evaluation to all those interested in the principals of the HARMONIC THERMAL ARRAY. To Stove list members the price would be discounted 20% from retail.