

*Java Programming for the New Generation of Mobile Devices*



*Programming*

# Android

**O'REILLY**<sup>®</sup>

*Zigurd Mednieks, Laird Dornin,  
G. Blake Meike & Masumi Nakamura*

# Programming Android

What does it take to build well-engineered Android applications? Explore Android's core building blocks and APIs in depth with this authoritative guide, and learn how to create compelling apps that work on a full range of Android devices. You'll work with proven approaches to app design and implementation—including application frameworks that you can use as a starting point for your own projects.

Delve into sensors, native development, 3D graphics, and many other topics, and discover how to build apps on the platform of your choice. If you're an intermediate to advanced programmer, you'll learn how to make great Android apps.

- Learn how to use the Android SDK with the Eclipse IDE
- Apply advanced Java concepts regardless of your experience with the language
- Create an Android user interface that's captivating and easy to navigate
- Understand Android's unique database design issues and the role of SQLite
- Use sensors and gestures to expand your app's input beyond just tapping and scrolling
- Explore Android APIs for multimedia, location, communication, NFC, and other applications

*“Finally! A book that goes into detail! Hooray!”*

—Perry J. Nally  
*FeetDog.com*

*“Great work. I read [a] few chapters and couldn't put it down.”*

—Wenjing Dai  
*Developer*

Zigurd Mednieks is a consultant to leading OEMs, enterprises, and entrepreneurial ventures creating Android-based systems.

Laird Dornin, a Senior Engineer at a major wireless carrier, has extensive experience with Java, Android, J2ME, SavaJe, and the WebKit.

G. Blake Meike is a veteran developer with wide experience building Java applications for a range of mobile and server-side platforms.

Masumi Nakamura is Principal Architect for the Big Data and Recommendations Group at Where, Inc.

US \$44.99

CAN \$51.99

ISBN: 978-1-449-38969-7



Twitter: @oreillymedia  
facebook.com/oreilly

**O'REILLY®**  
oreilly.com

---

# Programming Android





---

# Programming Android

*Zigurd Mednieks, Laird Dornin, G. Blake Meike,  
and Masumi Nakamura*

O'REILLY®  
Beijing • Cambridge • Farnham • Köln • Sebastopol • Tokyo

## **Programming Android**

by Zigurd Mednieks, Laird Dornin, G. Blake Meike, and Masumi Nakamura

Copyright © 2011 Zigurd Mednieks, Laird Dornin, G. Blake Meike, and Masumi Nakamura. All rights reserved.

Printed in the United States of America.

Published by O'Reilly Media, Inc., 1005 Gravenstein Highway North, Sebastopol, CA 95472.

O'Reilly books may be purchased for educational, business, or sales promotional use. Online editions are also available for most titles (<http://my.safaribooksonline.com>). For more information, contact our corporate/institutional sales department: (800) 998-9938 or [corporate@oreilly.com](mailto:corporate@oreilly.com).

**Editors:** Andy Oram and Brian Jepson

**Production Editor:** Adam Zaremba

**Copyeditor:** Audrey Doyle

**Technical Editors:** Vijay S. Yellapragada and Johan van der Hoeven

**Proofreader:** Sada Preisch

**Indexer:** Lucie Haskins

**Cover Designer:** Karen Montgomery

**Interior Designer:** David Futato

**Illustrator:** Rebecca Demarest

### **Printing History:**

July 2011: First Edition.

Nutshell Handbook, the Nutshell Handbook logo, and the O'Reilly logo are registered trademarks of O'Reilly Media, Inc. *Programming Android*, the image of a pine grosbeak, and related trade dress are trademarks of O'Reilly Media, Inc.

Many of the designations used by manufacturers and sellers to distinguish their products are claimed as trademarks. Where those designations appear in this book, and O'Reilly Media, Inc., was aware of a trademark claim, the designations have been printed in caps or initial caps.

While every precaution has been taken in the preparation of this book, the publisher and authors assume no responsibility for errors or omissions, or for damages resulting from the use of the information contained herein.

ISBN: 978-1-449-38969-7

[LSI]

1310671393

---

# Table of Contents

Preface .....	xiii
---------------	------

---

## Part I. Tools and Basics

<b>1. Your Toolkit .....</b>	<b>3</b>
Installing the Android SDK and Prerequisites	3
The Java Development Kit (JDK)	4
The Eclipse Integrated Development Environment (IDE)	5
The Android SDK	7
Adding Build Targets to the SDK	8
The Android Development Toolkit (ADT) Plug-in for Eclipse	9
Test Drive: Confirm That Your Installation Works	12
Making an Android Project	12
Making an Android Virtual Device (AVD)	16
Running a Program on an AVD	19
Running a Program on an Android Device	20
Troubleshooting SDK Problems: No Build Targets	21
Components of the SDK	21
The Android Debug Bridge (adb)	21
The Dalvik Debug Monitor Server (DDMS)	21
Components of the ADT Eclipse Plug-in	23
Android Virtual Devices	25
Other SDK Tools	26
Keeping Up-to-Date	28
Keeping the Android SDK Up-to-Date	28
Keeping Eclipse and the ADT Plug-in Up-to-Date	29
Keeping the JDK Up-to-Date	29
Example Code	30
SDK Example Code	30
Example Code from This Book	30
On Reading Code	32

---

<b>2. Java for Android .....</b>	<b>33</b>
Android Is Reshaping Client-Side Java	33
The Java Type System	34
Primitive Types	34
Objects and Classes	35
Object Creation	35
The Object Class and Its Methods	37
Objects, Inheritance, and Polymorphism	39
Final and Static Declarations	41
Abstract Classes	45
Interfaces	46
Exceptions	48
The Java Collections Framework	52
Garbage Collection	55
Scope	56
Java Packages	56
Access Modifiers and Encapsulation	57
Idioms of Java Programming	59
Type Safety in Java	59
Using Anonymous Classes	62
Modular Programming in Java	65
Basic Multithreaded Concurrent Programming in Java	68
Synchronization and Thread Safety	68
Thread Control with wait() and notify() Methods	71
Synchronization and Data Structures	73
<b>3. The Ingredients of an Android Application .....</b>	<b>75</b>
Traditional Programming Models Compared to Android	75
Activities, Intents, and Tasks	77
Other Android Components	78
Service	79
Content Providers	79
BroadcastReceiver	82
Static Application Resources and Context	82
Application Manifests	83
A Typical Source Tree	84
Initialization Parameters in AndroidManifest.xml	84
Resources	87
The Android Application Runtime Environment	88
The Dalvik VM	89
Zygote: Forking a New Process	89
Sandboxing: Processes and Users	89
Component Life Cycles	90

The Activity Life Cycle	90
Packaging an Android Application: The .apk File	92
On Porting Software to Android	93
<b>4. Getting Your Application into Users' Hands .....</b>	<b>95</b>
Application Signing	95
Public Key Encryption and Cryptographic Signing	95
How Signatures Protect Software Users, Publishers, and	
Secure Communications	97
Signing an Application	98
Placing an Application for Distribution in the Android Market	105
Becoming an Official Android Developer	106
Uploading Applications in the Market	106
Getting Paid	107
Google Maps API Keys	108
Specifying API-Level Compatibility	109
Compatibility with Many Kinds of Screens	109
Testing for Screen Size Compatibility	110
Resource Qualifiers and Screen Sizes	110
<b>5. Eclipse for Android Software Development .....</b>	<b>111</b>
Eclipse Concepts and Terminology	112
Plug-ins	112
Workspaces	113
Java Environments	114
Projects	115
Builders and Artifacts	115
Extensions	115
Associations	117
Eclipse Views and Perspectives	117
The Package Explorer View	118
The Task List View	118
The Outline View	119
The Problems View	120
Java Coding in Eclipse	120
Editing Java Code and Code Completion	120
Refactoring	121
Eclipse and Android	122
Preventing Bugs and Keeping Your Code Clean	122
Static Analyzers	123
Applying Static Analysis to Android Code	127
Limitations of Static Analysis	130
Eclipse Idiosyncrasies and Alternatives	130

<b>6. Effective Java for Android .....</b>	<b>133</b>
The Android Framework	133
The Android Libraries	133
Extending Android	135
Organizing Java Source	140
Concurrency in Android	142
AsyncTask and the UI Thread	143
Threads in an Android Process	154
Serialization	156
Java Serialization	157
Parcelable	159
Classes That Support Serialization	162
Serialization and the Application Life Cycle	163

---

## Part II. About the Android Framework

<b>7. Building a View .....</b>	<b>167</b>
Android GUI Architecture	167
The Model	167
The View	168
The Controller	169
Putting It Together	169
Assembling a Graphical Interface	171
Wiring Up the Controller	176
Listening to the Model	178
Listening for Touch Events	183
Listening for Key Events	186
Alternative Ways to Handle Events	187
Advanced Wiring: Focus and Threading	189
The Menu	193
<b>8. Fragments and Multiplatform Support .....</b>	<b>197</b>
Creating a Fragment	198
Fragment Life Cycle	201
The Fragment Manager	202
Fragment Transactions	203
The Compatibility Package	208
<b>9. Drawing 2D and 3D Graphics .....</b>	<b>211</b>
Rolling Your Own Widgets	211
Layout	212
Canvas Drawing	217

Drawables	228
Bitmaps	232
Bling	234
Shadows, Gradients, and Filters	237
Animation	238
OpenGL Graphics	243
<b>10. Handling and Persisting Data</b> .....	<b>247</b>
Relational Database Overview	247
SQLite	248
The SQL Language	248
SQL Data Definition Commands	249
SQL Data Manipulation Commands	252
Additional Database Concepts	254
Database Transactions	255
Example Database Manipulation Using sqlite3	255
SQL and the Database-Centric Data Model for Android Applications	258
The Android Database Classes	259
Database Design for Android Applications	260
Basic Structure of the SimpleVideoDbHelper Class	261
Using the Database API: MJAndroid	264
Android and Social Networking	264
The Source Folder (src)	265
Loading and Starting the Application	267
Database Queries and Reading Data from the Database	267
Modifying the Database	271

---

## Part III. A Skeleton Application for Android

<b>11. A Framework for a Well-Behaved Application</b> .....	<b>279</b>
Visualizing Life Cycles	280
Visualizing the Activity Life Cycle	280
Visualizing the Fragment Life Cycle	292
The Activity Class and Well-Behaved Applications	295
The Activity Life Cycle and the User Experience	296
Life Cycle Methods of the Application Class	296
A Flowing and Intuitive User Experience Across Activities	299
Multitasking in a Small-Screen Environment	299
Tasks and Applications	299
Specifying Launch and Task Behavior	300

<b>12. Using Content Providers .....</b>	<b>305</b>
Understanding Content Providers	306
Implementing a Content Provider	307
Browsing Video with Finch	308
Defining a Provider Public API	309
Defining the CONTENT_URI	310
Creating the Column Names	312
Declaring Column Specification Strings	312
Writing and Integrating a Content Provider	314
Common Content Provider Tasks	314
File Management and Binary Data	316
Android MVC and Content Observation	318
A Complete Content Provider: The SimpleFinchVideoContentProvider Code	319
The SimpleFinchVideoContentProvider Class and Instance Variables	319
Implementing the onCreate Method	321
Implementing the getType Method	322
Implementing the Provider API	322
Determining How Often to Notify Observers	327
Declaring Your Content Provider	327
<b>13. Exploring Content Providers .....</b>	<b>329</b>
Developing RESTful Android Applications	330
A “Network MVC”	331
Summary of Benefits	333
Code Example: Dynamically Listing and Caching YouTube Video Content	334
Structure of the Source Code for the Finch YouTube Video Example	335
Stepping Through the Search Application	336
Step 1: Our UI Collects User Input	337
Step 2: Our Controller Listens for Events	337
Step 3: The Controller Queries the Content Provider with a managedQuery on the Content Provider/Model	338
Step 4: Implementing the RESTful Request	338
Constants and Initialization	338
Creating the Database	339
A Networked Query Method	339
insert and ResponseHandlers	352
File Management: Storing Thumbnails	353



---

## Part IV. Advanced Topics

<b>14. Multimedia</b> .....	<b>359</b>
Audio and Video	359
Playing Audio and Video	360
Audio Playback	361
Video Playback	363
Recording Audio and Video	364
Audio Recording	365
Video Recording	368
Stored Media Content	369
<b>15. Location and Mapping</b> .....	<b>371</b>
Location-Based Services	372
Mapping	373
The Google Maps Activity	373
The MapView and MapActivity	374
Working with MapViews	375
MapView and MyLocationOverlay Initialization	375
Pausing and Resuming a MapActivity	378
Controlling the Map with Menu Buttons	379
Controlling the Map with the Keypad	381
Location Without Maps	382
The Manifest and Layout Files	382
Connecting to a Location Provider and Getting Location Updates	383
Updating the Emulated Location	386
<b>16. Sensors, NFC, Speech, Gestures, and Accessibility</b> .....	<b>391</b>
Sensors	391
Position	393
Other Sensors	395
Near Field Communication (NFC)	396
Reading a Tag	396
Writing to a Tag	403
P2P Mode	405
Gesture Input	406
Accessibility	407
<b>17. Communication, Identity, Sync, and Social Media</b> .....	<b>411</b>
Account Contacts	411
Authentication and Synchronization	414
Authentication	415

Synchronization	422
Bluetooth	429
The Bluetooth Protocol Stack	429
Bluez: The Linux Bluetooth Implementation	431
Using Bluetooth in Android Applications	431
<b>18. The Android Native Development Kit (NDK) .....</b>	<b>445</b>
Native Methods and JNI Calls	446
Conventions on the Native Method Side	446
Conventions on the Java Side	447
The Android NDK	448
Setting Up the NDK Environment	448
Compiling with the NDK	448
JNI, NDK, and SDK: A Sample App	449
Android-Provided Native Libraries	451
Building Your Own Custom Library Modules	453
Native Activities	456
<b>Index .....</b>	<b>463</b>

---

# Preface

The purpose of this book is to enable you to create well-engineered Android applications that go beyond the scope of small example applications.

This book is for people coming to Android programming from a variety of backgrounds. If you have been programming iPhone or Mac OS applications in Objective-C, you will find coverage of Android tools and Java language features relevant to Android programming that will help you bring your knowledge of mobile application development to Android. If you are an experienced Java coder, you will find coverage of Android application architecture that will enable you to use your Java expertise in this newly vibrant world of client Java application development. In short, this is a book for people with some relevant experience in object-oriented languages, mobile applications, REST applications, and similar disciplines who want to go further than an introductory book or online tutorials will take them.

## How This Book Is Organized

We want to get you off to a fast start. The chapters in the first part of this book will step you through using the SDK tools so that you can access example code in this book and in the SDK, even as you expand your knowledge of SDK tools, Java, and database design. The tools and basics covered in the first part might be familiar enough to you that you would want to skip to [Part II](#) where we build foundational knowledge for developing larger Android applications.

The central part of this book is an example of an application that uses web services to deliver information to the user—something many applications have at their core. We present an application architecture, and a novel approach to using Android’s framework classes that enables you to do this particularly efficiently. You will be able to use this application as a framework for creating your own applications, and as a tool for learning about Android programming.

In the final part of this book, we explore Android APIs in specific application areas: multimedia, location, sensors, and communication, among others, in order to equip you to program applications in your specific area of interest.

By the time you reach the end of this book, we want you to have gained knowledge beyond reference material and a walk-through of examples. We want you to have a point of view on how to make great Android applications.

## Conventions Used in This Book

The following typographical conventions are used in this book:

### *Italic*

Indicates new terms, URLs, email addresses, filenames, and file extensions

### **Constant width**

Used for program listings, as well as within paragraphs to refer to program elements such as variable or function names, databases, data types, environment variables, statements, and keywords

### **Constant width bold**

Shows commands or other text that should be typed literally by the user

### *Constant width italic*

Shows text that should be replaced with user-supplied values or by values determined by context



This icon signifies a tip, suggestion, or general note.

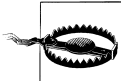

This icon indicates a warning or caution.

## Using Code Examples

This book is here to help you get your job done. In general, you may use the code in this book in your programs and documentation. You do not need to contact us for permission unless you're reproducing a significant portion of the code. For example, writing a program that uses several chunks of code from this book does not require permission. Selling or distributing a CD-ROM of examples from O'Reilly books does require permission. Answering a question by citing this book and quoting example code does not require permission. Incorporating a significant amount of example code from this book into your product's documentation does require permission.

We appreciate, but do not require, attribution. An attribution usually includes the title, author, publisher, and ISBN. For example: "*Programming Android* by Zigurd

Mednieks, Laird Dornin, G. Blake Meike, and Masumi Nakamura. Copyright 2011 O'Reilly Media, Inc., 978-1-449-38969-7.”

If you feel your use of code examples falls outside fair use or the permission given here, feel free to contact us at [permissions@oreilly.com](mailto:permissions@oreilly.com).

## Safari® Books Online

**Safari**  
Books Online  Safari Books Online is an on-demand digital library that lets you easily search more than 7,500 technology and creative reference books and videos to find the answers you need quickly.

With a subscription, you can read any page and watch any video from our library online. Read books on your cell phone and mobile devices. Access new titles before they are available for print, and get exclusive access to manuscripts in development and post feedback for the authors. Copy and paste code samples, organize your favorites, download chapters, bookmark key sections, create notes, print out pages, and benefit from tons of other time-saving features.

O'Reilly Media has uploaded this book to the Safari Books Online service. To have full digital access to this book and others on similar topics from O'Reilly and other publishers, sign up for free at <http://my.safaribooksonline.com>.

## How to Contact Us

Please address comments and questions concerning this book to the publisher:

O'Reilly Media, Inc.  
1005 Gravenstein Highway North  
Sebastopol, CA 95472  
800-998-9938 (in the United States or Canada)  
707-829-0515 (international or local)  
707-829-0104 (fax)

We have a web page for this book, where we list errata, examples, and any additional information. You can access this page at:

<http://oreilly.com/catalog/9781449389697>

To comment or ask technical questions about this book, send email to:

[bookquestions@oreilly.com](mailto:bookquestions@oreilly.com)

For more information about our books, courses, conferences, and news, see our website at <http://www.oreilly.com>.

Find us on Facebook: <http://facebook.com/oreilly>

Follow us on Twitter: <http://twitter.com/oreillymedia>

Watch us on YouTube: <http://www.youtube.com/oreillymedia>

## Acknowledgments

The authors have adapted portions of this book from their previously released title, *Android Application Development* (O'Reilly).

Drafts of this book were released on the O'Reilly Open Feedback Publishing System (OFPS) in order to get your feedback on whether and how we are meeting the goals for this book. We are very grateful for the readers who participated in OFPS, and we owe them much in correcting our errors and improving our writing. Open review of drafts will be part of future editions, and we welcome your views on every aspect of this book.

# Tools and Basics

[Part I](#) shows you how to install and use your tools, what you need to know about Java to write good Android code, and how to design and use SQL databases, which are central to the Android application model, persistence system, and implementation of key design patterns in Android programs.





# Your Toolkit

This chapter shows you how to install the Android software development kit (SDK) and all the related software you're likely to need. By the end, you'll be able to run a simple "Hello World" program on an emulator. Windows, Mac OS X, and Linux systems can all be used for Android application development. We will load the software, introduce you to the tools in the SDK, and point you to sources of example code.

Throughout this book, and especially in this chapter, we refer to instructions available on various websites for installing and updating the tools you will use for creating Android programs. The most important place to find information and links to tools is the Android Developers site:

<http://developer.android.com>

Our focus is on guiding you through installation, with explanations that will help you understand how the parts of Android and its developer tools fit together, even as the details of each part change.

The links cited in this book may change over time. Descriptions and updated links are posted on this book's website. You can find a link to the website on this book's [catalog page](#). You may find it convenient to have the book's website open as you read so that you can click through links on the site rather than entering the URLs printed in this book.

## Installing the Android SDK and Prerequisites

Successfully installing the Android SDK requires two other software systems that are not part of the Android SDK: the Java Development Kit (JDK) and the Eclipse integrated development environment (IDE). These two systems are not delivered as part of the Android SDK because you may be using them for purposes outside of Android software development, or because they may already be installed on your system, and redundant installations of these systems can cause version clashes.

The Android SDK is compatible with a range of recent releases of the JDK and the Eclipse IDE. Installing the current release of each of these tools will usually be the right choice. The exact requirements are specified on the System Requirements page of the Android Developers site: <http://developer.android.com/sdk/requirements.html>.

One can use IDEs other than Eclipse in Android software development, and information on using other IDEs is provided in the Android documentation at <http://developer.android.com/guide/developing/other-ide.html>. We chose Eclipse as the IDE covered in this book because Eclipse supports the greatest number of Android SDK tools and other plug-ins, and Eclipse is the most widely used Java IDE, but IntelliJ IDEA is an alternative many Java coders prefer.

## The Java Development Kit (JDK)

If your system has an up-to-date JDK installed, you won't need to install it again. The JDK provides tools, such as the Java compiler, used by IDEs and SDKs for developing Java programs. The JDK also contains a Java Runtime Environment (JRE), which enables Java programs, such as Eclipse, to run on your system.

If you are using a Macintosh running a version of Mac OS X supported by the Android SDK, the JDK is already installed.

If you are using Ubuntu Linux, you can install the JDK using the package manager, through the following command:

```
sudo apt-get install sun-java6-jdk
```

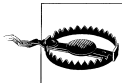

If this command reports that the JDK package is not available, you may need to enable the “partner” repositories using the Synaptic Package Manager utility in the System→Administration menu. The “partner” repositories are listed on the Other Software tab after you choose Settings→Repositories.

This is one of the very few places in this chapter where you will see a version number, and it appears here only because it can't be avoided. The version number of the JDK is in the package name. But, as with all other software mentioned in this chapter, you should refer to up-to-date online documentation to determine the version you will need.

If you are a Windows user, or you need to install the JDK from Oracle's site for some other reason, you can find the JDK at <http://www.oracle.com/technetwork/java/javase/downloads/index.html>.

The Downloads page will automatically detect your system and offer to download the correct version. The installer you download is an executable file. Run the executable installer file to install the JDK.

To confirm that the JDK is installed correctly, issue this command from the command line (Terminal on Linux and Mac; Command Prompt on Windows):

```
javac -version
```

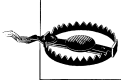

If the `javac` command is not in your `PATH`, you may need to add the `bin` directory in the JDK to your path manually.

It should display the version number corresponding to the version of the JDK you installed. If you installed revision 20 of the Java 6 JDK, the command would display:

```
javac 1.6.0_20
```

Depending on the current version of the JDK available when you read this, version numbers may differ from what you see here.



If it is unclear which JRE you are running, or if you think you have the wrong JRE running on a Debian-derived Linux system, such as Ubuntu, you can use the following command to display the available JREs and select the right one:

```
sudo update-alternatives --config java
```

## The Eclipse Integrated Development Environment (IDE)

Eclipse is a general-purpose technology platform. It has been applied to a variety of uses in creating IDEs for multiple languages and in creating customized IDEs for many specialized SDKs, as well as to uses outside of software development tools, such as providing a Rich Client Platform (RCP) for Lotus Notes and a few other applications.

Eclipse is usually used as an IDE for writing, testing, and debugging software, especially Java software. There are also several derivative IDEs and SDKs for various kinds of Java software development based on Eclipse. In this case, you will take a widely used Eclipse package and add a plug-in to it to make it usable for Android software development. Let's get that Eclipse package and install it.

Eclipse can be downloaded from <http://www.eclipse.org/downloads>.

You will see a selection of the most commonly used Eclipse packages on this page. An Eclipse “package” is a ready-made collection of Eclipse modules that make Eclipse better suited for certain kinds of software development. Usually, Eclipse users start with one of the Eclipse packages available for download on this page and customize it with plug-ins, which is what you will do when you add the Android Development Tools

(ADT) plug-in to your Eclipse installation. The System Requirements article on the Android Developers site lists three choices of Eclipse packages as a basis for an Eclipse installation for Android software development:

- Eclipse Classic (for Eclipse 3.5 or later)
- Eclipse IDE for Java Developers
- Eclipse for RCP/Plug-in Developers

Any of these will work, though unless you are also developing Eclipse plug-ins, choosing either Classic or the Java Developers package (EE or Standard) makes the most sense. The authors of this book started with the Java EE Developers package (“EE” stands for Enterprise Edition), and screenshots of Eclipse used in this book reflect that choice.

The Eclipse download site will automatically determine the available system-specific downloads for your system, though you may have to choose between 32 and 64 bits to match your operating system. The file you download is an archive. To install Eclipse, open the archive and copy the *eclipse* folder to your home folder. The executable file for launching Eclipse on your system will be found in the folder you just extracted from the archive.



We really mean it about installing Eclipse in your home folder (or another folder you own), especially if you have multiple user accounts on your system. Do not use your system’s package manager. Your Eclipse installation is one of a wide range of possible groupings of Eclipse plug-ins. In addition, you will probably further customize your installation of Eclipse. And Eclipse plug-ins and updates are managed separately from other software in your system.

For these reasons, it is very difficult to successfully install and use Eclipse as a command available to all users on your system, even if your system can do this from its package manager. To successfully complete an installation as it is described here, you must install Eclipse in a folder managed by one user, and launch it from this location.

If you are using Ubuntu or another Linux distribution, you should not install Eclipse from your distribution’s repositories, and if it is currently installed this way, you must remove it and install Eclipse as described here. The presence of an “eclipse” package in the Ubuntu repositories is an inheritance from the Debian repositories on which Ubuntu is based. It is not a widely used approach to installing and using Eclipse, because most of the time, your distribution’s repositories will have older versions of Eclipse.

To confirm that Eclipse is correctly installed and that you have a JRE that supports Eclipse, launch the executable file in the Eclipse folder. You may want to make a shortcut to this executable file to launch Eclipse more conveniently. You should see the Welcome screen shown in [Figure 1-1](#).

Eclipse is implemented in Java and requires a JRE. The JDK you previously installed provides a JRE. If Eclipse does not run, you should check that the JDK is correctly installed.

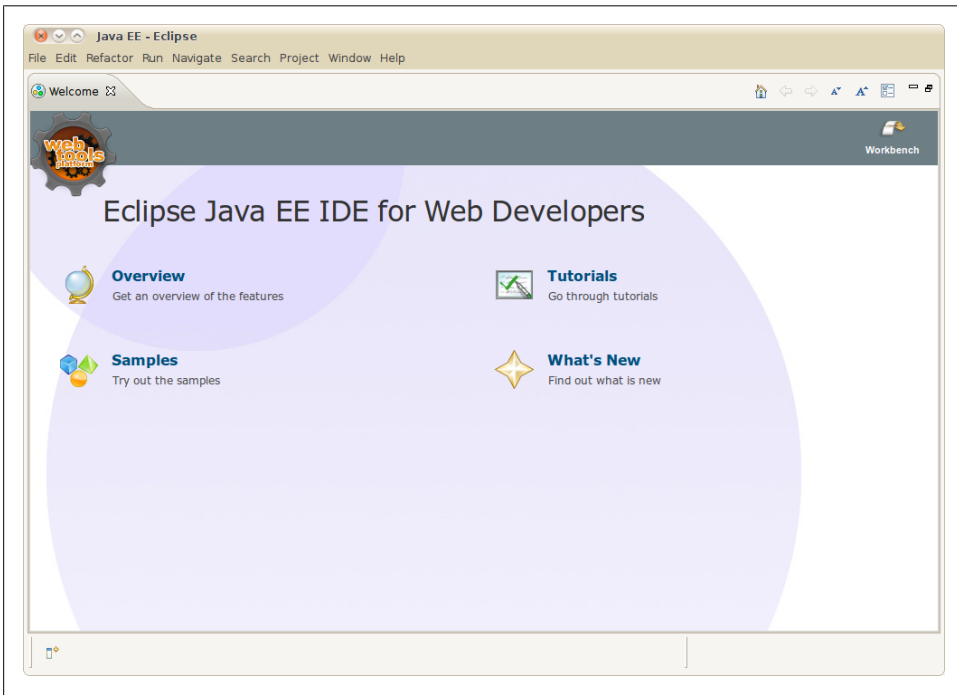

Figure 1-1. Welcome screen that you see the first time you run Eclipse

## The Android SDK

With the JDK and Eclipse installed, you have the prerequisites for the Android SDK, and are ready to install the SDK. The Android SDK is a collection of files: libraries, executables, scripts, documentation, and so forth. Installing the SDK means downloading the version of the SDK for your platform and putting the SDK files into a folder in your home directory.

To install the SDK, download the SDK package that corresponds to your system from <http://developer.android.com/sdk/index.html>.

The download is an archive. Open the archive and extract the folder in the archive to your home folder.



If you are using a 64-bit version of Linux, you may need to install the `ia32-libs` package.

To check whether you need this package, try running the `adb` command (`~/android-sdk-linux_*/platform-tools/adb`). If your system reports that `adb` cannot be found (despite being right there in the `platform-tools` directory) it likely means that the current version of `adb`, and possibly other tools, will not run without the `ia32-libs` package installed. The command to install the `ia32-libs` package is:

```
sudo apt-get install ia32-libs
```

The SDK contains one or two folders for tools: one named `tools` and, starting in version 8 of the SDK, another called `platform-tools`. These folders need to be on your path, which is a list of folders your system searches for executable files when you invoke an executable from the command line. On Macintosh and Linux systems, setting the `PATH` environment variable is done in the `.profile` (Ubuntu) or `.bash_profile` (Mac OS X) file in your home directory. Add a line to that file that sets the `PATH` environment variable to include the `tools` directory in the SDK (individual entries in the list are separated by colons). For example, you could use the following line (but replace both instances of `~/android-sdk-ARCH` with the full path to your Android SDK install):

```
export PATH=$PATH:~/android-sdk-ARCH/tools:~/android-sdk-ARCH/platform-tools
```

On Windows systems, click Start→right-click Computer, and choose Properties. Then click Advanced System Settings, and click the Environment Variables button. Double-click the path system variable, and add the path to the folders by going to the end of this variable's value (do not change anything that's already there!) and adding the two paths to the end, separated by semicolons with no space before them. For example:

```
;C:\android-sdk-windows\tools;C:\android-sdk-windows\platform-tools
```

After you've edited your path on Windows, Mac, or Linux, close and reopen any Command Prompts or Terminals to pick up the new `PATH` setting (on Ubuntu, you may need to log out and log in unless your Terminal program is configured as a login shell).

## Adding Build Targets to the SDK

Before you can build an Android application, or even create a project that would try to build an Android application, you must install one or more build targets. To do this, you will use the SDK and AVD Manager. This tool enables you to install packages in the SDK that will support multiple versions of the Android OS and multiple API levels.

Once the ADT plug-in is installed in Eclipse, which we describe in the next section, the SDK and AVD Manager can be invoked from within Eclipse. It can also be invoked from the command line, which is how we will do it here. To invoke the SDK and AVD Manager from the command line, issue this command:

```
android
```

The screenshot in [Figure 1-2](#) shows the SDK and AVD Manager, with all the available SDK versions selected for installation.

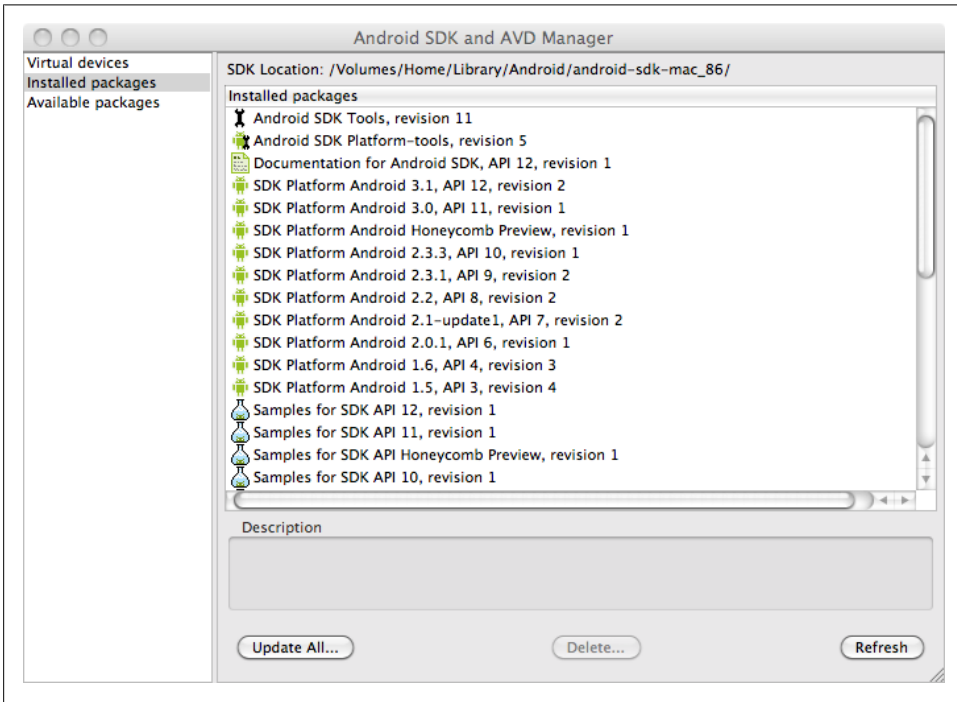

*Figure 1-2. The SDK and AVD Manager, which enables installation of Android API levels*

The packages labeled “SDK platform” support building applications compatible with different Android API levels. You should install, at a minimum, the most recent (highest numbered) version, but installing all the available API levels, and all the Google API add-on packages, is a good choice if you might someday want to build applications that run on older Android versions. You should also install, at a minimum, the most recent versions of the example applications package. You must also install the Android SDK Platform-Tools package.

## The Android Development Toolkit (ADT) Plug-in for Eclipse

Now that you have the SDK files installed, along with Eclipse and the JDK, there is one more critical part to install: the Android Developer Toolkit (ADT) plug-in. The ADT plug-in adds Android-specific functionality to Eclipse.

Software in the plug-in enables Eclipse to build Android applications, launch the Android emulator, connect to debugging services on the emulator, edit Android XML files, edit and compile Android Interface Definition Language (AIDL) files, create Android application packages (.apk files), and perform other Android-specific tasks.

## Using the Install New Software Wizard to download and install the ADT plug-in

You start the Install New Software Wizard by selecting Help→Install New Software (Figure 1-3). To install the ADT plug-in, type this URL into the Work With field and press Return or Enter: <https://dl-ssl.google.com/android/eclipse/> (see Figure 1-4).

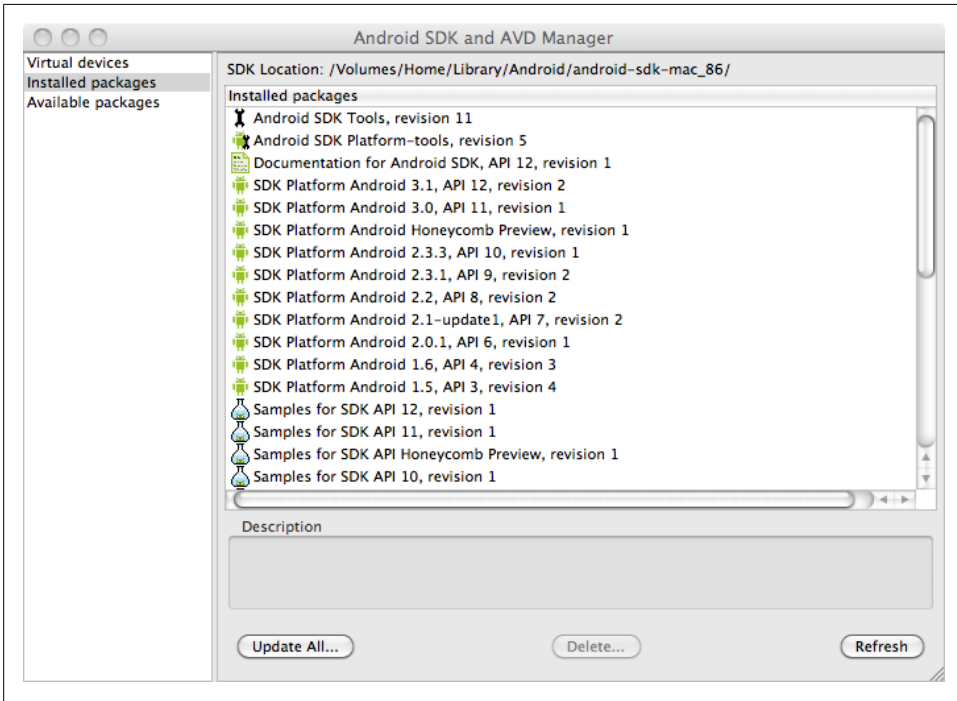

Figure 1-3. The Eclipse Add Site dialog



More information on installing the ADT plug-in using the Install New Software Wizard can be found on the Android Developers site, at <http://developer.android.com/sdk/eclipse-adt.html#downloading>.

Eclipse documentation on this wizard can be found on the Eclipse documentation site, at <http://help.eclipse.org/galileo/index.jsp?topic=org.eclipse.platform.doc.user/tasks/tasks-124.htm>.

Once you have added the URL to the list of sites for acquiring new plug-ins, you will see an entry called Developer Tools listed in the Available Software list.

Select the Developer Tools item by clicking on the checkbox next to it, and click on the Next button. The next screen will ask you to accept the license for this software. After you accept and click Finish, the ADT will be installed. You will have to restart Eclipse to complete the installation.



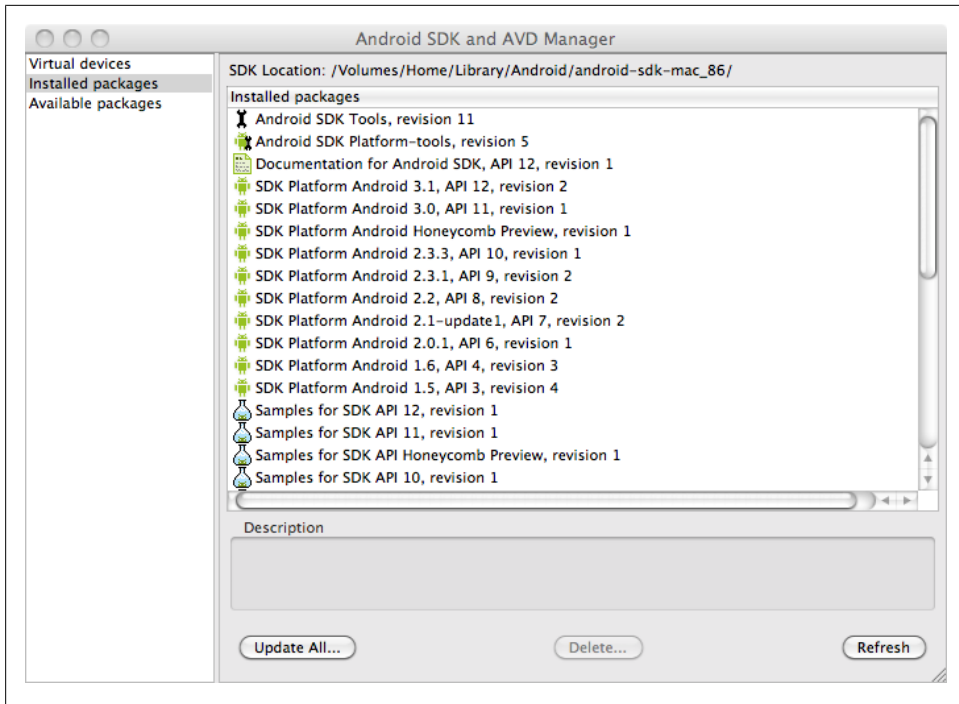

Figure 1-4. The Eclipse Install New Software dialog with the Android Hierarch Viewer plug-in shown as available

### Configuring the ADT plug-in

One more step, and you are done installing. Once you have installed the ADT plug-in, you will need to configure it. Installing the plug-in means that various parts of Eclipse now contain Android software development-specific dialogs, menu commands, and other tools, including the dialog you will now use to configure the ADT plug-in. Start the Preferences dialog using the Window→Preferences (Linux and Windows) or Eclipse→Preferences (Mac) menu option. Click the item labeled Android in the left pane of the Preferences dialog.



The first time you visit this section of the preferences, you'll see a dialog asking if you want to send some usage statistics to Google. Make your choice and click Proceed.

A dialog with the Android settings is displayed next. In this dialog, a text entry field labeled “SDK location” appears near the top. You must enter the path to where you put the SDK, or you can use the file browser to select the directory, as shown in [Figure 1-5](#). Click Apply. Note that the build targets you installed, as described in [“Adding Build Targets to the SDK” on page 8](#), are listed here as well.

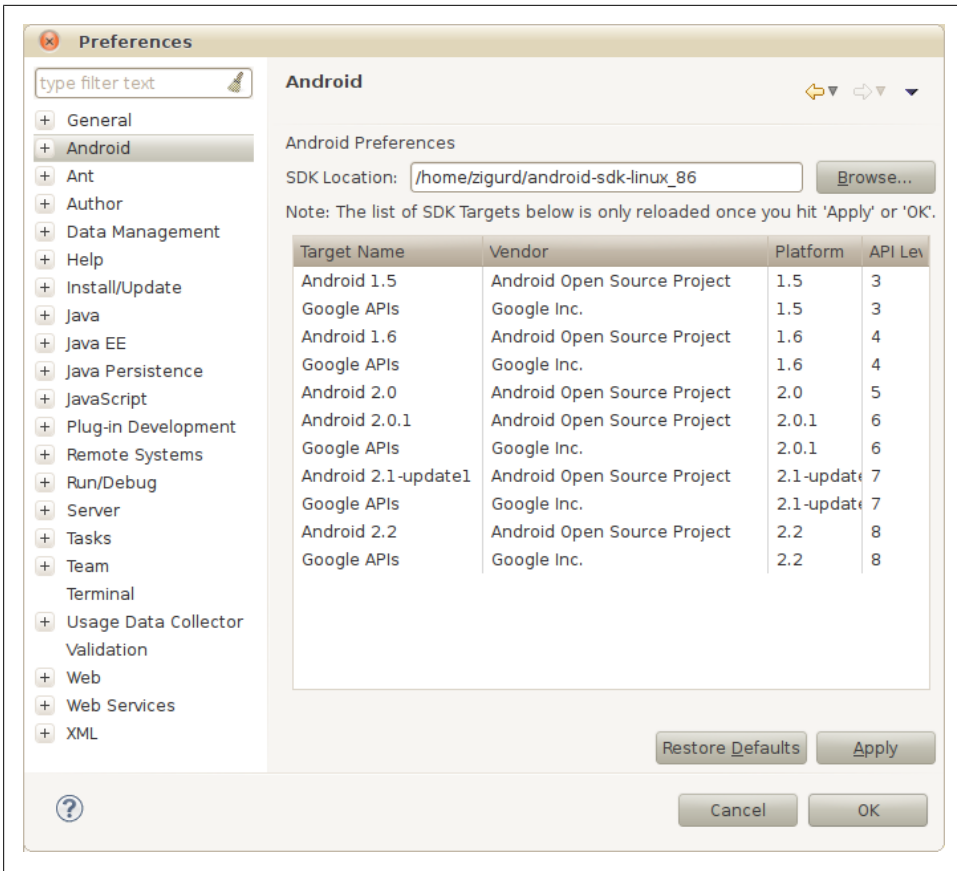

Figure 1-5. Configuring the SDK location into the Eclipse ADT plug-in using the Android Preferences dialog

Your Android SDK installation is now complete.

## Test Drive: Confirm That Your Installation Works

If you have followed the steps in this chapter, and the online instructions referred to here, your installation of the Android SDK is now complete. To confirm that everything you installed so far works, let's create a simple Android application.

### Making an Android Project

The first step in creating a simple Android application is to create an Android project. Eclipse organizes your work into “projects,” and by designating your project as an

Android project, you tell Eclipse that the ADT plug-in and other Android tools are going to be used in conjunction with this project.



Reference information and detailed online instructions for creating an Android project can be found at <http://developer.android.com/guide/developing/eclipse-adt.html>.

Start your new project with the File→New→Android Project menu command. Locate the Android Project option in the New Project dialog (it should be under a section named Android). Click Next, and the New Project dialog appears as shown in [Figure 1-6](#).

To create your Android project, you will provide the following information:

#### *Project name*

This is the name of the project (not the application) that appears in Eclipse. Type **TestProject**, as shown in [Figure 1-6](#).

#### *Workspace*

A workspace is a folder containing a set of Eclipse projects. In creating a new project, you have the choice of creating the project in your current workspace, or specifying a different location in the filesystem for your project. Unless you need to put this project in a specific location, use the defaults (“Create new project in workspace” and “Use default location”).

#### *Target name*

The Android system images you installed in the SDK are shown in the build target list. You can pick one of these system images, and the corresponding vendor, platform (Android OS version number), and API level as the target for which your application is built. The platform and API level are the most important parameters here: they govern the Android platform library that your application will be compiled with, and the API level supported—APIs with a higher API level than the one you select will not be available to your program. For now, pick the most recent Android OS version and API level you have installed.

#### *Application name*

This is the application name the user will see. Type **Test Application**.

#### *Package name*

The package name creates a Java package namespace that uniquely identifies packages in your application, and must also uniquely identify your whole Android application among all other installed applications. It consists of a unique domain name—the application publisher’s domain name—plus a name specific to the application. Not all package namespaces are unique in Java, but the conventions used for Android applications make namespace conflicts less likely. In our example we used `com.oreilly.testapp`, but you can put something appropriate for your domain

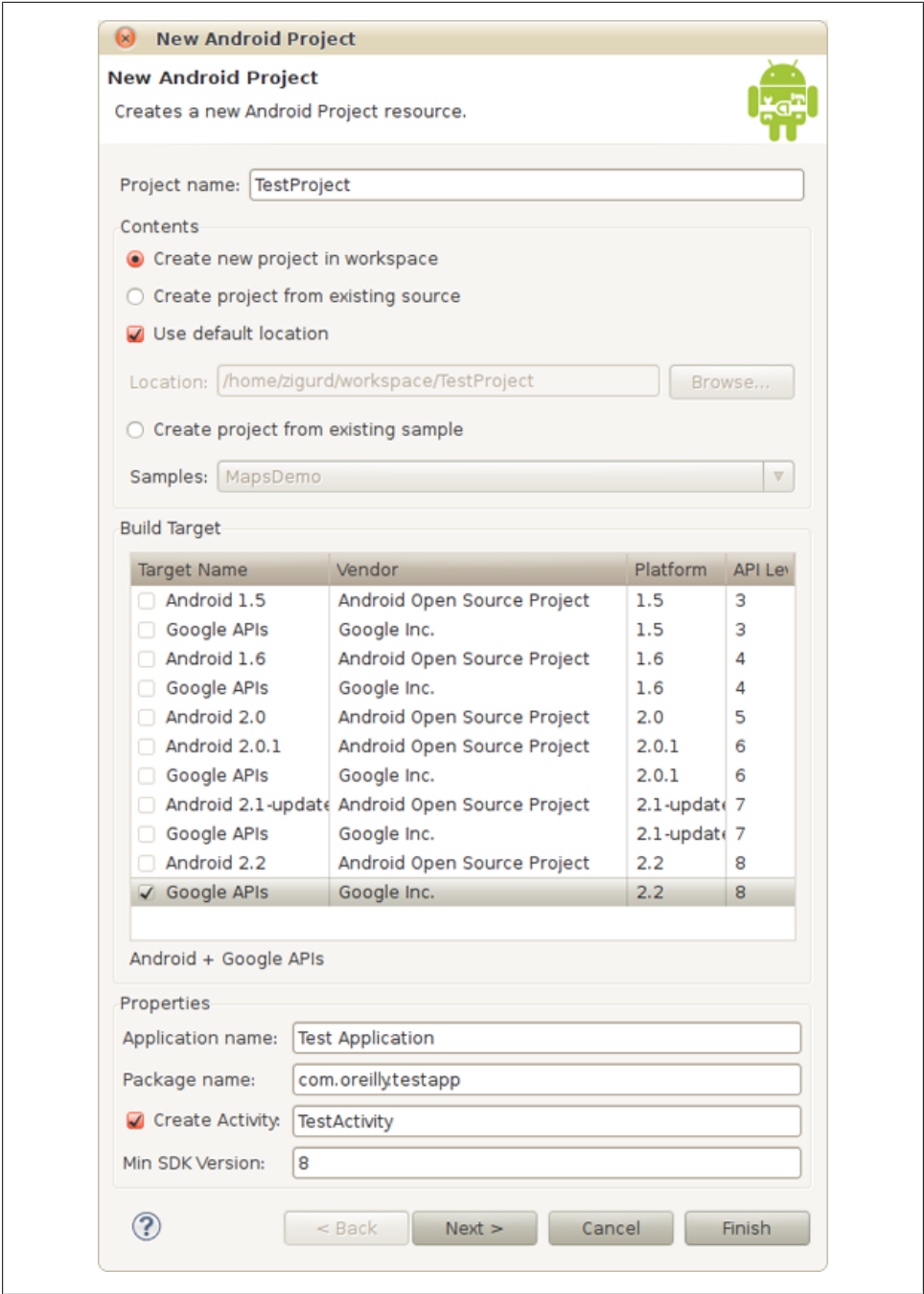

Figure 1-6. The New Android Project dialog

here (you can also use `com.example.testapp`, since `example.com` is a domain name reserved for examples such as this one).

### Activity

An *activity* is a unit of interactive user interface in an Android application, usually corresponding to a group of user interface objects occupying the entire screen. Optionally, when you create a project you can have a skeleton activity created for you. If you are creating a visual application (in contrast with a service, which can be “headless”—without a visual UI), this is a convenient way to create the activity the application will start with. In this example, you should create an activity called `TestActivity`.

### Minimum SDK version

The field labeled `Min SDK Version` should contain an integer corresponding to the minimum SDK version required by your application, and is used to initialize the `uses-sdk` attribute in the application’s manifest, which is a file that stores application attributes. See “[The Android Manifest Editor](#)” on page 24. In most cases, this should be the same as the API level of the build target you selected, which is displayed in the rightmost column of the list of build targets, as shown in [Figure 1-6](#).

Click `Finish` (not `Next`) to create your Android project, and you will see it listed in the left pane of the Eclipse IDE as shown in [Figure 1-7](#).

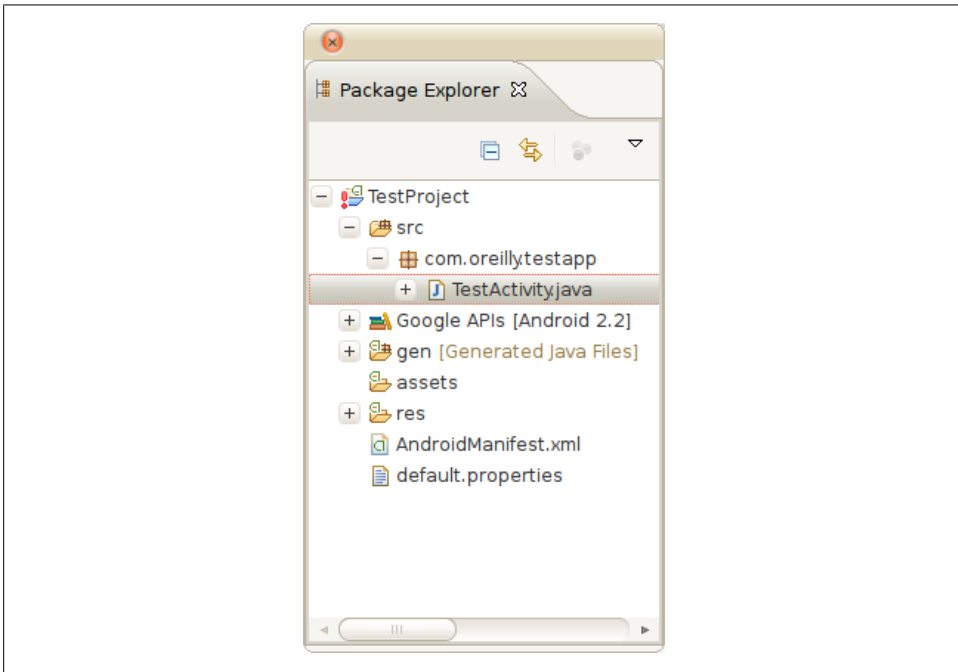

Figure 1-7. The Package Explorer view, showing the files, and their components, that are part of the project

If you expand the view of the project hierarchy by clicking the “+” (Windows) or triangle (Mac and Linux) next to the project name, you will see the various parts of an Android project. Expand the `src` folder and you will see a Java package with the name you entered in the wizard. Expand that package and you will see the `Activity` class created for you by the wizard. Double-click that, and you will see the Java code of your first Android program:

```
package com.oreilly.demo.pa.ch01.testapp;

import android.app.Activity;
import android.os.Bundle;
import com.oreilly.demo.pa.ch01.R;

public class TestActivity extends Activity {
    /** Called when the activity is first created. */
    @Override
    public void onCreate(Bundle savedInstanceState) {
        super.onCreate(savedInstanceState);
        setContentView(R.layout.main);
    }
}
```

If you’ve been following along and see the same thing on your computer, your SDK installation is probably working correctly. But let’s make sure, and explore the SDK just a bit further, by running your first program in an emulator and on an Android device if you have one handy.

## Making an Android Virtual Device (AVD)

The Android SDK provides an emulator, which emulates a device with an ARM CPU running an Android operating system (OS), for running Android programs on your PC. An Android Virtual Device (AVD) is a set of parameters for this emulator that configures it to use a particular system image—that is, a particular version of the Android operating system—and to set other parameters that govern screen size, memory size, and other emulated hardware characteristics. Detailed documentation on AVDs is available at <http://developer.android.com/guide/developing/tools/avd.html>, and detailed documentation on the emulator is found here: <http://developer.android.com/guide/developing/tools/emulator.html>.

Because we are just validating that your SDK installation works, we won’t go into depth on AVDs, much less details of the emulator, just yet. Here, we will use the Android SDK and AVD Manager (see [Figure 1-8](#)) to set up an AVD for the purpose of running the program we just created with the New Android Project Wizard.

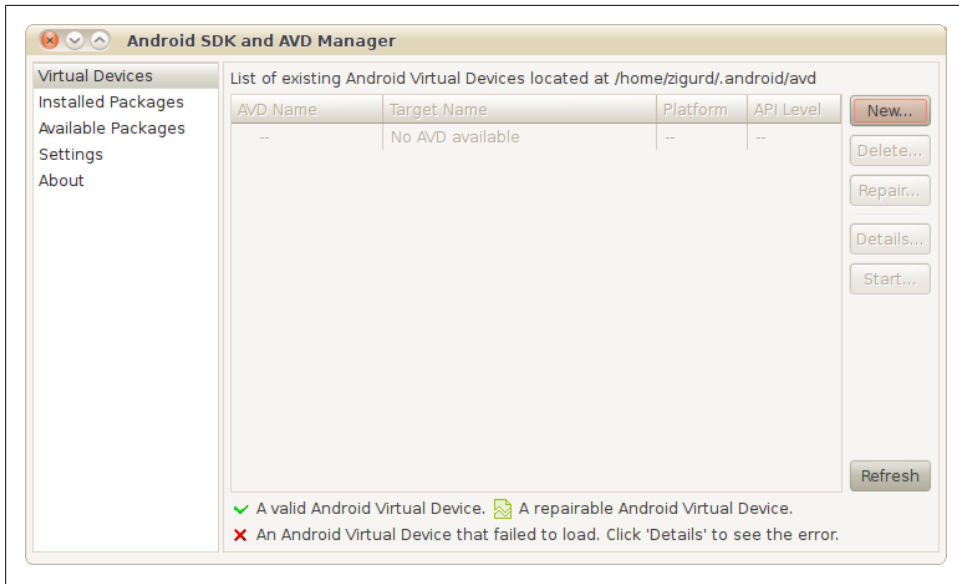

Figure 1-8. The SDK and AVD Manager

You will need to create an AVD with a system image that is no less recent than the target specified for the project you created. Click the New button. You will now see the Create New Android Virtual Device (AVD) dialog, shown in [Figure 1-9](#), where you specify the parameters of your new AVD.

This screen enables you to set the parameters of your new AVD:

#### *Name*

This is the name of the AVD. You can use any name for an AVD, but a name that indicates which system image it uses is helpful.

#### *Target*

The Target parameter sets which system image will be used in this AVD. It should be the same as, or more recent than, the target you selected as the build target for your first Android project.

#### *SD Card*

Some applications require an SD card that extends storage beyond the flash memory built into an Android device. Unless you plan to put a lot of data in SD card storage (media files, for example) for applications you are developing, you can create a small virtual SD card of, say, 100 MB in size, even though most phones are equipped with SD cards holding several gigabytes.

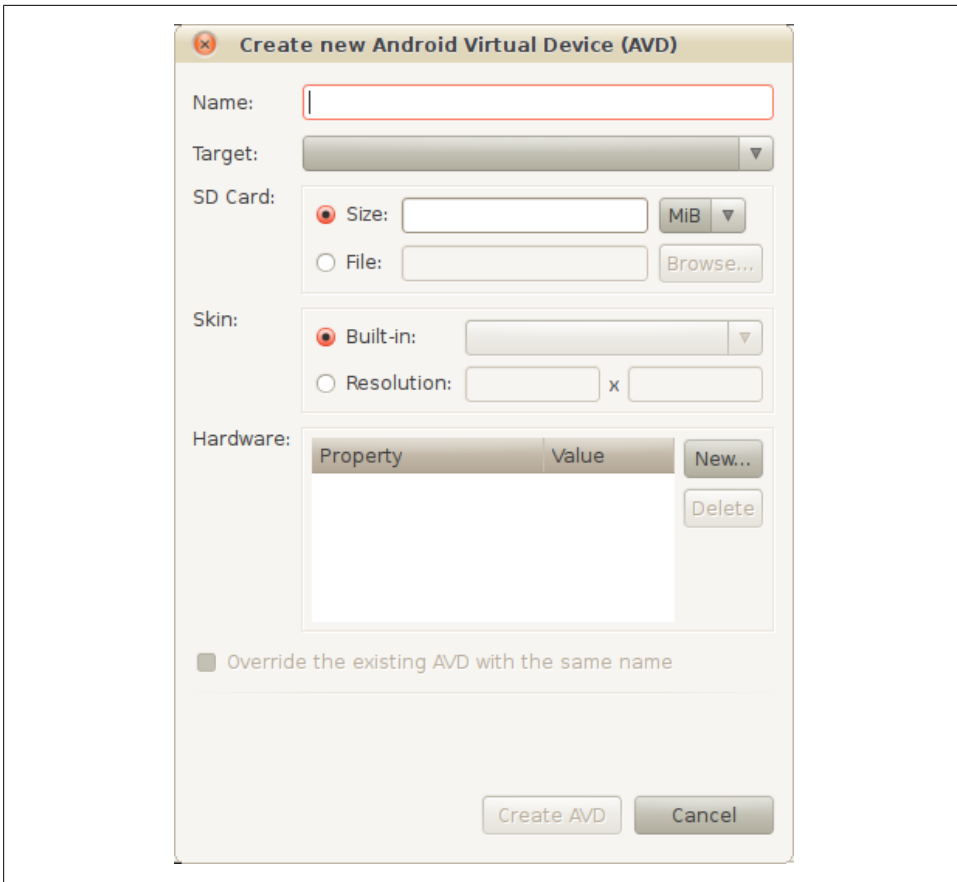

Figure 1-9. Creating a new AVD

### *Skin*

The “skin” of an AVD mainly sets the screen size. You won’t need to change the default for the purpose of verifying that your SDK installation works, but a variety of emulators with different screen sizes is useful to check that your layouts work across different devices.

### *Hardware*

The Hardware field of an AVD configuration enables you to set parameters indicating which optional hardware is present. You won’t need to change the defaults for this project.

Fill in the Name, Target, and SD Card fields, and create a new AVD by clicking the Create AVD button. If you have not created an AVD with a system image that matches or is more recent than the target you specified for an Android project, you won’t be able to run your program.



## Running a Program on an AVD

Now that you have a project that builds an application, and an AVD with a system image compatible with the application's build target and API level requirements, you can run your application and confirm that the SDK produced, and is able to run, an Android application.

To run your application, right-click on the project you created and, in the context menu that pops up, select Run As→Android Application.

If the AVD you created is compatible with the application you created, the AVD will start, the Android OS will boot on the AVD, and your application will start. You should see your application running in the AVD, similarly to what is shown in [Figure 1-10](#).



Figure 1-10. The application you just created, running in an AVD

If you have more than one compatible AVD configured, the Android Device Chooser dialog will appear and ask you to select among the AVDs that are already running, or among the Android devices attached to your system, if any, or to pick an AVD to start. [Figure 1-11](#) shows the Android Device Chooser displaying one AVD that is running, and one that can be launched.

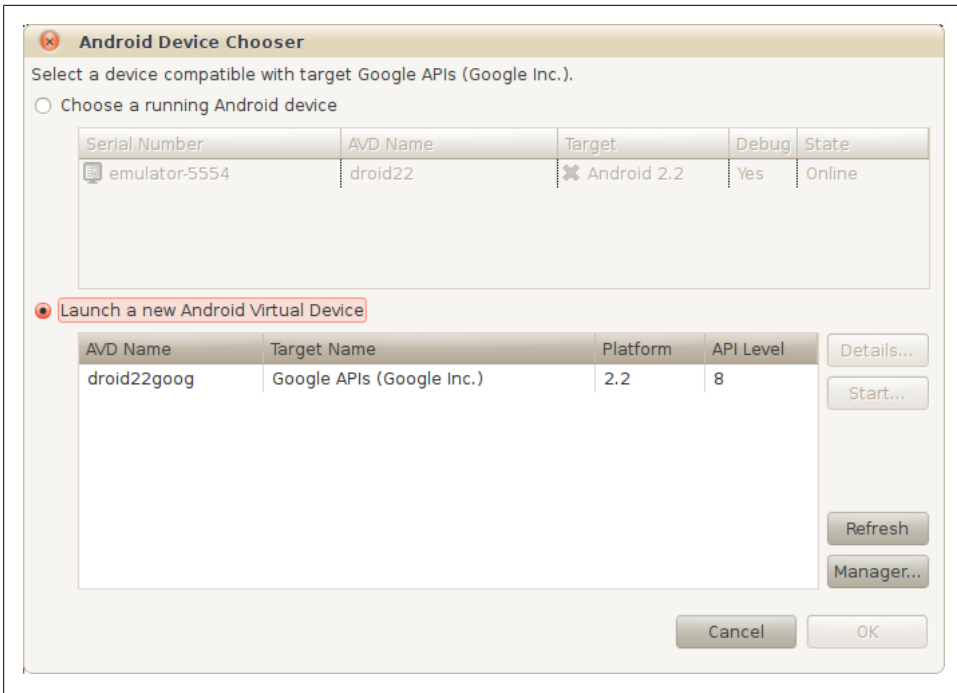

Figure 1-11. The Android Device Chooser

## Running a Program on an Android Device

You can also run the program you just created on most Android devices.

You will need to connect your device to your PC with a USB cable, and, if needed, install a driver, or set permissions to access the device when connected via USB.

System-specific instructions for Windows, along with the needed driver, are available at <http://developer.android.com/sdk/win-usb.html>.

If you are running Linux, you will need to create a “rules” file for your Android device.

If you are running Mac OS X, no configuration is required.

Detailed reference information on USB debugging is here: <http://developer.android.com/guide/developing/device.html>.

You will also need to turn on USB debugging in your Android device. In most cases, you will start the Settings application, select Applications and then Development, and then you will see an option to turn USB debugging on or off.

If an AVD is configured or is running, the Android Device Chooser will appear, displaying both the Android device you have connected and the AVD.

Select the device, and the Android application will be loaded and run on the device.

## Troubleshooting SDK Problems: No Build Targets

If you are unable to make a new project or import an example project from the SDK, you may have missed installing build targets into your SDK. Reread the instructions in “Adding Build Targets to the SDK” on page 8 and make sure the Android pane in the Preferences dialog lists build targets as installed in your SDK, as shown in Figure 1-5.

## Components of the SDK

The Android SDK is made of mostly off-the-shelf components, plus some purpose-built components. In many cases, configurations, plug-ins, and extensions adapt these components to Android. The Android SDK is a study in the efficient development of a modern and complete SDK. Google took this approach in order to bring Android to market quickly. You will see this for yourself as you explore the components of the Android SDK. Eclipse, the Java language, QEMU, and other preexisting platforms, tools, and technologies comprise some of the most important parts of the Android SDK.

In creating the simple program that confirms that your SDK installation is correct, you have already used many of the components of the SDK. Here we will identify and describe the components of the SDK involved in creating your program, and other parts you have yet to use.

### The Android Debug Bridge (adb)

adb is a program that enables you to control both emulators and devices, and to run a shell in order to execute commands in the environment of an emulator or device. adb is especially handy for installing and removing programs from an emulator or device. Documentation on adb can be found at <http://developer.android.com/guide/developing/tools/adb.html>.

### The Dalvik Debug Monitor Server (DDMS)

The Dalvik Debug Monitor Server (DDMS) is a traffic director between the single port that Eclipse (and other Java debuggers) looks for to connect to a Java Virtual Machine (JVM) and the several ports that exist for each Android device or virtual device, and for each instance of the Dalvik virtual machine (VM) on each device. The DDMS also provides a collection of functionality that is accessible through a standalone user interface or through an interface embedded in Eclipse via the ADT plug-in.

When you invoke the DDMS from the command line, you will see something similar to the window shown in Figure 1-12.

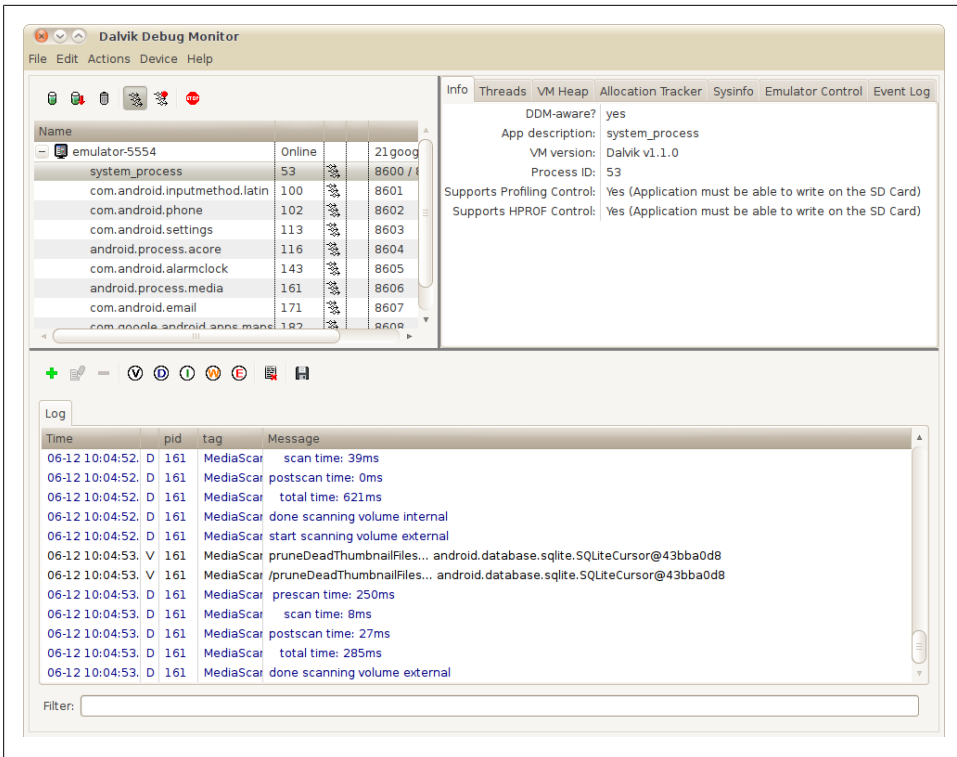

Figure 1-12. The Dalvik Debug Monitor running standalone

The DDMS's user interface provides access to the following:

*A list of devices and virtual devices, and the VMs running on those devices*

In the upper-left pane of the DDMS window, you will see listed the Android devices you have connected to your PC, plus any AVDs you have running. Listed under each device or virtual device are the tasks running in Dalvik VMs.

*VM information*

Selecting one of the Dalvik VMs running on a device or virtual device causes information about that VM to be displayed in the upper-right pane.

*Thread information*

Information for threads within each process is accessed through the “Threads” tab in the upper-right pane of the DDMS window.

*Filesystem explorer*

You can explore the filesystem on a device or virtual device using the DDMS file-system explorer, accessible through the “File explorer” menu item in the Devices menu. It displays the file hierarchy in a window similar to the one shown in [Figure 1-13](#).

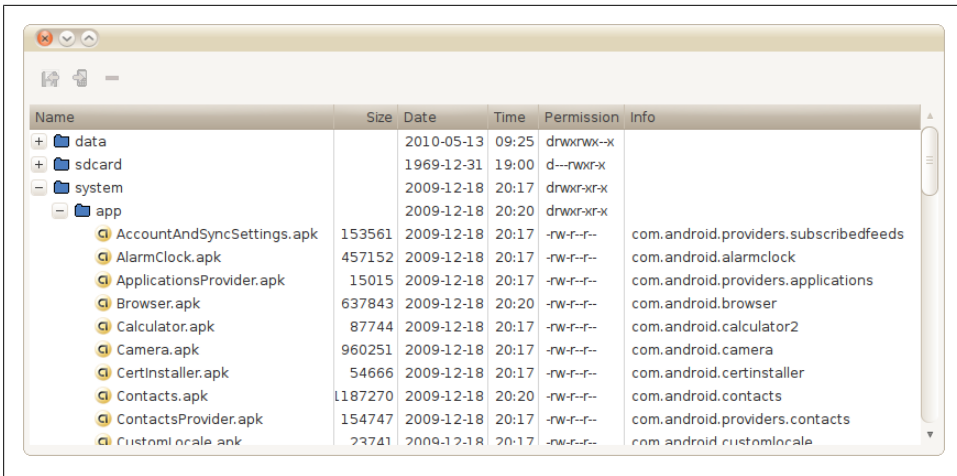

Figure 1-13. The DDMS file system explorer

### Simulating phone calls

The Emulator Control tab in the upper-right pane of the DDMS window enables you to “fake” a phone call or text message in an emulator.

### Screen capture

The “Screen capture” command in the Device menu fetches an image of the current screen from the selected Android device or virtual device.

### Logging

The bottom pane of the DDMS window displays log output from processes on the selected device or virtual device. You can filter the log output by selecting a filter from among the buttons on the toolbar above the logging pane.

### Dumping state for devices, apps, and the mobile radio

A set of commands in the Device menu enables you to command the device or virtual device to dump state for the whole device, an app, or the mobile radio.

Detailed documentation on the DDMS is available at <http://developer.android.com/guide/developing/tools/ddms.html>.

## Components of the ADT Eclipse Plug-in

Eclipse enables you to create specific project types, including several kinds of Java projects. The ADT plug-in adds the ability to make and use Android projects. When you make a new Android project, the ADT plug-in creates the project file hierarchy and all the required files for the minimal Android project to be correctly built. For Android projects, the ADT plug-in enables Eclipse to apply components of the ADT plug-in to editing, building, running, and debugging that project.

In some cases, components of the SDK can be used with Eclipse or in a standalone mode. But, in most of the Android application development cases covered in this book, the way these components are used in or with Eclipse will be the most relevant.

The ADT plug-in has numerous separate components, and, despite the connotations of a “plug-in” as a modest enhancement, it’s a substantial amount of software. Here we will describe each significant part of the ADT plug-in that you will encounter in using Eclipse for developing Android software.

### **The Android Layout Editor**

Layouts for user interfaces in Android applications can be specified in XML. The ADT plug-in adds a visual editor that helps you to compose and preview Android layouts. When you open a layout file, the ADT plug-in automatically starts this editor to view and edit the file. Tabs along the bottom of the editing pane enable you to switch between the visual editor and an XML editor.

In earlier versions of the Android SDK, the Android Layout Editor was too limited to be of much use. Now, though, you should consider using visual editing of Android layouts as a preferred way of creating layouts. Automating the specification of layouts makes it more likely that your layouts will work on the widest range of Android devices.

### **The Android Manifest Editor**

In Android projects, a manifest file is included with the project’s software and resources when the project is built. This file tells the Android system how to install and use the software in the archive that contains the built project. The manifest file is in XML, and the ADT plug-in provides a specialized XML editor to edit the manifest.

Other components of the ADT Eclipse plug-in, such as the application builders, can also modify the manifest.

### **XML editors for other Android XML files**

Other Android XML files that hold information such as specifications for menus, or resources such as strings, or that organize graphical assets of an application, have specialized editors that are opened when you open these files.

### **Building Android apps**

Eclipse projects are usually built automatically. That means you will normally not encounter a separate step for turning the source code and resources for a project into a deployable result. Android requires Android-specific steps to build a file you can deploy to an Android emulator or device, and the ADT plug-in provides the software that executes these steps. For Android projects, the result of building the project is an *.apk* file. You can find this file for the test project created earlier in this chapter in the *bin* subfolder of the project’s file hierarchy in your Eclipse workspace.

The Android-specific builders provided in the ADT plug-in enable you to use Java as the language for creating Android software while running that software on a Dalvik VM that processes its own bytecodes.

## Running and debugging Android apps

When you run or debug an Android project from within Eclipse, the *.apk* file for that project is deployed and started on an AVD or Android device, using the ADB and DDMS to communicate with the AVD or device and the Dalvik runtime environment that runs the project's code. The ADT plug-in adds the components that enable Eclipse to do this.

### The DDMS

In “[The Dalvik Debug Monitor Server \(DDMS\)](#)” on page 21 we described the Dalvik Debug Monitor and how to invoke the DDMS user interface from the command line. The DDMS user interface is also available from within Eclipse. You can access it by using the Window→Open Perspective→DDMS command in the Eclipse menu. You can also access each view that makes up the DDMS perspective separately by using the Window→Show View menu and selecting, for example, the LogCat view.

## Android Virtual Devices

AVDs are made up of QEMU-based emulators that emulate the hardware of an Android device, plus Android system images, which consist of Android software built to run on the emulated hardware. AVDs are configured by the SDK and AVD Manager, which sets parameters such as the size of emulated storage devices and screen dimensions, and which enables you to specify which Android system image will be used with which emulated device.

AVDs enable you to test your software on a broader range of system characteristics than you are likely to be able to acquire and test on physical devices. Because QEMU-based hardware emulators, system images, and the parameters of AVDs are all interchangeable parts, you can even test devices and system images before hardware is available to run them.

### QEMU

QEMU is the basis of AVDs. But QEMU is a very general tool that is used in a wide range of emulation systems outside the Android SDK. While you will configure QEMU indirectly, through the SDK and AVD Manager, you may someday need to tweak emulation in ways unsupported by the SDK tools, or you may be curious about the capabilities and limitations of QEMU. Luckily, QEMU has a large and vibrant developer and user community, which you can find at <http://www.qemu.org>.

## The SDK and AVD Manager

QEMU is a general-purpose emulator system. The Android SDK provides controls over the configuration of QEMU that make sense for creating emulators that run Android system images. The SDK and AVD Manager provides a user interface for you to control QEMU-based Android virtual devices.

## Other SDK Tools

In addition to the major tools you are likely to use in the normal course of most development projects, there are several other tools in the SDK, and those that are used or invoked directly by developers are described here. Still more components of the SDK are listed in the Tools Overview article in the Android documentation found at <http://developer.android.com/guide/developing/tools/index.html>.

### Hierarchy Viewer

The Hierarchy Viewer displays and enables analysis of the view hierarchy of the current activity of a selected Android device. This enables you to see and diagnose problems with your view hierarchies as your application is running, or to examine the view hierarchies of other applications to see how they are designed. It also lets you examine a magnified view of the screen with alignment guides that help identify problems with layouts. Detailed information on the Hierarchy Viewer is available at <http://developer.android.com/guide/developing/tools/hierarchy-viewer.html>.

### Layoutopt

Layoutopt is a static analyzer that operates on XML layout files and can diagnose some problems with Android layouts. Detailed information on Layoutopt is available at <http://developer.android.com/guide/developing/tools/layoutopt.html>.

### Monkey

Monkey is a test automation tool that runs in your emulator or device. You invoke this tool using another tool in the SDK: adb. Adb enables you to start a shell on an emulator or device, and Monkey is invoked from a shell, like this:

```
adb shell monkey --wait-dbg -p your.package.name 500
```

This invocation of Monkey sends 500 random events to the specified application (specified by the package name) after waiting for a debugger to be attached. Detailed information on Monkey can be found at <http://developer.android.com/guide/developing/tools/monkey.html>.



## sqlite3

Android uses SQLite as the database system for many system databases and provides APIs for applications to make use of SQLite, which is convenient for data storage and presentation. SQLite also has a command-line interface, and the `sqlite3` command enables developers to dump database schemas and perform other operations on Android databases.

These databases are, of course, in an Android device, or they are contained in an AVD, and therefore the `sqlite3` command is available in the adb shell. Detailed directions for how to access the `sqlite3` command line from inside the adb shell are available at <http://developer.android.com/guide/developing/tools/adb.html#shellcommands>. We introduce `sqlite3` in “Example Database Manipulation Using `sqlite3`” on page 255.

## keytool

`keytool` generates encryption keys, and is used by the ADT plug-in to create temporary debug keys with which it signs code for the purpose of debugging. In most cases, you will use this tool to create a signing certificate for releasing your applications, as described in “Creating a self-signed certificate” on page 99.

## Zipalign

Zipalign enables optimized access to data for production releases of Android applications. This optimization must be performed after an application is signed for release, because the signature affects byte alignment. Detailed information on Zipalign is available at <http://developer.android.com/guide/developing/tools/zipalign.html>.

## Draw9patch

A *9 patch* is a special kind of Android resource, composed of nine images, and useful when you want, for example, buttons that can grow larger without changing the radius of their corners. Draw9patch is a specialized drawing program for creating and previewing these types of resources. Details on draw9patch are available at <http://developer.android.com/guide/developing/tools/draw9patch.html>.

## android

The command named `android` can be used to invoke the SDK and AVD Manager from the command line, as we described in the SDK installation instructions in “The Android SDK” on page 7. It can also be used to create an Android project from the command line. Used in this way, it causes all the project folders, the manifest, the build properties, and the ant script for building the project to be generated. Details on this use of the `android` command can be found at <http://developer.android.com/guide/developing/other-ide.html#CreatingAProject>.

## Keeping Up-to-Date

The JDK, Eclipse, and the Android SDK each come from separate suppliers. The tools you use to develop Android software can change at a rapid pace. That is why, in this book, and especially in this chapter, we refer you to the Android Developers site for information on the latest compatible versions of your tools. Keeping your tools up-to-date and compatible is a task you are likely to have to perform even as you learn how to develop Android software.

Windows, Mac OS X, and Linux all have system update mechanisms that keep your software up-to-date. But one consequence of the way the Android SDK is put together is that you will need to keep separate software systems up-to-date through separate mechanisms.

### Keeping the Android SDK Up-to-Date

The Android SDK isn't part of your desktop OS, nor is it part of the Eclipse plug-in, and therefore the contents of the SDK folder are not updated by the OS or Eclipse. The SDK has its own update mechanism, which has a user interface in the SDK and AVD Manager. As shown in [Figure 1-14](#), select Installed Packages in the left pane to show a list of SDK components installed on your system. Click on the Update All button to start the update process, which will show you a list of available updates.

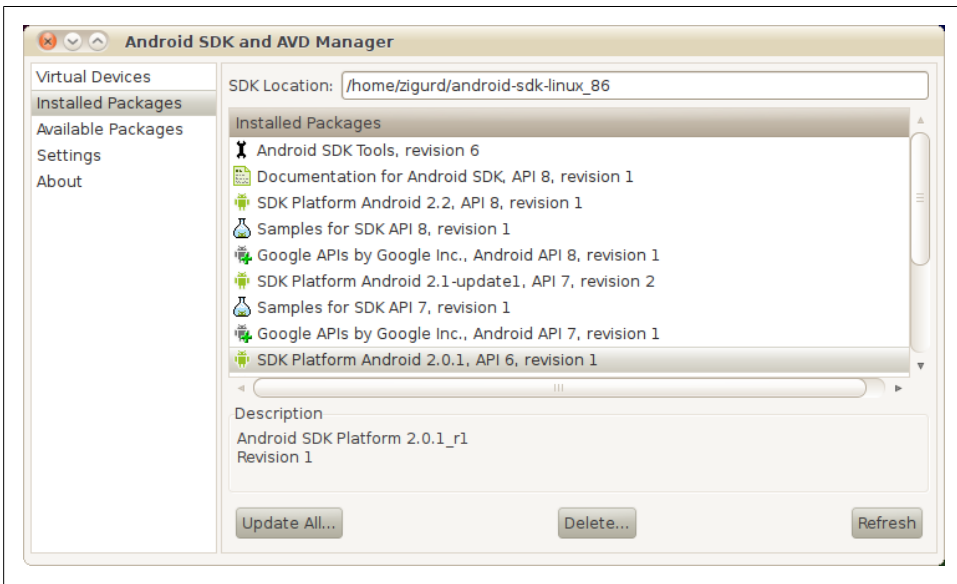

Figure 1-14. Updating the SDK with the SDK and AVD Manager

Usually, you will want to install all available updates.

## Keeping Eclipse and the ADT Plug-in Up-to-Date

While the SDK has to be updated outside of both your operating system and Eclipse, the ADT plug-in, and all other components of Eclipse, are updated using Eclipse’s own update management system. To update all the components you have in your Eclipse environment, including the ADT plug-in, use the “Check for Updates” command in the Help menu. This will cause the available updates to be displayed, as shown in [Figure 1-15](#).

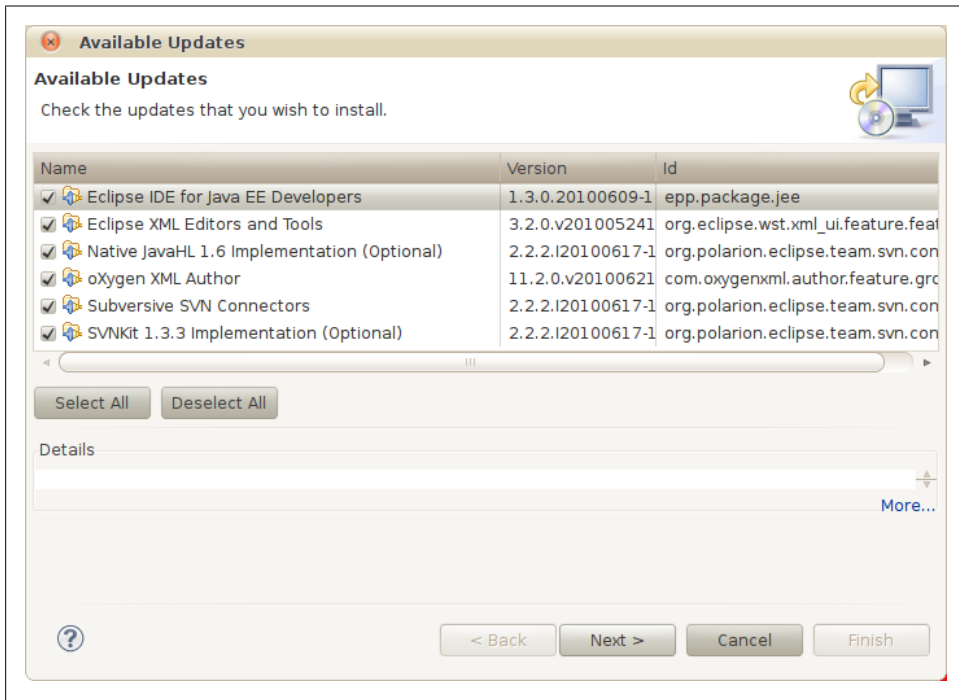

Figure 1-15. Updating Eclipse components and the ADT plug-in

Normally, you will want to use the Select All button to install all available updates. The updates you see listed on your system depend on what Eclipse modules you have installed and whether your Eclipse has been updated recently.

## Keeping the JDK Up-to-Date

You won’t be updating Java as much as the SDK, ADT plug-in, and other Eclipse plug-ins. Even if Java 7 has not been released by the time you read this, it is likely to happen soon enough to matter to Android developers. Before choosing to update the JDK, first check the System Requirements page of the Android Developers site at <http://developer.android.com/sdk/requirements.html>.

If an update is needed and you are using a Mac or Linux system, check the available updates for your system to see if a new version of the JDK is included. If the JDK was installed on your system by the vendor, or if you installed it from your Linux distribution's repositories, updates will be available through the updates mechanism on your system.

## Example Code

Having installed the Android SDK and tested that it works, you are ready to explore. Even if you are unfamiliar with the Android Framework classes and are new to Java, exploring some example code now will give you further confidence in your SDK installation, before you move on to other parts of this book.

### SDK Example Code

The most convenient sample code comes with the SDK. You can create a new project based on the SDK samples, as shown in [Figure 1-16](#). The sample you select appears in the left pane of the Eclipse window, where you can browse the files comprising the sample and run it to see what it does. If you are familiar with using IDEs to debug code, you may want to set some breakpoints in the sample code to see when methods get executed.

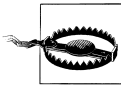

In the dialog pictured in [Figure 1-16](#), you must pick a build target before you pick a sample. Samples are organized by API level, and if you have not picked a build target, the drop-down list will be empty.

Each sample application that comes with the SDK corresponds to an article on the Android Developers site. More information about each sample can be found there. All of the samples are listed on the documentation page at <http://developer.android.com/resources/samples/index.html>.

There are more than a dozen applications, one of which—the API demos application—is a sprawling exploration of most of the Android APIs. Creating a few projects based on these code samples will give you familiarity with how these programs work, and will help you understand what you will read in the upcoming chapters of this book, even if you don't fully understand what you are looking at yet.

### Example Code from This Book

Example code from this book can be downloaded from the book's website at <http://oreilly.com/catalog/0636920010364>.

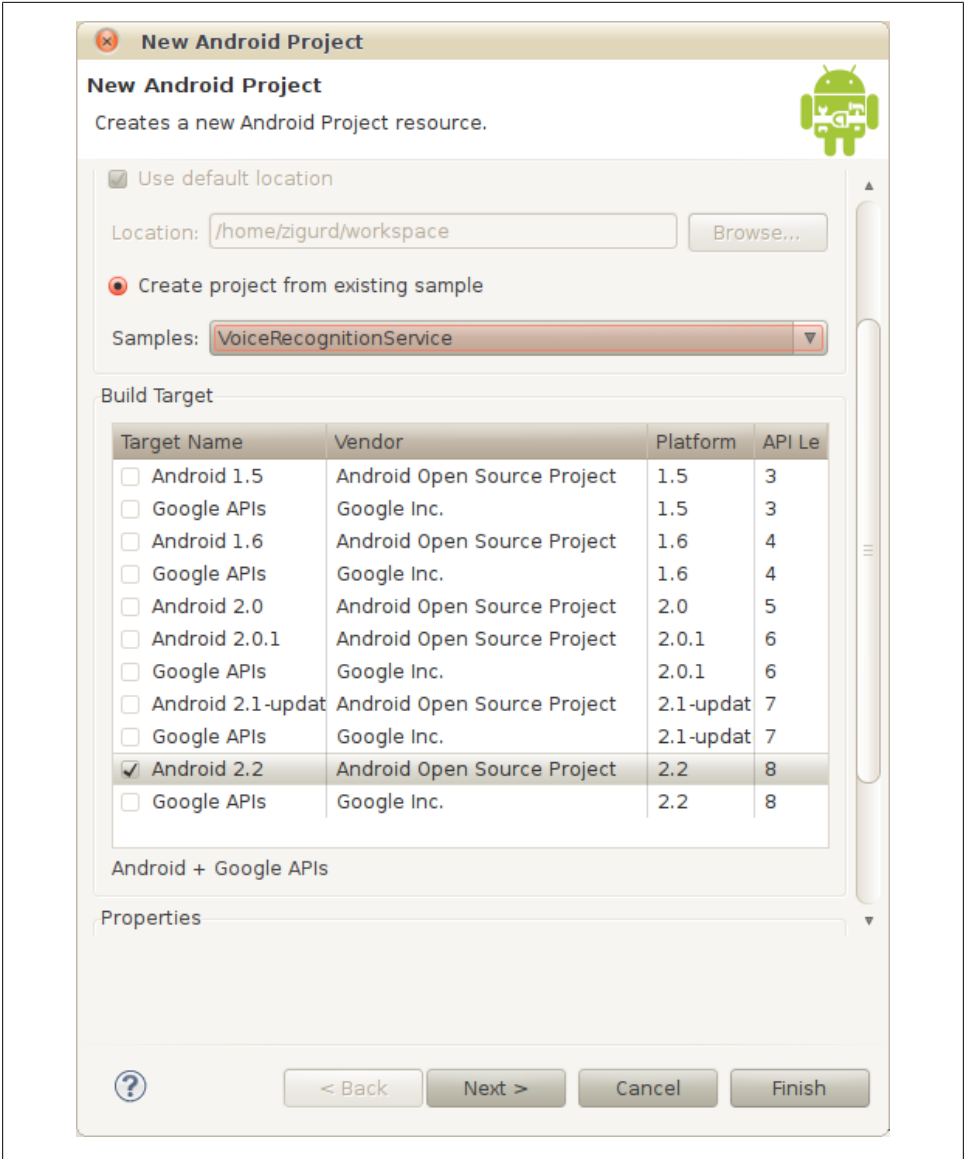

Figure 1-16. Creating a new project using example code from the SDK

## On Reading Code

Good coders read a lot of code. The example code provided by the authors of this book is intended to be both an example of good Java coding and an example of how to use capabilities of the Android platform.

Some examples you will read fall short of what you will need for creating the best possible extensible and maintainable commercial software. Many example applications make choices that make sense if the coder's goal is to create an example in a single Java class. In many cases, Android applications are overgrown versions of example code, and they end up unreadable and unmaintainable. But that does not mean you should avoid reading examples that are more expedient than a large application should be.

The next chapter will explore the Java language, with the goal of giving you the ability to evaluate example code with good engineering and design practices in mind. We want you to be able to take examples and make them better, and to apply the ideas in examples to code you engineer to create high-quality products.

# Java for Android

We don't teach you Java in this book, but in this chapter we'll help you understand the special use of Java within Android. Many people can benefit from this chapter: students who have learned some Java but haven't yet stumbled over the real-life programming dilemmas it presents, programmers from other mobile environments who have used other versions of Java but need to relearn some aspects of the language in the context of Android programming, and Java programmers in general who are new to Android's particular conventions and requirements.

If you find this chapter too fast-paced, pick up an introductory book on Java. If you follow along all right but a particular concept described in this chapter remains unclear to you, you might refer to the Java tutorial at [http://download.oracle.com/docs/cd/E17409\\_01/javase/tutorial/index.html](http://download.oracle.com/docs/cd/E17409_01/javase/tutorial/index.html).

## Android Is Reshaping Client-Side Java

Android is already the most widely used way of creating interactive clients using the Java language. Although there have been several other user interface class libraries for Java (AWT, SWT, Swing, J2ME Canvas, etc.), none of them have been as widely accepted as Android. For any Java programmer, the Android UI is worth learning just to understand what the future of Java UIs might look like.

The Android toolkit doesn't gratuitously bend Java in unfamiliar directions. The mobile environment is simply different. There is a much wider variety of display sizes and shapes; there is no mouse (though there might be a touch screen); text input might be triple-tap; and so on. There are also likely to be many more peripheral devices: motion sensors, GPS units, cameras, multiple radios, and more. Finally, there is the ever-present concern about power. While Moore's law affects processors and memory (doubling their power approximately every two years), no such law affects battery life. When processors were slow, developers used to be concerned about CPU speed and efficiency. Mobile developers, on the other hand, need to be concerned about energy efficiency.

This chapter provides a refresher for generic Java; Android-specific libraries are discussed in detail in [Chapter 3](#).

## The Java Type System

There are two distinct, fundamental types in the Java language: objects and primitives. Java provides type safety by enforcing static typing, which requires that every variable must be declared with its type before it is used. For example, a variable named `i` declared as type `int` (a primitive 32-bit integer) looks like this:

```
int i;
```

This mechanism stands in contrast to nonstatically typed languages where variables are only optionally declared. Though explicit type declarations are more verbose, they enable the compiler to prevent a wide range of programming errors—accidental variable creation resulting from misspelled variable names, calls to nonexistent methods, and so on—from ever making it into running code. Details of the Java Type System can be found in the [Java Language Specification](#).

## Primitive Types

Java primitive types are not objects and do not support the operations associated with objects described later in this chapter. You can modify a primitive type only with a limited number of predefined operators: “+”, “-”, “&”, “|”, “=”, and so on. The Java primitive types are:

`boolean`

The values `true` or `false`

`byte`

An 8-bit 2’s-complement integer

`short`

A 16-bit 2’s-complement integer

`int`

A 32-bit 2’s-complement integer

`long`

A 64-bit 2’s-complement integer

`char`

A 16-bit unsigned integer representing a UTF-16 code unit

`float`

A 32-bit IEEE 754 floating-point number

`double`

A 64-bit IEEE 754 floating-point number



## Objects and Classes

Java is an object-oriented language and focuses not on its primitives but on objects—combinations of data, and procedures for operating on that data. A *class* defines the fields (data) and methods (procedures) that comprise an object. In Java, this definition—the template from which objects are constructed—is, itself, a particular kind of object, a **Class**. In Java, classes form the basis of a type system that allows developers to describe arbitrarily complex objects with complex, specialized state and behavior.

In Java, as in most object-oriented languages, types may inherit from other types. A class that inherits from another is said to *subtype* or to be a *subclass* of its parent. The parent class, in turn, may be called the *supertype* or *superclass*. A class that has several different subclasses may be called the *base type* for those subclasses.

Both methods and fields have global scope within the class and may be visible from outside the object through a reference to an instance of the class.

Here is the definition of a very, very simple class with one field, `ctr`, and one method, `incr`:

```
public class Trivial {
    /** a field: its scope is the entire class */
    private long ctr;

    /** Modify the field. */
    public void incr() { ctr++; }
}
```

## Object Creation

A new object, an instance of some class, is created by using the `new` keyword:

```
Trivial trivial = new Trivial();
```

On the left side of the assignment operator “=”, this statement defines a variable, named `trivial`. The variable has a type, `Trivial`, so only objects of type `Trivial` can be assigned to it. The right side of the assignment allocates memory for a new instance of the `Trivial` class and initializes the instance. The assignment operator assigns a reference to the newly created object to the variable.

It may surprise you to know that the definition of `ctr`, in `Trivial`, is perfectly safe despite the fact that it is not explicitly initialized. Java guarantees that it will be initialized to have the value 0. Java guarantees that all fields are automatically initialized at object creation: `boolean` is initialized to `false`, numeric primitive types to 0, and all object types (including `Strings`) to `null`.



This applies only to object fields. Local variables must be initialized before they are referenced!

You can take greater control over the initialization of an object by adding a *constructor* to its class definition. A constructor definition looks like a method except that it doesn't specify a return type. Its name must be exactly the name of the class that it constructs:

```
public class LessTrivial {
    /** a field: its scope is the entire class */
    private long ctr;

    /** Constructor: initialize the fields */
    public LessTrivial(long initCtr) { ctr = initCtr; }

    /** Modify the field. */
    public void incr() { ctr++; }
}
```

In fact, every class in Java has a constructor. The Java compiler automatically creates a constructor with no arguments, if no other constructor is specified. Further, if a constructor does not explicitly call some superclass constructor, the Java compiler will automatically add an implicit call to the superclass no-arg constructor as the very first statement. The definition of `Trivial` given earlier (which specifies no explicit constructor), actually has a constructor that looks like this:

```
public Trivial() { super(); }
```

Since the `LessTrivial` class explicitly defines a constructor, Java does *not* implicitly add a default. That means that trying to create a `LessTrivial` object, with no arguments, will cause an error:

```
LessTrivial fail = new LessTrivial(); // ERROR!!
LessTrivial ok = new LessTrivial(18); // ... works
```

There are two concepts that it is important to keep separate: *no-arg constructor* and *default constructor*. A default constructor is the constructor that Java adds to your class, implicitly, if you don't define any other constructors. It happens to be a no-arg constructor. A no-arg constructor, on the other hand, is simply a constructor with no parameters. There is no requirement that a class have a no-arg constructor. There is no obligation to define one, unless you have a specific need for it.

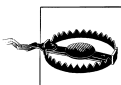

One particular case in which no-arg constructors are necessary deserves special attention. Some libraries need the ability to create new objects, generically, on your behalf. The JUnit framework, for instance, needs to be able to create new test cases, regardless of what they test. Libraries that marshal and unmarshal code to a persistent store or a network connection also need this capability. Since it would be pretty hard for these libraries to figure out, at runtime, the exact calling protocol for your particular object, they typically require a no-arg constructor.

If a class has more than one constructor, it is wise to cascade them, to make sure only a single copy of the code actually initializes the instance and that all other constructors

call it. For instance, as a convenience, we might add a no-arg constructor to the `LessTrivial` class, to accommodate a common case:

```
public class LessTrivial {
    /** a field: its scope is the entire class */
    private long ctr;

    /** Constructor: init counter to 0 */
    public LessTrivial() { this(0); }

    /** Constructor: initialize the fields */
    public LessTrivial(long initCtr) { ctr = initCtr; }

    /** Modify the field. */
    public void incr() { ctr++; }
}
```

Cascading methods is the standard Java idiom for defaulting the values of some arguments. All the code that actually initializes an object is in a single, complete method or constructor and all other methods or constructors simply call it. It is a particularly good idea to use this idiom with constructors that must make explicit calls to a superconstructor.

Constructors should be simple and should do no more work than is necessary to put an object into a consistent initial state. One can imagine, for instance, a design for an object that represents a database or network connection. It might create the connection, initialize it, and verify connectivity, all in the constructor. While this might seem entirely reasonable, in practice it creates code that is insufficiently modular and difficult to debug and modify. In a better design, the constructor simply initializes the connection state as closed and leaves it to an explicit `open` method to set up the network.

## The Object Class and Its Methods

The Java class `Object`—`java.lang.Object`—is the root ancestor of every class. Every Java object is an `Object`. If the definition of a class does not explicitly specify a superclass, it is a direct subclass of `Object`. The `Object` class defines the default implementations for several key behaviors that are common to every object. Unless they are overridden by the subclass, the behaviors are inherited directly from `Object`.

The methods `wait`, `notify`, and `notifyAll` in the `Object` class are part of Java’s concurrency support. They are discussed in [“Thread Control with `wait\(\)` and `notify\(\)` Methods” on page 71](#).

The `toString` method is the way an object creates a string representation of itself. One interesting use of `toString` is string concatenation: any object can be concatenated to a string. This example demonstrates two ways to print the same message: they both execute identically. In both, a new instance of the `Foo` class is created, its `toString` method is invoked, and the result is concatenated with a literal string. The result is then printed:

```
System.out.println(
    "This is a new foo: " + new Foo());
System.out.println(
    "This is a new foo: ".concat((new Foo()).toString()));
```

The `Object` implementation of `toString` returns a not-very-useful string that is based on the location of the object in the heap. Overriding `toString` in your code is a good first step toward making it easier to debug.

The `clone` and `finalize` methods are historical leftovers. The Java runtime will call the `finalize` method only if it is overridden in a subclass. If a class explicitly defines `finalize`, though, it is called for an object of the class just before that object is garbage-collected. Not only does Java not guarantee when this might happen, it actually can't guarantee that it will happen at all. In addition, a call to `finalize` can resurrect an object! This is tricky: objects are garbage-collected when there are no live references to them. An implementation of `finalize`, however, could easily *create* a new live reference, for instance, by adding the object being finalized to some kind of list! Because of this, the existence of a `finalize` method precludes the defining class from many kinds of optimization. There is little to gain and lots to lose in attempting to use `finalize`.

The `clone` method creates objects, bypassing their constructors. Although `clone` is defined on `Object`, calling it on an object will cause an exception unless the object implements the `Cloneable` interface. The `clone` method is an optimization that can be useful when object creation has a significant cost. While clever uses of `clone` may be necessary in specific cases, a copy constructor—one which takes an existing instance as its only argument—is much more straightforward and, in most cases, has negligible cost.

The last two `Object` methods, `hashCode` and `equals`, are the methods by which a caller can tell whether one object is “the same as” another.

The definition of the `equals` method in the API documentation for the `Object` class stipulates the contract to which every implementation of `equals` must adhere. A correct implementation of the `equals` method has the following attributes, and the associated statements must always be true:

reflexive

```
x.equals(x)
```

symmetric

```
x.equals(y) == y.equals(x)
```

transitive

```
(x.equals(y) && y.equals(z)) == x.equals(z)
```

consistent

If `x.equals(y)` is true at any point in the life of a program, it is always true, provided `x` and `y` do not change.

Getting this right is subtle and can be surprisingly difficult. A common error—one that violates reflexivity—is defining a new class that is sometimes equal to an existing class. Suppose your program uses an existing library that defines the class `EnglishWeekdays`. Suppose, now, that you define a class `FrenchWeekdays`. There is an obvious temptation to define an `equals` method for `FrenchWeekdays` that returns `true` when it compares one of the `EnglishWeekdays` to its French equivalent. Don't do it! The existing English class has no awareness of your new class and so will never recognize instances of your class as being equal. You've broken reflexivity!

`hashCode` and `equals` should be considered a pair: if you override either, you should override both. Many library routines treat `hashCode` as an optimized rough guess as to whether two objects are `equal` or not. These libraries first compare the hash codes of the two objects. If the two codes are different, they assume there is no need to do any more expensive comparisons because the objects are definitely different. The point of hash code computation, then, is to compute something very quickly that is a good proxy for the `equals` method. Visiting every cell in a large array, in order to compute a hash code, is probably no faster than doing the actual comparison. At the other extreme, it would be very fast to return `0`, always, from a hash code computation. It just wouldn't be very helpful.

## Objects, Inheritance, and Polymorphism

Java supports *polymorphism*, one of the key concepts in object-oriented programming. A language is said to be polymorphic if objects of a single type can have different behavior. This happens when subtypes of a given class can be assigned to a variable of the base class type. An example will make this much clearer.

Subtypes in Java are declared through use of the `extends` keyword. Here is an example of inheritance in Java:

```
public class Car {
    public void drive() {
        System.out.println("Going down the road!");
    }
}

public class Ragtop extends Car {
    // override the parent's definition.
    public void drive() {
        System.out.println("Top down!");

        // optionally use a superclass method
        super.drive();

        System.out.println("Got the radio on!");
    }
}
```

`Ragtop` is a subtype of `Car`. We noted previously that `Car` is, in turn, a subclass of `Object`. `Ragtop` changes the definition of `Car`'s `drive` method. It is said to *override* `drive`. `Car` and `Ragtop` are both of type `Car` (they are not both of type `Ragtop`!) and have different behaviors for the method `drive`.

We can now demonstrate polymorphic behavior:

```
Car auto = new Car();
auto.drive();
auto = new Ragtop();
auto.drive();
```

This code fragment will compile without error (despite the assignment of a `Ragtop` to a variable whose type is `Car`). It will also run without error and would produce the following output:

```
Going down the road!
Top down!
Going down the road!
Got the radio on!
```

The variable `auto` holds, at different times in its life, references to two different objects of type `Car`. One of those objects, in addition to being of type `Car`, is also of subtype `Ragtop`. The exact behavior of the statement `auto.drive()` depends on whether the variable currently contains a reference to the former or the latter. This is polymorphic behavior.

Like many other object-oriented languages, Java supports type casting to allow coercion of the declared type of a variable to be any of the types with which the variable is polymorphic:

```
Ragtop funCar;

Car auto = new Car();
funCar = (Ragtop) auto; //ERROR! auto is a Car, not a Ragtop!
auto.drive();

auto = new Ragtop();
Ragtop funCar = (Ragtop) auto; //Works! auto is a Ragtop
auto.drive();
```

While occasionally necessary, excessive use of casting is an indication that the code is missing the point. Obviously, by the rules of polymorphism, all variables could be declared to be of type `Object`, and then cast as necessary. To do that, however, is to abandon the value of static typing.

Java limits a method's arguments (its actual parameters) to objects of types that are polymorphic with its formal parameters. Similarly, methods return values that are polymorphic with the declared return type. For instance, continuing our automotive example, the following code fragment will compile and run without error:

```

public class JoyRide {
    private Car myCar;

    public void park(Car auto) {
        myCar = auto;
    }

    public Car whatsInTheGarage() {
        return myCar;
    }

    public void letsGo() {
        park(new Ragtop());
        whatsInTheGarage().drive();
    }
}

```

The method `park` is declared to take an object of type `Car` as its only parameter. In the method `letsGo`, however, it is called with an object of type `Ragtop`, a subtype of type `Car`. Similarly, the variable `myCar` is assigned a value of type `Ragtop`, and the method `whatsInTheGarage` returns it. The object is a `Ragtop`: if you call its `drive` method, it will tell you about its top and its radio. On the other hand, since it is also a `Car`, it can be used anywhere that one would use a `Car`. This subtype replacement capability is a key example of the power of polymorphism and how it works with type safety. Even at compile time, it is clear whether an object is compatible with its use, or not. Type safety enables the compiler to find errors, early, that might be much more difficult to find were they permitted to occur at runtime.

## Final and Static Declarations

There are 11 modifier keywords that can be applied to a declaration in Java. These modifiers change the behavior of the declared object, sometimes in important ways. The earlier examples used a couple of them, `public` and `private`, without explanation: they are among the several modifiers that control scope and visibility. We'll revisit them in a minute. In this section, we consider two other modifiers that are essential to a complete understanding of the Java type system: `final` and `static`.

A `final` declaration is one that cannot be changed. Classes, methods, fields, parameters, and local variables can all be `final`.

When applied to a class, `final` means that any attempt to define a subclass will cause an error. The class `String`, for instance, is `final` because strings must be immutable (i.e., you can't change the content of one after you create it). If you think about it for a while, you will see that this can be *guaranteed* only if `String` cannot be subtyped. If it were possible to subtype the `String` class, a devious library could create a subclass of `String`, `DeadlyString`, pass an instance to your code, and change its value from "fred" to ";; DROP TABLE contacts;" (an attempt to inject rogue SQL into your system that

might wipe out parts of your database) immediately after your code had validated its contents!

When applied to a method, `final` means that the method cannot be overridden in a subclass. Developers use `final` methods to design for inheritance, when the supertype needs to make a highly implementation-dependent behavior available to a subclass and cannot allow that behavior to be changed. A framework that implemented a generic cache might define a base class `CacheableObject`, for instance, which the programmer using the framework subtypes for each new cacheable object type. In order to maintain the integrity of the framework, however, `CacheableObject` might need to compute a cache key that was consistent across all object types. In this case, it might declare its `computeCacheKey` method `final`.

When applied to a variable—a field, a parameter, or a local variable—`final` means that the value of the variable, once assigned, may not change. This restriction is enforced by the compiler: it is not enough that the value *does not* change, the compiler must be able to prove that it *cannot* change. For a field, this means that the value must be assigned either as part of the declaration or in every constructor. Failure to initialize a `final` field at its declaration or in the constructor—or an attempt to assign to it anywhere else—will cause an error.

For parameters, `final` means that, within the method, the parameter value always has the value passed in the call. An attempt to assign to a `final` parameter will cause an error. Of course, since the parameter value is most likely to be a reference to some kind of object, it is possible that the object might change. The application of the keyword `final` to a parameter simply means that the parameter cannot be assigned.



In Java, parameters are passed by value: the method arguments are new copies of the values that were passed at the call. On the other hand, most things in Java are references to objects and Java only copies the reference, not the whole object! References are passed by value!

A `final` variable may be assigned no more than once. Since using a variable without initializing it is also an error, in Java, a `final` variable must be assigned exactly once. The assignment may take place anywhere in the enclosing block, prior to use.

A `static` declaration belongs to the class in which it is described, not to an instance of that class. The opposite of `static` is *dynamic*. Any entity that is not declared `static` is implicitly dynamic. This example illustrates:

```
public class QuietStatic {
    public static int classMember;
    public int instanceMember;
}

public class StaticClient {
    public void test() {
        QuietStatic.classMember++;
    }
}
```



```

        QuietStatic.instanceMember++; // ERROR!!

        QuietStatic ex = new QuietStatic();
        ex.classMember++; // WARNING!
        ex.instanceMember++;
    }
}

```

In this example, `QuietStatic` is the name of a class, and `ex` is a reference to an instance of that class. The static member `classMember` is an attribute of the class; you can refer to it simply by qualifying it with the class name. On the other hand, `instanceMember` is a member of an *instance* of the class. An attempt to refer to it through the class reference causes an error. That makes sense. There are many different variables called `instanceMember`, one belonging to each instance of `QuietStatic`. If you don't explicitly specify which one you are talking about, there's no way for Java to figure it out.

As the second pair of statements demonstrates, Java does actually allow references to class (static) variables through instance references. It is misleading, though, and considered a bad practice. Most compilers and IDEs will generate warnings if you do it.

The implications of static versus dynamic declarations can be subtle. It is easiest to understand the distinction for fields. Again, while there is exactly one copy of a static definition, there is one copy per instance of a dynamic definition. Static class members allow you to maintain information that is held in common by all members of a class. Here's some example code:

```

public class LoudStatic {
    private static int classMember;
    private int instanceMember;

    public void incr() {
        classMember++;
        instanceMember++;
    }

    @Override public String toString() {
        return "classMember: " + classMember
            + ", instanceMember: " + instanceMember;
    }

    public static void main(String[] args) {
        LoudStatic ex1 = new LoudStatic();
        LoudStatic ex2 = new LoudStatic();
        ex1.incr();
        ex2.incr();
        System.out.println(ex1);
        System.out.println(ex2);
    }
}

```

and its output:

```

classMember: 2, instanceMember: 1
classMember: 2, instanceMember: 1

```

The initial value of the variable `classMember` in the preceding example is 0. It is incremented by each of the two different instances. Both instances now see a new value, 2. The value of the variable `instanceMember` also starts at 0, in each instance. On the other hand, though, each instance increments its own copy and sees the value of its own variable, 1.

Static class and method definitions are similar in that, in both cases, a static object is visible using its qualified name, while a dynamic object is visible only through an instance reference. Beyond that, however, the differences are trickier.

One significant difference in behavior between statically and dynamically declared methods is that statically declared methods cannot be overridden in a subclass. The following, for instance, fails to compile:

```
public class Star {
    public static void twinkle() { }
}

public class Arcturus extends Star {
    public void twinkle() { } // ERROR!!
}

public class Rigel {
    // this one works
    public void twinkle() { Star.twinkle(); }
}
```

There is very little reason to use static methods in Java. In early implementations of Java, dynamic method dispatch was significantly slower than static dispatch. Developers used to prefer static methods in order to “optimize” their code. In Android’s just-in-time-compiled Dalvik environment, there is no need for this kind of optimization anymore. Excessive use of static methods is usually an indicator of bad architecture.

The difference between statically and dynamically declared classes is the subtlest. Most of the classes that comprise an application are static. A typical class is declared and defined at the *top level*—outside any enclosing block. Implicitly, all such declarations are static. Most other declarations, on the other hand, take place within the enclosing block of some class and are, by default, dynamic. Whereas most fields are dynamic by default and require a modifier to be static, most classes are static.



A *block* is the code between two curly braces: { and }. Anything—variables, types, methods, and so on—defined within the block is visible within the block and within lexically nested blocks. Except within the special block defining a class, things defined within a block are not visible outside the block.

This is, actually, entirely consistent. According to our description of static—something that belongs to the class, not to an instance of that class—top-level declarations should

be static (they belong to no class). When declared within an enclosing block, however—for example, inside the definition of a top-level class—a class definition is also dynamic by default. In order to create a dynamically declared class, just define it inside another class.

This brings us to the difference between a static and a dynamic class. A dynamic class has access to instance members of the enclosing class (since it belongs to the instance). A static class does not. Here's some code to demonstrate:

```
public class Outer {
    public int x;

    public class InnerOne {
        public int fn() { return x; }
    }

    public static class InnerTube {
        public int fn() {
            return x; // ERROR!!!
        }
    }
}

public class OuterTest {
    public void test() {
        new Outer.InnerOne(); // ERROR!!!
        new Outer.InnerTube();
    }
}
```

A moment's reflection will clarify what is happening here. The field `x` is a member of an instance of the class `Outer`. In other words, there are lots of variables named `x`, one for each runtime instance of `Outer`. The class `InnerTube` is a part of the class `Outer`, but not of any *instances* of `Outer`. It has no way of identifying an `x`. The class `InnerOne`, on the other hand, because it is dynamic, belongs to an instance of `Outer`. You might think of a separate class `InnerOne` for each instance of `Outer` (though this is not, actually, how it is implemented). Consequently, `InnerOne` has access to the members of the instance of `Outer` to which it belongs.

`OuterTest` demonstrates that, as with fields, we can use the static inner definition (in this case, create an instance of the class) simply by using its qualified name. The dynamic definition is useful, however, only in the context of an instance.

## Abstract Classes

Java permits a class declaration to entirely omit the implementation of one or more methods by declaring the class and unimplemented methods to be **abstract**:

```
public abstract class TemplatedService {

    public final void service() {
```

```

        // subclasses prepare in their own ways
        prepareService();
        // ... but they all run the same service
        runService()
    }

    public abstract void prepareService();

    private final void runService() {
        // implementation of the service ...
    }
}

public class ConcreteService extends TemplatedService {
    void prepareService() {
        // set up for the service
    }
}

```

An abstract class cannot be instantiated. Subtypes of an abstract class must either provide definitions for all the abstract methods in the superclass or must, themselves, be declared abstract.

As hinted in the example, abstract classes are useful in implementing the common template pattern, which provides a reusable piece of code that allows customization at specific points during its execution. The reusable pieces are implemented as an abstract class. Subtypes customize the template by implementing the abstract methods.

For more information on abstract classes, see the Java tutorial at <http://download.oracle.com/javase/tutorial/java/andl/abstract.html>.

## Interfaces

Other languages (e.g., C++, Python, and Perl) permit a capability known as multiple implementation inheritance, whereby an object can inherit implementations of methods from more than one parent class. Such inheritance hierarchies can get pretty complicated and behave in unexpected ways (such as inheriting two field variables with the same name from two different superclasses). Java's developers chose to trade the power of multiple inheritance for simplicity. Unlike the mentioned languages, in Java a class may extend only a single superclass.

Instead of multiple implementation inheritance, however, Java provides the ability for a class to inherit from several types, using the concept of an *interface*. Interfaces provide a way to define a type without defining its implementation. You can think of interfaces as abstract classes with all abstract methods. There is no limit on the number of interfaces that a class may implement.

Here's an example of a Java interface and a class that implements it:

```

public interface Growable {
    // declare the signature but not the implementation
}

```

```

    void grow(Fertilizer food, Water water);
}

public interface Eatable {
    // another signature with no implementation
    void munch();
}

/**
 * An implementing class must implement all interface methods
 */
public class Beans implements Growable, Eatable {

    @Override
    public void grow(Fertilizer food, Water water) {
        // ...
    }

    @Override
    public void munch() {
        // ...
    }
}

```

Again, interfaces provide a way to define a type distinct from the implementation of that type. This kind of separation is common even in everyday life. If you and a colleague are trying to mix mojitos, you might well divide tasks so that she goes to get the mint. When you start muddling things in the bottom of the glass, it is irrelevant whether she drove to the store to buy the mint or went out to the backyard and picked it from a shrub. What's important is that you have mint.

As another example of the power of interfaces, consider a program that needs to display a list of contacts, sorted by email address. As you would certainly expect, the Android runtime libraries contain generic routines to sort objects. Because they are generic, however, these routines have no intrinsic idea of what ordering means for the instances of any particular class. In order to use the library sorting routines, a class needs a way to define its own ordering. Classes do this in Java using the interface `Comparable`.

Objects of type `Comparable` implement the method `compareTo`. One object accepts another, similar object as an argument and returns an integer that indicates whether the argument object is greater than, equal to, or less than the target. The library routines can sort anything that is `Comparable`. A program's `Contact` type need only be `Comparable` and implement `compareTo` to allow contacts to be sorted:

```

public class Contact implements Comparable<Contact> {
    // ... other fields
    private String email;

    public Contact(
        // other params...
        String emailAddress)
    {

```

```

        // ... init other fields from corresponding params
        email = emailAddress;
    }

    public int compareTo(Contact c) {
        return email.compareTo(c.email);
    }
}

public class ContactView {
    // ...

    private List<Contact> getContactsSortedByEmail(
        List<Contact> contacts)
    {
        // getting the sorted list of contacts
        // is completely trivial
        return Collections.sort(contacts);
    }

    // ...
}

```

Internally, the `Collections.sort` routine knows only that `contacts` is a list of things of type `Comparable`. It invokes the class's `compareTo` method to decide how to order them.

As this example demonstrates, interfaces enable the developer to reuse generic routines that can sort any list of objects that implement `Comparable`. Beyond this simple example, Java interfaces enable a diverse set of programming patterns that are well described in other sources. We frequently and highly recommend the excellent *Effective Java* by Joshua Bloch (Prentice Hall).

## Exceptions

The Java language uses *exceptions* as a convenient way to handle unusual conditions. Frequently these conditions are errors.

Code trying to parse a web page, for instance, cannot continue if it cannot read the page from the network. Certainly, it is possible to check the results of the attempt to read and proceed only if that attempt succeeds, as shown in this example:

```

public void getPage(URL url) {
    String smallPage = readPageFromNet(url);
    if (null != smallPage) {
        Document dom = parsePage(smallPage);
        if (null != dom) {
            NodeList actions = getActions(dom);
            if (null != action) {
                // process the action here...
            }
        }
    }
}

```

Exceptions make this more elegant and robust:

```
public void getPage(URL url)
    throws NetworkException, ParseException, ActionNotFoundException
{
    String smallPage = readPageFromNet(url);
    Document dom = parsePage(smallPage);
    NodeList actions = getActions(dom);
    // process the action here...
}

public String readPageFromNet(URL url) throws NetworkException {
    // ...
public Document parsePage(String xml) throws ParseException {
    // ...
public NodeList getActions(Document doc) throws ActionNotFoundException {
    // ...
}
```

In this version of the code, each method called from `getPage` uses an exception to immediately short-circuit all further processing if something goes wrong. The methods are said to *throw* exceptions. For instance, the `getActions` method might look something like this:

```
public NodeList getActions(Document dom)
    throws ActionNotFoundException
{
    Object actions = xPathFactory.newXPath().compile("//node/@action")
        .evaluate(dom, XPathConstants.NODESET);
    if (null == actions) {
        throw new ActionNotFoundException("Action not found");
    }
    return (NodeList) actions;
}
```

When the `throw` statement is executed, processing is immediately interrupted and resumes at the nearest *catch* block. Here's an example of a try-catch block:

```
for (int i = 0; i < MAX_RETRIES; i++) {
    try {
        getPage(theUrl);
        break;
    }
    catch (NetworkException e) {
        Log.d("ActionDecoder", "network error: " + e);
    }
}
```

This code retries network failures. Note that it is not even in the same method, `readPageFromNet`, that threw the `NetworkException`. When we say that processing resumes at the “nearest” try-catch block, we’re talking about an interesting way that Java delegates responsibility for exceptions.

If there is no try-catch block surrounding the `throw` statement within the method, a thrown exception makes it seem as though the method returns immediately. No further statements are executed and no value is returned. In the previous example, for instance, none of the code following the attempt to get the page from the network needs to concern itself with the possibility that the precondition—a page was read—was not met. The method is said to have been *terminated abruptly* and, in the example, control returns to `getActions`. Since `getActions` does not contain a try-catch block either, it is terminated abruptly too. Control is passed back (up the stack) to the caller.

In the example, when a `NetworkException` is thrown, control returns to the first statement inside the example catch block, the call to log the network error. The exception is said to have been *caught* at the first catch statement whose argument type is the same type, or a supertype, of the thrown exception. Processing resumes at the first statement in the catch block and continues normally afterward.

In the example, a network error while attempting to read a page from the network will cause both `ReadPageFromNet` and `getPage` to terminate abruptly. After the catch block logs the failure, the `for` loop will retry getting the page, up to `MAX_RETRIES` times.

It is useful to have a clear understanding of the root of the Java exception class tree, shown in [Figure 2-1](#).

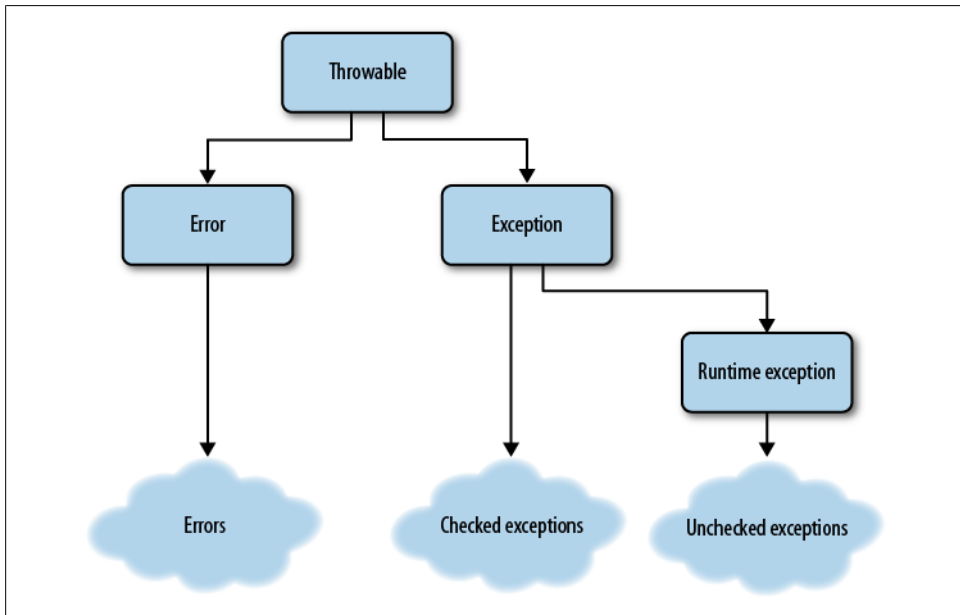

Figure 2-1. Exception base classes

All exceptions are subclasses of `Throwable`. There is almost never any reason to make reference to `Throwable` in your code. Think of it as just an abstract base class with two



subclasses: `Error` and `Exception`. `Error` and its subclasses are reserved for problems with the Dalvik runtime environment itself. While you can write code that appears to catch an `Error` (or a `Throwable`), you cannot, in fact, catch them. An obvious example of this, for instance, is the dreaded OOME, the `OutOfMemoryException` error. When the Dalvik system is out of memory, it may not be able to complete execution of even a single opcode! Writing tricky code that attempts to catch an OOME and then to release some block of preallocated memory might work—or it might not. Code that tries to catch `Throwable` or `Error` is absolutely whistling in the wind.

Java requires the signature of a method to include the exceptions that it throws. In the previous example, `getPage` declares that it throws three exceptions, because it uses three methods, each of which throws one. Methods that call `getPage` must, in turn, declare all three of the exceptions that `getPage` throws, along with any others thrown by any other methods that it calls.

As you can imagine, this can become onerous for methods far up the call tree. A top-level method might have to declare tens of different kinds of exceptions, just because it calls methods that throw them. This problem can be mitigated by creating an exception tree that is congruent to the application tree. Remember that a method needs only to declare supertypes for all the exceptions it throws. If you create a base class named `MyApplicationException` and then subclass it to create `MyNetworkException` and `MyUIException` for the networking and UI subsystems, respectively, your top-layer code need only handle `MyApplicationException`.

Really, though, this is only a partial solution. Suppose networking code somewhere way down in the bowels of your application fails, for instance, to open a network connection. As the exception bubbles up through retries and alternatives, at some point it loses any significance except to indicate that “something went wrong.” A specific database exception, for instance, means nothing to code that is trying to prepopulate a phone number. Adding the exception to a method signature, at that point, is really just a nuisance: you might as well simply declare that all your methods throw `Exception`.

`RuntimeException` is a special subclass of `Exception`. Subclasses of `RuntimeException` are called *unchecked* exceptions and do not have to be declared. This code, for instance, will compile without error:

```
public void ThrowsRuntimeException() {
    throw new RuntimeException();
}
```

There is considerable debate in the Java community about when to use and when not to use unchecked exceptions. Obviously, you could use only unchecked exceptions in your application and never declare any exception in any of your method signatures. Some schools of Java programming even recommend this. Using checked exceptions, however, gives you the chance to use the compiler to verify your code and is very much in the spirit of static typing. Experience and taste will be your guide.

## The Java Collections Framework

The Java Collections Framework is one of Java's most powerful and convenient tools. It provides objects that represent collections of objects: lists, sets, and maps. The interfaces and implementations that comprise the library are all to be found in the `java.util` package.

There are a few legacy classes in `java.util` that are historic relics and are not truly part of the framework. It's best to remember and avoid them. They are `Vector`, `Hashtable`, `Enumeration`, and `Dictionary`.

### Collection interface types

Each of the five main types of object in the Collections Library is represented by an interface:

#### Collection

This is the root type for all of the objects in the Collection Library. A `Collection` is a group of objects, not necessarily ordered, not necessarily addressable, possibly containing duplicates. You can add and remove things from it, get its size, and iterate over it (more on iteration in a moment).

#### List

A `List` is an ordered collection. There is a mapping between the integers 0 and `length-1` and the objects in the list. A `List` may contain duplicates. You can do anything to a `List` that you can do to a `Collection`. In addition, though, you can map an element to its index and an index to an element with the `get` and `indexOf` methods. You can also change the element at a specific index with the `add(index, e)` method. The iterator for a `List` returns the elements in order.

#### Set

A `Set` is an unordered collection that does not contain duplicates. You can do anything to a `Set` that you can do to a `Collection`. Attempting to add an element to a `Set` that already contains it, though, does not change the size of the `Set`.

#### Map

A `Map` is like a list except that instead of mapping integers to objects it maps a set of key objects to a collection of value objects. You can add and remove key-value pairs from the `Map`, get its size, and iterate over it, just like any other collection. Examples of maps might include mapping words to their definitions, dates to events, or URLs to cached content.

#### Iterator

An `Iterator` returns the elements of the collection from which it is derived, each exactly once, in response to calls to its `next` method. It is the preferred means for processing all the elements of a collection. Instead of:

```
for (int i = 0; i < list.size(); i++) {
    String s = list.get(i)
    // ...
}
```

the following is preferred:

```
for (Iterator<String> i = list.iterator(); i.hasNext();) {
    String s = i.next();
    // ...
}
```

In fact, the latter may be abbreviated, simply, as:

```
for (String s: list) {
    // ...
}
```

## Collection implementation types

These interface types have multiple implementations, each appropriate to its own use case. Among the most common of these are the following:

### ArrayList

An `ArrayList` is a list that is backed by an array. It is quick to index but slow to change size.

### LinkedList

A `LinkedList` is a list that can change size quickly but is slower to index.

### HashSet

A `HashSet` is a set that is implemented as a hash. `add`, `remove`, `contains`, and `size` all execute in constant time, assuming a well-behaved hash. A `HashSet` may contain (no more than one) `null`.

### HashMap

A `HashMap` is an implementation of the `Map` interface that uses a hash table as its index. `add`, `remove`, `contains`, and `size` all execute in constant time, assuming a well-behaved hash. It may contain a (single) `null` key, but any number of values may be `null`.

### TreeMap

A `TreeMap` is an ordered `Map`: objects in the map are sorted according to their natural order if they implement the `Comparable` interface, or according to a `Comparator` passed to the `TreeMap` constructor if they do not.

Idiomatic users of Java prefer to use declarations of interface types instead of declarations of implementation types, whenever possible. This is a general rule, but it is easiest to understand here in the context of the collection framework.

Consider a method that returns a new list of strings that is just like the list of strings passed as its second parameter, but in which each element is prefixed with the string passed as the first parameter. It might look like this:

```
public ArrayList<String> prefixList(
    String prefix,
    ArrayList<String> strs)
{
    ArrayList<String> ret
        = new ArrayList<String>(strs.size());
    for (String s: strs) { ret.add(prefix + s); }
    return ret;
}
```

There's a problem with this implementation, though: it won't work on just any list! It will only work on an `ArrayList`. If, at some point, the code that calls this method needs to be changed from using an `ArrayList` to a `LinkedList`, it can no longer use the method. There's no good reason for that, at all.

A better implementation might look like this:

```
public List<String> prefix(
    String prefix,
    List<String> strs)
{
    List<String> ret = new ArrayList<String>(strs.size());
    for (String s: strs) { ret.add(prefix + s); }
    return ret;
}
```

This version is more adaptable because it doesn't bind the method to a particular implementation of the list. The method depends only on the fact that the parameter implements a certain interface. It doesn't care how. By using the interface type as a parameter it requires exactly what it needs to do its job—no more, no less.

In fact, this could probably be further improved if its parameter and return type were `Collection`.

## Java generics

Generics in Java are a large and fairly complex topic. Entire books have been written on the subject. This section introduces them in their most common setting, the Collections Library, but will not attempt to discuss them in detail.

Before the introduction of generics in Java, it wasn't possible to statically type the contents of a container. One frequently saw code that looked like this:

```
public List makeList() {
    // ...
}

public void useList(List l) {
    Thing t = (Thing) l.get(0);
    // ...
}
```

```
}  
  
// ...  
useList(makeList());
```

The problem is obvious: `useList` has no guarantee that `makeList` created a list of `Thing`. The compiler cannot verify that the cast in `useList` will work, and the code might explode at runtime.

Generics solve this problem—at the cost of some significant complexity. The syntax for a generic declaration was introduced, without comment, previously. Here’s a version of the example, with the generics added:

```
public List<Thing> makeList() {  
    // ...  
}  
  
public void useList(List<Thing> l) {  
    Thing t = l.get(0);  
    // ...  
}  
  
// ...  
useList(makeList());
```

The type of the objects in a container is specified in the angle brackets (<>) that are part of the container type. Notice that the cast is no longer necessary in `useList` because the compiler can now tell that the parameter `l` is a list of `Thing`.

Generic type descriptions can get pretty verbose. Declarations like this are not uncommon:

```
Map<UUID, Map<String, Thing>> cache  
    = new HashMap<UUID, Map<String, Thing>>();
```

## Garbage Collection

Java is a garbage-collected language. That means your code does not manage memory. Instead, your code creates new objects, allocating memory, and then simply stops using those objects when it no longer needs them. The Dalvik runtime will delete them and compress memory, as appropriate.

In the not-so-distant past, developers had to worry about long and unpredictable periods of unresponsiveness in their applications when the garbage collector suspended all application processing to recover memory. Many developers, both those that used Java in its early days and those that used J2ME more recently, will remember the tricks, hacks, and unwritten rules necessary to avoid the long pauses and memory fragmentation caused by early garbage collectors. Garbage collection technology has come a long way since those days. Dalvik emphatically does not have these problems. Creating new objects has essentially no overhead. Only the most demandingly responsive of UIs—perhaps some games—will ever need to worry about garbage collection pauses.

# Scope

Scope determines where variables, methods, and other symbols are visible in a program. Outside of a symbol's scope, the symbol is not visible at all and cannot be used. We'll go over the major aspects of scope in this section, starting with the highest level.

## Java Packages

Java packages provide a mechanism for grouping related types together in a universally unique namespace. Such grouping prevents identifiers within the package namespace from colliding with those created and used by other developers in other namespaces.

A typical Java program is made up of code from a forest of packages. The standard Java Runtime Environment supplies packages like `java.lang` and `java.util`. In addition, the program may depend on other common libraries like those in the `org.apache` tree. By convention, application code—code you create—goes into a package whose name is created by reversing your domain name and appending the name of the program. Thus, if your domain name is `androidhero.com`, the root of your package tree will be `com.androidhero` and you will put your code into packages like `com.androidhero.awesomeprogram` and `com.androidhero.geohottness.service`. A typical package layout for an Android application might have a package for persistence, a package for the UI, and a package for application logic or controller code.

In addition to providing a unique namespace, packages have implications on member (field and method) visibility for objects in the same package. Classes in the same package may be able to see each other's internals in ways that are not available to classes outside the package. We'll return to this topic in a moment.

To declare a class as part of a package, use the `package` keyword at the top of the file containing your class definition:

```
package your.qualifieddomainname.functionalgrouping
```

Don't be tempted to shortcut your package name! As surely as a quick, temporary implementation lasts for years, so the choice of a package name that is not guaranteed unique will come back to haunt you.

Some larger projects use completely different top-level domains to separate public API packages from the packages that implement those APIs. For example, the Android API uses the top-level package, `android`, and implementation classes generally reside in the package, `com.android`. Sun's Java source code follows a similar scheme. Public APIs reside in the `java` package, but the implementation code resides in the package `sun`. In either case, an application that imports an implementation package is clearly doing something fast and loose, depending on something that is not part of the public API.

While it is possible to add code to existing packages, it is usually considered bad form to do so. In general, in addition to being a namespace, a package is usually a single source tree, at least up as far as the reversed domain name. It is only convention, but

Java developers usually expect that when they look at the source for the package `com.brashandroid.coolapp.ui`, they will see all the source for the UI for CoolApp. Most will be surprised if they have to find another source tree somewhere with, for instance, page two of the UI.



The Android application framework also has the concept of a **Package**. It is different, and we'll consider it in [Chapter 3](#). Don't confuse it with Java package names.

For more information on Java packages, see the Java tutorial at <http://download.oracle.com/javase/tutorial/java/package/packages.html>.

## Access Modifiers and Encapsulation

We hinted earlier that members of a class have special visibility rules. Definitions in most Java blocks are lexically scoped: they are visible only within the block and its nested blocks. The definitions in a class, however, may be visible outside the block. Java supports publishing top-level members of a class—its methods and fields—to code in other classes, through the use of *access modifiers*. Access modifiers are keywords that modify the visibility of the declarations to which they are applied.

There are three access-modifying keywords in the Java language: **public**, **protected**, and **private**. Together they support four levels of access. While access modifiers affect the visibility of a declaration from outside the class containing it, within the class, normal block scoping rules apply, regardless of access modification.

The **private** access modifier is the most restrictive. A declaration with **private** access is not visible outside the block that contains it. This is the safest kind of declaration because it guarantees that there are no references to the declaration, except within the containing class. The more **private** declarations there are in a class, the safer the class is.

The next most restrictive level of access is default or package access. Declarations that are not modified by any of the three access modifiers have default access and are visible only from other classes in the same package. Default access can be a very handy way to create state shared between objects, similar to the use of the **friend** declaration in C++.

The **protected** access modifier permits all the access rights that were permitted by default access but, in addition, allows access from within any subtype. Any class that extends a class with **protected** declarations has access to those declarations.

Finally, **public** access, the weakest of the modifiers, allows access from anywhere.

Here's an example that will make this more concrete. There are four classes in two different packages here, all of which refer to fields declared in one of the classes, Accessible:

```
package over.here;

public class Accessible {
    private String localAccess;
    String packageAccess;
    protected String subtypeAccess;
    public String allAccess;

    public void test() {
        // all of the assignments below work:
        // the fields are declared in an enclosing
        // block and are therefore visible.
        localAccess = "success!!";
        packageAccess = "success!!";
        subtypeAccess = "success!!";
        allAccess = "success!!";
    }
}
```

```
package over.here;
import over.here.Accessible;

// this class is in the same package as Accessible
public class AccessibleFriend {

    public void test() {
        Accessible target = new Accessible();

        // private members are not visible
        // outside the declaring class
        target.localAccess = "fail!!"; // ERROR!!

        // default access visible within package
        target.packageAccess = "success!!";

        // protected access is superset of default
        target.subtypeAccess = "success!!";

        // visible everywhere
        target.allAccess = "success!!";
    }
}
```

```
package over.there;
import over.here.Accessible;

// a subtype of Accessible
// in a different package
public class AccessibleChild extends Accessible {
```



```

// the visible fields from Accessible appear
// as if declared in a surrounding block
public void test() {
    localAccess = "fail!!"; // ERROR!!
    packageAccess = "fail!!"; // ERROR!!

    // protected declarations are
    // visible from subtypes
    subtypeAccess = "success!!";

    // visible everywhere
    allAccess = "success!!";
}
}

package over.there;
import over.here.Accessible;

// a class completely unrelated to Accessible
public class AccessibleStranger {

    public void test() {
        Accessible target = new Accessible();
        target.localAccess = "fail!!"; // ERROR!!
        target.packageAccess = "fail!!"; // ERROR!!
        target.subtypeAccess = "success!!"; // ERROR!!

        // visible everywhere
        target.allAccess = "success!!";
    }
}

```

## Idioms of Java Programming

Somewhere between getting the specifics of a programming language syntax right and good pattern-oriented design (which is language-agnostic), is idiomatic use of a language. An idiomatic programmer uses consistent code to express similar ideas and, by doing so, produces programs that are easy to understand, make optimal use of the runtime environment, and avoid the “gotchas” that exist in any language syntax.

### Type Safety in Java

A primary design goal for the Java language was programming safety. Much of the frequently maligned verbosity and inflexibility of Java, which is not present in languages such as Ruby, Python, and Objective-C, is there to make sure a compiler can guarantee that entire classes of errors will never occur at runtime.

Java’s static typing has proven to be valuable well beyond its own compiler. The ability for a machine to parse and recognize the semantics of Java code was a major force in the development of powerful tools like FindBugs and IDE refactoring tools.

Many developers argue that, especially with modern coding tools, these constraints are a small price to pay for being able to find problems immediately that might otherwise manifest themselves only when the code is actually deployed. Of course, there is also a huge community of developers who argue that they save so much time coding in a dynamic language that they can write extensive unit and integration tests and still come out ahead.

Whatever your position in this discussion, it makes a lot of sense to make the best possible use of your tools. Java’s static binding absolutely is a constraint. On the other hand, Java is a pretty good statically bound language. It is a lousy dynamic language. It is actually possible to do fairly dynamic things with Java by using its reflection and introspection APIs and doing a lot of type casting. Doing so, except in very limited circumstances, is using the language and its runtime environment to cross-purposes. Your program is likely to run very slowly, and the Android tool chain won’t be able to make heads or tails of it. Perhaps most important, if there are bugs in this seldom-used part of the platform, you’ll be the first to find them. We suggest embracing Java’s static nature—at least until there is a good, dynamic alternative—and taking every possible advantage of it.

## Encapsulation

Developers limit the visibility of object members in order to create *encapsulation*. Encapsulation is the idea that an object should never reveal details about itself that it does not intend to support. To return to the mojito-making example, recall that, when it comes time to make the cocktail, you don’t care at all how your colleague got the necessary mint. Suppose, though, that you had said to her, “Can you get the mint? And, oh, by the way, while you are out there, could you water the rosebush?” It is no longer true that you don’t care how your colleague produces mint. You now depend on the exact way that she does it.

In the same way, the interface (sometimes abbreviated as API) of an object consists of the methods and types that are accessible from calling code. By careful encapsulation, a developer keeps implementation details of an object hidden from code that uses it. Such control and protection produce programs that are more flexible and allow the developer of an object to change object implementation over time without causing ripple-effect changes in calling code.

## Getters and setters

A simple, but common, form of encapsulation in Java involves the use of getter and setter methods. Consider a naive definition of a `Contact` class:

```

public class Contact {
    public String name;
    public int age;
    public String email;
}

```

This definition makes it necessary for external objects to access the fields of the class directly. For example:

```

Contact c = new Contact();
c.name = "Alice";
c.age = 13;
c.email = "alice@mymail.com";

```

It will take only a tiny amount of use in the real world to discover that contacts actually have several email addresses. Unfortunately, adding a multiple-address feature to the naive implementation requires updating every single reference to `Contact.email`, in the entire program.

In contrast, consider the following class:

```

class Contact {
    private int age;
    private String name;
    private String email;

    Contact(int age, String name, String email) {
        this.age = age;
        this.name = name;
        this.email = email;
    }

    public int getAge() {
        return age;
    }

    public String getName() {
        return name;
    }

    public String getEmail() {
        return address;
    }
}

```

Use of the `private` access modifier prevents direct access to the fields of this version of the `Contact` class. Use of `public` getter methods provides the developer with the opportunity to change how the `Contact` object returns the name, age, or email address of the `Contact`. For example, the email address could be stored by itself, as in the preceding code or concatenated from a username and a hostname if that happened to be more convenient for a given application. Internally, the age could be held as an `int` or as an `Integer`. The class can be extended to support multiple email addresses without any change to any client.

Java does allow direct reference to fields and does not, like some languages, automatically wrap references to the fields in getters and setters. In order to preserve encapsulation, you must define each and every access method yourself. Most IDEs provide code generation features that will do this quickly and accurately.

Wrapper getter and setter methods provide future flexibility, whereas direct field access means that all code that uses a field will have to change if the type of that field changes, or if it goes away. Getter and setter methods represent a simple form of object encapsulation. An excellent rule of thumb recommends that all fields be either `private` or `final`. Well-written Java programs use this and other, more sophisticated forms of encapsulation in order to preserve adaptability in more complex programs.

## Using Anonymous Classes

Developers who have experience working with UI development will be familiar with the concept of a callback: your code needs to be notified when something in the UI changes. Perhaps a button is pushed and your model needs to make a corresponding change in state. Perhaps new data has arrived from the network and it needs to be displayed. You need a way to add a block of code to a framework, for later execution on your behalf.

Although the Java language does provide an idiom for passing blocks of code, it is slightly awkward because neither code blocks nor methods are first-class objects in the language. There is no way, in the language, to obtain a reference to either.

You can have a reference to an instance of a class. In Java, instead of passing blocks or functions, you pass an entire class that defines the code you need as one of its methods. A service that provides a callback API will define its protocol using an interface. The service client defines an implementation of this interface and passes it to the framework.

Consider, for instance, the Android mechanism for implementing the response to a user keypress. The Android `View` class defines an interface, `OnKeyListener`, which, in turn, defines an `onKey` method. If your code passes an implementation of `OnKeyListener` to a `View`, its `onKey` method will be called each time the `View` processes a new key event.

The code might look something like this:

```
public class MyDataModel {
    // Callback class
    private class KeyHandler implements View.OnKeyListener {
        public boolean onKey(View v, int keyCode, KeyEvent event) {
            handleKey(v, keyCode, event)
        }
    }

    /** @param view the view we model */
    public MyDataModel(View view) { view.setOnKeyListener(new KeyHandler()) }
}
```

```

    /** Handle a key event */
    void handleKey(View v, int keyCode, KeyEvent event) {
        // key handling code goes here...
    }
}

```

When a new `MyDataModel` is created, it is informed about the view to which it is attached by an argument to the constructor. The constructor creates a new instance of the trivial callback class, `KeyHandler`, and installs it in the view. Any subsequent key events will be relayed to the model instance's `handleKey` method.

While this certainly gets the job done, it can get pretty ugly, especially if your model class needs to handle multiple kinds of events from multiple views! After a while, all those type definitions clutter up the top of your program. The definitions can be a long way from their use and, if you think about it, they really serve no purpose at all.

Java provides a way to simplify this somewhat, using an *anonymous class*. Here is a code fragment similar to the one shown earlier, except that it is implemented using an anonymous class:

```

public class MyDataModel {
    /** @param view the view we model */
    public MyDataModel(View view) {
        view.setOnKeyListener(
            // this is an anonymous class!!
            new View.OnKeyListener() {
                public boolean onKey(View v, int keyCode, KeyEvent event) {
                    handleKey(v, keyCode, event)
                } } );
    }

    /** Handle a key event */
    void handleKey(View v, int keyCode, KeyEvent event) {
        // key handling code goes here...
    }
}

```

While it might take a minute to parse, this code is almost identical to the previous example. It passes a newly created instance of a subtype of `View.OnKeyListener` as an argument in the call to `view.setOnKeyListener`. In this example, though, the argument to the call to `view.setOnKeyListener` is special syntax that defines a new subclass of the interface `View.OnKeyListener` and instantiates it in a single statement. The new instance is an instance of a class that has no name: it is anonymous. Its definition exists only in the statement that instantiates it.

Anonymous classes are a very handy tool and are the Java idiom for expressing many kinds of code blocks. Objects created using an anonymous class are first-class objects of the language and can be used anywhere any other object of the same type would be legal. For instance, they can be assigned:

```

public class MyDataModel {
    /** @param view the view we model */

```

```

public MyDataModel(View view1, View view2) {
    // get a reference to the anonymous class
    View.OnKeyListener keyHdlr = new View.OnKeyListener() {
        public boolean onKey(View v, int keyCode, KeyEvent event) {
            handleKey(v, keyCode, event)
        }
    };

    // use the class to relay for two views
    view1.setOnKeyListener(keyHdlr);
    view2.setOnKeyListener(keyHdlr);
}

/** Handle a key event */
void handleKey(View v, int keyCode, KeyEvent event) {
    // key handling code goes here...
}
}

```

You might wonder why the anonymous class in this example delegates its actual implementation (the `handleKey` method) to the containing class. There's certainly no rule that constrains the content of the anonymous class: it absolutely could contain the complete implementation. On the other hand, good, idiomatic taste suggests putting the code that changes an object's state into the object class. If the implementation is in the containing class, it can be used from other methods and callbacks. The anonymous class is simply a relay and that is all it should do.

Java does have some fairly strong constraints concerning the use of the variables that are in scope—anything defined in any surrounding block—within an anonymous class. In particular, an anonymous class can only refer to a variable inherited from the surrounding scope if that variable is declared `final`. For example, the following code fragment will not compile:

```

/** Create a key handler that matches the passed key */
public View.OnKeyListener curry(int keyToMatch) {
    return new View.OnKeyListener() {
        public boolean onKey(View v, int keyCode, KeyEvent event) {
            if (keyToMatch == keyCode) { foundMatch(); } // ERROR!!
        }
    };
}

```

The remedy is to make the argument to `curry` `final`. Making it `final`, of course, means that it cannot be changed in the anonymous class. But there is an easy, idiomatic way around that:

```

/** Create a key handler that increments and matches the passed key */
public View.OnKeyListener curry(final int keyToMatch) {
    return new View.OnKeyListener() {
        private int matchTarget = keyToMatch;
        public boolean onKey(View v, int keyCode, KeyEvent event) {
            matchTarget++;
            if (matchTarget == keyCode) { foundMatch(); }
        }
    };
}

```

## Modular Programming in Java

While class extension in Java offers developers significant flexibility in being able to redefine aspects of objects as they are used in different contexts, it actually takes a reasonable amount of experience to make judicious use of classes and interfaces. Ideally, developers aim to create sections of code that are tolerant of change over time and that can be reused in as many different contexts as possible, in multiple applications or perhaps even as libraries. Programming in this way can reduce bugs and the application's time to market. Modular programming, encapsulation, and separation of concerns are all key strategies for maximizing code reuse and stability.

A fundamental design consideration in object-oriented development concerns the decision to delegate or inherit as a means of reusing preexisting code. The following series of examples contains different object hierarchies for representing automotive vehicles that might be used in a car gaming application. Each example presents a different approach to modularity.

A developer starts by creating a vehicle class that contains all vehicle logic and all logic for each different type of engine, as follows:

```
// Naive code!
public class MonolithicVehicle {
    private int vehicleType;

    // fields for an electric engine
    // fields for a gas engine
    // fields for a hybrid engine
    // fields for a steam engine

    public MonolithicVehicle(int vehicleType) {
        vehicleType = vehicleType;
    }

    // other methods for implementing vehicles and engine types.

    void start() {
        // code for an electric engine
        // code for a gas engine
        // code for a hybrid engine
        // code for a steam engine
    }
}
```

This is naive code. While it may be functional, it mixes together unrelated bits of implementation (e.g., all types of vehicle engines) and will be hard to extend. For instance, consider modifying the implementation to accommodate a new engine type (nuclear). The code for each kind of car engine has unrestricted access to the code for every other engine. A bug in one engine implementation might end up causing a bug in another, unrelated engine. A change in one might result in an unexpected change to another. And, of course, a car that has an electric engine must drag along representations of all existing engine types. Future developers working on the monolithic vehicle must

understand all the complex interactions in order to modify the code. This just doesn't scale.

How might we improve on this implementation? An obvious idea is to use subclassing. We might use the class hierarchy shown in the following code to implement different types of automotive vehicles, each tightly bound to its engine type:

```
public abstract class TightlyBoundVehicle {
    // has no engine field

    // each subclass must override this method to
    // implement its own way of starting the vehicle
    protected abstract void startEngine();

    public final void start() { startEngine(); }
}

public class ElectricVehicle extends TightlyBoundVehicle {
    protected void startEngine() {
        // implementation for engine start electric
    }
}

public class GasVehicle extends TightlyBoundVehicle {
    protected void startEngine() {
        // implementation for engine start gas
    }
}

public void anInstantiatingMethod() {
    TightlyBoundVehicle vehicle = new ElectricVehicle();
    TightlyBoundVehicle vehicle = new GasVehicle();
    TightlyBoundVehicle vehicle = new HybridVehicle();
    TightlyBoundVehicle vehicle = new SteamVehicle();
}
```

This is clearly an improvement. The code for each engine type is now encapsulated within its own class and cannot interfere with any others. You can extend individual types of vehicles without affecting any other type. In many circumstances, this is an ideal implementation.

On the other hand, what happens when you want to convert your tightly bound gas vehicle to biodiesel? In this implementation, cars and engines are the same object. They cannot be separated. If the real-world situation that you are modeling requires you to consider the objects separately, your architecture will have to be more loosely coupled:

```
interface Engine {
    void start();
}

class GasEngine implements Engine {
    void start() {
        // spark plugs ignite gas
    }
}
```



```

class ElectricEngine implements Engine {
    void start() {
        // run power to battery
    }
}

class DelegatingVehicle {
    // has an engine field
    private Engine mEngine;

    public DelegatingVehicle(Engine engine) {
        mEngine = engine;
    }

    public void start() {
        // delegating vehicle can use a gas or electric engine
        mEngine.start();
    }
}

void anInstantiatingMethod() {
    // new vehicle types are easily created by just
    // plugging in different kinds of engines.
    DelegatingVehicle electricVehicle =
        new DelegatingVehicle(new ElectricEngine());
    DelegatingVehicle gasVehicle = new DelegatingVehicle(new GasEngine());
    //DelegatingVehicle hybridVehicle = new DelegatingVehicle(new HybridEngine());
    //DelegatingVehicle steamVehicle = new DelegatingVehicle(new SteamEngine());
}

```

In this architecture, the vehicle class delegates all engine-related behaviors to an engine object that it owns. This is sometimes called *has-a*, as opposed to the previous, subclassed example, called *is-a*. It can be even more flexible because it separates the knowledge of how an engine actually works from the car that contains it. Each vehicle delegates to a loosely coupled engine type and has no idea how that engine implements its behavior. The earlier example makes use of a reusable `DelegatingVehicle` class that does not change at all when it is given a new kind of engine. A vehicle can use any implementation of the `Engine` interface. In addition, it's possible to create different types of vehicle—SUV, compact, or luxury, for instance—that each make use of any of the different types of `Engine`.

Using delegation minimizes the interdependence between the two objects and maximizes the flexibility to change them later. By preferring delegation over inheritance, a developer makes it easier to extend and improve the code. By using interfaces to define the contract between an object and its delegates, a developer guarantees that the delegates will have the expected behavior.

## Basic Multithreaded Concurrent Programming in Java

The Java language supports concurrent threads of execution. Statements in different threads are executed in program order, but there is no ordering relationship between the statements in different threads. The basic unit of concurrent execution in Java is encapsulated in the class `java.lang.Thread`. The recommended method of spawning a thread uses an implementation of the interface `java.lang.Runnable`, as demonstrated in the following example:

```
// program that interleaves messages from two threads
public class ConcurrentTask implements Runnable {
    public void run() {
        while (true) {
            System.out.println("Message from spawned thread");
        }
    }
}

public void spawnThread() {
    (new Thread(new ConcurrentTask())).start();

    while (true) {
        System.out.println("Message from main thread");
    }
}
```

In the preceding example, the method `spawnThread` creates a new thread, passing a new instance of `ConcurrentTask` to the thread's constructor. The method then calls `start` on the new thread. When the `start` method of the thread is called, the underlying virtual machine (VM) will create a new concurrent thread of execution, which will, in turn, call the `run` method of the passed `Runnable`, executing it in parallel with the spawning thread. At this point, the VM is running two independent processes: order of execution and timing in one thread are unrelated to order and timing in the other.

The class `Thread` is not final. It is possible to define a new, concurrent task by subclassing `Thread` and overriding its `run` method. There is no advantage to that approach, however. In fact, using a `Runnable` is more adaptable. Because `Runnable` is an interface, the `Runnable` that you pass in to the `Thread` constructor may extend some other, useful class.

## Synchronization and Thread Safety

When two or more running threads have access to the same set of variables, it's possible for the threads to modify those variables in a way that can produce data corruption and break the logic in one or more of those threads. These kinds of unintended concurrent access bugs are called *thread safety violations*. They are difficult to reproduce, difficult to find, and difficult to test.

Java does not explicitly enforce restrictions on access to variables by multiple threads. Instead, the primary mechanism Java provides to support thread safety is the `synchronized` keyword. This keyword serializes access to the block it controls and, more important, synchronizes visible state between two threads. It is very easy to forget, when trying to reason about concurrency in Java, that synchronization controls both access and visibility. Consider the following program:

```
// This code is seriously broken!!!
public class BrokenVisibility {
    public static boolean shouldStop;

    public static void main(String[] args) {
        new Thread(
            new Runnable() {
                @Override public void run() {
                    // this code runs in the spawned thread
                    final long stopTime
                        = System.currentTimeMillis() + 1000;
                    for (;;) {
                        shouldStop
                            = System.currentTimeMillis() > stopTime;
                    }
                }
            }
        ).start();

        // this runs in the main thread
        for (;;) {
            if (shouldStop) { System.exit(0); }
        }
    }
}
```

One might think, “Well, there’s no need to synchronize the variable `shouldStop`. Sure, the main thread and the spawned thread might collide when accessing it. So what? The spawned thread will, after one second, always set it to true. Boolean writes are atomic. If the main thread doesn’t see it as true this time, surely it will see it as true the next time.” This reasoning is dangerously flawed. It does not take into account optimizing compilers and caching processors! In fact, this program may well never terminate. The two threads might very easily each use their own copy of `shouldStop`, existing only in some local processor hardware cache. Since there is no synchronization between the two threads, the cache copy might never be published so that the spawned thread’s value is visible from the main thread.

There is a simple rule for avoiding thread safety violations in Java: when two different threads access the same mutable state (variable) *all* access to that state must be performed holding a single lock.

Some developers may violate this rule, after reasoning about the behavior of shared state in their program, in an attempt to optimize code. Since many of the devices on which the Android platform is currently implemented cannot actually provide

concurrent execution (instead, a single processor is shared, serially, across the threads), it is possible that these programs will appear to run correctly. However, when, inevitably, mobile devices have processors with multiple cores and large, multilayered processor caches, incorrect programs are likely to fail with bugs that are serious, intermittent, and extremely hard to find.

When implementing concurrent processes in Java, the best approach is to turn to the powerful `java.util.concurrent` libraries. Here you will find nearly any concurrent structure you might require, optimally implemented and well tested. In Java, there is seldom more reason for a developer to use the low-level concurrency constructs than there is for him to implement his own version of a doubly linked list.

The `synchronized` keyword can be used in three contexts: to create a block, on a dynamic method, or on a static method. When used to define a block, the keyword takes as an argument a reference to an object to be used as a semaphore. Primitive types cannot be used as semaphores, but any object can.

When used as a modifier on a dynamic method, the keyword behaves as though the contents of the method were wrapped in a synchronized block that used the instance itself as the lock. The following example demonstrates this:

```
class SynchronizationExample {

    public synchronized void aSynchronizedMethod() {
        // a thread executing this method holds
        // the lock on "this". Any other thread attempting
        // to use this or any other method synchronized on
        // "this" will be queued until this thread
        // releases the lock
    }

    public void equivalentSynchronization() {
        synchronized (this) {
            // this is exactly equivalent to using the
            // synchronized keyword in the method def.
        }
    }

    private Object lock = new Object();

    public void containsSynchronizedBlock() {
        synchronized (lock) {
            // A thread executing this method holds
            // the lock on "lock", not "this".
            // Threads attempting to seize "this"
            // may succeed. Only those attempting to
            // seize "lock" will be blocked
        }
    }
}
```

This is very convenient but must be used with caution. A complex class that has multiple high-use methods and synchronizes them in this way may be setting itself up for

lock contention. If several external threads are attempting to access unrelated pieces of data simultaneously, it is best to protect those pieces of data with separate locks.

If the `synchronized` keyword is used on a static method, it is as though the contents of the method were wrapped in a block synchronized on the object's class. All static synchronized methods for all instances of a given class will contend for the single lock on the class object itself.

Finally, it is worth noting that object locks in Java are reentrant. The following code is perfectly safe and does not cause a deadlock:

```
class SafeSeizure {
    private Object lock = new Object();

    public void method1() {
        synchronized (lock) {
            // do stuff
            method2();
        }
    }

    public void method2() {
        synchronized (lock) {
            // do stuff
        }
    }
}
```

## Thread Control with `wait()` and `notify()` Methods

The class `java.lang.Object` defines the methods `wait()` and `notify()` as part of the lock protocol that is part of every object. Since all classes in Java extend `Object`, all object instances support these methods for controlling the lock associated with the instance.

A complete discussion of Java's low-level concurrency tools is well beyond the scope of this book. Interested developers should turn to Brian Goetz's excellent *Java Concurrency in Practice* (Addison-Wesley Professional). This example, however, illustrates the essential element necessary to allow two threads to cooperate. One thread pauses while the other completes a task that it requires:

```
/**
 * Task that slowly fills a list and notifies the
 * lock on "this" when finished. Filling the
 * list is thread safe.
 */
public class FillListTask implements Runnable {
    private final int size;
    private List<String> strings;

    public FillListTask(int size) {
        this.size = size;
    }
}
```

```

public synchronized boolean isFinished() {
    return null != strings;
}

public synchronized List<String> getList() {
    return strings;
}

@Override
public void run() {
    List<String> str = new ArrayList<String>(size);
    try {
        for (int i = 0; i < size; i++ ) {
            Thread.sleep(2000);
            str.add("element " + String.valueOf(i));
        }

        synchronized (this) {
            strings = str;
            this.notifyAll();
        }
    }
    catch (InterruptedException e) {
        // catch interrupted exception outside loop,
        // since interrupted exception is a sign that
        // the thread should quit.
    }
}

/**
 * Waits for the fill list task to complete
 */
public static void main(String[] args)
    throws InterruptedException
{
    FillListTask task = new FillListTask(7);

    new Thread(task).start();

    // The call to wait() releases the lock
    // on task and suspends the thread until
    // it receives a notification
    synchronized (task) {
        while (!task.isFinished()) {
            task.wait();
        }
    }

    System.out.println("Array full: " + task.getList());
}
}

```

In fact, most developers will never use low-level tools like `wait` and `notify`, turning instead to the `java.util.concurrent` package for higher-level tools.

## Synchronization and Data Structures

Android supports the feature-rich Java Collections Library from Standard Edition Java. If you peruse the library, you'll find that there are two versions of most kinds of collections: `List` and `Vector`, `HashMap` and `Hashtable`, and so on. Java introduced an entirely new collections framework in version 1.3. The new framework completely replaces the old collections. To maintain backward compatibility, however, the old versions were not deprecated.

The new collections should be preferred over their legacy counterparts. They have a more uniform API, there are better tools to support them, and so on. Perhaps most important, however, the legacy collections are all synchronized. That might sound like a great idea but, as the following example shows, it is not necessarily sufficient:

```
public class SharedListTask implements Runnable {
    private final Vector<String> list;

    public SharedListTask(Vector<String> l) {
        this.list = l;
    }

    @Override
    public void run() {
        // the size of the list is obtained early
        int s = list.size();

        while (true) {
            for (int i = 0; i < s; i++ ) {
                // throws IndexOutOfBoundsException!!
                // when the list is size 3, and s is 4.
                System.out.println(list.get(i));
            }
        }
    }

    public static void main(String[] args) {
        Vector<String> list = new Vector<String>();
        list.add("one");
        list.add("two");
        list.add("three");
        list.add("four");

        new Thread(new SharedListTask(list)).start();

        try { Thread.sleep(2000); }
        catch (InterruptedException e) { /* ignore */ }

        // the data structure is fully synchronized,
        // but that only protects the individual methods!
        list.remove("three");
    }
}
```

Even though every use of the `Vector` is fully synchronized and each call to one of its methods is guaranteed to be atomic, this program breaks. The complete synchronization of the `Vector` is not sufficient, of course, because the code makes a copy of its size and uses it even while another thread changes that size.

Because simply synchronizing the methods of a collection object itself is so often insufficient, the collections in the new framework are not synchronized at all. If the code handling the collection is going to have to synchronize anyway, synchronizing the collection itself is redundant and wasteful.



---

# The Ingredients of an Android Application

Based on the foundation laid in the last chapter for writing robust Java code, this chapter introduces the major high-level concepts involved in programming for the Android platform.

## Traditional Programming Models Compared to Android

When starting applications, operating systems traditionally use a single entry point, often called `main`, which might parse some command-line arguments and then proceed to execute a loop that would read user input and produce output. The OS would load the program code into a process and then start executing it. Conceptually, this kind of process would look something like [Figure 3-1](#).

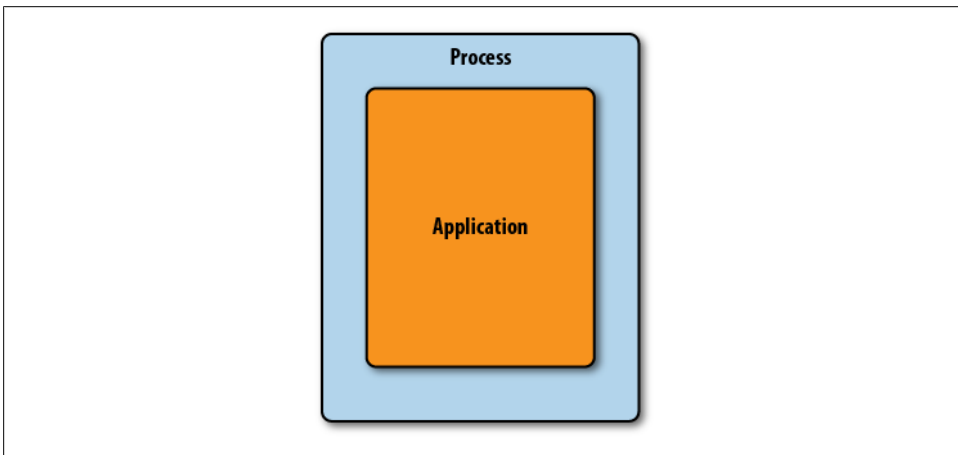

*Figure 3-1. A simple application in a process*

With programs written in Java, it gets a little more complex: a Java virtual machine (VM) in a process loads bytecode to instantiate Java classes as the program uses them. This process looks something like [Figure 3-2](#). If you use a rich graphical user interface system like Swing, you might start a UI system and then write callbacks to your code that process events.

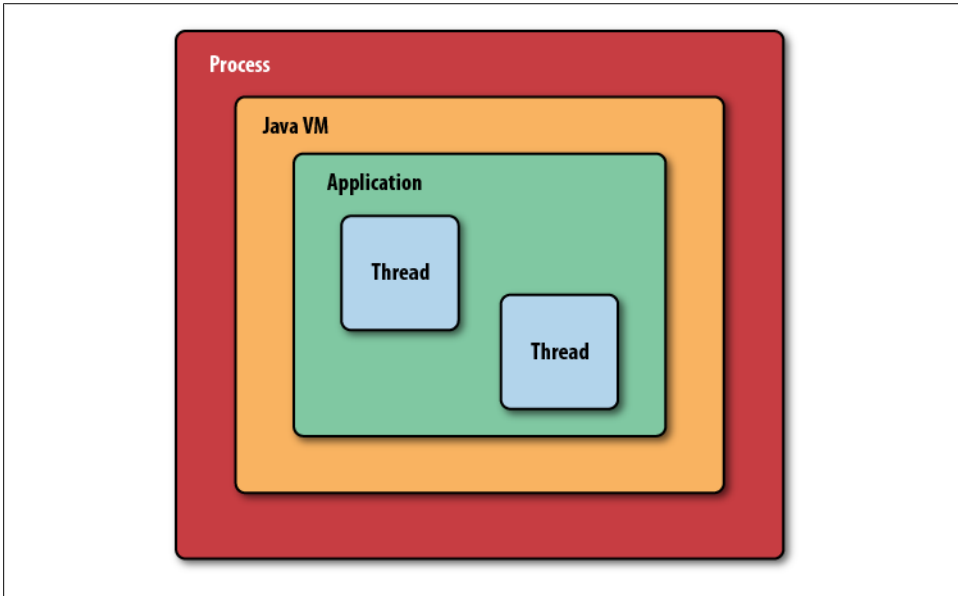

*Figure 3-2. A Java application, running in a Java virtual machine, in a process*

Android introduces a richer and more complex approach by supporting multiple application entry points. Android programs should expect the system to start them in different places, depending on where the user is coming from and what she wants to do next. Instead of a hierarchy of places, your program is a cooperating group of components that may be started from outside the normal flow of your application. For example, a component to scan a bar code provides a discrete function that many applications can integrate into their UI flow. Instead of relying on the user to directly start each application, the components themselves invoke one another to perform interactions on behalf of the user.

## Activities, Intents, and Tasks

An Android activity is both a unit of user interaction—typically filling the whole screen of an Android mobile device—and a unit of execution. When you make an interactive Android program, you start by subclassing the `Activity` class. Activities provide the reusable, interchangeable parts of the flow of UI components across Android applications.

How, then does one activity invoke another, and pass information about what the user wants to do? The unit of communication is the `Intent` class. An `Intent` represents an abstract description of a function that one activity requires another activity to perform, such as taking a picture. Intents form the basis of a system of loose coupling that allows activities to launch one another. When an application dispatches an intent, it's possible that several different activities might be registered to provide the desired operation.

You have already "written" the code for an activity in the test application you created to verify that your Android SDK is correctly installed. Let's take a look at that code again:

```
public class TestActivity extends Activity {
    /** Called when the activity is first created. */
    @Override
    public void onCreate(Bundle savedInstanceState) {
        super.onCreate(savedInstanceState);
        setContentView(R.layout.main);
    }
}
```

When the system starts this activity it calls the constructor for `TestActivity`, a subclass of `Activity`, and then calls its `onCreate` method. This causes the view hierarchy described in the `main.xml` file to load and display. The `onCreate` method kicks off the life cycle of the `Activity`, which [Chapter 11](#) covers in detail.

The `Activity` class is one of the most important classes in the Android system, promoting apps' modularity and allowing functionality to be shared. An `Activity` interacts with the Android runtime to implement key aspects of the application life cycle. Each activity can also be independently configured, through a `Context` class.

Each activity in an Android application is largely separate from other activities. The code that implements one activity does not directly call methods in the code that implements another activity. Other elements in the Android framework—such the `Intent` already mentioned—are used to manage communication instead. Thus, you are discouraged from keeping references to `Activity` objects. The Android Runtime Environment, which creates and manages activities and other application components, often reclaims the memory they use in order to restrict individual tasks to relatively small amounts of memory. You will find ad hoc attempts to manage activity memory to be largely counterproductive.



We use the word *activity* to refer to instances of the `Activity` class, much the way that *object* is used to refer to instances of classes.

Instead of a user interface flow control based on method calls, applications describe an `Intent` that they want to execute and ask the system to find one that matches. The Android Home screen application starts your program using these descriptions, and each app can then do the same using its own choice of intents. Android Developers call the resultant flow a “task”: a chain of activities that often span more than one application, and, indeed, more than one process. Figure 3-3 shows a task spanning three applications and multiple activities (Table 3-1 gives an example). The chain of activities comprising this task spans three separate processes and heaps, and can exist independently of other tasks that may have started other instances of the same `Activity` subclasses.

Table 3-1. Examples of a single task, made up of activities across applications

App	Activity	User's next action
Messaging	View list of messages	User taps on a message in the list
Messaging	View a message	User taps Menu→View Contact
Contacts	View a contact	User taps Call Mobile
Phone	Call the contact's mobile number	

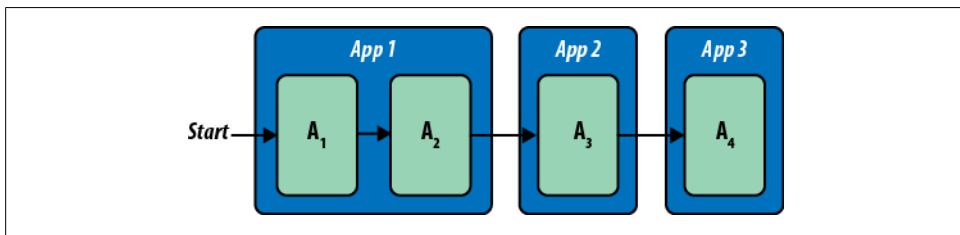

Figure 3-3. Activities in a single task, spanning multiple applications

## Other Android Components

Three other components in Android contribute to applications: services, content providers, and broadcast receivers. The `Service` class supports background functions. The `ContentProvider` class provides access to a data store for multiple applications, and the `Broadcast Receiver` allows multiple parties to listen for intents broadcast by applications.

You will find that, compared to its components, the application itself is a relatively unimportant unit. Well-designed applications “dissolve” into the Android

environment, where they can start activities in other applications to borrow their functions, and provide or augment their own functionality through the use of supporting Android components. You can think of Android's content providers and intents as a secondary API that you should learn to use in order to take advantage of Android's strongest features and integrate seamlessly with the Android platform.

## Service

The Android `Service` class is for background tasks that may be active but not visible on the screen. A music-playing application would likely be implemented as a service in order to continue to play music while a user might be viewing web pages. Services also allow applications to share functions through long-term connections. This practice is reminiscent of Internet services such as FTP and HTTP, which wait until a request from a client triggers them. The Android platform avoids reclaiming service resources, so once a service starts, it is likely to be available unless memory gets extremely constrained.

Like `Activity`, the `Service` class offers methods that control its life cycle, such as stopping and restarting the service.

## Content Providers

Content provider components are roughly analogous to a RESTful web service: you find them using a URI, and the operations of a `ContentProvider` subclass parallel RESTful web operations such as putting and getting data. A special URI starting with the `content://`, which is recognized across the local device, gives you access to the content provider data. To use a `ContentProvider`, you specify a URI and how to act on referenced data. Here is a list of content provider operations, which provide the well-known quartet of basic data handling activities: create (insert), read (query), update, and delete:

### *Insert*

The `insert` method of the `ContentProvider` class is analogous to the REST `POST` operation. It inserts new records into the database.

### *Query*

The `query` method of the `ContentProvider` class is analogous to the REST `GET` operation. It returns a set of records in a specialized collection class called `Cursor`.

### *Update*

The `update` method of the `ContentProvider` class is analogous to the REST `UPDATE` operation. It replaces records in the database with updated records.

### *Delete*

The `delete` method of the `ContentProvider` class is analogous to the REST `DELETE` operation. It removes matching records from the database.



REST stands for “Representational State Transfer.” It isn’t a formal protocol the way that HTTP is. It is more of a conceptual framework for using HTTP as a basis for easy access to data. While REST implementations may differ, they all strive for simplicity. Android’s content provider API formalizes REST-like operations into an API and is designed in the spirit of REST’s simplicity. You can find more information on REST on Wikipedia: <http://en.wikipedia.org/wiki/REST>.

Content provider components are the heart of the Android content model: by providing a `ContentProvider`, your application can share data with other applications and manage the data model of an application. A companion class, `ContentResolver`, enables other components in an Android system to find content providers. You will find content providers throughout the platform, used both in the operating system and in applications from other developers. Notably, the core Android applications make use of content providers that can provide quick and sophisticated functions for new Android applications, including providers for Browser, Calendar, Contacts, Call Log, Media, and Settings.

Content providers are unique among the IPC systems found on other platforms, such as CORBA, RMI, and DCOM, which focus on remote procedure calls. Content providers operate both as a persistence mechanism and as a form of interprocess communication. Instead of just enabling interprocess method calls, content providers allow developers to efficiently share entire SQL databases across processes: instead of sharing just objects, content providers manage entire SQL tables.

### Using a content provider

Due to its importance in Android, we provide a brief introduction here to writing a client that uses a content provider. This example, which uses one of the most important content providers—the Contacts database—should give you a somewhat more grounded understanding of how a content provider can fit into your application. The `ContentProvider` class provides the central content provider API, which you can subtype to manipulate specific types of data. Activities access specific content provider instances using the `ContentResolver` class and associated URLs as follows:

```
// code from an activity method
ContentProviderClient client = getContentResolver().
    acquireContentProviderClient("content://contacts/people");
ContentProvider provider = client.getLocalContentProvider();
```

Using a content provider involves calling its data operations with REST-style URIs defined by the `UriMatcher` class. `UriMatcher` provides a simple string matching utility for REST-based URLs, with support for wild-carding strings. Content provider URLs always take the following form:

```
content://authority/path/id
```

where *authority* is the Java package of the content provider namespace (often the Java namespace of the content provider implementation). Here are some example content provider URIs:

```
// references a person
content://contacts/people/25

// this URI designates the phone numbers of the person whose ID is "25"
content://contacts/people/25/phones
```

When a developer calls the `query` method on a content provider, the call will return a `Cursor` object that implements the `android.database.Cursor` interface. This interface lets you retrieve one result (like a row from a database) at a time using an index that is automatically updated as you retrieve each result. Developers familiar with JDBC can compare this to `java.sql.ResultSet`. In most cases, `Cursor` objects represent the results of queries on SQLite tables. Developers can access cursor fields using the indexes of the underlying SQLite table. Here is an example of iterating an Android cursor and accessing its fields:

```
// code from an activity method
Cursor contactsCursor =
    managedQuery(ContactsContract.Contacts.CONTENT_URI,
        null, null, null, null);

if (contactsCursor.moveToFirst()) {
    int idx = contactsCursor.getColumnIndex(Contacts.People.DISPLAY_NAME);

    do { name = contactsCursor.getString(idx); }
    while (contactsCursor.moveToNext());
}
```

Note here that whenever a client uses a cursor from a provider, it's critical to close the cursor when the client is done with it. Failure to do so will result in a serious memory leak that can crash your application. Android provides two ways to ensure that provider cursors get closed when not in use:

- The activity calls `Cursor.close` directly.
- The activity calls `managedQuery` to query content providers, or calls `startManagingCursor(Cursor c)`. Both of these calls rely on the system to watch cursor references to know when a given reference has no more active clients. When reference counts indicate that all clients have finished, the system will itself call `Cursor.close`.

We'll spend more time covering data and content providers in detail in Chapters [12](#) and [13](#).

## Content providers and the Internet

Together with the `Activity` component of an Android application, content providers provide the necessary parts of a Model-View-Controller (MVC) architecture. In addition to supporting REST-like operations, they support the observer pattern that

supports MVC. The `ContentResolver` class provides a `notifyChange` method that broadcasts a change in the database to `Cursor` objects that have registered content observers using the `registerContentObserver` method.

You may be thinking, “That’s nice, but the data I’m interested in is out there on the Internet.” As it happens, Android provides plenty of tools to make accessing that data simple. You have probably used some applications that access Internet-based data using Android’s network classes. Unfortunately, you can often recognize these applications because they take a noticeable amount of time to access and retrieve data from some server on the Internet. They might even show a progress indicator while you wait.

Wouldn’t it be nicer if you could harness the power of content providers to cache data locally, and the power of Android’s database-centric MVC architecture support to make fresh data appear on the user’s screen as it arrives? That’s what [Chapter 13](#) is about. There you will learn how to combine user interfaces, content providers and related classes, Android’s network APIs, and MVC support in Android to create a REST client that takes advantage of the similarity of the content provider architecture to REST to free the user from staring at a progress indicator while your application fetches data.

## BroadcastReceiver

The `BroadcastReceiver` class implements another variant of Android’s high-level inter-process communication mechanism using `Intent` objects. `BroadcastReceiver` has a simpler life cycle, than the other components we’ve covered. A broadcast receiver receives the action of `Intent` objects, similarly to an `Activity`, but does not have its own user interface. A typical use for a broadcast receiver might be to receive an alarm that causes an app to become active at a particular time. The system can broadcast an intent to multiple receivers.

## Static Application Resources and Context

Applications may need to store significant amounts of data to control their runtime behavior. Some of this data describes the application environment: the app name, the intents it registers, the permissions it needs and so on. This data is stored in a file called the *manifest*. Other data might be images to display or simple text strings, indicating what background color or font to use. These data are called *resources*. Together, all this information forms the *context* of the application, and Android provides access to it through the `Context` class. Both `Activity` and `Service` extend the `Context` class, which means that all activities and services have access to `Context` data through the `this` pointer. In subsequent sections, we will describe how to use a `Context` object to access application resources at runtime.



## Application Manifests

Android requires applications to explicitly describe their contents in an XML file called *AndroidManifest.xml*. Here, applications declare the presence of content providers, services, required permissions, and other elements. The application context makes this data available to the Android runtime. The manifest file organizes an Android application into a well-defined structure that is shared by all applications and enables the Android operating system to load and execute them in a managed environment. The structure encompasses a common directory layout and common file types in those directories.

As we've seen, the four components of Android applications—**Activity**, **Service**, **ContentProvider**, and **BroadcastReceiver**—provide the foundation of Android application development (see [Figure 3-4](#)). To make use of any of them, an application must include corresponding declarations in its *AndroidManifest.xml* file.

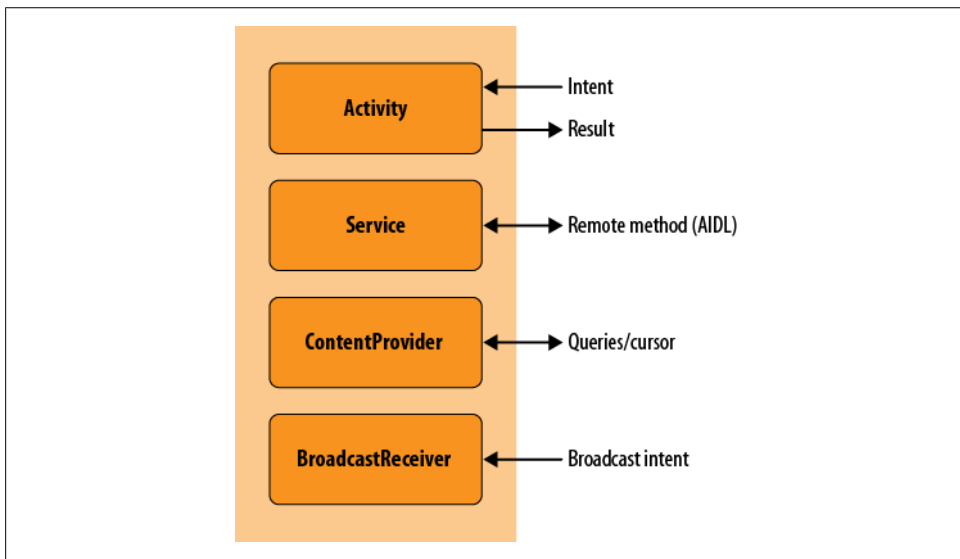

Figure 3-4. The four kinds of Android components

### The Application Class

There is a “fifth Beatle” of Android components: the **Application** class. But many Android applications do not subclass **Application**. Because, in most cases, subclassing **Application** is unnecessary, the Android project wizard doesn't create one automatically.

## A Typical Source Tree

The source code for Android applications almost always makes use of the following directory hierarchy:

```
AndroidManifest.xml
res/

    layout/
        ... contains application layout files ...
    drawable/
        ...contains images, patches, drawable xml ...
    raw/
        ... contains data files that can be loaded as streams ...
    values/
        ... contains xml files that contain string, number values used in code ...
src/
    java/package/directories/
```

We'll see in a minute how the *res* directory is particularly important for making application data accessible using a Context object.

## Initialization Parameters in AndroidManifest.xml

The following code shows the Android manifest from our test application that we introduced in [Chapter 1](#). The test application does not do anything beyond demonstrating the basic layout of an Android application. This manifest file contains basic elements that we have discussed:

```
<?xml version="1.0" encoding="utf-8"?>
<manifest xmlns:android="http://schemas.android.com/apk/res/android"
    package="com.oreilly.demo.pa.ch01.testapp"
    android:versionCode="1"
    android:versionName="1.0">

    <uses-permission android:name="android.permission.ACCESS_FINE_LOCATION" />
    <uses-permission android:name="android.permission.CALL_PHONE" />
    <uses-permission android:name="android.permission.ACCESS_MOCK_LOCATION" />
    <uses-permission android:name="android.permission.INTERNET" />

    <application android:icon="@drawable/icon"
        android:label="@string/app_name"
        android:debuggable="true">

        <activity android:name=".TestActivity"
            android:label="Test Activity">
            <intent-filter>
                <action android:name="android.intent.action.MAIN"/>
                <category android:name="android.intent.category.LAUNCHER"/>
            </intent-filter>
        </activity>

        <provider android:name=".TestProvider"
            android:authorities="com.oreilly.demo.pa.ch11.video.FinchVideo"
```

```

        />
        <service android:name=".TestService"
            android:label="Test Service"/>

        <receiver
            android:name=".TestBroadcastReceiver"
            android:label="Test Broadcast Receiver"/>
    </application>
    <uses-sdk android:minSdkVersion="7" />
</manifest>

```

Like all good XML files, line 1 has the standard declaration of the version of XML and the character encoding used. We then define a few parameters and declare needed permissions for the whole application. The following list describes the tags we have used:

#### manifest

`package="com.oreilly.demo.pa.ch01.testapp"`

The default package where modules in the application can be found.

#### `android:versionCode`

An arbitrary integer denoting versions of the application. Every application should include a version code, and it should always increase for each version released to customers. This lets other programs (like the Android Market, installers, and launchers) easily figure out which version of an application is later than another. The filename of your *.apk* file should include this same version number so that it is obvious which version is contained in it.

#### `android:versionName`

A string intended to be more like the version numbers you usually see for applications, such as 1.0.3. This is the version identifier that will be displayed to a user (either by your application or by another application). The naming convention is up to you, but in general, the idea is to use a scheme like *m.n.o* (for as many numbers as you want to use), to identify successive levels of change to the application.

#### `uses-permission android:name=...`

Four declarations in the `TestApp` manifest declare that the application intends to use features of Android that require explicit permission from the user of the device running the application. The permission is requested when the application is installed. From then on, Android remembers that the user said it was OK (or not) to run this application and allow access to the secure features. Many permissions are already defined in Android, and all are described in the Android documentation (search for `android.Manifest.permission`). What's more, you can define your own permissions and use them to restrict other applications' access to functions in your application, unless the user grants the other application that permission. We have requested the following commonly used permissions as an example:

`ACCESS_FINE_LOCATION`

Required to obtain location information from a GPS sensor

`CALL_PHONE`

Allows a phone call on behalf of the user

`ACCESS_MOCK_LOCATION`

Allows us to get fake location information when we're running under the emulator

`INTERNET`

Allows us to open Internet connections to retrieve data

`application`

`label`

Provides a human-readable application label.

`icon="@drawable/icon"`

The filename for a PNG file that contains the icon you'd like to use for your application. In this case, we're telling the Android SDK to look for the icon file in the *drawable* subdirectory of the *res* (resources) directory under *TestApp*. Android will use this icon for your application in the Android Desktop.

`activity`

Turning our attention to the definition of `TestActivity`, we first define a few attributes. The most important are:

`android:name`

The name of the class for the `Activity`. The full name of the activity includes the package name (which in this application is `com.oreilly.demo.pa.ch01.testapp`), but since this file is always used in the context of the package's namespace, we don't need to include the leading package names: we strip the name down to just `.TestActivity`. Actually, even the leading period is optional.

`android:label`

The label that we want to appear at the top of the Android screen when the activity is on the screen. We've defined this in *strings.xml* to match our application.

`intent-filter`

Here we declare an intent filter that tells Android when this `Activity` should be run. When an app asks Android to fulfill an `Intent`, the runtime looks among the available activities and services to find something that can service it. We set two attributes:

`action`

This tells Android how to launch this application once the runtime has decided this is the application to run. Android looks for an activity that declares itself ready to resolve the `MAIN` action. Any application that is going to be launched by the Launcher needs to have exactly one activity or service that makes this assertion.

### category

The `Intent` resolver in Android uses this attribute to further qualify the `Intent` that it's looking for. In this case, the qualification is that we'd like this `Activity` to be displayed in the User menu so that the user can select it to start this application. Specifying the `LAUNCHER` category accomplishes this. You can have a perfectly valid application without this attribute—you just won't be able to launch it from the Android desktop. Normally, again, you'll have exactly one `LAUNCHER` per application, and it will appear in the same intent filter as the opening `Activity` of your application.

### provider

Enables the declaration of a content provider. `name` specifies the name of the provider class and `authorities` specifies the URI authorities that the content provider should handle. A URI authority provides the domain section of a content provider URI and enables the Android content resolution system to locate a provider that should handle a particular type of URI. We'll provide more detail on how clients use content providers a bit later in the chapter. We've declared a provider with the name `TestProvider`.

### service

Enables the app to declare that it supports a given service, where `name` specifies the service class and `label` provides a human-readable label for the service. We've declared a service with the name `.TestService`.

### receiver

Provides a way to declare an app's support for a broadcast receiver. `name` again specifies the receiving class and `label` provides a human-readable label for the receiver. We've declared a receiver with the name `TestBroadcastReceiver`.

## Resources

Android applications place images, icons, and user interface layout files into a directory named *res*. The *res* directory usually will contain at least four subdirectories, as follows:

### *layout*

Contains Android user interface XML files, described in [Chapter 7](#).

### *drawable*

Contains drawing artifacts such as the application icon noted in the previous section.

### *raw*

Holds files that may be read as streams during the execution of an application. Raw files are a great way to provide debug information to a running application without having to access the network to retrieve data.

*values*

Contains values that the application will read during its execution, or static data an application will use for such purposes as internationalization of UI strings.

Applications access resources in these directories using the method `Context.getResources()` and the `R` class.

To access the data in the *res* directory, a traditional Java developer might think about writing code to build relative resource file paths and then using the file API to open the resources. After loading resource bytes, the application developer might expect to parse an application-specific format to finally get access to the same items every app needs: images, strings, and data files. Anticipating each application's need to load similar information, Android instead includes a utility that integrates with Eclipse, makes resources easily accessible to program logic, and standardizes program resources.

Eclipse and the Android SDK work together to create a directory called *gen*, which contains a class always named `R`, which resides in the Java application package named in the Android manifest. The `R` class file contains fields that uniquely identify all resources in the application package structure. A developer calls the `Context.getResources` method to obtain an instance of `android.content.res.Resources` that directly contains application resources. (Methods in the `Context` class can be called directly because `Activity`—and `Service` as well—extend `Context`.) Developers then call methods of the `Resources` object to obtain resources of the desired type as follows:

```
// code inside an Activity method
String helloWorld = this.getResources().getString(R.string.hello_world);
int anInt = this.getResources().getInteger(R.integer.an_int);
```

You will see that the `R` class is ubiquitous in Android, enabling easy access to resources such as the components in UI layout files.

## The Android Application Runtime Environment

Android's unique application component architecture is, in part, a product of the way Android implements a multiprocessing environment. In order to make that environment suitable for multiple applications from multiple vendors with a minimal requirement to trust each vendor, Android executes multiple instances of the Dalvik VM, one for each task. In [“Component Life Cycles” on page 90](#), and in later chapters, we will explore how component life cycles enable Android to enhance the way garbage collection works within application heaps, and how it enables a memory recovery strategy across multiple heaps.

As a result of this simple and reliable approach to multiprocessing, Android must efficiently divide memory into multiple heaps. Each heap should be relatively small so that many applications can fit in memory at the same time. Within each heap, the component life cycle enables components not in use—especially currently inactive user

interface components—to be garbage-collected when heap space is tight, and then restored when needed. This, in turn, motivates a database-centric approach to data models where most data is inherently persistent at all times, something you will read a lot more about throughout this book, and especially in [Chapter 11](#).

## The Dalvik VM

Android’s approach to multiprocessing, using multiple processes and multiple instances of a VM, requires that each instance of the VM be space-efficient. This is achieved partly through the component life cycle, which enables objects to be garbage-collected and recreated, and partly by the VM itself. Android uses the Dalvik VM to run a bytecode system developed specifically for Android, called dex. Dex bytecodes are approximately twice as space-efficient as Java bytecodes, inherently halving the memory overhead of Java classes for each process. Android systems also use copy-on-write memory to share heap memory among multiple instances of the same Dalvik executable.

## Zygote: Forking a New Process

It would also be inefficient for each new process to load all the necessary base classes each time it started a new instance of the VM. Since Android puts each application in a separate process, it can take advantage of the fork operation in the underlying Linux operating system to spawn new processes from a template process that is in the optimal state for launching a new VM instance. This template process is called Zygote. It is an instance of the Dalvik VM that contains a set of preloaded classes that, along with the rest of the state of the Zygote process, are duplicated into copies of Zygote created by forking.

## Sandboxing: Processes and Users

Android security relies heavily on security restrictions at the level of the Linux operating system, specifically on process and user-level boundaries. Since Android is designed for personal devices—that is, devices that are owned and used by one person—Android makes an interesting use Linux’s inherent multi-user support: Android creates a new user for each application vendor. This means each application runs with different user privileges (except for those signed by the same vendor). Files owned by one application are, by default, inaccessible by other applications.

The equivalent behavior on Windows would be as though you were running your word processor as your own user, and your web browser as a coworker’s user. You would have to log out and then switch users to see either the word processor or the web browser, but you would not be able to see both at once. Android allows a single logged-in phone user to see multiple applications that are running as different Linux-level users.

The net effect is increased security as a result of each application running in its own “silo.”

Desktop operating systems have typically not taken application sandboxing to this extent—once an application is installed, it is trusted with all of a user’s data. Android’s designers envisioned a world of numerous small applications from numerous vendors who cannot all be vetted for trustworthiness. Hence applications don’t have direct access to other applications’ data.

A complete description of Android security can be found in the Android documentation at <http://developer.android.com/guide/topics/security/security.html>.

## Component Life Cycles

Earlier we mentioned life cycles for components. For instance, `onCreate` starts an application. Component life cycles have two purposes: they facilitate efficient use of each application’s memory, or heap space, and they enable the state of entire processes to be preserved and restored so that the Android system can run more applications than can fit in memory.

### The Activity Life Cycle

The most complex component life cycle is the activity life cycle. Here we will diagram it and take a look at how these state transitions are handled in code. In [Figure 3-5](#), you see the states and state transitions in the activity life cycle. The key elements of handling life cycle state transitions are selecting which life cycle callbacks you need to implement, and knowing when they are called.

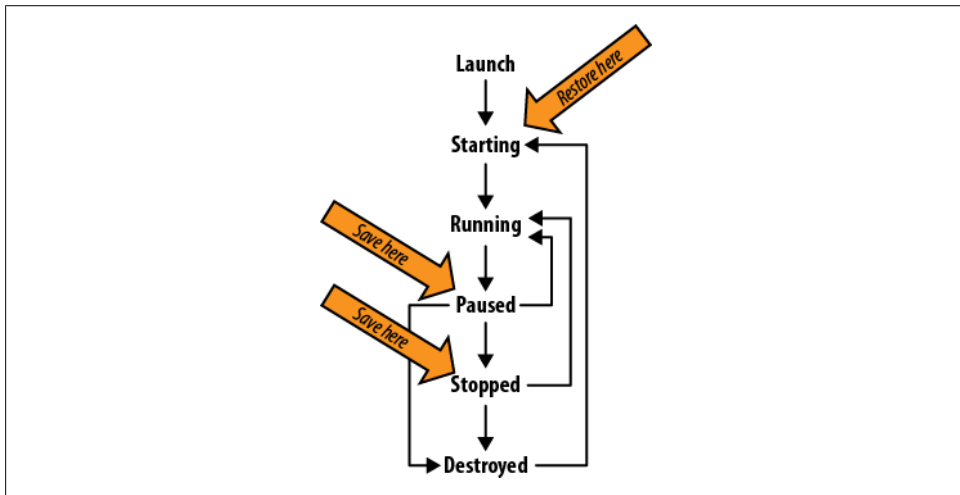

Figure 3-5. Activity life cycle states



In [Chapter 11](#), we will revisit this topic in detail. For now, let's look at two methods of the `Activity` class. The runtime calls the first to warn your application to save its state. It calls the second to allow a new `Activity` instance to restore the state of one that has been destroyed. The method implementations in the following code snippets are taken from [Chapter 11](#), where you can see the full program listing, including the member variables to which the code refers:

```
@Override
protected void onSaveInstanceState(Bundle outState) {
    // Save instance-specific state
    outState.putString("answer", state);
    super.onSaveInstanceState(outState);
    Log.i(TAG, "onSaveInstanceState");
}
```

The runtime calls `onSaveInstanceState` method when it determines that it might have to destroy the activity, but wants to be able to restore it later. That's an important distinction from other life cycle methods that are called on state transitions. If, for example, an activity is explicitly ending, there is no need to restore state, even though it will pass through the paused state, and have its `onPause` method called. As the previous code snippet shows, the work you need to do in your `onSaveInstanceState` method is to save any state that will let the user continue using the application later, hopefully not even aware that it might have been destroyed and restored since the previous use:

```
@Override
protected void onRestoreInstanceState(Bundle savedInstanceState) {
    super.onRestoreInstanceState(savedInstanceState);
    // Restore state; we know savedInstanceState is not null
    String answer = savedInstanceState.getString("answer");
    // ...
    Log.i(TAG, "onRestoreInstanceState"
        + (null == savedInstanceState ? "" : RESTORE) + " " + answer);
}
```

The `onRestoreInstanceState` method is called when an activity that was destroyed is being recreated. A new instance of your application's `Activity` is therefore running. The data you stored in the previous instance of the activity, through `onSaveInstanceState`, is passed to the new instance via the `onRestoreInstanceState` method.

You might think that, with such a complex life cycle and stringent requirements to adhere to heap utilization limitations, the Android activity life cycle would be readily apparent in Android application code, and that you will spend a lot of time and effort catering to activity life cycle requirements. Yet this is not the case.

In a lot of Android code, especially in small examples, very few life cycle callbacks are implemented. That is because the `Activity` parent class handles life cycle callbacks, the `View` class, and the children of the `View` class, and also saves their state, as shown in [Figure 3-6](#). This means that in many situations the Android `View` classes provide all the necessary user interface functionality, and that Android applications do not need to explicitly handle most life cycle callbacks.

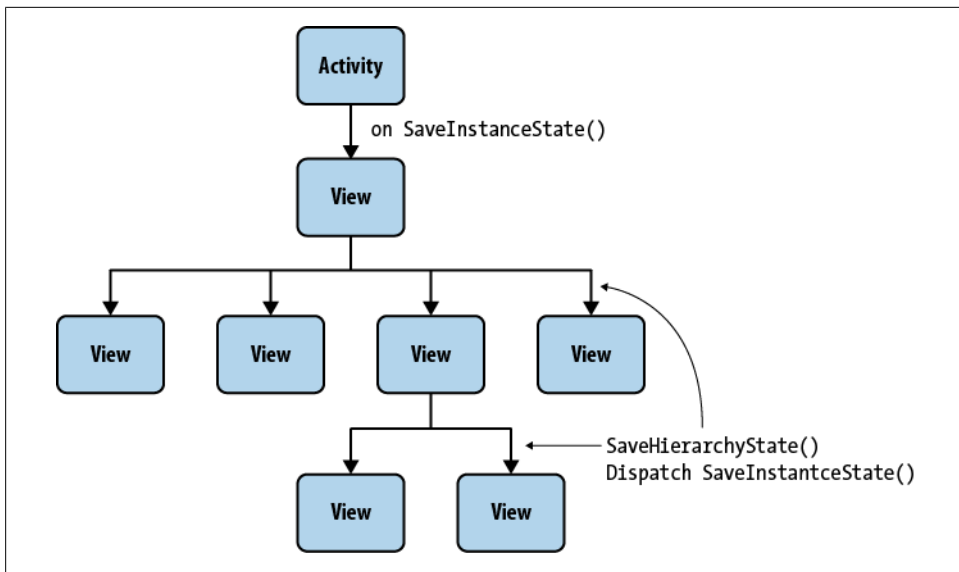

Figure 3-6. Saving the state of the user interface

This is essentially good, because it makes Android programming a lot more convenient. All of what you see diagrammed in [Figure 3-6](#) happens without you writing any code. But it has a bad side too, because it leads programmers down the path of ignoring the activity life cycle until they have coded themselves into a buggy mess. This is why we emphasize understanding life cycles here, and why, in [Chapter 11](#), we show how to handle all life cycle callbacks and log them. Starting with complete awareness of the activity life cycle is probably the most important thing you can do to prevent bugs that are difficult to diagnose.

## Packaging an Android Application: The .apk File

Android provides an application called `apkbuilder` for generating installable Android application files, which have the extension `.apk`. An `.apk` file is in ZIP file format, just like many other Java-oriented application formats, and contains the application manifest, compiled application classes, and application resources. Android provides the utility `aapt` for packaging the files that make up an `.apk` file, but developers typically prefer to allow their development environment to use this utility to build their applications for them. Most users simply rely on their IDE to build their `.apk`.

Once a developer has created an `.apk` file, he can choose to make it available for installation onto a device in one of several ways:

- Using the `adb` interface directory, or more commonly by using an IDE
- Using an SD card

- Making the file available on a web server
- Uploading the file to the Android Market, and then selecting Install

## On Porting Software to Android

In this chapter, you learned that Android has an application architecture radically different from the typical desktop application architecture and even quite different from most other systems on small devices, including the iOS operating system used in the iPhone, iPod Touch, and iPad. If you attempt to port software by subverting the Android application architecture and force-fitting a conventional application architecture into an Android application, in order to facilitate a method-by-method transliteration from Objective-C, C++, or C#, odds are the effort will come to grief.

If you want to port existing software to Android, first take it apart: the data model, the user interface, and major noninteractive modules and libraries should be ported or reimplemented in the Android application model depending on how they fit. Android does have similarities to other modern managed application runtime environments and language systems. Once you understand Android in greater depth, you will be equipped to see architectural analogies with other platforms and make better implementation choices when porting.



# Getting Your Application into Users' Hands

This chapter covers everything it takes to get your application into users' hands. Earlier in this book, we told you everything you needed to get started reading example code and creating simple programs. Here, we complete the picture, with all the other operations you need to perform to widely distribute your applications, sell them (if that is your aim), and subsequently get paid by Google, which operates the Android Market.

You may not be ready to put your application into the Android Market, but keeping this process in mind will shape the way you design and implement your application. Commerce has considerations that are distinct from most other aspects of software development, including identifying yourself to the Android Market and to your customers, obtaining permission to use certain APIs, protecting your identity, and preparing your app to be run on a variety of hardware as well as being updated over time.

## Application Signing

Application signing, or code signing, enables Android devices, the Android Market, and alternative means of distribution to know which applications originate with the owner of a signing certificate, and to be certain the code has not been modified since it was signed.

## Public Key Encryption and Cryptographic Signing

Public key cryptography depends on this mathematical principle: it is easy to multiply large prime numbers together, but it is extremely difficult to factor the product of large primes. The multiplication might take milliseconds, while factoring would take hundreds to millions of years and would require an astronomically large computer.

This asymmetry between multiplication and factoring means that a key made with the product of two large prime numbers can be made public. The knowledge that enables

encrypted messages to be decrypted is the pair of large primes that are part of the private key. That means that documents encrypted with the public key are secure, and only the possessor of the private key can decrypt them.

Signing, which is what we will do to Android applications, depends on related properties of public key encryption.

The steps to sign a document are:

1. Compute a unique number—a hash—from the document. This is also known as a *message digest*.
2. “Encrypt” the message digest with the signer’s private key. This is the signature.

Voilà! You now have a number—a signature—that is tied to the document by the hashing algorithm, and tied to the signer’s private key.

The steps to verify a signed document are:

1. Compute a unique number—a hash—from the document.
2. “Decrypt” the signature using the public key, which should also result in the same number as the hash.

Now you know some interesting facts: the document—in our case, an application—came from the person with the private key corresponding to the public key you used in the verification. And you know that the document was not altered; otherwise, the hash decrypted from the signature would not be the same as the one computed from the document.

Verifying a signature also verifies that the signature was not copied to a different document. Signatures are unalterably tied to the document from which they were created.



You may have noticed we put the words *encrypt* and *decrypt* in quotes when we said the message digest, or hash, is encrypted. This is because it’s not encryption in the way you normally use a public-private key system—to keep prying eyes away from a message by encrypting it with the public key so that only the person with the private key can read the message.

Here, “encrypt” just means “compute a number.” You are not hiding information when you “encrypt” a hash or message digest with a signer’s private key. The reason you use the words *encrypt* and *decrypt* is that you get the same hash or message digest when you decrypt with the public key.

*Anyone* with the public key and a published algorithm can “decrypt”—which is the point in verification: to see that you got the same hash the sender signed, which also *proves* that the sender is in possession of a private key corresponding to the public key, and *proves* that the document is what the sender signed.

Because verification can be computed using a public key, your Android system—and any other interested party—can verify that an application was signed with a particular key and that it was not modified since it was signed.

More generally, any electronic document—any set of bits—can be cryptographically signed, and cryptographic signatures, or “digital signatures,” can be used to sign documents in a way that can legally substitute for a person’s handwritten signature.

## **How Signatures Protect Software Users, Publishers, and Secure Communications**

As a user of computer software, you may already have been thinking, “It would be nice to know where my software comes from and that it has not been modified en route to my device.” Signed applications enable you to have this confidence. This is a form of confidence based on cryptographic signatures similar to one you already use. When you browse the Web you already rely on cryptographic signatures to trust that the ecommerce site you are communicating with is authentic, and not a rogue impostor set up to take your money and run. In the case of ecommerce, the client verifies a signature of the server’s certificate using a public key from a certificate authority. Your browser comes with keys from several certificate authorities used for this purpose.

The role of the certificate authority is to consolidate the number of parties you need to trust: you trust your browser vendor to use only keys from reputable certificate authorities, and ecommerce vendors obtain certificates from authorities browser vendors trust. The certificate authorities have a responsibility to verify that the people claiming to be, for example, Amazon.com are, in fact, Amazon.com. Now, when your browser initiates a secure session with Amazon.com, you know two things: your data is secured from eavesdropping by encryption that only the ecommerce vendor’s server can decrypt, and you are reasonably sure that the server you are connecting to is using a certificate issued by a certificate authority to the company you want to communicate with, because the certificate authority has taken steps to assure itself that it issues certificates to known parties.

### **Self-signed certificates for Android software**

In signing Android software, the signing certificate does not have to come from a certificate authority. It can be created by the software publisher—in this case, you. Unlike ecommerce transactions, where you have the additional requirement that you want to ensure that each and every connection your browser makes is to the authentic Amazon.com, perhaps through a link of unknown provenance, the act of using software does not depend as critically on knowing the identity of the signing party.

For organizations considering using a signature issued by a certificate authority, the Google documentation explicitly mentions that there is no need to have your

application signed using a certificate authority, and that self-certification is the informal standard for Android applications.

In addition to initially verifying application developer identity, digital signatures on Android are also used during application upgrades to ensure that an application upgrade should be permitted to access files created by an earlier version of the application, and that the upgrading application is not actually a malicious application trying to steal user data.

As long as you are confident that updates to the software come from the same party you obtained the software from in the first place, you can be reasonably sure the programs you are using are safe, and that the publisher of that software is known to the distributor of the software, which is the Android Market.

In addition to the assurance of updates from the original publisher, Android applications are sandboxed and require permissions, as described at <http://developer.android.com/guide/topics/security/security.html>, to access functionality that could compromise your data or cause chargeable events on your mobile service.

## Signing an Application

The concepts behind cryptographic signing are subtle and complex. But the complexity is managed by the SDK tools. When you compile and run Android code on a device or on an emulator, you are running signed code.

### Debug certificates

If you have been following the examples in this book and have created an Android project and run it in an emulator or device, you may have noticed you didn't need to create a certificate and that your application is installable on an Android handset, despite the fact that all Android code must be signed. This convenience is achieved through the use of an automatically created debug certificate. Let's take a look at the debug certificate.

Look in the *android* folder in your *home* folder. There you will find a file named *debug.keystore*. Using the `keytool` command, you can find out what is inside this file:

```
keytool -list -keystore debug.keystore
```

When you are prompted for a password, enter **android**. You will see output that looks like this:

```
Keystore type: JKS
Keystore provider: SUN
```

```
Your keystore contains 1 entry
```

```
androiddebugkey, May 13, 2010, PrivateKeyEntry,
Certificate fingerprint (MD5): 95:04:04:F4:51:0B:98:46:14:74:58:15:D3:CA:73:CE
```



The keystore type and provider indicate the keystore is a Java keystore, compatible with the Java Cryptography Architecture and Java classes that enable Android to use code signing and other cryptography tools. More information on the Java Cryptography Architecture is available at <http://download.oracle.com/javase/6/docs/technotes/tools/solaris/keytool.html>.

The `keytool` command is part of the JDK, and is described briefly in “[keytool](#)” on page 27 and in greater detail at <http://developer.android.com/guide/publishing/app-signing.html#cert>. Detailed documentation on `keytool` can also be found at <http://download.oracle.com/javase/6/docs/technotes/tools/solaris/keytool.html>.

The last line produced by the `list` option in `keytool` is a certificate fingerprint. This is a unique number generated from a key. You will see one way in which this number is used in “[Google Maps API Keys](#)” on page 108, where you will use it to get an API key.

This certificate expires in a short enough interval that it cannot be used to distribute Android software other than for testing. Do not mistake the convenience of using a debug certificate for signing software as an indication that you can do without a signing certificate for distributing your applications!

## Creating a self-signed certificate

Ready to sign some code for release? First, create a private key using the `keytool` command thusly:

```
keytool -genkey -v -keystore my-release-key.keystore -alias alias_name \  
-keyalg RSA -keysize 2048 -validity 50000
```



The `\` character indicates a line break, and is valid for multiline commands on Unix and Mac OS X. However, you will need to type this all on one line without the `\` on Windows.

You can substitute a name of your choice for `my-release-key` and an alias of your choice for `alias_name`. The `-keysize` and `-validity` parameters should remain as shown in the preceding code.

As shown in the following code, `keytool` will ask you for a password for the keystore, which you will need to remember when accessing it, and a series of questions about you, your organizational structure, and your location. `keytool` generates a private key, usable as a signing certificate with a valid life span of about 150 years, and puts it in the file named `my-release_key.keystore`:

```
example-user@default-hostname:~$ keytool -genkey -v \  
-keystore example-release-key.keystore -alias example_alias_name \  
-keyalg RSA -keysize 2048 -validity 50000  
Enter keystore password:  
Re-enter new password:  
What is your first and last name?
```

```

[Unknown]: Example ExampLenik
What is the name of your organizational unit?
[Unknown]: Example
What is the name of your organization?
[Unknown]: Example
What is the name of your City or Locality?
[Unknown]: Example
What is the name of your State or Province?
[Unknown]: Massachusetts
What is the two-letter country code for this unit?
[Unknown]: US
Is CN=Example ExampLenik, OU=Example, O=Example, L=Example, ST=Massachusetts,
C=US correct?
[no]: yes

```

```

Generating 2,048 bit RSA key pair and self-signed certificate (SHA1withRSA) with a
  validity of 50,000 days for: CN=Example ExampLenik, OU=Example, O=Example,
  L=Example, ST=Massachusetts, C=US
Enter key password for <example_alias_name>
(RETURN if same as keystore password):
Re-enter new password:
[Storing example-release-key.keystore]

```

You now have a valid key in a keystore.

### Don't lose it!

While cryptographic digital signatures are, in many ways, more reliable and secure than a handwritten signature, there is one way in which they differ: you can lose your ability to sign a document digitally.

If you lose your signing certificate, you lose your identity to Android devices and the Android Market. This means that, despite the fact that you compile and release the same code as before, you cannot use these newly compiled applications to update applications in the field, since neither Android devices nor the Android Market will recognize you as the same publisher.

Keep multiple backup copies of your signing certificate on multiple types of media, including paper, in multiple locations. And keep those backups secure. If your signing certificate is used by people other than you, they can replace your programs on your customers' Android devices.

Detailed recommendations from the Android Developers site regarding securing your signing certificate are available at <http://developer.android.com/guide/publishing/app-signing.html#secure-key>.



Conversely, your cryptographic signature is your signature solely because it is in your possession. Up to the time you want to publish an Android application and continue to be identified as the publisher, you can generate, use, and discard signatures as much as you like. Don't be afraid to experiment and learn!

## Using a self-signed certificate to sign an application

Now it's time to sign an application. In Eclipse, select the project of the application you want to sign for release, and select the File→Export command. “Why the ‘export’ command?” you may ask. After all, if you want to give someone your app to try out, you can just give her a copy of the *.apk* file in the *bin* directory of the project file hierarchy. It is as arbitrary as it seems: the “export” dialog is a grab bag of functionality, and it was a convenient place to put a procedure that isn't quite the same as “deploying.”

In this example we use the TestActivity project, but you can use any application—your own, or any project from the examples in this book.

You will be presented with a list of options for exporting, organized into folders. Select the Android folder and select Export Android Application (as shown in [Figure 4-1](#)), and click on the Next button.

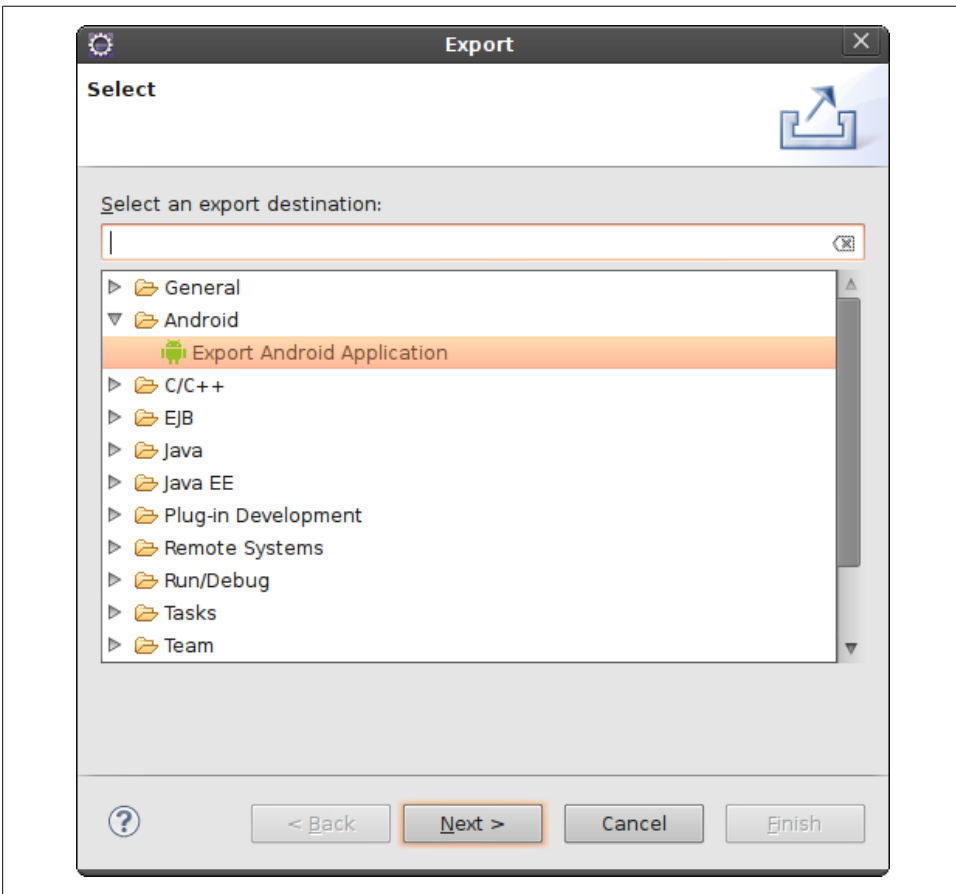
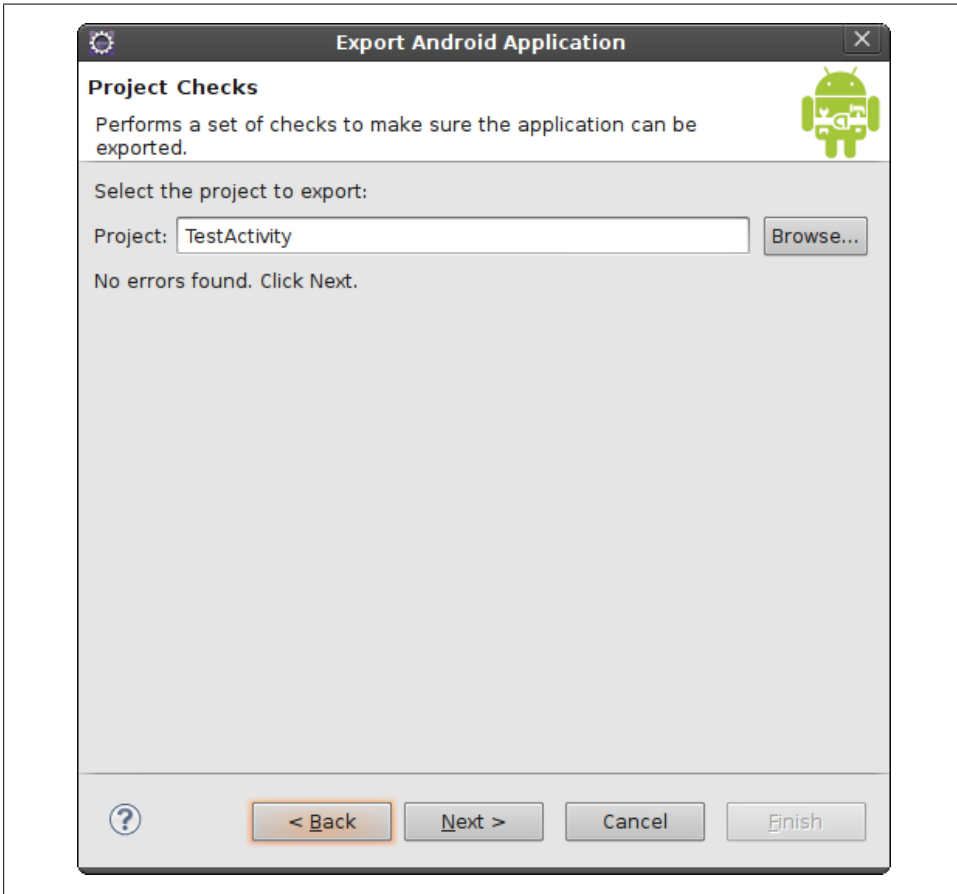

Figure 4-1. “Exporting” an Android application

First, you will see if your application has any errors in configuration that might prevent it from being ready to publish, such as having the `debuggable` attribute set to `true` in the manifest. If your app is ready to go, you will see the dialog in [Figure 4-2](#), which displays no errors.



*Figure 4-2. An Android application that has no problems preventing signing and publishing*

Subsequent dialog boxes in this multistep sequence focus on signing. The information requested mirrors the information you entered to create your release key in [“Creating a self-signed certificate” on page 99](#).

Next, you will select your keystore, as shown in [Figure 4-3](#). The keystore is the file holding your key.

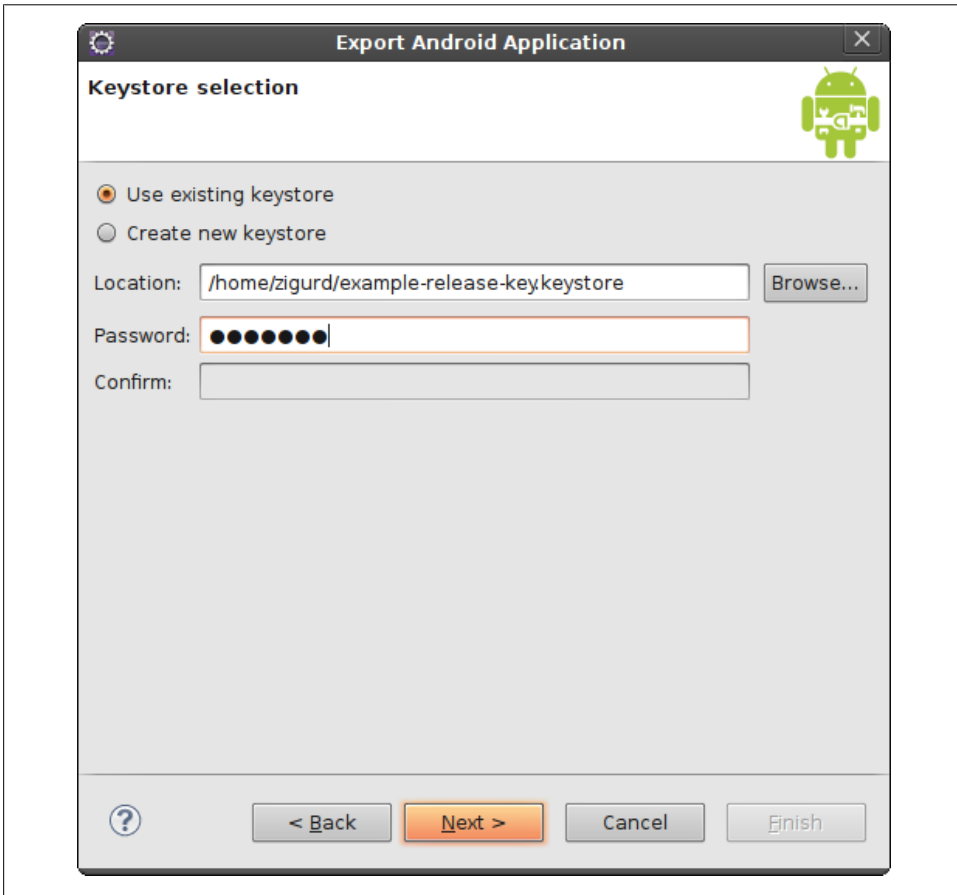

*Figure 4-3. Selecting the keystore*

Once you have entered the name of the keystore and the password, click Next and proceed to the next step: selecting the alias of the key, and entering the password for the alias, as shown in [Figure 4-4](#).

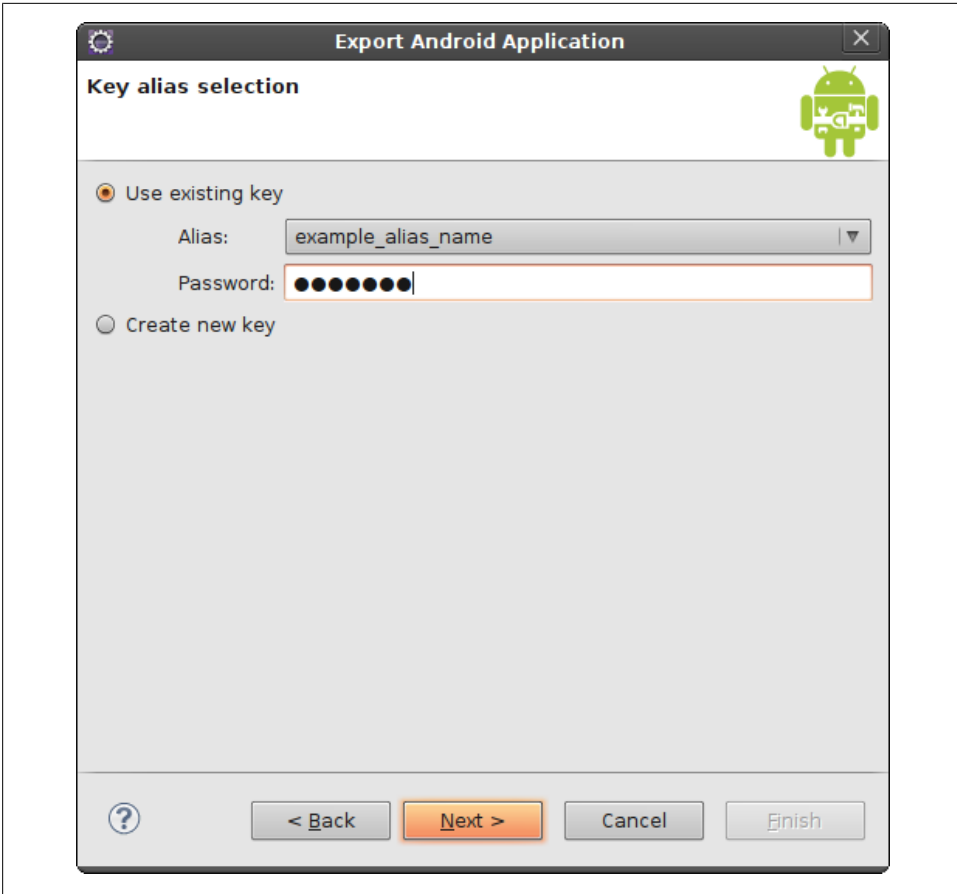

Figure 4-4. Selecting the key alias

If you followed the steps in [“Creating a self-signed certificate” on page 99](#), you have only one key, with one alias, in your keystore. Enter the password and click Next. The next step is to specify the destination *.apk* file and pass some checks to determine if anything else might be wrong with your app. If everything is in order, you will see a screen resembling that shown in [Figure 4-5](#).

When you click Finish you will get a signed *.apk* file in the specified location.

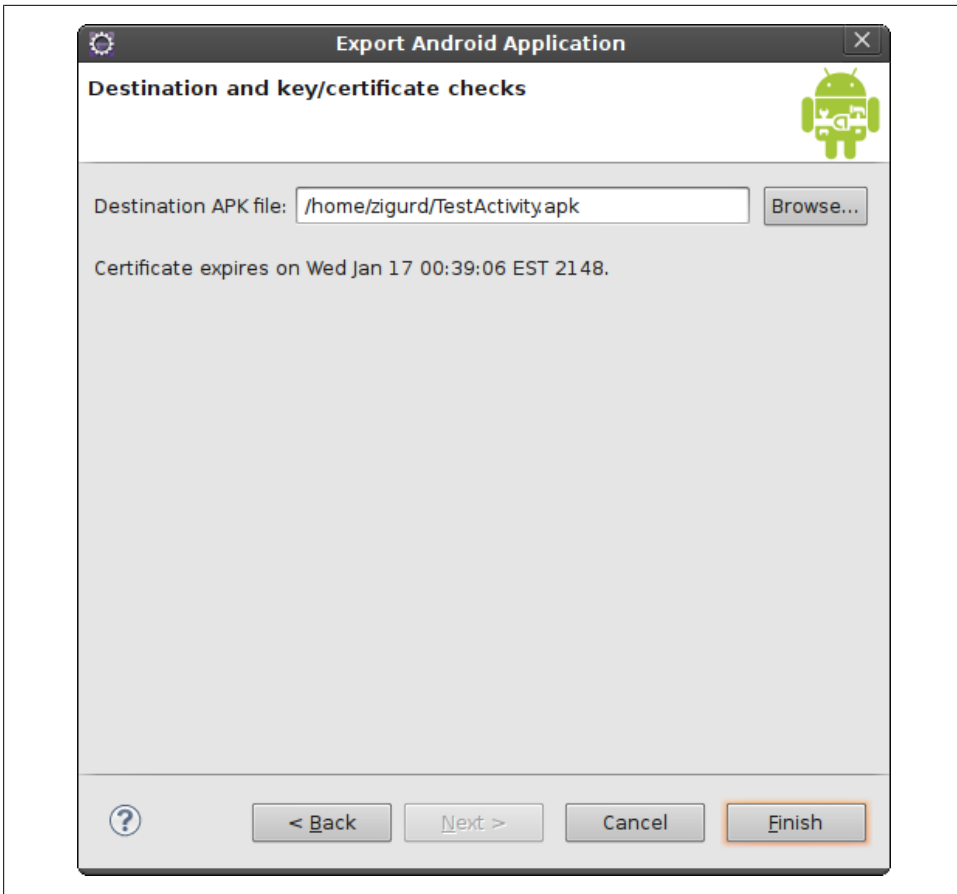

Figure 4-5. Selecting the destination, and final checks

## Placing an Application for Distribution in the Android Market

Putting an application on the Android Market is remarkably easy. The only prerequisite is that you have a Google account such as a Gmail account. A \$25 credit card transaction and some information about yourself are all you need to start uploading applications to the Android Market. Charging for applications and getting paid takes only slightly more information and effort—you don't even need a website or a corporate entity. (Consulting a lawyer before selling products is a good idea. A lawyer may suggest setting up a corporation and other ways to protect your personal assets from liabilities resulting from commercial activities.)

## Becoming an Official Android Developer

The Android Market site is where you become an official Android developer. You can sign up at <http://market.android.com/publish/signup>.

This site will ask you for identifying information, and will ask you to pay a \$25 fee using Google Checkout. This transaction confirms that you have a method of payment, such as a credit card, accepted by Google Checkout. Once you are signed up as a developer, you can use your Google account to log in to the Android Market site.

At this point, Google has reasonable assurance that you are who you say you are: a financial transaction linked to some entity that can pay off a credit card bill. This, combined with the fact that your applications are signed, means Google is also confident that the key you created to sign your applications is in the possession of the person who created the Android Market account for the purpose of uploading applications to the Android Market. If you turn out to be a spammer or a source of badware, you will be shut down, and you will need to find another identity with which to create another Google Checkout account and Android Market account.

## Uploading Applications in the Market

The page <https://market.android.com/publish/Home#AppEditorPlace> is where you upload applications. On it, you will see the latest requirements, and options, for providing information about your application. The page has upload buttons for the application's *.apk* file, plus screenshots, videos, and similar content, most of which is optional. When you have an application you would like to leave up on the Market for others to download, you should read the descriptions of the kinds of promotional and explanatory material you can upload, and make use of them. For now, let's get our app up with the minimum requirements met.

The first thing to do is to upload an *.apk* file. To try it out, you can use the *.apk* file you created if you followed along in “[Using a self-signed certificate to sign an application](#)” on page 101. Don't worry that this is not your application, and that it is just an example. You can publish it and then unpublish it right away, as you will see from the instructions in the rest of this section.

Most required information is either part of your profile as an Android developer, or part of the application manifest. As of this writing, the required uploads are two screenshots and an icon image. You will find usable images in the *doc* folder of the example project. If these requirements change—and the Android Market has changed substantially since it was first introduced—you will find out if you have skipped any required fields or uploads when you click the Publish button at the bottom of the page. Anything you missed will be highlighted, and you can go back and fill in fields or perform uploads as needed to make your application ready for publication.

Click the Publish button.



Congratulations, you have published an Android application. If you go back to <https://market.android.com/publish/Home>, you will see from the listing of applications that you have one published application (if you have not previously published an application). If you go to <https://market.android.com> and search for, say, your name, the search function should find the application you just published and list it the way a potential customer might see it if he were to find it in the Android Market. From there, you can click through to the application's page in the Android Market.

Now you can go back to the “Home” page where your application is listed and select it by clicking on the link in the listing. This takes you to a page where the information you entered when you published your app is displayed in such a way that you can modify it and update the application's listing. You can also unpublish your application from this page, using the Unpublish button at the bottom of the page. Whew! You thought you might start getting customer support inquiries!

An application that has been unpublished is not removed from the market system. It is still listed among your applications, but is not made available for download. You can reverse your decision to unpublish at any time by using the Publish button.

## Getting Paid

Google Checkout is the payment mechanism for the Android Market. That is, the Android Market provides a streamlined way to sign up as a Google Checkout merchant.

If you elect to be a publisher of paid applications, you will be directed to a page where you can create a “merchant account.” This may sound a bit intimidating, but Google has made it easy to get paid. You don't need to form a corporation or get a business bank account.

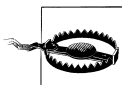

You should consult a lawyer about forming a corporate entity for your business and you should segregate your business finances from your personal accounts.

The process of getting a merchant account amounts to entering some more information—most importantly your tax ID, which can be your Social Security number—so that income from your sales can be reported.

Getting paid involves linking a bank account to your Google Checkout merchant account. Payments to Google Checkout for sales of your app will be deposited in your bank account. A full description of terms of service, payment terms, and similar information can be found in the sellers' section of the Google Checkout site, at <http://checkout.google.com/support/sell/bin/answer.py?hl=en&answer=113730>.

## Google Maps API Keys

A Google Maps API key, combined with the keys you use for signing applications, identifies you to Google and enables Google to enforce the terms of service for Google Maps. Google Maps relies on information Google collects and buys at significant expense, and must be protected from misappropriation and other misuse.

If you have been developing an application using the Google Maps API, you will have obtained an API key linked to the debug signature for your application. You can't use this API key when you ship your application. The Google Maps API, and the requirements for using it, are described in [Chapter 15](#).

When you ship your application, you will need a Google Maps API key linked to the signing key you used for distributing your application. That is, you will need a new API key that is made using an MD5 fingerprint of your signing key. Using the `keytool` command's `list` option, you can get the MD5 fingerprint of your signing key thusly:

```
keytool -list -keystore my-release-key.keystore
```

You will get this key the same way you got the API key for use with your debug signature, by visiting the Android Maps API Key Signup page at <http://code.google.com/android/maps-api-signup.html> and using the MD5 fingerprint of your signing key in the form, as shown in [Figure 4-6](#).

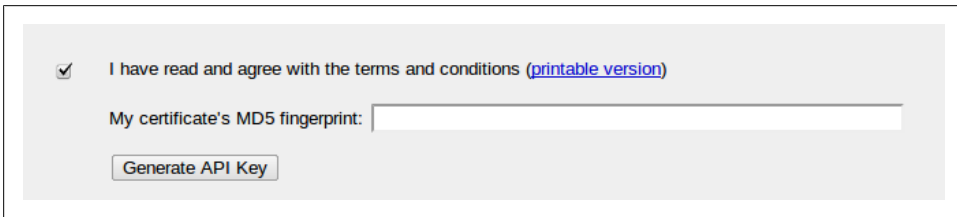

I have read and agree with the terms and conditions ([printable version](#))

My certificate's MD5 fingerprint:

Figure 4-6. Getting a Google Maps API key

When you click the Generate API Key button, you will get a web page showing the API key generated from your signing certificate's fingerprint, as shown in [Figure 4-7](#).

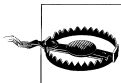

You really have to create your self-signing certificate and Google Maps API keys yourself. You cannot copy them from the screenshots here, you cannot use keys from example code you download, and you cannot use debug keys when releasing a product.

**Thank you for signing up for an Android Maps API key!**

Your key is:

```
090tqjF_xUZo0Vfd_632ZZzW5wt639keASXLsVA
```

This key is good for all apps signed with your certificate whose fingerprint is:

```
95:04:04:F4:51:0B:98:46:14:74:58:15:D3:CA:73:CE
```

Here is an example xml layout to get you started on your way to mapping glory:

```
<com.google.android.maps.MapView
  android:layout_width="fill_parent"
  android:layout_height="fill_parent"
  android:apiKey="090tqjF_xUZo0Vfd_632ZZzW5wt639keASXLsVA"
/>
```

Check out the [API documentation](#) for more information.

Figure 4-7. The Android Maps API key generated from your self-signing certificate

## Specifying API-Level Compatibility

At any one time, multiple versions of Android can be available, and not all the prospective users of your application will have the most recent version. By specifying application compatibility in the manifest, you can control which Android systems can install your application, preventing its use in systems that are incompatible with the APIs you are using.

In the example in “[Making an Android Project](#)” on page 12, the same API level is specified for the build target as for the Min SDK Version field. This means the program will only run on systems with the specified API level or higher.

Since you can detect the API level at runtime, there may be cases where you want to ship one application for systems with a lower API level than you use, and to test for the API level and only use methods and classes of higher API levels if they are available. In these cases, you would specify a higher build target API level than the Min SDK Version.

## Compatibility with Many Kinds of Screens

Android was built to accommodate multiple screen sizes and changes in screen orientation. The best way to accommodate screen size differences among Android devices is to enable your layouts to be as flexible as possible. The images your application uses

may not look optimal in very large or unusually small configurations, but it is possible to specify layouts that are usable at screen sizes ranging from the smallest screen of moderate resolution up to a 1920 × 1080 HD display.

In other words, don't start by designing multiple layouts and multiple graphical assets for different screen sizes. Start by accommodating a wide range of screen sizes well enough for your application to remain usable.

## Testing for Screen Size Compatibility

Testing is key to ensuring screen compatibility. The SDK and AVD Manager provides configurations for a range of screen sizes that cover all the smartphones on which Android runs. As described in “[Making an Android Virtual Device \(AVD\)](#)” on page 16, you can specify preset and custom screen sizes when creating an Android virtual device.

## Resource Qualifiers and Screen Sizes

Once you have layouts that can handle the majority of cases, you may want to improve the way your application looks on specific displays. You may need to use separate layouts in cases where you want to take advantage of greater screen real estate other than by just spreading a layout across the screen (a separate preview pane, for example). In these cases, or in cases of specialized apps that might be used for unusually small displays, you can design layouts for specific situations using resource qualifiers.

Resource qualifiers are a set of naming rules for resource directories that enable you to provide alternative resources for the conditions specified by the qualifier, such as high or low, pixel density, language, country, and certain hardware resource availability. The full range of resource qualifiers is described at <http://developer.android.com/guide/topics/resources/providing-resources.html#AlternativeResources>.

# Eclipse for Android Software Development

Eclipse is a controversial topic. It is a great open source success story, it is the most widely used Java Integrated Development Environment (IDE), it is powerful, and it is the center of the largest ecosystem of add-ons and derivative products available for software development. These are the reasons Eclipse was chosen as the development target for plug-ins that customize it for Android software development. But Eclipse has been criticized for being unfriendly and difficult to learn.

Eclipse isn't like most GUI software that takes pains to protect the user from invoking operations that cannot succeed. Eclipse's developers favor modularity and power over smoothing the sharp edges. For example, one of the first things you may have noticed in running an example program is that Eclipse offers to do things with your Android program that don't make much sense, like running it on a server, or as an applet, as shown in [Figure 5-1](#).

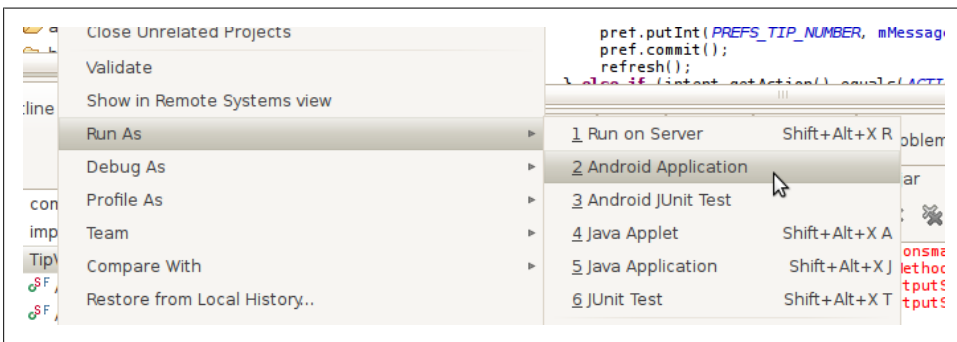

Figure 5-1. Running Eclipse as an applet, a task that is bound to fail

We are not here to criticize Eclipse, nor rationalize on its behalf. But we will explain why Eclipse does things like this. We will explain how Eclipse components fit together

and work together. We will familiarize you with what you are looking at when you launch Eclipse and start coding. With this knowledge you will be better equipped to make effective use of Eclipse and less likely to find it frustrating.

Documentation for Eclipse is available at <http://www.eclipse.org/documentation>.

## Eclipse Concepts and Terminology

Eclipse has its own nomenclature, behind which are the concepts that are key to understanding it. These concepts developed over a very long product life span, originating with VisualAge—a software development tool written in the SmallTalk language in the mid-1980s. The current implementation of Eclipse is written in the Java language, based on a framework called Equinox, which implements a specification for modular Java software systems called OSGi. OSGi is a way of specifying, in a manifest, the life cycle and dependencies of dynamically loaded modules, called bundles. That is, Eclipse is a collection of modules in a framework. When modules are added or removed, if they have dependencies on other modules, those dependencies will be satisfied automatically, if possible.

Further information on the Equinox OSGi implementation, including a detailed explanation of what happens when Eclipse starts up, is available at <http://eclipse.org/equinox/documents/quickstart.php>.

## Plug-ins

When you set up your Android software development tools, you added plug-ins to Eclipse: the Android Development Tools (ADT) plug-ins. Plug-ins are OSGi bundles.

The Android SDK adds two plug-ins to Eclipse. You can find them by showing the Plug-ins view, by selecting Window→Show View→Other... and expanding the “Plug-in development” item. Then select Plug-ins from the list of views. You will see the list shown in [Figure 5-2](#).



Note that in this chapter and in other places in this book, Eclipse view screenshots are shown in “detached” mode—in a separate window—so that we do not need to trim the surrounding views and toolbars out of screenshots. The way a view appears on your screen depends on the Eclipse perspective you are using and the other views in that perspective. Right-clicking on a view title pops up a menu with options for how to display the view, including the Detached option.

Plug-ins are listed alphabetically, so, near the top of the list you will see the two plug-ins required for working with the Android SDK: `com.android.ide.eclipse.adt` and `com.android.ide.eclipse.ddms`. Keep the Plug-ins view open. Later in this chapter we

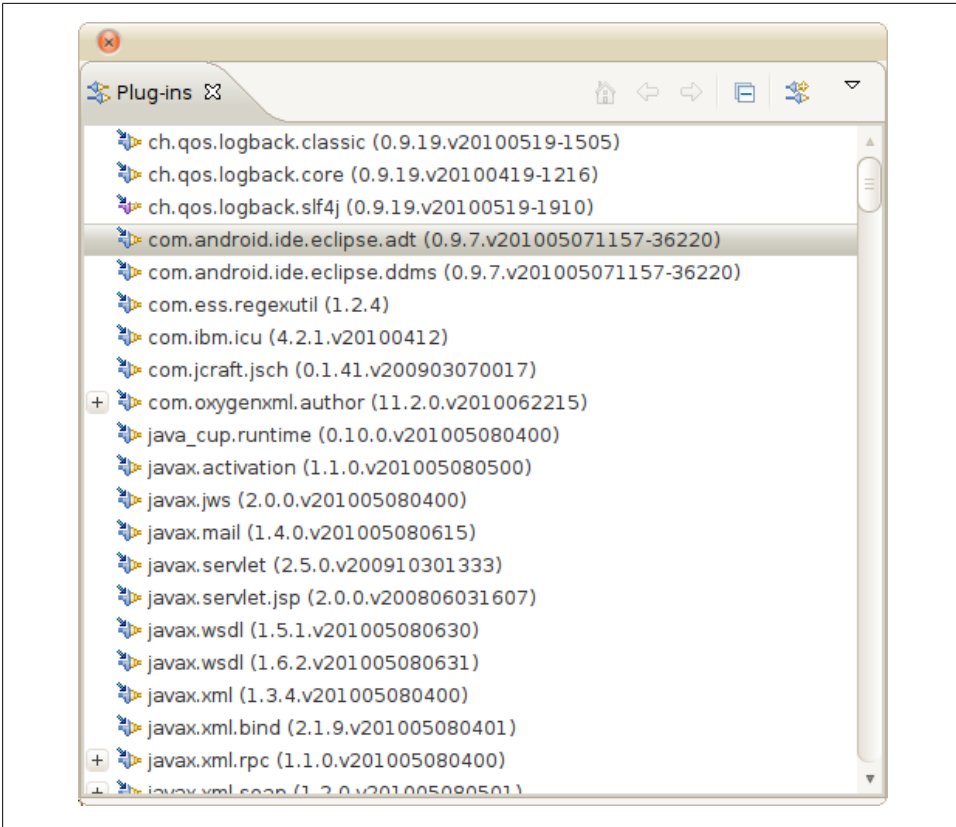

Figure 5-2. A list of all the plug-ins in an Eclipse environment

will look at some information about those plug-ins to see how they modify the Eclipse environment. You can also look at this list of plug-ins and see that Eclipse is, in fact, made of plug-ins, all the way down to the Equinox OSGi implementation.

## Workspaces

Eclipse keeps a lot of state, and workspaces are where it is kept. When you first run Eclipse, it will ask if you want to create a workspace. Thereafter, when you start Eclipse, it picks up right where you left off, with all the projects, files, and views as you left them, by reading its previous state from a workspace. Eclipse implements workspaces using directories.

Every project belongs to a workspace. By default, new projects are directories created inside the workspace directory. Even if you create a project from source that is not in the workspace directory, most of the meta information about that project is kept in the workspace.

Workspaces are independent. Settings that you set up in one workspace stay in that workspace. You can use multiple workspaces to separate projects that target different platforms, and that may use markedly different environments—for example, Rails projects and Android projects. You can use multiple workspaces to run more than one instance of Eclipse. Suppose you have Eclipse-based tools for some web application framework that are not compatible with the version of Eclipse you are using for Android development. By using a separate workspace for Android development, you can maintain separate state and even run both Eclipse versions at the same time.

## Java Environments

Three distinct Java environments are used in Java software development in Eclipse.

### Eclipse’s Java Runtime Environment

The first environment is that in which Eclipse itself is running. In [“The Eclipse Integrated Development Environment \(IDE\)” on page 5](#) we covered installing Java development tools and runtime environments, if your system does not already have one installed. If you need to use a different Java runtime for Eclipse, you can configure this choice in your *eclipse.ini* file in the folder where Eclipse is installed. If Eclipse is running out of memory, for instance, this is the environment you will want to adjust.

### The Java compiler

The second environment is used to compile your code. Eclipse comes with its own incremental Java compiler. In addition to producing the compiled Java *.class* files, it creates the error messages displayed in the Java editor and produces the typing information Eclipse uses for suggestions, autocompletion, and so on. This environment is configured using the Java→Compiler node in the Preferences pane, but you can override the defaults for a specific project from the project’s preferences.

In addition, this environment contains a description of the libraries against which the application is compiled. If you look at the Preferences→Build Path for an Android application, you will find that there is no Java runtime included in the list of libraries on which the project depends. Instead, an Android project depends on a version of the Android libraries. Because the Android tools are bolted onto Eclipse, though, you can’t directly change the Android library version from the Build Path pane. If you need to do that, you’ll have to open the Android preferences pane.

### The application runtime

The third environment is the one in which your application runs—in this case, one of the Android emulators. In setting up your development environment—either when you installed the SDK or when you set up the ADT plug-in—you set up one or more Android Virtual Devices (AVDs). When you create a new Android project you associate it with one of the AVDs. The plug-in uses the appropriate profile to set up both the compilation



environment and the emulator used for running the application, reducing the chance for a mismatch between the runtime environment: an application compiled against the Android 2.2 libraries may not run on a 1.5 platform.

## Projects

For software developers, Eclipse projects correspond to programs they are developing. For Android software developers, they correspond to Android applications. Within Eclipse, projects are how Eclipse plug-ins know which software to operate on: when you create an Android project, the project data includes information that Eclipse uses to select code from various plug-ins to perform various operations. The ADT plug-ins are invoked to help create a project with the right set of files and directory structure for an Android application. When you work on the files in an Android project, the right editors are used when you open XML files such as layouts and the manifest. When you modify files in a project, the right builders are called to build the application.

## Builders and Artifacts

The Eclipse framework defines the concept of a “builder,” used to generate project artifacts from their sources. Artifacts are files built from source files. The Android Eclipse plug-in defines several new builders that create *.dex* files from *.class* files, create Java constants that identify resources specified in XML, create *.apk* files, and perform other Android-specific operations that are part of turning code into an installable package. Eclipse will regenerate the installable application whenever you make changes. You should always be able to run it or debug it.

The transformation of *.class* files, which are the output of the Java compiler, to *.dex* files, which are bytecode interpreted by the Dalvik virtual machine (VM), is a neat trick: it enables you to program in Java, using the very highly developed editing and refactoring tools, as well as numerous other tools created to enhance the productivity and reliability of Java coding.

## Extensions

Extensions are all the places where a plug-in extends Eclipse functionality. You won't manipulate or change extensions as an Android software developer, but while we have that Plug-ins view open, let's take a brief look at some of the extensions the Android plug-ins add. This will give you a more concrete idea of the relationship of the ADT plug-ins and the rest of the Eclipse system. In the Plug-ins view, as shown in [Figure 5-2](#), double-click on the plug-in named `com.android.ide.eclipse.adt` and you will see an Extensions view, listing the extensions in the plug-in, as shown in [Figure 5-3](#).

For example, you can select each extension named `org.eclipse.core.resources.builders` and, on the right side of the Extensions view, it will show you the extension names: Android Resource Manager, Android Pre Compiler, and Android Package

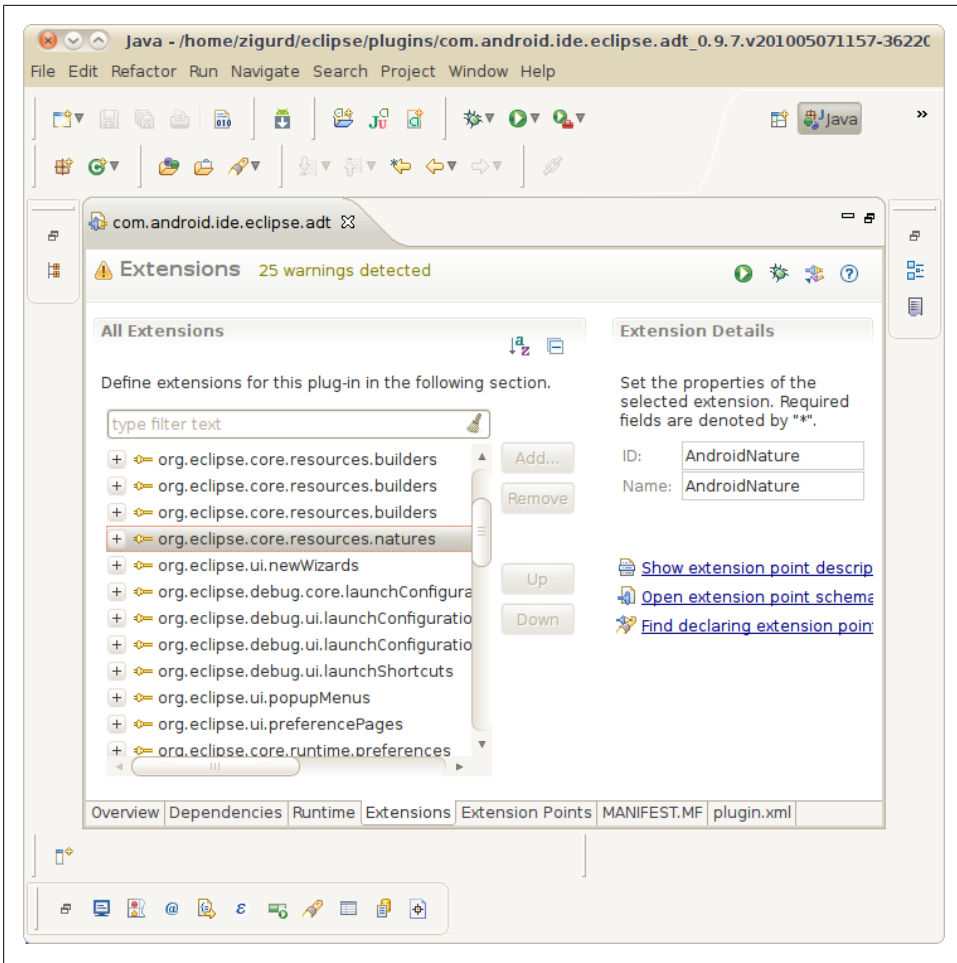

Figure 5-3. A list of extensions in the ADT plug-in

Builder. These are the extensions needed to process Android resources; precompile AIDL (Android Interface Definition Language), which is described in [Chapter 6](#), into Java code; and turn *.class* files, which are created using the Java builder, into *.dex* files as well as build the *.apk* file, which can be deployed to an Android device or AVD.

If you expand the `org.eclipse.ui.editors` item, you will see a list of the editors the ADT plug-in adds to the Eclipse system: the Android Manifest Editor, Android Resource Editor, Android Layout Editor, Android Menu Editor, and Android XML Resources Editor. There are many other extensions in this list, and this should give you an idea of the amount of code that is required to turn Eclipse into a tool for Android software development. The ones we've explored here are enough to reveal some of the most important aspects: how Android programs get built, and what is added to the

Eclipse environment to help you edit Android-specific files—including the XML files that comprise the manifest, layouts, and other resources.

If you explore the other ADT plug-in similarly, you will see how Dalvik Debug Monitor Service (DDMS) features are added to Eclipse.

## Associations

Associations are how files within a project are associated with, among other things, the editors that operate on them. For example, Java files within an Android project are edited with the Java editor, the same as any Java project, but XML files are edited with an Android-specific XML editor, which could be the Android Manifest Editor or the Android Resource Editor. These editors know how to edit specific structures in these files, but they fall short in other areas, such as general-purpose structure editing with the Outline view. If you wanted to open an Android XML file with an XML editor other than the one the association for the file calls for, you can override associations with the Open With command in the context menu for a source file, which pops up when you right-click on the file in the Package Explorer view.

The Open With command shows you a choice of editors that are likely to work on the file you selected. If you select the Other... option, you will see a list of all editors in your Eclipse configuration and be offered the option of opening the selected file with an external program.

## Eclipse Views and Perspectives

In addition to understanding the way the ADT plug-ins modify Eclipse, some familiarity with Eclipse's system of views and perspectives will help you recognize what you are looking at when you use Eclipse in Android software development. An Eclipse view is a part of the Eclipse window that displays information of a certain type, or in a certain way: a list of projects and project files, a list of errors in code, a hierarchical view of entities in a class, and so on. A perspective is an arrangement of views designed for a particular purpose, such as editing Java, or debugging.

If your Eclipse environment does not result in the same set of views shown in the examples here or listed among the main views, don't be alarmed. Different sets of plug-ins can result in different behavior, including the set of default views in some perspectives. The most important perspectives for Java coding are the Package Explorer, Editor, and Outline views, and those should be present in your Eclipse environment.

When you first start Eclipse (after you get past the Welcome screen) but before you have created any projects, you should see something similar to [Figure 5-4](#).

The workspace pictured here is a little more cramped than what you will probably experience. Most coders use larger screens in order to see the information in the views surrounding the editor that goes in the middle of an Eclipse perspective, and leave

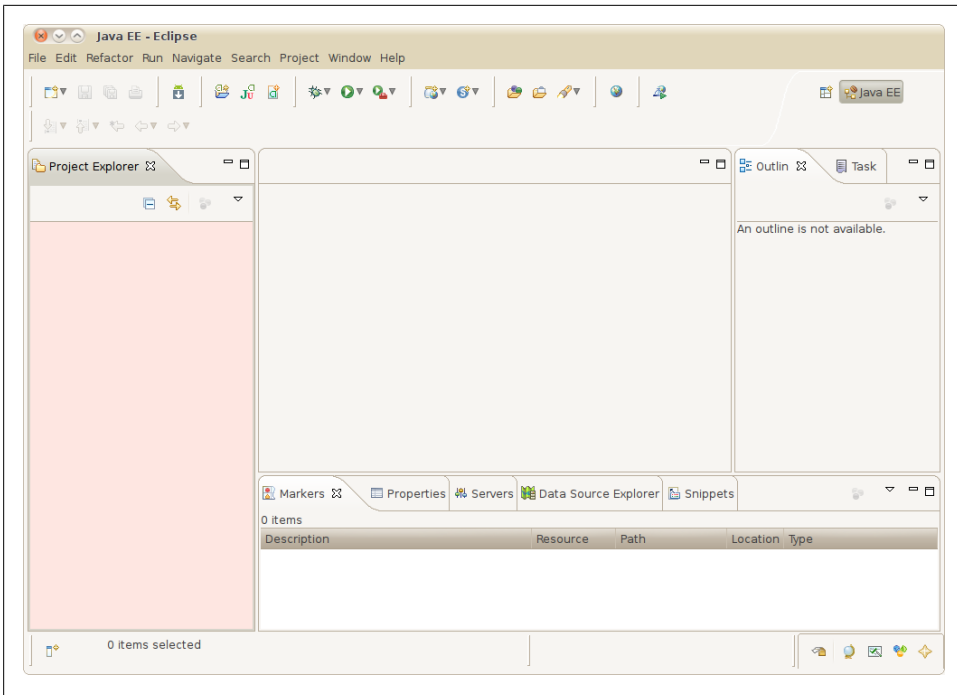

Figure 5-4. An empty workspace, with the ADT plug-in configured

enough room to see an adequate amount of code. We left these perspectives at the default minimum size in order to fit the screenshots on the page.

A typical Java editing perspective in Eclipse looks like the one in [Figure 5-5](#), with views for exploring the contents of projects, a list of tasks, the output of builders and other operations, and so on. You can see that some changes from the default set of views were made in creating an Android project and editing a Java source file in an Android project. Let's take a look at the views that are displayed by default here.

## The Package Explorer View

Eclipse is more than just an editor with a lot of chrome around the editing window. Most of the views displayed around the editor in an Eclipse perspective have the goal of speeding navigation in the project and in the project's files. The Package Explorer view will often be your starting point when editing source files and running and debugging your projects.

## The Task List View

The Task List view lists tasks that you may have created using the New Task command in the view's toolbar, or by turning an item in the Problems view into a task. You can

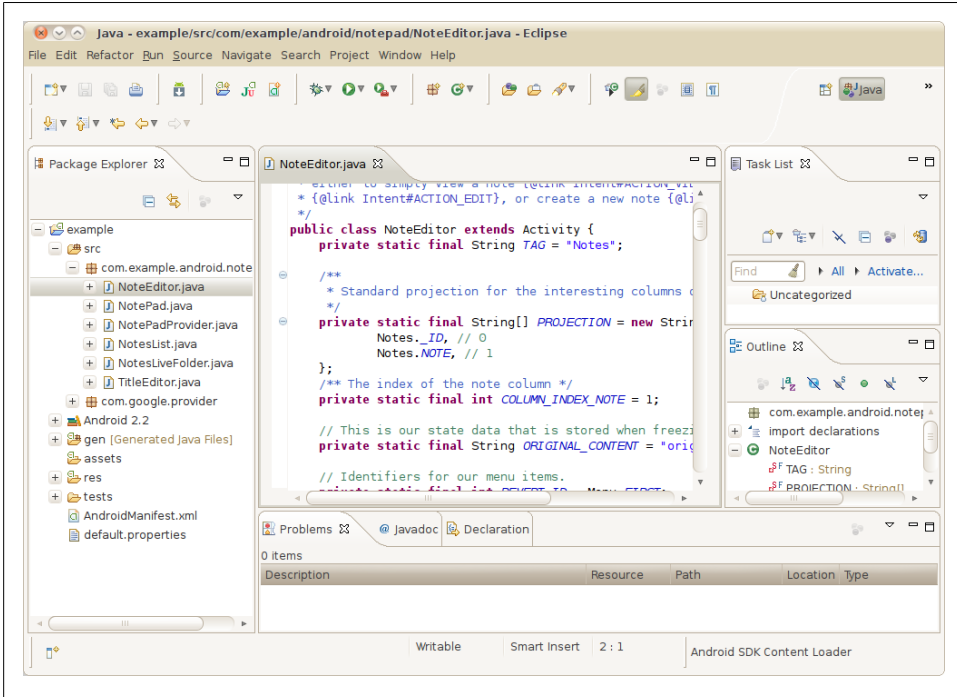

Figure 5-5. The Java editing perspective with an Android project, and an Android source file in the Java editor

link the task list with a source code repository or bug tracker in order to share it with other people working on a project with you. Curiously, the Task List view does not list the `TODO` items many coders use to insert task reminders into code. These are parsed by the Java editor and are marked with icons in the left margin. There may be something about the implementation of the plug-ins that implement these features that makes it difficult to present all tasks in one place.

## The Outline View

A program is both its source code—which is usually ordinary text—and the structure into which it is parsed, which consists, in the case of Java, of fields and methods. The Outline view shows the structure of a Java class, and enables you to operate on that structure with many of the same commands you would apply to the selection in an Editor view. The Java editor relies on knowing the underlying structure, too. But the Outline view enables you to see that structure explicitly laid out in a hierarchy, with icons that indicate type and scope information to the left of the name of each item in this structured view. More information on the Outline view is available at <http://help.eclipse.org/helios/topic/org.eclipse.jdt.doc.user/reference/views/ref-view-outline.htm>.

## The Problems View

The Eclipse concept of “builders” generalizes the idea of compiling source files into objects or, more generally in Eclipse parlance, artifacts. Problems are what prevent this from happening smoothly. Problems can be compiler errors, or any other error from a builder. Sometimes problems prevent a builder from completing an artifact, and sometimes they are warnings that do not prevent an artifact from being generated. The Problems view displays problems and enables fast navigation to them. Right-click on a problem to see the context menu: if you want to fix the problem right away, the Go To command opens the file and navigates to the line associated with the problem. If it is a warning that should eventually be fixed, you can track the problem by using the New Task From Marker... command. Double-clicking on a problem also navigates to the source of the problem.

## Java Coding in Eclipse

If you are new to Java and Eclipse, your first concern will be getting things right. But soon enough, your primary concern will be making coding fast and easy. Of all programming languages, Java has likely had the most effort applied to boosting programmer productivity through tools like Eclipse. For this reason, the story of Java coding in Eclipse is a story driven by the desire for the highest possible level of productivity. Productivity has three key aspects: creating new code efficiently, finding code you need to read or modify, and making changes to code that affect more than just the line of code you are editing.

### Editing Java Code and Code Completion

The central productivity feature for editing Java code in any Java-oriented IDE is code completion or, in Eclipse parlance, “content assist.” Nearly anywhere in a Java source file you can press the keyboard shortcut Ctrl-space bar to display a pop up that “proposes” to complete what you are currently doing. For example, if you know there is a method to find something, but you forgot exactly how that goes, type **fi** and press Ctrl-space bar. You will then see something similar to [Figure 5-6](#).

In this case, content assist is offering to insert the signature of a method, with a parameter list for you to fill in. You can see that the method `findViewById` is listed, and you can select this choice in order to avoid having to type the whole method name and argument list.

Had you pressed Ctrl-space bar before having typed anything, all the constants and methods of the class would have been offered as possible completions by content assist.

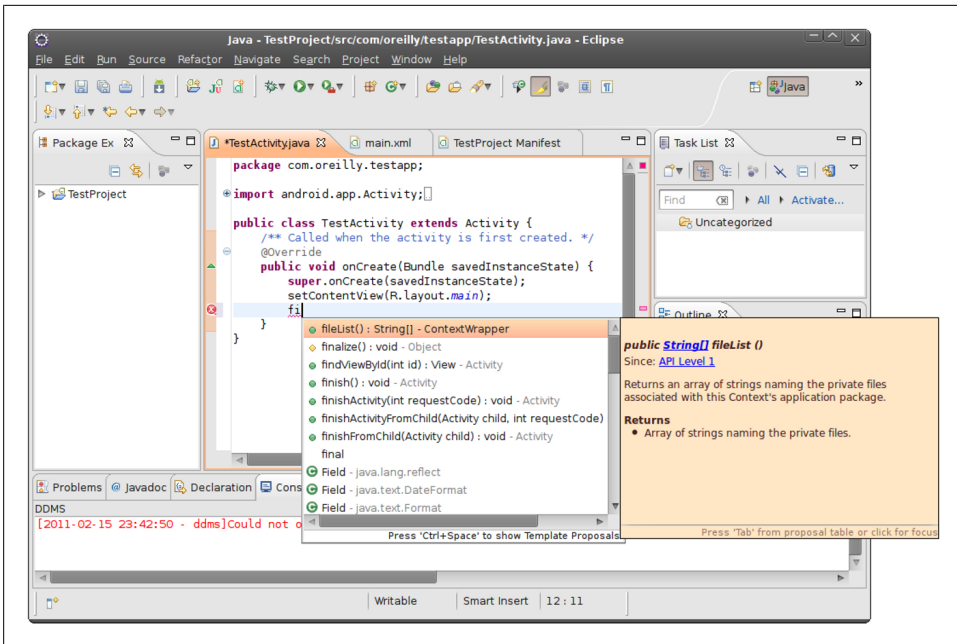

Figure 5-6. Offering a completion in the content assist pop up

## Refactoring

Java is statically typed, which requires every object and every reference to be explicitly declared before it is used. This can make Java look bureaucratic and inelegant, and make it seem as though coding in Java is needlessly wordy. IDEs like Eclipse compensate for the verbosity of Java syntax by providing code completion and other speed-ups for coders. There is one aspect of coding productivity that works far better in statically typed languages: refactoring.

Refactoring means making changes that preserve program behavior. That is, refactoring does not change what the program does. It changes how the program is organized. Ensuring that behavior does not change while code is reorganized enables powerful transformations: even renaming a reference or type name can be perilous if you have to do it with text substitution. But with refactoring, you are assured that all and only the right names are modified.

Two factors greatly improve the kinds of refactorings that can be performed: the language should be statically typed, and the IDE should have a compiled model of the program. By “model of the program,” we mean a data structure that represents compiled code, such that all the types and references in the program can be found within their scope. By knowing exact types, and the exact scope of a type or reference, the IDE can locate every use of that type or reference without any ambiguity.

Refactoring is the prime example of how languages can no longer be compared only by syntax, aesthetics, and expressive power. Conservatively designed languages like Java can be both as safe as possible and highly productive in the context of the typical set of tools a coder has at her fingertips.

## Eclipse and Android

The ADT plug-in adds several Android-specific tools to the Eclipse workbench. Most of these tools can be found in the Android perspective (Window→Open Perspective→Other..., select DDMS). Each tool is a separate Eclipse view (Window→Show View→Other..., select DDMS), though, and can be added to any other perspective, as convenience and screen real estate dictate. Here are a few of the most useful:

### LogCat

Displays the device logs in a scrolling pane. You can adjust filtering so that only the logs you are interested in are visible, or so that you can see everything down to the garbage collections and library loading.

### File Explorer

Displays the file explorer.

### Heap

Displays the heap.

### Threads

Displays threads.

### Pixel Perfect

Displays the Pixel Perfect view.

### Layout View

Displays the layout view.

### avdmgr

Displays the Android SDK and AVD Manager.

## Preventing Bugs and Keeping Your Code Clean

You can think of Eclipse as a specialized operating system: it is made up of thousands of files, has its own filesystem, and runs a web server. Eclipse is open and very extensible. Plug-ins—the Eclipse analog of an operating system’s applications—are relatively easy to write, and the Eclipse ecosystem has many more extensions than any one Eclipse user could ever install and use. Because Android code is written in Java, you can apply all kinds of plug-ins to Android software development.

Here we will explore an often very valuable category of Eclipse extensions: static analyzers, or source code analyzers.



## Static Analyzers

An informal definition of static analysis is that it picks up where compiler warnings leave off. In Eclipse, compiler warnings are, in general, very good. While a good compiler can provide you with warning messages that are helpful in catching potential runtime problems, it isn't a compiler's job to go hunting for hidden problems. Static analyzers cover that territory.

Static analyzers are called “static” because the analysis is performed on code that isn't running. While the compiler performs some functions that might come under the heading of static analysis—and the Java compiler in Eclipse does a very good job of cleaning up after the detritus of programming, such as variables and methods that are not used—static analyzers are more ambitious. Static analyzers attempt to find bugs, rather than just loose ends.

The three static analysis tools covered here are the three most widely used in Java software development, and they include a range of applicability and approaches to the problem of static analysis. All three of these tools are also open source projects, and all three are examples of the kinds of Eclipse plug-ins you might seek out and add to your Eclipse environment to enhance productivity in creating Android applications. You may not stick with using all three, but installing all three is a good place to start exploring static analysis.

## FindBugs

We will start exploring static analyzers by installing and using FindBugs. You can find documentation, as well as the source code for FindBugs, at <http://findbugs.sourceforge.net>. We will go into the installation process in some detail because it is similar to the installation process for most kinds of Eclipse plug-ins. To install FindBugs, you must first add the FindBugs repository to Eclipse's list of sites from which to install packages. You do this by using the Help→Install New Software Menu command, and clicking the Add... button in the Install dialog. This opens the Add Repository dialog that allows you to add the FindBugs repository located at <http://findbugs.cs.umd.edu/eclipse>, as shown in [Figure 5-7](#).

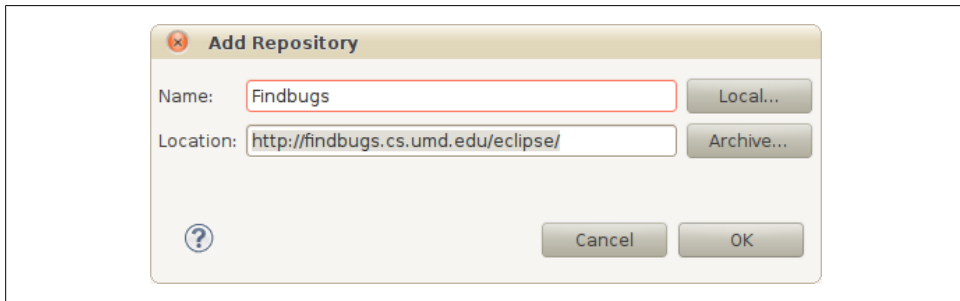

Figure 5-7. Adding a repository for the purpose of adding a plug-in to your Eclipse environment

The next step in installing FindBugs is to select the package from the repository, as shown in [Figure 5-8](#). In this case, there is only one package to select.

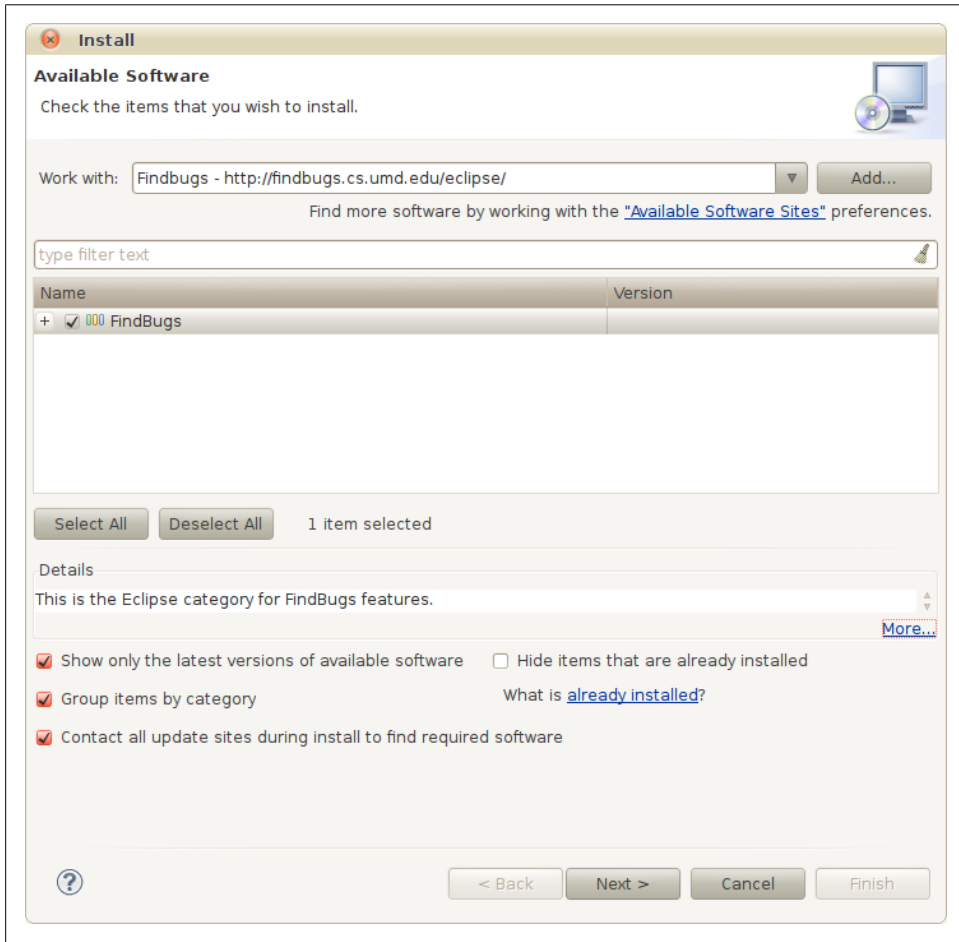

Figure 5-8. Selecting the only available package in the FindBugs repository

Once the package has been selected, you can advance to the next dialog, which shows the list of packages to be installed. In this case, there's only one, as shown in [Figure 5-9](#).

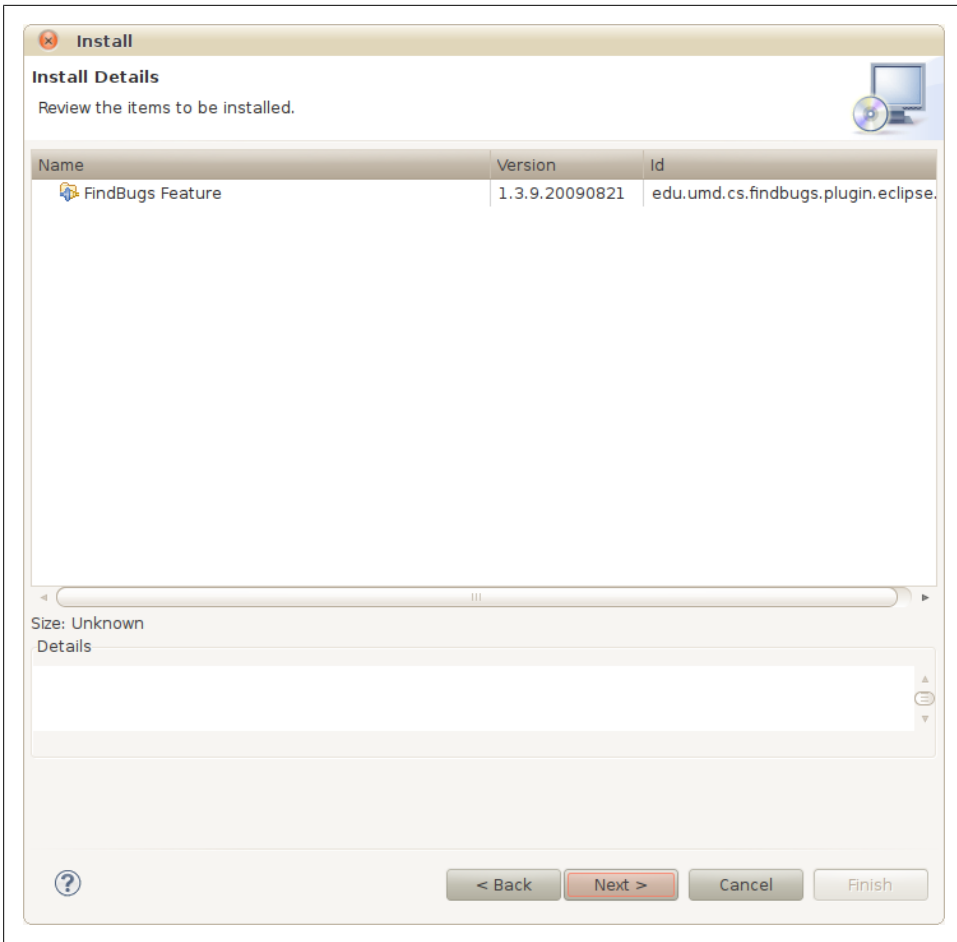

Figure 5-9. Reviewing that you have selected the only available package in the FindBugs repository

And there's more: the next dialog in the installation sequence enables you to read and accept, or not accept, the license agreement that accompanies this package, as shown in [Figure 5-10](#).

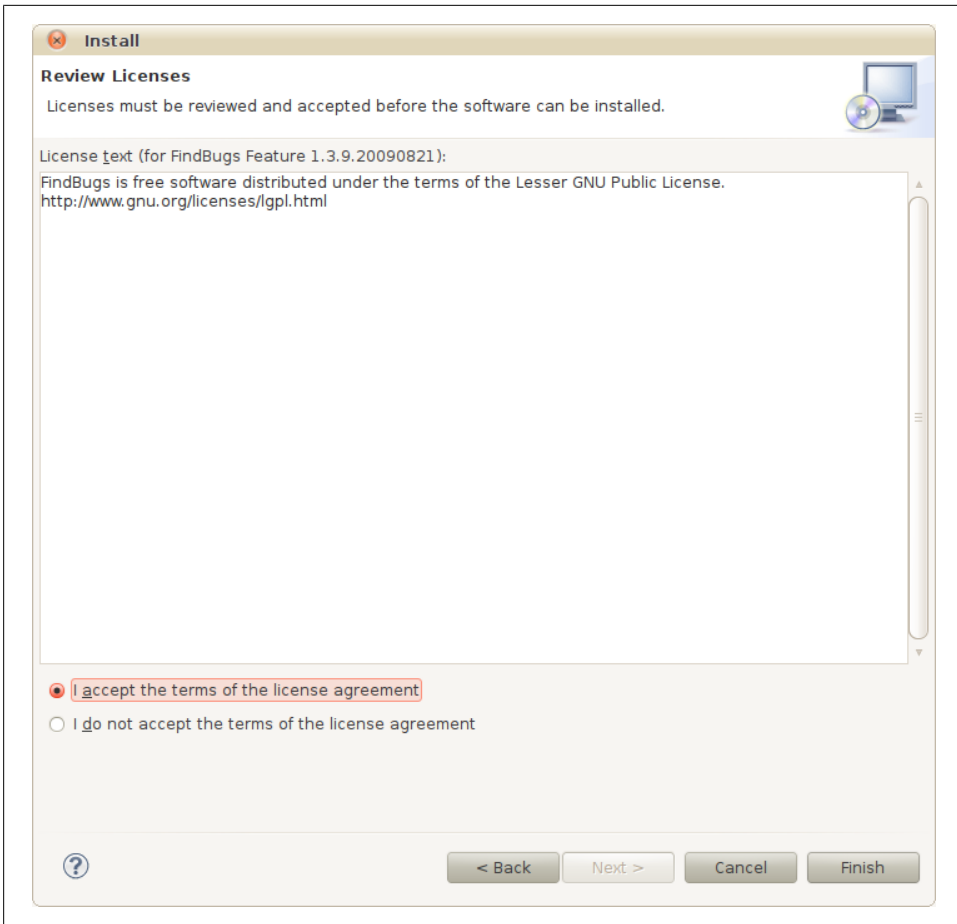

Figure 5-10. Accepting the FindBugs license agreement

There may be one more hurdle to cross in installing this Eclipse plug-in. Since the package is not signed, you get a security warning, as shown in Figure 5-11.

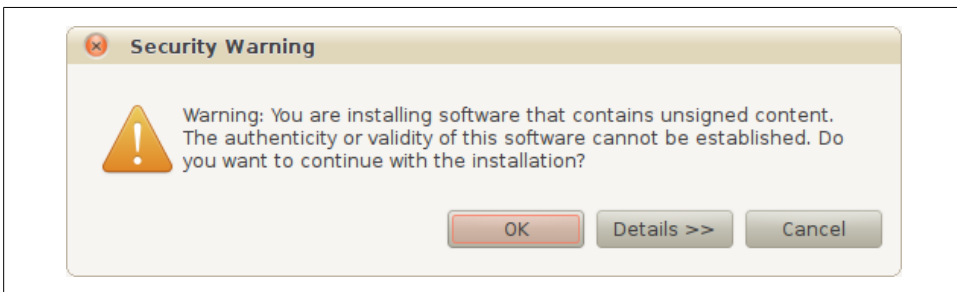

Figure 5-11. The security warning displayed when installing unsigned packages

And finally, you are prompted to restart Eclipse, as show in [Figure 5-12](#).

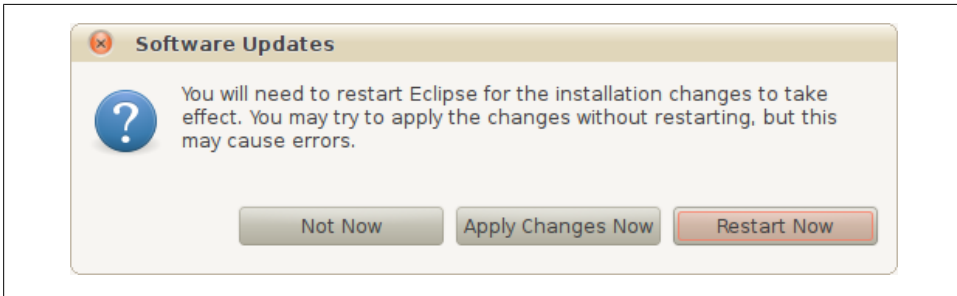

Figure 5-12. Restarting Eclipse after installing FindBugs

## Applying Static Analysis to Android Code

FindBugs has a menu command, a perspective, and some views you will find useful in finding bugs. To start FindBugs, use the menu command in the context menu of a project, as shown in [Figure 5-13](#).

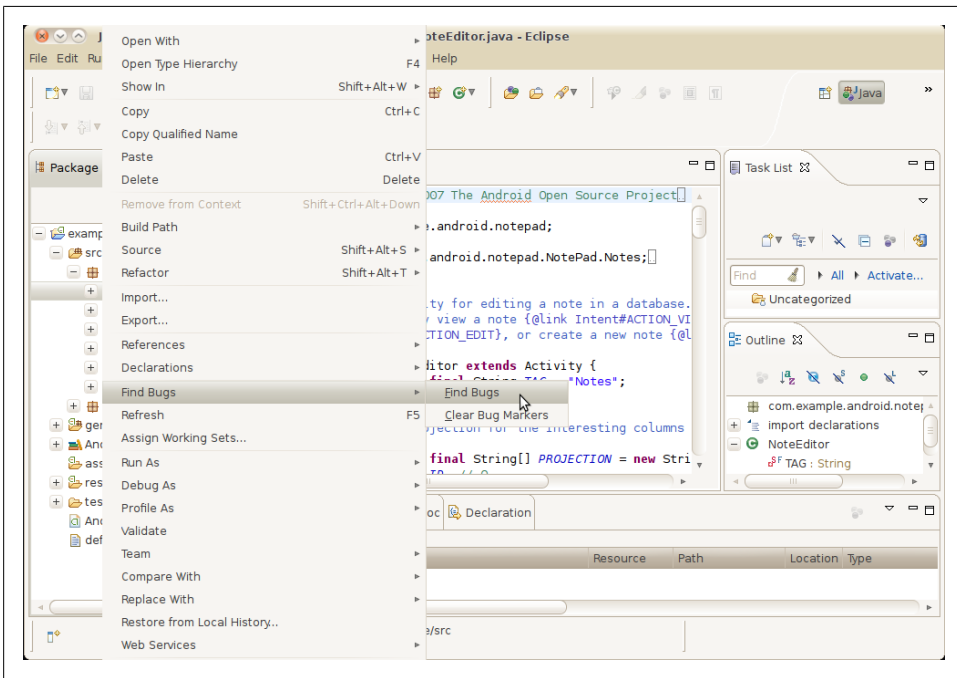

Figure 5-13. Invoking FindBugs

Once you have run FindBugs, you can change to the FindBugs perspective, as shown in [Figure 5-14](#). The FindBugs perspective includes views that display a hierarchical list of potential problems FindBugs has found, organized by type of problem; an Editor view that includes markers for the problems; and, if you open the properties for a problem, a detailed explanation of the problem, including an explanation of why FindBugs can raise “false positives.”

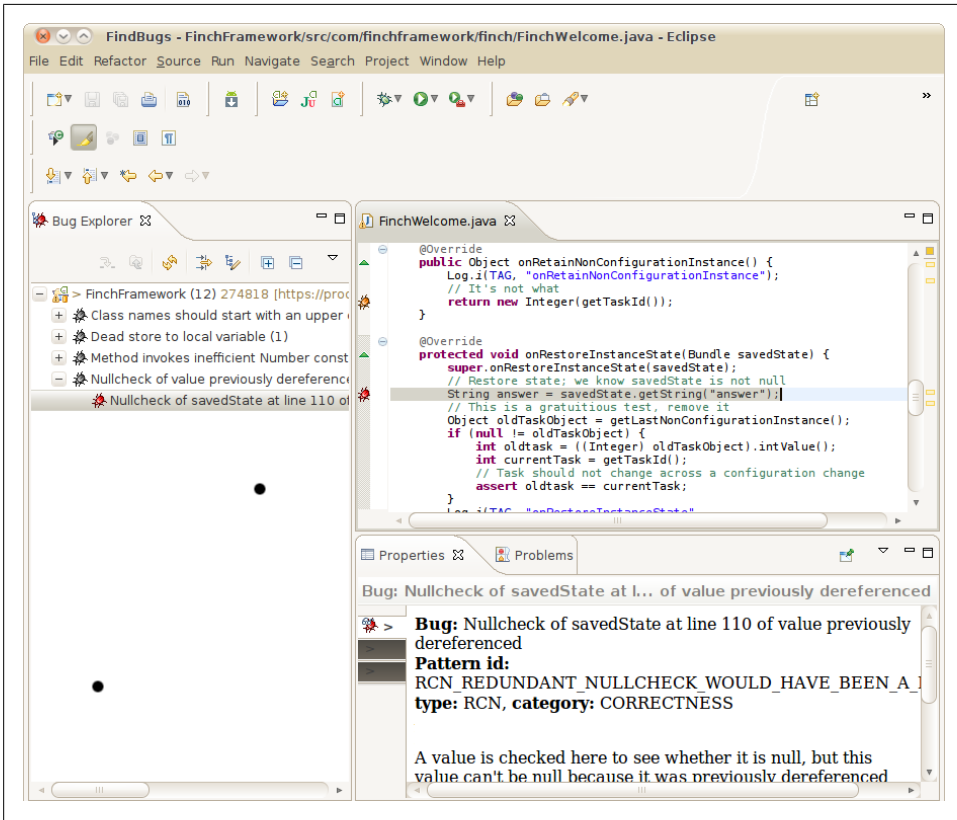

Figure 5-14. The FindBugs perspective

In this case, we will take a look at the “Null check of a value previously dereferenced” problem, as shown in the Bug Explorer view in [Figure 5-15](#).

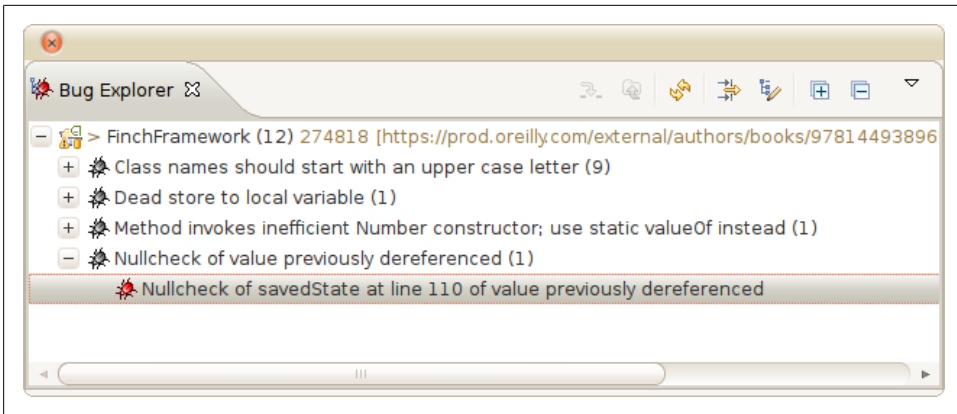

Figure 5-15. The FindBugs Bug Explorer

Verifying that a field has a non-null value field after already having dereferenced isn't syntactically incorrect Java, but it is almost certainly either useless or an outright error. In the following code, you can see that the field `savedState` is used with the assumption that it is never null, but a null check occurs in the logging call:

```
protected void onRestoreInstanceState(Bundle savedInstanceState) {
    super.onRestoreInstanceState(savedInstanceState);
    // Restore state; we know savedInstanceState is not null
    String answer = savedInstanceState.getString("answer");
    // This is a gratuitous test, remove it
    Object oldTaskObject = getLastNonConfigurationInstance();
    if (null != oldTaskObject) {
        int oldtask = ((Integer) oldTaskObject).intValue();
        int currentTask = getTaskId();
        // Task should not change across a configuration change
        assert oldtask == currentTask;
    }
    Log.i(TAG, "onRestoreInstanceState"
        + (null == savedInstanceState ? "" : RESTORE) + " " + answer);
}
```

In fact, `savedState` should be null-checked before it is used, because the value of `savedState` is not specified to be non-null. We will change the assignment that did not null-test `savedState` to the following:

```
String answer = null != savedInstanceState ? savedInstanceState.getString("answer") : "";
```

Running FindBugs again confirms that this change eliminates the possible problem.

This is a good example of the kind of bug static analysis can find. It is outside the realm of compiler warnings because there are cases where this is exactly what the programmer intended, but a simple inference enables a static analyzer to suggest that this might be a bug, and it very often is a bug.

## Limitations of Static Analysis

Static analyzers suffer from detecting false positives, because of the approaches they take to finding weaknesses in code. This is one thing that differentiates static analysis from compiler warnings. It would be considered a bug if a compiler error message indicated a problem that wasn't really a problem.

One of the weaker aspects of static analyzers is in finding code where coding conventions have not been observed. For example, the “Class names should start with an upper case letter” warning, shown in [Figure 5-15](#), was provoked by autogenerated code, which coders should not have to inspect unless they suspect bugs in the code generator.

Highly experienced coders often question the usefulness of static analyzers, since their code contains relatively few problems that static analyzers can catch, and therefore the results have a higher proportion of false positives. It is an accepted fact that static analysis of code written by highly experienced coders finds only a fraction of the bugs in that code, and that it is no substitute for module tests and good debugging skills. However, if you are a relative newcomer to Java as well as to Android, you may find static analyzers are a very useful adjunct to compiler warnings.

## Eclipse Idiosyncrasies and Alternatives

Now that you know that the Android SDK has many capabilities built on Eclipse, and how the Eclipse plug-in and extension architecture enables Android tools to “hook” so many aspects of an IDE's functionality, you may be wondering why it offers to run your Android application on a server, or as an applet. It is particularly troubling to have a tool that is supposed to enhance your productivity lay a red herring across your path in this way, since Eclipse expects you to find the right commands in a set of exceptionally lengthy menus.

Go ahead, see what happens: pick any Android project in your Eclipse workspace, right-click on the project name, and select Run As→Java Applet. You will see the dialog shown in [Figure 5-16](#).

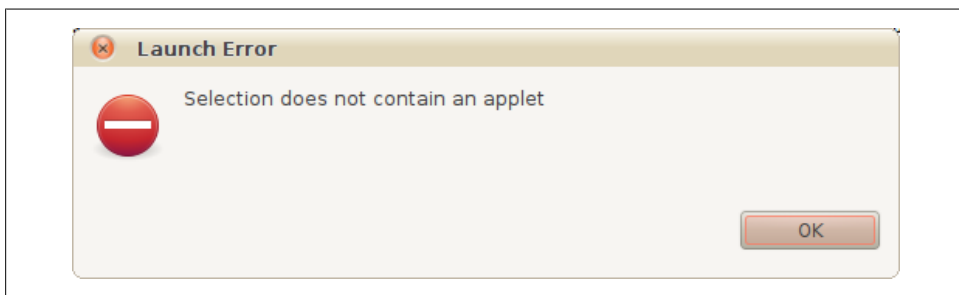

Figure 5-16. Dialog shown when the selection does not contain an applet



No harm done, but it is appalling: Eclipse, plus whatever plug-ins are in play at that moment, should know not to offer you an action that fails, guaranteed, 100% of the time. Eclipse is a bad example: don't treat the users of your Android programs this way! If the selection does not contain an applet, don't offer the user a command to run the selection as an applet. This is a fundamental precept of graphical user interfaces and foundational to the idea of generic operations on a selection: once the user has selected something, the program should know all the valid operations on that selection and present only valid operations. A good interface—especially a big, complex interface—should encourage safe exploration,

Why does Eclipse fail to be a good GUI application in such seemingly trivial ways? Such failure is baffling in light of the impressive power and ease of use of Eclipse refactoring and other features. There is no one fault to point to. Our conjecture is that the fine-grained modularity of Eclipse, which results in an explosion of extension interfaces, causes this combination of powerful features and niggling annoyances. At best, plug-in authors are faced with too many interfaces to hook in order to accomplish a highly polished user experience. At worst, Eclipse's architecture may make it practically impossible to do the right thing in some cases. This is why some people seek alternatives.



---

# Effective Java for Android

In [Chapter 2](#), we discussed the idiomatic use of Java. In this chapter, we'll expand that idea to lay out Java idioms pertinent to the Android platform.

## The Android Framework

Twenty years ago, an application probably ran from the command line and the bulk of its code was unique program logic. These days, though, applications need very complex support for interactive UIs, network management, call handling, and so on. The support logic is the same for all applications. The Android Framework addresses this in a way that has become fairly common as application environments have become increasingly complex: the *skeleton application*, or *application template*.

When you built the simple demo application that verified your Android SDK installation, back in [Chapter 1](#), you created a complete running application. It was able to make network requests and display on and handle input from the screen. It could handle incoming calls and, although there was no way to use it, check your location. You hadn't yet supplied anything for the application to do. That is the skeleton application.

Within the Android Framework, a developer's task is not so much to build a complete program as it is to implement specific behaviors and then inject them into the skeleton at the correct extension points. The motto of MacApp, one of the original skeleton application frameworks, was: "Don't call us, we'll call you." If creating Android applications is largely about understanding how to extend the framework, it makes sense to consider some generic best practices for making those extensions.

## The Android Libraries

Android introduces several new packages that, together with a handful of package trees from the forest of traditional Java (J2SE) packages, make up the API for the Android Runtime Environment. Let's take a minute to see what's in this combined API:

## *android and dalvik*

These package trees contain the entire Android-specific portion of the Android Runtime Environment. These libraries are the subject of much of this book, as they contain the Android GUI and text handling libraries (named `android.graphics`, `android.view`, `android.widget`, and `android.text`), as well as the application framework libraries called `android.app`, `android.content`, and `android.database`. They also contain several other key, mobile-oriented frameworks such as `android.telephony` and `android.webkit`. A fluent Android programmer will have to be very familiar with at least the first few of these packages. To navigate the Android documentation from a package tree perspective, you can start at the top of the Android developer documentation, at <http://developer.android.com/reference/packages.html>.

## *java*

This package contains the implementations of the core Java runtime libraries. The `java.lang` package contains the definition of the class `Object`, the base class for all Java objects. `java` also contains the `util` package, which contains the Java Collections framework: `Array`, `Lists`, `Map`, `Set`, and `Iterator` and their implementations. The Java Collections Library provides a well-designed set of data structures for the Java language—they relieve you of the need to write your own linked lists.

As mentioned in [Chapter 2](#), the `util` package contains collections from two different lineages. Some originate from Java 1.1 and some from a more recent, re-engineered idea of collections. The 1.1 collections (e.g., `Vector` and `Hashtable`) are fully synchronized and are less consistent in their interfaces. The newer versions, (e.g., `HashMap` and `ArrayList`) are not synchronized, are more consistent, and are preferred.

In order to maintain compatibility with the Java language, the Android library also contains implementations of some legacy classes that you should avoid altogether. The Collections framework, for instance, contains the `Dictionary` class, which has been explicitly deprecated. The `Enumeration` interface has been superseded by `Iterator`, and `TimerTask` has been replaced by `ScheduledThreadPoolExecutor` from the Concurrency framework. The Android reference documentation does a good job of identifying these legacy types.

`java` also contains base types for several other frequently used objects such as `Currency`, `Date`, `TimeZone`, and `UUID`, as well as basic frameworks for I/O and networking, concurrency, and security.

The `awt` and `rmi` packages are absent in the Android version of the `java` package hierarchy. The `awt` package has been replaced by Android GUI libraries. Remote messaging has no single replacement, but internal `ServiceProviders` using `Parcelable`s, described in [“Serialization” on page 156](#), provide similar functionality.

## javax

This package is very similar to the `java` package. It contains parts of the Java language that are officially optional. These are libraries whose behavior is fully defined but that are not required as part of a complete implementation of the Java language. Since the Android Runtime Environment doesn't include some of the parts that are required, the distinction exists in Android only to keep the Android packages looking as much like the Java packages as possible. Both package trees contain implementations of libraries described as part of the Java language.

The most important thing to be found in `javax` is the XML framework. There are both SAX and DOM parsers, an implementation of XPath, and an implementation of XSLT.

In addition, the `javax` package contains some important security extensions and the OpenGL API. A seasoned Java developer will notice that the Android Runtime Environment implementation of the `javax` packages is missing several important sections, notably those that have to do with UI and media. `javax.swing`, `javax.sound`, and other similar sections are all missing. There are Android-specific packages that replace them.

## org.apache.http

This package tree contains the standard Apache implementation of an HTTP client and server, HttpCore. This package provides everything you need to communicate using HTTP, including classes that represent messages, headers, connections, requests, and responses.

The Apache HttpCore project can be found on the Web at <http://hc.apache.org/httpcomponents-core/index.html>.

## org.w3c.dom, org.xml.sax, org.xmlpull, and org.json

These packages are the public API definitions for some common data formats: [XML](#), [XML Pull](#), and [JSON](#).

## Extending Android

Now that you have a basic road map to the Android Framework, the obvious question is: “How do I use it to build my application?” How do you extend the framework—which we’ve characterized as very complex, but a zombie—to turn it into a useful application?

As you would expect, this question has several answers. The Android libraries are organized to allow applications to obtain access into the framework at various levels.

### Overrides and callbacks

The simplest and easiest to implement—and a coder’s first choice for adding new behaviors to the framework—should be the callback. The basic idea of a callback, a pattern quite common in the Android libraries, was already illustrated in [Chapter 2](#).

To create a callback extension point, a class defines two things. First it defines a Java interface (typically with a name ending in “Handler”, “Callback”, or “Listener”) that describes, but does not implement, the callback action. It also defines a setter method that takes, as an argument, an object implementing the interface.

Consider an application that needs a way to use text input from a user. Text entry, editing, and display, of course, require a large and complex set of user interface classes. An application need not concern itself with most of that, however. Instead, it adds a library widget—say, an `EditText`—to its layout (layouts and widgets are described in [“Assembling a Graphical Interface” on page 171](#)). The framework handles instantiating the widget, displaying it on the screen, updating its contents when the user types, and so on. In fact, it does everything except the part your application actually cares about: handing the content text to the application code. That is done with a callback.

The Android documentation shows that the `EditText` object defines the method `addTextChangedListener` that takes, as an argument, a `TextWatcher` object. The `TextWatcher` defines methods that are invoked when the `EditText` widget’s content text changes. The sample application code might look like this:

```
public class MyModel {
    public MyModel(TextView textBox) {
        textBox.addTextChangedListener(
            new TextWatcher() {
                public void afterTextChanged(Editable s) {
                    handleTextChange(s);
                }
                public void beforeTextChanged(
                    CharSequence s,
                    int start,
                    int count,
                    int after)
                { }
                public void onTextChanged(
                    CharSequence s,
                    int start,
                    int count,
                    int after)
                { }
            });
    }

    void handleTextChange(Editable s) {
        // do something with s, the changed text.
    }
}
```

`MyModel` might be the heart of your application. It is going to take the text that the user types in and do something useful with it. When it is created, it is passed a `TextBox`, from which it will get the text that the user types. By now, you are an old hand at parsing code like this: in its constructor, `MyModel` creates a new anonymous implementation of the interface `TextWatcher`. It implements the three methods that the interface requires.

Two of them, `onTextChanged` and `beforeTextChanged`, do nothing. The third, though, `afterTextChanged`, calls the `MyModel` method `handleTextChange`.

This all works very nicely. Perhaps the two required methods that this particular application doesn't happen to use, `beforeTextChanged` and `onTextChanged`, clutter things a bit. Aside from that, though, the code separates concerns beautifully. `MyModel` has no idea how a `TextView` displays text, where it appears on the screen, or how it gets the text that it contains. The tiny relay class, an anonymous instance of `TextWatcher`, simply passes the changed text between the view and `MyModel`. `MyModel`, the model implementation, is concerned only with what happens when the text changes.

This process, attaching the UI to its behaviors, is often called *wiring up*. Although it is quite powerful, it is also quite restrictive. The client code—the code that registers to receive the callback—cannot change the behavior of the caller. Neither does the client receive any state information beyond the parameters passed in the call. The interface type—`TextWatcher` in this case—represents an explicit contract between the callback provider and the client.

Actually, there is one thing that a callback client can do that will affect the calling service: it can refuse to return. Client code should treat the callback as a notification only and not attempt to do any lengthy inline processing. If there is any significant work to be done—more than a few hundred instructions or any calls to slow services such as the filesystem or the network—they should be queued up for later execution, probably on another thread. We'll discuss how to do this, in depth, in [“AsyncTask and the UI Thread” on page 143](#).

By the same token, a service that attempts to support multiple callback clients may find itself starved for CPU resources, even if all the clients are relatively well behaved. While `addTextChangedListener` supports the subscription of multiple clients, many of the callbacks in the Android library support only one. With these callbacks (`setOnKeyListener`, for instance) setting a new client for a particular callback on a particular object replaces any previous client. The previously registered client will no longer receive any callback notifications. In fact, it won't even be notified that it is no longer the client. The newly registered client will, thenceforward, receive all notifications. This restriction in the code reflects the very real constraint that a callback cannot actually support an unlimited number of clients. If your code must fan notifications out to multiple recipients, you will have to implement a way of doing it so that it is safe in the context of your application.

The callback pattern appears throughout the Android libraries. Because the idiom is familiar to all Android developers, it makes a lot of sense to design your own application code this way too. Whenever one class might need notifications of changes in another—especially if the association changes dynamically, at runtime—consider implementing the relationship as a callback. If the relationship is not dynamic, consider using dependency injection—a constructor parameter and a final field—to make the required relationship permanent.

## Using polymorphism and composition

In Android development, as in other object-oriented environments, polymorphism and composition are compelling tools for extending the environment. By design, the previous example demonstrates both. Let's pause for a second to reinforce the concepts and restate their value as design goals.

The anonymous instance of `TextWatcher` that is passed to `addTextChangedListener` as a callback object uses composition to implement its behavior. The instance does not, itself, implement any behavior. Instead, it delegates to the `handleTextChanged` method in `MyModel`, preferring has-a implementation to is-a. This keeps concerns clear and separate. If `MyModel` is ever extended, for example, to use text that comes from another source, the new source will also use `handleTextChanged`. It won't be necessary to track down code in several anonymous classes.

The example also demonstrates the use of polymorphism. The instance passed in to the `addTextChangedListener` method is strongly and statically typed. It is an anonymous subtype of `TextWatcher`. Its particular implementation—in this case, delegation to the `handleTextChanged` in `MyModel`—is nearly certain to be unlike any other implementation of that interface. Since it is an implementation of the `TextWatcher` interface, though, it is statically typed, no matter how it does its job. The compiler can guarantee that the `addTextChangedListener` in `EditText` is passed only objects that are, at least, intended to do the right job. The implementation might have bugs, but at least `addTextChangedListener` will never be passed, say, an object intended to respond to network events. That is what polymorphism is all about.

It is worth mentioning one particular antipattern in this context, because it is so common. Many developers find anonymous classes to be a verbose and clumsy way of essentially passing a pointer to a function. In order to avoid using them, they skip the messenger object altogether, like this:

```
// !!! Anti-pattern warning
public class MyModel implements TextWatcher {
    public MyModel(TextView textBox) {
        textBox.addTextChangedListener(this);
    }

    public void afterTextChanged(Editable s) {
        handleTextChanged(s);
    }

    public void beforeTextChanged(
        CharSequence s,
        int start,
        int count,
        int after)
    { }

    public void onTextChanged(
        CharSequence s,
        int start,
```



```

        int count,
        int after)
    { }

    void handleTextChanged(Editable s) {
        // do something with s, the changed text.
    }
}

```

Sometimes this approach makes sense. If the callback client, `MyModel` in this case, is small, simple, and used in only one or two contexts, this code is clear and to the point.

On the other hand, if (as the name `MyModel` suggests) the class will be used broadly and in a wide variety of circumstances, eliminating the messenger classes breaks encapsulation and limits extension. Obviously, it's going to be messy to extend this implementation to handle input from a second `TextBox` that requires different behavior.

Nearly as bad, though, is something called *interface pollution*, which happens when this idea is taken to an extreme. It looks like this:

```

// !!! Anti-pattern ALERT!
public class MyModel
    implements TextWatcher, OnKeyListener, View.OnTouchListener,
        OnFocusChangeListener, Button.OnClickListener
{
    // ....
}

```

Code like this is seductively elegant, in a certain way, and fairly common. Unfortunately, though, `MyModel` is now very tightly coupled to every one of the events it handles.

As usual, there are no hard and fast rules about interface pollution. There is, as already noted, lots of working code that looks just like this. Still, smaller interfaces are less fragile and easier to change. When an object's interface expands beyond good taste, consider using composition to split it up into manageable pieces.

## Extending Android classes

While callbacks provide a clear, well-defined means of extending class behavior, there are circumstances in which they do not provide sufficient flexibility. An obvious problem with the callback pattern is that sometimes your code needs to seize control at some point not foreseen by the library designers. If the service doesn't define a callback, you'll need some other way to inject your code into the flow of control. One solution is to create a subclass.

Some classes in the Android library were specifically designed to be subclassed (e.g., the `BaseAdapter` class from `android.widgets`, and `AsyncTask`, described shortly). In general, however, subclassing is not something that a designer should do lightly.

A subclass can completely replace the behavior of any nonfinal method in its superclass and, thus, completely violate the class architectural contract. Nothing in the Java typing system will prevent a subclass of `TextBox`, for example, from overriding the `addText`

`ChangeListener` method so that it ignores its argument and does not notify callback clients of changes in text box content. (You might imagine, for example, an implementation of a “safe” text box that does not reveal its content.)

Such a violation of contract—and it isn’t always easy to recognize the details of the contract—can give rise to two classes of bugs, both quite difficult to find. The first and more obvious problem occurs when a developer uses a rogue subclass like the safe text box, described earlier.

Suppose a developer constructs a view containing several widgets and uses the `addTextChangedListener` method on each to register for its callbacks. During testing, though, he discovers that some widgets aren’t working as expected. He examines his code for hours before it occurs to him that “it’s as though that method isn’t *doing* anything!” Suddenly, dawn breaks and he looks at the source for the widget to confirm that it has broken the class semantic contract. Grrr!

More insidious than this, though, is that the Android Framework itself might change between releases of the SDK. Perhaps the implementation of the `addTextChangedListener` method changes. Maybe code in some other part of the Android Framework starts to call `addTextChangedListener`, expecting normal behavior. Suddenly, because the subclass overrides the method, the entire application fails in spectacular ways!

You can minimize the danger of this kind of problem by calling superimplementation for an overridden method, like this:

```
public void addTextChangedListener(TextWatcher watcher) {
    // your code here...
    super.addTextChangedListener(watcher)
    // more of your code here...
}
```

This guarantees that your implementation augments but does not replace existing behavior, even as, over time, the superclass implementation changes. There is a coding rule, enforced in some developer communities, called “Design for Extension.” The rule mandates that all methods be either abstract or final. While this may seem draconian, consider that an overriding method, by definition, breaks the object’s semantic contract unless it at least calls the superimplementation.

## Organizing Java Source

[Chapter 1](#) introduced the basics of the Android SDK. [Chapter 5](#) narrowed the focus with a closer look at one of the most common tools for Android development, the Eclipse IDE. Let’s move one step closer and look at the organization of code within a project.

To reiterate, a *project*, as introduced in “[Projects](#)” on page 115, is a workspace devoted to producing a single deployable artifact. In the wider world of Java, that artifact might be no more than a library (a `.jar` file that cannot be run by itself but that implements

some specific functionality). It might, on the other hand, be a deployable web application or a double-clickable desktop application.

In the Android space, the artifact is most likely to be a single runnable service: a `ContentProvider`, a `Service`, or an `Activity`. A content provider that is used by a single activity certainly might start its life as a part of the activity project. As soon as a second activity needs to use it, though, it is time to consider refactoring it into its own project.

Traditionally, the Java compiler expects directory trees to hold the source (*.java*) files that it parses and the binary (*.class*) files that it produces as output. While it's not necessary, it's much easier to manage a project if those trees have different roots, commonly directories named *src* and *bin*, respectively.

In an Android project, there are two other important directory trees, *res* and *gen*. The first of these, *res*, contains definitions for static resources: colors, constant strings, layouts, and so on. Android tools preprocess these definitions, and turn them into highly optimized representations and the Java source through which application code refers to them. The autogenerated code, along with code created for AIDL objects (see “[AIDL and Remote Procedure Calls](#)” on page 158), is put into the *gen* directory. The compiler compiles the code from both directories to produce the contents of *bin*. The full structure of a project was described in detail in [Chapter 3](#).



When you add your project to a revision control system like Git, Subversion, or Perforce, be sure to exclude the *bin* and *gen* directories!

Your application source code goes in the *src* directory. As noted in [Chapter 2](#), you should put all your code into a package whose name is derived from the domain name of the owner of the code. Suppose, for instance, that you are a developer at large, doing business as `awesome-android.net`. You are under contract to develop a weather-prediction application for `voracious-carrier.com`. You will probably choose to put all your code into the package `com.voraciouscarrier.weatherprediction`, or possibly `com.voracious_carrier.weather_prediction`. Although the character “-” is perfectly legal in a DNS domain name, it is not legal in a Java package name. The UI for this ambitious application might go in `com.voraciouscarrier.weatherprediction.ui` and the model in `com.voraciouscarrier.weatherprediction.futureweather`.

If you look inside the *src* directory in your project, you will see that it contains a single directory, *com*. *com* in turn contains the directory *voraciouscarrier*, and so on. The source directory tree mirrors the package tree. The Java compiler expects this organization and may be unable to compile your code if it is violated.

Eventually, when the FutureWeather content provider becomes valuable on its own, you'll want to factor it out into a new project with a package namespace that is not restricted by the name of the application in which it was originally created. Doing this

by hand is a nightmare. You have to create a new directory structure, correctly place the files within that structure, correct the package names that are at the head of each source file, and, finally, correct any references to things that have moved.

Eclipse refactoring tools are your best friend. With just a few clicks you can create a new project for the now standalone subtree, cut and paste the content provider code into it, and then rename the packages as appropriate. Eclipse will fix most things, including the changed references.

It's worth a reminder that shortcutting package names—using a package named just `weatherprediction`, for instance—is a bad idea. Even if you are pretty sure the code you are creating will never be used outside its current context, you may want to use externally produced code in that context. Don't set yourself up for a name collision.

## Concurrency in Android

As mentioned in [Chapter 2](#), writing correct concurrent programs can be very difficult. The Android libraries provide some convenient tools to make concurrency both easier and safer.

When discussing concurrent programs, developers get into the habit of talking as though writing code with multiple threads actually causes those threads to execute at the same time—as though threading actually makes the program run faster. Of course, it isn't quite that simple. Unless there are multiple processors to execute the threads, a program that needs to perform multiple, unrelated, compute-bound tasks will complete those tasks no more quickly if they are implemented as separate threads than it will if they are on the same thread. In fact, on a single processor, the concurrent version may actually run somewhat more slowly because of the overhead due to context switching.

Multithreaded Java applications were around for a long time before most people could afford machines with more than one processor on which to run them. In the Android world, multithreading is an essential tool, even though the majority of devices will probably have only a single CPU for another year or so. So what is the point of concurrency if not to make a program run faster?

If you've been programming for any length of time at all, you probably don't even think about how absolutely essential it is that the statements in your code are executed in a rigid sequential order. The execution of any given statement must, unconditionally, happen before the execution of the next statement. Threads are no more than an explicit way of relaxing this constraint. They are the abstraction that developers use to make it possible to write code that is still ordered, logical, and easy to read, even when tasks embodied by the code are not related by ordering.

Executing independent threads concurrently doesn't introduce any intrinsic complexity when the threads are completely independent (e.g., if one is running on your com-

puter and the other is running on mine). When two concurrent processes need to collaborate, however, they have to rendezvous. For instance, data from the network might have to be displayed on the screen or user input pushed to a data store. Arranging the rendezvous, especially in the context of code optimizers, pipelined processors, and multilayered memory cache, can be quite complex. This can become painfully apparent when a program that has run, apparently without problem, on a single processor, suddenly fails in strange and difficult-to-debug ways when run in a multiprocessor environment.

The rendezvous process, making data or state from one thread visible to another, is usually called *publishing* a reference. Whenever one thread stores state in a way that makes it visible from another thread, it is said to be publishing a reference to that state. As mentioned in [Chapter 2](#), the only way that a reference can be published safely is if all threads that refer to the data synchronize on the same object during use. Anything else is incorrect and unsafe.

## AsyncTask and the UI Thread

If you've worked with any modern GUI framework, the Android UI will look entirely familiar. It is event-driven, built on a library of nestable components, and, most relevant here, single-threaded. Designers discovered years ago that, because a GUI must respond to asynchronous events from multiple sources, it is nearly impossible to avoid deadlock if the UI is multithreaded. Instead, a single thread owns both the input (touch screen, keypad, etc.) and output devices (display, etc.) and executes requests from each, sequentially, usually in the order they were received.

While the UI runs on a single thread, nearly any nontrivial Android application will be multithreaded. The UI must, for instance, respond to the user and animate the display regardless of whether the code that retrieves data from the network is currently processing incoming data. The UI must be quick and responsive and cannot, fundamentally, be ordered with respect to other, long-running processes. The long-running processes must be run asynchronously.

One convenient tool for implementing an asynchronous task in the Android system is, in fact, called `AsyncTask`. It completely hides many of the details of the threads used to run the task.

Let's consider a very simplistic application that initializes a game engine, displaying some interstitial graphic while the content loads. [Figure 6-1](#) shows a very basic example of such an application. When you push the button, it initializes the game level and then displays a welcome message in a text box.



Figure 6-1. Simple application to initialize a game

Here is the boilerplate code for the application. All that is missing is the code that actually initializes the game and updates the text box:

```
/** AsyncTaskDemo */
public class AsyncTaskDemo extends Activity {

    int mInFlight;

    /** @see android.app.Activity#onCreate(android.os.Bundle) */
    @Override
    public void onCreate(Bundle state) {
        super.onCreate(state);

        setContentView(R.layout.asyncdemo);

        final View root = findViewById(R.id.root);
        final Drawable bg = root.getBackground();

        final TextView msg = ((TextView) findViewById(R.id.msg));

        final Game game = Game.newGame();

        ((Button) findViewById(R.id.start)).setOnClickListener(
            new View.OnClickListener() {
                @Override public void onClick(View v) {
                    // !!! initialize the game here!
                }
            }
        );
    }
}
```

Now, let's suppose, for this example, that we simply want to display an animated background (the crawling dots in [Figure 6-1](#)) while the user waits for the game to initialize. Here's a sketch of the necessary code:

```
/**
 * Synchronous request to remote service
 * DO NOT USE!!
 */
void initGame(
    View root,
    Drawable bg,
    Game game,
    TextView resp,
    String level)
{
    // if the animation hasn't been started yet,
    // do so now
    if (0 >= mInFlight++) {
        root.setBackgroundResource(R.anim.dots);
        ((AnimationDrawable) root.getBackground()).start();
    }

    // initialize the game and get the welcome message
    String msg = game.initialize(level);

    // if this is the last running initialization
    // remove and clean up the animation
    if (0 >= --mInFlight) {
        ((AnimationDrawable) root.getBackground()).stop();
        root.setBackgroundDrawable(bg);
    }

    resp.setText(msg);
}
```

This is pretty straightforward. The user might mash the start button, so there might be multiple initializations in flight. If the interstitial background is not already showing, show it and remember that there is one more game starting up. Next, make the slow call to the game engine initializer. Once the game completes its initialization, clean up. If this is the last game to complete initialization, clear the interstitial animation. Finally, display the greeting message in the text box.

While this code is very nearly what is needed to make the example application work as specified, it breaks down in one very important way: it blocks the UI thread for the entire duration of the call to `game.initialize`. That has all sorts of unpleasant effects.

The most apparent of these is that the background animation won't work. Even though the logic for setting up and running the animation is very nearly correct, the code specifies quite clearly that nothing else can happen in the UI until the call to the remote service is complete.

It gets worse. The Android Framework actually monitors application UI threads to prevent broken or malicious programs from hanging a device. If an application takes

too long to respond to input, the framework will suspend it, alert the user that there is a problem, and offer her a chance to force it to close. If you build and run this example application, with `initGame` implemented as shown in the example (try it; it's actually somewhat instructive), the first time you click the Send Request button the UI will freeze. If you click a couple more times, you will see an alert similar to the one shown in [Figure 6-2](#).

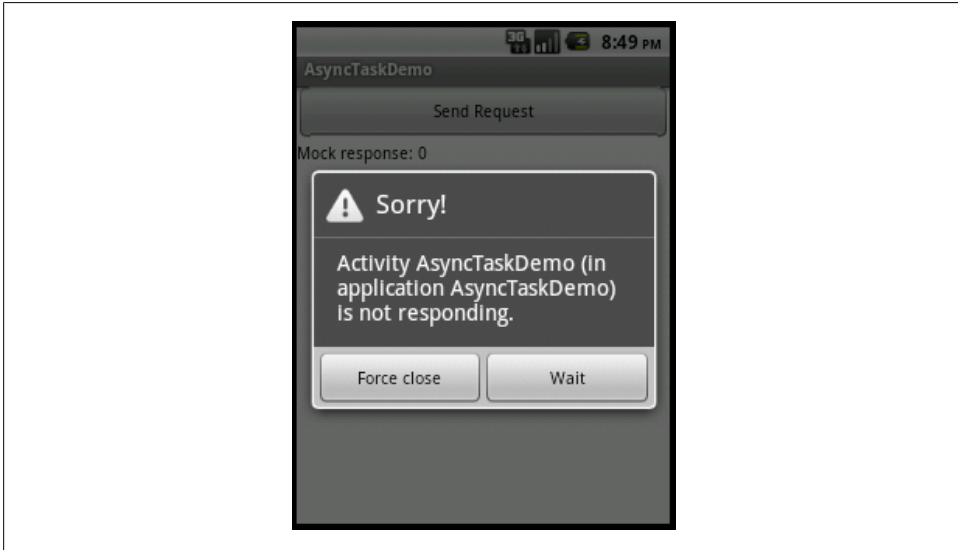

Figure 6-2. Unresponsive application

`AsyncTask` to the rescue! Android provides this class as a relatively safe, powerful, and easy-to-use way to run background tasks correctly. Here is a reimplementaion of `initGame` as an `AsyncTask`:

```
private final class AsyncInitGame
    extends AsyncTask<String, Void, String>
{
    private final View root;
    private final Game game;
    private final TextView message;
    private final Drawable bg;

    public AsyncInitGame(
        View root,
        Drawable bg,
        Game game,
        TextView msg)
    {
        this.root = root;
        this.bg = bg;
        this.game = game;
        this.message = msg;
    }
}
```



```

    }

    // runs on the UI thread
    @Override protected void onPreExecute() {
        if (0 >= mInFlight++) {
            root.setBackgroundResource(R.anim.dots);
            ((AnimationDrawable) root.getBackground()).start();
        }
    }

    // runs on the UI thread
    @Override protected void onPostExecute(String msg) {
        if (0 >= --mInFlight) {
            ((AnimationDrawable) root.getBackground()).stop();
            root.setBackgroundDrawable(bg);
        }

        message.setText(msg);
    }

    // runs on a background thread
    @Override protected String doInBackground(String... args) {
        return ((1 != args.length) || (null == args[0]))
            ? null
            : game.initialize(args[0]);
    }
}

```

This code is nearly identical to the first example. It has been divided into three methods that execute nearly the same code, in the same order, as in `initGame`.

This `AsyncTask` is created on the UI thread. When the UI thread invokes the task's `execute` method, first the `onPreExecute` method is called on the UI thread. This allows the task to initialize itself and its environment—in this case, installing the background animation. Next the `AsyncTask` creates a new background thread to run the `doInBackground` method concurrently. When, eventually, `doInBackground` completes, the background thread is deleted and the `onPostExecute` method is invoked, once again in the UI thread.

Assuming that this implementation of an `AsyncTask` is correct, the click listener need only create an instance and invoke it, like this:

```

((Button) findViewById(R.id.start)).setOnClickListener(
    new View.OnClickListener() {
        @Override public void onClick(View v) {
            new AsyncInitGame(
                root,
                bg,
                game,
                msg)
                .execute("basic");
        }
    });

```

In fact, `AsyncInitGame` is complete, correct, and reliable. Let's examine it in more detail.

First, notice that the base class `AsyncTask` is abstract. The only way to use it is to create a subclass specialized to perform some specific job (an is-a relationship, not a has-a relationship). Typically, the subclass will be simple, anonymous, and define only a few methods. A regard for good style and separation of concerns, analogous to the issues mentioned in [Chapter 2](#), suggests keeping the subclass small and delegating implementation to the classes that own the UI and the asynchronous task, respectively. In the example, for instance, `doInBackground` is simply a proxy to the `Game` class.

In general, an `AsyncTask` takes a set of parameters and returns a result. Because the parameters have to be passed between threads and the result returned between threads, some handshaking is necessary to ensure thread safety. An `AsyncTask` is invoked by calling its `execute` method with some parameters. Those parameters are eventually passed on, by the `AsyncTask` mechanism, to the `doInBackground` method, when it runs on a background thread. In turn, `doInBackground` produces a result. The `AsyncTask` mechanism returns that result by passing it as the argument to `doPostExecute`, run in the same thread as the original `execute`. [Figure 6-3](#) shows the data flow.

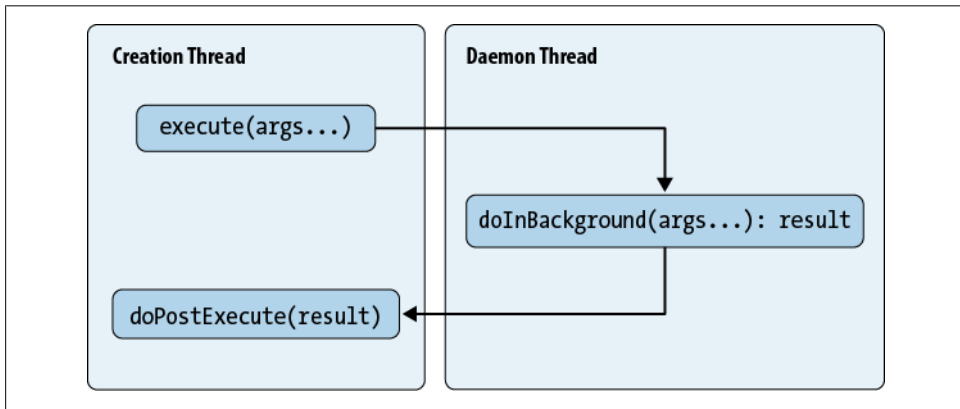

Figure 6-3. Data flow in `AsyncTask`

In addition to making this data flow thread-safe, `AsyncTask` also makes it type-safe. `AsyncTask` is a classic example of a type-safe template pattern. The abstract base class (`AsyncTask`) uses Java generics to allow implementations to specify the types of the task parameters and result.

When defining a concrete subclass of `AsyncTask`, you provide actual types for `Params`, `Progress`, and `Result`, the type variables in the definition of `AsyncTask`. The first and last of these type variables (`Params` and `Result`) are the types of the task parameters and the result, respectively. We'll get to that middle type variable in a minute.

The concrete type bound to `Params` is the type of the parameters to `execute`, and thus the type of the parameters to `doInBackground`. Similarly, the concrete type bound to `Result` is the type of the return value from `doInBackground`, and thus the type of the parameter to `onPostExecute`.

This is all a bit hard to parse, and the first example, `AsyncInitGame`, didn't help much because the input parameter and the result are both of the same type, `String`. Here are a couple of examples in which the parameter and result types are different. They provide a better illustration of the use of the generic type variables:

```
public class AsyncDBReq
    extends AsyncTask<PreparedStatement, Void, ResultSet>
{
    @Override
    protected ResultSet doInBackground(PreparedStatement... q) {
        // implementation...
    }

    @Override
    protected void onPostExecute(ResultSet result) {
        // implementation...
    }
}

public class AsyncHttpReq
    extends AsyncTask<HttpRequest, Void, HttpResponse>
{
    @Override
    protected HttpResponse doInBackground(HttpRequest... req) {
        // implementation...
    }

    @Override
    protected void onPostExecute(HttpResponse result) {
        // implementation...
    }
}
```

In the first example, the argument to the `execute` method of an `AsyncDBReq` instance will be one or more `PreparedStatement` variables. The implementation of `doInBackground` for an instance of `AsyncDBReq` will take those `PreparedStatement` parameters as its arguments and will return a `ResultSet`. The instance `onPostExecute` method will take that `ResultSet` as a parameter and use it appropriately.

Similarly, in the second example, the call to the `execute` method of an `AsyncHttpReq` instance will take one or more `HttpRequest` variables. `doInBackground` takes those requests as its parameters and returns an `HttpResponse`. `onPostExecute` handles the `HttpResponse`.



Note that an instance of an `AsyncTask` can be run only once. Calling `execute` on a task a second time will cause it to throw an `IllegalStateException`. Each task invocation requires a new instance.

As much as `AsyncTask` simplifies concurrent processing, its contract imposes strong constraints that cannot be verified automatically. It is absolutely essential to take great care not to violate these constraints! Violations will cause exactly the sort of bug

described at the beginning of this section: failures that are intermittent and very difficult to find.

The most obvious of these constraints is that the `doInBackground` method, since it is run on a different thread, must make only thread-safe references to variables inherited into its scope. Here, for example, is a mistake that is easy to make:

```
// ... some class

int mCount;

public void initButton1( Button button) {
    mCount = 0;
    button.setOnClickListener(
        new View.OnClickListener() {
            @SuppressWarnings("unchecked")
            @Override public void onClick(View v) {
                new AsyncTask<Void, Void, Void>() {
                    @Override
                    protected Void doInBackground(Void... args) {
                        mCount++; // !!! NOT THREAD SAFE!
                        return null;
                    }
                }.execute();
            }
        });
}
```

Although there is nothing to alert you to the problem—no compiler error, no runtime warning, probably not even an immediate failure when the bug is driven—this code is absolutely incorrect. The variable `mCount` is being accessed from two different threads, without synchronization.

In light of this, it may be a surprise to see that access to `mInFlight` is not synchronized in `AsyncTaskDemo`. This is actually OK. The `AsyncTask` contract guarantees that `onPreExecute` and `onPostExecute` will be run on the same thread, the thread from which `execute` was called. Unlike `mCount`, `mInFlight` is accessed from only a single thread and has no need for synchronization.

Probably the most pernicious way to cause the kind of concurrency problem we've just warned you about is by holding a reference to a parameter. This code, for instance, is incorrect. Can you see why?

```
public void initButton(
    Button button,
    final Map<String, String> vals)
{
    button.setOnClickListener(
        new View.OnClickListener() {
            @Override public void onClick(View v) {
                new AsyncTask<Map<String, String>, Void, Void>() {
                    @Override
                    protected Void doInBackground(
                        Map<String, String>... params)
```

```

        {
            // implementation, uses the params Map
        }
    }.execute(vals);
    vals.clear(); // !!! THIS IS NOT THREAD SAFE !!!
} });
}

```

The problem is pretty subtle. If you noticed that the argument to `initButton`, `vals`, is being referenced concurrently, without synchronization, you are correct! It is passed into the `AsyncTask`, as the argument to `execute`, when the task is invoked. The `AsyncTask` framework can guarantee that this reference is published correctly onto the background thread when `doInBackground` is called. It *cannot*, however, do anything about the reference to `vals` that is retained and used later, in the `initButton` method. The call to `vals.clear` modifies state that is being used on another thread, without synchronization. It is, therefore, not thread-safe.

The best solution to this problem is to make sure the arguments to `AsyncTask` are immutable. If they can't be changed—like a `String`, an `Integer`, or a POJO with only final fields—they are thread-safe and need no further care. The only way to be certain that a mutable object passed to an `AsyncTask` is thread-safe is to make sure that only the `AsyncTask` holds a reference. Because the parameter `vals` is passed into the `initButton` method in the previous example (Figure 6-1), it is completely impossible to guarantee that there are no dangling references to it. Even removing the call to `vals.clear` would not guarantee that this code was correct, because the caller of `initButton` might hold a reference to the map that is eventually passed as the parameter `vals`. The *only* way to make this code correct is to make a complete (deep) copy of the map and all the objects it contains!

Developers familiar with the Java Collections package might argue that an alternative to making a complete, deep copy of the map parameter would be to wrap it in an `unmodifiableMap`, like this:

```

public void initButton(
    Button button,
    final Map<String, String> vals)
{
    button.setOnClickListener(
        new View.OnClickListener() {
            @Override public void onClick(View v) {
                new AsyncTask<Map<String, String>, Void, Void>() {
                    @Override
                    protected Void doInBackground(
                        Map<String, String>... params)
                    {
                        // implementation, uses the params Map
                    }
                }.execute(Collections.unmodifiableMap(vals));
                vals.clear(); // !!! STILL NOT THREAD SAFE !!!
            } });
}

```

Unfortunately, this is *still* not correct. `Collections.unmodifiableMap` provides an immutable view of the map it wraps. It does not, however, prevent processes with access to a reference to the original, mutable object from changing that object at any time. In the preceding example, although the `AsyncTask` cannot change the map value passed to it in the `execute` method, the `onClickListener` method still changes the map referenced by `vals` at the same time the background thread uses it, without synchronization. Boom!

To close this section, note that `AsyncTask` has one more method, not used in the example: `onProgressUpdate`. It is there to allow the long-running tasks to push periodic status safely back to the UI thread. Here is how you might use it to implement a progress bar showing the user how much longer the game initialization process will take:

```
public class AsyncTaskDemoWithProgress extends Activity {

    private final class AsyncInit
        extends AsyncTask<String, Integer, String>
        implements Game.InitProgressListener
    {
        private final View root;
        private final Game game;
        private final TextView message;
        private final Drawable bg;

        public AsyncInit(
            View root,
            Drawable bg,
            Game game,
            TextView msg)
        {
            this.root = root;
            this.bg = bg;
            this.game = game;
            this.message = msg;
        }

        // runs on the UI thread
        @Override protected void onPreExecute() {
            if (0 >= mInFlight++) {
                root.setBackgroundResource(R.anim.dots);
                ((AnimationDrawable) root.getBackground()).start();
            }
        }

        // runs on the UI thread
        @Override protected void onPostExecute(String msg) {
            if (0 >= --mInFlight) {
                ((AnimationDrawable) root.getBackground()).stop();
                root.setBackgroundDrawable(bg);
            }

            message.setText(msg);
        }
    }
}
```

```

// runs on its own thread
@Override protected String doInBackground(String... args) {
    return ((1 != args.length) || (null == args[0]))
        ? null
        : game.initialize(args[0], this);
}

// runs on the UI thread
@Override protected void onProgressUpdate(Integer... vals) {
    updateProgressBar(vals[0].intValue());
}

// runs on the UI thread
@Override public void onInitProgress(int pctComplete) {
    publishProgress(Integer.valueOf(pctComplete));
}
}

int mInFlight;
int mComplete;

/** @see android.app.Activity#onCreate(android.os.Bundle) */
@Override
public void onCreate(Bundle state) {
    super.onCreate(state);

    setContentView(R.layout.asyncdemoprogress);

    final View root = findViewById(R.id.root);
    final Drawable bg = root.getBackground();

    final TextView msg = ((TextView) findViewById(R.id.msg));

    final Game game = Game.newGame();

    ((Button) findViewById(R.id.start)).setOnClickListener(
        new View.OnClickListener() {
            @Override public void onClick(View v) {
                mComplete = 0;
                new AsyncInit(
                    root,
                    bg,
                    game,
                    msg)
                    .execute("basic");
            }
        });
}

void updateProgressBar(int progress) {
    int p = progress;
    if (mComplete < p) {
        mComplete = p;
        ((ProgressBar) findViewById(R.id.progress))
            .setProgress(p);
    }
}

```

```
    }  
  }  
}
```

This example presumes that game initialization takes, as an argument, a `Game.InitProgressListener`. The initialization process periodically calls the listener's `onInitProgress` method to notify it of how much work has been completed. In this example, then, `onInitProgress` will be called from beneath `doInBackground` in the call tree, and therefore on the background thread. If `onInitProgress` were to call `AsyncTaskDemoWithProgress.updateProgressBar` directly, the subsequent call to `bar.setStatus` would also take place on the background thread, violating the rule that only the UI thread can modify `View` objects. It would cause an exception like this:

```
11-30 02:42:37.471: ERROR/AndroidRuntime(162):  
    android.view.ViewRoot$CalledFromWrongThreadException:  
        Only the original thread that created a view hierarchy can touch its views.
```

In order to correctly publish the progress back to the UI thread, `onInitProgress` instead calls the `AsyncTask` method `publishProgress`. The `AsyncTask` handles the details of scheduling `publishProgress` on the UI thread so that `onProgressUpdate` can safely use `View` methods.

Let's leave this detailed look into the `AsyncTask` by summarizing some of the key points it illustrated:

- The Android UI is single-threaded. To use it well a developer must be comfortable with the task queue idiom.
- In order to retain UI liveness, tasks that take more than a couple of milliseconds, or a few hundred instructions, should not be run on the UI thread.
- Concurrent programming is really tricky. It's amazingly easy to get it wrong and very hard to check for mistakes.
- `AsyncTask` is a convenient tool for running small, asynchronous tasks. Just remember that the `doInBackground` method runs on a different thread! It must not write any state visible from another thread or read any state writable from another thread. This includes its parameters.
- Immutable objects are an essential tool for passing information between concurrent threads.

## Threads in an Android Process

Together, `AsyncTask` and `ContentProvider` form a very powerful idiom and can be adapted to a wide variety of common application architectures. Nearly any MVC pattern in which the `View` polls the `Model` can (and probably should) be implemented this way. In an application whose architecture requires the `Model` to push changes to the `View` or in which the `Model` is long-lived and continuously running, `AsyncTask` may not be sufficient.



Recall that cardinal rule for sharing data between threads that we introduced back in “[Synchronization and Thread Safety](#)” on page 68. In its full generality, that rule is pretty onerous. The investigation of `AsyncTask` in the preceding section, however, illustrated one idiom that simplifies correct coordination of concurrent tasks in Android: the heavy lifting of publishing state from one thread into another was completely hidden in the implementation of a template class. At the same time, the discussion also reinforced some of the pitfalls of concurrency that lie in wait to entrap the incautious coder. There are other idioms that are safe and that can simplify specific classes of concurrent problems. One of them—a common idiom in Java programming in general—is baked into the Android Framework. It is sometimes called *thread confinement*.

Suppose that a thread, the `DBMinder`, creates an object and modifies it over a period of time. After it has completed its work, it must pass the object to another thread, `DBViewer`, for further processing. In order to do this, using thread confinement, `DBMinder` and `DBViewer` must share a drop point and an associated lock. The process looks like this:

1. `DBMinder` seizes the lock and stores a reference to the object in the drop.
2. `DBMinder` *destroys all its references to the object!*
3. `DBMinder` releases the lock.
4. `DBViewer` seizes the lock and notices that there is an object reference in the drop.
5. `DBViewer` recovers the reference from the drop and then clears the drop.
6. `DBViewer` releases the lock.

This process works for any object regardless of whether that object is thread-safe itself. This is because the only state that is ever shared among multiple threads is the drop box. Both threads correctly seize a single lock before accessing it. When `DBMinder` is done with an object, it passes it to `DBViewer` and retains no references: the state of the passed object is never shared by multiple threads.

Thread confinement is a surprisingly powerful trick. Implementations usually make the shared drop an ordered task queue. Multiple threads may contend for the lock, but each holds it only long enough to enqueue a task. One or more worker threads seize the queue to remove tasks for execution. This is a pattern that is sometimes called the *producer/consumer model*. As long as a unit of work can proceed entirely in the context of the worker thread that claims it, there is no need for further synchronization. If you look into the implementation of `AsyncTask` you will discover that this is exactly how it works.

Thread confinement is so useful that Android has baked it into its framework in the class called `Looper`. When initialized as a `Looper`, a Java thread turns into a task queue. It spends its entire life removing things from a local queue and executing them. Other threads enqueue work, as described earlier, for the initialized thread to process. As long as the enqueueing thread deletes all references to the object it enqueues, both threads can be coded without further concern for concurrency. In addition to making it

dramatically easier to make programs that are correct, this also removes any inefficiency that might be caused by extensive synchronization.

Perhaps this description of a task queue brings to mind a construct to which we alluded earlier in this chapter? Android's single-threaded, event-driven UI is, simply, a **Looper**. When it launches a **Context** the system does some bookkeeping and then initializes the launch thread as a **Looper**. That thread becomes the main thread for a service and the UI thread for an activity. In an activity, the UI framework preserves a reference to this thread, and its task queue becomes the UI event queue: all the external drivers, the screen, the keyboard, the call handler, and so on, enqueue actions on this queue.

The other half of **Looper** is **Handler**. A **Handler**, created on a **Looper** thread, provides a portal to the **Looper** queue. When a **Looper** thread wishes to allow some other enqueued thread access to its task queue, it creates a new **Handler** and passes it to the other thread. There are several shortcuts that make it easier to use a **Handler**: `View.post(Runnable)`, `View.postDelayed(Runnable, long)`, and `Activity.runOnUiThread(Runnable)`.

There is yet another convenient and powerful paradigm in the Android toolkit for interprocess communication and work sharing: the **ContentProvider**, which we'll discuss in [Chapter 12](#). Consider whether a content provider can fit your needs before you build your own architecture on the low-level components discussed in this section. Content providers are flexible and extensible, and handle concurrent processing in a way that is fast enough for all but the most time-sensitive applications.

## Serialization

Serialization is converting data from a fast, efficient, internal representation to something that can be kept in a persistent store or transmitted over a network. Converting data to its serialized form is often called *marshaling* it. Converting it back to its live, in-memory representation is called *deserializing* or *unmarshaling*.

Exactly how data is serialized depends on the reason for serializing it. Data serialized for transmission over a network, for instance, may not need to be legible in flight. Data serialized for storage in a database, however, will be far more useful if the representation permits SQL queries that are easy to construct and make sense. In the former case the serialization format might be binary. In the latter it is likely to be labeled text.

The Android environment addresses four common uses for serialization:

### *Life cycle management*

Unlike larger devices—laptop and desktop machines, for instance—Android devices cannot count on being able to swap an application to a fast backing store when that application becomes inactive. Instead, the framework provides an object called a **Bundle**. When an application is suspended it writes its state into the **Bundle**. When the application is re-created the Android Framework promises to supply a copy of the same **Bundle** during its initialization. An application must be

able to serialize anything it wants to keep across its suspension and to store the serialized version in the `Bundle`.

### *Persistence*

In addition to the immediate application state kept in a `Bundle`, most applications manage some kind of persistent data store. This data store is most likely an SQLite database wrapped in a `ContentProvider`. Applications must convert back and forth between the internal representation of object data and the representations of those same objects in the database. In larger systems, this process—called *object-relational mapping* or just *ORM*—is supported by frameworks such as Hibernate and iBATIS. Android's local data store is simpler and lighter weight. It is described in [Chapter 10](#).

### *Local interprocess communication*

The Android Framework promotes an architecture that breaks larger, monolithic applications into smaller components: UIs, content providers, and services. These components do not have access to each other's memory space and must pass information across process boundaries as serialized messages. Android provides a highly optimized tool for this, AIDL.

### *Network communication*

This is the part that makes mobile devices exciting. The ability to connect to the Internet and to use the incredible variety of services available there is what Android is all about. Applications need to be able to handle the protocols imposed by any external service, which includes translating internal information into queries to those services, and retranslating the response.

The following sections describe the various classes at your disposal for achieving these goals.

## Java Serialization

Java defines a serialization framework through the `Serializable` marker interface and the pair of serialization types called `ObjectOutputStream` and `ObjectInputStream`. Because Java serialization mostly just works, even experienced Java programmers may not recognize its complexity. It is certainly outside the scope of this book. Josh Bloch devotes nearly 10% of his seminal book *Effective Java* (Prentice Hall) to a discussion of Java's serialization framework and how to use it correctly. The chapter is worthwhile reading as a way to understand the issues, even if you don't expect to use Java's framework.

Android does support Java serialization. The `Bundle` type, for instance, has the pair of methods `putSerializable` and `getSerializable`, which, respectively, add a Java `Serializable` to and recover it from a `Bundle`. For example:

```
public class JSerialize extends Activity {
    public static final String APP_STATE
        = "com.oreilly.android.app.state";
```

```

private static class AppState implements Serializable {
    // definitions, getters and setters
    // for application state parameters here.
    // ...
}

private AppState applicationState;

/** Called when the activity is first created. */
@Override
public void onCreate(Bundle savedInstanceState) {
    super.onCreate(savedInstanceState);

    applicationState = (null == savedInstanceState)
        ? new AppState(/* ... */)
        : (AppState) savedInstanceState.getSerializable(APP_STATE);

    setContentView(R.layout.main);

    // ...
}

/**
 * @see android.app.Activity#onSaveInstanceState(android.os.Bundle)
 */
@Override
protected void onSaveInstanceState(Bundle outState) {
    super.onSaveInstanceState(outState);
    outState.putSerializable(APP_STATE, applicationState);
}
}

```

In this example, the application keeps some global state information—perhaps a list of recently used items—as a `Serializable` object. When a `JSerialize` activity is paused so that another activity can replace it in memory, the Android Framework invokes the `JSerialize` callback method `onSaveInstanceState`, passing a `Bundle` object. The callback method uses `Bundle.putSerializable` to save the state of the object into the `Bundle`. When `JSerialize` is resumed, the `onCreate` method retrieves the state from the `Bundle` using `getSerializable`.

## AIDL and Remote Procedure Calls

In order to declare an AIDL interface, you'll need several things:

- An AIDL file that describes the API.
- For every nonsimple type used in the API, a subclass of `Parcelable` defining the type, and an AIDL file naming the type as `parcelable`. One caution when doing this: you must be willing to distribute the source for those classes to all clients that serialize them.
- A service that returns an implementation of the API stub, in response to `onBind`. `onBind` must be prepared to return the correct implementation for each intent with

which it might be called. The returned instance provides the actual implementations of the API methods.

- On the client, an implementation of `ServiceConnection`. `onServiceConnected` should cast the passed binder, using `API.Stub.asInterface(binder)`, and save the result as a reference to the service API. `onServiceDisconnected` must null the reference. It calls `bindService` with an `Intent` that the API service provides, the `ServiceConnection`, and flags that control service creation.
- Binding that is asynchronous. Just because `bindService` returns true does not mean that you have a reference to the service yet. You must release the thread and wait for the invocation of `onServiceConnected` to use the service.

## Parcelable

Although the Android Framework supports Java serialization, it is usually not the best choice as a way to marshal program state. Android's own internal serialization protocol, `Parcelable`, is lightweight, highly optimized, and only slightly more difficult to use. It is the best choice for local interprocess communication. For reasons that will become apparent when we revisit `Parcelable` objects in [“Classes That Support Serialization” on page 162](#), they cannot be used to store objects beyond the lifetime of an application. They are not an appropriate choice for marshaling state to, say, a database or a file.

Here's a very simple object that holds some state. Let's see what it takes to make it “parcelable”:

```
public class SimpleParcelable {
    public enum State { BEGIN, MIDDLE, END; }

    private State state;
    private Date date;

    State getState() { return state; }
    void setState(State state) { this.state = state; }

    Date getDate() { return date; }
    void setDate(Date date) { this.date = date; }
}
```

An object must meet three requirements in order to be parcelable:

- It must implement the `Parcelable` interface.
- It must have a marshaler, an implementation of the interface method `writeToParcel`.
- It must have an unmarshaler, a `public static final` variable named `CREATOR`, containing a reference to an implementation of `Parcelable.Creator`.

The interface method `writeToParcel` is the marshaler. It is called for an object when it is necessary to serialize that object to a `Parcel`. The marshaler's job is to write everything necessary to reconstruct the object state to the passed `Parcel`. Typically, this will mean expressing the object state in terms of the six primitive data types: `byte`, `double`, `int`, `float`, `long`, and `String`. Here's the same simple object, but this time with the marshaler added:

```
public class SimpleParcelable implements Parcelable {
    public enum State { BEGIN, MIDDLE, END; }

    private static final Map<State, String> marshalState;
    static {
        Map<State, String> m = new HashMap<State, String>();
        m.put(State.BEGIN, "begin");
        m.put(State.MIDDLE, "middle");
        m.put(State.END, "end");
        marshalState = Collections.unmodifiableMap(m);
    }

    private State state;
    private Date date;

    @Override
    public void writeToParcel(Parcel dest, int flags) {
        // translate the Date to a long
        dest.writeLong(
            (null == date)
            ? -1
            : date.getTime());

        dest.writeString(
            (null == state)
            ? ""
            : marshalState.get(state));
    }

    State getState() { return state; }
    void setState(State state) { this.state = state; }

    Date getDate() { return date; }
    void setDate(Date date) { this.date = date; }
}
```

Of course, the exact implementation of `writeToParcel` will depend on the contents of the object being serialized. In this case, the `SimpleParcelable` object has two pieces of state and writes both of them into the passed `Parcel`.

Choosing a representation for most simple data types usually won't require anything more than a little ingenuity. The `Date` in this example, for instance, is easily represented by its time since the millennium.

Be sure, though, to think about future changes to data when picking the serialized representation. Certainly, it would have been much easier in this example to represent

`state` as an `int` whose value was obtained by calling `state.ordinal`. Doing so, however, would make it much harder to maintain forward compatibility for the object. Suppose it becomes necessary at some point to add a new state, `State.INIT`, before `State.BEGIN`. This trivial change makes new versions of the object completely incompatible with earlier versions. A similar, if slightly weaker, argument applies to using `state.toString` to create the marshaled representation of the state.

The mapping between an object and its representation in a `Parcel` is part of the particular serialization process. It is not an inherent attribute of the object. It is entirely possible that a given object has completely different representations when serialized by different serializers. To illustrate this principle—though it is probably overkill, given that the type `State` is locally defined—the map used to marshal `state` is an independent and explicitly defined member of the parcelable class.

`SimpleParcelable`, as shown earlier, compiles without errors. It could even be marshaled to a parcel. As yet, though, there is no way to get it back out. For that, we need the unmarshaller:

```
public class SimpleParcelable implements Parcelable {

    // Code elided...

    private static final Map<String, State> unmarshalState;
    static {
        Map<String, State> m = new HashMap<String, State>();
        m.put("begin", State.BEGIN);
        m.put("middle", State.MIDDLE);
        m.put("end", State.END);
        unmarshalState = Collections.unmodifiableMap(m);
    }

    // Unmarshaller
    public static final Parcelable.Creator<SimpleParcelable> CREATOR
        = new Parcelable.Creator<SimpleParcelable>() {
        public SimpleParcelable createFromParcel(Parcel src) {
            return new SimpleParcelable(
                src.readLong(),
                src.readString());
        }

        public SimpleParcelable[] newArray(int size) {
            return new SimpleParcelable[size];
        }
    };

    private State state;
    private Date date;

    public SimpleParcelable(long date, String state) {
        if (0 <= date) { this.date = new Date(date); }
        if ((null != state) && (0 < state.length())) {
            this.state = unmarshalState.get(state);
        }
    }
}
```

```

    }
    // Code elided...
}

```

This snippet shows only the newly added unmarshaller code: the public, static `final` field called `CREATOR` and its collaborators. The field is a reference to an implementation of `Parcelable.Creator<T>`, where `T` is the type of the parcelable object to be unmarshaled (in this case `SimpleParcelable`). It’s important to get all these things exactly right! If `CREATOR` is protected instead of public, not static, or spelled “Creator”, the framework will be unable to unmarshal the object.

The implementation of `Parcelable.Creator<T>` is an object with a single method, `createFromParcel`, which unmarshals a single instance from the `Parcel`. The idiomatic way to do this is to read each piece of state from the `Parcel`, in exactly the same order as it was written in `writeToParcel` (again, this is important), and then to call a constructor with the unmarshaled state. Since the unmarshaling constructor is called from class scope, it can be package-protected, or even private.

## Classes That Support Serialization

The `Parcel` API is not limited to the six primitive types mentioned in the previous section. The Android documentation gives the complete list of parcelable types, but it is helpful to think of them as divided into four groups.

The first group, simple types, consists of `null`, the six primitives (`int`, `float`, etc.), and the boxed versions of the six primitives (`Integer`, `Float`, etc.).

The next group consists of object types implementing `Serializable` or `Parcelable`. These objects are not simple, but they know how to serialize themselves.

Another group, collection types, covers arrays, lists, maps, bundles, and sparse arrays of the preceding two types (`int[]`, `float[]`, `ArrayList<?>`, `HashMap<String, ?>`, `Bundle<?>`, `SparseArray<?>`, etc.).

Finally, there are some special cases: `CharSequence` and active objects (`IBinder`).

While all these types can be marshaled into a `Parcel`, there are two to avoid if possible: `Serializable` and `Map`. As mentioned earlier, Android supports native Java serialization. Its implementation is not nearly as efficient as the rest of `Parcelable`. Implementing `Serializable` in an object is not an effective way to make it parcelable. Instead, objects should implement `Parcelable` and add a `CREATOR` object and a `writeToParcel` method as described in “[Parcelable](#)” on page 159. This can be a tedious task if the object hierarchy is complex, but the performance gains are usually well worth it.

The other parcelable type to avoid is the `Map`. `Parcel` doesn’t actually support maps in general; only those with keys that are strings. The Android-specific `Bundle` type provides the same functionality—a map with string keys—but is, in addition, type-safe. Objects



are added to a `Bundle` with methods such as `putDouble` and `putSparseParcelableArray`, one for each parcelable type. Corresponding methods such as `getDouble` and `getSparseParcelableArray` get the objects back out. A `Bundle` is just like a map except that it can hold different types of objects for different keys in a way that is perfectly type-safe. Using a `Bundle` eliminates the entire class of hard-to-find errors that arise when, say, a serialized `float` is mistakenly interpreted as an `int`.

Type safety is also a reason to prefer the methods `writeTypedArray` and `writeTypedList` to their untyped analogs `writeArray` and `writeList`.

## Serialization and the Application Life Cycle

As mentioned earlier, an Android application may not have the luxury of virtual memory. On a small device, there is no secondary store to which a running but hidden application can be pushed to make room for a new, visible application. Still, a good user experience demands that when the user returns to an application, it looks the way it did when he left it. The responsibility for preserving state across suspension falls to the application itself. Fortunately, the Android Framework makes preserving state straightforward.

The example in “[Java Serialization](#)” on page 157 showed the general framework mechanism that allows an application to preserve state across suspensions. Whenever the application is evicted from memory, its `onSaveInstanceState` method is called with a `Bundle` to which the application can write any necessary state. When the application is restarted, the framework passes the same `Bundle` to the `onCreate` method so that the application can restore its state. By sensibly caching content data in a `Content Provider` and saving lightweight state (e.g., the currently visible page) to the `onSaveInstanceState` `Bundle`, an application can resume, without interruption.

The framework provides one more tool for preserving application state. The `View` class—the base type for everything visible on the screen—has a hook method, `onSaveInstanceState`, that is called as part of the process of evicting an application from memory. In fact, it is called from `Activity.onSaveInstanceState`, which is why your application’s implementation of that method should always call `super.onSaveInstanceState`.

This method allows state preservation at the very finest level. An email application, for instance, might use it to preserve the exact location of the cursor in the text of an unsent mail message.



# **About the Android Framework**

The Android Framework is the set of base classes that underlie Android applications and the parts of Android system software that comprise the Android userland. Here we organize our presentation of the Android APIs around the goal of enabling you to implement applications that take maximum advantage of the Android system architecture.



---

# Building a View

Android comes with many requirements that herald complexity in the user interface; it's a multiprocessing system that supports multiple concurrent applications, accepts multiple forms of input, is highly interactive, and is flexible enough to support a wide range of devices now and in the future. The user interface is both rich and easy to use.

This chapter provides you with the techniques for implementing a graphical interface on Android. It explains the architecture of the Android UI toolkit, while showing you in practical terms how to use basic interface elements such as buttons and text boxes. It also covers event handling, using multiple threads to offload long-running tasks so that the UI doesn't freeze, and other topics that make user interfaces pleasant and performant.

## Android GUI Architecture

The Android environment adds yet another GUI toolkit to the Java ecosystem, joining AWT, Swing, SWT, LWUIT, and others. If you have worked with any of these, the Android UI framework will look familiar. Like them, it is single-threaded, event-driven, and built on a library of nestable components.

The Android UI framework is, like other Java UI frameworks, organized around the common Model-View-Controller pattern illustrated in [Figure 7-1](#). It provides structure and tools for building a Controller that handles user input (like keypresses and screen taps) and a View that renders graphical information to the screen.

## The Model

The Model is the guts of your application—what it actually does. It might be, for instance, the database of music on your device and the code for playing the music. It might be your list of contacts and the code that places phone calls or sends IMs to them. It is the subject of a large part of the rest of this book.

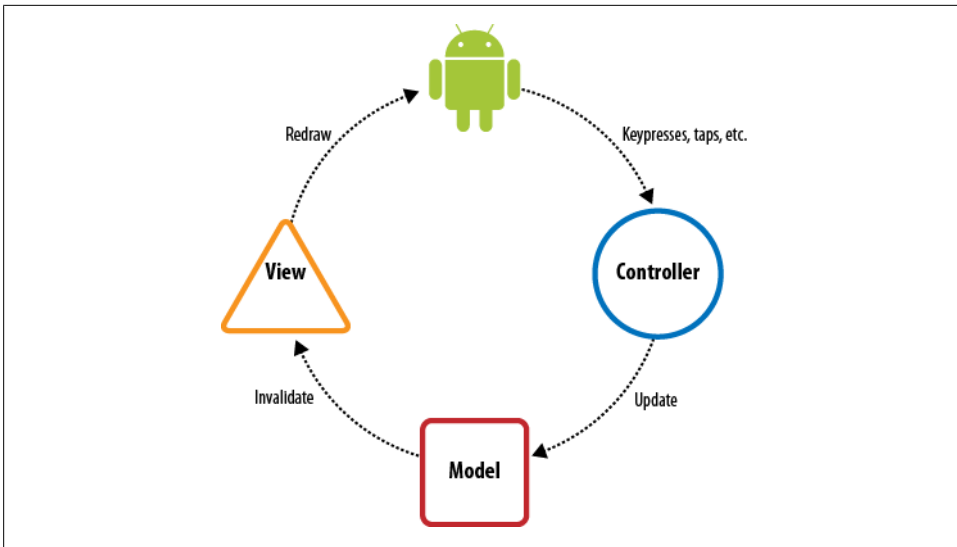

Figure 7-1. Model-View-Controller concept

While a particular application’s View and Controller will necessarily reflect the Model they manipulate, a single Model might be used by several different applications. Consider, for instance, an MP3 player and an application that converts MP3 files into WAV files. For both applications, the Model includes the MP3 file format. The former application, however, has the familiar Stop, Start, and Pause controls, and plays tunes. The latter may not produce any sound at all. Instead, it will have controls for things such as bit rate. The Model is all about the data.

## The View

The View is the visualization of the Model. More generally, a view is the portion of the application responsible for rendering the display, sending audio to the speakers, generating tactile feedback, and so on. The graphical portion of the Android UI framework, described in detail in [Chapter 9](#), is implemented as a tree of subclasses of the `View` class. Graphically, each object represents a rectangular area on the screen that is completely within the rectangular area represented by its parent in the tree. The root of this tree is the application window.

As an example, the display in a hypothetical MP3 player might contain a component that shows the album cover for the currently playing tune. Another View might display the name of the currently playing song while a third contains subviews such as the Play, Pause, and Stop buttons.

The UI framework paints the screen by walking the view tree, asking each component to draw itself in a *preorder traversal*. In other words, each View draws itself and then asks each of its children to do the same. When the whole tree has been rendered, the

smaller, nested components that are the leaves of the tree—and that were therefore painted later—appear to be painted on top of the components that are nearer to the root and that were painted first.

The Android UI framework is actually more efficient than this simplified description. It does not paint an area of a parent View if it can be certain that some child will later paint the same area. It would be a waste of time to paint the background underneath an opaque object. It would also be a waste of time to repaint portions of a View that have not changed.

## The Controller

The Controller is the portion of an application that responds to external actions: a keystroke, a screen tap, an incoming call, and so forth. It is implemented as an *event queue*. Each external action is represented as a unique event in the queue. The framework removes each event from the queue in order and dispatches it.

For example, when a user presses a key on her phone, the Android system generates a `KeyEvent` and adds it to the event queue. Eventually, after previously enqueued events have been processed, the `KeyEvent` is removed from the queue and passed as the parameter of a call to the `dispatchKeyEvent` method of the `View` that is currently selected.

Once an event is dispatched to the in-focus component, the component may take appropriate action to change the internal state of the program. In an MP3 player application, for instance, when the user taps a Play/Pause button on the screen and the event is dispatched to that button's object, the handler method might update the Model to resume playing some previously selected tune.

This chapter describes the construction of the Controller for an Android application.

## Putting It Together

We now have all the concepts necessary to describe the complete UI system. When an external action occurs—when the user scrolls, drags, or presses a button; a call comes in; or an MP3 player arrives at the end of its playlist—the Android system enqueues an event representing the action on the event queue. Eventually, the event is dequeued—first in, first out—and dispatched to an appropriate event handler. The handler, which is often code you write as part of your application, responds to the event by notifying the Model that there has been a change in state. The Model takes the appropriate action.

Nearly any change in Model state will require a corresponding change in the view. In response to a keypress, for instance, an `EditText` component must show the newly typed character at the insert point. Similarly, in a phone book application, clicking on a contact will cause that contact to be highlighted and the previously highlighted contact to have its highlighting removed.

When the Model updates its own state it almost certainly will have to change the current display to reflect the internal change. In order to update the display, the Model must notify the UI framework that some portion of the display is now stale and has to be redrawn. The redraw request is actually nothing more than another event enqueued in the same framework event queue that held the Controller event a moment ago. The redraw event is processed, in order, like any other UI event.

Eventually, the redraw event is removed from the queue and dispatched. The event handler for a redraw event is the **View**. The tree of views is redrawn; each View is responsible, exactly, for rendering its current state at the time it is drawn.

To make this concrete, we can trace the cycle through a hypothetical MP3 player application:

1. When the user taps the screen image of the Play/Pause button, the framework creates a new **MotionEvent** containing, among other things, the screen coordinates of the tap. The framework enqueues the new event at the end of the event queue.
2. As described in [“The Controller” on page 169](#), when the event percolates through the queue, the framework removes it and passes it down the view tree to the leaf widget within whose bounding rectangle the tap occurred.
3. Because the button widget represents the Play/Pause button, the application button handling code tells the core (the model) that it should resume playing a tune.
4. The application model code starts playing the selected tune. In addition, it sends a redraw request to the UI framework.
5. The redraw request is added to the event queue and eventually processed as described in [“The View” on page 168](#).
6. The screen gets redrawn with the Play button in its playing state and everything is again in sync.

UI component objects such as buttons and text boxes actually implement both View and Controller methods. This only makes sense. When you add a **Button** to your application’s UI, you want it to appear on the screen as well as do something when the user pushes it. Even though the two logical elements of the UI, the View and the Controller, are implemented in the same object, you should take care that they do not directly interact. Controller methods, for instance, should never directly change the display. Leave it to the code that actually changes state to request a redraw and trust that, later, calls to rendering methods will allow the component to reflect the new state. Coding in this way minimizes synchronization problems and helps to keep your program robust and bug-free.

There is one more aspect of the Android UI framework that is important to recall: it is single-threaded. A single thread removes events from the event queue to make Controller callbacks and to render the view. This is significant for several reasons.



The simplest consequence of a single-threaded UI is that it is not necessary to use **synchronized** blocks to coordinate state between the View and the Controller. This is a valuable optimization.

Another advantage of a single-threaded UI is that the application is guaranteed that each event on the event queue is processed completely and in the order in which it was enqueued. That may seem fairly obvious, but its implications make coding the UI much easier. When a UI component is called to handle an event, it is guaranteed that no other UI processing will take place until it returns. That means, for instance, that a component that requests multiple changes in the program state—each of which causes a corresponding request that the screen be repainted—is guaranteed that the repaint will *not* start until it has completed processing, performed all its updates, and returned. In short, UI callbacks are atomic.

The third reason to remember that only a single thread is dequeuing and dispatching events from the UI event queue is that if your code stalls that thread for any reason, your UI will freeze! If a component’s response to an event is simple—changing the state of variables, creating new objects, and so on—it is perfectly correct to do that processing on the main event thread. If, on the other hand, the handler must retrieve a response from some distant network service or run a complex database query, the entire UI will become unresponsive until the request completes. That definitely does not make for a great user experience! Long-running tasks must be delegated to another thread, as described in [“Advanced Wiring: Focus and Threading” on page 189](#).

## Assembling a Graphical Interface

The Android UI framework provides both a complete set of drawing tools with which to build a UI, and a rich collection of prebuilt components based on these tools. As we will see in [Chapter 9](#), the framework graphics tools provide plenty of support for applications that need to create their own controls or to render special views. On the other hand, many applications may work very well using only canned views from the toolkit. In fact, the `MapActivity` and `MyLocationOverlay` classes make it possible to create extremely sophisticated applications without doing any custom drawing at all.

We’ve already used the term *widget* once or twice, without explicitly defining it. Recall that the screen is rendered by a tree of components. In the Android UI framework, these components are all subclasses of `android.view.View`. The views that are leaves or nearly leaves do most of the actual drawing and are, in the context of an application UI, commonly called widgets.

The internal nodes, sometimes called *container views*, are special components that can have other components as children. In the Android UI framework, container views are subclasses of `android.view.ViewGroup`, which, of course, is in turn a subclass of `View`. They typically do very little drawing. Instead, they are responsible for arranging their

child views on the screen and keeping them arranged as the View changes shape, orientation, and so on. Doing this can be complex.

To create complex displays, you need to assemble a tree of containers for the views you want to use in your application. [Example 7-1](#) shows an application with a view tree that is three layers deep. A vertical linear layout contains two horizontal linear layouts. Each horizontal layout, in turn, contains two widgets.

*Example 7-1. A complex view tree*

```
package com.oreilly.android.intro;

import android.app.Activity;
import android.graphics.Color;
import android.os.Bundle;
import android.view.Gravity;
import android.view.ViewGroup;
import android.widget.Button;
import android.widget.EditText;
import android.widget.LinearLayout;

public class AndroidDemo extends Activity {
    private LinearLayout root;

    @Override
    public void onCreate(Bundle state) {
        super.onCreate(state);

        LinearLayout.LayoutParams containerParams
            = new LinearLayout.LayoutParams(
                ViewGroup.LayoutParams.FILL_PARENT,
                ViewGroup.LayoutParams.WRAP_CONTENT,
                0.0F);

        LinearLayout.LayoutParams widgetParams
            = new LinearLayout.LayoutParams(
                ViewGroup.LayoutParams.FILL_PARENT,
                ViewGroup.LayoutParams.FILL_PARENT,
                1.0F);

        root = new LinearLayout(this);
        root.setOrientation(LinearLayout.VERTICAL);
        root.setBackgroundColor(Color.LTGRAY);
        root.setLayoutParams(containerParams);

        LinearLayout ll = new LinearLayout(this);
        ll.setOrientation(LinearLayout.HORIZONTAL);
        ll.setBackgroundColor(Color.GRAY);
        ll.setLayoutParams(containerParams);
        root.addView(ll);

        EditText tb = new EditText(this);
        tb.setText(R.string.defaultLeftText);
    }
}
```

```

        tb.setFocusable(false);
        tb.setLayoutParams(widgetParams);
        ll.addView(tb);

        tb = new EditText(this);
        tb.setText(R.string.defaultRightText);
        tb.setFocusable(false);
        tb.setLayoutParams(widgetParams);
        ll.addView(tb);

        ll = new LinearLayout(this);
        ll.setOrientation(LinearLayout.HORIZONTAL);
        ll.setBackgroundColor(Color.DKGRAY);
        ll.setLayoutParams(containerParams);
        root.addView(ll);

        Button b = new Button(this);
        b.setText(R.string.labelRed);
        b.setTextColor(Color.RED);
        b.setLayoutParams(widgetParams);
        ll.addView(b);

        b = new Button(this);
        b.setText(R.string.labelGreen);
        b.setTextColor(Color.GREEN);
        b.setLayoutParams(widgetParams);
        ll.addView(b);

        setContentView(root);
    }
}

```

Note that the code preserves a reference to the root of the view tree for later use.

This example uses three `LinearLayout` views. A `LinearLayout`, just as its name implies, is a `View` that displays its children in a row or column, as determined by its orientation property. The child views are displayed in the order in which they are *added* to the `LinearLayout` (regardless of the order in which they were *created*), in the directions common for Western readers: left to right and top to bottom. The button labeled “Green”, for instance, is in the lower-right corner of this layout, because it is the second thing added to the horizontal `LinearLayout` view, which was, in turn, the second thing added to the root, vertical `LinearLayout`.

[Figure 7-2](#) shows what the results might look like to the user. The seven views in the tree are structured as shown in [Figure 7-3](#).

The Android Framework provides a convenient capability for separating data resources from code. This is particularly useful in building `View` layouts. The previous example can be replaced with the dramatically simpler code in [Example 7-2](#) and the XML definition of the `View` layout in [Example 7-3](#).

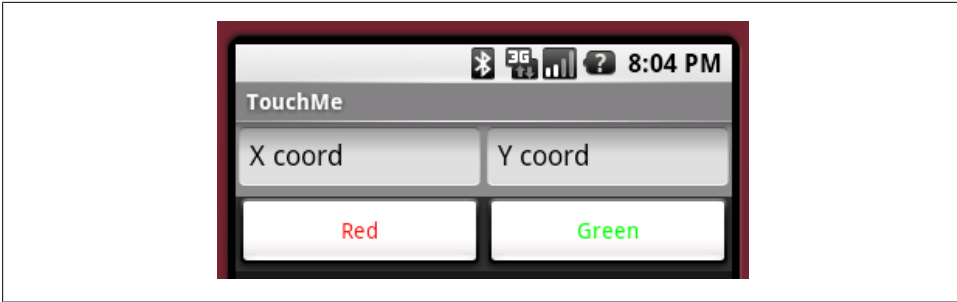

Figure 7-2. How panels appear to the viewer

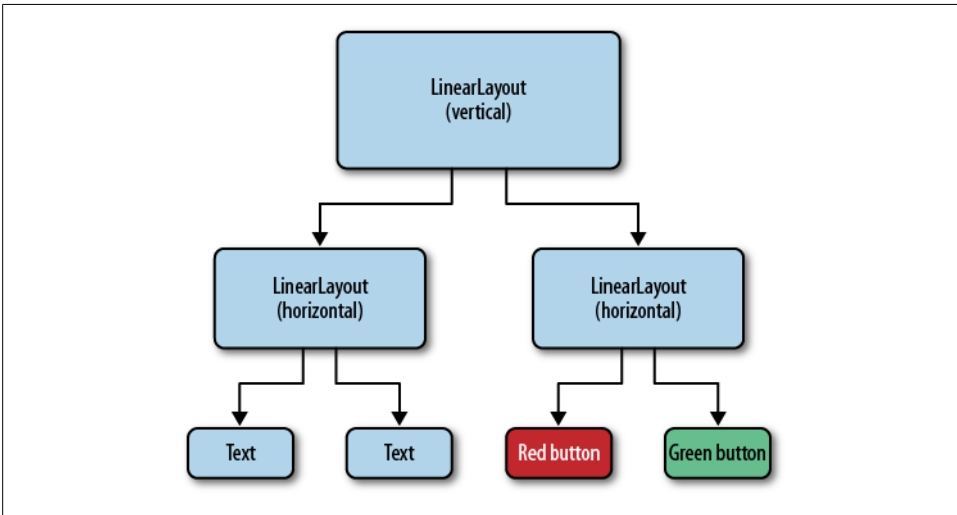

Figure 7-3. Hierarchy of panels in the View

Example 7-2. A complex View using a layout resource

```

package com.oreilly.android.intro;

import android.app.Activity;
import android.os.Bundle;

/**
 * Android UI demo program
 */
public class AndroidDemo extends Activity {
    private LinearLayout root;

    @Override public void onCreate(Bundle state) {
        super.onCreate(state);
        setContentView(R.layout.main);
        root = (LinearLayout) findViewById(R.id.root);
    }
}
  
```

```
}  
}
```

*Example 7-3. XML definition of a complex View layout resource*

```
<LinearLayout xmlns:android="http://schemas.android.com/apk/res/android"  
    android:id="@+id/root"  
    android:orientation="vertical"  
    android:background="@drawable/lt_gray"  
    android:layout_width="fill_parent"  
    android:layout_height="wrap_content">  
  
    <LinearLayout  
        android:orientation="horizontal"  
        android:background="@drawable/gray"  
        android:layout_width="fill_parent"  
        android:layout_height="wrap_content">  
  
        <EditText  
            android:id="@+id/text1"  
            android:text="@string/defaultLeftText"  
            android:focusable="false"  
            android:layout_width="fill_parent"  
            android:layout_height="fill_parent"  
            android:layout_weight="1"/>  
  
        <EditText  
            android:id="@+id/text2"  
            android:text="@string/defaultRightText"  
            android:focusable="false"  
            android:layout_width="fill_parent"  
            android:layout_height="fill_parent"  
            android:layout_weight="1"/>  
    </LinearLayout>  
  
    <LinearLayout  
        android:orientation="horizontal"  
        android:background="@drawable/dk_gray"  
        android:layout_width="fill_parent"  
        android:layout_height="wrap_content">  
  
        <Button  
            android:id="@+id/button1"  
            android:text="@string/labelRed"  
            android:textColor="@drawable/red"  
            android:layout_width="fill_parent"  
            android:layout_height="fill_parent"  
            android:layout_weight="1"/>  
  
        <Button  
            android:id="@+id/button2"  
            android:text="@string/labelGreen"  
            android:textColor="@drawable/green"  
            android:layout_width="fill_parent"  
            android:layout_height="fill_parent"  
            android:layout_weight="1"/>  
    </LinearLayout>  
</LinearLayout>
```

```
</LinearLayout>
</LinearLayout>
```

This version of the code, like the first one, also preserves a reference to the root of the view tree. It does this by tagging a widget in the XML layout (the root `LinearLayout`, in this case) with an `android:id` tag, and then using the `findViewById` method from the `Activity` class to recover the reference.

It is a very good idea to get into the habit of using a resource to define your view tree layout. Doing so allows you to separate the visual layout of a `View` from the code that brings it to life. You can tinker with the layout of a screen without recompiling. Most importantly, though, you can build your UI using tools that allow you to compose screens using a visual UI editor.



At Google I/O 2011, the Android Tools team introduced a new layout editor that is really exciting. It can even preview animations and developer-created views; most developers should never need to look at XML, let alone inline code, for laying out views ever again.

## Wiring Up the Controller

“[Assembling a Graphical Interface](#)” on page 171 demonstrated a `View` with two buttons. Although the buttons look nice—they even become highlighted when clicked—they aren’t very useful. Clicking them doesn’t actually do anything.

“[The Controller](#)” on page 169 described how the Android Framework translates external actions (screen taps, keypresses, etc.) into events that are enqueued and then passed into the application. [Example 7-4](#) shows how to add an event handler to one of the buttons in the demo so that it does something when it is clicked.

*Example 7-4. Wiring up a button*

```
@Override public void onCreate(Bundle state) {
    super.onCreate(state);
    setContentView(R.layout.main);

    final EditText tb1 = (EditText) findViewById(R.id.text1);
    final EditText tb2 = (EditText) findViewById(R.id.text2);

    ((Button) findViewById(R.id.button2)).setOnClickListener(
        new Button.OnClickListener() {
            // mRand is a class data member
            @Override public void onClick(View arg0) {
                tb1.setText(String.valueOf(mRand.nextInt(200)));
                tb2.setText(String.valueOf(mRand.nextInt(200)));
            }
        }
    );
}
```

When run, this version of the application still looks a lot like [Figure 7-2](#). Unlike the earlier example, though, in this version, every time a user clicks the button labeled “Green” the numbers in the `EditText` boxes change. This is illustrated in [Figure 7-4](#).

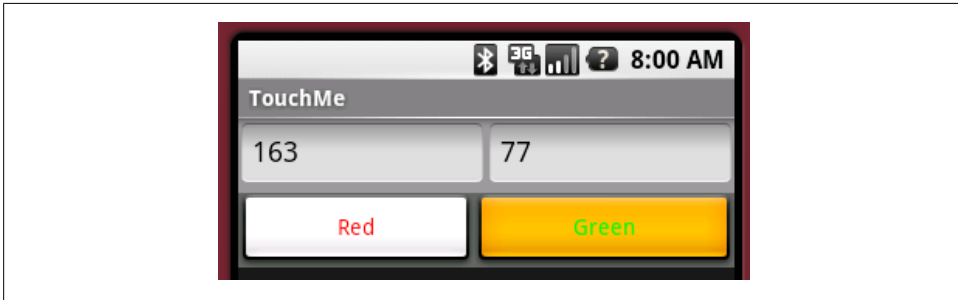

*Figure 7-4. Working button*

While simply changing numbers isn’t very interesting, this small example demonstrates the standard mechanism that an application uses to respond to UI events. It is important to note that, appearances notwithstanding, this example does not violate the MVC separation of concerns! In response to the call to `setText`, in this implementation of the `OnClickListener`, the `EditText` object updates an internal representation of the text it should display, and then calls its own `invalidate` method. It does not immediately draw on the screen. Very few rules in programming are absolute. The admonition to separate the Model, the View, and the Controller comes pretty close.

In the example, the instance of the `Button` class is wired to its behavior using a callback, as described in “[Overrides and callbacks](#)” on page 135. `Button` is a subclass of `View`, which defines an interface named `OnClickListener` and a method named `setOnClickListener` with which to register the listener. The `OnClickListener` interface defines a single method, `onClick`. When a `Button` receives an event from the framework, in addition to any other processing it might do, it examines the event to see if it qualifies as a “click.” (The button in our first example would become highlighted when pressed, even before the listener was added.) If the event does qualify as a click, and if a click listener has been installed, that listener’s `onClick` method is invoked.

The click listener is free to implement any custom behavior needed. In the example, the custom behavior creates two random numbers between 0 and 200 and puts one into each of the two text boxes. Instead of subclassing `Button` and overriding its event processing methods, all that is necessary to extend its behavior is to register a click listener that implements the desired behavior. Certainly a lot easier!

The click handler is especially interesting because, at the heart of the Android system—the framework event queue—there is no such thing as a click event! Instead, `View` event processing synthesizes the concept of a “click” from other events. If the device has a touch-sensitive screen, for instance, a single tap is considered a click. If the device has a center key in its D-pad, or an Enter key, pressing and releasing either will also register

as a click. View clients need not concern themselves with what exactly a click is, or how it is generated on a particular device. They need only handle the higher-level concept, leaving the details to the framework.

A `View` can have only one `onClickListener`. Calling `setOnClickListener` a second time, on a given `View`, will remove the old listener and install the new one. On the other hand, a single listener can listen to more than one `View`. The code in [Example 7-5](#), for instance, is part of another application that looks exactly like [Example 7-2](#). In this version, though, pushing *either* of the buttons will update the text box.

This capability can be very convenient in an application in which several actions produce the same behavior. Do not be tempted, though, to create a single, enormous listener in all of your widgets! Your code will be easier to maintain and modify if it contains multiple smaller listeners, each implementing a single, clear behavior.

*Example 7-5. Listening to multiple buttons*

```
@Override public void onCreate(Bundle state) {
    super.onCreate(state);
    setContentView(R.layout.main);

    final EditText tb1 = (EditText) findViewById(R.id.text1);
    final EditText tb2 = (EditText) findViewById(R.id.text2);

    Button.OnClickListener listener = new Button.OnClickListener() {
        @Override public void onClick(View arg0) {
            tb1.setText(String.valueOf(rand.nextInt(200)));
            tb2.setText(String.valueOf(rand.nextInt(200)));
        }
    };

    ((Button) findViewById(R.id.button1)).setOnClickListener(listener);
    ((Button) findViewById(R.id.button2)).setOnClickListener(listener);
}
```

## Listening to the Model

The Android UI framework uses the handler installation pattern pervasively. Although our earlier examples were all `Button` views, many other Android widgets define listeners. The `View` class defines several events and listeners that are ubiquitous, and which we will explore in further detail in a moment. Other classes, however, define other, specialized types of events and provide handlers for those events that are meaningful only for those classes. This is a standard idiom that allows clients to customize the behavior of a widget without having to subclass it.

This pattern is also an excellent way for your program to handle its own external, asynchronous actions. Whether responding to a change in state on a remote server or an update from a location-based service, your application can define its own events and listeners to allow its clients to react.



The examples so far have been elementary and have cut several corners. While they demonstrate connecting a View and a Controller, they have not had real models ([Example 7-4](#) actually used a `String` owned by the implementation of `EditText` as a model). To continue, we're going to have to take a brief detour to build a real, usable model.

The following two classes shown in [Example 7-6](#) comprise a Model that will support extensions to the demo application. They provide a facility for storing a list of objects, each of which has *x* and *y* coordinates, a color, and a size. They also provide a way to register a listener, and an interface that the listener must implement. The common Listener model underlies these examples, so they are fairly straightforward.

*Example 7-6. The Dots model*

```
package com.oreilly.android.intro.model;

/** A dot: the coordinates, color and size. */
public final class Dot {
    private final float x, y;
    private final int color;
    private final int diameter;

    /**
     * @param x horizontal coordinate.
     * @param y vertical coordinate.
     * @param color the color.
     * @param diameter dot diameter.
     */
    public Dot(float x, float y, int color, int diameter) {
        this.x = x;
        this.y = y;
        this.color = color;
        this.diameter = diameter;
    }

    /** @return the horizontal coordinate. */
    public float getX() { return x; }

    /** @return the vertical coordinate. */
    public float getY() { return y; }

    /** @return the color. */
    public int getColor() { return color; }

    /** @return the dot diameter. */
    public int getDiameter() { return diameter; }
}

package com.oreilly.android.intro.model;

import java.util.Collections;
import java.util.LinkedList;
import java.util.List;
```

```

/** A list of dots. */
public class Dots {
    /** DotChangeListener. */
    public interface DotsChangeListener {
        /** @param dots the dots that changed. */
        void onDotsChange(Dots dots);
    }

    private final LinkedList<Dot> dots = new LinkedList<Dot>();
    private final List<Dot> safeDots = Collections.unmodifiableList(dots);

    private DotsChangeListener dotsChangeListener;

    /** @param l the new change listener. */
    public void setDotsChangeListener(DotsChangeListener l) {
        dotsChangeListener = l;
    }

    /** @return the most recently added dot, or null. */
    public Dot getLastDot() {
        return (dots.size() <= 0) ? null : dots.getLast();
    }

    /** @return the list of dots. */
    public List<Dot> getDots() { return safeDots; }

    /**
     * @param x dot horizontal coordinate.
     * @param y dot vertical coordinate.
     * @param color dot color.
     * @param diameter dot size.
     */
    public void addDot(float x, float y, int color, int diameter) {
        dots.add(new Dot(x, y, color, diameter));
        notifyListener();
    }

    /** Delete all the dots. */
    public void clearDots() {
        dots.clear();
        notifyListener();
    }

    private void notifyListener() {
        if (null != dotsChangeListener) {
            dotsChangeListener.onDotsChange(this);
        }
    }
}

```

In addition to using this model, the next example also introduces a library widget used to view it, the `DotView`. Its job is to draw the dots represented in the model, in the correct

color, at the correct coordinates. The complete source for the application is on the website for this book.

[Example 7-7](#) shows the new demo application, after adding the new Model and view.

*Example 7-7. The Dots demo*

```
package com.oreilly.android.intro;

import java.util.Random;

import android.app.Activity;
import android.graphics.Color;
import android.os.Bundle;
import android.view.View;
import android.widget.Button;
import android.widget.EditText;
import android.widget.LinearLayout;

import com.oreilly.android.intro.model.Dot;
import com.oreilly.android.intro.model.Dots;
import com.oreilly.android.intro.view.DotView;

/** Android UI demo program */
public class TouchMe extends Activity {
    public static final int DOT_DIAMETER = 6;

    private final Random rand = new Random();

    final Dots dotModel = new Dots();

    DotView dotView;

    /** Called when the activity is first created. */
    @Override public void onCreate(Bundle state) {
        super.onCreate(state);

        dotView = new DotView(this, dotModel);

        // install the View
        setContentView(R.layout.main);
        ((LinearLayout) findViewById(R.id.root)).addView(dotView, 0);❶

        // wire up the Controller
        ((Button) findViewById(R.id.button1)).setOnClickListener(
            new Button.OnClickListener() {❷
                @Override public void onClick(View v) {
                    makeDot(dots, dotView, Color.RED);❸
                }
            });
        ((Button) findViewById(R.id.button2)).setOnClickListener(
            new Button.OnClickListener() {❷
                @Override public void onClick(View v) {
                    makeDot(dots, dotView, Color.GREEN);❸
                }
            });
    }
}
```

```

final EditText tb1 = (EditText) findViewById(R.id.text1);
final EditText tb2 = (EditText) findViewById(R.id.text2);
dots.setDotsChangeListener(new Dots.DotsChangeListener() {④
    @Override public void onDotsChange(Dots d) {
        Dot d = dots.getLastDot();
        tb1.setText((null == d) ? "" : String.valueOf(d.getX()));
        tb2.setText((null == d) ? "" : String.valueOf(d.getY()));
        dotView.invalidate();
    } });
}

/**
 * @param dots the dots we're drawing
 * @param view the view in which we're drawing dots
 * @param color the color of the dot
 */
void makeDot(Dots dots, DotView view, int color) {⑤
    int pad = (DOT_DIAMETER + 2) * 2;
    dots.addDot(
        DOT_DIAMETER + (rand.nextFloat() * (view.getWidth() - pad)),
        DOT_DIAMETER + (rand.nextFloat() * (view.getHeight() - pad)),
        color,
        DOT_DIAMETER);
}
}

```

Here are some of the highlights of the code:

- ❶ The new `DotView` is added to the top of the layout obtained from the XML definition.
- ❷ `onClick` listener callbacks are added to the “Red” and “Green” buttons. These event handlers differ from those in the previous example only in that, here, their behavior is proxied to the local method `makeDot`. This new method creates a dot (item 5).
- ❸ A call to `makeDot` is made within `onClick` (to take place when the button is clicked).
- ❹ The most substantial change to the example, this is where the Model is wired to the View, using a callback to install a `dotsChangeListener`. When the Model changes, this new listener is called. It installs the *x* and *y* coordinates of the last dot into the left and right text boxes, respectively, and requests that the `DotView` redraw itself (the `invalidate` call).
- ❺ This is the definition of `makeDot`. This new method creates a dot, checking to make sure it is within the `DotView`'s borders, and adds it to the model. It also allows the dot's color to be specified as a parameter.

Figure 7-5 shows what the application looks like when run.

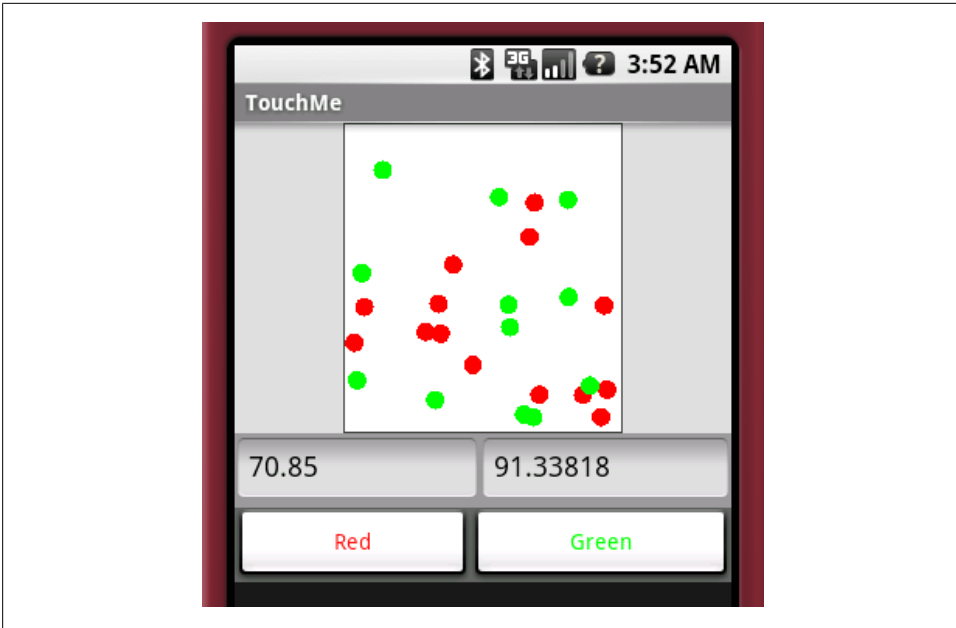

Figure 7-5. Running the Dots demo

Pushing the button labeled “Red” adds a new red dot to the `DotView`. Pushing the “Green” button adds a green one. The text fields contain the coordinates of the last dot added.

The basic structure of [Example 7-2](#) is still recognizable, with some extensions.

Here is the chain of events that results from clicking, for instance, the “Green” button:

1. When the button is clicked, its `onClickHandler` is called.
2. This causes a call to `makeDot` with the color argument `Color.GREEN`. The `makeDot` method generates random coordinates and adds a new, green `Dot` to the `Model` at those coordinates.
3. When the `Model` is updated, it calls its `onDotsChangeListener`.
4. The listener updates the values in the text views and requests that the `DotView` be redrawn.

## Listening for Touch Events

Modifying the demo application to handle taps, as you have surely guessed, is just a matter of adding a tap handler. The code in [Example 7-8](#) extends the demo application to place a cyan dot in the `DotView` at the point at which the screen is tapped. This code would be added to the demo application ([Example 7-7](#)) at the beginning of the `onCreate` function right after the call to its parent method. Notice that, because the code

that displays the  $x$  and  $y$  coordinates of the most recently added dot is wired only to the model, it continues to work correctly, no matter how the View adds the dot.

*Example 7-8. Touchable dots*

```
dotView.setOnTouchListener(new View.OnTouchListener() {
    @Override public boolean onTouch(View v, MotionEvent event) {
        if (MotionEvent.ACTION_DOWN != event.getAction()) {
            return false;
        }
        dots.addDot(event.getX(), event.getY(), Color.CYAN, DOT_DIAMETER);
        return true;
    }
});
```

The `MotionEvent` passed to the handler has several other properties in addition to the location of the tap that caused it. As the example indicates, it also contains the event type, one of `DOWN`, `UP`, `MOVE`, or `CANCEL`. A simple tap actually generates one `DOWN` and one `UP` event. Touching and dragging generates a `DOWN` event, a series of `MOVE` events, and a final `UP` event.

The gesture handling facilities provided by the `MotionEvent` are very interesting. The event contains the size of the touched area and the amount of pressure applied. That means that, on devices that support it, an application might be able to distinguish between a tap with one finger and a tap with two fingers, or between a very light brush and a firm push.

Efficiency is still important in the mobile world. A UI framework confronts the horns of a dilemma when tracking and reporting touch-screen events. Reporting too few events might make it impossible to follow motion with sufficient accuracy to do, for instance, handwriting recognition. On the other hand, reporting too many touch samples, each in its own event, could load a system unacceptably. The Android UI framework addresses this problem by bundling groups of samples together, reducing the load while still maintaining accuracy. To see all the samples associated with an event, use the history facility implemented with the methods `getHistoricalX`, `getHistoricalY`, and so on.

[Example 7-9](#) shows how to use the history facility. It extends the demo program to track a user's gestures when he touches the screen. The framework delivers sample  $x$  and  $y$  coordinates to the `onTouch` method of an object installed as the `OnTouchListener` for the `DotView`. The method displays a cyan dot for each sample.

*Example 7-9. Tracking motion*

```
private static final class TrackingTouchListener
    implements View.OnTouchListener
{
    private final Dots mDots;

    TrackingTouchListener(Dots dots) { mDots = dots; }

    @Override public boolean onTouch(View v, MotionEvent evt) {
```

```

switch (evt.getAction()) {
    case MotionEvent.ACTION_DOWN:
        break;

    case MotionEvent.ACTION_MOVE:
        for (int i = 0, n = evt.getHistorySize(); i < n; i++) {
            addDot(
                mDots,
                evt.getHistoricalX(i),
                evt.getHistoricalY(i),
                evt.getHistoricalPressure(i),
                evt.getHistoricalSize(i));
        }
        break;

    default:
        return false;
}

addDot(
    mDots,
    evt.getX(),
    evt.getY(),
    evt.getPressure(),
    evt.getSize());

return true;
}

private void addDot(Dots dots, float x, float y, float p, float s) {
    dots.addDot(
        x,
        y,
        Color.CYAN,
        (int) ((p * s * Dot.DIAMETER) + 1));
}
}

```

Figure 7-6 shows what the extended version of the application might look like after a few clicks and drags.

The implementation uses the size and pressure at a given location's sample to determine the diameter of the dot drawn there. Unfortunately, the Android emulator does not emulate touch pressure and size, so all the dots have the same diameter. Size and pressure values are normalized across devices, as floating-point values between 0.0 and 1.0. It is possible, however, depending on the calibration of the screen, that either value may actually be larger than 1.0. The emulator always reports the event pressure and size as zero, their minimum value.

The loop that handles `ACTION_MOVE` events processes batched historical events. When touch samples change more quickly than the framework can deliver them, the framework bundles them into a single event. The `MotionEvent` method `getHistorySize` returns

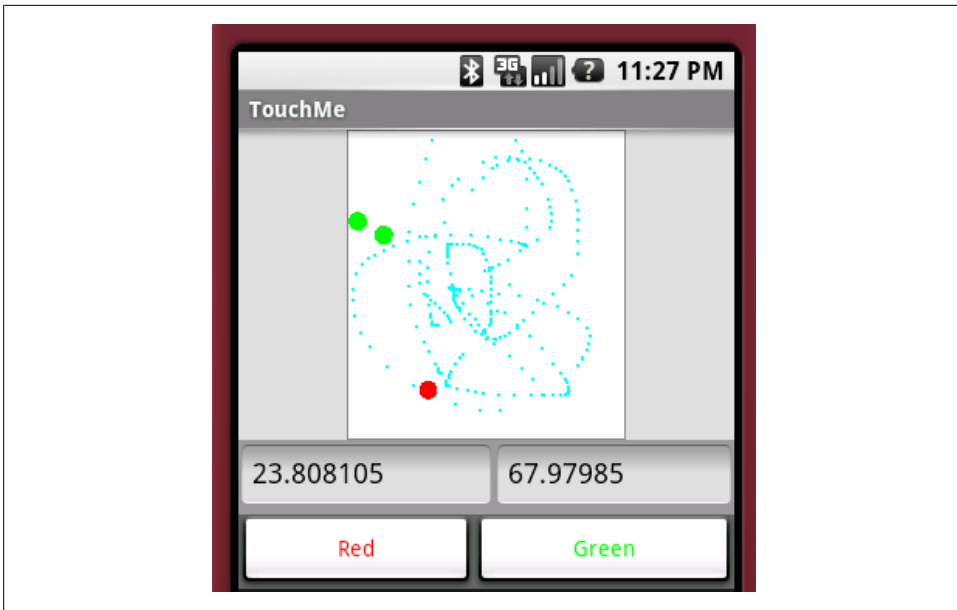

Figure 7-6. Running the Dots demo for an extended time

the number of samples in the batch, and the various `getHistory` methods get the subevent specifics.

Devices with trackballs also generate `MotionEvent`s when the trackball is moved. These events are similar to those generated by taps on a touch-sensitive screen, but they are handled differently. Trackball `MotionEvent`s are passed into the `View` through a call to `dispatchTrackballEvent`, not to `dispatchTouchEvent`, which delivered taps. While `dispatchTrackballEvent` does pass the event to `onTrackballEvent`, it does not first pass the event to a listener! Not only are trackball-generated `MotionEvent`s not visible through the normal tap handling machinery but, in order to respond to them, a widget must subclass `View` and override the `onTrackballEvent` method.

`MotionEvent`s generated by the trackball are handled differently in yet another way. If they are not *consumed* (to be defined shortly) they are converted into D-pad key events. This makes sense when you consider that most devices have either a D-pad or a trackball, but not both. Without this conversion, it wouldn't be possible to generate D-pad events on a device with only a trackball. Of course, it also implies that an application that handles trackball events must do so carefully, lest it break the translation.

## Listening for Key Events

Handling keystroke input across multiple platforms can be very tricky. Some devices have many more keys than others, some require triple-tapping for character input, and



so on. This is a great example of something that should be left to the framework—`EditText` or one of its subclasses—whenever possible.

To extend a widget's `KeyEvent` handling, use the `View` method `setOnKeyListener` to install an `OnKeyListener`. The listener will be called with multiple `KeyEvents` for each user keystroke, one for each action type: `DOWN`, `UP`, and `MULTIPLE`. The action types `DOWN` and `UP` indicate a key was pressed or released, just as they did for the `MotionEvent` class. A key action of `MULTIPLE` indicates that a key is being held down (autorepeating). The `KeyEvent` method `getRepeatCount` gives the number of keystrokes that a `MULTIPLE` event represents.

[Example 7-10](#) shows a sample key handler. When added to the demo program, it causes dots to be added to the display, at randomly chosen coordinates, when keys are pressed and released. A magenta dot is added when the space bar is pressed and released, a yellow dot when the Enter key is pressed and released, and a blue dot when any other key is pressed and released.

*Example 7-10. Handling keys*

```
dotView.setFocusable(true);

dotView.setOnKeyListener(new OnKeyListener() {
    @Override public boolean onKey(View v, int keyCode, KeyEvent event) {
        if (KeyEvent.ACTION_UP != event.getAction()) {
            int color = Color.BLUE;
            switch (keyCode) {
                case KeyEvent.KEYCODE_SPACE:
                    color = Color.MAGENTA;
                    break;
                case KeyEvent.KEYCODE_ENTER:
                    color = Color.YELLOW;
                    break;
                default: ;
            }

            makeDot(dots, dotView, color);
        }

        return true;
    } });
```

## Alternative Ways to Handle Events

You've probably noticed that the `on...` methods of all the listeners introduced thus far—including `onKey`—return a `boolean` value. This is a pattern for listeners that allows them to control subsequent event processing by their caller.

When a Controller event is handed to a widget, the framework code in the widget dispatches it, depending on its type, to an appropriate method: `onKeyDown`, `onTouchEvent`, and so on. These methods, either in `View` or in one of its subclasses, implement the widget's behavior. As described earlier, though, the framework first offers the event

to an appropriate listener (`onTouchListener`, `onKeyListener`, etc.) if one exists. The listener's return value determines whether the event is then dispatched to the `View` methods.

If the listener returns `false`, the event is dispatched to the `View` methods as though the handler did not exist. If, on the other hand, a listener returns `true`, the event is said to have been *consumed*. The `View` aborts any further processing for it. The `View` methods are never called and have no opportunity to process or respond to the event. As far as the `View` methods are concerned, it is as though the event did not exist.

There are, then, three ways that an event might be processed:

#### *No listener*

The event is dispatched to the `View` methods for normal handling. A widget implementation may, of course, override these methods.

#### *A listener exists and returns true*

Listener event handling completely replaces normal widget event handling. The event is never dispatched to the `View`.

#### *A listener exists and returns false*

The event is processed by the listener and then by the `View`. After listener event handling is completed the event is dispatched to the `View` for normal handling.

Consider, for instance, what would happen if the key listener from [Example 7-10](#) were added to an `EditText` widget. Since the `onKey` method always returns `true`, the framework will abort any further `KeyEvent` processing as soon as the method returns. That would prevent the `EditText` key handling mechanism from ever seeing the key events, and no text would ever appear in the text box. That is probably not the intended behavior!

If the `onKey` method instead returns `false` for some key events, the framework will dispatch those events to the `EditText` widget for continued processing. The `EditText` mechanism will see the events, and the associated characters will be appended to the `EditText` box, as expected. [Example 7-11](#) shows an extension of [Example 7-10](#) that, in addition to adding new dots to the model, also filters the characters passed to the hypothetical `EditText` box. It allows numeric characters to be processed normally but hides everything else.

#### *Example 7-11. Extended key handling*

```
new OnKeyListener() {
    @Override public boolean onKey(View v, int keyCode, KeyEvent event) {
        if (KeyEvent.ACTION_UP != event.getAction()) {
            int color = Color.BLUE;
            switch (keyCode) {
                case KeyEvent.KEYCODE_SPACE:
                    color = Color.MAGENTA;
                    break;
                case KeyEvent.KEYCODE_ENTER:
                    color = Color.YELLOW;
            }
        }
    }
}
```

```

        break;
        default: ;
    }

    makeDot(dotModel, dotView, color);
}

return (keyCode < KeyEvent.KEYCODE_0)
    || (keyCode > KeyEvent.KEYCODE_9);
}
}

```

If your application needs to implement entirely new ways of handling events—something that cannot be implemented reasonably by augmenting behavior and filtering, using an `onKeyListener`—you will have to understand and override `View` key event handling. To sketch the process: events are dispatched to the `View` through the `DispatchKeyEvent` method. `DispatchKeyEvent` implements the behavior described previously, offering the event to the `onKeyListener` first, and then, if the handler returns `false`, to the `View` methods implementing the `KeyEvent.Callback` interface: `onKeyDown`, `onKeyUp`, and `onKeyMultiple`.

## Advanced Wiring: Focus and Threading

As demonstrated in [Example 7-7](#) and “[Listening for Touch Events](#)” on page 183, `MotionEvent`s are delivered to the widget whose bounding rectangle contains the coordinates of the touch that generated them. It isn’t quite so obvious how to determine which widget should receive a `KeyEvent`. To do this, the Android UI framework, like most other UI frameworks, supports the concept of selection, or *focus*.

In order to accept focus, a widget’s `focusable` attribute must be set to `true`. This can be done using either an XML layout attribute (the `EditText` views in [Example 7-3](#) have their `focusable` attribute set to `false`) or the `setFocusable` method, as shown in the first line of [Example 7-10](#). A user changes which `View` has focus using D-pad keys or by tapping the screen when touch is supported.

When a widget is in focus, it usually renders itself with some kind of highlighting to provide feedback that it is the current target of keystrokes. For instance, when an `EditText` widget is in focus, it is drawn both highlighted and with a cursor at the text insert position.

To receive notification when a `View` enters or leaves focus, install an `OnFocusChangeListener`. [Example 7-12](#) shows the listener needed to add a focus-related feature to the demo program. It causes a randomly positioned black dot to be added to the `DotView` automatically, at random intervals, whenever it is in focus.

*Example 7-12. Handling focus*

```
dotView.setOnFocusChangeListener(new OnFocusChangeListener() {
    @Override public void onFocusChange(View v, boolean hasFocus) {
        if (!hasFocus && (null != dotGenerator)) {
            dotGenerator.done();
            dotGenerator = null;
        }
        else if (hasFocus && (null == dotGenerator)) {
            dotGenerator = new DotGenerator(dots, dotView, Color.BLACK);
            new Thread(dotGenerator).start();
        }
    }
});
```

There should be few surprises in the `OnFocusChangeListener`. When the `DotView` comes into focus, it creates the `DotGenerator` and spawns a thread to run it. When the widget leaves focus, the `DotGenerator` is stopped, and freed. The new data member `dotGenerator` (whose declaration is not shown in the example) is non-null only when the `DotView` is in focus. There is another important and powerful tool in the implementation of `DotGenerator`, and we'll return to it in a moment.

Focus is transferred to a particular widget by calling its `View` method, `requestFocus`. When `requestFocus` is called for a new target widget, the request is passed up the tree, parent by parent, to the tree root. The root remembers which widget is in focus and passes subsequent key events to it, directly.

This is exactly how the UI framework changes focus to a new widget in response to D-pad keystrokes. The framework identifies the widget that will next be in focus and calls that widget's `requestFocus` method. This causes the previously focused widget to lose focus and the target to gain it.

The process of identifying the widget that will gain focus is complicated. To do it, the navigation algorithm has to perform some tricky calculations that may depend on the locations of every other widget on the screen!

Consider, for instance, what happens when the right D-pad button is pressed and the framework attempts to transfer focus to the widget immediately to the right of the one that is currently in focus. It is may be completely obvious which widget that is when looking at the screen; in the view tree, however, it is not nearly so obvious. The target widget may be at another level in the tree and several branches away. Identifying it depends on the exact dimensions of widgets in yet other, distant parts of the tree. Fortunately, despite the considerable complexity, the Android UI framework implementation usually just works as expected.

When it does not, there are four properties—set either by application method or by XML attribute—that can be used to force the desired focus navigation behavior. They are `nextFocusDown`, `nextFocusLeft`, `nextFocusRight`, and `nextFocusUp`. Setting one of these properties with a reference to a specific widget will ensure that D-pad navigation transfers focus directly to that widget, when navigating in the respective direction.

Another complexity of the focus mechanism is the distinction that the Android UI framework makes between D-pad focus and touch focus, for devices with touch-sensitive screens. To understand why this is necessary, recall that, on a screen that does not accept touch input, the only way to push a button is to focus on it, using D-pad navigation, and then to use the center D-pad key to generate a click. On a screen that does accept touch events, however, there is no reason, ever, to focus on a button. Tapping the button clicks it, regardless of which widget happens to be in focus at the time. Even on a touch-sensitive screen, however, it is still necessary to be able to focus on a widget that accepts keystrokes—an `EditText` widget, for instance—in order to identify it as the target for subsequent key events. To handle both kinds of focus correctly, you will have to look into `View` handling of `FOCUSABLE_IN_TOUCH_MODE`, and the `View` methods `isFocusableInTouchMode` and `isInTouchMode`.

In an application with multiple windows, there is at least one more twist in the focus mechanism. It is possible for a window to lose focus without notifying the currently in-focus widget, in that window, that its focus has been lost. This makes sense when you think about it. If the out-of-focus window is brought back to the top, the widget that was in focus in that window will again be in focus, with no other action.

Consider entering a friend’s phone number into an address book application. Suppose you momentarily switch back to a phone application to refresh your memory of the last few digits of her phone number. You’d be annoyed if, on returning to the address book, you had to again focus on the `EditText` box in which you’d been typing. You expect the state to be just as you left it.

On the other hand, this behavior can have surprising side effects. In particular, the implementation of the auto-dot feature presented in [Example 7-12](#) continues to add dots to the `DotView` even when it is hidden by another window! If a background task should run only when a particular widget is visible, that task must be cleaned up when the widget loses focus, when the `Window` loses focus, and when the `Activity` is paused or stopped.

Most of the implementation of the focus mechanism is in the `ViewGroup` class, in methods like `requestFocus` and `requestChildFocus`. Should it be necessary to implement an entirely new focus mechanism, you’ll need to look carefully at these methods, and override them appropriately.

Leaving the subject of focus and returning to the implementation of the newly added auto-dot feature, [Example 7-13](#) shows the implementation of `DotGenerator`.

*Example 7-13. Handling threads*

```
private final class DotGenerator implements Runnable {
    final Dots dots;
    final DotView view;
    final int color;

    private final Handler hdlr = new Handler();❶
    private final Runnable makeDots = new Runnable() {❷
```

```

    public void run() { makeDot(dots, view, color); }
};

private volatile boolean done;

// Runs on the main thread
DotGenerator(Dots dots, DotView view, int color) {❸
    this.dots = dots;
    this.view = view;
    this.color = color;
}

// Runs on the main thread
public void done() { done = true; }

// Runs on a different thread!
public void run() {
    while (!done) {
        try { Thread.sleep(1000); }
        catch (InterruptedException e) { }
        hdlr.post(makeDots);❹
    }
}
}

```

Here are some of the highlights of the code:

- ❶ An `android.os.Handler` object is created.
- ❷ A new thread that will run `makeDot` in item 4 is created.
- ❸ `DotGenerator` is run on the main thread.
- ❹ `makeDot` is run from the `Handler` created in item 1.

A naive implementation of `DotGenerator` would simply call `makeDot` directly within its run block. Doing this wouldn't be safe, however, unless `makeDot` was thread-safe—and the `Dots` and `DotView` classes, too, for that matter. This would be tricky to get correct and hard to maintain. In fact, the Android UI framework actually forbids access to a `View` from multiple threads. Running the naive implementation would cause the application to fail with a `RuntimeException` similar to this:

```

11-30 02:42:37.471: ERROR/AndroidRuntime(162):
    android.view.ViewRoot$CalledFromWrongThreadException:
        Only the original thread that created a view hierarchy can touch its views.

```

We met this problem and one solution, the `Handler`, in [Chapter 6](#). To get around the restriction, `DotGenerator` creates a `Handler` object within its constructor. A `Handler` object is associated with the thread on which it is created and provides safe, concurrent access to the canonical event queue for that thread.

Because `DotGenerator` creates a `Handler` during its own construction, the `Handler` is associated with the main thread. Now `DotGenerator` can use the `Handler` to enqueue from another thread a `Runnable` that calls `makeDot` from the UI thread. It turns out, as

you might guess, that the canonical event queue to which the `Handler` points is exactly the same one that is used by the UI framework. The call to `makeDot` is dequeued and dispatched, like any other UI event, in its proper order. In this case, that causes its `Runnable` to be run. `makeDot` is called from the main thread, and the UI stays single-threaded.

It is worth reiterating that this is an essential pattern for coding with the Android UI framework. Whenever processing that is started on behalf of the user might take more than a few milliseconds to complete, doing that processing on the main thread might cause the entire UI to become sluggish or, worse, to freeze for a long time. If the main application thread does not service its event queue for a couple of seconds, the Android OS will kill the application for being unresponsive! The `Handler` and `AsyncTask` classes allows the programmer to avoid this danger by delegating slow or long-running tasks to other threads so that the main thread can continue to service the UI. This example demonstrates using a `Thread` with a `Handler` that periodically enqueues updates for the UI.

The demo application takes a slight shortcut here. It enqueues the creation of a new dot and its addition to the dot `Model` on the main thread. A more complex application might pass a main-thread `Handler` to the model, on creation, and provide a way for the UI to get a model-thread `Handler` from the model. The main thread would receive update events enqueued for it by the model, using its main-thread `Handler`. The model, running in its own thread, would use the `Looper` class to dequeue and dispatch incoming messages from the UI. Before architecting anything that complex, though, you should consider using a `Service` or a `ContentProvider` (see [Chapter 13](#)).

Passing events between the UI and long-running threads in this way dramatically reduces the constraints required to maintain thread safety. In particular, recall from [Chapter 6](#) that if an enqueueing thread retains no references to an enqueued object, or if that object is immutable, no additional synchronization is necessary.

## The Menu

The final aspect of application control we'll cover in this chapter is the menu. [Example 7-14](#) shows how to implement a simple menu by overriding two `Activity` methods.

*Example 7-14. Implementing a menu*

```
@Override public boolean onCreateOptionsMenu(Menu menu) {
    menu.add(Menu.NONE, CLEAR_MENU_ID, Menu.NONE, "Clear");
    return true;
}

@Override public boolean onOptionsItemSelected(MenuItem item) {
    switch (item.getItemId()) {
        case 1:
            dotModel.clearDots();
            return true;
    }
}
```

```

    default: ;
}
return false;
}

```

When this code is added to the `TouchMe` class, clicking the device's Menu key will cause the application to present a menu, as shown in [Figure 7-7](#).

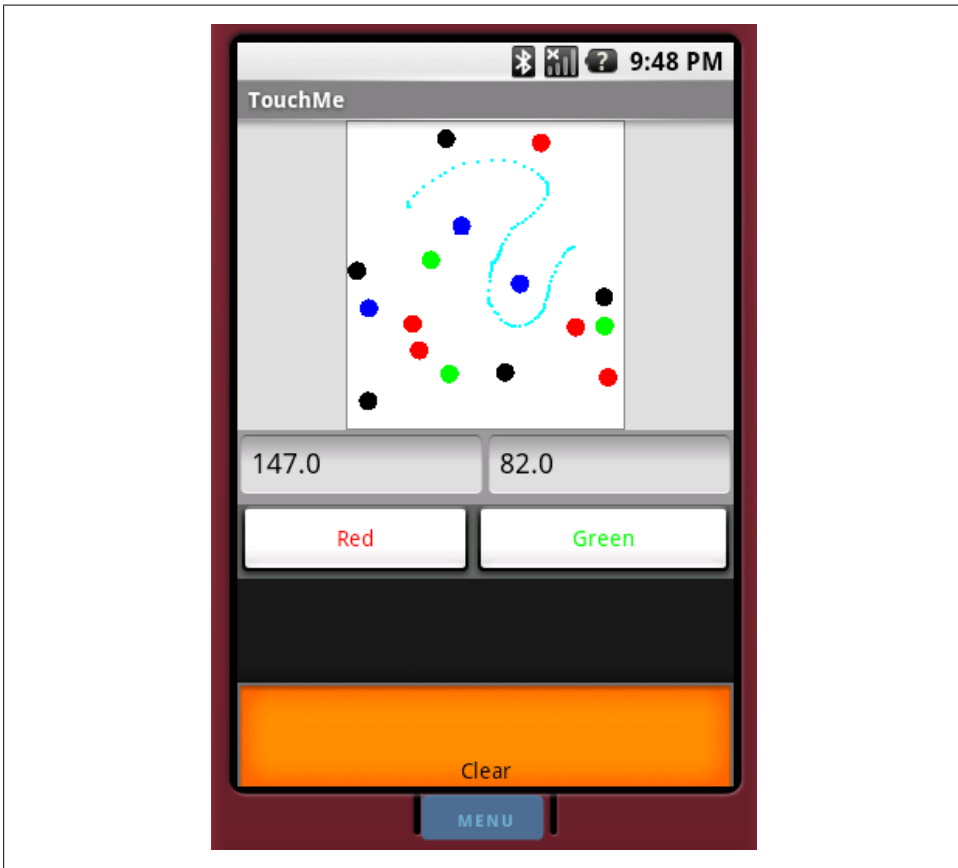

Figure 7-7. A simple menu

Clicking the Enter key, or tapping the menu item again, will clear the dot view.

Interestingly, if you run this application, you will find that while the added menu item works most of the time, it does not work when the `DotView` is in focus. Can you guess why?

If you guessed that the problem is caused by the `OnKeyListener` installed in the `DotView`, you are correct! As implemented in [Example 7-15](#), the listener swallows the menu



key event by returning `true` when it is clicked. This prevents the standard `View` processing of the menu key keystroke. In order to make the menu work, the `OnKeyListener` needs a new case.

*Example 7-15. Improved key handling*

```
switch (keyCode) {
    case KeyEvent.KEYCODE_MENU:
        return false;
    // ...
```

The Android UI framework also supports contextual menus. A `ContextMenu` appears in response to a long click in a widget that supports it. The code required to add a contextual menu to an application is entirely analogous to that for the options menu shown earlier except that the respective methods are `onCreateContextMenu` and `onContextItemSelected`. One additional call is required. In order to support contextual menus, a widget must be assigned a `View.OnCreateContextMenuListener` by calling its `View` method `setOnCreateContextMenuListener`. Fortunately, since `Activity` implements the `View.OnCreateContextMenuListener` interface, a common idiom looks like the code shown in [Example 7-16](#).

*Example 7-16. Installing a ContextMenuListener*

```
findViewById(R.id.ctxtMenuView).setOnCreateContextMenuListener(this);
```

Simply overriding the default, empty `Activity` implementations of the context menu's listener methods will give your application a context menu.

This chapter showed how the Android Controller interface works overall, and gave you the tools to manipulate its basic components: windows, views, and events. The following two chapters show you how to do your own graphics programming.



---

# Fragments and Multiplatform Support

Now that you have written some Android code you know that **Activity**, **View**, and the layout and widget subclasses of **View** are among the most important classes in Android. Typically, an Android user interface is built from widget views organized in layouts: a **ListView** in a **LinearLayout**, for instance. A single hierarchy of view objects gets loaded from a resource (or created by code) when an **Activity** is started. It is initialized and displayed on the device screen.

For small screens, this is fine: users move from screen to screen to access different parts of a program's UI, and the **Activity** class (Android's concept of a task) supports a back stack that enables quick and intuitive traversal through the strictly tree-structured interface. This changes completely, however, when the UI is spread over the surface of a larger tablet screen. Some parts of the screen remain constant over longer durations than others. Some parts of the screen determine the contents of other parts. A card-stack metaphor just doesn't cut it.

It is entirely possible to implement UIs in which some parts of the screen change in response to activities in another part, simply by showing and hiding views. Android's developers decided, however, that they needed more than just convention to encourage great large-screen UIs with a consistent feel and behavior. In order to facilitate this new kind of interaction, they introduced a new feature based on the **Fragment** class, as part of the Android 3.0 SDK (API 11, Honeycomb).

A **Fragment** object is somewhere between a **View** and an **Activity**. Like a **View**, it can be added to a **ViewGroup** or be part of a layout. It isn't a subclass of **View**, however, and can only be added to a **ViewGroup** using a **FragmentTransaction**. Like an **Activity**, a **Fragment** has a life cycle and implements both the **ComponentCallbacks** and **View.OnCreateContextMenuListener** interfaces. Unlike an **Activity**, though, a **Fragment** is not a **Context**, and its life cycle is dependent on that of the **Activity** to which it belongs.

Fragments constitute a major change in the Android API. In order to ease transition to the new API, Google provides a compatibility library that supports the feature in versions as far back as version 2.0 of the SDK (API 5, Éclair). We'll have a look at backward

compatibility in a moment. First, though, let's look at fragments in their native environment, Honeycomb.

## Creating a Fragment

Like any other view object, a fragment can either be part of the XML definition of a layout, or be added to a view programmatically. In a layout, a fragment looks like this:

```
<LinearLayout
    xmlns:android="http://schemas.android.com/apk/res/android"
    android:orientation="horizontal"
    android:layout_width="fill_parent"
    android:layout_height="fill_parent"
    >

    <fragment
        class="com.oreilly.demo.android.ch085.contactviewer.DateTime"
        android:id="@+id/date_time"
        android:layout_width="fill_parent"
        android:layout_height="fill_parent"
        />

</LinearLayout>
```

An activity would use this layout in the normal way:

```
@Override
public void onCreate(Bundle state) {
    super.onCreate(state);
    setContentView(R.layout.main);
}
```

This should all look pretty familiar by now. The only thing that is new is the `fragment` tag in *main.xml*. The tag uses a `class` attribute to specify the fully qualified name of a class that implements the fragment. There are a couple of constraints on a fragment implementation class, which in this case, is `com.oreilly.demo.android.ch085.contactviewer.DateTime`:

- A class with the exact name must exist and be visible from the application.
- The named class must be a subclass of `Fragment`.

Although it would be quite possible to verify both of these things statically, the current Android tools do not do so. You'll have to check both constraints by hand.

The Android Framework creates a new instance of the named class when the layout is inflated. The implications of this can be surprising. To begin, it means the class must have a no-args constructor. This is the constructor that Java supplies by default. The Android Developer Documentation recommends—strongly, in fact—against defining any constructors at all in subclasses of `Fragment` because a newly created `Fragment` object may not be in a consistent state at creation. The documentation recommends that fragment initialization be postponed until later in the fragment life cycle.

No matter how you use the fragment elsewhere in the application, if you use it in a layout, the inflation process must be able to create it, without supplying any initialization parameters. As a corollary, a fragment that is created in this way must be prepared to do something sensible even without initialization. A fragment, for instance, that displays content from a passed URL must handle the case where the URL—and therefore the content—is empty.

Here, then, is a very simple fragment:

```
public class DateTime extends Fragment {
    private String time;

    public void onCreate(Bundle state) {
        super.onCreate(state);

        if (null == time) {
            time = new SimpleDateFormat("d MMM yyyy HH:mm:ss")
                .format(new Date());
        }
    }

    @Override
    public View onCreateView(
        LayoutInflater inflater,
        ViewGroup container,
        Bundle b)
    {
        View view = inflater.inflate(
            R.layout.date_time,
            container,
            false); //!!! this is important

        ((TextView) view.findViewById(R.id.last_view_time))
            .setText(time);

        return view;
    }
}
```

This code demonstrates several essential points. First, just the existence of an `onCreate` life cycle method should bring to mind the `Activity` class and its life cycle methods. While the life cycle of a `Fragment` is not identical to that of an `Activity`, it does have many of the same methods. As for an activity, a fragment's `onCreate` method is called when the fragment is initialized. This is a great place to do the initialization that was postponed from the constructor. The example guarantees that the value of the variable `time`, the thing the fragment will display, is correctly initialized.

Fragments have a few additional life cycle methods, including `onCreateView`, also used in this example. The `onCreateView` method is called when a fragment's view is initialized (in contrast with `onCreate`, which is called when the fragment itself is initialized). Notice that the fragment creates the view it manages by using the passed `LayoutInflater` to instantiate the view shard `R.layout.date_time`. This simple view shard—just a pair of

TextViews in a `RelativeLayout`—is defined in its own file, `layout/date_time.xml` (not shown here), much as was the main layout shown earlier.

Also notice (and this is a bit of a gotcha) that there is a third parameter, the Boolean `false`, in that call to `inflate`. It is important! The inflater must have access to `container`, the view that will eventually be the newly created shard's parent. It needs the parent view in order to handle layout correctly. Suppose, for instance, that `container` happens to be a `RelativeLayout` that specifies the position of the newly created shard using a `layout_toRightOf` directive.

On the other hand, the fragment framework owns and manages the view that is returned by the `onCreateView` method. The code in `onCreateView` must not attach the view shard to its container, as it normally would during inflation. That third argument is the flag that tells the inflater that the fragment framework is in control and that it must not attach the view shard to the container.

Once the fragment's view shard is created, its `findViewById` method can be used to find other widgets nested within. The example uses it to locate the `TextView` that will display the time, and to set its value from the variable `time`, initialized in `onCreate`.

When run, this application looks like [Figure 8-1](#).

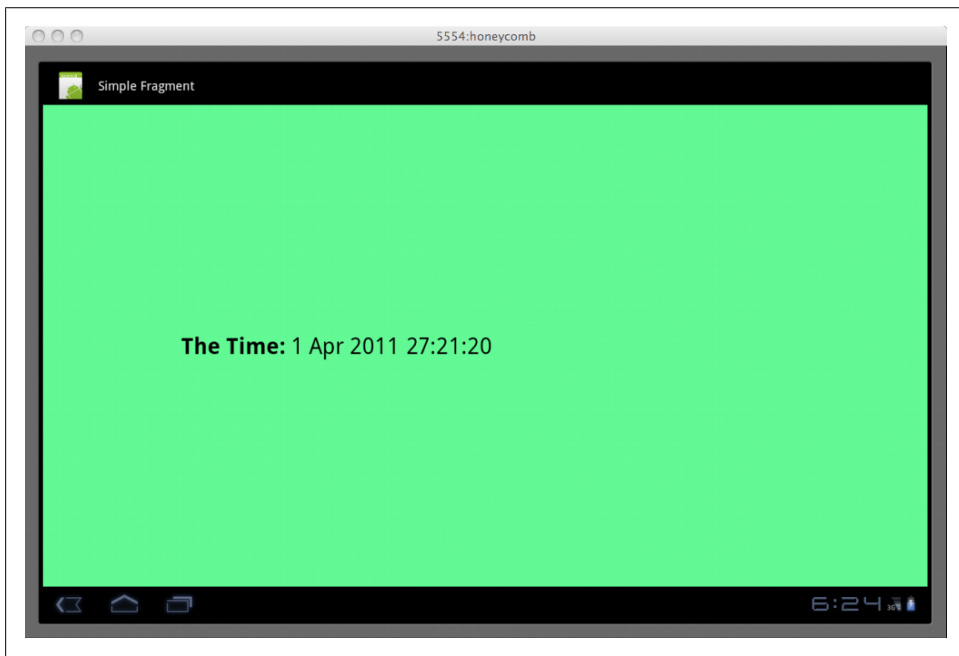

Figure 8-1. A simple fragment

# Fragment Life Cycle

If you run this application, as it is described so far, and rotate the screen while it is running, you'll notice that the displayed date changes each time the screen is rotated. Rotating the screen causes an application to be destroyed and re-created. This version of the example application loses all its state each time that happens.



This is a great way to test your application. Pressing Ctrl-F11 rotates the emulator 90 degrees. In response to this rotation, Android steps an activity through nearly its entire life cycle. With this one key-chord, you get coverage for most of your code!

In this trivial example application, losing state is not particularly significant. A real application, however, must not lose state. It would be incredibly annoying if, for instance, rotating your phone to landscape mode while looking at some web page caused the browser to return to a home page.

The application can be modified to keep its state with two small changes. First, override the `DateTime` fragment's life cycle method `onSaveInstanceState` to preserve its state. Second, change the `onCreate` method to recover the preserved state. As it did with activities (see [“The Activity Life Cycle” on page 90](#)), the Android Framework provides a `Bundle` object to the former method when it suspends the fragment. It provides the same bundle to `onCreate` when reconstructing a clone of a suspended fragment.

Here are the two affected methods, changed to support state preservation:

```
@Override
public void onCreate(Bundle state) {
    super.onCreate(state);

    if (null != state) { time = state.getString(TAG_DATE_TIME); }

    if (null == time) {
        time = new SimpleDateFormat("d MMM yyyy HH:mm:ss")
            .format(new Date());
    }
}

@Override
public void onSaveInstanceState(Bundle state) {
    super.onSaveInstanceState(state);
    state.putString(TAG_DATE_TIME, time);
}
```

That's it. Running this version of the program through its life cycle will no longer cause it to lose its state. Notice, incidentally, that because the variable `time` (and, in general, any fragment state) is initialized in the `onCreate` method, it cannot be declared `final`. This reduces the value of using a constructor to set up the fragment state and is in

keeping with the recommendation that `Fragment` subclasses not have any explicit constructors at all.

The [Android Developer Documentation](#) describes the complete fragment life cycle. One other life cycle callback method, though, deserves special notice: `onPause`. The `onPause` method is important for the same reason that it is important in an activity. In order for an application to play nicely in the Android environment, it should not be doing things (using the CPU, running down the battery, etc.) when it is not visible. The Android environment arranges to call a fragment's `onPause` method whenever the fragment becomes invisible. In this method, a fragment should release any resources it might be holding, terminate any long-running processes that it has started, and so on.

## The Fragment Manager

As mentioned earlier, fragments can be created programmatically as well as in layouts. Programmatic manipulation of fragments is accomplished using an instance of the class `FragmentManager` obtained from an `Activity` using its `getFragmentManager` method. The fragment manager handles three important groups of operations: fragment tagging and location, transactions, and the back stack. Let's extend the example program to investigate each, in turn.

Adapting the example application to use programmatically created fragments requires only two changes: one in the layout `main.xml` and the other in the `SimpleFragment` activity. In the layout, the fragment element is replaced with a nearly identical `FrameLayout`:

```
<LinearLayout
    xmlns:android="http://schemas.android.com/apk/res/android"
    android:orientation="horizontal"
    android:layout_width="fill_parent"
    android:layout_height="fill_parent"
    >

    <FrameLayout
        android:id="@+id/date_time"
        android:layout_width="fill_parent"
        android:layout_height="fill_parent"
        android:background="@color/green"
        />

</LinearLayout>
```

`SimpleFragment` will still use this layout, just as it did before. Now, though, the layout does not automatically create a new fragment. Instead, the following code does that:

```
@Override
public void onCreate(Bundle state) {
    super.onCreate(state);

    setContentView(R.layout.main);
}
```



```

FragmentManager fragMgr = getFragmentManager();

FragmentManager fragMgr = getFragmentManager();
FragmentTransaction xact = fragMgr.beginTransaction();
if (null == fragMgr.findFragmentByTag(FRAG1_TAG)) {
    xact.add(R.id.date_time, new DateTime(), FRAG1_TAG);
}
xact.commit();
}

```

These changes introduce no new application features. When run, this version of the example behaves exactly as did the original, layout-based version.

The important feature in this code snippet is the use of tagging. It is entirely possible that an activity's `onCreate` will be called while it is still associated with a previously created fragment. Simply adding a new fragment whenever `onCreate` is called will leak fragments. In order to prevent that, the example code makes use of the fragment manager's tagging and location features.

The third argument to the `add` method is a unique tag, assigned to the fragment as it is added to the activity. Once the tag has been created, the fragment manager method `findFragmentByTag` can be used to recover the exact, single fragment that was added with the given tag. The example checks to see if the tagged fragment already exists before it creates a new fragment instance. If there is no such fragment, it creates it. If the fragment already exists, no action is necessary. This guarantees that there is only a single fragment in a given role, and prevents fragment leaking.

Tagging and location can be used for other purposes as well. Whenever an activity needs to communicate some change of state to an attached fragment, it will probably do so by tagging that fragment, in advance, and then using the `FragmentManager` to look up the tag to obtain a reference to the fragment at the appropriate time.

## Fragment Transactions

In addition to using fragment tagging, the new code also alludes to fragment transactions. Let's extend the application once again to demonstrate their value.

Before we take on transactions, though, we need to take a brief detour. We noted earlier that the Android Developer Documentation recommends that fragment subclasses not have explicit constructors. So, how does an external object supply initialization state for a new fragment? The `Fragment` class supports two methods, `setArguments` and `getArguments`, that provide this capability. Respectively, they allow an external caller—probably the fragment creator—to store a `Bundle` in the fragment and the fragment to recover that bundle at some later time.

This elaborate combination of a new instance of the fragment, a `Bundle`, and a call to `setArguments` functions very much like a constructor. It makes sense, then, to combine them into a static factory method in the `Fragment` object, like this:

```

public static DateTime createInstance(Date time) {
    Bundle init = new Bundle();
    init.putString(
        DateTime.TAG_DATE_TIME,
        getDateTimeString(time));

    DateTime frag = new DateTime();
    frag.setArguments(init);
    return frag;
}

private static String getDateTimeString(Date time) {
    return new SimpleDateFormat("d MMM yyyy HH:mm:ss")
        .format(time);
}

```

Now we can use the static factory method in `SimpleFragment`'s `onCreate` method to create a new instance of the fragment with its argument bundle correctly initialized. This code is nearly identical to the preview version, except that it now uses `DateTime`'s static factory method, and passes it an argument:

```

@Override
public void onCreate(Bundle state) {
    super.onCreate(state);

    setContentView(R.layout.main);

    FragmentManager fragMgr = getFragmentManager();

    FragmentTransaction xact = fragMgr.beginTransaction();
    if (null == fragMgr.findFragmentByTag(FRAG1_TAG)) {
        xact.add(
            R.id.date_time,
            DateTime.newInstance(new Date()),
            FRAG1_TAG);
    }
    xact.commit();
}

```

Finally, the fragment `onCreate` method retrieves the initialization data from the passed argument bundle, unless there is state from a previous incarnation:

```

@Override
public void onCreate(Bundle state) {
    super.onCreate(state);

    if (null == state) { state = getArguments(); }

    if (null != state) { time = state.getString(TAG_DATE_TIME); }

    if (null == time) { time = getDateTimeString(new Date()); }
}

```

Once again, the application as modified to this point still behaves exactly as did the original. The implementation is quite different, though, and much more flexible. In

particular, we now have a fragment that can be initialized externally and can be used to demonstrate transactions.

The idea of a fragment transaction is, as the name implies, that all changes take place as a single, atomic action. To demonstrate this, let's make one final extension to the example program: let's add the ability to create pairs of fragments.

Here's the new layout:

```
<LinearLayout
    xmlns:android="http://schemas.android.com/apk/res/android"
    android:orientation="vertical"
    android:layout_width="fill_parent"
    android:layout_height="fill_parent"
    >

    <Button
        android:id="@+id/new_fragments"
        android:layout_width="fill_parent"
        android:layout_height="odp"
        android:layout_weight="1"
        android:textSize="24dp"
        android:text="@string/doit"
        />

    <FrameLayout
        android:id="@+id/date_time2"
        android:layout_width="fill_parent"
        android:layout_height="odp"
        android:layout_weight="2"
        android:background="@color/blue"
        />

    <FrameLayout
        android:id="@+id/date_time"
        android:layout_width="fill_parent"
        android:layout_height="odp"
        android:layout_weight="2"
        android:background="@color/green"
        />

</LinearLayout>
```

Here are the corresponding additions to the onCreate method in SimpleFragment:

```
public void onCreate(Bundle state) {
    super.onCreate(state);

    setContentView(R.layout.main);

    ((Button) findViewById(R.id.new_fragments))
        .setOnClickListener(
            new Button.OnClickListener() {
                @Override
                public void onClick(View v) { update(); }
            });
}
```

```

Date time = new Date();

FragmentManager fragMgr = getFragmentManager();

FragmentTransaction xact = fragMgr.beginTransaction();
if (null == fragMgr.findFragmentByTag(FRAG1_TAG)) {
    xact.add(
        R.id.date_time,
        DateTime.newInstance(time),
        FRAG1_TAG);
}

if (null == fragMgr.findFragmentByTag(FRAG2_TAG)) {
    xact.add(
        R.id.date_time2,
        DateTime.newInstance(time),
        FRAG2_TAG);
}

xact.commit();
}

```

Finally, the example application does something different. When run, it looks like [Figure 8-2](#).

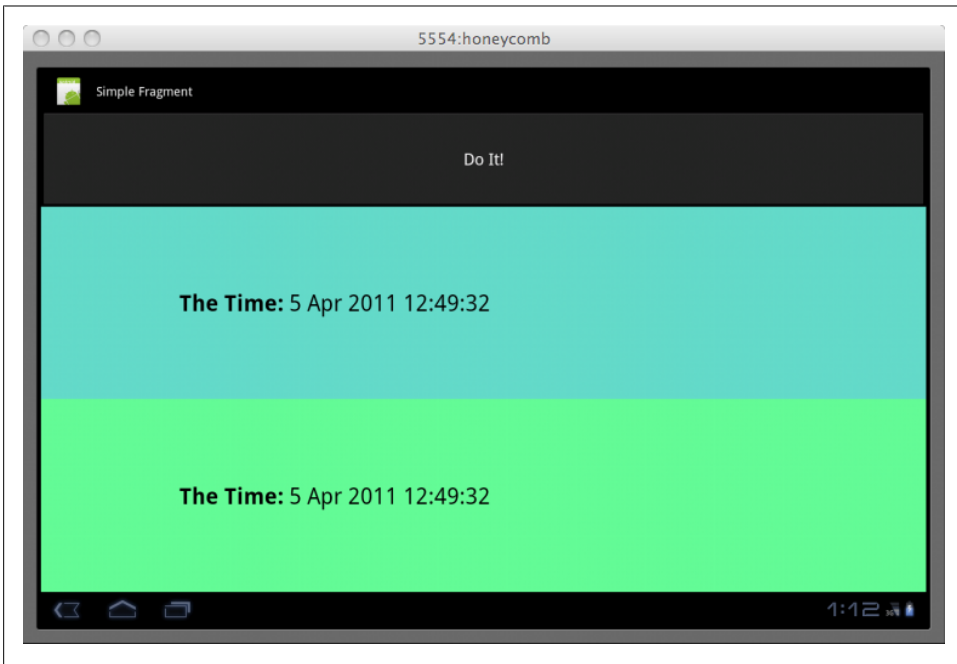

Figure 8-2. Fragment transactions

Both fragments display the exact same date and time because a single value is passed to both. Neither visiting other applications and returning to the demo nor rotating the display will cause this application to lose its state. It's pretty solid. So let's give the button an implementation. Here it is:

```
void update() {
    Date time = new Date();

    FragmentTransaction xact
        = getFragmentManager().beginTransaction();

    xact.replace(
        R.id.date_time,
        DateTime.newInstance(time),
        FRAG1_TAG);

    xact.replace(
        R.id.date_time2,
        DateTime.newInstance(time),
        FRAG2_TAG);

    xact.addToBackStack(null);
    xact.setTransition(FragmentTransaction.TRANSIT_FRAGMENT_OPEN);

    xact.commit();
}
```

This method actually makes use of the atomicity of fragment transactions. It looks a lot like the fragment initialization code in `SimpleFragment`'s `onCreate` method. Instead of using the transaction to add new fragment instances, however, it replaces the current fragments. The call to `commit` at the end of the method causes both of the new fragments to become visible simultaneously. The blue and the green times will always be in sync.

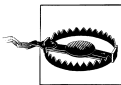

A fragment created in a layout (using an XML fragment tag) must never be replaced with a dynamically created fragment. Although it is pretty hard to tell just by looking at them, the life cycle of one is much different from that of the other. There's no reason you can't use both in your application, but never replace one with the other. Attempting to use `setContentView`, for instance, with a layout that has had a layout fragment replaced with one that was programmatically created will cause bugs that can be difficult to find and fix. A frequent symptom of this kind of problem is an `IllegalStateException` with the message "Fragment did not create a view."

This brings us to the last essential feature of fragments, the back stack. If you run several activities in sequence, you can return to them in reverse order using the back button. This behavior also applies to fragment transactions.

If you run this application, the display will look something like [Figure 8-2](#). When you push the button at the top of the display, the blue and green fragments will update

simultaneously. Better yet, though, if you push the back button (the left-facing arrow icon in the lower-right corner of the display), you will see, in reverse order, each update you generated by pushing the Do It! button. For instance, if both fragments display the time “5 Apr 2011 12:49:32” and you push the Do It! button, the display might be updated so that both the blue and the green regions show the date/time as “5 Apr 2011 13:02:43”. If you now push the back button, both fragments will again display “5 Apr 2011 12:49:32”. The entire transaction—the updates of both fragments—is pushed onto the back stack as a single event. When you push the back button, an entire transaction is removed, revealing the entire state from the previous transaction.

## The Compatibility Package

One of the most important aspects of fragments is that, although they were introduced in Android 3.0 and are not available in previous releases of the API, Google provides the Android Compatibility Package (ACP) to make it possible to use the fragment feature on devices that are still using an older version of Android.

The compatibility package is not a complete win. It is not forward compatible. An application that runs using the ACP requires the ACP, even when running on an Android 3.0 system. When choosing an implementation strategy for the ACP, Google faced a conundrum. Even if it had been possible to implement the ACP so that an application ported transparently, without change, from Android 3.0 to Android 2.0 + ACP, there would have been a problem. The ACP must be included as part of an application. If the ACP defined classes with names that are identical to those in Android 3.0, an application that embedded it would, without some serious class loader trickery, define classes that collided with their system definitions.

Instead, the ACP uses a different base package, `android.support.v4`, in which to define the compatibility features. A program developed for Android 3.0 will need code changes to use the ACP. You will need to make, at least, the following changes:

- Copy the ACP library to your project. Create a directory named *lib* at the top level of your project and copy *android-support-v4.jar* from the Android SDK folder *extras/android/compatibility/v4/* into it.
- Add the ACP to your project build path. In Eclipse, select the library in the Package Explorer (you may have to refresh the project to see it: press F5 or left-click→Refresh). Once it is selected, you should be able to left-click→Build Path→Add to Build Path.
- Change your project build target from Android 3.0 to Android 2.0.1 (Properties→Android). This will cause many errors to appear.
- Some imports that refer to *android.app* will have to be updated to refer to *android.support.v4.app*. Presuming your program had no errors before changing its build target, you need only find broken imports and update their base package.

- All the activities in the application that use fragments must be updated to the subclass `FragmentActivity` instead of `Activity`.
- Change all calls to `getFragmentManager` into calls to `getSupportFragmentManager`.
- Fix any remaining errors and test your program.





---

# Drawing 2D and 3D Graphics

The Android menagerie of widgets and the tools for assembling them are convenient and powerful, and cover a broad variety of needs. What happens, though, when none of the existing widgets offer what you need? Maybe your application needs to represent playing cards, phases of the moon, or the power diverted to the main thrusters of a rocket ship. In that case, you'll have to know how to roll your own.

This chapter is an overview of graphics and animation on Android. It's directed at programmers with some background in graphics, and goes into quite a bit of depth about ways to twist and turn the display. You will definitely need to supplement the chapter with Android documentation, particularly because, especially with the advent of Honeycomb, the interfaces are still undergoing changes. But the techniques here will help you dazzle your users.

## Rolling Your Own Widgets

As mentioned earlier, *widget* is just a convenient term for a subclass of `android.view.View`, typically a leaf node in the view tree. Internal nodes in the view tree, though they may contain complex code, tend to have simpler user interactions. The term *widget*, although informal, is useful for discussing the workhorse parts of the user interface that have the information and the behavior users care about.

You can accomplish a lot without creating a new widget. In this book, we have already constructed several applications consisting entirely of existing widgets or simple subclasses of existing widgets. The code in those applications just built trees of views, laying them out in code or through layout resources in XML files.

The nontrivial MicroJobs application, which we'll cover in [Chapter 10](#), has a view that contains a list of names corresponding to locations on a map. As additional locations are added to the map, new name-displaying widgets are added dynamically to the list. Even this dynamically changing layout is just a use of preexisting widgets; it is not creating new ones. The techniques in MicroJobs are, figuratively, adding or removing boxes from a tree like the one illustrated in [Figure 7-3](#) of [Chapter 7](#).

In contrast, this chapter shows you how to roll your own widget, which involves looking under the `View` hood. `TextView`, `Button`, and `DatePicker` are all examples of widgets provided by the Android UI toolkit. You can implement your own widget as a subclass of one of these, or as a direct subclass of `View`.

A more complex widget—one that can nest other widgets—will have to subclass `ViewGroup`, which is itself a subclass of `View`. A very complex widget, perhaps used as an interface tool implemented in several places (even by multiple applications), might be an entire package of classes, only one of which is a descendant of `View`.

This chapter is about graphics, and therefore about the `View` part of the Model-View-Controller (MVC) pattern. Widgets also contain Controller code, which is good design because it keeps together all the code relevant to a behavior and its representation on the screen. This part of this chapter discusses only the implementation of the `View`. The implementation of the Controller was discussed in [Chapter 7](#).

Concentrating on graphics, then, we can break the tasks of this chapter into two essential parts: finding space on the screen and drawing in that space. The first task is known as *layout*. A leaf widget can assert its space needs by defining an `onMeasure` method that the Android UI framework will call at the right time. The second task, actually rendering the widget, is handled by the widget’s `onDraw` method.

## Layout

Most of the heavy lifting in the Android Framework layout mechanism is implemented by *container views*. A container view is one that contains other views. It is an internal node in the view tree and in the subclasses of `ViewGroup`. The framework toolkit provides a variety of sophisticated container views that offer powerful and adaptable strategies for arranging a screen. `LinearLayout` and `RelativeLayout`, to name some common ones, are container views that are both relatively easy to use and fairly hard to reimplement correctly. Since convenient, powerful container views already exist, you will probably never have to implement one or the layout algorithm discussed here. Understanding how it works, though—how the Android UI framework manages the layout process—will help you build correct, robust widgets.

[Example 9-1](#) shows what is perhaps the simplest working widget one could design. If added to some `Activity`’s view tree, this widget will fill in the space allocated to it with the color cyan. Not very interesting, but before we move on to create anything more complex, let’s look carefully at how this example fulfills the two basic tasks of layout and drawing. We’ll start with the layout process; we’ll describe drawing later in [“Canvas Drawing” on page 217](#).

*Example 9-1. A trivial widget*

```
public class TrivialWidget extends View {  
  
    public TrivialWidget(Context context) {  
        super(context);  
        setMinimumWidth(100);  
        setMinimumHeight(20);  
    }  
  
    @Override  
    protected void onMeasure(int widthMeasureSpec, int heightMeasureSpec) {  
        setMeasuredDimension(  
            getSuggestedMinimumWidth(),  
            getSuggestedMinimumHeight());  
    }  
  
    @Override  
    protected void onDraw(Canvas canvas) {  
        canvas.drawColor(Color.CYAN);  
    }  
}
```

Dynamic layout is necessary because the space requirements for widgets change dynamically. Suppose, for instance, that a widget in a GPS-enabled application displays the name of the city in which you are currently driving. As you go from “Ely” to “Post Mills,” the widget receives notification of the change in location. When it prepares to redraw the city name, though, it notices that it doesn’t have enough room for the whole name of the new town. It needs to ask the display to redraw the screen in a way that gives it more space, if that is possible.

Layout can be a surprisingly complex task and very difficult to get right. It is probably not very hard to make a particular leaf widget look right on a single device. It can be very tricky, on the other hand, to get a widget that must arrange children to look right on multiple devices, even when the dimensions of the screen change.

The layout process is initiated when the `requestLayout` method is invoked on some view in the view tree. Typically, a widget calls `requestLayout` on itself, when it needs more space. The method could be invoked, though, from any place in an application, to indicate that some view in the current screen no longer has the right amount of room.

The `requestLayout` method causes the Android UI framework to enqueue an event on the UI event queue. When the event is processed, in order, the framework gives every container view an opportunity to ask each of its child widgets how much space it would like for drawing. The process is separated into two phases: measuring child views and then arranging them in their new positions. All views must implement the first phase, but the second is necessary only in the implementations of container views that must manage the layout of child views.

## Measurement

The goal of the measurement phase is to provide each view with an opportunity to dynamically request the space it would like, ideally, for drawing. The UI framework starts the process by invoking the `measure` method of the view at the root of the view tree. Starting there, each container view asks each of its children how much space it would prefer. The call is propagated to all descendants, depth first, so that every child gets a chance to compute its size before its parent. The parent computes its own size based on the sizes of its children and reports that to its parent, and so on, up the tree.

In “[Assembling a Graphical Interface](#)” on page 171, for instance, the topmost `LinearLayout` asks each nested `LinearLayout` widget for its preferred dimensions. They, in turn, ask the `Buttons` or `EditText` views they contain for theirs. Each child reports its desired size to its parent. The parents then add up the sizes of the children, along with any padding they insert themselves, and report the total to the topmost `LinearLayout`.

Because the framework must guarantee certain behaviors for all `Views` during this process, the `measure` method is final and cannot be overridden. Instead, `measure` calls `onMeasure`, which widgets may override to claim their space.

The arguments to the `onMeasure` method describe the space the parent is willing to make available: a width specification and a height specification, measured in pixels. The framework assumes that no view will ever be smaller than 0 or bigger than  $2^{30}$  pixels in size and, therefore, uses the high-order bits of the passed `int` parameter to encode the *measurement specification mode*. It is as though `onMeasure` were actually called with four arguments: the width specification mode, the width, the height specification mode, and the height. Do not be tempted to do your own bit shifting to separate the pairs of arguments! Instead, use the static methods `MeasureSpec.getMode` and `MeasureSpec.getSize`.

The specification modes describe how the container view wants the child to interpret the associated size. There are three of them:

### `MeasureSpec.EXACTLY`

The calling container view has already determined the exact size of the child view.

### `MeasureSpec.AT_MOST`

The calling container view has set a maximum size for this dimension, but the child is free to request less.

### `MeasureSpec.UNSPECIFIED`

The calling container view has not imposed any limits on the child; the child may request anything it chooses.

A widget is always responsible for telling its parent in the view tree how much space it needs. It does this by calling `setMeasuredDimensions` to set its height and width properties. The parent can later retrieve these properties through the methods `getMeasuredHeight` and `getMeasuredWidth`. If your implementation overrides `onMeasure` but does not

call `setMeasuredDimensions`, the `measure` method will throw `IllegalStateException` instead of completing normally.

The default implementation of `onMeasure`, inherited from `View`, calls `setMeasuredDimensions` with one of two values in each direction. If the parent specifies `MeasureSpec.UNSPECIFIED`, the child's `setMeasuredDimensions` method uses the default size of the view: the value supplied by either `getSuggestedMinimumWidth` or `getSuggestedMinimumHeight`. If the parent specifies either of the other two modes, the default implementation uses the size that was offered by the parent. This is a very reasonable strategy and allows a typical widget implementation to handle the measurement phase completely by simply setting the values returned by `getSuggestedMinimumWidth` and `getSuggestedMinimumHeight`. We used that minimal strategy in [Example 9-1](#).

Your widget may not actually get the space it requests. Consider a view that is 100 pixels wide and that has three children. It is probably obvious how the parent should arrange its children if the sum of the pixel widths requested by the children is 100 or less. If, however, each child requests 50 pixels, the parent container view is not going to be able to satisfy them all.

A container view has complete control of how it arranges its children. It might, in the circumstances just described, decide to be “fair” and allocate 33 pixels to each child. It might, just as easily, decide to allocate 50 pixels to the leftmost child, and 25 to each of the other two. In fact, it might decide to give one of the children the entire 100 pixels and nothing at all to the others. Whatever its method, though, in the end the parent determines a size and location for the bounding rectangle for each child.

Another example of a container view's control of the space allocated to a widget comes from the example widget in [Example 9-1](#). It always requests the amount of space it prefers, regardless of what it is offered (unlike the default implementation). This strategy is handy to remember for widgets that will be added to toolkit containers, notably `LinearLayout`, that implement *gravity*. Gravity is a property that some views use to specify the alignment of their subelements. You may be surprised, the first time you use one of these containers, to find that, by default, only the first of your custom widgets gets drawn! You can fix this either by using the `setGravity` method to change the property to `Gravity.FILL`, or by making your widgets insistent about the amount of space they request.

It is also important to note that a container view may call a child's `measure` method several times during a single measurement phase. As part of its implementation of `onMeasure`, a clever container view, attempting to lay out a horizontal row of widgets, might, for instance, call each child widget's `measure` method with mode `MeasureSpec.UNSPECIFIED` and a width of 0 to find out what size the widget would prefer. Once it has collected the preferred widths for each of its children, it could compare the sum to the actual width available (which was specified in its parent's call to its `measure` method). Now it might call each child widget's `measure` method again, this time with the mode `MeasureSpec.AT_MOST` and a width that is an appropriate proportion

of the space actually available. Because `measure` may be called multiple times, an implementation of `onMeasure` must be idempotent and must not change the application state.



An action is said to be “idempotent” if the effect of performing it once is the same as the effect of performing it multiple times. For instance, the statement  $x = 3$  is idempotent because no matter how many times you do it,  $x$  always ends up as 3.  $x = x + 1$ , however, is not idempotent because the value of  $x$  depends on how many times the statement is executed.

A container view’s implementation of `onMeasure` is likely to be fairly complex. `ViewGroup`, the superclass of all container views, does not supply a default implementation. Each Android UI framework container view has its own. If you contemplate implementing a container view, you might consider basing it on one of them. If, instead, you implement measurement from scratch, you are still likely to need to call `measure` for each child and should consider using the `ViewGroup` helper methods: `measureChild`, `measureChildren`, and `measureChildWithMargins`. At the conclusion of the measurement phase, a container view, like any other widget, must report the space it needs by calling `setMeasuredDimensions`.

### Arrangement

Once all the container views in the view tree have had a chance to negotiate the sizes of each of their children, the framework begins the second phase of layout, which consists of arranging the children. Again, unless you implement your own container view you will probably never have to implement your own arrangement code. This section describes the underlying process so that you can better understand how it might affect your widgets. The default method, implemented in `View`, will work for typical leaf widgets, as demonstrated by [Example 9-1](#).

Because a view’s `onMeasure` method might be called several times, the framework must use a different method to signal that the measurement phase is complete and that container views must fix the final locations of their children. Like the measurement phase, the arrangement phase is implemented with two methods. The framework invokes a final method, `layout`, at the top of the view tree. The `layout` method performs processing common to all views and then invokes `onLayout`, which custom widgets override to implement their own behaviors. A custom implementation of `onLayout` must, at least, calculate the bounding rectangle that it will supply to each child when it is drawn and, in turn, invoke the `layout` method for each child (because that child might, in turn, be a parent to other widgets). This process can be complex. If your widget needs to arrange child views, you might consider basing it on an existing container, such as `LinearLayout` or `RelativeLayout`.

It is worth reiterating that a widget is not guaranteed to receive the space it requests. It must be prepared to draw itself in whatever space is actually allocated to it. If it attempts to draw outside the space allocated to it by its parent, the drawing will be clipped by the clip rectangle (discussed later in this chapter). To exert fine control—to exactly fill the space allocated to it, for instance—a widget must either implement `onLayout` and record the dimensions of the allocated space, or inspect the clip rectangle of the `Canvas` that is the parameter to `onDraw`.

## Canvas Drawing

Now that we've explored how widgets allocate the space on the screen in which they draw themselves, we can turn to coding some widgets that actually do some drawing.

The Android UI framework handles drawing in a way that should seem familiar, now that you've read about measurement and arrangement. When some part of the application determines that the current screen drawing is stale because some state has changed, it calls the `View` method `invalidate`. This call causes a redraw event to be added to the event queue.

When, eventually, that event is processed, the framework calls the `draw` method at the top of the view tree. This time the call is propagated preorder, each view drawing itself before it calls its children. This means that leaf views are drawn after their parents, which are, in turn, drawn after their parents. Views that are lower in the tree appear to be drawn on top of those nearer the root of the tree.

The `draw` method calls `onDraw`, which each subclass overrides to implement its custom rendering. When your widget's `onDraw` method is called, it must render itself according to the current application state and return. It turns out, by the way, that neither `View.draw` nor `ViewGroup.dispatchDraw` (responsible for the traversal of the view tree) is final. But override them at your peril!

In order to prevent extra painting, the Android UI framework maintains some state information about the view, called the *clip rectangle*. A key concept in the framework, the clip rectangle is part of the state that is passed in calls to a component's graphical rendering methods. It has a location and size that can be retrieved and adjusted through methods on the canvas. It acts like a stencil through which a component does all its drawing: the component can only draw on the portions of the canvas visible through the clip rectangle. By correctly setting the size, shape, and location of the clip rectangle aperture, the framework can prevent a component from drawing outside its boundaries or redrawing regions that are already correctly drawn.

Before proceeding to the specifics of drawing, let's again put the discussion in the context of Android's single-threaded MVC design pattern. There are two essential rules:

- Drawing code should be inside the `onDraw` method. Your widget should draw itself completely, reflecting the program state, when `onDraw` is invoked.

- A widget should draw itself as quickly as possible when `onDraw` is invoked. The middle of the call to `onDraw` is no time to run a complex database query or to determine the status of some distant networked service. All the state you need to draw should be cached and ready for use, at drawing time. Long-running tasks should use a separate thread and one of the mechanisms described in “[Advanced Wiring: Focus and Threading](#)” on page 189. Model state information cached in the view is sometimes called the *view model*.

The Android UI framework uses four main classes in drawing. If you are going to implement custom widgets and do your own drawing you will want to become very familiar with them:

**Canvas** (*a subclass of `android.graphics.Canvas`*)

The canvas has no clear analog in real-life materials. You might think of it as a complex easel that can orient, bend, and even crumple the paper on which you are drawing, in interesting ways. It maintains the clip rectangle, the stencil through which you paint. It can also scale drawings as they are drawn, like a photographic enlarger. It can even perform other transformations for which material analogs are more difficult to find: mapping colors and drawing text along paths.

**Paint** (*a subclass of `android.graphics.Paint`*)

This is the medium with which you will draw. It controls the color, transparency, and brush size for objects painted on the canvas. It also controls font, size, and style when drawing text.

**Bitmap** (*a subclass of `android.graphics.Bitmap`*)

This is the paper you are drawing on. It holds the actual pixels that you draw.

**Drawable** (*likely a subclass of `android.graphics.drawable.Drawable`*)

This is the thing you want to draw: a rectangle or image. Although not all the things that you draw are `Drawables` (text, for instance, is not), many, especially the more complex ones, are.

[Example 9-1](#) accomplished its drawing by using only the `Canvas`, passed as a parameter to `onDraw`. In order to do anything more interesting, we will need, at the very least, `Paint`. `Paint` provides control over the color and transparency (alpha) of the graphics drawn with it. It also controls the width of the brush used for drawing. When used in connection with text drawing methods, it controls the font, size, and style of the text. `Paint` has many, many other capabilities, some of which are described in “[Bling](#)” on page 234. [Example 9-2](#), however, is enough to get you started. It sets two of the many parameters `Paint` controls (color and line width) before drawing a thick vertical line, followed by a series of horizontal lines. The alpha value (which plays the same role as the fourth value in RGB web colors) is reduced for each green line to make it more transparent than the previous one. Explore the class documentation for other useful attributes.



### Example 9-2. Using Paint

```
@Override
protected void onDraw(Canvas canvas) {
    canvas.drawColor(Color.WHITE);

    Paint paint = new Paint();

    canvas.drawLine(33, 0, 33, 100, paint);

    paint.setColor(Color.RED);
    paint.setStrokeWidth(10);
    canvas.drawLine(56, 0, 56, 100, paint);

    paint.setColor(Color.GREEN);
    paint.setStrokeWidth(5);

    for (int y = 30, alpha = 255; alpha > 2; alpha >>= 1, y += 10) {
        paint.setAlpha(alpha);
        canvas.drawLine(0, y, 100, y, paint);
    }
}
```

The graphic created by the code in the example is shown in [Figure 9-1](#).

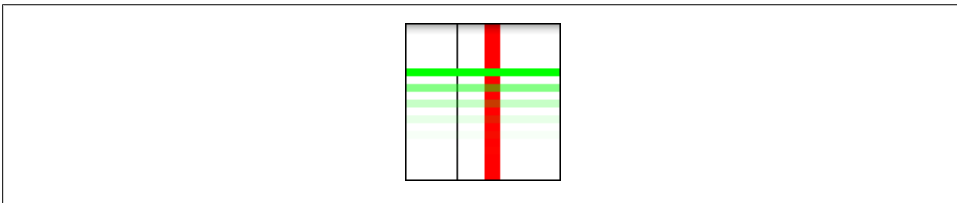

Figure 9-1. Output using Paint

With the addition of `Paint`, we are prepared to understand most of the other tools necessary to draw a useful widget. The code in [Example 9-3](#), for instance, is the widget used in [Example 7-7](#). While still not very complex, it demonstrates all the pieces of a fully functional widget. It handles layout, uses highlighting (whether the view has the user's focus), and reflects the state of the model to which it is attached. The widget draws a series of dots whose information is stored in a private array. Each dot specifies its own *x* and *y* location as well as its diameter and color. The `onDraw` function resets the color of its `Paint` for each, and uses the other parameters to specify the circle being drawn by the canvas's `drawCircle` method.

### Example 9-3. Dot widget

```
package com.oreilly.android.intro.view;

import android.content.Context;

import android.graphics.Canvas;
```

```

import android.graphics.Color;
import android.graphics.Paint;
import android.graphics.Paint.Style;

import android.view.View;

import com.oreilly.android.intro.model.Dot;
import com.oreilly.android.intro.model.Dots;

public class DotView extends View {
    private final Dots dots;

    /**
     * @param context the rest of the application
     * @param dots the dots we draw
     */
    public DotView(Context context, Dots dots) {
        super(context);
        this.dots = dots;
        setMinimumWidth(180);
        setMinimumHeight(200);
        setFocusable(true);
    }

    /** @see android.view.View#onMeasure(int, int) */
    @Override
    protected void onMeasure(int widthMeasureSpec, int heightMeasureSpec) {
        setMeasuredDimension(
            getSuggestedMinimumWidth(),
            getSuggestedMinimumHeight());
    }

    /** @see android.view.View#onDraw(android.graphics.Canvas) */
    @Override protected void onDraw(Canvas canvas) {
        canvas.drawColor(Color.WHITE);

        Paint paint = new Paint();
        paint.setStyle(Style.STROKE);
        paint.setColor(hasFocus() ? Color.BLUE : Color.GRAY);
        canvas.drawRect(0, 0, getWidth() - 1, getHeight() - 1, paint);

        paint.setStyle(Style.FILL);
        for (Dot dot : dots.getDots()) {
            paint.setColor(dot.getColor());
            canvas.drawCircle(
                dot.getX(),
                dot.getY(),
                dot.getDiameter(),
                paint);
        }
    }
}

```

As with `Paint`, we have only enough space to begin an exploration of `Canvas` methods. There are two groups of functionality, however, that are worth special notice.

## Drawing text

Among the most important `Canvas` methods are those used to draw text. Although some `Canvas` functionality is duplicated in other places, text rendering capabilities are not. In order to put text in your widget, you will have to use `Canvas` (or, of course, subclass some other widget that uses it).

`Canvas` provides several methods for rendering text that give you various amounts of flexibility over the placement of each character in the text. The methods come in pairs: one taking a `String` and the other taking a `char[]` array. In some cases, there are additional convenience methods. For instance, the simplest way to draw text passes the `x` and `y` coordinates where the text starts and `Paint` that specifies its font, color, and other attributes (see [Example 9-4](#)).

*Example 9-4. A pair of text drawing methods*

```
public void drawText(String text, float x, float y, Paint paint)
public void drawText(char[] text, int index, int count, float x,
                    float y, Paint paint)
```

While the first method passes text through a single `String` parameter, the second method uses three parameters: an array of `char`, an index indicating the first character in that array to be drawn, and the number of total characters in the text to be rendered.

If you want something fancier than a simple horizontal text, you can lay it out along a geometric path or even place each character precisely where you want. [Example 9-5](#) contains an `onDraw` method that demonstrates the use of each of the three text rendering methods. The output is shown in [Figure 9-2](#).

*Example 9-5. Three ways of drawing text*

```
@Override
protected void onDraw(Canvas canvas) {
    canvas.drawColor(Color.WHITE);

    Paint paint = new Paint();

    paint.setColor(Color.RED);
    canvas.drawText("Android", 25, 30, paint);

    Path path = new Path();
    path.addArc(new RectF(10, 50, 90, 200), 240, 90);
    paint.setColor(Color.CYAN);
    canvas.drawTextOnPath("Android", path, 0, 0, paint);

    float[] pos = new float[] {
        20, 80,
        29, 83,
        36, 80,
        46, 83,
        52, 80,
        62, 83,
        68, 80
    }
```

```

};
paint.setColor(Color.GREEN);
canvas.drawText("Android", pos, paint);
}

```



Figure 9-2. Output from three ways of drawing text

As you can see, the most elementary of the pairs, `drawText`, simply starts text at the passed coordinates. With `DrawTextOnPath`, on the other hand, you can draw text along any `Path`. The example path is just an arc. It could just as easily have been a line drawing or Bezier curve.

For those occasions on which even `DrawTextOnPath` is insufficient, `Canvas` offers `Draw PosText`, which lets you specify the exact position of each character in the text. Note that the character positions are specified by alternating array elements: `x1,y1,x2,y2...`

### Matrix transformations

The second interesting group of `Canvas` methods are the **Matrix** transformations and their related convenience methods, `rotate`, `scale`, and `skew`. These methods transform what you draw in ways that are immediately recognizable to those familiar with 3D graphics in other environments. The methods allow a single drawing to be rendered in ways that can make it appear as though the viewer were moving with respect to the objects in the drawing.

The small application in [Example 9-6](#) demonstrates the `Canvas`'s coordinate transformation capabilities.

*Example 9-6. Using a transformation in a canvas*

```

import android.app.Activity;

import android.content.Context;

import android.graphics.Canvas;
import android.graphics.Color;
import android.graphics.Paint;

```

```

import android.graphics.Rect;

import android.os.Bundle;

import android.view.View;

import android.widget.LinearLayout;

public class TransformationalActivity extends Activity {

    private interface Transformation {
        void transform(Canvas canvas);
        String describe();
    }

    private static class TransformedViewWidget extends View {❶
        private final Transformation transformation;

        public TransformedViewWidget(Context context, Transformation xform) {
            super(context);

            transformation = xform;❷

            setMinimumWidth(160);
            setMinimumHeight(105);
        }

        @Override
        protected void onMeasure(int widthMeasureSpec, int heightMeasureSpec) {
            setMeasuredDimension(
                getSuggestedMinimumWidth(),
                getSuggestedMinimumHeight());
        }

        @Override
        protected void onDraw(Canvas canvas) {❸
            canvas.drawColor(Color.WHITE);

            Paint paint = new Paint();

            canvas.save();❹
            transformation.transform(canvas);❺

            paint.setTextSize(12);
            paint.setColor(Color.GREEN);
            canvas.drawText("Hello", 40, 55, paint);

            paint.setTextSize(16);
            paint.setColor(Color.RED);
            canvas.drawText("Android", 35, 65, paint);

            canvas.restore();❻

            paint.setColor(Color.BLACK);
            paint.setStyle(Paint.Style.STROKE);

```

```

        Rect r = canvas.getClipBounds();
        canvas.drawRect(r, paint);

        paint.setTextSize(10);
        paint.setColor(Color.BLUE);
        canvas.drawText(transformation.describe(), 5, 100, paint);
    }
}

@Override
public void onCreate(Bundle savedInstanceState) {7
    super.onCreate(savedInstanceState);
    setContentView(R.layout.transformed);

    LinearLayout v1 = (LinearLayout) findViewById(R.id.v_left);8
    v1.addView(new TransformedViewWidget(9
        this,
        new Transformation() {10
            @Override public String describe() { return "identity"; }
            @Override public void transform(Canvas canvas) { }
        }
    ));
    v1.addView(new TransformedViewWidget(9
        this,
        new Transformation() {10
            @Override public String describe() { return "rotate(-30)"; }
            @Override public void transform(Canvas canvas) {
                canvas.rotate(-30.0F);
            }
        }
    ));
    v1.addView(new TransformedViewWidget(9
        this,
        new Transformation() {10
            @Override public String describe() { return "scale(.5,.8)"; }
            @Override public void transform(Canvas canvas) {
                canvas.scale(0.5F, .8F);
            }
        }
    ));
    v1.addView(new TransformedViewWidget(9
        this,
        new Transformation() {10
            @Override public String describe() { return "skew(.1,.3)"; }
            @Override public void transform(Canvas canvas) {
                canvas.skew(0.1F, 0.3F);
            }
        }
    ));

    LinearLayout v2 = (LinearLayout) findViewById(R.id.v_right);11
    v2.addView(new TransformedViewWidget(12
        this,
        new Transformation() {10
            @Override public String describe() { return "translate(30,10)"; }
            @Override public void transform(Canvas canvas) {
                canvas.translate(30.0F, 10.0F);
            }
        }
    ));
    v2.addView(new TransformedViewWidget(12
        this,
        new Transformation() {10

```

```

        @Override public String describe() {
            return "translate(110,-20),rotate(85)";
        }
        @Override public void transform(Canvas canvas) {
            canvas.translate(110.0F, -20.0F);
            canvas.rotate(85.0F);
        } }));
v2.addView(new TransformedViewWidget(12
    this,
    new Transformation() {10
        @Override public String describe() {
            return "translate(-50,-20),scale(2,1.2)";
        }
        @Override public void transform(Canvas canvas) {
            canvas.translate(-50.0F, -20.0F);
            canvas.scale(2F, 1.2F);
        } }));
v2.addView(new TransformedViewWidget(12
    this,
    new Transformation() {10
        @Override public String describe() { return "complex"; }
        @Override public void transform(Canvas canvas) {
            canvas.translate(-100.0F, -100.0F);
            canvas.scale(2.5F, 2F);
            canvas.skew(0.1F, 0.3F);
        } }));
    }
}

```

The results of this protracted exercise are shown in [Figure 9-3](#).

Here are some of the highlights of the code:

- ❶ This is the definition of the new widget, `TransformedViewWidget`.
- ❷ Gets the actual transformation to perform from the second argument of the constructor.
- ❸ This is the `onDraw` method of `TransformedViewWidget`.
- ❹ Pushes the current drawing state on the stack using `save` before performing any transformation.
- ❺ Performs the transformation passed as constructor argument 2.
- ❻ Restores the old state saved in item 4, in preparation for drawing the bound box and label.
- ❼ This is the `Activity`'s `onCreate` method.
- ❽ Creates the container view for the left-hand column of widgets.
- ❾ These are instantiations of `TransformedViewWidget`, added to the left-hand column.
- ❿ Creates a transformation as part of the parameter list to the constructor of `TransformedViewWidget`.

- ❶ Creates the container view for the right-hand column of widgets.
- ❷ These are instantiations of `TransformedViewWidget`, added to the right-hand column.

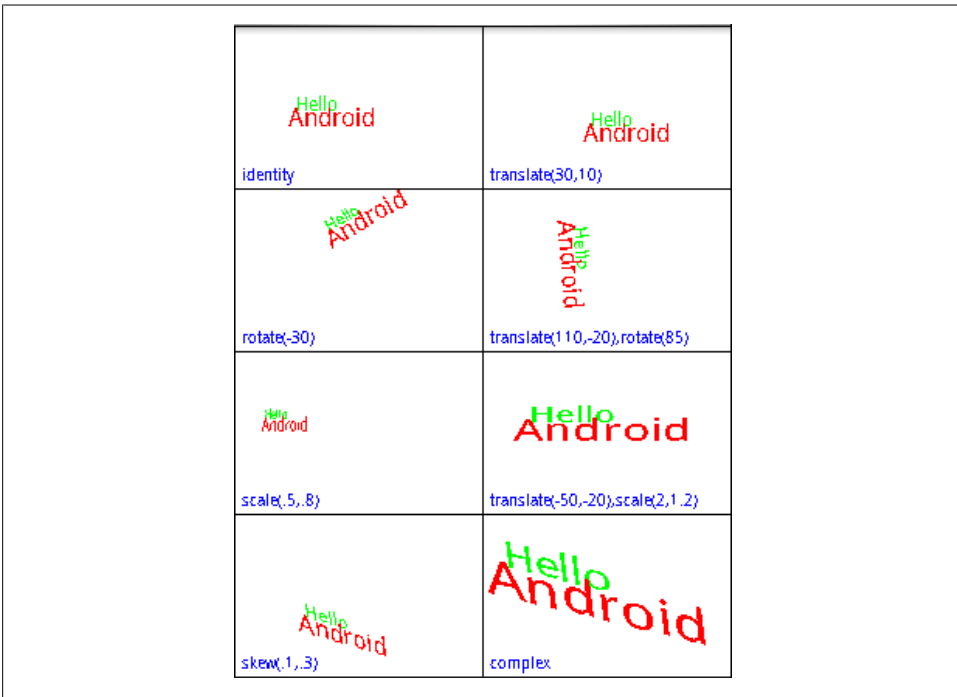

Figure 9-3. Transformed views

This small application introduces several new ideas. In terms of views and widgets, the application defines a single widget, `TransformedViewWidget`, of which it creates eight instances. For layout, the application creates two views named `v1` and `v2`, retrieving their parameters from resources. Then it adds four instances of `TransformedViewWidget` to each `LinearLayout` view. This is an example of how applications combine resource-based and dynamic views. Note that the creation of the layout views and the constructors of the new widgets take place within the Activity's `onCreate` method.

This application also makes the new widget flexible through a sophisticated division of labor between the widget and the parent view. Several simple objects are drawn directly within the definition of `TransformedViewWidget`, in its `onDraw` method:

- A white background
- The word `Hello` in 12-point green type
- The word `Android` in 16-point red type
- A black frame



- A blue label

In the middle of this, the `onDraw` method performs a transformation that is specified by the caller. The application defines its own interface called `Transformation`, and the constructor for `TransformedViewWidget` accepts a `Transformation` as a parameter. We'll see in a moment how the caller actually codes a transformation.

It's important first to see how `onDraw` preserves its own text while allowing the transformation. In this example, we want to make sure the frame and label are drawn last so that they are drawn over anything else drawn by the widget, even if they might overlap. We do not want the transformation to affect either the frame or the label.

Fortunately, the `Canvas` maintains an internal stack onto which we can record and recover the translation matrix, clip rectangle, and all other elements of mutable state in the `Canvas`. Taking advantage of this stack, `onDraw` calls `Canvas.save` to save its state before the transformation, and `Canvas.restore` afterward to restore the saved state.

The rest of the application controls the transformation applied to each of the eight instances of `TransformedViewWidget`. Each new instance of the widget is created with its own anonymous instance of `Transformation`. The image in the area labeled “identity” has no translation applied. The other seven areas are labeled with the transformations they demonstrate.

The base methods for `Canvas` translation are `setMatrix` and `concatMatrix`. These two methods allow you to build any possible transformation. The `getMatrix` method allows you to recover a dynamically constructed matrix for later use. The methods introduced in the example—`translate`, `rotate`, `scale`, and `skew`—are convenience methods that compose specific, constrained matrices into the current `Canvas` state.

While it may not be obvious at first, these transformation functions can be tremendously useful. They allow your application to appear to change its point of view with respect to a 3D object! It doesn't take too much imagination, for instance, to see the scene in the square labeled “`scale(.5,.8)`” as the same as that seen in the square labeled “identity”, but viewed from farther away. With a bit more imagination, the image in the box labeled “`skew(.1,.3)`” could be the untransformed image, again, but this time viewed from above and slightly to the side. Scaling or translating an object can make it appear to a user as though the object has moved. Skewing and rotating can make it appear that the object has turned.

When you consider that these transform functions apply to everything drawn on a canvas—lines, text, and even images—their importance in applications becomes even more apparent. A view that displays thumbnails of photos could be implemented trivially, though perhaps not optimally, as a view that scales everything it displays to 10% of its actual size. An application that displays what you see as you look to your left while driving down the street might be implemented, in part, by scaling and skewing a small number of images.

## Drawables

A `Drawable` is an object that knows how to render itself on a `Canvas`. Because a `Drawable` has complete control during rendering, even a very complex rendering process can be encapsulated in a way that makes it fairly easy to use.

Examples 9-7 and 9-8 show the changes necessary to implement the example shown in Figure 9-3, using a `Drawable`. The code that draws the red and green text has been refactored into a `HelloAndroidTextDrawable` class, used in rendering by the widget's `onDraw` method.

*Example 9-7. Using a `TextDrawable`*

```
private static class HelloAndroidTextDrawable extends Drawable {
    private ColorFilter filter;
    private int opacity;

    public HelloAndroidTextDrawable() {}

    @Override
    public void draw(Canvas canvas) {
        Paint paint = new Paint();

        paint.setColorFilter(filter);
        paint.setAlpha(opacity);

        paint.setTextSize(12);
        paint.setColor(Color.GREEN);
        canvas.drawText("Hello", 40, 55, paint);

        paint.setTextSize(16);
        paint.setColor(Color.RED);
        canvas.drawText("Android", 35, 65, paint);
    }

    @Override
    public int getOpacity() { return PixelFormat.TRANSLUCENT; }

    @Override
    public void setAlpha(int alpha) { }

    @Override
    public void setColorFilter(ColorFilter cf) { }
}
```

Using the new `Drawable` implementation requires only a few small changes to the `onDraw` method from our example.

*Example 9-8. Using a `Drawable` widget*

```
package com.oreilly.android.intro.widget;

import android.content.Context;
import android.graphics.Canvas;
```

```

import android.graphics.Color;
import android.graphics.Paint;
import android.graphics.Rect;
import android.graphics.drawable.Drawable;
import android.view.View;

/**A widget that renders a drawable with a transformation */
public class TransformedViewWidget extends View {

    /** A transformation */
    public interface Transformation {
        /** @param canvas */
        void transform(Canvas canvas);
        /** @return text description of the transform. */
        String describe();
    }

    private final Transformation transformation;
    private final Drawable drawable;

    /**
     * Render the passed drawable, transformed.
     *
     * @param context app context
     * @param draw the object to be drawn, in transform
     * @param xform the transformation
     */
    public TransformedViewWidget(
        Context context,
        Drawable draw,
        Transformation xform)
    {
        super(context);

        drawable = draw;
        transformation = xform;

        setMinimumWidth(160);
        setMinimumHeight(135);
    }

    /** @see android.view.View#onMeasure(int, int) */
    @Override
    protected void onMeasure(int widthMeasureSpec, int heightMeasureSpec) {
        setMeasuredDimension(
            getSuggestedMinimumWidth(),
            getSuggestedMinimumHeight());
    }

    /** @see android.view.View#onDraw(android.graphics.Canvas) */
    @Override
    protected void onDraw(Canvas canvas) {
        canvas.drawColor(Color.WHITE);

        canvas.save();

```

```

transformation.transform(canvas);
drawable.draw(canvas);
canvas.restore();

Paint paint = new Paint();
paint.setColor(Color.BLACK);
paint.setStyle(Paint.Style.STROKE);
Rect r = canvas.getClipBounds();
canvas.drawRect(r, paint);

paint.setTextSize(10);
paint.setColor(Color.BLUE);
canvas.drawText(
    transformation.describe(),
    5,
    getMeasuredHeight() - 5,
    paint);
}
}

```

This code begins to demonstrate the power of using a `Drawable`. This implementation of `TransformedViewWidget` will transform any `Drawable`, no matter what it happens to draw. It is no longer tied to rotating and scaling our original, hardcoded text. It can be reused to transform both the text from the previous example and a photo captured from the camera, as [Figure 9-4](#) demonstrates. It could even be used to transform a `Drawable` animation.

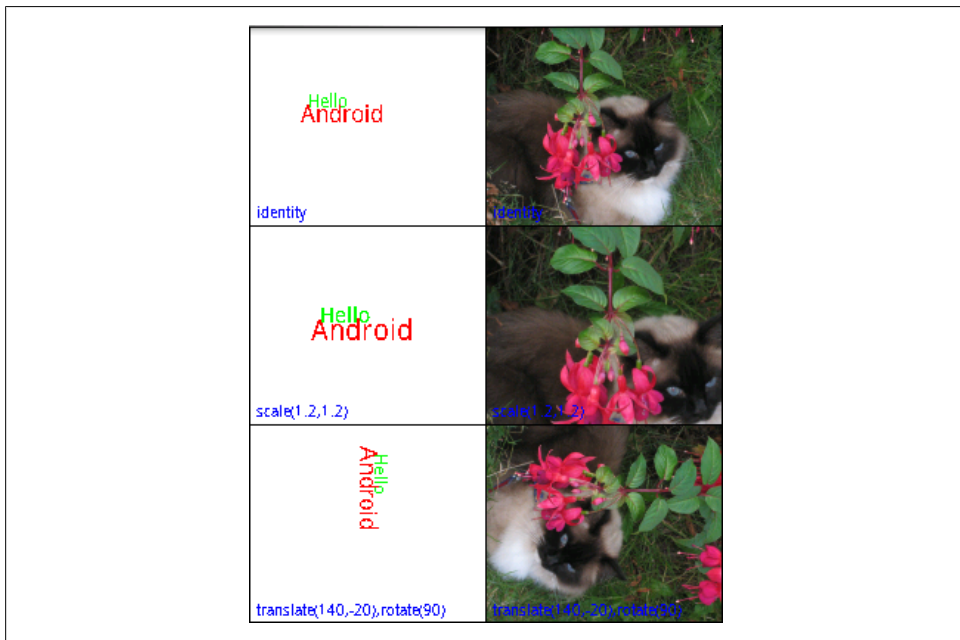

Figure 9-4. Transformed views with photos

**Drawables** make complex graphical techniques like 9-patches and animation tractable. In addition, since they wrap the rendering process completely, **Drawables** can be nested to decompose complex rendering into small reusable pieces.

Consider for a moment how we might extend the previous example to make each of the six images fade to white over a period of a minute. Certainly, we might just change the code in [Example 9-8](#) to do the fade. A different—and very appealing—implementation involves writing one new **Drawable**.

The constructor of this new **Drawable**, which we'll call **FaderDrawable**, will take as an argument a reference to its target, the **Drawable** that it will fade to white. In addition, it must have some notion of time, probably an integer—let's call it **t**—that is incremented by a timer. Whenever the **draw** method of **FaderDrawable** is called, it first calls the **draw** method of its target. Next, however, it paints over exactly the same area with the color white, using the value of **t** to determine the transparency (alpha value) of the paint (as demonstrated in [Example 9-2](#)). As time passes, **t** gets larger, the white gets increasingly opaque, and the target **Drawable** fades to white.

This hypothetical **FaderDrawable** demonstrates some of the important features of **Drawables**. Note, first of all, that **FaderDrawable** is eminently reusable. It will fade just about any **Drawable**. Also note that, since **FaderDrawable** extends **Drawable**, we can use it anywhere we would have used its target, the **Drawable** that it fades to white. Any code that uses a **Drawable** in its rendering process can use a **FaderDrawable**, without change.

Of course, a **FaderDrawable** could, itself, be wrapped. In fact, it is possible to achieve very complex effects, simply by building a chain of **Drawable** wrappers. The Android toolkit provides **Drawable** wrappers that support this strategy, including **ClipDrawable**, **RotateDrawable**, and **ScaleDrawable**.

At this point, you may be mentally redesigning your entire UI in terms of **Drawables**. While they are a powerful tool, they are not a panacea. There are several issues to keep in mind when considering the use of **Drawables**.

You may well have noticed that they share a lot of the functionality of the **View** class: location, dimensions, visibility, and so on. It's not always easy to decide when a **View** should draw directly on the **Canvas**, when it should delegate to a subview, and when it should delegate to one or more **Drawable** objects. There is even a **DrawableContainer** class that allows the grouping of several child **Drawables** within a parent. It is possible to build trees of **Drawables** that parallel the trees of **Views** we've been using so far. In dealing with the Android UI framework, you just have to accept that there is more than one way to scale a cat.

One difference between the two choices is that **Drawables** do not implement the **View** measure/layout protocol, which, you'll recall, allows a container view to negotiate the layout of its components in response to changing view size. When a renderable object needs to add, remove, or lay out internal components, it's a pretty good indication that it should be a full-fledged **View** instead of a **Drawable**.

A second issue to consider is that, because `Drawables` completely wrap the drawing process, they are not drawn like `String` or `Rect` objects. There are, for instance, no `Canvas` methods that will render a `Drawable` at specific coordinates. You may find yourself deliberating over whether, in order to render a certain image twice, a `View.onDraw` method should use two different, immutable `Drawables` or a single `Drawable` twice, re-setting its coordinates.

Perhaps most important, though, is a more generic problem. The reason the idea of a chain of `Drawables` works is that the `Drawable` interface contains no information about the internal implementation of the `Drawable`. When your code is passed a `Drawable`, there is no way for it to know whether it is something that will render a simple image or a complex chain of effects that rotates, flashes, and bounces. Clearly this can be a big advantage. It can also be a problem, though.

Quite a bit of the drawing process is stateful. You set up `Paint` and then draw with it. You set up `Canvas` clip regions and transformations and then draw through them. When cooperating in a chain, `Drawables` must be very careful, if they change state, that those changes never collide. The problem is that, when constructing a `Drawable` chain, the possibility of collision cannot, by definition (they are all just `Drawables`), be explicit in the object's type. A seemingly small change might have an effect that is not desirable and is difficult to debug.

To illustrate, consider two `Drawable` wrapper classes, one that is meant to shrink its contents and another that is meant to rotate them by 90 degrees. If either is implemented by setting the transformation matrix to a specific value, composing the two may not have the desired effect. Worse, it might work perfectly if A wraps B, but not if B wraps A! Careful documentation of how a `Drawable` is implemented is essential.

## Bitmaps

The `Bitmap` is the last member of the four essentials for drawing: something to draw (a `String`, `Rect`, etc.), a `Paint` with which to draw, a `Canvas` on which to draw, and the `Bitmap` to hold the bits. Most of the time, you don't have to deal directly with a `Bitmap`, because the `Canvas` provided as an argument to the `onDraw` method already has one behind it. There are circumstances, though, under which you may want to use a `Bitmap` directly.

A common use for a `Bitmap` is to cache a drawing that may be time-consuming to draw but unlikely to change frequently. Consider, for example, a drawing program that allows the user to draw in multiple layers. The layers act as transparent overlays on a base image, and the user turns them off and on at will. It might be very expensive to actually draw each individual layer every time `onDraw` gets called. Instead, it might be faster to render the entire drawing upon first appearance, with all visible layers, and then redraw the single layer that needs changing only when the user makes a visible change to it.

The implementation of such an application might look something like [Example 9-9](#).

*Example 9-9. Bitmap caching*

```
private class CachingWidget extends View {
    private Bitmap cache;

    public CachingWidget(Context context) {
        super(context);
        setMinimumWidth(200);
        setMinimumHeight(200);
    }

    public void invalidateCache() {
        cache = null;
        invalidate();
    }

    @Override
    protected void onDraw(Canvas canvas) {
        if (null == cache) {
            cache = Bitmap.createBitmap(
                getMeasuredWidth(),
                getMeasuredHeight(),
                Bitmap.Config.ARGB_8888);

            drawCachedBitmap(new Canvas(cache));
        }

        canvas.drawBitmap(cache, 0, 0, new Paint());
    }

    // ... definition of drawCachedBitmap
}
```

This widget normally just copies the cached `Bitmap`, `cache`, to the `Canvas` passed to `onDraw`. Only if the cache is marked stale, by calling `invalidateCache`, will `drawCachedBitmap` be called to actually render the widget.

The most common way to encounter a `Bitmap` is as the programmatic representation of a graphics resource. `Resources.getDrawable` returns a `BitmapDrawable` when the resource is an image.

Combining these two ideas, caching an image and wrapping it in a `Drawable`, opens yet another interesting window. It means anything that can be drawn can also be post-processed! An application that used all the techniques demonstrated in this chapter could allow a user to draw furniture in a room (creating a `bitmap`) and then to walk around it (using the matrix transforms).



With Honeycomb, there have been substantial changes in Android’s rendering architecture. These changes take advantage of the increasing power of GPUs and create a whole new set of rules for optimizing the way your UI is drawn. Consider `View.setLayerType` before creating new bitmaps.

## Bling

The Android UI framework is a lot more than just an intelligent, well-put-together GUI toolkit. When it takes off its glasses and shakes out its hair, it can be downright sexy! The tools mentioned here certainly do not make an exhaustive catalog. They might get you started, though, on the path to making your application Filthy Rich.

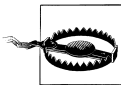

Several of the techniques discussed in this section are close to the edges of the Android landscape. As such, they are less well established than the classes we discussed earlier in the chapter: the documentation is not as thorough, some of the features are clearly in transition, and you may even find bugs. If you run into problems, the Google Group “Android Developers” is an invaluable resource. Questions about a particular aspect of the toolkit have sometimes been answered by the very person responsible for implementing that aspect.

Be careful about checking the dates on solutions you find by searching the Web. Some of these features are changing rapidly. Code that worked as recently as six months ago may not work now. A corollary, of course, is that any application that gets wide distribution is likely to be run on platforms that have differing implementations of the features discussed here. By using these techniques, you may limit the lifetime of your application, and the number of devices that it will support.

The rest of this section considers a single application, much like the one used in [Example 9-6](#): a couple of `LinearLayout`s that contain multiple instances of a single widget, each demonstrating a different graphics effect. [Example 9-10](#) provides the key parts of the widget, with code discussed previously, elided for brevity. The widget simply draws a few graphical objects and defines an interface through which various graphics effects can be applied to the rendering.

*Example 9-10. Effects widget*

```
public class EffectsWidget extends View {  
  
    /** The effect to apply to the drawing */  
    public interface PaintEffect { void setEffect(Paint paint); }  
  
    // ...  
  
    // PaintWidget's widget rendering method  
    protected void onDraw(Canvas canvas) {
```



```

Paint paint = new Paint();
paint.setAntiAlias(true);

effect.setEffect(paint);
paint.setColor(Color.DKGRAY);

paint.setStrokeWidth(5);
canvas.drawLine(10, 10, 140, 20, paint);

paint.setTextSize(26);
canvas.drawText("Android", 40, 50, paint);

paint = new Paint();
paint.setColor(Color.BLACK);
canvas.drawText(String.valueOf(id), 2.0F, 12.0F, paint);
paint.setStyle(Paint.Style.STROKE);
paint.setStrokeWidth(2);
canvas.drawRect(canvas.getClipBounds(), paint);
}
}

```

The application that uses this widget ([Example 9-11](#)) should also feel familiar. It creates several copies of the `EffectsWidget`, each with its own effect. There are two special widgets. The bottom widget in the left-hand column uses OpenGL animation. In the right column the bottom widget is empty, but the one above it shows a button with an animated background.

*Example 9-11. Effects application*

```

private void buildView() {
    setContentView(R.layout.main);

    LinearLayout view = (LinearLayout) findViewById(R.id.v_left);
    view.addView(new EffectsWidget(
        this,
        1,
        new EffectsWidget.PaintEffect() {
            @Override public void setEffect(Paint paint) {
                paint.setShadowLayer(1, 3, 4, Color.BLUE);
            }
        }
    ));
    view.addView(new EffectsWidget(
        this,
        3,
        new EffectsWidget.PaintEffect() {
            @Override public void setEffect(Paint paint) {
                paint.setShader(
                    new LinearGradient(
                        0.0F,
                        0.0F,
                        160.0F,
                        80.0F,
                        new int[] { Color.BLACK, Color.RED, Color.YELLOW },
                        null,
                        Shader.TileMode.REPEAT));
            }
        }
    ));
}

```

```

        } }));
view.addView(new EffectsWidget(
    this,
    5,
    new EffectsWidget.PaintEffect() {
        @Override public void setEffect(Paint paint) {
            paint.setMaskFilter(
                new BlurMaskFilter(2, BlurMaskFilter.Blur.NORMAL));
        } }));

// Not an EffectsWidget: this is the OpenGL Animation widget.
glWidget = new GLDemoWidget(this);
view.addView(glWidget);

view = (LinearLayout) findViewById(R.id.v_right);
view.addView(new EffectsWidget(
    this,
    2,
    new EffectsWidget.PaintEffect() {
        @Override public void setEffect(Paint paint) {
            paint.setShadowLayer(3, -8, 7, Color.GREEN);
        } }));
view.addView(new EffectsWidget(
    this,
    4,
    new EffectsWidget.PaintEffect() {
        @Override public void setEffect(Paint paint) {
            paint.setShader(
                new LinearGradient(
                    0.0F,
                    40.0F,
                    15.0F,
                    40.0F,
                    Color.BLUE,
                    Color.GREEN,
                    Shader.TileMode.MIRROR));
        } }));

// A widget with an animated background
View w = new EffectsWidget(
    this,
    6,
    new EffectsWidget.PaintEffect() {
        @Override public void setEffect(Paint paint) { }
    });
view.addView(w);
w.setBackgroundResource(R.drawable.throbber);

w.setOnClickListener(new OnClickListener() {
    @Override public void onClick(View v) {
        ((AnimationDrawable) v.getBackground()).start();
    } });
}

```

Figure 9-5 shows what the code looks like when run. Widgets 6 and 7 are animated. Widget 6 has a background that pulses red when clicked, and the green checkerboard moves from left to right across widget 7. Widget 8 is unused.

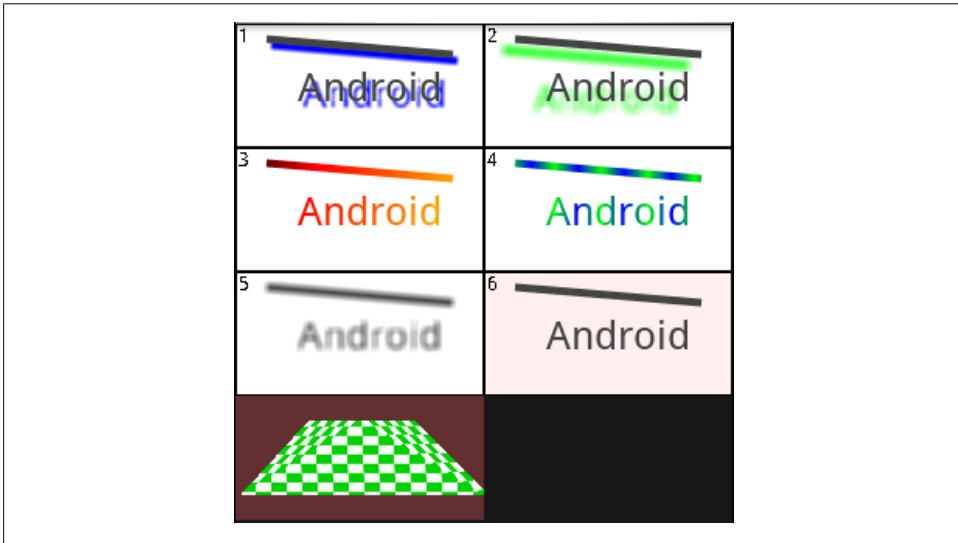

Figure 9-5. Graphics effects

## Shadows, Gradients, and Filters

`PathEffect`, `MaskFilter`, `ColorFilter`, `Shader`, and `ShadowLayer` are all attributes of `Paint`. Anything drawn with `Paint` can be drawn under the influence of one or more of these transformations. The top five widgets in Figure 9-5 give examples of several of these effects.

Widgets 1 and 2 demonstrate shadows. Shadows are currently controlled by the `setShadowLayer` method. The arguments, a blur radius and `x` and `y` displacements, control the apparent distance and position of the light source that creates the shadow with respect to the shadowed object.

The second row of widgets demonstrates `Shaders`. The Android toolkit contains several prebuilt shaders. Widgets 3 and 4 demonstrate one of them, the `LinearGradient` shader. A gradient is a regular transition between colors that can be used, for instance, to give a page background a bit more life without resorting to expensive bitmap resources.

A `LinearGradient` is specified with a vector that determines the direction and rate of the color transition, an array of colors through which to transition, and a mode. The final argument, the mode, determines what happens when a single complete transition through the gradient is insufficient to cover the entire painted object. For instance, in widget 4, the transition is only 15 pixels long, whereas the drawing is more than 100

pixels wide. Using the mode `Shader.TileMode.Mirror` causes the transition to repeat, alternating direction across the drawing. In the example, the gradient transitions from blue to green, in 15 pixels, then from green to blue in the next 15, and so on, across the canvas.

## Animation

The Android UI toolkit offers several different animation tools. Transition animations—which the Google documentation calls *tweened animations*—are subclasses of `android.view.animation.Animation`: `RotateAnimation`, `TranslateAnimation`, `ScaleAnimation`, and so on. These animations are used as transitions between pairs of views. A second type of animation, subclasses of `android.graphics.drawable.AnimationDrawable`, can be put into the background of any widget to provide a wide variety of effects. Finally, there is a full-on animation class on top of a `SurfaceView` that gives you complete control to do your own seat-of-the-pants animation.

Because both of the first two types of animation, transition and background, are supported by `View`, either can be used in nearly any widget.

### Transition animation

A transition animation is started by calling the `View` method `startAnimation` with an instance of `Animation` (or, of course, your own subclass). Once installed, the animation runs to completion: transition animations have no pause state.

The heart of the animation is its `applyTransformation` method. This method is called to produce successive frames of the animation. [Example 9-12](#) shows the implementation of one transformation. As you can see, it does not actually generate entire graphical frames for the animation. Instead, it generates successive transformations to be applied to a single image being animated. You will recall, from [“Matrix transformations” on page 222](#), that matrix transformations can be used to make an object appear to move. Transition animations depend on exactly this trick.

*Example 9-12. Transition animation*

```
@Override
protected void applyTransformation(float t, Transformation xf) {
    Matrix xform = xf.getMatrix();

    float z = ((dir > 0) ? 0.0f : -Z_MAX) - (dir * t * Z_MAX);
    camera.save();
    camera.rotateZ(t * 360);
    camera.translate(0.0f, 0.0f, z);
    camera.getMatrix(xform);
    camera.restore();

    xform.preTranslate(-xCenter, -yCenter);
}
```

```
xform.postTranslate(xCenter, yCenter);  
}
```

This particular implementation makes its target appear to spin in the screen plane (the `rotate` method call) and, at the same time, to shrink into the distance (the `translate` method call). The matrix that will be applied to the target image is obtained from the `Transformation` object passed in that call.

This implementation uses `camera`, an instance of the utility class `Camera`. This `Camera` class—not to be confused with the camera in the phone—is a utility that makes it possible to record rendering state. It is used here to compose the rotation and translation transformations into a single matrix, which is then stored as the animation transformation.

The first parameter to `applyTransformation`, named `t`, is effectively the frame number. It is passed as a floating-point number between 0.0 and 1.0, and might also be understood as the percent of the animation that is complete. This example uses `t` to increase the apparent distance, along the z-axis (a line perpendicular to the plane of the screen), of the image being animated, and to set the proportion of one complete rotation through which the image has passed. As `t` increases, the animated image appears to rotate further and further counterclockwise and to move farther and farther away, along the z-axis, into the distance.

The `preTranslate` and `postTranslate` operations are necessary in order to translate the image around its center. By default, matrix operations transform their target around the origin (upper-left corner). If we did not perform these bracketing translations, the target image would appear to rotate around its upper-left corner. `preTranslate` effectively moves the origin to the center of the animation target for the translation, and `postTranslate` causes the default to be restored after the translation.

If you consider what a transition animation must do, you'll realize that it is actually likely to compose two animations: the previous screen must be animated out and the next one animated in. [Example 9-12](#) supports this using the remaining, unexplained variable, `dir`. Its value is either 1 or -1, and controls whether the animated image seems to shrink into the distance or grow into the foreground. We need only find a way to compose a shrinking and a growing animation.

This is done using the familiar `Listener` pattern. The `Animation` class defines a listener named `Animation.AnimationListener`. Any instance of `Animation` that has a non-null listener calls that listener once when it starts, once when it stops, and once for each iteration in between. A listener that notices when the shrinking animation completes and spawns a new growing animation will create exactly the effect we desire. [Example 9-13](#) shows the rest of the implementation of the animation.

Example 9-13. Transition animation composition

```
public void runAnimation() {
    animateOnce(new AccelerateInterpolator(), this);
}

@Override
public void onAnimationEnd(Animation animation) {
    root.post(new Runnable() {
        public void run() {
            curView.setVisibility(View.GONE);
            nextView.setVisibility(View.VISIBLE);
            nextView.requestFocus();
            new RotationTransitionAnimation(-1, root, nextView, null)
                .animateOnce(new DecelerateInterpolator(), null);
        }
    });
}

void animateOnce(
    Interpolator interpolator,
    Animation.AnimationListener listener)
{
    setDuration(700);
    setInterpolator(interpolator);
    setAnimationListener(listener);
    root.startAnimation(this);
}
```

The `runAnimation` method starts the transition. The overridden `AnimationListener` method, `onAnimationEnd`, spawns the second half. Called when the target image appears to be far in the distance, it hides the image being animated out (the `curView`) and replaces it with the newly visible image, `nextView`. It then creates a new animation that, running in reverse, spins and grows the new image into the foreground.

The `Interpolator` class represents a nifty attention to detail. The values for `t`, passed to `applyTransformation`, need not be linearly distributed over time. In this implementation the animation appears to speed up as it recedes, and then to slow again as the new image advances. This is accomplished by using the two interpolators, `AccelerateInterpolator` for the first half of the animation and `DecelerateInterpolator` for the second. Without the interpolator, the difference between successive values of `t`, passed to `applyTransformation`, would be constant. This would make the animation appear to have a constant speed. The `AccelerateInterpolator` converts those equally spaced values of `t` into values that are close together at the beginning of the animation and much farther apart toward the end. This makes the animation appear to speed up. `DecelerateInterpolator` has exactly the opposite effect. Android also provides a `CycleInterpolator` and `LinearInterpolator` for use as appropriate.

Animation composition is actually built into the toolkit, using the (perhaps confusingly named) `AnimationSet` class. This class provides a convenient way to specify a list—fortunately *not* a set: it is ordered and may refer to a given animation more than once—of animations to be played, in order. In addition, the toolkit provides several

standard transitions: `AlphaAnimation`, `RotateAnimation`, `ScaleAnimation`, and `TranslateAnimation`. Certainly, there is no need for these transitional animations to be symmetric, as they are in the previous example. A new image might alpha-fade in as the old one shrinks into a corner, or slide up from the bottom as the old one fades out. The possibilities are endless.

## Background animation

*Frame-by-frame* animation, as it is called in the Google documentation, is completely straightforward: a set of frames, played in order at regular intervals. This kind of animation is implemented by subclasses of `AnimationDrawable`.

As subclasses of `Drawable`, `AnimationDrawable` objects can be used in any context that any other `Drawable` is used. The mechanism that animates them, however, is not a part of the `Drawable` itself. In order to animate, an `AnimationDrawable` relies on an external service provider—an implementation of the `Drawable.Callback` interface—to animate it.

The `View` class implements this interface and can be used to animate an `AnimationDrawable`. Unfortunately, it will supply animation services *only* to the one `Drawable` object that is installed as its background.

The good news, however, is that this is probably sufficient. A background animation has access to the entire widget canvas. Everything it draws will appear to be behind anything drawn by the `View.onDraw` method, so it would be hard to use it to implement full-fledged sprites. Still, with clever use of the `DrawableContainer` class (which allows you to animate several different animations simultaneously), and because the background can be changed at any time, it is possible to accomplish quite a bit without resorting to implementing your own animation framework.

An `AnimationDrawable` in a view background is entirely sufficient to do anything from, say, indicating that some long-running activity is taking place—maybe winged packets flying across the screen from a phone to a tower—to simply making the background to a button pulse.

The pulsing button example in widget 6 is illustrative and surprisingly easy to implement. Examples 9-14 and 9-15 show all you need. The animation is defined as a resource, and code applies it to the button. You can set a `Drawable` as a background using either `setBackgroundDrawable` or `setBackgroundResource`.

*Example 9-14. Frame-by-frame animation (resource)*

```
<animation-list
  xmlns:android="http://schemas.android.com/apk/res/android"
  android:oneshot="false">
  <item android:drawable="@drawable/throbber_f0" android:duration="70" />
  <item android:drawable="@drawable/throbber_f1" android:duration="70" />
  <item android:drawable="@drawable/throbber_f2" android:duration="70" />
  <item android:drawable="@drawable/throbber_f3" android:duration="70" />
```

```

<item android:drawable="@drawable/throbber_f4" android:duration="70" />
<item android:drawable="@drawable/throbber_f5" android:duration="70" />
<item android:drawable="@drawable/throbber_f6" android:duration="70" />
</animation-list>

```

*Example 9-15. Frame-by-frame animation (code)*

```

// w is a button that will "throb"
button.setBackgroundResource(R.drawable.throbber);

button.setOnClickListener(new OnClickListener() {
    @Override public void onClick(View v) {
        AnimationDrawable animation
            = (AnimationDrawable) v.getBackground();
        if (animation.isRunning()) { animation.stop(); }
        else { animation.start(); }
        // button action.
    } });

```

There are a couple gotchas here, though. First of all, there does not appear to be any way to start a background animation from an `Activity.onCreate` method: `((AnimationDrawable) view.getBackground()).start()` won't do it. If your application's background should be animated whenever it is visible, you'll have to use trickery to start it. The example implementation uses an `onClick` handler to start the animation. There are suggestions on the Web that the animation can also be started successfully from a thread that pauses briefly before calling `AnimationDrawable.start`.

Also, if you have worked with other UI frameworks, especially mobile UI frameworks, you may be accustomed to painting the view background in the first couple of lines of the `onDraw` method (or equivalent). If you do that here, you will paint over your animation! It is, in general, a good idea to get into the habit of using `setBackground` to control the `View` background, whether it is a solid color, a gradient, an image, or an animation.

Specifying a `DrawableAnimation` by resource is very flexible. You can specify a list of drawable resources—any images you like—that comprise the animation. If your animation needs to be dynamic, `AnimationDrawable` is a straightforward recipe for creating a dynamic drawable that can be animated in the background of a `View`.

### Surface view animation

Full-on animation requires a `SurfaceView`. The `SurfaceView` provides a node in the view tree—and, therefore, space on the display—on which any process at all can draw. After you lay out and size the `SurfaceView` node, it receives clicks and updates, just like any other widget. Instead of drawing, however, it simply reserves space on the screen, preventing other widgets from affecting any of the pixels within its frame.

Drawing on a `SurfaceView` requires implementing the `SurfaceHolder.Callback` interface. The two methods `surfaceCreated` and `surfaceDestroyed` inform the implementor



that the drawing surface is available for drawing, and that it has become unavailable, respectively. The argument to both calls is an instance of yet a third class, `SurfaceHolder`. In the interval between these two calls, a drawing routine can call the `SurfaceView` methods `lockCanvas` and `unlockCanvasAndPost` to edit the pixels there.

If this seems complex, even alongside some of the elaborate animation discussed previously—well, it is. As usual, concurrency increases the likelihood of nasty, hard-to-find bugs. The client of a `SurfaceView` must be sure, not only that access to any state shared across threads is properly synchronized, but also that it never touches the `SurfaceView`, `Surface`, or `Canvas` except in the interval between the calls to `surfaceCreated` and `surfaceDestroyed`. The toolkit could, clearly, benefit from a more complete framework support for `SurfaceView` animation.

If you are considering `SurfaceView` animation, you are probably also considering OpenGL graphics. As we'll see, an extension is available for OpenGL animation on a `SurfaceView`. It will turn up in a somewhat out-of-the-way place, though.

## OpenGL Graphics

The Android platform supports OpenGL graphics in roughly the same way that a silk hat supports rabbits. While this is certainly among the most exciting technologies in Android, it is definitely at the edge of the map. It also appears that, just before the final beta release, the interface underwent major changes. Much of the code and many of the suggestions found on the Web are obsolete and no longer work.

The API V1\_r2 release is an implementation of OpenGL ES 1.0 and much of ES 1.1. It is essentially a domain-specific language embedded in Java. Someone who has been doing gaming UIs for a while is likely to be much more comfortable developing Android OpenGL programs than a Java programmer, even a Java UI expert.

Before discussing the OpenGL graphics library itself, we should take a minute to consider exactly how pixels drawn with OpenGL appear on the display. Thus far, this chapter has discussed the intricate `View` framework that Android uses to organize and represent objects on the screen. OpenGL is a language in which an application describes an entire scene that will be rendered by an engine that is not only outside the JVM, but probably running on another processor altogether (the Graphics Processing Unit, or GPU). Coordinating the two processors' views of the screen is tricky.

The `SurfaceView`, discussed earlier, is nearly sufficient. Its purpose is to create a surface on which a thread other than the UI graphics thread can draw. The tool we'd like is an extension of `SurfaceView` that has a bit more support for concurrency combined with support for OpenGL.

It turns out that there is exactly such a tool. All the demo applications in the Android SDK distribution that do OpenGL animation depend on the utility class `GLSurfaceView`. Since the demo applications, written by the creators of Android, use this class, considering it for your applications seems advisable.

GLSurfaceView defines an interface, `GLSurfaceView.Renderer`, which dramatically simplifies the otherwise overwhelming complexity of using OpenGL and `GLSurfaceView`. `GLSurfaceView` calls the `getConfigSpec` rendering method to get its OpenGL configuration information. Two other methods, `sizeChanged` and `surfaceCreated`, are called by the `GLSurfaceView` to inform the renderer that its size has changed or that it should prepare to draw, respectively. Finally, `drawFrame`, the heart of the interface, is called to render a new OpenGL frame.

[Example 9-16](#) shows the important methods from the implementation of an OpenGL renderer.

*Example 9-16. Frame-by-frame animation with OpenGL*

```
// ... some state set up in the constructor

@Override
public void surfaceCreated(GL10 gl) {
    // set up the surface
    gl.glDisable(GL10.GL_DITHER);

    gl.glHint(
        GL10.GL_PERSPECTIVE_CORRECTION_HINT,
        GL10.GL_FASTEST);

    gl.glClearColor(0.4f, 0.2f, 0.2f, 0.5f);
    gl.glShadeModel(GL10.GL_SMOOTH);
    gl.glEnable(GL10.GL_DEPTH_TEST);

    // fetch the checker-board
    initImage(gl);
}

@Override
public void drawFrame(GL10 gl) {
    gl.glClear(GL10.GL_COLOR_BUFFER_BIT | GL10.GL_DEPTH_BUFFER_BIT);

    gl.glMatrixMode(GL10.GL_MODELVIEW);
    gl.glLoadIdentity();

    GLU.gluLookAt(gl, 0, 0, -5, 0f, 0f, 0f, 0f, 1.0f, 0.0f);

    gl.glEnableClientState(GL10.GL_VERTEX_ARRAY);
    gl.glEnableClientState(GL10.GL_TEXTURE_COORD_ARRAY);

    // apply the checker-board to the shape
    gl.glActiveTexture(GL10.GL_TEXTURE0);

    gl.glTexEnvx(
        GL10.GL_TEXTURE_ENV,
        GL10.GL_TEXTURE_ENV_MODE,
        GL10.GL_MODULATE);
    gl.glTexParameterx(
        GL10.GL_TEXTURE_2D,
        GL10.GL_TEXTURE_WRAP_S,
```

```

        GL10.GL_REPEAT);
gl.glTexParameterx(
    GL10.GL_TEXTURE_2D,
    GL10.GL_TEXTURE_WRAP_T,
    GL10.GL_REPEAT);

// animation
int t = (int) (SystemClock.uptimeMillis() % (10 * 1000L));
gl.glTranslatef(6.0f - (0.0013f * t), 0, 0);

// draw
gl.glFrontFace(GL10.GL_CCW);
gl.glVertexPointer(3, GL10.GL_FLOAT, 0, vertexBuf);
gl.glEnable(GL10.GL_TEXTURE_2D);
gl.glTexCoordPointer(2, GL10.GL_FLOAT, 0, textureBuf);
gl.glDrawElements(
    GL10.GL_TRIANGLE_STRIP,
    5,
    GL10.GL_UNSIGNED_SHORT, indexBuf);
}

private void initImage(GL10 gl) {
    int[] textures = new int[1];
    gl.glGenTextures(1, textures, 0);
    gl.glBindTexture(GL10.GL_TEXTURE_2D, textures[0]);

    gl.glTexParameterf(
        GL10.GL_TEXTURE_2D,
        GL10.GL_TEXTURE_MIN_FILTER,
        GL10.GL_NEAREST);
    gl.glTexParameterf(
        GL10.GL_TEXTURE_2D,
        GL10.GL_TEXTURE_MAG_FILTER,
        GL10.GL_LINEAR);
    gl.glTexParameterf(
        GL10.GL_TEXTURE_2D,
        GL10.GL_TEXTURE_WRAP_S,
        GL10.GL_CLAMP_TO_EDGE);
    gl.glTexParameterf(
        GL10.GL_TEXTURE_2D,
        GL10.GL_TEXTURE_WRAP_T,
        GL10.GL_CLAMP_TO_EDGE);
    gl.glTexEnvf(
        GL10.GL_TEXTURE_ENV,
        GL10.GL_TEXTURE_ENV_MODE,
        GL10.GL_REPLACE);

    InputStream in
        = context.getResources().openRawResource(R.drawable.cb);
    Bitmap image;
    try { image = BitmapFactory.decodeStream(in); }
    finally {
        try { in.close(); } catch(IOException e) { }
    }
}

```

```
GLUtils.texImage2D(GL10.GL_TEXTURE_2D, 0, image, 0);  
    image.recycle();  
}
```

The method `surfaceCreated` prepares the scene. It sets several OpenGL attributes that need to be initialized only when the widget gets a new drawing surface. In addition, it calls `initImage`, which reads in a bitmap resource and stores it as a 2D texture. When, finally, `drawFrame` is called, everything is ready for drawing. The texture is applied to a plane, whose vertices were set up in `vertexBuf` by the constructor; the animation phase is chosen; and the scene is redrawn.



It appears that, with the Honeycomb release, OpenGL has been fully integrated into Android graphics. According to the documentation, Honeycomb not only supports OpenGL 2.0, but also uses it as the basis for rendering `View` objects.

---

# Handling and Persisting Data

To accomplish many of the activities offered by modern mobile phones, such as tracking contacts, events, and tasks, a mobile operating system and its applications must be adept at storing and keeping track of large quantities of data. This data is usually structured in rows and columns, like a spreadsheet or a very simple database. Beyond a traditional application's requirements for storing data, the Android application life cycle demands rapid and consistent persistence of data for it to survive the volatility of the mobile environment, where devices can suddenly lose power or the Android operating system can arbitrarily decide to remove your application from memory.

Android provides the light-weight but powerful SQLite relational database engine for persisting data. Furthermore, as described in [Chapter 3](#), the content provider feature lets applications expose their data to other applications.

In this chapter, we provide a simple SQL tutorial so that you can learn to work with Android SQLite persistence. We also walk you through an interesting application—MJAndroid—that provides a real-world look at how to manipulate a database in Android. Later, in [Chapter 15](#), we'll reference the same example to demonstrate the use of the mapping API in Android. [Chapter 12](#) will show you how to implement a content provider.

## Relational Database Overview

A relational database provides an efficient, structured, and generic system for managing persistent information. With a database, applications use structured queries to modify information in persistent two-dimensional matrices called *tables* (or in the original theoretical papers, *relations*). Developers write queries in a high-level language called the Standard Query Language, or more commonly, SQL. SQL is the common language for relational database management systems (RDBMSs) that have been a popular tool for data management since the late 1970s. SQL became an industry-wide standard when it was adopted by NIST in 1986 and ISO in 1987. It is used for everything from terabyte Oracle and SQL Server installations to, as we shall see, storing email on your phone.

Database tables are a natural fit for data that includes many instances of the same kind of thing—a typical occurrence in software development. For example, a contact list has many contacts, all of which potentially have the same type of information (i.e., address, phone number, etc.). Each “row” of data in a table stores information about a different person, while each “column” stores a specific attribute of each person: names in one column, address in another column, and home phone number in a third. When someone is related to multiple things (such as multiple addresses), relational databases have ways of handling that too, but we won't go into such detail in this chapter.

## SQLite

Android uses the SQLite database engine, a self-contained, transactional database engine that requires no separate server process. Many applications and environments beyond Android make use of it, and a large open source community actively develops SQLite. In contrast to desktop-oriented or enterprise databases, which provide a plethora of features related to fault tolerance and concurrent access to data, SQLite aggressively strips out features that are not absolutely necessary in order to achieve a small footprint. For example, many database systems use static typing, but SQLite does not store database type information. Instead, it pushes the responsibility of keeping type information into high-level languages, such as Java, that map database structures into high-level types.

SQLite is not a Google project, although Google has contributed to it. SQLite has an international team of software developers who are dedicated to enhancing the software's capabilities and reliability. Reliability is a key feature of SQLite. More than half of the code in the project is devoted to testing the library. The library is designed to handle many kinds of system failures, such as low memory, disk errors, and power failures. The database should never be left in an unrecoverable state, as this would be a showstopper on a mobile phone where critical data is often stored in a database. Fortunately, the SQLite database is not susceptible to easy corruption—if it were, an inopportune battery failure could turn a mobile phone into an expensive paperweight.

The SQLite project provides comprehensive and detailed documentation at <http://www.sqlite.org/docs.html>.

## The SQL Language

Writing Android applications usually requires a basic ability to program in the SQL language, although higher-level classes are provided for the most common data-related activities. This chapter provides a beginner's introduction to SQLite. Although this is not a book about SQL, we will provide you with enough detail about Android-oriented SQL to let you implement data persistence in a wide variety of Android applications. For more comprehensive information pertaining to the SQLite language, see <http://www.sqlite.org/lang.html>. We'll use simple SQL commands to explain the SQLite

language, and along the way, we'll demonstrate how to use the `sqlite3` command to see the effects those queries have on the tables they modify. You may also find the W3Schools tutorial useful: [http://www.w3schools.com/sql/sql\\_intro.asp](http://www.w3schools.com/sql/sql_intro.asp).

With SQLite, the database is a simple file in the Android filesystem, which could reside in flash or external card memory, but you will find that most applications' databases reside in a directory called `/data/data/com.example.yourAppPackage/databases`. You can issue the `ls` command in the adb shell to list the databases that Android has created for you in that directory.

The database takes care of persistence—that is, it updates the SQLite file in the way specified by each SQL statement issued by an application. In the following text, we describe SQLite commands as they are used inside the `sqlite3` command-line utility. Later we will show ways to achieve the same effects using the Android API. Although command-line SQL will not be part of the application you ship, it can certainly help to debug applications as you're developing them. You will find that writing database code in Android is usually an iterative process of writing Java code to manipulate tables, and then peeking at created data using the command line.

## SQL Data Definition Commands

Statements in the SQL language fall into two distinct categories: those used to create and modify tables—the locations where data is stored—and those used to create, read, update, and delete the data in those tables. In this section we'll look at the former, the data definition commands:

### CREATE TABLE

Developers start working with SQL by creating a table to store data. The `CREATE TABLE` command creates a new table in an SQLite database. It specifies a name, which must be unique among the tables in the database, and various *columns* to hold the data. Each column has a unique name within the table and a type (the types are defined by SQL, such as a date or text string). The column may also specify other attributes, such as whether values have to be unique, whether there is a default value when a row is inserted without specifying a value, and whether `NULL` is allowed in the column.

A table is similar to a spreadsheet. Returning to the example of a contact database, each row in the table contains the information for one contact. The columns in the table are the various bits of information you collect about each individual contact: first name, last name, birthday, and so on. We provide several examples in this chapter that will help you to begin using our job database.



The tables created by SQL `CREATE TABLE` statements and the attributes they contain are called a *database schema*.

## DROP TABLE

This removes a table added with the `CREATE TABLE` statement. It takes the name of the table to be deleted. On completion, any data that was stored in the table may not be retrieved.

Here is some SQL code that will create and then delete a simple table for storing contacts:

```
CREATE TABLE contacts (  
    first_name TEXT,  
    last_name TEXT,  
    phone_number TEXT,  
    height_in_meters REAL);  
  
DROP TABLE contacts;
```

When entering commands through `sqlite3`, you must terminate each command with a semicolon.

You may change the database schema after you create tables (which you may want to do to add a column or change the default value of a column) by entering the `ALTER TABLE` command.

## SQLite types

You must specify a type for each column that you create in all tables that you define, as discussed in “[SQL Data Definition Commands](#)” on page 249. SQLite supports the following data types:

### TEXT

A text string, stored using the database encoding (UTF-8, UTF-16BE, or UTF-16LE). You will find that the `TEXT` type is the most common.

### REAL

A floating-point value, stored as an 8-byte IEEE floating-point number.

### BLOB

Arbitrary binary data, stored exactly as if it was input. You can use the `BLOB` data type to store any kind of variable-length data, such as an executable file, or a downloaded image. Generally, blobs can add a large performance overhead to a mobile database and you should usually avoid using them. In [Chapter 13](#), we present an alternate scheme to store images downloaded from the Internet.

### INTEGER

A signed integer, stored in 1, 2, 3, 4, 6, or 8 bytes depending on the magnitude of the value.

Specific information regarding SQLite types is available at <http://www.sqlite.org/datatype3.html>.



## Database constraints

Database constraints mark a column with particular attributes. Some constraints enforce data-oriented limitations, such as requiring all values in a column to be unique (e.g., a column containing Social Security numbers). Other constraints exhibit more functional uses. Relational constraints, `PRIMARY KEY` and `FOREIGN KEY`, form the basis of intertable relationships.

Most tables should have a particular column that uniquely identifies each given row. Designated in SQL as a `PRIMARY KEY`, this column tends to be used only as an identifier for each row and (unlike a Social Security number) has no meaning to the rest of the world. Thus, you do not need to specify values for the column. Instead, you can let SQLite assign incrementing integer values as new rows are added. Other databases typically require you to specially mark the column as autoincrementing to achieve this result. SQLite also offers an explicit `AUTOINCREMENT` constraint, but autoincrements primary keys by default. The incrementing values in the column take on a role similar to an opaque object pointer in a high-level language such as Java or C: other database tables and code in a high-level language can use the column to reference that particular row.

When database rows have a unique primary key, it is possible to start thinking about dependencies between tables. For example, a table used as an employee database could define an integer column called `employer_id` that would contain the primary key values of rows in a different table called `employers`. If you perform a query and select one or more rows from the `employers` table, you can use grab their IDs and to look up employees in an `employees` table through the table's `employer_id` column. This allows a program to find the employees of a given employer. The two tables (stripped down to a few columns relevant to this example) might look like this:

```
CREATE TABLE employers (  
    _id INTEGER PRIMARY KEY,  
    company_name TEXT);  
  
CREATE TABLE employees (  
    name TEXT,  
    annual_salary REAL NOT NULL CHECK (annual_salary > 0),  
    employer_id REFERENCES employers(_id));
```

The idea of a table referring to another table's primary key has formal support in SQL as the `FOREIGN KEY` column constraint, which enforces the validity of cross-table references. This constraint tells the database that integers in a column with a foreign key constraint must refer to valid primary keys of database rows in another table. Thus, if you insert a row into the `employees` table with an `employer_id` for a row that does not exist in the `employers` table, many flavors of SQL will raise a constraint violation. This may help you to avoid orphaned references, also known as enforcement of foreign keys. However, the foreign key constraint in SQLite is optional, and is turned off in Android. As of Android 2.2, you cannot rely on a foreign key constraint to catch incorrect foreign

key references, so you will need to take care when creating database schemas that use foreign keys.

There are several other constraints with less far-reaching effects:

#### UNIQUE

Forces the value of the given column to be different from the values in that column in all existing rows, whenever a row is inserted or updated. Any insert or update operation that attempts to insert a duplicate value will result in an SQLite constraint violation.

#### NOT NULL

Requires a value in the column; NULL cannot be assigned. Note that a primary key is both UNIQUE and NOT NULL.

#### CHECK

Takes a Boolean-valued expression and requires that the expression return true for any value inserted in the column. An example is the CHECK (`annual_salary > 0`), attribute shown earlier in the `employees` table.

## SQL Data Manipulation Commands

Once you have defined tables using data definition commands, you can then insert your data and query the database. The following data manipulation commands are the most commonly used SQL statements:

#### SELECT

This statement provides the main tool for querying the database. The result of this statement is zero or more rows of data, where each row has a fixed number of columns. You can think of the SELECT statement as producing a new table with only the rows and columns that you choose in the statement. The SELECT statement is the most complicated command in the SQL language, and supports a broad number of ways to build relationships between data across one or more database tables. Clauses for SQL's SELECT command, which are all supported by the Android API, include the following:

- **FROM**, which specifies the tables from which data will be pulled to fulfill the query.
- **WHERE**, which specifies conditions that selected rows in the tables must match to be returned by the query.
- **GROUP BY**, which orders results in clusters according to column name.
- **HAVING**, which further limits results by evaluating groups against expressions. You might remove groups from your query that do not have a minimum number of elements.
- **ORDER BY**, which sets the sort order of query results by specifying a column name that will define the sort, and a function (e.g., `ASC` for ascending, `DSC` for descending) that will sort the rows by elements in the specified column.

- **LIMIT**, which limits the number of rows in a query to the specified value (e.g., five rows).

Here are a few examples of **SELECT** statements:

```
SELECT * FROM contacts;

SELECT first_name, height_in_meters
FROM contacts
WHERE last_name = "Smith";

SELECT employees.name, employers.name
FROM employees, employers
WHERE employee.employer_id = employer._id
ORDER BY employer.company_name ASC;
```

The first statement retrieves all the rows in the `contacts` table, because no **WHERE** clause filters results. All columns (indicated by the asterisk, `*`) of the rows are returned. The second statement gets the names and heights of the members of the Smith family. The last statement prints a list of employees and their employers, sorted by company name.

For more information, see [http://www.sqlite.org/lang\\_select.html](http://www.sqlite.org/lang_select.html).

## INSERT

This statement adds a new data row to a specified database table along with a set of specified values of the proper SQLite type for each column (e.g., 5 for an **integer**). The insert may specify a list of columns affected by the insert, which may be less than the number of columns in the table. If you don't specify values for all columns, SQLite will fill in a default value for each unspecified column, if you defined one for that column in your **CREATE TABLE** statement. If you don't provide a default, SQLite uses a default of **NULL**.

Here are a few examples of **INSERT** statements:

```
INSERT INTO contacts(first_name)
VALUES("Thomas");

INSERT INTO employers VALUES(1, "Acme Balloons");
INSERT INTO employees VALUES("Wile E. Coyote", 100000.000, 1);
```

The first adds a new row to the `contacts` for someone whose first name is Thomas and whose last name, phone number, and height are unknown (**NULL**). The second adds Acme Balloons as a new employer, and the third adds Wile E. Coyote as an employee there.

For more information, see [http://www.sqlite.org/lang\\_insert.html](http://www.sqlite.org/lang_insert.html).

## UPDATE

This statement modifies some rows in a given table with new values. Each assignment specifies a table name and a given function that should provide a new value for the column. Like **SELECT**, you can specify a **WHERE** clause that will identify the rows that should be updated during an invocation of the **UPDATE** command. Like

INSERT, you can also specify a list of columns to be updated during command execution. The list of columns works in the same manner as it does with INSERT. The WHERE clause is critical; if it matches no rows, the UPDATE command will have no effect, but if the clause is omitted, the statement will affect every row in the table.

Here are a few examples of UPDATE statements:

```
UPDATE contacts
  SET height_in_meters = 10, last_name = "Jones"

UPDATE employees
  SET annual_salary = 200000.00
  WHERE employer_id = (
    SELECT id
      FROM employers
     WHERE company_name = "Acme Balloons");
```

The first claims that all your friends are giants with the last name Jones. The second is a more complex query. It gives a substantial raise to all the employees of Acme Balloons.

For more information, see [http://www.sqlite.org/lang\\_update.html](http://www.sqlite.org/lang_update.html).

## Additional Database Concepts

You now know enough simple SQL to be able to start working with databases in Android. As the applications you write grow in sophistication, you are likely to make use of the following SQL constructs that we won't cover in detail in this book:

### *Inner join*

An inner join selects data across two or more tables where data is related by a foreign key. This type of query is useful for assembling objects that need to be distributed across one or more tables. The employee/employer example earlier demonstrated an inner join. As we've noted, since Android does not enforce foreign keys, you can get into trouble here if a key for a join does not exist as a valid cross-table reference—that is, a foreign key column actually points to a primary key of a row in another table that actually exists.

### *Compound query*

SQLite supports complex database manipulations through combinations of statements. One of the update examples shown earlier was a compound query with a SELECT embedded in an UPDATE.

### *Triggers*

A database trigger allows a developer to write SQL statements that will receive a callback when particular database conditions occur.

For detailed information on these topics, we suggest you consult a book on SQL, such as *Learning SQL* by Alan Beaulieu or *SQL Pocket Guide* by Jonathan Gennick, both published by O'Reilly.

## Database Transactions

Database transactions make sequences of SQL statements atomic: either all statements succeed or none of them have any effect on the database. This can be important, for instance, if your app encounters an unfortunate occurrence such as a system crash. A transaction will guarantee that if the device fails partway through a given sequence of operations, none of the operations will affect the database. In database jargon, SQLite transactions support the widely recited ACID transaction properties: <http://en.wikipedia.org/wiki/ACID>.

With SQLite, every database operation that modifies a database runs in its own database transaction, which means a developer can be assured that all values of an insert will be written if the statement succeeds at all. You can also explicitly start and end a transaction so that it encompasses multiple statements. For a given transaction, SQLite does not modify the database until all statements in the transaction have completed successfully.

Given the volatility of the Android mobile environment, we recommend that in addition to meeting the needs for consistency in your app, you also make liberal use of transactions to support fault tolerance in your application.

## Example Database Manipulation Using sqlite3

Now that you understand the basics of SQL as it pertains to SQLite, let's have a look at a simple database for storing video metadata using the `sqlite3` command-line tool and the Android debug shell, which you can start by using the `adb` command. Using the command line will allow us to view database changes right away, and will provide some simple examples of how to work with this useful database debugging tool. SQLite has more information on `sqlite3` at <http://www.sqlite.org/sqlite.html>. Note that it is likely easiest at first to run this example using the Android emulator, since you will need root access in order to run it on a device.

We'll get the example started by initializing the database:

```
$ adb shell
# cd /data/data/
# mkdir com.oreilly.demo.pa.ch10.sql
# cd com.oreilly.demo.pa.ch10.sql
# mkdir databases
# cd databases
#
# sqlite3 simple_video.db
SQLite version 3.6.22
Enter ".help" for instructions
Enter SQL statements terminated with a ";"
sqlite>
```



Note that developers should not create these directories by hand, as we have done in this example, since Android will create them during installation of an application. Directory creation is merely useful for this particular example because we do not yet have an application in which the directories would have been automatically created.

The `sqlite3` command line accepts two kinds of commands: legal SQL, and single-word commands that begin with a period (`.`). You can see the first (and probably most important!) of these in the introduction message: `.help`. Try it out, just to get an idea of the options available to you:

```
sqlite> .help
.bail ON|OFF          Stop after hitting an error.  Default OFF
.databases            List names and files of attached databases
.dump ?TABLE? ...    Dump the database in a SQL text format
.echo ON|OFF         Turn command echo on or off
.exit                Exit this program
.explain ON|OFF      Turn output mode suitable for EXPLAIN on or off.
.header(s) ON|OFF   Turn display of headers on or off
.help                Show this message
.import FILE TABLE  Import data from FILE into TABLE
.indices TABLE      Show names of all indices on TABLE
.load FILE ?ENTRY?   Load an extension library
.mode MODE ?TABLE?   Set output mode where MODE is one of:
                    csv      Comma-separated values
                    column   Left-aligned columns.  (See .width)
                    html    HTML <table> code
                    insert   SQL insert statements for TABLE
                    line     One value per line
                    list     Values delimited by .separator string
                    tabs     Tab-separated values
                    tcl      TCL list elements
.nullvalue STRING    Print STRING in place of NULL values
.output FILENAME     Send output to FILENAME
.output stdout       Send output to the screen
.prompt MAIN CONTINUE Replace the standard prompts
.quit                Exit this program
.read FILENAME       Execute SQL in FILENAME
.schema ?TABLE?      Show the CREATE statements
.separator STRING    Change separator used by output mode and .import
.show                Show the current values for various settings
.tables ?PATTERN?   List names of tables matching a LIKE pattern
.timeout MS          Try opening locked tables for MS milliseconds
.timer ON|OFF        Turn the CPU timer measurement on or off
.width NUM NUM ...   Set column widths for "column" mode
```

There's another important command in this list: `.exit`. Remember it! It's how you get out of here. Alternatively, you can quit with the `Ctrl-D` keystroke.

Another important thing to remember is that every SQL command needs to be terminated with a semicolon. If you see something like this:

```
sqlite> select * from video
...>
```

it just means SQLite thinks you've started to enter SQL, and it is waiting for the `;` at the end. Note that the `.` commands do not need to be terminated by a semicolon.



We've used `ls` as an example of a command a user might have absent-mindedly typed if he forgot he was using `sqlite3`. `ls` is not actually a `sqlite3` command; if you type `;` after `ls`, `sqlite` will complain with an error, and then you can enter correct dot commands or `sql` statements.

Most of the “dot” commands aren't very interesting at this point, because this database is still empty. So let's add some data:

```
sqlite> create table video (
...> _id integer primary key,
...> title text,
...> description text,
...> url text);
```

These lines create a new table called `video`. The types of the columns are `integer` and `text`. The table contains a primary key called `_id`. This particular column name is not chosen accidentally. Android requires the use of this exact name in order for the table to work with its cursor system.

We can see the newly created tables using the “dot” command `.table`:

```
sqlite> .table
video
sqlite>
```

Next we'll go through a few different queries that illustrate the SQL concepts we introduced earlier, and that an application based on these tables. First, let's insert some data into our new tables so that our queries return some example results:

```
INSERT INTO video (_id, title, url)
VALUES(1, "Epic Fail Car", "http://www.youtube.com/watch?v=01ynapTnYVkeGE");
INSERT INTO video (_id, title, url)
VALUES(2, "Epic Fail Bicycle", "http://www.youtube.com/watch?v=7n7apTnYVkeGE");
INSERT INTO video (_id, title, url)
VALUES(3, "Epic Fail Wagon", "http://www.youtube.com/watch?v=m0iGn2c47LA");
INSERT INTO video (_id, title, url)
VALUES(4, "Epic Fail Sidewalk", "http://www.youtube.com/watch?v=m0iGn2cNcNo");
INSERT INTO video (_id, title, url)
VALUES(5, "Epic Fail Motorcycle",
"http://www.youtube.com/watch?v=7n7apBB8qkeGE");
```

Be careful to balance your quotes. If you enter a single quote, `sqlite3` will prompt you forever, until it gets the match.

In this example, we did not enter values for all the columns in the table. The contents of the parentheses after the `INTO` phrase in the statement list the columns into which

the statement will put data. The parentheses after the `VALUES` phrase contain the values themselves, in the same order.

Now suppose you want to find the names of all the videos that have the word fragment *cycle* in them. Use a `SELECT` query:

```
sqlite> SELECT title FROM video WHERE title LIKE "%cycle%";
Epic Fail Bicycle
Epic Fail Motorcycle
```

Sqlite3 prints the rows one to a line. In the example, we capitalized SQL reserved words to help keep syntax clear. It is not necessary to do so. They can be uppercase, lowercase, or mixed case.

The example also shows the rudimentary pattern matching available in SQL. The keyword `LIKE`, combined with the wildcard percent sign character (`%`), allows you to match parts of strings.

Suppose now that we'd like all the videos, with their URLs, sorted in reverse alphabetical order by title:

```
sqlite> SELECT title, url FROM video ORDER BY title DESC;
Epic Fail Wagon|http://www.youtube.com/watch?v=m0iGn2c47LA
Epic Fail Sidewalk|http://www.youtube.com/watch?v=m0iGn2cNcNo
Epic Fail Motorcycle|http://www.youtube.com/watch?v=7n7apBB8qkeGE
Epic Fail Car|http://www.youtube.com/watch?v=01ynapTnYVkeGE
Epic Fail Bicycle|http://www.youtube.com/watch?v=7n7apTnYVkeGE
```

You can see that sqlite3 uses the pipe character (`|`) to separate the values in different columns.

We didn't add descriptions for our videos. Let's add just one, now:

```
sqlite> UPDATE video SET description="Crash!" WHERE title LIKE "%Car";
sqlite> UPDATE video SET description="Trip!" WHERE title LIKE "%Sidewalk%";
sqlite> SELECT title, description FROM video WHERE NOT description IS NULL;
Epic Fail Car|Crash!
Epic Fail Sidewalk|Trip!
```

Finally, let's delete a record using its ID:

```
sqlite> DELETE FROM video WHERE _id = 1;
sqlite> SELECT _id, description FROM videos;
2|Epic Fail Bicycle
3|Epic Fail Wagon
4|Epic Fail Sidewalk
5|Epic Fail Motorcycle
```

## SQL and the Database-Centric Data Model for Android Applications

Now that you have some basic SQL programming knowledge, we can start thinking about how to put it to use in an Android application. Our goal is to create robust



applications based on the popular Model-View-Controller (MVC) pattern that underlies well-written UI programs, specifically in a way that works well for Android. Wikipedia has background information on MVC at [http://en.wikipedia.org/wiki/Model\\_view\\_controller](http://en.wikipedia.org/wiki/Model_view_controller).

One fundamental difference between mobile phone apps and desktop apps is how they handle persistence. Traditional desktop-based applications—word processors, text editors, drawing programs, presentation programs, and so on—often use a document-centric form of the MVC pattern. They open a document, read it into memory, and turn it into objects in memory that form the data model. Such programs will make views for the data model, process user input through their controller, and then modify the data model (Figure 10-1). The key consequence of this design is that you explicitly open and save documents in order to make the data model persist between program invocations. We’ve seen how user interface components work in Android. Next we’ll explore the Android APIs for database manipulation, which will prepare you to implement an application data model that works in a new way.

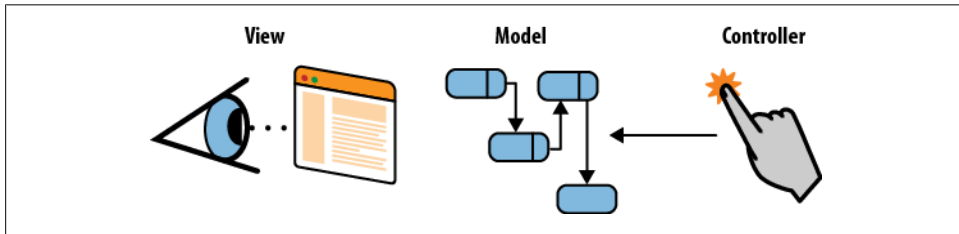

Figure 10-1. Document-centric applications, which implement a data model with in-memory objects

Robust use of Android combines data models and user interface elements in a different manner. Apps run on mobile devices with limited memory, which can run out of battery power at unpredictable and possibly inopportune times. Small mobile devices also place a premium on reducing the interactive burden on the user: reminding a user he ought to save a document when he is trying to answer a phone call is not a good user experience. The whole concept of a document is absent in Android. The user should always have the right data at hand and be confident her data is safe.

To make it easy to store and use application data incrementally, item by item, and always have it in persistent memory without explicitly saving the whole data model, Android provides support in its database, view, and activity classes for database-centric data (Figure 10-2). We’ll explain how to use Android database classes to implement this kind of model.

## The Android Database Classes

This section introduces the Java classes that give you access to the SQLite functions described earlier in the chapter, with the data-centric model we just described in mind:

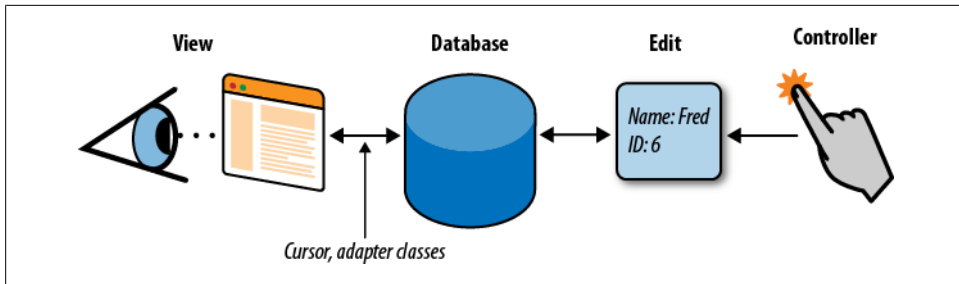

Figure 10-2. Android support for a data model that mostly resides in a database

### SQLiteDatabase

Android's Java interface to its relational database, SQLite. It supports an SQL implementation rich enough for anything you're likely to need in a mobile application, including a cursor facility.

### Cursor

A container for the results of a database query that supports an MVC-style observation system. Cursors are similar to JDBC result sets and are the return value of a database query in Android. A cursor can represent many objects without requiring an instance for each one. With a cursor, you can move to the start of query results and access each row one at a time as needed. To access cursor data, you call methods named as `Cursor.getAs*(int columnName)` (e.g., `getAsString`). The values the cursor will return depend on the current cursor index, which you can increment by calling `Cursor.moveToNext`, or decrement by calling `Cursor.moveToPrevious`, as needed. You can think of the current index of the cursor as a pointer to a result object.

Cursors are at the heart of the basis for Android MVC, which we will cover in detail in [Chapter 12](#).

### SQLiteOpenHelper

Provides a life cycle framework for creating and upgrading your application database. It's quite helpful to use this class to assist with the critical task of transitioning the data from one version of an application to a possible new set of database tables in a new version of an application.

### SQLiteQueryBuilder

Provides a high-level abstraction for creating SQLite queries for use in Android applications. Using this class can simplify the task of writing a query since it saves you from having to fiddle with SQL syntax yourself.

## Database Design for Android Applications

In the next section, we'll examine some code from [Chapter 12](#) that deals with persistent storage of video-related metadata information: title, description, and video URL. This code resides inside an Android content provider, which we feel is an appropriate loca-

tion for database code. Without explaining much about content providers, we'll discuss how to write a database for one. [Chapter 12](#) explains in detail how to write a content provider. The following code will help us illustrate how to create and use an SQLite database in Android. This application will use roughly the same database that we just examined using the `sqlite3` command-line tool. This time, though, we'll be writing code that uses the Android API to manipulate the data.

## Basic Structure of the SimpleVideoDbHelper Class

In our example, the `SimpleFinchVideoContentProvider.java` file encapsulates all the SQL logic necessary to work with the `simple_video` database in Android. Applications that need access to the persistent data in this database interact with the provider and the cursors it supplies, as we'll explain in [Chapter 12](#). Clients are completely insulated from the details of how the data is actually stored. This is good programming practice and should be emulated in all your Android applications that use databases.

For now, since we are focusing on how to use databases in Android, it's sufficient to know that `SimpleVideoDbHelper` is the model of the database in the provider: everything specific to the implementation of the database—its name, the names of its columns, the definitions of its tables—takes effect in this class. For a large, complex database, of course, the helper class may be much more complex and be composed of several components.

`SimpleVideoDbHelper` inherits from the abstract `SQLiteOpenHelper` class, and therefore must override the `onCreate` and `onUpgrade` methods. The `onCreate` method is automatically called when the application starts for the first time. Its job is to create the database. When new versions of the application ship, it may be necessary to update the database, perhaps adding tables, adding columns, or even changing the schema entirely. When this is necessary, the task falls to the `onUpgrade` method, which is called whenever the `DATABASE_VERSION` in the call to the constructor is different from the one stored with the database. When you ship a new version of a database, you must increment the version number:

```
public static final String VIDEO_TABLE_NAME = "video";

public static final String DATABASE_NAME = SIMPLE_VIDEO + ".db";
private static int DATABASE_VERSION = 2;

public static final int ID_COLUMN = 0;
public static final int TITLE_COLUMN = 1;
public static final int DESCRIPTION_COLUMN = 2;
public static final int TIMESTAMP_COLUMN = 3;
public static final int QUERY_TEXT_COLUMN = 4;
public static final int MEDIA_ID_COLUMN = 5;

private static class SimpleVideoDbHelper extends SQLiteOpenHelper {
    private SimpleVideoDbHelper(Context context, String name,
                               SQLiteDatabase.CursorFactory factory)
    {
```

```

        super(context, name, factory, DATABASE_VERSION);
    }

    @Override
    public void onCreate(SQLiteDatabase sqLiteDatabase) {
        createTable(sqLiteDatabase);
    }

    private void createTable(SQLiteDatabase sqLiteDatabase) {
        String qs = "CREATE TABLE " + VIDEO_TABLE_NAME + " (" +
            FinchVideo.SimpleVideos._ID +
            " INTEGER PRIMARY KEY AUTOINCREMENT, " +
            FinchVideo.SimpleVideos.TITLE_NAME + " TEXT, " +
            FinchVideo.SimpleVideos.DESCRPTION_NAME + " TEXT, " +
            FinchVideo.SimpleVideos.URI_NAME + " TEXT)";
        sqLiteDatabase.execSQL(qs);
    }

    @Override
    public void onUpgrade(SQLiteDatabase sqLiteDatabase,
        int oldv, int newv)
    {
        sqLiteDatabase.execSQL("DROP TABLE IF EXISTS " +
            VIDEO_TABLE_NAME + ";");
        createTable(sqLiteDatabase);
    }
}

```

The general elements associated with `SimpleVideoDbHelper` code are:

### Constants

The `SimpleVideoDbHelper` class defines two important constants:

#### DATABASE\_NAME

This holds the filename of the database, *simple\_video.db* in this case. This names the actual SQLite database file. Recall that we mentioned this file resides in the following path, and that Android will take care to create the database file for you: */data/data/com.oreilly.demo.pa.finchvideo/databases/simple\_video.db*.

#### DATABASE\_VERSION

This defines the database version, which you choose arbitrarily and increment whenever you change the database schema. If the version of the database on the machine is less than `DATABASE_VERSION`, the system runs your `onUpgrade` method to upgrade the database to the current level.

#### VIDEO\_TABLE\_NAME

This is the name of the only table in our simple database.

#### \*\_NAME

These are the names of the columns in the database. As mentioned earlier, it is essential to define a column named `_id` and use it as the primary key, for any table that you will access through a cursor.

## Constructor

The constructor for the database in this provider, `SimpleVideoDbHelper`, uses the `super` function to call its parent's constructor. The parent does most of the work of creating the database object.

## onCreate

When an Android application attempts to read or write data to a database that does not exist, the framework executes the `onCreate` method. The `onCreate` method in the `YouTubeDbHelper` class shows one way to create the database. If initializing the database required a substantial amount of SQL code, it might be preferable to keep the code in the `strings.xml` resource file. This might make the Java code much more readable. But it also forces a developer modifying the code to look in two separate files to see what's really going on. Of course, if a program has a simple database, it might be easier to just write the SQL in Java, as we have done in `SimpleVideoDbHelper`, or if you use a query builder, there may be no SQL at all.



If you intend to load your SQL from a `String` resource, you must take care of a change to the string mentioned only briefly in the Android documentation: escape all single quotes and double quotes with a backslash (changing `"` to `\` and `'` to `\'`) within a resource string, or enclose the entire string in either single or double quotes. You should also turn off formatting in the string, using the `formatted="false"` attribute. For example:

```
<string name="sql_query" formatted="false">
    SELECT * FROM videos WHERE name LIKE \"%cycle%\"
</string>
```

The `onCreate` method doesn't actually have to create the database. It is passed a brand-new, empty database and must completely initialize it. In `SimpleVideoDbHelper`, this is a simple task and is accomplished with the call to `createVideosTable`.

## onUpdate

The `onUpdate` method for `SimpleVideoContentProvider` is very simple: it deletes the database. When the provider tries to use it later, Android will call the `onCreate` method because it does not exist. While such a crude approach might be acceptable in this extremely simple case, a provider intended only as a cache for network data, it would certainly not be acceptable for, say, a database of contacts! Your customers won't be very happy if they have to rekey their information each time they upgrade software versions. So our `onUpdate` method won't work very well in real life. In general, the `onUpdate` method will have to recognize all previous versions of databases used by an application and have a data-safe strategy for converting those databases to the most recent format. A larger application would have several upgrade scripts, one for each version that might be out in the wild. The application would then execute each upgrade script in turn until the database was completely up-to-date.

`createVideosTable`

We created this function to encapsulate the SQL code that creates our table.

## Using the Database API: MJAndroid

In this section, we present a more advanced example application, called MJAndroid, that demonstrates the use of a small database for a hypothetical job-searching application. In this chapter, we explore the data persistence aspects of this program. In [Chapter 15](#), we take a look at how the application integrates mapping features to show job query results on a map. First we'll explain the application in a bit more detail.

### Android and Social Networking

One of the great promises of Android mobile phones is their ability to run applications that enhance opportunities for social networking among users. This promise echoes the reality of the Internet—the first generation of Internet applications were about user access to information, and many of those applications have been very popular. The second wave of Internet applications were about connecting users to one another. Applications such as Facebook, YouTube, and many others enhance our ability to connect with people of similar interests, and allow the application users to provide some or all of the content that makes the application what it is. Android has the potential to take that concept and add a new dimension—mobility. It's expected that a whole new generation of applications will be built for users of mobile devices: social networking applications that are easy to use while walking down the street, applications that are aware of the user's location, applications that allow the easy sharing of content-rich information like pictures and videos, etc. MJAndroid provides a concrete example of how Android can address this growing niche.

In the case of the MJAndroid MicroJobs application, the user is trying to locate a temporary job in her geographic vicinity, where she can work for a few hours to earn some extra money. The premise is that employers looking for temporary help have entered available jobs, descriptions, hours, and offered wages in a web-based database that is accessible from Android mobile phones. People looking for a few hours' work can use the MicroJobs application to access that database, look for jobs in their immediate area, communicate with friends about potential employers and potential jobs, and call the employer directly if they are interested in the position. For our purposes here, we won't create an online service, we'll just have some canned data on the phone. The application has a number of features that extend that central idea in ways that are unique to mobile handsets:

#### *Mapping*

The Android mobile phone environment provides support for dynamic, interactive maps, and we're going to take full advantage of its capabilities. In [“The MapView and MapActivity” on page 374](#) you'll see that with very little code, we'll be able

to show dynamic maps of our local neighborhood, getting location updates from the internal GPS to automatically scroll the map as we move. We'll be able to scroll the map in two directions, zoom in and out, and even switch to satellite views.

#### *Finding friends and events*

Again in [Chapter 15](#), we'll see a graphic overlay on the map that will show us where jobs are located in the area, and will allow us to get more information about a job by just touching its symbol on the map. We will access Android's contact manager application to get address information for our friends (telephone numbers, instant messaging addresses, etc.), and the MicroJobs database to get more information about posted jobs.

#### *Instant messaging*

When we find friends we want to chat with, we will be able to contact them via instant messages, by trading SMS messages with our friends' mobile phones.

#### *Talking with friends or employers*

If IMing is too slow or cumbersome, we'll be able to easily place a cellular call to our friends, or call the employer offering a job.

#### *Browsing the Web*

Most employers have an associated website that provides more detailed information. We'll be able to select an employer off a list or off the map and quickly zero in on their website to find out, for example, what the place looks like.

This is a fun application that could easily be developed further into a full-blown service, but our intent in this book is to show you just how easy it is to develop and combine these powerful capabilities in your own application. Like all the code in this book, the complete code is available for download. Although it's not absolutely required in order to understand the material in the book, you are strongly encouraged to download the source to your own computer. That way you'll have it readily available for reference, and it will be easy to cut sections of code and paste them into your own applications as you move on. For now, we'll use the MJAndroid example to provide a "close to real world" example to dig into the Android database API.

[Figure 10-3](#) shows the screen displayed by MJAndroid when you first run it. It's a map of your local area, overlaid with a few buttons and pins.

## **The Source Folder (src)**

The package name for MJAndroid is `com.microjobsinc.mjandroid`. Eclipse lays out the equivalent directory structure, just as it would for any Java project, and shows you the whole thing when you open the `src` folders. In addition to these package folders there is a folder named for the package that contains all the Java files for the project. These include the following files:

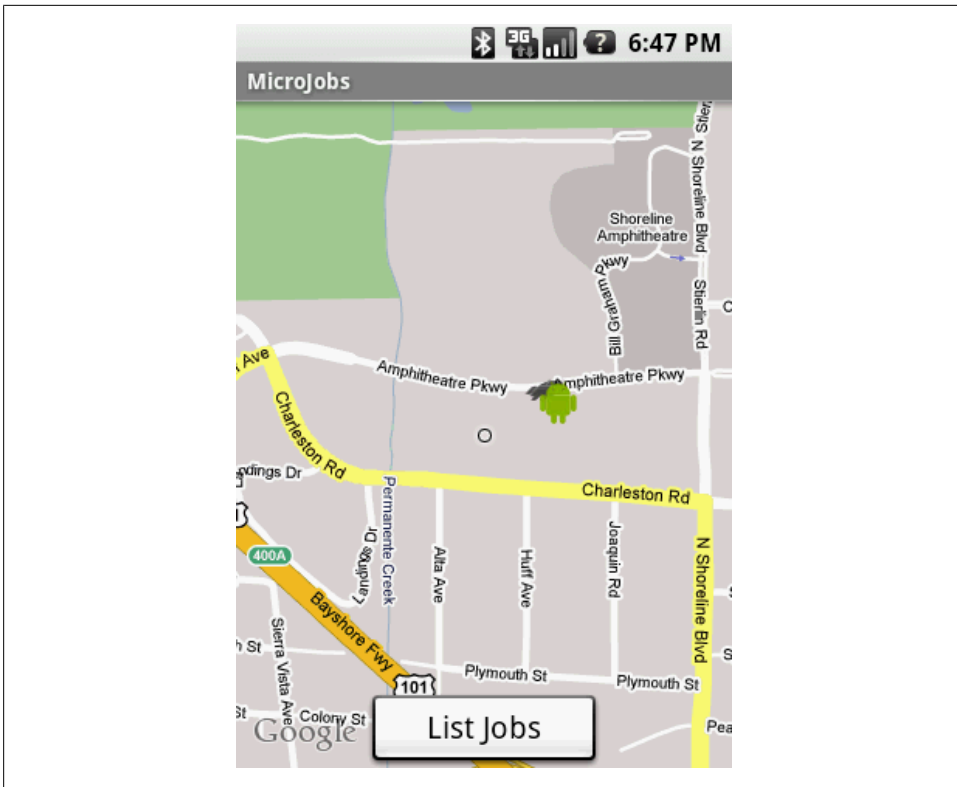

Figure 10-3. MJAndroid opening screenshot

#### *MicroJobs.java*

The main source file for the application—the activity that starts first, displays the map that is the centerpiece of the application, and calls other activities or services as necessary to implement different features in the user interface.

#### *MicroJobsDatabase.java*

A database helper that provides easy access to the local MJAndroid database. This is where all the employer, user, and job information is stored, using SQLite.

#### *AddJob.java and EditJob.java*

Part of the database portion of MJAndroid. They provide screens that the user can use to add or edit job entries in the database.

#### *MicroJobsDetail.java*

The Activity that displays all the detail information about a particular job opportunity.

#### *MicroJobsEmpDetail.java*

The Activity that displays information about an employer, including name, address, reputation, email address, phone number, and so forth.



*MicroJobsList.java*

The **Activity** that displays a list of jobs (as opposed to the map view in *MicroJobs.java*). It shows a simple list of employers and jobs, and allows the user to sort the list by either field, as well as to call up specifics about the job or employer by touching the name on the list.

## Loading and Starting the Application

Running MJAndroid from the SDK is complicated by the fact that the application uses a **MapView**. Android requires a special Maps API key whenever you use a **MapView**, and the key is tied to your particular development machine. We learned in “[Application Signing](#)” on page 95 about the requirements for signing and starting your application, and since this application relies on the maps API, you will need to have set up your API key for the example to work properly. To start MJAndroid, just open and run the eclipse project for this chapter, as you have done for other chapters.

## Database Queries and Reading Data from the Database

There are many ways to read data from an SQL database, but they all come down to a basic sequence of operations:

1. Create a SQL statement that describes the data you need to retrieve.
2. Execute that statement against the database.
3. Map the resultant SQL data into data structures that the language you’re working in can understand.

This process can be very complex in the case of object-relational mapping software, or relatively simple but labor-intensive when writing the queries directly into your application. Object relational mapping (ORM, at [http://en.wikipedia.org/wiki/Object\\_relational\\_mapping](http://en.wikipedia.org/wiki/Object_relational_mapping)) tools shield your code from the complexities of database programming and object mapping by moving that complexity out of your immediate field of vision. Your code may be more robust in the face of database changes, but at the cost of complex ORM setup and maintenance. Currently, it’s not typical to use an ORM in an Android application.

The simple approach of writing queries directly into your application works well only for very small projects that will not change much over time. Applications directly containing database code have some added risk of fragility, because when the database schema changes, any code that references the schema must be examined and potentially rewritten.

A common middle-ground approach is to sequester all the database logic into a set of objects whose sole purpose is to translate application requests into database requests and deliver the results back to the application. This is the approach we have taken with the MJAndroid application; all the database code is contained in the single class **Micro**

JobsDatabase, which also extends SQLiteOpenHelper. But with SimpleFinchVideoContentProvider the database is simple enough that we don't bother to use external strings.

When not used with a content provider, Android gives us the ability to customize cursors, and we use that ability to further reduce code dependencies by hiding all the information about each specific database operation inside a custom cursor. The interface to the caller in the getJobs method of MicroJobsDatabase appears first in the code that follows. The method's job is to return a JobsCursor filled with jobs from the database. The user can choose (through the single parameter passed to the getJobs method) to sort jobs by either the title column or the employer\_name column:

```
public class MicroJobsDatabase extends SQLiteOpenHelper {
    ...
    /** Return a sorted JobsCursor
     * @param sortBy the sort criteria
     */
    public JobsCursor getJobs(JobsCursor.SortBy sortBy) {①
        String sql = JobsCursor.QUERY + sortBy.toString();②
        SQLiteDatabase d = getReadableDatabase();③
        JobsCursor c = (JobsCursor) d.rawQueryWithFactory(④
            new JobsCursor.Factory(),
            sql,
            null,
            null);
        c.moveToFirst();⑤
        return c;⑥
    }
    ...
    public static class JobsCursor extends SQLiteCursor{⑦
        public static enum SortBy{⑧
            title,
            employer_name
        }
        private static final String QUERY =
            "SELECT jobs._id, title, employer_name, latitude, longitude, status "+
            "FROM jobs, employers "+
            "WHERE jobs.employer_id = employers._id "+
            "ORDER BY ";
        private JobsCursor(SQLiteDatabase db, SQLiteCursorDriver driver,
            String editTable, SQLiteQuery query) {⑨
            super(db, driver, editTable, query);
        }
        private static class Factory implements SQLiteDatabase.CursorFactory{⑩
            @Override
            public Cursor newCursor(SQLiteDatabase db,
                SQLiteCursorDriver driver, String editTable,
                SQLiteQuery query) {⑪
                return new JobsCursor(db, driver, editTable, query);⑫
            }
        }
        public long getColJobsId(){⑬
            return getLong(getColumnIndexOrThrow("jobs._id"));
        }
        public String getColTitle(){
```

```

        return getString(getColumnIndexOrThrow("title"));
    }
    public String getColEmployerName(){
        return getString(getColumnIndexOrThrow("employer_name"));
    }
    public long getColLatitude(){
        return getLong(getColumnIndexOrThrow("latitude"));
    }
    public long getColLongitude(){
        return getLong(getColumnIndexOrThrow("longitude"));
    }
    public long getColStatus(){
        return getLong(getColumnIndexOrThrow("status"));
    }
}

```

Here are some of the highlights of the code:

- ❶ Function that fashions a query based on the user's requested sort column (the `sortBy` parameter) and returns results as a cursor.
- ❷ Creates the query string. Most of the string is static (the `QUERY` variable), but this line tacks on the sort column. Even though `QUERY` is private, it is still available to the enclosing class. This is because the `getJobs` method and the `JobsCursor` class are both within the `MicroJobsDatabase` class, which makes `JobsCursor`'s private data members available to the `getJobs` method.

To get the text for the sort column, we just run `toString` on the enumerated parameter passed by the caller. We could have defined an associative array, which would give us more flexibility in naming variables, but this solution is simpler. Additionally, the names of the columns pop up quite nicely using your IDE's autocompletion.

- ❸ Retrieves a handle to the database.
- ❹ Creates the `JobsCursor` cursor using the `SQLiteDatabase` object's `rawQueryWithFactory` method. This method lets us pass a factory method that Android will use to create the exact type of cursor we need. If we had used the simpler `rawQuery` method, we would get back a generic `Cursor` lacking the special features of `JobsCursor`.
- ❺ As a convenience to the caller, moves to the first row in the result. This way the cursor is returned ready to use. A common mistake is to forget the `moveToFirst` call and then pull your hair out trying to figure out why the `Cursor` object is throwing exceptions.
- ❻ The cursor is the return value.
- ❼ Class that creates the cursor returned by `getJobs`.
- ❽ Simple way to provide alternate sort criteria: store the names of columns in an enum. This type is used in item 2.

- 9 Constructor for the customized cursor. The final argument is the query passed by the caller.
- 10 Factory class to create the cursor, embedded in the `JobsCursor` class.
- 11 Creates the cursor from the query passed by the caller.
- 12 Returns the cursor to the enclosing `JobsCursor` class.
- 13 Convenience functions that extract particular columns from the row under the cursor. For instance, `getColTitle` returns the value of the `title` column in the row currently referenced by the cursor. This separates the database implementation from the calling code and makes that code easier to read.



While subclassing a cursor is a nice trick for using a database within a single application, it won't work with the content provider API, since Android does not have a way for cursor subclasses to be shared across processes. Additionally, the MJAndroid application is a contrived example to demonstrate using a database: we present an application with a more robust architecture that you might see in a production application in [Chapter 13](#).

A sample use of the database follows. The code gets a cursor, sorted by title, through a call to `getJobs`. It then iterates through the jobs:

```
MicroJobsDatabase db = new MicroJobsDatabase(this);1
JobsCursor cursor = db.getJobs(JobsCursor.SortBy.title);2

for (int rowNum = 0; rowNum < cursor.getCount(); rowNum++) {3
    cursor.moveToPosition(rowNum);
    doSomethingWith(cursor.getColTitle());4
}
```

Here are some of the highlights of the code:

- 1 Creates a `MicroJobsDatabase` object. The argument, `this`, represents the context as discussed previously.
- 2 Creates the `JobsCursor` cursor, referring to the `SortBy` enumeration discussed earlier.
- 3 Uses generic `Cursor` methods to iterate through the cursor.
- 4 Still within the loop, invokes one of the custom accessor methods provided by `JobsCursor` to “do something” chosen by the user with the value of each row's title column.

### Using the query method

While it's helpful for applications that execute nontrivial database operations to isolate their SQL statements as shown previously, it's also convenient for applications with simple database operations, such as our `SimpleFinchVideoContentProvider`, to make

use of the method `SQLiteDatabase.query`, as shown in the following video-related example:

```
videoCursor = mDb.query(VIDEO_TABLE_NAME, projection,
    where, whereArgs,
    null, null, sortOrder);
```

As with `SQLiteDatabase.rawQueryWithFactory` shown previously, the return value of the `query` method is a `Cursor` object. Here, we assign this cursor to the previously defined `videoCursor` variable.

The `query` method runs a `SELECT` on a given table name, in this case the constant `VIDEO_TABLE_NAME`. The method takes two parameters. First, a projection that names the columns that should only show up in the query—other column values will not show up in the cursor results. Many applications work just fine passing `null` for the projection, which will cause all column values to show up in the resultant cursor. Next, the `where` argument contains a SQL `where` clause, without the `WHERE` keyword. The `where` argument can also contain a number of `'?'` strings that will be replaced with the values of `whereArgs`. We'll discuss in more detail how these two values bind together when we discuss the `execSQL` method.

## Modifying the Database

Android `Cursors` are great when you want to read data from the database, but the class `android.database.Cursor` does not provide methods for creating, updating, or deleting data. The `SQLiteDatabase` class provides two basic APIs that you can use for both reading and writing:

- A set of four methods called simply `insert`, `query`, `update`, and `delete`
- A more general `execSQL` method that takes any single SQL statement that does not return data and runs it against the database

We recommend using the first set of calls when your operations fit its capabilities. We'll show you both ways to use the MJAndroid operations.

### Inserting data into the database

The SQL `INSERT` statement is used whenever you want to insert data into an SQL database. The `INSERT` statement maps to the “create” operation of the CRUD methodology.

In the MJAndroid application, the user can add jobs to the list by clicking on the Add Job menu item when looking at the Jobs list. The user can then fill out a form to input the employer, job title, and description. After the user clicks on the Add Job button on the form, the following line of code is executed:

```
db.addJob(employer.id, txtTitle.getText().toString(),
    txtDescription.getText().toString());
```

This code calls the `addJob` function, passing in the employer ID, the job title, and the job description. The `addJob` function does the actual work of writing the job out to the database.

**Using the `insert` method.** The following example demonstrates use of the `insert` method:

```
/**
 * Add a new job to the database. The job will have a status of open.
 * @param employer_id The employer offering the job
 * @param title The job title
 * @param description The job description
 */
public void addJob(long employer_id, String title, String description) {
    ContentValues map = new ContentValues();❶
    map.put("employer_id", employer_id);
    map.put("title", title);
    map.put("description", description);
    try{
        getWritableDatabase().insert("jobs", null, map);❷
    } catch (SQLException e) {
        Log.e("Error writing new job", e.toString());
    }
}
```

Here are some of the highlights of the code:

- ❶ The `ContentValues` object is a map of column names to column values. Internally, it's implemented as a `HashMap<String, Object>`. However, unlike a simple `HashMap`, `ContentValues` is strongly typed. You can specify the data type of each value stored in a `ContentValues` container. When you pull values back out, `ContentValues` will automatically convert values to the requested type if possible.
- ❷ The second parameter to the `insert` method is `nullColumnHack`. It's used only as a default value when the third parameter, the map, is `null` and therefore the row would otherwise be completely empty.

**Using the `execSQL` method.** This solution works at a lower level than the `insert` solution. It creates SQL and passes it to the library to execute. Although you could hardcode every statement, including the data passed by the user, this section shows a preferable method that employs bind parameters.

A bind parameter is a question mark that holds a place in an SQL statement, usually for a parameter passed by the user such as a value in a `WHERE` clause. After creating an SQL statement with bind parameters, you can reuse it repeatedly, setting the actual value of the bind parameters before executing it each time:

```
/**
 * Add a new job to the database. The job will have a status of open.
 * @param employer_id The employer offering the job
 * @param title The job title
 * @param description The job description
 */
public void addJob(long employer_id, String title, String description){
```

```

String sql = ❶
    "INSERT INTO jobs " +
    "(_id, employer_id, title, description, start_time, end_time, status) " +
    "VALUES " +
    "(NULL, ?,           ?,           0,           0,           3)";
Object[] bindArgs = new Object[]{employer_id, title, description};
try{
    getWritableDatabase().execSQL(sql, bindArgs);❷
} catch (SQLException e) {
    Log.e("Error writing new job", e.toString());
}
}

```

Here are some of the highlights of the code:

- ❶ Builds an SQL query template named `sql` that contains bindable parameters that will be filled in with user data. The bindable parameters are marked by question marks in the string. Next, we build an object array named `bindArgs` that contains one object per element in our SQL template. There are three question marks in the template, so there must be three elements in the object array.
- ❷ Executes the SQL command by passing the SQL template string and the bind arguments to `execSQL`.

Using an SQL template and bind arguments is much preferred over building up the SQL statement, complete with parameters, into a `String` or `StringBuilder`. By using a template with parameters, you protect your application from SQL injection attacks. These attacks occur when a malicious user enters information into a form that is deliberately meant to modify the database in a way that was not intended by the developer. Intruders normally do this by ending the current SQL command prematurely, using SQL syntax characters, and then adding new SQL commands directly in the form field. The template-plus-parameters approach also protects you from more run-of-the-mill errors, such as invalid characters in the parameters. It also leads to cleaner code as it avoids long sequences of manually appended strings by automatically replacing question marks.

### Updating data already in the database

The `MicroJobs` application enables the user to edit a job by clicking on the job in the Jobs list and choosing the Edit Job menu item. The user can then modify the strings for employer, job title, and description in the `editJob` form. After the user clicks on the Update button on the form, the following line of code is executed:

```

db.editJob((long)job_id, employer.id, txtTitle.getText().toString(),
    txtDescription.getText().toString());

```

This code calls the `editJob` method, passing the job ID and the three items the user can change: employer ID, job title, and job description. The `editJob` method does the actual work of modifying the job in the database.

**Using the update method.** The following example demonstrates use of the `update` method:

```

/**
 * Update a job in the database.
 * @param job_id      The job id of the existing job
 * @param employer_id The employer offering the job
 * @param title       The job title
 * @param description The job description
 */
public void editJob(long job_id, long employer_id, String title, String description)
{
    ContentValues map = new ContentValues();
    map.put("employer_id", employer_id);
    map.put("title", title);
    map.put("description", description);
    String[] whereArgs = new String[]{Long.toString(job_id)};
    try{
        getWritableDatabase().update("jobs", map, "_id=?", whereArgs);❶
    } catch (SQLException e) {
        Log.e("Error writing new job", e.toString());
    }
}

```

Here are some of the highlights of the code:

- ❶ The first parameter to `update` is the name of the table to manipulate. The second is the map of column names to new values. The third is a small snippet of SQL. In this case, it's an SQL template with one parameter. The parameter is marked with a question mark, and is filled out with the contents of the fourth argument.

**Using the `execSQL` method.** The following example demonstrates use of the `execSQL` method:

```

/**
 * Update a job in the database.
 * @param job_id      The job id of the existing job
 * @param employer_id The employer offering the job
 * @param title       The job title
 * @param description The job description
 */
public void editJob(long job_id, long employer_id, String title, String description)
{
    String sql =
        "UPDATE jobs " +
        "SET employer_id = ?, "+
        " title = ?, "+
        " description = ? "+
        "WHERE _id = ? ";
    Object[] bindArgs = new Object[]{employer_id, title, description, job_id};
    try{
        getWritableDatabase().execSQL(sql, bindArgs);
    } catch (SQLException e) {
        Log.e("Error writing new job", e.toString());
    }
}

```



For this example application, we show the simplest possible function. This makes it easy to understand in a book, but is not enough for a real application. In a real application you would want to check input strings for invalid characters, verify that the job exists before trying to update it, verify that the `employer_id` value is valid before using it, do a better job of catching errors, and so on. You would also probably authenticate the user for any application that is shared by multiple people.

## Deleting data in the database

The `MicroJobs` application enables the user to delete a job as well as create and change it. From the main application interface, the user clicks on the List Jobs button to get a list of jobs and then clicks on a particular job to see the job detail. At this level, the user can click on the “Delete this job” menu item to delete the job. The application asks the user whether he really wants to delete the job. When the user hits the Delete button in response, the following line of code in the `MicroJobsDetail.java` file is executed:

```
db.deleteJob(job_id);
```

This code calls the `deleteJob` method of the `MicroJobsDatabase` class, passing it the job ID to delete. The code is similar to the functions we’ve already seen and lacks the same real-world features.

**Using the delete method.** The following example demonstrates use of the `delete` method:

```
/**
 * Delete a job from the database.
 * @param job_id      The job id of the job to delete
 */
public void deleteJob(long job_id) {
    String[] whereArgs = new String[]{Long.toString(job_id)};
    try{
        getWritableDatabase().delete("jobs", "_id=?", whereArgs);
    } catch (SQLException e) {
        Log.e("Error deleting job", e.toString());
    }
}
```

**Using the execSQL method.** The following example demonstrates use of the `execSQL` method:

```
/**
 * Delete a job from the database.
 * @param job_id      The job id of the job to delete
 */
public void deleteJob(long job_id) {
    String sql = String.format(
        "DELETE FROM jobs " +
        "WHERE _id = '%d' ",
        job_id);
    try{
        getWritableDatabase().execSQL(sql);
    } catch (SQLException e) {
        Log.e("Error deleting job", e.toString());
    }
}
```

```
} }
```

# A Skeleton Application for Android

The first two parts of this book describe an approach to key architectural issues in Android applications. The skeleton applications described in [Part III](#) embody this approach. You can use the code as a starting point for your own applications.



# A Framework for a Well-Behaved Application

In this chapter and the next, we introduce framework or “skeleton” applications that exemplify many of the design and implementation approaches presented in this book, especially in [Chapter 3](#) where we introduced the components of an application.

The framework application in this chapter can be used as a starting point for your own applications. We recommend this approach to creating applications over starting from scratch, or from smaller examples that do not implement all the aspects of the `Activity` object and process life cycle.

The approach we take in this chapter enables you to visualize and understand the component life cycle before you know you need it. Retrofitting life cycle handling to an application that was written without understanding life cycles, or with the expectation that life cycle handling won't be needed, is one of the easiest ways to create an Android application that fails unexpectedly, in ways that are hard to reproduce consistently, and that has persistent bugs that can remain undiscovered across multiple attempts to eradicate them. In other words, it's best to learn this before it bites you in the ass.

While this chapter isn't about user interfaces, you should keep in mind that the Android user interface classes were designed with both the constraints of the Android architecture and the capabilities of the Android system in mind. Implementations of user interface and life cycle handling go hand in hand. Correctly handling the life cycles of an application, the process that contains the application, the `Activity` objects that contain the UI of the application, and the `Fragment` objects that might be contained in an `Activity` instance are key to a good user experience.

To get the application framework code as you read it here, you can download an archive from the Examples link on the book's website, <http://oreilly.com/catalog/0636920010364>, which may include more features and corrections of errata.

# Visualizing Life Cycles

Earlier in this book, and in the Android developer documentation, you saw aspects of component life cycles diagrammed and read about how life cycles work. The problem with these descriptions is that component life cycles are dynamic, and a state diagram is a static picture. Moreover, component and process life cycle transitions are driven by memory management: when you run out, things start to happen in component life cycles to recover memory. Memory allocation, garbage collection, and the way Android enables memory recovery to span processes are inherently not as deterministic as running a block of code, and are configuration-dependent. Here, by instrumenting and running code, we will see application life cycles as they happen, and enable you to experiment with them in a running program.

## Visualizing the Activity Life Cycle

We will make the Activity component life cycle more visible to you by running an instrumented program and observing the behavior of the Activity life cycle methods using the LogCat view in Eclipse. The following code is a listing of the Activity subclass with the life cycle methods implemented, and logging calls in each method. The callouts in the code refer to a method-by-method explanation of life cycle handling in [“Life cycle methods of the Activity class” on page 288](#). Take a look at this listing to see what kind of information will be logged:

```
package com.oreilly.demo.pa.ch10.finchlifecycle;

import android.app.Activity;
import android.os.Bundle;
import android.util.Log;
import android.view.Menu;
import android.view.MenuItem;

public class FinchLifecycle extends Activity {

    // Make strings for logging
    private final String TAG = this.getClass().getSimpleName();
    private final String RESTORE = ", can restore state";

    // The string "fortytwo" is used as an example of state
    private final String state = "fortytwo";

    @Override
    public void onCreate(Bundle savedInstanceState) {❶
        super.onCreate(savedInstanceState);
        setContentView(R.layout.main);
        String answer = null;
        // savedInstanceState could be null
        if (null != savedInstanceState) {
            answer = savedInstanceState.getString("answer");
        }
        Log.i(TAG, "onCreate"
```

```

        + (null == savedInstanceState ? "" : (RESTORE + " " + answer)));
    }

    @Override
    protected void onRestart() {❷
        super.onRestart();
        // Notification that the activity will be started
        Log.i(TAG, "onRestart");
    }

    @Override
    protected void onStart() {❸

        super.onStart();
        // Notification that the activity is starting
        Log.i(TAG, "onStart");
    }

    @Override
    protected void onResume() {❹

        super.onResume();
        // Notification that the activity will interact with the user
        Log.i(TAG, "onResume");
    }

    protected void onPause() {❺

        super.onPause();
        // Notification that the activity will stop interacting with the user
        Log.i(TAG, "onPause" + (isFinishing() ? " Finishing" : ""));
    }

    @Override
    protected void onStop() {❻

        super.onStop();
        // Notification that the activity is no longer visible
        Log.i(TAG, "onStop");
    }

    @Override
    protected void onDestroy() {❼

        super.onDestroy();
        // Notification that the activity will be destroyed
        Log.i(TAG,
            "onDestroy "
            // Log which, if any, configuration changed
            + Integer.toString(getChangingConfigurations(), 16));
    }

    // //////////////////////////////////////
    // Called during the life cycle, when instance state should be saved/restored
    // //////////////////////////////////////

```

```

@Override
protected void onSaveInstanceState(Bundle outState) { 8
    // Save instance-specific state
    outState.putString("answer", state);
    super.onSaveInstanceState(outState);
    Log.i(TAG, "onSaveInstanceState");
}

@Override
public Object onRetainNonConfigurationInstance() { 9

    Log.i(TAG, "onRetainNonConfigurationInstance");
    return new Integer(getTaskId());
}

@Override
protected void onRestoreInstanceState(Bundle savedInstanceState) {10
    super.onRestoreInstanceState(savedInstanceState);
    // Restore state; we know savedInstanceState is not null
    String answer = null != savedInstanceState ? savedInstanceState.getString("answer") : "";
    Object oldTaskObject = getLastNonConfigurationInstance();
    if (null != oldTaskObject) {
        int oldtask = ((Integer) oldTaskObject).intValue();
        int currentTask = getTaskId();
        // Task should not change across a configuration change
        assert oldtask == currentTask;
    }
    Log.i(TAG, "onRestoreInstanceState"
        + (null == savedInstanceState ? "" : RESTORE) + " " + answer);
}

// ////////////////////////////////////////
// These are the minor life cycle methods, you probably won't need these
// ////////////////////////////////////////

@Override
protected void onCreate(Bundle savedInstanceState) { 11

    super.onCreate(savedInstanceState);
    String answer = null;
    // savedInstanceState could be null
    if (null != savedInstanceState) {
        answer = savedInstanceState.getString("answer");
    }
    Log.i(TAG, "onCreate"
        + (null == savedInstanceState ? "" : (RESTORE + " " + answer)));
}

@Override
protected void onResume() { 12

    super.onResume();
}

```



```

        Log.i(TAG, "onPostResume");
    }

    @Override
    protected void onUserLeaveHint() { 15
        super.onUserLeaveHint();
        Log.i(TAG, "onUserLeaveHint");
    }
}

```

When you are ready to run the application, first show the LogCat view by selecting Window→Show View→Other... and expanding the Android folder in the Show View dialog. Then select LogCat, as shown in [Figure 11-1](#).

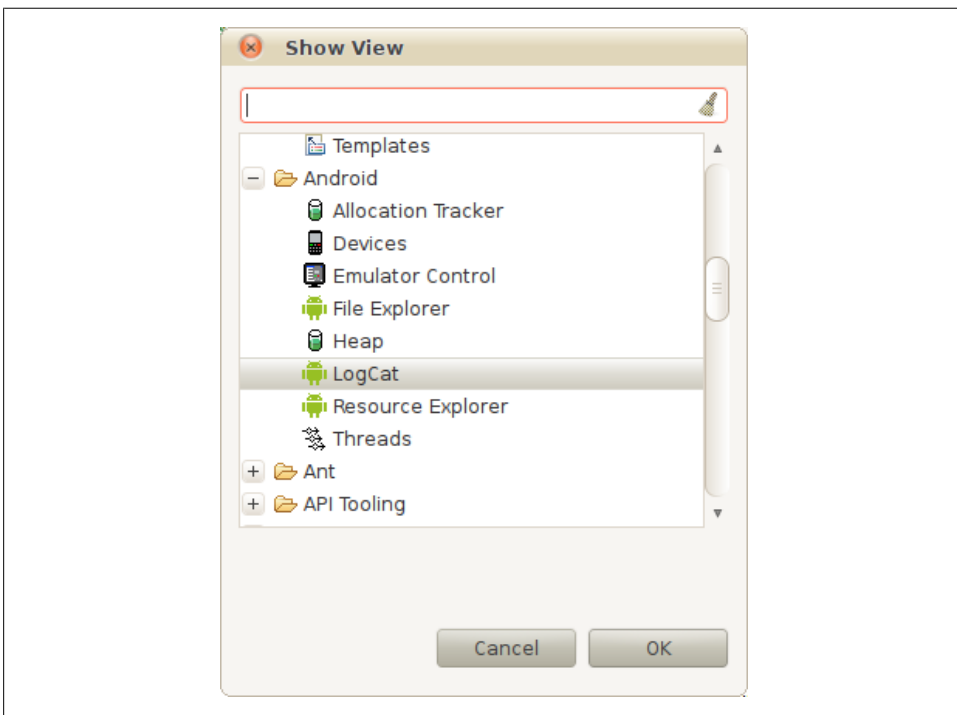
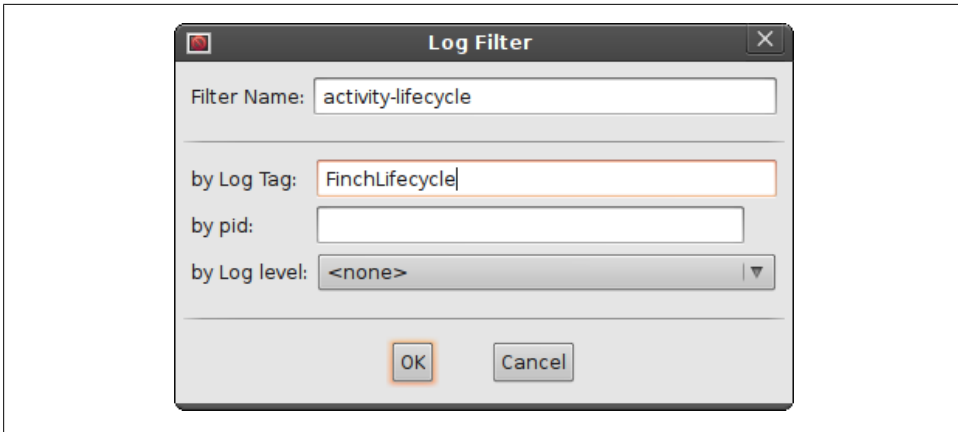

Figure 11-1. Selecting the LogCat view from the list shown

Now run the application in an emulator, or on a physical device. Since the example in this chapter has been built with both the Fragment API in Android API level 11, corresponding to Android version 3.0 “Honeycomb,” and the version of the Fragment class in the Android Compatibility Package, you can use either code base to run the example.

You will start to see logging information in the LogCat view in Eclipse. To see only the logging information from the code in the previous listing, you can filter the logging information. Click the green plus sign in the toolbar of the logging window to bring up a dialog for defining a logging filter, as shown in [Figure 11-2](#).

In this case, you will want to filter the log based on the tag we use in the `FinchLifecycle` class, which happens to be the name of the class: “`FinchLifecycle`”. We name the filter “`activity-lifecycle`”, as shown in [Figure 11-2](#).



*Figure 11-2. Making a filter that will show only log data tagging with “`FinchLifecycle`”*

Now, when you run the program, you will see only the logging output for the activity life cycle methods in the tab labeled “`activity-lifecycle`” in the LogCat view, as shown in [Figure 11-4](#). If you want to see all the logging information, the Log tab will show an unfiltered log.

When you run the program, you will see, if you use an emulator running Android 3.0, something like the screenshot in [Figure 11-3](#).

We use Android 3.0 here because this chapter includes coverage of life cycles and the `Fragment` class.



If you want to run the example on a device or emulator that predates Android 3.0, you can use the “backported” version of the example that makes use of the Android Compatibility Package, which enables the use of `Fragment` and other Android API level 11 classes in Android versions back to API level 4, corresponding to Android 1.6.

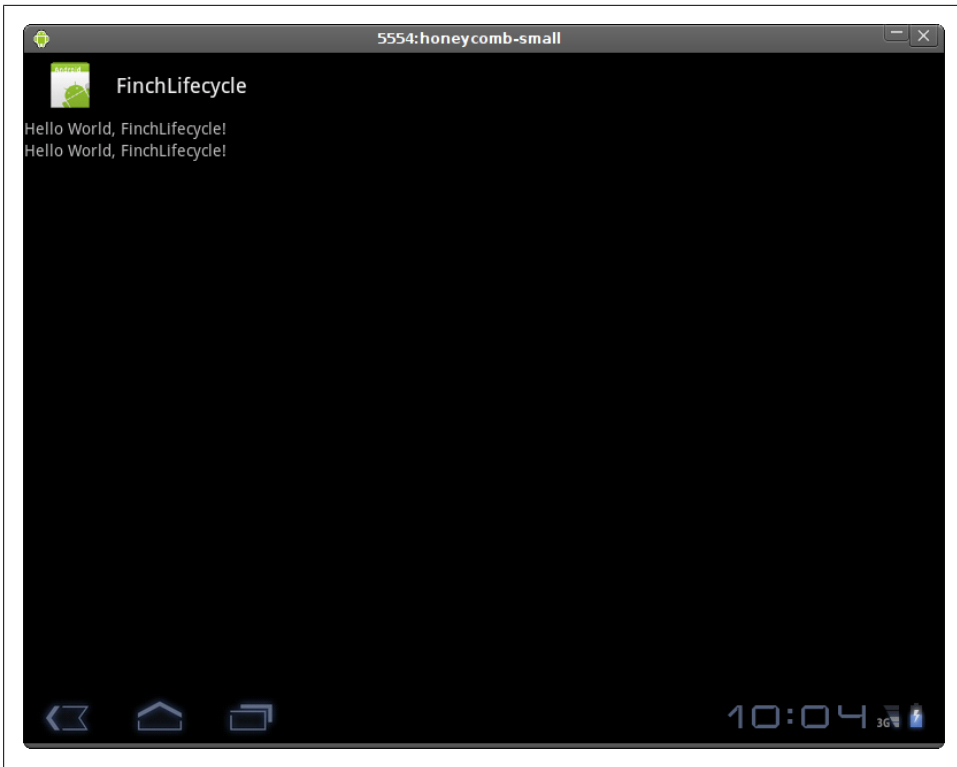

Figure 11-3. The example code of this chapter running in an Android 3.0 emulator

The first thing you will see in the “activity-lifecycle” tab of the LogCat view is the set of log messages in [Figure 11-4](#).

In order to generate interesting logging information, you can start other applications and go back and forth, using the application switcher or the Launcher to return to the Finch application. Start enough other applications, and on returning to the Finch application, you will see that the process ID, or PID, has changed, but the application appears to be in the same state as you left it. This is because state was restored for this activity, and all other components of the application, from the saved state. The log information shown in the screenshot in [Figure 11-5](#) shows just such a transition.



If you find there is no output in the LogCat view, switch to the DDMS perspective (using the Window menu) and click on the device, or emulator, you are using in the Devices view.

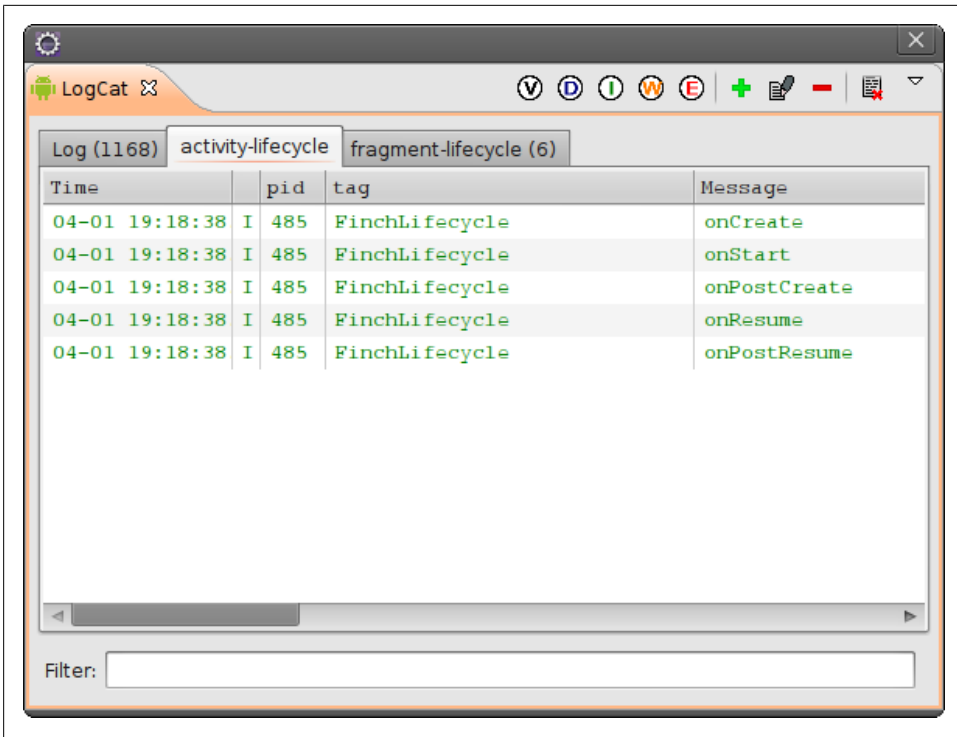

Figure 11-4. Logging output showing a new process and activity state being restored

By starting other applications that need memory, you have triggered some of the strategies Android uses to recover memory. Of course, since Android applications run in a virtual machine similar to a Java virtual machine, the first thing that happens is garbage collection, where the memory taken up by unused, unreferenced instances of objects is recovered. Android adds another strategy to garbage collection: activity components that are not visible to the user can have their state saved, and then they are “destroyed,” which really just means the system deletes its references to those components and they can then be garbage-collected. Android has yet another strategy for memory recovery: by telling all the components in an application to save their state, whole processes can be deleted and their memory recovered. This is how Android enables a form of “garbage collection” that spans multiple processes.

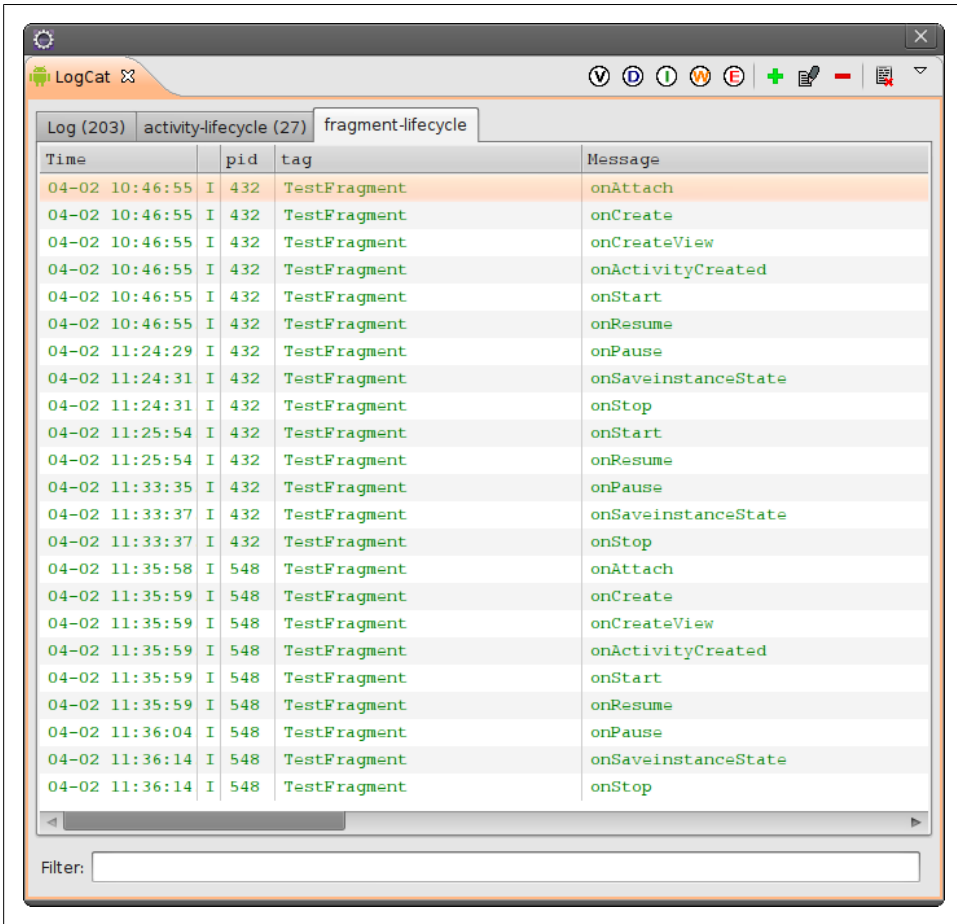

Figure 11-5. Logging output showing a new process and activity state being restored

### Memory recovery and life cycles

The life of an Android activity seems perilous and fleeting. An activity’s process can be *killed* or the `Activity` object *destroyed*, seemingly at the system’s whim. On top of that, you don’t even get a guarantee that all your life cycle method overrides will get called when the process is killed.

A good basis for understanding life cycles in Android is to focus on what happens when an `Activity` instance is destroyed, and when a process is killed:

#### *Destroying an activity*

An activity is destroyed and the `onDestroy` method is called when Android wants to discard *this instance of the Activity class*. “Discard” means that the Android system will set its references to the `Activity` instance to null. And that means that,

unless your code is holding a reference to this `Activity`, the `Activity` will, by and by, get garbage-collected. The word *destroy* is confusing to some—it implies actively wiping out something.

After the `onDestroy` method is called, you can be sure that this instance of your subclass of `Activity` will not be used again. But this does not necessarily mean that your application, or the process it is running in, is going to stop running. In fact, a new instance of the same `Activity` subclass could be instantiated and called. For example, this happens almost immediately after a configuration change (changing the screen orientation, for example) causes the previously used `Activity` object to be destroyed so that resource loading can start afresh for the new configuration.

### *Killing a process*

When an Android system starts running out of memory, it finds processes to kill. Typically, Android applications run in separate processes, so garbage collection in one process can't reach all the memory in an Android system. That means that in low-memory conditions, Android finds processes that do not have components that are in use and kills them. In extremis, Android will also kill processes that do have components that are being used. For simple applications, their process becomes a candidate for being killed after `onPause` has been called. That is, all the other `Activity` life cycle methods that can be called after `onPause` have no guarantee they will be called if the Android system needs to acquire some free memory by killing a process.

In both of these cases, your application is likely to need to save some state that exists temporarily in the user interface of an application: various inputs the user entered that have not yet been processed, the state of some visual indicator that is not part of the data model, and so on. This is why each component of your application, and especially each activity, will need to override some life cycle methods.

### **Life cycle methods of the `Activity` class**

Now that we know when and why the life cycle methods are called in general, let's look at the individual methods in the previous program listing and see what they do:

- ❶ The `onCreate` method is called after an `Activity` instance has been created. This is where most applications perform most of their initialization: reading in the layouts and creating `View` instances, binding to data, and so on. Note that, if this `Activity` instance has not been destroyed, nor the process killed, this is not called again. It is called only if a new instance of an `Activity` class is created. The argument to this method is a `Bundle` object that contains saved application state. If there is no saved state, the value of this argument is `null`.
- ❷ The `onRestart` method is called only if an activity has been stopped. “Stopped” means the activity is not in the foreground, interacting with the user. This method is called before the `onStart` method.

- ③ The `onStart` method is called when the `Activity` object and its views become visible to the user.
- ④ The `onResume` method is called when the `Activity` object and its views become interactive with the user.
- ⑤ The `onPause` method is called when a different `Activity` instance is going to be visible and the current `Activity` has stopped interacting with the user.
- ⑥ The `onStop` method is called when an activity is no longer visible to, or interacting with, the user.
- ⑦ The `onDestroy` method is called when an `Activity` instance is going to be destroyed—no longer used. Before this method is called, the activity has already stopped interacting with the user and is no longer visible on the screen. If this method is being called as the result of a call to `finish`, a call to `isFinishing` will return `true`.

### Saving and restoring instance state

Memory recovery and the component life cycle is why your `Activity` subclasses need to save state. Here is how and when they should do it:

The `Bundle` class exists to hold serialized data in the form of key-value pairs. The data can be primitive types, or it can be any type that implements the `Parcelable` interface (see “[Parcelable](#)” on page 159). You can find out more about `Bundle` on the Android Developers site, at <http://developer.android.com/reference/android/os/Bundle.html>. In saving `Activity` instance state, you will use the “put” methods of the `Bundle` class.

In the call to `onCreate`, and in the call to `onRestoreInstanceState`, a `Bundle` object is passed to the method. It contains data that a previous instance of the same `Activity` class put there in order to store it across instantiations. That is, if an `Activity` instance has state, apart from what is persisted in a data model, it can be saved and restored across multiple instances of that `Activity` class. To the user, it looks like she has picked up right where she left off, but she may be looking at an entirely new instance of an `Activity` class, possibly in an entirely new process.

You may have noticed that the `onPause` life cycle method does not provide a `Bundle` object for storing state. So when is state stored? There are separate methods in the `Activity` class for saving state, and for being notified that state is being restored:

- ⑧ This is where an application gets a chance to save instance state. Instance state should be state that is not persisted with an application’s data model, such as the state of an indicator or other state that is only part of the `Activity` object. This method has an implementation in the parent class: it calls the `onSaveInstanceState` method of each `View` object in this instance of `Activity`, which has the result of saving the state of these `View` objects, and this is often the only state you need to store this way. Data that your subclass needs to store is saved using the “put” methods of the `Bundle` class.

- ⑩ The `onRestoreInstanceState` method is called when there is instance state to be restored. If this method is called, it is called after `onStart` and before `onPostCreate`, which is a minor life cycle method described in “[Minor life cycle methods of the Activity class](#)” on page 291.

### Configuration changes and the activity life cycle

Previously, we covered how you can provoke the Android system into killing the process that your activity, and every other component of your application, is running in by launching enough applications that some processes are killed. The logs you would see, and the one in the screenshot in [Figure 11-5](#), show that the process ID changes, and that a new instance of the `Activity` subclass that defines how this application interacts with the user is created. This new instance reloads all the resources for this activity, and if there were any application data to be loaded, that would be loaded anew, too. The net effect is that the user proceeds as though nothing has happened: the new instance looks like the old one because it has the same state.

There is another way to force Android to use a new `Activity` instance: change the configuration of the system. The most common configuration change applications encounter is a change in screen orientation. But there are many dimensions to what counts as a new configuration: changes in whether a hard keyboard is accessible or not, changes in locale, changes in font size, and more. The common factor in all changes to configuration is that they *can* require resources to be reloaded, usually because they need layouts to be recalculated.

The easiest way to make sure every resource used in an activity is loaded anew in light of the new configuration is for the current instance of the activity to be discarded, and a new instance created, so that it reloads all resources. To cause this to occur while running the application in an emulator, press the 9 key on the numeric keypad. This changes the screen orientation in the emulator. In the log, you will see something like what is in the screenshot in [Figure 11-6](#). You will see in the log that the `onDestroy` method is called since the `Activity` instance is discarded as part of changing configurations, not when the system, running low on memory, kills the process. You will also notice that across new instances of the `Activity` object the process ID stays the same—the system has no need to recover the memory the application is using.

This approach may seem profligate: a new instance of the `Activity`? What for? Why can't I preserve this instance? Isn't that going to be slow? In most cases, however, the resources loaded by an activity when it starts constitute most of the state of that `Activity` instance. In many cases, the largest amount of computation that takes place in an activity happens when it reads the XML file and calculates layouts. And, in most cases, a configuration change such as screen orientation or locale change requires nearly every resource to have its layout recalculated. So, turning a configuration change into what amounts to a restart of an activity is inevitable, as is the amount of processing that goes into that restart.



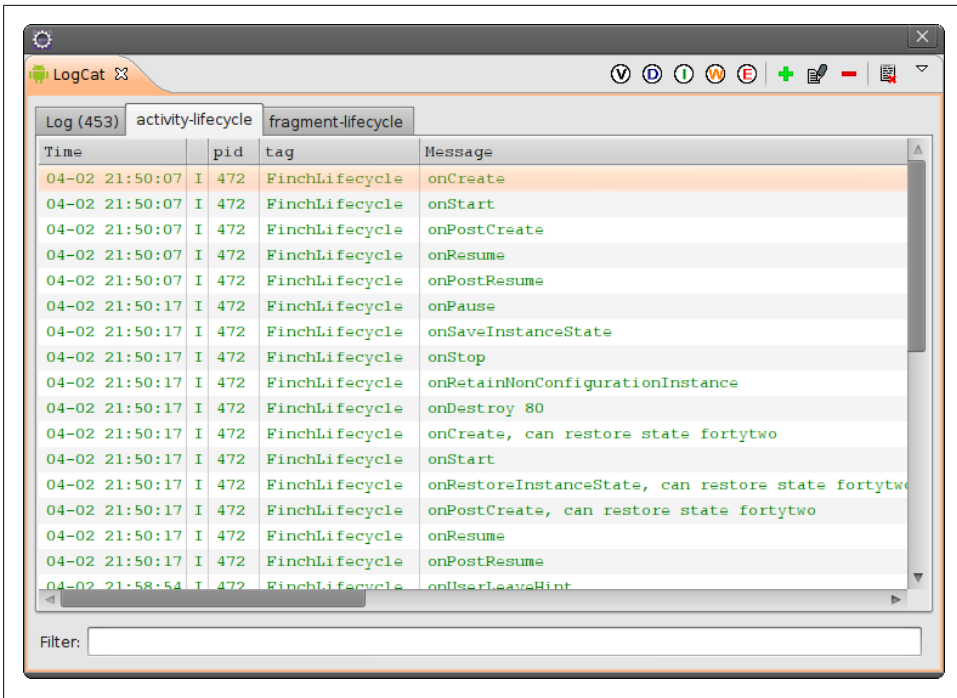

Figure 11-6. The PID remaining unchanged when the `onDestroy` method is called

Keep in mind that the only thing going on when Android “destroys” an activity is that the reference to the activity is discarded, eventually to be garbage-collected. Every time the user moves from one activity to a new activity, all the computation that goes into creating that new activity is performed. Doing the same when a configuration change occurs is not an extraordinary amount of work for the system.

### Minor life cycle methods of the Activity class

Several additional methods, other than the main life cycle methods used in the Android documentation to describe the activity life cycle, are also called as an activity moves through its life cycle:

- 11 The `onPostCreate` method is called after `onRestoreInstanceState` is called. It may be useful if your application requires that state be restored in two stages. It is passed a `Bundle` object containing instance state.
- 12 The `onPostResume` method is called after `onResume`, when the `Activity` instance should be visible and is interacting with the user.
- 13 The `onUserLeaveHint` method is called if an activity is going to stop being visible and interacting with the user due to the user’s actions—for example, pressing the back or home hard keys. This is a convenient place to clear alerts and dialogs.

You can see in the program listing in [Figure 11-6](#) that we have implemented overrides of these methods in order to log when they are called. These methods exist for cases where, for example, you need an additional stage for restoring instance state.

However, if you really need to preserve some data across configuration changes, and it isn't part of the state that gets stored in the `Bundle` object between instances, and it isn't part of the data model that would get saved, you can use the `onRetainNonConfigurationInstance` method to “stash” a reference to an object. This reference can then be requested by a new `Activity` instance using the `getLastNonConfigurationInstance` method:

- ⑨ The `onRetainNonConfigurationInstance` method is called after `onStop`, which means there is no guarantee it will be called, nor even, if it is called, that the reference returned will be preserved and provided to the subsequent `Activity` instance. The `getLastNonConfigurationInstance()` method can be called in the `onCreate` method, or subsequently when restoring activity state.

To illustrate the use of these methods, we return an object containing the task ID of the activity when `onRetainNonConfigurationInstance` is called, and when `onRestoreInstanceState(Bundle)` is called, we check it to see that the task ID has not changed. This confirms that, even if the instance of the component or even of the whole process is different to the user, it's the same task.

The most commonly cited use case for using these methods is to store the results of a web query: you could redo the query, but the latency of a query to a web server might be a few seconds. So, while the data can be re-created if the system cannot preserve it for the new `Activity` object instance to retrieve, there is a significant upside to caching it. However, in this book we show you, in [Chapter 13](#), how to interpose a local database as a cache in RESTful applications, reducing the need for this kind of optimization.

## Visualizing the Fragment Life Cycle

If you are developing for Android 3.0 “Honeycomb,” API level 11 or later, the `Fragment` API is available. If, however, you prefer to develop for a pre-Honeycomb version of Android and would like to use `Fragment` objects in your user interface, you can use the Android Compatibility Package, as described in [Chapter 8](#). The example code for this chapter is provided in two forms: one that is set up to work with API level 11 as the target API, and one that can be targeted to API levels as low as API level 4, corresponding to Android 1.6. You will find the following `Fragment` code identical except for the package declaration for the `Fragment` class, and you will find it behaves identically with respect to the `Fragment` life cycle.

This code, like the `Activity` class presented earlier, instruments the life cycle callbacks so that they can be observed as the program runs:

```

package com.oreilly.demo.pa.ch10.finchlifecycle;

import android.app.Activity;
import android.app.Fragment;
import android.os.Bundle;
import android.util.Log;
import android.view.LayoutInflater;
import android.view.View;
import android.view.ViewGroup;

public class TestFragment extends Fragment {

    // get a label for our log entries
    private final String TAG = this.getClass().getSimpleName();

    public TestFragment() {

    }

    @Override
    public void onAttach(Activity activity) {❶
        super.onAttach(activity);
        Log.i(TAG, "onAttach");
    }

    @Override
    public void onCreate(Bundle saved) {❷
        super.onCreate(saved);
        if (null != saved) {
            // Restore state here
        }
        Log.i(TAG, "onCreate");
    }

    @Override
    public View onCreateView(LayoutInflater inflater, ViewGroup container,❸
        Bundle saved) {
        View v = inflater.inflate(R.layout.fragment_content, container, false);
        Log.i(TAG, "onCreateView");
        return v;
    }

    @Override
    public void onActivityCreated(Bundle saved) {❹
        super.onActivityCreated(saved);
        Log.i(TAG, "onActivityCreated");
    }

    @Override
    public void onStart() {❺
        super.onStart();
        Log.i(TAG, "onStart");
    }

    @Override

```

```

public void onResume() {❸
    super.onResume();
    Log.i(TAG, "onResume");
}

@Override
public void onPause() {❹
    super.onPause();
    Log.i(TAG, "onPause");
}

@Override
public void onStop() {❺
    super.onStop();
    Log.i(TAG, "onStop");
}

// //////////////////////////////////////
// Called during the life cycle, when instance state should be saved/restored
// //////////////////////////////////////

@Override
public void onSaveInstanceState(Bundle toSave) {❻
    super.onSaveInstanceState(toSave);
    Log.i(TAG, "onSaveinstanceState");
}
}

```

As you did with the LogCat filter for finding the log entries that show Activity component callbacks, you will set up a filter for **Fragment** callbacks.

If you repeat the steps you took—starting other applications until you see in the LogCat window that the **Fragment** life cycle methods are being called—you will see that each **Fragment** instance in an **Activity** instance behaves like the enclosing **Activity** with respect to the **Views** it contains. Similar life cycle transitions and states are called.

Let's take a look at each method that gets called, now that we know when they are called:

- ❶ The **onAttach** method is called when the **Fragment** instance is associated with an **Activity** instance. This does not mean the **Activity** is fully initialized.
- ❷ The **onCreate** method is called when the **Fragment** instance is being created, or re-created. If it is being re-created after the **Fragment** or the containing **Activity** component has been destroyed, the bundle argument will be non-null if any state had been saved.
- ❸ The **onCreateView** method is called when the **Fragment** instance should create the **View** object hierarchy it contains. **Fragment** has an unusual role in an **Activity**: it behaves somewhat like a **ViewGroup**, but it isn't part of the **View** class hierarchy. You can think of it as enabling the **Activity** to contain multiple sets of **View** instances. In our example, we load an extremely simple layout containing a **TextView**.

- ④ The `onActivityCreated` method is called when the `Activity` containing the `Fragment` instance has been created, and the `View` objects contained by the `Fragment` have been created. At this point, it is safe to search for `View` objects by their ID, for example.
- ⑤ The `onStart` method is called when the `Fragment` becomes visible, in a very similar way to the `Activity` method `onStart`.
- ⑥ The `onResume` method is called when the `Fragment` becomes visible, and is running.
- ⑦ The `onPause` method also is called under the same conditions as an `Activity` instance's `onPause` method when the `Fragment` is about to be taken out of the foreground.
- ⑧ The `onStop` method is called when the `Fragment` is about to stop running.
- ⑨ The `onSaveInstanceState` method is called when it is necessary to save instance state so that if the instance is destroyed (really, just dereferenced) any class-specific state that needs to be stored can be stored in the `Bundle` object passed to this call.

`Fragment` objects are not components. You can think of them as a way of breaking up an `Activity` object into multiple objects contained within an `Activity`, each with its own `View` hierarchy that behaves like it is inside an `Activity`.

## The Activity Class and Well-Behaved Applications

Understanding application life cycles is key to implementing well-behaved applications, and it is also key to understanding misbehaving applications. Lagging performance, excessive resource use, and unexpected user interface behavior can often be diagnosed by observing the application's life cycle. Life cycle is difficult to understand just by looking at code or the documentation page for the `Activity` class. To enable you to observe life cycle as it is happening, we will put logging calls into our implementations of Android life cycle methods, run the programs, and observe how life cycle works in a running program. In using this framework, you can leave these logging calls in your application's code as you develop it because applications often come to need logging in these methods to diagnose problems.

Most of the methods called on changes in life cycle are implemented on a per-component basis, and some on a per-process basis. Each type of component—`Service`, `BroadcastReceiver`, `ContentProvider`, and `Activity`—has its own life cycle. Life cycles of components other than `Activity` are covered in [Chapter 3](#). Most life cycles are simpler than the `Activity` life cycle. This is because the `Activity` class interacts with the user, and when an `Activity` is no longer a visible part of the user interface, it is likely that the memory occupied by resources associated with that `Activity` instance could be scavenged if needed. Managing memory occupied by resources related to components is one of the principal purposes of component life cycles.

## The Activity Life Cycle and the User Experience

In fact, if your application is well designed for the mobile environment in general, it will need less code in application life cycle management:

- If the data used by an activity is always up-to-date and in a database, you will not have to explicitly store it in the code in an application life cycle method.
- If your user interface has minimal state, you won't have to save much, if any, state in an activity life cycle method.

These seem like stringent constraints, but in mobile and other appliance-like devices, they are not. The battery on a mobile phone can die at any time, and the less an application's data model and state are held in memory, the less the user will lose when the device shuts off unexpectedly. A mobile user may be interrupted by a phone call and the user will never get a chance to return to an application to perform operations that save data. Mobile applications are not intended to work like typical interactive applications on personal computers, with documents on filesystems that become in-memory data models, to be explicitly saved, or else the data is lost.

In this chapter and the next, you will see that application life cycle, the data model and other aspects of application architecture, and the user experience are all intertwined, and that the path of least resistance, and least implementation in life cycle methods, leads to application implementations that are robust, are easy to use, are good citizens of the Android environment, and perform well. If you treat a battery failure the same as the user no longer using an activity or the same as the system killing an activity to claw back memory and other system resources, you will simplify your implementation and unburden the user. Explicit actions such as “save” and “quit” should be avoided in the mobile user experience, and in the implementation of well-behaved applications.

## Life Cycle Methods of the Application Class

The life cycle methods of the `Application` class are, and should be, infrequently used in simple applications. And they should be used with restraint even in complex applications. It is easy to bloat `Application` class overrides with data that hangs around in memory across multiple activities. This defeats Android's ability to manage resources on a per-component basis. For example, if you move the reference to some data from an `Activity` object to the `Application` object, all you have done is extend the system's chase for resources in a low-memory situation to the application life cycle, and you must manage this data separately from the activity life cycle.

Here, we implement the life cycle methods of the `Application` class to show their place in the Android application life cycle, and because logging information from these methods may be useful:

```
package com.finchframework.finch;
```

```

import android.app.Application;
import android.content.res.Configuration;
import android.util.Log;

/**
 * @author zigurd
 *
 * This the framework's Application subclass. This illustrates what
 * you may need to do in an Application subclass.
 *
 * To get this class instantiated, you must refer to it in the
 * application tag of the manifest.
 */
public class FinchApplication extends Application {
    private final String TAG = this.getClass().getSimpleName();

    @Override
    public void onCreate() {
        // First, call the parent class
        super.onCreate();

        // This is a good place to put code that must manage global data across
        // multiple activities, but it's better to keep most things in a
        // database, rather than in memory
        Log.i(TAG, "onCreate");
    }

    @Override
    public void onTerminate() {
        Log.i(TAG, "onTerminate");
    }

    @Override
    public void onLowMemory() {
        // In-memory caches should be thrown overboard here
        Log.i(TAG, "onLowMemory");
    }

    @Override
    public void onConfigurationChanged(Configuration newConfig) {
        Log.i(TAG, "onConfigurationChanged");
        if (Log.isLoggable(TAG, Log.VERBOSE)) {
            Log.v(TAG, newConfig.toString());
        }
    }
}

```

Earlier we mentioned that many applications can do without subclassing `Application`. Because of this, the New Android Project Wizard does not create an `Application` subclass, nor does it add a reference to it in the manifest. Like the initial object that gets started when an interactive application starts, the `Application` subclass

you create gets instantiated by the Android system as part of launching an application. In much the same way as Android handles **Activity** subclasses, it knows which class to make an instance of, and uses the `android:name` property of the `application` tag in the manifest. The easiest way to get this right is by using the Application tab of the manifest editor. The first field on that editing tab is labeled Name (see [Figure 11-7](#)). Clicking the Browse button next to that field shows the **Application** subclasses in your application.

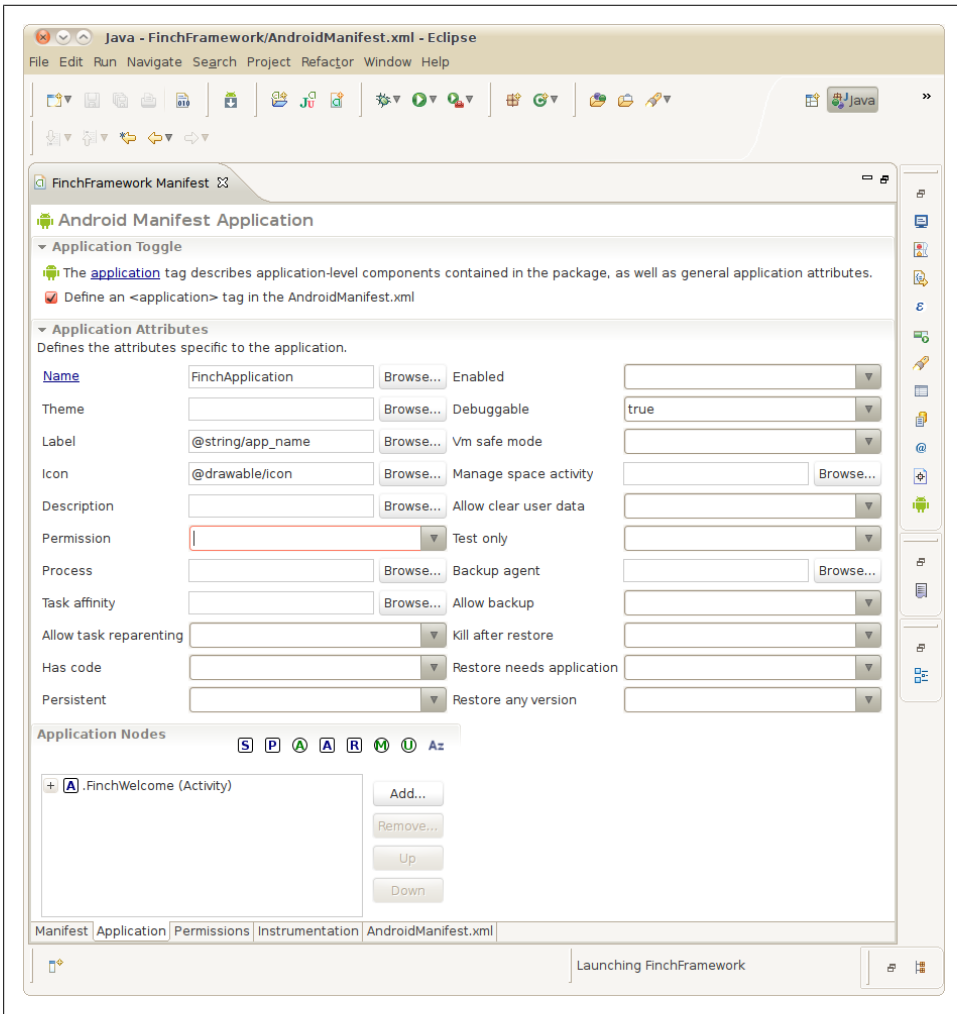

Figure 11-7. The Name field on the Application tab of the manifest editor, where you enter the name of the Application subclass you have defined

As with the **Activity** class's life cycle methods, it is most revealing to know when life cycle methods get called. You can, of course, find this out by debugging an application



and setting breakpoints in each method, but often the most informative information is found by looking at long-running applications' behavior, and filtering a log by the tags used in the `Activity` and `Application` subclasses, to get an idea of when life cycle methods have been called.

Two of the most interesting callbacks to track in the `Application` class are `onLowMemory` and `onTerminate`, which will tell you when, obviously enough, the system thinks it is in a low-memory condition and when your application terminates. The second situation is usually not obvious because most Android applications do not need to explicitly exit, since Android's memory management, in concert with component life cycles, is enough to sweep out unused code if it was correctly implemented with respect to life cycle and memory management.

## A Flowing and Intuitive User Experience Across Activities

After the basics of the life cycle of an activity, navigation and flow from one activity to another is the next most fundamental aspect of the architecture of Android applications, and it goes hand in hand with life cycle. In a mobile device with a small screen, an intuitive flow among multiple screens is key to maximizing the visual information the user can access and use. When applications are correctly implemented and maximally cooperative, a user may navigate among several activities, each of which is implemented in a separate application, and think he has used only one application.

### Multitasking in a Small-Screen Environment

Keeping track of multiple tasks—multiple programs, documents, and so forth—in a personal computer's user interface is something so commonplace that you may not think much about how it is accomplished. Multiple documents, overlapping windows, and a mouse pointer are all ingredients of a user interface paradigm called the “desktop metaphor.” Your personal computer screen is a metaphor for a real desk, with overlapping documents on it. Move a document to the top by selecting it with the pointer, and it becomes the document you are working on.

On a small screen, the entire screen is devoted to a single task, and the concept of a task, and task switching, is inherently less visual. In mobile user interfaces, a back stack—a stack of activities you can go back to—is often a central concept. In Android, the back stack is called the “activity stack.”

### Tasks and Applications

If an activity is the basic unit of Android user interaction, a “task” is the next-larger grouping. In Android, the word *task* does not denote an executable object such as a process or application; instead, it refers to a single activity stack with, potentially, multiple activities from multiple applications in it. Those activities can be implemented in

multiple separate applications, as shown in [Figure 3-3](#) in [Chapter 3](#). As the user interacts with the system, sometimes one activity will, by way of an `Intent` object, ask the system to find an activity that matches the intent's specifications. If that activity is in another application, it usually becomes part of the task the user began when she launched an application from the Launcher or Home screen shortcut.

When the user launches what she thinks of as an application, she also starts the “root activity” of a task. This becomes concrete to the user through Android's methods of task switching: after an application has been launched, pressing an application icon in the Home activity, or the Recent Tasks switcher that pops up when you long-press the Home button, returns to an already-started task (in most cases).

Tasks are not processes. In fact, the process for the current activity of a task may have been killed, but it will be restarted, and a new instance of the `Activity` object instantiated, and its state restored, when the user switches to that task. The user doesn't have to concern herself with how memory is managed. The Android system will restore processes and activities in a task as the user needs them.

Android provides developers with rich control over the behavior of tasks. Used correctly, your control over task behavior will reinforce the Android concept of tasks and make the user feel as though the back button always does what she expects. If it's used incorrectly or in poor taste, the user may find herself asking, “How did I get here?”

## Specifying Launch and Task Behavior

Tasks are not represented by a class in the Android APIs, and you won't be controlling task objects with method calls. Task behavior is set by parameters in an application's manifest. Task behavior can also be modified as part of creating and using an intent. As you will see from the explanation of how task behavior is controlled, activity life cycle and task behavior are intertwined.

### Launch mode

An activity's launch mode is an attribute set in the `activity` tag in an application's manifest. This attribute affects task behavior and, indirectly, life cycle.

The `android:launchMode` attribute has four valid values, which are mutually exclusive:

#### "standard"

The "standard" launch mode is the default. With this value of the `android:launchMode` attribute, an activity can be launched multiple times, with multiple instances of this `Activity` class existing at the same time. These instances may belong to multiple tasks, usually the task that owns the component that called `startActivity()` to cause the activity to be launched. The diagram in [Figure 11-8](#) shows multiple instances of an activity at the top of a task.

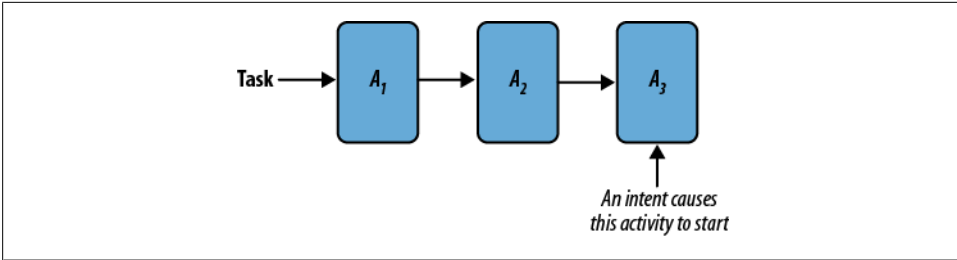

Figure 11-8. The standard launch mode, which creates a new activity

"singleTop"

The "singleTop" launch mode differs from "standard" in that, if an instance of an activity with this value of the `android:launchMode` attribute already exists, and is in the task that would own the activity to be launched, and is at the top of the activity stack, the existing activity gets the `Intent` object via the `onNewIntent()` method, rather than a new activity being started. The diagram in Figure 11-9 shows a single instance of a "singleTop" activity at the top of a task.

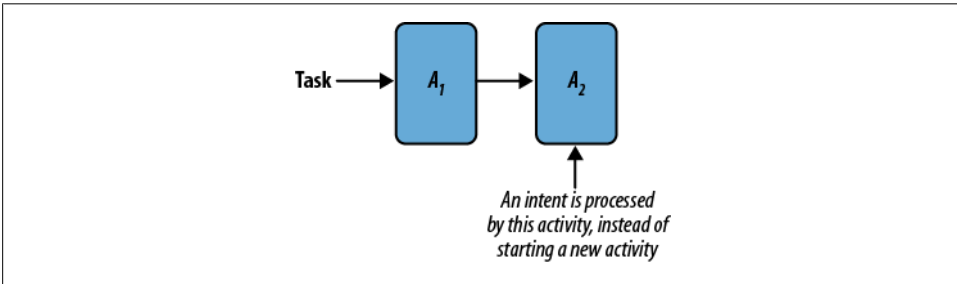

Figure 11-9. The singleTop launch mode, which causes the intent to be processed by the top activity if it matches the intent

"singleTask"

The "singleTask" launch mode specifies that the activity to be launched is the root of a new task, unless an instance of this activity already exists, in which case the behavior is like "singleTop", and the `Intent` object associated with launching this activity is processed through a call to `onNewIntent()`.

"singleInstance"

The "singleInstance" launch mode specifies that the activity to be launched is the root of a new task, and it specifies that any activity launched by this activity is also in a new task, ensuring that this activity is the one and only activity in its task.

**Task affinity**

The `android:taskAffinity` attribute can be set to be the same as the value of an `android:name` attribute of an activity. If it is not set, the default value is the name of the package specified in the `<manifest>` tag.

Task affinity is used to put an activity in a specific task. That is, if you do not want the default behavior in Android, where new activities become part of the task that started those activities, task affinity enables you to override that behavior and specify the desired task, which usually is a task associated with the application that implements this activity.

### Other activity attributes affecting task behavior

Other attributes that modify task behavior include the `android:noHistory` attribute. If this attribute is set to `true` the activity is not placed on the activity stack when the user navigates away from it. This is useful for activities such as log in screens that should not be revisited, except when authentication is actually required.

The `android:process` attribute can be set to the name of a process in which the activity should run, instead of the process created for the first component to run in an application. This attribute is notable mainly because it does *not* affect task behavior: even though the activity is running in a different process, it is grouped into a task as though it ran in the same process from which it was launched.

The `android:finishOnTaskLaunch` attribute causes any other instance of this activity to be finished when a new instance is launched. Using this attribute ensures that these kinds of activities are never stacked, and appear only once among all activities in all tasks.

The `android:alwaysRetainTaskState` attribute tells the Android system, if it is set to `true`, that the stack of activities above a root activity should never be cleared. By default, the system can clear the activity stack above a root activity after an interval in which the task has not been used.

### Modifying task behavior with intent flags

Most task behavior is determined by attributes in the `activity` tag of the manifest. The exception to this is in a set of flags that can be set in an `Intent` object.

There is a surprisingly large number of ways to modify task behavior in intent flags. Some are obviously useful, but some are just perplexing, in an area of functionality that is perplexing enough as it is:

#### `FLAG_ACTIVITY_BROUGHT_TO_FRONT`

This flag is used by the system to implement the behavior to be used when an `Activity` has the `singleTask` or `singleInstance` launch mode attribute specified.

#### `FLAG_ACTIVITY_CLEAR_TASK`

This flag indicates the tasks to be cleared before the new activity starts. This means the new activity is the new root activity of the task.

#### `FLAG_ACTIVITY_CLEAR_TOP`

This flag has the effect of putting the activity the `Intent` object matches on top of the activity stack, if it is in the activity stack of the current task, by finishing all

activities on top of the one the `Intent` object matches. The activity that ends up at the top of the activity stack is itself finished and re-created, unless it is capable of receiving a new intent via the `onNewIntent()` method.

#### `FLAG_ACTIVITY_CLEAR_WHEN_TASK_RESET`

This flag indicates that the activity being launched is the activity that should be on top of the activity stack if the task is reset. “Reset” means the top of the activity stack is cleared. This is done after some time has passed.

#### `FLAG_ACTIVITY_EXCLUDE_FROM_RECENTS`

The activity started with this flag is not saved on the activity stack.

#### `FLAG_ACTIVITY_FORWARD_RESULT`

This flag means the new activity can provide a result to the activity that launched the current activity. In other words, “Here, you answer this.”

#### `FLAG_ACTIVITY_LAUNCHED_FROM_HISTORY`

This flag means the new activity was launched from the “recents” menu to replace an instance that had been destroyed.

#### `FLAG_ACTIVITY_MULTIPLE_TASK`

This flag means the new activity can be the root of multiple tasks, and if used with `FLAG_ACTIVITY_NEW_TASK`, in fact creates multiple tasks. This can be confusing to the user, since the Android system does not provide the user with a way to distinguish among multiple tasks with the same root activity.

#### `FLAG_ACTIVITY_NEW_TASK`

This flag means the new activity is the root of a new task, unless `FLAG_ACTIVITY_MULTIPLE_TASK` is also set, in which case multiple tasks with the same root activity are created and the aforementioned cautions apply.

#### `FLAG_ACTIVITY_NO_ANIMATION`

This flag suppresses transition animation.

#### `FLAG_ACTIVITY_NO_HISTORY`

The new activity is not on the back stack. It is the same as the `noHistory` attribute.

#### `FLAG_ACTIVITY_NO_USER_ACTION`

This flag suppresses the `onUserLeaveHint` callback for the current activity. Assuming this callback is used to clear alerts, the alerts will stay up. This is useful for activity transitions the user did not initiate, such as displaying an incoming call or message.

#### `FLAG_ACTIVITY_PREVIOUS_IS_TOP`

This flag means the new activity will not be treated as the top of the activity stack, and the previous top activity will be treated as the top for the purposes of deciding whether the intent should be delivered to the top activity, or whether a new activity should be created. There is no known use case for this flag.

#### `FLAG_ACTIVITY_REORDER_TO_FRONT`

If the activity is already running, it will be raised to the top of the activity stack and made visible.

Some of these flags have been added since API level 1, and are ignored in earlier APIs. Some of these flags have the effect of overriding task behavior set in the manifest. Some flags affect other behavior, such as transition animations. And in some cases, a flag in an `Intent` object is the only way to modify task behavior.

Use all of these with caution. Unexpected task behavior can destroy the user's sense of place in the Android UI.

---

# Using Content Providers

When Android applications share data, they rely on the content provider API to expose data within their database. For example, the Android contact content provider allows an unlimited number of applications to reuse contact persistence on the Android platform. By simply invoking this content provider, an application can integrate access to a user's contacts stored locally and synchronized with the Google cloud. Applications can read and write data in content providers without having to provide their own database manipulation code. In this way, content providers provide a powerful feature that allows developers to easily create applications with sophisticated data management—in many cases, applications will end up writing very little data persistence code of their own.

The content provider API enables client applications to query the OS for relevant data using a Uniform Resource Identifier (URI), similar to the way a browser requests information from the Internet. For a given URI query, a client does not know which application will provide the data; it simply presents the OS with a URI and leaves it to the platform to start the appropriate application to provide the result. The platform also provides a permission that allows clients to limit access to content provider data.

The content provider API enables full create, read, update, and delete access to shared content. This means applications can use URI-oriented requests to:

- Create new records
- Retrieve one, all, or a limited set of records
- Update records
- Delete records

This chapter shows you how to write your own content provider by examining the inner workings of an example content provider, `SimpleFinchVideoContentProvider`, included within the Finch source tree. All file references are contained in the source directory for this chapter. Thus, when the `AndroidManifest.xml` file is referenced in this section, the `$(FinchVideo)/AndroidManifest.xml` file is assumed. We'll use this code to describe how to create a content provider by implementing each method required by

the main content provider API, the class `ContentProvider`. We will also explain how to integrate a SQLite database into that content provider. We'll describe how to implement the basic function of a content provider, which is to provide a mapping between URIs that reference data and database rows. You will see how a content provider encapsulates data persistence functions and enables your application to share data across processes when you declare your provider in *AndroidManifest.xml*. We will show you how to hook content provider data into Android UI components, thus completing the MVC architecture that we have led up to so far in this book. Finally, we will build a data viewing activity that automatically refreshes its display in response to changes in data.



Throughout this chapter, we make the assumption that local content provider storage uses a SQLite database. Given the content provider `query`, `insert`, `update`, and `delete` API methods, it's actually a bit of a stretch to think about mapping it to anything else, even though, in theory, the API can store and retrieve data using any backend, such as a flat file, that could support the required operations.

We follow this introduction in the next chapter by showing you how to extend and enhance the very concept of a content provider. In the process, you will learn to leverage the content provider API to enable integration of RESTful network services into Android. This simple architecture will prevent many common mobile programming errors, even though it only relies on basic Android components. You will see that this approach leads logically into a mobile application architecture that adds significant robustness and performance improvements to Android applications.

We will walk through a video listing application that provides a simplified illustration of this architecture. This application will follow the suggested approach by loading, parsing, and caching YouTube video content entries from the RESTful web service at <http://gdata.youtube.com>. We'll simply be using `gData` as an example of a RESTful service that we can integrate into an Android content provider. The application UI will use content providers to dynamically display video entries as they are loaded and parsed from the network. You will be able to apply this approach to integrate the large number of web services available on the Internet into your Android-based application. Incidentally, the `gData` URI provides a pretty neat demo from Google and worth checking out in its own right.

## Understanding Content Providers

Content providers encapsulate data management so that other parts of an application, such as the view and controller, do not need to participate in persisting application data. Saying this in a different way: content providers persist application data because the view and controller should not handle it. Specialized software layers that do not



attempt to perform tasks of other layers are the hallmark of well-crafted code. Bugs and unneeded complexity arise when software layers perform tasks that are beyond their scope. Thus, a UI should consist only of well-laid-out UI components fine-tuned to collect events from their end user. A well-written application controller will contain only the domain logic of the mobile application. And in connection with this chapter, simplifications arise when both types of code can outsource data persistence to a logical third party: content providers. Recalling the discussion from “[SQL and the Database-Centric Data Model for Android Applications](#)” on page 258, content providers are well suited to implementing the nondocument-centric data model.

With the assistance of a content provider, applications do not need to open their own SQLite tables, since that detail will take place behind the content provider interface in tables owned by the content provider. In the past, to share data, mobile applications might have had to store it in files in the local filesystem with an application-defined configuration format. Instead, with Android, applications can often rely solely on content provider storage.

Before digging into the `SimpleFinchVideoContentProvider`, we’ll provide an overview of the simple finch video application and provide background on content provider implementation tasks.

## Implementing a Content Provider

To take advantage of this design structure, you will need to write your own content provider, which involves completing the following tasks:

- Create a content provider public API for client consumption by:
  - Defining the `CONTENT_URI` for your content provider
  - Creating column names for communication with clients
  - Declaring public static `String` objects that clients use to specify columns
  - Defining MIME types for any new data types
- Implement your content provider. This requires the following:
  - Extending the main content provider API, the `ContentProvider` class, to create a custom content provider implementation
  - Setting up a provider URI
  - Creating a SQLite database and associated cursors to store content provider data
  - Using cursors to make data available to clients while supporting dynamic data updates
  - Defining the process by which binary data is returned to the client
  - Implementing the basic `query`, `insert`, `update`, and `delete` data methods of a `Cursor` to return to the client
- Update the `AndroidManifest.xml` file to declare your `<provider>`.

When we have finished discussing the implementation of a basic content provider, we will describe tasks related to using content providers to develop the more advanced network architecture that we have mentioned.

## Browsing Video with Finch

The Finch video viewer enables users to list video-related metadata. We have included two versions of a video listing application, and two versions of underlying content providers. The first version, presented in this chapter, is a simple video listing application that uses `SimpleFinchVideoContentProvider`, which is designed to teach you to implement your first content provider. A second version of the app, presented in the next chapter, uses a slightly more complex content provider that adds the ability to pull content from the online YouTube video search service. This second version of the app has the ability to cache results and the ability to show video thumbnails.

Now we will explore the first app in detail. This simple application has one activity: `SimpleFinchVideoActivity`, which allows a user to create and list his own video metadata (e.g., video title, description, URI, and ID), as shown in [Figure 12-1](#).

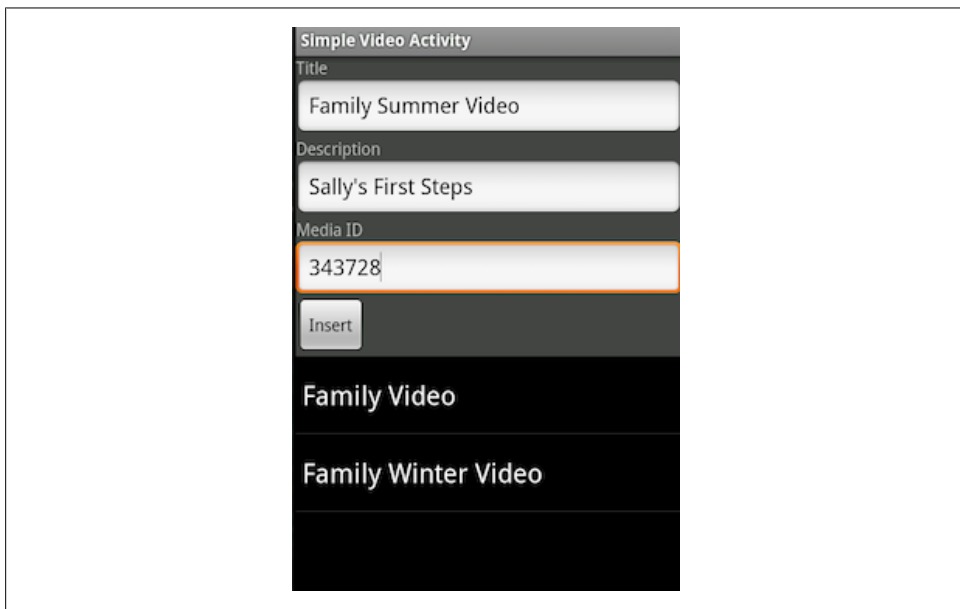

Figure 12-1. An activity for our simple video provider that lets users enter their own video “metadata”

To use this application, simply enter appropriate data for a “video” entry, and then press the Insert button. The list underneath the text fields uses Android MVC to automatically refresh its view of data.

## The simple video database

To store the data you enter into this application, the `SimpleFinchVideoContentProvider` class creates its database with the following SQL statement:

```
CREATE TABLE video (_id INTEGER PRIMARY KEY, title TEXT, description TEXT, uri TEXT);
```

The `_id` column is required for use with the Android cursor system. It provides the unique identity of a row in a cursor as well as the identity of an object in the database. As such, you need to define this column with the SQL attributes `INTEGER PRIMARY KEY AUTOINCREMENT` to make certain its value is unique.

The `title` and `description` columns store video title and description data, respectively. The `uri` column contains a media URI that could be used to play a video entry in an actual working version of this application.

## Structure of the simple version of the code

This section briefly examines relevant files within the simple Finch video application:

### *AndroidManifest.xml*

We've created a manifest for a simple video content provider application that will contain a reference to our activity `SimpleFinchVideoActivity` as well as our content provider `SimpleFinchVideoContentProvider`.

### *\$(FinchVideo)/src/com/oreilly/demo/pal/finchvideo/FinchVideo.java*

The `FinchVideo` class contains the `AUTHORITY` attribute (discussed later) and the `SimpleVideo` class that defines the names of the content provider columns. Neither the `FinchVideo` class nor the `SimpleVideo` class contains any executable code.

### *\$(FinchVideo)/src/com/oreilly/demo/pal/finchvideo/provider/SimpleFinchVideoContentProvider.java*

The `SimpleFinchVideoContentProvider` class is the content provider for the simple video database. It handles URI requests as appropriate for the simple video application. This file is the subject of the first half of this chapter.

### *\$(FinchVideo)/src/com/oreilly/demo/pal/finchvideo/SimpleFinchVideoActivity.java*

The `SimpleFinchVideoActivity` class is an activity that allows the user to view a list of videos.

## Defining a Provider Public API

Though we saw in [Chapter 3](#) how clients use content providers, we provide more information here for content provider authors to fully implement the provider public API. For clients to use your content provider, you will need to create a public API class that contains a set of constants that clients use to access column fields of `Cursor` objects returned by your provider's query method. This class will also define the content provider authority URI that provides the foundation of the whole provider URI

communication scheme. Our class, `FinchVideo.SimpleVideos`, provides the API to our `SimpleFinchVideo`.

First we'll explain the class in pieces, providing background on its fields, and then we'll show a full listing.

## Defining the `CONTENT_URI`

For a client application to query content provider data, it needs to pass a URI that identifies relevant data to one of the Android content resolver's data access methods. These methods, `query`, `insert`, `update`, and `delete`, mirror the methods found on a content resolver that we define in [“Writing and Integrating a Content Provider” on page 314](#). On receiving such an invocation, the content resolver will use an authority string to match the incoming URI with the `CONTENT_URI` of each content provider it knows about to find the right provider for the client. Thus, the `CONTENT_URI` defines the type of URIs your content provider can process.

A `CONTENT_URI` consists of these parts:

`content://`

A prefix that tells the Android Framework that it must find a content provider to resolve the URI.

*The authority*

This string uniquely identifies the content provider and consists of up to two sections: the organizational section and the provider identifier section. The organizational section uniquely identifies the organization that created the content provider. The provider identifier section identifies a particular content provider that the organization created. For content providers that are built into Android, the organizational section is omitted. For instance, the built-in “media” authority that returns one or more images does not have the organizational section of the authority. However, any content providers that are created by developers outside of Google's Android team must define both sections of the content provider. Thus, the simple Finch video example application's authority is `com.oreilly.demo.pa.finchvideo.SimpleFinchVideo`. The organizational section is `com.oreilly.demo.pa.finchvideo`, and the provider identifier section is `SimpleFinchVideo`. The Google documentation suggests that the best solution for picking the authority section of your `CONTENT_URI` is to use the fully qualified class name of the class implementing the content provider.

The authority section uniquely identifies the particular content provider that Android will call to respond to queries that it handles.

*The path*

The content provider can interpret the rest of the URI however it wants, but it must adhere to some requirements:

- If the content provider can return multiple data types, the URI must be constructed so that some part of the path specifies the type of data to return.

For instance, the built-in “contacts” content provider provides many different types of data: people, phones, contact methods, and so on. The contacts content provider uses strings in the URI to differentiate which type of data the user is requesting. Thus, to request a specific person, the URI will be something like this:

```
content://contacts/people/1
```

To request a specific phone number, the URI could be something like this:

```
content://contacts/people/1/phone/3
```

In the first case, the MIME data type returned will be `vnd.android.cursor.item/person`, whereas in the second case, it will be `vnd.android.cursor.item/phone`.

- The content provider must be capable of returning either one item or a set of item identifiers. The content provider will return a single item when an item identifier appears in the final portion of the URI. Looking back at our previous example, the URI `content://contacts/people/1/phone/3` returned a single phone number of type `vnd.android.cursor.item/phone`. If the URI had instead been `content://contacts/people/1/phone`, the application would instead return a list of all the phone numbers for the person having the person identifier number 1, and the MIME type of the data returned would be `vnd.android.cursor.dir/phone`.

As mentioned earlier, content providers can interpret the path portions of the URIs to suit their needs. This means the path portion can use items in the path to filter data to return to the caller. For instance, the built-in “media” content provider can return either internal or external data depending on whether the URI contains the word *internal* or *external* in the path.

The full `CONTENT_URI` for the simple Finch video is `content://com.oreilly.demo.pa.finch-video.SimpleFinchVideo/video`.

The `CONTENT_URI` must be of type `public static final Uri`. It is defined in the `FinchVideo` class of our simple video application. In our public API class we start by extending the class `BaseColumns`, and then define a string named `AUTHORITY`:

```
public final class FinchVideo.SimpleVideos extends BaseColumns {
    public static final String SIMPLE_AUTHORITY =
        "com.oreilly.demo.pa.finchvideo.FinchVideo";
}
```

Then we define the `CONTENT_URI` itself:

```
public static final class FinchVideo.SimpleVideos implements BaseColumns {
    public static final Uri CONTENT_URI =
        Uri.parse("content://" + AUTHORITY + "/video");
}
```

Put more simply, defining this URI just involves picking an authority string that should use a Java package used by your application as the organizational identifier—a public

API package is likely a better candidate here than an implementation package, as we discussed in “[Java Packages](#)” on page 56. The content provider identifier is just the name of your content provider class. The provider URI for our simple Finch video provider looks as follows:

```
"content://" + FinchVideo.FinchVideoContentProvider.SIMPLE_AUTHORITY + "/" +  
    FinchVideo.SimpleVideos.VIDEO
```

## Creating the Column Names

Content providers exchange data with their clients in much the same way a SQL database exchanges data with database applications: using cursors full of rows and columns of data. A content provider must define the column names it supports just as database applications must define the columns they support. When the content provider uses a SQLite database as its data store, the obvious solution is to give the content provider columns with the same name as the database columns, and that’s just what `SimpleFinchVideoContentProvider` does. Because of this, no mapping is necessary between the `SimpleFinchVideoContentProvider` columns and the underlying database columns.



Not all applications make all of their data available to content provider clients, and some more complex applications may want to make derivative views available to content provider clients. The projection map described in “[The SimpleFinchVideoContentProvider Class and Instance Variables](#)” on page 319 is available to handle these complexities.

## Declaring Column Specification Strings

The `SimpleFinchVideoProvider` columns are defined in the `FinchVideo.SimpleVideos` class discussed in this section. Every content provider must define an `_id` column to hold the record number of each row. The value of each `_id` must be unique within the content provider; it is the number that a client will append to the content provider’s `vnd.android.cursor.item` URI when attempting to query for a single record.

When the content provider is backed by a SQLite database, as is the case for `SimpleFinchVideoProvider`, the `_id` should have the type `INTEGER PRIMARY KEY AUTO INCREMENT`. This way, the rows will have a unique `_id` number and `_id` numbers will not be reused, even when rows are deleted. This helps support referential integrity by ensuring that each new row has an `_id` that has never been used before. If row `_ids` are reused, there is a chance that cached URIs could point to the wrong data.

Here is a complete program listing of the simple Finch video provider API, the class `FinchVideo.SimpleVideos`. Note that we have only included constants that serve the purposes we have outlined. We take care not to define content provider implementation constants here, since they will not be useful to a client and might tie clients to using a particular implementation of a content provider. We strive to achieve good software

design and ensure that our software layers remain separable where clients should not have direct compilation dependencies on content provider implementation classes. The complete listing of the public API of the finch video provider API follows:

```
/**
 * Simple Videos columns
 */
public class FinchVideo {
    public static final class SimpleVideos implements BaseColumns {
        // This class cannot be instantiated
        private SimpleVideos() {}

        // uri references all videos
        public static final Uri VIDEOS_URI = Uri.parse("content://" +
            SIMPLE_AUTHORITY + "/" + SimpleVideos.VIDEO);

        /**
         * The content:// style URL for this table
         */
        public static final Uri CONTENT_URI = VIDEOS_URI;❶

        /**
         * The MIME type of {@link #CONTENT_URI} providing a directory of notes.
         */
        public static final String CONTENT_TYPE =
            "vnd.android.cursor.dir/vnd.finch.video";❷

        /**
         * The MIME type of a {@link #CONTENT_URI} sub-directory of a single
         * video.
         */
        public static final String CONTENT_VIDEO_TYPE =
            "vnd.android.cursor.item/vnd.finch.video";

        ❸
        /**
         * The video itself
         * <P>Type: TEXT</P>
         */
        public static final String VIDEO = "video";

        /**
         * Column name for the title of the video
         * <P>Type: TEXT</P>
         */
        public static final String TITLE = "title";

        /**
         * Column name for the description of the video.
         */
        public static final String DESCRIPTION = "description";

        /**
         * Column name for the media uri
         */
    }
}
```

```

        public static final String URI = "uri";

        /**
         * Unique identifier for an element of media
         */
        public static final String MEDIA_ID = "media_id";
    }

    ...
    // The API for FinchVideo.Videos is also defined in this class.
}

```

Here are some of the highlights of the code:

- ❶ We use the `VIDEOS_URI` to define the value for our `CONTENT_URI`. The videos URI contains that content URI as described.
- ❷ This is the MIME type of the video entries that our provider will store. In [“Implementing the `getType` Method” on page 322](#) we explain how our content provider uses this type.
- ❸ These are the names of the columns that clients can use to access values in `Cursor` objects that our provider creates.

## Writing and Integrating a Content Provider

Now that we’ve examined the general structure of the simple video list application, and provided a way for clients to access our content provider, it’s time to look at how the application both implements and consumes the `SimpleFinchVideoContentProvider`.

### Common Content Provider Tasks

In the following sections, we provide a high-level guide to tasks associated with writing a content provider. We then provide an introduction to Android MVC and finish with an explanation of the `SimpleFinchVideoContentProvider` code.

#### Extending `ContentProvider`

Applications extend the `ContentProvider` class to handle URIs that refer to a particular type of data, such as MMS messages, pictures, videos, and so forth. For example, for a content provider class that handled videos, the `ContentProvider.insert` method would insert data that described a video into a SQLite table with columns appropriate for that information, such as a title, description, and similar information.

Start writing your content provider by implementing the following two methods:



## `onCreate`

This method provides a hook to allow your content provider to initialize itself. Any code you want to run just once, such as making a database connection, should reside in this method.

## `String getType(Uri uri)`

This method, given a URI, returns the MIME type of the data that this content provider provides at the given URI. The URI comes from the client application interested in accessing the data.

You'll continue to implement by overriding the main content provider data access methods:

## `insert(Uri uri, ContentValues values)`

This method is called when the client code needs to insert data into the database your content provider is serving. Normally, the implementation for this method will either directly or indirectly result in a database insert operation.

## `Cursor query(Uri uri, String[] projection, String selection, String[] selectionArgs, String sortOrder)`

This method is called whenever a client wishes to read data from the content provider's database. Normally, here, you retrieve data using an SQL `SELECT` statement and return a cursor containing the requested data. Developers call this method indirectly using `Activity`'s `managedQuery` method, or call `startManagingQuery` on the return values from this method. If your activity fails to "manage" the returned cursor, or fails to close the cursor, your application will contain a serious memory leak that will result in poor performance and, likely, crashes.

## `update(Uri uri, ContentValues values, String selection, String[] selectionArgs)`

This method is called when a client wishes to update one or more rows in the content provider's database. It translates to an SQL `UPDATE` statement.

## `delete(Uri uri, String selection, String[] selectionArgs)`

This method is called when a client wishes to delete one or more rows in the content provider's database. It translates to an SQL `DELETE` statement.

These four methods each perform an action on data referenced by a given URI parameter. A typical implementation of each of these methods starts with matching the incoming URI argument to a particular type of data. For example, a content provider implementation needs to figure out whether a given URI refers to a specific video, or to a group of videos. After a provider matches the URI, appropriate SQL operations follow. Each method then returns a value that either contains referenced data, describes affected data, or refers to the number of elements that were affected by the operation. For example, a query for a specific video would return a cursor that contained a single video element, if the given URI referenced a single element present in a local table.

Matching URIs to table data is an integral part of the job of a content provider. While you might not think it would be that hard to parse a content provider URI yourself,

Android provides a nice utility for doing that job for you, which is convenient, but more importantly, helps developers to standardize on the format of provider URIs that we have discussed. The `URIMatcher` class supports mapping from URIs containing authority, path, and ID strings to application-defined constants usable with `case` statements that handle particular subtypes of URIs. From there, the provider can decide what SQL operations to use to manage actual table rows. A typical content provider will create a static instance of `URIMatcher` and populate it using a static initializer that calls `URIMatcher.addURI` to establish the first-level mapping used later in content provider data methods. Our simple video content provider does this in “[The SimpleFinchVideoContentProvider Class and Instance Variables](#)” on page 319.

## File Management and Binary Data

Content providers often need to manage large chunks of binary data, such as a bitmap or music clip. Storage of large datafiles should influence the design of an application, and will likely have significant performance implications. A content provider can serve files through content provider URIs in a way that encapsulates the location of actual physical files so that clients can be agnostic about that information. Clients use content provider URIs to access files without knowing where the files actually reside. This layer of indirection enables a content provider to manage these files in a way that makes the most sense for the content provider data without having that information leak into the client—which could end up causing code changes in a client if the content provider needed to make a change in the way the physical files are stored. Generally, it’s much easier to change just the provider than all of its potential clients. Clients should not need to know that a set of provider media files might reside in flash memory, on the SD card, or entirely on the network, so long as the provider makes the files accessible from a set of content provider URIs that the client understands. The client will just use the method `ContentResolver.openInputStream` for a given URI and then read data from the resultant stream.

Additionally, when sharing large amounts of data between applications, since an Android application should not read or write files that another application has created, a content provider must be used to access the relevant bytes. Therefore, when the first content provider returns a pointer to a file, that pointer must be in the form of a `content://` URI instead of a Unix filename. The use of a `content://` URI causes the file to be opened and read under the permissions of the content provider that owns the file, not the client application (which should not have access rights to the file).

It’s also important to consider that filesystem I/O is much faster and more versatile than dealing with SQLite blobs, and it’s better to use the Unix filesystem to directly store binary data. Additionally, there’s no advantage to putting binary data in a database, since you can’t search on it!

To implement this approach in your app, the Android SDK documentation suggests one strategy where a content provider persists data to a file and stores a `content://` URI

in the database that points to the file, as shown in [Figure 12-2](#). Client applications will pass the URI in this field to `ContentProvider.openStream` to retrieve the byte stream from the file it specifies.

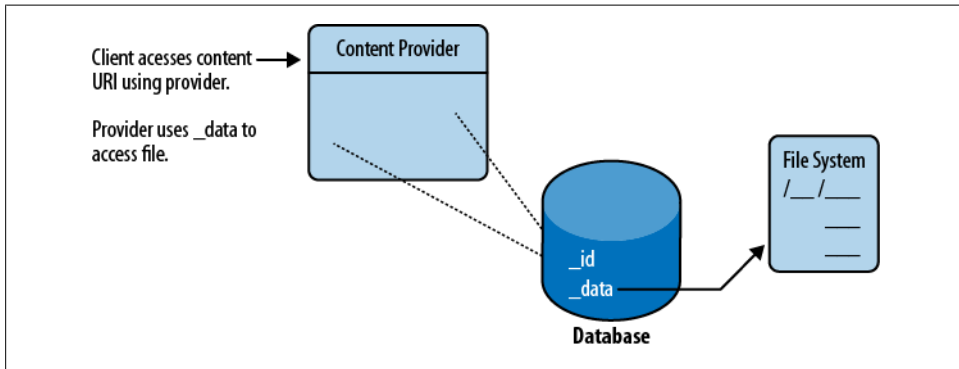

Figure 12-2. Android MVC's typical use of cursors and content providers

In detail, to implement the file approach, instead of creating a hypothetical user table like this:

```
CREATE TABLE user ( _id INTEGER PRIMARY KEY AUTOINCREMENT, name TEXT, password
                    TEXT, picture BLOB );
```

the documentation suggests two tables that look like this:

```
CREATE TABLE user ( _id INTEGER PRIMARY KEY AUTOINCREMENT, name TEXT, password
                    TEXT, picture TEXT );
CREATE TABLE userPicture ( _id INTEGER PRIMARY KEY AUTOINCREMENT,
                           _data TEXT );
```

The `picture` column of the `user` table will store a `content://` URI that points to a row in the `userPicture` table. The `_data` column of the `userPicture` table will point to a real file on the Android filesystem.

If the path to the file were stored directly in the `user` table, clients would get a path but be unable to open the file, because it's owned by the application serving up the content provider and the clients don't have permission to read it. In the solution shown here, however, access is controlled by a `ContentResolver` class we'll examine later.

The `ContentResolver` class looks for a column named `_data` when processing requests. If the file specified in that column is found, the provider's `openOutputStream` method opens the file and returns a `java.io.OutputStream` to the client. This is the same object that would be returned if the client were able to open the file directly. The `ContentResolver` class is part of the same application as the content provider, and therefore is able to open the file when the client cannot.

Later in this chapter, we will demonstrate a content provider that uses the content provider file management facility to store thumbnail images.

## Android MVC and Content Observation

It's important to relate a bigger picture of how MVC works with content providers in Android. Additionally, a more detailed discussion of MVC in Android will lead us into “A “Network MVC”” on page 331.

In order to understand the power of the content provider framework, we need to discuss how cursor update events drive dynamic updates of Android UIs. We think it will help to highlight the often-overlooked communications pathways in the traditional MVC programming pattern, where the following occurs: the View delivers user input events to the Controller; the Controller makes modifications to the Model, and the Model sends update events to the View and to any other observer that registers interest in the Model; the View renders the contents of the Model, usually without directly engaging in application logic, and ideally, just simply iterates over the data in the Model.

In Android, the MVC pattern works as shown in [Figure 12-3](#), where explicitly:

- The Model consists of a content provider and the cursors it returns from its `query` method, as well as the data it holds in its SQLite tables.
- Content providers should be written to send notification events whenever they change data by calling `ContentResolver.notifyChange`. Since the provider has sole access to modify the data, it will always know when data changes.
- Notifications are delivered to a UI component, often a `ListView`, through observation of `Cursor` objects that are bound to content provider URIs. Cursor update messages fire from the Model to the View in response to the provider's invocation of `notifyChange`. The View and Controller correspond to Android activities and their views, and to the classes that listen to the events they generate. Specifically, the system delivers `ContentObserver.onChange` messages to instances of `ContentObserver` registered using `Cursor.registerContentObserver`. The Android classes automatically register for cursor changes whenever a developer calls a method such as `ListView.setAdapter(ListAdapter)`. The list view has an internal content observer, and the list adapter will register with the `Cursor` object.

To think about how this notification works in practice, suppose an activity were to call `ContentResolver.delete`. As we'll see shortly, the corresponding content provider would first delete a row from its database, and then notify the content resolver URI corresponding to that row. Any listening cursors embedded in any view will be notified simply that data has changed; the views will, in turn, get the update event and then repaint themselves to reflect the new state. The views paint whatever state resides in their display area; if that happened to include the deleted element, it will disappear from the UI. The `Cursor` objects act as a proxy object between cursor consumers and the content provider system. Events flow from the provider, through the cursor, and into the View system. The degree of automation in this chain of events results in significant convenience for developers who need to perform only the minimum amount of work to put it into action. Additionally, programs don't have to explicitly poll to

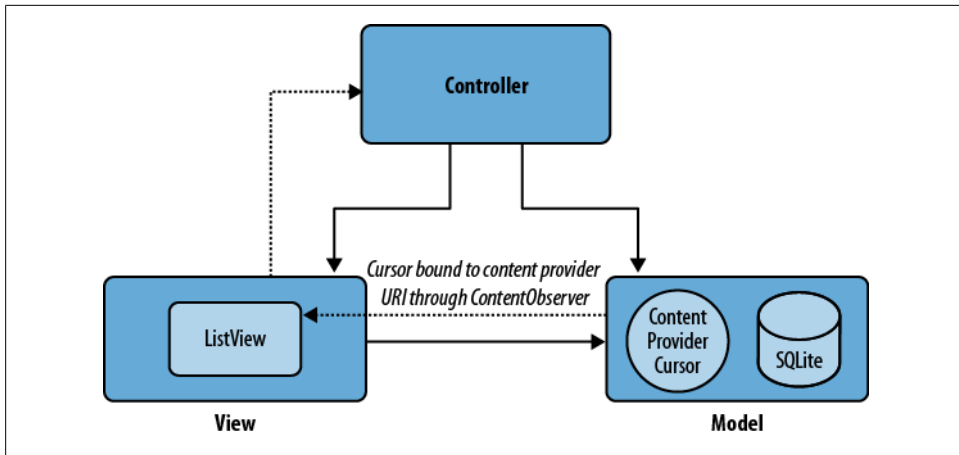

Figure 12-3. Typical use of cursors and content providers in the Android MVC

keep their rendering of the model up-to-date since the model tells the view when state changes.

## A Complete Content Provider: The SimpleFinchVideoContentProvider Code

Now that you understand the important tasks associated with writing a content provider and Android MVC—the communication system for Android content providers—let’s see how to build your own content provider. The `SimpleFinchVideoContentProvider` class extends `ContentProvider` as shown here:

```
public class SimpleFinchVideoContentProvider extends ContentProvider {
```

### The SimpleFinchVideoContentProvider Class and Instance Variables

As usual, it’s best to understand the major class and instance variables used by a method before examining how the method works. The member variables we need to understand for `SimpleFinchVideoContentProvider` are:

```
private static final String DATABASE_NAME = "simple_video.db";
private static final int DATABASE_VERSION = 2;
private static final String VIDEO_TABLE_NAME = "video";
private DatabaseHelper mOpenHelper;
```

#### DATABASE\_NAME

The name of the database file on the device. For the simple Finch video, the full path to the file is `/data/data/com.oreilly.demo.pa.finchvideo/databases/simple_video.db`.

## DATABASE\_VERSION

The version of the database that is compatible with this code. If this number is higher than the database version of the database itself, the application calls the `DatabaseHelper.onUpdate` method.

## VIDEO\_TABLE\_NAME

The name of the video table within the `simple_video` database.

## mOpenHelper

The database helper instance variable that is initialized during `onCreate`. It provides access to the database for the `insert`, `query`, `update`, and `delete` methods.

## sUriMatcher

A static initialization block that performs initializations of static variables that can't be performed as simple one-liners. For example, our simple video content provider begins by establishing a content provider URI mapping in a static initialization of a `UriMatcher` as follows:

```
private static UriMatcher sUriMatcher;

private static final int VIDEOS = 1;
private static final int VIDEO_ID = 2;

static {
    sUriMatcher = new UriMatcher(UriMatcher.NO_MATCH);
    sUriMatcher.addURI(AUTHORITY, FinchVideo.SimpleVideos.VIDEO_NAME, VIDEOS);
    // use of the hash character indicates matching of an id
    sUriMatcher.addURI(AUTHORITY,
        FinchVideo.SimpleVideos.VIDEO_NAME + "/#", VIDEO_ID);
    ...
    // more initialization to follow
```

The `UriMatcher` class provides the basis of the convenience utilities that Android provides for mapping content provider URIs. To use an instance of it, you populate it with mappings from a URI string such as “videos” to a constant field. Our mappings work as follows: the application first provides an argument, `UriMatcher.NO_MATCH`, to the constructor of the provider `UriMatcher` to define the value that indicates when a URI does not match any URI. The application then adds mappings for multiple videos to `VIDEOS`, and then a mapping for a specific video to `VIDEO_ID`. With all provider URIs mapped to an integer value the provider can perform a switch operation to jump to the appropriate handling code for multiple and single videos.

This mapping causes a URI such as `content://com.oreilly.demo.pa.finchvideo.SimpleFinchVideo/video` to map to the constant `VIDEOS`, meaning all videos. A URI for a single video, such as `content://oreilly.demo.pa.finchvideo.SimpleFinchVideo/video/7`, will map to the constant `VIDEO_ID` for a single video. The hash mark at the end of the URI matcher binding is a wildcard for a URI ending with any integer number.

## sVideosProjectionMap

The projection map used by the query method. This `HashMap` maps the content provider's column names to database column names. A projection map is not required, but when used it must list all column names that might be returned by the query. In `SimpleFinchVideoContentProvider`, the content provider column names and the database column names are identical, so the `sVideosProjectionMap` is not required. But we provide it as an example for applications that might need it. In the following code, we create our example projection mapping:

```
// example projection map, not actually used in this application
sVideosProjectionMap = new HashMap<String, String>();
sVideosProjectionMap.put(FinchVideo.Videos._ID,
    FinchVideo.Videos._ID);
sVideosProjectionMap.put(FinchVideo.Videos.TITLE,
    FinchVideo.Videos.TITLE);
sVideosProjectionMap.put(FinchVideo.Videos.VIDEO,
    FinchVideo.Videos.VIDEO);
sVideosProjectionMap.put(FinchVideo.Videos.DESCRPTION,
    FinchVideo.Videos.DESCRPTION);
```

## Implementing the onCreate Method

During initialization of the simple Finch video content provider, we create the video's SQLite data store as follows:

```
private static class DatabaseHelper extends SQLiteOpenHelper {
    public void onCreate(SQLiteDatabase sqLiteDatabase) {
        createTable(sqLiteDatabase);
    }

    // create table method may also be called from onUpgrade
    private void createTable(SQLiteDatabase sqLiteDatabase) {
        String qs = "CREATE TABLE " + VIDEO_TABLE_NAME + " (" +
            FinchVideo.SimpleVideos.ID + " INTEGER PRIMARY KEY, " +
            FinchVideo.SimpleVideos.TITLE_NAME + " TEXT, " +
            FinchVideo.SimpleVideos.DESCRPTION_NAME + " TEXT, " +
            FinchVideo.SimpleVideos.URI_NAME + " TEXT)";
        sqLiteDatabase.execSQL(qs);
    }
}
```

When creating SQLite tables to support content provider operations, developers are required to provide a field with a primary key called `_id`. While it's not immediately clear that this field is required, unless you read the Android developer docs in detail, the Android content management system actually does enforce the presence of the `_id` field in the cursors that are returned by the query method. `_id` is used in query matching with the `#` special character in content provider URLs. For example, a URL such as `content://contacts/people/25` would map to a data row in a `contacts` table with `_id` 25. The requirement is really just to use a specific name for a table primary key.

## Implementing the getType Method

Next, we implement the `getType` method to determine MIME types of arbitrary URIs passed from the client. As you can see in the following code, we provide URI matching for `VIDEOS`, and `VIDEO_ID` to MIME types we defined in our public API:

```
public String getType(Uri uri) {
    switch (sUriMatcher.match(uri)) {
        case VIDEOS:
            return FinchVideo.SimpleVideos.CONTENT_TYPE;

        case VIDEO_ID:
            return FinchVideo.SimpleVideos.CONTENT_VIDEO_TYPE;

        default:
            throw new IllegalArgumentException("Unknown video type: " + uri);
    }
}
```

## Implementing the Provider API

A content provider implementation must override the data methods of the `ContentProvider` base class: `insert`, `query`, `update`, and `delete`. For the simple video application, these methods are defined by the `SimpleFinchVideoContentProvider` class.

### The query method

After matching the incoming URI, our content provider `query` method performs a corresponding select on a readable database, by delegating to `SQLiteDatabase.query`, and then returns the results in the form of a database `Cursor` object. The cursor will contain all database rows described by the URI argument. After we've made the query, the Android content provider mechanism automatically supports the use of cursor instances across processes, which permits our provider `query` method to simply return the cursor as a normal return value to make it available to clients that might reside in another process.

The `query` method also supports the parameters `uri`, `projection`, `selection`, `selectionArgs`, and `sortOrder`, which are used in the same manner as the arguments to `SQLiteDatabase.query` that we saw in [Chapter 10](#). Just as with any SQL `SELECT`, parameters to the `query` method enable our provider clients to select only specific videos that match the query parameters. In addition to passing a URI, a client calling the simple video content provider could also pass an additional `where` clause with `where` arguments. For example, these arguments would enable a developer to query for videos from a particular author.





As we've seen, MVC in Android relies on cursors and the data they contain, as well as framework-based delivery of content observer update messages. Since clients in different processes share `Cursor` objects, a content provider implementation must take care not to close a cursor that it has served from its `query` method. If a cursor is closed in this manner, clients will not see exceptions thrown; instead, the cursor will always act like it is empty, and it will no longer receive update events—it's up to the activity to properly manage the returned cursors.

When the database query completes, our provider then calls `Cursor.setNotificationUri` to set the URI that the provider infrastructure will use to decide which provider update events get delivered to the newly created cursor. This URI becomes the point of interaction between clients that observe data referenced by that URI and the content provider that notifies that URI. This simple method call drives the content provider update messages that we discussed in [“Android MVC and Content Observation” on page 318](#).

Here, we provide the code for our simple content provider's `query` method, which performs URI matching, queries the database, and then returns the cursor:

```
@Override
public Cursor query(Uri uri, String[] projection, String where,
                   String[] whereArgs, String sortOrder)
{
    // If no sort order is specified use the default
    String orderBy;
    if (TextUtils.isEmpty(sortOrder)) {
        orderBy = FinchVideo.SimpleVideos.DEFAULT_SORT_ORDER;
    } else {
        orderBy = sortOrder;
    }

    int match = sUriMatcher.match(uri);❶

    Cursor c;

    switch (match) {
        case VIDEOS:
            // query the database for all videos
            c = mDb.query(VIDEO_TABLE_NAME, projection,
                        where, whereArgs,
                        null, null, sortOrder);

            c.setNotificationUri(
                getContext().getContentResolver(),
                FinchVideo.SimpleVideos.CONTENT_URI);❷
            break;
        case VIDEO_ID:
            // query the database for a specific video
            long videoID = ContentUris.parseId(uri);
            c = mDb.query(VIDEO_TABLE_NAME, projection,
```

```

        FinchVideo.Videos._ID + " = " + videoID +
            (!TextUtils.isEmpty(where) ?
                " AND (" + where + ') ' : ""),
        whereArgs, null, null, sortOrder);
    c.setNotificationUri(
        getContext().getContentResolver(),
        FinchVideo.SimpleVideos.CONTENT_URI);
    break;
default:
    throw new IllegalArgumentException("unsupported uri: " + uri);
}

return c;❸
}

```

Here are some of the highlights of the code:

- ❶ This matches the URI using our prebuilt URI matcher.
- ❷ Setting the notification URI to `FinchVideo.SimpleVideos.CONTENT_URI` causes the cursor to receive all content resolver notification events for data referenced by that URI. In this case, the cursor will receive all events related to all videos, since that is what `FinchVideo.SimpleVideos.CONTENT_URI` references.
- ❸ The cursor is returned directly. As mentioned, the Android content provider system provides support for sharing any data in the cursor across processes. Interprocess data sharing happens “for free” as part of the content provider system; you can just return the cursor and it will become available to activities in different processes.

## The insert method

Let’s move on to the `insert` method , which receives values from a client, validates them, and then adds a new row to the database containing those values. The values are passed to the `ContentProvider` class in a `ContentValues` object:

```

@Override
public Uri insert(Uri uri, ContentValues initialValues) {

    // Validate the requested uri
    if (sUriMatcher.match(uri) != VIDEOS) {
        throw new IllegalArgumentException("Unknown URI " + uri);
    }

    ContentValues values;
    if (initialValues != null) {
        values = new ContentValues(initialValues);
    } else {
        values = new ContentValues();
    }

    verifyValues(values);

    // insert the initialValues into a new database row
    SQLiteDatabase db = mOpenHelper.getWritableDatabase();

```

```

    long rowId = db.insert(VIDEO_TABLE_NAME,
        FinchVideo.SimpleVideos.VIDEO_NAME, values);
    if (rowId > 0) {
        Uri videoUri =
            ContentUris.withAppendedId(
                FinchVideo.SimpleVideos.CONTENT_URI, rowId);❶
        getContext().getContentResolver().
            notifyChange(videoUri, null);❷
        return videoUri;
    }

    throw new SQLException("Failed to insert row into " + uri);
}

```

The `insert` method will also match the incoming URI, perform a corresponding database insert operation, and then return a URI that references the new database row. Since the `SQLiteDatabase.insert` method returns the database row ID of the newly inserted row, which is also its value for the `_id` field, the content provider can easily put together the right URI by appending the `rowId` variable to the content provider authority defined in the content provider public API that we discussed in [Chapter 3](#).

Here are some of the highlights of the code:

- ❶ We use Android’s utilities for manipulating content provider URIs—specifically, the method `ContentUris.withAppendedId` to append the `rowId` as the ID of the returned insertion URI. Clients can turn around and query the content provider using this same URI to select a cursor containing the data values for the inserted row.
- ❷ Here the content provider notifies a URI that will cause a content update event to be fired and delivered to observing cursors. Note that the provider’s invocation of `notify` is the only reason an event will be sent to content observers.

## The update method

The `update` method operates in the same manner as `insert`, but instead calls `update` on the appropriate database to change database rows that the URI references. The `update` method returns the number of rows affected by the update operation:

```

@Override
public int update(Uri uri, ContentValues values, String where,
    String[] whereArgs)
{
    // the call to notify the uri after deletion is explicit
    getContext().getContentResolver().notifyChange(uri, null);

    SQLiteDatabase db = mOpenHelper.getWritableDatabase();
    int affected;
    switch (sUriMatcher.match(uri)) {
        case VIDEOS:
            affected = db.update(VIDEO_TABLE_NAME, values,
                where, whereArgs);
            break;
    }
}

```

```

        case VIDEO_ID:
            String videoId = uri.getPathSegments().get(1);
            affected = db.update(VIDEO_TABLE_NAME, values,
                FinchVideo.SimpleVideos._ID + "=" + videoId
                    + (!TextUtils.isEmpty(where) ?
                        " AND (" + where + ')' : ""),
                whereArgs);
            break;

        default:
            throw new IllegalArgumentException("Unknown URI " + uri);
    }

    getContext().getContentResolver().notifyChange(uri, null);
    return affected;
}

```

## The delete method

The delete method is similar to update, but will delete rows referenced by the given URI. Like update, delete returns the number of rows affected by the delete operation:

```

@Override
public int delete(Uri uri, String where, String[] whereArgs) {
    int match = sUriMatcher.match(uri);
    int affected;

    switch (match) {
        case VIDEOS:
            affected = mDb.delete(VIDEO_TABLE_NAME,
                (!TextUtils.isEmpty(where) ?
                    " AND (" + where + ')' : ""),
                whereArgs);
            break;
        case VIDEO_ID:
            long videoId = ContentUris.parseId(uri);
            affected = mDb.delete(VIDEO_TABLE_NAME,
                FinchVideo.SimpleVideos._ID + "=" + videoId
                    + (!TextUtils.isEmpty(where) ?
                        " AND (" + where + ')' : ""),
                whereArgs);

            // the call to notify the uri after deletion is explicit
            getContext().getContentResolver().
                notifyChange(uri, null);

            break;
        default:
            throw new IllegalArgumentException("unknown video element: " +
                uri);
    }

    return affected;
}

```

Note that the preceding descriptions relate only to our simple implementation of a content provider; more involved scenarios could involve joining across tables for a query or cascaded deletes for deleting a given data item. The content provider is free to pick its own scheme for data management using the Android SQLite API so long as it does not break the content provider client API.

## Determining How Often to Notify Observers

As we've seen from our listing of the content provider data management operations, notification does not happen for free in the Android content management system: an insert into a SQLite table does not automatically set up a database trigger that fires notification on behalf of a content provider. It's up to the developer of the provider to implement a scheme that determines the appropriate time to send notifications and decides which URIs to send when content provider data changes. Usually content providers in Android send notifications immediately for all URIs that have changed during a particular data operation.

When designing a notification scheme, a developer should consider the following trade-off: fine-grained notification results in more precise change updates that can reduce load on the user interface system. If a list is told a single element has changed, it can decide to repaint only that element if it happens to be visible. But fine-grained notification also has the drawback that more events get pushed through the system. The UI will likely repaint more times since it will be getting more individual notification events. Coarse-grained notification runs fewer events through the system, but running fewer events often means that the UI will have to repaint more of itself on receiving notification. For example, a list could receive a single event directing it to update all elements when only three individual elements had actually changed. We suggest keeping this trade-off in mind when picking a notification scheme. For example, you might consider waiting until you finish reading a large number of events and then firing a single “everything changed” event, rather than sending an update for each event.

Often, content providers simply notify clients of whatever URIs were involved when data changes.

## Declaring Your Content Provider

In [“Using a content provider” on page 80](#) we saw how clients access and use a content provider. Now that we have our own simple content provider, all that is left is to make it available to clients by adding the following line of XML to your *AndroidManifest.xml*:

```
<provider android:name=".provider.SimpleFinchVideoContentProvider"
          android:authorities="oreilly.demo.pa.finchvideo.SimpleFinchVideo"/>
```

After you have built your application, its *.apk* file contains the provider implementation classes, and its manifest file contains a line similar to the line of XML we just added,

all application code on the Android platform will be able to access it, assuming it has requested and been granted permission to do so, as described in [Chapter 3](#).

Having completed the task of creating your own simple content provider in this chapter, it's time to look into some novel content provider patterns, which we'll do in [Chapter 13](#).

---

# Exploring Content Providers

In [Chapter 7](#), we saw that user interfaces that need to interact with remote services face interesting challenges, such as not tying up the UI thread with long-running tasks. We also noted in [Chapter 3](#) that the Android content provider API shares symmetry with REST-style web services. Content provider data operations map straight onto REST data operations, and now we'll show you how to translate content provider URIs to request network data. We suggest taking advantage of this symmetry by writing content providers to operate as an asynchronous buffer between the domain or unique aspects of your application, and the network requests that acquire the data on which your application operates. Writing your application in this way will simplify your application, and will solve common UI and network programming errors encountered in Android and other types of Java programming.

Historically, Java UI programmers, both enterprise and mobile, have written mobile and desktop-based applications in a rather brittle way, and sometimes did run network requests directly on the UI thread, often without caching data obtained from those requests. In most applications, showing anything in a UI would require accessing the network every time a user requested the display of data. Believe it or not, Unix workstations from the 1980s and 1990s would frequently lock up when access to remotely mounted filesystems became unavailable. If applications had used a local dynamic caching scheme, they would have been able to continue running for the duration in which the file server was absent, and then synchronize when it returned. Developers needed to pay conscious attention, but often did not, to make certain that their applications accessed and stored network data correctly.

The trend continued in J2ME, where developers could cache network state in the anemic record management system known as RMS. This library did not support a query language, or an MVC notification system. J2ME developers would need to spawn their own plain Java threads to make network requests, but in many cases did not, which led to brittle applications. If web browsers were to load network data on the UI thread, you would often see them completely freeze to the point where the operating system would have to kill the browser to get rid of it—whenever the network would hang, the UI thread would lock up. Pages and all the images they referenced would always have

to be downloaded at every viewing, making for a very slow experience—assuming one of the requests did not hang the whole application. The takeaway from these anecdotes is that traditionally, operating systems have left the loading and caching of network data up to the application, providing little direct library support to help developers implement these tasks correctly.

To resolve these problems, you could use a completely asynchronous interface to handle network interaction and data storage. With such an approach, developers would not have to think about when it was OK to request data from the network—it would always be safe to use such an API, on or off the UI thread. Such considerations become significantly more important in a mobile environment, where intermittent network connectivity increases the likelihood of a hang in incorrectly written code.

We suggest using the content provider API as an asynchronous model of the network, and as a cache of network state so that your application View and Controller do not need their own mechanisms for opening connections or accessing a database. It's easy to map the provider API onto the API of existing REST-based web services—the provider simply sits in between the application, forwarding requests to the network and caching results as needed. In this chapter, we will show you how this approach can simplify your application, and we will explain more general benefits of the technique, including how it introduces some of the more positive characteristics of web and AJAX programming to Android applications. For more information on AJAX programming, go to [http://en.wikipedia.org/wiki/Ajax\\_\(programming\)](http://en.wikipedia.org/wiki/Ajax_(programming)).

## Developing RESTful Android Applications

We are not the only ones who see the benefits of this approach. At the Google I/O conference in May 2010, Virgil Dobjanschi of Google presented a talk that outlined the following three patterns for using content providers to integrate RESTful web services into Android applications:

### Activity→Service→ContentProvider

This pattern involves an activity contacting a service to access application data, which in turn delegates to a content provider to access that data. In this scenario, the activity invokes an asynchronous method on a service that performs asynchronous RESTful invocations.

### Activity→ContentProvider→Service

An activity contacts a content provider, which in turn delegates to a service to asynchronously load data. This approach allows the activity to use the convenience of the content provider API to interact with data. The content provider invokes methods on the asynchronous service implementation to invoke a RESTful request. This approach capitalizes on the convenient symmetry between the content provider API and RESTful use of HTTP.



### Activity→ContentProvider→SyncAdapter

Android sync adapters provide a framework for synchronizing user data between a device and the cloud. Google Contacts uses a sync adapter. In this scenario, an activity uses the content provider API to access data synchronized by a sync adapter.

In this chapter, we'll explore the second pattern in detail with our second Finch video example; this strategy will yield a number of important benefits for your applications. Due to the elegance with which this approach integrates network operations into Android MVC, we've given it the moniker "Network MVC."

A future edition of *Programming Android* may address the other two approaches, as well as document more details of this Google presentation. After you finish reading this chapter, we suggest that you view [Google's talk](#).

## A "Network MVC"

We like to think of the second pattern as a networked form of MVC, where the content provider itself pulls data from the network and then pumps it into the regular Android MVC. We'll view the content provider as a model of network state—the provider can fulfill data requests with local state, or can retrieve data from the network. With this approach, the Controller and View code should not directly create network requests to access and manage application data. Instead, your application View and Controller should use the `ContentResolver` API to make data queries through a content provider, which alone should asynchronously load network resources and store the results in a local data cache. Additionally, the provider should always respond quickly to a request by initially avoiding a network invocation that might be needed to fulfill the request by using whatever data is already available in the local database. Executing the request in this manner ensures that the UI thread is blocked for no longer than absolutely necessary, and that the UI has some data to display as soon as possible, thus improving overall snappiness and user satisfaction when using the UI. Here is the provider sequence for querying data, in more detail:

1. The provider matches the incoming URI and queries local database contents for items that previously matched the query.
2. Our provider always attempts to obtain the latest state for the query and subsequently spawns an asynchronous REST request to load content from the network. You could make this behavior configurable based on the request.
3. The provider returns the cursor from the initial local query to the client.
4. The asynchronous loading thread should decide if data in the provider cache needs to be refreshed; if it does, the provider loads and parses data from the network.
5. When content arrives from the network, the provider directly inserts each new data item into the database and then notifies clients of the URIs for the new data. Since the insertion is already happening inside the content provider, there is no need to

call `ContentResolver.insert`. Clients holding existing cursors that contain an older version of data can call `Cursor.requery` to refresh their data.

With this sequence, the View and Controller eventually get updated with network data, but only the content provider creates the network request. We view a request for a resource that does not currently exist in the provider's data set as a request to load the resource—the network request that loads data into the cache is a side effect of the activity provider query.

Figure 13-1 illustrates the operations taking place inside the content provider during execution of operations in the sequence.

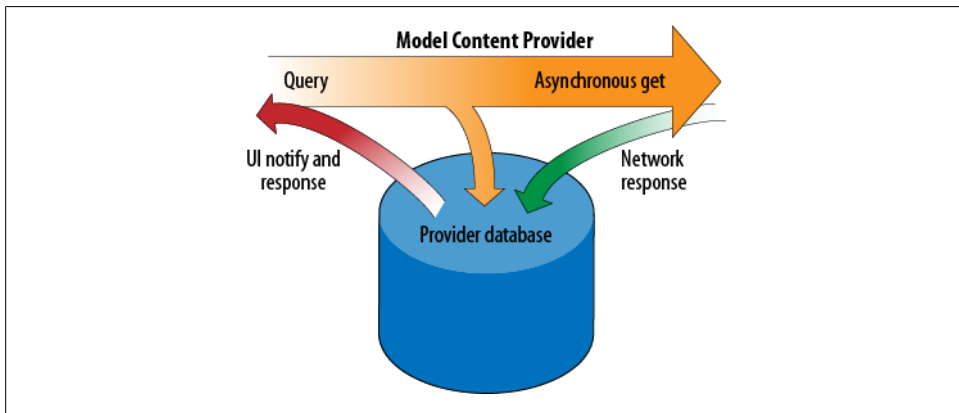

Figure 13-1. Network provider caching content on behalf of the client

For each query, this sequence uses a single `Cursor` object created by a provider and then returned to the view. Only the provider has the requirement to notify the UI when data changes. The View and Controller do not have to collect data, and do not have to update the model. When data is available, the content provider notifies the cursor for the query. The role of data management is encapsulated inside the content provider, which simplifies the code in the View and Controller. The provider client requests data and receives a cursor quickly; the cursor is notified when network data arrives. It's critical to recall that notification depends on database and `Cursor` objects remaining open as long as content provider clients are using them. Closed cursors and databases will result in client views showing no results, which can make it difficult to know if a component such as a list is empty because its cursor was closed erroneously, or if a given query actually had no results.

## Summary of Benefits

It's worth summarizing the benefits of the Network MVC approach:

- Increased perceived performance overall, and increased actual performance from caching, are among the main benefits of this pattern. Mobile programming often performs like the Web would with no caching system.
- Storing data in memory is not a good idea, since you do not know when Android will remove your activity from memory. This pattern emphasizes storing data in the content provider as quickly as possible.
- Most potential UI thread-safety violations cannot happen. Android View components have already been written to dynamically update to reflect current cursor contents. If the size of the data in the model shrinks, `ListView` will make sure to reduce the number of times it iterates over the cursor. Other component systems, for readers familiar with J2SE Swing, would leave this type of task up to the developer, which would leave open the possibility that the list component might iterate beyond the bounds of its model on deletion of data elements.
- This approach leverages the cursor management system and the user interface's built-in capabilities for dynamic updates in response to content observation events. User interface developers don't need to write their own polling and update systems; they just rely on content observation and the content provider interface.
- Like with any correct request for network resources, it's not possible for the UI thread to hang on the network.
- Delivery of network events happens without requiring the presence of a user interface. Even if a particular activity is not present when a network event arrives, the content provider will still be around to handle it. When the user loads the activity, a query will reveal the event that arrived in the background. The absence of an active UI activity will not result in events simply getting dropped.
- Elements of the application are encapsulated and have a special purpose, since, as we've mentioned, the content provider handles all network and SQLite interactions. The View and Controller just use a provider as a generic system for data management.
- It's easier to write applications since it's difficult to use the API incorrectly—just make content provider calls and the system handles the REST (pun intended).
- Finally, in a book on mobile programming, it's easy to focus on device issues, but if clients end up relying on their cache, and referring to the network only when absolutely necessary, they will end up significantly reducing the network load on systems that serve data to devices. This pattern provides a significant benefit for servers as well as clients.

## Our Approach in Context

To be clear, we are suggesting that applications should write content providers to access and store network data wherever possible. While this might seem like an onerous burden at first, consider that web browsers also use an asynchronous mechanism for loading URI referenced content. For readers familiar with basic web programming, the default Android API may be more flexible and extensive than that found in AJAX, but AJAX has long had a foolproof architecture. Modern browsers load URI data using asynchronous I/O mechanisms (see [http://en.wikipedia.org/wiki/Asynchronous\\_io](http://en.wikipedia.org/wiki/Asynchronous_io)), which prevents most opportunities for a browser user interface to hang. While it may not seem like the browser is doing much when a given URI fails to load, the UI thread itself is never in danger of blocking due to a network connection becoming unresponsive. If the UI thread were to hang, the whole browser would stop working. It would not even be able to tell you that it was hung—especially since many browsers are entirely single-threaded. Instead, browsers are able to provide you with the opportunity to halt any given page load request, and then load another page that will hopefully be more responsive. Going further, all modern browsers make use of a persistent web cache, and we are simply suggesting that Android applications should also have a similar construct.

Beyond the pattern we are describing, Google provides specific documentation for improving application responsiveness, and reducing the likelihood of “Application Not Responding” notifications, at <http://developer.android.com/guide/practices/design/responsiveness.html>.

## Code Example: Dynamically Listing and Caching YouTube Video Content

To demonstrate the prescribed architecture, we present the Finch video listing application that allows a user to perform a mobile video search using the RESTful API, at <http://gdata.youtube.com>. Our example code is written with an eye toward intermittent connectivity in a mobile environment. The application preserves user data so that it will remain usable even when the network cannot be reached—even if that means our application can only display older, locally cached results when that happens.

When a user runs a query, the application attempts to retrieve the latest YouTube results for that query. If the application successfully loads new results, it will flush results that are older than one week. If the application were to blindly drop old results before running an update query, it might end up with no results to view, which would render the app useless until network access returned. The screen in [Figure 13-2](#) shows a query for the keyword “dogs”. Pressing Enter in the search box or hitting the refresh button spawns a new query.

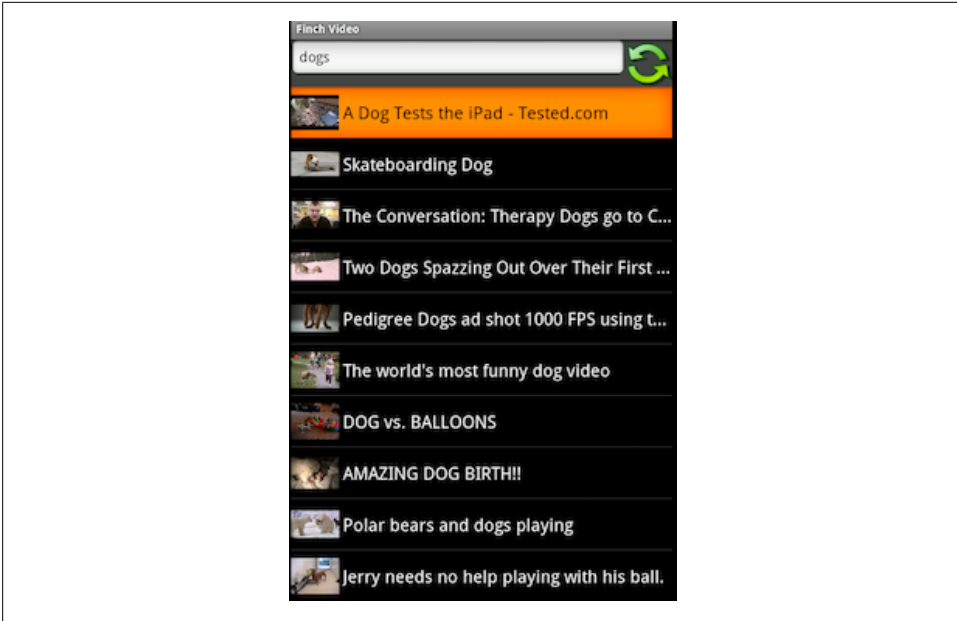

Figure 13-2. Finch video SampleApplication

Our application includes a caching content provider that queries the YouTube API to access YouTube video metadata. Query results are cached in a SQLite table called `video`, as part of the content provider query method. The provider makes use of the Finch framework for invoking asynchronous REST requests. The UI consists of an activity as shown in [Figure 13-2](#), a list with a search query box, and a refresh button. The list dynamically refreshes on content provider data notification. Whenever the user enters a search query and then presses Enter, the activity invokes the query request on the `FinchVideoContentProvider` with the appropriate URI query. We'll now explore the details of this example.

## Structure of the Source Code for the Finch YouTube Video Example

This section briefly examines relevant Java source within the Finch YouTube video application that is unique to the simple version of our video listing application. To start, the files reside in two different directories: that of the Finch video application directory for [Chapter 12](#), and that of the Finch Framework library on which [Chapter 12](#) has a dependency. The source files that make up our YouTube application include:

## Chapter 12 files in `$(FinchVideo)/src/`

`$(FinchVideo)/src/com/oreilly/demo/pa/finchvideo/FinchVideo.java`

The `FinchVideo` class contains the `Videos` class, which serves the same function as `FinchVideo.SimpleVideos` did in the simple video app. The `FinchVideo.Videos` class defines several more constants in addition to the names of the content provider columns that our simple version defined for the YouTube application. Neither the `FinchVideo` class nor the `Videos` class contain any executable code.

`$(FinchVideo)/src/com/oreilly/demo/pa/finchvideo/provider/FinchVideoContentProvider.java`

This is the main content provider that serves YouTube metadata and carries out asynchronous RESTful requests on the YouTube GData API.

`$(FinchVideo)/lib-src/com/oreilly/demo/pa/finchvideo/provider/YouTubeHandler.java`

This parses responses from the YouTube GData API and inserts data entries as they arrive.

## Finch framework source code in `$(FinchFramework)/lib-src`

`$(FinchFramework)/lib-src/com/finchframework/finch/rest/RESTfulContentProvider.java`

This contains a simple framework for invoking RESTful HTTP requests from within an Android content provider. `FinchVideoContentProvider` extends this class to reuse behavior for asynchronously managing HTTP requests.

`$(FinchFramework)/lib-src/com/finchframework/finch/rest/FileHandler.java`

`$(FinchFramework)/lib-src/com/finchframework/finch/rest/FileHandlerFactory.java`

These are simple frameworks for downloading URI content to a file-based cache. They handle the response when the app requests thumbnail URIs.

`$(FinchFramework)/lib-src/com/finchframework/finch/rest/ResponseHandler.java`

This provides a simple abstraction layer for handling downloaded HTTP content from the YouTube API. `YouTubeHandler` extends this class.

`$(FinchFramework)/lib-src/com/finchframework/finch/rest/UriRequestTask.java`

This is a runnable object specialized to download HTTP content. It uses the Apache HTTP client framework.

## Stepping Through the Search Application

In [Figure 13-3](#), we depict the steps involved as our content provider services search requests from the View and Controller using a REST-style network request. The content provider has the opportunity to cache network results in SQLite tables before notifying observers listening to URIs associated with the relevant data. Requests should move asynchronously between components. The View and Controller should not directly or synchronously invoke their own network requests.

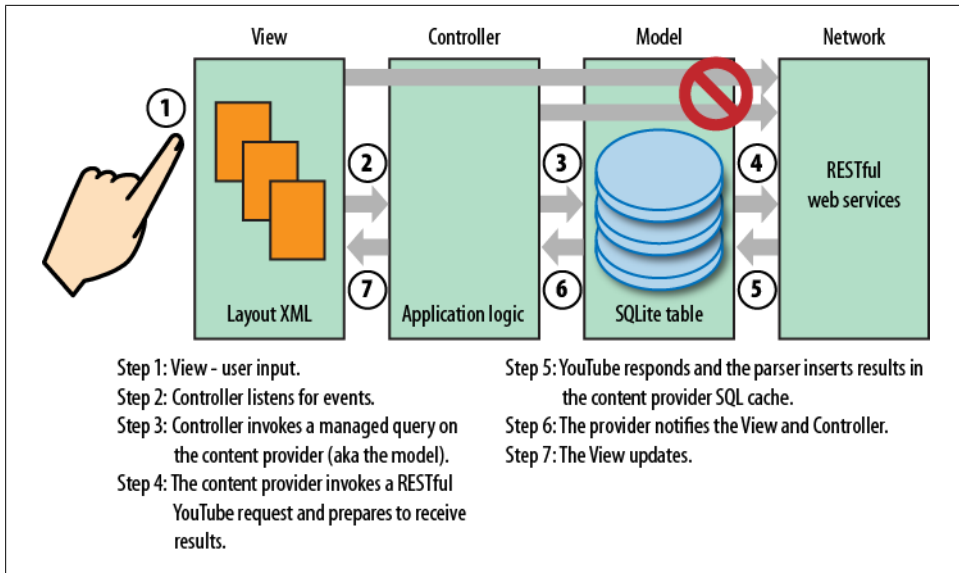

Figure 13-3. The sequence of events that implement a client request for content provider data

The rest of this chapter steps through our second Finch video example to implement this pattern in an Android application. We recommend keeping [Figure 13-3](#) and its steps in mind as we move forward. Note that the steps do not always appear in order as we describe the code to you, but we'll note the steps in bold without having to break from the flow of the code.

## Step 1: Our UI Collects User Input

Our UI in [Figure 13-2](#) uses a simple EditText to collect search keywords.

## Step 2: Our Controller Listens for Events

Our `FinchVideoActivity` registers a text listener, our “Controller,” that receives an event when the user presses the Enter key:

```
class FinchVideoActivity {
    ...
    mSearchText.setOnEditorActionListener(
        new EditText.OnEditorActionListener() {
            public boolean onEditorAction(TextView textView,
                int actionId,
                KeyEvent keyEvent)
            {
                ...
                query();
                ...
            }
        }
    );
}
```

```
    }  
);
```

## Step 3: The Controller Queries the Content Provider with a managedQuery on the Content Provider/Model

The controller then invokes the activity's `query` method in response to user text input (for a search):

```
// inside FinchVideoActivity  
  
...  
  
// sends the query to the finch video content provider  
private void query() {  
    if (!mSearchText.isEmpty()) {  
        String queryString =  
            FinchVideo.Videos.QUERY_PARAM_NAME + "=" +  
            Uri.encode(mSearchText.getText().toString());  
        Uri queryUri =  
            Uri.parse(FinchVideo.Videos.CONTENT_URI + "?" +  
                queryString);  
        Cursor c = managedQuery(queryUri, null, null, null, null);  
        mAdapter.changeCursor(c);  
    }  
}
```

## Step 4: Implementing the RESTful Request

Step 4 is quite a bit more involved than the other components of the sequence so far. We'll need to walk through our RESTful `FinchVideoContentProvider` as we did for `SimpleFinchVideoContentProvider`. To start, `FinchVideoContentProvider` extends our utility called `RESTfulContentProvider` which in turn extends `ContentProvider`:

```
FinchVideoContentProvider extend RESTfulContentProvider {
```

`RESTfulContentProvider` provides asynchronous REST operations in a way that allows the Finch provider to plug in custom request-response handler components. We'll explain this in more detail shortly, when we discuss our enhanced `query` method.

## Constants and Initialization

`FinchVideoContentProvider` initialization is pretty close to the simple video content provider. As with the simple version, we set up a URI matcher. Our only extra task is to add support for matching specific thumbnails. We don't add support for matching multiple thumbnails, since our viewer activity does not need that support—it only needs to load individual thumbnails:



```
sUriMatcher.addURI(FinchVideo.AUTHORITY,
    FinchVideo.Videos.THUMB + "/#", THUMB_ID);
```

## Creating the Database

We create the Finch video database with Java code that executes the following SQL:

```
CREATE TABLE video (_ID INTEGER PRIMARY KEY AUTOINCREMENT,
    title TEXT, description TEXT, thumb_url TEXT,
    thumb_width TEXT, thumb_height TEXT, timestamp TEXT,
    query_text TEXT, media_id TEXT UNIQUE);
```

Note that we've added the ability to store the following attributes beyond the simple version of our database:

**thumb\_url, thumb\_width, thumb\_height**

This is the URL, width, and height associated with a given video thumbnail.

**timestamp**

When we insert a new video record, we stamp it with the current time.

**query\_text**

We store the query text, or query keywords, in the database with each result for that query.

**media\_id**

This is a unique value for each video response that we receive from the GData API. We don't allow two video entries to have the same `media_id`.

## A Networked Query Method

Here's what we've been leading up to: the implementation of the `FinchYouTubeProvider` query method calls out to the network to satisfy a query request for YouTube data. It does this by calling a method of its superclass, `RESTfulContentProvider.asyncQueryRequest(String queryTag, String queryUri)`. Here `queryTag` is a unique string that allows us to reject duplicate requests when appropriate, and `queryUri` is the complete URI that we need to asynchronously download. Specifically, we invoke requests on the following URI after we have appended `URLEncoder.encode` query parameters obtained from our application's search text input field:

```
/** URI for querying video, expects appended keywords. */
private static final String QUERY_URI =
    "http://gdata.youtube.com/feeds/api/videos?" +
    "max-results=15&format=1&q=";
```



You can learn how to create a GData YouTube URI that meets the needs of your application quite easily. Google has created a beta (what else?) utility located at <http://gdata.youtube.com>. If you visit this page in your browser, it will show you a web UI consisting of a plethora of options that you can customize to create a URI like the one shown in the previous code listing. We have used the UI to select up to 15 results, and have selected the use of a mobile video format.

Our networked query method does the usual URI match, and then adds the following tasks, which represent “Step 4: Implementing the RESTful Request” from our sequence:

```
/**
 * Content provider query method that converts its parameters into a YouTube
 * RESTful search query.
 *
 * @param uri a reference to the query for videos, the query string can
 * contain, "q='key_words'". The keywords are sent to the google YouTube
 * API where they are used to search the YouTube video database.
 * @param projection
 * @param where not used in this provider.
 * @param whereArgs not used in this provider.
 * @param sortOrder not used in this provider.
 * @return a cursor containing the results of a YouTube search query.
 */
@Override
public Cursor query(Uri uri, String[] projection, String where,
                   String[] whereArgs, String sortOrder)
{
    Cursor queryCursor;

    int match = sUriMatcher.match(uri);
    switch (match) {
        case VIDEOS:
            // the query is passed out of band of other information passed
            // to this method -- it's not an argument.
            String queryText = uri.
                getQueryParameter(FinchVideo.Videos.QUERY_PARAM_NAME);❶

            if (queryText == null) {
                // A null cursor is an acceptable argument to the method,
                // CursorAdapter.changeCursor(Cursor c), which interprets
                // the value by canceling all adapter state so that the
                // component for which the cursor is adapting data will
                // display no content.
                return null;
            }

            String select = FinchVideo.Videos.QUERY_TEXT_NAME +
                " = '" + queryText + "'";

            // quickly return already matching data
            queryCursor =
```

```

        mDb.query(VIDEOS_TABLE_NAME, projection,
                select,
                whereArgs,
                null,
                null, sortOrder);②

// make the cursor observe the requested query
queryCursor.setNotificationUri(
    getContext().getContentResolver(), uri);③

/*
 * Always try to update results with the latest data from the
 * network.
 *
 * Spawning an asynchronous load task thread guarantees that
 * the load has no chance to block any content provider method,
 * and therefore no chance to block the UI thread.
 *
 * While the request loads, we return the cursor with existing
 * data to the client.
 *
 * If the existing cursor is empty, the UI will render no
 * content until it receives URI notification.
 *
 * Content updates that arrive when the asynchronous network
 * request completes will appear in the already returned cursor,
 * since that cursor query will match that of
 * newly arrived items.
 */
if (!"".equals(queryText)) {
    asyncQueryRequest(queryText, QUERY_URI + encode(queryText));④
}
break;
case VIDEO_ID:
case THUMB_VIDEO_ID:
    long videoID = ContentUris.parseId(uri);
    queryCursor =
        mDb.query(VIDEOS_TABLE_NAME, projection,
            FinchVideo.Videos.ID + " = " + videoID,
            whereArgs, null, null, null);
    queryCursor.setNotificationUri(
        getContext().getContentResolver(), uri);
    break;
case THUMB_ID:
    String uriString = uri.toString();
    int lastSlash = uriString.lastIndexOf("/");
    String mediaID = uriString.substring(lastSlash + 1);

    queryCursor =
        mDb.query(VIDEOS_TABLE_NAME, projection,
            FinchVideo.Videos.MEDIA_ID_NAME + " = " +
                mediaID,
            whereArgs, null, null, null);
    queryCursor.setNotificationUri(
        getContext().getContentResolver(), uri);

```

```

        break;

        default:
            throw new IllegalArgumentException("unsupported uri: " +
                QUERY_URI);
    }

    return queryCursor;
}

```

- ❶ Extract a query parameter out of the incoming URI. We need to send this parameter in the URI itself and not with the other arguments to the `query` method, since they have different functions in the `query` method and could not be used to hold query keywords.
- ❷ Check first for data already in the local database that matches the query keywords.
- ❸ Set the notification URI so that cursors returned from the `query` method will receive update events whenever the provider changes data they are observing. This action sets up Step 6 of our sequence, which will enable the view to update when the provider fires notification events when it changes data, as it will when data returns from a given request. Once notification arrives, Step 7 occurs when the UI repaints. Note that Steps 6 and 7 are out of order in our description, but it's appropriate to talk about those stages here since they relate to the notification URI and the query.
- ❹ Spawn an asynchronous query to download the given query URI. The method `asyncQueryRequest` encapsulates the creation of a new thread to service each request. Note that this is Step 5 in our diagram; the asynchronous request will spawn a thread to actually initiate network communication and the YouTube service will return a response.

### RESTfulContentProvider: A REST helper

Now we'll look into the behaviors that `FinchVideoProvider` inherits from `RESTfulContentProvider` in order to execute RESTful requests. To start we'll consider the behavior of a given YouTube request: as we've seen, query requests run asynchronously from the main thread. A RESTful provider needs to handle a few special cases: if a user searches for "Funny Cats" while another request for the same keywords is in progress, our provider will drop the second request. On the other hand, if a user searches for "dogs" and then "cats" before "dogs" finishes, our provider allows "dogs" to run in parallel to "cats", since the user might search again for "dogs" and then obtain the benefit of cached results in which she had shown some interest.

`RESTfulContentProvider` enables a subclass to asynchronously spawn requests and, when request data arrives, supports custom handling of the response using a simple plug-in interface called `ResponseHandler`. Subclasses should override the abstract method, `RESTfulContentProvider.newResponseHandler`, to return handlers specialized to parse response data requested by their host provider. Each handler will override the method `ResponseHandler.handleResponse(HttpResponse)` to provide custom handling

for `HttpEntity`s contained in passed `HttpResponse` objects. For example, our provider uses `YouTubeHandler` to parse a YouTube RSS feed, inserting database video rows for each entry it reads. More detail on this in a bit...

Additionally, the class `RESTfulContentProvider` enables a subclass to easily make asynchronous requests and reject duplicate requests. `RESTfulContentProvider` tracks each request with a unique tag that enables a subclass to drop duplicate queries. Our `FinchVideoContentProvider` uses the user's query keywords as the request tag since they uniquely identify a given search request.

Our `FinchVideoContentProvider` overrides `newResponseHandler` as follows:

```
/**
 * Provides a handler that can parse YouTube GData RSS content.
 *
 * @param requestTag unique tag identifying this request.
 * @return a YouTubeHandler object.
 */
@Override
protected ResponseHandler newResponseHandler(String requestTag) {
    return new YouTubeHandler(this, requestTag);
}
```

Now we'll discuss the implementation of `RESTfulContentProvider` to explain the operations it provides to subclasses. The class `UriRequestTask` provides a runnable for asynchronously executing REST requests. `RESTfulContentProvider` uses a map, `mRequestsInProgress`, keyed by a string to guarantee uniqueness of requests:

```
/**
 * Encapsulates functions for asynchronous RESTful requests so that subclass
 * content providers can use them for initiating requests while still using
 * custom methods for interpreting REST-based content such as RSS, ATOM,
 * JSON, etc.
 */
public abstract class RESTfulContentProvider extends ContentProvider {
    protected FileHandlerFactory mFileHandlerFactory;
    private Map<String, UriRequestTask> mRequestsInProgress =
        new HashMap<String, UriRequestTask>();

    public RESTfulContentProvider(FileHandlerFactory fileHandlerFactory) {
        mFileHandlerFactory = fileHandlerFactory;
    }

    public abstract Uri insert(Uri uri, ContentValues cv, SQLiteDatabase db);

    private UriRequestTask getRequestTask(String queryText) {
        return mRequestsInProgress.get(queryText);❶
    }

    /**
     * Allows the subclass to define the database used by a response handler.
     *
     * @return database passed to response handler.
     */
}
```

```

public abstract SQLiteDatabase getDatabase();

public void requestComplete(String mQueryText) {
    synchronized (mRequestsInProgress) {
        mRequestsInProgress.remove(mQueryText);❷
    }
}

/**
 * Abstract method that allows a subclass to define the type of handler
 * that should be used to parse the response of a given request.
 *
 * @param requestTag unique tag identifying this request.
 * @return The response handler created by a subclass used to parse the
 * request response.
 */
protected abstract ResponseHandler newResponseHandler(String requestTag);

UriRequestTask newQueryTask(String requestTag, String url) {
    UriRequestTask requestTask;

    final HttpGet get = new HttpGet(url);
    ResponseHandler handler = newResponseHandler(requestTag);
    requestTask = new UriRequestTask(requestTag, this, get,❸
        handler, getContext());

    mRequestsInProgress.put(requestTag, requestTask);
    return requestTask;
}

/**
 * Creates a new worker thread to carry out a RESTful network invocation.
 *
 * @param queryTag unique tag that identifies this request.
 *
 * @param queryUri the complete URI that should be accessed by this request.
 */
public void asyncQueryRequest(String queryTag, String queryUri) {
    synchronized (mRequestsInProgress) {
        UriRequestTask requestTask = getRequestTask(queryTag);
        if (requestTask == null) {
            requestTask = newQueryTask(queryTag, queryUri);❹
            Thread t = new Thread(requestTask);
            // allows other requests to run in parallel.
            t.start();
        }
    }
}
...
}

```

- ❶ The method `getRequestTask` uses `mRequestsInProgress` to access any identical requests in progress, which allows the `asyncQueryRequest` to block duplicate requests with a simple `if` statement.

- ② When a request completes after the `ResponseHandler.handleResponse` method returns, `RESTfulContentProvider` removes the task from `mRequestsInProgress`.
- ③ `newQueryTask` creates instances of `UriRequestTask` that are instances of `Runnable` that will, in turn, open an HTTP connection, and then call `handleResponse` on the appropriate handler.
- ④ Finally, our code has a unique request, creates a task to run it, and then wraps the task in a thread for asynchronous execution.

While `RESTfulContentProvider` contains the guts of the reusable task system, for completeness we'll show you the other components in our framework.

**UriRequestTask.** `UriRequestTask` encapsulates the asynchronous aspects of handling a REST request. It's a simple class that has fields that enable it to execute a RESTful GET inside its `run` method. Such an action would be part of Step 4, "Implementing the RESTful Request," of our sequence. As discussed, once it has the response from the request, it passes it to an invocation of `ResponseHandler.handleResponse`. We expect the `handleResponse` method to insert database entries as needed, which we'll see in `YouTubeHandler`:

```
/**
 * Provides a runnable that uses an HttpClient to asynchronously load a given
 * URI. After the network content is loaded, the task delegates handling of the
 * request to a ResponseHandler specialized to handle the given content.
 */
public class UriRequestTask implements Runnable {
    private HttpUriRequest mRequest;
    private ResponseHandler mHandler;

    protected Context mAppContext;

    private RESTfulContentProvider mSiteProvider;
    private String mRequestTag;

    private int mRawResponse = -1;
    // private int mRawResponse = R.raw.map_src;

    public UriRequestTask(HttpUriRequest request,
                          ResponseHandler handler, Context appContext)
    {
        this(null, null, request, handler, appContext);
    }

    public UriRequestTask(String requestTag,
                          RESTfulContentProvider siteProvider,
                          HttpUriRequest request,
                          ResponseHandler handler, Context appContext)
    {
        mRequestTag = requestTag;
        mSiteProvider = siteProvider;
        mRequest = request;
        mHandler = handler;
    }
}
```

```

        mAppContext = appContext;
    }

    public void setRawResponse(int rawResponse) {
        mRawResponse = rawResponse;
    }

    /**
     * Carries out the request on the complete URI as indicated by the protocol,
     * host, and port contained in the configuration, and the URI supplied to
     * the constructor.
     */
    public void run() {
        HttpResponse response;

        try {
            response = execute(mRequest);
            mHandler.handleResponse(response, getUri());
        } catch (IOException e) {
            Log.w(Finch.LOG_TAG, "exception processing asynch request", e);
        } finally {
            if (mSiteProvider != null) {
                mSiteProvider.requestComplete(mRequestTag);
            }
        }
    }

    private HttpResponse execute(HttpUriRequest mRequest) throws IOException {
        if (mRawResponse >= 0) {
            return new RawResponse(mAppContext, mRawResponse);
        } else {
            HttpClient client = new DefaultHttpClient();
            return client.execute(mRequest);
        }
    }

    public Uri getUri() {
        return Uri.parse(mRequest.getURI().toString());
    }
}

```

**YouTubeHandler.** As required by the abstract method, `RESTfulContentProvider.newResponseHandler`, we've seen that our `FinchVideoContentProvider` returns `YouTubeHandler` to handle YouTube RSS feeds. `YouTubeHandler` uses a memory saving XML Pull parser to parse incoming data, iterating through requested XML RSS data. `YouTubeHandler` contains some complexity, but generally, it's just matching XML tags as needed to create a `ContentValues` object that it can insert into the `FinchVideoContentProvider`'s database. Part of Step 5 occurs when the handler inserts the parsed result into the provider database:

```

/**
 * Parses YouTube Entity data and inserts it into the finch video content
 * provider.
 */

```



```

public class YouTubeHandler implements ResponseHandler {
    public static final String MEDIA = "media";
    public static final String GROUP = "group";
    public static final String DESCRIPTION = "description";
    public static final String THUMBNAIL = "thumbnail";
    public static final String TITLE = "title";
    public static final String CONTENT = "content";

    public static final String WIDTH = "width";
    public static final String HEIGHT = "height";

    public static final String YT = "yt";
    public static final String DURATION = "duration";
    public static final String FORMAT = "format";

    public static final String URI = "uri";
    public static final String THUMB_URI = "thumb_uri";

    public static final String MOBILE_FORMAT = "1";

    public static final String ENTRY = "entry";
    public static final String ID = "id";

    private static final String FLUSH_TIME = "5 minutes";

    private RESTfulContentProvider mFinchVideoProvider;

    private String mQueryText;
    private boolean isEntry;

    public YouTubeHandler(RESTfulContentProvider restfulProvider,
        String queryText)
    {
        mFinchVideoProvider = restfulProvider;
        mQueryText = queryText;
    }

    /*
     * Handles the response from the YouTube GData server, which is in the form
     * of an RSS feed containing references to YouTube videos.
     */
    public void handleResponse(HttpResponse response, Uri uri)
        throws IOException
    {
        try {
            int newCount = parseYoutubeEntity(response.getEntity());❶

            // only flush old state now that new state has arrived
            if (newCount > 0) {
                deleteOld();
            }

        } catch (IOException e) {
            // use the exception to avoid clearing old state, if we cannot
            // get new state. This way we leave the application with some

```

```

        // data to work with in absence of network connectivity.

        // we could retry the request for data in the hope that the network
        // might return.
    }
}

private void deleteOld() {
    // delete any old elements, not just ones that match the current query.

    Cursor old = null;

    try {
        SQLiteDatabase db = mFinchVideoProvider.getDatabase();
        old = db.query(FinchVideo.Videos.VIDEO, null,
            "video." + FinchVideo.Videos.TIMESTAMP +
                " < strftime('%s', 'now', '-' + FLUSH_TIME + ')",
            null, null, null, null);
        int c = old.getCount();
        if (old.getCount() > 0) {
            StringBuffer sb = new StringBuffer();
            boolean next;
            if (old.moveToNext()) {
                do {
                    String ID = old.getString(FinchVideo.ID_COLUMN);
                    sb.append(FinchVideo.Videos._ID);
                    sb.append(" = ");
                    sb.append(ID);

                    // get rid of associated cached thumb files
                    mFinchVideoProvider.deleteFile(ID);

                    next = old.moveToNext();
                    if (next) {
                        sb.append(" OR ");
                    }
                } while (next);
            }
            String where = sb.toString();

            db.delete(FinchVideo.Videos.VIDEO, where, null);

            Log.d(Finch.LOG_TAG, "flushed old query results: " + c);
        }
    } finally {
        if (old != null) {
            old.close();
        }
    }
}

private int parseYoutubeEntity(HttpEntity entity) throws IOException {
    InputStream youTubeContent = entity.getContent();
    InputStreamReader inputReader = new InputStreamReader(youTubeContent);
}

```

```

int inserted = 0;

try {
    XmlPullParserFactory factory = XmlPullParserFactory.newInstance();
    factory.setNamespaceAware(false);
    XmlPullParser xpp = factory.newPullParser();

    xpp.setInput(inputReader);

    int eventType = xpp.getEventType();
    String startName = null;
    ContentValues mediaEntry = null;

    // iterative pull parsing is a useful way to extract data from
    // streams, since we don't have to hold the DOM model in memory
    // during the parsing step.

    while (eventType != XmlPullParser.END_DOCUMENT) {
        if (eventType == XmlPullParser.START_DOCUMENT) {
        } else if (eventType == XmlPullParser.END_DOCUMENT) {
        } else if (eventType == XmlPullParser.START_TAG) {
            startName = xpp.getName();

            if ((startName != null)) {

                if ((ENTRY).equals(startName)) {
                    mediaEntry = new ContentValues();
                    mediaEntry.put(FinchVideo.Videos.QUERY_TEXT_NAME,
                                   mQueryText);
                }

                if ((MEDIA + ":" + CONTENT).equals(startName)) {
                    int c = xpp.getAttributeCount();
                    String mediaUri = null;
                    boolean isMobileFormat = false;

                    for (int i = 0; i < c; i++) {
                        String attrName = xpp.getAttributeName(i);
                        String attrValue = xpp.getAttributeValue(i);

                        if ((attrName != null) &&
                            URI.equals(attrName))
                        {
                            mediaUri = attrValue;
                        }

                        if ((attrName != null) && (YT + ":" + FORMAT).
                            equals(MOBILE_FORMAT))
                        {
                            isMobileFormat = true;
                        }
                    }

                    if (isMobileFormat && (mediaUri != null)) {
                        mediaEntry.put(URI, mediaUri);
                    }
                }
            }
        }
    }
}

```

```

    }
}

if ((MEDIA + ":" + THUMBNAIL).equals(startName)) {
    int c = xpp.getAttributeCount();
    for (int i = 0; i < c; i++) {
        String attrName = xpp.getAttributeName(i);
        String attrValue = xpp.getAttributeValue(i);

        if (attrName != null) {
            if ("url".equals(attrName)) {
                mediaEntry.put(
                    FinchVideo.Videos.
                        THUMB_URI_NAME,
                    attrValue);
            } else if (WIDTH.equals(attrName))
            {
                mediaEntry.put(
                    FinchVideo.Videos.
                        THUMB_WIDTH_NAME,
                    attrValue);
            } else if (HEIGHT.equals(attrName))
            {
                mediaEntry.put(
                    FinchVideo.Videos.
                        THUMB_HEIGHT_NAME,
                    attrValue);
            }
        }
    }
}

if (ENTRY.equals(startName)) {
    isEntry = true;
}
} else if(eventType == XmlPullParser.END_TAG) {
    String endName = xpp.getName();

    if (endName != null) {
        if (ENTRY.equals(endName)) {
            isEntry = false;
        } else if (endName.equals(MEDIA + ":" + GROUP)) {
            // insert the complete media group
            inserted++;

            // Directly invoke insert on the finch video
            // provider, without using content resolver. We
            // would not want the content provider to sync this
            // data back to itself.
            SQLiteDatabase db =
                mFinchVideoProvider.getDatabase();

            String mediaID = (String) mediaEntry.get(
                FinchVideo.Videos.MEDIA_ID_NAME);

```

```

        // insert thumb uri
        String thumbContentUri =
            FinchVideo.Videos.THUMB_URI + "/" + mediaID;
        mediaEntry.put(FinchVideo.Videos.
            THUMB_CONTENT_URI_NAME,
            thumbContentUri);

        String cacheFileName =
            mFinchVideoProvider.getCacheName(mediaID);
        mediaEntry.put(FinchVideo.Videos._DATA,
            cacheFileName);

        Uri providerUri = mFinchVideoProvider.
            insert(FinchVideo.Videos.CONTENT_URI,
                mediaEntry, db);❷
        if (providerUri != null) {
            String thumbUri = (String) mediaEntry.
                get(FinchVideo.Videos.THUMB_URI_NAME);

            // We might consider lazily downloading the
            // image so that it was only downloaded on
            // viewing. Downloading more aggressively
            // could also improve performance.

            mFinchVideoProvider.
                cacheUri2File(String.valueOf(ID),
                    thumbUri);❸
        }
    }
}

} else if (eventType == XmlPullParser.TEXT) {
    // newline can turn into an extra text event
    String text = xpp.getText();
    if (text != null) {
        text = text.trim();
        if ((startName != null) && (!"".equals(text))){
            if (ID.equals(startName) && isEntry) {
                int lastSlash = text.lastIndexOf("/");
                String entryId =
                    text.substring(lastSlash + 1);
                mediaEntry.put(FinchVideo.Videos.MEDIA_ID_NAME,
                    entryId);
            } else if ((MEDIA + ":" + TITLE).
                equals(startName)) {
                mediaEntry.put(TITLE, text);
            } else if ((MEDIA + ":" +
                DESCRIPTION).equals(startName))
            {
                mediaEntry.put(DESCRIPTION, text);
            }
        }
    }
}
}

```

```

        eventType = xpp.next();
    }

    // an alternate notification scheme might be to notify only after
    // all entries have been inserted.

    } catch (XmlPullParserException e) {
        Log.d(Ch11.LOG_TAG,
            "could not parse video feed", e);
    } catch (IOException e) {
        Log.d(Ch11.LOG_TAG,
            "could not process video stream", e);
    }

    return inserted;
}
}

```

- ❶ Our handler implements `handleResponse` by parsing a YouTube HTTP entity in its method, `parseYoutubeEntity`, which inserts new video data. The handler then deletes old video data by querying for elements that are older than a timeout period, and then deleting the rows of data in that query.
- ❷ The handler has finished parsing a media element, and uses its containing content provider to insert its newly parsed `ContentValues` object. Note that this is Step 5, “Response handler inserts elements into local cache,” in our sequence.
- ❸ The provider initiates its own asynchronous request after it inserts a new media entry to also download thumbnail content. We’ll explain more about this feature of our provider shortly.

## insert and ResponseHandlers

Going into Step 5 in a bit more detail, our Finch video provider implements `insert` in much the same way as our simple video provider. Also, as we’ve seen in our application, video insertion happens as a side effect of the `query` method. It’s worth pointing out that our `insert` method is broken into two pieces. We intend that content provider clients call the first form and that response handlers call the second form, shown in the following code. The first form delegates to the second. We break up `insert` because the response handler is part of the content provider and does not need to route through the content resolver to itself:

```

@Override
public Uri insert(Uri uri, ContentValues initialValues) {
    // Validate the requested uri
    if (sUriMatcher.match(uri) != VIDEOS) {
        throw new IllegalArgumentException("Unknown URI " + uri);
    }

    ContentValues values;
    if (initialValues != null) {

```

```

        values = new ContentValues(initialValues);
    } else {
        values = new ContentValues();
    }

    SQLiteDatabase db = getDatabase();
    return insert(uri, initialValues, db);
}

```

YouTubeHandler uses the following method to directly insert rows into the simple video database. Note that we don't insert the media if the database already contains a video entry with the same `mediaID` as the one we are inserting. In this way, we avoid duplicate video entries, which could occur when integrating new data with older, but not expired, data:

```

public Uri insert(Uri uri, ContentValues values, SQLiteDatabase db) {
    verifyValues(values);

    // Validate the requested uri
    int m = sUriMatcher.match(uri);
    if (m != VIDEOS) {
        throw new IllegalArgumentException("Unknown URI " + uri);
    }

    // insert the values into a new database row
    String mediaID = (String) values.get(FinchVideo.Videos.MEDIA_ID);

    Long rowID = mediaExists(db, mediaID);
    if (rowID == null) {
        long time = System.currentTimeMillis();
        values.put(FinchVideo.Videos.TIMESTAMP, time);
        long rowId = db.insert(VIDEOS_TABLE_NAME,
            FinchVideo.Videos.VIDEO, values);
        if (rowId >= 0) {
            Uri insertUri =
                ContentUris.withAppendedId(
                    FinchVideo.Videos.CONTENT_URI, rowId);
            mContentResolver.notifyChange(insertUri, null);
            return insertUri;
        } else {
            throw new IllegalStateException("could not insert " +
                "content values: " + values);
        }
    }

    return ContentUris.withAppendedId(FinchVideo.Videos.CONTENT_URI, rowID);
}

```

## File Management: Storing Thumbnails

Now that we've explained how our RESTful provider framework operates, we'll end the chapter with an explanation of how the provider handles thumbnails.

Earlier we described the `ContentResolver.openInputStream` method as a way for content providers to serve files to clients. In our Finch video example, we use this feature to serve thumbnail images. Storing images as files allows us to avoid use of database blobs and their performance overhead, and allows us to only download images when a client requests them. For a content provider to serve files, it *must* override the method `ContentProvider.openFile`, which opens a file descriptor to the file being served. The content resolver takes care of creating an input stream from the file descriptor. The simplest implementation of this method will call `openFileHelper` to activate the convenience utility that allows the `ContentResolver` to read the `_data` variable to load the file it references. If your provider does not override this method at all, you will see an exception generated that has a message as follows: **No files supported by provider at ...** Our simple implementation only allows read-only access, as shown in the following code:

```
/**
 * Provides read-only access to files that have been downloaded and stored
 * in the provider cache. Specifically, in this provider, clients can
 * access the files of downloaded thumbnail images.
 */
@Override
public ParcelFileDescriptor openFile(Uri uri, String mode)
    throws FileNotFoundException
{
    // only support read-only files
    if (!"r".equals(mode.toLowerCase())) {
        throw new FileNotFoundException("Unsupported mode, " +
            mode + ", for uri: " + uri);
    }

    return openFileHelper(uri, mode);
}
```

Finally, we use a `FileHandler` implementation of `ResponseHandler` to download image data from YouTube thumbnail URLs corresponding to each media entry. Our `FileHandlerFactory` allows us to manage cache files stored in a specified cache directory. We allow the factory to decide where to store the files:

```
/**
 * Creates instances of FileHandler objects that use a common cache directory.
 * The cache directory is set in the constructor to the file handler factory.
 */
public class FileHandlerFactory {
    private String mCacheDir;

    public FileHandlerFactory(String cacheDir) {
        mCacheDir = cacheDir;
        init();
    }

    private void init() {
        File cacheDir = new File(mCacheDir);
        if (!cacheDir.exists()) {
```



```

        cacheDir.mkdir();
    }
}

public FileHandler newFileHandler(String id) {
    return new FileHandler(mCacheDir, id);
}

// not really used since ContentResolver uses _data field.
public File getFile(String ID) {
    String cachePath = getFileName(ID);

    File cacheFile = new File(cachePath);
    if (cacheFile.exists()) {
        return cacheFile;
    }
    return null;
}

public void delete(String ID) {
    String cachePath = mCacheDir + "/" + ID;

    File cacheFile = new File(cachePath);
    if (cacheFile.exists()) {
        cacheFile.delete();
    }
}

public String getFileName(String ID) {
    return mCacheDir + "/" + ID;
}
}

/**
 * Writes data from URLs into a local file cache that can be referenced by a
 * database ID.
 */
public class FileHandler implements ResponseHandler {
    private String mId;
    private String mCacheDir;

    public FileHandler(String cacheDir, String id) {
        mCacheDir = cacheDir;
        mId = id;
    }

    public
    String getFileName(String ID) {
        return mCacheDir + "/" + ID;
    }

    public void handleResponse(HttpResponse response, Uri uri)
        throws IOException
    {
        InputStream urlStream = response.getEntity().getContent();

```

```
        FileOutputStream fout =
            new FileOutputStream(getFileName(mId));
        byte[] bytes = new byte[256];
        int r = 0;
        do {
            r = urlStream.read(bytes);
            if (r >= 0) {
                fout.write(bytes, 0, r);
            }
        } while (r >= 0);

        urlStream.close();
        fout.close();
    }
}
```

# Advanced Topics

In [Part IV](#) we cover Android APIs that are important to many applications, but that are not part of the core Android Framework and that not every application is likely to make use of.



# Multimedia

In today's world of converging technologies, the mobile phone is used for a variety of tasks beyond simple voice calls. Multimedia capabilities, or the playing and recording of audio and video, is one such significant task that many users find to be of great value. Take a quick look around and you will find people using the phone as a means to enjoy a variety of programs as well as share self-recorded media among friends. Android provides the APIs to easily access this capability as well as embed multimedia and its manipulation directly within an application.

## Audio and Video

Android supports playback of most popular audio and video formats. It also lets you record some formats. Recordings are stored in files, and can optionally be put in a persistent media store. The MediaStore is the content provider within Android that enables the storing and sharing of media data such as images, video, and audio. Once placed within this content provider, metadata associated with the media files becomes available for other applications to use.

As of this writing, most Android devices currently on the market support the following audio and video formats. Note that device makers can add support for other formats not listed here:

### *Audio*

- AAC LC/LTP \*
- HE-AACv1 (AAC+)
- HE-AACv2 (enhanced AAC+)
- AMR-NB \*
- AMR-WB \*
- MP3
- MIDI
- Ogg Vorbis
- PCM/WAVE

## Video

H.263 \*  
H.264 AVC  
MPEG-4 SP

The asterisk (\*) indicates the formats for which encoding is available. For all others, only decoding is possible.

Check the Developers site at <http://developer.android.com/guide/appendix/media-formats.html> for further details and changes.

## Playing Audio and Video

Android provides a standard means to play audio or video: the `MediaPlayer` class. For audio content, you can also play back raw data, which is useful in sophisticated applications where you generate the audio dynamically.

A `MediaPlayer` goes through several states during its life cycle:

### *Idle*

The `MediaPlayer` is instantiated.

### *Initialized*

The media source is set.

### *Preparing*

The `MediaPlayer` is preparing the media source for playback.

### *Prepared*

The `MediaPlayer` is prepared for playback.

### *Started*

Playback is in progress.

### *Paused*

Playback has been paused.

### *Playback complete*

Playback of source is done (the playback can be started again).

### *Stopped*

The `MediaPlayer` is no longer prepared to play the source.

### *End*

The `MediaPlayer` is no more, and all associated resources are released.

For details on these states, view the state diagram provided on the Developers site at <http://developer.android.com/reference/android/media/MediaPlayer.html#StateDiagram>. To get started with `MediaPlayer`, it's useful at this point to view it as a series of steps in your application:

1. Create a `MediaPlayer` instance through the `create()` method (idle state).
2. Initialize the `MediaPlayer` with the media source to play (initialized state).
3. Prepare the `MediaPlayer` for playback through the `prepare()` method (preparing and prepared states).
4. Play the `MediaPlayer` through the `start()` method (started state).
5. During playback, if desired, you can pause, stop, or replay the `MediaPlayer` (started, paused, playback complete, and stopped states).
6. Once playback is finished, make sure to release the `MediaPlayer`'s associated resources by calling `release()` (end state).

The following sections provide more detail.

## Audio Playback

Audio can be played through two methods, `MediaPlayer` and `AudioTrack`. `MediaPlayer` is the standard, simple way to do playback. Its data must be in a file or be stream-based. `AudioTrack`, in contrast, provides direct access to raw audio in memory.

### MediaPlayer audio playback

When you first start using the `MediaPlayer`, you should determine whether a file placed within the application's resources is to be used. If so, `MediaPlayer` has a convenient static method that will set up the data source and prepare the player:

```
MediaPlayer mediaPlayer = MediaPlayer.create(this, R.raw.example);
```

If you are not using an application resource, such as referencing an audio file residing on the filesystem (SD card and the like) or on a website (e.g., <http://SomeServer/SomeAudioFile.mp3>), you'll have to manually set up and call your data source. You can take the data from a URI through a call to:

```
setDataSource(context, uri)
```

The context in the first argument is a means for the `MediaPlayer` to access the resources of the application itself, and thus be able to resolve the URI. Either the application or activities context will do.

The alternative is to specify an absolute file path through:

```
setDataSource(path)
```

API version 9 lets you attach some auxiliary effects (such as reverb) to the player. Set any effects you want while setting the data source, before calling `prepare()`:

```

MediaPlayer mediaplayer = new MediaPlayer();

// Uri mediaReference = "http://someUriToaMediaFile.mp3";
// mediaplayer.setDataSource(this, mediaReference);

// use absolute path
mediaplayer.setDataSource("/sdcard/somefile.mp3");

// prepare mediaplayer
mediaplayer.prepare();

```

Once the `MediaPlayer` is prepared, you can play it:

```
mediaplayer.start();
```

During play, the player can be paused or stopped. When in the paused state, it may be unpaused simply by calling `start()` again. Once the `MediaPlayer` is stopped, you can't start it again without resetting it through the `reset()` method, reinitializing it with the data source as shown earlier, and issuing `prepare()`. However, look at the following:

```

mediaplayer.pause(); // pausing
mediaplayer.start(); // going from pause to play

mediaplayer.stop(); // stopping

...

// to be able to play again reset must be called
mediaplayer.reset();
// now the media player must be reinitialized to play again

```

While the `MediaPlayer` is playing, you can track its current position in the file through `getCurrentPosition()`. This returns the amount of time played through in the file, in millisecond units:

```
mediaplayer.getCurrentPosition();
```

Once the `MediaPlayer` is no longer needed, make sure to release it so that the resources are cleaned up and made available for the system:

```
mediaplayer.release();
```

## AudioTrack audio playback

`AudioTrack` provides a much more direct method of playing audio. The following example shows the parameters required to set up an `AudioTrack`:

```

File mediafile = new File(mediaFilePath);
short[] audio = new short[(int) (mediafile.length()/2)];

// read in file and fill up audio[]

AudioTrack audiotrack = new AudioTrack(
    // stream type
    AudioManager.STREAM_MUSIC,
    // frequency

```



```

11025,
        // channel config-mono, stereo, etc.
AudioFormat.CHANNEL_CONFIGURATION_MONO,
        // audio encoding
AudioFormat.ENCODING_PCM_16BIT,
        // length
audio.length,
        // mode
AudioTrack.MODE_STREAM
);

```

The `AudioTrack` method provides the type of audio stream (music, ringtone, alarm, voice call, etc.), the sample rate in Hertz (44100, 22050, 11025), the audio configuration (mono or stereo), the audio format/encoding, the length of the audio in number of bytes, and the mode (static or stream). Android's `AudioTrack`, once configured, will automatically know how to interface with the hardware on the device, thus providing a painless experience.

To play the audio, issue the `play()` method and write the data out to the hardware:

```

// start playing state
audiotrack.play();

// write audio to hardware
audiotrack.write(audio, 0, audio.length);

```

To pause the track, utilize the `pause()` method:

```

// pause
audiotrack.pause();

```

To stop playing the track, set it to the stopped state. If you don't need the track anymore, release it. Otherwise, to replay the audio, you must reinitialize it:

```

// stop
audiotrack.stop();

// release all resources
audiotrack.release();

```

## Video Playback

Video playback, unlike audio playback, can use only the `MediaPlayer`. There is no video equivalent to `AudioTrack`. Video uses the `MediaPlayer` similarly to audio files, but you must additionally specify a view (called a *surface*) on which the video can be displayed. Android offers a convenient control that includes its own surface: the `VideoView` view. An example of its use follows. It includes the addition of an optional controller that lets the user control the playback through a simple interface that includes buttons to start, stop, and pause the playback, as well as a seek bar to skip forward or back within the video's playback progress:

```

// create the view (in this case it is already included in the layout resource)
VideoView videoview = (VideoView) findViewById(R.id.videoview);
videoview.setKeepScreenOn(true);

// used if streaming
if (videouri != null) videoview.setVideoURI(videouri);
// absolute path if it is a file
else videoview.setVideoPath(videopath);

// let's add a media control so we can control the playback
mediacontroller = new MediaController(this);
mediacontroller.setAnchorView(videoview);
videoview.setMediaController(mediacontroller);
if (videoview.canSeekForward())
    videoview.seekTo(videoview.getDuration()/2);

// start the playback
videoview.start();

```

## Recording Audio and Video

The standard class that supports recording is the `MediaRecorder`. Much like the `MediaPlayer`, it passes through various states during its life cycle. The states are as follows (for more details, view the state diagram provided by the Developers site, at <http://developer.android.com/reference/android/media/MediaRecorder.html>):

### *Initialize*

The `MediaRecorder` class is instantiated.

### *Initialized*

The `MediaRecorder` is ready to be used.

### *DataSource configured*

The media source (where the output will be placed) is configured.

### *Prepared*

The `MediaRecorder` is prepared to record.

### *Recording*

Recording is underway.

### *Released*

All resources are released.

To utilize the `MediaRecorder`, some permissions may need to be set in the manifest:

- To enable video recording, enable `RECORD_VIDEO` and the `CAMERA`:
 

```

<uses-permission android:name="android.permission.RECORD_VIDEO"/>
<uses-permission android:name="android.permission.CAMERA"/>

```
- To record audio, enable `RECORD_AUDIO`:
 

```

<uses-permission android:name="android.permission.RECORD_AUDIO"/>

```

## Audio Recording

There are three methods to record audio. The `MediaRecorder` is the standard method; using an `Intent` is the simplest method; and the `AudioRecorder` can be used to record directly from hardware buffers.

### MediaRecorder audio recording

First, initialize the `MediaRecorder`. Then set the data source information (the audio input source, the output format, the encoding type, where the file is to be recorded to, etc.). Starting with version 8, you can set the bit rate and sampling rate. Once all this is done, call the `prepare()` method:

```
// initialize the MediaRecorder
MediaRecorder mediarecorder = new MediaRecorder();

// configure the data source
// the source of the audio input
mediarecorder.setAudioSource(MediaRecorder.AudioSource.MIC);
// output format
mediarecorder.setOutputFormat(MediaRecorder.OutputFormat.THREE_GPP);
// encoding
mediarecorder.setAudioEncoder(MediaRecorder.AudioEncoder.AMR_NB);
// use absolute path to file where output is stored
mediarecorder.setOutputFile("/sdcard/audiorecordexample.3gpp");

// prepare to record
mediarecorder.prepare();
```

Then when the recording needs to start, call the `start()` method:

```
mediarecorder.start();
```

When the recording needs to be stopped, call the `stop()` method. If you want to continue recording after this, call `reset()` to force the `MediaRecorder` back to the idle state. Then reconfigure the data source to prepare the `MediaRecorder` again:

```
mediarecorder.stop();
...
mediarecorder.reset();
```

Once the `MediaRecorder` is no longer needed, make sure to release it:

```
mediarecorder.release();
```

The following example is a convenient little app that uses the code we developed to provide a “record” button for the user. When the button is clicked, the `record` method executes with the file path already referenced. A “stop” button is then made visible and the “record” button becomes invisible. When the “stop” button is clicked, the `stopRecord` method is called and the “record” button comes back:

```

public class AudioRecorder extends Activity {
    private MediaRecorder mediarecorder;

    public void onCreate(Bundle savedInstanceState) {
        super.onCreate(savedInstanceState);

        setContentView(R.layout.audiorecorderlayout);

        ImageButton recordbutton = (ImageButton) findViewById(R.id.record);
        recordbutton.setOnClickListener(new OnClickListener() {
            public void onClick(View v) {
                record("/sdcard/audiorecordexample.3gpp");
            }
        });

        ImageButton stopbutton = (ImageButton) findViewById(R.id.stop);
        stopbutton.setOnClickListener(new OnClickListener() {
            public void onClick(View v) {
                stopRecord();
            }
        });
    }

    private void record(String filePath) {
        try {
            File mediafile = new File(filePath);
            if(mediafile.exists()) {
                mediafile.delete();
            }
            mediafile = null;

            // record button goes away
            ImageButton button = (ImageButton) findViewById(R.id.record);
            button.setVisibility(View.GONE);
            // stop button shows up
            ImageButton stopbutton = (ImageButton) findViewById(R.id.stop);
            stopbutton.setVisibility(View.VISIBLE);

            // set up media recorder
            if(mediarecorder == null) mediarecorder = new MediaRecorder();
            mediarecorder.setAudioSource(MediaRecorder.AudioSource.MIC);
            mediarecorder.setOutputFormat(MediaRecorder.OutputFormat.THREE_GPP);
            mediarecorder.setAudioEncoder(MediaRecorder.AudioEncoder.AMR_NB);
            mediarecorder.setOutputFile(filePath);

            // prepare media recorder
            mediarecorder.prepare();
            // start media recorder
            mediarecorder.start();
        } catch (Exception e) {
            e.printStackTrace();
        }
    }
}

```

```

private void stopRecord() {
    // stop media recorder
    mediarecorder.stop();
    // reset media recorder
    mediarecorder.reset();

    // record button shows up
    ImageButton button = (ImageButton) findViewById(R.id.record);
    button.setVisibility(View.VISIBLE);
    // stop button goes away
    ImageButton stopbutton = (ImageButton) findViewById(R.id.stop);
    stopbutton.setVisibility(View.GONE);
}
}

```

## Intent audio recording

Recording via Intent is the easiest of the methods. Just construct the `MediaStore.Audio.Media.RECORD_SOUND_ACTION` intent, and start it using the `startActivityForResult()` from within the Activity. This will launch the default audio recorder that is provided in most Android devices and proceeds to record some audio:

```

Intent intent = new Intent(MediaStore.Audio.Media.RECORD_SOUND_ACTION);
startActivityForResult(intent, 1); // intent and requestCode of 1

```

Once the recording is complete and the audio recorder finishes, your Activity that originated the call to `startActivityForResult()` will be brought back to the fore. When that occurs, your Activity's `onActivityResult()` method will be triggered with the `requestCode` you provided (in this case, 1), a result code (OK or error), and an intent carrying the URI referencing the recorded audio file:

```

protected void onActivityResult(int requestCode, int resultCode, Intent intent) {
    // is it our requestCode?
    if (requestCode == 1) {
        // is the resultCode OK?
        if (resultCode == RESULT_OK) {
            // lets get the uri
            Uri audioUri = intent.getData();
            // lets play the uri or do something with it.
            playAudio(audioUri);
        }
    }
}

```

## AudioRecorder audio recording

In parallel with `AudioTrack`, `AudioRecorder` provides a much more direct recording experience:

```

short[] buffer = new short[10000];

recorder = new AudioRecord( // source to record from
    MediaRecorder.AudioSource.MIC,
    // frequency

```

```

11025,
    // channel config—mono, stereo, etc.
    AudioFormat.CHANNEL_CONFIGURATION_MONO,
    // audio encoding
    AudioFormat.ENCODING_PCM_16BIT,
    // buffer size
    buffer.length
);

```

The `AudioRecord` method provides the type of source to record audio from (Mic, Camcorder [mic facing the same direction as the camera], or VoiceCall), the sample rate in Hertz (44100, 22050, or 11025), the audio configuration (mono or stereo), the audio format/encoding, and the length of the buffer in number of bytes. Note that the size of this buffer determines how long an `AudioRecord` can record before “over-running” data that has not been read yet. Data should be read from the audio hardware in chunks of sizes less than the total recording buffer size. Android’s `AudioRecord`, once configured, will automatically know how to interface with the hardware on the device, thus providing a painless experience.

To start recording, set the `AudioRecord`’s state to the Record state and read data repeatedly from the hardware buffer:

```

recorder.startRecording();
while(recordablestate) {
    try {
        // read in up to buffer size
        int readBytes = recorder.read(buffer, 0, buffer.length);

        // do something with the bytes that are read
    } catch (Exception t) {
        recordablestate = false;
    }
}

```

To stop recording, set the `AudioRecord`’s state to Stop. If you no longer wish to record, do not forget to release all resources associated with the recording. Otherwise, you may call `startRecording()` to start recording again:

```

// stop recording
recorder.stop();

// release recording resources
recorder.release();

```

## Video Recording

You can record video in two ways: by using the `MediaRecorder` or by using an Intent. Raw recording is not supported, as it is for audio.

## MediaRecorder video recording

The process for recording video with the `MediaRecorder` is much the same as that for recording audio: initialize the `MediaRecorder`, prepare the data source, and start the `MediaRecorder`. You can offer the user a preview window so that he can preview the video being captured, by providing a surface as shown earlier for playing back video. Generally, a `VideoView` is used:

```
// initialize
MediaRecorder mediarecorder = new MediaRecorder();

// set data source
mediarecorder.setAudioSource(MediaRecorder.AudioSource.MIC);
mediarecorder.setVideoSource(MediaRecorder.VideoSource.CAMERA);
mediarecorder.setOutputFormat(MediaRecorder.OutputFormat.DEFAULT);
mediarecorder.setAudioEncoder(MediaRecorder.AudioEncoder.DEFAULT);
mediarecorder.setVideoEncoder(MediaRecorder.VideoEncoder.DEFAULT);
mediarecorder.setOutputFile("/sdcard/someexamplevideo.mp4");

// provide a surface to show the preview in. in this case a VideoView is used
videoview = (VideoView) findViewById(R.id.videosurface);
SurfaceHolder holder = videoview.getHolder();
mediarecorder.setPreviewDisplay(holder.getSurface());

// prepare
mediarecorder.prepare();

// start recording
mediarecorder.start();
```

## Intent video recording

Intent-based video recording is like using an intent to record audio. The intent to use is `MediaStore.ACTION_VIDEO_CAPTURE`, and the resultant data is the URI of the video file.

## Stored Media Content

Even when media is saved to a file (as in the case of recording), the media file is not immediately available to other applications. To make the file available, you must insert it into the `MediaStore`. The `MediaStore` is a content provider dedicated to the storage and retrieval of media data (images, video, audio) with the device. To store a reference to the file, create a `ContentValues` object and insert it into the appropriate `MediaStore` content provider. The following example inserts an audio file with appropriate meta-data, such as title and artist:

```
// generate ContentValues and add appropriate metadata values

ContentValues content = new ContentValues();

// VERY IMPORTANT! Must reference the absolute path of the data.
content.put(MediaStore.MediaColumns.DATA, "/sdcard/AudioExample.3gpp");
```

```
content.put(MediaStore.MediaColumns.TITLE, "AudioRecordExample");
content.put(MediaStore.MediaColumns.MIME_TYPE, "audio/amr");
content.put(MediaStore.Audio.Media.ARTIST, "Me");
content.put(MediaStore.Audio.Media.IS_MUSIC, true);

// get the Content Resolver
ContentResolver resolve = getContentResolver();

// insert into the content resolver
Uri uri = resolve.insert(MediaStore.Audio.Media.EXTERNAL_CONTENT_URI, content);

// announce to everyone that cares that it was inserted
sendBroadcast(new Intent(Intent.ACTION_MEDIA_SCANNER_SCAN_FILE, uri));
```



# Location and Mapping

Ever since mobile phones started to incorporate standalone GPS receivers, developers have foreseen a new era of location-based applications. Location awareness enables a new generation of mobile applications. If your application is looking up restaurants, it's clearly advantageous if you can restrict your search to the area around you. It's even better if you can see a map of the restaurants' locations, and perhaps be able to look up driving or walking directions. If you're looking for a temporary job, as in the MJAndroid application highlighted in [“Using the Database API: MJAndroid” on page 264](#), it's definitely a benefit to be able to graphically view job opportunities on a map.

Navigation is really just the first generation of location-based services (LBS). Applications that enable users either to opt in to allow sharing of their location with friends, such as Google Latitude, or to attach importance to geographic sites, such as Four-square, have begun to arrive in a big way. The world of LBS is really taking off, and as we'll see, Google's Android provides powerful features that greatly simplify development of this type of application.

In economic terms, location-based applications are a major factor in mobile telephony, making up a significant portion of the revenue from mobile applications, and growing fast. Because they are based on the ability of the mobile network to locate devices and the relationship of mobility and location, location-based applications are as fundamental to mobile telephony as communication.

Applications often combine location awareness with search: Where are my contacts? Where are services or products I'm looking for? Where are people with common interests?

In this chapter, we'll explore how the MJAndroid application uses Android to address some of these questions.

## Location-Based Services

Mobile phones use several related methods, alone and in combination, to determine where they are:

### *Cell ID*

Whether you're actually talking on the phone or not, as long as it's powered up, your mobile phone carries on a constant conversation with nearby cell towers. It has to do this to be able to respond when someone calls you, so every few seconds it "pings" the cell tower it was using last to tell it that it's still in range and to note network parameters such as the current time, the current signal strength (uplink and downlink), and so on.

If you happen to be moving, your phone may initiate a handover to another cell tower, all in the background and without you having to intervene. Each cell tower worldwide has a unique identifier called, appropriately enough, its Cell ID, and each tower knows its latitude and longitude, so it's easy enough for a mobile phone to know *approximately* where you are located by noting the current Cell ID's geographic location. Cell network sizes vary depending on the expected traffic in an area, but in the United States their radius ranges from a half mile (cities) to five miles or more (wide-open spaces).

### *Triangulation*

Most of the time your mobile phone is in range of more than one cell tower. In 2G and later mobile technologies, the cell tower has the ability to tell what direction your signal is coming from. If there are two or three towers that can see your phone, together they can triangulate on your phone's location. With some operators, your phone then has the ability to query the network to find out where it's been located. This sounds a little backward, but it can be very accurate, and it doesn't depend on any extra hardware on the mobile phone.

### *GPS*

The satellite-based Global Positioning System is ubiquitous these days, found in car navigation units, handheld navigators, and mobile phones. The good news is that, using GPS, your mobile phone can determine its location very accurately, including its altitude if that's important for some particular application. There are several downsides to GPS, but it is gaining popularity nonetheless. The downsides are:

#### *Increased cost*

GPS radios and processors are fairly inexpensive, but still, an increase of even \$10 in the bill-of-materials cost of a mobile phone is considerable.

#### *Reduced battery life*

There have been great strides in reducing the power required by GPS radios and processors, but they still suck battery power. Most phones that include GPS also have a feature that lets the user turn it on and off. If your application depends on GPS accuracy, it's good to remember that your application might

have to check to see whether the GPS device is turned on, and notify the user if it isn't.

#### *Unreliable availability*

Nothing “always works,” but GPS in particular depends on your mobile device being able to see the satellites currently overhead. If you're in the basement of a high-rise building, surrounded by steel-reinforced concrete, you probably aren't going to be able to use GPS.

It's reasonable to expect that all Android phones will include one or all of these location finding methods. Most recent Android phones, in particular, can use them all. So now we'll proceed to techniques for using the location capabilities.

## Mapping

Google is most famous for its search engine, but not far behind that comes the acclaim of Google Maps. When creating Android, the folks at Google could easily see the potential in LBS and how well that fit with their mapping expertise. Most LBS applications end up displaying a map. Meanwhile, Google already had the technology to display and update interactive maps, and the business processes in place to allow others to use those maps and add features for their own websites. It still required a significant leap to make that mapping technology available to application developers for mobile phones, but Google has certainly answered the challenge in Android.

## The Google Maps Activity

One of the applications that comes with Android is the Google Maps application itself. If it's appropriate, you can start Google Maps from your application the same way you start any other **Activity**:

1. Create an **Intent** (`new Intent(String action, Uri uri)`) that says you need to display a map. The parameters are:
  - An **action**, for which you must specify `ACTION_VIEW`.
  - A **Uri**, for which you should specify one of the following URI schemes, substituting your data:
    - `geo:latitude, longitude`
    - `geo: latitude , longitude ?z= zoom`
    - `geo:0,0?q my_street_address`
    - `geo:0,0?q business_near_city`
2. Call `startActivity(Intent intent)`, using the intent you just created.

An example that creates a map is:

```
Intent intent = new Intent(ACTION_VIEW, "geo:37.422006,-122.084095");
startActivity(intent);
```

This is certainly easy, and it gets you all the power of Google Maps, but you can't really integrate the map into your application this way. Google Maps is an application unto itself, and there's no way for you to change anything about the user interface or add overlay graphics to the map to point out whatever is of interest to your users. Android provides more flexible packages to add that power.

## The MapView and MapActivity

Chapter 10's MJAndroid sample application needs to add overlays that show the locations for jobs in the area. So, instead of using the Google Maps application, we will use a `MapView`, which we can overlay with graphics as needed. You can have only one `MapView` per `Activity`, and that activity has to extend `MapActivity`. As you'll see, that's a small price to pay for the powerful geographic functions that `MapView` adds to your application.

There are a couple of unique prerequisites for using `MapView`s, and we touched on both of them when we looked at the initialization of MJAndroid in Chapter 10:

### *Include the MapViews library*

The `MapView` is not included in the default Android libraries. Instead, you need to specify in *AndroidManifest.xml* that you are using this additional library:

```
<application android:icon="@drawable/icon2">
    <uses-library android:name="com.google.android.maps" />
```

You can't put the `uses-library` line just anywhere in *AndroidManifest.xml*; it needs to be within the `<application>` tag and outside the `<activity>` tag definitions.

### *Sign your application and obtain a Maps API key from Google*

When you use a `MapView` in your application, you are using actual Google Maps data to draw the map. For legal reasons, Google needs to track who is using its map data. Google doesn't care what your application does with the data, but you need to register with Google for an API key and agree to appropriate Terms of Service. This tells Google your application is using mapping data, and whether you are also using the routing data that is available from Google Maps. "Application Signing" on page 95 covered the processes of signing your application and getting an API key.



Remember that programs using a `MapView` must be signed. To make it easy for you to try out the MJAndroid example from this book, we've included an *.apk* file as described in "Application Signing" on page 95. If you change the code or do any coding of your own, get your own key, which is also described in "Application Signing" on page 95.

## Working with MapViews

The `MapView` encapsulates a lot of very complex mapping software and is available for you to use in your Android applications—for free. Here are some of the things you can do with a `MapView`, with only a little programming on your part:

- Show a street map of any area in the world, with up-to-date mapping information courtesy of Google.
- Change the map view to show:

### *Street view*

Photographs taken at street level for many areas in North America.

### *Satellite view*

An aerial, photographic view of the area.

### *Traffic view*

Real-time traffic information superimposed on the map or satellite views.

- Move the map under program control.
- Plot your own graphics in overlays on top of the map.
- Respond to user touch events on the map.

## MapView and MyLocationOverlay Initialization

The map in `MicroJobs` has two modes:

- At startup, and when we select Current Location from the Spinner, we want to display a map of our current location, and we want that map to track us as we move around. For this map, we will use the `MyLocationOverlay` class.
- When we select a specific location from the Spinner, we want to display a map of that location, turn off location updates, and not track movement.

Let's look at the code in `MicroJobs.java` that initializes the `MapView` and the `MyLocationOverlay` that tracks our current location:

```
@Override
public void onCreate(Bundle savedInstanceState) {
    ...

    mvMap = (MapView) findViewById(R.id.mapmain);❶

    // get the map controller
    final MapController mc = mvMap.getController();❷

    mMyLocationOverlay = new MyLocationOverlay(this, mvMap);❸
    mMyLocationOverlay.runOnFirstFix(❹
        new Runnable() {
            public void run() {
```

```

        mc.animateTo(mMyLocationOverlay.getMyLocation());⑤
        mc.setZoom(16);
    }
});

Drawable marker = getResources().getDrawable(R.drawable.android_tiny_image);⑥
marker.setBounds(0, 0, marker.getIntrinsicWidth(), marker.getIntrinsicHeight());
mvMap.getOverlays().add(new MJJobsOverlay(marker));

mvMap.setClickable(true);⑦
mvMap.setEnabled(true);
mvMap.setSatellite(false);
mvMap.setTraffic(false);
mvMap.setStreetView(false);

// start out with a general zoom
mc.setZoom(16);⑧
...
/**
 * Required method to indicate whether we display routes
 */
@Override
protected boolean isRouteDisplayed() { return false; }⑨

```

Here are some of the highlights of the code:

- ① We first find the `MapView` in the *main.xml* layout file the same way we find any other view, and assign it to the variable `mvMap`, of type `MapView`, so that we can refer to it when we need to.
- ② We also get a handle on the `MapController` associated with `MapView`. We'll use that to pan (animate) the map, zoom in, zoom out, change views, and so on.
- ③ To use `MyLocationOverlay`, we create a new instance, giving it the highly creative name `mMyLocationOverlay`.
- ④ The first thing we do with `mMyLocationOverlay` is define a method that Android will call when we receive our first location fix from the location provider.
- ⑤ This `runOnFirstFix` method moves the map to the current location (given by `mMyLocationOverlay.getMyLocation()`), and zooms to a reasonable level for us to see nearby job prospects.
- ⑥ Next we identify a marker that we've decided to use on `mMyLocationOverlay` to mark available jobs. We use an image that's stored in our *res/drawable* directory, called *android\_tiny\_image*. It's a picture of a little Android robot. We define the bounds of the `Drawable`, and add the marker overlay to the list of overlays for the `MapView` `mvMap`.
- ⑦ Now we'd like to set some initial attributes for `mvMap`, described later in this section. We'll allow the user to change most of these through menu buttons.

- ⑧ Then, following a belt-and-suspenders philosophy, just in case there isn't a location provider to trigger `runOnFirstFix`, we'll set the zoom level again here.
- ⑨ Finally, `MapView` requires us to override the `isRouteDisplayed()` method to indicate whether we are displaying route information on our map. We are not, so we return `false`.

`MyLocationOverlay` encapsulates a wealth of location and mapping code. In our single call to the constructor we:

- Ask Android to figure out what location providers are available in our environment (GPS, Cell ID, triangulation).
- Connect to the “best” of those location providers.
- Ask the location provider to provide us with periodic location updates as our handset moves.
- Link to routines that will automatically move our map as needed to track any changes in location.

`MyLocationOverlay` also allows us to place a compass rose on the `MapView` and have that updated as well, but we won't be using that in `MJAndroid`.

The map attributes set by the code are:

#### `setClickable`

We want users to be able to tap on a job to cause `MJAndroid` to display more detail about that job, so we set this to `true`.

#### `setEnabled`

This method is actually inherited from `android.view.View`. Google doesn't tell us exactly what this means in the case of a `MapView`, but presumably it enables the standard map functions—zooming, panning, and so on.

#### `setSatellite`

Setting this flag adds a satellite view from the composite map, whereas clearing the flag removes the view. To start with, we don't want the satellite information on the map.

#### `setTraffic`

Similarly, setting or clearing this flag adds or removes current traffic information from the map, respectively. Again, we don't want to start with traffic information on the map.

#### `setStreetView`

We don't want street views right now either, although we'll let the user enable them later.

## Zooming in Android Maps

Android maps come equipped with support for zooming in and out. The “i” key zooms in on the map, whereas the “o” key zooms out. Maps can also zoom in and out under program control, through the `MapController`.

Several methods are defined for zooming, all using the `MapController`. Android defines 21 zoom levels for maps. At zoom level 1, the equator of the Earth is 256 pixels long. Every step up in zoom level multiplies that by 2. Google warns that the higher-resolution maps are not available worldwide. All the zoom methods clamp the zoom level to the range 1 through 21 if you ask it to go beyond those limits.

The methods that control zoom, along with their parameters, are:

`zoomIn`

Zooms in one level.

`zoomOut`

Zooms out one level.

`setZoom(int zoomLevel)`

Zooms to the given level, restricting it to the range 1 to 21.

`zoomInFixing(int xpixel, int ypixel), zoomOutFixing(int xpixel, int ypixel)`

Zoom in one level, but keep the given point fixed on the screen. Normally when you zoom in and out, the center of the screen is the only point that stays fixed. These routines let you pick any point on the map to be the fixed point.

`zoomToSpan(int latSpanE6, int longSpanE6)`

Attempts to zoom so that the given span is displayed on the map. What it actually does is select the zoom level that is the closest match for the span requested. The latitude and longitude span parameters are expressed as integers with a value  $10^6$  times the actual value in degrees. For instance, a latitude/longitude span of 2.5 degrees by 1.0 degrees would be expressed as `zoomToSpan(2500000, 1000000)`.

## Pausing and Resuming a MapActivity

For a minute, let’s focus on map activities and note a way we can help save battery power. The good news is that Android makes this pretty easy.

In a mobile environment, battery life is everything, and if we’re not the application that is currently being displayed, we want to do everything we can to minimize the power we consume. Recall from the discussion of the Android life cycle ([“Visualizing Life Cycles” on page 280](#)) that when an `Activity` (such as `MicroJobs`) starts another `Activity` (such as `MicroJobsList`), the new `Activity` takes over the screen, and the calling `Activity` gets pushed onto a stack of activities that are waiting to run. At that time, Android calls the `onPause` routine in the calling `Activity` so that it can prepare itself to go into hibernation. At this point, in `MicroJobs.java` (or just about any `MapActivity` that uses location updates), we want to turn off location updates. Doing so will at least save



the cycles devoted to doing the update, and may allow the handset to save even more power by putting the location provider in a quiescent state that uses less power.

When the called `Activity` (in our case, `MicroJobsList`) exits and the calling `Activity` is popped off the stack and takes control of the screen, the framework calls the `onResume` method in the calling `Activity`. In a `MapActivity`, we want to turn on location updates again when this method is invoked.

In `MicroJobs`, the `onPause` and `onResume` methods are straightforward:

```
/**
 * @see com.google.android.maps.MapActivity#onPause()
 */
@Override
public void onPause() {
    super.onPause();
    mMyLocationOverlay.disableMyLocation();
}

/**
 * @see com.google.android.maps.MapActivity#onResume()
 */
@Override
public void onResume() {
    super.onResume();
    mMyLocationOverlay.enableMyLocation();
}
```

Note that if we'd had a compass rose as part of our `MyLocationOverlay`, we would have to disable and enable it as well. Otherwise, the system would be wasting cycles and battery updating the direction of the compass rose, even though it wasn't visible on-screen.

## Controlling the Map with Menu Buttons

We want to give the user the ability to turn on satellite, traffic, and street views of the map. In addition, we'll throw in a few menu buttons to enable zooming and another way to get to the Jobs list.

Android has a sophisticated set of menu capabilities that includes three types of menus (options, context, and submenus), each with its own capabilities, icon menu buttons, and other advanced features. We just use text-based menu buttons. We need to do two things:

1. Create the menu of buttons that will be displayed.
2. Catch the menu events and invoke appropriate actions.

The following code creates the menu in `MicroJobs.java`:

```
/**
 * Set up menus for this page
 */
```

```

    * @see android.app.Activity#onCreateOptionsMenu(android.view.Menu)
    */
    @Override
    public boolean onCreateOptionsMenu(Menu menu) {
        boolean supRetVal = super.onCreateOptionsMenu(menu);
        menu.add(Menu.NONE, 0, Menu.NONE, getString(R.string.map_menu_zoom_in));
        menu.add(Menu.NONE, 1, Menu.NONE, getString(R.string.map_menu_zoom_out));
        menu.add(Menu.NONE, 2, Menu.NONE, getString(R.string.map_menu_set_satellite));
        menu.add(Menu.NONE, 3, Menu.NONE, getString(R.string.map_menu_set_map));
        menu.add(Menu.NONE, 4, Menu.NONE, getString(R.string.map_menu_set_traffic));
        menu.add(Menu.NONE, 5, Menu.NONE, getString(R.string.map_menu_show_list));
        return supRetVal;
    }

```

We create menu buttons by overriding the `onCreateOptionsMenu` method, where we are passed a menu parameter for the Activity's menu. After dutifully allowing the superclass a chance to do what it needs to do, we simply add items (buttons) to the menu using `menu.add`. The version of `menu.add` that we've chosen takes four parameters:

#### `int groupId`

Android allows you to group menu items so that you can quickly change the whole menu at once. We don't have a need for that in `MicroJobs`, so `Menu.NONE` says we don't need it.

#### `int itemId`

We need a unique identifier for this menu item so that we can tell later whether it was picked.

#### `int order`

The `itemId` we defined in the second parameter does not imply order. If we cared about the order in which the items were presented, we'd do that with this parameter. Since we don't care, we use `Menu.NONE` again.

#### `int titleRes`

This is the ID of the string resource we want to use for the button title. Note that this is an `Integer`, not a `String`, so the menu strings need to be predefined in `string.xml`, under the `res` directory. Recall that Android takes care of compiling the strings in `res/strings.xml` into a `.java` file (`R.java`) that assigns an integer to each string. The `getString` method retrieves that integer for you (despite the name, the method returns an integer and not a string).

To catch the menu events, we override the `onOptionsItemSelected` method:

```

/**
 * @see android.app.Activity#onOptionsItemSelected(android.view.MenuItem)
 */
@Override
public boolean onOptionsItemSelected(MenuItem item) {
    switch (item.getItemId()) {
        case 0:
            // Zoom in
            zoomIn();
            return true;
    }
}

```

```

        case 1:
            // Zoom out
            zoomOut();
            return true;
        case 2:
            // Toggle satellite views
            mvMap.setSatellite(!mvMap.isSatellite());
            return true;
        case 3:
            // Toggle street views
            mvMap.setStreetView(!mvMap.isStreetView());
            return true;
        case 4:
            // Toggle traffic views
            mvMap.setTraffic(!mvMap.isTraffic());
            return true;
        case 5:
            // Show the job list activity
            startActivity(new Intent(MicroJobs.this, MicroJobsList.class));
            return true;
    }
    return false;
}

```

We use the `MenuItem` parameter, and the switch has a case for each button that we defined for the menu. We’ve already seen code similar to that contained in each case.

## Controlling the Map with the Keypad

Some users might prefer to control the map through the keypad (generally one “click,” versus two “clicks” to cause a menu event). Enabling this behavior also demonstrates how to respond to `Keypad` events in general, so we’ve added some code to zoom in, zoom out, and back out of the current activity:

```

/**
 * @see android.app.Activity#onKeyDown(int, android.view.KeyEvent)
 */
@Override
public boolean onKeyDown(int keyCode, KeyEvent event) {
    switch (keyCode) {
        case KeyEvent.KEYCODE_DPAD_UP: // zoom in
            zoomIn();
            return true;
        case KeyEvent.KEYCODE_DPAD_DOWN: // zoom out
            zoomOut();
            return true;
        case KeyEvent.KEYCODE_BACK: // go back (meaning exit the app)
            finish();
            return true;
        default:
            return false;
    }
}

```

To catch key-down events, we simply override `onKeyDown` and provide a switch for the different keys that are of interest. In addition to the keycodes you would expect (`KEYCODE_A`, ...`KEYCODE_Z`; and things like `KEYCODE_SPACE`, `KEYCODE_SHIFT_LEFT`, and `KEYCODE_SHIFT_RIGHT`), Android includes keycodes that may or may not appear on any particular device (`KEYCODE_CAMERA` and `KEYCODE_VOLUME_UP`). A complete set of keycodes can be found at <http://code.google.com/android/reference/android/view/KeyEvent.html>.

## Location Without Maps

What if your activity needs to access location information, but it doesn't include a `MapView`? When you use a `MapView`, Android makes everything very easy with `MyLocationOverlay`, but if you don't need a map it still isn't that hard to get location information. The code in this section is not part of MJAndroid, but it shows how you obtain location information independent of `MapView`.

Let's look at a very simple, one-activity application that displays the current location in a `TextView`.

## The Manifest and Layout Files

An appropriate *AndroidManifest.xml* file follows. We created this file using the Android SDK and the Android Manifest Editor that comes as part of it. The only change we needed to make with the editor was to add the `uses-permission` tag for `android.permission.ACCESS_FINE_LOCATION` (in the next-to-last line of the file). We always need this permission in order to get location information from a GPS location provider:

```
<?xml version="1.0" encoding="utf-8"?>
  <manifest xmlns:android="http://schemas.android.com/apk/res/android"
    package="com.microjobsinc.dloc"
    android:versionCode="1"
    android:versionName="1.0.0">
    <application android:icon="@drawable/icon" android:label="@string/app_name">
      <activity android:name=".Main"
        android:label="@string/app_name">
        <intent-filter>
          <action android:name="android.intent.action.MAIN" />
          <category android:name="android.intent.category.LAUNCHER" />
        </intent-filter>
      </activity>
    </application>

    <uses-permission android:name="android.permission.ACCESS_FINE_LOCATION">
    </uses-permission>
  </manifest>
```

We'll use a very simple layout file with four `TextView`s: one label and one text box each for latitude and longitude:

```
<?xml version="1.0" encoding="utf-8"?>
  <LinearLayout xmlns:android="http://schemas.android.com/apk/res/android"
```

```

        android:orientation="vertical"
        android:layout_width="fill_parent"
        android:layout_height="fill_parent"
    >
    <TextView
        android:id="@+id/lblLatitude"
        android:layout_width="fill_parent"
        android:layout_height="wrap_content"
        android:text="Latitude:"
    />
    <TextView
        android:id="@+id/tvLatitude"
        android:layout_width="fill_parent"
        android:layout_height="wrap_content"
    />
    <TextView
        android:id="@+id/lblLongitude"
        android:layout_width="fill_parent"
        android:layout_height="wrap_content"
        android:text="Longitude:"
    />
    <TextView
        android:id="@+id/tvLongitude"
        android:layout_width="fill_parent"
        android:layout_height="wrap_content"
    />
</LinearLayout>

```

## Connecting to a Location Provider and Getting Location Updates

Let's start with an activity that just connects with the GPS LocationProvider and gets and displays our current location (no updates):

```

package com.oreilly.demo.pa.microJobs;

import android.app.Activity;
import android.content.Context;
import android.location.Location;
import android.location.LocationManager;
import android.os.Bundle;
import android.widget.TextView;

public class Main extends Activity {
    /** Called when the activity is first created. */
    @Override
    public void onCreate(Bundle savedInstanceState) {
        super.onCreate(savedInstanceState);
        setContentView(R.layout.main);

        // find the TextViews
        TextView tvLatitude = (TextView)findViewById(R.id.tvLatitude);
        TextView tvLongitude = (TextView)findViewById(R.id.tvLongitude);

        // get handle for LocationManager
        LocationManager lm = (LocationManager)

```

```

        getSystemService(Context.LOCATION_SERVICE);❶

        // connect to the GPS location service
        Location loc = lm.getLastKnownLocation("gps");❷

        // fill in the TextViews
        tvLatitude.setText(Double.toString(loc.getLatitude()));❸
        tvLongitude.setText(Double.toString(loc.getLongitude()));
    }
}

```

The procedure is pretty straightforward. Here are some of the highlights of the code:

- ❶ Connects to the `LocationManager` using `getSystemService(Context.LOCATION_SERVICE)`.
- ❷ Asks the `LocationManager` where we are using `getLastKnownLocation("provider")`.
- ❸ Gets the latitude and longitude from the `Location` returned and uses it as needed.

But we also want to get periodic location updates from the `LocationManager` so that we can track our location as we move about. For that we need to add a listener routine and ask the `LocationManager` to call it when it has an update.

Location updates from the `LocationManager` are accessible to an application through a `DispLocListener` class, so we will create an instance of this class in the `onCreate` method of our main activity. We are required to override a number of methods in `DispLocListener` to meet the `LocationListener` interface definition, but we don't need them for this application, so we'll leave the definitions empty. The full implementation follows:

```

package com.oreilly.demo.pa.MicroJobs;

import android.app.Activity;
import android.content.Context;
import android.location.Location;
import android.location.LocationListener;
import android.location.LocationManager;
import android.os.Bundle;
import android.widget.TextView;

public class Main extends Activity {
    private LocationManager lm;
    private LocationListener locListenD;
    public TextView tvLatitude;
    public TextView tvLongitude;

    /** Called when the activity is first created. */
    @Override
    public void onCreate(Bundle savedInstanceState) {
        super.onCreate(savedInstanceState);
        setContentView(R.layout.main);

        // find the TextViews
        tvLatitude = (TextView)findViewById(R.id.tvLatitude);
        tvLongitude = (TextView)findViewById(R.id.tvLongitude);
    }
}

```

```

// get handle for LocationManager
LocationManager lm =
    (LocationManager) getSystemService(Context.LOCATION_SERVICE);

// connect to the GPS location service
Location loc = lm.getLastKnownLocation("gps");

// fill in the TextViews
tvLatitude.setText(Double.toString(loc.getLatitude()));
tvLongitude.setText(Double.toString(loc.getLongitude()));

// ask the Location Manager to send us location updates
locListenD = new DispLocListener();
lm.requestLocationUpdates("gps", 30000L, 10.0f, locListenD);
}

private class DispLocListener implements LocationListener {

    @Override
    public void onLocationChanged(Location location) {
        // update TextViews
        tvLatitude.setText(Double.toString(location.getLatitude()));
        tvLongitude.setText(Double.toString(location.getLongitude()));
    }

    @Override
    public void onProviderDisabled(String provider) {
    }

    @Override
    public void onProviderEnabled(String provider) {
    }

    @Override
    public void onStatusChanged(String provider, int status, Bundle extras) {
    }
}
}

```

Our `onCreate` method creates an instance of `DispLocListener` and requests that the `LocationManager` update it as needed using `requestLocationUpdates`. This method takes four parameters:

#### String provider

Which location provider to use. We assume GPS is available in this case.

#### long minTime

Minimum update time, in milliseconds. The `LocationManager` will wait at least this long between updates. Here's an opportunity to tune your application for battery life: more frequent updates mean more battery usage.

float minDistance

Minimum distance, in meters, required to trigger an update. The `LocationManager` will update us only if we've moved at least this far since the last update.

`LocationListener listener`

The name of the listener method to call when there is an update. This is the `DispLocListener` instance we just created.

Finally, we want to add the `onPause` and `onResume` code to turn location updates off when we're not actually displaying on the user's screen, and turn them back on when we are:

```
/**
 * Turn off location updates if we're paused
 */
@Override
public void onPause() {
    super.onPause();
    lm.removeUpdates(listener);
}

/**
 * Resume location updates when we're resumed
 */
@Override
public void onResume() {
    super.onResume();
    lm.requestLocationUpdates("gps", 30000L, 10.0f, listener);
}
```

## Updating the Emulated Location

While developing and debugging an application like the one shown in the preceding section, you're normally running on the emulator. It would be nice (maybe even essential) to be able to update the current location that the emulator uses as it's running your code. Such a mock location provider can get very fancy, but Android provides some built-in ways of updating the emulated location:

- The geo program built into the Android shell
- One-time updates via DDMS
- Tracks that are sequentially updated via DDMS

We'll look at each of these.

### Using geo to update location

The geo utility is built into the Android image that runs on the emulator. It has a number of capabilities, two of which are useful here:



`geo fix`

You can use the `geo fix` command to send a location to Android by telnetting to the console of the emulated Android. The `LocationProvider` will then use this as the current location:

```
telnet localhost 5554
Android Console: type 'help' for a list of commands
OK
geo fix -122.842232 38.411908 0
OK
```

`geo fix` takes three parameters:

`longitude`

Specified in decimal

`latitude`

Also specified in decimal

`altitude`

Specified in meters

### Using DDMS to update location

In [Chapter 1](#), we discussed the Dalvik Debug Monitor Service (DDMS). Here we will discuss two features of this tool related to location updates. The Emulator Control pane of the DDMS screen provides several ways of controlling the running emulator. After switching to the DDMS perspective (click on DDMS in the upper right of the Eclipse window) you should see the Emulator Control pane in the middle left of the DDMS window ([Figure 15-1](#)). You will probably have to scroll down in that pane to see the controls related to Location Controls.

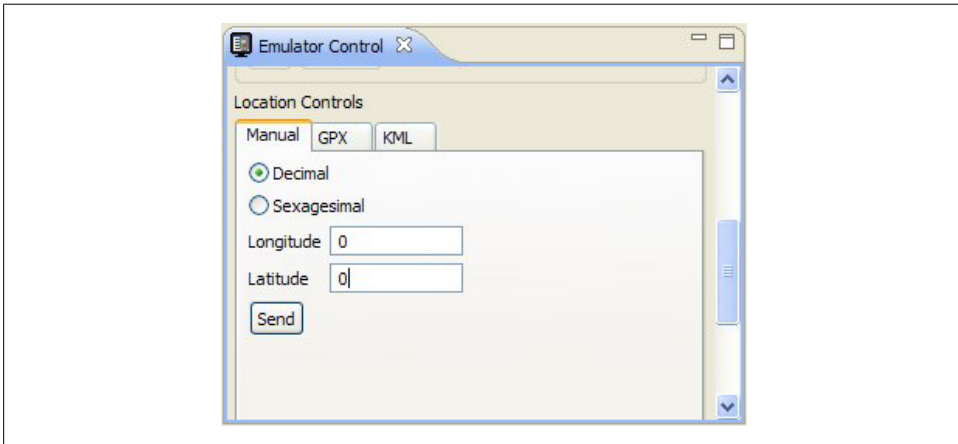

Figure 15-1. DDMS Emulator Control pane

To send a one-time update of a location to the emulator, just enter the longitude and latitude in the appropriate boxes and click Send.

If you click on either the GPX or KML tab, you will be able to load a GPX or KML file that describes a path, as shown in Figure 15-2. Here we've already loaded the file *OR.kml*, which is included on the website for this book. It traces a path near O'Reilly headquarters in Sebastopol, California.

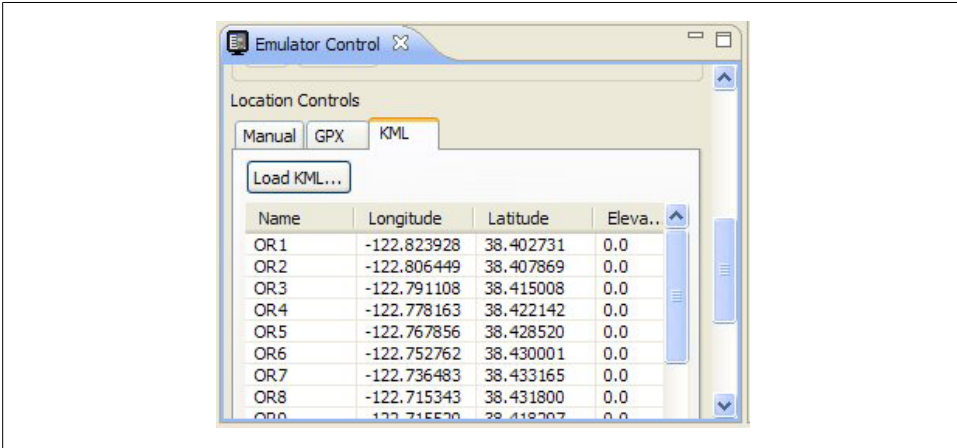

Figure 15-2. DDMS emulator with KML location updates

You can create GPX tracks with many GPS navigation software tools, and KML tracks with Google Earth or many other navigation programs. The *OR.kml* file was generated by plotting a series of Google Earth placemarks and concatenating them together into a single file. Here's an excerpt of *OR.kml*:

```
<?xml version="1.0" encoding="UTF-8"?>
<kml xmlns="http://earth.google.com/kml/2.2">
<Document>
  <name>OR1.kml</name>
  <StyleMap id="msn_ylw-pushpin">
    <Pair>
      <key>normal</key>
      <styleUrl>#sn_ylw-pushpin</styleUrl>
    </Pair>
    <Pair>
      <key>highlight</key>
      <styleUrl>#sh_ylw-pushpin</styleUrl>
    </Pair>
  </StyleMap>
  <Style id="sh_ylw-pushpin">
    <IconStyle>
      <scale>1.3</scale>
      <Icon>
        <href>http://maps.google.com/mapfiles/kml/pushpin/ylw-pushpin.png</href>
      </Icon>
    </IconStyle>
  </Style>
</Document>
```

```

        <hotSpot x="20" y="2" xunits="pixels" yunits="pixels"/>
    </IconStyle>
    <ListStyle>
    </ListStyle>
</Style>
<Style id="sn_ylw-pushpin">
    <IconStyle>
        <scale>1.1</scale>
        <Icon>
            <href>http://maps.google.com/mapfiles/kml/pushpin/ylw-pushpin.png</href>
        </Icon>
        <hotSpot x="20" y="2" xunits="pixels" yunits="pixels"/>
    </IconStyle>
    <ListStyle>
    </ListStyle>
</Style>
<Placemark>
    <name>OR1</name>
    <LookAt>
        <longitude>-122.7583711698369</longitude>
        <latitude>38.38922415809942</latitude>
        <altitude>0</altitude>
        <range>14591.7166300043</range>
        <tilt>0</tilt>
        <heading>0.04087372005871314</heading>
        <altitudeMode>relativeToGround</altitudeMode>
    </LookAt>
    <styleUrl>#msn_ylw-pushpin</styleUrl>
    <Point>
        <coordinates>-122.8239277647483,38.40273084940345,0</coordinates>
    </Point>
</Placemark>
<Placemark>
    <name>OR2</name>
    <LookAt>
        <longitude>-122.7677364592949</longitude>
        <latitude>38.3819544049429</latitude>
        <altitude>0</altitude>
        <range>11881.3330990845</range>
        <tilt>0</tilt>
        <heading>-8.006283077460853e-010</heading>
        <altitudeMode>relativeToGround</altitudeMode>
    </LookAt>
    <styleUrl>#msn_ylw-pushpin</styleUrl>
    <Point>
        <coordinates>-122.8064486052584,38.40786910573772,0</coordinates>
    </Point>
</Placemark>
<Placemark>
    <name>OR3</name>
    <LookAt>
        <longitude>-122.7677364592949</longitude>
        <latitude>38.3819544049429</latitude>
        <altitude>0</altitude>
        <range>11881.3330990845</range>

```

```
        <tilt>0</tilt>
        <heading>-8.006283077460853e-010</heading>
        <altitudeMode>relativeToGround</altitudeMode>
    </LookAt>
    <styleUrl>#msn_ylw-pushpin</styleUrl>
    <Point>
        <coordinates>-122.7911077944045,38.41500788727795,0</coordinates>
    </Point>
</Placemark>
...

```

---

# Sensors, NFC, Speech, Gestures, and Accessibility

Thanks to advances in technology, both the environment and the user can interact with devices in a variety of ways, from external sensors that can detect when a device has changed orientation within an environment, to touch-screen adaptations that enable complex gestures to trigger an event within the device. Android provides APIs that enable the developer to access these sensors and the user to interact with these devices in a variety of ways. In this chapter, we will explore some of these APIs—sensors, NFC (Near Field Communication), the Gesture libraries, and accessibility.

## Sensors

The modern smartphone provides more than just the ability to send and receive communication in various forms. The addition of external sensors that can report information about the environment the phone is in has made the phone more powerful and useful for the user as well as the developer. Starting with Android 1.5 (API level 3), a standard set of sensors are available. The physical sensors include, but are not limited to, accelerometers that measure acceleration along various axes, gyroscopes that measure rotational change around some axes, magnetic field sensors that sense the strength of magnetic fields along a set of axes, a light sensor that measures the amount of ambient light, a proximity sensor that measures external objects' proximity to the device, temperature sensors that measure ambient temperature, and pressure sensors that act as a barometer. The direct measured value of each sensor is considered a raw measurement, and thus the associative sensor is a “raw sensor.” With some of the sensors, the measurements can be combined or collected and calculations can be made over the collected measurements to show a more complex measurement. For example, by integrating the gyroscope's measurements of rotational change over time you can measure the rotational vector. This sort of complex measurement is often derived from a composite sensor.

To access a sensor or set of sensors, Android provides a convenient system service called the `SensorManager`. This can be accessed via the `getSystemService()` method of the `Context` with the argument of `Context.SENSOR_SERVICE`. With the `SensorManager` you then can get a specific sensor via the `getDefaultSensor()` method.

However, a composite sensor may sometimes be returned, so if you wish to get access to the raw sensor and its associated data, you should use `getSensorList()`:

```
SensorManager mngr =
    (SensorManager) context.getSystemService(Context.SENSOR_SERVICE);
// getting the default accelerometer
Sensor accel = mngr.getDefaultSensor (Sensor.TYPE_ACCELEROMETER);
// getting the raw accelerometer
List<Sensor> list = mngr.getSensorList(Sensor.TYPE_ACCELEROMETER);
```

Once you get a sensor or set of sensors, you can actually enable them and start getting their data by registering a listener against the sensors. Data should begin to come in at the rate you give as an argument. This rate can be `SENSOR_DELAY_NORMAL`, `SENSOR_DELAY_UI` (a rate appropriate for basic UI interaction), `SENSOR_DELAY_GAME` (a high rate that many games would find sufficient), `SENSOR_DELAY_FASTEST` (“give it to me as fast as you can”), or a specified delay between events in units of milliseconds:

```
SensorEventListener listener = new SensorEventListener() {
    @Override
    public void onAccuracyChanged(Sensor sensor, int accuracy) { }

    @Override
    public void onSensorChanged(SensorEvent event) { }
};

// registering a listener
mngr.registerListener(listener, sensor, SensorManager.SENSOR_DELAY_UI);
```

The two methods in a `SensorEventListener`—`onAccuracyChanged()` and `onSensorChanged()`—are called when data from the sensor in question is available. `onAccuracyChanged()` is called whenever a change to the degree of error or accuracy with the sensor occurs. The `onSensorChanged()` method is perhaps the more interesting method, in that the data the sensor is measuring is passed to it wrapped in a `SensorEvent` object.

It is incredibly important to unregister the listener and thus disable the sensor when you no longer need it (e.g., when an activity is paused); otherwise, the device will continue to use resources and drain power. The system will not take care of this for you even when the screen is turned off:

```
mngr.unregisterListener(listener);
```

While the sensor is on, `SensorEvent` is passed to the listener via the `onSensorChanged()` method. It is in this `SensorEvent`'s values that each sensor type differs.

## Position

The phone's coordinate system is based on the screen and default orientation of the phone. The x-, y-, and z-axes are as shown in [Figure 16-1](#) and work as follows:

### *x-axis*

Horizontal, with positive values to the right and negative values to the left

### *y-axis*

Vertical, with positive values upward and negative values downward

### *z-axis*

Positive values coming out of the screen toward the front and negative values behind the screen (the  $z$  zero point rests on the screen)

When the user moves the phone, the axes follow the phone's movement and do not swap places.

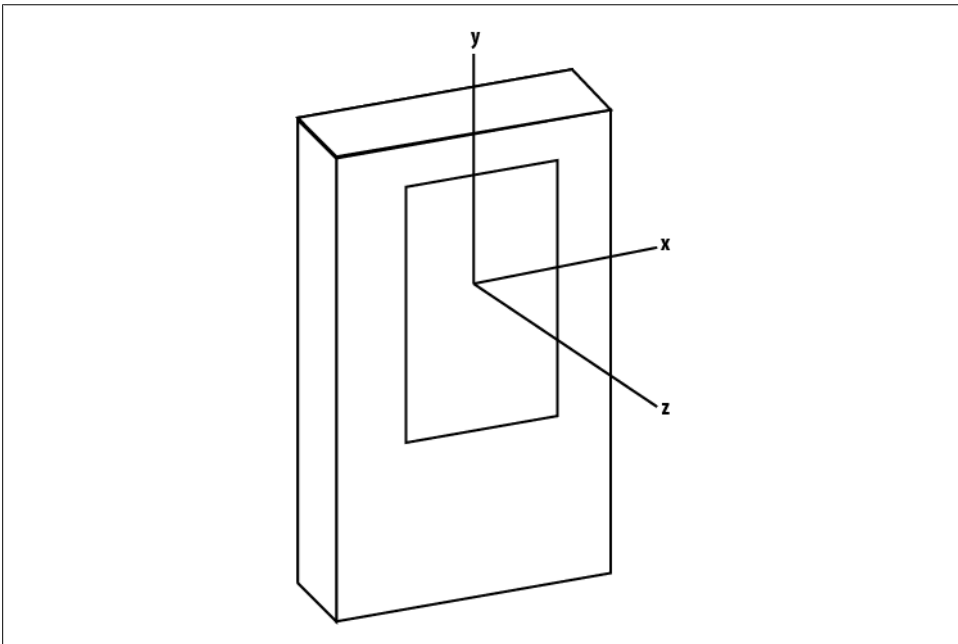

*Figure 16-1. Phone coordinate system*

The accuracy and variance of the various sensors depend on the quality of hardware. In many cases, significant levels of jitter/noise will need to be eliminated (through the use of low-pass filters, for example). The type of filter and its construction is up to the developer to design and create.

## Accelerometer

The accelerometer measures the acceleration applied to the device and returns values along the three axes (value[0] for the x-axis, value[1] for the y-axis, and value[2] for the z-axis). The values are in SI units ( $m/s^2$ ). It is important to note that the force of gravity is not eliminated from the values returned. Thus, when the device is sitting on a table (say, face up) value[2] will read  $9.81 m/s^2$ .

Since it became a fairly common need to eliminate or determine the force of gravity along the various axes, Android 2.3 (API level 9) also supports a linear acceleration sensor and a gravity sensor, discussed later in this chapter.

## Gyroscope

The gyroscope measures the angular speed or rate of rotation around the three axes. All values are in radians/second. Rotation is positive in the counterclockwise direction. That is, an observer looking at the device screen normally—located at 0, 0, 100 in device coordinates—would report positive rotation if the device appeared to be rotating counterclockwise. Since this is angular speed, to calculate an angle you must integrate the values over a period of time:

```
private static final float NS2S = 1.0f / 1000000000.0f;
private float timestamp;
private float[] angle;

@Override
public void onSensorChanged(SensorEvent event) {
    float gyrox = event.values[0];
    float gyroy = event.values[1];
    float gyroz = event.values[2];

    // here we integrate over time to figure out the rotational angle around each axis
    if (timestamp != 0) {
        final float dT = (event.timestamp - timestamp) * NS2S;
        angle[0] += gyrox * dT;
        angle[1] += gyroy * dT;
        angle[2] += gyroz * dT;
    }

    timestamp = event.timestamp;
}
```

Since this is a common problem set, Android 2.3 (API level 9) supports a rotation vector sensor, which we discuss in the following section.

## Rotation vector

The rotation vector, in Android 2.3 and later versions, represents the orientation of the device as a combination of an angle and an axis, in which the device has rotated through an angle  $\Theta$  around an axis  $\langle x, y, z \rangle$ . Even though this can be calculated via the



gyroscope, many developers ended up doing this often enough that Google provided the rotation vector to help simplify the use case.

The three elements of the rotation vector are  $\langle x \cdot \sin(\Theta/2), y \cdot \sin(\Theta/2), \text{ and } z \cdot \sin(\Theta/2) \rangle$ , such that the magnitude of the rotation vector is equal to  $\sin(\Theta/2)$  and the direction of the rotation vector is equal to the direction of the axis of rotation. The three elements of the rotation vector are equal to the last three components of a unit quaternion  $\langle \cos(\Theta/2), x \cdot \sin(\Theta/2), y \cdot \sin(\Theta/2), \text{ and } z \cdot \sin(\Theta/2) \rangle$ . Elements of the rotation vector are unitless.

### Linear acceleration

Another sensor type is supported by Android 2.3 (API level 9) to simplify a common calculation with the use of the accelerometer. The value sent is a three-dimensional vector indicating acceleration along each device axis, not including gravity. This means the values are the result of linear acceleration on each axis minus the effects of gravity along that axis. This makes it easier to filter out gravity's constant effects for those of us using the phone while on Earth. All values have units of  $m/s^2$ .

### Gravity

The values resulting from this sensor make up a three-dimensional vector indicating the direction and magnitude of gravity. This too is an Android 2.3 (API level 9) sensor that provides a common calculation. Units are  $m/s^2$ .

## Other Sensors

Android also supports the following sensors:

#### *Light*

This sensor provides a single-valued array (`value[0]`) that represents the ambient light level in SI lux units (lx).

#### *Magnetic*

This sensor measures the ambient magnetic fields in microteslas ( $\mu T$ ) along the x-, y-, and z-axes.

#### *Pressure*

Not many devices provide this sensor. Those that do will provide the values in kilopascals (kPa).

#### *Proximity*

This sensor measures a single-valued array (`value[0]`) representing distance measured in centimeters (cm) to the sensor. In some cases, the proximity sensor may provide only a “near” (0) versus “far” (1) binary measurement. In that case, a distance equal to or greater than the sensor's `getMaximumRange()` value will return “far” and anything less than that will return “near.”

### *Temperature*

This is another sensor that not many devices provide. The values will be in centigrade (C).

## Near Field Communication (NFC)

Near Field Communication is a short-range (up to 20 cm), high-frequency, wireless communication technology. It is a standard that extends the Radio Frequency Identification (RFID) standard by combining the interface of a smartcard and a reader into a single device. This standard is primarily built for mobile phone use, and thus is attracting a lot of attention among vendors that are interested in contactless data transmission (such as credit card sales). The standard enables NFC to be used in three specific ways:

### *Card emulation*

The device is a contactless card (and thus can be read by other readers).

### *Reader mode*

The device can read RFID tags.

### *P2P mode*

Two devices can communicate back and forth and exchange data.

In Android 2.3 (API level 9), Google introduced the Reader Mode NFC functionality. Starting in Android 2.3.3 (API level 10), the ability to write data to an NFC tag and exchange data via P2P mode is also available.

NFC tags consist of data encoded in NFC Data Exchange Format (NDEF), a message format specified by the NFC Forum Type 2 Specification. Each NDEF message consists of one or more NDEF records. The official technical specification for NFC can be found at <http://www.nfc-forum.org/>. To develop and test an NFC reading application it is highly suggested that you get an NFC-compliant device (such as the Nexus S, at <http://www.google.com/phone/detail/nexus-s>) and an NFC-compliant tag.

To use NFC functionality in your application, you need to declare the following permission in your manifest:

```
<uses-permission android:name="android.permission.NFC" />
```

To restrict the installation of the application to devices that can use NFC, add the following to your manifest as well:

```
<uses-feature android:name="android.hardware.nfc" />
```

## Reading a Tag

Reader mode is for receiving notices when an RFID/NFC tag is scanned. In Android 2.3 (API level 9), the only means to do this is to create an **Activity** that listens for the `android.nfc.action.TAG_DISCOVERED` intent, which is broadcast when a tag is read.

Android 2.3.3 (API level 10) offers a more comprehensive means to receive this notice, following the process shown in [Figure 16-2](#).

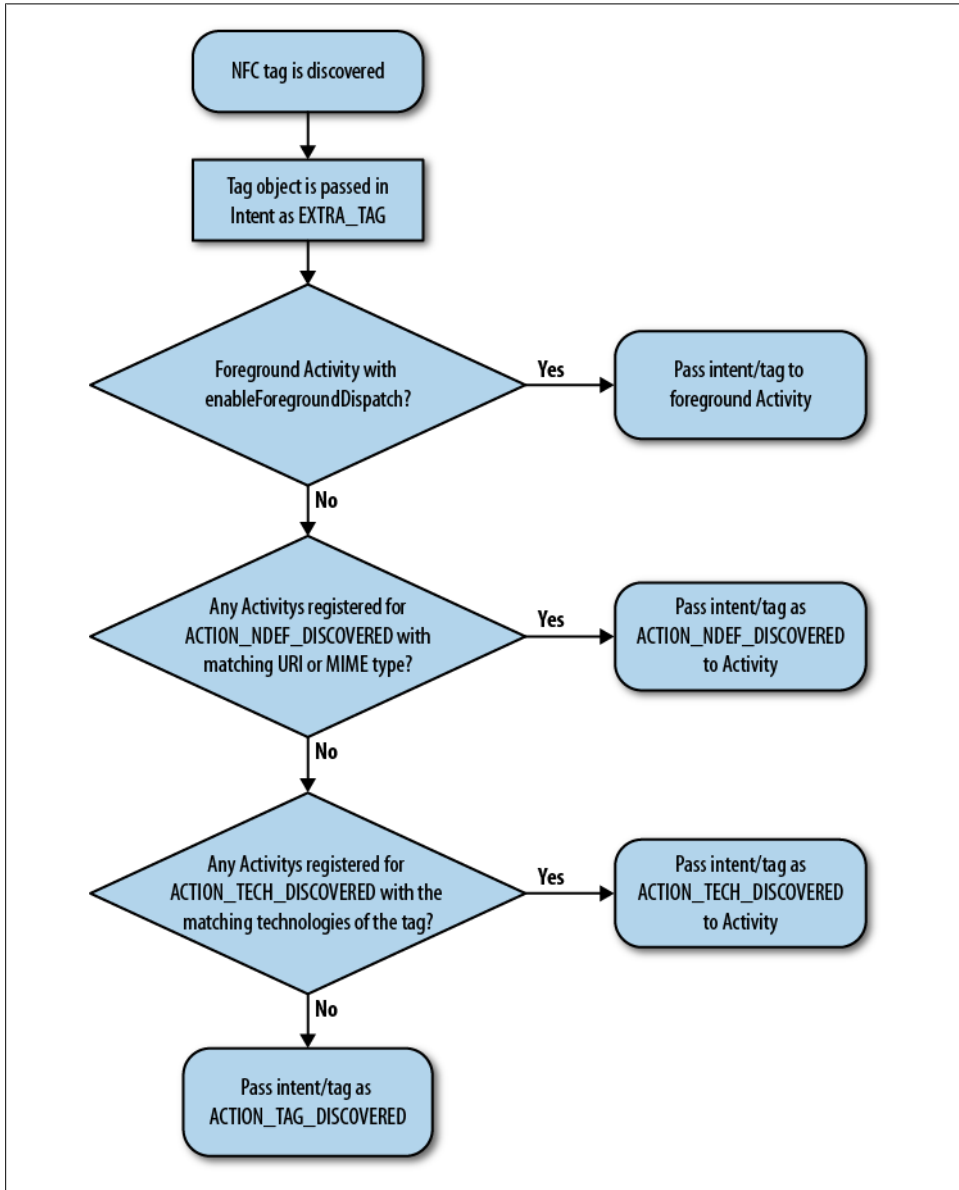

Figure 16-2. NFC tag flow in Android 2.3.3 (API level 10)

In Android 2.3.3 (API level 10) and later, when an NFC tag is discovered the tag object (a `Parcelable`) is placed into an `Intent` as an `EXTRA_TAG`. The system then begins to follow

a logic flow to determine the best `Activity` to which to send the intent. This is designed to give a high probability of dispatching a tag to the correct activity without showing the user an activity chooser dialog (i.e., in a transparent manner), and thus prevent the connection between the tag and the device from being broken by unneeded user interaction. The first thing that is checked is whether there is an `Activity` in the foreground that has called the `enableForegroundDispatch()` method. If so, the intent is passed to the `Activity` and things stop there. If not, the system inspects the first `NdefRecord` in the first `NdefMessage` of the tag's data. If the `NdefRecord` is URI, Smart Poster, or MIME data, the system then checks for an `Activity` registered for the `ACTION_NDEF_DISCOVERED` intent (`android.nfc.action.NDEF_DISCOVERED`) with that type of data. If this exists, the `Activity` that matches (the narrower the match, the better) receives the intent and things stop there. If this is not the case, the system seeks an `Activity` that is registered for `ACTION_TECH_DISCOVERED` and that matches the specific set of technologies of the tag (again, the narrower the match, the better). If there is a match, the intent is passed to that `Activity` and everything is settled. However, should no `Activity` exist that passes the prior checks, the intent is finally passed as an `ACTION_TAG_DISCOVERED` action, much as Android 2.3 (API level 9) handles the tag.

To set up a foreground `Activity` to be the first to receive the tag, you must retrieve the NFC device adapter and call `enableForegroundDispatch` with the `Activity`'s context reference. The actual NFC device adapter is represented by the `NfcAdapter` class. To retrieve the actual adapter of the device, issue `getDefaultAdapter()` in Android 2.3 (API level 9) or `getDefaultAdapter(context)` in Android 2.3.3 (API level 10):

```
NfcAdapter adapter = NfcAdapter.getDefaultAdapter();

// --- for API 10 only
// NfcAdapter adapter = NfcAdapter.getDefaultAdapter(context);

if(adapter != null) {
    // true if enabled, false if not
    boolean enabled = adapter.isEnabled();
}
```

Once the NFC device adapter is retrieved, construct a `PendingIntent` and pass it to the `enableForegroundDispatch()` method. This method must be called from the main thread and only when the `Activity` is in the foreground (after `onResume()` has been called):

```
PendingIntent intent =
    PendingIntent.getActivity(this, 0,
        new Intent(this, getClass()).addFlags(Intent.FLAG_ACTIVITY_SINGLE_TOP),
        0);

NfcAdapter.getDefaultAdapter(this).enableForegroundDispatch(this, intent,
    null, null);
```

It is extremely important that when the `Activity` leaves the foreground (when `onPause()` is called) you call the `disableForegroundDispatch()` method:

```
@Override
protected void onPause() {
```

```

        super.onPause();
        if(NfcAdapter.getDefaultAdapter(this) != null)
            NfcAdapter.getDefaultAdapter(this).disableForegroundDispatch(this);
    }
}

```

In the case of registering an Activity for ACTION\_NDEF\_DISCOVERED, the Activity must have android.nfc.action.NDEF\_DISCOVERED as an intent-filter and any specific data filters in the manifest file:

```

<activity android:name=".NFC233">
    <!-- listen for android.nfc.action.NDEF_DISCOVERED -->
    <intent-filter>
        <action android:name="android.nfc.action.NDEF_DISCOVERED"/>
        <data android:mimeType="text/*" />
    </intent-filter>
</activity>

```

This goes for the TECH\_DISCOVERED case as well (the following example also includes a metadata resource describing the specific technology that resides in the NFC tag that we are narrowing in on, such as NDEF content):

```

<activity android:name=".NFC233">
    <intent-filter>
        <action android:name="android.nfc.action.TECH_DISCOVERED" />
    </intent-filter>

    <meta-data android:name="android.nfc.action.TECH_DISCOVERED"
        android:resource="@xml/nfcfilter"
    />
</activity>

<?xml version="1.0" encoding="utf-8"?>
    <!-- capture anything using NfcF or with NDEF payloads-->
    <resources xmlns:xliff="urn:oasis:names:tc:xliff:document:1.2">
        <tech-list>
            <tech>android.nfc.tech.NfcF</tech>
        </tech-list>

        <tech-list>
            <tech>android.nfc.tech.NfcA</tech>
            <tech>android.nfc.tech.MifareClassic</tech>
            <tech>android.nfc.tech.Ndef</tech>
        </tech-list>
    </resources>

```

An example of registering for the ACTION\_TAG\_DISCOVERED intent would be written in the manifest file like this:

```

    <!-- this will show up as a dialog when the nfc tag is scanned -->
    <activity android:name=".NFC" android:theme="@android:style/Theme.Dialog">
        <intent-filter>
            <action android:name="android.nfc.action.TAG_DISCOVERED"/>
            <category android:name="android.intent.category.DEFAULT"/>
        </intent-filter>
    </activity>

```

When a tag is read, the system broadcasts an intent with the payload as the associated data. In Android 2.3.3 (API level 10), a `Tag` object is also included as an `EXTRA_TAG`. This `Tag` object provides a means to retrieve the specific `TagTechnology` and to perform advanced operations (such as I/O). Be aware that `Arrays` passed to and returned by this class are not cloned, so be careful not to modify them:

```
Tag tag = (Tag) intent.getParcelableExtra(NfcAdapter.EXTRA_TAG);
```

In Android 2.3 (API level 9) and later, the ID of the tag is wrapped within the intent and keyed with the term “`android.nfc.extra.ID`” (`NfcAdapter.EXTRA_ID`) as a byte array:

```
byte[] byte_id = intent.getByteArrayExtra(NfcAdapter.EXTRA_ID);
```

This data is packaged up as an array of `Parcelable` objects (`NdefMessage`) keyed with the term “`android.nfc.extra.NDEF_MESSAGES`” (`NfcAdapter.EXTRA_NDEF_MESSAGES`):

```
Parcelable[] msgs =
    intent.getParcelableArrayExtra(NfcAdapter.EXTRA_NDEF_MESSAGES);
NdefMessage[] nmsgs = new NdefMessage[msgs.length];
for(int i=0;i<msgs.length;i++) {
    nmsgs[i] = (NdefMessage) msgs[i];
}
```

Within each `NdefMessage` is an array of `NdefRecord`. This record will always include a 3-bit TNF (type name format), the type of record, a unique ID, and the payload. For specifics look at the `NdefRecord` doc (<http://developer.android.com/reference/android/nfc/NdefRecord.html>). Currently there are several known types, of which we cover the four most common: `TEXT`, `URI`, `SMART_POSTER`, and `ABSOLUTE_URI`:

```
// enum of types we are interested in
private static enum NFCType {
    UNKNOWN, TEXT, URI, SMART_POSTER, ABSOLUTE_URI
}

private NFCType getTagType(final NdefMessage msg) {
    if(msg == null) return null;
    // we are only grabbing the first recognizable item

    for (NdefRecord record : msg.getRecords()) {
        if(record.getTnf() == NdefRecord.TNF_WELL_KNOWN) {
            if(Arrays.equals(record.getType(), NdefRecord.RTD_TEXT)) {
                return NFCType.TEXT;
            }
            if(Arrays.equals(record.getType(), NdefRecord.RTD_URI)) {
                return NFCType.URI;
            }
            if(Arrays.equals(record.getType(), NdefRecord.RTD_SMART_POSTER)) {
                return NFCType.SMART_POSTER;
            }
        } else if(record.getTnf() == NdefRecord.TNF_ABSOLUTE_URI) {
            return NFCType.ABSOLUTE_URI;
        }
    }
    return null;
}
```

To read the payload of an `NdefRecord.RTD_TEXT` type, the first byte of the payload will define the status, and thus the encoding type of the text payload:

```

/*
 * the First Byte of the payload contains the "Status Byte Encodings" field,
 * per the NFC Forum "Text Record Type Definition" section 3.2.1.
 *
 * Bit_7 is the Text Encoding Field.
 * * if Bit_7 == 0 the the text is encoded in UTF-8
 * * else if Bit_7 == 1 then the text is encoded in UTF16
 * Bit_6 is currently always 0 (reserved for future use)
 * Bits 5 to 0 are the length of the IANA language code.
 */
private String getText(final byte[] payload) {
    if(payload == null) return null;
    try {
        String textEncoding = ((payload[0] & 0200) == 0) ? "UTF-8" : "UTF-16";
        int languageCodeLength = payload[0] & 0077;
        return new String(payload, languageCodeLength + 1,
            payload.length - languageCodeLength - 1, textEncoding);
    } catch (Exception e) {
        e.printStackTrace();
    }
    return null;
}

```

When reading in the payload of a standard URI (`NdefRecord.RTD_URI`) type, the first byte of the payload defines the URI's prefix:

```

/**
 * NFC Forum "URI Record Type Definition"
 *
 * Conversion of prefix based on section 3.2.2 of the NFC Forum URI Record
 * Type Definition document.
 */
private String convertUriPrefix(final byte prefix) {
    if(prefix == (byte) 0x00) return "";
    else if(prefix == (byte) 0x01) return "http://www.";
    else if(prefix == (byte) 0x02) return "https://www.";
    else if(prefix == (byte) 0x03) return "http://";
    else if(prefix == (byte) 0x04) return "https://";
    else if(prefix == (byte) 0x05) return "tel:";
    else if(prefix == (byte) 0x06) return "mailto:";
    else if(prefix == (byte) 0x07) return "ftp://anonymous:anonymous@";
    else if(prefix == (byte) 0x08) return "ftp://ftp.";
    else if(prefix == (byte) 0x09) return "ftps://";
    else if(prefix == (byte) 0x0A) return "sftp://";
    else if(prefix == (byte) 0x0B) return "smb://";
    else if(prefix == (byte) 0x0C) return "nfs://";
    else if(prefix == (byte) 0x0D) return "ftp://";
    else if(prefix == (byte) 0x0E) return "dav://";
    else if(prefix == (byte) 0x0F) return "news:";
    else if(prefix == (byte) 0x10) return "telnet://";
    else if(prefix == (byte) 0x11) return "imap:";
    else if(prefix == (byte) 0x12) return "rtsp://";
    else if(prefix == (byte) 0x13) return "urn:";
}

```

```

else if(prefix == (byte) 0x14) return "pop:";
else if(prefix == (byte) 0x15) return "sip:";
else if(prefix == (byte) 0x16) return "sips:";
else if(prefix == (byte) 0x17) return "tftp:";
else if(prefix == (byte) 0x18) return "btspp://";
else if(prefix == (byte) 0x19) return "bt12cap://";
else if(prefix == (byte) 0x1A) return "btgoep://";
else if(prefix == (byte) 0x1B) return "tcpobex://";
else if(prefix == (byte) 0x1C) return "irdaobex://";
else if(prefix == (byte) 0x1D) return "file://";
else if(prefix == (byte) 0x1E) return "urn:epc:id:";
else if(prefix == (byte) 0x1F) return "urn:epc:tag:";
else if(prefix == (byte) 0x20) return "urn:epc:pat:";
else if(prefix == (byte) 0x21) return "urn:epc:raw:";
else if(prefix == (byte) 0x22) return "urn:epc:";
else if(prefix == (byte) 0x23) return "urn:nfc:";
return null;
}

```

In the case of an absolute URI (NdefRecord.TNF\_ABSOLUTE\_URI) type, the whole payload is encoded in UTF-8 and makes up the URI:

```

if(record.getTnf() == NdefRecord.TNF_ABSOLUTE_URI) {
    String uri = new String(record.getPayload(), Charset.forName("UTF-8"));
}

```

The special Smart Poster (NdefRecord.RTD\_SMART\_POSTER) type consists of multiple subrecords of text or URI (or absolute URI) data:

```

private void getTagData(final NdefMessage msg) {
    if(Arrays.equals(record.getType(), NdefRecord.RTD_SMART_POSTER)) {
        try {
            // break out the subrecords
            NdefMessage subrecords = new NdefMessage(record.getPayload());
            // get the subrecords
            String fullldata = getSubRecordData(subrecords);
            System.out.println("SmartPoster: "+fullldata);
        } catch (Exception e) {
            e.printStackTrace();
        }
    }
}

```

```

// method to get subrecord data
private String getSubRecordData(final NdefRecord[] records) {
    if(records == null || records.length < 1) return null;
    String data = "";
    for(NdefRecord record : records) {
        if(record.getTnf() == NdefRecord.TNF_WELL_KNOWN) {
            if(Arrays.equals(record.getType(), NdefRecord.RTD_TEXT)) {
                data += getText(record.getPayload()) + "\n";
            }
            if(Arrays.equals(record.getType(), NdefRecord.RTD_URI)) {
                data += getURI(record.getPayload()) + "\n";
            }
        } else {
            data += "OTHER KNOWN DATA\n";
        }
    }
}

```



```

    }
    } else if(record.getTnf() == NdefRecord.TNF_ABSOLUTE_URI) {
        data += getAbsoluteURI(record.getPayload()) + "\n";
    } else data += "OTHER UNKNOWN DATA\n";
    }
    return data;
}
}

```

## Writing to a Tag

As of Android 2.3.3 (API level 10), the ability to write data to a tag is available. To do this, the `Tag` object must be used to get the appropriate `TagTechnology` within the tag. NFC tags are based on a number of independently developed technologies and offer a wide range of capabilities. The `TagTechnology` implementations provide access to these different technologies and capabilities. In this case, the NDEF technology is needed to retrieve and modify the `NdefRecords` and `NdefMessages` in the tag:

```

// get the tag from the Intent
Tag mytag = (Tag) intent.getParcelableExtra(NfcAdapter.EXTRA_TAG);

// get the Ndef (TagTechnology) from the tag
Ndef ndefref = Ndef.get(mytag);

```

Note the following requirements when performing I/O operations with a `TagTechnology`:

- `connect()` must be called before using any other I/O operation.
- I/O operations may block, and should never be called on the main application thread.
- Only one `TagTechnology` can be connected at a time. Other calls to `connect()` will return an `IOException`.
- `close()` must be called after completing I/O operations with a `TagTechnology`, and it will cancel all other blocked I/O operations on other threads (including `connect()`) with an `IOException`.

Therefore, to write data to a tag, a `connect()` is called from within a thread that is separate from that of the main thread. Once this is done, `isConnected()` should be checked to verify that the connection has been established. If the connection is established, `writeNdefMessage()` with a constructed `NdefMessage` (containing at least one `NdefRecord`) may be called. Once the data is written, `close()` is called to cleanly terminate the process.

The full code to write a text record to a tag using its NDEF `TagTechnology` reference is as follows:

```

// pass in the Ndef TagTechnology reference and the text we wish to encode

private void writeTag(final Ndef ndefref, final String text) {
    if(ndefref == null || text == null || !ndefref.isWritable()) {
        return;
    }
}

```

```

    }

    (new Thread() {
        public void run() {
            try {
                Message.obtain(mgsToaster, 0,
                    "Tag writing attempt started").sendToTarget();
                int count = 0;
                if(!ndefref.isConnected()) {
                    ndefref.connect();
                }
                while(!ndefref.isConnected()) {
                    if(count > 6000) {
                        throw new Exception("Unable to connect to tag");
                    }
                    count++;
                    sleep(10);
                }
                ndefref.writeNdefMessage(msg);
                Message.obtain(mgsToaster, 0,
                    "Tag write successful!").sendToTarget();
            } catch (Exception t) {
                t.printStackTrace();
                Message.obtain(mgsToaster, 0,
                    "Tag writing failed! - "+t.getMessage()).sendToTarget();
            } finally {
                // ignore close failure...
                try { ndefref.close(); }
                catch (IOException e) { }
            }
        }
    }).start();
}

// create a new NdefRecord
private NdefRecord newTextRecord(String text) {
    byte[] langBytes = Locale.ENGLISH.
        getLanguage().
        getBytes(Charset.forName("US-ASCII"));

    byte[] textBytes = text.getBytes(Charset.forName("UTF-8"));

    char status = (char) (langBytes.length);

    byte[] data = new byte[1 + langBytes.length + textBytes.length];
    data[0] = (byte) status;
    System.arraycopy(langBytes, 0, data, 1, langBytes.length);
    System.arraycopy(textBytes, 0, data, 1 + langBytes.length, textBytes.length);

    return new NdefRecord(NdefRecord.TNF_WELL_KNOWN,
        NdefRecord.RTD_TEXT,
        new byte[0],
        data);
}

```

## P2P Mode

P2P mode is enabled in Android 2.3.3 (API level 10) when one device is set up to transmit data over NFC to another device that can receive NFC data. The sending device may also receive data from the receiving device, and thus peer-to-peer (P2P) communication occurs. To do this, the `enableForegroundNdefPush()` method in the `NfcAdapter` class is used. This enables the `Activity` to transmit an `NdefMessage`, when it is in the foreground, to another NFC device that supports the “com.android.npp” NDEF push protocol. The `enableForegroundNdefPush()` method must be called from the main thread (such as in `onResume()`):

```
@Override
public void onResume() {
    super.onResume();

    NdefRecord[] rec = new NdefRecord[1];
    rec[0] = newTextRecord("NFC Foreground Push Message");
    NdefMessage msg = new NdefMessage(rec);

    NfcAdapter.getDefaultAdapter(this).enableForegroundNdefPush(this, msg);
}

// create a new NdefRecord
private NdefRecord newTextRecord(String text) {
    byte[] langBytes = Locale.ENGLISH.
        getLanguage().
        getBytes(Charset.forName("US-ASCII"));

    byte[] textBytes = text.getBytes(Charset.forName("UTF-8"));

    char status = (char) (langBytes.length);

    byte[] data = new byte[1 + langBytes.length + textBytes.length];
    data[0] = (byte) status;
    System.arraycopy(langBytes, 0, data, 1, langBytes.length);
    System.arraycopy(textBytes, 0, data, 1 + langBytes.length, textBytes.length);

    return new NdefRecord(NdefRecord.TNF_WELL_KNOWN,
        NdefRecord.RTD_TEXT,
        new byte[0],
        data);
}
```

While `enableForegroundNdefPush()` is active, standard tag dispatch is disabled. Only the foreground activity may receive tag-discovered dispatches via `enableForegroundDispatch()`.

It is important that when the `Activity` is no longer in the foreground (`onPause()`) `disableForegroundNdefPush()` is called:

```
@Override
protected void onPause() {
    super.onPause();
}
```

```

        if(NfcAdapter.getDefaultAdapter(this) != null) {
            NfcAdapter.getDefaultAdapter(this).disableForegroundNdefPush(this);
        }
    }
}

```

## Gesture Input

In the world of touch-screen devices, the use of complex gestures (such as multiple swipes of the finger in different directions on the screen) is a great way to make interactions both fun and easy to do. Starting with Android 1.6 (API level 4), a gestures API is available for use. Within this API, the easiest way to add gesture input capability to an app is to use `android.gesture.GestureOverlayView`:

```

<!-- an example usage of GestureOverlayView in a layout xml -->

<android.gesture.GestureOverlayView
    xmlns:android="http://schemas.android.com/apk/res/android"
    android:id="@+id/gestures"
    android:layout_width="fill_parent"
    android:layout_height="fill_parent"
    android:gestureStrokeType="multiple"
    android:eventsInterceptionEnabled="true">
</android.gesture.GestureOverlayView>

```

`GestureOverlayView` is a specialized `FrameLayout` that you can place over other widgets or that can contain other widgets. It can capture strokes on the touch screen as well as display a colored line (the default is yellow) representing the stroke path. A `GestureOverlayView.OnGesturePerformedListener` interface is provided to enable the ability to react to a gesture that has been performed:

```

GestureOverlayView gestures = (GestureOverlayView) findViewById(R.id.gestures);
gestures.addOnGesturePerformedListener(
    new GestureOverlayView.OnGesturePerformedListener() {
        @Override
        public void onGesturePerformed(GestureOverlayView overlay, Gesture gesture) {
            // do nothing for now
        }
    });

```

Once the gesture is performed, you can see if it is recognized within the Gesture library. The Gesture library can be read in via various means using the `GestureLibraries` class's static methods. Once the library is loaded (loading a `GestureStore`), the performed gesture can be passed to it and then analyzed using the `recognize` method. This method returns a list of `Predictions`, each holding a score and name, with the score indicating the closeness to the named gesture within the library:

```

final GestureLibrary library = GestureLibraries.fromFile("/Some/File/Path");
library.load(); // load library

GestureOverlayView gestures = (GestureOverlayView) findViewById(R.id.gestures);
gestures.addOnGesturePerformedListener(
    new GestureOverlayView.OnGesturePerformedListener() {

```

```

@Override
public void onGesturePerformed(GestureOverlayView overlay, Gesture gesture) {
    // do the recognize
    ArrayList<Prediction> predictions = library.recognize(gesture);
    if (predictions.size() > 0) {
        for(Prediction prediction: predictions) {
            // the score is high enough that we know it's a hit
            if (prediction.score > 1.0) {
                // let's show a toast telling us what the gesture is named
                Toast.makeText(this,
                    prediction.name, Toast.LENGTH_SHORT).show();
            }
        }
    }
}
});

```

The basic anatomy of a `Gesture` consists of multiple `GestureStroke` objects, and each `GestureStroke` object is made up of `GesturePoint` objects. The `GesturePoint` is made up of  $x$  and  $y$  spatial coordinates and a single timestamp indicating when the point was generated. When a `Gesture` is stored in a `GestureStore` (within a `GestureLibrary`) it is keyed with a name (`String`).

Adding a `Gesture` to a `GestureLibrary` is pretty straightforward. You provide a name to associate the gesture, as well as the `Gesture` object, and then save it to the library. Note that a library must be read from an external file source (such as the SD card or private file) for the library to be modifiable and, thus, a gesture store. A library read from a raw resource is read-only (use of `GestureLibraries.fromRawResource(context, resId)`):

```

public void saveGesture(String name, Gesture gesture) {
    library.addGesture(name, gesture);
    library.save();
}

```

## Accessibility

Starting with Android 1.6 (API level 4), an accessibility API designed to make Android apps more widely usable by blind and low-vision users is available. The core of the accessibility API is the `AccessibilityService`, an abstract class that is run in the background.

This use of the `AccessibilityService` ultimately means you are extending it, and thus it is a service and must be declared within the manifest. Not only must the declaration be made, but this type of service also has a specific intent it must handle (`android.accessibilityservice.AccessibilityService`):

```

<service android:name=".Accessibility">
    <intent-filter>
        <action android:name="android.accessibilityservice.AccessibilityService" />
    </intent-filter>
</service>

```

```
</intent-filter>
</service>
```

When creating an `AccessibilityService` class you must declare the feedback and event types. You do this by generating an `AccessibilityServiceInfo` object, setting the various variables, and then passing it to the `setServiceInfo()` method. Please note that the system will pick up this information only after it has bound to the class/object:

```
AccessibilityServiceInfo info = new AccessibilityServiceInfo();
info.eventTypes = AccessibilityEvent.TYPES_ALL_MASK;
// timeout (ms) after the most recent event of a given type before notification
info.notificationTimeout = 50;
info.feedbackType = AccessibilityServiceInfo.FEEDBACK_GENERIC |
                    AccessibilityServiceInfo.FEEDBACK_AUDIBLE |
                    AccessibilityServiceInfo.FEEDBACK_HAPTIC |
                    AccessibilityServiceInfo.FEEDBACK_SPOKEN |
                    AccessibilityServiceInfo.FEEDBACK_VISUAL;

info.packageNames = new String[1];
// only handle this package
info.packageNames[0] = getPackageName();
setServiceInfo(info);
```

Once the service has started and the system has bound to it, events will be received and passed to the `onAccessibilityEvent()` method:

```
@Override
public void onAccessibilityEvent(AccessibilityEvent event) {
    // here we check to see if it was a 'click' event
    if(event.getEventType() == AccessibilityEvent.TYPE_VIEW_CLICKED) {
        // do something with the click event
    }
}
```

At this point, you have various options to react to the event. Usually the `Vibrator Service` is used to provide a haptic response along with sound or speech. The `Vibrator` is a system-level service that is retrieved via the context `getSystemService()` method. Once the `Vibrator` object is retrieved, a pattern of vibrations can be applied when reacting to an event:

```
// get Vibrator
Vibrator vibrate = (Vibrator) getSystemService(Service.VIBRATOR_SERVICE);
// pattern to vibrate with
long[] pattern = new long[] { 0L, 100L };
// vibrate
vibrate.vibrate(pattern, -1);
```

Android provides a `TextToSpeech` engine that you can use to provide speech. To use this you instantiate an `android.speech.tts.TextToSpeech` class, which initializes the `TextToSpeech` engine. Once initialized, speech can be produced by calling the `speak` method on the class. A variety of methods and options can be called, such as setting locale, pitch, or speech speed. Be sure to call the `shutdown` method when the `TextToSpeech` instance is no longer needed so that its resources can be recovered:

```
TextToSpeech tts = new TextToSpeech(thisContext, new TextToSpeech.OnInitListener() {
    @Override
    public void onInit(int status) {
        // notification when the TextToSpeech Engine has been initialized
    }
});

// say 'click'
tts.speak("Click", 2, null);
// no longer needed and thus we shut down and release the resources
tts.shutdown();
```

For more accessibility-related resources check out the Eyes-Free open source project (<http://code.google.com/p/eyes-free>).





---

# Communication, Identity, Sync, and Social Media

One of the primary data types that is stored and used (and reused) in Android is contact data. This consists of the various pieces of information associated with a contact—name, phone number, email, and so on. In Android 2.0 (API level 5), contact data was significantly expanded (allowing access to multiple accounts and support for aggregation of similar contacts). In earlier chapters we covered the use of content providers and Android database classes, so we will not cover that preliminary material in this chapter. Instead, we will focus on the use of the `ContactsContract` content provider.

## Account Contacts

To access the account contacts the following permissions must be provided in the manifest:

```
<uses-permission android:name="android.permission.GET_ACCOUNTS" />
<uses-permission android:name="android.permission.READ_CONTACTS" />
<uses-permission android:name="android.permission.WRITE_CONTACTS" />
```

Within an Activity, we can use the `managedQuery` method to query the `ContactsContract.Contacts` data and return a `Cursor` for our use:

```
private Cursor getContacts() {
    Uri uri = ContactsContract.Contacts.CONTENT_URI;

    String[] projection = new String[] {
        ContactsContract.Contacts._ID,
        ContactsContract.Contacts.LOOKUP_KEY,
        ContactsContract.Contacts.DISPLAY_NAME
    };

    String selection = null;
    String[] selectionArgs = null;
    String sortOrder = ContactsContract.Contacts.DISPLAY_NAME +
        " COLLATE LOCALIZED ASC";
```

```

        return managedQuery(uri, projection, selection, selectionArgs, sortOrder);
    }

```

For complete information on the columns and constants available in the `ContactsContract.Contacts` class, refer to the developer documentation at <http://developer.android.com/reference/android/provider/ContactsContract.Contacts.html>.

Once we have the `Cursor`, we can load it within a `SimpleCursorAdapter` and have it display the specific data fields we want, in this case the “display name” of the contact:

```

String[] fields = new String[] {
    ContactsContract.Data.DISPLAY_NAME
};
SimpleCursorAdapter adapter = new SimpleCursorAdapter(this,
    R.layout.contact,
    cursor,
    fields,
    new int[] {R.id.name});

// get the listview
ListView contactlist = (ListView) findViewById(R.id.contactlist);
// set the adapter and let it render
contactlist.setAdapter(adapter);

```

Here is the layout that contains the `ListView` (referenced as `R.id.contactlist`):

```

<?xml version="1.0" encoding="utf-8"?>
<LinearLayout xmlns:android="http://schemas.android.com/apk/res/android"
    android:orientation="vertical"
    android:layout_width="fill_parent"
    android:layout_height="fill_parent"
    android:background="#fff"
    >
    <ListView android:id="@+id/contactlist"
        android:layout_width="fill_parent"
        android:layout_height="wrap_content"
        />
</LinearLayout>

```

Here is the contact layout (referenced as `R.layout.contact`) used for the `SimpleCursorAdapter`:

```

<?xml version="1.0" encoding="utf-8"?>

<LinearLayout xmlns:android="http://schemas.android.com/apk/res/android"
    android:layout_width="wrap_content"
    android:layout_height="wrap_content"
    android:background="#fff"
    >
    <TextView android:id="@+id/name"
        android:layout_width="fill_parent"
        android:layout_height="wrap_content"
        android:textColor="#000"
        android:textSize="25sp"
        android:padding="5dp"
    >

```

```

        />
    </LinearLayout>

```

Here we delete a contact by providing the `Cursor` and the position within the `Cursor` to delete:

```

private void deleteContact(Cursor cursor, int position) {
    cursor.moveToPosition(position);
    long id = cursor.getLong(0);
    String lookupkey = cursor.getString(1);
    Uri uri = ContactsContract.Contacts.getLookupUri(id, lookupkey);

    String[] selectionArgs = null;
    String where = null;
    ContentResolver cr = getContentResolver();
    cr.delete(uri, where, selectionArgs);
}

```

To add a contact in this example we construct a collection of `ContentProviderOperations` and batch-apply them. Note that we first insert the new contact and then add the phone information should it be available (as it is in this case). In order to do the inserts, we generate an insert-specific `ContentProviderOperation` by creating a `ContentProviderOperation.Builder` with the `SimpleCursorContentProviderOperation.newInsert()` method and then building with the `build()` method:

```

String accountNameWeWant = "SpecialAccount";

String phone = "8885551234";
String name = "Bob";

String accountname = null;
String accounttype = null;

Account[] accounts = AccountManager.get(this).getAccounts();

// find the account we want. if we don't find it we use 'null' - the default
for(Account account : accounts) {
    if(account.equals(accountNameWeWant)) {
        accountname = account.name;
        accounttype = account.type;
        break;
    }
}

ArrayList<ContentProviderOperation> ops =
    new ArrayList<ContentProviderOperation>();

ops.add(ContentProviderOperation.newInsert
    (ContactsContract.RawContacts.CONTENT_URI)
        .withValue(ContactsContract.RawContacts.ACCOUNT_TYPE, accountname)
        .withValue(ContactsContract.RawContacts.ACCOUNT_NAME, accounttype)
        .build());

// create the new contact
ops.add(

```

```

        ContentProviderOperation.newInsert(ContactsContract.Data.CONTENT_URI)
            .withValueBackReference(ContactsContract.Data.RAW_CONTACT_ID, 0)
            .withValue(ContactsContract.Data.MIMETYPE,
                ContactsContract.CommonDataKinds.StructuredName.CONTENT_ITEM_TYPE)
            .withValue(ContactsContract.CommonDataKinds.StructuredName.DISPLAY_NAME,
                name)
            .build());

// if there is a phone num we add it
if(phone.getText() != null
    && phone.getText().toString().trim().length() > 0) {
    ops.add(ContentProviderOperation.newInsert
        (ContactsContract.Data.CONTENT_URI)
            .withValueBackReference(ContactsContract.Data.RAW_CONTACT_ID, 0)
            .withValue(ContactsContract.Data.MIMETYPE,
                ContactsContract.CommonDataKinds.Phone.CONTENT_ITEM_TYPE)
            .withValue(ContactsContract.CommonDataKinds.Phone.NUMBER,
                phone)
            .withValue(ContactsContract.CommonDataKinds.Phone.TYPE,
                ContactsContract.CommonDataKinds.Phone.TYPE_HOME)
            .build());
}

try {
    getContentResolver().applyBatch(ContactsContract.AUTHORITY, ops);
} catch (Exception e) {
    e.printStackTrace();
}

```

## Authentication and Synchronization

Starting with Android 2.0 (API level 5), it is possible to write custom sync providers to integrate with system contacts, calendars, and so forth. Synchronizing with a remote service at this time is unfortunately a precarious endeavor, as any misstep at particular points can literally cause the Android system to crash and reboot (with very little indication as to what was done incorrectly). Hopefully, as Android evolves, synchronizing will become easier and less tricky. For now, the process consists of two parts—authentication (Account Authenticator) and synchronization (Sync Provider).

Before diving into the details of the two parts, we would like to note that the examples we provide here have two components—a server side and the Android client side. The server side that we use is a basic web service that accepts specific GET requests and responds back with a JSON-formatted response. The relevant GET URI as well as the example response are provided within each section. The source that comes with this book includes the full server-side source for completeness.

The other thing to note is that in the example we provide, we choose to sync with the account contacts. This is not the only thing that you can sync up. You can sync up with any content provider you have access to, or even to application-specific stored data.

## Authentication

To get the client to authenticate with a remote server using the Android Account Authenticator system, three pieces must be put into place:

- A service that is triggered by the `android.accounts.AccountAuthenticator` intent and that, in its `onBind` method, returns a subclass of `AbstractAccountAuthenticator`
- An activity that prompts the user to enter her credentials
- An XML file describing how your account should look when displayed to the user

Let's address the service first. In the manifest we need `android.permission.AUTHENTICATE_ACCOUNTS` to be enabled:

```
<uses-permission android:name="android.permission.AUTHENTICATE_ACCOUNTS" />
```

Then the service needs to be described in the manifest. Note that the `android.accounts.AccountAuthenticator` intent is included within the `intent-filter` descriptor. The manifest also describes a resource for the `AccountAuthenticator`:

```
<service android:name=".sync.authsync.AuthenticationService">
  <intent-filter>
    <action android:name="android.accounts.AccountAuthenticator" />
  </intent-filter>
  <meta-data android:name="android.accounts.AccountAuthenticator"
    android:resource="@xml/authenticator" />
</service>
```

The resource we indicated in the manifest follows. In particular, it describes the `accountType` that will distinguish this authenticator from other authenticators using the account's definition. Be very careful with this XML document (e.g., do not directly assign a string to the `android:label` or have a missing drawable indicated), as Android will crash and burn the moment you attempt to add a new account (from within the Account & Sync settings):

```
<?xml version="1.0" encoding="utf-8"?>
<account-authenticator xmlns:android="http://schemas.android.com/apk/res/android"
  android:accountType="com.oreilly.demo.pa.ch17.sync"
  android:icon="@drawable/icon"
  android:smallIcon="@drawable/icon"
  android:label="@string/authlabel"
/>
```

Now that the service is described within the manifest, we can turn to the service itself. Note that the `onBind()` method returns an `Authenticator` class. This class extends the `AbstractAccountAuthenticator` class:

```
package com.oreilly.demo.pa.ch17.sync.authsync;

import android.app.Service;
import android.content.Intent;
import android.os.IBinder;
```

```

public class AuthenticationService extends Service {
    private static final Object lock = new Object();
    private Authenticator auth;

    @Override
    public void onCreate() {
        synchronized (lock) {
            if (auth == null) {
                auth = new Authenticator(this);
            }
        }
    }

    @Override
    public IBinder onBind(Intent intent) {
        return auth.getIBinder();
    }
}

```

Before we get to the full source of the `Authenticator` class, there is a method within the `AbstractAccountAuthenticator` that is important—`addAccount()`. This method ultimately is called when the button indicating our custom account is selected from the Add Account screen. A `LoginActivity` (our custom `Activity`, which will ask the user to sign in) is described within the `Intent` that is placed within the `Bundle` that is returned. The `AccountManager.KEY_ACCOUNT_AUTHENTICATOR_RESPONSE` key included in the intent is vital, as it includes the `AccountAuthenticatorResponse` object that is needed to ship back the account keys once the user has successfully certified against the remote service:

```

public class Authenticator extends AbstractAccountAuthenticator {

    public Bundle addAccount(AccountAuthenticatorResponse response,
        String accountType, String authTokenType,
        String[] requiredFeatures, Bundle options) {

        Intent intent = new Intent(context, LoginActivity.class);
        intent.putExtra(AccountManager.KEY_ACCOUNT_AUTHENTICATOR_RESPONSE, response);
        Bundle bundle = new Bundle();
        bundle.putParcelable(AccountManager.KEY_INTENT, intent);
        return bundle;
    }
}

```

Now for the full `Authenticator` activity that extends the `AbstractAccountAuthenticator`:

```

package com.oreilly.demo.pa.ch17.sync.authsync;

import com.oreilly.demo.pa.ch17.sync.LoginActivity;
import android.accounts.AbstractAccountAuthenticator;
import android.accounts.Account;
import android.accounts.AccountAuthenticatorResponse;
import android.accounts.AccountManager;
import android.content.Context;
import android.content.Intent;
import android.os.Bundle;

```

```

public class Authenticator extends AbstractAccountAuthenticator {
    public static final String AUTHTOKEN_TYPE
        = "com.oreilly.demo.pa.ch17.sync";
    public static final String ACCOUNT_TYPE
        = "com.oreilly.demo.pa.ch17.sync";

    private final Context context;

    public Authenticator(Context context) {
        super(context);
        this.context = context;
    }

    @Override
    public Bundle addAccount(AccountAuthenticatorResponse response,
        String accountType, String authTokenType,
        String[] requiredFeatures, Bundle options) {

        Intent intent = new Intent(context, LoginActivity.class);
        intent.putExtra(AccountManager.KEY_ACCOUNT_AUTHENTICATOR_RESPONSE, response);
        Bundle bundle = new Bundle();
        bundle.putParcelable(AccountManager.KEY_INTENT, intent);
        return bundle;
    }

    @Override
    public Bundle confirmCredentials(AccountAuthenticatorResponse response,
        Account account, Bundle options) {
        return null;
    }

    @Override
    public Bundle editProperties(AccountAuthenticatorResponse response,
        String accountType) {

        return null;
    }

    @Override
    public Bundle getAuthToken(AccountAuthenticatorResponse response,
        Account account, String authTokenType, Bundle loginOptions) {

        return null;
    }

    @Override
    public String getAuthTokenLabel(String authTokenType) {

        return null;
    }

    @Override
    public Bundle hasFeatures(AccountAuthenticatorResponse response,
        Account account, String[] features) {

        return null;
    }
}

```

```

    }

    @Override
    public Bundle updateCredentials(AccountAuthenticatorResponse response,
        Account account, String authTokenType, Bundle loginOptions) {
        return null;
    }
}

```

For this exercise, the remote server has a login API call (accessed via an HTTP URI) that takes the username and password as variables. Should the login succeed, the response comes back with a JSON string containing a token:

```

uri: http://<serverBaseUrl>:<port>/login?username=<name>&password=<pass>

response: { "token" : "someAuthenticationToken" }

```

The `LoginActivity` that requests the user to input the username and password for the account then proceeds to contact the remote server. Once the expected JSON string is returned, the `handleLoginResponse()` method is called and passes the relevant information about the account back to the `AccountManager`:

```

package com.oreilly.demo.pa.ch17.sync;

import org.json.JSONObject;

import com.oreilly.demo.pa.ch17.R;
import com.oreilly.demo.pa.ch17.sync.authsync.Authenticator;
import android.accounts.Account;
import android.accounts.AccountAuthenticatorActivity;
import android.accounts.AccountManager;
import android.app.Dialog;
import android.app.ProgressDialog;
import android.content.ContentResolver;
import android.content.Intent;
import android.os.Bundle;
import android.os.Handler;
import android.os.Message;
import android.provider.ContactsContract;
import android.view.View;
import android.view.View.OnClickListener;
import android.widget.EditText;
import android.widget.Toast;

public class LoginActivity extends AccountAuthenticatorActivity {
    public static final String PARAM_AUTHTOKEN_TYPE = "authtokenType";
    public static final String PARAM_USERNAME = "username";
    public static final String PARAM_PASSWORD = "password";

    private String username;
    private String password;

    @Override
    public void onCreate(Bundle savedInstanceState) {

```



```

        super.onCreate(savedInstanceState);
        getVars();
        setupView();
    }

    @Override
    protected Dialog onCreateDialog(int id) {
        final ProgressDialog dialog = new ProgressDialog(this);
        dialog.setMessage("Attempting to login");
        dialog.setIndeterminate(true);
        dialog.setCancelable(false);
        return dialog;
    }

    private void getVars() {
        username = getIntent().getStringExtra(PARAM_USERNAME);
    }

    private void setupView() {
        setContentView(R.layout.login);

        findViewById(R.id.login).setOnClickListener(new OnClickListener() {
            @Override
            public void onClick(View v) {
                login();
            }
        });

        if(username != null) {
            ((EditText) findViewById(R.id.username)).setText(username);
        }
    }

    private void login() {
        if(((EditText) findViewById(R.id.username)).getText() == null ||
            ((EditText) findViewById(R.id.username)).getText().toString().
                trim().length()
                < 1) {
            Toast.makeText(this, "Please enter a Username",
                Toast.LENGTH_SHORT).show();
            return;
        }
        if(((EditText) findViewById(R.id.password)).getText() == null ||
            ((EditText) findViewById(R.id.password)).getText().toString().
                trim().length()
                < 1) {
            Toast.makeText(this, "Please enter a Password",
                Toast.LENGTH_SHORT).show();
            return;
        }

        username = ((EditText) findViewById(R.id.username)).getText().toString();
        password = ((EditText) findViewById(R.id.password)).getText().toString();

        showDialog(0);
    }

```

```

Handler loginHandler = new Handler() {
    @Override
    public void handleMessage(Message msg) {
        if(msg.what == NetworkUtil.ERR) {
            dismissDialog(0);
            Toast.makeText(LoginActivity.this, "Login Failed: "+
                msg.obj, Toast.LENGTH_SHORT).show();
        } else if(msg.what == NetworkUtil.OK) {
            handleLoginResponse((JSONObject) msg.obj);
        }
    }
};

NetworkUtil.login(getString(R.string.baseurl),
    username, password, loginHandler);
}

private void handleLoginResponse(JSONObject resp) {
    dismissDialog(0);

    final Account account = new Account(username, Authenticator.ACCOUNT_TYPE);

    if (getIntent().getStringExtra(PARAM_USERNAME) == null) {
        AccountManager.get(this).addAccountExplicitly(account, password, null);
        ContentResolver.setSyncAutomatically(account,
            ContactsContract.AUTHORITY, true);
    } else {
        AccountManager.get(this).setPassword(account, password);
    }

    Intent intent = new Intent();
    intent.putExtra(AccountManager.KEY_ACCOUNT_NAME, username);
    intent.putExtra(AccountManager.KEY_ACCOUNT_TYPE,
        Authenticator.ACCOUNT_TYPE);
    if (resp.has("token")) {
        intent.putExtra(AccountManager.KEY_AUTHTOKEN, resp.optString("token"));
    }
    setAccountAuthenticatorResult(intent.getExtras());
    setResult(RESULT_OK, intent);
    finish();
}
}
}

```

The LoginActivity's layout XML is:

```

<?xml version="1.0" encoding="utf-8" ?>
<LinearLayout
    xmlns:android="http://schemas.android.com/apk/res/android"
    android:orientation="vertical"
    android:layout_width="fill_parent"
    android:layout_height="wrap_content"
    android:background="#fff">
    <ScrollView
        android:layout_width="fill_parent"
        android:layout_height="odip"

```

```

android:layout_weight="1">
<LinearLayout
    android:layout_width="fill_parent"
    android:layout_height="wrap_content"
    android:layout_weight="1"
    android:orientation="vertical"
    android:paddingTop="5dip"
    android:paddingBottom="13dip"
    android:paddingLeft="20dip"
    android:paddingRight="20dip">
    <EditText
        android:id="@+id/username"
        android:singleLine="true"
        android:layout_width="fill_parent"
        android:layout_height="wrap_content"
        android:minWidth="250dip"
        android:scrollHorizontally="true"
        android:capitalize="none"
        android:hint="Username"
        android:autoText="false" />
    <EditText
        android:id="@+id/password"
        android:singleLine="true"
        android:layout_width="fill_parent"
        android:layout_height="wrap_content"
        android:minWidth="250dip"
        android:scrollHorizontally="true"
        android:capitalize="none"
        android:autoText="false"
        android:password="true"
        android:hint="Password"
        android:inputType="textPassword" />
    </LinearLayout>
</ScrollView>
<FrameLayout
    android:layout_width="fill_parent"
    android:layout_height="wrap_content"
    android:background="#fff"
    android:minHeight="54dip"
    android:paddingTop="4dip"
    android:paddingLeft="2dip"
    android:paddingRight="2dip">
    <Button
        android:id="@+id/login"
        android:layout_width="wrap_content"
        android:layout_height="wrap_content"
        android:layout_gravity="center_horizontal"
        android:minWidth="100dip"
        android:text="Login" />
    </FrameLayout>
</LinearLayout>

```

At this point, the account is established and is ready to be used to synchronize data.

## Synchronization

To synchronize an account's data we once again are dealing with three pieces—a service that is registered to listen for an `android.content.SyncAdapter` intent and that returns an `AbstractThreadedSyncAdapter` extended class on the `onBind()` method, an XML descriptor describing the structure of the data that is to be viewed and synced, and a class extending the `AbstractThreadedSyncAdapter` that handles the actual sync.

For our example, we wish to sync up contact information for the account that we described in the preceding section. Do note that contact information is not the only information you can sync up. You can sync up with any content provider you have access to, or even to application-specific stored data.

The following permissions are indicated in the manifest:

```
<uses-permission android:name="android.permission.GET_ACCOUNTS" />
<uses-permission android:name="android.permission.READ_CONTACTS" />
<uses-permission android:name="android.permission.WRITE_CONTACTS" />
<uses-permission android:name="android.permission.AUTHENTICATE_ACCOUNTS" />
<uses-permission android:name="android.permission.USE_CREDENTIALS" />
<uses-permission android:name="android.permission.MANAGE_ACCOUNTS" />
<uses-permission android:name="android.permission.INTERNET" />
<uses-permission android:name="android.permission.WRITE_SETTINGS" />
<uses-permission android:name="android.permission.WRITE_SECURE_SETTINGS" />
<uses-permission android:name="android.permission.READ_SYNC_STATS" />
<uses-permission android:name="android.permission.READ_SYNC_SETTINGS" />
<uses-permission android:name="android.permission.WRITE_SYNC_SETTINGS" />
```

Now we describe the service we intend to use. Note that the `android.content.SyncAdapter` intent is included and both a structure for the contact data and the `SyncAdapter` are described:

```
<service android:name=".sync.authsync.SyncService">
  <intent-filter>
    <action android:name="android.content.SyncAdapter" />
  </intent-filter>
  <meta-data android:name="android.content.SyncAdapter"
             android:resource="@xml/syncadapter" />
  <meta-data android:name="android.provider.CONTACTS_STRUCTURE"
             android:resource="@xml/contacts" />
</service>
```

In the `sync_adapter` XML resource, note the `accountType` descriptor. The content we intend to work with is the Android contacts data:

```
<?xml version="1.0" encoding="utf-8"?>

<sync_adapter xmlns:android="http://schemas.android.com/apk/res/android"
             android:contentAuthority="com.android.contacts"
             android:accountType="com.oreilly.demo.pa.ch17.sync"
 />
```

Here is the contacts descriptor XML. Note the names of the various columns we described:

```

<?xml version="1.0" encoding="utf-8"?>
<ContactsSource xmlns:android="http://schemas.android.com/apk/res/android">

    <ContactsDataKind
        android:mimeType=
            "vnd.android.cursor.item/vnd.com.oreilly.demo.pa.ch17.sync.profile"
        android:icon="@drawable/icon"
        android:summaryColumn="data2"
        android:detailColumn="data3"
        android:detailSocialSummary="true" />

</ContactsSource>

```

The SyncService we created returns the SyncAdapter class. This is our custom class that extends AbstractThreadedSyncAdapter:

```

package com.oreilly.demo.pa.ch17.sync.authsync;

import android.app.Service;
import android.content.Intent;
import android.os.IBinder;

public class SyncService extends Service {
    private static final Object lock = new Object();
    private static SyncAdapter adapter = null;

    @Override
    public void onCreate() {
        synchronized (lock) {
            if (adapter == null) {
                adapter = new SyncAdapter(getApplicationContext(), true);
            }
        }
    }

    @Override
    public void onDestroy() {
        adapter = null;
    }

    @Override
    public IBinder onBind(Intent intent) {
        return adapter.getSyncAdapterBinder();
    }
}

```

Continuing with this exercise, we create a `getfriends` method on the remote server side. This takes the token that was passed back and stored by the successful login coded up in the previous section, and a time indicating the last time the call was made (if it is the first time, 0 is passed). The response is another JSON string describing the friends (with ID, name, and phone), the time the call was made (in Unix time on the server), and a history describing additions and deletions of friends for this account. In the history, the `type` field is 0 to add and 1 to delete. The `who` field is the ID of the friend, and the `time` shows when the operation occurred:

uri: http://<serverBaseUrl>:<port>/getfriends?token=<token>&time=<lasttime>

response:

```
{
  "time" : 1295817666232,
  "history" : [
    {
      "time" : 1295817655342,
      "type" : 0,
      "who" : 1
    }
  ],
  "friend" : [
    {
      "id" : 1,
      "name" : "Mary",
      "phone" : "8285552334"
    }
  ]
}
```

The `AbstractThreadedSyncAdapter` class, extending `SyncAdapter`, follows:

```
public class SyncAdapter extends AbstractThreadedSyncAdapter {
    private final Context context;

    private static long lastsynctime = 0;

    public SyncAdapter(Context context, boolean autoInitialize) {
        super(context, autoInitialize);
        this.context = context;
    }

    @Override
    public void onPerformSync(Account account, Bundle extras, String authority,
        ContentProviderClient provider, SyncResult syncResult) {
        String authtoken = null;
        try {
            authtoken = AccountManager.get(context).blockingGetAuthToken(account,
                Authenticator.AUTHTOKEN_TYPE, true);

            ListFriends friendsdata =
                ListFriends.fromJSON(
                    NetworkUtil.getFriends(context.getString(R.string.baseUrl),
                        authtoken, lastsynctime, null));

            lastsynctime = friendsdata.time;

            sync(account, friendsdata);
        } catch (Exception e) {
            e.printStackTrace();
        }
    }

    private void sync(Account account, ListFriends data) {
```

```

        // MAGIC HAPPENS
    }
}

```

The full `SyncAdapter` class follows, with the various actions that occur when the sync method receives data. The various additions and deletions of the contact information are included. (Contact and `ContentProvider` operations are covered in previous chapters and sections.)

```

package com.oreilly.demo.pa.ch17.sync.authsync;

import java.util.ArrayList;

import android.accounts.Account;
import android.accounts.AccountManager;
import android.content.AbstractThreadedSyncAdapter;
import android.content.ContentProviderClient;
import android.content.ContentProviderOperation;
import android.content.ContentUris;
import android.content.Context;
import android.content.SyncResult;
import android.database.Cursor;
import android.os.Bundle;
import android.provider.ContactsContract;
import android.provider.ContactsContract.RawContacts;

import com.oreilly.demo.pa.ch17.R;
import com.oreilly.demo.pa.ch17.sync.NetworkUtil;
import com.oreilly.demo.pa.ch17.sync.dataobjects.Change;
import com.oreilly.demo.pa.ch17.sync.dataobjects.ListFriends;
import com.oreilly.demo.pa.ch17.sync.dataobjects.User;

public class SyncAdapter extends AbstractThreadedSyncAdapter {
    private final Context context;

    private static long lastsynctime = 0;

    public SyncAdapter(Context context, boolean autoInitialize) {
        super(context, autoInitialize);
        this.context = context;
    }

    @Override
    public void onPerformSync(Account account, Bundle extras, String authority,
        ContentProviderClient provider, SyncResult syncResult) {
        String authToken = null;
        try {
            // get accounttoken. this eventually calls our Authenticator
            // getAuthToken()
            authToken = AccountManager.get(context).blockingGetAuthToken(account,
                Authenticator.AUTHTOKEN_TYPE, true);

            ListFriends friendsdata =
                ListFriends.fromJSON(
                    NetworkUtil.getFriends(context.getString(R.string.baseurl),

```

```

        authToken, lastsynctime, null));

        lastsynctime = friendsdata.time;

        sync(account, friendsdata);
    } catch (Exception e) {
        e.printStackTrace();
    }
}

// where the magic happens
private void sync(Account account, ListFriends data) {
    User self = new User();
    self.username = account.name;

    ArrayList<ContentProviderOperation> ops =
        new ArrayList<ContentProviderOperation>();

    // cycle through the history to find the deletes
    if(data.history != null && !data.history.isEmpty()) {
        for(Change change : data.history) {
            if(change.type == Change.ChangeType.DELETE) {
                ContentProviderOperation op = delete(account, change.who);
                if(op != null) ops.add(op);
            }
        }
    }

    // cycle through the friends to find ones we do not already have and add them
    if(data.friends != null && !data.friends.isEmpty()) {
        for(User f : data.friends) {
            ArrayList<ContentProviderOperation> op = add(account, f);
            if(op != null) ops.addAll(op);
        }
    }

    if(!ops.isEmpty()) {
        try {
            context.getContentResolver().applyBatch(ContactsContract.AUTHORITY,
                ops);
        } catch (Exception e) {
            e.printStackTrace();
        }
    }
}

// adding a contact. note we are storing the id referenced in the response
// from the server in the SYNC1 field - this way we can find it with this
// server based id
private ArrayList<ContentProviderOperation> add(Account account, User f) {
    long rawid = lookupRawContact(f.id);

    if(rawid != 0) return null;
    ArrayList<ContentProviderOperation> ops =
        new ArrayList<ContentProviderOperation>();

```



```

ops.add(ContentProviderOperation.newInsert(
    ContactsContract.RawContacts.CONTENT_URI)
    .withValue(RawContacts.SOURCE_ID, 0)
    .withValue(RawContacts.SYNC1, f.id)
    .withValue(ContactsContract.RawContacts.ACCOUNT_TYPE,
        Authenticator.ACCOUNT_TYPE)
    .withValue(ContactsContract.RawContacts.ACCOUNT_NAME,
        account.name)
    .build());

if(f.name != null && f.name.trim().length() > 0) {
    ops.add(ContentProviderOperation.newInsert(
        ContactsContract.Data.CONTENT_URI)
        .withValueBackReference(ContactsContract.Data.RAW_CONTACT_ID,
            0)
        .withValue(ContactsContract.Data.MIMETYPE,
            ContactsContract.CommonDataKinds.StructuredName.CONTENT_ITEM_TYPE)
        .withValue(ContactsContract.CommonDataKinds.
            StructuredName.DISPLAY_NAME, f.name)
        .build());
}

if(f.phone != null && f.phone.trim().length() > 0) {
    ops.add(ContentProviderOperation.newInsert(
        ContactsContract.Data.CONTENT_URI)
        .withValueBackReference(ContactsContract.Data.RAW_CONTACT_ID, 0)
        .withValue(ContactsContract.Data.MIMETYPE,
            ContactsContract.CommonDataKinds.Phone.CONTENT_ITEM_TYPE)
        .withValue(ContactsContract.CommonDataKinds.Phone.NUMBER, f.phone)
        .withValue(ContactsContract.CommonDataKinds.Phone.TYPE,
            ContactsContract.CommonDataKinds.Phone.TYPE_HOME)
        .build());
}

ops.add(ContentProviderOperation.newInsert(ContactsContract.Data.CONTENT_URI)
    .withValueBackReference(ContactsContract.Data.RAW_CONTACT_ID, 0)
    .withValue(ContactsContract.Data.MIMETYPE,
        "vnd.android.cursor.item/vnd.com.oreilly.demo.pa.ch17.sync.profile")
    .withValue(ContactsContract.Data.DATA2, "Ch15 Profile")
    .withValue(ContactsContract.Data.DATA3, "View profile")
    .build()
    );
return ops;
}

// delete contact via the server based id
private ContentProviderOperation delete(Account account, long id) {
    long rawid = lookupRawContact(id);
    if(rawid == 0) return null;
    return ContentProviderOperation.newDelete(
        ContentUris.withAppendedId(
            ContactsContract.RawContacts.CONTENT_URI,
            rawid))
        .build();
}

```

```

// look up the actual raw id via the id we have stored in the SYNC1 field
private long lookupRawContact(long id) {
    long rawid = 0;
    Cursor c = context.getContentResolver().query(
        RawContacts.CONTENT_URI, new String[] {RawContacts._ID},
        RawContacts.ACCOUNT_TYPE + "=" +
        Authenticator.ACCOUNT_TYPE + "' AND '" +
        RawContacts.SYNC1 + "=?",
        new String[] {String.valueOf(id)},
        null);
    try {
        if(c.moveToFirst()) {
            rawid = c.getLong(0);
        }
    } finally {
        if (c != null) {
            c.close();
            c = null;
        }
    }
    return rawid;
}
}

```

An important detail might be missed in the previous `SyncAdapter` class: during the `onPerformSync()` call, we attempt to get the `authToken` from the `AccountManager` by using the `blockingGetAuthToken()` method. This eventually calls the `AbstractAccountAuthenticator` that is associated with this account. In this case, it calls the `Authenticator` class we provided in the previous section. Within the `Authenticator` class, the method `getAuthToken()` is called. An example follows:

```

@Override
public Bundle getAuthToken(AccountAuthenticatorResponse response, Account account,
    String authTokenType, Bundle loginOptions) {
    // check and make sure it is the right token type we want
    if (!authTokenType.equals(AUTHTOKEN_TYPE)) {
        final Bundle result = new Bundle();
        result.putString(AccountManager.KEY_ERROR_MESSAGE,
            "invalid authTokenType");
        return result;
    }
    // if we have the password, let's try and get the current
    // authToken from the server
    String password = AccountManager.get(context).getPassword(account);
    if (password != null) {
        JSONObject json = NetworkUtil.login(context.getString(R.string.baseurl),
            account.name, password, true, null);
        if (json != null) {
            Bundle result = new Bundle();
            result.putString(AccountManager.KEY_ACCOUNT_NAME, account.name);
            result.putString(AccountManager.KEY_ACCOUNT_TYPE, ACCOUNT_TYPE);
            result.putString(AccountManager.KEY_AUTHTOKEN,
                json.optString("token"));
        }
    }
}

```

```

        return result;
    }
}
// if all else fails let's see about getting the user to log in
Intent intent = new Intent(context, LoginActivity.class);
intent.putExtra(LoginActivity.PARAM_USERNAME, account.name);
intent.putExtra(AccountManager.KEY_ACCOUNT_AUTHENTICATOR_RESPONSE, response);
Bundle bundle = new Bundle();
bundle.putParcelable(AccountManager.KEY_INTENT, intent);
return bundle;
}

```

## Bluetooth

Bluetooth was the nickname for King Harald of Denmark. The following article on Sun’s developer site (<http://developers.sun.com/mobility/midp/articles/bluetooth1/>) contains a variety of information about Bluetooth, including the possibly apocryphal assertion that a runic stone erected in honor of Harald states:

Harald Christianized the Danes

Harald controlled Denmark and Norway

Harald thinks notebooks and cellular phones should communicate seamlessly

To show you how to use Android’s Bluetooth classes in your applications, we will create a utility for connecting to and transferring data to and from Bluetooth devices. This code is based on the BluetoothChat example in the Android SDK. It has been generalized to cover more applications of Bluetooth, and it has been modified to make it easier to adapt to your purposes.

As we explore Android’s Bluetooth APIs, we will see how this code makes use of these APIs, and how you can use the code for application-specific purposes, including as a diagnostic tool for Bluetooth development.

First we will learn more about how Bluetooth works, and how it is implemented in Android.

## The Bluetooth Protocol Stack

This section takes a look at the standards and protocols that make up the Bluetooth protocol stack (see [Figure 17-1](#)). These protocols and standards are what characterize Bluetooth: the kinds of data Bluetooth is designed to move, how many devices can be connected at the same time, latency, and so on.

Bluetooth has emerged as a separate form of networking because it is a “personal area network,” or PAN, also referred to as a piconet. Bluetooth is designed to connect up to eight devices and to carry data at a maximum of approximately three megabits per second. The connected devices must be close to one another: within about 10 meters. Bluetooth operates at very low power levels, in milliwatts. That means very small

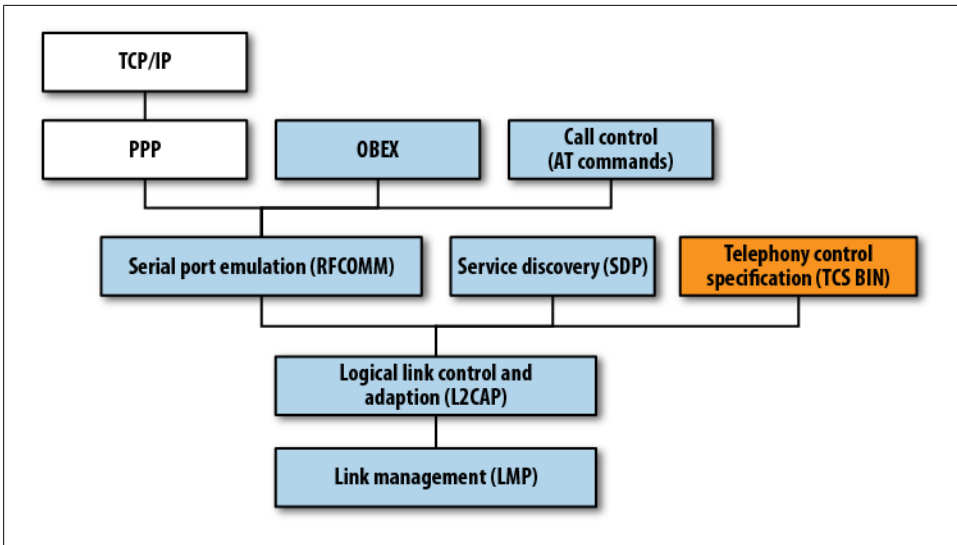

Figure 17-1. The Android Bluetooth protocol stack

batteries can last a long time: a Bluetooth headset with a tiny, lightweight battery can last for hours of talking—about as long as the much larger battery in your mobile handset can last, because the mobile radio signal must be able to reach a relatively distant antenna.

The kinds of devices for which Bluetooth is useful include low and medium data-rate devices such as keyboards, mice, tablets, printers, speakers, headphones, and headsets, and the mobile and personal computing devices those peripheral devices may want to talk to. Bluetooth also supports connections among PCs and mobile handsets.

### Bluetooth-specific protocols and adopted protocols

One useful way of thinking about the Bluetooth protocol stack is to separate it into Bluetooth-specific protocols and “adopted” protocols that run on top of Bluetooth. Taken together, Bluetooth and the adopted protocols can be dauntingly complex, but if you set aside, for a while, the fact that large, complex protocols such as OBEX and TCP/IP run on top of Bluetooth, it’s more understandable. Therefore, we will start with the lower layers of Bluetooth and emphasize how these layers shape how you can make use of Bluetooth.

Another useful mental model of Bluetooth is that it replaces serial ports. This means the lower layers of Bluetooth emulate, and enable you to manage, a virtual set of serial cables between peripherals. This is the type of Bluetooth protocol we will be using. This, in turn, enables us to use the simple `java.io` classes `InputStream` and `OutputStream` to read and write data.

## Bluez: The Linux Bluetooth Implementation

A mobile handset may want to connect to all kinds of Bluetooth devices, unlike peripheral devices that need to be connectable only to a computer or handset. That means a mobile handset wants to have a fairly complete implementation of Bluetooth and the adopted protocols, as well as a user interface that enables the necessary interactions for making and managing connections and for using applications that communicate over Bluetooth.

Android uses the Bluez Bluetooth stack, which is the most commonly used Bluetooth stack for Linux. It superseded a project called Open BT. Information on Bluez can be found at the Bluez project site, <http://www.bluez.org>.

Bluez was developed at Qualcomm, and has been adopted into the Linux kernel. The project was begun in 2001 and has been an active and well-supported project ever since. Bluez is, therefore, a stable and compatible implementation—another reason Linux is a good choice for handset operating systems.

## Using Bluetooth in Android Applications

Using Bluetooth in Android means using classes that were designed to encapsulate the way Bluetooth works in the Android operating system: the Bluez stack provides ways to enumerate devices, listen for connections, and use connections; the `java.io` package provides classes for reading and writing data; and the `Handler` and `Message` classes provide a way to bridge between the threads that manage Bluetooth input and output and the user interface. Let's take a look at the code and how these classes are used.

Compiling and running this code will give you an idea of what Android's Bluetooth classes can do for applications that need to build simple connections to nearby devices.

The first step in trying out this Bluetooth application is to pair your handset with a PC. Then, you need a program that monitors what the PC has received via Bluetooth to see that what you send from this application got to your PC. In this case we'll use the Linux utility `hcidump`.

Start the program under the debugger if you want to set some breakpoints and step through it, especially the parts of the application that open and accept connections. You can create the connection from your PC, using the `Blueman` applet in Linux, or from the app. Once the connection is created, start `hcidump` in a terminal to see that what you typed into the app is received by the PC. Use the flags shown below to show only the content of the Bluetooth connection:

```
sudo hcidump -a -R
```

Now, what you send from your device should show up as the output of `hcidump` on your PC.

## Bluetooth and related I/O classes

This program relies on the `BluetoothAdapter` class to control the device's Bluetooth adapter, the `BluetoothDevice` class to represent the state of the connected device, and the `BluetoothSocket` class to represent sockets for listening for and making connections:

```
package com.finchframework.bluetooth;

import android.os.Handler;
import android.os.Message;

public class BtHelperHandler extends Handler {

    public enum MessageType {
        STATE,
        READ,
        WRITE,
        DEVICE,
        NOTIFY;
    }

    public Message obtainMessage(MessageType message, int count, Object obj) {
        return obtainMessage(message.ordinal(), count, -1, obj);
    }

    public MessageType getMessageType(int ordinal) {
        return MessageType.values()[ordinal];
    }
}
```

The `BtHelperHandler` class defines some constants and provides a little bit of wrapper code that makes message-related methods cleaner.

`BtSPPHelper.java` is what encapsulates our use of the Bluetooth Serial Port Protocol (SPP):

```
package com.finchframework.bluetooth;

import java.io.IOException;
import java.io.InputStream;
import java.io.OutputStream;
import java.util.UUID;

import com.finchframework.finch.R;

import android.bluetooth.BluetoothAdapter;
import android.bluetooth.BluetoothDevice;
import android.bluetooth.BluetoothServerSocket;
import android.bluetooth.BluetoothSocket;
import android.content.Context;
import android.os.Bundle;
import android.os.Message;
import android.util.Log;
```

```

/**
 * Helper class that runs AsyncTask objects for communicating with a Bluetooth
 * device. This code is derived from the Bluetoothchat example, but modified in
 * several ways to increase modularity and generality: The Handler is in a
 * separate class to make it easier to drop into other components.
 *
 * Currently this only does Bluetooth SPP. This can be generalized to other
 * services.
 */
public class BtSPPHelper {
    // Debugging
    private final String TAG = getClass().getSimpleName();
    private static final boolean D = true;

    public enum State {
        NONE,
        LISTEN,
        CONNECTING,
        CONNECTED;
    }

    // Name for the SDP record when creating server socket
    private static final String NAME = "BluetoothTest";

    // Unique UUID for this application
    private static final UUID SPP_UUID =
        UUID.fromString("00001101-0000-1000-8000-00805F9B34FB");

    // Member fields
    private final BluetoothAdapter mAdapter;
    private final BtHelperHandler mHandler;
    private AcceptThread mAcceptThread;
    private ConnectThread mConnectThread;
    private ConnectedThread mConnectedThread;
    private State mState;
    private Context mContext;

    /**
     * Constructor. Prepares a new Bluetooth SPP session.
     * @param context The UI Activity Context
     * @param handler A Handler to send messages back to the UI Activity
     */
    public BtSPPHelper(Context context, BtHelperHandler handler) {
        mContext = context;
        mAdapter = BluetoothAdapter.getDefaultAdapter();
        mState = State.NONE;
        mHandler = handler;
    }

    /**
     * Set the current state of the chat connection
     * @param state The current connection state
     */
    private synchronized void setState(State state) {

```

```

        if (D) Log.d(TAG, "setState() " + mState + " -> " + state);
        mState = state;

        // Give the new state to the Handler so the UI Activity can update
        mHandler.obtainMessage(BtHelperHandler.MessageType.STATE,
            -1, state).sendToTarget();
    }

    /**
     * Return the current connection state.
     */
    public synchronized State getState() {
        return mState;
    }

    /**
     * Start the session. Start AcceptThread to begin a
     * session in listening (server) mode.
     *
     * Typically, call this in onResume()
     */
    public synchronized void start() {
        if (D) Log.d(TAG, "start");

        // Cancel any thread attempting to make a connection
        if (mConnectThread != null) {mConnectThread.cancel(); mConnectThread = null;}

        // Cancel any thread currently running a connection
        if (mConnectedThread != null) {
            mConnectedThread.cancel();
            mConnectedThread = null;
        }

        // Start the thread to listen on a BluetoothServerSocket
        if (mAcceptThread == null) {
            mAcceptThread = new AcceptThread();
            mAcceptThread.start();
        }
        setState(State.LISTEN);
    }

    /**
     * Start the ConnectThread to initiate a connection to a remote device.
     * @param device The BluetoothDevice to connect
     */
    public synchronized void connect(BluetoothDevice device) {
        if (D) Log.d(TAG, "connect to: " + device);

        // Cancel any thread attempting to make a connection
        if (mState == State.CONNECTING) {
            if (mConnectThread != null) {
                mConnectThread.cancel();
                mConnectThread = null;
            }
        }
    }
}

```



```

        // Cancel any thread currently running a connection
        if (mConnectedThread != null) {
            mConnectedThread.cancel();
            mConnectedThread = null;
        }

        // Start the thread to connect with the given device
        mConnectThread = new ConnectThread(device);
        mConnectThread.start();
        setState(State.CONNECTING);
    }

    /**
     * Start the ConnectedThread to begin managing a Bluetooth connection
     *
     * @param socket
     *         The BluetoothSocket on which the connection was made
     * @param device
     *         The BluetoothDevice that has been connected
     */
    private synchronized void connected(BluetoothSocket socket,
        BluetoothDevice device) {
        if (D)
            Log.d(TAG, "connected");

        // Cancel the thread that completed the connection
        if (mConnectThread != null) {
            mConnectThread.cancel();
            mConnectThread = null;
        }

        // Cancel any thread currently running a connection
        if (mConnectedThread != null) {
            mConnectedThread.cancel();
            mConnectedThread = null;
        }

        // Cancel the accept thread because we only want to connect to one
        // device
        if (mAcceptThread != null) {
            mAcceptThread.cancel();
            mAcceptThread = null;
        }

        // Start the thread to manage the connection and perform transmissions
        mConnectedThread = new ConnectedThread(socket);
        mConnectedThread.start();

        // Send the name of the connected device back to the UI Activity
        mHandler.obtainMessage(BtHelperHandler.MessageType.DEVICE, -1,
            device.getName()).sendToTarget();
        setState(State.CONNECTED);
    }
}

```

```

/**
 * Stop all threads
 */
public synchronized void stop() {
    if (D) Log.d(TAG, "stop");
    if (mConnectThread != null) {
        mConnectThread.cancel();
        mConnectThread = null;
    }
    if (mConnectedThread != null) {
        mConnectedThread.cancel();
        mConnectedThread = null;
    }
    if (mAcceptThread != null) {
        mAcceptThread.cancel();
        mAcceptThread = null;
    }
    setState(State.NONE);
}

/**
 * Write to the ConnectedThread in an unsynchronized manner
 * @param out The bytes to write
 * @see ConnectedThread#write(byte[])
 */
public void write(byte[] out) {
    ConnectedThread r;

    // Synchronize a copy of the ConnectedThread
    synchronized (this) {
        if (mState != State.CONNECTED) return;
        r = mConnectedThread;
    }
    // Perform the write unsynchronized
    r.write(out);
}

private void sendErrorMessage(int messageId) {
    setState(State.LISTEN);
    mHandler.obtainMessage(BtHelperHandler.MessageType.NOTIFY, -1,
        mContext.getResources().getString(messageId)).sendToTarget();
}

/**
 * This thread listens for incoming connections.
 */
private class AcceptThread extends Thread {
    // The local server socket
    private final BluetoothServerSocket mmServerSocket;

    public AcceptThread() {
        BluetoothServerSocket tmp = null;

        // Create a new listening server socket
        try {

```

```

        tmp = mAdapter.listenUsingRfcommWithServiceRecord(NAME, SPP_UUID);
    } catch (IOException e) {
        Log.e(TAG, "listen() failed", e);
    }
    mmServerSocket = tmp;
}

public void run() {
    if (D) Log.d(TAG, "BEGIN mAcceptThread" + this);
    setName("AcceptThread");
    BluetoothSocket socket = null;

    // Listen to the server socket if we're not connected
    while (mState != BtSPPHelper.State.CONNECTED) {
        try {
            // This is a blocking call and will only return on a
            // successful connection or an exception
            socket = mmServerSocket.accept();
        } catch (IOException e) {
            Log.e(TAG, "accept() failed", e);
            break;
        }

        // If a connection was accepted
        if (socket != null) {
            synchronized (BtSPPHelper.this) {
                switch (mState) {
                    case LISTEN:
                    case CONNECTING:
                        // Situation normal. Start the connected thread.
                        connected(socket, socket.getRemoteDevice());
                        break;
                    case NONE:
                    case CONNECTED:
                        // Either not ready or already connected.
                        // Terminate new socket.
                        try {
                            socket.close();
                        } catch (IOException e) {
                            Log.e(TAG, "Could not close unwanted socket", e);
                        }
                        break;
                }
            }
        }
    }
    if (D) Log.i(TAG, "END mAcceptThread");
}

public void cancel() {
    if (D) Log.d(TAG, "cancel " + this);
    try {
        mmServerSocket.close();
    } catch (IOException e) {
        Log.e(TAG, "close() of server failed", e);
    }
}

```

```

    }
}

/**
 * This thread runs while attempting to make an outgoing connection
 * with a device. It runs straight through; the connection either
 * succeeds or fails.
 */
private class ConnectThread extends Thread {
    private final BluetoothSocket mmSocket;
    private final BluetoothDevice mmDevice;

    public ConnectThread(BluetoothDevice device) {
        mmDevice = device;
        BluetoothSocket tmp = null;

        // Get a BluetoothSocket for a connection with the
        // given BluetoothDevice
        try {
            tmp = device.createRfcommSocketToServiceRecord(SPP_UUID);
        } catch (IOException e) {
            Log.e(TAG, "create() failed", e);
        }
        mmSocket = tmp;
    }

    public void run() {
        Log.i(TAG, "BEGIN mConnectThread");
        setName("ConnectThread");

        // Always cancel discovery because it will slow down a connection
        mAdapter.cancelDiscovery();

        // Make a connection to the BluetoothSocket
        try {
            // This is a blocking call and will only return on a
            // successful connection or an exception
            mmSocket.connect();
        } catch (IOException e) {
            sendErrorMessage(R.string.bt_unable);
            // Close the socket
            try {
                mmSocket.close();
            } catch (IOException e2) {
                Log.e(TAG, "unable to close() socket during connection failure",
                    e2);
            }
            // Start the service over to restart listening mode
            BtSPPHelper.this.start();
            return;
        }

        // Reset the ConnectThread because we're done
        synchronized (BtSPPHelper.this) {

```

```

        mConnectThread = null;
    }

    // Start the connected thread
    connected(mmSocket, mmDevice);
}

public void cancel() {
    try {
        mmSocket.close();
    } catch (IOException e) {
        Log.e(TAG, "close() of connect socket failed", e);
    }
}
}

/**
 * This thread runs during a connection with a remote device.
 * It handles all incoming and outgoing transmissions.
 */
private class ConnectedThread extends Thread {
    private final BluetoothSocket mmSocket;
    private final InputStream mmInStream;
    private final OutputStream mmOutStream;

    public ConnectedThread(BluetoothSocket socket) {
        Log.d(TAG, "create ConnectedThread");
        mmSocket = socket;
        InputStream tmpIn = null;
        OutputStream tmpOut = null;

        // Get the BluetoothSocket input and output streams
        try {
            tmpIn = socket.getInputStream();
            tmpOut = socket.getOutputStream();
        } catch (IOException e) {
            Log.e(TAG, "temp sockets not created", e);
        }

        mmInStream = tmpIn;
        mmOutStream = tmpOut;
    }

    public void run() {
        Log.i(TAG, "BEGIN mConnectedThread");
        byte[] buffer = new byte[1024];
        int bytes;

        // Keep listening to the InputStream while connected
        while (true) {
            try {
                // Read from the InputStream
                bytes = mmInStream.read(buffer);

                // Send the obtained bytes to the UI Activity

```

```

        mHandler.obtainMessage(BtHelperHandler.MessageType.READ,
            bytes, buffer).sendToTarget();
    } catch (IOException e) {
        Log.e(TAG, "disconnected", e);
        sendErrorMessage(R.string.bt_connection_lost);
        break;
    }
}

/**
 * Write to the connected OutputStream.
 * @param buffer The bytes to write
 */
public void write(byte[] buffer) {
    try {
        mmOutputStream.write(buffer);

        // Share the sent message back to the UI Activity
        mHandler.obtainMessage(BtHelperHandler.MessageType.WRITE, -1, buffer)
            .sendToTarget();
    } catch (IOException e) {
        Log.e(TAG, "Exception during write", e);
    }
}

public void cancel() {
    try {
        mmSocket.close();
    } catch (IOException e) {
        Log.e(TAG, "close() of connect socket failed", e);
    }
}
}
}
}

```

The `BtSPPHelper` class brings the use of these classes together, and also contains the definition of private `Thread` subclasses that listen for, connect, and run connections.

This is also where the `java.io` package meets Android Bluetooth: the `BluetoothSocket` objects contain methods that return references to `InputStream` and `OutputStream` objects to be used to read and write data on the socket connection:

```

package com.finchframework.bluetooth;

import java.util.Set;

import com.finchframework.finch.R;

import android.app.Activity;
import android.bluetooth.BluetoothAdapter;
import android.bluetooth.BluetoothDevice;
import android.content.BroadcastReceiver;
import android.content.Context;
import android.content.Intent;

```

```

import android.content.IntentFilter;
import android.os.Bundle;
import android.util.Log;
import android.view.View;
import android.view.Window;
import android.view.View.OnClickListener;
import android.widget.AdapterView;
import android.widget.AdapterView.OnItemClickListener;
import android.widget.ArrayAdapter;
import android.widget.Button;
import android.widget.ListView;
import android.widget.TextView;
import android.widget.AdapterView.OnItemClickListener;

/**
 * Derived from the Bluetooth Chat example, an activity that enables
 * picking a paired or discovered Bluetooth device
 */
public class DeviceListActivity extends Activity {
    // Debugging
    private static final String TAG = "DeviceListActivity";
    private static final boolean D = true;

    // Return Intent extra
    public static String EXTRA_DEVICE_ADDRESS = "device_address";

    // Member fields
    private BluetoothAdapter mBtAdapter;
    private ArrayAdapter<String> mPairedDevicesArrayAdapter;
    private ArrayAdapter<String> mNewDevicesArrayAdapter;

    @Override
    protected void onCreate(Bundle savedInstanceState) {
        super.onCreate(savedInstanceState);

        // Set up the window
        setContentView(R.layout.device_list);

        // Set result CANCELED in case the user backs out
        setResult(Activity.RESULT_CANCELED);

        // Initialize the button to perform device discovery
        Button scanButton = (Button) findViewById(R.id.button_scan);
        scanButton.setOnClickListener(new OnClickListener() {
            public void onClick(View v) {
                doDiscovery();
                v.setVisibility(View.GONE);
            }
        });

        // Initialize array adapters. One for already paired devices and
        // one for newly discovered devices
        mPairedDevicesArrayAdapter = new ArrayAdapter<String>(this,
            R.layout.device_name);
        mNewDevicesArrayAdapter = new ArrayAdapter<String>(this,
            R.layout.device_name);

```

```

// Find and set up the ListView for paired devices
ListView pairedListView = (ListView) findViewById(R.id.paired_devices);
pairedListView.setAdapter(mPairedDevicesArrayAdapter);
pairedListView.setOnItemClickListener(mDeviceClickListener);

// Find and set up the ListView for newly discovered devices
ListView newDevicesListView = (ListView) findViewById(R.id.new_devices);
newDevicesListView.setAdapter(mNewDevicesArrayAdapter);
newDevicesListView.setOnItemClickListener(mDeviceClickListener);

// Register for broadcasts when a device is discovered
IntentFilter filter = new IntentFilter(BluetoothDevice.ACTION_FOUND);
this.registerReceiver(mReceiver, filter);

// Register for broadcasts when discovery has finished
filter = new IntentFilter(BluetoothAdapter.ACTION_DISCOVERY_FINISHED);
this.registerReceiver(mReceiver, filter);

// Get the local Bluetooth adapter
mBtAdapter = BluetoothAdapter.getDefaultAdapter();

// Get a set of currently paired devices
Set<BluetoothDevice> pairedDevices = mBtAdapter.getBondedDevices();

// If there are paired devices, add each one to the ArrayAdapter
if (pairedDevices.size() > 0) {
    findViewById(R.id.title_paired_devices).setVisibility(View.VISIBLE);
    for (BluetoothDevice device : pairedDevices) {
        mPairedDevicesArrayAdapter.add(device.getName() +
            "\n" + device.getAddress());
    }
} else {
    String noDevices =
        getResources().getText(R.string.none_paired).toString();
    mPairedDevicesArrayAdapter.add(noDevices);
}
}

@Override
protected void onDestroy() {
    super.onDestroy();

    // Make sure we're not doing discovery anymore
    if (mBtAdapter != null) {
        mBtAdapter.cancelDiscovery();
    }

    // Unregister broadcast listeners
    this.unregisterReceiver(mReceiver);
}

/**
 * Start device discover with the BluetoothAdapter
 */

```



```

private void doDiscovery() {
    if (D) Log.d(TAG, "doDiscovery()");

    // Indicate scanning in the title
    setProgressBarIndeterminateVisibility(true);
    setTitle(R.string.scanning);

    // Turn on sub-title for new devices
    findViewById(R.id.title_new_devices).setVisibility(View.VISIBLE);

    // If we're already discovering, stop it
    if (mBtAdapter.isDiscovering()) {
        mBtAdapter.cancelDiscovery();
    }

    // Request discover from BluetoothAdapter
    mBtAdapter.startDiscovery();
}

// The on-click listener for all devices in the ListViews
private OnItemClickListener mDeviceClickListener = new OnItemClickListener() {
    public void onItemClick(AdapterView<?> av, View v, int arg2, long arg3) {
        // Cancel discovery because it's costly and we're about to connect
        mBtAdapter.cancelDiscovery();

        // Get the device MAC address, which is the last 17 chars in the View
        String info = ((TextView) v).getText().toString();
        String address = info.substring(info.length() - 17);

        // Create the result Intent and include the MAC address
        Intent intent = new Intent();
        intent.putExtra(EXTRA_DEVICE_ADDRESS, address);

        // Set result and finish this Activity
        setResult(Activity.RESULT_OK, intent);
        finish();
    }
};

// The BroadcastReceiver that listens for discovered devices and
// changes the title when discovery is finished
private final BroadcastReceiver mReceiver = new BroadcastReceiver() {
    @Override
    public void onReceive(Context context, Intent intent) {
        String action = intent.getAction();

        // When discovery finds a device
        if (BluetoothDevice.ACTION_FOUND.equals(action)) {
            // Get the BluetoothDevice object from the Intent
            BluetoothDevice device =
                intent.getParcelableExtra(BluetoothDevice.EXTRA_DEVICE);
            // If it's already paired, skip it, because it's been listed already
            if (device.getBondState() != BluetoothDevice.BOND_BONDED) {
                mNewDevicesArrayAdapter.add(
                    device.getName() + "\n" + device.getAddress());
            }
        }
    }
};

```



---

# The Android Native Development Kit (NDK)

Java Native Interface (JNI) is a part of the Java standard that enables developers to write native methods in other languages, such as C and C++, and call those methods from Java code. This is especially useful when you want to use platform-specific features or take advantage of hardware in the platform, such as achieving faster numerical computation by taking advantage of FPU instruction set extensions, or letting graphics-intensive code exploit the OpenGL API. This chapter covers JNI basics for programmers using the Android NDK. For further details, see the [Java Native Interface Specification](#).

Typical good candidates for implementation in C or C++ using the NDK are self-contained, CPU-intensive operations that don't allocate much memory, such as signal processing, physics simulation, and so on. Simply recoding a random method to run in C usually does not result in a large performance increase. When examining whether you should develop in native code, think about your requirements and see whether the Android SDK already provides the functionality you need. You'll find that in most cases the Android SDK will fulfill your needs. It is worth remembering that, although most Android platforms are ARM right now, there are likely to be others (such as Atom) in the future. Using NDK makes your code nonportable.

JNI is what Android uses to access code implemented in C or C++, and the Android NDK is an optional extension to the Android SDK that supports the use of C or C++ code in Android applications. To make things as easy as possible for the Java developer, JNI lets a native method use Java objects in the same way that Java code uses these objects. Within the native method, Java objects can be created, inspected, and used to perform its tasks. This same ability to inspect and use Java objects enables the native method to use other Java objects passed to it from the Java application (and thus the Android application).

# Native Methods and JNI Calls

JNI created certain conventions to allow calls to methods from other languages. The changes on the side of the native methods (essentially C or C++ libraries) are greater than the changes required on the Java side.

## Conventions on the Native Method Side

When a virtual machine (VM)—in Android’s case, Dalvik—invokes a function implemented in C or C++, it passes two special parameters:

- A `JNIEnv` pointer, which is a kind of handle for the thread in the VM that called the native method
- A `jobject` pointer, which is a reference to the calling class

These parameters are passed transparently to Java code. That is, they do not appear in the method signature declared in the calling Java code. The Java call just explicitly passes any other parameters needed by the called function.

A JNI function may look like this:

```
/* sample method where the Java call passed no parameters */
void Java_ClassName_MethodName (JNIEnv *env, jobject obj) {
    /* do something */
}

/* another sample method with two parameters passed, returning a double */
jdouble Java_ClassName_MethodName ( JNIEnv* env, jobject obj,
                                     jdouble x,  jdouble y) {
    return x + y;
}
```

These examples show the two parameters passed automatically to every native method, and two parameters with types that map to Java types.

When a native method is called, it runs in the same process and the same thread as the Java code that calls it. As we will see later in this chapter, it can allocate memory from the Java heap to take advantage of garbage collection, or outside the Java heap to circumvent Java memory management. Variables allocated on the stack in C or C++ code have the same semantics as in native executables in those languages. They are allocated from the stack space for the process they run in.

JNI provides types that correspond to Java types, as shown in [Table 18-1](#).

Table 18-1. Data mapping

Native type	Java type	Description
boolean	jboolean	Unsigned 8 bits
byte	jbyte	Signed 8 bits
char	jchar	Unsigned 16 bits
short	jshort	Signed 16 bits
int	jint	Signed 32 bits
long	jlong	Signed 64 bits
float	jfloat	32 bits
double	jdouble	64 bits
void	void	N/A

In compound types such as objects, arrays, and strings, the native code must explicitly convert the data by calling conversion methods, which are accessible through the `JNIEnv` pointer.

## Conventions on the Java Side

Before native methods can be used within a Java class, the library containing native methods must be loaded by calling `System.loadLibrary`. Typically, the class that needs the native method would statically load this. Native methods accessed by a class are declared in the class using the `native` keyword:

```
public class ClassWithNativeMethod {  
    public native double nativeMethod();    // native method  
  
    static {  
        System.loadLibrary("sample"); // load lib called 'sample'  
    }  
  
    public static void main(String[] args) {  
        ClassWithNativeMethod cwmm = new ClassWithNativeMethod();  
  
        double answer = cwmm.nativeMethod(); // call native method  
  
        System.out.println("Answer is : "+answer);  
    }  
}
```

# The Android NDK

The Android Native Development Kit (NDK) is a companion tool to the Android SDK. If you use the NDK to create native code, your applications are still packaged into an *.apk* file and run inside a VM on the device. The fundamental Android application model does not change.

## Setting Up the NDK Environment

In order to use the NDK, you must first install and set up the SDK. The system requirements for installing and using the NDK are as follows:

- Windows XP (32-bit) or Vista (32- or 64-bit) with Cygwin 1.7 or later
- Mac OS X 10.4.8 or later
- Linux (32- or 64-bit)

Necessary development tools that are not provided in the NDK are as follows:

- GNU Make 3.81 or later
- A recent version of Awk (either GNU Awk or Nawk)

First, download and install the NDK (<http://developer.android.com/sdk/ndk/index.html>). Installation is simple: unzip the NDK into any directory. Here, we will refer to that directory as *ndk*.

Once the NDK is downloaded and installed, you will find quite a bit of documentation (located in the *ndk/docs* directory). We highly recommend that you read the documentation, starting with *OVERVIEW.html*. Also included in the NDK are samples (located in *ndk/samples*). The samples cover quite a bit more than this chapter will, so after you have used the NDK a bit, we recommend that you go through the samples.

## Compiling with the NDK

In order to develop native code with the NDK, you will need to do the following:

1. Create a *jni* directory within your project.
2. Place your native source in the *jni* directory.
3. Create an *Android.mk* file (and, optionally, an *Application.mk* file) in the *jni* directory.
4. Run the *ndk/ndk-build* command from within the *jni* directory.

The optional *Application.mk* file describes what native modules are needed for your application as well as specific ABI types to build against. For more details, check *APPLICATION-MK.html* in the documentation. A sample *Application.mk* file follows:

```
# Build both ARMv5TE and ARMv7-A machine code.
APP_ABI := armeabi armeabi-v7a
```

```
# What platform to build against (android-3 (1.5) - android-9 (2.3))
APP_PLATFORM := android-9
```

The *Android.mk* file describes your source to the build system. It is really a tiny GNU Makefile fragment that is parsed by the build system when building your app. For more details, read the *ANDROID-MK.html* documentation file. A sample *Android.mk* follows:

```
# Must define the LOCAL_PATH and return the current dir
LOCAL_PATH := $(call my-dir)

# Cleans various variables... making a clean build
include $(CLEAR_VARS)

# Identify the module/library's name
LOCAL_MODULE := sample
# Specify the source files
LOCAL_SRC_FILES := sample.c
# Load local libraries (here we load the log library)
LOCAL_LDLIBS := -llog

# Build the shared library defined above
include $(BUILD_SHARED_LIBRARY)
```

Once you have written *Android.mk*, and optionally *Application.mk* and the native source files themselves, run *ndk/ndk-build* within the project directory to build your libraries. Should the build be successful, the shared libraries will be copied into your application's root project directory and added to its build.

## JNI, NDK, and SDK: A Sample App

To help you understand how the SDK and native source can be put together, we provide the following sample app. It describes an activity called `SampleActivityWithNativeMethods`. The Android manifest fragment is:

```
<activity android:name=".SampleActivityWithNativeMethods"
    android:label="Sample Activity With Native Methods"
    android:debuggable="true" />
```

The `SampleActivityWithNativeMethods` activity uses the following layout:

```
<?xml version="1.0" encoding="utf-8"?>
<LinearLayout xmlns:android="http://schemas.android.com/apk/res/android"
    android:orientation="vertical"
    android:layout_width="fill_parent"
    android:layout_height="fill_parent"
    >
<Button
    android:id="@+id/whatami"
    android:layout_width="fill_parent"
    android:layout_height="wrap_content"
    android:paddingTop="5dp"
    android:paddingBottom="5dp"
    android:text="What CPU am I?"
```

```

    />
</LinearLayout>

```

The sample C library source has a method called `whatAmI`, which our Java activity will hook to the button with the `whatami` ID. We also define a function named `LOGINFO`, resolving to an `__android_log_print` call. This is how the Android log is written:

```

// the jni library MUST be included
#include <jni.h>
// the log lib is included
#include <android/log.h>

// usage of log
#define LOGINFO(x...) __android_log_print(ANDROID_LOG_INFO,"SampleJNI",x)

jstring Java_com_oreilly_demo_pa_ch18_SampleActivityWithNativeMethods_whatAmI(
    JNIEnv* env, jobject thisobject) {
    LOGINFO("SampleJNI", "Sample Info Log Output");

    return (*env)->NewStringUTF(env, "Unknown");
}

```

Our `Android.mk` file follows. Note that it causes the `log` library to be loaded:

```

LOCAL_PATH := $(call my-dir)

include $(CLEAR_VARS)

LOCAL_MODULE     := sample
LOCAL_SRC_FILES  := sample.c
LOCAL_LDLIBS     := -llog

include $(BUILD_SHARED_LIBRARY)

```

Finally, here is the `SampleActivityWithNativeMethods` Java activity's source code. The class loads the sample library and declares the `whatAmI()` native method. When the button is clicked, the `whatAmI()` method is called and returns "Unknown". This then shows a `Toast` with the string "CPU: Unknown". If you find the output uninformative, rest assured that we will include the CPU information in a later section:

```

package com.oreilly.pa.ch18;

import com.oreilly.pa.ch18.R;
import android.widget.Toast;

public class SampleActivityWithNativeMethods extends Activity {

    static {
        System.loadLibrary("sample"); // load our sample lib
    }

    @Override
    public void onCreate(Bundle savedInstanceState) {
        super.onCreate(savedInstanceState);
        setContentView(R.layout.sample);
    }
}

```



```

        setupview();
    }

    public native String whatAmI(); // sample lib native method

    private void setupview() {
        findViewById(R.id.whatami).setOnClickListener(
            new View.OnClickListener() {

                public void onClick(View v) {
                    String whatami = whatAmI();
                    Toast.makeText(getBaseContext(), "CPU: "+whatami,
                        Toast.LENGTH_SHORT).show();
                }
            }
        });
    }
}

```

## Android-Provided Native Libraries

The NDK comes with the following set of headers for stable native APIs:

- `libc` (C library) headers
- `libm` (math library) headers
- JNI interface headers
- `libz` (Zlib compression) headers
- `liblog` (Android logging) header
- OpenGL ES 1.1 and OpenGL ES 2.0 (3D graphics libraries) headers
- `libjnigraphics` (pixel buffer access) header (for Android 2.2 and later)
- A minimal set of headers for C++ support
- OpenSL ES native audio libraries
- Android native application APIs



Except for the libraries just listed, native system libraries in the Android platform are not stable and may change in future platform versions. Your applications should use only the stable native system libraries provided in the NDK.

Some libraries, such as `libc` and `libm`, are automatically referenced in the build and thus need to be referenced only in the source code as includes. However, some libraries are not automatically referenced, and thus require specific statements within the *Android.mk* build file.

Here is a sample *Android.mk* file that imports the `cpufeatures` module, which will give us the information missing from our earlier `whatAmI` example:

```

LOCAL_PATH := $(call my-dir)

include $(CLEAR_VARS)

LOCAL_MODULE := sample
LOCAL_SRC_FILES := sample.c
LOCAL_LDLIBS := -llog
# Here we reference the cpufeatures module
LOCAL_STATIC_LIBRARIES := cpufeatures

include $(BUILD_SHARED_LIBRARY)

# Here we import the cpufeatures modules
$(call import-module,cpufeatures)

```

The following source (extending the `whatAmI` function we showed in the previous section) utilizes the `cpufeatures` module we have included:

```

// Include the cpu-features module
#include <cpu-features.h>
#include <jni.h>
#include <android/log.h>

#define LOGINFO(x...) __android_log_print(ANDROID_LOG_INFO,"SampleJNI",x)

jstring Java_com_oreilly_demo_pa_ch18_SampleActivityWithNativeMethods_whatAmI(
    JNIEnv* env, jobject thisobject) {
    LOGINFO("SampleJNI", "Sample Info Log Output");

    // -- Here we use the cpufeatures -- //
    uint64_t cpu_features;

    if (android_getCpuFamily() != ANDROID_CPU_FAMILY_ARM) {
        return (*env)->NewStringUTF(env, "Not ARM");
    }

    cpu_features = android_getCpuFeatures();

    if ((cpu_features & ANDROID_CPU_ARM_FEATURE_ARMv7) != 0) {
        return (*env)->NewStringUTF(env, "ARMv7");
    } else if ((cpu_features & ANDROID_CPU_ARM_FEATURE_VFPv3) != 0) {
        return (*env)->NewStringUTF(env, "ARM w VFPv3 support");
    } else if ((cpu_features & ANDROID_CPU_ARM_FEATURE_NEON) != 0) {
        return (*env)->NewStringUTF(env, "ARM w NEON support");
    }

    // -- End cpufeatures usage -- //

    return (*env)->NewStringUTF(env, "Unknown");
}

```

## Building Your Own Custom Library Modules

This section puts together several techniques shown throughout the chapter to create and use a simple C module that uses the math library to calculate a power. We'll start with the *Android.mk* file. Notice that we need to build the library (`sample_lib`) and export the includes. This library is then referenced in the sample:

```
LOCAL_PATH := $(call my-dir)

# this is our sample library
include $(CLEAR_VARS)

LOCAL_MODULE     := sample_lib
LOCAL_SRC_FILES  := samplelib/sample_lib.c
# we need to make sure everything knows where everything is
LOCAL_EXPORT_C_INCLUDES := $(LOCAL_PATH)/samplelib

include $(BUILD_STATIC_LIBRARY)

# sample uses the sample lib we created
include $(CLEAR_VARS)

LOCAL_MODULE     := sample
LOCAL_SRC_FILES  := sample.c
LOCAL_LDLIBS     := -llog
# We load our sample lib
LOCAL_STATIC_LIBRARIES := sample_lib

include $(BUILD_SHARED_LIBRARY)
```

We have a short header file, *sample\_lib.h*:

```
#ifndef SAMPLE_LIB_H
#define SAMPLE_LIB_H

extern double calculatePower(double x, double y);

#endif
```

The source code for our function, *sample\_lib.c*, is:

```
#include "sample_lib.h"
// we include the math lib
#include "math.h"

// we use the math lib
double calculatePower(double x, double y) {
    return pow(x, y);
}
```

Following is the *sample.c* file that glues our `sample_lib` library to the Java code:

```
// we include the sample_lib
#include "sample_lib.h"
#include <jni.h>
#include <android/log.h>
```

```

#define LOGINFO(x...) __android_log_print(ANDROID_LOG_INFO,"SampleJNI",x)

jdouble
Java_com_oreilly_demo_pa_ch18_SampleActivityWithNativeMethods_calculatePower(
    JNIEnv* env, jobject thisobject, jdouble x, jdouble y) {

    LOGINFO("Sample Info Log Output");

    // we call sample-lib's calculate method
    return calculatePower(x, y);
}

```

The layout the Activity will use is:

```

<?xml version="1.0" encoding="utf-8"?>
<LinearLayout xmlns:android="http://schemas.android.com/apk/res/android"
    android:orientation="vertical"
    android:layout_width="fill_parent"
    android:layout_height="fill_parent"
    >
<EditText
    android:id="@+id/x"
    android:layout_width="fill_parent"
    android:layout_height="wrap_content"
    android:paddingTop="5dp"
    android:paddingBottom="5dp"
    android:textColor="#000"
    android:hint="X Value"
    />
<EditText
    android:id="@+id/y"
    android:layout_width="fill_parent"
    android:layout_height="wrap_content"
    android:paddingTop="5dp"
    android:paddingBottom="5dp"
    android:textColor="#000"
    android:hint="Y Value"
    />
<Button
    android:id="@+id/calculate"
    android:layout_width="fill_parent"
    android:layout_height="wrap_content"
    android:paddingTop="5dp"
    android:paddingBottom="5dp"
    android:text="Calculate X^Y"
    />
</LinearLayout>

```

Following is the `SampleActivityWithNativeMethods` activity that we have modified to use with this new library. The sample library is loaded and the `calculatePower()` method is declared. When the “calculate” button is clicked, we then take the numbers provided from the two edit text boxes (using a default of 2 if the text is missing or is

not a number) and pass them to the `calculatePower()` method. The returned double is then popped up as part of a `Toast`:

```
package com.oreilly.pa.ch18;

import com.oreilly.pa.ch18.R;
import android.app.Activity;
import android.os.Bundle;
import android.view.View;
import android.widget.EditText;
import android.widget.Toast;

public class SampleActivityWithNativeMethods extends Activity {

    static {
        System.loadLibrary("sample"); // load our sample lib
    }

    @Override
    public void onCreate(Bundle savedInstanceState) {
        super.onCreate(savedInstanceState);
        setContentView(R.layout.sample);

        setupview();
    }

    // sample lib native method
    public native double calculatePower(double x, double y);

    private void setupview() {

        findViewById(R.id.calculate).setOnClickListener(
            new View.OnClickListener() {

                public void onClick(View v) {
                    String answer = "";
                    double x = 2;
                    double y = 2;

                    String sx = ((EditText) findViewById(R.id.x)).getText().toString();
                    String sy = ((EditText) findViewById(R.id.y)).getText().toString();

                    if(sx == null) {
                        answer = "X defaults to 2\n";
                    } else {
                        try {
                            x = Double.parseDouble(sx);
                        } catch (Exception e) {
                            answer = "X is not a number, defaulting to 2\n";
                            x = 2;
                        }
                    }

                    if(sy == null) {
                        answer += "Y defaults to 2\n";
                    }
                }
            }
        );
    }
}
```

```

    } else {
        try {
            y = Double.parseDouble(sy);
        } catch (Exception e) {
            answer = "Y is not a number, defaulting to 2\n";
            y = 2;
        }
    }

    double z = calculatePower(x, y);

    answer += x+"^"+y+" = "+z;

    Toast.makeText(SampleActivityWithNativeMethods.this, answer,
        Toast.LENGTH_SHORT).show();
    });
}
}
}

```

## Native Activities

Android 2.3 (API level 9) and Android NDK revision 5 let you write entire activities and applications as native source by using the `NativeActivity` class to access the Android application life cycle.

To utilize this method, the `android.app.NativeActivity` needs to be referenced in the Android manifest file. Note that the application reference has a `hasCode` attribute. This attribute should be set to `false` if there is no Java in the application (only the `NativeActivity`). In this case, however, since we do have Java code, we set the value to `true`:

```

<!-- This .apk has Java code, so set hasCode to true which is the default. -->
<!-- if this only had a native app (only the activity
    called 'android.app.NativeActivity') -->
<!-- then set to false -->

<application android:icon="@drawable/icon" android:label="@string/app_name"
    android:hasCode="true" >

    <activity android:name=".NDKApp" android:label="@string/app_name">
        <intent-filter>
            <action android:name="android.intent.action.MAIN" />
            <category android:name="android.intent.category.LAUNCHER" />
        </intent-filter>
    </activity>

    <activity android:name="android.app.NativeActivity"
        android:label="SampleNativeActivity"
        android:debuggable="true" >

        <!-- here we declare what lib to reference -->
        <meta-data android:name="android.app.lib_name"

```

```

        android:value="sample_native_activity" />
    </activity>
</application>

```

In this example, we use the *android\_native\_app\_glue.h* header file instead of *native\_activity.h*. The *native\_activity.h* interface is based on a set of application-provided callbacks that will be called by the Activity's main thread when certain events occur. This means callbacks should not block, and thereby is constraining. The *android\_native\_app\_glue.h* file exposes a helper library with a different execution model that provides a means for the application to implement its own main function in a different thread. The function must be named `android_main()`, and is called when the application is created and an `android_app` object is passed to it. This provides a means to reference the application or activity and listen in on various life cycle events.

The following simple `nativeactivity` example constructs an Activity and listens in on Motion events. The Motion events' `x` and `y` screen coordinates are then sent to the LogCat:

```

#include <jni.h>
#include <android/log.h>
#include <android_native_app_glue.h>

// usage of log
#define LOGINFO(x...) __android_log_print(ANDROID_LOG_INFO,"SampleNativeActivity",x)

// handle commands
static void custom_handle_cmd(struct android_app* app, int32_t cmd) {
    switch(cmd) {
        case APP_CMD_INIT_WINDOW:
            LOGINFO("App Init Window");
            break;
    }
}

// handle input
static int32_t custom_handle_input(struct android_app* app, AInputEvent* event) {
    // we see a motion event and we log it
    if (AInputEvent_getType(event) == AINPUT_EVENT_TYPE_MOTION) {
        LOGINFO("Motion Event: x %f / y %f", AMotionEvent_getX(event, 0),
            AMotionEvent_getY(event, 0));
    }
    return 1;
}
return 0;
}

// This is the function that application code must implement,
// representing the main entry to the app.
void android_main(struct android_app* state) {
    // Make sure glue isn't stripped.
    app_dummy();

    int events;
    // set up so when commands happen we call our custom handler
    state->onAppCmd = custom_handle_cmd;
}

```

```

// set up so when input happens we call our custom handler
state->onInputEvent = custom_handle_input;

while (1) {
    struct android_poll_source* source;

    // we block for events
    while (ALooper_pollAll(-1, NULL, &events, (void**)&source) >= 0) {

        // Process this event.
        if (source != NULL) {
            source->process(state, source);
        }

        // Check if we are exiting.
        if (state->destroyRequested != 0) {
            LOGINFO("We are exiting");
            return;
        }
    }
}
}

```

This is the *Android.mk* file for the sample nativeactivity. Note that it loads and refers to the `android_native_app_glue` module:

```

LOCAL_PATH := $(call my-dir)

# this is our sample native activity
include $(CLEAR_VARS)

LOCAL_MODULE     := sample_native_activity
LOCAL_SRC_FILES  := sample_nativeactivity.c
LOCAL_LDLIBS     := -llog -landroid
LOCAL_STATIC_LIBRARIES := android_native_app_glue

include $(BUILD_SHARED_LIBRARY)

$(call import-module,android/native_app_glue)

```

Following is the main Java Android activity that is called when the user launches the application. Clicking on the button launches the `NativeActivity` that we have provided:

```

package com.oreilly.pa.ch18;

import com.oreilly.pa.ch18.R;
import android.app.Activity;
import android.content.Intent;
import android.os.Bundle;
import android.view.View;

public class NDKApp extends Activity {
    @Override
    public void onCreate(Bundle savedInstanceState) {
        super.onCreate(savedInstanceState);
        setContentView(R.layout.main);
    }
}

```



```

        findViewById(R.id.nativeactivity).setOnClickListener(
            new View.OnClickListener() {

                public void onClick(View v) {
                    startActivity(new Intent(getApplicationContext(),
                        android.app.NativeActivity.class)); // call nativeactivity
                }

            });
    }
}

```

If you compile and run this example, you will note that when the native activity is launched, the screen is blank, and if you are viewing the LogCat you will see various log messages appear (especially when moving your finger across the screen). This, however, is not much fun. So to spruce things up, we wish to do something with the screen. The following example adds the use of OpenGL ES to change the screen's color.

Here is the native source with the additional OpenGL ES material. It simply turns the screen bright red when the activity is displayed:

```

#include <jni.h>
#include <android/log.h>
#include <android_native_app_glue.h>

#include <EGL/egl.h>
#include <GLES/gl.h>

// usage of log
#define LOGINFO(x...)
__android_log_print(ANDROID_LOG_INFO, "NativeWOpenGL", x)

struct eglengine {
    EGLDisplay display;
    EGLSurface surface;
    EGLContext context;
};

// initialize the egl engine
static int engine_init_display(struct android_app* app, struct eglengine* engine) {
    const EGLint attribs[] = {
        EGL_SURFACE_TYPE, EGL_WINDOW_BIT,
        EGL_BLUE_SIZE, 8,
        EGL_GREEN_SIZE, 8,
        EGL_RED_SIZE, 8,
        EGL_NONE
    };
    EGLint w, h, dummy, format;
    EGLint numConfigs;
    EGLConfig config;
    EGLSurface surface;
    EGLContext context;

    EGLDisplay display = eglGetDisplay(EGL_DEFAULT_DISPLAY);

```

```

eglInitialize(display, 0, 0);
eglChooseConfig(display, attribs, &config, 1, &numConfigs);
eglGetConfigAttrib(display, config, EGL_NATIVE_VISUAL_ID, &format);

ANativeWindow_setBuffersGeometry(app->window, 0, 0, format);

surface = eglCreateWindowSurface(display, config, app->window, NULL);
context = eglCreateContext(display, config, NULL, NULL);

if (eglMakeCurrent(display, surface, surface, context) == EGL_FALSE) {
    LOGINFO("eglMakeCurrent FAIL");
    return -1;
}

eglQuerySurface(display, surface, EGL_WIDTH, &w);
eglQuerySurface(display, surface, EGL_HEIGHT, &h);

engine->display = display;
engine->context = context;
engine->surface = surface;

glHint(GL_PERSPECTIVE_CORRECTION_HINT, GL_FASTEST);
glEnable(GL_CULL_FACE);
glShadeModel(GL_SMOOTH);
glDisable(GL_DEPTH_TEST);

return 0;
}

// draw to the screen
static void engine_color_screen(struct eglengine* engine) {
    if (engine->display == NULL) {
        return;
    }

    glClearColor(255, 0, 0, 1); // let's make the screen all red
    glClear(GL_COLOR_BUFFER_BIT);

    eglSwapBuffers(engine->display, engine->surface);
}

// when things need to be terminated
static void engine_terminate(struct eglengine* engine) {
    if (engine->display != EGL_NO_DISPLAY) {
        eglMakeCurrent(engine->display, EGL_NO_SURFACE, EGL_NO_SURFACE,
            EGL_NO_CONTEXT);
        if (engine->context != EGL_NO_CONTEXT) {
            eglDestroyContext(engine->display, engine->context);
        }
        if (engine->surface != EGL_NO_SURFACE) {
            eglDestroySurface(engine->display, engine->surface);
        }
        eglTerminate(engine->display);
    }
    engine->display = EGL_NO_DISPLAY;
}

```

```

    engine->context = EGL_NO_CONTEXT;
    engine->surface = EGL_NO_SURFACE;
}

// handle commands
static void custom_handle_cmd(struct android_app* app, int32_t cmd) {
    struct eglengine* engine = (struct eglengine*)app->userData;
    switch(cmd) {
        // things are starting up... let's initialize the engine and color the screen
        case APP_CMD_INIT_WINDOW:
            if (app->window != NULL) {
                engine_init_display(app, engine);
                engine_color_screen(engine);
            }
            break;
        case APP_CMD_TERM_WINDOW: // things are ending...let's clean up the engine
            engine_terminate(engine);
            break;
    }
}

// handle input
static int32_t custom_handle_input(struct android_app* app, AInputEvent* event) {
    // we see a motion event and we log it
    if (AInputEvent_getType(event) == AINPUT_EVENT_TYPE_MOTION) {
        LOGINFO("Motion Event: x %f / y %f", AMotionEvent_getX(event, 0),
            AMotionEvent_getY(event, 0));
    }
    return 1;
}

// This is the function that application code must implement,
// representing the main entry to the app.
void android_main(struct android_app* state) {
    // Make sure glue isn't stripped.
    app_dummy();

    // here we add the eglengine to the app
    struct eglengine engine;
    memset(&engine, 0, sizeof(engine));
    // set engine as userdata so we can reference
    state->userData = &engine;

    int events;
    // set up so when commands happen we call our custom handler
    state->onAppCmd = custom_handle_cmd;
    // set up so when input happens we call our custom handler
    state->onInputEvent = custom_handle_input;

    while (1) {
        struct android_poll_source* source;

        // we block for events
        while (ALooper_pollAll(-1, NULL, &events, (void**)&source) >= 0) {

```

```

        // Process this event.
        if (source != NULL) {
            source->process(state, source);
        }

        // Check if we are exiting.
        if (state->destroyRequested != 0) {
            LOGINFO("We are exiting");
            return;
        }
    }
}
}

```

The *Android.mk* file for the `sample_native_activity_opengl` activity loads the EGL and GLESv1\_CM libraries:

```

LOCAL_PATH := $(call my-dir)

# this is our sample native activity with opengl
include $(CLEAR_VARS)

LOCAL_MODULE     := sample_native_activity_opengl
LOCAL_SRC_FILES := sample_nativeactivity_opengl.c
# loading the log , android, egl, gles libraries
LOCAL_LDLIBS     := -llog -landroid -lEGL -lGLESv1_CM
LOCAL_STATIC_LIBRARIES := android_native_app_glue

include $(BUILD_SHARED_LIBRARY)

$(call import-module,android/native_app_glue)

```

## Symbols

" (quotation marks), 257  
% ([percent sign), 258  
. (period), 256  
; (semicolon), 250  
= (assignment operator), 35  
{ } (curly braces), 44  
| (pipe character), 258

## A

abstract classes

about, 45

additional information, 46

AbstractAccountAuthenticator class

addAccount method, 416

authentication example, 415–421

AbstractThreadedSyncAdapter class

onPerformSync method, 428

synchronization example, 422–428

AccelerateInterpolator class, 240

accelerometers, 394

access modifiers

defined, 57

encapsulation and, 57

getters and setters, 61

accessibility API, 407

AccessibilityService class

about, 408

onAccessibilityEvent method, 408

setServiceInfo method, 408

AccessibilityServiceInfo class, 408

ACCESS\_FINE\_LOCATION permission, 382

Account Authenticator system, 415–421

account contacts

about, 411–413

authenticating, 415–421

synchronizing, 422

AccountAuthenticatorResponse class, 416

AccountManager class

blockingGetAuthToken method, 428

getAuthToken method, 428

KEY\_ACCOUNT\_AUTHENTICATOR\_R

ESPONSE constant, 416

ACID transaction properties, 255

ACP (Android Compatibility Package), 208,

284

activity

android:alwaysRetainTaskState attribute,  
302

android:finishOnTaskLaunch attribute,  
302

android:launchMode attribute, 301

android:name attribute, 301

android:noHistory attribute, 302

android:process attribute, 302

android:taskAffinity attribute, 301

attributes affecting task behavior, 302

content providers and, 141

defined, 15, 77

launch mode, 300

life cycle overview, 90–92, 288

native, 456–462

task affinity, 301

user experience across, 299–304

Activity class

about, 16, 77, 197

activity life cycle, 91

configuration changes and life cycles, 290–  
291

- Context class and, 82
- findViewById method, 176
- getFragmentManager method, 202
- getLastNonConfigurationInstance method, 292
- getString method, 380
- isFinishing method, 289
- life cycle methods and, 288, 291
- managedQuery method, 315, 411
- manifest files and, 83
- memory recovery and life cycles, 287–288
- native activities and, 457
- onActivityResult method, 367
- onContextItemSelected method, 195
- onCreate method, 225, 242, 288, 289
- onCreateContextMenu method, 195
- onCreateOptionsMenu method, 380
- onDestroy method, 287, 289, 290
- onKeyDown method, 382
- onNewIntent method, 301
- onOptionsItemSelected method, 380
- onPause method, 91, 288, 289, 398
- onPostCreate method, 290, 291
- onPostResume method, 291
- onRestart method, 288
- onRestoreInstanceState method, 91, 289
- onResume method, 289, 398
- onRetainNonConfigurationInstance method, 292
- onSaveInstanceState method, 91, 289
- onStart method, 289, 290
- onStop method, 289
- onUserLeaveHint method, 291
- reading tags, 398
- RESTful applications and, 330
- runOnUiThread method, 156
- saving/restoring instance state, 289
- startActivity method, 300, 373
- startActivityForResult method, 367
- visualizing life cycles, 280–286
- well-behaved applications and, 295–296
- adb (Android Debug Bridge), 7, 21
- adb command, 7
- ADT Eclipse plug-in
  - about, 6, 9
  - components supported, 23–25
  - configuring, 11
  - installing, 10
  - keeping up-to-date, 29
  - tools supported, 122
- AIDL (Android Interface Definition Language)
  - ADT plug-in support, 9
  - gen directory and, 141
  - remote procedure calls and, 158
- AlphaAnimation class, 241
- Android applications, 248
  - (see also application development; skeleton applications)
  - activities and intents, 77
  - API support, 78
  - applying static analysis, 127–129
  - Bluetooth in, 431–444
  - building, 24
  - component life cycles, 90–92
  - Context class hierarchy, 82
  - creating Android projects, 12–16, 115
  - database design for, 260–264
  - debugging, 25
  - developing RESTful, 330
  - exporting, 101
  - manifest files and, 83–87
  - MJAndroid application example, 264–275
  - packaging, 92
  - porting software to, 93
  - publishing, 107
  - res directory, 87
  - running, 25
  - runtime environment, 88–90, 114
  - security considerations, 90
  - SimpleVideoDbHelper class example, 261–264
  - SQL and, 248
  - traditional programming models, 75
  - unpublishing, 107
  - uploading in Android Market, 106–107
- android command, 8, 27
- Android Compatibility Package (ACP), 208, 284
- Android Debug Bridge (adb), 7, 21
- Android Developers site
  - about, 3
  - installing ADT plug-in, 10
  - System Requirements page, 4, 6
  - Tools Overview article, 26
- Android Development Tools plug-in (see ADT Eclipse plug-in)
- Android Device Chooser dialog, 19
- Android devices

- audio and video formats, 359
- running programs on, 20
- social networking and, 264
- Android Framework, 167
  - (see also Android GUI framework)
  - about, 133
  - Android libraries, 133–135
  - concurrent programming, 142–156
  - extending classes, 139–140
  - fragments, 197–209
  - layout mechanism, 212–217
  - monitoring threads, 145
  - organizing Java source, 140–142
  - overrides and callbacks, 135–137
  - polymorphism and composition, 138–139
  - serialization, 156–163
  - thread confinement, 155
- Android GUI framework
  - architectural overview, 167–171
  - assembling, 171–176
  - AsyncTask and, 143–154
  - clip rectangle, 217
  - drawing classes, 218
  - implementing menus, 193–195
  - rolling your own widgets, 211–233
  - tools supported, 234–246
  - wiring up controller, 176–193
- Android Interface Definition Language (see AIDL)
- Android Layout Editor, 24, 116
- Android libraries, 451
  - (see also specific libraries)
  - about, 133–135
  - concurrent programming and, 142
  - extending Android, 135–140
  - NDK supported, 451
- Android Manifest Editor, 24, 116, 382
- Android Maps API Key Signup page, 108
- Android Market
  - about, 95
  - becoming official Android developer, 106
  - getting paid, 107
  - losing signing certificate and, 100
  - placing applications in, 105–107
- Android Menu Editor, 116
- Android NDK (see NDK)
- Android Package Builder, 116
- android package tree, 134
- Android Pre Compiler, 115
- Android projects (see projects)
- Android Resource Editor, 116
- Android Resource Manager, 115
- Android SDK
  - about, 7
  - adding build targets, 8
  - components supported, 21–27
  - confirming installation, 12–21
  - downloading package, 7
  - example code, 30
  - folders for tools, 8
  - installing, 3–12, 7
  - keeping up-to-date, 28
  - organizing Java source, 140–142
  - prerequisites, 3–12
  - sample application, 449–450
  - tools supported, 26–27
  - troubleshooting problems, 21
- Android Virtual Device (see AVD)
- Android XML Resources Editor, 116
- android.app library, 134
- android.content library, 134
- android.database library, 134
- android.graphics library, 134
- android.telephony library, 134
- android.text library, 134
- android.view library, 134, 171
- android.webkit library, 134
- android.widget library, 134
- android.widgets package, 139
- android:alwaysRetainTaskState attribute, 302
- android:finishOnTaskLaunch attribute, 302
- android:launchMode attribute, 300
- android:name attribute, 301
- android:noHistory attribute, 302
- android:process attribute, 302
- android:taskAffinity attribute, 301
- AndroidManifest.xml file
  - about, 83
  - declarations in, 83
  - initialization parameters in, 84–87
- android\_native\_app\_glue module, 458
- animation
  - background, 241–242
  - frame-by-frame, 241–242
  - OpenGL example, 235
  - surface view, 242
  - transition, 238–241
  - tweened, 238

- Animation class
  - about, 238
  - AnimationListener interface, 239
  - applyTransformation method, 238, 239
- AnimationDrawable class
  - about, 238, 241
  - start method, 242
- AnimationListener interface
  - about, 239
  - onAnimationEnd method, 240
- AnimationSet class, 240
- anonymous classes, 62–64
- Apache HttpCore project, 135
- APIs (application programming interfaces)
  - accessibility, 407–409
  - Android applications and, 78
  - application distribution and, 109
  - external sensors, 391–396
  - gesture input, 406–407
  - Near Field Communication, 396–405
  - SimpleFinchVideoContentProvider
    - example, 309–312, 322–327
- .apk files
  - about, 25, 92
  - building, 116
  - uploading, 106
- apkbuilder application, 92
- Application class
  - about, 83
  - life cycle methods, 296–299
- application development, 248
  - (see also Android applications; skeleton applications)
  - additional information, 134
  - applying static analysis, 127–129
  - content assist, 120
  - database design, 260–264
  - Design for Extension coding rule, 140
  - graphics effects, 234–246
  - Java coding in Eclipse, 120–122
  - MJAndroid application example, 264–275
  - modular programming, 65–67
  - refactoring, 121
  - rolling your own widgets, 211–233
  - SimpleVideoDbHelper class example, 261–264
  - SQL and, 248
  - traditional programming models, 75
- application distribution
  - application signing, 95–104
    - exporting Android applications, 101
    - Google Maps API keys, 108
    - placing in Android Market, 105–107
    - screen compatibility and, 109
    - specifying API-level compatibility, 109
  - application programming interfaces (see APIs)
  - application signing
    - about, 95
    - cryptographic, 95–97
    - process overview, 98–104
    - protection and, 97–98
    - self-signed certificates, 97
  - application template (see skeleton applications)
- applications (see Android applications)
- ArrayList class, 53, 134
- Arrays class, 134
- artifacts
  - defined, 115
  - projects and, 140
- assignment operator (=), 35
- associations, defined, 117
- asynchronous I/O mechanisms, 334
- AsyncTask class
  - doInBackground method, 147
  - onClickListener method, 152
  - onPostExecute method, 147
  - onPreExecute method, 150
  - onProgressUpdate method, 152
  - publishProgress method, 154
  - subclassing and, 139
  - UI thread and, 143–154
- audio
  - Android supported formats, 359
  - AudioRecorder recording, 367
  - AudioTrack playback, 362
  - Intent recording, 367
  - MediaPlayer playback, 361
  - MediaRecorder recording, 365
  - playback methods, 361–363
  - recording methods, 365–368
- AudioRecorder class
  - audio recording, 367
  - startRecording method, 368
- AudioTrack class
  - audio playback, 362
  - pause method, 363
  - play method, 363
  - release method, 363



- stop method, 363
- AUTHENTICATE\_ACCOUNTS permission, 415
- authenticating contact data, 415–421
- AUTOINCREMENT constraint, 251, 312
- AVD (Android Virtual Device)
  - about, 16, 25
  - additional information, 16
  - creating, 17–18
  - running programs on, 19
  - setting parameters, 17
- avdmgr tool, 122

## B

- background animation, 241–242
- BaseAdapter class, 139
- Beaulieu, Alan, 254
- bin directory, 141
- binary data, 316
- Bitmap class, 218, 232
- BitmapDrawable class, 233
- BLOB type (SQLite), 250
- Bloch, Joshua, 48, 157
- block, defined, 44
- Bluetooth standard
  - about, 429
  - Android applications and, 431–444
  - Linux implementation, 431
  - protocol stack and, 429
  - SPP support, 432
- BluetoothAdapter class, 432
- BluetoothDevice class, 432
- BluetoothSocket class, 432
- Bluez Bluetooth stack, 431
- boolean type, 34, 447
- BroadcastReceiver class
  - about, 78, 82
  - manifest files and, 83
  - well-behaved applications and, 295
- builders, defined, 115
- Bundle class
  - fragment life cycle and, 201
  - getSerializable method, 157
  - putSerializable method, 157
  - serialization and, 157, 289
- Button class
  - about, 170
  - setOnClickListener method, 177
  - widgets and, 212

- byte type, 34, 447

## C

- Callback interface (Drawable), 241
- Callback interface (SurfaceHolder)
  - about, 242
  - surfaceCreated method, 242
  - surfaceDestroyed method, 242
- callbacks, defined, 135–137
- Camera class
  - about, 239
  - rotate method, 239
  - translate method, 239
- CAMERA permission, 364
- Canvas class
  - about, 218
  - concatMatrix method, 227
  - coordinate transformation, 222
  - drawCircle method, 219
  - drawing text, 221–222
  - drawPosText method, 222
  - drawText method, 222
  - drawTextOnPath method, 222
  - getMatrix method, 227
  - restore method, 227
  - rotate method, 222, 227
  - save method, 227
  - scale method, 222, 227
  - setMatrix method, 227
  - skew method, 222, 227
  - translate method, 227
- canvas drawing
  - about, 217–220
  - drawing text, 221–222
  - matrix transformations, 222–227
- cascading methods, 37
- Cell ID, 372
- certificate authority, 97
- certificate fingerprint, 99
- certificates
  - debug, 98
  - self-signed, 97, 99, 101–104
- char type, 34, 221, 447
- CHECK constraint, 252
- class attribute, 198
- .class files, 114, 115
- classes, 37
  - (see also specific classes)
  - about, 35

- abstract, 45
- anonymous, 62–64
- extending, 139–140
- final and static declarations, 41–45
- object creation, 35–37
- serialization support, 162
- clip rectangle, 217
- ClipDrawable class, 231
- Cloneable interface, 38
- code signing (see application signing)
- Collection interface, 52
- Collections Library, 52, 54
- ColorFilter class, 237
- com.android.ide.eclipse.adt plug-in, 112
- com.android.ide.eclipse.ddms plug-in, 112
- Comparable interface
  - about, 47
  - compareTo method, 47
- composition, defined, 138–139
- compound queries, 254
- concurrent programming
  - Android libraries and, 142
  - AsyncTask and UI thread, 143–154
  - multi-threaded, 68, 142
  - threads in Android processes, 154
- constructors
  - defined, 36
  - Fragment class and, 198
- contact data
  - about, 411–413
  - authenticating, 415–421
  - synchronizing, 422
- Contacts class
  - additional information, 412
  - querying, 411
- ContactsContract content provider, 411–413
- container views, 171, 212
- content assist, 120
- content providers
  - about, 79–80
  - activities and, 141
  - binary data, 316
  - building, 306–314
  - ContactsContract, 411–413
  - CONTENT\_URI constant, 307, 310–312
  - declaring, 327
  - developing RESTful applications, 330
  - file management, 316
  - implementing, 307
  - MediaStore, 359, 369
  - MVC architecture and, 81, 318–319
  - network MVC and, 331–334
  - REST and, 329
  - SimpleFinchVideoContentProvider
    - example, 319–327
  - usage considerations, 80–81
  - writing/integrating, 314
  - YouTube video example, 334–354
- content:// URI, 316
- ContentObserver.onChange method, 318
- ContentProvider class
  - about, 78, 79
  - delete method, 79, 310, 315, 322
  - extending, 307, 314–316
  - getType method, 315, 322
  - insert method, 79, 310, 314, 315, 322
  - manifest files and, 83
  - onCreate method, 315, 321
  - openFile method, 354
  - openStream method, 317
  - query method, 79, 310, 315, 322
  - RESTful applications and, 330
  - serialization and, 157
  - update method, 79, 310, 315, 322
  - well-behaved applications and, 295
- ContentProviderOperation class
  - about, 413
  - newInsert method, 413
- ContentProviderOperation.Builder class, 413
- ContentResolver class
  - about, 80
  - delete method, 318
  - insert method, 332
  - notifyChange method, 82, 318
  - openInputStream method, 316, 354
  - openOutputStream method, 317
  - registerContentObserver method, 82
- ContentUri.withAppendedId method, 325
- ContentValues class
  - about, 272
  - creating, 346
  - stored media content, 369
- Context class
  - about, 82
  - getResources method, 88
  - getSystemService method, 384, 392, 408
- ContextMenu class, 195
- contextual menus, 195

- Controller component (MVC)
  - about, 169
  - focus and threading, 189–193
  - listening for key events, 186
  - listening for touch events, 183–186
  - listening to the Model, 178–183
  - wiring up, 176–178
- cpufeatures module, 451
- Create New Android Virtual Device (AVD)
  - dialog, 17
- CREATE TABLE statement (SQL), 249
- CRUD methodology, 271
- Ctrl-F11, 201
- Ctrl-space bar, 120
- curly braces {}, 44
- Currency class, 134
- Cursor interface
  - about, 81, 260
  - account contacts example, 411, 413
  - moveToFirst method, 269
  - moveToNext method, 260
  - moveToPrevious method, 260
  - registerContentObserver method, 318
  - query method, 332
  - setNotificationUri method, 323
- CycleInterpolator class, 240

**D**

- D-pads, 186, 191
- Dalvik Debug Monitor Server (see DDMS)
- dalvik package tree, 134
- Dalvik virtual machines (VMs)
  - about, 21
  - Android runtime environment, 89
  - Zygote process and, 89
- data structures, synchronization and, 73
- data types
  - contact data, 411–413
  - Java supported, 34
  - JNI calls and, 447
  - SQLite supported, 250
- database schemas
  - defined, 249
  - foreign key constraints, 252
- database triggers, 254
- databases (see relational databases)
- Date class, 134
- DatePicker class, 212
- DateTime class, 198, 201, 204

- DDMS (Dalvik Debug Monitor Server)
  - about, 21–23, 25
  - Emulator Control pane, 387
  - JNI conventions, 446
  - location updates, 387
- debug certificate, 98
- debuggable attribute, 102
- debugging
  - Android applications, 25
  - Android devices, 20
- DecelerateInterpolator class, 240
- default constructors, 36
- DELETE operation (REST), 79
- DELETE statement (SQL), 315
- dependency injection, 137
- deserializing data, 156
- Design for Extension coding rule, 140
- developing applications (see application development)
- .dex files, 115
- Dictionary class, 52, 134
- distributing applications (see application distribution)
- double type, 34, 447
- Draw9patch drawing program, 27
- Drawable class
  - about, 218, 228–232
  - Callback interface, 241
  - usage considerations, 231
  - wrappers supporting, 231
- drawable directory, 87
- drawing graphics
  - animations, 238–243
  - Bitmap class support, 232
  - Canvas class support, 217–227
  - Drawable class support, 228–232
  - graphics effects examples, 234–246
  - layout considerations, 212–217
  - OpenGL support, 235, 243–246
  - rolling your own widgets, 211
  - shadows, gradients, filters, 237
- DROP TABLE statement (SQL), 250
- dynamic declarations, 42

**E**

- Eclipse IDE, 6
  - (see also ADT Eclipse plug-in)
  - about, 5
  - additional information, 10, 112

- concepts and terminology, 112–117
- confirming installation, 7
- downloading, 5
- Extensions view, 115
- File Explorer view, 122
- Heap view, 122
- idiosyncrasies and alternatives, 130–131
- installing, 6
- Java coding in, 120–122
- JRE requirements, 7, 114
- keeping up-to-date, 29
- Layout view, 122
- LogCat view, 122, 280–286
- Outline view, 119
- Package Explorer view, 117, 118
- Pixel Perfect view, 122
- Plug-ins view, 112, 115
- Problems view, 120
- SDK and AVD Manager support, 8
- static analyzers, 123–130
- Task List view, 118
- Threads view, 122
- views and perspectives, 117–120

eclipse.ini file, 114

EditText class

- addTextChangedListener method, 136
- handling events, 188
- invalidate method, 177

encapsulation

- about, 60
- access modifiers and, 57
- getter and setter methods, 60

encryption, public key, 95–97

Enumeration interface, 52, 134

Equinox framework, 112

event queues, 169

events

- alternative ways to handle, 187
- listening for key events, 186
- listening for touch events, 183–186

Exception class, 51

exceptions, 48–51, 48

- (see also specific exceptions)

.exit command (SQLite), 256

exporting Android applications, 101

extends keyword, 39

extensions, defined, 115–117

external sensors (see sensors)

Eyes-Free open source project, 409

## F

File Explorer view (Eclipse), 122

file management, 316, 353

FileHandler class, 354

filters (drawing graphics), 237

final declarations, 41

final keyword, 42

FindBugs tool

- about, 123–127
- applying static analysis, 127–129
- type safety in Java, 60

float type, 34, 447

focusable attribute, 189

FOREIGN KEY constraint, 251

forking processes, 89

Fragment class

- about, 197
- creating fragments, 198
- getArguments method, 203
- onActivityCreated method, 295
- onAttach method, 294
- onCreate method, 199, 201, 294
- onCreateView method, 199, 294
- onPause method, 202, 295
- onResume method, 295
- onSaveInstanceState method, 201, 295
- onStart method, 295
- onStop method, 295
- setArguments method, 203
- visualizing life cycles, 292–295

FragmentManager class

- about, 202
- findFragmentByTag method, 203

fragments

- about, 197
- Android Compatibility Package and, 208
- creating, 198–200
- life cycles of, 201–202, 292–295
- manipulating, 202
- transactions involving, 203–208

frame-by-frame animation, 241–242

FrameLayout class, 202, 406

framework applications (see skeleton applications)

## G

garbage collection, 55

gen directory, 141

- generics, 54
- Gennick, Jonathan, 254
- geo utility, 386
- Gesture class, 407
- gesture input
  - about, 406
  - listening for, 183–186
- GestureLibraries class
  - about, 406
  - fromRawResource method, 407
- GestureLibrary class, 406
- GestureOverlayView class
  - about, 406
  - OnGesturePerformedListener interface, 406
- GesturePoint class, 407
- GestureStore class, 406
- GestureStroke class, 407
- GET operation (REST), 79
- getter methods, 60
- Global Positioning System (GPS), 372, 382–387
- GLSurfaceView class
  - about, 244
  - Renderer interface, 244
  - sizeChanged method, 244
  - surfaceCreated method, 244
- Goetz, Brian, 71
- Google Checkout, 106, 107
- Google Earth, 388
- Google I/O conference, 330
- Google Maps
  - about, 373
  - API keys, 108
  - MapView class and, 374
  - starting, 373
- GPS (Global Positioning System), 372, 382–387
- GPU (Graphics Processing Unit), 243
- gradients (drawing graphics), 237
- Graphics Processing Unit (GPU), 243
- graphics, drawing (see drawing graphics)
- gravity, 395
- GUI framework (see Android GUI framework)
- gyroscopes, 394

## H

- Handler class
  - about, 192

- Looper class and, 156
- HashMap class
  - about, 53
  - Android libraries and, 134
  - ContentProvider class and, 321
  - ContentValues class and, 272
- HashSet class, 53
- Hashtable class, 52, 134
- hcidump utility, 431
- Heap view (Eclipse), 122
- .help command (SQLite), 256
- Hibernate framework, 157
- Hierarchy Viewer tool, 26
- HttpEntity interface, 343

## I

- ia32-libs package, 7
- iBATIS framework, 157
- IllegalStateException, 149, 207, 215
- inheritance
  - interfaces and, 46
  - Java support, 39
  - Java types and, 35
- inner joins, 254
- InputStream class, 430
- INSERT statement (SQL), 253, 271
- Install New Software Wizard, 10
- instance variables, 319–321
- int type, 34, 447
- INTEGER type (SQLite), 250, 312
- IntelliJ IDEA, 4
- Intent class
  - about, 77
  - android:launchMode attribute and, 301
  - audio recording, 367
  - FLAG\_ACTIVITY\_BROUGHT\_TO\_FRONT constant, 302
  - FLAG\_ACTIVITY\_CLEAR\_TASK constant, 302
  - FLAG\_ACTIVITY\_CLEAR\_TOP constant, 302
  - FLAG\_ACTIVITY\_CLEAR\_WHEN\_TASK\_RESET constant, 303
  - FLAG\_ACTIVITY\_EXCLUDE\_FROM\_RECENTS constant, 303
  - FLAG\_ACTIVITY\_FORWARD\_RESULT constant, 303
  - FLAG\_ACTIVITY\_LAUNCHED\_FROM\_HISTORY constant, 303

- FLAG\_ACTIVITY\_MULTIPLE\_TASK
    - constant, 303
  - FLAG\_ACTIVITY\_NEW\_TASK constant, 303
  - FLAG\_ACTIVITY\_NO\_ANIMATION
    - constant, 303
  - FLAG\_ACTIVITY\_NO\_HISTORY
    - constant, 303
  - FLAG\_ACTIVITY\_NO\_USER\_ACTION
    - constant, 303
  - FLAG\_ACTIVITY\_PREVIOUS\_IS\_TOP
    - constant, 303
  - FLAG\_ACTIVITY\_REORDER\_TO\_FRONT constant, 303
  - setting flags, 302–304
  - starting Google Maps, 373
  - video recording, 369
- interfaces, 46
- (see also specific interfaces)
  - about, 46–48
  - additional information, 48
- Interpolator class, 240
- IOException, 403
- ISO (International Organization for Standardization), 247
- Iterator interface, 52, 134
- ## J
- Java Collections Framework
- about, 52
  - collection interface types, 52
  - java.util package and, 134
- Java Collections Library, 134
- Java compiler, 114, 141
- Java Cryptography Architecture, 99
- Java Development Kit (see JDK)
- .java files, organizing, 140–142
- Java language
- abstract classes, 45
  - additional information, 33
  - anonymous classes, 62–64
  - coding in Eclipse, 120–122
  - exceptions support, 48–51
  - final and static declarations, 41–45
  - garbage collection, 55
  - generics, 54
  - inheritance support, 39
  - interface support, 46–48
  - modular programming in, 65–67
  - multi-threaded concurrent programming, 68
  - Object class and its methods, 37–39
  - object creation, 35–37
  - objects and classes, 35
  - passing parameters by value, 42
  - polymorphism support, 39–41
  - primitive types, 34
  - serialization support, 157
  - synchronization and data structures, 73
  - synchronization and thread safety, 68–71
  - thread control, 71
  - type system, 34, 59–62
- Java Native Interface (see JNI)
- Java packages, 134
- (see also specific packages)
  - about, 134
  - namespaces and, 56
  - scope and, 56
- Java Runtime Environment (JRE)
- about, 4
  - Eclipse requirements, 7, 114
- Java Virtual Machine (JVM)
- DDMS support, 21
  - process overview, 76
- java.awt package, 134
- java.io package, 430
- java.lang package, 56, 134
- java.rmi package, 134
- java.util package, 52, 56, 134
- java.util.concurrent package, 72
- javac command, 5
- javax package, 135
- javax.sound package, 135
- javax.swing package, 135
- JDK (Java Development Kit)
- confirming installation, 5
  - downloading, 4
  - installing, 4
  - keeping up-to-date, 29
- JNI (Java Native Interface)
- about, 445
  - additional information, 445
  - conventions for method calls, 446
  - sample application, 449–450
- JRE (Java Runtime Environment)
- about, 4
  - Eclipse requirements, 7, 114
- JVM (Java Virtual Machine)

- DDMS support, 21
- process overview, 76

## K

- keycodes, KeyEvent class, 382
- KeyEvent class
  - focus and threading, 189
  - getRepeatCount method, 187
  - handling events, 189
  - keycodes, 382
- KeyHandler.handleKey method, 63
- keystore
  - about, 99, 103
  - remembering password, 99
- keystrokes
  - controlling map with, 381
  - listening for, 186
- keytool command
  - about, 27
  - creating private keys, 99
  - list option, 98, 108

## L

- layout directory, 87
- layout process
  - about, 212–213
  - arrangement phase, 216
  - measurement phase, 214–216
- Layout view (Eclipse), 122
- Layoutopt static analyzer, 26
- LBS (location-based services)
  - about, 371
  - Cell ID, 372
  - GPS, 372
  - triangulation, 372
- libraries, Android (see Android libraries)
- life cycles
  - Activity class and, 280–292
  - Android components, 90–92
  - Application class and, 296–299
  - configuration changes and, 290–291
  - fragment, 199, 201–202
  - Fragment class and, 292
  - managing, 156
  - memory recovery and, 287–288
  - serialization and, 163
  - user experience and, 296
  - well-behaved applications and, 295–296

- light sensors, 395
- LIKE keyword, 258
- linear acceleration, 395
- LinearGradient class, 237
- LinearInterpolator class, 240
- LinearLayout class
  - about, 173, 197, 212
  - measurement process, 214
  - onMeasure method, 215
  - setGravity method, 215
- LinkedList class, 53
- Linux environment
  - Bluetooth implementation, 431
  - hcidump utility, 431
  - installing Android SDK, 7, 8
  - installing Eclipse, 6
  - installing JDK, 4
  - NDK requirements, 448
  - running programs on Android devices, 20
  - sandboxing and, 89
- List interface, 52, 134
- ListView class
  - about, 197
  - account contacts example, 412
  - notifications and, 318
  - setAdapter method, 318
- location and mapping
  - about, 373
  - accessing without maps, 382–388
  - controlling with keypad, 381
  - controlling with menu buttons, 379–381
  - Google Maps, 373
  - location-based services, 372
  - MapActivity class, 374, 378
  - MapView class, 374–377
  - mobile phones and, 371
  - MyLocationOverlay class, 375–377
  - zooming in, 378
- location-based services (see LBS)
- LocationListener interface, 384
- LocationManager class
  - getLastKnownLocation method, 384
  - requestLocationUpdates method, 385
- LocationProvider class, 383–387
- LogCat view (Eclipse), 122, 280–286
- long type, 34, 447
- Looper class, 155
- ls command, 249

## M

- Macintosh environment
  - installing Android SDK, 8
  - installing JDK, 4
  - NDK requirements, 448
  - running programs on Android devices, 20
- magnetic sensors, 395
- manifest files
  - about, 24
  - AndroidManifest.xml, 83–87
  - authentication example, 415
  - location without maps example, 382
- Map interface, 52, 134
- MapActivity class
  - about, 374
  - graphical interfaces and, 171
  - isRouteDisplayed method, 377
  - onPause method, 378
  - onResume method, 379
- MapController class
  - about, 376, 378
  - setZoom method, 378
  - zoomIn method, 378
  - zoomInFixing method, 378
  - zoomOut method, 378
  - zoomToSpan method, 378
- mapping (see location and mapping)
- MapView class
  - about, 374
  - initializing, 375–377
  - prerequisites, 374
  - setClickable attribute, 377
  - setEnabled attribute, 377
  - setSatellite attribute, 377
  - setStreetView attribute, 377
  - setTraffic attribute, 377
  - usage suggestions, 375
- marshaling data, 156
- MaskFilter class, 237
- Matrix class
  - Canvas class and, 222
  - postTranslate method, 239
  - preTranslate method, 239
- MeasureSpec class
  - AT\_MOST constant, 214
  - EXACTLY constant, 214
  - getMode method, 214
  - getSize method, 214
  - UNSPECIFIED constant, 214
- Media Store content provider, 359
- MediaPlayer class
  - additional information, 361
  - audio playback, 361
  - create method, 361
  - getCurrentPosition method, 362
  - life cycle states, 360
  - pause method, 361
  - prepare method, 361
  - release method, 361
  - reset method, 362
  - setDataSource method, 361
  - start method, 361, 362
  - stop method, 361
  - video playback, 363
- MediaRecorder class
  - audio recording, 365
  - life cycle states, 364
  - permissions supported, 364
  - prepare method, 365
  - release method, 365
  - reset method, 365
  - start method, 365
  - stop method, 365
  - video recording, 369
- MediaStore content provider, 369
- memory recovery and life cycles, 287–288
- Menu interface
  - add method, 380
  - NONE constant, 380
- MenuItem interface, 381
- menus
  - controlling maps with, 379–381
  - implementing, 193–195
  - types of, 379
- merchant accounts, 107
- methods
  - cascading, 37
  - final and static declarations, 42–45
  - getters and setters, 60
  - JNI conventions, 446
  - throwing exceptions, 49
- MJAndroid sample application
  - about, 264–265
  - controlling map with keypad, 381
  - controlling map with menu buttons, 379–381
  - database queries, 267–271
  - loading and starting, 267



- MapActivity class, 374, 378
- MapView class, 374–377
  - modifying database, 271–275
- MyLocationOverlay class, 375–377
  - reading data from database, 267–271
  - source folder, 265
- Model component (MVC), 167, 178–183
- Model-View-Controller architecture (see MVC architecture)
- modular programming, 65–67
- Monkey test automation tool, 26
- MotionEvent class
  - ACTION\_MOVE constant, 185
  - creating, 170
  - focus and threading, 189
  - getHistoricalX method, 184
  - getHistoricalY method, 184
  - getHistorySize method, 185
  - native activities and, 457
- multimedia
  - audio and video formats, 359
  - playing audio and video, 360
  - recording audio and video, 364–369
  - stored content, 369
- MVC (Model-View-Controller) architecture
  - additional information, 258
  - Android GUI and, 167–171
  - content providers and, 81, 318–319
  - Controller component, 169, 176–193
  - essential design rules, 217
  - Model component, 167, 178–183
  - RESTful applications and, 331–334
  - SQL support, 258–259
  - threads in Android process and, 154
  - tying concepts together, 169–171
  - View component, 168, 212
- MyLocationOverlay class
  - getLocation method, 376
  - graphical interfaces and, 171
  - initializing, 375–377
  - runOnFirstFix method, 376

**N**

- namespaces, Java packages and, 56
- Native Development Kit (see NDK)
- native keyword, 447
- NativeActivity class, 456–462
- NDEF (NFC Data Exchange Format), 396
- Ndef.writeNdefMessage method, 403
- NdefMessage class, 398, 403
- NdefRecord class
  - reading tags, 398, 400
  - RTD\_SMART\_POSTER constant, 402
  - RTD\_TEXT constant, 401
  - RTD\_URI constant, 401
  - TNF\_ABSOLUTE\_URI constant, 402
  - writing tags, 403
- NDK (Native Development Kit)
  - about, 445, 448
  - building custom library modules, 453
  - compiling with, 448
  - native activities, 456–462
  - native libraries, 451
  - sample application, 449–450
  - setting up environment, 448
- Near Field Communication (see NFC)
- NetworkException, 50
- New Android Project dialog, 13
- New Android Project Wizard, 16
- new keyword, 35
- NFC (Near Field Communication)
  - about, 396
  - P2P mode, 405
  - reading tags, 396–402
  - writing tags, 403
- NFC Data Exchange Format (NDEF), 396
- NfcAdapter class
  - ACTION\_NDEF\_DISCOVERED constant, 398
  - ACTION\_TAG\_DISCOVERED constant, 398
  - ACTION\_TECH\_DISCOVERED constant, 398
  - disableForegroundDispatch method, 398, 405
  - enableForegroundDispatch method, 398, 405
  - enableForegroundNdefPush method, 405
  - EXTRA\_ID constant, 400
  - EXTRA\_NDEF\_MESSAGES constant, 400
  - getDefaultAdapter method, 398
- 9 patch (Android resource), 27, 231
- NIST (National Institute of Standards and Technology), 247
- no-arg constructors, 36
- NOT NULL constraint, 252

## O

- Object class
  - about, 37
  - clone method, 38
  - equals method, 38
  - finalize method, 38
  - hashCode method, 38
  - java.lang package and, 134
  - notify method, 37, 71
  - notifyAll method, 37
  - toString method, 37
  - wait method, 37, 71
- object-relational mapping (ORM), 157, 267
- ObjectInputStream class, 157
- ObjectOutputStream class, 157
- objects
  - about, 35
  - creating, 35–37
- OnClickListener.onClick method, 177
- OnCreateContextMenuListener interface, 195, 197
- OnFocusChangeListener interface, 189
- OnGesturePerformedListener interface, 406
- OnKeyListener interface
  - handling events, 62, 188
  - onKey method, 188
  - troubleshooting, 194
- OnTouchListener interface
  - handling events, 188
  - onTouch method, 184
- Open With command, 117
- OpenGL
  - about, 243
  - animation example, 235
  - graphics support, 243–246
  - javax package support, 135
- org.apache.http package tree, 135
- org.json package, 135
- org.w3c.dom package, 135
- org.xml.sax package, 135
- org.xmlpull package, 135
- ORM (object-relational mapping), 157, 267
- OSGi bundles, 112
- OutOfMemoryException, 51
- OutputStream class, 317, 430
- overrides, defined, 135–137

## P

- P2P (peer-to-peer) communication, 405
- packaging Android applications, 92
- Paint class
  - about, 218
  - attributes of, 237
  - setShadowLayer method, 237
- PAN (personal area network), 429
- parameters
  - AndroidManifest.xml file, 84–87
  - passing by value, 42
- Parcelable interface
  - serialization support, 159–162, 289
  - writeToParcel method, 159
- password, remembering for keystore, 99
- PATH environment variable, 5, 8
- PathEffect class, 237
- peer-to-peer (P2P) communication, 405
- PendingIntent class, 398
- percent sign (%), 258
- period (.), 256
- permissions
  - account contacts, 411
  - authentication, 415
  - GPS location providers, 382
  - MediaRecorder class, 364
  - synchronization, 422
- persistence, applications and, 157, 259
- personal area network (PAN), 429
- phone coordinate systems
  - about, 393
  - accelerometers, 394
  - gravity, 395
  - gyroscopes, 394
  - linear acceleration, 395
  - rotation vector, 394
- piconet, 429
- pipe character (|), 258
- Pixel Perfect view (Eclipse), 122
- playback
  - audio methods, 361
  - life cycle states, 360
  - video methods, 363
- plug-ins, 112
  - (see also ADT Eclipse plug-in)
  - defined, 112
  - extensions and, 115–117
- polymorphism, 39–41, 138–139
- porting software to Android, 93

- POST operation (REST), 79
- Prediction class, 406
- Preferences dialog, 11, 21
- preorder traversal, 168
- pressure sensors, 395
- PRIMARY KEY constraint, 251, 312
- primitive types, defined, 34
- private keys
  - creating, 99
  - losing, 100
  - as signing certificates, 99
- private keyword, 57, 61
- projects
  - about, 115, 140
  - additional information, 13
  - creating, 12–16
  - manifest files, 24
- protected keyword, 57
- proximity sensors, 395
- public key encryption, 95–97
- public keyword, 57, 61
- publishing
  - Android applications, 107
  - references, 143

## Q

- QEMU, 25
- queries
  - account contacts, 411
  - compound, 254
  - MJAndroid application example, 267–271
  - networked method, 339–352
- quotation marks ("), 257

## R

- R class, 88
- Radio Frequency Identification (see RFID)
- raw directory, 87
- RCP (Rich Client Platform), 5
- RDBMSs (relational database management systems), 247
- REAL type (SQLite), 250
- recording multimedia
  - audio methods, 365–368
  - life cycle states, 364
  - video methods, 368
- RECORD\_AUDIO permission, 364
- RECORD\_VIDEO permission, 364

- refactoring, 121, 142
- relational database management systems (RDBMSs), 247
- relational databases
  - about, 247
  - additional information, 254
  - compound queries, 254
  - database constraints, 251–252, 312
  - database manipulation example, 255–258
  - database transactions, 255
  - design for Android applications, 260–264
  - inner joins, 254
  - MJAndroid application example, 264, 267–275
  - SimpleFinchVideoContentProvider example, 309
  - SimpleVideoDbHelper class example, 261–264
  - SQLite supported classes, 259
  - triggers, 254
  - YouTube video example, 339
- RelativeLayout class, 200, 212
- remote procedure calls, AIDL and, 158
- Renderer interface, 244
- res directory, 87, 141
- resource qualifiers, 110
- Resources.getDrawable method, 233
- ResponseHandler interface
  - about, 342
  - handleResponse method, 345
- REST (Representational State Transfer)
  - about, 79
  - additional information, 79
  - constants and initialization, 338
  - content providers and, 329
  - creating database, 339
  - DELETE operation, 79
  - developing Android applications, 330
  - file management, 353
  - GET operation, 79
  - insert and ResponseHandlers, 352–353
  - network MVC and, 331–334
  - networked query method, 339–352
  - POST operation, 79
  - UPDATE operation, 79
- RFID (Radio Frequency Identification)
  - about, 396
  - reading tags, 396–402
- Rich Client Platform (RCP), 5

- RotateAnimation class, 238, 241
- RotateDrawable class, 231
- rotation vector, 394
- Runnable interface, 192
- runtime environment
  - about, 88–90, 114
  - Android libraries and, 134–135
- RuntimeException, 51, 192

## S

- sandboxing, 89, 98
- ScaleAnimation class, 238, 241
- ScaleDrawable class, 231
- ScheduledThreadPoolExecutor class, 134
- scope
  - about, 56
  - access modifiers and encapsulation, 57
  - Java packages and, 56
- SDK and AVD Manager
  - about, 8, 26
  - configuring AVDs, 25
  - creating AVDs, 16
  - invoking, 8, 27, 122
  - screen configurations, 110
- search application example
  - controller collecting user input, 337
  - implementing RESTful request, 338–354
  - UI collecting user input, 337
- security
  - additional information, 90
  - self-signed certificates and, 98
- SELECT statement (SQL)
  - about, 252
  - ContentProvider class and, 315
  - FROM clause, 252
  - GROUP BY clause, 252
  - HAVING clause, 252
  - LIMIT clause, 253
  - ORDER BY clause, 252
  - WHERE clause, 252
- self-signed certificates
  - about, 97
  - creating, 99
  - signing applications, 101–104
- semicolon (;), 250
- Sensor.getMaximumRange method, 395
- SensorEvent class, 392
- SensorEventListener interface
  - onAccuracyChanged method, 392

- onSensorChanged method, 392
- SensorManager class
  - about, 392
  - getDefaultSensor method, 392
  - getSensorList method, 392
  - SENSOR\_DELAY\_FASTEST constant, 392
  - SENSOR\_DELAY\_GAME constant, 392
  - SENSOR\_DELAY\_NORMAL constant, 392
  - SENSOR\_DELAY\_UI constant, 392
- sensors
  - about, 391–392
  - accelerometers, 394
  - gravity, 395
  - gyroscopes, 394
  - light, 395
  - linear acceleration, 395
  - magnetic, 395
  - phone coordinate systems, 393–395
  - pressure, 395
  - proximity, 395
  - rotation vector, 394
  - temperature, 396
- Serial Port Protocol (SPP), 432
- Serializable interface, 157, 158, 162
- serialization
  - application life cycle and, 163
  - classes supporting, 162, 289
  - common uses for, 156
  - defined, 156
  - Java support, 157
  - Parcelable interface, 159–162
- Service class
  - about, 78, 79
  - Context class and, 82
  - manifest files and, 83
  - RESTful applications and, 330
  - well-behaved applications and, 295
- Set interface, 52, 134
- setClickable attribute, 377
- setEnabled attribute, 377
- setSatellite attribute, 377
- setStreetView attribute, 377
- setter methods, 60
- setTraffic attribute, 377
- Shader class, 237
- shaders (drawing graphics), 237
- ShadowLayer class, 237
- shadows (drawing graphics), 237

- short type, 34, 447
- Show View dialog, 283
- signing, application (see application signing)
- SimpleCursorAdapter class, 412
- SimpleFinchVideoContentProvider example
  - about, 308, 319
  - column names, 312
  - column specification strings, 312–314
  - creating database, 309
  - defining provider public API, 309–312
  - extending ContentProvider class, 314–316
  - implementing delete method, 326
  - implementing getType method, 322
  - implementing insert method, 324
  - implementing onCreate method, 321
  - implementing query method, 322–324
  - implementing update method, 325
  - instance variables and, 319–321
  - notifying observers, 327
  - source code structure, 309
- SimpleVideoOpenHelper class (example), 261–264
- skeleton applications
  - about, 133
  - Activity class life cycles, 280–292
  - Application class life cycles, 296–299
  - binary data, 316
  - building content providers, 306–314
  - content providers and REST, 329
  - declaring content providers, 327
  - developing RESTful, 330
  - file management, 316
  - flowing/intuitive user experience, 299–304
  - Fragment class life cycles, 292–295
  - MVC and content observation, 318–319
  - network MVC and, 331–334
  - SimpleFinchVideoContentProvider
    - example, 319–327
    - well-behaved, 295–296
    - writing/integrating content providers, 314
    - YouTube video example, 334–354
- SmallTalk language, 112
- social networking, 264
- software development (see application development)
- SPP (Serial Port Protocol), 432
- SQL (Standard Query Language)
  - about, 247
  - additional information, 249
  - Android applications and, 248
  - data definition commands, 249–252
  - data manipulation commands, 252–254
  - database constraints, 251–252
  - MVC model and, 258
- SQLite database system
  - about, 248, 249
  - additional information, 248
  - compound queries, 254
  - data types supported, 250
  - database classes, 259
  - database constraints, 251–252, 312
  - database transactions, 255
  - persistence and, 157
  - sqlite3 command, 27
- sqlite3 command
  - about, 27
  - balancing quotes, 257
  - database manipulation example, 255–258
  - percent sign in, 258
  - period in, 256
  - pipe character in, 258
  - semicolon in, 250
- SQLiteOpenHelper class
  - about, 260
  - delete method, 271, 275
  - execSQL method, 271, 272, 274, 275
  - insert method, 271, 272, 325
  - query method, 270, 271, 322
  - rawQuery method, 269
  - rawQueryWithFactory method, 269, 271
  - update method, 271, 273
- SQLiteOpenHelper class
  - about, 260
  - extending, 268
  - onCreate method, 261
  - onUpgrade method, 261
- SQLiteQueryBuilder class, 260
- src directory, 141
- Standard Query Language (see SQL)
- static analysis
  - about, 123–127
  - applying to Android code, 127–129
  - FindBugs tool and, 123–127
  - limitations of, 130
- static declarations, 42
- String class
  - Canvas class and, 221
  - as final declaration, 41

- subclasses
  - defined, 35
  - programming considerations, 66, 139
- superclasses, defined, 35
- SurfaceHolder class
  - Callback interface, 242
  - unlockCanvasAndPost method, 243
- SurfaceView class
  - about, 243
  - animation support, 238, 242
- Synaptic Package Manager utility, 4
- synchronization
  - account data, 422
  - data structures and, 73
  - thread safety and, 68–71
- synchronized keyword, 68–71
- System.loadLibrary method, 447

## T

- .table command (SQLite), 257
- tables
  - database constraints, 251–252
  - defined, 247
  - SQL data definition commands, 249–252
  - SQL data manipulation commands, 252–254
- TagTechnology interface
  - close method, 403
  - connect method, 403
  - isConnected method, 403
  - reading tags, 400
  - writing tags, 403
- tasks
  - applications and, 299
  - specifying behavior, 300–304
  - tracking, 299
- temperature sensors, 396
- TEXT type (SQLite), 250
- text, drawing, 221–222
- TextToSpeech class
  - about, 408
  - shutdown method, 408
  - speak method, 408
- TextView class
  - location without maps example, 382–386
  - widgets and, 212
- TextWatcher interface
  - afterTextChanged method, 136
  - beforeTextChanged method, 136

- onTextChanged method, 136
- Thread class, 68
- thread confinement, 155
- thread safety violations, 68
- threads
  - Android GUI and, 143–154
  - in Android processes, 154
  - concurrent, 68, 142
  - monitoring, 145
  - Object class support, 71
  - spawning, 68
  - synchronization and, 68–71
- Threads view (Eclipse), 122
- Throwable class, 50
- TimerTask class, 134
- TimeZone class, 134
- touch events
  - gesture input, 406
  - listening for, 183–186
- trackballs, 186
- transactions
  - database, 255
  - fragment, 203–208
- transformations, matrix, 222–227
- transition animations, 238–241
- TranslateAnimation class, 238, 241
- TreeMap class, 53
- triangulation, 372
- triggers, database, 254
- troubleshooting
  - OnKeyListener interface, 194
  - SDK problems, 21
- try-catch block, 49
- tweened animations, 238

## U

- Ubuntu Linux environment
  - installing Eclipse, 6
  - installing JDK, 4
- unchecked exceptions, 51
- UNIQUE constraint, 252
- unmarshaling data, 156
- unpublishing Android applications, 107
- UPDATE operation (REST), 79
- UPDATE statement (SQL)
  - about, 253
  - ContentProvider class and, 315
  - WHERE clause, 253

uploading applications in Android Market, 106–107

UriMatcher class

about, 80, 316

addURI method, 316

initializing, 320

NO\_MATCH constant, 320

URLEncoder.encode method, 339

USB

accessing Android devices, 20

debugging Android devices, 20

user experience

Activity life cycle and, 296

flowing and intuitive, 299–304

uses-sdk attribute, 15

UUID class, 134

## V

values directory, 88

Vector class, 52, 134

Vibrator class, 408

video

Android supported formats, 359

Intent recording, 369

MediaPlayer playback, 363

MediaRecorder recording, 369

playback methods, 363

recording methods, 368

VideoView class, 363

View class, 211

(see also widgets)

about, 62

assembling GUI, 171

background animation, 241

dispatchKeyEvent method, 169

DispatchKeyEvent method, 189

dispatchTrackballEvent method, 186

draw method, 217

findViewById method, 200

getBackground method, 242

getMeasuredHeight method, 214

getMeasuredWidth method, 214

getSuggestedMinimumHeight method, 215

getSuggestedMinimumWidth method, 215

handling events, 188

invalidate method, 217

isFocusableInTouchMode method, 191

isInTouchMode method, 191

measure method, 214

OnClickListener interface, 177

OnCreateContextMenuListener interface, 195, 197

onDraw method, 232, 242

OnFocusChangeListener interface, 189

onKeyDown method, 187

OnKeyListener interface, 62, 188, 194

onLayout method, 216

onMeasure method, 214, 216

onTouchEvent method, 187

OnTouchListener interface, 184, 188

onTrackballEvent method, 186

post method, 156

postDelayed method, 156

requestFocus method, 190

requestLayout method, 213

setBackgroundDrawable method, 241

setBackgroundResource method, 241

setFocusable method, 189

setMeasuredDimensions method, 215, 216

setOnCreateContextMenuListener method, 195

setOnKeyListener method, 187

startAnimation method, 238

widgets and, 212

View component (MVC), 168, 212

(see also drawing graphics)

view model, 218

ViewGroup class

container views and, 171

dispatchDraw method, 217

Fragment class and, 197

measureChild method, 216

measureChildren method, 216

measureChildWithMargins method, 216

requestChildFocus method, 191

requestFocus method, 191

widgets and, 212

virtual machines (see Dalvik virtual machines (VMs))

VisualAge tool, 112

VMs (virtual machines) (see Dalvik virtual machines (VMs))

## W

whatami example, 450

widgets, 211

(see also View class)

Bitmap class, 232

- canvas drawing, 217–227
  - defined, 171, 211
  - Drawable class, 228–232
  - focusable attribute, 189
  - fully functional example, 219
  - graphics effects examples, 234–246
  - layout process, 212–217
  - onDraw method, 212, 217, 219, 225, 228
  - onLayout method, 217
  - onMeasure method, 212
- Windows environment
  - installing JDK, 4
  - NDK requirements, 448
  - running programs on Android devices, 20
  - sandboxing and, 89
- workspaces
  - defined, 13, 113
  - depicted, 117
  - projects and, 140

## X

- XML editors, 24

## Y

- YouTube video example
  - about, 334
  - constants and initialization, 338
  - controller collecting user input, 337
  - creating database, 339
  - file management, 353
  - insert and ResponseHandlers, 352–353
  - networked query method, 339–352
  - structure of source code, 335
  - UI collecting user input, 337

## Z

- Zipalign tool, 27
- zooming in Android maps, 378
- Zygote process, 89



## About the Authors

---

**Zigurd Mednieks** is a consultant to leading OEMs, enterprises, and entrepreneurial ventures creating Android-based systems and software. Previously he was chief architect at D2 Technologies, a Voice over IP (VoIP) technology provider. There he led engineering and product definition work for products that blended communication and social media in purpose-built embedded systems and on the Android platform.

**Laird Dornin** is a mobile development architect with extensive experience in Java, Android, J2ME, SavaJe, and the WebKit browser library. He was a member of the J2SE development team at Sun Microsystems, specializing in Java RMI and Jini technology. He is currently a senior engineer at a major wireless carrier, where he provides Android architectural guidance and Network API support to members of the carrier's developer community.

**G. Blake Meike** is a veteran developer with wide experience building Java applications for a range of mobile and server-side platforms.

With more than a decade of software engineering experience, **Masumi Nakamura** has worked in various positions within the mobile technology arena, from building out mobile infrastructure to founding his own mobile company. He was one of the primary Android developers of the WHERE Android app and is now principal architect for the Big Data and Recommendations group at WHERE, Inc. Outside of coding, he spends his time practicing Ba Gua Zhang and caring for his two cats.

## Colophon

---

The animal on the cover of *Programming Android* is a pine grosbeak (*Pinicola enucleator*). A member of the finch family, these largest of the so-called “winter finches” can be found throughout the coniferous forests of the northern hemisphere: in Alaska, Canada, Scandinavia, and Siberia. More rarely, during the winter some individuals stray as far south as the upper Midwest and New England portions of the United States, and on occasion even into temperate Europe.

Adult pine grosbeaks are rather distinctive looking. Both males and females have long forked black tails and black wings with white wing bars. The remainder of a male's plumage is predominantly red, while females display an olive color on the head and rump and gray on the back and underside. Conversely, colors on young pine grosbeaks are noticeably more subdued.

Pine grosbeaks feed mostly on vegetable matter, including the buds, seeds, and fruit of various varieties of tree, though they will also eat insects, and in fact prefer to feed such to their young. Interestingly, breeding adults will develop pouches in the floor of its mouth specifically designed to carry this food back to the nest.

The cover image is from *Johnson's Natural History*. The cover font is Adobe ITC Garamond. The text font is Linotype Birka; the heading font is Adobe Myriad Condensed; and the code font is LucasFont's TheSans Mono Condensed.